

INFORMATION DISCLOSURE STATEMENT BY APPLICANT	Application No.	12/513,147
	Filing Date	March 1, 2010
	First Named Inventor	Perreault, Clay
	Art Unit	2653
<i>(Multiple sheets used when necessary)</i>	Examiner	Sing, Simon P.
SHEET 1 OF 1	Attorney Docket No.	SMARB19.001APC

U.S. PATENT DOCUMENTS					
Examiner Initials	Cite No.	Document Number <i>Number - Kind Code (if known)</i> Example: 1,234,567 B1	Publication Date MM-DD-YYYY	Name of Patentee or Applicant	Pages, Columns, Lines Where Relevant Passages or Relevant Figures Appear

FOREIGN PATENT DOCUMENTS						
Examiner Initials	Cite No.	Foreign Patent Document <i>Country Code-Number-Kind Code</i> Example: JP 1234567 A1	Publication Date MM-DD-YYYY	Name of Patentee or Applicant	Pages, Columns, Lines Where Relevant Passages or Relevant Figures Appear	T ¹

NON PATENT LITERATURE DOCUMENTS			
Examiner Initials	Cite No.	Include name of the author (in CAPITAL LETTERS), title of the article (when appropriate), title of the item (book, magazine, journal, serial, symposium, catalog, etc.), date, page(s), volume-issue number(s), publisher, city and/or country where published.	T ¹
	1	Wikipedia, "International mobile subscriber identity (IMSI)," http://en.wikipedia.org/wiki/IMSI , 7-16-2013.	All pages
	2	Wikipedia, "Roaming," http://en.wikipedia.org/wiki/Roaming , 7-16-2013.	All pages

16256973
091913

Examiner Signature	Date Considered
<p>*Examiner: Initial if reference considered, whether or not citation is in conformance with MPEP 609. Draw line through citation if not in conformance and not considered. Include copy of this form with next communication to applicant.</p>	

T¹ - Place a check mark in this area when an English language Translation is attached. PETITIONER APPLE INC. EX. 1002-1

Electronic Acknowledgement Receipt

EFS ID:	16905890
Application Number:	12513147
International Application Number:	
Confirmation Number:	9611
Title of Invention:	PRODUCING ROUTING MESSAGES FOR VOICE OVER IP COMMUNICATIONS
First Named Inventor/Applicant Name:	Clay Perreault
Customer Number:	20995
Filer:	John M Carson/Norman Green
Filer Authorized By:	John M Carson
Attorney Docket Number:	SMARB19.001APC
Receipt Date:	19-SEP-2013
Filing Date:	01-MAR-2010
Time Stamp:	18:11:01
Application Type:	U.S. National Stage under 35 USC 371

Payment information:

Submitted with Payment	no
------------------------	----

File Listing:

Document Number	Document Description	File Name	File Size(Bytes)/ Message Digest	Multi Part /.zip	Pages (if appl.)
1	Non Patent Literature	Ref1__WIKI_IMSI.pdf	316123 <small>e2bf56b6db834ff63a7e776c6a468b8e033d7bd2</small>	no	4

Warnings:

Information:

PETITIONER APPLE INC. EX. 1002-2

2	Non Patent Literature	Ref2__WIKI_ROAMING.pdf	837516 b56a3eb9a59331bd90d887ce6cbce1ad35e743b4	no	8
Warnings:					
Information:					
3		IDS_SMARB19_001APC_09_19_2013.pdf	76320 d1455991a321cc6c5d4f2e0d440f8bbaed68cf5	yes	2
	Multipart Description/PDF files in .zip description				
	Document Description		Start	End	
	Transmittal Letter		1	1	
	Information Disclosure Statement (IDS) Form (SB08)		2	2	
Warnings:					
Information:					
Total Files Size (in bytes):			1229959		
<p>This Acknowledgement Receipt evidences receipt on the noted date by the USPTO of the indicated documents, characterized by the applicant, and including page counts, where applicable. It serves as evidence of receipt similar to a Post Card, as described in MPEP 503.</p> <p><u>New Applications Under 35 U.S.C. 111</u> If a new application is being filed and the application includes the necessary components for a filing date (see 37 CFR 1.53(b)-(d) and MPEP 506), a Filing Receipt (37 CFR 1.54) will be issued in due course and the date shown on this Acknowledgement Receipt will establish the filing date of the application.</p> <p><u>National Stage of an International Application under 35 U.S.C. 371</u> If a timely submission to enter the national stage of an international application is compliant with the conditions of 35 U.S.C. 371 and other applicable requirements a Form PCT/DO/EO/903 indicating acceptance of the application as a national stage submission under 35 U.S.C. 371 will be issued in addition to the Filing Receipt, in due course.</p> <p><u>New International Application Filed with the USPTO as a Receiving Office</u> If a new international application is being filed and the international application includes the necessary components for an international filing date (see PCT Article 11 and MPEP 1810), a Notification of the International Application Number and of the International Filing Date (Form PCT/RO/105) will be issued in due course, subject to prescriptions concerning national security, and the date shown on this Acknowledgement Receipt will establish the international filing date of the application.</p>					

INFORMATION DISCLOSURE STATEMENT

Inventor : Clay Perreault, et al.
App. No. : 12/513,147
Filed : March 1, 2010
For : PRODUCING ROUTING MESSAGES FOR
VOICE OVER IP COMMUNICATIONS
Examiner : Sing, Simon P.
Art Unit : 2653
Conf. No. : 9611

Commissioner for Patents
P.O. Box 1450
Alexandria, VA 22313-1450

References and Listing

Submitted herewith in the above-identified application is an Information Disclosure Statement listing references for consideration. Copies of any listed foreign and non-patent literature references are being submitted.

Timing of Disclosure

This Information Disclosure Statement is being filed after the mailing date of a final action or after the mailing date of a Notice of Allowance. Please place these references in the file in accordance with 37 CFR 1.97(i).

Respectfully submitted,
KNOBBE, MARTENS, OLSON & BEAR, LLP

Dated: _____

9/19/13

By: _____

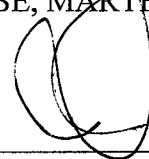

John M. Carson
Registration No. 34,303
Attorney of Record
Customer No. 20995
(858) 707-4000

IDS
16257060
091913



UNITED STATES PATENT AND TRADEMARK OFFICE

UNITED STATES DEPARTMENT OF COMMERCE
United States Patent and Trademark Office
Address: COMMISSIONER FOR PATENTS
P.O. Box 1450
Alexandria, Virginia 22313-1450
www.uspto.gov

APPLICATION NO.	ISSUE DATE	PATENT NO.	ATTORNEY DOCKET NO.	CONFIRMATION NO.
12/513,147	09/24/2013	8542815	SMARB19.001APC	9611

20995 7590 09/04/2013
KNOBBE MARTENS OLSON & BEAR LLP
2040 MAIN STREET
FOURTEENTH FLOOR
IRVINE, CA 92614

ISSUE NOTIFICATION

The projected patent number and issue date are specified above.

Determination of Patent Term Adjustment under 35 U.S.C. 154 (b)
(application filed on or after May 29, 2000)

The Patent Term Adjustment is 853 day(s). Any patent to issue from the above-identified application will include an indication of the adjustment on the front page.

If a Continued Prosecution Application (CPA) was filed in the above-identified application, the filing date that determines Patent Term Adjustment is the filing date of the most recent CPA.

Applicant will be able to obtain more detailed information by accessing the Patent Application Information Retrieval (PAIR) WEB site (<http://pair.uspto.gov>).

Any questions regarding the Patent Term Extension or Adjustment determination should be directed to the Office of Patent Legal Administration at (571)-272-7702. Questions relating to issue and publication fee payments should be directed to the Application Assistance Unit (AAU) of the Office of Data Management (ODM) at (571)-272-4200.

APPLICANT(s) (Please see PAIR WEB site <http://pair.uspto.gov> for additional applicants):

Clay Perreault, Panama City, PANAMA;
Steve Nicholson, Hamilton, NEW ZEALAND;
Rod Thomson, North Vancouver, BC, CANADA;
Johan Emil Victor Bjorsell, Vancouver, BC, CANADA;
Fuad Arafa, Vancouver, BC, CANADA;

The United States represents the largest, most dynamic marketplace in the world and is an unparalleled location for business investment, innovation, and commercialization of new technologies. The USA offers tremendous resources and advantages for those who invest and manufacture goods here. Through SelectUSA, our nation works to encourage and facilitate business investment. To learn more about why the USA is the best country in the world to develop technology, manufacture products, and grow your business, visit SelectUSA.gov.

INFORMATION DISCLOSURE STATEMENT BY APPLICANT	Application No.	12/513,147
	Filing Date	March 1, 2010
	First Named Inventor	Clay Perreault
	Art Unit	2614
<i>(Multiple sheets used when necessary)</i>	Examiner	Unassigned
SHEET 2 OF 6	Attorney Docket No.	SMARB19.001APC

U.S. PATENT DOCUMENTS

Examiner Initials	Cite No.	Document Number Number - Kind Code (if known) Example: 1,234,567 B1	Publication Date MM-DD-YYYY	Name of Patentee or Applicant	Pages, Columns, Lines Where Relevant Passages or Relevant Figures Appear
	20	2008/0063153 A1	03-13-2008	Krivorot et al.	
	21	4,916,491	04-10-1990	Katoh	
	22	5,146,491	09-08-1992	Silver et al.	
	23	5,247,571	09-21-1993	Kay et al .	
	24	5,303,297	04-12-1994	Hillis	
	25	5,359,642	10-25-1994	Castro	
	26	5,425,085	06-13-1995	Weinberger et al.	
	27	5,440,621	08-08-1995	Castro	
	28	5,469,497	11-21-1995	Pierce et al.	
	29	5,506,893	04-09-1996	Buscher et al.	
	30	5,519,769	05-21-1996	Weinberger et al.	
	31	5,559,871	09-24-1996	Smith	
	32	5,590,133	12-31-1996	Billstrom et al.	
	33	5,608,786	05-04-1997 3/1997	Gordon	
	34	5,621,787	04-15-1997	McKoy et al.	
	35	5,661,790	08-26-1997	Hsu	
	36	5,712,907	01-27-1998	Wegner et al.	
	37	5,724,355	05-03-1998 3/1998	Bruno et al.	
	38	5,726,984	05-10-1998 3/1998	Kubler et al.	

Change(s) applied
to document,
/J.M.S./
8/15/2013

Examiner Signature	Date Considered
--------------------	-----------------

*Examiner: Initial if reference considered, whether or not citation is in conformance with MPEP 609. Draw line through citation if not in conformance and not considered. Include copy of this form with next communication to applicant.

INFORMATION DISCLOSURE STATEMENT BY APPLICANT	Application No.	12/513,147
	Filing Date	March 1, 2010
	First Named Inventor	Clay Perreault
	Art Unit	2614
<i>(Multiple sheets used when necessary)</i>	Examiner	Unassigned
SHEET 5 OF 6	Attorney Docket No.	SMARB19.001APC

U.S. PATENT DOCUMENTS

Examiner Initials	Cite No.	Document Number Number - Kind Code (if known) Example: 1,234,567 B1	Publication Date MM-DD-YYYY	Name of Patentee or Applicant	Pages, Columns, Lines Where Relevant Passages or Relevant Figures Appear
	77	6,137,869	10-24-2000	Voit et al	
	78	6,141,404	10-31-2000	Westerlage et al.	
	79	6,188,752 B1	02-13-2001	Lesley	
	80	6,282,574	08-28-2001	Voit	
	81	6,298,062	10-02-2001	Gardell et al.	
	82	6,351,464	02-26-2002	Galvin et al.	
	83	6,359,880	05-19-2002 3/2002	Curry et al.	
	84	6,430,275	08-06-2002	Voit et al	
	85	6,507,644 B1	01-14-2003	Henderson et al.	
	86	6,766,159 B2	07-20-2004	Lindholm	
	87	6,819,929 B2	11-16-2004	Antonucci et al.	
	88	6,954,453	10-11-2005	Schindler	
	89	7,068,772	06-27-2006	Widger et al.	
	90	7,120,682 B1	10-10-2006	Salama	
	91	7,212,522 B1	05-01-2007	Shankar et al.	

Change(s) applied
to document,
/J.M.S/
8/15/2013

FOREIGN PATENT DOCUMENTS

Examiner Initials	Cite No.	Foreign Patent Document Country Code-Number-Kind Code Example: JP 1234567 A1	Publication Date MM-DD-YYYY	Name of Patentee or Applicant	Pages, Columns, Lines Where Relevant Passages or Relevant Figures Appear	T ¹
	92	CA 2,249,668	04-07-1999	Bruno et al.		
	93	EP 1 389 862 A1	02-18-2004	Shen et al.		

Examiner Signature	Date Considered
--------------------	-----------------

*Examiner: Initial if reference considered, whether or not citation is in conformance with MPEP 609. Draw line through citation if not in conformance and not considered. Include copy of this form with next communication to applicant.

T¹ - Place a checkmark in the box if the reference is considered pertinent to the prior art. /SS/

INFORMATION DISCLOSURE STATEMENT BY APPLICANT	Application No.	12/513,147
	Filing Date	March 1, 2010
	First Named Inventor	Clay Perreault
	Art Unit	2614
<i>(Multiple sheets used when necessary)</i>	Examiner	Unassigned
SHEET 4 OF 6	Attorney Docket No.	SMARB19.001APC

U.S. PATENT DOCUMENTS

Examiner Initials	Cite No.	Document Number Number - Kind Code (if known) Example: 1,234,567 B1	Publication Date MM-DD-YYYY	Name of Patentee or Applicant	Pages, Columns, Lines Where Relevant Passages or Relevant Figures Appear
	58	5,930,343	07-27-1999	Vasquez	
	59	5,937,045	08-10-1999	Yaoya et al.	
	60	5,940,598	08-17-1999	Strauss et al.	
	61	5,953,504	09-14-1999	Sokal et al.	
	62	5,956,391	09-21-1999	Melen et al.	
	63	5,970,477	10-19-1999	Roden	
	64	5,974,043	10-26-1999	Solomon	
	65	5,991,291	11-23-1999	Asai et al.	
	66	6,005,926	12-21-1999	Mashinsky	
	67	6,014,379	01-11-2000	White et al.	
	68	6,021,126	02-01-2000	White et al.	
	69	6,052,445	10-28-2000 4/2000	Bashoura et al.	
	70	6,058,300	05-02-2000	Hanson	
	71	6,069,890	05-30-2000	White et al.	
	72	6,073,013	06-06-2000	Agre et al.	
	73	6,104,704	08-15-2000	Buhler et al.	
	74	6,104,711	08-15-2000	Voit	
	75	6,115,737	09-05-2000	Ely et al.	
	76	6,128,304	10-03-2000	Gardell et al.	

Change(s) applied
to document,
/J.M.S./
8/15/2013

Examiner Signature	Date Considered
--------------------	-----------------

*Examiner: Initial if reference considered, whether or not citation is in conformance with MPEP 609. Draw line through citation if not in conformance and not considered. Include copy of this form with next communication to applicant.

INFORMATION DISCLOSURE STATEMENT BY APPLICANT	Application No.	12/513,147
	Filing Date	March 1, 2010
	First Named Inventor	Clay Perreault
	Art Unit	2614
<i>(Multiple sheets used when necessary)</i>	Examiner	Unassigned
SHEET 3 OF 6	Attorney Docket No.	SMARB19.001APC

U.S. PATENT DOCUMENTS

Examiner Initials	Cite No.	Document Number Number - Kind Code (if known) Example: 1,234,567 B1	Publication Date MM-DD-YYYY	Name of Patentee or Applicant	Pages, Columns, Lines Where Relevant Passages or Relevant Figures Appear
	39	5,737,414	04-07-1998	Walker et al.	
	40	5,751,961	05-12-1998	Smyk	
	41	5,793,762	08-11-1998	Penners et al.	
	42	5,799,072	08-25-1998	Vulcan et al.	
	43	5,802,502	09-01-1998	Gell et al.	
	44	5,825,863	10-20-1998	Walker	
	45	5,828,740	10-27-1998	Khuc et al.	
	46	5,838,682	11-17-1998	Dekelbaum et al.	
	47	5,845,267	12-01-1998	Ronen	
	48	5,850,433	12-15-1998	Rondeau	
	49	5,864,610	01-26-1999	Ronen	
	50	5,867,495	02-02-1999	Elliott et al.	
	51	5,883,891	05-18-1999 3/1999	Williams et al.	
	52	5,889,774	05-08-1999 3/1999	Mirashrafi et al.	
	53	5,905,736	05-18-1999	Ronen et al.	
	54	5,907,547	05-25-1999	Foladare et al.	
	55	5,910,946	06-08-1999	Csapo	
	56	5,915,005	06-22-1999	He	
	57	5,923,659	01-30-2001 7/1999	Curry et al.	

Change(s) applied
to document,
/J.M.S./
8/15/2013

Examiner Signature	Date Considered
*Examiner: Initial if reference considered, whether or not citation is in conformance with MPEP 609. Draw line through citation if not in conformance and not considered. Include copy of this form with next communication to applicant.	

T¹ - Place a checkmark in this area when an original language document is examined through. /SS/



UNITED STATES PATENT AND TRADEMARK OFFICE

UNITED STATES DEPARTMENT OF COMMERCE
United States Patent and Trademark Office
Address: COMMISSIONER FOR PATENTS
P.O. Box 1450
Alexandria, Virginia 22313-1450
www.uspto.gov

Table with 5 columns: APPLICATION NO., FILING DATE, FIRST NAMED INVENTOR, ATTORNEY DOCKET NO., CONFIRMATION NO.
Row 1: 12/513,147, 03/01/2010, Clay Perreault, SMARB19.001APC, 9611
Row 2: 20995, 7590, 08/21/2013, KNOBBE MARTENS OLSON & BEAR LLP, 2040 MAIN STREET, FOURTEENTH FLOOR, IRVINE, CA 92614, EXAMINER SING, SIMON P, ART UNIT 2653, PAPER NUMBER, NOTIFICATION DATE 08/21/2013, DELIVERY MODE ELECTRONIC

Please find below and/or attached an Office communication concerning this application or proceeding.

The time period for reply, if any, is set in the attached communication.

Notice of the Office communication was sent electronically on above-indicated "Notification Date" to the following e-mail address(es):

jayna.cartee@knobbe.com
efiling@knobbe.com

Response to Rule 312 Communication	Application No. 12/513,147	Applicant(s) PERREAULT ET AL.
	Examiner SIMON SING	Art Unit 2653

-- The MAILING DATE of this communication appears on the cover sheet with the correspondence address --

1. The amendment filed on 09 August 2013 under 37 CFR 1.312 has been considered, and has been:
- a) entered.
 - b) entered as directed to matters of form not affecting the scope of the invention.
 - c) disapproved because the amendment was filed after the payment of the issue fee.
Any amendment filed after the date the issue fee is paid must be accompanied by a petition under 37 CFR 1.313(c)(1) and the required fee to withdraw the application from issue.
 - d) disapproved. See explanation below.
 - e) entered in part. See explanation below.

	/Simon Sing/ Primary Examiner, Art Unit 2653
--	---

IN THE UNITED STATES PATENT AND TRADEMARK OFFICE

Inventor	: Clay Perreault, et al.
App. No.	: 12/513,147
Filed	: March 1, 2010
For	: PRODUCING ROUTING MESSAGES FOR VOICE OVER IP COMMUNICATIONS
Examiner	: Sing, Simon P.
Art Unit	: 2653
Conf No.	: 9611

AMENDMENT AFTER ALLOWANCE UNDER 37 C.F.R. § 1.312

Mail Stop Issue Fee

Commissioner for Patents
P.O. Box 1450
Alexandria, VA 22313-1450

Dear Sir:

Pursuant to 37 C.F.R. § 1.312, this paper is filed after the Notice of Allowance transmitted on July 16, 2013.

Amendments to the Claims are reflected in the listing of claims which begins on page 2 of this paper.

Remarks begin on page 27 of this paper.

PART B - FEE(S) TRANSMITTAL

Complete and send this form, together with applicable fee(s), to: **Mail** **Mail Stop ISSUE FEE**
Commissioner for Patents
P.O. Box 1450
Alexandria, Virginia 22313-1450
 or **Fax** **(571)-273-2885**

INSTRUCTIONS: This form should be used for transmitting the ISSUE FEE and PUBLICATION FEE (if required). Blocks 1 through 5 should be completed where appropriate. All further correspondence including the Patent, advance orders and notification of maintenance fees will be mailed to the current correspondence address as indicated unless corrected below or directed otherwise in Block 1, by (a) specifying a new correspondence address; and/or (b) indicating a separate "FEE ADDRESS" for maintenance fee notifications.

CURRENT CORRESPONDENCE ADDRESS (Note: Use Block 1 for any change of address)

20995 7590 07/16/2013
KNOBBE MARTENS OLSON & BEAR LLP
 2040 MAIN STREET
 FOURTEENTH FLOOR
 IRVINE, CA 92614

Note: A certificate of mailing can only be used for domestic mailings of the Fee(s) Transmittal. This certificate cannot be used for any other accompanying papers. Each additional paper, such as an assignment or formal drawing, must have its own certificate of mailing or transmission.

Certificate of Mailing or Transmission

I hereby certify that this Fee(s) Transmittal is being deposited with the United States Postal Service with sufficient postage for first class mail in an envelope addressed to the Mail Stop ISSUE FEE address above, or being facsimile transmitted to the USPTO (571) 273-2885, on the date indicated below.

(Depositor's name)
(Signature)
(Date)

APPLICATION NO.	FILING DATE	FIRST NAMED INVENTOR	ATTORNEY DOCKET NO.	CONFIRMATION NO.
12/513,147	03/01/2010	Clay Perreault	SMARB19.001APC	9611

TITLE OF INVENTION: PRODUCING ROUTING MESSAGES FOR VOICE OVER IP COMMUNICATIONS

APPLN. TYPE	ENTITY STATUS	ISSUE FEE DUE	PUBLICATION FEE DUE	PREV. PAID ISSUE FEE	TOTAL FEE(S) DUE	DATE DUE
nonprovisional	SMALL	\$890	\$300	\$0	\$1190	10/16/2013

EXAMINER	ART UNIT	CLASS-SUBCLASS
SING, SIMON P	2653	379-142040

1. Change of correspondence address or indication of "Fee Address" (37 CFR 1.363).
 Change of correspondence address (or Change of Correspondence Address form PTO/SB/122) attached.
 "Fee Address" indication (or "Fee Address" Indication form PTO/SB/47; Rev 03-02 or more recent) attached. Use of a **Customer Number is required.**

2. For printing on the patent front page, list
 (1) the names of up to 3 registered patent attorneys or agents OR, alternatively,
 (2) the name of a single firm (having as a member a registered attorney or agent) and the names of up to 2 registered patent attorneys or agents. If no name is listed, no name will be printed.

1 Knobbe Martens
 2 Olson & Bear LLP
 3 _____

3. ASSIGNEE NAME AND RESIDENCE DATA TO BE PRINTED ON THE PATENT (print or type)

PLEASE NOTE: Unless an assignee is identified below, no assignee data will appear on the patent. If an assignee is identified below, the document has been filed for recordation as set forth in 37 CFR 3.11. Completion of this form is NOT a substitute for filing an assignment.

(A) NAME OF ASSIGNEE (B) RESIDENCE: (CITY and STATE OR COUNTRY)

DIGIFONICA (INTERNATIONAL) LIMITED **VANCOUVER, CANADA**

Please check the appropriate assignee category or categories (will not be printed on the patent): Individual Corporation or other private group entity Government

4a. The following fee(s) are submitted:

- Issue Fee
- Publication Fee (No small entity discount permitted)
- Advance Order - # of Copies _____

4b. Payment of Fee(s): (Please first reapply any previously paid issue fee shown above)

- A check is enclosed.
- Payment by credit card. Form PTO-2038 is attached.
- The Director is hereby authorized to charge ~~the required fee(s)~~ any deficiency, or credit any overpayment, to Deposit Account Number 111410 (enclose an extra copy of this form).

5. **Change in Entity Status** (from status indicated above)

- Applicant certifying micro entity status. See 37 CFR 1.29
- Applicant asserting small entity status. See 37 CFR 1.27
- Applicant changing to regular undiscounted fee status.

NOTE: Absent a valid certification of Micro Entity Status (see form PTO/SB/15A and 15B), issue fee payment in the micro entity amount will not be accepted at the risk of application abandonment.

NOTE: If the application was previously under micro entity status, checking this box will be taken to be a notification of loss of entitlement to micro entity status.

NOTE: Checking this box will be taken to be a notification of loss of entitlement to small or micro entity status, as applicable.

NOTE: The Issue Fee and Publication Fee (if required) will not be accepted from anyone other than the applicant; a registered attorney or agent; or the assignee or other party in interest as shown by the records of the United States Patent and Trademark Office.

Authorized Signature _____

Date 8/9/13

Typed or printed name John M. Carson

Registration No. 34,303

This collection of information is required by 37 CFR 1.311. The information is required to obtain or retain a benefit by the public which is to file (and by the USPTO to process) an application. Confidentiality is governed by 35 U.S.C. 122 and 37 CFR 1.14. This collection is estimated to take 12 minutes to complete, including gathering, preparing, and submitting the completed application form to the USPTO. Time will vary depending upon the individual case. Any comments on the amount of time you require to complete this form and/or suggestions for reducing this burden, should be sent to the Chief Information Officer, U.S. Patent and Trademark Office, U.S. Department of Commerce, P.O. Box 1450, Alexandria, Virginia 22313-1450. DO NOT SEND FEES OR COMPLETED FORMS TO THIS ADDRESS. SEND TO: Commissioner for Patents, P.O. Box 1450, Alexandria, Virginia 22313-1450.

Under the Paperwork Reduction Act of 1995, no persons are required to respond to a collection of information unless it displays a valid OMB control number.

Please Direct All Correspondence to Customer Number 20995

Inventor	: Clay Perreault, et al.
App. No.	: 12/513,147
Filed	: March 01, 2010
For	: PRODUCING ROUTING MESSAGES FOR VOICE OVER IP COMMUNICATIONS
Examiner	: Sing, Simon P.
Art Unit	: 2653
Conf. No.	: 9611

COMMENTS ON EXAMINER'S STATEMENTS OF REASONS FOR ALLOWANCE

Mail Stop Issue Fee
 Commissioner for Patents
 P.O. Box 1450
 Alexandria, VA 22313-1450

Dear Sir:

Applicant wishes to address the Examiner's statement of reasons for allowance. Applicant respectfully submits that the claims should be allowed based on the entire language rather than focusing on any specific portion thereof. Please charge any additional fees, including any fees for additional extension of time, or credit overpayment to Deposit Account No. 11-1410.

Respectfully submitted,
 KNOBBE, MARTENS, OLSON & BEAR, LLP

Dated: 8/9/13

By: 
 John M. Carson
 Registration No. 34,303
 Attorney of Record
 Customer No. 20,995
 (858) 707-4000

15991785
 080913

Electronic Patent Application Fee Transmittal

Application Number:	12513147
Filing Date:	01-Mar-2010
Title of Invention:	PRODUCING ROUTING MESSAGES FOR VOICE OVER IP COMMUNICATIONS
First Named Inventor/Applicant Name:	Clay Perreault
Filer:	John M Carson/Catherine Tolo
Attorney Docket Number:	SMARB19.001APC

Filed as Small Entity

U.S. National Stage under 35 USC 371 Filing Fees

Description	Fee Code	Quantity	Amount	Sub-Total in USD(\$)
Basic Filing:				
Pages:				
Claims:				
Miscellaneous-Filing:				
Petition:				
Patent-Appeals-and-Interference:				
Post-Allowance-and-Post-Issuance:				
Utility Appl Issue Fee	2501	1	890	890
Publ. Fee- Early, Voluntary, or Normal	1504	1	300	300
PETITIONER APPLE INC. EX. 1002-16				

Description	Fee Code	Quantity	Amount	Sub-Total in USD(\$)
Extension-of-Time:				
Miscellaneous:				
Total in USD (\$)				1190

Electronic Acknowledgement Receipt

EFS ID:	16555018
Application Number:	12513147
International Application Number:	
Confirmation Number:	9611
Title of Invention:	PRODUCING ROUTING MESSAGES FOR VOICE OVER IP COMMUNICATIONS
First Named Inventor/Applicant Name:	Clay Perreault
Customer Number:	20995
Filer:	John M Carson/Tony Do
Filer Authorized By:	John M Carson
Attorney Docket Number:	SMARB19.001APC
Receipt Date:	09-AUG-2013
Filing Date:	01-MAR-2010
Time Stamp:	19:59:00
Application Type:	U.S. National Stage under 35 USC 371

Payment information:

Submitted with Payment	yes
Payment Type	Credit Card
Payment was successfully received in RAM	\$1190
RAM confirmation Number	6565
Deposit Account	111410
Authorized User	KNOBBE MARTENS OLSON AND BEAR

The Director of the USPTO is hereby authorized to charge indicated fees and credit any overpayment as follows:

Charge any Additional Fees required under 37 C.F.R. 1.492 (National application filing, search, and examination fees)

Charge any Additional Fees required under 37 C.F.R. Section 1.17 (Patent Application and Examination processing fees)

PETITIONER APPLE INC. EX: 1002-18

File Listing:					
Document Number	Document Description	File Name	File Size(Bytes)/ Message Digest	Multi Part /.zip	Pages (if appl.)
1		SMARB19_001APC_AMEND.pdf	1172957 2eb6162054fd405c56fc5438354458e197990	yes	28
Multipart Description/PDF files in .zip description					
Document Description			Start	End	
Amendment after Notice of Allowance (Rule 312)			1	1	
Claims			2	26	
Applicant Arguments/Remarks Made in an Amendment			27	28	
Warnings:					
Information:					
2	Issue Fee Payment (PTO-85B)	SMARB19_001APC_IFEE.pdf	116361 b559306205de81f79bf6dfcd6a2536901b1e6736	no	2
Warnings:					
Information:					
3	Miscellaneous Incoming Letter	SMARB19_001APC_COMMENT S.pdf	34863 765f0feebe7dceaae6964e6811f423ec644e7b32	no	1
Warnings:					
Information:					
4	Fee Worksheet (SB06)	fee-info.pdf	31726 b0f62ef5b3ddfac0adfaf0f422ff43856d46252	no	2
Warnings:					
Information:					
Total Files Size (in bytes):			1355907		

This Acknowledgement Receipt evidences receipt on the noted date by the USPTO of the indicated documents, characterized by the applicant, and including page counts, where applicable. It serves as evidence of receipt similar to a Post Card, as described in MPEP 503.

New Applications Under 35 U.S.C. 111

If a new application is being filed and the application includes the necessary components for a filing date (see 37 CFR 1.53(b)-(d) and MPEP 506), a Filing Receipt (37 CFR 1.54) will be issued in due course and the date shown on this Acknowledgement Receipt will establish the filing date of the application.

National Stage of an International Application under 35 U.S.C. 371

If a timely submission to enter the national stage of an international application is compliant with the conditions of 35 U.S.C. 371 and other applicable requirements a Form PCT/DO/EO/903 indicating acceptance of the application as a national stage submission under 35 U.S.C. 371 will be issued in addition to the Filing Receipt, in due course.

New International Application Filed with the USPTO as a Receiving Office

If a new international application is being filed and the international application includes the necessary components for an international filing date (see PCT Article 11 and MPEP 1810), a Notification of the International Application Number and of the International Filing Date (Form PCT/RO/105) will be issued in due course, subject to prescriptions concerning national security, and the date shown on this Acknowledgement Receipt will establish the international filing date of the application.

IN THE UNITED STATES PATENT AND TRADEMARK OFFICE

Inventor	: Clay Perreault, et al.
App. No.	: 12/513,147
Filed	: March 1, 2010
For	: PRODUCING ROUTING MESSAGES FOR VOICE OVER IP COMMUNICATIONS
Examiner	: Sing, Simon P.
Art Unit	: 2653
Conf No.	: 9611

AMENDMENT AFTER ALLOWANCE UNDER 37 C.F.R. § 1.312

Mail Stop Issue Fee

Commissioner for Patents
P.O. Box 1450
Alexandria, VA 22313-1450

Dear Sir:

Pursuant to 37 C.F.R. § 1.312, this paper is filed after the Notice of Allowance transmitted on July 16, 2013.

Amendments to the Claims are reflected in the listing of claims which begins on page 2 of this paper.

Remarks begin on page 27 of this paper.

Application No.: 12/513,147
Filing Date: March 1, 2010

AMENDMENTS TO THE CLAIMS

1. (Currently amended) A process for operating a call routing controller to facilitate communication between callers and callees in a system comprising a plurality of nodes with which callers and callees are associated, the process comprising:

in response to initiation of a call by a calling subscriber, receiving a caller identifier and a callee identifier;

locating a caller dialing profile comprising a username associated with the caller and a plurality of calling attributes associated with the caller;

~~performing a comparison of said~~ determining a match when at least one of said calling attributes matches at least a portion of said callee identifier;

classifying the call as a public network call when said match meets public network classification criteria and classifying the call as a private network call when said match meets private network classification criteria;

when the call is classified as a private network call, producing a private network routing message for receipt by a call controller, said private network routing message identifying an address, on the private network, associated with the callee;

when the call is classified as a public network call, producing a public network routing message for receipt by the call controller, said public network routing message identifying a gateway to the public network.

2. (Original) The process of claim 1 further comprising receiving a request to establish a call, from a call controller in communication with a caller identified by said callee identifier.

3. (Cancelled)

Application No.: 12/513,147
Filing Date: March 1, 2010

4. (Cancelled)

5. (Cancelled)

6. (Previously presented) The process of claim 1 wherein determining said match comprises determining said match when said callee identifier includes a portion that matches an International Dialing Digit (IDD) associated with said caller dialing profile.

7. (Previously presented) The process of claim 1 wherein determining said match comprises determining said match when said callee identifier includes a portion that matches a National Dialing Digit (NDD) associated with said caller dialing profile.

8. (Previously presented) The process of claim 1 wherein determining said match comprises determining said match when said callee identifier includes a portion that matches an area code associated with said caller dialing profile.

9. (Previously presented) The process of claim 1 wherein determining said match comprises determining said match when said callee identifier has a length within a range specified in said caller dialing profile.

10. (Previously presented) The process of claim 1 further comprising formatting said callee identifier into a pre-defined digit format to produce a re-formatted callee identifier.

11. (Original) The process of claim 10 wherein formatting comprises removing an international dialing digit from said callee identifier, when said callee identifier begins with a digit matching an international dialing digit specified by said caller dialing profile associated with said caller.

12. (Original) The process of claim 10 wherein formatting comprises removing a national dialing digit from said callee identifier and prepending a caller country code to said callee

Application No.: 12/513,147
Filing Date: March 1, 2010

identifier when said callee identifier begins with a national dialing digit.

13. (Original) The process of claim 10 wherein formatting comprises prepending a caller country code to said callee identifier when said callee identifier begins with digits identifying an area code specified by said caller dialing profile.

14. (Original) The process of claim 10 wherein formatting comprises prepending a caller country code and area code to said callee identifier when said callee identifier has a length that matches a caller dialing number format specified by said caller dialing profile and only one area code is specified as being associated with said caller in said caller dialing profile.

15. (Previously presented) The process of claim 10 wherein classifying comprises classifying said call as a private network call when said re-formatted callee identifier identifies a subscriber to the private network.

16. (Currently amended) The process of claim 10 wherein classifying comprises determining whether said callee identifier complies with a pre-defined username format and, if so, classifying the call as a private network call.

17. (Currently amended) The process of claim 10 to further comprising, causing a database of records to be searched to locate a Direct-Inward-Dial (DID) bank table record associating a public telephone number with said reformatted callee identifier and if said DID bank table record is found, classifying the call as a private network call and if a DID bank table record is not found, classifying the call as a public network call.

18. (Previously presented) The process of claim 17 wherein producing said private network routing message identifying a node on the private network comprises setting a callee identifier in response to a username associated with said DID bank table record.

Application No.: 12/513,147
Filing Date: March 1, 2010

19. (Previously presented) The process of claim 18 wherein producing said private network routing message comprises determining whether a node associated with the reformatted callee identifier is the same as a node associated the caller identifier.

20. (Previously presented) The process of claim 19 wherein determining whether a node associated with the reformatted callee identifier is the same as a node associated with the caller identifier comprises determining whether a prefix of said re-formatted callee identifier matches a corresponding prefix of a username associated with said caller dialing profile.

21. (Original) The process of claim 20 wherein when said node associated with said caller is not the same as the node associated with the callee, producing a routing message including said caller identifier, said reformatted callee identifier and an identification of a private network node associated with said callee and communicating said routing message to a call controller.

22. (Previously presented) The process of claim 19 wherein when said node associated with said caller identifier is the same as the node associated with said callee identifier, determining whether to perform at least one of the following: forward said call to another party, block the call and direct the caller to a voicemail server associated with the callee.

23. (Previously presented) The process of claim 22 wherein producing said private network routing message comprises producing a routing message having an identification of at least one of the callee identifier, an identification of a party to whom the call should be forwarded and an identification of a voicemail server associated with the callee.

24. (Original) The process of claim 23 further comprising communicating said routing message to a call controller.

25. (Previously presented) The process of claim 10 wherein producing said public network routing message identifying a gateway to the public network comprises searching a database of route records associating route identifiers with dialing codes to find a route record having a

Application No.: 12/513,147
Filing Date: March 1, 2010

dialing code having a number pattern matching at least a portion of said reformatted callee identifier.

26. (Original) The process of claim 25 further comprising searching a database of supplier records associating supplier identifiers with said route identifiers to locate at least one supplier record associated with said route identifier associated with said route record having a dialing code having a number pattern matching at least a portion of said reformatted callee identifier.

27. (Original) The process of claim 26 further comprising loading a routing message buffer with the reformatted callee identifier and an identification of specific routes associated respective ones of the supplier records associated with said route record and loading said routing message buffer with a time value and a timeout value.

28. (Currently amended) The process of claim 27 wherein said public network routing message comprises the contents of said routing message buffer and wherein said process comprises communicating said public network routing message to a call controller.

29. (Previously presented) The process of claim 1 further comprising causing said dialing profile to include a maximum concurrent call value and a concurrent call count value and causing said concurrent call count value to be incremented when the user associated with said dialing profile initiates a call and causing said concurrent call count value to be decremented when a call with said user associated with said dialing profile is ended.

30. (Currently amended) A non-transitory computer readable medium encoded with codes for directing a processor to execute a method of operating a call routing controller to facilitate communication between callers and callees in a system comprising a plurality of nodes with which callers and callees are associated, the method comprising:

in response to initiation of a call by a calling subscriber, receiving a caller identifier and a callee identifier;

Application No.: 12/513,147
Filing Date: March 1, 2010

locating a caller dialing profile comprising a username associated with the caller and a plurality of calling attributes associated with the caller;

~~performing a comparison of said~~ determining a match when at least one of said calling attributes matches at least a portion of said callee identifier;

classifying the call as a public network call when said match meets public network classification criteria and classifying the call as a private network call when said match meets private network classification criteria;

when the call is classified as a private network call, producing a private network routing message for receipt by a call controller, said private network routing message identifying an address, on the private network, associated with the callee; and

when the call is classified as a public network call, producing a public network routing message for receipt by a call controller, said public network routing message identifying a gateway to the public network.

31. (Previously presented) A call routing apparatus for facilitating communications between callers and callees in a system comprising a plurality of nodes with which callers and callees are associated, the apparatus comprising:

receiving means for receiving a caller identifier and a callee identifier, in response to initiation of a call by a calling subscriber;

means for locating a caller dialing profile comprising a username associated with the caller and a plurality of calling attributes associated with the caller;

means for determining a match when at least one of said calling attributes matches at least

Application No.: 12/513,147
Filing Date: March 1, 2010

a portion of said callee identifier;

means for classifying the call as a public network call when said match meets public network classification criteria;

means for classifying the call as a private network call when said match meets private network classification criteria;

means for producing a private network routing message for receipt by a call controller, when the call is classified as a private network call, said private network routing message identifying an address, on the private network, associated with the callee; and

means for producing a public network routing message for receipt by a call controller, when the call is classified as a public network call, said public network routing message identifying a gateway to the public network.

32. (Original) The apparatus of claim 31 wherein said receiving means is operably configured to receive a request to establish a call, from a call controller in communication with a caller identified by said callee identifier.

33. (Cancelled)

34. (Cancelled)

35. (Cancelled)

36. (Previously presented) The apparatus of claim 31 wherein said calling attributes include an international dialing digit and wherein said means for determining is operably configured to determine whether said callee identifier includes a portion that matches an International Dialing Digit (IDD) associated with said caller dialing profile.

Application No.: 12/513,147
Filing Date: March 1, 2010

37. (Previously presented) The apparatus of claim **31** wherein said calling attributes include a national dialing digit and wherein said means for determining is operably configured to determine whether said callee identifier includes a portion that matches a National Dialing Digit (NDD) associated with said caller dialing profile.

38. (Previously presented) The apparatus of claim **31** wherein said calling attributes include an area code and wherein said means for determining is operably configured to determine whether said callee identifier includes a portion that matches an area code associated with said caller dialing profile.

39. (Currently amended) The apparatus of claim **31** wherein said calling attribute includes a number length range and wherein said means for determining is operably configured to determine whether said callee identifier has a length within a range specified in said caller dialing profile.

40. (Previously presented) The apparatus of claim **31** further comprising formatting means for formatting said callee identifier into a pre-defined digit format to produce a re-formatted callee identifier.

41. (Original) The apparatus of claim **40** wherein said formatting means is operably configured to remove an international dialing digit from said callee identifier, when said callee identifier begins with a digit matching an international dialing digit specified by said caller dialing profile associated with said caller.

42. (Original) The apparatus of claim **40** wherein said formatting means is operably configured to remove a national dialing digit from said callee identifier and prepend a caller country code to said callee identifier when said callee identifier begins with a national dialing digit.

43. (Original) The apparatus of claim **40** wherein said formatting means is operably configured to prepend a caller country code to said callee identifier when said callee identifier begins with

Application No.: 12/513,147
Filing Date: March 1, 2010

digits identifying an area code specified by said caller dialing profile.

44. (Original) The apparatus of claim **40** wherein said formatting means is operably configured to prepend a caller country code and area code to said callee identifier when said callee identifier has a length that matches a caller dialing number format specified by said caller dialing profile and only one area code is specified as being associated with said caller in said caller dialing profile.

45. (Previously presented) The apparatus of claim **40** wherein said means for classifying the call as a private network call is operably configured to classify said call as a private network call when said re-formatted callee identifier identifies a subscriber to the private network.

46. (Previously presented) The apparatus of claim **40** wherein said means for classifying the call as a private network call is operably configured to classify the call as a private network call when said callee identifier complies with a pre-defined username format.

47. (Previously presented) The apparatus of claim **40** further comprising searching means for searching a database of records to locate a Direct-Inward-Dial (DID) bank table record associating a public telephone number with said reformatted callee identifier and wherein said means for classifying the call as a private network call is operably configured to classify the call as a private network call when said DID bank table record is found and said means for classifying the call as a public network call is operably configured to classify the call as a public network call when a DID bank table record is not found.

48. (Original) The apparatus of claim **47** wherein said private network routing message producing means is operably configured to produce a routing message having a callee identifier set according to a username associated with said DID bank table record.

49. (Original) The apparatus of claim **48** wherein said private network routing message producing means is operably configured to determine whether a node associated with the

Application No.: 12/513,147
Filing Date: March 1, 2010

reformatted callee identifier is the same as a node associated the caller identifier.

50. (Original) The apparatus of claim 49 wherein said private network routing means includes means for determining whether a prefix of said re-formatted callee identifier matches a corresponding prefix of a username associated with said caller dialing profile.

51. (Currently amended) The apparatus of claim 50 wherein said private network routing message producing means is operably configured to produce a routing message including said caller identifier, said reformatted callee identifier and an identification of a private network node associated with said callee and to communicating said routing message to a call controller.

52. (Previously presented) The apparatus of claim 49 wherein said private network routing message producing means is operably configured to perform at least one of the following: forward said call to another party, block the call and direct the caller to a voicemail server associated with the callee identifier, when said node associated with said caller identifier is the same as the node associated with said callee identifier.

53. (Original) The apparatus of claim 52 wherein said means for producing said private network routing message is operably configured to produce a routing message having an identification of at least one of the callee identifier, an identification of a party to whom the call should be forwarded and an identification of a voicemail server associated with the callee.

54. (Original) The apparatus of claim 53 further comprising means for communicating said routing message to a call controller.

55. (Previously presented) The apparatus of claim 40 wherein said means for producing said public network routing message identifying a gateway to the public network comprises means for searching a database of route records associating route identifiers with dialing codes to find a route record having a dialing code having a number pattern matching at least a portion of said reformatted callee identifier.

Application No.: 12/513,147
Filing Date: March 1, 2010

56. (Original) The apparatus of claim **55** further comprising means for searching a database of supplier records associating supplier identifiers with said route identifiers to locate at least one supplier record associated with said route identifier associated with said route record having a dialing code having a number pattern matching at least a portion of said reformatted callee identifier.

57. (Original) The apparatus of claim **56** further comprising a routing message buffer and means for loading said routing message buffer with the reformatted callee identifier and an identification of specific routes associated respective ones of the supplier records associated with said route record and loading said routing message buffer with a time value and a timeout value.

58. (Previously presented) The apparatus of claim **57** further comprising means for causing said public network routing message to include the contents of said routing message buffer and means for communicating the public network routing message to a call controller.

59. (Previously presented) The apparatus of claim **31** further comprising means for causing said dialing profile to include a maximum concurrent call value and a concurrent call count value and for causing said concurrent call count value to be incremented when the user associated with said dialing profile initiates a call and for causing said concurrent call count value to be decremented when a call with said user associated with said dialing profile is ended.

60. (Previously presented) A process for operating a call routing controller to establish a call between a caller and a callee in a communication system, the process comprising:

in response to initiation of a call by a calling subscriber, locating a caller dialing profile comprising a plurality of calling attributes associated with the caller; and

when at least one of said calling attributes and at least a portion of a callee identifier associated with the callee match and when the match meets a private network classification

Application No.: 12/513,147
Filing Date: March 1, 2010

criterion, producing a private network routing message for receipt by a call controller, said private network routing message identifying an address, on a private network, the address being associated with the callee; and

when at least one of said calling attributes and said at least said portion of said callee identifier associated with the callee match and when the match meets a public network classification criterion, producing a public network routing message for receipt by a call controller, said public network routing message identifying a gateway to a public network.

61. (Previously presented) The process of claim **60** wherein said private network classification criteria include:

- a) said callee identifier does not begin with the same digit pattern as an international dialing digit (IDD) attribute of said callee identifier; and
- b) said callee identifier does not begin with the same digit pattern as a national dialing digit (NDD) attribute of said callee identifier; and
- c) said callee identifier does not begin with the same area code as an area code of said caller; and
- d) said callee identifier does not have a length that is within a range of caller local number lengths; and
- e) said callee identifier is a valid username.

62. (Previously presented) The process of claim **61** further comprising identifying the call as a cross-domain call on the private network when said callee identifier identifies a callee that is not associated with the same network node as said caller.

Application No.: 12/513,147
Filing Date: March 1, 2010

63. (Previously presented) The process of claim **61** further comprising:

locating a callee dialing profile for the callee when said callee identifier identifies a callee that is associated with the same network node as said caller; and

retrieving call handling information associated with the callee, where said call handling information is available, said call handling information including at least one of call blocking information, call forwarding information, and voicemail information.

64. (Previously presented) The process of claim **63** further comprising, where said call handling information including said call blocking information is available, blocking the call when said call blocking information identifies the caller as a caller from whom calls are to be blocked from being established with the callee.

65. (Previously presented) The process of claim **63** further comprising, where said call handling information including said call forwarding information is available, causing said call forwarding information to be included in said private network routing message.

66. (Previously presented) The process of claim **63** further comprising, where said call handling information including said voicemail information is available, causing said voicemail information to be included in said private network routing message.

67. (Previously presented) The process of claim **60** further comprising associating at least one direct inward dial record with at least one subscriber to said communication system, each of said at least one direct inward dial records comprising a field storing a direct inward dial number associated with said at least one subscriber.

68. (Previously presented) The process of claim **67** wherein said public network classification criteria include:

Application No.: 12/513,147
Filing Date: March 1, 2010

- a) said callee identifier begins with the same digit pattern as an international dialing digit (IDD) attribute of said callee identifier; and
- b) a reformatted callee identifier produced by removing the IDD attribute from said callee identifier has no DID bank table record.

69. (Previously presented) The process of claim 67 wherein said public network classification criteria include:

- a) said callee identifier begins with the same digit pattern as a national dialing digit (NDD) attribute of said callee identifier; and
- b) a reformatted callee identifier produced by removing the NDD attribute from said callee identifier and including a caller country code has no DID bank table record.

70. (Previously presented) The process of claim 67 wherein said public network classification criteria include:

- a) said callee identifier begins with the same area code as an area code of said caller; and
- b) a reformatted callee identifier produced by reformatting the callee identifier to include a caller country code has no DID bank table record.

71. (Previously presented) The process of claim 67 wherein said public network classification criteria include:

- a) said callee identifier has a length that is within a range of caller local number lengths; and

Application No.: 12/513,147
Filing Date: March 1, 2010

- b) a reformatted callee identifier produced by reformatting the callee identifier to include a caller country code and area code has no DID bank table record.

72. (Previously presented) The process of claim **60** wherein said plurality of calling attributes includes at least one of an international dialing digits field, a national dialing digits field, a country code field, a local area codes field, a caller minimum local length field, a caller maximum local length field, a reseller field, a maximum number of concurrent calls field and a current number of concurrent calls field.

73. (Previously presented) The process of claim **67** wherein said DID record comprises a user name field, a user domain field and a DID number field.

74. (Previously presented) The process of claim **60** further comprising maintaining a list of public network route suppliers and when said public network classification criterion is met identifying at least one of said public network route suppliers that satisfies public network routing selection criteria.

75. (Previously presented) The process of claim **74** wherein said producing said public network routing message comprises producing a public network routing message identifying said at least one public network route supplier that satisfies said public network routing selection criteria.

76. (Previously presented) The process of claim **75** wherein producing said public network routing message comprises causing said at least one public network route supplier that satisfies said public network routing selection criteria to be placed in a preferred order,

77. (Previously presented) The process of claim **76** wherein said preferred order is by at least one of rate and preferred service agreements with said at least one public network route supplier.

Application No.: 12/513,147
Filing Date: March 1, 2010

78. (Previously presented) The process of claim **60** further comprising causing the private network routing message or the public network routing message to be communicated to a call controller to effect routing of the call.

79. (Previously presented) A non-transitory computer readable medium encoded with codes for directing a processor to execute the method of claim **60**.

80. (Previously presented) A call routing controller apparatus for establishing a call between a caller and a callee in a communication system, the apparatus comprising:

a processor operably configured to:

access a database of caller dialing profiles wherein each dialing profile associates a plurality of calling attributes with a respective subscriber, to locate a dialing profile associated with the caller, in response to initiation of a call by a calling subscriber; and

produce a private network routing message for receipt by a call controller, said private network routing message identifying an address, on a private network, through which the call is to be routed, when at least one of said calling attributes and at least a portion of a callee identifier associated with the callee match and when the match meets a private network classification criterion, the address being associated with the callee; and

produce a public network routing message for receipt by a call controller, said public network routing message identifying a gateway to a public network, when at least one of said calling attributes and said at least said portion of said callee identifier associated with the callee match and when the match meets a public network classification criterion.

81. (Previously presented) The apparatus of claim **80** wherein said private network classification criteria include:

Application No.: 12/513,147
Filing Date: March 1, 2010

- a) said callee identifier does not begin with the same digit pattern as an international dialing digit (IDD) attribute of said callee identifier; and
- b) said callee identifier does not begin with the same digit pattern as a national dialing digit (NDD) attribute of said callee identifier; and
- c) said callee identifier does not begin with the same area code as an area code of said caller; and
- d) said callee identifier does not have a length that is within a range of caller local number lengths; and
- e) said callee identifier is a valid username.

82. (Previously presented) The apparatus of claim 81 wherein said processor is further operably configured to identify the call as a cross-domain call on the private network when said callee identifier identifies a callee that is not associated with the same network node as said caller.

83. (Previously presented) The apparatus of claim 81 wherein said processor is further configured to:

access the database of caller dialing profiles to locate a callee dialing profile for the callee when said callee identifier identifies a callee that is associated with the same network node as said caller; and

retrieve call handling information associated with the callee, where said call handling information is available, said call handling information including at least one of call blocking information, call forwarding information, and voicemail information.

Application No.: 12/513,147
Filing Date: March 1, 2010

84. (Currently amended) The apparatus of claim 83 wherein said processor is further operably configured to determine whether said call handling information including said call blocking information is available and to block the call when said call blocking information identifies the caller as a caller from whom calls are to be blocked.

85. (Previously presented) The apparatus of claim 83 wherein said processor is further operably configured to determine whether said call handling information including said call forwarding information is available and to cause said call forwarding information to be included in said private network routing message.

86. (Previously presented) The apparatus of claim 83 wherein said processor is further operably configured to determine whether said call handling information including said voicemail information is available and to cause said voicemail information to be included in said private network routing message.

87. (Previously presented) The apparatus of claim 80 wherein said processor is further operably configured to access a database of direct inward dial records each associating at least one direct inward dial number with at least one subscriber to said communication system.

88. (Previously presented) The apparatus of claim 87 wherein said public network classification criteria include:

- a) said callee identifier begins with the same digit pattern as an international dialing digit (IDD) attribute of said callee identifier; and
- b) a reformatted callee identifier produced by removing the IDD attribute from said callee identifier has no DID record.

89. (Previously presented) The apparatus of claim 87 wherein said public network classification

Application No.: 12/513,147
Filing Date: March 1, 2010

criteria include:

- a) said callee identifier begins with the same digit pattern as a national dialing digit (NDD) attribute of said callee identifier; and
- b) a reformatted callee identifier produced by removing the NDD attribute from said callee identifier and including a caller country code has no DID record.

90. (Previously presented) The apparatus of claim 87 wherein said public network classification criteria include:

- a) said callee identifier begins with the same area code as an area code of said caller; and
- b) a reformatted callee identifier produced by reformatting the callee identifier to include a caller country code has no DID record.

91. (Previously presented) The apparatus of claim 87 wherein said public network classification criteria include:

- a) said callee identifier has a length that is within a range of caller local number lengths; and
- b) a reformatted callee identifier produced by reformatting the callee identifier to include a caller country code and area code has no DID record.

92. (Previously presented) The apparatus of claim 80 wherein said plurality of calling attributes includes at least one of an international dialing digits field, a national dialing digits field, a

Application No.: 12/513,147
Filing Date: March 1, 2010

country code field, a local area codes field, a caller minimum local length field, a caller maximum local length field, a reseller field, a maximum number of concurrent calls field and a current number of concurrent calls field.

93. (Previously presented) The apparatus of claim **87** wherein said DID record comprises a user name field, a user domain field and a DID number field.

94. (Previously presented) The apparatus of claim **80** wherein said processor is further operably configured to access a list of public network route suppliers when said public network classification criterion is met and to identify at least one of said public network route suppliers that satisfies public network routing selection criteria.

95. (Previously presented) The apparatus of claim **94** wherein said processor is further operably configured to produce a public network routing message identifying said at least one public network route supplier that satisfies said public network routing selection criteria.

96. (Previously presented) The apparatus of claim **95** wherein said processor is further operably configured to cause said at least one public network route supplier that satisfies said public network routing selection criteria to be placed in a preferred order.

97. (Previously presented) The apparatus of claim **96** wherein said preferred order is by at least one of rate and preferred service agreements with said at least one public network route supplier.

98. (Previously presented) The apparatus of claim **80** wherein said processor is further operably configured to cause the private network routing message or the public network routing message to be communicated to a call controller to effect routing of the call.

99. (Previously presented) A call routing controller apparatus for establishing a call between a caller and a callee in a communication system, the apparatus comprising:

Application No.: 12/513,147
Filing Date: March 1, 2010

means for accessing a database of caller dialing profiles wherein each dialing profile associates a plurality of calling attributes with a respective subscriber, to locate a dialing profile associated with the caller, in response to initiation of a call by a calling subscriber; and

means for producing a private network routing message for receipt by a call controller, said private network routing message identifying an address, on a private network, through which the call is to be routed, when at least one of said calling attributes and at least a portion of a callee identifier associated with the callee match and when the match meets a private network classification criterion, the address being associated with the callee; and

means for producing a public network routing message for receipt by a call controller, said public network routing message identifying a gateway to a public network when at least one of said calling attributes and said at least said portion of said callee identifier associated with the callee match and when the match meets a public network classification criterion.

100. (Previously presented) The apparatus of claim 99 wherein said private network classification criteria include:

- a) said callee identifier does not begin with the same digit pattern as an international dialing digit (IDD) attribute of said callee identifier; and
- b) said callee identifier does not begin with the same digit pattern as a national dialing digit (NDD) attribute of said callee identifier; and
- c) said callee identifier does not begin with the same area code as an area

Application No.: 12/513,147
Filing Date: March 1, 2010

code of said caller; and

- d) said callee identifier does not have a length that is within a range of caller local number lengths; and
- e) said callee identifier is a valid username.

101. (Previously presented) The apparatus of claim **100** further comprising means for identifying the call as a cross-domain call on the private network when said callee identifier identifies a callee that is not associated with the same network node as said caller.

102. (Previously presented) The apparatus of claim **100** further comprising:

means for accessing the database of caller dialing profiles to locate a callee dialing profile for the callee when said callee identifier identifies a callee that is associated with the same network node as said caller; and

means for retrieving call handling information associated with the callee, where said call handling information is available, said call handling information including at least one of call blocking information, call forwarding information, and voicemail information.

103. (Currently amended) The apparatus of claim **102** further comprising, where said call handling information including said call blocking information is available, means for blocking the call being established with the callee when said call blocking information identifies the caller as a caller from whom calls are to be blocked ~~being established with the callee~~.

104. (Previously presented) The apparatus of claim **102** further comprising, means for causing said call forwarding information to be included in said private network routing message, where said call handling information including said call forwarding information is available.

Application No.: 12/513,147
Filing Date: March 1, 2010

105. (Previously presented) The apparatus of claim **102** further comprising, where said call handling information including said voicemail information is available, means for causing said voicemail information to be included in said private network routing message.

106. (Previously presented) The apparatus of claim **99** further comprising means for accessing a database of direct inward dial records each associating at least one direct inward dial number with at least one subscriber to said communication system.

107. (Previously presented) The apparatus of claim **106** wherein said public network classification criteria include:

- a) said callee identifier begins with the same digit pattern as an international dialing digit (IDD) attribute of said callee identifier; and
- b) a reformatted callee identifier produced by removing the IDD attribute from said callee identifier has no DID record.

108. (Previously presented) The apparatus of claim **106** wherein said public network classification criteria include:

- a) said callee identifier begins with the same digit pattern as a national dialing digit (NDD) attribute of said callee identifier; and
- b) a reformatted callee identifier produced by removing the NDD attribute from said callee identifier and including a caller country code has no DID record.

109. (Previously presented) The apparatus of claim **106** wherein said public network classification criteria include:

Application No.: 12/513,147
Filing Date: March 1, 2010

- a) said callee identifier begins with the same area code as an area code of said caller; and
- b) a reformatted callee identifier produced by reformatting the callee identifier to include a caller country code has no DID record.

110. (Previously presented) The apparatus of claim **106** wherein said public network classification criteria include:

- a) said callee identifier has a length that is within a range of caller local number lengths; and
- b) a reformatted callee identifier produced by reformatting the callee identifier to include a caller country code and area code has no DID record.

111. (Previously presented) the apparatus of claim **99** wherein said plurality of calling attributes includes at least one of an international dialing digits field, a national dialing digits field, a country code field, a local area codes field, a caller minimum local length field, a caller maximum local length field, a reseller field, a maximum number of concurrent calls field and a current number of concurrent calls field.

112. (Previously presented) The apparatus of claim **106** wherein said DID record comprises a user name field, a user domain field and a DID number field.

113. (Previously presented) The apparatus of claim **99** further comprising means for accessing a list of public network route suppliers when said public network classification criterion is met and means for identifying at least one of said public network route suppliers that satisfies public network routing selection criteria.

Application No.: 12/513,147
Filing Date: March 1, 2010

114. (Previously presented) The apparatus of claim 113 wherein said means for producing said public network routing message comprises means for producing a public network routing message identifying said at least one public network route supplier that satisfies said public network routing selection criteria.

115. (Previously presented) The apparatus of claim 114 wherein said means for producing said public network routing message comprises means for causing said at least one public network route supplier that satisfies said public network routing selection criteria to be placed in a preferred order.

116. (Previously presented) The apparatus of claim 115 wherein said preferred order is by at least one of rate and preferred service agreements with said at least one public network route supplier.

117. (Previously presented) The apparatus of claim 99 further comprising means for causing the private network routing message or the public network routing message to be communicated to a call controller to effect routing of the call.

Application No.: 12/513,147
Filing Date: March 1, 2010

REMARKS

Claims 1, 16, 17, 28, 30, 39, 51, 84, and 103 have been amended for clarification of antecedent bases, claim consistencies, and to correct punctuation. No new subject matter has been added. Applicant respectfully submits that the amendments contained herewith concern merely formal matters without changing the scope thereof, and request the Examiner enter the amendments without withdrawing the application from issue. *See* M.P.E.P. § 714.16.

No Disclaimers or Disavowals

Although the present communication may include alterations to the application or claims, or characterizations of claim scope or referenced art, Applicant is not conceding in this application that previously pending claims are not patentable over the cited references. Rather, any alterations or characterizations are being made to facilitate expeditious prosecution of this application. Applicant reserves the right to pursue at a later date any previously pending or other broader or narrower claims that capture any subject matter supported by the present disclosure, including subject matter found to be specifically disclaimed herein or by any prior prosecution. Accordingly, reviewers of this or any parent, child or related prosecution history shall not reasonably infer that Applicant has made any disclaimers or disavowals of any subject matter supported by the present application.

Co-Pending Applications of Assignee

Applicant wishes to draw the Examiner's attention to the following co-pending applications of the present application's assignee.

Docket No.	Serial No.	Title	Filed
SMARB19.002C1	13/863306	Intercepting Voice Over IP Communications and Other Data Communications	04/15/13
SMARB19.003APC	12/532989	Emergency Assistance Calling for Voice Over IP Communications Systems	03/05/10
SMARB19.004APC	13/056277	Mobile Gateway	01/27/11
SMARB19.005APC	13/496864	Uninterrupted Transmission of Internet Protocol Transmissions During Endpoint Changes	03/16/12

Application No.: 12/513,147
Filing Date: March 1, 2010

Please charge any additional fees, including any fees for additional extension of time, or credit overpayment to Deposit Account No. 11-1410.

Respectfully submitted,

KNOBBE, MARTENS, OLSON & BEAR, LLP

Dated: _____

8/9/13

By: _____

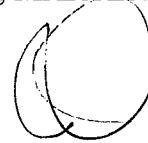

John M. Carson
Registration No. 34,303
Attorney of Record
Customer No. 20995
(858) 707-4000

AMEND

15839725
071913



NOTICE OF ALLOWANCE AND FEE(S) DUE

20995 7590 07/16/2013
KNOBBE MARTENS OLSON & BEAR LLP
2040 MAIN STREET
FOURTEENTH FLOOR
IRVINE, CA 92614

Table with 2 columns: EXAMINER (SING, SIMON P), ART UNIT (2653), PAPER NUMBER (9611)

DATE MAILED: 07/16/2013

Table with 5 columns: APPLICATION NO., FILING DATE, FIRST NAMED INVENTOR, ATTORNEY DOCKET NO., CONFIRMATION NO.

TITLE OF INVENTION: PRODUCING ROUTING MESSAGES FOR VOICE OVER IP COMMUNICATIONS

Table with 7 columns: APPLN. TYPE, ENTITY STATUS, ISSUE FEE DUE, PUBLICATION FEE DUE, PREV. PAID ISSUE FEE, TOTAL FEE(S) DUE, DATE DUE

THE APPLICATION IDENTIFIED ABOVE HAS BEEN EXAMINED AND IS ALLOWED FOR ISSUANCE AS A PATENT. PROSECUTION ON THE MERITS IS CLOSED. THIS NOTICE OF ALLOWANCE IS NOT A GRANT OF PATENT RIGHTS. THIS APPLICATION IS SUBJECT TO WITHDRAWAL FROM ISSUE AT THE INITIATIVE OF THE OFFICE OR UPON PETITION BY THE APPLICANT. SEE 37 CFR 1.313 AND MPEP 1308.

THE ISSUE FEE AND PUBLICATION FEE (IF REQUIRED) MUST BE PAID WITHIN THREE MONTHS FROM THE MAILING DATE OF THIS NOTICE OR THIS APPLICATION SHALL BE REGARDED AS ABANDONED. THIS STATUTORY PERIOD CANNOT BE EXTENDED. SEE 35 U.S.C. 151. THE ISSUE FEE DUE INDICATED ABOVE DOES NOT REFLECT A CREDIT FOR ANY PREVIOUSLY PAID ISSUE FEE IN THIS APPLICATION. IF AN ISSUE FEE HAS PREVIOUSLY BEEN PAID IN THIS APPLICATION (AS SHOWN ABOVE), THE RETURN OF PART B OF THIS FORM WILL BE CONSIDERED A REQUEST TO REAPPLY THE PREVIOUSLY PAID ISSUE FEE TOWARD THE ISSUE FEE NOW DUE.

HOW TO REPLY TO THIS NOTICE:

I. Review the ENTITY STATUS shown above. If the ENTITY STATUS is shown as SMALL or MICRO, verify whether entitlement to that entity status still applies. If the ENTITY STATUS is the same as shown above, pay the TOTAL FEE(S) DUE shown above. If the ENTITY STATUS is changed from that shown above, on PART B - FEE(S) TRANSMITTAL, complete section number 5 titled "Change in Entity Status (from status indicated above)". For purposes of this notice, small entity fees are 1/2 the amount of undiscounted fees, and micro entity fees are 1/2 the amount of small entity fees.

II. PART B - FEE(S) TRANSMITTAL, or its equivalent, must be completed and returned to the United States Patent and Trademark Office (USPTO) with your ISSUE FEE and PUBLICATION FEE (if required). If you are charging the fee(s) to your deposit account, section "4b" of Part B - Fee(s) Transmittal should be completed and an extra copy of the form should be submitted. If an equivalent of Part B is filed, a request to reapply a previously paid issue fee must be clearly made, and delays in processing may occur due to the difficulty in recognizing the paper as an equivalent of Part B.

III. All communications regarding this application must give the application number. Please direct all communications prior to issuance to Mail Stop ISSUE FEE unless advised to the contrary.

IMPORTANT REMINDER: Utility patents issuing on applications filed on or after Dec. 12, 1980 may require payment of maintenance fees. It is patentee's responsibility to ensure timely payment of maintenance fees when due.

PART B - FEE(S) TRANSMITTAL

**Complete and send this form, together with applicable fee(s), to: Mail Mail Stop ISSUE FEE
 Commissioner for Patents
 P.O. Box 1450
 Alexandria, Virginia 22313-1450
 or Fax (571)-273-2885**

INSTRUCTIONS: This form should be used for transmitting the ISSUE FEE and PUBLICATION FEE (if required). Blocks 1 through 5 should be completed where appropriate. All further correspondence including the Patent, advance orders and notification of maintenance fees will be mailed to the current correspondence address as indicated unless corrected below or directed otherwise in Block 1, by (a) specifying a new correspondence address; and/or (b) indicating a separate "FEE ADDRESS" for maintenance fee notifications.

CURRENT CORRESPONDENCE ADDRESS (Note: Use Block 1 for any change of address)

Note: A certificate of mailing can only be used for domestic mailings of the Fee(s) Transmittal. This certificate cannot be used for any other accompanying papers. Each additional paper, such as an assignment or formal drawing, must have its own certificate of mailing or transmission.

20995 7590 07/16/2013
KNOBBE MARTENS OLSON & BEAR LLP
 2040 MAIN STREET
 FOURTEENTH FLOOR
 IRVINE, CA 92614

Certificate of Mailing or Transmission

I hereby certify that this Fee(s) Transmittal is being deposited with the United States Postal Service with sufficient postage for first class mail in an envelope addressed to the Mail Stop ISSUE FEE address above, or being facsimile transmitted to the USPTO (571) 273-2885, on the date indicated below.

(Depositor's name)
(Signature)
(Date)

APPLICATION NO.	FILING DATE	FIRST NAMED INVENTOR	ATTORNEY DOCKET NO.	CONFIRMATION NO.
12/513,147	03/01/2010	Clay Perreault	SMARB19.001APC	9611

TITLE OF INVENTION: PRODUCING ROUTING MESSAGES FOR VOICE OVER IP COMMUNICATIONS

APPLN. TYPE	ENTITY STATUS	ISSUE FEE DUE	PUBLICATION FEE DUE	PREV. PAID ISSUE FEE	TOTAL FEE(S) DUE	DATE DUE
nonprovisional	SMALL	\$890	\$300	\$0	\$1190	10/16/2013

EXAMINER	ART UNIT	CLASS-SUBCLASS
SING, SIMON P	2653	379-142040

<p>1. Change of correspondence address or indication of "Fee Address" (37 CFR 1.363).</p> <p><input type="checkbox"/> Change of correspondence address (or Change of Correspondence Address form PTO/SB/122) attached.</p> <p><input type="checkbox"/> "Fee Address" indication (or "Fee Address" Indication form PTO/SB/47; Rev 03-02 or more recent) attached. Use of a Customer Number is required.</p>	<p>2. For printing on the patent front page, list</p> <p>(1) the names of up to 3 registered patent attorneys or agents OR, alternatively, _____ 1</p> <p>(2) the name of a single firm (having as a member a registered attorney or agent) and the names of up to 2 registered patent attorneys or agents. If no name is listed, no name will be printed. _____ 2</p> <p>_____ 3</p>
---	---

3. ASSIGNEE NAME AND RESIDENCE DATA TO BE PRINTED ON THE PATENT (print or type)

PLEASE NOTE: Unless an assignee is identified below, no assignee data will appear on the patent. If an assignee is identified below, the document has been filed for recordation as set forth in 37 CFR 3.11. Completion of this form is NOT a substitute for filing an assignment.

(A) NAME OF ASSIGNEE _____ (B) RESIDENCE: (CITY and STATE OR COUNTRY) _____

Please check the appropriate assignee category or categories (will not be printed on the patent) : Individual Corporation or other private group entity Government

<p>4a. The following fee(s) are submitted:</p> <p><input type="checkbox"/> Issue Fee</p> <p><input type="checkbox"/> Publication Fee (No small entity discount permitted)</p> <p><input type="checkbox"/> Advance Order - # of Copies _____</p>	<p>4b. Payment of Fee(s): (Please first reapply any previously paid issue fee shown above)</p> <p><input type="checkbox"/> A check is enclosed.</p> <p><input type="checkbox"/> Payment by credit card. Form PTO-2038 is attached.</p> <p><input type="checkbox"/> The Director is hereby authorized to charge the required fee(s), any deficiency, or credit any overpayment, to Deposit Account Number _____ (enclose an extra copy of this form).</p>
---	---

5. **Change in Entity Status** (from status indicated above)

- Applicant certifying micro entity status. See 37 CFR 1.29
- Applicant asserting small entity status. See 37 CFR 1.27
- Applicant changing to regular undiscounted fee status.

NOTE: Absent a valid certification of Micro Entity Status (see form PTO/SB/15A and 15B), issue fee payment in the micro entity amount will not be accepted at the risk of application abandonment.

NOTE: If the application was previously under micro entity status, checking this box will be taken to be a notification of loss of entitlement to micro entity status.

NOTE: Checking this box will be taken to be a notification of loss of entitlement to small or micro entity status, as applicable.

NOTE: The Issue Fee and Publication Fee (if required) will not be accepted from anyone other than the applicant; a registered attorney or agent; or the assignee or other party in interest as shown by the records of the United States Patent and Trademark Office.

Authorized Signature _____

Date _____

Typed or printed name _____

Registration No. _____

This collection of information is required by 37 CFR 1.311. The information is required to obtain or retain a benefit by the public which is to file (and by the USPTO to process) an application. Confidentiality is governed by 35 U.S.C. 122 and 37 CFR 1.14. This collection is estimated to take 12 minutes to complete, including gathering, preparing, and submitting the completed application form to the USPTO. Time will vary depending upon the individual case. Any comments on the amount of time you require to complete this form and/or suggestions for reducing this burden, should be sent to the Chief Information Officer, U.S. Patent and Trademark Office, U.S. Department of Commerce, P.O. Box 1450, Alexandria, Virginia 22313-1450. DO NOT SEND FEES OR COMPLETED FORMS TO THIS ADDRESS. SEND TO: Commissioner for Patents, P.O. Box 1450, Alexandria, Virginia 22313-1450.

Under the Paperwork Reduction Act of 1995, no persons are required to respond to a collection of information unless it displays a valid OMB control number.



UNITED STATES PATENT AND TRADEMARK OFFICE

UNITED STATES DEPARTMENT OF COMMERCE
United States Patent and Trademark Office
Address: COMMISSIONER FOR PATENTS
P.O. Box 1450
Alexandria, Virginia 22313-1450
www.uspto.gov

Table with 5 columns: APPLICATION NO., FILING DATE, FIRST NAMED INVENTOR, ATTORNEY DOCKET NO., CONFIRMATION NO.
12/513,147 03/01/2010 Clay Perreault SMARB19.001APC 9611

20995 7590 07/16/2013
KNOBBE MARTENS OLSON & BEAR LLP
2040 MAIN STREET
FOURTEENTH FLOOR
IRVINE, CA 92614

EXAMINER

SING, SIMON P

ART UNIT PAPER NUMBER

2653

DATE MAILED: 07/16/2013

Determination of Patent Term Adjustment under 35 U.S.C. 154 (b)

(application filed on or after May 29, 2000)

The Patent Term Adjustment to date is 659 day(s). If the issue fee is paid on the date that is three months after the mailing date of this notice and the patent issues on the Tuesday before the date that is 28 weeks (six and a half months) after the mailing date of this notice, the Patent Term Adjustment will be 659 day(s).

If a Continued Prosecution Application (CPA) was filed in the above-identified application, the filing date that determines Patent Term Adjustment is the filing date of the most recent CPA.

Applicant will be able to obtain more detailed information by accessing the Patent Application Information Retrieval (PAIR) WEB site (http://pair.uspto.gov).

Any questions regarding the Patent Term Extension or Adjustment determination should be directed to the Office of Patent Legal Administration at (571)-272-7702. Questions relating to issue and publication fee payments should be directed to the Customer Service Center of the Office of Patent Publication at 1-(888)-786-0101 or (571)-272-4200.

Privacy Act Statement

The Privacy Act of 1974 (P.L. 93-579) requires that you be given certain information in connection with your submission of the attached form related to a patent application or patent. Accordingly, pursuant to the requirements of the Act, please be advised that: (1) the general authority for the collection of this information is 35 U.S.C. 2(b)(2); (2) furnishing of the information solicited is voluntary; and (3) the principal purpose for which the information is used by the U.S. Patent and Trademark Office is to process and/or examine your submission related to a patent application or patent. If you do not furnish the requested information, the U.S. Patent and Trademark Office may not be able to process and/or examine your submission, which may result in termination of proceedings or abandonment of the application or expiration of the patent.

The information provided by you in this form will be subject to the following routine uses:

1. The information on this form will be treated confidentially to the extent allowed under the Freedom of Information Act (5 U.S.C. 552) and the Privacy Act (5 U.S.C. 552a). Records from this system of records may be disclosed to the Department of Justice to determine whether disclosure of these records is required by the Freedom of Information Act.
2. A record from this system of records may be disclosed, as a routine use, in the course of presenting evidence to a court, magistrate, or administrative tribunal, including disclosures to opposing counsel in the course of settlement negotiations.
3. A record in this system of records may be disclosed, as a routine use, to a Member of Congress submitting a request involving an individual, to whom the record pertains, when the individual has requested assistance from the Member with respect to the subject matter of the record.
4. A record in this system of records may be disclosed, as a routine use, to a contractor of the Agency having need for the information in order to perform a contract. Recipients of information shall be required to comply with the requirements of the Privacy Act of 1974, as amended, pursuant to 5 U.S.C. 552a(m).
5. A record related to an International Application filed under the Patent Cooperation Treaty in this system of records may be disclosed, as a routine use, to the International Bureau of the World Intellectual Property Organization, pursuant to the Patent Cooperation Treaty.
6. A record in this system of records may be disclosed, as a routine use, to another federal agency for purposes of National Security review (35 U.S.C. 181) and for review pursuant to the Atomic Energy Act (42 U.S.C. 218(c)).
7. A record from this system of records may be disclosed, as a routine use, to the Administrator, General Services, or his/her designee, during an inspection of records conducted by GSA as part of that agency's responsibility to recommend improvements in records management practices and programs, under authority of 44 U.S.C. 2904 and 2906. Such disclosure shall be made in accordance with the GSA regulations governing inspection of records for this purpose, and any other relevant (i.e., GSA or Commerce) directive. Such disclosure shall not be used to make determinations about individuals.
8. A record from this system of records may be disclosed, as a routine use, to the public after either publication of the application pursuant to 35 U.S.C. 122(b) or issuance of a patent pursuant to 35 U.S.C. 151. Further, a record may be disclosed, subject to the limitations of 37 CFR 1.14, as a routine use, to the public if the record was filed in an application which became abandoned or in which the proceedings were terminated and which application is referenced by either a published application, an application open to public inspection or an issued patent.
9. A record from this system of records may be disclosed, as a routine use, to a Federal, State, or local law enforcement agency, if the USPTO becomes aware of a violation or potential violation of law or regulation.

Notice of Allowability	Application No. 12/513,147	Applicant(s) PERREAULT ET AL.	
	Examiner SIMON SING	Art Unit 2653	AIA (First Inventor to File) Status No

-- The MAILING DATE of this communication appears on the cover sheet with the correspondence address--

All claims being allowable, PROSECUTION ON THE MERITS IS (OR REMAINS) CLOSED in this application. If not included herewith (or previously mailed), a Notice of Allowance (PTOL-85) or other appropriate communication will be mailed in due course. **THIS NOTICE OF ALLOWABILITY IS NOT A GRANT OF PATENT RIGHTS.** This application is subject to withdrawal from issue at the initiative of the Office or upon petition by the applicant. See 37 CFR 1.313 and MPEP 1308.

1. This communication is responsive to amendment filed on 04/29/2013.
 A declaration(s)/affidavit(s) under 37 CFR 1.130(b) was/were filed on _____.
2. An election was made by the applicant in response to a restriction requirement set forth during the interview on _____; the restriction requirement and election have been incorporated into this action.
3. The allowed claim(s) is/are 1,2,6-32 and 36-117. As a result of the allowed claim(s), you may be eligible to benefit from the **Patent Prosecution Highway** program at a participating intellectual property office for the corresponding application. For more information, please see http://www.uspto.gov/patents/init_events/oph/index.jsp or send an inquiry to PPHfeedback@uspto.gov.
4. Acknowledgment is made of a claim for foreign priority under 35 U.S.C. § 119(a)-(d) or (f).

Certified copies:

- a) All b) Some *c) None of the:
1. Certified copies of the priority documents have been received.
 2. Certified copies of the priority documents have been received in Application No. _____.
 3. Copies of the certified copies of the priority documents have been received in this national stage application from the International Bureau (PCT Rule 17.2(a)).

* Certified copies not received: _____.

Applicant has THREE MONTHS FROM THE "MAILING DATE" of this communication to file a reply complying with the requirements noted below. Failure to timely comply will result in ABANDONMENT of this application.

THIS THREE-MONTH PERIOD IS NOT EXTENDABLE.

5. CORRECTED DRAWINGS (as "replacement sheets") must be submitted.
 including changes required by the attached Examiner's Amendment / Comment or in the Office action of Paper No./Mail Date _____.
Identifying indicia such as the application number (see 37 CFR 1.84(c)) should be written on the drawings in the front (not the back) of each sheet. Replacement sheet(s) should be labeled as such in the header according to 37 CFR 1.121(d).
6. DEPOSIT OF and/or INFORMATION about the deposit of BIOLOGICAL MATERIAL must be submitted. Note the attached Examiner's comment regarding REQUIREMENT FOR THE DEPOSIT OF BIOLOGICAL MATERIAL.

Attachment(s)

- | | |
|--|--|
| 1. <input checked="" type="checkbox"/> Notice of References Cited (PTO-892) | 5. <input checked="" type="checkbox"/> Examiner's Amendment/Comment |
| 2. <input checked="" type="checkbox"/> Information Disclosure Statements (PTO/SB/08),
Paper No./Mail Date <u>05/10/2013</u> | 6. <input checked="" type="checkbox"/> Examiner's Statement of Reasons for Allowance |
| 3. <input type="checkbox"/> Examiner's Comment Regarding Requirement for Deposit
of Biological Material | 7. <input type="checkbox"/> Other _____. |
| 4. <input type="checkbox"/> Interview Summary (PTO-413),
Paper No./Mail Date _____. | |

/Simon Sing/
Primary Examiner, Art Unit 2653

DETAILED ACTION

EXAMINER'S AMENDMENT

An examiner's amendment to the record appears below. Should the changes and/or additions be unacceptable to applicant, an amendment may be filed as provided by 37 CFR 1.312. To ensure consideration of such an amendment, it MUST be submitted no later than the payment of the issue fee.

Authorization for this examiner's amendment was given in a telephone interview with Mr. Raimond Salenieks on 07/09/2013.

The application has been amended as follows:

Replacing claims 1-117 with:

1. (Currently amended) A process for operating a call routing controller to facilitate communication between callers and callees in a system comprising a plurality of nodes with which callers and callees are associated, the process comprising:

in response to initiation of a call by a calling subscriber, receiving a caller identifier and a callee identifier;

locating a caller dialing profile comprising a username associated with the caller and a plurality of calling attributes associated with the caller;

performing a comparison of said determining a match when at least one of said calling attributes matches at least a portion of said callee identifier;

Art Unit: 2653

classifying the call as a public network call when said match meets public network classification criteria and classifying the call as a private network call when said match meets private network classification criteria;

when the call is classified as a private network call, producing a private network routing message for receipt by a call controller, said private network routing message identifying an address, on the private network, associated with the callee;

when the call is classified as a public network call, producing a public network routing message for receipt by the call controller, said public network routing message identifying a gateway to the public network.

2. (Original) The process of claim 1 further comprising receiving a request to establish a call, from a call controller in communication with a caller identified by said callee identifier.

3. (Cancelled)

4. (Cancelled)

5. (Cancelled)

6. (**Currently amended**) The process of claim 1 wherein determining said match comprises determining said match when said callee identifier includes a portion that matches an International Dialing Digit (IDD) associated with said caller dialing profile.

7. (**Currently amended**) The process of claim 1 wherein determining said match comprises determining said match when said callee identifier includes a portion that matches a National Dialing Digit (NDD) associated with said caller dialing profile.

8. (**Currently amended**) The process of claim 1 wherein determining said match comprises

Art Unit: 2653

determining said match when said callee identifier includes a portion that matches an area code associated with said caller dialing profile.

9. (Currently amended) The process of claim **1** wherein determining said match comprises determining said match when said callee identifier has a length within a range specified in said caller dialing profile.

10. (Previously presented) The process of claim **1** further comprising formatting said callee identifier into a pre-defined digit format to produce a re-formatted callee identifier.

11. (Original) The process of claim **10** wherein formatting comprises removing an international dialing digit from said callee identifier, when said callee identifier begins with a digit matching an international dialing digit specified by said caller dialing profile associated with said caller.

12. (Original) The process of claim **10** wherein formatting comprises removing a national dialing digit from said callee identifier and prepending a caller country code to said callee identifier when said callee identifier begins with a national dialing digit.

13. (Original) The process of claim **10** wherein formatting comprises prepending a caller country code to said callee identifier when said callee identifier begins with digits identifying an area code specified by said caller dialing profile.

14. (Original) The process of claim **10** wherein formatting comprises prepending a caller country code and area code to said callee identifier when said callee identifier has a length that matches a caller dialing number format specified by said caller dialing profile and only one area code is specified as being associated with said caller in said caller dialing profile.

15. (Previously presented) The process of claim **10** wherein classifying comprises classifying said call as a private network call when said re-formatted callee identifier identifies a subscriber to the private network.

Art Unit: 2653

16. (Previously presented) The process of claim **10** wherein classifying comprises determining whether said callee identifier complies with a pre-defined username format and if so classifying the call as a private network call.

17. (Previously presented) The process of claim **10** further comprising, causing a database of records to be searched to locate a Direct-Inward-Dial (DID) bank table record associating a public telephone number with said reformatted callee identifier and if said DID bank table record is found classifying the call as a private network call and if a DID bank table record is not found classifying the call as a public network call.

18. (**Currently amended**) The process of claim **17** wherein producing said private network routing message identifying a node on the private network comprises setting a callee identifier in response to a username associated with said DID bank table record.

19. (**Currently amended**) The process of claim **18** wherein producing said private network routing message comprises determining whether a node associated with the reformatted callee identifier is the same as a node associated the caller identifier.

20. (Previously presented) The process of claim **19** wherein determining whether a node associated with the reformatted callee identifier is the same as a node associated with the caller identifier comprises determining whether a prefix of said re-formatted callee identifier matches a corresponding prefix of a username associated with said caller dialing profile.

21. (Original) The process of claim **20** wherein when said node associated with said caller is not the same as the node associated with the callee, producing a routing message including said caller identifier, said reformatted callee identifier and an identification of a private network node associated with said callee and communicating said routing message to a call controller.

22. (Previously presented) The process of claim **19** wherein when said node associated with said

Art Unit: 2653

caller identifier is the same as the node associated with said callee identifier, determining whether to perform at least one of the following: forward said call to another party, block the call and direct the caller to a voicemail server associated with the callee.

23. (Currently amended) The process of claim **22** wherein producing said private network routing message comprises producing a routing message having an identification of at least one of the callee identifier, an identification of a party to whom the call should be forwarded and an identification of a voicemail server associated with the callee.

24. (Original) The process of claim **23** further comprising communicating said routing message to a call controller.

25. (Currently amended) The process of claim **10** wherein producing said public network routing message identifying a gateway to the public network comprises searching a database of route records associating route identifiers with dialing codes to find a route record having a dialing code having a number pattern matching at least a portion of said reformatted callee identifier.

26. (Original) The process of claim **25** further comprising searching a database of supplier records associating supplier identifiers with said route identifiers to locate at least one supplier record associated with said route identifier associated with said route record having a dialing code having a number pattern matching at least a portion of said reformatted callee identifier.

27. (Original) The process of claim **26** further comprising loading a routing message buffer with the reformatted callee identifier and an identification of specific routes associated respective ones of the supplier records associated with said route record and loading said routing message buffer with a time value and a timeout value.

28. (Currently amended) The process of claim **27** wherein said public network routing message

Art Unit: 2653

comprises the contents of said routing message buffer and wherein said process comprises communicating said public network routing message to a call controller.

29. (Previously presented) The process of claim **1** further comprising causing said dialing profile to include a maximum concurrent call value and a concurrent call count value and causing said concurrent call count value to be incremented when the user associated with said dialing profile initiates a call and causing said concurrent call count value to be decremented when a call with said user associated with said dialing profile is ended.

30. (Currently amended) A non-transitory computer readable medium encoded with codes for directing a processor to execute a method of operating a call routing controller to facilitate communication between callers and callees in a system comprising a plurality of nodes with which callers and callees are associated, the method comprising:

in response to initiation of a call by a calling subscriber, receiving a caller identifier and a callee identifier;

locating a caller dialing profile comprising a username associated with the caller and a plurality of calling attributes associated with the caller;

performing a comparison of said determining a match when at least one of said calling attributes matches at least a portion of said callee identifier;

classifying the call as a public network call when said match meets public network classification criteria and classifying the call as a private network call when said match meets private network classification criteria;

when the call is classified as a private network call, producing a private network routing message for receipt by a call controller, said private network routing message identifying an address, on the private network, associated with the callee; and

Art Unit: 2653

when the call is classified as a public network call, producing a public network routing message for receipt by a call controller, said public network routing message identifying a gateway to the public network.

31. (Currently amended) A call routing apparatus for facilitating communications between callers and callees in a system comprising a plurality of nodes with which callers and callees are associated, the apparatus comprising:

receiving means for receiving a caller identifier and a callee identifier, in response to initiation of a call by a calling subscriber;

means for locating a caller dialing profile comprising a username associated with the caller and a plurality of calling attributes associated with the caller;

means for determining a match when at least one of said calling attributes matches at least a portion of said callee identifier;

means for classifying the call as a public network call when said match meets public network classification criteria;

means for classifying the call as a private network call when said match meets private network classification criteria;

means for producing a private network routing message for receipt by a call controller, when the call is classified as a private network call, said private network routing message identifying an address, on the private network, associated with the callee; and

Art Unit: 2653

means for producing a public network routing message for receipt by a call controller, when the call is classified as a public network call, said public network routing message identifying a gateway to the public network.

32. (Original) The apparatus of claim **31** wherein said receiving means is operably configured to receive a request to establish a call, from a call controller in communication with a caller identified by said callee identifier.

33. (Cancelled)

34. (Cancelled)

35. (Cancelled)

36. (Currently amended) The apparatus of claim **31** wherein said calling attributes include an international dialing digit and wherein said means for determining is operably configured to determine whether said callee identifier includes a portion that matches an International Dialing Digit (IDD) associated with said caller dialing profile.

37. (Currently amended) The apparatus of claim **31** wherein said calling attributes include a national dialing digit and wherein said means for determining is operably configured to determine whether said callee identifier includes a portion that matches a National Dialing Digit (NDD) associated with said caller dialing profile.

38. (Currently amended) The apparatus of claim **31** wherein said calling attributes include an area code and wherein said means for determining is operably configured to determine whether said callee identifier includes a portion that matches an area code associated with said caller dialing profile.

39. (Currently amended) The apparatus of claim **31** wherein said calling attribute include a

Art Unit: 2653

number length range and wherein said means for determining is operably configured to determine whether said callee identifier has a length within a range specified in said caller dialing profile.

40. (Previously presented) The apparatus of claim **31** further comprising formatting means for formatting said callee identifier into a pre-defined digit format to produce a re-formatted callee identifier.

41. (Original) The apparatus of claim **40** wherein said formatting means is operably configured to remove an international dialing digit from said callee identifier, when said callee identifier begins with a digit matching an international dialing digit specified by said caller dialing profile associated with said caller.

42. (Original) The apparatus of claim **40** wherein said formatting means is operably configured to remove a national dialing digit from said callee identifier and prepend a caller country code to said callee identifier when said callee identifier begins with a national dialing digit.

43. (Original) The apparatus of claim **40** wherein said formatting means is operably configured to prepend a caller country code to said callee identifier when said callee identifier begins with digits identifying an area code specified by said caller dialing profile.

44. (Original) The apparatus of claim **40** wherein said formatting means is operably configured to prepend a caller country code and area code to said callee identifier when said callee identifier has a length that matches a caller dialing number format specified by said caller dialing profile and only one area code is specified as being associated with said caller in said caller dialing profile.

45. (**Currently amended**) The apparatus of claim **40** wherein said means for classifying the call as a private network call is operably configured to classify said call as a private network call when said re-formatted callee identifier identifies a subscriber to the private network.

Art Unit: 2653

46. (Currently amended) The apparatus of claim **40** wherein said means for classifying the call as a private network call is operably configured to classify the call as a private network call when said callee identifier complies with a pre-defined username format.

47. (Currently amended) The apparatus of claim **40** further comprising searching means for searching a database of records to locate a Direct-Inward-Dial (DID) bank table record associating a public telephone number with said reformatted callee identifier and wherein said means for classifying the call as a private network call is operably configured to classify the call as a private network call when said DID bank table record is found and said means for classifying the call as a public network call is operably configured to classify the call as a public network call when a DID bank table record is not found.

48. (Original) The apparatus of claim **47** wherein said private network routing message producing means is operably configured to produce a routing message having a callee identifier set according to a username associated with said DID bank table record.

49. (Original) The apparatus of claim **48** wherein said private network routing message producing means is operably configured to determine whether a node associated with the reformatted callee identifier is the same as a node associated the caller identifier.

50. (Original) The apparatus of claim **49** wherein said private network routing means includes means for determining whether a prefix of said re-formatted callee identifier matches a corresponding prefix of a username associated with said caller dialing profile.

51. (Original) The apparatus of claim **50** wherein said private network routing message producing means is operably configured to produce a routing message including said caller identifier, said reformatted callee identifier and an identification of a private network node associated with said callee and communicating said routing message to a call controller.

Art Unit: 2653

52. (Previously presented) The apparatus of claim **49** wherein said private network routing message producing means is operably configured to perform at least one of the following: forward said call to another party, block the call and direct the caller to a voicemail server associated with the callee identifier, when said node associated with said caller identifier is the same as the node associated with said callee identifier.

53. (Original) The apparatus of claim **52** wherein said means for producing said private network routing message is operably configured to produce a routing message having an identification of at least one of the callee identifier, an identification of a party to whom the call should be forwarded and an identification of a voicemail server associated with the callee.

54. (Original) The apparatus of claim **53** further comprising means for communicating said routing message to a call controller.

55. (Currently amended) The apparatus of claim **40** wherein said means for producing said public network routing message identifying a gateway to the public network comprises means for searching a database of route records associating route identifiers with dialing codes to find a route record having a dialing code having a number pattern matching at least a portion of said reformatted callee identifier.

56. (Original) The apparatus of claim **55** further comprising means for searching a database of supplier records associating supplier identifiers with said route identifiers to locate at least one supplier record associated with said route identifier associated with said route record having a dialing code having a number pattern matching at least a portion of said reformatted callee identifier.

57. (Original) The apparatus of claim **56** further comprising a routing message buffer and means for loading said routing message buffer with the reformatted callee identifier and an

Art Unit: 2653

identification of specific routes associated respective ones of the supplier records associated with said route record and loading said routing message buffer with a time value and a timeout value.

58. (Currently amended) The apparatus of claim **57** further comprising means for causing said public network routing message to include the contents of said routing message buffer and means for communicating the public network routing message to a call controller.

59. (Previously presented) The apparatus of claim **31** further comprising means for causing said dialing profile to include a maximum concurrent call value and a concurrent call count value and for causing said concurrent call count value to be incremented when the user associated with said dialing profile initiates a call and for causing said concurrent call count value to be decremented when a call with said user associated with said dialing profile is ended.

60. (Currently amended) A process for operating a call routing controller to establish a call between a caller and a callee in a communication system, the process comprising:

in response to initiation of a call by a calling subscriber, locating a caller dialing profile comprising a plurality of calling attributes associated with the caller; and

when at least one of said calling attributes and at least a portion of a callee identifier associated with the callee match and when the match meets a private network classification criterion, producing a private network routing message for receipt by a call controller, said private network routing message identifying an address, on a private network, the address being associated with the callee; and

when at least one of said calling attributes and said at least said portion of said callee identifier associated with the callee match and when the match meets a public network classification criterion, producing a public network routing message for receipt by a call controller, said public network routing message identifying a gateway to a public network.

61. (Previously presented) The process of claim **60** wherein said private network classification criteria include:

- a) said callee identifier does not begin with the same digit pattern as an international dialing digit (IDD) attribute of said callee identifier; and
- b) said callee identifier does not begin with the same digit pattern as a national dialing digit (NDD) attribute of said callee identifier; and
- c) said callee identifier does not begin with the same area code as an area code of said caller; and
- d) said callee identifier does not have a length that is within a range of caller local number lengths; and
- e) said callee identifier is a valid username.

62. (Previously presented) The process of claim **61** further comprising identifying the call as a cross-domain call on the private network when said callee identifier identifies a callee that is not associated with the same network node as said caller.

63. (Previously presented) The process of claim **61** further comprising:

locating a callee dialing profile for the callee when said callee identifier identifies a callee that is associated with the same network node as said caller; and

retrieving call handling information associated with the callee, where said call handling information is available, said call handling information including at least one of call blocking information, call forwarding information, and voicemail information.

Art Unit: 2653

64. (Previously presented) The process of claim **63** further comprising, where said call handling information including said call blocking information is available, blocking the call when said call blocking information identifies the caller as a caller from whom calls are to be blocked from being established with the callee.

65. (Previously presented) The process of claim **63** further comprising, where said call handling information including said call forwarding information is available, causing said call forwarding information to be included in said private network routing message.

66. (Previously presented) The process of claim **63** further comprising, where said call handling information including said voicemail information is available, causing said voicemail information to be included in said private network routing message.

67. (Previously presented) The process of claim **60** further comprising associating at least one direct inward dial record with at least one subscriber to said communication system, each of said at least one direct inward dial records comprising a field storing a direct inward dial number associated with said at least one subscriber.

68. (Previously presented) The process of claim **67** wherein said public network classification criteria include:

- a) said callee identifier begins with the same digit pattern as an international dialing digit (IDD) attribute of said callee identifier; and
- b) a reformatted callee identifier produced by removing the IDD attribute from said callee identifier has no DID bank table record.

69. (Previously presented) The process of claim **67** wherein said public network classification criteria include:

- a) said callee identifier begins with the same digit pattern as a national dialing digit (NDD) attribute of said callee identifier; and
- b) a reformatted callee identifier produced by removing the NDD attribute from said callee identifier and including a caller country code has no DID bank table record.

70. (Previously presented) The process of claim **67** wherein said public network classification criteria include:

- a) said callee identifier begins with the same area code as an area code of said caller; and
- b) a reformatted callee identifier produced by reformatting the callee identifier to include a caller country code has no DID bank table record.

71. (Previously presented) The process of claim **67** wherein said public network classification criteria include:

- a) said callee identifier has a length that is within a range of caller local number lengths; and
- b) a reformatted callee identifier produced by reformatting the callee identifier to include a caller country code and area code has no DID bank table record.

72. (**Currently amended**) The process of claim **60** wherein said plurality of calling attributes includes at least one of an international dialing digits field, a national dialing digits field, a country code field, a local area codes field, a caller minimum local length field, a caller maximum local length field, a reseller field, a maximum number of concurrent calls field and a current number of concurrent calls field.

Art Unit: 2653

73. (Previously presented) The process of claim **67** wherein said DID record comprises a user name field, a user domain field and a DID number field.

74. (Previously presented) The process of claim **60** further comprising maintaining a list of public network route suppliers and when said public network classification criterion is met identifying at least one of said public network route suppliers that satisfies public network routing selection criteria.

75. (Previously presented) The process of claim **74** wherein said producing said public network routing message comprises producing a public network routing message identifying said at least one public network route supplier that satisfies said public network routing selection criteria.

76. (Previously presented) The process of claim **75** wherein producing said public network routing message comprises causing said at least one public network route supplier that satisfies said public network routing selection criteria to be placed in a preferred order.

77. (Previously presented) The process of claim **76** wherein said preferred order is by at least one of rate and preferred service agreements with said at least one public network route supplier.

78. (Previously presented) The process of claim **60** further comprising causing the private network routing message or the public network routing message to be communicated to a call controller to effect routing of the call.

79. (Previously presented) A non-transitory computer readable medium encoded with codes for directing a processor to execute the method of claim **60**.

80. (**Currently amended**) A call routing controller apparatus for establishing a call between a caller and a callee in a communication system, the apparatus comprising:

a processor operably configured to:

access a database of caller dialing profiles wherein each dialing profile associates a plurality of calling attributes with a respective subscriber, to locate a dialing profile associated with the caller, in response to initiation of a call by a calling subscriber; and

produce a private network routing message for receipt by a call controller, said private network routing message identifying an address, on a private network, through which the call is to be routed, when at least one of said calling attributes and at least a portion of a callee identifier associated with the callee match and when the match meets a private network classification criterion, the address being associated with the callee; and

produce a public network routing message for receipt by a call controller, said public network routing message identifying a gateway to a public network, when at least one of said calling attributes and said at least said portion of said callee identifier associated with the callee match and when the match meets a public network classification criterion.

81. (Previously presented) The apparatus of claim **80** wherein said private network classification criteria include:

- a) said callee identifier does not begin with the same digit pattern as an international dialing digit (IDD) attribute of said callee identifier; and
- b) said callee identifier does not begin with the same digit pattern as a national dialing digit (NDD) attribute of said callee identifier; and

Art Unit: 2653

- c) said callee identifier does not begin with the same area code as an area code of said caller; and
- d) said callee identifier does not have a length that is within a range of caller local number lengths; and
- e) said callee identifier is a valid username.

82. (Previously presented) The apparatus of claim **81** wherein said processor is further operably configured to identify the call as a cross-domain call on the private network when said callee identifier identifies a callee that is not associated with the same network node as said caller.

83. (Previously presented) The apparatus of claim **81** wherein said processor is further configured to:

access the database of caller dialing profiles to locate a callee dialing profile for the callee when said callee identifier identifies a callee that is associated with the same network node as said caller; and

retrieve call handling information associated with the callee, where said call handling information is available, said call handling information including at least one of call blocking information, call forwarding information, and voicemail information.

84. (Previously presented) The apparatus of claim **83** wherein said processor is further operably configured to determine whether said call handling information including said call blocking information is available and to block the call when said call blocking information identifies the caller as a caller from whom calls are to be blocked,

Art Unit: 2653

85. (Previously presented) The apparatus of claim **83** wherein said processor is further operably configured to determine whether said call handling information including said call forwarding information is available and to cause said call forwarding information to be included in said private network routing message.

86. (Previously presented) The apparatus of claim **83** wherein said processor is further operably configured to determine whether said call handling information including said voicemail information is available and to cause said voicemail information to be included in said private network routing message.

87. (Previously presented) The apparatus of claim **80** wherein said processor is further operably configured to access a database of direct inward dial records each associating at least one direct inward dial number with at least one subscriber to said communication system.

88. (Previously presented) The apparatus of claim **87** wherein said public network classification criteria include:

- a) said callee identifier begins with the same digit pattern as an international dialing digit (IDD) attribute of said callee identifier; and
- b) a reformatted callee identifier produced by removing the IDD attribute from said callee identifier has no DID record.

89. (Previously presented) The apparatus of claim **87** wherein said public network classification criteria include:

- a) said callee identifier begins with the same digit pattern as a national dialing digit (NDD) attribute of said callee identifier; and

Art Unit: 2653

- b) a reformatted callee identifier produced by removing the NDD attribute from said callee identifier and including a caller country code has no DID record.

90. (Previously presented) The apparatus of claim **87** wherein said public network classification criteria include:

- a) said callee identifier begins with the same area code as an area code of said caller; and
- b) a reformatted callee identifier produced by reformatting the callee identifier to include a caller country code has no DID record.

91. (Previously presented) The apparatus of claim **87** wherein said public network classification criteria include:

- a) said callee identifier has a length that is within a range of caller local number lengths; and
- b) a reformatted callee identifier produced by reformatting the callee identifier to include a caller country code and area code has no DID record.

92. (**Currently amended**) The apparatus of claim **80** wherein said plurality of calling attributes includes at least one of an international dialing digits field, a national dialing digits field, a country code field, a local area codes field, a caller minimum local length field, a caller maximum local length field, a reseller field, a maximum number of concurrent calls field and a current number of concurrent calls field.

93. (Previously presented) The apparatus of claim **87** wherein said DID record comprises a user name field, a user domain field and a DID number field.

94. (Previously presented) The apparatus of claim **80** wherein said processor is further operably configured to access a list of public network route suppliers when said public network classification criterion is met and to identify at least one of said public network route suppliers that satisfies public network routing selection criteria.

95. (Previously presented) The apparatus of claim **94** wherein said processor is further operably configured to produce a public network routing message identifying said at least one public network route supplier that satisfies said public network routing selection criteria.

96. (Previously presented) The apparatus of claim **95** wherein said processor is further operably configured to cause said at least one public network route supplier that satisfies said public network routing selection criteria to be placed in a preferred order.

97. (Previously presented) The apparatus of claim **96** wherein said preferred order is by at least one of rate and preferred service agreements with said at least one public network route supplier.

98. (Previously presented) The apparatus of claim **80** wherein said processor is further operably configured to cause the private network routing message or the public network routing message to be communicated to a call controller to effect routing of the call.

99. (**Currently amended**) A call routing controller apparatus for establishing a call between a caller and a callee in a communication system, the apparatus comprising:

means for accessing a database of caller dialing profiles wherein each dialing profile associates a plurality of calling attributes with a respective subscriber, to locate a dialing profile associated with the caller, in response to initiation of a call by a calling subscriber; and

Art Unit: 2653

means for producing a private network routing message for receipt by a call controller, said private network routing message identifying an address, on a private network, through which the call is to be routed, when at least one of said calling attributes and at least a portion of a callee identifier associated with the callee match and when the match meets a private network classification criterion, the address being associated with the callee; and

means for producing a public network routing message for receipt by a call controller, said public network routing message identifying a gateway to a public network when at least one of said calling attributes and said at least said portion of said callee identifier associated with the callee match and when the match meets a public network classification criterion.

100. (Previously presented) The apparatus of claim **99** wherein said private network classification criteria include:

- a) said callee identifier does not begin with the same digit pattern as an international dialing digit (IDD) attribute of said callee identifier; and
- b) said callee identifier does not begin with the same digit pattern as a national dialing digit (NDD) attribute of said callee identifier; and
- c) said callee identifier does not begin with the same area code as an area code of said caller; and
- d) said callee identifier does not have a length that is within a range of caller local number lengths; and
- e) said callee identifier is a valid username.

Art Unit: 2653

101. (Previously presented) The apparatus of claim **100** further comprising means for identifying the call as a cross-domain call on the private network when said callee identifier identifies a callee that is not associated with the same network node as said caller.

102. (Previously presented) The apparatus of claim **100** further comprising:

means for accessing the database of caller dialing profiles to locate a callee dialing profile for the callee when said callee identifier identifies a callee that is associated with the same network node as said caller; and

means for retrieving call handling information associated with the callee, where said call handling information is available, said call handling information including at least one of call blocking information, call forwarding information, and voicemail information.

103. (Previously presented) The apparatus of claim **102** further comprising, where said call handling information including said call blocking information is available, means for blocking the call when said call blocking information identifies the caller as a caller from whom calls are to be blocked from being established with the callee.

104. (Previously presented) The apparatus of claim **102** further comprising, means for causing said call forwarding information to be included in said private network routing message, where said call handling information including said call forwarding information is available.

105. (Previously presented) The apparatus of claim **102** further comprising, where said call handling information including said voicemail information is available, means for causing said voicemail information to be included in said private network routing message.

106. (Previously presented) The apparatus of claim **99** further comprising means for accessing a database of direct inward dial records each associating at least one direct inward dial number with at least one subscriber to said communication system.

107. (Previously presented) The apparatus of claim **106** wherein said public network classification criteria include:

- a) said callee identifier begins with the same digit pattern as an international dialing digit (IDD) attribute of said callee identifier; and
- b) a reformatted callee identifier produced by removing the IDD attribute from said callee identifier has no DID record.

108. (Previously presented) The apparatus of claim **106** wherein said public network classification criteria include:

- a) said callee identifier begins with the same digit pattern as a national dialing digit (NDD) attribute of said callee identifier; and
- b) a reformatted callee identifier produced by removing the NDD attribute from said callee identifier and including a caller country code has no DID record.

109. (Previously presented) The apparatus of claim **106** wherein said public network classification criteria include:

- a) said callee identifier begins with the same area code as an area code of said caller; and
- b) a reformatted callee identifier produced by reformatting the callee identifier to include a caller country code has no DID record.

110. (Previously presented) The apparatus of claim **106** wherein said public network classification criteria include:

Art Unit: 2653

- a) said callee identifier has a length that is within a range of caller local number lengths; and
- b) a reformatted callee identifier produced by reformatting the callee identifier to include a caller country code and area code has no DID record.

111. (Currently amended) The apparatus of claim **99** wherein said plurality of calling attributes includes at least one of an international dialing digits field, a national dialing digits field, a country code field, a local area codes field, a caller minimum local length field, a caller maximum local length field, a reseller field, a maximum number of concurrent calls field and a current number of concurrent calls field.

112. (Previously presented) The apparatus of claim **106** wherein said DID record comprises a user name field, a user domain field and a DID number field.

113. (Previously presented) The apparatus of claim **99** further comprising means for accessing a list of public network route suppliers when said public network classification criterion is met and means for identifying at least one of said public network route suppliers that satisfies public network routing selection criteria.

114. (Previously presented) The apparatus of claim **113** wherein said means for producing said public network routing message comprises means for producing a public network routing message identifying said at least one public network route supplier that satisfies said public network routing selection criteria.

115. (Previously presented) The apparatus of claim **114** wherein said means for producing said public network routing message comprises means for causing said at least one public network route supplier that satisfies said public network routing selection criteria to be placed in a preferred order.

116. (Previously presented) The apparatus of claim **115** wherein said preferred order is by at least one of rate and preferred service agreements with said at least one public network route supplier.

117. (Previously presented) The apparatus of claim **99** further comprising means for causing the private network routing message or the public network routing message to be communicated to a call controller to effect routing of the call.

Allowable Subject Matter

Claims 1, 2, 6-32, and 36-117 allowed.

The following is an examiner's statement of reasons for allowance:

Prior art on record does not teach matching one of calling attributes, retrieved from a calling party's profile, with at least a portion of a callee identifier, and based on the match to identify a public or private network for call routing.

Any comments considered necessary by applicant must be submitted no later than the payment of the issue fee and, to avoid processing delays, should preferably accompany the issue fee. Such submissions should be clearly labeled "Comments on Statement of Reasons for Allowance."

Conclusion

The prior art made of record and not relied upon is considered pertinent to applicant's disclosure.

Art Unit: 2653

- a) US 4,992,971 (Hayashi).
- b) US 5,633,913 (Talarmo).
- c) US 6,078,647 (D'Eletto).
- d) US 2007/0127676 (Khadri).

Any inquiry concerning this communication or earlier communication from the examiner should be directed to Simon Sing whose telephone number is 571-272-7545. The examiner can normally be reached on Monday - Thursday from 9:00 AM to 5:30 PM. If attempts to reach the examiner by telephone are unsuccessful, the examiner's supervisor, Fan Tsang, can be reached at 571-272-7547. The fax phone number for the organization where this application or proceeding is assigned is 571-273-8300. Any inquiry of a general nature or relating to the status of this application or proceeding should be directed to the receptionist whose telephone number is 571-272-2600.

/Simon Sing/

Primary Examiner, Art Unit 2653

Notice of References Cited	Application/Control No. 12/513,147	Applicant(s)/Patent Under Reexamination PERREAU ET AL.	
	Examiner SIMON SING	Art Unit 2653	Page 1 of 1

U.S. PATENT DOCUMENTS

*	Document Number Country Code-Number-Kind Code	Date MM-YYYY	Name	Classification
*	A US-4,992,971	02-1991	Hayashi, Kazuhisa	717/140
*	B US-5,633,913	05-1997	Talarmo, Reino	455/446
*	C US-6,078,647	06-2000	D'Eletto, Robert A.	379/32.01
*	D US-2007/0127676	06-2007	Khadri, Seetharaman	379/211.02
	E US-			
	F US-			
	G US-			
	H US-			
	I US-			
	J US-			
	K US-			
	L US-			
	M US-			

FOREIGN PATENT DOCUMENTS

*	Document Number Country Code-Number-Kind Code	Date MM-YYYY	Country	Name	Classification
	N				
	O				
	P				
	Q				
	R				
	S				
	T				

NON-PATENT DOCUMENTS

*	Document Number Country Code-Number-Kind Code	Date MM-YYYY	Country	Name	Classification
	Include as applicable: Author, Title Date, Publisher, Edition or Volume, Pertinent Pages)				
	U				
	V				
	W				
	X				

*A copy of this reference is not being furnished with this Office action. (See MPEP § 707.05(a).)
Dates in MM-YYYY format are publication dates. Classifications may be US or foreign.

INFORMATION DISCLOSURE STATEMENT BY APPLICANT	Application No.	12/513,147
	Filing Date	March 1, 2010
	First Named Inventor	Perreault, Clay
	Art Unit	2653
<i>(Multiple sheets used when necessary)</i>	Examiner	Sing, Simon P.
SHEET 1 OF 1	Attorney Docket No.	SMARB19.001APC

U.S. PATENT DOCUMENTS					
Examiner Initials	Cite No.	Document Number <i>Number - Kind Code (if known)</i> Example: 1,234,567 B1	Publication Date MM-DD-YYYY	Name of Patentee or Applicant	Pages, Columns, Lines Where Relevant Passages or Relevant Figures Appear
	1	5,454,030	09-26-1995	de Oliveira et al.	
	2	6,674,745	01-06-2004	Schuster et al.	
	3	7,079,526	07-18-2006	Wipliez et al.	
	4	7,950,046	05-24-2011	Kropivny, Alexander	
	5	2002/0122391	09-05-2002	Shalit, Andrew L.	
	6	2006/0264200	11-23-2006	Laiho et al.	
	7	2008/0056235	03-06-2008	Albina et al.	
	8	2009/0292539	11-26-2009	Jaroker, Jon	
	9	2009/0325558	12-31-2009	Pridmore et al.	
	10	2010/0086119	04-08-2010	De Luca et al.	

FOREIGN PATENT DOCUMENTS						
Examiner Initials	Cite No.	Foreign Patent Document <i>Country Code-Number-Kind Code</i> Example: JP 1234567 A1	Publication Date MM-DD-YYYY	Name of Patentee or Applicant	Pages, Columns, Lines Where Relevant Passages or Relevant Figures Appear	T ¹

NON PATENT LITERATURE DOCUMENTS			
Examiner Initials	Cite No.	Include name of the author (in CAPITAL LETTERS), title of the article (when appropriate), title of the item (book, magazine, journal, serial, symposium, catalog, etc.), date, page(s), volume-issue number(s), publisher, city and/or country where published.	T ¹

15313909
042913

Examiner Signature	/Simon Sing/	Date Considered	07/10/2013
--------------------	--------------	-----------------	------------

***Examiner:** Initial if reference considered, whether or not citation is in conformance with MPEP 609. Draw line through citation if not in conformance and not considered. Include copy of this form with next communication to applicant.

T¹ - Place a check mark in this area when an English language translation is attached. PETITIONER: APPLE INC. EX. 1002-83

ALL REFERENCES CONSIDERED EXCEPT WHERE LINED THROUGH. /SS/

Issue Classification 	Application/Control No. 12513147	Applicant(s)/Patent Under Reexamination PERREAU ET AL.	
	Examiner SIMON SING	Art Unit 2653	

CPC			
Symbol		Type	Version

CPC Combination Sets				
Symbol	Type	Set	Ranking	Version

NONE		Total Claims Allowed:	
(Assistant Examiner)	(Date)	111	
/SIMON SING/ Primary Examiner. Art Unit 2653	07/10/2013	O.G. Print Claim(s)	O.G. Print Figure
(Primary Examiner)	(Date)	1	1

Issue Classification 	Application/Control No. 12513147	Applicant(s)/Patent Under Reexamination PERREAULT ET AL.
	Examiner SIMON SING	Art Unit 2653

US ORIGINAL CLASSIFICATION					INTERNATIONAL CLASSIFICATION								
CLASS		SUBCLASS			CLAIMED				NON-CLAIMED				
379		221.02			H	0	4	M	7 / 00 (2006.01.01)				
CROSS REFERENCE(S)													
CLASS	SUBCLASS (ONE SUBCLASS PER BLOCK)												
379	142.04												

NONE			Total Claims Allowed:	
(Assistant Examiner)	(Date)	111		
/SIMON SING/ Primary Examiner. Art Unit 2653	07/10/2013	O.G. Print Claim(s)	O.G. Print Figure	
(Primary Examiner)	(Date)	1	1	

Issue Classification 	Application/Control No. 12513147	Applicant(s)/Patent Under Reexamination PERREAULT ET AL.
	Examiner SIMON SING	Art Unit 2653

<input type="checkbox"/> Claims renumbered in the same order as presented by applicant		<input type="checkbox"/> CPA		<input type="checkbox"/> T.D.		<input type="checkbox"/> R.1.47									
Final	Original	Final	Original	Final	Original	Final	Original	Final	Original	Final	Original	Final	Original	Final	Original
1	1	14	17	-	33	43	49	59	65	75	81	91	97	107	113
2	2	15	18	-	34	44	50	60	66	76	82	92	98	108	114
-	3	16	19	-	35	45	51	61	67	77	83	93	99	109	115
-	4	17	20	30	36	46	52	62	68	78	84	94	100	110	116
-	5	18	21	31	37	47	53	63	69	79	85	95	101	111	117
3	6	19	22	32	38	48	54	64	70	80	86	96	102		
4	7	20	23	33	39	49	55	65	71	81	87	97	103		
5	8	21	24	34	40	50	56	66	72	82	88	98	104		
6	9	22	25	35	41	51	57	67	73	83	89	99	105		
7	10	23	26	36	42	52	58	68	74	84	90	100	106		
8	11	24	27	37	43	53	59	69	75	85	91	101	107		
9	12	25	28	38	44	54	60	70	76	86	92	102	108		
10	13	26	29	39	45	55	61	71	77	87	93	103	109		
11	14	27	30	40	46	56	62	72	78	88	94	104	110		
12	15	28	31	41	47	57	63	73	79	89	95	105	111		
13	16	29	32	42	48	58	64	74	80	90	96	106	112		

NONE		Total Claims Allowed:	
(Assistant Examiner)	(Date)	111	
/SIMON SING/ Primary Examiner. Art Unit 2653	07/10/2013	O.G. Print Claim(s)	O.G. Print Figure
(Primary Examiner)	(Date)	1	1

Search Notes 	Application/Control No. 12513147	Applicant(s)/Patent Under Reexamination PERREAULT ET AL.
	Examiner SIMON SING	Art Unit 2653

CPC- SEARCHED		
Symbol	Date	Examiner

CPC COMBINATION SETS - SEARCHED		
Symbol	Date	Examiner

US CLASSIFICATION SEARCHED			
Class	Subclass	Date	Examiner
379	142.04, 220.01-221.06	07/10/2013	SS

SEARCH NOTES		
Search Notes	Date	Examiner
EAST	02/12/2013	SS
EAST	07/10/2013	SS

INTERFERENCE SEARCH			
US Class/ CPC Symbol	US Subclass / CPC Group	Date	Examiner
379	142.04, 220.01-221.06	07/10/2013	SS

--	--

EAST Search History

EAST Search History (Prior Art)

Ref #	Hits	Search Query	DBs	Default Operator	Plurals	Time Stamp
S1	70	calling adj attribute	US-PGPUB; USPAT; USOCR; FPRS; EPO; JPO; DERWENT; IBM_TDB	OR	ON	2013/07/10 09:39
S3	2	S1 and 379/142.04	US-PGPUB; USPAT; USOCR; FPRS; EPO; JPO; DERWENT; IBM_TDB	OR	ON	2013/07/10 09:41
S4	2	S1 same ((public or private) adj3 network)	US-PGPUB; USPAT; USOCR; FPRS; EPO; JPO; DERWENT; IBM_TDB	OR	ON	2013/07/10 09:45
S5	3	S1 and (rout\$3 adj2 message)	US-PGPUB; USPAT; USOCR; FPRS; EPO; JPO; DERWENT; IBM_TDB	OR	ON	2013/07/10 09:49
S6	5	S1 with (profile or database)	US-PGPUB; USPAT; USOCR; FPRS; EPO; JPO; DERWENT; IBM_TDB	OR	ON	2013/07/10 09:50
S7	3	S1 with (compar\$3 or match\$3)	US-PGPUB; USPAT; USOCR; FPRS; EPO; JPO; DERWENT; IBM_TDB	OR	ON	2013/07/10 09:51
S8	1064	((public or private) adj3 network) same (rout\$3 adj2 message)	US-PGPUB; USPAT; USOCR; FPRS; EPO; JPO; DERWENT; IBM_TDB	OR	ON	2013/07/10 09:52
S9	342	((public or private) adj3 network) with (rout\$3 adj2 message)	US-PGPUB; USPAT; USOCR; FPRS; EPO; JPO; DERWENT; IBM_TDB	OR	ON	2013/07/10 09:53
S11	2	S9 same (calling with called)	US-PGPUB; USPAT; USOCR; FPRS; EPO; JPO; DERWENT; IBM_TDB	OR	ON	2013/07/10 09:54
S12	0	S1 and 379/220.01-221.06.ccls.	US-PGPUB; USPAT; USOCR; FPRS; EPO; JPO; DERWENT; IBM_TDB	OR	ON	2013/07/10 10:03
S13	0	S1 and 379/88.17	US-PGPUB; USPAT; USOCR; FPRS; EPO; JPO; DERWENT; IBM_TDB	OR	ON	2013/07/10 10:04

7/ 10/ 2013 11:25:48 AM

C:\Users\ssing\Documents\EAST\Workspaces\default.wsp

INFORMATION DISCLOSURE STATEMENT BY APPLICANT	Application No.	12/513,147
	Filing Date	March 1, 2010
	First Named Inventor	Perreault, Clay
	Art Unit	2653
<i>(Multiple sheets used when necessary)</i>	Examiner	Sing, Simon P.
SHEET 1 OF 1	Attorney Docket No.	SMARB19.001APC

U.S. PATENT DOCUMENTS					
Examiner Initials	Cite No.	Document Number <i>Number - Kind Code (if known)</i> Example: 1,234,567 B1	Publication Date MM-DD-YYYY	Name of Patentee or Applicant	Pages, Columns, Lines Where Relevant Passages or Relevant Figures Appear
	1	5,454,030	09-26-1995	de Oliveira et al.	
	2	6,674,745	01-06-2004	Schuster et al.	
	3	7,079,526	07-18-2006	Wipliez et al.	
	4	7,950,046	05-24-2011	Kropivny, Alexander	
	5	2002/0122391	09-05-2002	Shalit, Andrew L.	
	6	2006/0264200	11-23-2006	Laiho et al.	
	7	2008/0056235	03-06-2008	Albina et al.	
	8	2009/0292539	11-26-2009	Jaroker, Jon	
	9	2009/0325558	12-31-2009	Pridmore et al.	
	10	2010/0086119	04-08-2010	De Luca et al.	

FOREIGN PATENT DOCUMENTS						
Examiner Initials	Cite No.	Foreign Patent Document <i>Country Code-Number-Kind Code</i> Example: JP 1234567 A1	Publication Date MM-DD-YYYY	Name of Patentee or Applicant	Pages, Columns, Lines Where Relevant Passages or Relevant Figures Appear	T ¹

NON PATENT LITERATURE DOCUMENTS			
Examiner Initials	Cite No.	Include name of the author (in CAPITAL LETTERS), title of the article (when appropriate), title of the item (book, magazine, journal, serial, symposium, catalog, etc.), date, page(s), volume-issue number(s), publisher, city and/or country where published.	T ¹

15313909
042913

Examiner Signature	Date Considered
* Examiner: Initial if reference considered, whether or not citation is in conformance with MPEP 609. Draw line through citation if not in conformance and not considered. Include copy of this form with next communication to applicant.	

T¹ - Place a check mark in this area when an English language translation is attached. PETITIONER: APPLE INC. EX. 1002-89

Electronic Patent Application Fee Transmittal

Application Number:	12513147
Filing Date:	01-Mar-2010
Title of Invention:	PRODUCING ROUTING MESSAGES FOR VOICE OVER IP COMMUNICATIONS
First Named Inventor/Applicant Name:	Clay Perreault
Filer:	John M Carson/Aaron Dunn
Attorney Docket Number:	SMARB19.001 APC

Filed as Small Entity

U.S. National Stage under 35 USC 371 Filing Fees

Description	Fee Code	Quantity	Amount	Sub-Total in USD(\$)
Basic Filing:				
Pages:				
Claims:				
Miscellaneous-Filing:				
Petition:				
Patent-Appeals-and-Interference:				
Post-Allowance-and-Post-Issuance:				
Extension-of-Time:				

Description	Fee Code	Quantity	Amount	Sub-Total in USD(\$)
Miscellaneous:				
Submission- Information Disclosure Stmt	2806	1	90	90
Total in USD (\$)				90

Electronic Acknowledgement Receipt

EFS ID:	15743432
Application Number:	12513147
International Application Number:	
Confirmation Number:	9611
Title of Invention:	PRODUCING ROUTING MESSAGES FOR VOICE OVER IP COMMUNICATIONS
First Named Inventor/Applicant Name:	Clay Perreault
Customer Number:	20995
Filer:	John M Carson/Aaron Dunn
Filer Authorized By:	John M Carson
Attorney Docket Number:	SMARB19.001APC
Receipt Date:	10-MAY-2013
Filing Date:	01-MAR-2010
Time Stamp:	13:34:50
Application Type:	U.S. National Stage under 35 USC 371

Payment information:

Submitted with Payment	yes
Payment Type	Credit Card
Payment was successfully received in RAM	\$90
RAM confirmation Number	9966
Deposit Account	111410
Authorized User	KNOBBE MARTENS OLSON AND BEAR

The Director of the USPTO is hereby authorized to charge indicated fees and credit any overpayment as follows:

Charge any Additional Fees required under 37 C.F.R. 1.492 (National application filing, search, and examination fees)

Charge any Additional Fees required under 37 C.F.R. Section 1.17 (Benefit of publication and examination processing fees)

PETITIONER APPLE INC. EX: 1002-92

File Listing:					
Document Number	Document Description	File Name	File Size(Bytes)/ Message Digest	Multi Part /.zip	Pages (if appl.)
1		IDS_SMARB19_001APC_05_10_2013.pdf	86292 7f0102137568e511ef812fbd901360ccb3c3167	yes	2
Multipart Description/PDF files in .zip description					
Document Description			Start	End	
Transmittal Letter			1	1	
Information Disclosure Statement (IDS) Form (SB08)			2	2	
Warnings:					
Information:					
2	Fee Worksheet (SB06)	fee-info.pdf	30371 ddc4daccbd32ced00d6d4d5a114dfca3b8ad571a	no	2
Warnings:					
Information:					
Total Files Size (in bytes):			116663		
<p>This Acknowledgement Receipt evidences receipt on the noted date by the USPTO of the indicated documents, characterized by the applicant, and including page counts, where applicable. It serves as evidence of receipt similar to a Post Card, as described in MPEP 503.</p> <p><u>New Applications Under 35 U.S.C. 111</u> If a new application is being filed and the application includes the necessary components for a filing date (see 37 CFR 1.53(b)-(d) and MPEP 506), a Filing Receipt (37 CFR 1.54) will be issued in due course and the date shown on this Acknowledgement Receipt will establish the filing date of the application.</p> <p><u>National Stage of an International Application under 35 U.S.C. 371</u> If a timely submission to enter the national stage of an international application is compliant with the conditions of 35 U.S.C. 371 and other applicable requirements a Form PCT/DO/EO/903 indicating acceptance of the application as a national stage submission under 35 U.S.C. 371 will be issued in addition to the Filing Receipt, in due course.</p> <p><u>New International Application Filed with the USPTO as a Receiving Office</u> If a new international application is being filed and the international application includes the necessary components for an international filing date (see PCT Article 11 and MPEP 1810), a Notification of the International Application Number and of the International Filing Date (Form PCT/RO/105) will be issued in due course, subject to prescriptions concerning national security, and the date shown on this Acknowledgement Receipt will establish the international filing date of the application.</p>					

INFORMATION DISCLOSURE STATEMENT

Inventor : Perreault, et al.
App. No. : 12/513,147
Filed : March 1, 2010
For : PRODUCING ROUTING MESSAGES FOR
VOICE OVER IP COMMUNICATIONS
Examiner : Sing, Simon P.
Art Unit : 2653
Conf. No. : 9611

Commissioner for Patents
P.O. Box 1450
Alexandria, VA 22313-1450

References and Listing

Submitted herewith in the above-identified application is an Information Disclosure Statement listing references for consideration. Copies of any listed foreign and non-patent literature references are being submitted.

Timing of Disclosure

This Information Disclosure Statement is being filed after receipt of a first office action, but before the mailing date of a final action and before the mailing date of a Notice of Allowance. This Statement is accompanied by the fees set forth in 37 C.F.R. § 1.17(p). The Commissioner is hereby authorized to charge any additional fees which may be required or to credit any overpayment to Account No. 11-1410.

Respectfully submitted,

KNOBBE, MARTENS, OLSON & BEAR, LLP

Dated: _____

5/10/13

By: _____



John M. Carson
Registration No. 34,303
Attorney of Record
Customer No. 20995
(858) 707-4000

IDS
15315136
043013

IN THE UNITED STATES PATENT AND TRADEMARK OFFICE

Inventor	: Clay Perreault, et al.
App. No.	: 12/513,147
Filed	: March 1, 2010
For	: PRODUCING ROUTING MESSAGES FOR VOICE OVER IP COMMUNICATIONS
Examiner	: Simon P. Sing
Art Unit	: 2653
Conf. No.	: 9611

REPLY TO NON-FINAL OFFICE ACTION WITH AMENDMENT

Mail Stop Amendment

Commissioner for Patents
P.O. Box 1450
Alexandria, VA 22313-1450

Dear Sir:

In reply to the non-final Office Action dated March 1, 2013, Applicant presents the following amendments and remarks.

Amendments to the Claims are reflected in the listing of claims which begins on page 2 of this paper.

Remarks begin on page 32 of this paper.

Application No.: 12/513,147
Filing Date: March 1, 2010

AMENDMENTS TO THE CLAIMS

1. (**Currently amended**) A process for operating a call routing controller to facilitate communication between callers and callees in a system comprising a plurality of nodes with which callers and callees are associated, the process comprising:

in response to initiation of a call by a calling subscriber, receiving a caller identifier and a callee identifier;

~~using call classification criteria associated with the caller identifier to classify the call as a public network call or a private network call;~~

locating a caller dialing profile comprising a username associated with the caller and at least one calling attribute associated with the caller;

performing a comparison of said at least one calling attribute with at least a portion of said callee identifier;

classifying the call as a public network call when said comparison meets public network classification criteria and classifying the call as a private network call when said comparison meets private network classification criteria;

when the call is classified as a private network call, producing a private network routing message for receipt by a call controller, said private network routing message identifying an address, on the private network, associated with the callee ~~when the call is classified as a private network call;~~ and

when the call is classified as a public network call, producing a private network routing message for receipt by the call controller, said public network routing message

Application No.: 12/513,147
Filing Date: March 1, 2010

identifying a gateway to the public network ~~when the call is classified as a public network~~
call.

2. (Original) The process of claim 1 further comprising receiving a request to establish a call,
from a call controller in communication with a caller identified by said callee identifier.

3. (Cancelled)

4. (Cancelled)

5. (Cancelled)

6. (Currently amended) The process of claim [[4]] 1 wherein comparing comprises determining
whether said callee identifier includes a portion that matches an International Dialing Digit (IDD)
associated with said caller dialing profile.

7. (Currently amended) The process of claim [[4]] 1 wherein comparing comprises determining
whether said callee identifier includes a portion that matches an a National Dialing Digit (NDD)
associated with said caller dialing profile.

8. (Currently amended) The process of claim [[4]] 1 wherein comparing comprises determining
whether said callee identifier includes a portion that matches an area code associated with said
caller dialing profile.

Application No.: 12/513,147
Filing Date: March 1, 2010

9. (Currently amended) The process of claim **[[4]] 1** wherein comparing comprises determining whether said callee identifier has a length within a range specified in said caller dialing profile.

10. (Currently amended) The process of claim **[[4]] 1** further comprising formatting said callee identifier into a pre-defined digit format to produce a re-formatted callee identifier.

11. (Original) The process of claim **10** wherein formatting comprises removing an international dialing digit from said callee identifier, when said callee identifier begins with a digit matching an international dialing digit specified by said caller dialing profile associated with said caller.

12. (Original) The process of claim **10** wherein formatting comprises removing a national dialing digit from said callee identifier and prepending a caller country code to said callee identifier when said callee identifier begins with a national dialing digit.

13. (Original) The process of claim **10** wherein formatting comprises prepending a caller country code to said callee identifier when said callee identifier begins with digits identifying an area code specified by said caller dialing profile.

14. (Original) The process of claim **10** wherein formatting comprises prepending a caller country code and area code to said callee identifier when said callee identifier has a length that matches a

Application No.: 12/513,147
Filing Date: March 1, 2010

caller dialing number format specified by said caller dialing profile and only one area code is specified as being associated with said caller in said caller dialing profile.

15. (Currently amended) The process of claim 10 ~~further comprising~~ wherein classifying comprises classifying said call as a private network call when said re-formatted callee identifier identifies a subscriber to the private network.

16. (Currently amended) The process of claim 10 ~~further comprising~~ wherein classifying comprises determining whether said callee identifier complies with a pre-defined username format and if so classifying the call as a private network call.

17. (Currently amended) The process of claim 10 further comprising, causing a database of records to be searched to locate a ~~direct in dial~~ Direct-Inward-Dial (DID) bank table record associating a public telephone number with said reformatted callee identifier and if said DID bank table record is found classifying the call as a private network call and if a DID bank table record is not found classifying the call as a public network call.

18. (Original) The process of claim 17 wherein producing said routing message identifying a node on the private network comprises setting a callee identifier in response to a username associated with said DID bank table record.

19. (Original) The process of claim 18 wherein producing said routing message comprises

Application No.: 12/513,147
Filing Date: March 1, 2010

determining whether a node associated with the reformatted callee identifier is the same as a node associated the caller identifier.

20. (Currently amended) The process of claim **19** wherein determining whether a node associated with the reformatted callee identifier is the same as a node associated with the caller identifier comprises determining whether a prefix of said re-formatted callee identifier matches a corresponding prefix of a username associated with said caller dialing profile.

21. (Original) The process of claim **20** wherein when said node associated with said caller is not the same as the node associated with the callee, producing a routing message including said caller identifier, said reformatted callee identifier and an identification of a private network node associated with said callee and communicating said routing message to a call controller.

22. (Currently amended) The process of claim **19** wherein when said node associated with said caller identifier is the same as the node associated with said callee identifier, determining whether to perform at least one of the following: forward said call to another party, block the call and direct the caller to a voicemail server associated with the callee.

23. (Original) The process of claim **22** wherein producing said routing message comprises producing a routing message having an identification of at least one of the callee identifier, an identification of a party to whom the call should be forwarded and an identification of a voicemail server associated with the callee.

Application No.: 12/513,147
Filing Date: March 1, 2010

24. (Original) The process of claim 23 further comprising communicating said routing message to a call controller.

25. (Original) The process of claim 10 wherein producing a routing message identifying a gateway to the public network comprises searching a database of route records associating route identifiers with dialing codes to find a route record having a dialing code having a number pattern matching at least a portion of said reformatted callee identifier.

26. (Original) The process of claim 25 further comprising searching a database of supplier records associating supplier identifiers with said route identifiers to locate at least one supplier record associated with said route identifier associated with said route record having a dialing code having a number pattern matching at least a portion of said reformatted callee identifier.

27. (Original) The process of claim 26 further comprising loading a routing message buffer with the reformatted callee identifier and an identification of specific routes associated respective ones of the supplier records associated with said route record and loading said routing message buffer with a time value and a timeout value.

28. (Currently amended) The process of claim 27 ~~further comprising communicating a~~ wherein said routing message comprising comprises the contents of said routing message buffer and wherein said process comprises communicating said routing message to a call controller.

Application No.: 12/513,147
Filing Date: March 1, 2010

29. (Currently amended) The process of claim [[4]] 1 further comprising causing said dialing profile to include a maximum concurrent call value and a concurrent call count value and causing said concurrent call count value to be incremented when the user associated with said dialing profile initiates a call and causing said concurrent call count value to be decremented when a call with said user associated with said dialing profile is ended.

30. (Currently amended) A non-transitory computer readable medium encoded with codes for directing a processor to execute a method of operating a call routing controller to facilitate communication between callers and callees in a system comprising a plurality of nodes with which callers and callees are associated, the method comprising:

in response to initiation of a call by a calling subscriber, receiving a caller identifier and a callee identifier;

~~using call classification criteria associated with the caller identifier to classify the call as a public network call or a private network call;~~

locating a caller dialing profile comprising a username associated with the caller and at least one calling attribute associated with the caller;

performing a comparison of said at least one calling attribute with at least a portion of said callee identifier;

classifying the call as a public network call when said comparison meets public network classification criteria and classifying the call as a private network call when said comparison meets private network classification criteria;

when the call is classified as a private network call, producing a private network routing message for receipt by a call controller, said private network routing message

Application No.: 12/513,147
Filing Date: March 1, 2010

identifying an address, on the private network, associated with the callee ~~when the call is classified as a private network call~~; and

when the call is classified as a public network call, producing a private network routing message for receipt by a call controller, said public network routing message identifying a gateway to the public network when the call is classified as a public network call.

31. (Currently amended) A call routing apparatus for facilitating communications between callers and callees in a system comprising a plurality of nodes with which callers and callees are associated, the apparatus comprising:

receiving means for receiving a caller identifier and a callee identifier, in response to initiation of a call by a calling subscriber;

~~classifying means for classifying the call as a private network call or a public network call according to call classification criteria associated with the caller identifier;~~

means for locating a caller dialing profile comprising a username associated with the caller and at least one calling attribute associated with the caller;

means for performing a comparison of said at least one calling attribute with at least a portion of said callee identifier;

means for classifying the call as a public network call when said comparison meets public network classification criteria;

means for classifying the call as a private network call when said comparison meets private network classification criteria;

Application No.: 12/513,147
Filing Date: March 1, 2010

means for producing a public network routing message for receipt by a call controller, when the call is classified as a private network call, said private network routing message identifying an address, on the private network, associated with the callee ~~when the call is classified as a private network call~~; and

means for producing a public network routing message for receipt by a call controller, when the call is classified as a public network call, said public network routing message identifying a gateway to the public network ~~if the call is classified as a public network call~~.

32. (Original) The apparatus of claim **31** wherein said receiving means is operably configured to receive a request to establish a call, from a call controller in communication with a caller identified by said callee identifier.

33. (Cancelled)

34. (Cancelled)

35. (Cancelled)

36. (Currently amended) The apparatus of claim ~~35~~ **31** wherein said calling attributes include an international dialing digit and wherein said call classification means is operably configured to determine whether said callee identifier includes a portion that matches an International Dialing Digit (IDD) associated with said caller dialing profile.

Application No.: 12/513,147
Filing Date: March 1, 2010

37. (Currently amended) The apparatus of claim 34 31 wherein said calling attributes include an a national dialing digit and wherein said call classification means is operably configured to determine whether said callee identifier includes a portion that matches an a National Dialing Digit (NDD) associated with said caller dialing profile.

38. (Currently amended) The apparatus of claim 34 31 wherein said calling attributes include an area code and wherein said call classification means is operably configured to determine whether said callee identifier includes a portion that matches an area code associated with said caller dialing profile.

39. (Currently amended) The apparatus of claim 34 31 wherein said calling attribute include a number length range and wherein said call classification means is operably configured to determine whether said callee identifier has a length within a range specified in said caller dialing profile.

40. (Currently amended) The apparatus of claim 34 31 further comprising formatting means for formatting said callee identifier into a pre-defined digit format to produce a re-formatted callee identifier.

41. (Original) The apparatus of claim **40** wherein said formatting means is operably configured to remove an international dialing digit from said callee identifier, when said callee identifier

Application No.: 12/513,147
Filing Date: March 1, 2010

begins with a digit matching an international dialing digit specified by said caller dialing profile associated with said caller.

42. (Original) The apparatus of claim **40** wherein said formatting means is operably configured to remove a national dialing digit from said callee identifier and prepend a caller country code to said callee identifier when said callee identifier begins with a national dialing digit.

43. (Original) The apparatus of claim **40** wherein said formatting means is operably configured to prepend a caller country code to said callee identifier when said callee identifier begins with digits identifying an area code specified by said caller dialing profile.

44. (Original) The apparatus of claim **40** wherein said formatting means is operably configured to prepend a caller country code and area code to said callee identifier when said callee identifier has a length that matches a caller dialing number format specified by said caller dialing profile and only one area code is specified as being associated with said caller in said caller dialing profile.

45. (Currently amended) The apparatus of claim **40** wherein said classifying means is operably configured to ~~classifying~~ classify said call as a private network call when said re-formatted callee identifier identifies a subscriber to the private network.

46. (Original) The apparatus of claim **40** wherein said classifying means is operably configured

Application No.: 12/513,147
Filing Date: March 1, 2010

to classify the call as a private network call when said callee identifier complies with a pre-defined username format.

47. (Currently amended) The apparatus of claim **40** further comprising searching means for searching a database of records to locate a ~~direct in-dial~~ Direct-Inward-Dial (DID) bank table record associating a public telephone number with said reformatted callee identifier and wherein said classifying means is operably configured to classify the call as a private network call when said DID bank table record is found and to classify the call as a public network call when a DID bank table record is not found.

48. (Original) The apparatus of claim **47** wherein said private network routing message producing means is operably configured to produce a routing message having a callee identifier set according to a username associated with said DID bank table record.

49. (Original) The apparatus of claim **48** wherein said private network routing message producing means is operably configured to determine whether a node associated with the reformatted callee identifier is the same as a node associated the caller identifier.

50. (Original) The apparatus of claim **49** wherein said private network routing means includes means for determining whether a prefix of said re-formatted callee identifier matches a corresponding prefix of a username associated with said caller dialing profile.

Application No.: 12/513,147
Filing Date: March 1, 2010

51. (Original) The apparatus of claim **50** wherein said private network routing message producing means is operably configured to produce a routing message including said caller identifier, said reformatted callee identifier and an identification of a private network node associated with said callee and communicating said routing message to a call controller.

52. (Currently amended) The apparatus of claim **49** wherein said private network routing message producing means is operably configured to perform at least one of the following: forward said call to another party, block the call and direct the caller to a voicemail server associated with the callee identifier, when said node associated with said caller identifier is the same as the node associated with said callee identifier.

53. (Original) The apparatus of claim **52** wherein said means for producing said private network routing message is operably configured to produce a routing message having an identification of at least one of the callee identifier, an identification of a party to whom the call should be forwarded and an identification of a voicemail server associated with the callee.

54. (Original) The apparatus of claim **53** further comprising means for communicating said routing message to a call controller.

55. (Original) The apparatus of claim **40** wherein said means for producing a public network routing message identifying a gateway to the public network comprises means for searching a database of route records associating route identifiers with dialing codes to find a route record

Application No.: 12/513,147
Filing Date: March 1, 2010

having a dialing code having a number pattern matching at least a portion of said reformatted callee identifier.

56. (Original) The apparatus of claim **55** further comprising means for searching a database of supplier records associating supplier identifiers with said route identifiers to locate at least one supplier record associated with said route identifier associated with said route record having a dialing code having a number pattern matching at least a portion of said reformatted callee identifier.

57. (Original) The apparatus of claim **56** further comprising a routing message buffer and means for loading said routing message buffer with the reformatted callee identifier and an identification of specific routes associated respective ones of the supplier records associated with said route record and loading said routing message buffer with a time value and a timeout value.

58. (Currently amended) The apparatus of claim **57** further comprising means for ~~communicating a~~ causing said routing message ~~comprising to include~~ the contents of said routing message buffer and means for communicating the routing message to a call controller.

59. (Currently amended) The apparatus of claim ~~34~~ 31 further comprising means for causing said dialing profile to include a maximum concurrent call value and a concurrent call count value and for causing said concurrent call count value to be incremented when the user associated with said dialing profile initiates a call and for causing said concurrent call count value to be decremented when a call with said user associated with said dialing profile is ended.

60. (New) A process for operating a call routing controller to establish a call between a caller and a callee in a communication system, the process comprising:

in response to initiation of a call by a calling subscriber, locating a caller dialing profile comprising at least one calling attribute associated with the caller;
and

when said at least one calling attribute and at least a portion of a callee identifier associated with the callee meet private network classification criterion, producing a private network routing message for receipt by a call controller, said private network routing message identifying an address, on a private network, the address being associated with the callee; and

when said at least one calling attribute and said at least said portion of said callee identifier associated with the call meet a public network classification criterion, producing a public network routing message for receipt by a call controller, said public network routing message identifying a gateway to a public network.

61. (New) The process of claim **60** wherein said private network classification criteria include:

- a) said callee identifier does not begin with the same digit pattern as an international dialing digit (IDD) attribute of said callee identifier; and
- b) said callee identifier does not begin with the same digit pattern as a national dialing digit (NDD) attribute of said callee identifier; and

Application No.: 12/513,147
Filing Date: March 1, 2010

- c) said callee identifier does not begin with the same area code as an area code of said caller; and
- d) said callee identifier does not have a length that is within a range of caller local number lengths; and
- e) said callee identifier is a valid username.

62. (New) The process of claim **61** further comprising identifying the call as a cross-domain call on the private network when said callee identifier identifies a callee that is not associated with the same network node as said caller.

63. (New) The process of claim **61** further comprising:

locating a callee dialing profile for the callee when said callee identifier identifies a callee that is associated with the same network node as said caller; and

retrieving call handling information associated with the callee, where said call handling information is available, said call handling information including at least one of call blocking information, call forwarding information, and voicemail information.

64. (New) The process of claim **63** further comprising, where said call handling information including said call blocking information is available, blocking the call when said call blocking information identifies the caller as a caller from whom calls are to be blocked from being established with the callee.

Application No.: 12/513,147
Filing Date: March 1, 2010

65. (New) The process of claim 63 further comprising, where said call handling information including said call forwarding information is available, causing said call forwarding information to be included in said private network routing message.

66. (New) The process of claim 63 further comprising, where said call handling information including said voicemail information is available, causing said voicemail information to be included in said private network routing message.

67. (New) The process of claim 60 further comprising associating at least one direct inward dial record with at least one subscriber to said communication system, each of said at least one direct inward dial records comprising a field storing a direct inward dial number associated with said at least one subscriber.

68. (New) The process of claim 67 wherein said public network classification criteria include:

- a) said callee identifier begins with the same digit pattern as an international dialing digit (IDD) attribute of said callee identifier; and
- b) a reformatted callee identifier produced by removing the IDD attribute from said callee identifier has no DID bank table record.

69. (New) The process of claim 67 wherein said public network classification criteria include:

Application No.: 12/513,147
Filing Date: March 1, 2010

- a) said callee identifier begins with the same digit pattern as a national dialing digit (NDD) attribute of said callee identifier; and
- b) a reformatted callee identifier produced by removing the NDD attribute from said callee identifier and including a caller country code has no DID bank table record.

70. (New) The process of claim 67 wherein said public network classification criteria include:

- a) said callee identifier begins with the same area code as an area code of said caller; and
- b) a reformatted callee identifier produced by reformatting the callee identifier to include a caller country code has no DID bank table record.

71. (New) The process of claim 67 wherein said public network classification criteria include:

- a) said callee identifier has a length that is within a range of caller local number lengths; and
- b) a reformatted callee identifier produced by reformatting the callee identifier to include a caller country code and area code has no DID bank table record.

72. (New) The process of claim 60 wherein said at least one of said calling attributes includes at least one of an international dialing digits field, a national dialing digits field, a country code field, a local area codes field, a caller minimum local length field, a caller maximum local length

Application No.: 12/513,147
Filing Date: March 1, 2010

field, a reseller field, a maximum number of concurrent calls field and a current number of concurrent calls field.

73. (New) The process of claim 67 wherein said DID record comprises a user name field, a user domain field and a DID number field.

74. (New) The process of claim 60 further comprising maintaining a list of public network route suppliers and when said public network classification criterion is met identifying at least one of said public network route suppliers that satisfies public network routing selection criteria.

75. (New) The process of claim 74 wherein said producing said public network routing message comprises producing a public network routing message identifying said at least one public network route supplier that satisfies said public network routing selection criteria.

76. (New) The process of claim 75 wherein producing said public network routing message comprises causing said at least one public network route supplier that satisfies said public network routing selection criteria to be placed in a preferred order.

77. (New) The process of claim 76 wherein said preferred order is by at least one of rate and preferred service agreements with said at least one public network route supplier.

Application No.: 12/513,147
Filing Date: March 1, 2010

78. (New) The process of claim 60 further comprising causing the private network routing message or the public network routing message to be communicated to a call controller to effect routing of the call.

79. (New) A non-transitory computer readable medium encoded with codes for directing a processor to execute the method of claim 60.

80. (New) A call routing controller apparatus for establishing a call between a caller and a callee in a communication system, the apparatus comprising:

a processor operably configured to:

access a database of caller dialing profiles wherein each dialing profile associates at least one calling attribute with a respective subscriber, to locate a dialing profile associated with the caller, in response to initiation of a call by a calling subscriber; and

produce a private network routing message for receipt by a call controller, said private network routing message identifying an address, on a private network, through which the call is to be routed, when said at least one calling attribute and at least a portion of a callee identifier associated with the callee meet private network classification criterion, the address being associated with the callee; and

produce a public network routing message for receipt by a call controller, said public network routing message identifying a gateway to a public network, when said at least one calling attribute and said at least

Application No.: 12/513,147
Filing Date: March 1, 2010

said portion of said callee identifier associated with the call meet a public network classification criterion.

81. (New) The apparatus of claim **80** wherein said private network classification criteria include:

- a) said callee identifier does not begin with the same digit pattern as an international dialing digit (IDD) attribute of said callee identifier; and
- b) said callee identifier does not begin with the same digit pattern as a national dialing digit (NDD) attribute of said callee identifier; and
- c) said callee identifier does not begin with the same area code as an area code of said caller; and
- d) said callee identifier does not have a length that is within a range of caller local number lengths; and
- e) said callee identifier is a valid username.

82. (New) The apparatus of claim **81** wherein said processor is further operably configured to identify the call as a cross-domain call on the private network when said callee identifier identifies a callee that is not associated with the same network node as said caller.

83. (New) The apparatus of claim **81** wherein said processor is further configured to:

Application No.: 12/513,147
Filing Date: March 1, 2010

access the database of caller dialing profiles to locate a callee dialing profile for the callee when said callee identifier identifies a callee that is associated with the same network node as said caller; and

retrieve call handling information associated with the callee, where said call handling information is available, said call handling information including at least one of call blocking information, call forwarding information, and voicemail information.

84. (New) The apparatus of claim **83** wherein said processor is further operably configured to determine whether said call handling information including said call blocking information is available and to block the call when said call blocking information identifies the caller as a caller from whom calls are to be blocked.

85. (New) The apparatus of claim **83** wherein said processor is further operably configured to determine whether said call handling information including said call forwarding information is available and to cause said call forwarding information to be included in said private network routing message.

86. (New) The apparatus of claim **83** wherein said processor is further operably configured to determine whether said call handling information including said voicemail information is available and to cause said voicemail information to be included in said private network routing message.

Application No.: 12/513,147
Filing Date: March 1, 2010

87. (New) The apparatus of claim **80** wherein said processor is further operably configured to access a database of direct inward dial records each associating at least one direct inward dial number with at least one subscriber to said communication system.

88. (New) The apparatus of claim **87** wherein said public network classification criteria include:

- a) said callee identifier begins with the same digit pattern as an international dialing digit (IDD) attribute of said callee identifier; and
- b) a reformatted callee identifier produced by removing the IDD attribute from said callee identifier has no DID record.

89. (New) The apparatus of claim **87** wherein said public network classification criteria include:

- a) said callee identifier begins with the same digit pattern as a national dialing digit (NDD) attribute of said callee identifier; and
- b) a reformatted callee identifier produced by removing the NDD attribute from said callee identifier and including a caller country code has no DID record.

90. (New) The apparatus of claim **87** wherein said public network classification criteria include:

- a) said callee identifier begins with the same area code as an area code of said caller;
and

Application No.: 12/513,147
Filing Date: March 1, 2010

- b) a reformatted callee identifier produced by reformatting the callee identifier to include a caller country code has no DID record.

91. (New) The apparatus of claim **87** wherein said public network classification criteria include:

- a) said callee identifier has a length that is within a range of caller local number lengths; and
- b) a reformatted callee identifier produced by reformatting the callee identifier to include a caller country code and area code has no DID record.

92. (New) The apparatus of claim **80** wherein said at least one of said calling attributes includes at least one of an international dialing digits field, a national dialing digits field, a country code field, a local area codes field, a caller minimum local length field, a caller maximum local length field, a reseller field, a maximum number of concurrent calls field and a current number of concurrent calls field.

93. (New) The apparatus of claim **87** wherein said DID record comprises a user name field, a user domain field and a DID number field.

94. (New) The apparatus of claim **80** wherein said processor is further operably configured to access a list of public network route suppliers when said public network classification criterion is met and to identify at least one of said public network route suppliers that satisfies public network routing selection criteria.

95. (New) The apparatus of claim 94 wherein said processor is further operably configured to produce a public network routing message identifying said at least one public network route supplier that satisfies said public network routing selection criteria.

96. (New) The apparatus of claim 95 wherein said processor is further operably configured to cause said at least one public network route supplier that satisfies said public network routing selection criteria to be placed in a preferred order.

97. (New) The apparatus of claim 96 wherein said preferred order is by at least one of rate and preferred service agreements with said at least one public network route supplier.

98. (New) The apparatus of claim 80 wherein said processor is further operably configured to cause the private network routing message or the public network routing message to be communicated to a call controller to effect routing of the call.

99. (New) A call routing controller apparatus for establishing a call between a caller and a callee in a communication system, the apparatus comprising:

means for accessing a database of caller dialing profiles wherein each dialing profile associates at least one calling attribute with a respective subscriber, to locate a dialing profile associated with the caller, in response to initiation of a call by a calling subscriber; and

Application No.: 12/513,147
Filing Date: March 1, 2010

means for producing a private network routing message for receipt by a call controller, said private network routing message identifying an address, on a private network, through which the call is to be routed, when said at least one calling attribute and at least a portion of a callee identifier associated with the callee meet private network classification criterion, the address being associated with the callee; and

means for producing a public network routing message for receipt by a call controller, said public network routing message identifying a gateway to a public network when said at least one calling attribute and said at least said portion of said callee identifier associated with the call meet a public network classification criterion.

100. (New) The apparatus of claim **99** wherein said private network classification criteria include:

- a) said callee identifier does not begin with the same digit pattern as an international dialing digit (IDD) attribute of said callee identifier; and
- b) said callee identifier does not begin with the same digit pattern as a national dialing digit (NDD) attribute of said callee identifier; and
- c) said callee identifier does not begin with the same area code as an area code of said caller; and
- d) said callee identifier does not have a length that is within a range of caller local number lengths; and
- e) said callee identifier is a valid username.

101. (New) The apparatus of claim **100** further comprising means for identifying the call as a cross-domain call on the private network when said callee identifier identifies a callee that is not associated with the same network node as said caller.

102. (New) The apparatus of claim **100** further comprising:

means for accessing the database of caller dialing profiles to locate a callee dialing profile for the callee when said callee identifier identifies a callee that is associated with the same network node as said caller; and

means for retrieving call handling information associated with the callee, where said call handling information is available, said call handling information including at least one of call blocking information, call forwarding information, and voicemail information.

103. (New) The apparatus of claim **102** further comprising, where said call handling information including said call blocking information is available, means for blocking the call when said call blocking information identifies the caller as a caller from whom calls are to be blocked from being established with the callee.

104. (New) The apparatus of claim **102** further comprising, means for causing said call forwarding information to be included in said private network routing message, where said call handling information including said call forwarding information is available.

Application No.: 12/513,147
Filing Date: March 1, 2010

105. (New) The apparatus of claim **102** further comprising, where said call handling information including said voicemail information is available, means for causing said voicemail information to be included in said private network routing message.

106. (New) The apparatus of claim **99** further comprising means for accessing a database of direct inward dial records each associating at least one direct inward dial number with at least one subscriber to said communication system.

107. (New) The apparatus of claim **106** wherein said public network classification criteria include:

- a) said callee identifier begins with the same digit pattern as an international dialing digit (IDD) attribute of said callee identifier; and
- b) a reformatted callee identifier produced by removing the IDD attribute from said callee identifier has no DID record.

108. (New) The apparatus of claim **106** wherein said public network classification criteria include:

- a) said callee identifier begins with the same digit pattern as a national dialing digit (NDD) attribute of said callee identifier; and
- b) a reformatted callee identifier produced by removing the NDD attribute from said callee identifier and including a caller country code has no DID record.

Application No.: 12/513,147
Filing Date: March 1, 2010

109. (New) The apparatus of claim **106** wherein said public network classification criteria include:

- a) said callee identifier begins with the same area code as an area code of said caller;
and
- b) a reformatted callee identifier produced by reformatting the callee identifier to include a caller country code has no DID record.

110. (New) The apparatus of claim **106** wherein said public network classification criteria include:

- a) said callee identifier has a length that is within a range of caller local number lengths; and
- b) a reformatted callee identifier produced by reformatting the callee identifier to include a caller country code and area code has no DID record.

111. (New) The apparatus of claim **99** wherein said at least one of said calling attributes includes at least one of an international dialing digits field, a national dialing digits field, a country code field, a local area codes field, a caller minimum local length field, a caller maximum local length field, a reseller field, a maximum number of concurrent calls field and a current number of concurrent calls field.

112. (New) The apparatus of claim **106** wherein said DID record comprises a user name field, a user domain field and a DID number field.

Application No.: 12/513,147
Filing Date: March 1, 2010

113. (New) The apparatus of claim **99** further comprising means for accessing a list of public network route suppliers when said public network classification criterion is met and means for identifying at least one of said public network route suppliers that satisfies public network routing selection criteria.

114. (New) The apparatus of claim **113** wherein said means for producing said public network routing message comprises means for producing a public network routing message identifying said at least one public network route supplier that satisfies said public network routing selection criteria.

115. (New) The apparatus of claim **114** wherein said means for producing said public network routing message comprises means for causing said at least one public network route supplier that satisfies said public network routing selection criteria to be placed in a preferred order.

116. (New) The apparatus of claim **115** wherein said preferred order is by at least one of rate and preferred service agreements with said at least one public network route supplier.

117. (New) The apparatus of claim **99** further comprising means for causing the private network routing message or the public network routing message to be communicated to a call controller to effect routing of the call.

Application No.: 12/513,147
Filing Date: March 1, 2010

REMARKS

Claims 1, 6, 7, 8, 9, 10, 15, 16, 17, 20, 22, 28, 29, 30, 31, 36, 37, 38, 39, 40, 45, 47, 52, 58 and 59 have been amended, and Claims 3-5 and 33-35 have been cancelled. Claims 60-117 have been added. No new subject matter has been added. Applicant respectfully requests reconsideration of the rejections in light of the amendments and the following remarks. Claims 1-2, 6-32 and 36-117 are pending.

Claims 1, 30 and 31 are amended versions of the former independent claims. Claims 1 and 30 have been amended to incorporate the elements of the former Claims 3, 4 and 5 which have now been cancelled. Similarly, Claim 31 has been amended to include the corresponding apparatus elements formerly provided by Claims 33, 34 and 35. As a result of incorporating subject matter from the now cancelled claims, the subparagraph relating to “using call classification criteria...” was removed to make the independent claims simpler to read. The remaining amendments to the former claims are merely minor editorial amendments or dependency changes in view of the cancellation of some claims.

Discussion of Claim Objections

Claims 6, 7, 17, 36, 37 and 47 have been objected to because the terms “IDD”, “NDD” and “DID” in claims 6/36, 7/37 and 17/47 lack antecedent basis. The claims using these terms (acronyms) have been amended on the first occurrence of each term to include the words each acronym represents and therefore the objection is overcome.

Discussion of Claim Rejections Under 35 U.S.C. § 103(a)

The Examiner has rejected Claims 1-59 as being unpatentable over Alexander et al. (U.S. Patent No. 6,798,767). Applicant respectfully submits that all pending claims are patentable over the prior art of record as discussed below.

Standard of *Prima facie* Obviousness

The Patent and Trademark Office has the burden under section 103 to establish a *prima facie* case of obviousness. The rationale to support a conclusion that the claim would have been

Application No.: 12/513,147
Filing Date: March 1, 2010

obvious is that **all the claimed elements** were known in the prior art and one skilled in the art could have combined the elements as claimed by known methods with no change in their respective functions, and the combination yielded nothing more than predictable results to one of ordinary skill in the art. It can be important to identify a reason that would have prompted a person of ordinary skill in the relevant field to combine the elements in the way the claimed new invention does. If any of these findings cannot be made, then this rationale cannot be used to support a conclusion that the claim would have been obvious to one of ordinary skill in the art. M.P.E.P. § 2143.

Discussion of Patentability of Pending Claims

Applicant's amended independent Claims **1, 30** and **31** each recite:

in response to initiation of a call by a calling subscriber, receiving a caller identifier and a callee identifier;

The Examiner equates this to column 4, lines 38-40 and column 5 lines 26-29 of Alexander, but the immediately adjacent lines to column 4, lines 38-40, i.e., lines 40-42 indicate that "the calling device transmits a signal to call manager 26a indicating the desired function and telephony device to be called. There is no mention of a caller identifier being received.

In addition, amended Claims **1, 30** and **31** recite:

locating a caller dialing profile comprising a username associated with the caller and at least one calling attribute associated with the caller;

While this is a new element to the former Claim **1**, it was previously recited in former Claim **4** to which the Examiner cited the database 120 of Alexander and the fact that in Alexander the user is a registered user. From this, the Examiner has concluded that the call manager "obviously" has a user profile including a name, an IP address/domain name and an assigned telephone number (for people in the PSTN to call). Applicant respectfully submits that the entries in the database 120 appear to associate all registered users of the system with IP addresses. However, when a call is initiated, the calling device transmits a signal to call manager 26a indicating the desired function and telephony device to be called and the call manager appears to use only the

Application No.: 12/513,147
Filing Date: March 1, 2010

indication of the telephony device to be called to access the database to determine the corresponding IP address through which the call should be routed. It should be noted that Alexander locates an entry in the database but, in the context of routing, the entry is associated with the callee, not the caller. Therefore the entity that is located by Alexander is not a dialing profile associated with the caller as claimed by the present Applicant. Alexander makes no mention of locating any entry associated with the caller and provides no suggestion or motivation to do so. Furthermore, while the entries in the database of Alexander include phone number, device/group name and IP address. None of these entities can be regarded by one skilled in the art as a "calling attribute" within the meaning intended by the context of the language of Applicant's claims and disclosure. Therefore it is respectfully submitted that Alexander fails to recite *locating a dialing profile associated with the caller or a dialing profile having calling attributes associated with the caller*, as claimed by Applicant.

Amended claims **1**, **30** and **31** also recite:

performing a comparison of said at least one calling attribute with at least a portion of said callee identifier;

Similar language to this was formerly recited in Claim **5** to which the Examiner suggested that Alexander teaches comparing callee's telephone number/IP address to determine whether the outgoing call is an intra-LAN call. A reference to the specific passage of Alexander that the Examiner relies on for this suggestion was not provided, but from the foregoing it appears that Alexander locates an entry associated with the callee, not the caller, when attempting to route a call and Alexander neither describes nor suggests anything like a calling attribute of the type recited in Applicant's claims. Even if it could be shown that a field of any of the entries in Alexander's database 120 could be interpreted to be a calling attribute, such attribute would be associated with the callee and not the caller and therefore there still would be no suggestion to perform a comparison involving a calling attribute associated with the caller.

Amended claims **1**, **30** and **31** further recite:

Application No.: 12/513,147
Filing Date: March 1, 2010

classifying the call as a public network call when said comparison meets public network classification criteria and classifying the call as a private network call when said comparison meets private network classification criteria;

Similar language was provided in the former Claim 1 to which the Examiner suggested Alexander checks the callee's telephone number/IP address in the outgoing call to determine whether the outgoing call is an intra-LAN call or is directed to a telephone in a public switched telephone network (PSTN 60), with specific reference to column 4, lines 26-34 and column 5, lines 26-34. Applicant respectfully submits that Alexander indicates no call classification per se, but simply looks up the callee number in the mapping table 120 to find the associated IP address and causes the call to be routed there. Alexander fails to disclose or suggest any criteria that are used in conjunction with the comparison involving calling attributes of the caller recited in the clause discussed above to classify a call. Rather, in Alexander, it appears that calls are merely routed to the IP address or gateway associated with the callee, whether the callee is on the LAN or on a public network, wherein the gateway is identified by an entry associated with the callee in the database 120. This is no suggestion or motivation to classify the call as a public network call when applicant's recited comparison meets public network classification criteria or to classify the call as a private network call when said comparison meets private network classification criteria.

Amended claims **1**, **30** and **31** also recite:

when the call is classified as a private network call, producing a private network routing message for receipt by a call controller, said private network routing message identifying an address, on the private network, associated with the callee; and

when the call is classified as a public network call, producing a public network routing message for receipt by a call controller, said public network routing message identifying a gateway to the public network.

The Examiner correctly observed that Alexander does not explicitly recite a routing message. However, the Examiner suggests that "obviously, the call manager produces a routing message to route the outgoing call through the LAN 20 to the callee's device and causing it to ring" and

Application No.: 12/513,147
Filing Date: March 1, 2010

produces a routing message identifying a gateway to the public network when the call is classified as a public network call. The Examiner makes specific reference to column 5, lines 26-31 and column 9, lines 42-55. Applicant respectfully submits that neither of these passages discloses or suggests the production of a routing message. Applicant directs the Examiner to column 6 lines 28-31 which state, in reference to whether the originating telephony device is an IP telephony device or a non-IP telephony device: "In either case, once call manager 26a receives the call initiation request, call manager 26a sends a signal to the target IP telephony device offering the call to the telephony device." There is nothing to suggest that this signal is a routing message in the sense one skilled in the art would understand this term, and it seems quite clear that the call manager sends a signal directly to the target IP telephony device to try to set up the call. Contrast this with Applicant's independent claims which recite that the public network routing message or private network routing message is for receipt by a call controller. The target IP telephony device of Alexander is not a call controller in the context in which it is described in Applicant's application and there is nothing in Alexander that discloses or suggests a routing message should be produced and sent to a call controller.

In view of the foregoing, Applicant respectfully submits that the amended independent claims recite substantial subject matter that is neither disclosed nor suggested by Alexander and therefore Claims 1, 30 and 31 are not obvious, the rejection has been overcome and amended Claims 1, 30 and 31 are allowable.

Regarding Claims 2 and 32, the Examiner states that Alexander teaches receiving a request to establish the outgoing call from a call manager 26 and cites column 4, lines 26-50; column 5, lines 26-67 and column 9, lines 42-55. Applicant's Claim 1 recites a process for operating a call routing controller. Applicant's Claim 2 recites receiving a request from a call controller. A call routing controller and a call controller are two different entities, as explained in applicant's description. The Examiner considers the process of Claim 1 to be obvious in view of the operation of the call manager 26 of Alexander. Thus, it seems the Examiner believes the call manager of Alexander is similar to the call routing controller of Applicant's claim. Since the call routing controller recited by Applicant is different from the call controller recited by the Applicant and since the Examiner equates the call manager of Alexander with the call routing controller recited by the Applicant, the call manager of Alexander cannot also be a call controller

Application No.: 12/513,147
Filing Date: March 1, 2010

in the sense suggested by the context of Applicant's claims. There is nothing in Alexander to suggest that the call manager can be both a call routing controller and a call controller.

Regarding Claims 6 and 36, the Examiner appears to regard the mapping table of Alexander as relating to determining whether said callee identifier includes a portion that matches an International Dialing Digit (IDD) associated with said caller dialing profile. The Examiner is requested to note that the IDD is a specific part of the callee identifier and there is nothing in Alexander to suggest that this specific part be involved in a comparison of the type claimed.

Regarding Claims 7, 8, 37 and 38, the mere mentioning of a telephone number does not suggest that a specific part such as an NDD or area code of the callee identifier could have any significance for a comparison of the type claimed.

Regarding Claims 9 and 39, the mere mentioning of a telephone number in Alexander does not suggest the length of the telephone number has any significance for a comparison of the type claimed.

Regarding Claims 11-14 and 41-44, Alexander describes a telephone mapping table but the context of Alexander suggests that for any telephone, including an international telephone, to be contactable through Alexander's system it must first be registered in the mapping table. Furthermore, it is apparent that any such telephone that is contactable must be associated with a gateway whose address is stored in the mapping table. There is nothing in Alexander to suggest removing an IDD under certain conditions as recited in Claim 11, removing an NDD and/or pre-pending a caller country code under certain conditions as recited in Claims 12 and 13 or pre-pending in response to a length determination such as recited in Claim 14. The same discussion applies for Claims 41-44.

Regarding Claims 15 and 45, there is nothing in Alexander to suggest classifying the call based on a reformatted callee identifier. In Alexander's system, any telephone that can be contacted must be pre-associated with a particular gateway registered in the mapping table for the system to be able to contact it. There is no specific reformatted callee identifier and no explicit classification of calls based on a reformatted callee identifier in Alexander. Alexander is not concerned with and makes no specific mention of call classification.

Application No.: 12/513,147
Filing Date: March 1, 2010

Regarding Claims 17, 18, 47 and 48, Claims 17 and 47 recite classifying the call based on whether or not a DID bank table record is found, and when a DID bank table is not found classifying the call as a public network call. If the Examiner regards the entries in the mapping table of Alexander to suggest DID records, all devices in the system would have to have such records because all devices must be registered in the mapping table. Therefore, there is no suggestion to consider the case where a callee does not have a DID record. **Claims 18 and 48**, depend on Claims 17 and 47, respectively, and are therefore also patentable.

Regarding Claims 19-21 and 49-51, Alexander does not suggest determining whether a node associated with the reformatted callee identifier is the same as a node associated with the caller identifier because there is no need to. Since his system employs a mapping table, it is of no consequence whether a reformatted callee identifier is the same as a node associated with the caller identifier. Claims 20-21 and 50-51 relate to comparing specific aspects of a re-formatted callee identifier and a username of a caller dialing profile and producing a routing message comprising the caller identifier, the reformatted callee identifier and an identification of a private network node associated with the callee. Alexander provides no suggestion or motivation to perform such a comparison or to produce a routing message, let alone a routing message having the specific fields recited in Claims 21 and 51.

Regarding Claims 22-24 and 52-54, from the foregoing it has been established that Alexander provides no suggestion that there is any significance in whether a node associated with the caller is the same as a node associated with the callee. Therefore Alexander provides no suggestion or motivation to determine whether this situation exists or to forward the call to another party, block the call or direct the caller to a voicemail server associated with the callee, when this situation exists.

Regarding Claims 25-28 and 55-58, these claims relate to producing a routing message and it has been shown above that Alexander does not produce a routing message. Furthermore, while Alexander may identify a gateway in the mapping table, there is no suggestion to search a database of route records associating route identifiers with dialing codes to find a route record having a dialing code having a number pattern matching at least a portion of the reformatted callee identifier. The IP address in the mapping table of Alexander may arguably be considered to be the route identifier and the Examiner appears to regard the re-formatted callee identifier to

Application No.: 12/513,147
Filing Date: March 1, 2010

be the IP address in the mapping table. In Alexander, once the IP address is found from the mapping table call, connection procedures are implemented without any further searching to find a route record having a dialing code having a number pattern matching at least a portion of the reformatted callee identifier. Claims 26 and 56 relate to searching a database of supplier records associating supplier identifiers with route identifiers. In Alexander there is no suggestion or motivation to provide such a database or to involve the notion of a supplier identifier or route identifier. Furthermore, since Alexander does not produce a routing message there is no suggestion or motivation to provide a routing message buffer. Because there is no suggestion or motivation to provide a database of supplier records associating supplier identifiers with route identifiers, there is no suggestion or motivation to load a routing message buffer with an identification of specific routes associated with respective ones of the supplier records found in a search of supplier records, or to load the routing message buffer with a time value and a timeout value, as recited in Claims 27 and 57. Regarding Claims 28 and 58, again Alexander provides no suggestion or motivation to provide a routing message.

Regarding Claims 29 and 59, because Alexander provides no suggestion or motivation to employ a dialing profile, there is certainly no suggestion or motivation to cause a dialing profile to include a maximum concurrent call value and a concurrent call count value or to increment the concurrent call count value on initiating a call and decrement the concurrent call count value when ending a call.

From the foregoing Applicant respectfully submits that there is nothing in the cited reference that would lead a person skilled in the art to modify the teachings of the cited reference to arrive at the subject matter of Applicant's claims as amended herewith. Therefore, Applicant respectfully submits that the amended claims are not obvious in view of the cited reference, comply with 35 USC 103(a), and are allowable.

Discussion of Dependent Claims

Although Applicant has not addressed all the issues of the dependent claims, Applicant respectfully submits that Applicant does not necessarily agree with the characterization and assessments of the dependent claims made by the Examiner, and Applicant believes that each claim is patentable on its own merits. The dependent claims are dependent either directly or

Application No.: 12/513,147
Filing Date: March 1, 2010

indirectly on the above-discussed independent claims. Applicant respectfully submits that pursuant to 35 U.S.C. § 112, ¶ 4, the dependent claims incorporate by reference all the features of the claim to which they refer and include their own patentable features, and are therefore in condition for allowance. Therefore, Applicant respectfully requests the withdrawal of all claim rejections and prompt allowance of the claims.

New Claims

New Claims 60-117 have been added. The new independent **Claims 60, 80 and 99** are similar to the amended former independent claims and generally recite the same elements as the amended former independent claims in a more concise form. Many of the dependent claims are also similar to some of the originally filed dependent claims or similar to amended versions of some of the originally filed dependent claims.

New independent **Claims 60, 80 and 99** recite the above-mentioned dialing profile comprising at least one calling attribute associated with the caller, and producing a private or public routing message for receipt by a call controller depending on whether the at least one calling attribute and said at least a portion of the callee identifier meet private or public network routing criteria. Therefore, remarks generally similar to those presented above in connection with the amended claims also apply to the new claims herewith. Therefore the new claims and the claims dependent thereon should also be allowable over Alexander.

No Disclaimers or Disavowals

Although the present communication may include alterations to the application or claims, or characterizations of claim scope or referenced art, Applicant is not conceding in this application that previously pending claims are not patentable over the cited references. Rather, any alterations or characterizations are being made to facilitate expeditious prosecution of this application. Applicant reserves the right to pursue at a later date any previously pending or other broader or narrower claims that capture any subject matter supported by the present disclosure, including subject matter found to be specifically disclaimed herein or by any prior prosecution. Accordingly, reviewers of this or any parent, child or related prosecution history shall not

Application No.: 12/513,147
Filing Date: March 1, 2010

reasonably infer that Applicant has made any disclaimers or disavowals of any subject matter supported by the present application.

Co-Pending Applications of Assignee

Applicant wishes to draw the Examiner's attention to the following co-pending applications of the present application's assignee.

Docket No.	Serial No.	Title	Filed
SMARB19.002C1	13/863306	Intercepting Voice Over IP Communications and Other Data Communications	04/15/13
SMARB19.003APC	12/532989	Emergency Assistance Calling for Voice Over IP Communications Systems	03/05/10
SMARB19.004APC	13/056277	Mobile Gateway	01/27/11
SMARB19.005APC	13/496864	Uninterrupted Transmission of Internet Protocol Transmissions During Endpoint Changes	03/16/12

Conclusion

Applicant has endeavored to address all of the Examiner's concerns as expressed in the outstanding Office Action. In light of the above remarks, reconsideration and withdrawal of the outstanding rejections is respectfully requested. If the Examiner has any questions which may be answered by telephone, the Examiner is invited to call the undersigned directly.

Any remarks in support of patentability of one claim should not be imputed to any other claim in this or a related application, even if similar terminology is used. Any remarks referring to only a portion of a claim should not be understood to base patentability on solely that portion; rather, patentability must rest on each claim taken as a whole.

Application No.: 12/513,147
Filing Date: March 1, 2010

Please charge any additional fees, including any fees for additional extension of time, or credit overpayment to Deposit Account No. 11-1410.

Respectfully submitted,

KNOBBE, MARTENS, OLSON & BEAR, LLP



Dated: _____

4/29/13

By: _____

John M. Carson
Registration No. 34,303
Attorney of Record
Customer No. 20995
(858) 707-4000

15288820
042413

Electronic Patent Application Fee Transmittal

Application Number:	12513147
Filing Date:	01-Mar-2010
Title of Invention:	PRODUCING ROUTING MESSAGES FOR VOICE OVER IP COMMUNICATIONS
First Named Inventor/Applicant Name:	Clay Perreault
Filer:	John M Carson/Deborah LaGuardia
Attorney Docket Number:	SMARB19.001APC

Filed as Small Entity

U.S. National Stage under 35 USC 371 Filing Fees

Description	Fee Code	Quantity	Amount	Sub-Total in USD(\$)
Basic Filing:				
Pages:				
Claims:				
Claims in excess of 20	2615	52	40	2080
Independent claims in excess of 3	2614	3	210	630

Miscellaneous-Filing:

Petition:

Patent-Appeals-and-Interference:

Post-Allowance-and-Post-Issuance:

PETITIONER APPLE INC. EX. 1002-137

Description	Fee Code	Quantity	Amount	Sub-Total in USD(\$)
Extension-of-Time:				
Miscellaneous:				
Total in USD (\$)				2710

Electronic Acknowledgement Receipt

EFS ID:	15641211
Application Number:	12513147
International Application Number:	
Confirmation Number:	9611
Title of Invention:	PRODUCING ROUTING MESSAGES FOR VOICE OVER IP COMMUNICATIONS
First Named Inventor/Applicant Name:	Clay Perreault
Customer Number:	20995
Filer:	John M Carson/Gustavo Lopez
Filer Authorized By:	John M Carson
Attorney Docket Number:	SMARB19.001APC
Receipt Date:	29-APR-2013
Filing Date:	01-MAR-2010
Time Stamp:	18:25:47
Application Type:	U.S. National Stage under 35 USC 371

Payment information:

Submitted with Payment	yes
Payment Type	Credit Card
Payment was successfully received in RAM	\$2710
RAM confirmation Number	6291
Deposit Account	111410
Authorized User	KNOBBE MARTENS OLSON AND BEAR

The Director of the USPTO is hereby authorized to charge indicated fees and credit any overpayment as follows:

Charge any Additional Fees required under 37 C.F.R. 1.492 (National application filing, search, and examination fees)

Charge any Additional Fees required under 37 C.F.R. Section 1.17 (Patent application and examination processing fees)

PETITIONER APPLE INC. PEX: 1902139

File Listing:					
Document Number	Document Description	File Name	File Size(Bytes)/ Message Digest	Multi Part /.zip	Pages (if appl.)
1		SMARB19001APCreplytononfinaloa.pdf	1704371 7de3a7abac503e011977da9aab2e3d43506560be	yes	42
Multipart Description/PDF files in .zip description					
Document Description			Start	End	
Amendment/Req. Reconsideration-After Non-Final Reject			1	1	
Claims			2	31	
Applicant Arguments/Remarks Made in an Amendment			32	42	
Warnings:					
Information:					
2	Fee Worksheet (SB06)	fee-info.pdf	31998 9498ec8d3bfb807a67a99e7753f15cfd44201b3d	no	2
Warnings:					
Information:					
Total Files Size (in bytes):			1736369		
<p>This Acknowledgement Receipt evidences receipt on the noted date by the USPTO of the indicated documents, characterized by the applicant, and including page counts, where applicable. It serves as evidence of receipt similar to a Post Card, as described in MPEP 503.</p> <p><u>New Applications Under 35 U.S.C. 111</u> If a new application is being filed and the application includes the necessary components for a filing date (see 37 CFR 1.53(b)-(d) and MPEP 506), a Filing Receipt (37 CFR 1.54) will be issued in due course and the date shown on this Acknowledgement Receipt will establish the filing date of the application.</p> <p><u>National Stage of an International Application under 35 U.S.C. 371</u> If a timely submission to enter the national stage of an international application is compliant with the conditions of 35 U.S.C. 371 and other applicable requirements a Form PCT/DO/EO/903 indicating acceptance of the application as a national stage submission under 35 U.S.C. 371 will be issued in addition to the Filing Receipt, in due course.</p> <p><u>New International Application Filed with the USPTO as a Receiving Office</u> If a new international application is being filed and the international application includes the necessary components for an international filing date (see PCT Article 11 and MPEP 1810), a Notification of the International Application Number and of the International Filing Date (Form PCT/RO/105) will be issued in due course, subject to prescriptions concerning national security, and the date shown on this Acknowledgement Receipt will establish the international filing date of the application.</p>					

Under the Paperwork Reduction Act of 1995, no persons are required to respond to a collection of information unless it displays a valid OMB control number.

PATENT APPLICATION FEE DETERMINATION RECORD Substitute for Form PTO-875	Application or Docket Number 12/513,147	Filing Date 03/01/2010	<input type="checkbox"/> To be Mailed
---	---	----------------------------------	---------------------------------------

ENTITY: LARGE SMALL MICRO

APPLICATION AS FILED – PART I

FOR	NUMBER FILED	NUMBER EXTRA	RATE (\$)	FEE (\$)
<input type="checkbox"/> BASIC FEE <small>(37 CFR 1.16(a), (b), or (c))</small>	N/A	N/A	N/A	
<input type="checkbox"/> SEARCH FEE <small>(37 CFR 1.16(k), (l), or (m))</small>	N/A	N/A	N/A	
<input type="checkbox"/> EXAMINATION FEE <small>(37 CFR 1.16(o), (p), or (q))</small>	N/A	N/A	N/A	
TOTAL CLAIMS <small>(37 CFR 1.16(i))</small>	minus 20 =	*	X \$ =	
INDEPENDENT CLAIMS <small>(37 CFR 1.16(h))</small>	minus 3 =	*	X \$ =	
<input type="checkbox"/> APPLICATION SIZE FEE <small>(37 CFR 1.16(s))</small>	If the specification and drawings exceed 100 sheets of paper, the application size fee due is \$310 (\$155 for small entity) for each additional 50 sheets or fraction thereof. See 35 U.S.C. 41(a)(1)(G) and 37 CFR 1.16(s).			
<input type="checkbox"/> MULTIPLE DEPENDENT CLAIM PRESENT <small>(37 CFR 1.16(j))</small>				
* If the difference in column 1 is less than zero, enter "0" in column 2.			TOTAL	

APPLICATION AS AMENDED – PART II

	(Column 1)	(Column 2)	(Column 3)	PRESENT EXTRA	RATE (\$)	ADDITIONAL FEE (\$)
AMENDMENT	04/29/2013	CLAIMS REMAINING AFTER AMENDMENT	HIGHEST NUMBER PREVIOUSLY PAID FOR			
	Total <small>(37 CFR 1.16(i))</small>	* 111	Minus	** 59 = 52	X \$40 =	2080
	Independent <small>(37 CFR 1.16(h))</small>	* 8	Minus	***5 = 3	X \$210 =	630
	<input type="checkbox"/> Application Size Fee <small>(37 CFR 1.16(s))</small>					
<input type="checkbox"/> FIRST PRESENTATION OF MULTIPLE DEPENDENT CLAIM <small>(37 CFR 1.16(j))</small>						
					TOTAL ADD'L FEE	2710

	(Column 1)	(Column 2)	(Column 3)	PRESENT EXTRA	RATE (\$)	ADDITIONAL FEE (\$)
AMENDMENT		CLAIMS REMAINING AFTER AMENDMENT	HIGHEST NUMBER PREVIOUSLY PAID FOR			
	Total <small>(37 CFR 1.16(i))</small>	*	Minus	** =	X \$ =	
	Independent <small>(37 CFR 1.16(h))</small>	*	Minus	*** =	X \$ =	
	<input type="checkbox"/> Application Size Fee <small>(37 CFR 1.16(s))</small>					
<input type="checkbox"/> FIRST PRESENTATION OF MULTIPLE DEPENDENT CLAIM <small>(37 CFR 1.16(j))</small>						
					TOTAL ADD'L FEE	

* If the entry in column 1 is less than the entry in column 2, write "0" in column 3.
 ** If the "Highest Number Previously Paid For" IN THIS SPACE is less than 20, enter "20".
 *** If the "Highest Number Previously Paid For" IN THIS SPACE is less than 3, enter "3".
 The "Highest Number Previously Paid For" (Total or Independent) is the highest number found in the appropriate box in column 1.

LIE
/BRUCE HARRISON/

This collection of information is required by 37 CFR 1.16. The information is required to obtain or retain a benefit by the public which is to file (and by the USPTO to process) an application. Confidentiality is governed by 35 U.S.C. 122 and 37 CFR 1.14. This collection is estimated to take 12 minutes to complete, including gathering, preparing, and submitting the completed application form to the USPTO. Time will vary depending upon the individual case. Any comments on the amount of time you require to complete this form and/or suggestions for reducing this burden, should be sent to the Chief Information Officer, U.S. Patent and Trademark Office, U.S. Department of Commerce, P.O. Box 1450, Alexandria, VA 22313-1450. DO NOT SEND FEES OR COMPLETED FORMS TO THIS ADDRESS. **SEND TO: Commissioner for Patents, P.O. Box 1450, Alexandria, VA 22313-1450.**

If you need assistance in completing the form, call 1-800-PTO-9199 and select option 2.

PATENT ASSIGNMENT

Electronic Version v1.1
 Stylesheet Version v1.1

SUBMISSION TYPE:	NEW ASSIGNMENT
NATURE OF CONVEYANCE:	Correction by Declaration of the Reel and Frame 029995/0668 and the Patent Application numbers 12513147, 12517026, 12532989, 13056277 and 13496864.

CONVEYING PARTY DATA

Name	Execution Date
Digifonica (International) Limited	04/01/2013

RECEIVING PARTY DATA

Name:	Digifonica (International) Limited
Street Address:	773 Hornby St
City:	Vancouver
State/Country:	CANADA
Postal Code:	V6Z1S4

PROPERTY NUMBERS Total: 5

Property Type	Number
Application Number:	12513147
Application Number:	12517026
Application Number:	12532989
Application Number:	13056277
Application Number:	13496864

CORRESPONDENCE DATA

Fax Number:
Correspondence will be sent via US Mail when the fax attempt is unsuccessful.

Phone: 7788779434

Email: konstantin@telus.net

Correspondent Name: Emil Malak

Address Line 1: 773 Hornby St

Address Line 4: Vancouver, CANADA V6Z1S4

NAME OF SUBMITTER: Emil Malak

PETITIONER APPLE INC. EX. 1002-142

OP \$200.00 12513147

This document serves as an Oath/Declaration (37 CFR 1.63).

Total Attachments: 2

source=Digifonica Gibraltar 3300#page1.tif

source=Digifonica Affidavit2#page1.tif

Subject: FW: Digifonica (International) Limited

Subject: Digifonica (International) Limited
Date: Mon, 25 Mar 2013 09:41:20 +0000
From: Karen.Shiels@stanleydavis.co.uk
To: emil_malak@hotmail.com

Dear Emil

Further to our discussion, I can confirm that the officers and shareholders of the above named Gibraltar registered company are as follows:

Director:

Sole director is Emil Malak

Shareholder:

Sole shareholder holding 10,000,000 of Gib£0.01 shares is Emil Malak

Please note that there have been no changes to the above and in the event that a 3rd party requested any changes to the company, we would require your authorisation as you are our client of record. We would further not action any changes to the directors or shareholders without full due diligence on the proposed companies/individuals.

Kind regards

Karen

Karen Shiels
Offshore and Technical Department
Stanley Davis Group Limited, 41 Chalton Street, London NW1 1JD
Direct tel: +44 (207) 554 2252
email: karen.shiels@stanleydavis.co.uk

Affidavit of Ownership

Date: April 1, 2013

To: USPTO Assignment Department

From: Emil Malak, President

Digifonica (International) Limited

These five (5) Patent Application #s 12513147, 12517026, 12532989, 13056277 and 13496864 belong to Digifonica (International) Limited and Digifonica (International) Limited is the rightful owner. These patent applications should have never been recorded by these particular parties. Digifonica (International) Limited has never assigned these patent applications to anyone.

I, Emil Malak, President of Digifonica (International) Limited, hereby affirm that these statements are true and accurate.

BY:

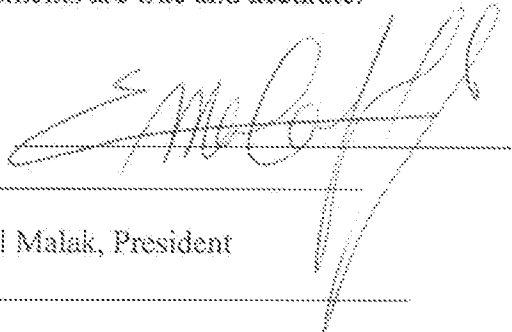

Emil Malak, President

773 Hornby Street

Vancouver, BC V6Z 1S4

604 889 0516

emil_malak@hotmail.com

WITNESS BY:

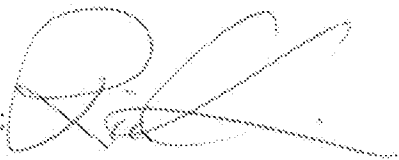

Print Name:

Ric Chin,

2090 Comox Street

Vancouver BC V6G 1R8

778 989 3872

ric_chin@hotmail.com

PATENT ASSIGNMENT

Electronic Version v1.1
 Stylesheet Version v1.1

SUBMISSION TYPE:	NEW ASSIGNMENT												
NATURE OF CONVEYANCE:	Correction by Declaration of the Reel and Frame 029995/0777 and the Patent Application numbers 12513147, 12517026, 12532989, 13056277 and 13496864.												
CONVEYING PARTY DATA													
<table border="1" style="width:100%; border-collapse: collapse;"> <thead> <tr> <th style="width:70%;">Name</th> <th>Execution Date</th> </tr> </thead> <tbody> <tr> <td>Digifonica (International) Limited</td> <td>04/01/2013</td> </tr> </tbody> </table>		Name	Execution Date	Digifonica (International) Limited	04/01/2013								
Name	Execution Date												
Digifonica (International) Limited	04/01/2013												
RECEIVING PARTY DATA													
Name:	Digifonica (International) Limited												
Street Address:	773 Hornby St												
City:	Vancouver												
State/Country:	CANADA												
Postal Code:	V6Z1S4												
PROPERTY NUMBERS Total: 5													
<table border="1" style="width:100%; border-collapse: collapse;"> <thead> <tr> <th style="width:30%;">Property Type</th> <th>Number</th> </tr> </thead> <tbody> <tr> <td>Application Number:</td> <td>12513147</td> </tr> <tr> <td>Application Number:</td> <td>12517026</td> </tr> <tr> <td>Application Number:</td> <td>12532989</td> </tr> <tr> <td>Application Number:</td> <td>13056277</td> </tr> <tr> <td>Application Number:</td> <td>13496864</td> </tr> </tbody> </table>		Property Type	Number	Application Number:	12513147	Application Number:	12517026	Application Number:	12532989	Application Number:	13056277	Application Number:	13496864
Property Type	Number												
Application Number:	12513147												
Application Number:	12517026												
Application Number:	12532989												
Application Number:	13056277												
Application Number:	13496864												
CORRESPONDENCE DATA													
Fax Number: <i>Correspondence will be sent via US Mail when the fax attempt is unsuccessful.</i>													
Phone:	7788779434												
Email:	konstantin@telus.net												
Correspondent Name:	Emil Malak												
Address Line 1:	773 Hornby St												
Address Line 4:	Vancouver, CANADA V6Z1S4												
NAME OF SUBMITTER:	Emil Malak												
PETITIONER APPLE INC. EX. 1002-146													

OP \$200.00 12513147

This document serves as an Oath/Declaration (37 CFR 1.63).

Total Attachments: 2

source=Digifonica Gibraltar 3300#page1.tif

source=Digifonica Affidavit2#page1.tif

Subject: FW: Digifonica (International) Limited

Subject: Digifonica (International) Limited
Date: Mon, 25 Mar 2013 09:41:20 +0000
From: Karen.Shiels@stanleydavis.co.uk
To: emil_malak@hotmail.com

Dear Emil

Further to our discussion, I can confirm that the officers and shareholders of the above named Gibraltar registered company are as follows:

Director:

Sole director is Emil Malak

Shareholder:

Sole shareholder holding 10,000,000 of Gib£0.01 shares is Emil Malak

Please note that there have been no changes to the above and in the event that a 3rd party requested any changes to the company, we would require your authorisation as you are our client of record. We would further not action any changes to the directors or shareholders without full due diligence on the proposed companies/individuals.

Kind regards

Karen

Karen Shiels
Offshore and Technical Department
Stanley Davis Group Limited, 41 Chalton Street, London NW1 1JD
Direct tel: +44 (207) 554 2252
email: karen.shiels@stanleydavis.co.uk

Affidavit of Ownership

Date: April 1, 2013

To: USPTO Assignment Department

From: Emil Malak, President

Digifonica (International) Limited

These five (5) Patent Application #s 12513147, 12517026, 12532989, 13056277 and 13496864 belong to Digifonica (International) Limited and Digifonica (International) Limited is the rightful owner. These patent applications should have never been recorded by these particular parties. Digifonica (International) Limited has never assigned these patent applications to anyone.

I, Emil Malak, President of Digifonica (International) Limited, hereby affirm that these statements are true and accurate.

BY:

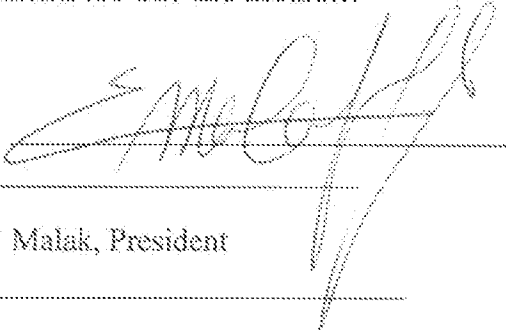

Emil Malak, President

773 Hornby Street

Vancouver, BC V6Z 1S4

604 889 0516

emil_malak@hotmail.com

WITNESS BY:

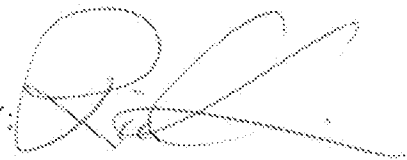

Print Name:

Ric Chin,

2090 Comox Street

Vancouver BC V6G 1R8

778 989 3872

ric_chin@hotmail.com

PATENT ASSIGNMENT

Electronic Version v1.1
 Stylesheet Version v1.1

SUBMISSION TYPE:	NEW ASSIGNMENT												
NATURE OF CONVEYANCE:	Correction by Declaration of the Reel and Frame 029942/0905 and the Patent Application numbers 12513147, 12517026, 12532989, 13056277 and 13496864.												
CONVEYING PARTY DATA													
<table border="1" style="width:100%; border-collapse: collapse;"> <thead> <tr> <th style="width:70%;">Name</th> <th>Execution Date</th> </tr> </thead> <tbody> <tr> <td>Digifonica (International) Limited</td> <td>04/01/2013</td> </tr> </tbody> </table>		Name	Execution Date	Digifonica (International) Limited	04/01/2013								
Name	Execution Date												
Digifonica (International) Limited	04/01/2013												
RECEIVING PARTY DATA													
Name:	Digifonica (International) Limited												
Street Address:	773 Hornby St												
City:	Vancouver												
State/Country:	CANADA												
Postal Code:	V6Z1S4												
PROPERTY NUMBERS Total: 5													
<table border="1" style="width:100%; border-collapse: collapse;"> <thead> <tr> <th style="width:30%;">Property Type</th> <th>Number</th> </tr> </thead> <tbody> <tr> <td>Application Number:</td> <td>12513147</td> </tr> <tr> <td>Application Number:</td> <td>12517026</td> </tr> <tr> <td>Application Number:</td> <td>12532989</td> </tr> <tr> <td>Application Number:</td> <td>13056277</td> </tr> <tr> <td>Application Number:</td> <td>13496864</td> </tr> </tbody> </table>		Property Type	Number	Application Number:	12513147	Application Number:	12517026	Application Number:	12532989	Application Number:	13056277	Application Number:	13496864
Property Type	Number												
Application Number:	12513147												
Application Number:	12517026												
Application Number:	12532989												
Application Number:	13056277												
Application Number:	13496864												
CORRESPONDENCE DATA													
Fax Number: <i>Correspondence will be sent via US Mail when the fax attempt is unsuccessful.</i> Phone: 7788779434 Email: konstantin@telus.net Correspondent Name: Emil Malak Address Line 1: 773 Hornby St Address Line 4: Vancouver, CANADA V6Z1S4													
NAME OF SUBMITTER:	Emil Malak												
PETITIONER APPLE INC. EX. 1002-150													

OP \$200.00 12513147

This document serves as an Oath/Declaration (37 CFR 1.63).

Total Attachments: 2

source=Digifonica Gibraltar 3300#page1.tif

source=Digifonica Affidavit2#page1.tif

Subject: FW: Digifonica (International) Limited

Subject: Digifonica (International) Limited
Date: Mon, 25 Mar 2013 09:41:20 +0000
From: Karen.Shiels@stanleydavis.co.uk
To: emil_malak@hotmail.com

Dear Emil

Further to our discussion, I can confirm that the officers and shareholders of the above named Gibraltar registered company are as follows:

Director:

Sole director is Emil Malak

Shareholder:

Sole shareholder holding 10,000,000 of Gib£0.01 shares is Emil Malak

Please note that there have been no changes to the above and in the event that a 3rd party requested any changes to the company, we would require your authorisation as you are our client of record. We would further not action any changes to the directors or shareholders without full due diligence on the proposed companies/individuals.

Kind regards

Karen

Karen Shiels
Offshore and Technical Department
Stanley Davis Group Limited, 41 Chalton Street, London NW1 1JD
Direct tel: +44 (207) 554 2252
email: karen.shiels@stanleydavis.co.uk

Affidavit of Ownership

Date: April 1, 2013

To: USPTO Assignment Department

From: Emil Malak, President

Digifonica (International) Limited

These five (5) Patent Application #s 12513147, 12517026, 12532989, 13056277 and 13496864 belong to Digifonica (International) Limited and Digifonica (International) Limited is the rightful owner. These patent applications should have never been recorded by these particular parties. Digifonica (International) Limited has never assigned these patent applications to anyone.

I, Emil Malak, President of Digifonica (International) Limited, hereby affirm that these statements are true and accurate.

BY:

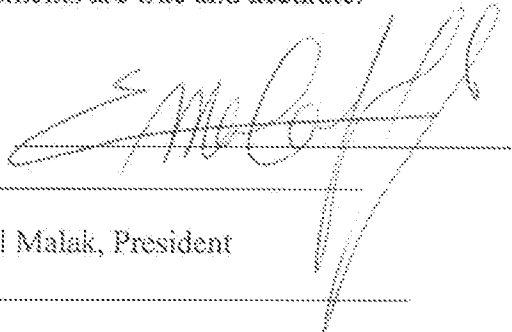

Emil Malak, President

773 Hornby Street

Vancouver, BC V6Z 1S4

604 889 0516

emil_malak@hotmail.com

WITNESS BY:

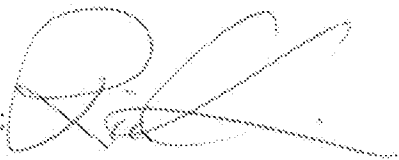

Print Name:

Ric Chin,

2090 Comox Street

Vancouver BC V6G 1R8

778 989 3872

ric_chin@hotmail.com



UNITED STATES PATENT AND TRADEMARK OFFICE

UNITED STATES DEPARTMENT OF COMMERCE
United States Patent and Trademark Office
Address: COMMISSIONER FOR PATENTS
P.O. Box 1450
Alexandria, Virginia 22313-1450
www.uspto.gov

APPLICATION NO.	FILING DATE	FIRST NAMED INVENTOR	ATTORNEY DOCKET NO.	CONFIRMATION NO.
12/513,147	03/01/2010	Clay Perreault	SMARB19.001APC	9611
20995	7590	03/01/2013	EXAMINER	
KNOBBE MARTENS OLSON & BEAR LLP 2040 MAIN STREET FOURTEENTH FLOOR IRVINE, CA 92614			SING, SIMON P	
			ART UNIT	PAPER NUMBER
			2653	
			NOTIFICATION DATE	DELIVERY MODE
			03/01/2013	ELECTRONIC

Please find below and/or attached an Office communication concerning this application or proceeding.

The time period for reply, if any, is set in the attached communication.

Notice of the Office communication was sent electronically on above-indicated "Notification Date" to the following e-mail address(es):

jayna.cartee@knobbe.com
efiling@knobbe.com

Office Action Summary

Application No. 12/513,147	Applicant(s) PERREAULT ET AL.	
Examiner SIMON SING	Art Unit 2653	

-- The MAILING DATE of this communication appears on the cover sheet with the correspondence address --

Period for Reply

A SHORTENED STATUTORY PERIOD FOR REPLY IS SET TO EXPIRE 3 MONTH(S) OR THIRTY (30) DAYS, WHICHEVER IS LONGER, FROM THE MAILING DATE OF THIS COMMUNICATION.

- Extensions of time may be available under the provisions of 37 CFR 1.136(a). In no event, however, may a reply be timely filed after SIX (6) MONTHS from the mailing date of this communication.
- If NO period for reply is specified above, the maximum statutory period will apply and will expire SIX (6) MONTHS from the mailing date of this communication.
- Failure to reply within the set or extended period for reply will, by statute, cause the application to become ABANDONED (35 U.S.C. § 133). Any reply received by the Office later than three months after the mailing date of this communication, even if timely filed, may reduce any earned patent term adjustment. See 37 CFR 1.704(b).

Status

- 1) Responsive to communication(s) filed on 04/30/2009.
- 2a) This action is **FINAL**.
- 2b) This action is non-final.
- 3) An election was made by the applicant in response to a restriction requirement set forth during the interview on _____; the restriction requirement and election have been incorporated into this action.
- 4) Since this application is in condition for allowance except for formal matters, prosecution as to the merits is closed in accordance with the practice under *Ex parte Quayle*, 1935 C.D. 11, 453 O.G. 213.

Disposition of Claims

- 5) Claim(s) 1-59 is/are pending in the application.
5a) Of the above claim(s) _____ is/are withdrawn from consideration.
- 6) Claim(s) _____ is/are allowed.
- 7) Claim(s) 1-59 is/are rejected.
- 8) Claim(s) _____ is/are objected to.
- 9) Claim(s) _____ are subject to restriction and/or election requirement.

* If any claims have been determined allowable, you may be eligible to benefit from the **Patent Prosecution Highway** program at a participating intellectual property office for the corresponding application. For more information, please see http://www.uspto.gov/patents/init_events/pph/index.jsp or send an inquiry to PPHfeedback@uspto.gov.

Application Papers

- 10) The specification is objected to by the Examiner.
- 11) The drawing(s) filed on 30 April 2009 is/are: a) accepted or b) objected to by the Examiner.
Applicant may not request that any objection to the drawing(s) be held in abeyance. See 37 CFR 1.85(a).
Replacement drawing sheet(s) including the correction is required if the drawing(s) is objected to. See 37 CFR 1.121(d).

Priority under 35 U.S.C. § 119

- 12) Acknowledgment is made of a claim for foreign priority under 35 U.S.C. § 119(a)-(d) or (f).
a) All b) Some * c) None of:
1. Certified copies of the priority documents have been received.
2. Certified copies of the priority documents have been received in Application No. _____.
3. Copies of the certified copies of the priority documents have been received in this National Stage application from the International Bureau (PCT Rule 17.2(a)).

* See the attached detailed Office action for a list of the certified copies not received.

Attachment(s)

- 1) Notice of References Cited (PTO-892)
- 2) Information Disclosure Statement(s) (PTO/SB/08)
Paper No(s)/Mail Date _____.
- 3) Interview Summary (PTO-413)
Paper No(s)/Mail Date. _____.
- 4) Other: _____.

DETAILED ACTION

Claim Objections

1. Claims 6, 7, 17, 36, 37 and 47 are objected to because of the following informalities:

“IDD”, “NDD” and “DID” in claims 6/36; 7/37, and 17/47 respectively lack antecedent basis.

Appropriate correction is required.

Claim Rejections - 35 USC § 103

The following is a quotation of 35 U.S.C. 103(a) which forms the basis for all obviousness rejections set forth in this Office action:

(a) A patent may not be obtained though the invention is not identically disclosed or described as set forth in section 102 of this title, if the differences between the subject matter sought to be patented and the prior art are such that the subject matter as a whole would have been obvious at the time the invention was made to a person having ordinary skill in the art to which said subject matter pertains. Patentability shall not be negated by the manner in which the invention was made.

2. Claims 1-59 are rejected under 35 U.S.C. 103(a) as being unpatentable over Alexander et al. US 6,798,767.

2.1 Regarding claims 1, 30 and 31, Alexander discloses call manager 26a in figure 1 for:

in response to initiation of an outgoing call by a calling subscriber, receiving a caller identifier and a callee identifier (caller at IP phone placing the outgoing call; column 4, lines 38-40; column 5, lines 26-29);

Art Unit: 2653

using call classification criteria associated with the caller identifier to classify the call as a public network call or a private network call (check callee's telephone number/IP address in the outgoing call to determine whether the outgoing call is an intra-LAN call, or is directed to a telephone in a public switched telephone network (PSTN) 60); column 4, lines 26-34, 38-51; column 5, lines 26-34);

producing a routing message identifying an address, on the private network, associated with the callee when the call is classified as a private network call (column 4, lines 38-62; column 6, lines 18-24, 32-38; Alexander does not explicitly recite a routing message, but obviously, the call manager produces a routing message to route the outgoing call through the LAN 20 to the callee's device and causing it to ring); and

producing a routing message identifying a gateway to the public network when the call is classified as a public network call (column 5, lines 26-31; column 9, lines 42-55).

2.2 Regarding claims 2 and 32, Alexander teaches receiving a request to establish the outgoing call from call manager 26 as stated above; column 4, lines 26-50; column 5, lines 26-67; column 9, lines 42-55).

2.3 Regarding claim 3 and 33, Alexander teaches searching a database to locate calling attributes (telephone number/IP address) of the caller and the callee (figures 2-4; column 8, line 47 - column 9, line 41).

2.4 Regarding claim 4 and 34, Alexander teaches a database 120, and since a user (caller or callee) in the LAN 20 is a register user. Therefore, the call manager obviously has a user profile including a name, an IP address/domain name, an assigned telephone number (for people in the PSTN to call).

2.5 Regarding claim 5 and 35, as stated above, Alexander teaches comparing callee's telephone number/IP address to determine whether the outgoing call is an intra LAN call.

2.6 Regarding claim 6 and 36, Alexander teaches a mapping table in figure 4 for look-up.

2.7 Regarding claim 7 and 37, Alexander teaches telephone numbers figure 4.

2.8 Regarding claims 8 and 38, Alexander teaches area codes in figure 4.

2.9 Regarding claims 9 and 39, Alexander teaches telephone numbers in figure 4.

2.10 Regarding claims 10 and 40, Alexander teaches converting phone number to IP address in figure 4.

Art Unit: 2653

2.11 Regarding claim 11-14 and 41-44, Alexander teaches a telephone mapping table in figure 4, and obviously, international calling can also be included to enable an IP phone to make international call. And when an international call is placed, a calling country code obviously is appended to notify a callee where the international call is originated.

2.12 Regarding claims 15 and 45, Alexander teaches identifying the outgoing call is an intra-LAN call (column 4, lines 26-62).

2.13 Regarding claims 16 and 46, Alexander teaches that the callee's number can be an extension number (figure 4).

2.14 Regarding claims 17, 18, 47 and 48, Alexander teaches a mapping table in figure 4.

2.15 Regarding claims 19-21 and 49-51, Alexander teaches determines whether the outgoing call is an intra-LAN call as stated above (in an intra-LAN call, caller and callee obviously can be with the same node, otherwise, they are with different nodes, one in LAN and on in PSTN).

2.16 Regarding claims 22-24 and 52-54, examiner takes an official notice that it was well known in the art and obvious that when a call was not answered, the unanswered call was routed to a callee's voicemail.

Art Unit: 2653

2.17 Regarding claims 25-28 and 55-58, Alexander teaches routing table for telephone numbers and alternate numbers (figures 3 and 4).

2.18 Regarding claims 29 and 59, examiner take an official notice that it was well known in the art that a caller had a limited call credit to make calls.

Conclusion

3. Any inquiry concerning this communication or earlier communication from the examiner should be directed to Simon Sing whose telephone number is 571-272-7545. The examiner can normally be reached on Monday - Thursday from 9:00 AM to 5:30 PM. If attempts to reach the examiner by telephone are unsuccessful, the examiner's supervisor, Fan Tsang, can be reached at 571-272-7547. The fax phone number for the organization where this application or proceeding is assigned is 571-273-8300. Any inquiry of a general nature or relating to the status of this application or proceeding should be directed to the receptionist whose telephone number is 571-272-2600.

/Simon Sing/

Primary Examiner, Art Unit 2653

Notice of References Cited	Application/Control No. 12/513,147	Applicant(s)/Patent Under Reexamination PERREAU ET AL.	
	Examiner SIMON SING	Art Unit 2653	Page 1 of 1

U.S. PATENT DOCUMENTS

*	Document Number Country Code-Number-Kind Code	Date MM-YYYY	Name	Classification
*	A US-6,798,767	09-2004	Alexander et al.	370/352
	B US-			
	C US-			
	D US-			
	E US-			
	F US-			
	G US-			
	H US-			
	I US-			
	J US-			
	K US-			
	L US-			
	M US-			

FOREIGN PATENT DOCUMENTS

*	Document Number Country Code-Number-Kind Code	Date MM-YYYY	Country	Name	Classification
	N				
	O				
	P				
	Q				
	R				
	S				
	T				

NON-PATENT DOCUMENTS

*	Document Number Country Code-Number-Kind Code	Date MM-YYYY	Country	Name	Classification
	Include as applicable: Author, Title Date, Publisher, Edition or Volume, Pertinent Pages)				
	U				
	V				
	W				
	X				

*A copy of this reference is not being furnished with this Office action. (See MPEP § 707.05(a).)
Dates in MM-YYYY format are publication dates. Classifications may be US or foreign.

INFORMATION DISCLOSURE STATEMENT BY APPLICANT	Application No.	12/513,147
	Filing Date	March 1, 2010
	First Named Inventor	Clay Perreault et al.
	Art Unit	2614 2653
<i>(Multiple sheets used when necessary)</i>	Examiner	Simon P. Sing
SHEET 1 OF 1	Attorney Docket No.	SMARB19.001APC

U.S. PATENT DOCUMENTS					
Examiner Initials	Cite No.	Document Number Number - Kind Code (if known) Example: 1,234,567 B1	Publication Date MM-DD-YYYY	Name of Patentee or Applicant	Pages, Columns, Lines Where Relevant Passages or Relevant Figures Appear

FOREIGN PATENT DOCUMENTS						
Examiner Initials	Cite No.	Foreign Patent Document Country Code-Number-Kind Code Example: JP 1234567 A1	Publication Date MM-DD-YYYY	Name of Patentee or Applicant	Pages, Columns, Lines Where Relevant Passages or Relevant Figures Appear	T ¹

NON PATENT LITERATURE DOCUMENTS			
Examiner Initials	Cite No.	Include name of the author (in CAPITAL LETTERS), title of the article (when appropriate), title of the item (book, magazine, journal, serial, symposium, catalog, etc.), date, page(s), volume-issue number(s), publisher, city and/or country where published.	T ¹
/SS/	1	Supplementary European Search Report for European Application No. 07816106 dated June 18, 2012.	

13927953-sjw 090712

Examiner Signature	/Simon Sing/	Date Considered	02/15/2013
--------------------	--------------	-----------------	------------

***Examiner:** Initial if reference considered, whether or not citation is in conformance with MPEP 609. Draw line through citation if not in conformance and not considered. Include copy of this form with next communication to applicant.

T¹ - Place a check mark in this area when an English language translation is attached. PETITIONER APPLE INC. EX. 1002-162

INFORMATION DISCLOSURE STATEMENT BY APPLICANT	Application No.	12/513,147	
	Filing Date	March 1, 2010	
	First Named Inventor	Clay Perreault et al.	
	Art Unit	2614 2653	
<i>(Multiple sheets used when necessary)</i>		Examiner	Simon P. Sing
SHEET 1 OF 1		Attorney Docket No.	SMARB19.001APC

U.S. PATENT DOCUMENTS					
Examiner Initials	Cite No.	Document Number <i>Number - Kind Code (if known)</i> Example: 1,234,567 B1	Publication Date MM-DD-YYYY	Name of Patentee or Applicant	Pages, Columns, Lines Where Relevant Passages or Relevant Figures Appear
/SS/	1	8,116,307	2/14/2012	Thesayi et al.	
/SS/	2	2006/0093135 A1	5/4/2006	Fiatal et al.	

FOREIGN PATENT DOCUMENTS						
Examiner Initials	Cite No.	Foreign Patent Document <i>Country Code-Number-Kind Code</i> Example: JP 1234567 A1	Publication Date MM-DD-YYYY	Name of Patentee or Applicant	Pages, Columns, Lines Where Relevant Passages or Relevant Figures Appear	T ¹

NON PATENT LITERATURE DOCUMENTS			
Examiner Initials	Cite No.	Include name of the author (in CAPITAL LETTERS), title of the article (when appropriate), title of the item (book, magazine, journal, serial, symposium, catalog, etc.), date, page(s), volume-issue number(s), publisher, city and/or country where published.	T ¹

13684957-sjw 072612

Examiner Signature	/Simon Sing/	Date Considered	02/15/2013
--------------------	--------------	-----------------	------------

*Examiner: Initial if reference considered, whether or not citation is in conformance with MPEP 609. Draw line through citation if not in conformance and not considered. Include copy of this form with next communication to applicant.

T¹ - Place a check mark in this area when an English language translation is attached. **PETITIONER APPLE INC. EX. 1002-163**

EAST Search History

EAST Search History (Prior Art)

Ref #	Hits	Search Query	DBs	Default Operator	Plurals	Time Stamp
S5	8907	(class or classification or classif\$4) with routing	US-PGPUB; USPAT; USOCR; FPRS; EPO; JPO; DERWENT; IBM_TDB	OR	ON	2013/02/08 18:05
S6	10	S5 same (call with caller) same ((private or public) near2 network)	US-PGPUB; USPAT; USOCR; FPRS; EPO; JPO; DERWENT; IBM_TDB	OR	ON	2013/02/08 18:06
S7	134	S5 same (call with caller)	US-PGPUB; USPAT; USOCR; FPRS; EPO; JPO; DERWENT; IBM_TDB	OR	ON	2013/02/08 18:12
S8	71	S5 with (call with caller)	US-PGPUB; USPAT; USOCR; FPRS; EPO; JPO; DERWENT; IBM_TDB	OR	ON	2013/02/08 18:13
S9	3006	((voice adj over adj IP) or VolP) same server same router	US-PGPUB; USPAT; USOCR; FPRS; EPO; JPO; DERWENT; IBM_TDB	OR	ON	2013/02/12 11:41
S10	562	S9 same ((caller adj ID) or address)	US-PGPUB; USPAT; USOCR; FPRS; EPO; JPO; DERWENT; IBM_TDB	OR	ON	2013/02/12 11:52
S11	21	S10 same (gateway near3 address)	US-PGPUB; USPAT; USOCR; FPRS; EPO; JPO; DERWENT; IBM_TDB	OR	ON	2013/02/12 11:53
S17	2	S9 same (routing with message with gateway with address)	US-PGPUB; USPAT; USOCR; FPRS; EPO; JPO; DERWENT; IBM_TDB	OR	ON	2013/02/12 11:57
S18	21	S9 same (gateway near3 address)	US-PGPUB; USPAT; USOCR; FPRS; EPO; JPO; DERWENT; IBM_TDB	OR	ON	2013/02/12 11:59
S19	277	S10 same gateway	US-PGPUB; USPAT; USOCR; FPRS; EPO; JPO; DERWENT; IBM_TDB	OR	ON	2013/02/12 12:05
S20	263	((voice adj over adj IP) or VolP) same server same (gateway near3 address)	US-PGPUB; USPAT; USOCR; FPRS; EPO; JPO; DERWENT; IBM_TDB	OR	ON	2013/02/12 12:06
S21	66	((voice adj over adj IP) or VolP) same server same (rout\$3 adj message)	US-PGPUB; USPAT; USOCR; FPRS; EPO; JPO; DERWENT; IBM_TDB	OR	ON	2013/02/12 12:06

2/ 19/ 2013 12:33:02 PM

C:\Users\ssing\Documents\EAST\Workspaces\default.wsp

INFORMATION DISCLOSURE STATEMENT BY APPLICANT	Application No.	12/513,147
	Filing Date	March 1, 2010
	First Named Inventor	Clay Perreault
	Art Unit	2614 2653
<i>(Multiple sheets used when necessary)</i>	Examiner	Unassigned Simon Sing
SHEET 1 OF 6	Attorney Docket No.	SMARB19.001APC

U.S. PATENT DOCUMENTS					
Examiner Initials	Cite No.	Document Number Number - Kind Code (if known) Example: 1,234,567 B1	Publication Date MM-DD-YYYY	Name of Patentee or Applicant	Pages, Columns, Lines Where Relevant Passages or Relevant Figures Appear
	1	2002/0051518 A1	05-02-2002	Bondy et al.	
	2	2002/0116464 A1	08-22-2002	Mak	
	3	2003/0219103 A1	11-27-2003	Rao et al.	
	4	2004/0157629 A1	08-12-2004	Kallio et al.	
	5	2004/0165709 a1	08-26-2004	Pence et al.	
	6	2004/0181599 A1	09-16-2004	Kreusch et al.	
	7	2004/0202295 A1	10-14-2004	Shen et al.	
	8	2004/0255126 A1	12-16-2004	Reith	
	9	2005/0083911 A1	04-21-2005	Grabelsky et al.	
	10	2005/0094651 A1	05-05-2005	Lutz et al.	
	11	2005/0169248 A1	08-04-2005	Truesdale et al.	
	12	2005/0174937 A1	08-11-2005	Scoggins et al.	
	13	2005/0177843 A1	08-11-2005	Williams	
	14	2006/0072547 A1	04-06-2006	Florkey et al.	
	15	2006/0111116 A1	05-25-2006	Palmer et al.	
	16	2006/0160565 A1	07-20-2006	Singh et al.	
	17	2006/0177035 A1	08-10-2006	Cope et al.	
	18	2006/0209768 A1	09-21-2006	Yan et al.	
	19	2008/0037715 A1	02-14-2008	Prozeniuk et al.	

Examiner Signature	Date Considered
<p>*Examiner: Initial if reference considered, whether or not citation is in conformance with MPEP 609. Draw line through citation if not in conformance and not considered. Include copy of this form with next communication to applicant.</p>	

T¹ - Place a checkmark in the reference box if the reference is considered pertinent to the art. /SS/

INFORMATION DISCLOSURE STATEMENT BY APPLICANT	Application No.	12/513,147
	Filing Date	March 1, 2010
	First Named Inventor	Clay Perreault
	Art Unit	2614
<i>(Multiple sheets used when necessary)</i>	Examiner	Unassigned
SHEET 2 OF 6	Attorney Docket No.	SMARB19.001APC

U.S. PATENT DOCUMENTS

Examiner Initials	Cite No.	Document Number Number - Kind Code (if known) Example: 1,234,567 B1	Publication Date MM-DD-YYYY	Name of Patentee or Applicant	Pages, Columns, Lines Where Relevant Passages or Relevant Figures Appear
	20	2008/0063153 A1	03-13-2008	Krivorot et al.	
	21	4,916,491	04-10-1990	Katoh	
	22	5,146,491	09-08-1992	Silver et al.	
	23	5,247,571	09-21-1993	Kay et al .	
	24	5,303,297	04-12-1994	Hillis	
	25	5,359,642	10-25-1994	Castro	
	26	5,425,085	06-13-1995	Weinberger et al.	
	27	5,440,621	08-08-1995	Castro	
	28	5,469,497	11-21-1995	Pierce et al.	
	29	5,506,893	04-09-1996	Buscher et al.	
	30	5,519,769	05-21-1996	Weinberger et al.	
	31	5,559,871	09-24-1996	Smith	
	32	5,590,133	12-31-1996	Billstrom et al.	
	33	5,608,786	05-04-1997	Gordon	
	34	5,621,787	04-15-1997	McKoy et al.	
	35	5,661,790	08-26-1997	Hsu	
	36	5,712,907	01-27-1998	Wegner et al.	
	37	5,724,355	05-03-1998	Bruno et al.	
	38	5,726,984	05-10-1998	Kubler et al.	

Examiner Signature	Date Considered
--------------------	-----------------

***Examiner:** Initial if reference considered, whether or not citation is in conformance with MPEP 609. Draw line through citation if not in conformance and not considered. Include copy of this form with next communication to applicant.

INFORMATION DISCLOSURE STATEMENT BY APPLICANT	Application No.	12/513,147
	Filing Date	March 1, 2010
	First Named Inventor	Clay Perreault
	Art Unit	2614
<i>(Multiple sheets used when necessary)</i>	Examiner	Unassigned
SHEET 3 OF 6	Attorney Docket No.	SMARB19.001APC

U.S. PATENT DOCUMENTS

Examiner Initials	Cite No.	Document Number Number - Kind Code (if known) Example: 1,234,567 B1	Publication Date MM-DD-YYYY	Name of Patentee or Applicant	Pages, Columns, Lines Where Relevant Passages or Relevant Figures Appear
	39	5,737,414	04-07-1998	Walker et al.	
	40	5,751,961	05-12-1998	Smyk	
	41	5,793,762	08-11-1998	Penners et al.	
	42	5,799,072	08-25-1998	Vulcan et al.	
	43	5,802,502	09-01-1998	Gell et al.	
	44	5,825,863	10-20-1998	Walker	
	45	5,828,740	10-27-1998	Khuc et al.	
	46	5,838,682	11-17-1998	Dekelbaum et al.	
	47	5,845,267	12-01-1998	Ronen	
	48	5,850,433	12-15-1998	Rondeau	
	49	5,864,610	01-26-1999	Ronen	
	50	5,867,495	02-02-1999	Elliott et al.	
	51	5,883,891	05-16-1999	Williams et al.	
	52	5,889,774	05-30-1999	Mirashrafi et al.	
	53	5,905,736	05-18-1999	Ronen et al.	
	54	5,907,547	05-25-1999	Foladare et al.	
	55	5,910,946	06-08-1999	Csapo	
	56	5,915,005	06-22-1999	He	
	57	5,923,659	01-30-2001	Curry et al.	

Examiner Signature	Date Considered
--------------------	-----------------

*Examiner: Initial if reference considered, whether or not citation is in conformance with MPEP 609. Draw line through citation if not in conformance and not considered. Include copy of this form with next communication to applicant.

T¹ - Place a checkmark in this area when an English language translation is provided. **ALL REFERENCES CONSIDERED PERTINENT AND INCORPORATED BY REFERENCE THROUGHOUT.** /SS/

INFORMATION DISCLOSURE STATEMENT BY APPLICANT	Application No.	12/513,147
	Filing Date	March 1, 2010
	First Named Inventor	Clay Perreault
	Art Unit	2614
<i>(Multiple sheets used when necessary)</i>	Examiner	Unassigned
SHEET 4 OF 6	Attorney Docket No.	SMARB19.001APC

U.S. PATENT DOCUMENTS

Examiner Initials	Cite No.	Document Number Number - Kind Code (if known) Example: 1,234,567 B1	Publication Date MM-DD-YYYY	Name of Patentee or Applicant	Pages, Columns, Lines Where Relevant Passages or Relevant Figures Appear
	58	5,930,343	07-27-1999	Vasquez	
	59	5,937,045	08-10-1999	Yaoya et al.	
	60	5,940,598	08-17-1999	Strauss et al.	
	61	5,953,504	09-14-1999	Sokal et al.	
	62	5,956,391	09-21-1999	Melen et al.	
	63	5,970,477	10-19-1999	Roden	
	64	5,974,043	10-26-1999	Solomon	
	65	5,991,291	11-23-1999	Asai et al.	
	66	6,005,926	12-21-1999	Mashinsky	
	67	6,014,379	01-11-2000	White et al.	
	68	6,021,126	02-01-2000	White et al.	
	69	6,052,445	10-28-2003	Bashoura et al.	
	70	6,058,300	05-02-2000	Hanson	
	71	6,069,890	05-30-2000	White et al.	
	72	6,073,013	06-06-2000	Agre et al.	
	73	6,104,704	08-15-2000	Buhler et al.	
	74	6,104,711	08-15-2000	Voit	
	75	6,115,737	09-05-2000	Ely et al.	
	76	6,128,304	10-03-2000	Gardell et al.	

Examiner Signature	Date Considered
--------------------	-----------------

***Examiner:** Initial if reference considered, whether or not citation is in conformance with MPEP 609. Draw line through citation if not in conformance and not considered. Include copy of this form with next communication to applicant.

INFORMATION DISCLOSURE STATEMENT BY APPLICANT	Application No.	12/513,147
	Filing Date	March 1, 2010
	First Named Inventor	Clay Perreault
	Art Unit	2614
<i>(Multiple sheets used when necessary)</i>	Examiner	Unassigned
SHEET 5 OF 6	Attorney Docket No.	SMARB19.001APC

U.S. PATENT DOCUMENTS

Examiner Initials	Cite No.	Document Number Number - Kind Code (if known) Example: 1,234,567 B1	Publication Date MM-DD-YYYY	Name of Patentee or Applicant	Pages, Columns, Lines Where Relevant Passages or Relevant Figures Appear
	77	6,137,869	10-24-2000	Voit et al	
	78	6,141,404	10-31-2000	Westerlage et al.	
	79	6,188,752 B1	02-13-2001	Lesley	
	80	6,282,574	08-28-2001	Voit	
	81	6,298,062	10-02-2001	Gardell et al.	
	82	6,351,464	02-26-2002	Galvin et al.	
	83	6,359,880	05-19-2002	Curry et al.	
	84	6,430,275	08-06-2002	Voit et al	
	85	6,507,644 B1	01-14-2003	Henderson et al.	
	86	6,766,159 B2	07-20-2004	Lindholm	
	87	6,819,929 B2	11-16-2004	Antonucci et al.	
	88	6,954,453	10-11-2005	Schindler	
	89	7,068,772	06-27-2006	Widger et al.	
	90	7,120,682 B1	10-10-2006	Salama	
	91	7,212,522 B1	05-01-2007	Shankar et al.	

FOREIGN PATENT DOCUMENTS

Examiner Initials	Cite No.	Foreign Patent Document Country Code-Number-Kind Code Example: JP 1234567 A1	Publication Date MM-DD-YYYY	Name of Patentee or Applicant	Pages, Columns, Lines Where Relevant Passages or Relevant Figures Appear	T ¹
	92	CA 2,249,668	04-07-1999	Bruno et al.		
	93	EP 1 389 862 A1	02-18-2004	Shen et al.		

Examiner Signature	Date Considered
--------------------	-----------------

*Examiner: Initial if reference considered, whether or not citation is in conformance with MPEP 609. Draw line through citation if not in conformance and not considered. Include copy of this form with next communication to applicant.

T¹ - Place a checkmark in the box if the reference is considered pertinent to the applicant's invention. /SS/

INFORMATION DISCLOSURE STATEMENT BY APPLICANT	Application No.	12/513,147
	Filing Date	March 1, 2010
	First Named Inventor	Clay Perreault
	Art Unit	2614
<i>(Multiple sheets used when necessary)</i>	Examiner	Unassigned
SHEET 6 OF 6	Attorney Docket No.	SMARB19.001APC

FOREIGN PATENT DOCUMENTS

Examiner Initials	Cite No.	Foreign Patent Document Country Code-Number-Kind Code Example: JP 1234567 A1	Publication Date MM-DD-YYYY	Name of Patentee or Applicant	Pages, Columns, Lines Where Relevant Passages or Relevant Figures Appear	T ¹
	94	WO 2007/044454 A2	04-19-2007	Croy et al.		
	95	WO 2008/052340 A1	05-08-2008	Perreault et al.		
	96	WO 2008/064481 A1	06-05-2008	Bjorsell et al.		
	97	WO 2008/116296 A1	10-02-2008	Bjorsell et al.		

NON PATENT LITERATURE DOCUMENTS

Examiner Initials	Cite No.	Include name of the author (in CAPITAL LETTERS), title of the article (when appropriate), title of the item (book, magazine, journal, serial, symposium, catalog, etc.), date, page(s), volume-issue number(s), publisher, city and/or country where published.	T ¹
	98	F. Baker et al. "RFC 3924 - Cisco Architecture for Lawful Intercept in IP Networks." October 2004.	
	99	Cisco. "Lawful Intercept Requirements Summary." http://www.faqs.org/rfcs/rfc3924.html . November 8, 2006.	
	100	Sippy SIP B2BUA. "About Sippy RTPproxy." http://www.rtpproxy.org . July 15, 2009.	
	101	ETSI Technical Specification. "Lawful Interception (LI); Handover Interface and Service-Specific Details (SSD) for IP delivery; Part 5: Service-specific details for IP Multimedia Services." Apr 2008, 25 pgs, v.2.3.1, France.	
	102	M. Handley et al. "RFC 2543 - SIP: Session Initiation Protocol." March 1999.	
	103	A copy of the International Search Report and Written Opinion of the International Searching Authority completed June 6, 2008 for related PCT/CA2008/000545.	
	104	A copy of the International Search Report and Written Opinion of the International Searching Authority completed February 6, 2008 for corresponding PCT/CA2007/001956.	
	105	A copy of the International Preliminary Report on Patentability mailed May 14, 2009 for corresponding PCT/CA2007/001956.	
	106	A copy of the International Search Report and Written Opinion of the International Searching Authority completed March 3, 2008 for related PCT/CA2007/002150.	
	107	A copy of the International Preliminary Report on Patentability mailed February 13, 2009 for related PCT/CA2007/002150.	

8659055\cey
030410

Examiner Signature	/Simon Sing/	Date Considered	02/15/2013
--------------------	--------------	-----------------	------------

***Examiner:** Initial if reference considered, whether or not citation is in conformance with MPEP 609. Draw line through citation if not in conformance and not considered. Include copy of this form with next communication to applicant.

T¹ - Place a checkmark in this area when an additional language translation is required. /SS/

INFORMATION DISCLOSURE STATEMENT BY APPLICANT	Application No.	12/513147	
	Filing Date	03-01-2010	
	First Named Inventor	Clay Perreault et al	
	Art Unit	2614 2653	
<i>(Multiple sheets used when necessary)</i>		Examiner	Curtis A. Kuntz Simon Sing
SHEET 1 OF 1		Attorney Docket No.	SMARB19.001APC

U.S. PATENT DOCUMENTS

Examiner Initials	Cite No.	Document Number Number - Kind Code (if known) Example: 1,234,567 B1	Publication Date MM-DD-YYYY	Name of Patentee or Applicant	Pages, Columns, Lines Where Relevant Passages or Relevant Figures Appear
	1	7,454,510	11-18-2008	Kleyman et al.	
	2	2004/0022237 A1	02-05-2004	Elliot et al.	
	3	2007/0036143 A1	02-15-2007	Alt et al.	
	4	2007/0112964 A1	05-17-2007	Guedalia et al.	
	5	2007/0253418	11-01-2007	Shiri et al.	
	6	2009/0028146 A1	01-29-2009	Kleyman et al.	

FOREIGN PATENT DOCUMENTS

Examiner Initials	Cite No.	Foreign Patent Document Country Code-Number-Kind Code Example: JP 1234567 A1	Publication Date MM-DD-YYYY	Name of Patentee or Applicant	Pages, Columns, Lines Where Relevant Passages or Relevant Figures Appear	T ¹
	7	EP 1 389 862 B1	11-03-2004	Shen et al.		

NON PATENT LITERATURE DOCUMENTS

Examiner Initials	Cite No.	Include name of the author (in CAPITAL LETTERS), title of the article (when appropriate), title of the item (book, magazine, journal, serial, symposium, catalog, etc.), date, page(s), volume-issue number(s), publisher, city and/or country where published.	T ¹
	8	A copy of the International Preliminary Report on Patentability and Written Opinion of the International Searching Authority mailed February 10, 2011 for related PCT Application No. PCT/CA2009/001062, February 10, 2011.	
	9	A copy of the International Preliminary Report on Patentability mailed February 13, 2009 for corresponding PCT/CA2007/002150.	
	10	A copy of the International Preliminary Report on Patentability mailed May 14, 2009 for related PCT/CA2007/001956.	
	11	A copy of the International Search Report and Written Opinion mailed on March 12, 2010 for corresponding PCT Application No. PCT/CA2009/001062.	
	12	A copy of the International Search Report and Written Opinion of the International Searching Authority completed February 6, 2008 for related PCT/CA2007/001956.	
	13	A copy of the International Search Report and Written Opinion of the International Searching Authority completed June 6, 2008 for corresponding PCT/CA2008/000545.	
	14	A copy of the International Search Report completed on March 3, 2008 for corresponding PCT/CA2007/002150.	
	15	A copy of the Written Opinion and International Search Report completed on June 17, 2010 for related PCT Application No. PCT/CA2009/001317, June 17, 2010.	

11179518\cey
050411

Examiner Signature	/Simon Sing/	Date Considered	02/15/2013
--------------------	--------------	-----------------	------------

*Examiner: Initial if reference considered, whether or not citation is in conformance with MPEP 609. Draw line through citation if not in conformance and not considered. Include copy of this form with next communication to applicant.

T¹ - Place a check mark in this area when an English language PATE N T I O N E R A P P L I C A N T . I N C . EX. 1002-171

ALL REFERENCES CONSIDERED EXCEPT WHERE LINED THROUGH. /SS/

INFORMATION DISCLOSURE STATEMENT BY APPLICANT	Application No.	12/513,147	
	Filing Date	March 1, 2010	
	First Named Inventor	Clay Perreault et al.	
	Art Unit	2614 2653	
<i>(Multiple sheets used when necessary)</i>		Examiner	Simon P. Sing
SHEET 1 OF 1		Attorney Docket No.	SMARB19.001APC

U.S. PATENT DOCUMENTS					
Examiner Initials	Cite No.	Document Number Number - Kind Code (if known) Example: 1,234,567 B1	Publication Date MM-DD-YYYY	Name of Patentee or Applicant	Pages, Columns, Lines Where Relevant Passages or Relevant Figures Appear

FOREIGN PATENT DOCUMENTS						
Examiner Initials	Cite No.	Foreign Patent Document Country Code-Number-Kind Code Example: JP 1234567 A1	Publication Date MM-DD-YYYY	Name of Patentee or Applicant	Pages, Columns, Lines Where Relevant Passages or Relevant Figures Appear	T ¹

NON PATENT LITERATURE DOCUMENTS			
Examiner Initials	Cite No.	Include name of the author (in CAPITAL LETTERS), title of the article (when appropriate), title of the item (book, magazine, journal, serial, symposium, catalog, etc.), date, page(s), volume-issue number(s), publisher, city and/or country where published.	T ¹
	1	A copy of the International Preliminary Report on Patentability issued on September 29, 2009 for PCT/CA2008/000545.	
	2	A copy of the International Preliminary Report on Patentability issued on March 20, 2012 for PCT/CA2009/001317.	
	3	Townsley, et al.; "RFC 2661 - Layer Two Tunneling Protocol 'L2TP' ", August 1999.	
	4	IP2Location, http://www.ip2location.com/ ; printed June 20, 2012.	
	5	DOTS IP Address Validation, "Overview", http://www.serviceobjects.com/products/dots_ipgeo.asp ; printed June 21, 2012.	
	6	List of North American Numbering Plan area codes, http://en.wikipedia.org/wiki/List_of_NANP_area_codes ; printed June 20, 2012.	
	7	DOTS Phone Exchange, "Overview", http://www.serviceobjects.com/demos/PhoneExchangeDemo.asp (URL no longer valid, current URL is http://www.serviceobjects.com/products/phone/phone-exchange); printed June 21, 2012.	
	8	Rosenberg, et al.; "RFC 3261 - SIP: Session Initiation Protocol", June 2002.	

13464825-sjw 061512

Examiner Signature	/Simon Sing/	Date Considered	02/15/2013
--------------------	--------------	-----------------	------------

*Examiner: Initial if reference considered, whether or not citation is in conformance with MPEP 609. Draw line through citation if not in conformance and not considered. Include copy of this form with next communication to applicant.

T¹ - Place a check mark in this area when an English language translation is attached.

ALL REFERENCES CONSIDERED EXCEPT WHERE LINED THROUGH. /SS/

INFORMATION DISCLOSURE STATEMENT BY APPLICANT	Application No.	12/513,147
	Filing Date	March 1, 2010
	First Named Inventor	Clay Perreault et al.
	Art Unit	2614 2653
<i>(Multiple sheets used when necessary)</i>	Examiner	Simon P. Sing
SHEET 1 OF 1	Attorney Docket No.	SMARB19.001APC

U.S. PATENT DOCUMENTS					
Examiner Initials	Cite No.	Document Number Number - Kind Code (if known) Example: 1,234,567 B1	Publication Date MM-DD-YYYY	Name of Patentee or Applicant	Pages, Columns, Lines Where Relevant Passages or Relevant Figures Appear
	1	6,151,385	11/21/2000	Reich et al.	
	2	6,597,686	07/22/2003	Darek A Smyk	
	3	6,724,860	04/20/2004	Stumer et al.	
	4	6,744,858	06/01/2004	Ryan et al.	
	5	6,963,557	11/08/2005	Mark Clinton Knox	
	6	7,046,658	05/16/2006	Vinay Kundaje	
	7	2005/025043 A1	02/03/2005	Mussman et al	
	8	2006/0153342 A1	07/13/2006	Syouichi Sasaki	
	9	2006/0258328 A1	11/16/2006	Mario Francisco Godoy	

FOREIGN PATENT DOCUMENTS						
Examiner Initials	Cite No.	Foreign Patent Document Country Code-Number-Kind Code Example: JP 1234567 A1	Publication Date MM-DD-YYYY	Name of Patentee or Applicant	Pages, Columns, Lines Where Relevant Passages or Relevant Figures Appear	T ¹

NON PATENT LITERATURE DOCUMENTS			
Examiner Initials	Cite No.	Include name of the author (in CAPITAL LETTERS), title of the article (when appropriate), title of the item (book, magazine, journal, serial, symposium, catalog, etc.), date, page(s), volume-issue number(s), publisher, city and/or country where published.	T ¹
	10	Lind AT&T S: "ENUM Call Flows for VoIP Interworking; draft-lind-enum-callflows-03.txt", 20020201, no. 3, 1 February 2002, pages 1-17.	
	11	IETF ENUM WG R STASTNY OEFEG INFORMATIONAL NUMBERING FOR VOIP AND OTHER IP COMMUNICATIONS: "Numbering for VoIP and other IP Communications, draft-stastny-enum-numbering-voip-00.txt", 20031001, 1 October 2003, pages 1-43.	

13890436-sjw 083112

Examiner Signature /Simon Sing/	Date Considered 02/15/2013
---------------------------------	----------------------------

***Examiner:** Initial if reference considered, whether or not citation is in conformance with MPEP 609. Draw line through citation if not in conformance and not considered. Include copy of this form with next communication to applicant.

T¹ - Place a check mark in this area when an English language translation is attached. PETITIONER APPLE INC. EX. 1002-173

ALL REFERENCES CONSIDERED EXCEPT WHERE LINED THROUGH. /SS/

Search Notes 	Application/Control No. 12513147	Applicant(s)/Patent Under Reexamination PERREAU ET AL.
	Examiner SIMON SING	Art Unit 2653

CPC- SEARCHED		
Symbol	Date	Examiner

CPC COMBINATION SETS - SEARCHED		
Symbol	Date	Examiner

US CLASSIFICATION SEARCHED			
Class	Subclass	Date	Examiner

SEARCH NOTES		
Search Notes	Date	Examiner
EAST	02/12/2013	SS

INTERFERENCE SEARCH			
US Class/ CPC Symbol	US Subclass / CPC Group	Date	Examiner

--	--

UNITED STATES PATENT AND TRADEMARK OFFICE

UNITED STATES DEPARTMENT OF COMMERCE
United States Patent and Trademark Office
 Address: COMMISSIONER FOR PATENTS
 P.O. Box 1450
 Alexandria, Virginia 22313-1450
 www.uspto.gov

BIB DATA SHEET
CONFIRMATION NO. 9611

SERIAL NUMBER	FILING or 371(c) DATE	CLASS	GROUP ART UNIT	ATTORNEY DOCKET NO.		
12/513,147	03/01/2010	379	2653	SMARB19.001APC		
APPLICANTS Clay Perreault, Panama City, PANAMA; Steve Nicholson, Hamilton, NEW ZEALAND; Rod Thomson, North Vancouver, BC, CANADA; Johan Emil Victor Bjorsell, Vancouver, BC, CANADA; Fuad Arafa, Vancouver, BC, CANADA;						
** CONTINUING DATA ***** This application is a 371 of PCT/CA07/01956 11/01/2007 which claims benefit of 60/856,212 11/02/2006						
** FOREIGN APPLICATIONS *****						
** IF REQUIRED, FOREIGN FILING LICENSE GRANTED ** ** SMALL ENTITY ** 03/03/2010						
Foreign Priority claimed	<input type="checkbox"/> Yes <input checked="" type="checkbox"/> No	<input type="checkbox"/> Met after Allowance	STATE OR COUNTRY	SHEETS DRAWINGS	TOTAL CLAIMS	INDEPENDENT CLAIMS
35 USC 119(a-d) conditions met	<input type="checkbox"/> Yes <input checked="" type="checkbox"/> No	Initials	PANAMA	32	59	3
Verified and Acknowledged	/SIMON P SING/ Examiner's Signature					
ADDRESS KNOBBE MARTENS OLSON & BEAR LLP 2040 MAIN STREET FOURTEENTH FLOOR IRVINE, CA 92614 UNITED STATES						
TITLE PRODUCING ROUTING MESSAGES FOR VOICE OVER IP COMMUNICATIONS						
FILING FEE RECEIVED 1704	FEES: Authority has been given in Paper No. _____ to charge/credit DEPOSIT ACCOUNT No. _____ for following:			<input type="checkbox"/> All Fees <input type="checkbox"/> 1.16 Fees (Filing) <input type="checkbox"/> 1.17 Fees (Processing Ext. of time) <input type="checkbox"/> 1.18 Fees (Issue) <input type="checkbox"/> Other _____ <input type="checkbox"/> Credit		

<i>Index of Claims</i> 	Application/Control No. 12513147	Applicant(s)/Patent Under Reexamination PERREULT ET AL.
	Examiner SIMON SING	Art Unit 2653

✓	Rejected
=	Allowed

-	Cancelled
÷	Restricted

N	Non-Elected
I	Interference

A	Appeal
O	Objected

Claims renumbered in the same order as presented by applicant
 CPA
 T.D.
 R.1.47

CLAIM		DATE							
Final	Original	02/19/2013							
	1	✓							
	2	✓							
	3	✓							
	4	✓							
	5	✓							
	6	✓							
	7	✓							
	8	✓							
	9	✓							
	10	✓							
	11	✓							
	12	✓							
	13	✓							
	14	✓							
	15	✓							
	16	✓							
	17	✓							
	18	✓							
	19	✓							
	20	✓							
	21	✓							
	22	✓							
	23	✓							
	24	✓							
	25	✓							
	26	✓							
	27	✓							
	28	✓							
	29	✓							
	30	✓							
	31	✓							
	32	✓							
	33	✓							
	34	✓							
	35	✓							
	36	✓							

Index of Claims 	Application/Control No. 12513147	Applicant(s)/Patent Under Reexamination PERREAULT ET AL.
	Examiner SIMON SING	Art Unit 2653

✓	Rejected
=	Allowed

-	Cancelled
÷	Restricted

N	Non-Elected
I	Interference

A	Appeal
O	Objected

Claims renumbered in the same order as presented by applicant
 CPA
 T.D.
 R.1.47

CLAIM		DATE							
Final	Original	02/19/2013							
	37	✓							
	38	✓							
	39	✓							
	40	✓							
	41	✓							
	42	✓							
	43	✓							
	44	✓							
	45	✓							
	46	✓							
	47	✓							
	48	✓							
	49	✓							
	50	✓							
	51	✓							
	52	✓							
	53	✓							
	54	✓							
	55	✓							
	56	✓							
	57	✓							
	58	✓							
	59	✓							

INFORMATION DISCLOSURE STATEMENT BY APPLICANT	Application No.	12/513,147	
	Filing Date	March 1, 2010	
	First Named Inventor	Clay Perreault et al.	
	Art Unit	2614 2653	
<i>(Multiple sheets used when necessary)</i>		Examiner	Simon P. Sing
SHEET 1 OF 1		Attorney Docket No.	SMARB19.001APC

U.S. PATENT DOCUMENTS

Examiner Initials	Cite No.	Document Number <i>Number - Kind Code (if known)</i> Example: 1,234,567 B1	Publication Date MM-DD-YYYY	Name of Patentee or Applicant	Pages, Columns, Lines Where Relevant Passages or Relevant Figures Appear
	1	7,055,174 B1	05-30-2006	Cope et al.	
	2	2003/0200311 A1	10-23-2003	Baum	
	3	2004/0240439 A1	12-02-2004	Castleberry et al.	
	4	2006/0072550 A1	04-06-2006	Davis et al.	

FOREIGN PATENT DOCUMENTS

Examiner Initials	Cite No.	Foreign Patent Document <i>Country Code-Number-Kind Code</i> Example: JP 1234567 A1	Publication Date MM-DD-YYYY	Name of Patentee or Applicant	Pages, Columns, Lines Where Relevant Passages or Relevant Figures Appear	T ¹
	5	WO 01/89145 A2	11-22-2001	Telefonaktiebolaget LM Ericsson		

NON PATENT LITERATURE DOCUMENTS

Examiner Initials	Cite No.	Include name of the author (in CAPITAL LETTERS), title of the article (when appropriate), title of the item (book, magazine, journal, serial, symposium, catalog, etc.), date, page(s), volume-issue number(s), publisher, city and/or country where published.	T ¹
	6	EPO, Supplementary European Search Report, dated November 2, 2012, Application No. 07855436.7, corresponds to U.S. Application No. 12/517,026, Attorney Docket No. SMARB19.002APC.	

14648756:djl
011113

Examiner Signature	/Simon Sing/	Date Considered	02/15/2013
--------------------	--------------	-----------------	------------

*Examiner: Initial if reference considered, whether or not citation is in conformance with MPEP 609. Draw line through citation if not in conformance and not considered. Include copy of this form with next communication to applicant.

T¹ - Place a check mark in this area when an English language PETSIFONER APPLIED INC. EX. 1002-178

ALL REFERENCES CONSIDERED EXCEPT WHERE LINED THROUGH. /SS/

INFORMATION DISCLOSURE STATEMENT BY APPLICANT	Application No.	12/513,147	
	Filing Date	March 1, 2010	
	First Named Inventor	Clay Perreault et al.	
	Art Unit	2614	
<i>(Multiple sheets used when necessary)</i>		Examiner	Simon P. Sing
SHEET 1 OF 1		Attorney Docket No.	SMARB19.001APC

U.S. PATENT DOCUMENTS

Examiner Initials	Cite No.	Document Number <i>Number - Kind Code (if known)</i> Example: 1,234,567 B1	Publication Date MM-DD-YYYY	Name of Patentee or Applicant	Pages, Columns, Lines Where Relevant Passages or Relevant Figures Appear
	1	7,055,174 B1	05-30-2006	Cope et al.	
	2	2003/0200311 A1	10-23-2003	Baum	
	3	2004/0240439 A1	12-02-2004	Castleberry et al.	
	4	2006/0072550 A1	04-06-2006	Davis et al.	

FOREIGN PATENT DOCUMENTS

Examiner Initials	Cite No.	Foreign Patent Document <i>Country Code-Number-Kind Code</i> Example: JP 1234567 A1	Publication Date MM-DD-YYYY	Name of Patentee or Applicant	Pages, Columns, Lines Where Relevant Passages or Relevant Figures Appear	T ¹
	5	WO 01/89145 A2	11-22-2001	Telefonaktiebolaget LM Ericsson		

NON PATENT LITERATURE DOCUMENTS

Examiner Initials	Cite No.	Include name of the author (in CAPITAL LETTERS), title of the article (when appropriate), title of the item (book, magazine, journal, serial, symposium, catalog, etc.), date, page(s), volume-issue number(s), publisher, city and/or country where published.	T ¹
	6	EPO, Supplementary European Search Report, dated November 2, 2012, Application No. 07855436.7, corresponds to U.S. Application No. 12/517,026, Attorney Docket No. SMARB19.002APC.	

14648756:djl
011113

Examiner Signature	Date Considered
*Examiner: Initial if reference considered, whether or not citation is in conformance with MPEP 609. Draw line through citation if not in conformance and not considered. Include copy of this form with next communication to applicant.	

T¹ - Place a check mark in this area when an English language translation is applied. EX. 1002-179

Electronic Acknowledgement Receipt

EFS ID:	14692913
Application Number:	12513147
International Application Number:	
Confirmation Number:	9611
Title of Invention:	PRODUCING ROUTING MESSAGES FOR VOICE OVER IP COMMUNICATIONS
First Named Inventor/Applicant Name:	Clay Perreault
Customer Number:	20995
Filer:	John M Carson/Jessica Egigian
Filer Authorized By:	John M Carson
Attorney Docket Number:	SMARB19.001APC
Receipt Date:	14-JAN-2013
Filing Date:	01-MAR-2010
Time Stamp:	19:18:05
Application Type:	U.S. National Stage under 35 USC 371

Payment information:

Submitted with Payment	no
------------------------	----

File Listing:

Document Number	Document Description	File Name	File Size(Bytes)/ Message Digest	Multi Part /.zip	Pages (if appl.)
1	Foreign Reference	WO0189145A2.PDF	1074842 e642b7efbe177a86fa7f74fc0a134c462c07b460	no	24

Warnings:

Information:

PETITIONER APPLE INC. EX. 1002-180

2	Non Patent Literature	EPOextendedsdearchteport. PDF	363464 <small>23f4a2bbe8a8d9ce8b78411429b42933a8e1ae59</small>	no	8
Warnings:					
Information:					
3		SMARB19001APCids.pdf	95714 <small>82eb5f7ce445315dca6bcd0c542870389d41536</small>	yes	2
	Multipart Description/PDF files in .zip description				
	Document Description		Start	End	
	Transmittal Letter		1	1	
	Information Disclosure Statement (IDS) Form (SB08)		2	2	
Warnings:					
Information:					
Total Files Size (in bytes):			1534020		
<p>This Acknowledgement Receipt evidences receipt on the noted date by the USPTO of the indicated documents, characterized by the applicant, and including page counts, where applicable. It serves as evidence of receipt similar to a Post Card, as described in MPEP 503.</p> <p><u>New Applications Under 35 U.S.C. 111</u> If a new application is being filed and the application includes the necessary components for a filing date (see 37 CFR 1.53(b)-(d) and MPEP 506), a Filing Receipt (37 CFR 1.54) will be issued in due course and the date shown on this Acknowledgement Receipt will establish the filing date of the application.</p> <p><u>National Stage of an International Application under 35 U.S.C. 371</u> If a timely submission to enter the national stage of an international application is compliant with the conditions of 35 U.S.C. 371 and other applicable requirements a Form PCT/DO/EO/903 indicating acceptance of the application as a national stage submission under 35 U.S.C. 371 will be issued in addition to the Filing Receipt, in due course.</p> <p><u>New International Application Filed with the USPTO as a Receiving Office</u> If a new international application is being filed and the international application includes the necessary components for an international filing date (see PCT Article 11 and MPEP 1810), a Notification of the International Application Number and of the International Filing Date (Form PCT/RO/105) will be issued in due course, subject to prescriptions concerning national security, and the date shown on this Acknowledgement Receipt will establish the international filing date of the application.</p>					

(12) INTERNATIONAL APPLICATION PUBLISHED UNDER THE PATENT COOPERATION TREATY (PCT)

(19) World Intellectual Property Organization
International Bureau



(43) International Publication Date
22 November 2001 (22.11.2001)

PCT

(10) International Publication Number
WO 01/89145 A2

(51) International Patent Classification⁷: H04L 12/00

(21) International Application Number: PCT/SE01/00972

(22) International Filing Date: 4 May 2001 (04.05.2001)

(25) Filing Language: English

(26) Publication Language: English

(30) Priority Data:
09/570,997 15 May 2000 (15.05.2000) US

(71) Applicant: TELEFONAKTIEBOLAGET LM ERICSSON (PUBL) [SE/SE]; S-126 25 Stockholm (SE).

(72) Inventor: FOTI, Georges; 163 Mozart, Dollard des Ormeaux, Quebec H9G 2Z8 (CA).

(74) Agent: MAGNUSSON, Monica; Ericsson Radio Systems AB, Patent Unit Radio Access, S-164 80 Stockholm (SE).

(81) Designated States (*national*): AE, AG, AL, AM, AT, AU, AZ, BA, BB, BG, BR, BY, BZ, CA, CH, CN, CO, CR, CU, CZ, DE, DK, DM, DZ, EE, ES, FI, GB, GD, GE, GH, GM, HR, HU, ID, IL, IN, IS, JP, KE, KG, KP, KR, KZ, LC, LK, LR, LS, LT, LU, LV, MA, MD, MG, MK, MN, MW, MX, MZ, NO, NZ, PL, PT, RO, RU, SD, SE, SG, SI, SK, SL, TJ, TM, TR, TT, TZ, UA, UG, UZ, VN, YU, ZA, ZW.

(84) Designated States (*regional*): ARIPO patent (GH, GM, KE, LS, MW, MZ, SD, SL, SZ, TZ, UG, ZW), Eurasian patent (AM, AZ, BY, KG, KZ, MD, RU, TJ, TM), European patent (AT, BE, CH, CY, DE, DK, ES, FI, FR, GB, GR, IE, IT, LU, MC, NL, PT, SE, TR), OAPI patent (BF, BJ, CF, CG, CI, CM, GA, GN, GW, ML, MR, NE, SN, TD, TG).

Published:

— without international search report and to be republished upon receipt of that report

For two-letter codes and other abbreviations, refer to the "Guidance Notes on Codes and Abbreviations" appearing at the beginning of each regular issue of the PCT Gazette.



WO 01/89145 A2

(54) Title: METHOD OF MONITORING CALLS IN AN INTERNET PROTOCOL (IP)-BASED NETWORK

(57) Abstract: A method of monitoring a call with a mobile terminal (MT) (11) in an Internet Protocol (IP)-based network (10) having a Gatekeeper (17) that controls the network, a plurality of access routers (12, 14) that provide access to the network, and a Monitoring Station (18) having monitoring facilities and a database of MTs to be monitored. When the MT sends an Admission Request message (21) to the Gatekeeper, the Gatekeeper sends a query (23) to the Monitoring Station asking whether the MT is to be monitored. The Monitoring Station sends a reply (25) to the Gatekeeper indicating that the MT is to be monitored and providing an IP address where monitored packets are to be sent. The Gatekeeper then sends a monitoring request message (28) to the access router (12) associated with the MT. The request identifies the MT to be monitored, instructs the access router to monitor the MT, and provides a unique call identification (Call ID) and the IP address where monitored packets are to be sent. When the access router detects a packet associated with the MT, the router sends all packets associated with the MT to the Monitoring Station. The method also controls monitoring during intra-domain and inter-domain handoffs of the MT.

**METHOD OF MONITORING CALLS
IN AN INTERNET PROTOCOL (IP)-BASED NETWORK**

BACKGROUND OF THE INVENTION

5 Technical Field of the Invention

This invention relates to telecommunication systems and, more particularly, to a method of monitoring calls in an Internet Protocol (IP)-based network.

Description of Related Art

10 In existing circuit-switched telecommunications networks such as the Public Switched Telephone Network (PSTN) and the legacy Public Land Mobile Network (PLMN), law enforcement agencies are able to easily monitor telephone calls because the calls, once established, are routed over a dedicated path from one subscriber to another. In an IP-based telecommunications network, this is not the case.

15 For IP calls that originate in a circuit-switched network, a gateway provides an interface between the circuit-switched network and the packet-switched IP network. The gateway takes bits of digitized voice, packetizes them, puts on a header, and ships them over the IP network. The packetized call may enter the core IP network at any access (edge) router near the originating subscriber. Thereafter, the individual packets follow any available route to the destination address. At that point, all of the packets
20 exit the core network through a single access router near the destination subscriber. The same principle applies if both the calling terminal and the called terminal are IP-based. Since one or both of the subscribers involved in the call may be mobile, calls between the same subscribers may enter and leave the IP network through different access routers at different times. As a result of the changing access routers and the
25 independent routing of the packets in the IP network, law enforcement agencies are not able to monitor real-time IP applications such as Voice-over-IP (VoIP) calls.

 It would be advantageous to have a method of monitoring calls in an Internet Protocol (IP)-based network. The present invention provides such a method.

30

-2-

SUMMARY OF THE INVENTION

In one aspect, the present invention is a method of monitoring a call from a mobile terminal (MT) in an IP-based network having a Gatekeeper that controls the network, a plurality of access routers that provide access to the network, and a Monitoring Station having monitoring facilities and a database of MTs to be monitored. The method includes the steps of sending an access request from the MT to the Gatekeeper, sending a query from the Gatekeeper to the Monitoring Station asking whether the MT is to be monitored, and sending a reply from the Monitoring Station to the Gatekeeper indicating that the MT is to be monitored and providing an IP address where monitored packets are to be sent. This is followed by sending a monitoring request from the Gatekeeper to the access router associated with the monitored MT, the request identifying the MT to be monitored, instructing the access router to monitor the MT, and providing the IP address where monitored packets are to be sent. When the access router detects a packet associated with the MT, the router sends all packets associated with the MT to the Monitoring Station.

When the monitored MT is handed off from a first base station to a second base station, and each of the base stations is controlled by a single Radio Network Controller (RNC), the RNC sends a monitoring request to the second base station. The monitoring request identifies the MT to be monitored, instructs the second base station to monitor the MT, and provides a unique call identification (Call ID) and the IP address where monitored packets are to be sent. The unique Call ID is assigned by the Gatekeeper. The RNC also sends a notification to the Gatekeeper that the MT is being served by the second base station, and includes the unique Call ID and a new transport address for the MT, if any.

When the monitored MT is handed off from a first base station controlled by a first RNC to a second base station controlled by a second RNC, and both RNCs are in a single Gatekeeper domain, the method performs the steps of sending identifying information regarding the MT being monitored from the first RNC to the second RNC, and sending a monitoring request from the second RNC to the second base station, the request identifying the MT to be monitored, instructing the second base station to monitor the MT, and providing the unique Call ID and the IP address where monitored

-3-

packets are to be sent. The second RNC also sends a notification to the Gatekeeper that the MT is being served by the second base station, and includes the Call ID and the new transport address for the MT. Whenever there is a change to the transport address of the MT, the Gatekeeper forwards the Call ID and the new transport address
5 to the Monitoring Station.

When the monitored MT is handed off from a first base station controlled by a first RNC in a first Gatekeeper domain, to a second base station controlled by a second RNC in a second Gatekeeper domain, the method performs the steps of sending a notification from the first RNC to the second RNC that the MT is being monitored,
10 and sending a monitoring request from the second RNC to the second base station. The monitoring request identifies the MT to be monitored, instructs the base station to monitor the MT, and provides the unique Call ID and the IP address of a Monitoring Station where monitored packets are to be sent. The second base station then begins sending media packets having the MT address as a source address or destination
15 address to the Monitoring Station. Then, the second RNC sends the unique Call ID it received and a new transport address for the MT to the second Gatekeeper. The second Gatekeeper forwards this information to the Monitoring Station. This is followed by sending an access request from the MT to the second Gatekeeper, and allocating bandwidth to the MT by the Gatekeeper.

20 In another aspect, the present invention is a method performed within a Gatekeeper in an IP-based network. The method monitors a call from an MT and routes the monitored call to a Monitoring Station having monitoring facilities and a database of MTs to be monitored. The method includes the steps of receiving in the Gatekeeper, a network access request from the MT, sending a query from the
25 Gatekeeper to the Monitoring Station asking whether the MT is to be monitored, and receiving in the Gatekeeper, a reply from the Monitoring Station indicating that the MT is to be monitored and providing an IP address where monitored packets are to be sent. This is followed by sending a monitoring request from the Gatekeeper to the access router that is associated with the monitored MT and is providing access to the
30 network. The request identifies the MT to be monitored, instructs the access router

-4-

to send any packets associated with the MT to the Monitoring Station, and provides the unique Call ID and the IP address where monitored packets are to be sent.

BRIEF DESCRIPTION OF THE DRAWINGS

5 The invention will be better understood and its numerous objects and advantages will become more apparent to those skilled in the art by reference to the following drawings, in conjunction with the accompanying specification, in which:

FIG. 1 is an illustrative drawing of an IP network modified in accordance with the teachings of the present invention to monitor a call between two IP terminals;

10 FIG. 2 is a message flow diagram illustrating the flow of messages when setting up a call for monitoring in the IP network of FIG. 1 in accordance with the teachings of the present invention;

FIG. 3 is an illustrative drawing of an IP network modified in accordance with the teachings of the present invention to monitor a call between an IP terminal and a terminal in the Public Switched Telephone Network (PSTN);

15 FIG. 4 is a message flow diagram illustrating the flow of messages when a monitored mobile terminal is handed off from an old base station to a new base station controlled by the same Radio Network Controller (RNC) as the old base station;

FIG. 5 is a message flow diagram illustrating the flow of messages when a monitored mobile terminal roams into a new subnet within the same domain, and acquires a new RNC, a new base station, and a new transport address; and

20 FIG. 6 is a message flow diagram illustrating the flow of messages when the mobile terminal roams into a new domain and acquires a new Gatekeeper, a new RNC, a new base station, and a new transport address.

25

DETAILED DESCRIPTION OF EMBODIMENTS

The present invention is described herein primarily in terms of the International Telecommunications Union (ITU) H.323 protocol, but is equally applicable to both H.323 and the Session Initiation Protocol (SIP) developed by the Internet Engineering Task Force (IETF). In particular, the term "Gatekeeper" which

30

-5-

is used herein refers to both an H.323 Gatekeeper and a SIP proxy server and registry. In addition, reference to an H.245 address herein also refers to a SIP address.

In a typical IP network, PC clients or IP telephony terminals (fixed or mobile) are identified and addressed by an e-mail address (proxy/alias), or an IP address, or both. Prior to making any calls, such terminals register with a Gatekeeper in an H.323 network, or with a SIP proxy server in a SIP network. If the registration is accepted by the Gatekeeper, the Gatekeeper handles incoming calls to the terminal as well as outgoing calls from the terminal. The Gatekeeper maintains a subscriber profile that includes, among other things, the services to which the subscriber is entitled. For simplicity, the term "mobile terminal (MT)" is used herein to refer generically to IP clients, both fixed and mobile since the most challenging monitoring tasks involve intra-domain and inter-domain handoff of MTs.

FIG. 1 is an illustrative drawing of an IP network 10 modified in accordance with the teachings of the present invention to monitor a call between two IP terminals. IP Terminal-1 11, which may be originating a call, is connected to the IP network through Access Router-1 12. Media traffic (i.e., data) 13 is carried by independent paths through the network to Access Router-2 14 through which IP Terminal-2 15 has accessed the network. IP Terminal-2 may be the terminating (destination) terminal. Control signaling between the two subscribers is carried in a control plane 16 which passes through a Gatekeeper 17, and from the Gatekeeper to a Monitoring Station 18 which may be operated by a law enforcement agency.

In order for the two IP subscribers 11 and 15 to communicate over the IP-based network 10, they have to go through the Gatekeeper 17 which can be likened to a mobile switching center (MSC) in a circuit-switched network. The Gatekeeper is the brain of the network regarding the routing of calls. The Gatekeeper manages the bandwidth (with the help of other network entities), generates the accounting data, etc.

In a first scenario, the calling and called subscribers are within the same domain. In that case, when a subscriber wants to make or receive a call, an Admission Request (ARQ) message (when using H.323) is sent to the Gatekeeper. In response to the ARQ message, the Gatekeeper allocates the bandwidth for the call or, if none is available, the Gatekeeper denies the call. The present invention extends the

-6-

procedure performed by the Gatekeeper when a bandwidth allocation request (i.e., ARQ) is received from a device that is originating or receiving a call. Additionally, new mandatory parameters are introduced in the ARQ message.

The Gatekeeper does not know which subscribers need to be monitored. Only
5 the law enforcement Monitoring Station has this information. The Monitoring Station includes a database of all subscribers who should be monitored for security reasons. So for each call that is originated by or terminated to a subscriber in its domain, the Gatekeeper queries the Monitoring Station to determine whether the subscriber should be monitored.

10 FIG. 2 is a message flow diagram illustrating the flow of messages when setting up a call for monitoring in the IP network of FIG. 1 in accordance with the teachings of the present invention. In the illustrated example, IP Terminal-1 11 is the subscriber to be monitored. After Terminal-1 sends an ARQ message 21 to the Gatekeeper 17, the Gatekeeper performs the bandwidth allocation function at 22, and
15 then sends a monitor query message 23 to the Monitoring Station 18. The monitor query message includes the H.245 source address and the H.245 destination address for the call, if available, as well as subscriber addressing information (e-mail/proxy) and the unique Call ID that it generates for the call. The Monitoring Station checks the database at 24 and returns a monitor reply message 25 to the Gatekeeper indicating
20 whether any of the parties in the call should be monitored, as well as the IP address of the Monitoring Station to which the monitored conversation should be sent. In the illustrated example, the message indicates that Terminal-1 is to be monitored. If none of the terminals is being monitored, the Gatekeeper then returns an Admission Confirm (ACF) message 26 to Terminal-1. If any of the subscribers is being
25 monitored, the Gatekeeper sets a flag in the subscriber record at 27 indicating that fact.

The Gatekeeper finds, through normal IP routing protocols, the path for the media to follow. The Gatekeeper obtains this information in the course of allocating bandwidth since the policy related to the QoS of the call must be downloaded to all of the routers in the media path. The routers, in this case, act as policy enforcement
30 points to ensure that the subscribers are respecting the QoS agreements. However, for

-7-

the sake of monitoring, it suffices that the Gatekeeper identifies only the access router associated with IP Terminal-1.

Hence, the Gatekeeper is able to identify the access router for this call. The Gatekeeper then sends a Monitoring Request message 28 to the access router associated with the subscriber (for example, Access Router-1), and includes the
5 Monitoring Station IP address and the unique Call ID for that call. Access Router-1 sends back an Acknowledgment message 29. Once the Gatekeeper receives the Acknowledgment message from the Access Router, the Gatekeeper sends an ACF message 31 to Terminal-1.

10 It should also be noted that in IP networks, addressing is different in each media direction. Therefore, the IP address to be monitored is the source address in the IP header while the monitored subscriber is initiating the conversation, and is the destination field in the IP header while the monitored subscriber is listening. Thus, while the Access Router performs its normal routing functions, it has to monitor both
15 the source and the destination addresses in the IP headers that it handles in order to identify addresses that match the monitored address. Media packets then begin to flow from the IP Terminal to Access Router-1 at 32, and Access Router-1 sends the packets to the Monitoring Station at 33.

To send media packets to the Monitoring Station, the Access Router
20 encapsulates every identified packet with a new header that includes the router's address as the source address, and the Monitoring Station's address as the destination address. The unique Call ID is also included in the IP header. This enables the Monitoring Station to correlate packets belonging to the same conversation. Other parameters may be included in the header as well. Upon receipt, the Monitoring
25 Station strips away the header and recovers the original packets. When the call is cleared, the connection from the access router to the Monitoring Station is also cleared.

In another scenario, the calling and called subscribers are in different domains. In that case, two different Gatekeepers must deal with the calling and called
30 subscribers. Additional information must be exchanged between the Gatekeepers as

-8-

part of the call setup for the management and coordination of monitoring a call. Otherwise, both Gatekeepers may end up monitoring the same call.

In this scenario, the originating Gatekeeper will likely not know the IP address of the destination. Thus, the originating Gatekeeper follows the same procedure previously described. However, the query that the originating Gatekeeper sends to the Monitoring Station includes only the calling subscriber identity. If the calling subscriber is not the one being monitored, then the originating Gatekeeper returns an ACF message and proceeds with normal call setup. During the setup, the originating Gatekeeper forwards to the Gatekeeper that deals with the destination terminal, a special flag informing the destination Gatekeeper that the calling subscriber is not the one being monitored. The destination Gatekeeper follows the previously described procedure, including the monitoring procedure, when the called terminal sends an ARQ message to accept the incoming call.

On the other hand, if the calling subscriber is the one being monitored, the originating Gatekeeper follows the same procedure described previously when it receives an ARQ message from the calling subscriber. The originating Gatekeeper then sends a flag to the destination Gatekeeper identifying the calling subscriber as a subscriber to be monitored. The destination Gatekeeper follows the same procedure previously described when the called terminal sends an ARQ message to accept the call, but bypasses the monitoring procedure.

It should also be noted that in this scenario, the originating Gatekeeper receives only the destination IP address as part of the call setup procedure. Therefore, the originating Gatekeeper must send a second Monitoring Request Message to the Access Router to convey the destination IP address.

FIG. 3 is an illustrative drawing of an IP network 20 modified in accordance with the teachings of the present invention to monitor a call between an IP terminal (IP Terminal-3) 41 and a terminal in a circuit-switched network (PSTN Terminal) 42 such as the Public Switched Telephone Network (PSTN) 43. If the subscriber to be monitored is in a circuit-switched network such as the PSTN, the call goes through a Gateway 44 to the IP subscriber in the IP network. If the subscriber to be monitored is on the PSTN side, then existing procedures in the PSTN ensure that monitoring

-9-

takes place. However, if the subscriber to be monitored is on the IP side, the procedure described previously is invoked when the called subscriber (to be monitored) sends an ARQ message to the Gatekeeper to accept an incoming call.

5 Again in this case, coordination is needed to ensure that no double monitoring occurs when both subscribers are to be monitored. Therefore, for an H.323 endpoint of the gateway type (as opposed to a terminal type of endpoint), the ARQ message sent to the Gatekeeper from the Gateway 44 includes a flag to indicate whether an incoming call is already being monitored from the PSTN side. The Gatekeeper then bypasses the monitoring procedure. The PSTN, of course, must convey this
10 information to the Gateway so that it can be passed to the Gatekeeper. In one embodiment, Integrated Services User Part (ISUP) signaling is extended to carry this information. Optionally, specialized control messages can convey the information to the Gateway from the entity that is coordinating the monitoring in the PSTN. In all cases, the globally unique Call ID must be transferred to uniquely identify the
15 impacted call.

Mobility/Handoff Scenarios

Mobility adds another level of complexity to the task of IP monitoring due to the potential changing of the point of attachment of the MT to the network. In this case, the base stations serve as Access Routers since they are the closest point of
20 attachment to the subscriber. However, Gatekeepers do not communicate directly with base stations since base stations belong to the Radio Access Network (RAN). Therefore, the Gatekeepers must go through the Radio Network Controller/Base Station Controller (RNC/BSC) that controls these base stations for all requests to the base stations regarding the monitoring of subscribers.

25 Therefore, the same procedures described above for monitoring fixed subscribers still apply for mobile subscribers except that all Gatekeeper requests that are sent directly to the Access Routers for fixed subscribers, are sent instead to the RNC. The RNC, in turn, sends them to the base stations.

FIG. 4 is a message flow diagram illustrating the flow of messages when the
30 monitored mobile terminal (MT) is handed off from an old base station (BS-1) 51 to a new base station (BS-2) 52 controlled by the same RNC 53 as the old base station.

-10-

When the MT does not change its transport address, but roams in a new base station, the link layer in the base station ensures delivery of the call to the MT. After handoff occurs at 54, the RNC instructs BS-2 to monitor the subscriber at 55 and includes the address of the Monitoring Station and the unique Call ID. The RNC then informs the Gatekeeper 17 of the new base station at 56, and includes the unique Call ID to identify the impacted call. If there is a change in the transport address of the mobile terminal as a result of the handoff, the new address is also sent to the Gatekeeper by the RNC. The RNC learns the new address during the handoff procedure. In the preferred embodiment, this information is passed only for monitored subscribers in order to minimize the signaling load. At 57, the Gatekeeper forwards the Call ID and the new transport address, if any, to the Monitoring Station 18. At 58, media is passed from BS-2 to the Monitoring Station.

FIG. 5 is a message flow diagram illustrating the flow of messages when the monitored MT is handed off from an old base station (BS-1) 61 controlled by an old RNC (RNC-1) 62 to a new base station (BS-3) 63 controlled by a new RNC (RNC-2) 64 within the same Gatekeeper domain. Thus, in this scenario, the MT roams into a new subnet within the same domain, and acquires a new RNC, a new base station, and a new transport address. At 65, the MT is handed off from BS-1 to BS-3. At 66, RNC-1 forwards to RNC-2 all of the pertinent information regarding the subscriber being monitored, including the unique Call ID for the call being monitored. At 67, the new RNC (RNC-2) instructs the new base station (BS-3) to monitor the subscriber, and includes the unique Call ID and the address of the Monitoring Station.

Since the mobile terminal changed transport addresses, it is required to register its new transport address with the Gatekeeper 17. Therefore, at 68, RNC-2 informs the Gatekeeper of the new base station and the new transport address assigned to the mobile terminal. The unique Call ID is also included. At 69, the new transport address and the Call ID are passed by the Gatekeeper to the Monitoring Station 18 so that all the packets belonging to the same monitored call can be correlated. Thereafter, media packets are forwarded from BS-3 to the Monitoring Station at 70.

FIG. 6 is a message flow diagram illustrating the flow of messages when the mobile terminal roams into a new domain and acquires a new Gatekeeper, a new RNC,

-11-

a new base station, and a new transport address. The monitored MT 71 is initially operating in IP Network-1 which includes Gatekeeper-1 72. RNC-1 73 and BS-1 74 are in RAN-1 which provides radio access for IP Network-1. At handoff 75, the monitored MT is handed off from BS-1 to a new base station (BS-2) 76 controlled by
5 a new RNC (RNC-2) 77. RNC-2 and BS-2 are in RAN-2 which provides radio access for IP Network-2 which includes Gatekeeper-2 78. Monitoring Station 18 is monitoring the call with the MT.

At 79, the new RNC (RNC-2) is informed by RNC-1 that the MT is being monitored. At 81, the RNC-2 instructs the new base station (BS-2) to monitor the
10 subscriber, and includes the unique Call ID and the address of the Monitoring Station. Media then begins to flow from BS-2 to the Monitoring Station at 82. RNC-2 then informs Gatekeeper-2 at 83 that a new subscriber is now roaming in its service area, and that the new subscriber needs to be monitored. RNC-2 includes the IMSI for the MT, the unique Call ID, and the MT's new transport address in the message to
15 Gatekeeper-2. Every time there is a change in the transport address of a monitored mobile terminal, the controlling Gatekeeper must inform the Monitoring Station of the new transport address. Thus, at 84, the new transport address and the Call ID are passed to the Monitoring Station. The unique Call ID is used by the Monitoring Station to track all packets belonging to the same conversation. In addition, the Call
20 ID is used by any Gatekeeper that handles a portion of the call (other than the original Gatekeeper) to report the same call to the Monitoring Station. Thus, during a handoff scenario, the RNC passes the Call ID to the same Gatekeeper if there is no change of domain, and to the new Gatekeeper when there is a change of domain.

At 85, Gatekeeper-2 sets a flag in the subscriber record for MT 71 indicating
25 that the MT is in its area and is being monitored. The flag also indicates that a subscriber will soon have to register with his transport address. Since the MT changed its transport address, the MT is required to register with the new Gatekeeper and report its new transport address. A registration timer is started when the flag is set in case the registration never arrives (registration is lost, subscriber hangs up, etc.).

30 At 86, an ARQ message is sent from the MT to Gatekeeper-2. When the ARQ arrives, the registration timer in Gatekeeper-2 is stopped at 87, and bandwidth is

-12-

allocated. Gatekeeper-2 then returns an ACF message 88 to the MT. Gatekeeper-2 knows that the MT is being monitored because Gatekeeper-2 was informed by RNC-2. Therefore, Gatekeeper-2 does not perform the monitoring procedure associated with the new registration. Thus, double monitoring of the conversation is avoided.

5 Whenever any monitored subscriber hangs up, a De-Admission Request is sent to the Gatekeeper. The Gatekeeper clears the flag for monitoring the subscriber and sends a message to the Monitoring Station to stop the monitoring of the call. This message is also propagated to the Access Router performing the monitoring.

10 It is thus believed that the operation and construction of the present invention will be apparent from the foregoing description. While the method shown and described has been characterized as being preferred, it will be readily apparent that various changes and modifications could be made therein without departing from the scope of the invention as defined in the following claims.

-13-

WHAT IS CLAIMED IS:

1. A method of monitoring a call with an Internet Protocol (IP) client in an IP-based network having a Gatekeeper that controls the network, a plurality of
5 access routers that provide access to the network, and a Monitoring Station having monitoring facilities and a database of IP clients to be monitored, said method comprising:

 sending an access request from the IP client to the Gatekeeper;

 sending a query from the Gatekeeper to the Monitoring Station asking whether
10 the IP client is to be monitored;

 sending a reply from the Monitoring Station to the Gatekeeper indicating that the IP client is to be monitored and providing an IP address where monitored packets are to be sent;

 sending a monitoring request from the Gatekeeper to an access router
15 associated with the IP client, said request identifying the IP client to be monitored, instructing the access router to monitor the IP client, and providing the IP address where monitored packets are to be sent;

 detecting by the access router, a packet associated with the IP client; and

 routing by the access router, all packets associated with the IP client to the
20 Monitoring Station.

2. The method of monitoring a call with an IP client in an IP-based network of claim 1 further comprising, before the step of sending a query from the Gatekeeper to the Monitoring Station asking whether the IP client is to be monitored,
25 the step of performing bandwidth allocation functions by the Gatekeeper to determine whether network access can be granted to the IP client.

3. The method of monitoring a call with an IP client in an IP-based network of claim 2 further comprising, after the step of sending a reply from the
30 Monitoring Station to the Gatekeeper indicating that the IP client is to be monitored,

-14-

the step of setting a flag in the Gatekeeper identifying the IP client as a monitored IP client.

4. The method of monitoring a call with an IP client in an IP-based network of claim 3 further comprising, after the step of sending a monitoring request from the Gatekeeper to the access router, the steps of:

5 sending an acknowledgment message from the access router to the Gatekeeper;
and

10 sending an admission confirm message from the Gatekeeper to the IP client when the acknowledgment message has been received from the access router.

5. The method of monitoring a call with an IP client in an IP-based network of claim 4 wherein the step of detecting a packet associated with the IP client includes detecting a packet that has the IP client as its source address.

15

6. The method of monitoring a call with an IP client in an IP-based network of claim 4 wherein the step of detecting a packet associated with the IP client includes detecting a packet that has the IP client as its destination address.

20 7. The method of monitoring a call with an IP client in an IP-based network of claim 3 further comprising the steps of:

sending a de-admission request from the IP client to the Gatekeeper;

clearing the flag in the Gatekeeper that identifies the IP client as a monitored IP client;

25 sending a message from the Gatekeeper to the Monitoring Station to stop the monitoring of the call; and

sending a message from the Gatekeeper to the access router to stop the routing of packets to the Monitoring Station.

-15-

8. The method of monitoring a call with an IP client in an IP-based network of claim 1 wherein the IP client is a mobile terminal (MT), and the method further comprises the steps of:

5 handing off the MT from a first base station to a second base station, each of said base stations being controlled by a single radio network controller (RNC);

sending a monitoring request from the RNC to the second base station, said request identifying the MT to be monitored, instructing the second base station to monitor the MT, and providing a unique call identification (Call ID) and the IP address where monitored packets are to be sent; and

10 sending a notification from the RNC to the Gatekeeper that the MT is being served by the second base station, said notification including the unique Call ID and a new transport address for the MT.

9. The method of monitoring a call with an IP client in an IP-based network of claim 8 further comprising sending the Call ID and the new transport address from the Gatekeeper to the Monitoring Station.

10. The method of monitoring a call with an IP client in an IP-based network of claim 1 wherein the IP client is a mobile terminal (MT), and the method further comprises the steps of:

20 handing off the MT from a first base station to a second base station, the first base station being controlled by a first radio network controller (RNC), and the second base station being controlled by a second RNC, and both RNCs being in a single Gatekeeper domain;

25 sending identifying information regarding the MT being monitored from the first RNC to the second RNC, said information including a unique call identification (Call ID);

30 sending a monitoring request from the second RNC to the second base station, said request identifying the MT to be monitored, instructing the second base station to monitor the MT, and providing the unique Call ID and the IP address where monitored packets are to be sent;

-16-

sending a notification from the second RNC to the Gatekeeper that the MT is being served by the second base station, said notification including the unique Call ID and a new transport address for the MT; and

5 sending the Call ID and the new transport address from the Gatekeeper to the Monitoring Station.

11. The method of monitoring a call with an IP client in an IP-based network of claim 1 wherein the step of detecting a packet associated with the IP client includes detecting a media having the IP client address as either a source
10 address or destination address.

12. The method of monitoring a call with an IP client of claim 11 wherein the step of routing all packets associated with the IP client to the Monitoring Station includes encapsulating each packet associated with the IP client
15 with a new header that includes the router's address as a source address, and the Monitoring Station's address as a destination address.

13. A method of handing off a monitored mobile terminal (MT) in an Internet Protocol (IP)-based network, said method comprising:

20 handing off the MT from a first base station to a second base station, the first base station being controlled by a first radio network controller (RNC) in a first Gatekeeper domain, and the second base station being controlled by a second RNC in a second Gatekeeper domain,

25 sending a notification from the first RNC to the second RNC that the MT is being monitored, said notification including a unique call identification (Call ID) and an IP address of a Monitoring Station where monitored packets are to be sent;

30 sending a monitoring request from the second RNC to the second base station, said request identifying the MT to be monitored, instructing the base station to monitor the MT, and providing the Call ID and the IP address of the Monitoring Station;

-17-

sending by the second base station, media packets having the MT address as a source address or destination address to the Monitoring Station;

sending the unique Call ID and a new transport address for the MT from the second RNC to the second Gatekeeper;

5 sending the unique Call ID and the new transport address for the MT from the second Gatekeeper to the Monitoring Station;

sending an access request from the MT to the second Gatekeeper;

and

allocating bandwidth to the MT by the Gatekeeper.

10

14. The method of handing off a monitored MT in an IP-based network of claim 13 further comprising, after the step of sending a unique Call ID and a new transport address for the MT from the second RNC to the second Gatekeeper and to the Monitoring Station, the steps of:

15 setting a flag in the second Gatekeeper indicating that a monitored MT is in the second Gatekeeper's area, and that the MT will soon register with the second Gatekeeper; and

starting a registration timer in the second Gatekeeper.

20

15. The method of handing off a monitored MT in an IP-based network of claim 14 further comprising the steps of:

sending a de-admission request from the monitored MT to the second Gatekeeper;

25 clearing the flag in the second Gatekeeper that identifies the MT as a monitored MT;

sending a message from the second Gatekeeper to the Monitoring Station to stop the monitoring of the call; and

sending a message from the second Gatekeeper to the second base station to stop the routing of packets to the Monitoring Station.

30

-18-

16. The method of handing off a monitored MT in an IP-based network of claim 13 further comprising, after the step of sending an access request from the MT to the second Gatekeeper, the step of stopping the registration timer.

5 17. The method of handing off a monitored MT in an IP-based network of claim 13 wherein the step of sending media packets having the MT address as a source address or destination address to the Monitoring Station includes encapsulating each packet associated with the MT with a new header that includes the second base station's address as a source address, and the Monitoring Station's
10 address as a destination address.

18. A method of monitoring a call with a mobile terminal (MT) and routing the monitored call to a Monitoring Station having monitoring facilities and a database of MTs to be monitored, said method being performed within a
15 Gatekeeper in an Internet Protocol (IP)-based network, and comprising the steps of:
receiving in the Gatekeeper, a network access request from the MT;
sending a query from the Gatekeeper to the Monitoring Station asking whether the MT is to be monitored;
receiving in the Gatekeeper, a reply from the Monitoring Station indicating
20 that the MT is to be monitored and providing an IP address where monitored packets are to be sent; and
sending a monitoring request from the Gatekeeper to an access router providing the MT with access to the network, said request identifying the MT to be monitored, instructing the access router to send any packets associated with the MT
25 to the Monitoring Station, and providing a unique call identification (Call ID) and the IP address where monitored packets are to be sent.

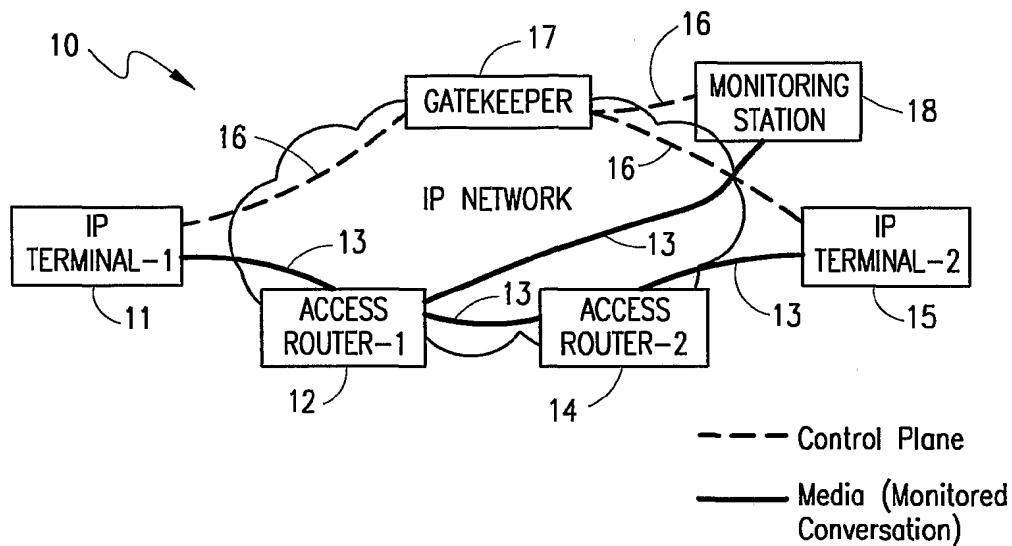

FIG. 1

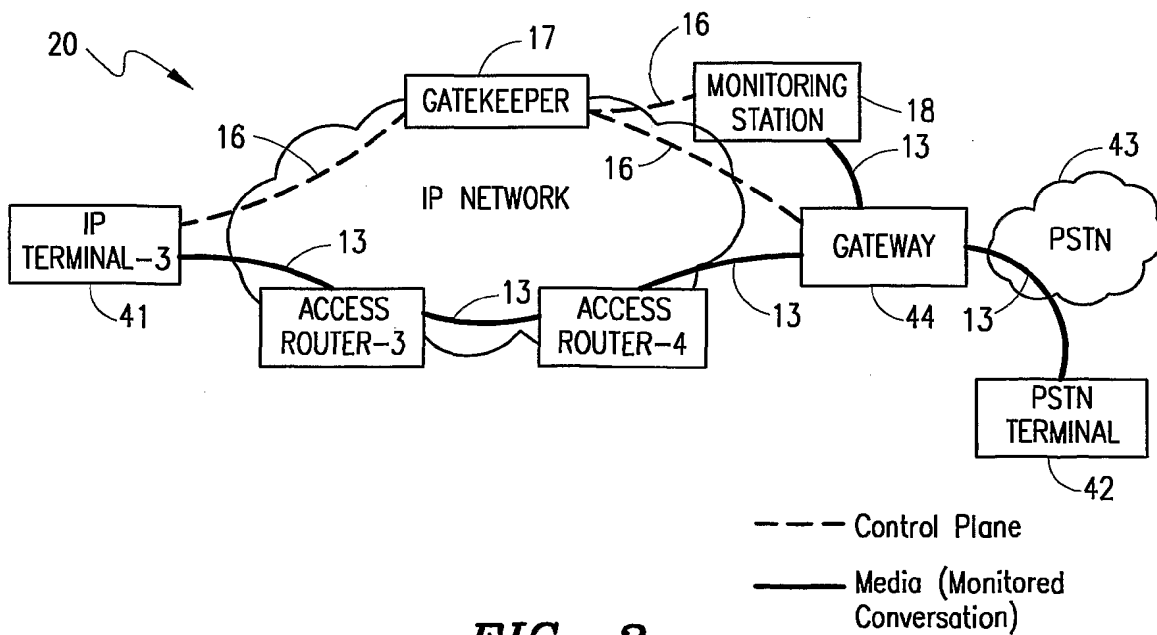

FIG. 3

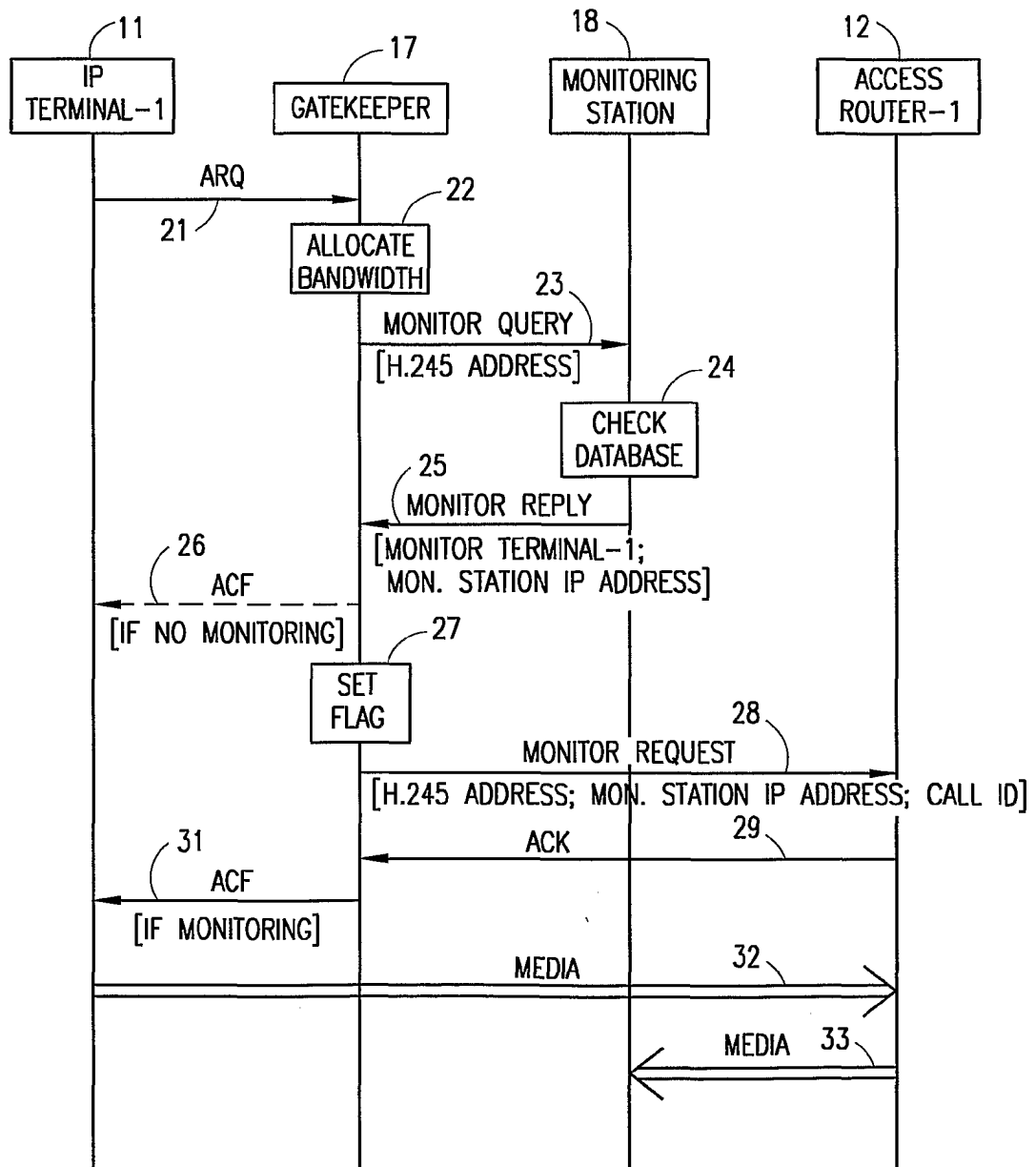

FIG. 2

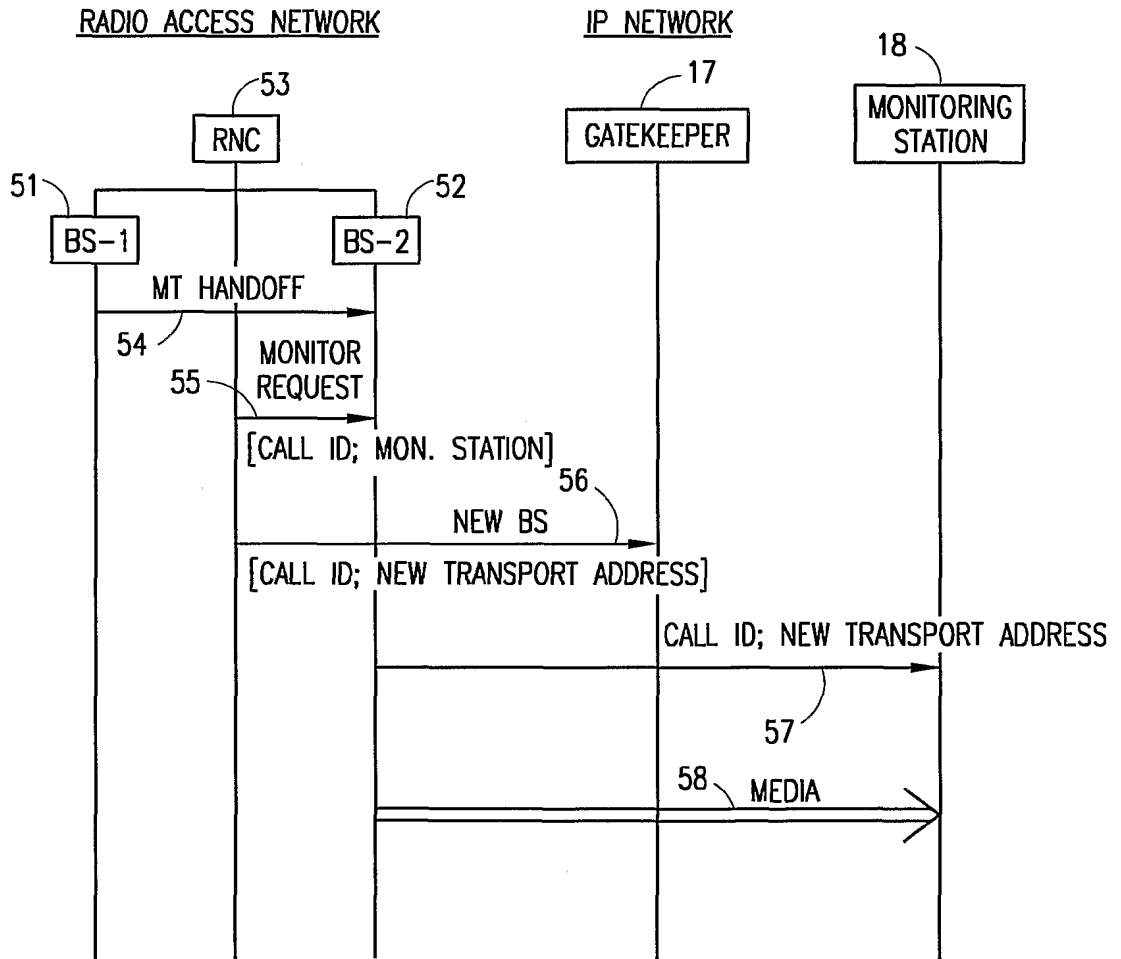

FIG. 4

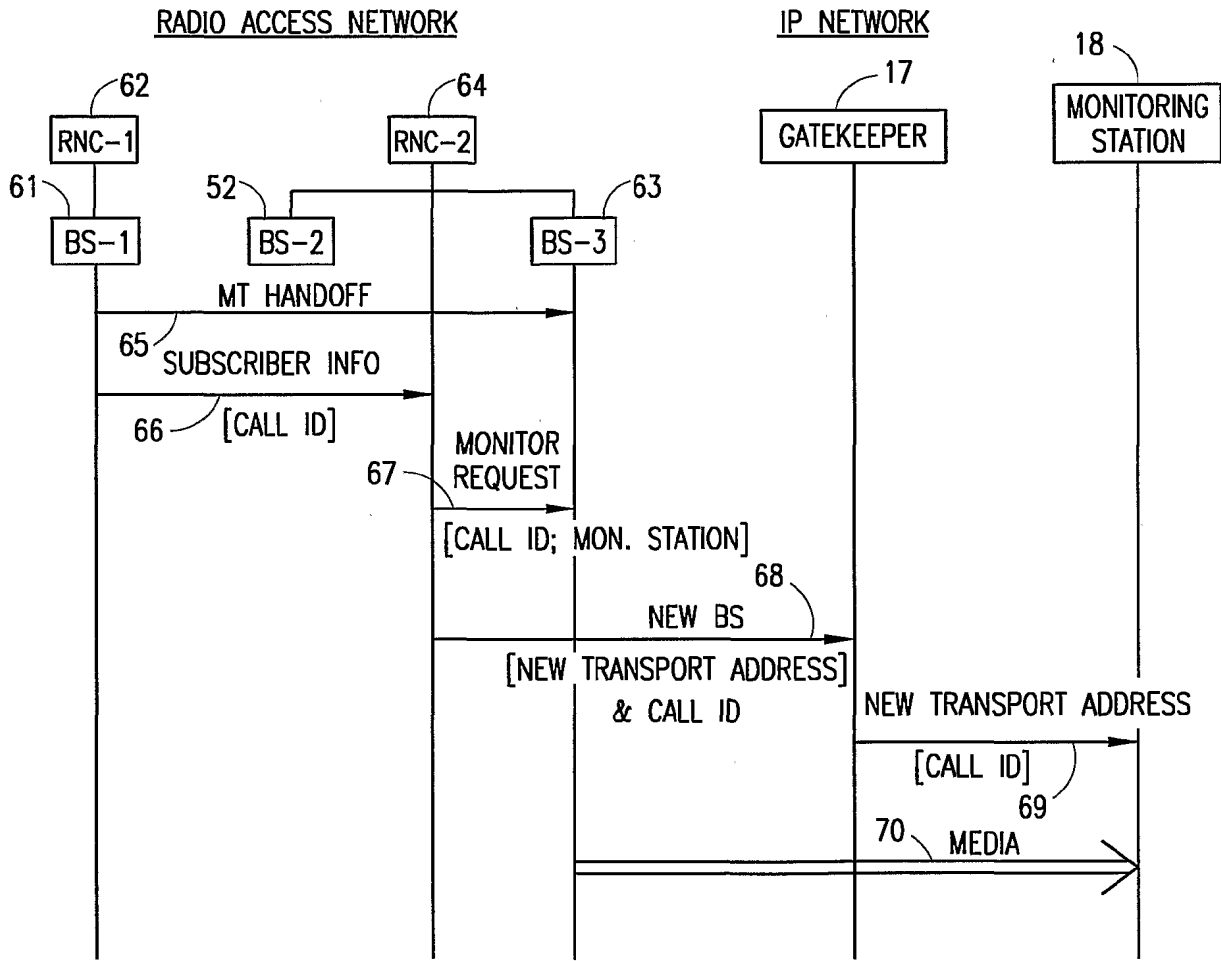

FIG. 5

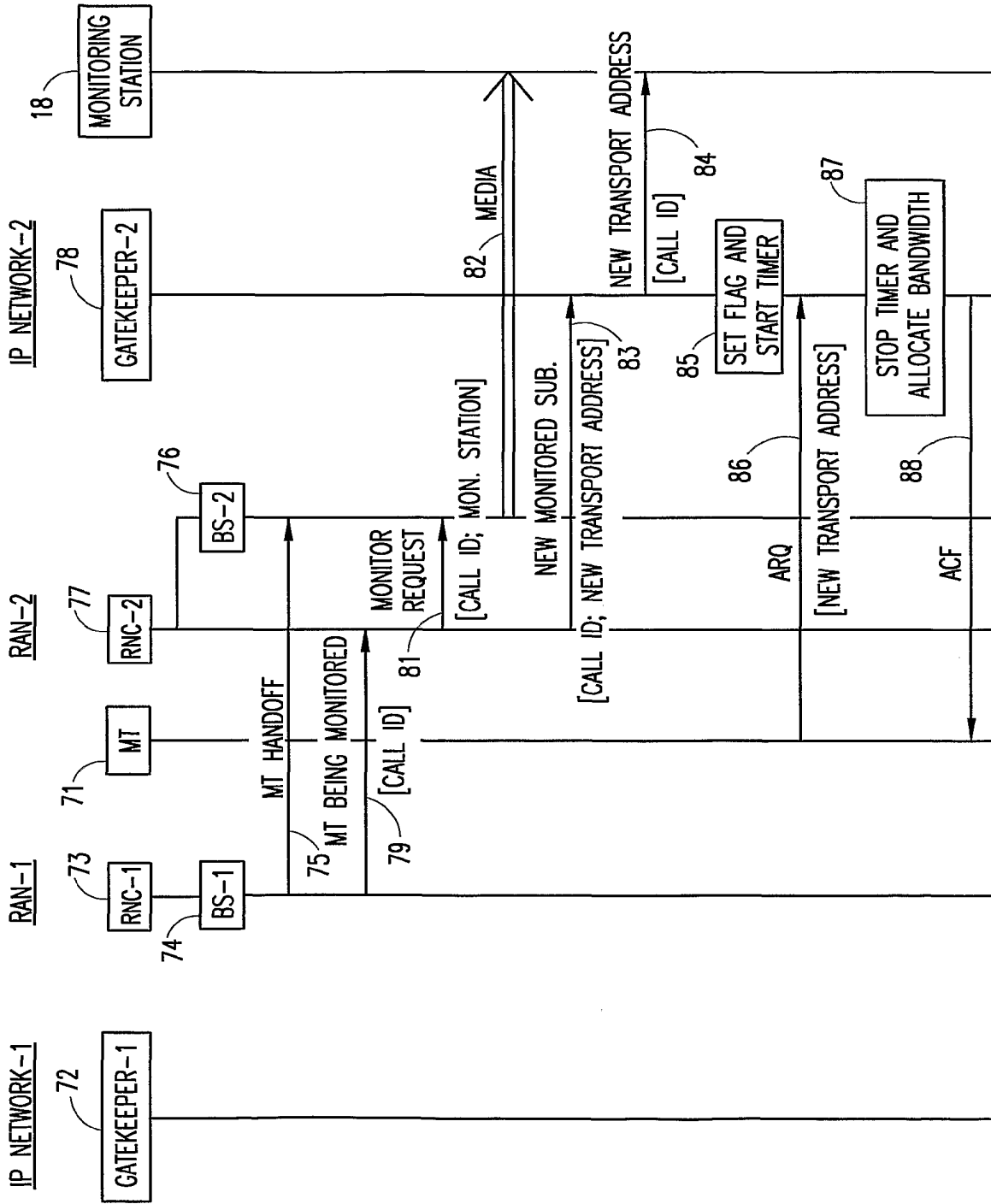

FIG. 6

INFORMATION DISCLOSURE STATEMENT

Inventor	: Clay Perreault et al.
App. No.	: 12/513,147
Filed	: March 1, 2010
For	: PRODUCING ROUTING MESSAGES FOR VOICE OVER IP COMMUNICATIONS
Examiner	: Simon P. Sing
Art Unit	: 2614
Conf. No.	: 9611

Commissioner for Patents
P.O. Box 1450
Alexandria, VA 22313-1450

References and Listing

Submitted herewith in the above-identified application is an Information Disclosure Statement listing references for consideration. Copies of any listed foreign and non-patent literature references are being submitted.

Timing of Disclosure

This Information Disclosure Statement is being filed before the receipt of a first Office Action on the merits, and presumably no fee is required. If a first Office Action on the merits was mailed before the mailing date of this Statement, the Commissioner is authorized to charge the fee set forth in 37 CFR 1.17(p) to Deposit Account No. 11-1410.

Respectfully submitted,
KNOBBE, MARTENS, OLSON & BEAR, LLP

Dated: 1/14/13

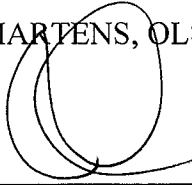
By: 

John M. Carson
Registration No. 34,303
Attorney of Record
Customer No. 20995
(858) 707-4000

INFORMATION DISCLOSURE STATEMENT BY APPLICANT	Application No.	12/513,147
	Filing Date	March 1, 2010
	First Named Inventor	Clay Perreault et al.
	Art Unit	2614
<i>(Multiple sheets used when necessary)</i>	Examiner	Simon P. Sing
SHEET 1 OF 1	Attorney Docket No.	SMARB19.001APC

U.S. PATENT DOCUMENTS					
Examiner Initials	Cite No.	Document Number <i>Number - Kind Code (if known)</i> Example: 1,234,567 B1	Publication Date MM-DD-YYYY	Name of Patentee or Applicant	Pages, Columns, Lines Where Relevant Passages or Relevant Figures Appear

FOREIGN PATENT DOCUMENTS						
Examiner Initials	Cite No.	Foreign Patent Document <i>Country Code-Number-Kind Code</i> Example: JP 1234567 A1	Publication Date MM-DD-YYYY	Name of Patentee or Applicant	Pages, Columns, Lines Where Relevant Passages or Relevant Figures Appear	T ¹

NON PATENT LITERATURE DOCUMENTS			
Examiner Initials	Cite No.	Include name of the author (in CAPITAL LETTERS), title of the article (when appropriate), title of the item (book, magazine, journal, serial, symposium, catalog, etc.), date, page(s), volume-issue number(s), publisher, city and/or country where published.	T ¹
	1	Supplementary European Search Report for European Application No. 07816106 dated June 18, 2012.	

13927953-sjw 090712

Examiner Signature	Date Considered
<p>*Examiner: Initial if reference considered, whether or not citation is in conformance with MPEP 609. Draw line through citation if not in conformance and not considered. Include copy of this form with next communication to applicant.</p>	

T¹ - Place a check mark in this area when an English language translation is attached. PETITIONER APPLE INC. EX. 1002-207

Electronic Acknowledgement Receipt

EFS ID:	13699081
Application Number:	12513147
International Application Number:	
Confirmation Number:	9611
Title of Invention:	PRODUCING ROUTING MESSAGES FOR VOICE OVER IP COMMUNICATIONS
First Named Inventor/Applicant Name:	Clay Perreault
Customer Number:	20995
Filer:	Raimond J Salenieks/Heide Young
Filer Authorized By:	Raimond J Salenieks
Attorney Docket Number:	SMARB19.001APC
Receipt Date:	10-SEP-2012
Filing Date:	01-MAR-2010
Time Stamp:	17:22:03
Application Type:	U.S. National Stage under 35 USC 371

Payment information:

Submitted with Payment	no
------------------------	----

File Listing:

Document Number	Document Description	File Name	File Size(Bytes)/ Message Digest	Multi Part /.zip	Pages (if appl.)
1		SMARB19001APC_IDS.pdf	74002 <small>2e2e7eca7291f3a1710fc6f291cf5dde4a761fcc</small>	yes	2

Multipart Description/PDF files in .zip description			
	Document Description	Start	End
	Transmittal Letter	1	1
	Information Disclosure Statement (IDS) Form (SB08)	2	2

Warnings:

Information:

2	Non Patent Literature	Supplementary_European_SR.pdf	64795 c399f75eb631044ea69c18b9ec7dcbabaa0b8aa3	no	2
---	-----------------------	-------------------------------	---	----	---

Warnings:

Information:

Total Files Size (in bytes):		138797
-------------------------------------	--	--------

This Acknowledgement Receipt evidences receipt on the noted date by the USPTO of the indicated documents, characterized by the applicant, and including page counts, where applicable. It serves as evidence of receipt similar to a Post Card, as described in MPEP 503.

New Applications Under 35 U.S.C. 111

If a new application is being filed and the application includes the necessary components for a filing date (see 37 CFR 1.53(b)-(d) and MPEP 506), a Filing Receipt (37 CFR 1.54) will be issued in due course and the date shown on this Acknowledgement Receipt will establish the filing date of the application.

National Stage of an International Application under 35 U.S.C. 371

If a timely submission to enter the national stage of an international application is compliant with the conditions of 35 U.S.C. 371 and other applicable requirements a Form PCT/DO/EO/903 indicating acceptance of the application as a national stage submission under 35 U.S.C. 371 will be issued in addition to the Filing Receipt, in due course.

New International Application Filed with the USPTO as a Receiving Office

If a new international application is being filed and the international application includes the necessary components for an international filing date (see PCT Article 11 and MPEP 1810), a Notification of the International Application Number and of the International Filing Date (Form PCT/RO/105) will be issued in due course, subject to prescriptions concerning national security, and the date shown on this Acknowledgement Receipt will establish the international filing date of the application.

INFORMATION DISCLOSURE STATEMENT

Applicant	:	Clay Perreault, et al.
App. No.	:	12/513,147
Filed	:	March 1, 2010
For	:	PRODUCING ROUTING MESSAGES FOR VOICE OVER IP COMMUNICATIONS
Examiner	:	Sing, Simon P.
Art Unit	:	2614
Conf. No.	:	9611

Commissioner for Patents
P.O. Box 1450
Alexandria, VA 22313-1450

References and Listing

Submitted herewith in the above-identified application is an Information Disclosure Statement listing references for consideration. Copies of any listed foreign and non-patent literature references are being submitted.

Timing of Disclosure

This Information Disclosure Statement is being filed before the receipt of a first Office Action on the merits, and presumably no fee is required. If a first Office Action on the merits was mailed before the mailing date of this Statement, the Commissioner is authorized to charge the fee set forth in 37 CFR 1.17(p) to Deposit Account No. 11-1410.

Respectfully submitted,

KNOBBE, MARTENS, OLSON & BEAR, LLP

Dated: 9-10-2012

By: 

Raimond J. Salenieks
Registration No. 37,924
Agent of Record
Customer No. 20995
(858) 707-4000

INFORMATION DISCLOSURE STATEMENT BY APPLICANT	Application No.	12/513,147
	Filing Date	March 1, 2010
	First Named Inventor	Clay Perreault et al.
	Art Unit	2614
<i>(Multiple sheets used when necessary)</i>	Examiner	Simon P. Sing
SHEET 1 OF 1	Attorney Docket No.	SMARB19.001APC

U.S. PATENT DOCUMENTS					
Examiner Initials	Cite No.	Document Number <i>Number - Kind Code (if known)</i> Example: 1,234,567 B1	Publication Date MM-DD-YYYY	Name of Patentee or Applicant	Pages, Columns, Lines Where Relevant Passages or Relevant Figures Appear
	1	6,151,385	11/21/2000	Reich et al.	
	2	6,597,686	07/22/2003	Darek A Smyk	
	3	6,724,860	04/20/2004	Stumer et al.	
	4	6,744,858	06/01/2004	Ryan et al.	
	5	6,963,557	11/08/2005	Mark Clinton Knox	
	6	7,046,658	05/16/2006	Vinay Kundaje	
	7	2005/025043 A1	02/03/2005	Mussman et al	
	8	2006/0153342 A1	07/13/2006	Syouichi Sasaki	
	9	2006/0258328 A1	11/16/2006	Mario Francisco Godoy	

FOREIGN PATENT DOCUMENTS						
Examiner Initials	Cite No.	Foreign Patent Document <i>Country Code-Number-Kind Code</i> Example: JP 1234567 A1	Publication Date MM-DD-YYYY	Name of Patentee or Applicant	Pages, Columns, Lines Where Relevant Passages or Relevant Figures Appear	T ¹

NON PATENT LITERATURE DOCUMENTS			
Examiner Initials	Cite No.	Include name of the author (in CAPITAL LETTERS), title of the article (when appropriate), title of the item (book, magazine, journal, serial, symposium, catalog, etc.), date, page(s), volume-issue number(s), publisher, city and/or country where published.	T ¹
	10	Lind AT&T S: "ENUM Call Flows for VoIP Interworking; draft-lind-enum-callflows-03.txt", 20020201, no. 3, 1 February 2002, pages 1-17.	
	11	IETF ENUM WG R STASTNY OEFEG INFORMATIONAL NUMBERING FOR VOIP AND OTHER IP COMMUNICATIONS: "Numbering for VoIP and other IP Communications, draft-stastny-enum-numbering-voip-00.txt", 20031001, 1 October 2003, pages 1-43.	

13890436-sjw 083112

Examiner Signature	Date Considered
* Examiner: Initial if reference considered, whether or not citation is in conformance with MPEP 609. Draw line through citation if not in conformance and not considered. Include copy of this form with next communication to applicant.	

T¹ - Place a check mark in this area when an English language translation is attached. **PETITIONER APPLE INC. EX. 1002-211**

Electronic Acknowledgement Receipt

EFS ID:	13676886
Application Number:	12513147
International Application Number:	
Confirmation Number:	9611
Title of Invention:	PRODUCING ROUTING MESSAGES FOR VOICE OVER IP COMMUNICATIONS
First Named Inventor/Applicant Name:	Clay Perreault
Customer Number:	20995
Filer:	Raimond J Salenieks/Heide Young
Filer Authorized By:	Raimond J Salenieks
Attorney Docket Number:	SMARB19.001APC
Receipt Date:	06-SEP-2012
Filing Date:	01-MAR-2010
Time Stamp:	18:33:15
Application Type:	U.S. National Stage under 35 USC 371

Payment information:

Submitted with Payment	no
------------------------	----

File Listing:

Document Number	Document Description	File Name	File Size(Bytes)/ Message Digest	Multi Part /.zip	Pages (if appl.)
1	Non Patent Literature	ENUM_Call_Flows_for_VOIP_In terworking.pdf	655943 2e107052eda6dc6e2c59d87b242a6eadc16523b7	no	18

Warnings:

Information:

PETITIONER APPLE INC. EX. 1002-212

2	Non Patent Literature	Numbering_for_VOIP.pdf	1961611 696280310d5968b5c122b757a200e820b3aba73a	no	44
Warnings:					
Information:					
3		SMARB19_001APC_IDS2.pdf	78511 d3e0aadeff4d0654a6c7395525ba5fcc420a5a2	yes	2
	Multipart Description/PDF files in .zip description				
	Document Description		Start	End	
	Transmittal Letter		1	1	
	Information Disclosure Statement (IDS) Form (SB08)		2	2	
Warnings:					
Information:					
Total Files Size (in bytes):			2696065		
<p>This Acknowledgement Receipt evidences receipt on the noted date by the USPTO of the indicated documents, characterized by the applicant, and including page counts, where applicable. It serves as evidence of receipt similar to a Post Card, as described in MPEP 503.</p> <p><u>New Applications Under 35 U.S.C. 111</u> If a new application is being filed and the application includes the necessary components for a filing date (see 37 CFR 1.53(b)-(d) and MPEP 506), a Filing Receipt (37 CFR 1.54) will be issued in due course and the date shown on this Acknowledgement Receipt will establish the filing date of the application.</p> <p><u>National Stage of an International Application under 35 U.S.C. 371</u> If a timely submission to enter the national stage of an international application is compliant with the conditions of 35 U.S.C. 371 and other applicable requirements a Form PCT/DO/EO/903 indicating acceptance of the application as a national stage submission under 35 U.S.C. 371 will be issued in addition to the Filing Receipt, in due course.</p> <p><u>New International Application Filed with the USPTO as a Receiving Office</u> If a new international application is being filed and the international application includes the necessary components for an international filing date (see PCT Article 11 and MPEP 1810), a Notification of the International Application Number and of the International Filing Date (Form PCT/RO/105) will be issued in due course, subject to prescriptions concerning national security, and the date shown on this Acknowledgement Receipt will establish the international filing date of the application.</p>					

INFORMATION DISCLOSURE STATEMENT

Applicant	: Clay Perreault, et al.
App. No.	: 12/513,147
Filed	: March 1, 2010
For	: PRODUCING ROUTING MESSAGES FOR VOICE OVER IP COMMUNICATIONS
Examiner	: Sing, Simon P.
Art Unit	: 2614
Conf. No.	: 9611

Commissioner for Patents
P.O. Box 1450
Alexandria, VA 22313-1450

References and Listing

Submitted herewith in the above-identified application is an Information Disclosure Statement listing references for consideration. Copies of any listed foreign and non-patent literature references are being submitted.

Timing of Disclosure

This Information Disclosure Statement is being filed before the receipt of a first Office Action on the merits, and presumably no fee is required. If a first Office Action on the merits was mailed before the mailing date of this Statement, the Commissioner is authorized to charge the fee set forth in 37 CFR 1.17(p) to Deposit Account No. 11-1410.

Respectfully submitted,
KNOBBE, MARTENS, OLSON & BEAR, LLP

Dated: 9-6-2012

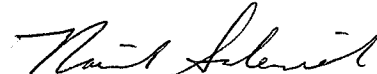
By: 
Raimond J. Salenieks
Registration No. 37,924
Agent of Record
Customer No. 20995
(858) 707-4000

INFORMATION DISCLOSURE STATEMENT BY APPLICANT	Application No.	12/513,147
	Filing Date	March 1, 2010
	First Named Inventor	Clay Perreault et al.
	Art Unit	2614
<i>(Multiple sheets used when necessary)</i>	Examiner	Simon P. Sing
SHEET 1 OF 1	Attorney Docket No.	SMARB19.001APC

U.S. PATENT DOCUMENTS					
Examiner Initials	Cite No.	Document Number <i>Number - Kind Code (if known)</i> Example: 1,234,567 B1	Publication Date MM-DD-YYYY	Name of Patentee or Applicant	Pages, Columns, Lines Where Relevant Passages or Relevant Figures Appear
	1	8,116,307	2/14/2012	Thesayi et al.	
	2	2006/0093135 A1	5/4/2006	Fiatal et al.	

FOREIGN PATENT DOCUMENTS						
Examiner Initials	Cite No.	Foreign Patent Document <i>Country Code-Number-Kind Code</i> Example: JP 1234567 A1	Publication Date MM-DD-YYYY	Name of Patentee or Applicant	Pages, Columns, Lines Where Relevant Passages or Relevant Figures Appear	T ¹

NON PATENT LITERATURE DOCUMENTS			
Examiner Initials	Cite No.	Include name of the author (in CAPITAL LETTERS), title of the article (when appropriate), title of the item (book, magazine, journal, serial, symposium, catalog, etc.), date, page(s), volume-issue number(s), publisher, city and/or country where published.	T ¹

13684957-sjw 072612

Examiner Signature	Date Considered
*Examiner: Initial if reference considered, whether or not citation is in conformance with MPEP 609. Draw line through citation if not in conformance and not considered. Include copy of this form with next communication to applicant.	

T¹ - Place a check mark in this area when an English language translation is attached. PETITIONER APPLE INC. EX. 1002-215

Electronic Acknowledgement Receipt

EFS ID:	13412030
Application Number:	12513147
International Application Number:	
Confirmation Number:	9611
Title of Invention:	PRODUCING ROUTING MESSAGES FOR VOICE OVER IP COMMUNICATIONS
First Named Inventor/Applicant Name:	Clay Perreault
Customer Number:	20995
Filer:	Raimond J Salenieks/Sabrina Jacob
Filer Authorized By:	Raimond J Salenieks
Attorney Docket Number:	SMARB19.001APC
Receipt Date:	03-AUG-2012
Filing Date:	01-MAR-2010
Time Stamp:	15:00:04
Application Type:	U.S. National Stage under 35 USC 371

Payment information:

Submitted with Payment	no
------------------------	----

File Listing:

Document Number	Document Description	File Name	File Size(Bytes)/ Message Digest	Multi Part /.zip	Pages (if appl.)
1		SMARB19_001APC_IDS.pdf	79112 440171ea74e61dae8c84f264a1eb3b0d26607804	yes	2

Multipart Description/PDF files in .zip description			
Document Description		Start	End
Transmittal Letter		1	1
Information Disclosure Statement (IDS) Form (SB08)		2	2

Warnings:

Information:

Total Files Size (in bytes):	79112
-------------------------------------	-------

This Acknowledgement Receipt evidences receipt on the noted date by the USPTO of the indicated documents, characterized by the applicant, and including page counts, where applicable. It serves as evidence of receipt similar to a Post Card, as described in MPEP 503.

New Applications Under 35 U.S.C. 111

If a new application is being filed and the application includes the necessary components for a filing date (see 37 CFR 1.53(b)-(d) and MPEP 506), a Filing Receipt (37 CFR 1.54) will be issued in due course and the date shown on this Acknowledgement Receipt will establish the filing date of the application.

National Stage of an International Application under 35 U.S.C. 371

If a timely submission to enter the national stage of an international application is compliant with the conditions of 35 U.S.C. 371 and other applicable requirements a Form PCT/DO/EO/903 indicating acceptance of the application as a national stage submission under 35 U.S.C. 371 will be issued in addition to the Filing Receipt, in due course.

New International Application Filed with the USPTO as a Receiving Office

If a new international application is being filed and the international application includes the necessary components for an international filing date (see PCT Article 11 and MPEP 1810), a Notification of the International Application Number and of the International Filing Date (Form PCT/RO/105) will be issued in due course, subject to prescriptions concerning national security, and the date shown on this Acknowledgement Receipt will establish the international filing date of the application.

INFORMATION DISCLOSURE STATEMENT

Applicant	:	Clay Perreault, et al.
App. No.	:	12/513,147
Filed	:	March 1, 2010
For	:	PRODUCING ROUTING MESSAGES FOR VOICE OVER IP COMMUNICATIONS
Examiner	:	Simon P. Sing
Art Unit	:	2614
Conf. No.	:	9611

Commissioner for Patents
P.O. Box 1450
Alexandria, VA 22313-1450

References and Listing

Submitted herewith in the above-identified application is an Information Disclosure Statement listing references for consideration. Copies of any listed foreign and non-patent literature references are being submitted.

Timing of Disclosure

This Information Disclosure Statement is being filed before the receipt of a first Office Action on the merits, and presumably no fee is required. If a first Office Action on the merits was mailed before the mailing date of this Statement, the Commissioner is authorized to charge the fee set forth in 37 CFR 1.17(p) to Deposit Account No. 11-1410.

Respectfully submitted,
KNOBBE, MARTENS, OLSON & BEAR, LLP

Dated: August 3, 2012

By: 
Raimond J. Salenieks
Registration No. 37,924
Agent of Record
Customer No. 20995
(858) 707-4000

INFORMATION DISCLOSURE STATEMENT BY APPLICANT	Application No.	12/513,147	
	Filing Date	March 1, 2010	
	First Named Inventor	Clay Perreault et al.	
	Art Unit	2614	
<i>(Multiple sheets used when necessary)</i>		Examiner	Simon P. Sing
SHEET 1 OF 1		Attorney Docket No.	SMARB19.001APC

U.S. PATENT DOCUMENTS					
Examiner Initials	Cite No.	Document Number Number - Kind Code (if known) Example: 1,234,567 B1	Publication Date MM-DD-YYYY	Name of Patentee or Applicant	Pages, Columns, Lines Where Relevant Passages or Relevant Figures Appear

FOREIGN PATENT DOCUMENTS						
Examiner Initials	Cite No.	Foreign Patent Document Country Code-Number-Kind Code Example: JP 1234567 A1	Publication Date MM-DD-YYYY	Name of Patentee or Applicant	Pages, Columns, Lines Where Relevant Passages or Relevant Figures Appear	T ¹

NON PATENT LITERATURE DOCUMENTS			
Examiner Initials	Cite No.	Include name of the author (in CAPITAL LETTERS), title of the article (when appropriate), title of the item (book, magazine, journal, serial, symposium, catalog, etc.), date, page(s), volume-issue number(s), publisher, city and/or country where published.	T ¹
	1	A copy of the International Preliminary Report on Patentability issued on September 29, 2009 for PCT/CA2008/000545.	
	2	A copy of the International Preliminary Report on Patentability issued on March 20, 2012 for PCT/CA2009/001317.	
	3	Townsley, et al.; "RFC 2661 - Layer Two Tunneling Protocol 'L2TP' ", August 1999.	
	4	IP2Location, http://www.ip2location.com/ ; printed June 20, 2012.	
	5	DOTS IP Address Validation, "Overview", http://www.serviceobjects.com/products/dots_ipgeo.asp ; printed June 21, 2012.	
	6	List of North American Numbering Plan area codes, http://en.wikipedia.org/wiki/List_of_NANP_area_codes ; printed June 20, 2012.	
	7	DOTS Phone Exchange, "Overview", http://www.serviceobjects.com/demos/PhoneExchangeDemo.asp (URL no longer valid, current URL is http://www.serviceobjects.com/products/phone/phone-exchange); printed June 21, 2012.	
	8	Rosenberg, et al.; "RFC 3261 - SIP: Session Initiation Protocol", June 2002.	

13464825-sjw 061512

Examiner Signature	Date Considered
*Examiner: Initial if reference considered, whether or not citation is in conformance with MPEP 609. Draw line through citation if not in conformance and not considered. Include copy of this form with next communication to applicant.	

T¹ - Place a check mark in this area when an English language translation is attached. PETITIONER APPLE INC. EX. 1002-219

PATENT COOPERATION TREATY

PCT

INTERNATIONAL PRELIMINARY REPORT ON PATENTABILITY

(Chapter I of the Patent Cooperation Treaty)

(PCT Rule 44bis)

Applicant's or agent's file reference 83636-18	FOR FURTHER ACTION		See item 4 below
International application No. PCT/CA2008/000545	International filing date (<i>day/month/year</i>) 20 March 2008 (20.03.2008)	Priority date (<i>day/month/year</i>) 26 March 2007 (26.03.2007)	
International Patent Classification (8th edition unless older edition indicated) See relevant information in Form PCT/ISA/237			
Applicant DIGIFONICA (INTERNATIONAL) LIMITED			

<p>1. This international preliminary report on patentability (Chapter I) is issued by the International Bureau on behalf of the International Searching Authority under Rule 44 bis.1(a).</p> <p>2. This REPORT consists of a total of 6 sheets, including this cover sheet.</p> <p>In the attached sheets, any reference to the written opinion of the International Searching Authority should be read as a reference to the international preliminary report on patentability (Chapter I) instead.</p>																								
<p>3. This report contains indications relating to the following items:</p> <table> <tr> <td><input checked="" type="checkbox"/></td> <td>Box No. I</td> <td>Basis of the report</td> </tr> <tr> <td><input type="checkbox"/></td> <td>Box No. II</td> <td>Priority</td> </tr> <tr> <td><input type="checkbox"/></td> <td>Box No. III</td> <td>Non-establishment of opinion with regard to novelty, inventive step and industrial applicability</td> </tr> <tr> <td><input type="checkbox"/></td> <td>Box No. IV</td> <td>Lack of unity of invention</td> </tr> <tr> <td><input checked="" type="checkbox"/></td> <td>Box No. V</td> <td>Reasoned statement under Article 35(2) with regard to novelty, inventive step or industrial applicability; citations and explanations supporting such statement</td> </tr> <tr> <td><input type="checkbox"/></td> <td>Box No. VI</td> <td>Certain documents cited</td> </tr> <tr> <td><input checked="" type="checkbox"/></td> <td>Box No. VII</td> <td>Certain defects in the international application</td> </tr> <tr> <td><input checked="" type="checkbox"/></td> <td>Box No. VIII</td> <td>Certain observations on the international application</td> </tr> </table> <p>4. The International Bureau will communicate this report to designated Offices in accordance with Rules 44bis.3(c) and 93bis.1 but not, except where the applicant makes an express request under Article 23(2), before the expiration of 30 months from the priority date (Rule 44bis .2).</p>	<input checked="" type="checkbox"/>	Box No. I	Basis of the report	<input type="checkbox"/>	Box No. II	Priority	<input type="checkbox"/>	Box No. III	Non-establishment of opinion with regard to novelty, inventive step and industrial applicability	<input type="checkbox"/>	Box No. IV	Lack of unity of invention	<input checked="" type="checkbox"/>	Box No. V	Reasoned statement under Article 35(2) with regard to novelty, inventive step or industrial applicability; citations and explanations supporting such statement	<input type="checkbox"/>	Box No. VI	Certain documents cited	<input checked="" type="checkbox"/>	Box No. VII	Certain defects in the international application	<input checked="" type="checkbox"/>	Box No. VIII	Certain observations on the international application
<input checked="" type="checkbox"/>	Box No. I	Basis of the report																						
<input type="checkbox"/>	Box No. II	Priority																						
<input type="checkbox"/>	Box No. III	Non-establishment of opinion with regard to novelty, inventive step and industrial applicability																						
<input type="checkbox"/>	Box No. IV	Lack of unity of invention																						
<input checked="" type="checkbox"/>	Box No. V	Reasoned statement under Article 35(2) with regard to novelty, inventive step or industrial applicability; citations and explanations supporting such statement																						
<input type="checkbox"/>	Box No. VI	Certain documents cited																						
<input checked="" type="checkbox"/>	Box No. VII	Certain defects in the international application																						
<input checked="" type="checkbox"/>	Box No. VIII	Certain observations on the international application																						

<p align="center">The International Bureau of WIPO 34, chemin des Colombettes 1211 Geneva 20, Switzerland</p> <p>Facsimile No. +41 22 338 82 70</p>	<p>Date of issuance of this report 29 September 2009 (29.09.2009)</p>
	<p>Authorized officer</p> <p align="center">Athina Nickitas-Etienne</p> <p>e-mail: pt04.pct@wipo.int</p>

PATENT COOPERATION TREATY

From the
INTERNATIONAL SEARCHING AUTHORITY

To: SMART & BIGGAR Box 11560 Vancouver Centre 2200 - 650 W. Georgia Street VANCOUVER, British Columbia Canada, V6B 4N8		PCT WRITTEN OPINION OF THE INTERNATIONAL SEARCHING AUTHORITY (PCT Rule 43bis.1)																									
		Date of mailing 20 June 2008 (20-06-2008) <i>(day/month/year)</i>																									
Applicant's or agent's file reference 83636-18		FOR FURTHER ACTION See paragraph 2 below																									
International application No. PCT/CA2008/000545	International filing date <i>(day/month/year)</i> 20 March 2008 (20-03-2008)	Priority date <i>(day/month/year)</i> 26 March 2007 (26-03-2007)																									
International Patent Classification (IPC) or both national classification and IPC IPC: H04L 12/66 (2006.01) , H04M 11/06 (2006.01) , H04M 3/42 (2006.01) , H04Q 3/00 (2006.01) , H04Q 3/64 (2006.01)																											
Applicant DIGIFONICA (INTERNATIONAL) LIMITED ET AL																											
1. This opinion contains indications relating to the following items : <table style="width: 100%; border: none;"> <tr> <td style="width: 10%;"><input checked="" type="checkbox"/></td> <td style="width: 20%;">Box No. I</td> <td>Basis of the opinion</td> </tr> <tr> <td><input type="checkbox"/></td> <td>Box No. II</td> <td>Priority</td> </tr> <tr> <td><input type="checkbox"/></td> <td>Box No. III</td> <td>Non-establishment of opinion with regard to novelty, inventive step and industrial applicability</td> </tr> <tr> <td><input type="checkbox"/></td> <td>Box No. IV</td> <td>Lack of unity of invention</td> </tr> <tr> <td><input checked="" type="checkbox"/></td> <td>Box No. V</td> <td>Reasoned statement under Rule 43bis.1(a)(i) with regard to novelty, inventive step or industrial applicability; citations and explanations supporting such statement</td> </tr> <tr> <td><input type="checkbox"/></td> <td>Box No. VI</td> <td>Certain documents cited</td> </tr> <tr> <td><input checked="" type="checkbox"/></td> <td>Box No. VII</td> <td>Certain defects in the international application</td> </tr> <tr> <td><input checked="" type="checkbox"/></td> <td>Box No. VIII</td> <td>Certain observations on the international application</td> </tr> </table>				<input checked="" type="checkbox"/>	Box No. I	Basis of the opinion	<input type="checkbox"/>	Box No. II	Priority	<input type="checkbox"/>	Box No. III	Non-establishment of opinion with regard to novelty, inventive step and industrial applicability	<input type="checkbox"/>	Box No. IV	Lack of unity of invention	<input checked="" type="checkbox"/>	Box No. V	Reasoned statement under Rule 43bis.1(a)(i) with regard to novelty, inventive step or industrial applicability; citations and explanations supporting such statement	<input type="checkbox"/>	Box No. VI	Certain documents cited	<input checked="" type="checkbox"/>	Box No. VII	Certain defects in the international application	<input checked="" type="checkbox"/>	Box No. VIII	Certain observations on the international application
<input checked="" type="checkbox"/>	Box No. I	Basis of the opinion																									
<input type="checkbox"/>	Box No. II	Priority																									
<input type="checkbox"/>	Box No. III	Non-establishment of opinion with regard to novelty, inventive step and industrial applicability																									
<input type="checkbox"/>	Box No. IV	Lack of unity of invention																									
<input checked="" type="checkbox"/>	Box No. V	Reasoned statement under Rule 43bis.1(a)(i) with regard to novelty, inventive step or industrial applicability; citations and explanations supporting such statement																									
<input type="checkbox"/>	Box No. VI	Certain documents cited																									
<input checked="" type="checkbox"/>	Box No. VII	Certain defects in the international application																									
<input checked="" type="checkbox"/>	Box No. VIII	Certain observations on the international application																									
2. FURTHER ACTION If a demand for international preliminary examination is made, this opinion will be considered to be a written opinion of the International Preliminary Examining Authority ("IPEA") except that this does not apply where the applicant chooses an Authority other than this one to be the IPEA and the chosen IPEA has notified the International Bureau under Rule 66.1bis(b) that written opinions of this International Searching Authority will not be so considered. If this opinion is, as provided above, considered to be a written opinion of the IPEA, the applicant is invited to submit to the IPEA a written reply together, where appropriate, with amendments, before the expiration of 3 months from the date of mailing of Form PCT/ISA/220 or before the expiration of 22 months from the priority date, whichever expires later. For further options, see Form PCT/ISA/220.																											
3. For further details, see notes to Form PCT/ISA/220.																											
Name and mailing address of the ISA/CA Canadian Intellectual Property Office Place du Portage I, C114 - 1st Floor, Box PCT 50 Victoria Street Gatineau, Quebec K1A 0C9 Facsimile No.: 001-819-953-2476		Date of completion of this opinion 13 June 2008 (13-06-2008)	Authorized officer Arthur Smith 819-953-1360																								

Box No. I **Basis of this opinion**

1. With regard to the **language**, this opinion has been established on the basis of:
 - the international application in the language in which it was filed
 - a translation of the international application into _____, which is the language of a translation furnished for the purposes of international search (Rules 12.3(a) and 23.1(b)).
2. This opinion has been established taking into account the **rectification of an obvious mistake** authorized by or notified to this Authority under Rule 91 (Rule 43*bis*.1(a))
3. With regard to any **nucleotide and/or amino acid sequence** disclosed in the international application and necessary to the claimed invention, this opinion has been established on the basis of :
 - a. type of material
 - a sequence listing
 - table(s) related to the sequence listing
 - b. format of material
 - on paper
 - in electronic form
 - c. time of filing/furnishing
 - contained in the international application as filed.
 - filed together with the international application in electronic form
 - furnished subsequently to this Authority for the purposes of search.
4. In addition, in the case that more than one version or copy of a sequence listing and/or table(s) relating thereto has been filed or furnished, the required statements that the information in the subsequent or additional copies is identical to that in the application as filed or does not go beyond the application as filed, as appropriate, were furnished.
5. Additional comments :

Box No. V Reasoned statement under Rule 43bis.1(a)(i) with regard to novelty, inventive step or industrial applicability; citations and explanations supporting such statement

1. Statement

Novelty (N)	Claims <u>1-43</u>	YES
	Claims <u>None</u>	NO
Inventive step (IS)	Claims <u>1-43</u>	YES
	Claims <u>None</u>	NO
Industrial applicability (IA)	Claims <u>1-43</u>	YES
	Claims <u>None</u>	NO

2. Citations and explanations :

The following document is referred to in this communication:

D1 US2005/0083911 A1

D1 is considered to form the closest prior art. D1 describes providing E911 emergency services to an IP telephony-based PBX or similar system by establishing a 911 Location Server Database comprising an Emergency Response Location (ERL) database and a Phone Location database. The location of a caller stored in the ERL database is used to route an emergency call to an end-office switch corresponding to the nearest Public Safety Answering Point (PSAP). The Phone Location database stores one record for each registered phone in the system.

Novelty

D1 fails to disclose all the elements of independent claims 1, 15, 29, and 43. In particular, D1 fails to teach a direct inward dialing (DID) identifier or producing a DID identifier for a caller identifier that has no pre-associated DID identifier. Claims 2-14, 16-28 and 30-42 depend on the above independent claims, respectively.

Thus, claims 1-43 **are considered to be novel** in accordance with Article 33(2) PCT.

Inventive Step

D1 fails to teach or suggest producing a routing message including an emergency response center identifier and temporary DID identifier for establishing a route between a caller and an emergency response center as claimed in independent claims 1, 15, 29, and 43. Claims 2-14, 16-28, and 30-42 depend on the above independent claims, respectively.

Thus, claims 1-43 **are considered to have inventive step** in accordance with Article 33(3) PCT.

Industrial Applicability

Including location information for emergency VoIP callers located behind a VoIP PBX finds application in IP telephony networks. Thus, claims 1-43 **are industrially applicable** in accordance with Article 33(4) PCT.

Box No. VII Certain defects in the international application

The following defects in the form or contents of the international application have been noted :

Description-Related Deficiencies

On page 1, line 19, of the description, the term “presended” (sic) is misspelled. Applicant may have intended “presented to”.

Box No. VIII Certain observations on the international application

The following observations on the clarity of the claims, description, and drawings or on the question whether the claims are fully supported by the description, are made :

Claims-Related Deficiencies

Claims 1 and 22 do not comply with PCT Article 6. In claim 1, the term “the method” (line 3) lacks an antecedent and in claim 22, the term “said pool” (line 15) lacks an antecedent.

PCT

INTERNATIONAL PRELIMINARY REPORT ON PATENTABILITY (Chapter I of the Patent Cooperation Treaty)

(PCT Rule 44bis)

Applicant's or agent's file reference 83636-56	FOR FURTHER ACTION		See item 4 below
International application No. PCT/CA2009/001317	International filing date (<i>day/month/year</i>) 17 September 2009 (17.09.2009)	Priority date (<i>day/month/year</i>)	
International Patent Classification (8th edition unless older edition indicated) See relevant information in Form PCT/ISA/237			
Applicant DIGIFONICA (INTERNATIONAL) LIMITED			

<p>1. This international preliminary report on patentability (Chapter I) is issued by the International Bureau on behalf of the International Searching Authority under Rule 44 bis.1(a).</p> <p>2. This REPORT consists of a total of 5 sheets, including this cover sheet.</p> <p>In the attached sheets, any reference to the written opinion of the International Searching Authority should be read as a reference to the international preliminary report on patentability (Chapter I) instead.</p>																								
<p>3. This report contains indications relating to the following items:</p> <table style="width: 100%; border-collapse: collapse;"> <tr> <td style="width: 5%; text-align: center;"><input checked="" type="checkbox"/></td> <td style="width: 25%;">Box No. I</td> <td>Basis of the report</td> </tr> <tr> <td style="text-align: center;"><input type="checkbox"/></td> <td>Box No. II</td> <td>Priority</td> </tr> <tr> <td style="text-align: center;"><input type="checkbox"/></td> <td>Box No. III</td> <td>Non-establishment of opinion with regard to novelty, inventive step and industrial applicability</td> </tr> <tr> <td style="text-align: center;"><input type="checkbox"/></td> <td>Box No. IV</td> <td>Lack of unity of invention</td> </tr> <tr> <td style="text-align: center;"><input checked="" type="checkbox"/></td> <td>Box No. V</td> <td>Reasoned statement under Article 35(2) with regard to novelty, inventive step or industrial applicability; citations and explanations supporting such statement</td> </tr> <tr> <td style="text-align: center;"><input type="checkbox"/></td> <td>Box No. VI</td> <td>Certain documents cited</td> </tr> <tr> <td style="text-align: center;"><input type="checkbox"/></td> <td>Box No. VII</td> <td>Certain defects in the international application</td> </tr> <tr> <td style="text-align: center;"><input type="checkbox"/></td> <td>Box No. VIII</td> <td>Certain observations on the international application</td> </tr> </table> <p>4. The International Bureau will communicate this report to designated Offices in accordance with Rules 44bis.3(c) and 93bis.1 but not, except where the applicant makes an express request under Article 23(2), before the expiration of 30 months from the priority date (Rule 44bis .2).</p>	<input checked="" type="checkbox"/>	Box No. I	Basis of the report	<input type="checkbox"/>	Box No. II	Priority	<input type="checkbox"/>	Box No. III	Non-establishment of opinion with regard to novelty, inventive step and industrial applicability	<input type="checkbox"/>	Box No. IV	Lack of unity of invention	<input checked="" type="checkbox"/>	Box No. V	Reasoned statement under Article 35(2) with regard to novelty, inventive step or industrial applicability; citations and explanations supporting such statement	<input type="checkbox"/>	Box No. VI	Certain documents cited	<input type="checkbox"/>	Box No. VII	Certain defects in the international application	<input type="checkbox"/>	Box No. VIII	Certain observations on the international application
<input checked="" type="checkbox"/>	Box No. I	Basis of the report																						
<input type="checkbox"/>	Box No. II	Priority																						
<input type="checkbox"/>	Box No. III	Non-establishment of opinion with regard to novelty, inventive step and industrial applicability																						
<input type="checkbox"/>	Box No. IV	Lack of unity of invention																						
<input checked="" type="checkbox"/>	Box No. V	Reasoned statement under Article 35(2) with regard to novelty, inventive step or industrial applicability; citations and explanations supporting such statement																						
<input type="checkbox"/>	Box No. VI	Certain documents cited																						
<input type="checkbox"/>	Box No. VII	Certain defects in the international application																						
<input type="checkbox"/>	Box No. VIII	Certain observations on the international application																						

The International Bureau of WIPO 34, chemin des Colombettes 1211 Geneva 20, Switzerland Facsimile No. +41 22 338 82 70	Date of issuance of this report 20 March 2012 (20.03.2012) Authorized officer <p style="text-align: center;">Athina Nickitas-Etienne</p> e-mail: pt04.pct@wipo.int
---	---

PATENT COOPERATION TREATY

From the
INTERNATIONAL SEARCHING AUTHORITY

To:
SMART & BIGGAR
Box 11560 Vancouver Centre
2200 - 650 W. Georgia Street
VANCOUVER, British Columbia
Canada, V6B 4N8

PCT

WRITTEN OPINION OF THE
INTERNATIONAL SEARCHING AUTHORITY

(PCT Rule 43bis.1)

Date of mailing 18 June 2010 (18-06-2010)
(day/month/year)

Applicant's or agent's file reference
83636-56

FOR FURTHER ACTION
See paragraph 2 below

International application No.
PCT/CA2009/001317

International filing date (day/month/year)
17 September 2009 (17-09-2009)

Priority date (day/month/year)

International Patent Classification (IPC) or both national classification and IPC
IPC: *H04L 12/66* (2006.01) , *H04L 29/06* (2006.01) , *H04W 36/02* (2009.01) , *H04W 36/18* (2009.01)

Applicant
DIGIFONICA (INTERNATIONAL) LIMITED ET AL

1. This opinion contains indications relating to the following items :

<input checked="" type="checkbox"/>	Box No. I	Basis of the opinion
<input type="checkbox"/>	Box No. II	Priority
<input type="checkbox"/>	Box No. III	Non-establishment of opinion with regard to novelty, inventive step and industrial applicability
<input type="checkbox"/>	Box No. IV	Lack of unity of invention
<input checked="" type="checkbox"/>	Box No. V	Reasoned statement under Rule 43bis.1(a)(I) with regard to novelty, inventive step or industrial applicability; citations and explanations supporting such statement
<input type="checkbox"/>	Box No. VI	Certain documents cited
<input type="checkbox"/>	Box No. VII	Certain defects in the international application
<input type="checkbox"/>	Box No. VIII	Certain observations on the international application

2. **FURTHER ACTION**
If a demand for international preliminary examination is made, this opinion will be considered to be a written opinion of the International Preliminary Examining Authority ("IPEA") except that this does not apply where the applicant chooses an Authority other than this one to be the IPEA and the chosen IPEA has notified the International Bureau under Rule 66.1bis(b) that written opinions of this International Searching Authority will not be so considered.

If this opinion is, as provided above, considered to be a written opinion of the IPEA, the applicant is invited to submit to the IPEA a written reply together, where appropriate, with amendments, before the expiration of 3 months from the date of mailing of Form PCT/ISA/220 or before the expiration of 22 months from the priority date, whichever expires later.

For further options, see Form PCT/ISA/220.

3. For further details, see notes to Form PCT/ISA/220.

Name and mailing address of the ISA/CA
Canadian Intellectual Property Office
Place du Portage I, C114 - 1st Floor, Box PCT
50 Victoria Street
Gatineau, Quebec K1A 0C9
Facsimile No.: 001-819-953-2476

Date of completion of this opinion
17 June 2010 (17-06-2010)

Authorized officer
Salvatore Ginese (819) 934-4888

Box No. I

Basis of this opinion

1. With regard to the **language**, this opinion has been established on the basis of:
 - the international application in the language in which it was filed
 - a translation of the international application into _____, which is the language of a translation furnished for the purposes of international search (Rules 12.3(a) and 23.1(b)).
2. This opinion has been established taking into account the **rectification of an obvious mistake** authorized by or notified to this Authority under Rule 91 (Rule 43*bis*.1(a))
3. With regard to any **nucleotide and/or amino acid sequence** disclosed in the international application, this opinion has been established on the basis of a sequence listing filed or furnished:
 - a. (means)
 - on paper
 - in electronic form
 - b. (time)
 - the international application as filed.
 - together with the international application in electronic form
 - subsequently to this Authority for the purposes of search
4. In addition, in the case that more than one version or copy of a sequence listing has been filed or furnished, the required statements that the information in the subsequent or additional copies is identical to that in the application as filed or does not go beyond the application as filed, as appropriate, were furnished.
5. Additional comments :

Box No. V Reasoned statement under Rule 43bis.1(a)(i) with regard to novelty, inventive step or industrial applicability; citations and explanations supporting such statement

1. Statement

Novelty (N)	Claims <u>1 to 16</u>	YES
	Claims <u>None</u>	NO
Inventive step (IS)	Claims <u>1 to 16</u>	YES
	Claims <u>None</u>	NO
Industrial applicability (IA)	Claims <u>1 to 16</u>	YES
	Claims <u>None</u>	NO

2. Citations and explanations :

Reference is made to the following documents:

D1: US 2009/0028146 A1	KLEYMAN et al.	29 January 2009	(29-01-2009)
D2: US 7454510 B2	KLEYMAN et al.	18 November 2008	(18-11-2008)
D3: US 2007/0253418 A1	SHIRI et al.	01 November 2007	(01-11-2007)
D4: US 2007/0036143 A1	ALT et al.	15 February 2007	(15-02-2007)

Novelty

None of D1 to D4 individually teaches explicitly a method for facilitating uninterrupted transmission of internet protocol (IP) transmissions containing real time transport protocol (RTP) data during endpoint changes, the method comprising: maintaining records, each record associating session information, caller information and callee information for IP communication sessions; said session information including caller and callee RTP port identifiers identifying caller and callee RTP ports respectively of a media relay; said caller information including a caller IP address identifier and a caller port identifier to which IP transmission received at said callee RTP port are transmitted from the media relay, and a caller synchronization source (SSRC) identifier; and said callee information including a callee IP address identifier and a callee port identifier to which IP transmissions received at said caller RTP port are transmitted from the media relay, and a callee SSRC identifier; and when an IP transmission is received at said caller RTP port or said callee RTP port; locating one of said records having said caller RTP port identifier or said callee RTP port identifier matching a destination port identifier in said IP transmission; when said one of said records is located and when said destination port identifier in said IP transmission matches the (caller or callee) RTP port identifier of said one of said records; setting a source IP address identifier and source port identifier from said IP transmission as the (caller or callee) IP address identifier and (caller/callee) IP address identifier and (caller/callee) port identifier respectively of said one of said records when said (caller/callee) IP address identifier and (caller/callee) port identifier do not match said source IP address identifier and source port identifier respectively; and a received SSRC identifier in said IP transmission matches said (caller/callee) SSRC identifier.

The subject matter of claims 1 to 16 is therefore considered to be novel, satisfying the requirements of **Article 33(2)**.

(Continued in supplemental box 1 of 1)

Supplemental Box

In case the space in any of the preceding boxes is not sufficient.

Continuation of: Box No. V (This is supplemental box 1 of 1)

Inventive step

None of D1 to D4 teaches or suggests in combination the aforementioned features.

The subject matter of claims 1 to 16 is therefore considered to contain an inventive step, satisfying the requirements of **Article 33(3)**.

Industrial applicability

The subject matter of claims 1 to 16 is considered to be industrially applicable, thus fulfilling the requirements of **Article 33(4)**.

Electronic Acknowledgement Receipt

EFS ID:	13076737
Application Number:	12513147
International Application Number:	
Confirmation Number:	9611
Title of Invention:	PRODUCING ROUTING MESSAGES FOR VOICE OVER IP COMMUNICATIONS
First Named Inventor/Applicant Name:	Clay Perreault
Customer Number:	20995
Filer:	Raimond J Salenieks/Jessica Egigian
Filer Authorized By:	Raimond J Salenieks
Attorney Docket Number:	SMARB19.001APC
Receipt Date:	21-JUN-2012
Filing Date:	01-MAR-2010
Time Stamp:	18:44:10
Application Type:	U.S. National Stage under 35 USC 371

Payment information:

Submitted with Payment	no
------------------------	----

File Listing:

Document Number	Document Description	File Name	File Size(Bytes)/ Message Digest	Multi Part /.zip	Pages (if appl.)
1		SMARB19_001APC_IDS.pdf	97632 <small>9cf3b3ce7cfcc7b0f5eb3e12cacedb043a567885</small>	yes	2

Multipart Description/PDF files in .zip description					
Document Description			Start	End	
Transmittal Letter			1	1	
Information Disclosure Statement (IDS) Form (SB08)			2	2	
Warnings:					
Information:					
2	Non Patent Literature	IPRP_PCTCA2008000545_0929 2009.pdf	191084 6367b5a9b63e6455efcf350e67e1102ed0b dbd96	no	6
Warnings:					
Information:					
3	Non Patent Literature	IPRP_PCTCA2009001317_0320 2012.pdf	199609 8016fc296e452d2bf6a5110264d714b7fcd b79a	no	5
Warnings:					
Information:					
4	Non Patent Literature	Townsley_RFC2661.pdf	2687119 73bea52a5c7379715b5d7662f3bf633b4be 650a5	no	69
Warnings:					
Information:					
5	Non Patent Literature	IP2Location.pdf	186325 3e92bd32f5262d45afc4083142811fa49203 eb8e	no	2
Warnings:					
Information:					
6	Non Patent Literature	DOTS_IP_Address_Validation. pdf	81650 c6c7eddd8aedc86d1e91287e3e7fc22c697 c02ef	no	1
Warnings:					
Information:					
7	Non Patent Literature	List_of_North_American_Num bering_Plan_area_codes.pdf	3469194 53995f3a6fcb3e411494494489e115f706c 1299	no	45
Warnings:					
Information:					
8	Non Patent Literature	DOTS_Phone_Exchange.pdf	77864 aea0e6f8600b8e1f73ee20933b3b96166ac d17d6	no	1
Warnings:					
Information:					

9	Non Patent Literature	Rosenburg_RFC3261.pdf	19972958 0bf0bed951959461ef343d77deae1135ce8a131	no	232
---	-----------------------	-----------------------	---	----	-----

Warnings:

Information:

Total Files Size (in bytes):	26963435
-------------------------------------	----------

This Acknowledgement Receipt evidences receipt on the noted date by the USPTO of the indicated documents, characterized by the applicant, and including page counts, where applicable. It serves as evidence of receipt similar to a Post Card, as described in MPEP 503.

New Applications Under 35 U.S.C. 111

If a new application is being filed and the application includes the necessary components for a filing date (see 37 CFR 1.53(b)-(d) and MPEP 506), a Filing Receipt (37 CFR 1.54) will be issued in due course and the date shown on this Acknowledgement Receipt will establish the filing date of the application.

National Stage of an International Application under 35 U.S.C. 371

If a timely submission to enter the national stage of an international application is compliant with the conditions of 35 U.S.C. 371 and other applicable requirements a Form PCT/DO/EO/903 indicating acceptance of the application as a national stage submission under 35 U.S.C. 371 will be issued in addition to the Filing Receipt, in due course.

New International Application Filed with the USPTO as a Receiving Office

If a new international application is being filed and the international application includes the necessary components for an international filing date (see PCT Article 11 and MPEP 1810), a Notification of the International Application Number and of the International Filing Date (Form PCT/RO/105) will be issued in due course, subject to prescriptions concerning national security, and the date shown on this Acknowledgement Receipt will establish the international filing date of the application.

INFORMATION DISCLOSURE STATEMENT

Applicant	:	Clay Perreault, et al.
App. No.	:	12/513,147
Filed	:	March 1, 2010
For	:	PRODUCING ROUTING MESSAGES FOR VOICE OVER IP COMMUNICATIONS
Examiner	:	Simon P. Sing
Art Unit	:	2614
Conf. No.	:	9611

Commissioner for Patents
P.O. Box 1450
Alexandria, VA 22313-1450

References and Listing

Submitted herewith in the above-identified application is an Information Disclosure Statement listing references for consideration. Copies of any listed foreign and non-patent literature references are being submitted.

Timing of Disclosure

This Information Disclosure Statement is being filed before the receipt of a first Office Action on the merits, and presumably no fee is required. If a first Office Action on the merits was mailed before the mailing date of this Statement, the Commissioner is authorized to charge the fee set forth in 37 CFR 1.17(p) to Deposit Account No. 11-1410.

Respectfully submitted,

KNOBBE, MARTENS, OLSON & BEAR, LLP

Dated: 6-21-2012

By: 

Raimond J. Salenieks
Registration No. 37,924
Agent of Record
Customer No. 20995
(858) 707-4000

INFORMATION DISCLOSURE STATEMENT BY APPLICANT	Application No.	12/513147	
	Filing Date	03-01-2010	
	First Named Inventor	Clay Perreault et al	
	Art Unit	2614	
<i>(Multiple sheets used when necessary)</i>		Examiner	Curtis A. Kuntz
SHEET 1 OF 1		Attorney Docket No.	SMARB19.001APC

U.S. PATENT DOCUMENTS

Examiner Initials	Cite No.	Document Number <i>Number - Kind Code (if known)</i> Example: 1,234,567 B1	Publication Date MM-DD-YYYY	Name of Patentee or Applicant	Pages, Columns, Lines Where Relevant Passages or Relevant Figures Appear
	1	7,454,510	11-18-2008	Kleyman et al.	
	2	2004/0022237 A1	02-05-2004	Elliot et al.	
	3	2007/0036143 A1	02-15-2007	Alt et al.	
	4	2007/0112964 A1	05-17-2007	Guedalia et al.	
	5	2007/0253418	11-01-2007	Shiri et al.	
	6	2009/0028146 A1	01-29-2009	Kleyman et al.	

FOREIGN PATENT DOCUMENTS

Examiner Initials	Cite No.	Foreign Patent Document <i>Country Code-Number-Kind Code</i> Example: JP 1234567 A1	Publication Date MM-DD-YYYY	Name of Patentee or Applicant	Pages, Columns, Lines Where Relevant Passages or Relevant Figures Appear	T ¹
	7	EP 1 389 862 B1	11-03-2004	Shen et al.		

NON PATENT LITERATURE DOCUMENTS

Examiner Initials	Cite No.	Include name of the author (in CAPITAL LETTERS), title of the article (when appropriate), title of the item (book, magazine, journal, serial, symposium, catalog, etc.), date, page(s), volume-issue number(s), publisher, city and/or country where published.	T ¹
	8	A copy of the International Preliminary Report on Patentability and Written Opinion of the International Searching Authority mailed February 10, 2011 for related PCT Application No. PCT/CA2009/001062, February 10, 2011.	
	9	A copy of the International Preliminary Report on Patentability mailed February 13, 2009 for corresponding PCT/CA2007/002150.	
	10	A copy of the International Preliminary Report on Patentability mailed May 14, 2009 for related PCT/CA2007/001956.	
	11	A copy of the International Search Report and Written Opinion mailed on March 12, 2010 for corresponding PCT Application No. PCT/CA2009/001062.	
	12	A copy of the International Search Report and Written Opinion of the International Searching Authority completed February 6, 2008 for related PCT/CA2007/001956.	
	13	A copy of the International Search Report and Written Opinion of the International Searching Authority completed June 6, 2008 for corresponding PCT/CA2008/000545.	
	14	A copy of the International Search Report completed on March 3, 2008 for corresponding PCT/CA2007/002150.	
	15	A copy of the Written Opinion and International Search Report completed on June 17, 2010 for related PCT Application No. PCT/CA2009/001317, June 17, 2010.	

11179518\cey
050411

Examiner Signature	Date Considered
--------------------	-----------------

***Examiner:** Initial if reference considered, whether or not citation is in conformance with MPEP 609. Draw line through citation if not in conformance and not considered. Include copy of this form with next communication to applicant.

T¹ - Place a check mark in this area when an English language translation is available. EX. 1002-235

Electronic Acknowledgement Receipt

EFS ID:	10023936
Application Number:	12513147
International Application Number:	
Confirmation Number:	9611
Title of Invention:	PRODUCING ROUTING MESSAGES FOR VOICE OVER IP COMMUNICATIONS
First Named Inventor/Applicant Name:	Clay Perreault
Customer Number:	20995
Filer:	John M Carson/Alexandra Benitez
Filer Authorized By:	John M Carson
Attorney Docket Number:	SMARB19.001APC
Receipt Date:	06-MAY-2011
Filing Date:	01-MAR-2010
Time Stamp:	12:54:12
Application Type:	U.S. National Stage under 35 USC 371

Payment information:

Submitted with Payment	no
------------------------	----

File Listing:

Document Number	Document Description	File Name	File Size(Bytes)/ Message Digest	Multi Part /.zip	Pages (if appl.)
1	NPL Documents	IPRP_001062.pdf	293201 <small>dcd77431b47d1b19e6453c616531c29a8801cbbb</small>	no	7

Warnings:

Information:

PETITIONER APPLE INC. EX. 1002-236

2	NPL Documents	IPRP_002150.pdf	1138415	no	27
			ac7f2a930f363ff846c404dfb423e748360f67b3		
Warnings:					
Information:					
3	NPL Documents	IPRP_001956.pdf	535190	no	10
			50b674114b078f2c665d9e060a0eb18335273e69		
Warnings:					
Information:					
4	NPL Documents	ISR_WO_001062.pdf	335892	no	8
			17b27ecfd0e8456cea3ffcf6c8b2c8621274ea2		
Warnings:					
Information:					
5	NPL Documents	ISR_WO_001956.pdf	703721	no	12
			f9277a31dd1e5e1f8593ab3faa963fa6ef100cb5		
Warnings:					
Information:					
6	NPL Documents	ISR_WO_000545.pdf	465629	no	9
			73e1c60478b6c0911685c4bc4120f9798f2a74b7		
Warnings:					
Information:					
7	NPL Documents	ISR_WO_002150.pdf	772250	no	12
			46225a5684736c59ee6ad21f7f6200e0712565		
Warnings:					
Information:					
8	NPL Documents	ISR_WO_001317.pdf	323665	no	7
			4fd39f37ec65a31c3062c9be2f84cee455e374c		
Warnings:					
Information:					
9	Foreign Reference	EP_1389862.pdf	551343	no	11
			938583fb2be7f59e4a66cff10aad2f1b708f1dcb		
Warnings:					
Information:					
10		SMARB19_001PC_IDS.pdf	106733	yes	2
			9154d9f92177570c2ec6bc4cef955c792574745b		

Multipart Description/PDF files in .zip description			
Document Description		Start	End
NPL Documents		1	1
Information Disclosure Statement (IDS) Filed (SB/08)		2	2

Warnings:

Information:

Total Files Size (in bytes):	5226039
-------------------------------------	---------

This Acknowledgement Receipt evidences receipt on the noted date by the USPTO of the indicated documents, characterized by the applicant, and including page counts, where applicable. It serves as evidence of receipt similar to a Post Card, as described in MPEP 503.

New Applications Under 35 U.S.C. 111

If a new application is being filed and the application includes the necessary components for a filing date (see 37 CFR 1.53(b)-(d) and MPEP 506), a Filing Receipt (37 CFR 1.54) will be issued in due course and the date shown on this Acknowledgement Receipt will establish the filing date of the application.

National Stage of an International Application under 35 U.S.C. 371

If a timely submission to enter the national stage of an international application is compliant with the conditions of 35 U.S.C. 371 and other applicable requirements a Form PCT/DO/EO/903 indicating acceptance of the application as a national stage submission under 35 U.S.C. 371 will be issued in addition to the Filing Receipt, in due course.

New International Application Filed with the USPTO as a Receiving Office

If a new international application is being filed and the international application includes the necessary components for an international filing date (see PCT Article 11 and MPEP 1810), a Notification of the International Application Number and of the International Filing Date (Form PCT/RO/105) will be issued in due course, subject to prescriptions concerning national security, and the date shown on this Acknowledgement Receipt will establish the international filing date of the application.

From the INTERNATIONAL BUREAU

PCT

NOTIFICATION CONCERNING
TRANSMITTAL OF COPY OF INTERNATIONAL
PRELIMINARY REPORT ON PATENTABILITY
(CHAPTER I OF THE PATENT COOPERATION
TREATY)

(PCT Rule 44bis.1(c))

To:

KNOX, John, W.
SMART & BIGGAR
2200-650 West Georgia Street
Vancouver, British Columbia V6B 4N8
CANADA

RECEIVED
MAIL ROOM
FEB 24 11: 20
INTERNATIONAL BUREAU
OF PATENT COOPERATION
CHAMBERLAIN SQUARE
GENEVA SWITZERLAND

Date of mailing (day/month/year) 10 February 2011 (10.02.2011)		IMPORTANT NOTICE	
Applicant's or agent's file reference 83636-55			
International application No. PCT/CA2009/001062	International filing date (day/month/year) 28 July 2009 (28.07.2009)	Priority date (day/month/year) 28 July 2008 (28.07.2008)	
Applicant DIGIFONICA (INTERNATIONAL) LIMITED et al			

The International Bureau transmits herewith a copy of the international preliminary report on patentability (Chapter I of the Patent Cooperation Treaty)

The International Bureau of WIPO 34, chemin des Colombettes 1211 Geneva 20, Switzerland	Authorized officer <p style="text-align: center;">Athina Nickitas-Etienne</p>
Facsimile No. +41 22 338 82 70	e-mail: p104.pct@wipo.int

PETITIONER APPLE INC. EX. 1002-239

PATENT COOPERATION TREATY

PCT

INTERNATIONAL PRELIMINARY REPORT ON PATENTABILITY
(Chapter I of the Patent Cooperation Treaty)

(PCT Rule 44bis)

2011 FEB 24 A 11: 38

Applicant's or agent's file reference 83636-55	FOR FURTHER ACTION		See item 4 below -
International application No. PCT/CA2009/001062	International filing date (day/month/year) 28 July 2009 (28.07.2009)	Priority date (day/month/year) 28 July 2008 (28.07.2008)	
International Patent Classification (8th edition unless older edition indicated) See relevant information in Form PCT/ISA/237			
Applicant DIGIFONICA (INTERNATIONAL) LIMITED			

1. This international preliminary report on patentability (Chapter I) is issued by the International Bureau on behalf of the International Searching Authority under Rule 44 bis.1(a).

2. This REPORT consists of a total of 6 sheets, including this cover sheet.

In the attached sheets, any reference to the written opinion of the International Searching Authority should be read as a reference to the international preliminary report on patentability (Chapter I) instead.

3. This report contains indications relating to the following items:

<input checked="" type="checkbox"/>	Box No. I	Basis of the report
<input type="checkbox"/>	Box No. II	Priority
<input type="checkbox"/>	Box No. III	Non-establishment of opinion with regard to novelty, inventive step and industrial applicability
<input type="checkbox"/>	Box No. IV	Lack of unity of invention
<input checked="" type="checkbox"/>	Box No. V	Reasoned statement under Article 35(2) with regard to novelty, inventive step or industrial applicability; citations and explanations supporting such statement
<input type="checkbox"/>	Box No. VI	Certain documents cited
<input type="checkbox"/>	Box No. VII	Certain defects in the international application
<input checked="" type="checkbox"/>	Box No. VIII	Certain observations on the international application

4. The International Bureau will communicate this report to designated Offices in accordance with Rules 44bis.3(c) and 93bis.1 but not, except where the applicant makes an express request under Article 23(2), before the expiration of 30 months from the priority date (Rule 44bis.2).

The International Bureau of WIPO 34, chemin des Colombettes 1211 Geneva 20, Switzerland Facsimile No. +41 22 338 82 70	Date of issuance of this report 01 February 2011 (01.02.2011)
	Authorized officer Athina Nickitas-Etienne e-mail: pt04.pct@wipo.int

Form PCT/IB/373 (January 2004)

PATENT COOPERATION TREATY

From the
INTERNATIONAL SEARCHING AUTHORITY

PCT

WRITTEN OPINION OF THE
INTERNATIONAL SEARCHING AUTHORITY

(PCT Rule 43bis.1)

To: SMART & BIGGAR Box 11560 Vancouver Centre 2200 - 650 W. Georgia Street VANCOUVER, British Columbia Canada, V6B 4N8		Date of mailing 12 March 2010 (12-03-2010) <i>(day/month/year)</i>																									
Applicant's or agent's file reference 83636-55		FOR FURTHER ACTION See paragraph 2 below																									
International application No. PCT/CA2009/001062	International filing date <i>(day/month/year)</i> 28 July 2009 (28-07-2009)	Priority date <i>(day/month/year)</i> 28 July 2008 (28-07-2008)																									
International Patent Classification (IPC) or both national classification and IPC IPC: <i>H04W 76/02</i> (2009.01), <i>H04W 88/06</i> (2009.01), <i>H04W 88/16</i> (2009.01)																											
Applicant DIGIFONICA (INTERNATIONAL) LIMITED ET AL																											
1. This opinion contains indications relating to the following items : <table style="width: 100%; border: none;"> <tr> <td style="width: 10%;"><input checked="" type="checkbox"/></td> <td style="width: 20%;">Box No. I</td> <td style="width: 5%;">Basis of the opinion</td> </tr> <tr> <td><input type="checkbox"/></td> <td>Box No. II</td> <td>Priority</td> </tr> <tr> <td><input type="checkbox"/></td> <td>Box No. III</td> <td>Non-establishment of opinion with regard to novelty, inventive step and industrial applicability</td> </tr> <tr> <td><input type="checkbox"/></td> <td>Box No. IV</td> <td>Lack of unity of invention</td> </tr> <tr> <td><input checked="" type="checkbox"/></td> <td>Box No. V</td> <td>Reasoned statement under Rule 43bis.1(a)(I) with regard to novelty, inventive step or industrial applicability, citations and explanations supporting such statement</td> </tr> <tr> <td><input type="checkbox"/></td> <td>Box No. VI</td> <td>Certain documents cited</td> </tr> <tr> <td><input type="checkbox"/></td> <td>Box No. VII</td> <td>Certain defects in the international application</td> </tr> <tr> <td><input checked="" type="checkbox"/></td> <td>Box No. VIII</td> <td>Certain observations on the international application</td> </tr> </table>				<input checked="" type="checkbox"/>	Box No. I	Basis of the opinion	<input type="checkbox"/>	Box No. II	Priority	<input type="checkbox"/>	Box No. III	Non-establishment of opinion with regard to novelty, inventive step and industrial applicability	<input type="checkbox"/>	Box No. IV	Lack of unity of invention	<input checked="" type="checkbox"/>	Box No. V	Reasoned statement under Rule 43bis.1(a)(I) with regard to novelty, inventive step or industrial applicability, citations and explanations supporting such statement	<input type="checkbox"/>	Box No. VI	Certain documents cited	<input type="checkbox"/>	Box No. VII	Certain defects in the international application	<input checked="" type="checkbox"/>	Box No. VIII	Certain observations on the international application
<input checked="" type="checkbox"/>	Box No. I	Basis of the opinion																									
<input type="checkbox"/>	Box No. II	Priority																									
<input type="checkbox"/>	Box No. III	Non-establishment of opinion with regard to novelty, inventive step and industrial applicability																									
<input type="checkbox"/>	Box No. IV	Lack of unity of invention																									
<input checked="" type="checkbox"/>	Box No. V	Reasoned statement under Rule 43bis.1(a)(I) with regard to novelty, inventive step or industrial applicability, citations and explanations supporting such statement																									
<input type="checkbox"/>	Box No. VI	Certain documents cited																									
<input type="checkbox"/>	Box No. VII	Certain defects in the international application																									
<input checked="" type="checkbox"/>	Box No. VIII	Certain observations on the international application																									
2. FURTHER ACTION If a demand for international preliminary examination is made, this opinion will be considered to be a written opinion of the International Preliminary Examining Authority ("IPEA") except that this does not apply where the applicant chooses an Authority other than this one to be the IPEA and the chosen IPEA has notified the International Bureau under Rule 66.1bis(b) that written opinions of this International Searching Authority will not be so considered. If this opinion is, as provided above, considered to be a written opinion of the IPEA, the applicant is invited to submit to the IPEA a written reply together, where appropriate, with amendments, before the expiration of 3 months from the date of mailing of Form PCT/ISA/220 or before the expiration of 22 months from the priority date, whichever expires later. For further options, see Form PCT/ISA/220.																											
3. For further details, see notes to Form PCT/ISA/220.																											
Name and mailing address of the ISA/CA Canadian Intellectual Property Office Place du Portage I, C114 - 1st Floor, Box PCT 50 Victoria Street Gatineau, Quebec K1A 0C9 Facsimile No.: 001-819-953-2476		Date of completion of this opinion 12 March 2010 (12-03-2010)	Authorized officer Elena Mikhailova (819) 953-5206																								

WRITTEN OPINION OF THE
INTERNATIONAL SEARCHING AUTHORITY

International application No.
PCT/CA2009/001062

Box No. I Basis of this opinion

1. With regard to the **language**, this opinion has been established on the basis of:
 - the international application in the language in which it was filed
 - a translation of the international application into _____, which is the language of a translation furnished for the purposes of international search (Rules 12.3(a) and 23.1(b)).
2. This opinion has been established taking into account the **rectification of an obvious mistake** authorized by or notified to this Authority under Rule 91 (Rule 43*bis*.1(a))
3. With regard to any **nucleotide and/or amino acid sequence** disclosed in the international application, this opinion has been established on the basis of a sequence listing filed or furnished:
 - a. (means)
 - on paper
 - in electronic form
 - b. (time)
 - the international application as filed.
 - together with the international application in electronic form
 - subsequently to this Authority for the purposes of search
4. In addition, in the case that more than one version or copy of a sequence listing has been filed or furnished, the required statements that the information in the subsequent or additional copies is identical to that in the application as filed or does not go beyond the application as filed, as appropriate, were furnished.
5. Additional comments :

**WRITTEN OPINION OF THE
INTERNATIONAL SEARCHING AUTHORITY**

International application No.
PCT/CA2009/001062

Box No. V Reasoned statement under Rule 43bis.1(a)(I) with regard to novelty, inventive step or industrial applicability; citations and explanations supporting such statement

1. Statement

Novelty (N)	Claims	<u>1 to 90</u>	YES
	Claims	<u>None</u>	NO
Inventive step (IS)	Claims	<u>None</u>	YES
	Claims	<u>1 to 90</u>	NO
Industrial applicability (IA)	Claims	<u>1 to 90</u>	YES
	Claims	<u>None</u>	NO

2. Citations and explanations :

Reference is made to the following documents:

- D1:** US 20070112964 A1 (Guedalia et al.) 17 May 2007 (17-05-2007)
D2: US 20040022237 A1 (Elliot et al.) 05 February 2004 (05-02-2004)

The present application relates to initiating a long distance call using a mobile telephone. The application is concerned with providing a technique (other than using a "calling card") for avoiding long distance charges when the mobile telephone is roaming in another mobile telephone service provider's network. To achieve the above object the following technique is suggested: the user of the mobile telephone provides a callee identifier and requests an access code from an access server. Upon receiving the access code, which is different from the callee identifier, a call to the callee is initiated using the access code. Claim 1, which defines a method of initiating a call to a callee using a mobile telephone, is directed to the above described technique. D1 discloses systems and methods for establishing and maintaining communications between two or more devices coupled to different communication networks. In particular, D1 teaches a method of initiating a call to a callee *using a mobile telephone* (abstract, claims 15, 53, par. 0014, 0115) including the steps of receiving from a user of the mobile phone a callee identifier associated with the callee (claim 1, par. 0068), transmitting an access code request message including the callee identifier (claim 1, par. 0011, 0014, 0068, 0142), receiving an access code reply message (par. 0135, 0142), and initiating a call with the mobile telephone using the access code to identify the callee (par. 0137). Although D1 does not explicitly mention that the access code reply message includes an access code different from the callee identifier and associated with the callee identifier, the mentioned technical feature is well known in the art, and disclosed in D2. D2 describes a toll-free Service Control Point (SCP) which can translate a toll free number to a final routing destination based on a flexible set of options selected by a subscriber which include NPA or NPA-XXX of a calling party. The SCP can have several possible responses to a routing request. One of the responses includes returning a *circuit identifier* associated with a called party to connect the call (par. 0710 and 0711). Therefore, D1 in combination with D2 discloses the subject matter of claim 1. As independent claims 12, 21, 22, 31, 32, 33, 52, 71 and 90 are all directed to the same subject matter as claim 1 the above arguments also apply to claims 12, 21, 22, 31, 32, 33, 52, 71 and 90.

It appears that dependent claims 2 to 11, 13 to 20, 23 to 30, 34 to 51, 53 to 70 and 72 to 89 fail to introduce any inventive limitation.

Article 33(2) PCT - Novelty

As none of the cited references taken alone discloses the technical features of claims 1 to 90, the subject matter of the claimed invention is considered to be novel thus meeting the requirements of **Article 33(2) PCT**.

Article 33(3) PCT - Inventive step

For the reason indicated in the above discussion the subject matter of claims 1 to 90 is not considered to involve inventive step thus failing to fulfill the requirements of **Article 33(3) PCT**.

WRITTEN OPINION OF THE
INTERNATIONAL SEARCHING AUTHORITY

International application No.
PCT/CA2009/001062

Box No. VIII **Certain observations on the international application**

The following observations on the clarity of the claims, description, and drawings or on the question whether the claims are fully supported by the description, are made :

Article 6

In claims 52, 71 and 90 the term *said routing controller* lacks the antecedent.

WRITTEN OPINION OF THE
INTERNATIONAL SEARCHING AUTHORITY

International application No.
PCT/CA2009/001062

Supplemental Box

In case the space in any of the preceding boxes is not sufficient.

Continuation of: Box V on page 3

Article 33(4) PCT - Industrial Applicability

As the present application relates to a well established field of wireless communication, the subject matter of claims 1 to 90 is considered to be industrially applicable under **Article 33(4) PCT**.

PATENT COOPERATION TREATY

from the
INTERNATIONAL PRELIMINARY EXAMINING AUTHORITY

RECEIVED

PCT

To:
SMART & BIGGAR
Box 11560 Vancouver Centre
2200 - 650 W. Georgia Street
VANCOUVER, British Columbia
Canada, V6B 4N8

2009 FEB 19 A 9:35
2200-650 WEST GEORGIA ST.
VANCOUVER, B.C.

NOTIFICATION OF TRANSMITTAL OF
INTERNATIONAL PRELIMINARY
REPORT ON PATENTABILITY
(Chapter II of the Patent Cooperation Treaty)

(PCT Rule 71.1)

Date of mailing 13 February 2009 (13-02-2009)
(day/month/year)

Applicant's or agent's file reference
83636-13

IMPORTANT NOTIFICATION

International application No.
PCT/CA2007/002150

International filing date (day/month/year)
29 November 2007 (29-11-2007)

Priority date (day/month/year)
29 November 2006 (29-11-2006)

Applicant
DIGIFONICA (INTERNATIONAL) LIMITED ET AL

1. The applicant is hereby notified that this International Preliminary Examining Authority transmits herewith the international preliminary report on patentability and its annexes, if any, established on the international application.
2. A copy of the report and its annexes, if any, is being transmitted to the International Bureau for communication to all the elected Offices.
3. Where required by any of the elected Offices, the International Bureau will prepare an English translation of the report (but not of any annexes) and will transmit such translation to those Offices.

4. REMINDER

The applicant must enter the national phase before each elected Office by performing certain acts (filing translations and paying national fees) within 30 months from the priority date (or later in some Offices) (Article 39(1)) (see also the reminder sent by the International Bureau with Form PCT/IB/301).

Where a translation of the international application must be furnished to an elected Office, that translation must contain a translation of any annexes to the international preliminary report on patentability. It is the applicant's responsibility to prepare and furnish such translation directly to each elected Office concerned.

For further details on the applicable time limits and requirements of the elected Offices, see Volume II of the *PCT Applicant's Guide*.

The applicant's attention is drawn to Article 33(5), which provides that the criteria of novelty, inventive step and industrial applicability described in Article 33(2) to (4) merely serve the purposes of international preliminary examination and that "any Contracting State may apply additional or different criteria for the purposes of deciding whether, in that State, the claimed invention is patentable or not" (see also Article 27(5)). Such additional criteria may relate, for example, to exemptions from patentability, requirements for enabling disclosure, clarity and support for the claims.

Name and mailing address of the IPEA/CA
Canadian Intellectual Property Office
Place du Portage I, C114 - 1st Floor, Box PCT
50 Victoria Street
Gatineau, Quebec K1A 0C9
Facsimile No.: 001-819-953-2476

Authorized officer

Maureen Matheson 819- 953-1495

Form PCT/IPEA/416 (January 2004)

PATENT COOPERATION TREATY

PCT

INTERNATIONAL PRELIMINARY REPORT ON PATENTABILITY
(Chapter II of the Patent Cooperation Treaty)

RECEIVED

(PCT Article 36 and Rule 70)

2009 FEB 19 A 9:35

Applicant's or agent's file reference 83636-13	<p style="text-align: right;">2200-650 WEST GEORGIA ST. VICTORIA, B.C.</p> FOR FURTHER ACTION See Form PCT/IPEA/416	
International application No. PCT/CA2007/002150	International filing date (day/month/year) 29 November 2007 (29-11-2007)	Priority date (day/month/year) 29 November 2006 (29-11-2006)
International Patent Classification (IPC) or national classification and IPC IPC: <i>H04L 12/26</i> (2006.01), <i>H04L 12/66</i> (2006.01), <i>H04M 11/06</i> (2006.01), <i>H04M 3/22</i> (2006.01)		
Applicant DIGIFONICA (INTERNATIONAL) LIMITED ET AL		
<p>1. This report is the international preliminary examination report, established by this International Preliminary Examining Authority under Article 35 and transmitted to the applicant according to Article 36.</p> <p>2. This REPORT consists of a total of <u>3</u> sheets, including this cover sheet.</p> <p>3. This report is also accompanied by ANNEXES, comprising:</p> <p style="margin-left: 20px;">a. <input checked="" type="checkbox"/> (sent to the applicant and to the International Bureau) a total of <u>23</u> sheets, as follows:</p> <p style="margin-left: 40px;"><input checked="" type="checkbox"/> sheets of the description, claims and/or drawings which have been amended and are the basis of this report and/or sheets containing rectifications authorized by this Authority (see Rule 70.16 and Section 607 of the Administrative Instructions).</p> <p style="margin-left: 40px;"><input type="checkbox"/> sheets which supersede earlier sheets, but which this Authority considers contain an amendment that goes beyond the disclosure in the international application as filed, as indicated in item 4 of Box No. 1 and the Supplemental Box.</p> <p style="margin-left: 20px;">b. <input type="checkbox"/> (sent to the International Bureau only) a total of (indicate type and number of electronic carrier(s)) _____, containing a sequence listing and/or tables related thereto, in electronic form only, as indicated in the Supplemental Box Relating to Sequence Listing (see Section 802 of the Administrative Instructions).</p>		
<p>4. This report contains indications relating to the following items:</p> <p><input checked="" type="checkbox"/> Box No. I Basis of the report</p> <p><input type="checkbox"/> Box No. II Priority</p> <p><input type="checkbox"/> Box No. III Non-establishment of opinion with regard to novelty, inventive step and industrial applicability</p> <p><input type="checkbox"/> Box No. IV Lack of unity of invention</p> <p><input checked="" type="checkbox"/> Box No. V Reasoned statement under Article 35(2) with regard to novelty, inventive step or industrial applicability; citations and explanations supporting such statement</p> <p><input type="checkbox"/> Box No. VI Certain documents cited</p> <p><input type="checkbox"/> Box No. VII Certain defects in the international application</p> <p><input type="checkbox"/> Box No. VIII Certain observations on the international application</p>		
Date of submission of the demand 13 May 2008 (13-05-2008)	Date of completion of this report 13 February 2009 (13-02-2009)	
Name and mailing address of the IPEA/CA Canadian Intellectual Property Office Place du Portage I, C114 - 1st Floor, Box PCT 50 Victoria Street Gatineau, Quebec K1A 0C9 Facsimile No.: 001-819-953-2476	Authorized officer Daniela Savin 819- 934-4890	

Box No. I Basis of the report

1. With regard to the **language**, this report is based on:
 - the international application in the language in which it was filed
 - a translation of the international application into _____, which is the language of a translation furnished for the purposes of:
 - international search (Rules 12.3(a) and 23.1(b))
 - publication of the international application (Rule 12.4(a))
 - international preliminary examination (Rules 55.2(a) and/or 55.3(a))

2. With regard to the **elements** of the international application, this report is based on (*replacement sheets which have been furnished to the receiving Office in response to an invitation under Article 14 are referred to in this report as "originally filed" and are not annexed to this report*):
 - the international application as originally filed/furnished
 - the description:

pages	2-23, 25-54, 56-62	
		as originally filed/furnished
pages*	1	received by this Authority on
		13 May 2008 (13-05-2008)
pages*	24, 55	received by this Authority on
		22 January 2009 (22-01-2009)
 - the claims:

pages		
		as originally filed/furnished
pages*		as amended (together with any statement) under Article 19
pages*	63-70	received by this Authority on
		05 February 2009 (05-02-2009)
pages*		received by this Authority on
 - the drawings:

pages	1/29-5/29, 10/29-12/29, 14/29, 17/29, 19/29-22/29, 24/29, 27/29, 29/29	
		as originally filed/furnished
pages*	6/29-9/29, 13/29, 15/29-16/29	received by this Authority on
		22 January 2009 (22-01-2009)
pages*	18/29, 23/29, 25/29-26/29, 28/29	received by this Authority on
		22 January 2009 (22-01-2009)
 - a sequence listing and/or any related table(s) - see Supplemental Box Relating to Sequence Listing.

3. The amendments have resulted in the cancellation of:
 - the description, pages _____
 - the claims, Nos. _____
 - the drawings, sheets/figs _____
 - the sequence listing (*specify*): _____
 - any table(s) related to sequence listing (*specify*): _____

4. This report has been established as if (some of) the amendments annexed to this report and listed below had not been made, since they have been considered to go beyond the disclosure as filed, as indicated in the Supplemental Box (Rule 70.2(c)).
 - the description, pages _____
 - the claims, Nos. _____
 - the drawings, sheets/figs _____
 - the sequence listing (*specify*): _____
 - any table(s) related to sequence listing (*specify*): _____

5. This opinion has been established taking into account the **rectification of an obvious mistake** authorized by or notified to this Authority under Rule 91 (Rule 66.1(d-bis))

6. Supplementary international search report(s) from Authority(ies) _____ have been received and taken into account in drawing up this report (Rule 45bis.8(b) and (c)).

**If item 4 applies, some or all of those sheets may be marked "superseded."*

Box No. V Reasoned statement under Article 35(2) with regard to novelty, inventive step or industrial applicability; citations and explanations supporting such statement

1. Statement

Novelty (N)	Claims	1-26	YES
	Claims	None	NO
Inventive step (IS)	Claims	1-26	YES
	Claims	None	NO
Industrial applicability (IA)	Claims	1-26	YES
	Claims	None	NO

2. Citations and explanations (Rule 70.7)

Reference is made to the following document cited in the International Search Report:
D1: US 2004/0181599 A1 (Kreusch et al.) 16 September 2004 (16-09-2004)

The following is a review of how the subject matter described by the claims relates to the prior art of record.

Claims 1-26 are directed to a method and apparatus for intercepting communications in an IP network, in which communications between a subscriber and another party occur through a media relay. The aforementioned claims recite a methodology for intercepting IP communications comprising the following: determining whether determination information associated with a subscriber dialing profile meets intercept criteria; when said determination information meets said intercept criteria, causing the same media relay through which communications between said subscriber and said another party are relayed to produce a copy of said communications between said subscriber and said another party, while said same media relay relays communications between said subscriber and said another party; and causing said same media relay to send said copy to a mediation device identified by destination information associated with said subscriber dialing profile. Associating intercept information with a subscriber dialing profile happens when communications involving the subscriber are not in progress, as well as when the communications are in progress.

D1 is considered to be the prior art closest to claims 1-26. D1 describes a method for monitoring an IP data flow between at least two telecommunications terminals, which are connected to a data network via at least one access server. When monitoring takes place, the data flow is rerouted from the access server to a monitoring server, which makes a copy of the data flow and further transmits the copy to an evaluation unit (*see D1: abstract; paragraphs [0011]-[0015], [0019]-[0022], [0028], [0034]-[0036], [0048]-[0053], [0055]-[0061], [0067], [0072]-[0074], [0078]-[0083]; Figs. 1, 2a-2b; claims 1-3, 7-8, 25-26*).

However, D1 does not describe the same features as are found in independent claims 1 and 14. Specifically, the prior art of reference does not show that communications between a subscriber of an IP network and another party occur through a media relay only, and not through a gateway, an access server and eventually a monitoring server. Moreover, the same media relay through which communications between the subscriber and the other party are relayed, produces a copy of the communications when determination information meets intercept criteria, while continuing to relay the communications. This is in contrast with the intercept method disclosed in prior art, which diverts the communications to a monitoring server in order to make a copy of the data flow, since the monitoring server is not part of the normal communications flow, and it is only used when the communications need to be intercepted. Thus, the present application describes a methodology for intercepting IP communications directly at layer 3 of the OSI model, using only a media relay that relays communications between two telecommunications terminals and also makes copies of the communications, without the need of a dedicated monitoring server.

2.1 Novelty

Claims 1-26 are novel under Article 33(2) of the PCT, as the features of these claims are not explicitly shown in the prior art.

2.2 Inventive Step

Claims 1-26 involve an inventive step over the prior art, and therefore they comply with PCT Article 33(3).

2.3 Industrial Applicability

Claims 1-26 are considered to be industrially applicable as per PCT Article 33(4).

INTERCEPTING VOICE OVER IP COMMUNICATIONS AND OTHER DATA COMMUNICATIONS

BACKGROUND OF THE INVENTION

5 **1. Field of Invention**

This invention relates to data communications and methods and apparatus for intercepting data communications, particularly voice over IP data communications, in an IP network.

10 **2. Description of Related Art**

The term "lawful intercept" is used to describe a procedure which allows law enforcement agencies to perform electronic surveillance of telecommunications. Lawful intercept of telecommunications, particularly phone calls, is premised on a notion that a law enforcement agency has identified a person of interest, obtained a legal authorization for the surveillance (for example, a judicial or administrative warrant), and then contacted the person's telecommunications service provider that will be required to provide the law enforcement agency with a real-time copy of the person's communications. This real-time copy can then be used by the law enforcement agency to monitor or record the person's communications. Within the framework of traditional telecommunications networks, such as, for example, the Public Switched Telephone Network (PSTN) or cellular networks, lawful intercept generally presents a purely economic problem for the service providers that have to ensure that sufficient interception equipment and dedicated links to the law enforcement agencies have been deployed to satisfy lawful intercept requirements mandated by law. However, in the context of Voice over Internet Protocol (VoIP) communications, in addition to the economic problems mentioned above, lawful intercept presents

AMENDED SHEET

22 JANUARY 2009 22.01.09

-24-

Routing Controller

Referring to Figure 7, the routing controller **16** is shown in greater detail and includes a routing controller processor circuit shown generally at **200**. The RC processor circuit **200** includes a microprocessor **202**, program memory **204**, a
5 table memory **206** and an I/O interface **208**, all in communication with the processor. There may be a plurality of processor circuits (**202**), memories (**204**), etc.

The I/O interface **208** includes a database output port **210** through which a
10 request to the database **18** (Figure 1) can be made and includes a database response port **212** for receiving a reply from the database. The I/O interface **208** further includes an RC Request message input **214** for receiving the RC Request message from the call controller **14** and includes a routing message output **216** for sending a routing message back to the call controller **14**.

The program memory **204** includes blocks of codes for directing the RC processor circuit **200** to carry out various functions of the routing controller **16**. One of these blocks implements an RC Request message handler process **250** which directs the RC to produce a routing message in response to a
20 received RC Request message of the type shown at **150** in Figure 6. Referring back to Figure 7, the program memory **204** further includes a Law Enforcement Authority (LEA) request message handler **1400** and an in-call intercept shut down routine **1500**.

The RC Request message handler process **250** is shown in greater detail in
25 Figures **8A** through **8D**.

RC Request Message Handler

Referring to Figure **8A**, the RC Request message handler process **250** begins
30 with a first block **252** that directs the RC processor circuit **200** (Figure 7) to store the contents of the RC Request message **150** (Figure 6) in buffers. Block **254** then directs the RC processor circuit **200** to use the contents of the

AMENDED SHEET

the IP/UDP port address to which the audio data received at the caller and callee IP/UDP port addresses were being copied.

5 It will be appreciated that in the foregoing description, the components described cooperate to detect a requirement for intercept at the time a call is set up. In the following description an explanation is provided to describe how to intercept a call while the call is in progress.

Intercepting a Call in Progress

10 Referring back to Figure 1, to intercept a call while the call is in progress, the law enforcement authority **293** may communicate with a mediation device, or may communicate with the call controller or may communicate with the routing controller or may communicate with a handover interface that communicates with any of the foregoing components to cause the routing
15 controller to receive a law enforcement authority (LEA) intercept request message including intercept information, such as that which would be associated with fields **702-710** in Figure 9, for example.

20 In response to receipt of a LEA intercept request message, the routing controller LEA request message handler shown at **1400** in Figure 44 is invoked.

25 The LEA request message handler **1400** begins with a first block **1402** that directs the routing controller processor circuit to communicate with the database **18** in which dialing profile records of the type shown in Figure 9 are stored to find a dialing profile associated with the user whose calls are to be monitored.

30 If the username is not known, but a DID number (i.e. a PSTN number) is known, the routing controller may cause a search through the DID bank table records of the type shown in Figure 13, for example to find a username associated with a DID number. If the username is not known but a name and

AMENDED SHEET

What is claimed is:

1. A method for intercepting communications in an Internet Protocol (IP) network system in which communications between a subscriber of said system and another party occur through a media relay to which said subscriber and said another party address their communications destined for each other and which relays said communications between said subscriber and said another party, the method comprising:

5

10

determining whether determination information associated with a subscriber dialing profile associated with said subscriber meets intercept criteria;

15

when said determination information meets said intercept criteria, causing the same media relay through which communications between said subscriber and said another party are relayed to produce a copy of said communications between said subscriber and said another party, while said same media relay relays communications between said subscriber and said another party; and

20

causing said same media relay to send said copy to a mediation device identified by destination information associated with said subscriber dialing profile.

25

2. The method of claim 1 further comprising associating said determination information and said destination information with said dialing profile when communications involving said subscriber are not in progress.

30

~~AMENDED SHEET~~

- 5
3. The method of claim 1 further comprising associating said determination information and said destination information with said subscriber dialing profile when communications involving said subscriber are in progress.
- 10
4. The method of claim 2 or 3 wherein associating said determination information and said destination information comprises populating intercept information fields in said dialing profile of a subscriber whose communications are to be monitored.
- 15
5. The method of claim 1 further comprising producing a routing message for routing communications involving the subscriber through components of the IP network and determining whether said determination information meets said intercept criteria prior to producing said routing message and including at least some of said determination information and said destination information in said routing message when said determination information meets said intercept criteria.
- 20
6. The method of claim 5 wherein determining whether said determination information meets said intercept criteria comprises determining whether a current date and time is within a range specified by said determination information.
- 25
7. The method of claim 6 wherein producing a routing message comprises identifying a media relay through which communications involving said subscriber will be conducted and including an identification of said media relay in said routing message such that said media relay acts as said same media relay through which
- 30
- communications between said subscriber and said another party are relayed.

AMENDED SHEET

5 8. The method of claim 7 further comprising pre-associating at least one media relay with said dialing profile associated with the subscriber whose communications are to be monitored and wherein identifying said media relay comprises identifying the media relay pre-associated with said subscriber whose communications are to be monitored.

10 9. The method of claim 8 wherein pre-associating comprises populating media relay fields in said dialing profile with an identification of said at least one media relay.

15 10. The method of claim 3 wherein associating said determination information and said destination information comprises associating said determination information and said destination information with said dialing profile of the subscriber whose communications are to be monitored, in response to receipt of an intercept request message, wherein said intercept request message comprises said determination information and said destination information.

20 11. The method of claim 10 further comprising invoking an intercept request message handler to:

- a) find a dialing profile associated with the subscriber whose communications are to be monitored;
- b) perform the step of associating said determination information and said destination information with said dialing profile;
- c) determine whether said intercept criteria are met; and
- d) identify a media relay through which said communications are being conducted such that said media relay can be caused to send said copy to said mediation device.

30

AMENDED SHEET

5 12. The method of claim 11 wherein said dialing profile includes a username identifier and further comprising maintaining active call records for communications in progress, said active call records comprising a username identifier and a media relay identifier identifying the media relay through which said communications are being conducted and wherein identifying the media relay comprises locating an active call record associated with communications of the subscriber whose communication are to be monitored to identify the media relay associated with said communications.

10 13. The method of claim 12 further comprising maintaining direct-in-dial (DID) records associating PST telephone numbers with usernames of users subscribing to said IP network, and wherein finding a dialing profile associated with the subscriber whose communications are to be monitored comprises finding a username in a DID record bearing a PSTN number associated with the subscriber whose communications are to be monitored and using said username to locate a dialing profile associated with said username.

20 14. An apparatus for intercepting communications in an Internet Protocol (IP) network, the apparatus comprising:

25 means for accessing dialing profiles associated with respective subscribers of the IP network, at least one of said dialing profiles being associated with a subscriber whose communications are to be monitored, the dialing profile of the subscriber whose communications are to be monitored including intercept information including determination information for determining
30 whether to intercept a communication involving said subscriber, and destination information identifying a mediation device to which intercepted communications involving said subscriber are to be sent;

AMENDED SHEET

means for determining whether said determination information meets intercept criteria;

5

means for causing the same media relay through which communications between said subscriber and said another party are relayed to produce a copy of said communications between said subscriber and said another party, while said media relay relays communications between said subscriber and said another party;

10

means for communicating with said same media relay to cause said same media relay to send said copy of said communications to a mediation device specified by said destination information, when said determination information meets said intercept criteria.

15

15. The apparatus of claim **14** further comprising means for associating said intercept information with said dialing profile when communications involving said subscriber are not in progress.

20

16. The apparatus of claim **14** further comprising means for associating said intercept information with said dialing profile when communications involving said subscriber are in progress.

25

17. The apparatus of claim **15** or **16** wherein said means for associating said intercept information is operably configured to populate intercept information fields in said dialing profile of the subscriber whose communications are to be monitored.

30

18. The apparatus of claim **14** further comprising means for producing a routing message for routing communications involving the subscriber through components of the IP network and means for determining

AMENDED SHEET

5 whether said determination information meets said intercept criteria prior to producing said routing message and wherein said means for producing said routing message is operably configured to include at least some of said intercept information in said routing message when said determination information meets said intercept criteria.

10 19. The apparatus of claim 18 wherein said means for determining whether said determination information meets said intercept criteria is operably configured to determine whether a current date and time is within a range specified by said determination information.

15 20. The apparatus of claim 19 wherein said means for producing said routing message is operably configured to identify a media relay through which communications involving said subscriber will be conducted and to include an identification of said media relay in said routing message such that said media relay acts as said same media relay through which communications between said subscriber and said another party are relayed.

20 21. The apparatus of claim 20 further comprising means for pre-associating at least one media relay with said dialing profile of the subscriber whose communications are to be monitored and wherein said routing means is operably configured to identify from said dialing profile the media relay pre-associated with said subscriber whose communications are to be monitored.

25 22. The apparatus of claim 21 wherein said means for pre-associating is operably configured to populate media relay fields in said dialing profile with an identification of at said least one media relay.

30 23. The apparatus of claim 16 wherein said means for associating said intercept information is operably configured to associate said intercept information associated with said dialing profile of the subscriber whose

AMENDED SHEET

communications are to be monitored, in response to receipt of an intercept request message, wherein said intercept request message comprises said intercept information.

5 **24.** The apparatus of claim **23** further comprising means for handling an intercept request message, said means for handling said intercept request message comprising:

10 a) means for finding a dialing profile associated with the subscriber whose communications are to be monitored, said means for finding a dialing profile cooperating with said means for associating said intercept information with said dialing profile to cause said intercept information to be associated with said dialing profile;

15 b) means for determining whether said intercept criteria are met; and

20 c) means for identifying a media relay through which said communications are being conducted such that said media relay can be caused to send said copy to said mediation device.

25 **25.** The apparatus of claim **24** wherein said dialing profile includes a username identifier and further comprising means for maintaining active call records for communications in progress, said active call records comprising a username identifier and a media relay identifier identifying a media relay through which said communications are being conducted and wherein said means for identifying the media relay is operably configured to locate an active call record associated with communications of the subscriber whose communications are to be monitored to identify the media relay associated with said
30 communications.

AMENDED SHEET

- 5 26. The apparatus of claim 25 further comprising means for maintaining direct-in-dial (DID) records associating PST telephone numbers with usernames of users subscribing to said IP network, and wherein said means for finding a dialing profile associated with the subscriber whose communications are to be monitored is operably configured to find a username in a DID record bearing a PSTN number associated with the subscriber whose communications are to be monitored and use said username to locate a dialing profile associated with said username.

AMENDED SHEET

6/29

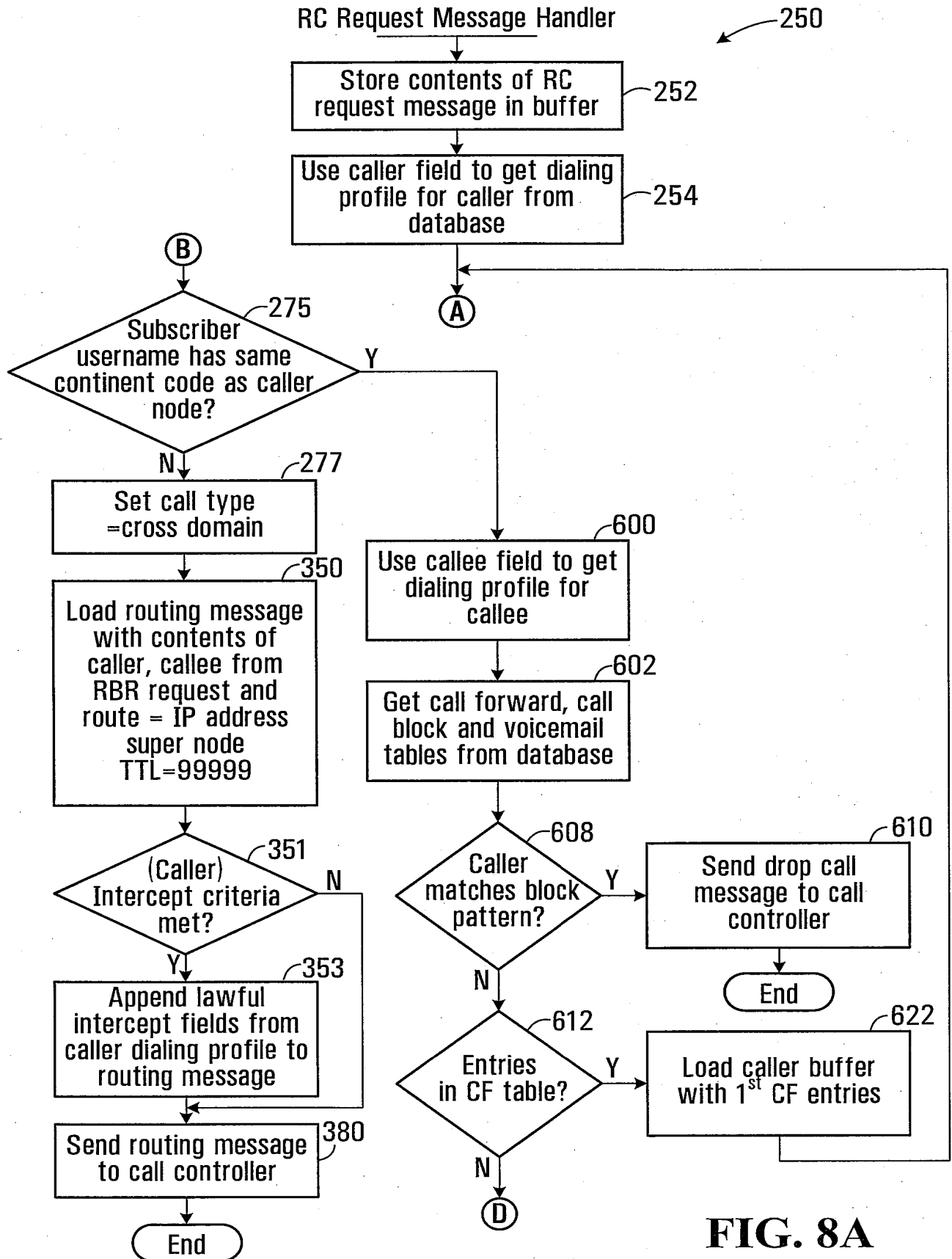

FIG. 8A

7/29

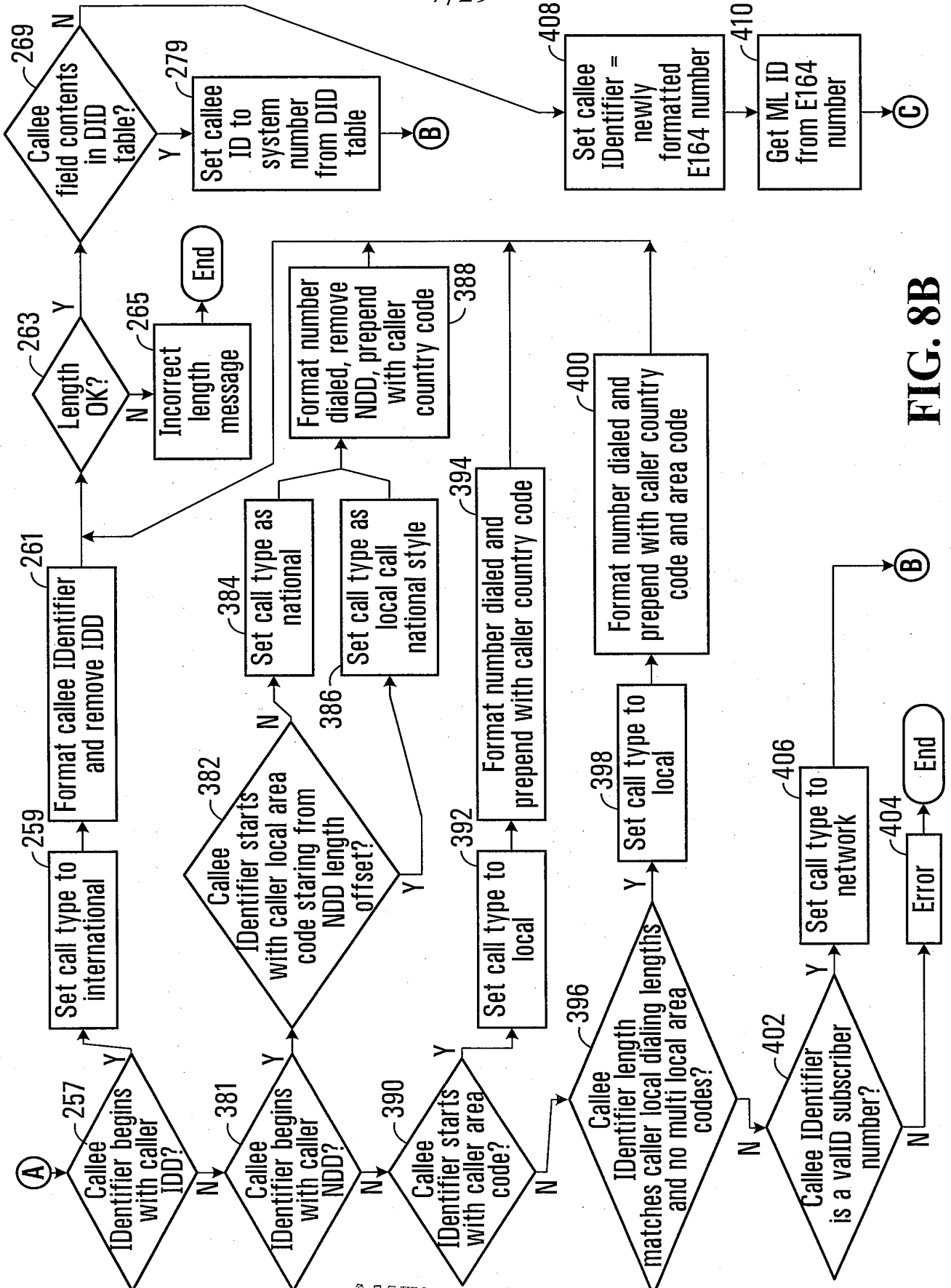

FIG. 8B

8/29

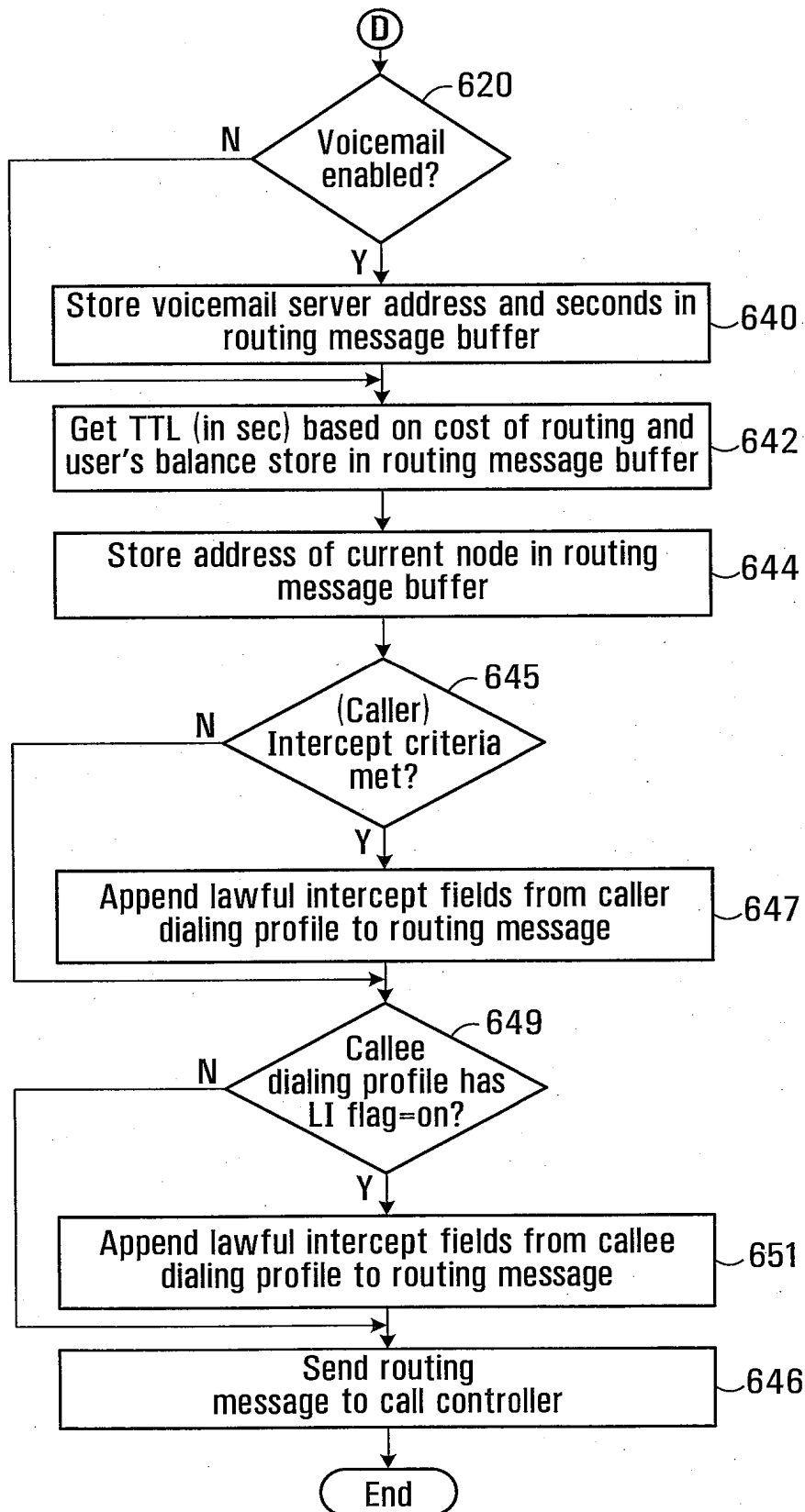

FIG. 8C

ASSEMBLY SHEET

9/29

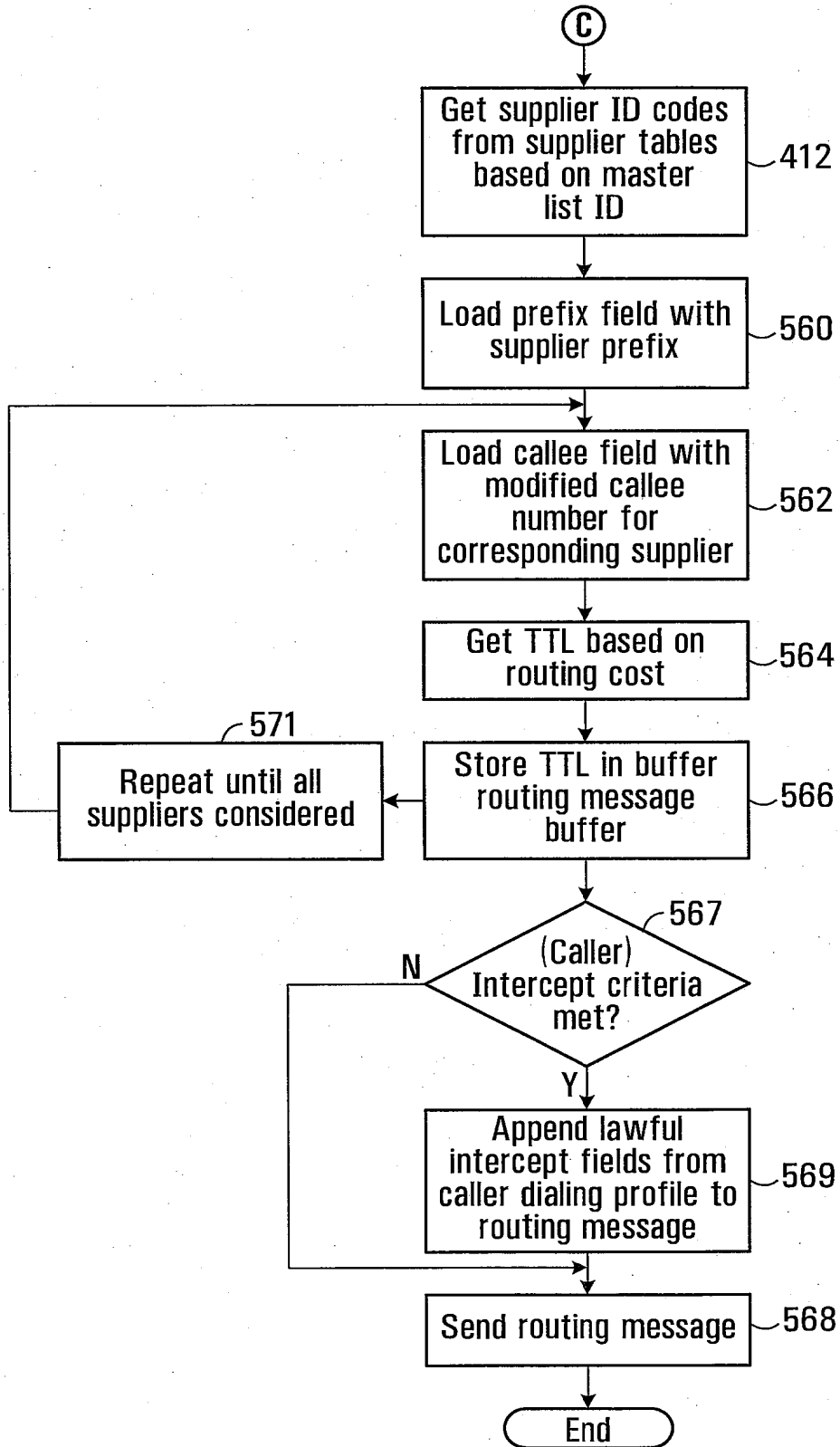

FIG. 8D

13/29

352

Routing Message Format

354	Supplier Prefix (optional)	Code identifying supplier traffic
356	Delimiter	Symbol separating fields
358	Callee	PSTN compatible number or Digifonica number
360	Route	Domain name and IP address
362	Time to Live(TTL)	In seconds
364	Other	TBD

FIG. 15

366

Routing Message - Different Node

440110624444@sp.lhr.digifonica.com;tll=9999

358 360 362

1152 ~ Media Relays (optional)

FIG. 16

Routing Message - Different Node with lawful intercept fields

440110624444@sp.lhr.digifonica.com;tll=999;Liflag=on;MDaddress=192.168.1.10;
WarrantID=20060515142;
Llstart=2006 05 16 00:00:00
Llstop=2006 12 31 23:59:59;
1152 ~ Media Relays (optional)

FIG. 16A

370

Prefix to Supernode Table Record Format

372	Prefix	First n digits of callee identifier
374	Supernode Address	IP address or fully qualified domain name

FIG. 17

Prefix to Supernode Table Record for London Subscriber

Prefix 4
Supernode Address sp.lhr.digifonica.com

FIG. 18

15/29

Suppliers List Record Format

540	Sup_ID	Name code
542	Route_ID	Numeric code
544	Prefix (optional)	String identifying supplier's traffic #
546	Route	IP address
548	NDD/IDD rewrite	
550	Rate	Cost per second to Digifonica to use this route

FIG. 21**Telus Supplier Record**

	Sup_ID	2010 (Telus)
	Route_ID	1019
	Prefix (optional)	4973#
546	Route	72.64.39.58
	NDD/IDD rewrite	011
550	Rate	\$0.02/min

FIG. 22**Shaw Supplier Record**

	Sup_ID	2011 (Shaw)
	Route_ID	1019
	Prefix (optional)	4974#
	Route	73.65.40.59
	NDD/IDD rewrite	011
550	Rate	\$0.025/min

FIG. 23**Sprint Supplier Record**

	Sup_ID	2012 (Sprint)
	Route_ID	1019
	Prefix (optional)	4975#
	Route	74.66.41.60
	NDD/IDD rewrite	011
550	Rate	\$0.03/min

FIG. 24

22 JANUARY 2009 22.01.09

16/29

Routing Message Buffer for Gateway Call

4973#0116048675309@72.64.39.58;tll=3600 ~ 570
 4974#0116048675309@73.65.40.59;tll=3600 ~ 572
 4975#0116048675309@74.66.41.60;tll=3600 ~ 574
 Media Relays (optional) ~ 1152

FIG. 25**Routing Message Buffer for Gateway Call with Lawful Intercept Fields**

4973#0116048675309@72.64.39.58;tll=3600
 4974#0116048675309@73.65.40.59;tll=3600
 4975#0116048675309@74.66.41.60;tll=3600
 LIflag=on;MDaddress=192.168.1.10;WarrantID=20060515142;
 LIstart=2006051600:00:00;LIstop=2006123123:59:59
 Media Relays (optional) ~ 1152

FIG. 25A**Call Block Record Format**

604 ~ Username Digifonica #
 606 ~ Block Pattern PSTN compatible or Digifonica #

FIG. 26**Call Block Record for Calgary Callee**

604 ~ Username of Callee 2001 1050 2222
 606 ~ Block Pattern 2001 1050 8664

FIG. 27**Call Forwarding Record Format for Callee**

614 ~ Username of Callee Digifonica #
 616 ~ Destination Number Digifonica #
 618 ~ Sequence Number Integer indicating order to try this

FIG. 28

18/29

Routing Message Buffer for CF/VM Routing Message

650 ~ 200110502222@sp.yvr.digifonica.com;ttl=3600
 652 ~ 200110552223@sp.yvr.digifonica.com;ttl=3600
 654 ~ vm.yvr.digifonica.com;20;ttl=60
 656 ~ sp.yvr.digifonica.com
 1152 ~ Media Relays (optional)

FIG. 32**Routing Message Buffer for CF/VM Routing Message with Caller Lawful Intercept Fields**

200110502222@sp.yvr.digifonica.com;ttl=3600
 200110552223@sp.yvr.digifonica.com;ttl=3600
 vm.yvr.digifonica.com;20;ttl=60
 sp.yvr.digifonica.com
 LIflag=on;MDaddress=192.168.1.10;WarrantID=20060615142;
 LIstart=2006061500:00:00;LIstop=2006123123:59:59
 Media Relays (optional) ~ 1152

FIG. 32A**Routing Message Buffer for CF/VM Routing Message with Caller and Callee Lawful Intercept Fields**

200110502222@sp.yvr.digifonica.com;ttl=3600
 200110552223@sp.yvr.digifonica.com;ttl=3600
 vm.yvr.digifonica.com;20;ttl=60
 sp.yvr.digifonica.com
 LI1flag=on;Mdaddress=192.168.1.10;WarrantID=20060515142;
 LI1start=2006051600:00:00;LI1stop=2006123123:59:59
 LI2flag=0;MD2address=192.168.1.20;WarrantID=20060615142;
 LI2start=2006061500:00:00;LI2stop=2006123123:59:59
 Media Relays (optional) ~ 1152

FIG. 32B

AMENDED SHEET

23/29

900

SIP Bye Message

902 ~	Caller	Username
904 ~	Callee	PSTN compatible # or Username
906 ~	Call ID	unique call identifier (hexadecimal string@IP)

FIG. 39

908

SIP Bye Message

902 ~	Caller	2001 1050 8667
904 ~	Callee	2001 1050 2222
906 ~	Call ID	FA10@192.168.0.20

FIG. 40

AMENDED SHEET

22 JANUARY 2009 22.01.09

25/29

RC Call Stop Message

1000
↙

1002	Caller	Username
1004	Callee	PSTN compatible # or Username
1006	Call ID	unique call identifier (hexadecimal string@IP)
1008	Acct Start Time	start time of call
1010	Acct Stop Time	time the call ended
1012	Acct Session Time	start time-stop time (in seconds)
1014	Route	IP address for gateway, where a gateway is used

FIG. 42**RC Call Stop Message for Calgary Callee**

1021
↙

1002	Caller	2001 1050 8667
1004	Callee	2001 1050 2222
1006	Call ID	FA10@192.168.0.20
1008	Acct Start Time	2006-12-30 12:12:12
1010	Acct Stop Time	2006-12-30 12:12:14
1012	Acct Session Time	2
1014	Route	(72.64.39.58 if Telus gateway is used)

FIG. 43

AMENDED SHEET

26/29

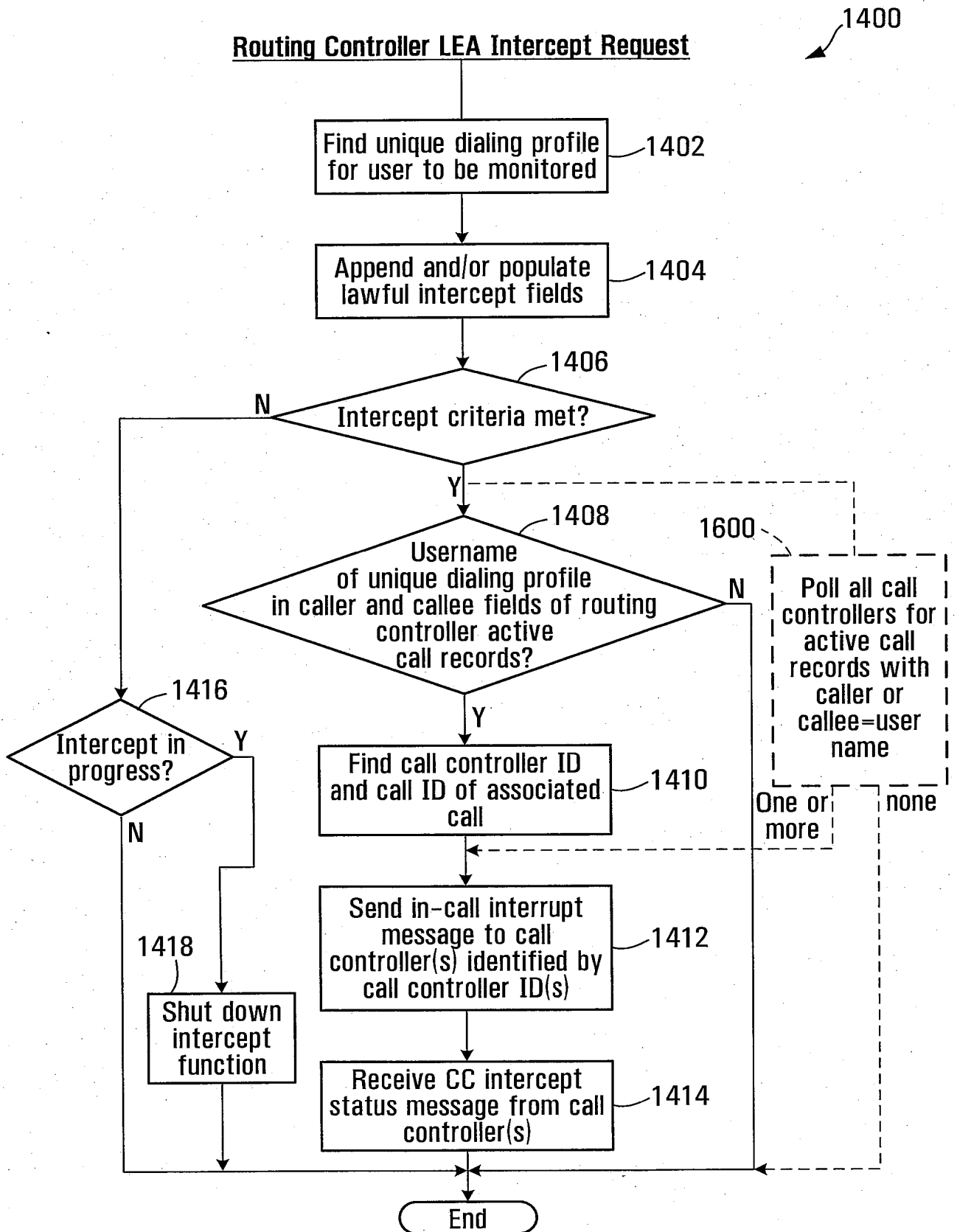

FIG. 44

28/29

1500

Routing Controller In-Call Intercept Shut Down Routine

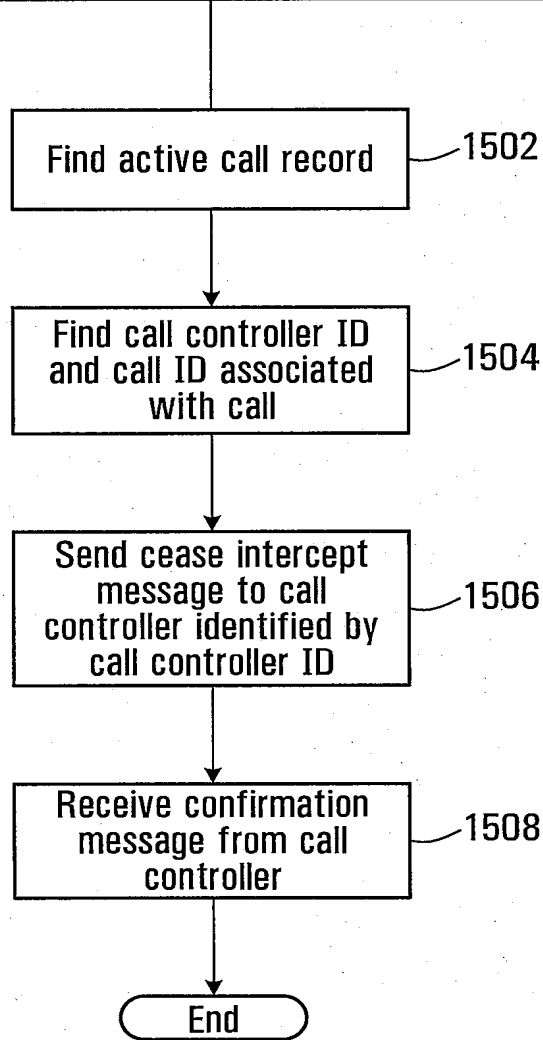

FIG. 46

AMENDED SHEET

From the INTERNATIONAL BUREAU

PCT

NOTIFICATION CONCERNING
TRANSMITTAL OF COPY OF INTERNATIONAL
PRELIMINARY REPORT ON PATENTABILITY
(CHAPTER I OF THE PATENT COOPERATION
TREATY)

(PCT Rule 44bis.1(c))

To:

KNOX, John, W.
SMART & BIGGAR
Box 11560, Vancouver Centre
650 West Georgia Street
Suite 2200
Vancouver, British Columbia V6B 4N8
CANADA

RECEIVED

2009 MAY 26 A 10:00

650-650 WEST GEORGIA ST.
VANCOUVER, B.C.

Date of mailing (<i>day/month/year</i>) 14 May 2009 (14.05.2009)		IMPORTANT NOTICE	
Applicant's or agent's file reference 83636-16			
International application No. PCT/CA2007/001956	International filing date (<i>day/month/year</i>) 01 November 2007 (01.11.2007)	Priority date (<i>day/month/year</i>) 02 November 2006 (02.11.2006)	
Applicant DIGIFONICA (INTERNATIONAL) LIMITED et al			

The International Bureau transmits herewith a copy of the international preliminary report on patentability (Chapter I of the Patent Cooperation Treaty)

The International Bureau of WIPO 34, chemin des Colombettes 1211 Geneva 20, Switzerland Facsimile No. +41 22 338 82 70	Authorized officer Athina Nickitas-Etienne e-mail: pt04.pct@wipo.int
---	--

PATENT COOPERATION TREATY

PCT

INTERNATIONAL PRELIMINARY REPORT ON PATENTABILITY
(Chapter I of the Patent Cooperation Treaty)

(PCT Rule 44bis)

RECEIVED
2009 MAY 26 A 10:00

Applicant's or agent's file reference 83636-16	FOR FURTHER ACTION		See item 4 below. WEST GEORGIA ST VANCOUVER, B.C.
International application No. PCT/CA2007/001956	International filing date (day/month/year) 01 November 2007 (01.11.2007)	Priority date (day/month/year) 02 November 2006 (02.11.2006)	
International Patent Classification (8th edition unless older edition indicated) See relevant information in Form PCT/ISA/237			
Applicant DIGIFONICA (INTERNATIONAL) LIMITED			

1. This international preliminary report on patentability (Chapter I) is issued by the International Bureau on behalf of the International Searching Authority under Rule 44 bis.1(a).

2. This REPORT consists of a total of 8 sheets, including this cover sheet.

In the attached sheets, any reference to the written opinion of the International Searching Authority should be read as a reference to the international preliminary report on patentability (Chapter I) instead.

3. This report contains indications relating to the following items:

<input checked="" type="checkbox"/>	Box No. I	Basis of the report
<input type="checkbox"/>	Box No. II	Priority
<input type="checkbox"/>	Box No. III	Non-establishment of opinion with regard to novelty, inventive step and industrial applicability
<input checked="" type="checkbox"/>	Box No. IV	Lack of unity of invention
<input checked="" type="checkbox"/>	Box No. V	Reasoned statement under Article 35(2) with regard to novelty, inventive step or industrial applicability; citations and explanations supporting such statement
<input type="checkbox"/>	Box No. VI	Certain documents cited
<input type="checkbox"/>	Box No. VII	Certain defects in the international application
<input checked="" type="checkbox"/>	Box No. VIII	Certain observations on the international application

4. The International Bureau will communicate this report to designated Offices in accordance with Rules 44bis.3(c) and 93bis.1 but not, except where the applicant makes an express request under Article 23(2), before the expiration of 30 months from the priority date (Rule 44bis .2).

The International Bureau of WIPO 34, chemin des Colombettes 1211 Geneva 20, Switzerland Facsimile No. +41 22 338 82 70	Date of issuance of this report 05 May 2009 (05.05.2009)
	Authorized officer Athina Nickitas-Etienne e-mail: pt04.pct@wipo.int

Form PCT/IB/373 (January 2004)

PATENT COOPERATION TREATY

From the
INTERNATIONAL SEARCHING AUTHORITY

To: SMART & BIGGAR Box 11560 Vancouver Centre 2200 - 650 W. Georgia Street VANCOUVER, British Columbia Canada, V6B 4N8		RECEIVED PCT 2008 MAY 26 A 10:00 WRITTEN OPINION OF THE INTERNATIONAL SEARCHING AUTHORITY VANCOUVER, B.C. (PCT Rule 43bis.1)																									
Applicant's or agent's file reference 83636-16		Date of mailing 20 February 2008 (20-02-2008) (day/month/year) FOR FURTHER ACTION See paragraph 2 below																									
International application No. PCT/CA2007/001956	International filing date (day/month/year) 01 November 2007 (01-11-2007)	Priority date (day/month/year) 02 November 2006 (02-11-2006)																									
International Patent Classification (IPC) or both national classification and IPC IPC: <i>H04L 12/66</i> (2006.01), <i>H04L 12/14</i> (2006.01), <i>H04M 11/06</i> (2006.01), <i>H04M 15/00</i> (2006.01), <i>H04Q 3/64</i> (2006.01)																											
Applicant DIGIFONICA (INTERNATIONAL) LIMITED ET AL																											
<p>1. This opinion contains indications relating to the following items :</p> <table border="0"> <tr> <td><input checked="" type="checkbox"/></td> <td>Box No. I</td> <td>Basis of the opinion</td> </tr> <tr> <td><input type="checkbox"/></td> <td>Box No. II</td> <td>Priority</td> </tr> <tr> <td><input type="checkbox"/></td> <td>Box No. III</td> <td>Non-establishment of opinion with regard to novelty, inventive step and industrial applicability</td> </tr> <tr> <td><input checked="" type="checkbox"/></td> <td>Box No. IV</td> <td>Lack of unity of invention</td> </tr> <tr> <td><input checked="" type="checkbox"/></td> <td>Box No. V</td> <td>Reasoned statement under Rule 43bis.1(a)(i) with regard to novelty, inventive step or industrial applicability, citations and explanations supporting such statement</td> </tr> <tr> <td><input type="checkbox"/></td> <td>Box No. VI</td> <td>Certain documents cited</td> </tr> <tr> <td><input type="checkbox"/></td> <td>Box No. VII</td> <td>Certain defects in the international application</td> </tr> <tr> <td><input checked="" type="checkbox"/></td> <td>Box No. VIII</td> <td>Certain observations on the international application</td> </tr> </table> <p>2. FURTHER ACTION If a demand for international preliminary examination is made, this opinion will be considered to be a written opinion of the International Preliminary Examining Authority ("IPEA") except that this does not apply where the applicant chooses an Authority other than this one to be the IPEA and the chosen IPEA has notified the International Bureau under Rule 66.1bis(b) that written opinions of this International Searching Authority will not be so considered.</p> <p>If this opinion is, as provided above, considered to be a written opinion of the IPEA, the applicant is invited to submit to the IPEA a written reply together, where appropriate, with amendments, before the expiration of 3 months from the date of mailing of Form PCT/ISA/220 or before the expiration of 22 months from the priority date, whichever expires later.</p> <p>For further options, see Form PCT/ISA/220.</p> <p>3. For further details, see notes to Form PCT/ISA/220.</p>				<input checked="" type="checkbox"/>	Box No. I	Basis of the opinion	<input type="checkbox"/>	Box No. II	Priority	<input type="checkbox"/>	Box No. III	Non-establishment of opinion with regard to novelty, inventive step and industrial applicability	<input checked="" type="checkbox"/>	Box No. IV	Lack of unity of invention	<input checked="" type="checkbox"/>	Box No. V	Reasoned statement under Rule 43bis.1(a)(i) with regard to novelty, inventive step or industrial applicability, citations and explanations supporting such statement	<input type="checkbox"/>	Box No. VI	Certain documents cited	<input type="checkbox"/>	Box No. VII	Certain defects in the international application	<input checked="" type="checkbox"/>	Box No. VIII	Certain observations on the international application
<input checked="" type="checkbox"/>	Box No. I	Basis of the opinion																									
<input type="checkbox"/>	Box No. II	Priority																									
<input type="checkbox"/>	Box No. III	Non-establishment of opinion with regard to novelty, inventive step and industrial applicability																									
<input checked="" type="checkbox"/>	Box No. IV	Lack of unity of invention																									
<input checked="" type="checkbox"/>	Box No. V	Reasoned statement under Rule 43bis.1(a)(i) with regard to novelty, inventive step or industrial applicability, citations and explanations supporting such statement																									
<input type="checkbox"/>	Box No. VI	Certain documents cited																									
<input type="checkbox"/>	Box No. VII	Certain defects in the international application																									
<input checked="" type="checkbox"/>	Box No. VIII	Certain observations on the international application																									
Name and mailing address of the ISA/CA Canadian Intellectual Property Office Place du Portage I, C114 - 1st Floor, Box PCT 50 Victoria Street Gatineau, Quebec K1A 0C9 Facsimile No.: 001-819-953-2476	Date of completion of this opinion 7 February 2008 (07-02-2008)	Authorized officer Arthur Smith 819-953-1360																									

WRITTEN OPINION OF THE
INTERNATIONAL SEARCHING AUTHORITY

International application No.
PCT/CA2007/001956

Box No. I Basis of this opinion

1. With regard to the **language**, this opinion has been established on the basis of:
 - the international application in the language in which it was filed
 - a translation of the international application into _____, which is the language of a translation furnished for the purposes of international search (Rules 12.3(a) and 23.1(b)).
2. This opinion has been established taking into account the **rectification of an obvious mistake** authorized by or notified to this Authority under Rule 91 (Rule 43bis.1(a))
3. With regard to any **nucleotide and/or amino acid sequence** disclosed in the international application and necessary to the claimed invention, this opinion has been established on the basis of:
 - a. type of material
 - a sequence listing
 - table(s) related to the sequence listing
 - b. format of material
 - on paper
 - in electronic form
 - c. time of filing/furnishing
 - contained in the international application as filed.
 - filed together with the international application in electronic form
 - furnished subsequently to this Authority for the purposes of search.
4. In addition, in the case that more than one version or copy of a sequence listing and/or table(s) relating thereto has been filed or furnished, the required statements that the information in the subsequent or additional copies is identical to that in the application as filed or does not go beyond the application as filed, as appropriate, were furnished.
5. Additional comments :

Box No. IV Lack of unity of invention

1. In response to the invitation (Form PCT/ISA/206) to pay additional fees the applicant has, within the applicable time limit :

- paid additional fees
- paid additional fees under protest and, where applicable, the protest fee
- paid additional fees under protest but the applicable protest fee was not paid
- not paid additional fees

2. This Authority found that the requirement of unity of invention is not complied with and chose not to invite the applicant to pay additional fees.

3. This Authority considers that the requirement of unity of invention in accordance with Rules 13.1, 13.2 and 13.3 is

- complied with
- not complied with for the following reasons :

This International Searching Authority considers that there are four inventions claimed in the international application covered by the claims indicated below:

- I Claims 1-59
- II Claims 60, 61
- III Claims 62-84
- IV Claims 85-107

The claims of Group I have in common a call routing controller for facilitating communications between callers and callees in a communications system comprising a plurality of nodes in which, in response to initiation of a call, uses call classification criteria to classify the call as a public network call or a private network call, and produces accordingly a routing message.

The claims of Group II have in common a data structure for access by an apparatus for producing a routing message for use by a call routing controller in a communications system.

The claims of Group III have in common determining a time to permit a communication session to be conducted, the determination based on calculating a cost per unit time, a participant's billing pattern, and the quotient of a funds balance held by the participant.

The claims of Group IV have in common attributing charges for communications services by determining chargeable times and changing account balances of both user and communications services reseller.

Groups I and II have in common the call routing controller; however, call routing controllers are well known in the art so the claims of Groups I and II lack unity *a posteriori*.

Because the remainder of the claims of Groups I, II, III, and IV have no elements in common and would require separate searches by the examiner, these groups lack unity *a priori*.

4. Consequently, this opinion has been established in respect of the following parts of the international application :

- all parts
- the parts relating to claim Nos.

Box No. V Reasoned statement under Rule 43bis.1(a)(i) with regard to novelty, inventive step or industrial applicability; citations and explanations supporting such statement

1. Statement

Novelty (N)	Claims	<u>1-107</u>	YES
	Claims	<u>None</u>	NO
Inventive step (IS)	Claims	<u>1-61, 64-72, 76-107</u>	YES
	Claims	<u>62, 63, 73-75</u>	NO
Industrial applicability (IA)	Claims	<u>1-107</u>	YES
	Claims	<u>None</u>	NO

2. Citations and explanations :

Group I (Claims 1-59)

The following document is referred to in this communication:

D1 CA 2249668

D1 is considered to form the closest prior art. D1 discloses routing information in an integrated global communications network in which a central routing processor collects routing capabilities of network nodes for which it has responsibility. The routing processor evaluates the routing requirements of a routing query signal transmitted by a source router, determines which routers and communication paths within the network are capable and available to route the information, evaluates the statistical availability of such routers, and selects an optimal routing path to a destination router.

Novelty

D1 fails to individually disclose all the elements of claims 1-59; therefore, claims 1-59 **are considered to be novel** in accordance with Article 33(2) PCT.

Inventive Step

Independent claims 1, 30, and 31 each claim operating a call routing controller to facilitate communication between callers and callees in a system or network comprising a plurality of nodes in which call classification criteria associated with a caller identifier is used to classify the call as a public network call or a private network call, and producing a routing message in accordance with the classification. D1 teaches facilitation of communication between callers and callees within a private network, including producing a routing message for a private network call. However, D1 fails to teach classification of a call as a public network call, and fails to teach producing an appropriate routing message for a public network call.

Claims 2-29 and 32-59 depend on independent claims 1 and 31, respectively.

Therefore, claims 1-59 **are considered to have an inventive step** in accordance with Article 33(3) PCT.

Industrial Applicability

Routing IP phone calls through a communication network including both private and public aspects finds use in telecommunications, and, thus, claims 1-59 **are industrially applicable** in accordance with Article 33(4) PCT.

Group II (Claims 60, 61)

The following documents are referred to in this communication:

D2 US7,068,772

D3 US2006/0209768

D2 and D3 are considered to form the closest prior art. D2 discloses a call processing system and method for providing one-number telecommunication services, wherein a data structure of a subscriber record for access by an apparatus for producing a routing message, the data structure comprising the subscriber's various profiles and the associated 1-800 number or address that the subscriber may be contacted.

Box No. VIII Certain observations on the international application

The following observations on the clarity of the claims, description, and drawings or on the question whether the claims are fully supported by the description, are made :

Claim-Related Objections

Claim 60 is unclear and does not comply with Article 6 of the PCT. The following terms lack a proper antecedent basis:

- “the subscriber” (claim 60, page 83, line 16)
- “subscriber name” (claim 60, page 83, line 17)

Claim 60 is unclear and does not comply with Article 6 of the PCT. The double inclusion of any element renders the claims indefinite. The following expressions have already been defined previously in the claims and should therefore be referred to using a definite article:

- “a user domain” (claim 60, page 83, lines 14, 17)
- “a direct-in-dial number” (claim 60, page 83, line 18)

Claim 60 is indefinite and does not comply with Article 6 of the PCT. The terms “a subscriber user name” (claim 60, page 82, line 32) and “subscriber name” (claim 60, page 83, lines 14, 15, 16-17, 17) cause ambiguity. It is not clear whether they are the same or different.

Claim 61 is indefinite and does not comply with Article 6 of the PCT. The term “master list records” (page 83, line 27) causes ambiguity. It should read “said master list records”.

Claim 61 is indefinite and does not comply with Article 6 of the PCT. The term “aid” (page 83, line 28) causes ambiguity. It should read “said aid”.

Claim 61 is indefinite and does not comply with Article 6 of the PCT. The term “dialing codes” (page 84, line 8) causes ambiguity. It should read “said dialing codes”.

Supplemental Box

In case the space in any of the preceding boxes is not sufficient.

Continuation of: Box V

D3 discloses a system for managing address allocation of a mobile terminal in wireless LAN (WLAN) to inter-work with another WLAN or a public cellular network, wherein a data structure comprises: Message_Type, Message_Length, Domain_Name, MT_ID, Service_Request, Session_ID, Address_Request, Tunnel_Request, WLAN_ID and Security_Field.

Novelty

The subject matter of claim 60 is considered to be novel and complies with the requirement of **Article 33(2) of the PCT**. The cited references, when taken alone, fail to disclose a data structure for access by an apparatus for producing a routing message for use by a call routing controller in a communications system, the data structure comprising: dialing profile records comprising fields for associating with respective subscribers to the system: a subscriber user name; direct-in-dial records comprising fields for associating with respective subscriber usernames: a user domain; and a direct-in-dial number; prefix to node records comprising fields for associating with at least a portion of said respective subscriber usernames: a node address of a node in said system, whereby a subscriber name can be used to find a user domain, at least a portion of said subscriber name can be used to find a node with which the subscriber identified by the subscriber name is associated, and a user domain and subscriber name can be located in response to a direct-in-dial number.

The subject matter of claim 61 is considered to be novel and complies with the requirement of **Article 33(2) of the PCT**. The cited references, when taken alone, fail to disclose a data structure for access by an apparatus for producing a routing message for use by a call routing controller in a communications system, the data structure comprising: master list records comprising fields for associating a dialing code with respective master list identifiers; and supplier list records linked to master list records by said master list identifiers, said supplier list records comprising fields for associating with a communications service supplier: a supplier id; a master list id; a route identifier; and a billing rate code, whereby communications services suppliers are associated with dialing codes, such that dialing codes can be used to locate suppliers capable of providing a communications link associated with a given dialing code.

Inventive Step

The subject matter of claim 60 is considered to involve an inventive step and does comply with **Article 33(3) of the PCT**. The prior art, D2 and D3, alone or in combination, does not fairly suggest a data structure comprising: dialing profile records; direct-in-dial records; prefix to node records, whereby a subscriber name can be used to find a user domain, at least a portion of said subscriber name can be used to find a node with which the subscriber identified by the subscriber name is associated, and a user domain and subscriber name can be located in response to a direct-in-dial number.

The subject matter of claim 61 is considered to involve an inventive step and does comply with **Article 33(3) of the PCT**. The prior art, D2 and D3, alone or in combination, does not fairly suggest a data structure comprising: master list records; and supplier list records linked to master list records, said supplier list records comprising fields for associating with a communications service supplier, whereby communications services suppliers are associated with dialing codes, such that dialing codes can be used to locate suppliers capable of providing a communications link associated with a given dialing code.

Industrial Applicability

Claims 60 and 61 are considered to be industrially applicable and do comply with **Article 33(4) of the PCT**.

Group III (Claims 62-84)

The following documents are referred to in this communication:

D4 US 6058300
D5 US 2005/0177843 A1

D4 discloses, in part, a calculation of a maximum call duration in response to a customer account balance for a prepay telecommunications system.

D5 discloses, in part, calculation of a maximum call duration to a specific callee in response to a caller request to make a call in a prepay telecommunications system. If the maximum call duration is sufficient, the system permits the call to take place.

Novelty

Each of D4 and D5 fail to individually disclose all the elements of claims 62-84; therefore, claims 62-84 are considered to be novel in accordance with Article 33(2) PCT.

(Continued in next Supplemental Box)

Supplemental Box

In case the space in any of the preceding boxes is not sufficient.

Continuation of: Previous Supplemental Box

Inventive Step

Claim 62 claims a method of determining a time to permit a communications session to be conducted (ie, a maximum call duration). Either of D4 or D5 disclose determination of a maximum call duration and cause claim 62 to lack an inventive step. Both of D4 and D5 teach determination of a cost per unit time (D4: "rate per minute" (col. 5, line 58); D5: "call credits" (para. 65)), calculating a first time value as a sum of a free time attributed to a participant in the communication session and the quotient of a funds balance held by the participant to the cost per unit time value (D4: col. 5, lines 61 - 65; D5: para. 67), and producing a second time value in response to the first time value and a billing pattern (D4: roaming or not roaming; D5: "call history"), the second time value being the time to permit a communications session to be conducted. Additional differences between claim 62 and either D4 or D5 such as "free time", "cost per unit time" and "billing pattern" also lack inventive step. Thus claim 62 is considered to **lack an inventive step** in accordance with Article 33(3) PCT.

As claims 73 and 74 are apparatus for carrying out methods steps similar or identical to those of claim 62, these claims **lack an inventive step** in accordance with Article 33(3) PCT for the same reasons as listed above.

Claim 63 and 75 lack an inventive step in view of either of D4 or D5 in that D4 and D5 disclose retrieving a record associated with said participant (D4: "customer's account" (col. 5, lines 63-64); D5: "certificate information" (para. 67)) and obtaining from said record said funds balance (D4: col. 5, line 63; D5: para. 67). To also obtain a participant's free time also lack an inventive step. Thus, claims 63 and 75 **lack an inventive step** in accordance with Article 33(3) PCT.

Claims 64-72 and 76-84 are found to be inventive since no combination of prior art documents were found which disclose the subject matter as set forth in claims 64-72 and 76-84 in accordance with Article 33(3) PCT.

Industrial Applicability

Determination of maximum time for a communication session finds application within Internet telephony; thus, claims 62-84 are considered to **have industrial applicability** in accordance with Article 33(4) PCT.

Group IV (Claims 85-107)

The following document is referred to in this communication:

D6 US 6188752

D6 is considered to form the closest prior art. D6 discloses provision of prepaid telecommunications services by a telecommunications network. A database record includes subscriber information fields such as account numbers, prepaid account information, and a current prepayment monetary amounts. Once a call or communication session has been established, the network monitors parameters related to any fee to be charged for the service such as start time, elapsed time, origination and destination locations, and rate information (ie, billing pattern) preferably in real time. D6 further discloses determining the cost of the call and debiting the account balance associated with the subscriber.

Novelty

D6 fails to individually disclose all the elements of claims 85-107; therefore, claims 85-107 **are considered to be novel** in accordance with Article 33(2) PCT.

Inventive Step

Independent claims 85, 96, and 97 each claim attributing charges for communications services including determining a chargeable time in response to a communication session time and a pre-defined billing pattern, determining a user cost value, and changing account balances associated with the user, reseller, and operator of the communications services. D6 teaches attributing charges for communications services, determining a chargeable time in response to a communication session time and a pre-defined billing pattern, determining a user cost value in response to said first chargeable time associated with a user of said communications services, and changing an account balance associated with said user in response to a user cost per unit time. However, D6 fails to suggest a free time value, nor does D6 teach changing the account balances of either a reseller or an operator of said communications services.

Claims 86-95 and 98-107 depend on independent claims 85 and 97, respectively.

Therefore, claims 85-107 **are considered to have an inventive step** in accordance with Article 33(3) PCT.

Industrial Applicability

Billing or attributing charges for communications services finds use in telecommunications, and, thus, claims 85-107 are considered to

PATENT COOPERATION TREATY
PCT
INTERNATIONAL SEARCH REPORT
(PCT Article 18 and Rules 43 and 44)

RECEIVED

Applicant's or agent's file reference 83636-55	FOR FURTHER ACTION	see Form PCT/ISA/220 51 as well as, where applicable, item 5 below
International application No. PCT/CA2009/001062	International filing date (<i>day/month/year</i>) 28 July 2009 (28-07-2009)	(Earliest) Priority date (<i>day/month/year</i>) 28 July 2008 (28-07-2008)
Applicant DIGIFONICA (INTERNATIONAL) LIMITED ET AL		

This international search report has been prepared by this International Searching Authority and is transmitted to the applicant according to Article 18. A copy is being transmitted to the International Bureau.

This international search report consists of a total of 3 sheets.

It is also accompanied by a copy of each prior art document cited in this report.

1. Basis of the report

a. With regard to the **language**, the international search was carried out on the basis of:

the international application in the language in which it was filed

a translation of the international application into _____, which is the language of a translation furnished for the purposes of international search (Rules 12.3(a) and 23.1(b))

b. This international search report has been established taking into account the **rectification of an obvious mistake** authorized by or notified to this Authority under Rule 91 (Rule 43.6bis(a)).

c. With regard to any **nucleotide and/or amino acid sequence** disclosed in the international application, see Box No. I

2. **Certain claims were found unsearchable** (see Box No. II)

3. **Unity of invention is lacking** (see Box No. III)

4. With regard to the **title**,

the text is approved as submitted by the applicant

the text has been established by this Authority to read as follows :

5. With regard to the **abstract**,

the text is approved as submitted by the applicant

the text has been established, according to Rule 38.2, by this Authority as it appears in Box No. IV. The applicant may, within one month from the date of mailing of this international search report, submit comments to this Authority

6. With regard to the **drawings**,

a. the figure of the **drawings** to be published with the abstract is Figure No. 1

as suggested by the applicant

as selected by this Authority, because the applicant failed to suggest a figure

as selected by this Authority, because this figure better characterizes the invention

b. none of the figures is to be published with the abstract

INTERNATIONAL SEARCH REPORT

International application No.
PCT/CA2009/001062

<p>A. CLASSIFICATION OF SUBJECT MATTER IPC: <i>H04W 76/02</i> (2009.01), <i>H04W 88/06</i> (2009.01), <i>H04W 88/16</i> (2009.01) According to International Patent Classification (IPC) or to both national classification and IPC</p>		
<p>B. FIELDS SEARCHED</p>		
<p>Minimum documentation searched (classification system followed by classification symbols) IPC: <i>H04W 76/02</i> (2009.01), <i>H04W 88/06</i> (2009.01), <i>H04W 88/16</i> (2009.01)</p>		
<p>Documentation searched other than minimum documentation to the extent that such documents are included in the fields searched</p>		
<p>Electronic database(s) consulted during the international search (name of database(s) and, where practicable, search terms used) Canadian Patent Database, USPTO, Esp@cenet, Delphion, IEEE, Google and keywords such as wireless, mobile, call setup, request, connection, access code, identifier and the like keywords</p>		
<p>C. DOCUMENTS CONSIDERED TO BE RELEVANT</p>		
Category*	Citation of document, with indication, where appropriate, of the relevant passages	Relevant to claim No.
Y	US 20070112964 A1 (Guedalia et al.) 17 May 2007 (17-05-2007) (abstract, par.0011, 0014, 0068, 0115, 0135, 0137 and 0142, claims 1, 15 and 53)	1 to 90
Y	US 20040022237 A1 (Elliot et al.) 05 February 2004 (05-02-2004) (par. 0710, 0711)	1 to 90
<p><input type="checkbox"/> Further documents are listed in the continuation of Box C. <input checked="" type="checkbox"/> See patent family annex.</p>		
* "A" "E" "L" "O" "P"	Special categories of cited documents : document defining the general state of the art which is not considered to be of particular relevance earlier application or patent but published on or after the international filing date document which may throw doubts on priority claim(s) or which is cited to establish the publication date of another citation or other special reason (as specified) document referring to an oral disclosure, use, exhibition or other means document published prior to the international filing date but later than the priority date claimed	"T" later document published after the international filing date or priority date and not in conflict with the application but cited to understand the principle or theory underlying the invention "X" document of particular relevance; the claimed invention cannot be considered novel or cannot be considered to involve an inventive step when the document is taken alone "Y" document of particular relevance; the claimed invention cannot be considered to involve an inventive step when the document is combined with one or more other such documents, such combination being obvious to a person skilled in the art "&" document member of the same patent family
Date of the actual completion of the international search 11 January 2010 (11-01-2010)		Date of mailing of the international search report 12 March 2010 (12-03-2010)
Name and mailing address of the ISA/CA Canadian Intellectual Property Office Place du Portage I, C114 - 1st Floor, Box PCT 50 Victoria Street Gatineau, Quebec K1A 0C9 Facsimile No.: 001-819-953-2476		Authorized officer Elena Mikhailova (819) 953-5206

INTERNATIONAL SEARCH REPORT
Information on patent family members

International application No.
PCT/CA2009/001062

Patent Document Cited in Search Report	Publication Date	Patent Family Member(s)	Publication Date
US2007112964A1	17-05-2007	AU2006266426A1	11-01-2007
		CA2614090A1	11-01-2007
		CN101253746A	27-08-2008
		EP1915844A2	30-04-2008
		EP2100431A2	16-09-2009
		KR20080058322A	25-06-2008
		US2007112964A1	17-05-2007
		US2007143397A1	21-06-2007
		US2007293207A1	20-12-2007
		WO2007005124A2	11-01-2007
		WO2007005124A3	08-03-2007
		WO2008073980A2	19-06-2008
		WO2008073980A3	25-09-2008
		WO2008106509A2	04-09-2008
		WO2008106509A3	23-10-2008
		US2004022237A1	05-02-2004
CA2352961A1	02-06-2000		
EP1131926A1	12-09-2001		
EP1131926A4	31-08-2005		
US6614781B1	02-09-2003		
US2004022237A1	05-02-2004		
US7564840B2	21-07-2009		
US2008013531A1	17-01-2008		
US2008025294A1	31-01-2008		
US2008025295A1	31-01-2008		
WO0031933A1	02-06-2000		

PATENT COOPERATION TREATY

From the
INTERNATIONAL SEARCHING AUTHORITY

To: SMART & BIGGAR Box 11560 Vancouver Centre 2200 - 650 W. Georgia Street VANCOUVER, British Columbia Canada, V6B 4N8		RECEIVED 2010 MAR 22 A 9:51 2200-650 WEST GEORGIA ST. VANCOUVER, B.C.		PCT WRITTEN OPINION OF THE INTERNATIONAL SEARCHING AUTHORITY (PCT Rule 43bis.1)	
Applicant's or agent's file reference 83636-55			FOR FURTHER ACTION See paragraph 2 below		
International application No. PCT/CA2009/001062	International filing date (day/month/year) 28 July 2009 (28-07-2009)	Priority date (day/month/year) 28 July 2008 (28-07-2008)			
International Patent Classification (IPC) or both national classification and IPC IPC: <i>H04W 76/02</i> (2009.01), <i>H04W 88/06</i> (2009.01), <i>H04W 88/16</i> (2009.01)					
Applicant DIGIFONICA (INTERNATIONAL) LIMITED ET AL					
1. This opinion contains indications relating to the following items : <ul style="list-style-type: none"> <input checked="" type="checkbox"/> Box No. I Basis of the opinion <input type="checkbox"/> Box No. II Priority <input type="checkbox"/> Box No. III Non-establishment of opinion with regard to novelty, inventive step and industrial applicability <input type="checkbox"/> Box No. IV Lack of unity of invention <input checked="" type="checkbox"/> Box No. V Reasoned statement under Rule 43bis.1(a)(I) with regard to novelty, inventive step or industrial applicability; citations and explanations supporting such statement <input type="checkbox"/> Box No. VI Certain documents cited <input type="checkbox"/> Box No. VII Certain defects in the international application <input checked="" type="checkbox"/> Box No. VIII Certain observations on the international application 					
2. FURTHER ACTION If a demand for international preliminary examination is made, this opinion will be considered to be a written opinion of the International Preliminary Examining Authority ("IPEA") except that this does not apply where the applicant chooses an Authority other than this one to be the IPEA and the chosen IPEA has notified the International Bureau under Rule 66.1bis(b) that written opinions of this International Searching Authority will not be so considered. If this opinion is, as provided above, considered to be a written opinion of the IPEA, the applicant is invited to submit to the IPEA a written reply together, where appropriate, with amendments, before the expiration of 3 months from the date of mailing of Form PCT/ISA/220 or before the expiration of 22 months from the priority date, whichever expires later. For further options, see Form PCT/ISA/220.					
3. For further details, see notes to Form PCT/ISA/220.					
Name and mailing address of the ISA/CA Canadian Intellectual Property Office Place du Portage I, C114 - 1st Floor, Box PCT 50 Victoria Street Gatineau, Quebec K1A 0C9 Facsimile No.: 001-819-953-2476		Date of completion of this opinion 12 March 2010 (12-03-2010)		Authorized officer Elena Mikhailova (819) 953-5206	

WRITTEN OPINION OF THE
INTERNATIONAL SEARCHING AUTHORITY

International application No.
PCT/CA2009/001062

Box No. I **Basis of this opinion**

1. With regard to the **language**, this opinion has been established on the basis of:
 - the international application in the language in which it was filed
 - a translation of the international application into _____, which is the language of a translation furnished for the purposes of international search (Rules 12.3(a) and 23.1(b)).
2. This opinion has been established taking into account the **rectification of an obvious mistake** authorized by or notified to this Authority under Rule 91 (Rule 43*bis*.1(a))
3. With regard to any **nucleotide and/or amino acid sequence** disclosed in the international application, this opinion has been established on the basis of a sequence listing filed or furnished:
 - a. (means)
 - on paper
 - in electronic form
 - b. (time)
 - the international application as filed.
 - together with the international application in electronic form
 - subsequently to this Authority for the purposes of search
4. In addition, in the case that more than one version or copy of a sequence listing has been filed or furnished, the required statements that the information in the subsequent or additional copies is identical to that in the application as filed or does not go beyond the application as filed, as appropriate, were furnished.
5. Additional comments :

**WRITTEN OPINION OF THE
INTERNATIONAL SEARCHING AUTHORITY**

International application No.
PCT/CA2009/001062

Box No. V Reasoned statement under Rule 43bis.1(a)(I) with regard to novelty, inventive step or industrial applicability; citations and explanations supporting such statement

1. Statement

Novelty (N)	Claims <u>1 to 90</u>	YES
	Claims <u>None</u>	NO
Inventive step (IS)	Claims <u>None</u>	YES
	Claims <u>1 to 90</u>	NO
Industrial applicability (IA)	Claims <u>1 to 90</u>	YES
	Claims <u>None</u>	NO

2. Citations and explanations :

Reference is made to the following documents:

D1: US 20070112964 A1 (Guedalia et al.) 17 May 2007 (17-05-2007)

D2: US 20040022237 A1 (Elliot et al.) 05 February 2004 (05-02-2004)

The present application relates to initiating a long distance call using a mobile telephone. The application is concerned with providing a technique (other than using a "calling card") for avoiding long distance charges when the mobile telephone is roaming in another mobile telephone service provider's network. To achieve the above object the following technique is suggested: the user of the mobile telephone provides a callee identifier and requests an access code from an access server. Upon receiving the access code, which is different from the callee identifier, a call to the callee is initiated using the access code. Claim 1, which defines a method of initiating a call to a callee using a mobile telephone, is directed to the above described technique. D1 discloses systems and methods for establishing and maintaining communications between two or more devices coupled to different communication networks. In particular, D1 teaches a method of initiating a call to a callee *using a mobile telephone* (abstract, claims 15, 53, par. 0014, 0115) including the steps of receiving from a user of the mobile phone a callee identifier associated with the callee (claim 1, par. 0068), transmitting an access code request message including the callee identifier (claim 1, par. 0011, 0014, 0068, 0142), receiving an access code reply message (par. 0135, 0142), and initiating a call with the mobile telephone using the access code to identify the callee (par. 0137). Although D1 does not explicitly mention that the access code reply message includes an access code different from the callee identifier and associated with the callee identifier, the mentioned technical feature is well known in the art, and disclosed in D2. D2 describes a toll-free Service Control Point (SCP) which can translate a toll free number to a final routing destination based on a flexible set of options selected by a subscriber which include NPA or NPA-XXX of a calling party. The SCP can have several possible responses to a routing request. One of the responses includes returning a *circuit identifier* associated with a called party to connect the call (par. 0710 and 0711). Therefore, D1 in combination with D2 discloses the subject matter of claim 1. As independent claims 12, 21, 22, 31, 32, 33, 52, 71 and 90 are all directed to the same subject matter as claim 1 the above arguments also apply to claims 12, 21, 22, 31, 32, 33, 52, 71 and 90.

It appears that dependent claims 2 to 11, 13 to 20, 23 to 30, 34 to 51, 53 to 70 and 72 to 89 fail to introduce any inventive limitation.

Article 33(2) PCT - Novelty

As none of the cited references taken alone discloses the technical features of claims 1 to 90, the subject matter of the claimed invention is considered to be novel thus meeting the requirements of **Article 33(2) PCT**.

Article 33(3) PCT - Inventive step

For the reason indicated in the above discussion the subject matter of claims 1 to 90 is not considered to involve inventive step thus failing to fulfill the requirements of **Article 33(3) PCT**.

Box No. VIII **Certain observations on the international application**

The following observations on the clarity of the claims, description, and drawings or on the question whether the claims are fully supported by the description, are made :

Article 6

In claims 52, 71 and 90 the term *said routing controller* lacks the antecedent.

Supplemental Box

In case the space in any of the preceding boxes is not sufficient.

Continuation of: Box V on page 3

Article 33(4) PCT - Industrial Applicability

As the present application relates to a well established field of wireless communication, the subject matter of claims 1 to 90 is considered to be industrially applicable under **Article 33(4) PCT**.

PATENT COOPERATION TREATY
PCT

INTERNATIONAL SEARCH REPORT
(PCT Article 18 and Rules 43 and 44)

RECEIVED

Applicant's or agent's file reference 83636-16	FOR FURTHER ACTION	7500 Form PCT/ISA/210: 2b as well as, where applicable, item 5 below 600 WEST GEORGIA ST. ATLANTA, GA 30308-3801 UNITED STATES OF AMERICA
International application No. PCT/CA2007/001956	International filing date (day/month/year) 01 November 2007 (01-11-2007)	(Earliest) Priority date (day/month/year) 02 November 2006 (02-11-2006)
Applicant DIGIFONICA (INTERNATIONAL) LIMITED ET AL		

This international search report has been prepared by this International Searching Authority and is transmitted to the applicant according to Article 18. A copy is being transmitted to the International Bureau.

This international search report consists of a total of 5 sheets.

It is also accompanied by a copy of each prior art document cited in this report.

1. Basis of the report

a. With regard to the **language**, the international search was carried out on the basis of:

the international application in the language in which it was filed

a translation of the international application into _____, which is the language of a translation furnished for the purposes of international search (Rules 12.3(a) and 23.1(b))

b. This international search report has been established taking into account the **rectification of an obvious mistake** authorized by or notified to this Authority under Rule 91 (Rule 43.6bis(a)).

c. With regard to any **nucleotide and/or amino acid sequence** disclosed in the international application, see Box No. I

2. **Certain claims were found unsearchable** (see Box No. II)

3. **Unity of invention is lacking** (see Box No. III)

4. With regard to the **title**,

the text is approved as submitted by the applicant

the text has been established by this Authority to read as follows :

5. With regard to the **abstract**,

the text is approved as submitted by the applicant

the text has been established, according to Rule 38.2, by this Authority as it appears in Box No. IV. The applicant may, within one month from the date of mailing of this international search report, submit comments to this Authority

6. With regard to the **drawings**,

a. the figure of the **drawings** to be published with the abstract is Figure No. 1

as suggested by the applicant

as selected by this Authority, because the applicant failed to suggest a figure

as selected by this Authority, because this figure better characterizes the invention

b. none of the figures is to be published with the abstract



DOC
JLE
JWK

Box No. II Observations where certain claims were found unsearchable (Continuation of item 2 of the first sheet)

This international search report has not been established in respect of certain claims under Article 17(2)(a) for the following reasons :

1. Claim Nos. :
because they relate to subject matter not required to be searched by this Authority, namely :

2. Claim Nos. :
because they relate to parts of the international application that do not comply with the prescribed requirements to such an extent that no meaningful international search can be carried out, specifically :

3. Claim Nos. :
because they are dependant claims and are not drafted in accordance with the second and third sentences of Rule 6.4(a).

Box No. III Observations where unity of invention is lacking (Continuation of item 3 of first sheet)

This International Searching Authority found multiple inventions in this international application, as follows :

Group I	Claims 1-59
Group II	Claims 60, 61
Group III	Claims 62-84
Group IV	Claims 85-107

1. As all required additional search fees were timely paid by the applicant, this international search report covers all searchable claims.
2. As all searchable claims could be searched without effort justifying additional fees, this Authority did not invite payment of additional fees.
3. As only some of the required additional search fees were timely paid by the applicant, this international search report covers only those claims for which fees were paid, specifically claim Nos. :
4. No required additional search fees were timely paid by the applicant. Consequently, this international search report is restricted to the invention first mentioned in the claims; it is covered by claim Nos. :

Remark on Protest The additional search fees were accompanied by the applicant's protest and, where applicable, the payment of a protest fee.

The additional search fees were accompanied by the applicant's protest but the applicable protest fee was not paid within the time limit specified in the invitation.

No protest accompanied the payment of additional search fees.

INTERNATIONAL SEARCH REPORT

International application No.
PCT/CA2007/001956

A. CLASSIFICATION OF SUBJECT MATTER
 IPC: *H04L 12/66* (2006.01), *H04L 12/14* (2006.01), *H04M 11/06* (2006.01), *H04M 15/00* (2006.01),
H04Q 3/64 (2006.01)
 According to International Patent Classification (IPC) or to both national classification and IPC

B. FIELDS SEARCHED

Minimum documentation searched (classification system followed by classification symbols)
 IPC: H04L (2006.01), H04M (2006.01), H04Q (2006.01); US classes: 370, 379 in combination with keywords

Documentation searched other than minimum documentation to the extent that such documents are included in the fields searched

Electronic database(s) consulted during the international search (name of database(s) and, where practicable, search terms used)
 Canadian Patent Database, USPTO West, Delphion. Keywords: public network, private network, routing message, instant messaging, ip phone, voip, routing controller, sip, gateway, tfl, metric, skype, data structure, routing message, billing, communication session, prepaid

C. DOCUMENTS CONSIDERED TO BE RELEVANT

Category*	Citation of document, with indication, where appropriate, of the relevant passages	Relevant to claim No.
A	CA2249668 C (Bruno et al.) 7 April 1999 (07-04-1999) * Page 9, line 4 to page 14, line 18; Figs 1, 2 *	1-59
A	US7120682 B1 (Salama) 10 October 2006 (10-10-2006) * Col. 1, line 47 to col. 4, line 67 *	1-59
A	US2006/0160565 A1 (Singh et al.) 20 July 2006 (20-07-2006) * Paragraphs 14, 15, 18; Figs 1, 2 *	1-59
A	US2006/0177035 A1 (Cope et al.) 10 August 2006 (10-08-2006) * Paragraphs 5, 6, 12 *	1-59
A, P	US7212522 B1 (Shankar et al.) 1 May 2007 (01-05-2007) * Col. 4, line 47 to col. 5, line 11; Fig. 1 *	1-59

Further documents are listed in the continuation of Box C.

See patent family annex.

* Special categories of cited documents :

- "A" document defining the general state of the art which is not considered to be of particular relevance
- "E" earlier application or patent but published on or after the international filing date
- "L" document which may throw doubts on priority claim(s) or which is cited to establish the publication date of another citation or other special reason (as specified)
- "O" document referring to an oral disclosure, use, exhibition or other means
- "P" document published prior to the international filing date but later than the priority date claimed

- "T" later document published after the international filing date or priority date and not in conflict with the application but cited to understand the principle or theory underlying the invention
- "X" document of particular relevance; the claimed invention cannot be considered novel or cannot be considered to involve an inventive step when the document is taken alone
- "Y" document of particular relevance; the claimed invention cannot be considered to involve an inventive step when the document is combined with one or more other such documents, such combination being obvious to a person skilled in the art
- "&" document member of the same patent family

Date of the actual completion of the international search

6 February 2008 (06-02-2008)

Date of mailing of the international search report

20 February 2008 (20-02-2008)

Name and mailing address of the ISA/CA
 Canadian Intellectual Property Office
 Place du Portage I, C114 - 1st Floor, Box PCT
 50 Victoria Street
 Gatineau, Quebec K1A 0C9
 Facsimile No.: 001-819-953-2476

Authorized officer

Arthur Smith 819-953-1360

INTERNATIONAL SEARCH REPORT

International application No.
PCT/CA2007/001956

C (Continuation). DOCUMENTS CONSIDERED TO BE RELEVANT

Category*	Citation of document, with indication, where appropriate, of the relevant passages	Relevant to claim No.
A	US7068772 (Widger et al.) 27 June 2006 (27-06-2006) * Col. 12, line 49 to col. 14, line 44; col. 15, line 26 to col. 16, line 30 Figs. 3, 5 *	60, 61
A	US2006/0209768 A1 (Yan et al.) 21 September 2006 (21-09-2006) * Paras. 71-99, 111-118, 128-141, 179-188; Figs. 3, 4, 7-9 *	60, 61
X	US6058300 (Hanson) 2 May 2000 (02-05-2000) * Col. 2, lines 9-13; col. 5, line 55 to col. 6, line 23; col. 6, line 55 to col. 7, line 18 *	62, 63, 73-75
A		64-72, 76-84
X	US2005/0177843 A1 (Williams) 11 August 2005 (11-08-2005) * Paragraphs 64 - 69 *	62, 63, 73-75
A		64-72, 76-84
A	US6188752 B1 (Lesley) 13 February 2001 (13-02-2001) * Col. 4, line 24 to col. 9, line 6; Figs 1, 3 *	85-107
A	US6507644 B1 (Henderson et al.) 14 January 2003 (14-01-2003) * Col. 1, line 51 to col. 6, line 28 *	85-107
A	US5359642 (Castro) 25 October 1994 (25-10-1994) * Abstract; Col. 5, lines 7-12, col. 6, line 5 to col. 8, line 38; col. 10, line 10 to col. 12, line 68 *	85-107

INTERNATIONAL SEARCH REPORT
Information on patent family members

International application No.
PCT/CA2007/001956

Patent Document Cited in Search Report	Publication Date	Patent Family Member(s)	Publication Date
CA2249668	07-04-1999	EP0915594 A2 US6614765 B1	12-05-1999 02-09-2003
US7120682	10-10-2006	NONE	
US2006160565	20-07-2006	NONE	
US2006177035	10-08-2006	CA2595429 A1 WO2006081115 A1	03-08-2006 03-08-2006
US7212522	01-05-2007	US6570869 B1 US6658022 B1 US6768733 B1	27-05-2003 02-12-2003 27-07-2004
US7068772	27-06-2006	NONE	
US2006209768	21-09-2006	CA2512959 A1 CN1762129 A EP1585270 A1 JP2004266310 A KR20050092405 A WO2004077754 A1	10-09-2004 19-04-2006 12-10-2005 24-09-2004 21-09-2005 10-09-2004
US6058300	02-05-2000	AU6142498 A CA2250845 A1 US6029062 A US6208851 B1 US6625438 B2 US7162220 B2 WO9834393 A2	25-08-1998 06-08-1998 22-02-2000 27-03-2001 23-09-2003 09-01-2007 06-08-1998
US2005177843	11-08-2005	AU2002351582 A1 CA2469959 A1 CA2471113 A1 US2003120553 A1 US2006190353 A1 WO03056803 A2	15-07-2003 10-07-2003 10-07-2003 26-06-2003 24-08-2006 10-07-2003
US6188752	13-02-2001	AU730021B B2 AU5073398 A BR9713025 A CA2271311 A1 CN1244987 A DE69732526D D1 DE69732526T T2 EP0944994 A1 ES2237791T T3 JP2001504299T T KR20000053241 A NO992280 A US6333976 B2 WO9821874 A1	22-02-2001 03-06-1998 25-01-2000 22-05-1998 16-02-2000 24-03-2005 28-07-2005 29-09-1999 01-08-2005 27-03-2001 25-08-2000 12-07-1999 25-12-2001 22-05-1998
US6507644	14-01-2003	NONE	
US5359642	25-10-1994	NONE	

PATENT COOPERATION TREATY

From the
INTERNATIONAL SEARCHING AUTHORITY

To:
SMART & BIGGAR
Box 11560 Vancouver Centre
2200 - 650 W. Georgia Street
VANCOUVER, British Columbia
Canada, V6B 4N8

RECEIVED REPTIVED

2008 FEB 26 A 10:27 AM
INTERNATIONAL SEARCHING AUTHORITY
2200 - 650 WEST GEORGIA ST. VANCOUVER, B.C.
WEST GEORGIA ST. VANCOUVER, B.C.
(PCT Rule 43bis)

Date of mailing (day/month/year) 20 February 2008 (20-02-2008)

Applicant's or agent's file reference
83636-16

FOR FURTHER ACTION
See paragraph 2 below

International application No.
PCT/CA2007/001956

International filing date (day/month/year)
01 November 2007 (01-11-2007)

Priority date (day/month/year)
02 November 2006 (02-11-2006)

International Patent Classification (IPC) or both national classification and IPC
IPC: *H04L 12/66* (2006.01), *H04L 12/14* (2006.01), *H04M 11/06* (2006.01), *H04M 15/00* (2006.01),
H04Q 3/64 (2006.01)

Applicant
DIGIFONICA (INTERNATIONAL) LIMITED ET AL

NKS
Written Opinion
due Sep 2/08
DOCKET
dock: Sep 1/08

1. This opinion contains indications relating to the following items :

- Box No. I Basis of the opinion
- Box No. II Priority
- Box No. III Non-establishment of opinion with regard to novelty, inventive step and industrial applicability
- Box No. IV Lack of unity of invention
- Box No. V Reasoned statement under Rule 43bis.1(a)(i) with regard to novelty, inventive step or industrial applicability; citations and explanations supporting such statement
- Box No. VI Certain documents cited
- Box No. VII Certain defects in the international application
- Box No. VIII Certain observations on the international application

2. FURTHER ACTION

If a demand for international preliminary examination is made, this opinion will be considered to be a written opinion of the International Preliminary Examining Authority ("IPEA") except that this does not apply where the applicant chooses an Authority other than this one to be the IPEA and the chosen IPEA has notified the International Bureau under Rule 66.1bis(b) that written opinions of this International Searching Authority will not be so considered.

If this opinion is, as provided above, considered to be a written opinion of the IPEA, the applicant is invited to submit to the IPEA a written reply together, where appropriate, with amendments, before the expiration of 3 months from the date of mailing of Form PCT/ISA/220 or before the expiration of 22 months from the priority date, whichever expires later.

For further options, see Form PCT/ISA/220.

3. For further details, see notes to Form PCT/ISA/220.

Name and mailing address of the ISA/CA
Canadian Intellectual Property Office
Place du Portage I, C114 - 1st Floor, Box PCT
50 Victoria Street
Gatineau, Quebec K1A 0C9
Facsimile No.: 001-819-953-2476

Date of completion of this opinion
7 February 2008 (07-02-2008)

Authorized officer
Arthur Smith 819-953-1360

Doc
JCC
JWW

WRITTEN OPINION OF THE
INTERNATIONAL SEARCHING AUTHORITY

International application No.
PCT/CA2007/001956

Box No. I Basis of this opinion

1. With regard to the **language**, this opinion has been established on the basis of:
 - the international application in the language in which it was filed
 - a translation of the international application into _____, which is the language of a translation furnished for the purposes of international search (Rules 12.3(a) and 23.1(b)).
2. This opinion has been established taking into account the **rectification of an obvious mistake** authorized by or notified to this Authority under Rule 91 (Rule 43bis.1(a))
3. With regard to any **nucleotide and/or amino acid sequence** disclosed in the international application and necessary to the claimed invention, this opinion has been established on the basis of:
 - a. type of material
 - a sequence listing
 - table(s) related to the sequence listing
 - b. format of material
 - on paper
 - in electronic form
 - c. time of filing/furnishing
 - contained in the international application as filed.
 - filed together with the international application in electronic form
 - furnished subsequently to this Authority for the purposes of search.
4. In addition, in the case that more than one version or copy of a sequence listing and/or table(s) relating thereto has been filed or furnished, the required statements that the information in the subsequent or additional copies is identical to that in the application as filed or does not go beyond the application as filed, as appropriate, were furnished.
5. Additional comments :

WRITTEN OPINION OF THE
INTERNATIONAL SEARCHING AUTHORITY

International application No.
PCT/CA2007/001956

Box No. IV Lack of unity of invention

1. In response to the invitation (Form PCT/ISA/206) to pay additional fees the applicant has, within the applicable time limit :
- paid additional fees
 - paid additional fees under protest and, where applicable, the protest fee
 - paid additional fees under protest but the applicable protest fee was not paid
 - not paid additional fees

2. This Authority found that the requirement of unity of invention is not complied with and chose not to invite the applicant to pay additional fees.

3. This Authority considers that the requirement of unity of invention in accordance with Rules 13.1, 13.2 and 13.3 is

complied with

not complied with for the following reasons :

This International Searching Authority considers that there are four inventions claimed in the international application covered by the claims indicated below:

- I Claims 1-59
- II Claims 60, 61
- III Claims 62-84
- IV Claims 85-107

The claims of Group I have in common a call routing controller for facilitating communications between callers and callees in a communications system comprising a plurality of nodes in which, in response to initiation of a call, uses call classification criteria to classify the call as a public network call or a private network call, and produces accordingly a routing message.

The claims of Group II have in common a data structure for access by an apparatus for producing a routing message for use by a call routing controller in a communications system.

The claims of Group III have in common determining a time to permit a communication session to be conducted, the determination based on calculating a cost per unit time, a participant's billing pattern, and the quotient of a funds balance held by the participant.

The claims of Group IV have in common attributing charges for communications services by determining chargeable times and changing account balances of both user and communications services reseller.

Groups I and II have in common the call routing controller; however, call routing controllers are well known in the art so the claims of Groups I and II lack unity *a posteriori*.

Because the remainder of the claims of Groups I, II, III, and IV have no elements in common and would require separate searches by the examiner, these groups lack unity *a priori*.

4. Consequently, this opinion has been established in respect of the following parts of the international application :

all parts

the parts relating to claim Nos.

WRITTEN OPINION OF THE
INTERNATIONAL SEARCHING AUTHORITY

International application No.
PCT/CA2007/001956

Box No. V Reasoned statement under Rule 43bis.1(a)(i) with regard to novelty, inventive step or industrial applicability; citations and explanations supporting such statement

1. Statement

Novelty (N)	Claims <u>1-107</u>	YES
	Claims <u>None</u>	NO
Inventive step (IS)	Claims <u>1-61, 64-72, 76-107</u>	YES
	Claims <u>62, 63, 73-75</u>	NO
Industrial applicability (IA)	Claims <u>1-107</u>	YES
	Claims <u>None</u>	NO

2. Citations and explanations :

Group I (Claims 1-59)

The following document is referred to in this communication:

D1 CA 2249668

D1 is considered to form the closest prior art. D1 discloses routing information in an integrated global communications network in which a central routing processor collects routing capabilities of network nodes for which it has responsibility. The routing processor evaluates the routing requirements of a routing query signal transmitted by a source router, determines which routers and communication paths within the network are capable and available to route the information, evaluates the statistical availability of such routers, and selects an optimal routing path to a destination router.

Novelty

D1 fails to individually disclose all the elements of claims 1-59; therefore, claims 1-59 are considered to be novel in accordance with Article 33(2) PCT.

Inventive Step

Independent claims 1, 30, and 31 each claim operating a call routing controller to facilitate communication between callers and callees in a system or network comprising a plurality of nodes in which call classification criteria associated with a caller identifier is used to classify the call as a public network call or a private network call, and producing a routing message in accordance with the classification. D1 teaches facilitation of communication between callers and callees within a private network, including producing a routing message for a private network call. However, D1 fails to teach classification of a call as a public network call, and fails to teach producing an appropriate routing message for a public network call.

Claims 2-29 and 32-59 depend on independent claims 1 and 31, respectively.

Therefore, claims 1-59 are considered to have an inventive step in accordance with Article 33(3) PCT.

Industrial Applicability

Routing IP phone calls through a communication network including both private and public aspects finds use in telecommunications, and, thus, claims 1-59 are industrially applicable in accordance with Article 33(4) PCT.

Group II (Claims 60, 61)

The following documents are referred to in this communication:

D2 US7,068,772

D3 US2006/0209768

D2 and D3 are considered to form the closest prior art. D2 discloses a call processing system and method for providing one-number telecommunication services, wherein a data structure of a subscriber record for access by an apparatus for producing a routing message, the data structure comprising the subscriber's various profiles and the associated 1-800 number or address that the subscriber may be contacted.

(Continued in Supplemental Box)

Box No. VIII **Certain observations on the international application**

The following observations on the clarity of the claims, description, and drawings or on the question whether the claims are fully supported by the description, are made :

Claim-Related Objections

Claim 60 is unclear and does not comply with Article 6 of the PCT. The following terms lack a proper antecedent basis:

- “the subscriber” (claim 60, page 83, line 16)
- “subscriber name” (claim 60, page 83, line 17)

Claim 60 is unclear and does not comply with Article 6 of the PCT. The double inclusion of any element renders the claims indefinite. The following expressions have already been defined previously in the claims and should therefore be referred to using a definite article:

- “a user domain” (claim 60, page 83, lines 14, 17)
- “a direct-in-dial number” (claim 60, page 83, line 18)

Claim 60 is indefinite and does not comply with Article 6 of the PCT. The terms “a subscriber user name” (claim 60, page 82, line 32) and “subscriber name” (claim 60, page 83, lines 14, 15, 16-17, 17) cause ambiguity. It is not clear whether they are the same or different.

Claim 61 is indefinite and does not comply with Article 6 of the PCT. The term “master list records” (page 83, line 27) causes ambiguity. It should read “said master list records”.

Claim 61 is indefinite and does not comply with Article 6 of the PCT. The term “aid” (page 83, line 28) causes ambiguity. It should read “said aid”.

Claim 61 is indefinite and does not comply with Article 6 of the PCT. The term “dialing codes” (page 84, line 8) causes ambiguity. It should read “said dialing codes”.

Supplemental Box

In case the space in any of the preceding boxes is not sufficient.

Continuation of: Box V

D3 discloses a system for managing address allocation of a mobile terminal in wireless LAN (WLAN) to inter-work with another WLAN or a public cellular network, wherein a data structure comprises: Message_Type, Message_Length, Domain_Name, MT_ID, Service_Request, Session_ID, Address_Request, Tunnel_Request, WLAN_ID and Security_Field.

Novelty

The subject matter of claim 60 is considered to be novel and complies with the requirement of **Article 33(2) of the PCT**. The cited references, when taken alone, fail to disclose a data structure for access by an apparatus for producing a routing message for use by a call routing controller in a communications system, the data structure comprising: dialing profile records comprising fields for associating with respective subscribers to the system: a subscriber user name; direct-in-dial records comprising fields for associating with respective subscriber usernames: a user domain; and a direct-in-dial number; prefix to node records comprising fields for associating with at least a portion of said respective subscriber usernames: a node address of a node in said system, whereby a subscriber name can be used to find a user domain, at least a portion of said subscriber name can be used to find a node with which the subscriber identified by the subscriber name is associated, and a user domain and subscriber name can be located in response to a direct-in-dial number.

The subject matter of claim 61 is considered to be novel and complies with the requirement of **Article 33(2) of the PCT**. The cited references, when taken alone, fail to disclose a data structure for access by an apparatus for producing a routing message for use by a call routing controller in a communications system, the data structure comprising: master list records comprising fields for associating a dialing code with respective master list identifiers; and supplier list records linked to master list records by said master list identifiers, said supplier list records comprising fields for associating with a communications service supplier: a supplier id; a master list id; a route identifier; and a billing rate code, whereby communications services suppliers are associated with dialing codes, such that dialing codes can be used to locate suppliers capable of providing a communications link associated with a given dialing code.

Inventive Step

The subject matter of claim 60 is considered to involve an inventive step and does comply with **Article 33(3) of the PCT**. The prior art, D2 and D3, alone or in combination, does not fairly suggest a data structure comprising: dialing profile records; direct-in-dial records; prefix to node records, whereby a subscriber name can be used to find a user domain, at least a portion of said subscriber name can be used to find a node with which the subscriber identified by the subscriber name is associated, and a user domain and subscriber name can be located in response to a direct-in-dial number.

The subject matter of claim 61 is considered to involve an inventive step and does comply with **Article 33(3) of the PCT**. The prior art, D2 and D3, alone or in combination, does not fairly suggest a data structure comprising: master list records; and supplier list records linked to master list records, said supplier list records comprising fields for associating with a communications service supplier, whereby communications services suppliers are associated with dialing codes, such that dialing codes can be used to locate suppliers capable of providing a communications link associated with a given dialing code.

Industrial Applicability

Claims 60 and 61 are considered to be industrially applicable and do comply with **Article 33(4) of the PCT**.

Group III (Claims 62-84)

The following documents are referred to in this communication:

D4 US 6058300
D5 US 2005/0177843 A1

D4 discloses, in part, a calculation of a maximum call duration in response to a customer account balance for a prepaid telecommunications system.

D5 discloses, in part, calculation of a maximum call duration to a specific callee in response to a caller request to make a call in a prepaid telecommunications system. If the maximum call duration is sufficient, the system permits the call to take place.

Novelty

Each of D4 and D5 fail to individually disclose all the elements of claims 62-84; therefore, claims 62-84 are considered to be novel in accordance with Article 33(2) PCT.

(Continued in next Supplemental Box)

Supplemental Box

In case the space in any of the preceding boxes is not sufficient.

Continuation of: Previous Supplemental Box

Inventive Step

Claim 62 claims a method of determining a time to permit a communications session to be conducted (ie, a maximum call duration). Either of D4 or D5 disclose determination of a maximum call duration and cause claim 62 to lack an inventive step. Both of D4 and D5 teach determination of a cost per unit time (D4: "rate per minute" (col. 5, line 58); D5: "call credits" (para. 65)), calculating a first time value as a sum of a free time attributed to a participant in the communication session and the quotient of a funds balance held by the participant to the cost per unit time value (D4: col. 5, lines 61 - 65; D5: para. 67), and producing a second time value in response to the first time value and a billing pattern (D4: roaming or not roaming; D5: "call history"), the second time value being the time to permit a communications session to be conducted. Additional differences between claim 62 and either D4 or D5 such as "free time", "cost per unit time" and "billing pattern" also lack inventive step. Thus claim 62 is considered to **lack an inventive step** in accordance with Article 33(3) PCT.

As claims 73 and 74 are apparatus for carrying out methods steps similar or identical to those of claim 62, these claims **lack an inventive step** in accordance with Article 33(3) PCT for the same reasons as listed above.

Claim 63 and 75 lack an inventive step in view of either of D4 or D5 in that D4 and D5 disclose retrieving a record associated with said participant (D4: "customer's account" (col. 5, lines 63-64); D5: "certificate information" (para. 67)) and obtaining from said record said funds balance (D4: col. 5, line 63; D5: para. 67). To also obtain a participant's free time also lack an inventive step. Thus, claims 63 and 75 **lack an inventive step** in accordance with Article 33(3) PCT.

Claims 64-72 and 76-84 are found to be inventive since no combination of prior art documents were found which disclose the subject matter as set forth in claims 64-72 and 76-84 in accordance with Article 33(3) PCT.

Industrial Applicability

Determination of maximum time for a communication session finds application within Internet telephony; thus, claims 62-84 are considered to **have industrial applicability** in accordance with Article 33(4) PCT.

Group IV (Claims 85-107)

The following document is referred to in this communication:

D6 US 6188752

D6 is considered to form the closest prior art. D6 discloses provision of prepaid telecommunications services by a telecommunications network. A database record includes subscriber information fields such as account numbers, prepaid account information, and a current prepayment monetary amounts. Once a call or communication session has been established, the network monitors parameters related to any fee to be charged for the service such as start time, elapsed time, origination and destination locations, and rate information (ie, billing pattern) preferably in real time. D6 further discloses determining the cost of the call and debiting the account balance associated with the subscriber.

Novelty

D6 fails to individually disclose all the elements of claims 85-107; therefore, claims 85-107 **are considered to be novel** in accordance with Article 33(2) PCT.

Inventive Step

Independent claims 85, 96, and 97 each claim attributing charges for communications services including determining a chargeable time in response to a communication session time and a pre-defined billing pattern, determining a user cost value, and changing account balances associated with the user, reseller, and operator of the communications services. D6 teaches attributing charges for communications services, determining a chargeable time in response to a communication session time and a pre-defined billing pattern, determining a user cost value in response to said first chargeable time associated with a user of said communications services, and changing an account balance associated with said user in response to a user cost per unit time. However, D6 fails to suggest a free time value, nor does D6 teach changing the account balances of either a reseller or an operator of said communications services.

Claims 86-95 and 98-107 depend on independent claims 85 and 97, respectively.

Therefore, claims 85-107 **are considered to have an inventive step** in accordance with Article 33(3) PCT.

Industrial Applicability

Billing or attributing charges for communications services finds use in telecommunications, and, thus, claims 85-107 are considered to **have industrial applicability** in accordance with Article 33(4) PCT.

PATENT COOPERATION TREATY

From the INTERNATIONAL SEARCHING AUTHORITY

To:
 SMART & BIGGAR
 Box 11560 Vancouver Centre
 2200 - 650 W. Georgia Street
 VANCOUVER, British Columbia
 Canada, V6B 4N8

RECEIVED
 INFO TO BE FILED
 JUN 25 A 9 14
 ME 8020 10
 DOCK
 DOCK

PCT

NOTIFICATION OF TRANSMITTAL OF
 THE INTERNATIONAL SEARCH REPORT AND
 THE WRITTEN OPINION OF THE INTERNATIONAL
 SEARCHING AUTHORITY, OR THE DECLARATION

(PCT Rule 44.1)

Date of mailing (day/month/year) 20 June 2008 (20-06-2008)

Applicant's or agent's file reference 83636-18 AMENDS UNDER REQUEST FOR FURTHER ACTION See paragraphs 1 and 4 below

International application No. PCT/CA2008/000545 International filing date (day/month/year) 20 March 2008 (20-03-2008)

Applicant DIGIFONICA (INTERNATIONAL) LIMITED ET AL

1. The applicant is hereby notified that the international search report and the written opinion of the International Searching Authority have been established and are transmitted herewith.

Filing of amendments and statement under Article 19 :

The applicant is entitled, if he so wishes, to amend the claims of the international application (see Rule 46) :

When? The time limit for filing such amendments is normally two months from the date of transmittal of the international search report.

Where? Directly to the International Bureau of WIPO, 34 chemin des Colombettes
 1211 Geneva 20, Switzerland, Facsimile No.: +41 22 338 82 70

For more detailed instructions, see the notes on the accompanying sheet.

2. The applicant is hereby notified that no international search report will be established and that the declaration under Article 17(2)(a) to that effect and the written opinion of the International Searching Authority are transmitted herewith.

3. With regard to the protest against payment of (an) additional fee(s) under Rule 40.2, the applicant is notified that :

the protest together with the decision thereon has been transmitted to the International Bureau together with the applicant's request to forward the texts of both the protest and the decision thereon to the designated Offices.

no decision has been made yet on the protest; the applicant will be notified as soon as a decision is made.

4. Reminders

Shortly after the expiration of 18 months from the priority date, the international application will be published by the International Bureau. If the applicant wishes to avoid or postpone publication, a notice of withdrawal of the international application, or of the priority claim, must reach the International Bureau as provided in Rules 90bis.1 and 90bis.3, respectively, before the completion of the technical preparations for the international publication.

The applicant may submit comments on an informal basis on the written opinion of the International Searching Authority to the International Bureau. The International Bureau will send a copy of such comments to all designated Offices unless an international preliminary examination report has been or is to be established. These comments would also be made available to the public but not before the expiration of 30 months from the priority date.

Within 19 months from the priority date, but only in respect of some designated Offices, a demand for international preliminary examination must be filed if the applicant wishes to postpone the entry into the national phase until 30 months from the priority date (in some Offices even later); otherwise, the applicant must, within 20 months from the priority date, perform the prescribed acts for entry into the national phase before those designated Offices.

In respect of other designated Offices, the time limit of 30 months (or later) will apply even if no demand is filed within 19 months.

See the Annex to Form PCT/IB/301 and, for details about the applicable time limits, Office by Office, see the PCT Applicant's Guide, Volume II, National Chapters and the WIPO Internet site.

Name and mailing address of the ISA/CA
 Canadian Intellectual Property Office
 Place du Portage I, C114 - 1st Floor, Box PCT
 50 Victoria Street
 Gatineau, Quebec K1A 0C9
 Facsimile No.: 001-819-953-2476

Authorized officer
 Donna Daly 819-953-8972

(See notes on accompanying sheet)

Form PCT/ISA/220 (October 2005)

Doc
 JWK

NOTES TO FORM PCT/ISA/220 (continued)

The letter must indicate the differences between the claims as filed and the claims as amended. It must, in particular, indicate, in connection with each claim appearing in the international application (it being understood that identical indications concerning several claims may be grouped), whether

- (i) the claim is unchanged;
- (ii) the claim is cancelled;
- (iii) the claim is new;
- (iv) the claim replaces one or more claims as filed;
- (v) the claim is the result of the division of a claim as filed.

The following examples illustrate the manner in which amendments must be explained in the accompanying letter :

1. [Where originally there were 48 claims and after amendment of some claims there are 51]:
"Claims 1 to 29, 31, 32, 34, 35, 37 to 48 replaced by amended claims bearing the same numbers; claims 30, 33 and 36 unchanged; new claims 49 to 51 added."
2. [Where originally there were 15 claims and after amendment of all claims there are 11]:
"Claims 1 to 15 replaced by amended claims 1 to 11."
3. [Where originally there were 14 claims and the amendments consist in cancelling some claims and in adding new claims]:
"Claims 1 to 6 and 14 unchanged; claims 7 to 13 cancelled; new claims 15, 16 and 17 added."
"Claims 7 to 13 cancelled; new claims 15, 16 and 17 added; all other claims unchanged."
4. [Where various kinds of amendments are made]:
"Claims 1-10 unchanged; claims 11 to 13, 18 and 19 cancelled; claims 14, 15 and 16 replaced by amended claim 14; claim 17 subdivided into amended claims 15, 16 and 17; new claims 20 and 21 added."

"Statement under Article 19(1)" (Rule 46.4)

The amendments may be accompanied by a statement explaining the amendments and indicating any impact that such amendments might have on the description and the drawings (which cannot be amended under Article 19(1)).

The statement will be published with the international application and the amended claims.

It must be in the language in which the international application is to be published.

It must be brief, not exceeding 500 words if in English or if translated into English.

It should not be confused with and does not replace the letter indicating the differences between the claims as filed and as amended. It must be filed on a separate sheet and must be identified as such by a heading, preferably by using the words "Statement under Article 19(1)."

It may not contain any disparaging comments on the international search report or the relevance of citations contained in that report. Reference to citations, relevant to a given claim, contained in the international search report may be made only in connection with an amendment of that claim.

Consequence if a demand for international preliminary examination has already been filed

If, at the time of filing any amendments and any accompanying statement, under Article 19, a demand for international preliminary examination has already been submitted, the applicant must preferably, at the time of filing the amendments (and any statement) with the International Bureau, also file with the International Preliminary Examining Authority a copy of such amendments (and of any statement) and, where required, a translation of such amendments for the procedure before that Authority (see Rules 55.3(a) and 62.2, first sentence). For further information, see the Notes to the demand form (PCT/IPEA/401).

If a demand for international preliminary examination is made, the written opinion of the International Searching Authority will, except in certain cases where the International Preliminary Examining Authority did not act as International Searching Authority and where it has notified the International Bureau under Rule 66.1bis(b), be considered to be a written opinion of the International Preliminary Examining Authority. If a demand is made, the applicant may submit to the International Preliminary Examining Authority a reply to the written opinion together, where appropriate, with amendments before the expiration of 3 months from the date of mailing of Form PCT/ISA/220 or before the expiration of 22 months from the priority date, whichever expires later (Rule 43bis.1(c)).

Consequence with regard to translation of the international application for entry into the national phase

The applicant's attention is drawn to the fact that, upon entry into the national phase, a translation of the claims as amended under Article 19 may have to be furnished to the designated/elected Offices, instead of, or in addition to, the translation of the claims as filed.

For further details on the requirements of each designated/elected Office, see the *PCT Applicant's Guide*, Volume II.

PATENT COOPERATION TREATY
PCT
INTERNATIONAL SEARCH REPORT

(PCT Article 18 and Rules 43 and 44)

RECEIVED

Applicant's or agent's file reference 83636-18	FOR FURTHER ACTION	2008 Form PCT/ISA/220 as well as, where applicable, item 5 below 2008 JUN 25 A 8:10 2200 GSW WEST GEORGIA ST ATLANTA, GA 30303-1000
International application No. PCT/CA2008/000545	International filing date (day/month/year) 20 March 2008 (20-03-2008)	(Earliest) Priority date (day/month/year) 26 March 2007 (26-03-2007)
Applicant DIGIFONICA (INTERNATIONAL) LIMITED ET AL		

This international search report has been prepared by this International Searching Authority and is transmitted to the applicant according to Article 18. A copy is being transmitted to the International Bureau.

This international search report consists of a total of 3 sheets.

It is also accompanied by a copy of each prior art document cited in this report.

1. Basis of the report

a. With regard to the **language**, the international search was carried out on the basis of:

the international application in the language in which it was filed

a translation of the international application into _____, which is the language of a translation furnished for the purposes of international search (Rules 12.3(a) and 23.1(b))

b. This international search report has been established taking into account the **rectification of an obvious mistake** authorized by or notified to this Authority under Rule 91 (Rule 43.6bis(a)).

c. With regard to any **nucleotide and/or amino acid sequence** disclosed in the international application, see Box No. I

2. **Certain claims were found unsearchable** (see Box No. II)

3. **Unity of invention is lacking** (see Box No. III)

4. With regard to the **title**,

the text is approved as submitted by the applicant

the text has been established by this Authority to read as follows :

5. With regard to the **abstract**,

the text is approved as submitted by the applicant

the text has been established, according to Rule 38.2, by this Authority as it appears in Box No. IV. The applicant may, within one month from the date of mailing of this international search report, submit comments to this Authority

6. With regard to the **drawings**,

a. the figure of the **drawings** to be published with the abstract is Figure No. 1

as suggested by the applicant

as selected by this Authority, because the applicant failed to suggest a figure

as selected by this Authority, because this figure better characterizes the invention

b. none of the figures is to be published with the abstract

Doc
JWK

A. CLASSIFICATION OF SUBJECT MATTER
 IPC: *H04L 12/66* (2006.01), *H04M 11/06* (2006.01), *H04M 3/42* (2006.01), *H04Q 3/00* (2006.01),
H04Q 3/64 (2006.01)
 According to International Patent Classification (IPC) or to both national classification and IPC

B. FIELDS SEARCHED

Minimum documentation searched (classification system followed by classification symbols)
 IPC: H04L (2006.01), H04M (2006.01), H04Q (2006.01); US classes: 379/45, 370 in combination with keywords

Documentation searched other than minimum documentation to the extent that such documents are included in the fields searched

Electronic database(s) consulted during the international search (name of database(s) and, where practicable, search terms used)
 Canadian Patent Database, USPTO West, Delphion. Keywords: pbx, inward dialing, dial-in, voip, sip, psap, etc, ali, flag and variations thereof.

C. DOCUMENTS CONSIDERED TO BE RELEVANT

Category*	Citation of document, with indication, where appropriate, of the relevant passages	Relevant to claim No.
X, P	US 2008/0063153 A1 (Krivorot et al.) 13 March 2008 (13-03-2008) * Para. [0004] - [0024], [0042] - [0082]; Fig. 1 *	1, 15, 29, 43
A, P		2-14, 16-28, 30-42
A	US 2005/0083911 A1 (Grabelsky et al.) 21 April 2005 (21-04-2005) * Para. [0041] - [0055], [0060] - [0138]; Fig. 1, 2 *	1-43
A	US 2005/0169248 A1 (Truesdale et al.) 4 August 2005 (04-08-2005) * Para. [0013] - [0050] *	1-43
A, P	US 2008/0037715 A1 (Prozeniuk et al.) 14 February 2008 (14-02-2008) * Entire document *	1-43
A, P	WO 2007/044454 A2 (Croy et al.) 19 April 2007 (19-04-2007) * Entire document *	1-43

Further documents are listed in the continuation of Box C.

See patent family annex.

* Special categories of cited documents :	"T" later document published after the international filing date or priority date and not in conflict with the application but cited to understand the principle or theory underlying the invention
"A" document defining the general state of the art which is not considered to be of particular relevance	"X" document of particular relevance; the claimed invention cannot be considered novel or cannot be considered to involve an inventive step when the document is taken alone
"E" earlier application or patent but published on or after the international filing date	"Y" document of particular relevance; the claimed invention cannot be considered to involve an inventive step when the document is combined with one or more other such documents, such combination being obvious to a person skilled in the art
"L" document which may throw doubts on priority claim(s) or which is cited to establish the publication date of another citation or other special reason (as specified)	"&" document member of the same patent family
"O" document referring to an oral disclosure, use, exhibition or other means	
"P" document published prior to the international filing date but later than the priority date claimed	

Date of the actual completion of the international search

6 June 2008 (06-06-2008)

Date of mailing of the international search report

20 June 2008 (20-06-2008)

Name and mailing address of the ISA/CA
 Canadian Intellectual Property Office
 Place du Portage I, C114 - 1st Floor, Box PCT
 50 Victoria Street
 Gatineau, Quebec K1A 0C9
 Facsimile No.: 001-819-953-2476

Authorized officer

Arthur Smith 819-953-1360

INTERNATIONAL SEARCH REPORT
Information on patent family members

International application No.
PCT/CA2008/000545

Patent Document Cited in Search Report	Publication Date	Patent Family Member(s)	Publication Date
US2008063153	13-03-2008	CA2598200 A1	21-02-2008
US2005083911	21-04-2005	EP1526697 A2	27-04-2005
US2005169248	04-08-2005	NONE	
US2008037715	14-02-2008	NONE	
WO2007044454	19-04-2007	US2007091831 A1	26-04-2007
		US2007091906 A1	26-04-2007
		US2007092070 A1	26-04-2007
		WO2007044455 A2	19-04-2007
		WO2007055971 A2	18-05-2007

PATENT COOPERATION TREATY

From the
INTERNATIONAL SEARCHING AUTHORITY

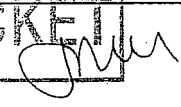
To: SMART & BIGGAR Box 11560 Vancouver Centre 2200 - 650 W. Georgia Street VANCOUVER, British Columbia Canada, V6B 4N8		RECEIVED 2008 JUN 25 A 9:48 2200-650 WEST GEORGIA ST. VANCOUVER, B.C.	PCT WRITTEN OPINION OF THE INTERNATIONAL SEARCHING AUTHORITY (PCT Rule 43bis.1)
Applicant's or agent's file reference 83636-18		Date of mailing (day/month/year) 20 June 2008 (20-06-2008)	
International application No. PCT/CA2008/000545		International filing date (day/month/year) 20 March 2008 (20-03-2008)	Priority date (day/month/year) 26 March 2007 (26-03-2007)
International Patent Classification (IPC) or both national classification and IPC IPC: H04L 12/66 (2006.01), H04M 11/06 (2006.01), H04M 3/42 (2006.01), H04Q 3/00 (2006.01), H04Q 3/64 (2006.01)			
Applicant DIGIFONICA (INTERNATIONAL) LIMITED ET AL		WRITTEN OPINION DUE: JAN 26/09 DUE: JAN 23/09 DOCKET 	
1. This opinion contains indications relating to the following items :			
<input checked="" type="checkbox"/>	Box No. I	Basis of the opinion	
<input type="checkbox"/>	Box No. II	Priority	
<input type="checkbox"/>	Box No. III	Non-establishment of opinion with regard to novelty, inventive step and industrial applicability	
<input type="checkbox"/>	Box No. IV	Lack of unity of invention	
<input checked="" type="checkbox"/>	Box No. V	Reasoned statement under Rule 43bis.1(a)(i) with regard to novelty, inventive step or industrial applicability, citations and explanations supporting such statement	
<input type="checkbox"/>	Box No. VI	Certain documents cited	
<input checked="" type="checkbox"/>	Box No. VII	Certain defects in the international application	
<input checked="" type="checkbox"/>	Box No. VIII	Certain observations on the international application	
2. FURTHER ACTION If a demand for international preliminary examination is made, this opinion will be considered to be a written opinion of the International Preliminary Examining Authority ("IPEA") except that this does not apply where the applicant chooses an Authority other than this one to be the IPEA and the chosen IPEA has notified the International Bureau under Rule 66.1bis(b) that written opinions of this International Searching Authority will not be so considered. If this opinion is, as provided above, considered to be a written opinion of the IPEA, the applicant is invited to submit to the IPEA a written reply together, where appropriate, with amendments, before the expiration of 3 months from the date of mailing of Form PCT/ISA/220 or before the expiration of 22 months from the priority date, whichever expires later. For further options, see Form PCT/ISA/220.			
3. For further details, see notes to Form PCT/ISA/220.			
Name and mailing address of the ISA/CA Canadian Intellectual Property Office Place du Portage I, C114 - 1st Floor, Box PCT 50 Victoria Street Gatineau, Quebec K1A 0C9 Facsimile No.: 001-819-953-2476		Date of completion of this opinion 13 June 2008 (13-06-2008)	Authorized officer Arthur Smith 819-953-1360

Form PCT/ISA/237 (cover sheet) (April 2007)

Page 1 of 5

DEC
JMK

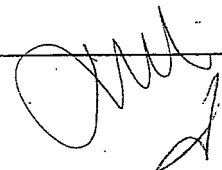

WRITTEN OPINION OF THE
INTERNATIONAL SEARCHING AUTHORITY

International application No.
PCT/CA2008/000545

Box No. V Reasoned statement under Rule 43bis.1(a)(i) with regard to novelty, inventive step or industrial applicability; citations and explanations supporting such statement

1. Statement

Novelty (N)	Claims <u>1-43</u>	YES
	Claims <u>None</u>	NO
Inventive step (IS)	Claims <u>1-43</u>	YES
	Claims <u>None</u>	NO
Industrial applicability (IA)	Claims <u>1-43</u>	YES
	Claims <u>None</u>	NO

2. Citations and explanations :

The following document is referred to in this communication:

D1 US2005/0083911 A1

D1 is considered to form the closest prior art. D1 describes providing E911 emergency services to an IP telephony-based PBX or similar system by establishing a 911 Location Server Database comprising an Emergency Response Location (ERL) database and a Phone Location database. The location of a caller stored in the ERL database is used to route an emergency call to an end-office switch corresponding to the nearest Public Safety Answering Point (PSAP). The Phone Location database stores one record for each registered phone in the system.

Novelty

D1 fails to disclose all the elements of independent claims 1, 15, 29, and 43. In particular, D1 fails to teach a direct inward dialing (DID) identifier or producing a DID identifier for a caller identifier that has no pre-associated DID identifier. Claims 2-14, 16-28 and 30-42 depend on the above independent claims, respectively.

Thus, claims 1-43 are considered to be novel in accordance with Article 33(2) PCT.

Inventive Step

D1 fails to teach or suggest producing a routing message including an emergency response center identifier and temporary DID identifier for establishing a route between a caller and an emergency response center as claimed in independent claims 1, 15, 29, and 43. Claims 2-14, 16-28, and 30-42 depend on the above independent claims, respectively.

Thus, claims 1-43 are considered to have inventive step in accordance with Article 33(3) PCT.

Industrial Applicability

Including location information for emergency VoIP callers located behind a VoIP PBX finds application in IP telephony networks. Thus, claims 1-43 are industrially applicable in accordance with Article 33(4) PCT.

Box No. VII Certain defects in the international application

The following defects in the form or contents of the international application have been noted :

Description-Related Deficiencies

On page 1, line 19, of the description, the term "presended" (sic) is misspelled. Applicant may have intended "presented to".

Box No. VIII **Certain observations on the international application**

The following observations on the clarity of the claims, description, and drawings or on the question whether the claims are fully supported by the description, are made :

Claims-Related Deficiencies

Claims 1 and 22 do not comply with PCT Article 6. In claim 1, the term "the method" (line 3) lacks an antecedent and in claim 22, the term "said pool" (line 15) lacks an antecedent.

PATENT COOPERATION TREATY

From the INTERNATIONAL SEARCHING AUTHORITY

To:
 SMART & BIGGAR
 Box 11560 Vancouver Centre
 2200 - 650 W. Georgia Street
 VANCOUVER, British Columbia
 Canada, V6B 4N8

INFO TO BE FILED
 DUE ON 14/08
 DOCKET
 JMU

PCT RECEIVED

NOTIFICATION OF TRANSMITTAL OF THE INTERNATIONAL SEARCH REPORT AND THE WRITTEN OPINION OF THE INTERNATIONAL SEARCHING AUTHORITY, OR THE DECLARATION
 (PCT Rule 44.1)

Applicant's or agent's file reference 83636-13	Date of mailing (day/month/year) 14 March 2008 (14-03-2008)
International application No. PCT/CA2007/002150	FOR FURTHER ACTION See paragraphs 1 and 4 below
International filing date (day/month/year) 29 November 2007 (29-11-2007)	

Applicant
 DIGIFONICA (INTERNATIONAL) LIMITED ET AL

- The applicant is hereby notified that the international search report and the written opinion of the International Searching Authority have been established and are transmitted herewith.
Filing of amendments and statement under Article 19 :
 The applicant is entitled, if he so wishes, to amend the claims of the international application (see Rule 46) :
When? The time limit for filing such amendments is normally two months from the date of transmittal of the international search report.
Where? Directly to the International Bureau of WIPO, 34 chemin des Colombettes
 1211 Geneva 20, Switzerland, Facsimile No.: +41 22 338 82 70
For more detailed instructions, see the notes on the accompanying sheet.
- The applicant is hereby notified that no international search report will be established and that the declaration under Article 17(2)(a) to that effect and the written opinion of the International Searching Authority are transmitted herewith.
- With regard to the protest** against payment of (an) additional fee(s) under Rule 40.2, the applicant is notified that :
 the protest together with the decision thereon has been transmitted to the International Bureau together with the applicant's request to forward the texts of both the protest and the decision thereon to the designated Offices.
 no decision has been made yet on the protest; the applicant will be notified as soon as a decision is made.
- Reminders**
 Shortly after the expiration of **18 months** from the priority date, the international application will be published by the International Bureau. If the applicant wishes to avoid or postpone publication, a notice of withdrawal of the international application, or of the priority claim, must reach the International Bureau as provided in Rules 90bis.1 and 90bis.3, respectively, before the completion of the technical preparations for the international publication.
 The applicant may submit comments on an informal basis on the written opinion of the International Searching Authority to the International Bureau. The International Bureau will send a copy of such comments to all designated Offices unless an international preliminary examination report has been or is to be established. These comments would also be made available to the public out not before the expiration of 30 months from the priority date.
 Within **19 months** from the priority date, but only in respect of some designated Offices, a demand for international preliminary examination must be filed if the applicant wishes to postpone the entry into the national phase **until 30 months** from the priority date (in some Offices even later); otherwise, the applicant must, **within 20 months** from the priority date, perform the prescribed acts for entry into the national phase before those designated Offices.
 In respect of other designated Offices, the time limit of **30 months** (or later) will apply even if no demand is filed within 19 months.
 See the Annex to Form PCT/IB/301 and, for details about the applicable time limits, Office by Office, see the *PCT Applicant's Guide*, Volume II, National Chapters and the WIPO Internet site.

Name and mailing address of the ISA/CA Canadian Intellectual Property Office Place du Portage I, C114 - 1st Floor, Box PCT 50 Victoria Street Gatineau, Quebec K1A 0C9 Facsimile No.: 001-819-953-2476	Authorized officer Donna Daly 819- 953-8972
---	--

Form PCT/ISA/220 (October 2005)

(See notes on accompanying sheet)

Doc
 JLG
 JWL

PETITIONER APPLE INC. EX. 1002-312

NOTES TO FROM PCT/ISA/220

These Notes are intended to give instructions concerning the filing of amendments under Article 19. The Notes are based on the requirements of the Patent Cooperation Treaty, the Regulations and the Administrative Instructions under that Treaty. In case of discrepancy between these Notes and those requirements, the latter are applicable. For more detailed information, see also the *PCT Applicant's Guide*, a publication of WIPO.

In these Notes, "Article," "Rule" and "Section" refer to the provisions of the PCT, the PCT Regulations and the PCT Administrative Instructions, respectively.

INSTRUCTIONS CONCERNING AMENDMENTS UNDER ARTICLE 19

The applicant has, after having received the international search report and the written opinion of the International Searching Authority, one opportunity to amend the claims of the international application. It should however be emphasized that, since all parts of the international application (claims, description and drawings) may be amended during the international preliminary examination procedure, there is usually no need to file amendments of the claims under Article 19 except where, e.g. the applicant wants the latter to be published for the purposes of provisional protection or has another reason for amending the claims before international publication. Furthermore, it should be emphasized that provisional protection is available in some States only (see *PCT Applicant's Guide*, Volume I/A, Annexes B1 and B2).

The attention of the applicant is drawn to the fact that amendments to the claims under Article 19 are not allowed where the International Searching Authority has declared, under Article 17(2), that no international search report would be established (see *PCT Applicant's Guide*, Volume I/A, paragraph 296).

What parts of the international application may be amended?

Under Article 19, only the claims may be amended.

During the international phase, the claims may also be amended (or further amended) under Article 34 before the International Preliminary Examining Authority. The description and drawings may only be amended under Article 34 before the International Preliminary Examining Authority.

Upon entry into the national phase, all parts of the international application may be amended under Article 28 or, where applicable, Article 41.

When? Within 2 months from the date of transmittal of the international search report or 16 months from the priority date, whichever time limit expires later. It should be noted, however, that the amendments will be considered as having been received on time if they are received by the International Bureau after the expiration of the applicable time limit but before the completion of the technical preparations for international publication (Rule 46.1).

Where not to file the amendments?

The amendments may only be filed with the International Bureau and not with the receiving Office or the International Searching Authority (Rule 46.2).

Where a demand for international preliminary examination has been/is filed, see below.

How? Either by cancelling one or more entire claims, by adding one or more new claims or by amending the text of one or more of the claims as filed.

A replacement sheet must be submitted for each sheet of the claims which, on account of an amendment or amendments, differs from the sheet originally filed.

All the claims appearing on a replacement sheet must be numbered in Arabic numerals. Where a claim is cancelled, no renumbering of the other claims is required. In all cases where claims are renumbered, they must be renumbered consecutively (Section 205(b)).

The amendments must be made in the language in which the international application is to be published.

What documents must/may accompany the amendments?

Letter (Section 205(b)) :

The amendments must be submitted with a letter.

The letter will not be published with the international application and the amended claims. It should not be confused with the "Statement under Article 19(1)" (see below, under "Statement under Article 19(1)").

The letter must be in English or French, at the choice of the applicant. However, if the language of the international application is English, the letter must be in English; if the language of the international application is French, the letter must be in French.

NOTES TO FORM PCT/ISA/220 (continued)

The letter must indicate the differences between the claims as filed and the claims as amended. It must, in particular, indicate, in connection with each claim appearing in the international application (it being understood that identical indications concerning several claims may be grouped), whether

- (i) the claim is unchanged;
- (ii) the claim is cancelled;
- (iii) the claim is new;
- (iv) the claim replaces one or more claims as filed;
- (v) the claim is the result of the division of a claim as filed.

The following examples illustrate the manner in which amendments must be explained in the accompanying letter :

1. [Where originally there were 48 claims and after amendment of some claims there are 51]:
"Claims 1 to 29, 31, 32, 34, 35, 37 to 48 replaced by amended claims bearing the same numbers; claims 30, 33 and 36 unchanged; new claims 49 to 51 added."
2. [Where originally there were 15 claims and after amendment of all claims there are 11]:
"Claims 1 to 15 replaced by amended claims 1 to 11."
3. [Where originally there were 14 claims and the amendments consist in cancelling some claims and in adding new claims]:
"Claims 1 to 6 and 14 unchanged; claims 7 to 13 cancelled; new claims 15, 16 and 17 added." or
"Claims 7 to 13 cancelled; new claims 15, 16 and 17 added; all other claims unchanged."
4. [Where various kinds of amendments are made]:
"Claims 1-10 unchanged; claims 11 to 13, 18 and 19 cancelled; claims 14, 15 and 16 replaced by amended claim 14; claim 17 subdivided into amended claims 15, 16 and 17; new claims 20 and 21 added."

"Statement under Article 19(1)" (Rule 46.4)

The amendments may be accompanied by a statement explaining the amendments and indicating any impact that such amendments might have on the description and the drawings (which cannot be amended under Article 19(1)).

The statement will be published with the international application and the amended claims.

It must be in the language in which the international application is to be published.

It must be brief, not exceeding 500 words if in English or if translated into English.

It should not be confused with and does not replace the letter indicating the differences between the claims as filed and as amended. It must be filed on a separate sheet and must be identified as such by a heading, preferably by using the words "Statement under Article 19(1)."

It may not contain any disparaging comments on the international search report or the relevance of citations contained in that report. Reference to citations, relevant to a given claim, contained in the international search report may be made only in connection with an amendment of that claim.

Consequence if a demand for international preliminary examination has already been filed

If, at the time of filing any amendments and any accompanying statement, under Article 19, a demand for international preliminary examination has already been submitted, the applicant must preferably, at the time of filing the amendments (and any statement) with the International Bureau, also file with the International Preliminary Examining Authority a copy of such amendments (and of any statement) and, where required, a translation of such amendments for the procedure before that Authority (see Rules 55.3(a) and 62.2, first sentence). For further information, see the Notes to the demand form (PCT/IPEA/401).

If a demand for international preliminary examination is made, the written opinion of the International Searching Authority will, except in certain cases where the International Preliminary Examining Authority did not act as International Searching Authority and where it has notified the International Bureau under Rule 66.1bis(b), be considered to be a written opinion of the International Preliminary Examining Authority. If a demand is made, the applicant may submit to the International Preliminary Examining Authority a re- to the written opinion together, where appropriate, with amendments before the expiration of 3 months from the date of mailing of For... PCT/ISA/220 or before the expiration of 22 months from the priority date, whichever expires later (Rule 43bis.1(c)).

Consequence with regard to translation of the international application for entry into the national phase

The applicant's attention is drawn to the fact that, upon entry into the national phase, a translation of the claims as amended under Article 19 may have to be furnished to the designated/elected Offices, instead of, or in addition to, the translation of the claims as filed.

For further details on the requirements of each designated/elected Office, see the *PCT Applicant's Guide*, Volume II.

PATENT COOPERATION TREATY
PCT
INTERNATIONAL SEARCH REPORT
(PCT Article 18 and Rules 43 and 44)

RECEIVED

Applicant's or agent's file reference 83636-13	FOR FURTHER ACTION	see Form PCT/ISA/220 9:55 as well as, where applicable, item 5 below
International application No. PCT/CA2007/002150	International filing date (<i>day/month/year</i>) 29 November 2007 (29-11-2007)	(Earliest) Priority date (<i>day/month/year</i>) 29 November 2006 (29-11-2006)

Applicant
DIGIFONICA (INTERNATIONAL) LIMITED ET AL

This international search report has been prepared by this International Searching Authority and is transmitted to the applicant according to Article 18. A copy is being transmitted to the International Bureau.

This international search report consists of a total of 4 sheets.
 It is also accompanied by a copy of each prior art document cited in this report.

1. **Basis of the report**
 - a. With regard to the **language**, the international search was carried out on the basis of:
 - the international application in the language in which it was filed
 - a translation of the international application into _____, which is the language of a translation furnished for the purposes of international search (Rules 12.3(a) and 23.1(b))
 - b. This international search report has been established taking into account the **rectification of an obvious mistake** authorized by or notified to this Authority under Rule 91 (Rule 43.6bis(a)).
 - c. With regard to any **nucleotide and/or amino acid sequence** disclosed in the international application, see Box No. I
2. **Certain claims were found unsearchable** (see Box No. II)
3. **Unity of invention is lacking** (see Box No. III)
4. With regard to the **title**,
 - the text is approved as submitted by the applicant
 - the text has been established by this Authority to read as follows :
5. With regard to the **abstract**,
 - the text is approved as submitted by the applicant
 - the text has been established, according to Rule 38.2, by this Authority as it appears in Box No. IV. The applicant may, within one month from the date of mailing of this international search report, submit comments to this Authority
6. With regard to the **drawings**,
 - a. the figure of the **drawings** to be published with the abstract is Figure No. 1
 - as suggested by the applicant
 - as selected by this Authority, because the applicant failed to suggest a figure
 - as selected by this Authority, because this figure better characterizes the invention
 - b. none of the figures is to be published with the abstract

Doc
JLG
TWW

PETITIONER APPLE INC. EX. 1002-315

INTERNATIONAL SEARCH REPORT

International application No.
PCT/CA2007/002150

A. CLASSIFICATION OF SUBJECT MATTER IPC: <i>H04L 12/26</i> (2006.01), <i>H04L 12/66</i> (2006.01), <i>H04M 11/06</i> (2006.01), <i>H04M 3/22</i> (2006.01) According to International Patent Classification (IPC) or to both national classification and IPC		
B. FIELDS SEARCHED Minimum documentation searched (classification system followed by classification symbols) IPC: <i>H04L 12/26</i> (2006.01), <i>H04L 12/66</i> (2006.01), <i>H04M 11/06</i> (2006.01), <i>H04M 3/22</i> (2006.01) Documentation searched other than minimum documentation to the extent that such documents are included in the fields searched Electronic database(s) consulted during the international search (name of database(s) and, where practicable, search terms used) West, Delphion, Canadian Patents Database, IEEEXplore, Google Keywords: lawful intercept, (monitor* OR record* or intercept*) near (communicat* OR voip OR phone call* OR audio OR video), electronic surveillance, intercept* near device*, intercept* same IP network*, record* same IP network*, intercept* same voip, record* same voip, media relay, mediation device, (intercept* field OR flag) same profile		
C. DOCUMENTS CONSIDERED TO BE RELEVANT		
Category*	Citation of document, with indication, where appropriate, of the relevant passages	Relevant to claim No.
X Y	US 2004/0181599 A1 (Kreusch et al.) 16 September 2004 (16-09-2004) *paragraphs [0011]-[0015], [0019]-[0022], [0028], [0034]-[0036], [0048]-[0053], [0055]-[0061], [0067], [0072]-[0074], [0078]-[0083]; Figs. 1, 2a-2b; claims 1-3, 7-8, 25-26*	1-2, 4-5, 10-15, 17-18, 23-26 3, 6-9, 16, 19-22
X	US 2003/0219103 A1 (Rao et al.) 27 November 2003 (27-11-2003) *Abstract; paragraphs [0005], [0026]-[0037], [0051]-[0062], [0071]-[0079], [0086]-[0090]; Figs. 1-9*	1, 14
Y	US 2002/0051518 A1 (Bondy et al.) 2 May 2002 (02-05-2002) *Abstract; paragraphs [0030]-[0032], [0036]-[0037], [0039], [0044]-[0052], [0055]-[0057], [0060]; Figs 1, 3, 5; claims 1-5*	3, 6-9, 16, 19-22
A	EP 1 389 862 B1 (Shen et al.) 3 November 2004 (03-11-2004) *paragraphs [0007]-[0014], [0051]-[0060]; Fig. 2; claim 1*	1-3, 14-16
A	US 2004/0165709 A1 (Pence et al.) 26 August 2004 (26-08-2004) *whole document*	1-26
<input checked="" type="checkbox"/> Further documents are listed in the continuation of Box C.		<input checked="" type="checkbox"/> See patent family annex.
* Special categories of cited documents :		"T" later document published after the international filing date or priority date and not in conflict with the application but cited to understand the principle or theory underlying the invention
"A" document defining the general state of the art which is not considered to be of particular relevance		"X" document of particular relevance; the claimed invention cannot be considered novel or cannot be considered to involve an inventive step when the document is taken alone
"E" earlier application or patent but published on or after the international filing date		"Y" document of particular relevance; the claimed invention cannot be considered to involve an inventive step when the document is combined with one or more other such documents, such combination being obvious to a person skilled in the art
"L" document which may throw doubts on priority claim(s) or which is cited to establish the publication date of another citation or other special reason (as specified)		"&" document member of the same patent family
"O" document referring to an oral disclosure, use, exhibition or other means		
"P" document published prior to the international filing date but later than the priority date claimed		
Date of the actual completion of the international search 3 March 2008 (03-03-2008)	Date of mailing of the international search report 14 March 2008 (14-03-2008)	
Name and mailing address of the ISA/CA Canadian Intellectual Property Office Place du Portage I, C114 - 1st Floor, Box PCT 50 Victoria Street Gatineau, Quebec K1A 0C9 Facsimile No.: 001-819-953-2476	Authorized officer Daniela Savin 819- 934-4890	

INTERNATIONAL SEARCH REPORT

International application No.
PCT/CA2007/002150

C (Continuation). DOCUMENTS CONSIDERED TO BE RELEVANT

Category*	Citation of document, with indication, where appropriate, of the relevant passages	Relevant to claim No.
A	US 2004/0255126 A1 (Reith) 16 December 2004 (16-12-2004) *paragraphs [0010]-[0014], [0020]-[0031], [0041]-[0046]; Figs. 1-2, 4-6; claims 1, 6-10*	1-26
A	US 2004/0157629 A1 (Kallio et al.) 12 August 2004 (12-08-2004) *paragraphs [0006]-[0021], [0050]-[0057], [0080]-[0109]; Figs. 1-12; claims 1, 7-23, 29-43*	1-26
A	US 2005/0174937 A1 (Scoggins et al.) 11 August 2005 (11-08-2005) *paragraphs [0068]-[0089], [0112]-[0138], [0153]-[0156], [0173]-[0176], [0184]-[0193]; Figs. 1-11; claims 1-2*	1-26

PATENT COOPERATION TREATY

From the
INTERNATIONAL SEARCHING AUTHORITY

To:
SMART & BIGGAR
Box 11560 Vancouver Centre
2200 - 650 W. Georgia Street
VANCOUVER, British Columbia
Canada, V6B 4N8

PCT RECEIVED

WRITTEN OPINION OF THE
INTERNATIONAL SEARCHING AUTHORITY
A 9:54
(PCT Rule 43bis.1)
100 WEST GEORGIA ST.
VANCOUVER, B.C.

Date of mailing (day/month/year) 14 March 2008 (14-03-2008)

Applicant's or agent's file reference
83636-13

FOR FURTHER ACTION
See paragraph 2 below

International application No.
PCT/CA2007/002150

International filing date (day/month/year)
29 November 2007 (29-11-2007)

Priority date (day/month/year)
29 November 2006 (29-11-2006)

International Patent Classification (IPC) or both national classification and IPC
IPC: *H04L 12/26* (2006.01), *H04L 12/66* (2006.01), *H04M 11/06* (2006.01), *H04M 3/22* (2006.01)

Applicant
DIGIFONICA (INTERNATIONAL) LIMITED ET AL

WRITTEN OPINION
DUE: ON 29/08
DOCK: SEP 26/08
DOCKET
JML

1. This opinion contains indications relating to the following items :

- Box No. I Basis of the opinion
- Box No. II Priority
- Box No. III Non-establishment of opinion with regard to novelty, inventive step and industrial applicability
- Box No. IV Lack of unity of invention
- Box No. V Reasoned statement under Rule 43bis.1(a)(i) with regard to novelty, inventive step or industrial applicability; citations and explanations supporting such statement
- Box No. VI Certain documents cited
- Box No. VII Certain defects in the international application
- Box No. VIII Certain observations on the international application

2. FURTHER ACTION

If a demand for international preliminary examination is made, this opinion will be considered to be a written opinion of the International Preliminary Examining Authority ("IPEA") except that this does not apply where the applicant chooses an Authority other than this one to be the IPEA and the chosen IPEA has notified the International Bureau under Rule 66.1bis(b) that written opinions of this International Searching Authority will not be so considered.

If this opinion is, as provided above, considered to be a written opinion of the IPEA, the applicant is invited to submit to the IPEA a written reply together, where appropriate, with amendments, before the expiration of 3 months from the date of mailing of Form PCT/ISA/220 or before the expiration of 22 months from the priority date, whichever expires later.

For further options, see Form PCT/ISA/220.

3. For further details, see notes to Form PCT/ISA/220.

Name and mailing address of the ISA/CA
Canadian Intellectual Property Office
Place du Portage I, C114 - 1st Floor, Box PCT
50 Victoria Street
Gatineau, Quebec K1A 0C9
Facsimile No.: 001-819-953-2476

Date of completion of this opinion
04 March 2008 (04-03-2008)

Authorized officer
Daniela Savin 819- 934-4890

DOC
JLL
Trik

PETITIONER APPLE INC. EX. 1002-318

WRITTEN OPINION OF THE
INTERNATIONAL SEARCHING AUTHORITY

International application No.
PCT/CA2007/002150

Box No. I Basis of this opinion

1. With regard to the language, this opinion has been established on the basis of:

the international application in the language in which it was filed

a translation of the international application into _____, which is the language of a translation furnished for the purposes of international search (Rules 12.3(a) and 23.1(b)).

2. This opinion has been established taking into account the rectification of an obvious mistake authorized by or notified to this Authority under Rule 91 (Rule 43bis.1(a))

3. With regard to any nucleotide and/or amino acid sequence disclosed in the international application and necessary to the claimed invention, this opinion has been established on the basis of:

a. type of material

a sequence listing

table(s) related to the sequence listing

b. format of material

on paper

in electronic form

c. time of filing/furnishing

contained in the international application as filed.

filed together with the international application in electronic form

furnished subsequently to this Authority for the purposes of search.

4. In addition, in the case that more than one version or copy of a sequence listing and/or table(s) relating thereto has been filed or furnished, the required statements that the information in the subsequent or additional copies is identical to that in the application as filed or does not go beyond the application as filed, as appropriate, were furnished.

5. Additional comments :

WRITTEN OPINION OF THE
INTERNATIONAL SEARCHING AUTHORITY

International application No.
PCT/CA2007/002150

Box No. V Reasoned statement under Rule 43bis.1(a)(i) with regard to novelty, inventive step or industrial applicability; citations and explanations supporting such statement

1. Statement

Novelty (N)	Claims <u>3, 6-9, 12-13, 16, 19-22, 25-26</u>	YES
	Claims <u>1-2, 4-5, 10-11, 14-15, 17-18, 23-24</u>	NO
Inventive step (IS)	Claims <u>None</u>	YES
	Claims <u>1-26</u>	NO
Industrial applicability (IA)	Claims <u>1-26</u>	YES
	Claims <u>None</u>	NO

2. Citations and explanations :

Reference is made to the following documents cited in the International Search Report:

D1: US 2004/0181599 A1 (Kreusch et al.) 16 September 2004 (16-09-2004)

D2: US 2003/0219103 A1 (Rao et al.) 27 November 2003 (27-11-2003)

D3: US 2002/0051518 A1 (Bondy et al.) 2 May 2002 (02-05-2002)

2.1 Novelty

a) **Claims 1 and 14 do not comply with PCT Article 33(2).** D1 or D2 disclosed the claimed subject matter before the claim date.

Using the wording of **claim 1**, D1 or D2 each discloses (*references in parenthesis apply to D1 or D2*):

A method for intercepting communications in an Internet Protocol network, the method comprising (*see D1: paragraphs [0011], [0022]; Fig. 1; claims 1-3; or see D2: Abstract; Figs. 1-9*):

maintaining dialing profiles for respective subscribers to the IP network, each said dialing profile including a username associated with the corresponding subscriber (*see D1: paragraphs [0019]-[0021], [0034]-[0036], [0053]; claims 7-8; or see D2: paragraphs [0027], [0029]*);

associating intercept information with the dialing profile of a subscriber whose communications are to be monitored, said intercept information including determination information for determining whether to intercept a communication involving said subscriber, and destination information identifying a device to which intercepted communications involving said subscriber are to be sent (*see D1: paragraphs [0055], [0067], [0078]; Figs. 2a-2b; or see D2: paragraphs [0027], [0029], [0052], [0072]*); and

when said determination information meets intercept criteria, communicating with a media relay through which said communications involving said subscriber will be conducted or are being conducted to cause said media relay to send a copy of said communications to a mediation device specified by said destination information (*see D1: paragraphs [0012], [0015], [0019], [0022], [0028], [0053], [0055], [0060]-[0061], [0081]-[0083]; claim 7; or see D2: paragraphs [0026]-[0037], [0051]-[0062], [0071]-[0079]; [0086]-[0090]; Figs. 1-9*).

Since the language of **claim 1** reads on the prior art represented by D1 or D2, the subject matter of this claim is considered to lack novelty.

As **independent claim 14** is of the same scope as **claim 1**, it is similarly considered to lack novelty, for the same reasons indicated above for **claim 1**.

b) **Claims 2, 4-5, 10-11, 15, 17-18 and 23-24 do not comply with PCT Article 33(2).** D1 disclosed the claimed subject matter before the claim date.

Regarding **claim 2**, D1 discloses associating intercept information with the subscriber profile at login time, when communications involving the subscriber are not in progress (*see D1: paragraphs [0048]-[0053], [0072]-[0074]*).

Box No. VIII Certain observations on the international application

The following observations on the clarity of the claims, description, and drawings or on the question whether the claims are fully supported by the description, are made :

The description does not comply with Article 5 of the PCT. All documents referred to in the description of an application must be available to the public. Reference to the document on page 1, lines 5-6 must be deleted or replaced by its corresponding patent number or publication number.

Claims 1 and 14 are indefinite and do not comply with PCT Article 6. The following terms have no antecedents: "dialing profile" (claim 1, line 6; claim 14, line 8), "intercept information" (claim 1, line 10; claim 14, line 12) and "intercept criteria" (claim 1, line 18; claim 14, line 25).

Claims 1 and 14 are indefinite and do not comply with PCT Article 6. The inclusion of "... identifying a device to which intercepted communications ..." (claim 1, lines 14-15; claim 14, lines 17-18) causes ambiguity. It is not clear whether "a device" refers to a mediation device or any other type of device.

Claims 2-3 and 15-16 are indefinite and do not comply with PCT Article 6. The inclusion of "method of claim 1" and "apparatus of claim 14" causes ambiguity. The applicant likely meant "method of claim 1" and "apparatus of claim 14".

Claim 11 is unclear and does not comply with PCT Article 6. The inclusion of "... identify a media relay ..." causes ambiguity. It is not clear whether the media relay is identified by the intercept request message handler as recited by claim 11, or in response to the routing message, as recited by claim 7. The same comment applies to claim 24 (but in regards to routing message recited by claim 20), since claim 24 is of the same scope as claim 11.

Claim 12 is unclear and does not comply with PCT Article 6. The inclusion of "maintaining a active call records" causes ambiguity, as the aforementioned expression is not grammatically correct.

Claim 24 is unclear and does not comply with PCT Article 6. The inclusion of "a means for find ..." causes ambiguity. It is suggested that "means for find ..." should read "means for finding ...", in order to be consistent with the tense used for the other verbs in claim 24.

diff
claim 1
border

7 11 10 1
10 19 24 23 20 24

Supplemental Box

In case the space in any of the preceding boxes is not sufficient.

Continuation of: Box V

Regarding claim 4, D1 discloses populating the intercept information fields in the hidden database, which is similar to the dialing profile recited by this claim (see D1: paragraph [0079]; claims 7-8, 25-26).

As claim 17 is of the same scope as claim 4, it is similarly considered to lack novelty, for the same reasons indicated above for claim 4.

Regarding claim 5, D1 discloses the routing message containing at least part of the intercept information, when determination information meets intercept criteria (see D1: paragraphs [0055]-[0060], [0067], [0072], [0081]; Figs. 2a-2b).

As claim 18 is of the same scope as claim 5, it is similarly considered to lack novelty, for the same reasons indicated above for claim 5.

Regarding claims 10-11, D1 discloses that in response to receipt of an intercept request message, the corresponding message handler finds the dialing profile associated with the subscriber whose communications are to be monitored, associates the intercept information with the dialing profile, determines whether the intercept criteria are met and identifies the media relay through which communications are being conducted (see D1: paragraphs [0019], [0067], [0072], [0079]).

As claims 23-24 are of the same scope as claims 10-11, they are similarly considered to lack novelty, for the same reasons indicated above for claims 10-11.

However, claims 3, 6-9, 12-13, 16, 19-22 and 25-26 appear to be novel and are deemed to comply with PCT Article 33(2) since the search of the prior art has not revealed a single document disclosing the claimed subject matter.

2.2 Inventive Step

c) Claims 1 and 14 do not involve an inventive step over D1 or D2 since they are not novel over D1 or D2, and therefore they do not comply with PCT Article 33(3). Claims 2, 4-5, 10-11, 15, 17-18 and 23-24 do not involve an inventive step over D1 since they are not novel over D1, and therefore they do not comply with PCT Article 33(3).

e) Claim 3 does not comply with PCT Article 33(3). The subject matter of this claim does not appear to involve an inventive step in view of D1 and D3. D1 does not specifically disclose associating the intercept information with the dialing profile when communications involving the subscriber are in progress. D1 mentions that the interception is possible even when the interception subject is mobile and changes location (see D1: paragraph [0013]). D3, however complements the teachings of D1 by disclosing the interception happening not only at login or call origination, but also for any service invocation during the call, such as call waiting, conference call, call forwarding or message retrieval (see D3: paragraph [0030]; claims 4-5).

As claim 16 is of the same scope as claim 3, it is similarly considered to lack an inventive step in view of D1 and D3.

f) Claim 6 does not comply with PCT Article 33(3). The subject matter of this claim does not appear to involve an inventive step in view of D1 and D3. D1 does not specifically disclose determining whether a current date and time is within a range specified by the determination information. However, D3 discloses the interception information containing the start and stop time for the interception (see D3: paragraph [0039]; claim 3), and it would have been obvious for someone skilled in the art to add these start and stop times to the determination information taught by D1, in order to determine whether to intercept a call or not, depending on the current time.

As claim 19 is of the same scope as claim 6, it is similarly considered to lack an inventive step in view of D1 and D3.

g) Claims 7-9 do not comply with PCT Article 33(3). The subject matter of these claims does not appear to involve an inventive step in view of D1 and D3. D1 does not specifically disclose the routing message containing an identification of the media relay through which communications and interception will be conducted, and pre-associating this media relay with the dialing profile. However, the inclusion of the media relay address in the routing message is a normal design procedure, since no communication would be possible without the presence of the media relay. Moreover, D3 discloses the surveillance information containing all the entities comprising the surveillance path, including the identification of the media relay, and it would have been obvious for someone skilled in the art to include this identification to the monitoring information stored in the hidden database taught by D1 (see D3: paragraphs [0032], [0044], [0051]-[0052], [0057], [0060]; claims 1-3).

As claims 20-22 are of the same scope as claims 7-9, they are similarly considered to lack an inventive step in view of D1 and D3.

Supplemental Box

In case the space in any of the preceding boxes is not sufficient.

Continuation of: Supplemental sheet on page 5

h **Claims 12-13 do not comply with PCT Article 33(3).** The subject matter of these claims does not appear to involve an inventive step in view of D1 and the common knowledge in the art. D1 does not specifically disclose maintaining a list of all the active call records, linking the username with the corresponding media relay identifier, and another list that associates every PST telephone number with its corresponding username, for all the subscribers in the network. However, creating and maintaining these lists would have been an obvious design alternative on the claim date to a person skilled in the art having regards to D1, since keeping a record of all the calls in progress is a standard functionality of any generic network management entity.

As **claims 25-26** are of the same scope as claims 12-13, they are similarly considered to lack an inventive step in view of D1 and the common knowledge in the art.

2.3 Industrial Applicability

Claims 1-26 are considered to be industrially applicable as per **PCT Article 33(4)**.

PATENT COOPERATION TREATY
PCT
INTERNATIONAL SEARCH REPORT
(PCT Article 18 and Rules 43 and 44)

RECEIVED

Applicant's or agent's file reference 83636-56	FOR FURTHER ACTION	see Form PCT/ISA/220 as well as, where applicable, item 5 below 19
International application No. PCT/CA2009/001317	International filing date (<i>day/month/year</i>) 17 September 2009 (17-09-2009)	(Earliest) Priority date (<i>day/month/year</i>) VANCOUVER, BC
Applicant DIGIFONICA (INTERNATIONAL) LIMITED ET AL		

This international search report has been prepared by this International Searching Authority and is transmitted to the applicant according to Article 18. A copy is being transmitted to the International Bureau.

This international search report consists of a total of 3 sheets.

It is also accompanied by a copy of each prior art document cited in this report.

1. Basis of the report

a. With regard to the **language**, the international search was carried out on the basis of:

the international application in the language in which it was filed

a translation of the international application into _____, which is the language of a translation furnished for the purposes of international search (Rules 12.3(a) and 23.1(b))

b. This international search report has been established taking into account the **rectification of an obvious mistake** authorized by or notified to this Authority under Rule 91 (Rule 43.6bis(a)).

c. With regard to any **nucleotide and/or amino acid sequence** disclosed in the international application, see Box No. I

2. **Certain claims were found unsearchable** (see Box No. II)

3. **Unity of invention is lacking** (see Box No. III)

4. With regard to the **title**,

the text is approved as submitted by the applicant

the text has been established by this Authority to read as follows:

5. With regard to the **abstract**,

the text is approved as submitted by the applicant

the text has been established, according to Rule 38.2, by this Authority as it appears in Box No. IV. The applicant may, within one month from the date of mailing of this international search report, submit comments to this Authority

6. With regard to the **drawings**,

a. the figure of the **drawings** to be published with the abstract is Figure No. 1

as suggested by the applicant

as selected by this Authority, because the applicant failed to suggest a figure

as selected by this Authority, because this figure better characterizes the invention

b. none of the figures is to be published with the abstract

INTERNATIONAL SEARCH REPORT

International application No.
PCT/CA2009/001317

A. CLASSIFICATION OF SUBJECT MATTER

IPC: *H04L 12/66* (2006.01), *H04L 29/06* (2006.01), *H04W 36/02* (2009.01), *H04W 36/18* (2009.01)

According to International Patent Classification (IPC) or to both national classification and IPC

B. FIELDS SEARCHED

Minimum documentation searched (classification system followed by classification symbols)

IPC (2006.01): H04L, H04W

Documentation searched other than minimum documentation to the extent that such documents are included in the fields searched

Electronic database(s) consulted during the international search (name of database(s) and, where practicable, search terms used)

Canadian patent database, IEEE Xplore, TotalPatent: media relay, Internet Protocol (IP), Real Time Transport Protocol (RT)P, endpoint, change, transmissions, data, port identifier, caller, callee, destination, port match, source, destination, address identifier, Caller Synchronization Source (SSRC) identifier, base station, GSM, UDP, record, maintenance, port identifier, matching and all such related terms.

C. DOCUMENTS CONSIDERED TO BE RELEVANT

Category*	Citation of document, with indication, where appropriate, of the relevant passages	Relevant to claim No.
A	US 2009/0028146 A1 KLEYMAN et al. 29 January 2009 (29-01-2009) Entire document	1 to 16
A	US 7454510 B2 KLEYMAN et al. 18 November 2008 (18-11-2008) Entire document	1 to 16
A	US 2007/0253418 A1 SHIRI et al. 01 November 2007 (01-11-2007) Entire document	1 to 16
A	US 2007/0036143 A1 ALT et al. 15 February 2007 (15-02-2007) Entire document	1 to 16

 Further documents are listed in the continuation of Box C. See patent family annex.

* Special categories of cited documents :

- "A" document defining the general state of the art which is not considered to be of particular relevance
- "E" earlier application or patent but published on or after the international filing date
- "L" document which may throw doubts on priority claim(s) or which is cited to establish the publication date of another citation or other special reason (as specified)
- "O" document referring to an oral disclosure, use, exhibition or other means
- "P" document published prior to the international filing date but later than the priority date claimed

- "T" later document published after the international filing date or priority date and not in conflict with the application but cited to understand the principle or theory underlying the invention
- "X" document of particular relevance; the claimed invention cannot be considered novel or cannot be considered to involve an inventive step when the document is taken alone
- "Y" document of particular relevance; the claimed invention cannot be considered to involve an inventive step when the document is combined with one or more other such documents, such combination being obvious to a person skilled in the art
- "&" document member of the same patent family

Date of the actual completion of the international search

17 July 2010 (17-06-2010)

Date of mailing of the international search report

18 June 2010 (18-06-2010)

Name and mailing address of the ISA/CA
Canadian Intellectual Property Office
Place du Portage I, C114 - 1st Floor, Box PCT
50 Victoria Street
Gatineau, Quebec K1A 0C9
Facsimile No.: 001-819-953-2476

Authorized officer

Salvatore Ginese (819) 934-4888

INTERNATIONAL SEARCH REPORT
Information on patent family members

International application No.
PCT/CA2009/001317

Patent Document Cited in Search Report	Publication Date	Patent Family Member(s)	Publication Date
US2009028146A1	29-01-2009	CN1574798A	02-02-2005
		EP1484883A2	08-12-2004
		JP2004355628A	16-12-2004
		KR20040103441A	08-12-2004
		US2004244010A1	02-12-2004
		US7454510B2	18-11-2008
US7454510B2	18-11-2008	CN1574798A	02-02-2005
		EP1484883A2	08-12-2004
		JP2004355628A	16-12-2004
		KR20040103441A	08-12-2004
		US2004244010A1	02-12-2004
		US2009028146A1	29-01-2009
US2007253418A1	01-11-2007	US2007253418A1	01-11-2007
		WO2007125530A2	08-11-2007
		WO2007125530A3	27-12-2007
US2007036143A1	15-02-2007	AU2005272561A1	23-02-2006
		AU2005272561B2	01-10-2009
		BRPI0514326A	10-06-2008
		CA2577123A1	23-02-2006
		CN101084686A	05-12-2007
		EP1784959A2	16-05-2007
		EP1784959A4	26-08-2009
		EP1784999A1	16-05-2007
		EP1784999A4	09-07-2008
		EP1787441A2	23-05-2007
		EP1787441A4	23-09-2009
		JP2008510393T	03-04-2008
		JP2008510394T	03-04-2008
		JP2008515246T	08-05-2008
		KR20070104509A	26-10-2007
		US2006072542A1	06-04-2006
		US7602748B2	13-10-2009
		US2006209794A1	21-09-2006
		US7706401B2	27-04-2010
		US2009279506A1	12-11-2009
		WO2006020975A2	23-02-2006
		WO2006020975A9	06-04-2006
		WO2006020975A3	26-05-2006
		WO2006020977A1	23-02-2006
WO2006020997A2	23-02-2006		
WO2006020997A3	07-08-2008		

PATENT COOPERATION TREATY

From the
INTERNATIONAL SEARCHING AUTHORITY

To: SMART & BIGGAR Box 11560 Vancouver Centre 2200 - 650 W. Georgia Street VANCOUVER, British Columbia Canada, V6B 4N8		PCT WRITTEN OPINION OF THE INTERNATIONAL SEARCHING AUTHORITY (PCT Rule 43bis.1)	
		RECEIVED 2010 JUN 23 A WEST GEORGIA ST. VANCOUVER	
Applicant's or agent's file reference 83636-56		FOR FURTHER ACTION See paragraph 2 below	
International application No. PCT/CA2009/001317	International filing date (day/month/year) 17 September 2009 (17-09-2009)	Priority date (day/month/year)	
International Patent Classification (IPC) or both national classification and IPC IPC: <i>H04L 12/66</i> (2006.01), <i>H04L 29/06</i> (2006.01), <i>H04W 36/02</i> (2009.01), <i>H04W 36/18</i> (2009.01)			
Applicant DIGIFONICA (INTERNATIONAL) LIMITED ET AL			
1. This opinion contains indications relating to the following items : <ul style="list-style-type: none"> <input checked="" type="checkbox"/> Box No. I Basis of the opinion <input type="checkbox"/> Box No. II Priority <input type="checkbox"/> Box No. III Non-establishment of opinion with regard to novelty, inventive step and industrial applicability <input type="checkbox"/> Box No. IV Lack of unity of invention <input checked="" type="checkbox"/> Box No. V Reasoned statement under Rule 43bis.1(a)(I) with regard to novelty, inventive step or industrial applicability; citations and explanations supporting such statement <input type="checkbox"/> Box No. VI Certain documents cited <input type="checkbox"/> Box No. VII Certain defects in the international application <input type="checkbox"/> Box No. VIII Certain observations on the international application 			
2. FURTHER ACTION If a demand for international preliminary examination is made, this opinion will be considered to be a written opinion of the International Preliminary Examining Authority ("IPEA") except that this does not apply where the applicant chooses an Authority other than this one to be the IPEA and the chosen IPEA has notified the International Bureau under Rule 66.1bis(b) that written opinions of this International Searching Authority will not be so considered. If this opinion is, as provided above, considered to be a written opinion of the IPEA, the applicant is invited to submit to the IPEA a written reply together, where appropriate, with amendments, before the expiration of 3 months from the date of mailing of Form PCT/ISA/220 or before the expiration of 22 months from the priority date, whichever expires later. For further options, see Form PCT/ISA/220.			
3. For further details, see notes to Form PCT/ISA/220.			
Name and mailing address of the ISA/CA Canadian Intellectual Property Office Place du Portage I, C114 - 1st Floor, Box PCT 50 Victoria Street Gatineau, Quebec K1A 0C9 Facsimile No.: 001-819-953-2476	Date of completion of this opinion 17 June 2010 (17-06-2010)	Authorized officer Salvatore Ginese (819) 934-4888	

WRITTEN OPINION OF THE
INTERNATIONAL SEARCHING AUTHORITY

International application No.
PCT/CA2009/001317

Box No. I Basis of this opinion

1. With regard to the **language**, this opinion has been established on the basis of:
 - the international application in the language in which it was filed
 - a translation of the international application into _____, which is the language of a translation furnished for the purposes of international search (Rules 12.3(a) and 23.1(b)).
2. This opinion has been established taking into account the **rectification of an obvious mistake** authorized by or notified to this Authority under Rule 91 (Rule 43*bis*.1(a))
3. With regard to any **nucleotide and/or amino acid sequence** disclosed in the international application, this opinion has been established on the basis of a sequence listing filed or furnished:
 - a. (means)
 - on paper
 - in electronic form
 - b. (time)
 - the international application as filed.
 - together with the international application in electronic form
 - subsequently to this Authority for the purposes of search
4. In addition, in the case that more than one version or copy of a sequence listing has been filed or furnished, the required statements that the information in the subsequent or additional copies is identical to that in the application as filed or does not go beyond the application as filed, as appropriate, were furnished.
5. Additional comments :

WRITTEN OPINION OF THE
INTERNATIONAL SEARCHING AUTHORITY

International application No.
PCT/CA2009/001317

Box No. V Reasoned statement under Rule 43bis.1(a)(i) with regard to novelty, inventive step or industrial applicability; citations and explanations supporting such statement

1. Statement

Novelty (N)	Claims <u>1 to 16</u>	YES
	Claims <u>None</u>	NO
Inventive step (IS)	Claims <u>1 to 16</u>	YES
	Claims <u>None</u>	NO
Industrial applicability (IA)	Claims <u>1 to 16</u>	YES
	Claims <u>None</u>	NO

2. Citations and explanations :

Reference is made to the following documents:

D1: US 2009/0028146 A1	KLEYMAN et al.	29 January 2009	(29-01-2009)
D2: US 7454510 B2	KLEYMAN et al.	18 November 2008	(18-11-2008)
D3: US 2007/0253418 A1	SHIRI et al.	01 November 2007	(01-11-2007)
D4: US 2007/0036143 A1	ALT et al.	15 February 2007	(15-02-2007)

Novelty

None of D1 to D4 individually teaches explicitly a method for facilitating uninterrupted transmission of internet protocol (IP) transmissions containing real time transport protocol (RTP) data during endpoint changes, the method comprising: maintaining records, each record associating session information, caller information and callee information for IP communication sessions; said session information including caller and callee RTP port identifiers identifying caller and callee RTP ports respectively of a media relay; said caller information including a caller IP address identifier and a caller port identifier to which IP transmission received at said callee RTP port are transmitted from the media relay, and a caller synchronization source (SSRC) identifier; and said callee information including a callee IP address identifier and a callee port identifier to which IP transmissions received at said caller RTP port are transmitted from the media relay, and a callee SSRC identifier; and when an IP transmission is received at said caller RTP port or said callee RTP port; locating one of said records having said caller RTP port identifier or said callee RTP port identifier matching a destination port identifier in said IP transmission; when said one of said records is located and when said destination port identifier in said IP transmission matches the (caller or callee) RTP port identifier of said one of said records; setting a source IP address identifier and source port identifier from said IP transmission as the (caller or callee) IP address identifier and (caller/callee) IP address identifier and (caller/callee) port identifier respectively of said one of said records when said (caller/callee) IP address identifier and (caller/callee) port identifier do not match said source IP address identifier and source port identifier respectively; and a received SSRC identifier in said IP transmission matches said (caller/callee) SSRC identifier.

The subject matter of claims 1 to 16 is therefore considered to be novel, satisfying the requirements of **Article 33(2)**.

(Continued in supplemental box 1 of 1)

Supplemental Box

In case the space in any of the preceding boxes is not sufficient.

Continuation of: Box No. V (This is supplemental box 1 of 1)

Inventive step

None of D1 to D4 teaches or suggests in combination the aforementioned features.

The subject matter of claims 1 to 16 is therefore considered to contain an inventive step, satisfying the requirements of **Article 33(3)**.

Industrial applicability

The subject matter of claims 1 to 16 is considered to be industrially applicable, thus fulfilling the requirements of **Article 33(4)**.



(12) **EUROPEAN PATENT APPLICATION**

(43) Date of publication: **18.02.2004 Bulletin 2004/08** (51) Int Cl.7: **H04L 29/06, H04M 7/00**

(21) Application number: **02360235.2**

(22) Date of filing: **08.08.2002**

(84) Designated Contracting States:
AT BE BG CH CY CZ DE DK EE ES FI FR GB GR
IE IT LI LU MC NL PT SE SK TR
 Designated Extension States:
AL LT LV MK RO SI

• **Gorges, Thomas**
71638 Ludwigsburg (DE)

(74) Representative:
Menziotti, Domenico, Dipl.-Ing et al
Alcatel
Intellectual Property Department, Stuttgart
70430 Stuttgart (DE)

(71) Applicant: **ALCATEL**
75008 Paris (FR)

(72) Inventors:
 • **Shen, Yuzhong**
70499 Stuttgart (DE)

(54) **Lawful interception for VoIP calls in IP based networks**

(57) The lawful interception device to monitor media streams of two IP parties includes a SIP (Session Initiation Protocol) proxy server or a MGC (Media Gateway Controller) to detect information in the signalling information being transmitted between the two IP (Internet Protocol) parties and to generate instructions out of the

detected signalling information for instructing a RTP (Real-time Transport Protocol) proxy server to create channels to bypass a media stream to be intercepted via an intermediate storage medium. Due to adaptation of connection parameters in the SDP part of the SIP messages sent to the IP parties the interception is transparent to the IP parties.

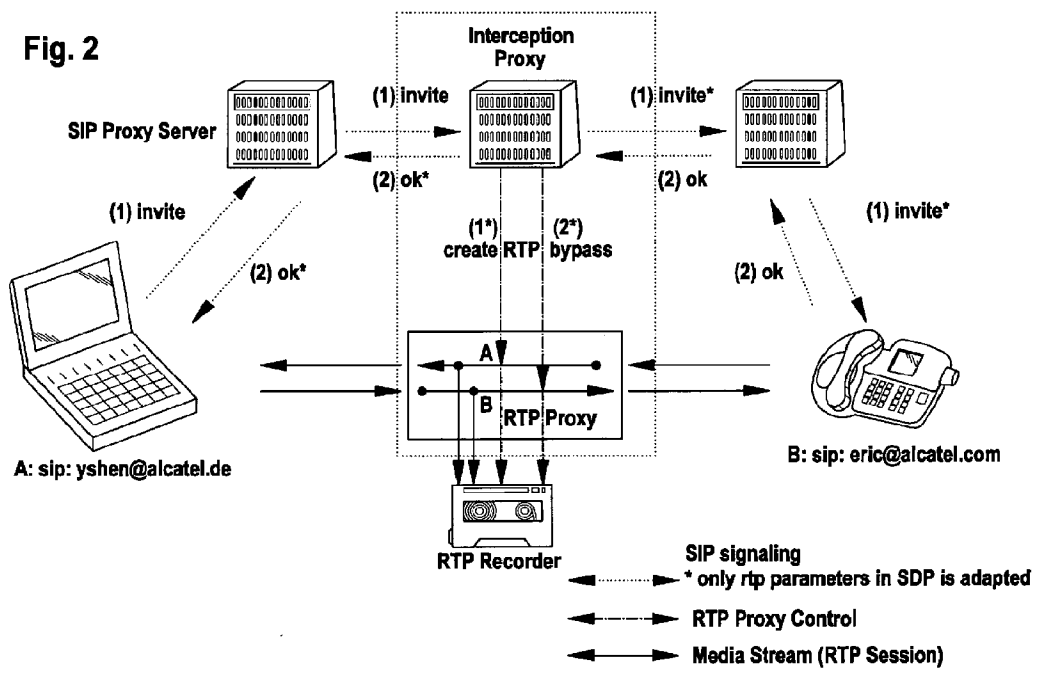

EP 1 389 862 A1

Description

TECHNICAL FIELD OF THE INVENTION

[0001] This invention is related in general to the field of telecommunications systems. More particularly, the invention is related to a lawful interception device for media streams, in particular VoIP calls in IP based networks.

BACKGROUND OF THE INVENTION

[0002] Current lawful interceptions are deployed in class4/class5 switches of PSTN/PLMN networks. In 3G/UMTS or next generation networks, a connection may be IP end to end. No traffics will go through class 5/class4 switches. That means current lawful interception solutions cannot be used here. One solution may undertake an analysis of IP packets in a related network node, but it's difficult to know which route a call (media stream) will take through the network.

SUMMARY OF THE INVENTION

[0003] It is an object of the invention to provide a lawful interception device for VoIP calls in IP based networks.

[0004] The inventive lawful interception device detects information in the signalling information being transmitted between two IP parties and generates instructions out of the detected signalling information for instructing a RTP (Real-time Transport Protocol) proxy server to create channels to bypass a VoIP call to be intercepted via an intermediate storage medium. Instead of voice each media stream could be intercepted, e.g. data, internet access, e-mail, video, real-time pictures, etc.

[0005] In a SIP (Session Initiation Protocol) interception proxy server, where interception should be controlled, applications for interception are running to chose calls for interception. If a call should be monitored, the SIP proxy server has first to hold the invite message from A party. There are listening information in SDP (session description protocol) part of invite message.

[0006] SIP proxy server then instructs a RTP proxy server via a RTP proxy control interface to allocate a bypass channel for monitoring the media stream (A channel: sending to A party). The RTP information of this bypass channel (listening part: ip and port) is included in SDP part in the SIP invite message and passed to its destination.

[0007] When SIP proxy server has received a response of B party, he instructs RTP proxy via RTP proxy control interface to allocate another bypass channel for monitoring the media stream (B channel: sending to B party). The RTP information of this second bypass channel (listening part: ip and port) is included in SDP part in SIP ok message and send to its origination (A party).

[0008] After session setup, both parties will start RTP connections to RTP proxy server depending on connection parameters in its received SIP messages. But those are transparent to A and B. They do not know they are connected to a RTP proxy.

[0009] The RTP proxy can start record both media channels (A and B). At the end of this call, e.g. a media file with two sound tracks will be created by RTP proxy.

[0010] Advantages:

- centralized network node to intercept media streams,
- low cost of deployment,
- transparent to end users,
- the RTP proxy can also be used in the same way as above in a media gateway control (MEGACO, H.248) based network or H.323 network.

BRIEF DESCRIPTION OF THE DRAWINGS

[0011] For a better understanding of the present invention, reference is made to the accompanying drawings, in which:

FIG. 1 is a simplified block diagram of a portion of an exemplary telecommunications network according to the teachings of the prior art;

FIG. 2 is a simplified block diagram of a portion of an exemplary telecommunications network according to the teachings of the present invention.

DETAILED DESCRIPTION OF THE INVENTION

[0012] FIG. 1 shows a portion of an exemplary telecommunications network according to the teachings of the prior art.

[0013] Two IP parties, e.g. yshen@alcatel.de and eric@alcatel.com, are interconnected via two networks: a SIP signaling network and a transmission network. Via the SIP signaling network signaling is performed, e.g. a connection is established between the two IP parties. Via the transmission network the information to be transmitted, e.g. voice, data, etc. is transmitted in media streams (RTP session).

[0014] In the SIP based network, each SIP proxy server is responsible for signaling and session monitoring. The media stream will go from one IP endpoint to another IP endpoint. There is no need of a centralized media path like in PSTN network. A lawful interception of media stream could be done only in the network layer.

[0015] Recording media stream by analyzing network traffics for lawful interception is very expensive, due to the packet route through the IP network could change. Therefore the recording could only be done very closely to the endpoints. Additionally a resembling of recorded packets is needed. A playing in real time will be difficult.

[0016] In the following definition and background information is provided regarding SIP, proxy server, RTP, SDP, etc.

SIP:

[0017] The Session Initiation Protocol (SIP) is an application-layer control (signaling) protocol for creating, modifying and terminating sessions with one or more participants. These sessions include Internet multimedia conferences, Internet telephone calls and multimedia distribution. Members in a session can communicate via multicast or via a mesh of unicast relations, or a combination of these.

[0018] SIP invitations used to create sessions carry session descriptions which allow participants to agree on a set of compatible media types. SIP supports user mobility by proxying and redirecting requests to the user's current location. Users can register their current location. SIP is not tied to any particular conference control protocol. SIP is designed to be independent of the lower-layer transport protocol and can be extended with additional capabilities.

[0019] The Session Initiation Protocol (SIP) is an application-layer control protocol that can establish, modify and terminate multimedia sessions or calls. These multimedia sessions include multimedia conferences, distance learning, Internet telephony and similar applications. SIP can invite both persons and "robots", such as a media storage service. SIP can invite parties to both unicast and multicast sessions; the initiator does not necessarily have to be a member of the session to which it is inviting. Media and participants can be added to an existing session.

[0020] SIP can be used to initiate sessions as well as invite members to sessions that have been advertised and established by other means. Sessions can be advertised using multicast protocols such as electronic mail, news groups, web pages or directories (LDAP), among others.

[0021] SIP transparently supports name mapping and redirection services, allowing the implementation of ISDN and Intelligent Network telephony subscriber services. These facilities also enable personal mobility. In the parlance of telecommunications intelligent network services, this is defined as: "Personal mobility is the ability of end users to originate and receive calls and access subscribed telecommunication services on any terminal in any location, and the ability of the network to identify end users as they move. Personal mobility is based on the use of a unique personal identity (i.e., personal number)." Personal mobility complements terminal mobility, i.e., the ability to maintain communications when moving a single end system from one subnet to another.

[0022] SIP supports five facets of establishing and terminating multimedia communications:

User location: determination of the end system to

be used for communication;

User capabilities: determination of the media and media parameters to be used;

User availability: determination of the willingness of the called party to engage in communications;

Call setup: "ringing", establishment of call parameters at both called and calling party;

Call handling: including transfer and termination of calls.

5

10

15

20

25

30

35

40

45

50

55

[0023] SIP can also initiate multi-party calls using a multipoint control unit (MCU) or fully-meshed interconnection instead of multicast.

Internet telephony gateways that connect Public Switched Telephone Network (PSTN) parties can also use SIP to set up calls between them.

[0024] SIP is designed as part of the overall IETF multimedia data and control architecture currently incorporating protocols such as the real-time transport protocol (RTP) for transporting real-time data and providing QoS feedback.

[0025] A request and a response form together a transaction. SIP uses e.g. invite and ack messages to build up connections. Other messages used are e.g. ok, bye, options, register, cancel. SIP parties are identified via a SIP-ULR, e.g.: sip:cfientname@hostaddress. Each client may transmit requests to a proxy server or directly to an IP address.

[0026] An establishment of a connection is performed in three steps: sending an invite (request) message from a first IP party to a second IP party, sending an ok (response) message from the second IP party to the first IP party, sending an ack (response) message from the first IP party to the second IP party. The invite message includes as much information as needed to allow the second IP party to judge whether a connection is wanted or not. The ack message is an acknowledgement, which serves to increase safety of the connection. SIP is thus not dependent on TCP or UDP.

[0027] The SIP according to the invention is the SIP currently standardized and modifications thereof and equivalents thereof.

RTP:

[0028] The Audio/Video Transport Working Group of IETF was formed to specify a protocol for real-time transmission of audio and video over UDP and IP multicast. This is the Real-time Transport Protocol, RTP, together with its associated profile for audio/video conferences and payload format documents. The payload formats currently under discussion include a number of media specific formats (MPEG-4, DTMF, PureVoice) and FEC techniques applicable to multiple formats (par-

ity FEC, Reed-Solomon coding). RTP is used to replace a normal circuit-switched trunk between two nodes.

[0029] The real-time transport protocol (RTP) is a payload format to be used for e.g. Adaptive Multi-Rate (AMR) and Adaptive Multi-Rate Wideband (AMR-WB) encoded speech signals. RTP provides end-to-end network transport functions suitable for applications transmitting real-time data, such as audio, video or simulation data, over multicast or unicast network services. RTP does not address resource reservation and does not guarantee quality-of-service for real-time services. The data transport is e.g. augmented by the control protocol RTCP (Real-time Transport Control Protocol) to allow monitoring of the data delivery in a manner scalable to large multicast networks, and to provide minimal control and identification functionality. RTP and RTCP are designed to be independent of the underlying transport and network layers. The protocol supports the use of RTP-level translators and mixers. The data transported by RTP in a packet, for example audio samples or compressed video data. A data packet includes e.g. the fixed RTP header, a possibly empty list of contributing sources, and the payload data.

[0030] The RTP according to the invention is the RTP currently under discussion and modifications thereof and equivalents thereof. RTP may be a protocol for both audio and video, or audio only, or video only, or audio, video and data, or audio and data, etc. One modification of RTP is e.g. RTP/I, an application level real-time protocol for distributed interactive media. Typical examples of distributed interactive media are shared whiteboards, networked computer games and distributed virtual environments. RTP/I defines a standardized framing for the transmission of data and provides mechanisms that are universally needed for this media class. Thereby RTP/I enables the development of reusable functionality and generic services that can be employed for multiple distributed interactive media. Examples for this kind of functionality are the ability to record sessions, to support late coming participants, and to provide security services. PTP/I is a protocol that follows the ideas of application level framing and integrated layer processing. It has been designed to be independent of the underlying network and transport layers. Thus RTP/I as a modified RTP protocol that reuses many aspects of RTP while it is thoroughly adapted to the specific needs of distributed interactive media.

Proxy, proxy server:

[0031] An intermediary program that acts as both a server and a client for the purpose of making requests on behalf of other clients. Requests are serviced internally or by passing them on, possibly after translation, to other servers. A proxy interprets, and, if necessary, rewrites a request message before forwarding it.

Server:

[0032] A server is an application program that accepts requests in order to service requests and sends back responses to those requests. Servers are either proxy, redirect or user agent servers or registrars.

User agent client (UAC), calling user agent:

[0033] A user agent client is a client application that initiates the SIP request.

SDP:

[0034] The Session Description Protocol (SDP) is intended for describing multimedia sessions for the purposes of session announcement, session invitation, and other forms of multimedia session initiation.

[0035] The purpose of SDP is to convey information about media streams in multimedia sessions to allow the recipients of a session description to participate in the session. SDP is primarily intended for use in an inter-network, although it is sufficiently general that it can describe conferences in other network environments.

[0036] A multimedia session, for these purposes, is defined as a set of media streams that exist for some duration of time. Media streams can be many-to-many. The times during which the session is active need not be continuous.

[0037] Thus far, multicast based sessions on the Internet have differed from many other forms of conferencing in that anyone receiving the traffic can join the session (unless the session traffic is encrypted). In such an environment, SDP serves two primary purposes. It is a means to communicate the existence of a session, and is a means to convey sufficient information to enable joining and participating in the session. In a unicast environment, only the latter purpose is likely to be relevant.

[0038] Thus SDP includes:

- o Session name and purpose
- o Time(s) the session is active
- o The media comprising the session
- o Information to receive those media (addresses, ports, formats and so on)

[0039] As resources necessary to participate in a session may be limited, some additional information may also be desirable:

- o Information about the bandwidth to be used by the conference
- o Contact information for the person responsible for the session

[0040] In general, SDP must convey sufficient information to be able to join a session (with the possible

exception of encryption keys) and to announce the resources to be used to non-participants that may need to know.

[0041] SDP includes:

- o The type of media (video, audio, etc)
- o The transport protocol (RTP/UDP/IP, H.320, etc)
- o The format of the media (H.261 video, MPEG video, etc)

[0042] For an IP multicast session, the following are also conveyed:

- o Multicast address for media
- o Transport Port for media

[0043] This address and port are the destination address and destination port of the multicast stream, whether being sent, received, or both.

[0044] For an IP unicast session, the following are conveyed:

- o Remote address for media
- o Transport port for contact address

[0045] The semantics of this address and port depend on the media and transport protocol defined. By default, this is the remote address and remote port to which data is sent, and the remote address and local port on which to receive data. However, some media may define to use these to establish a control channel for the actual media flow.

[0046] The SDP according to the invention is the SDP currently standardized and modifications thereof and equivalents thereof.

[0047] FIG. 2 shows a portion of an exemplary telecommunications network according to the teachings of the present invention.

[0048] Like in fig. 1 two IP parties, e.g. yshen@alcatel.de and eric@alcatel.com, are interconnected via two networks: a SIP signaling network and a transmission network. Via the SIP signaling network signaling is performed, e.g. a connection is established between the two IP parties. Via the transmission network the information to be transmitted, e.g. voice, data, etc. is transmitted in media streams (RTP session).

[0049] Different from fig. 1 a lawful interception device is included in fig. 2. The lawful interception device is e.g. a processor with particular software. The processor is e.g. a digital signal processor, a controller, a micro-processor or the like. Instead of one processor two or more processors could be used. Two or more processors could be located at different sites. One processor could be used to perform SIP proxy server operations and another processor could be used to perform RTP proxy server operations. In general, one, two or more hardwares could be used to run one, two, or more softwares. Each software could in addition be run in parts

on different hardware.

[0050] The lawful interception device includes a SIP (Session Initiation Protocol) proxy server or a MGC (Media Gateway Controller) to detect information in the signalling information being transmitted between two IP (Internet Protocol) parties and to generate instructions out of the detected signalling information for instructing a RTP (Real-time Transport Protocol) proxy server to create channels to bypass a media stream to be intercepted via an intermediate storage medium. Media streams are e.g. VoIP, data, internet access, e-mail, video, real-time pictures, music, video clips, video games, etc. The storage medium could be a compact disk, a magnetic storage medium, a read access memory, or the like.

[0051] The method for performing SIP signaling for a media stream includes the following steps:

receiving a SIP invite message of a first IP party,

adapting at least one connection parameter in the SDP (Session Description Protocol) of the received SIP invite message,

transmitting the adapted SIP invite message to a second IP party,

receiving a SIP response message of the second IP party,

adapting at least one connection parameter in the SDP (Session Description Protocol) of the received SIP response message,

transmitting the adapted SIP response message to the first IP party.

[0052] At least one RTP parameter includes information about a bypass channel, an address, or a port. The RTP parameters sent to both IP parties differ from each other.

[0053] After receipt of the SIP invite message of the first IP party the SIP interception proxy server sends a request to the RTP interception proxy server to assign at least two channels for bothway communication. The interface used to communicate between SIP interception proxy server and RTP interception proxy server is a XML based API. The number of channels to be assigned may vary dependent of the amount of data to be transmitted, of the bandwidth requested, of the quality of service requested, of the kind of information to be transmitted, e.g. voice, voice and data, voice and video, etc. At least one channel is assigned to transmit information between the RTP interception proxy server and the terminal of the first IP party. The terminal could be a phone, a laptop, a personal computer, a screenphone, a mobile phone, etc. At least one other channel is assigned to transmit information between the RTP interception proxy server and the terminal of the second IP party.

[0054] Assume channel A at the RTP interception proxy server is assigned to transmit information between the second IP terminal and the terminal of the first IP party, and channel B is assigned to transmit information between the terminal of the first IP party and the second IP terminal. Then the RTP interception proxy server sends information about the assignment of channels A and B to the SIP interception proxy server. The SIP interception proxy server includes information about channel A in the invite message to be send to the second IP party. The information about channel A is advantageously included in the connection parameter information to be included in the SDP of the SIP invite message. After receipt of the SIP response message of the second IP party, which corresponds to an ok message stating that a connection to the first IP party is desired, the SIP interception proxy server exchanges the connection parameter included in the SDP part of the ok message by the information about channel B. The modified ok message including the information about channel B is send to the first IP party.

[0055] Thus the first IP party will send data to channel B and receive data via channel A of the RTP interception proxy server. The second IP party will send data to channel A and receive data via channel B of the RTP interception proxy server. Within the lawful interception device the intermediate storage medium is connected to both channel A and B. Thus the information flow between both IP parties will transfer the intermediate storage medium and thus interception is enabled. The first party is not aware on which channel the second party is sending, and the second party is not aware on which channel the first party is sending. Thus interception is transparent regarding the two IP parties.

[0056] A computer program for performing at least part of the steps of the inventive method could be used as an upgrade software, which is sold e.g. to service providers, which will upgrade one or more SIP proxy server thus enabling a usual SIP proxy server having the functionality of an SIP interception proxy server. The computer program includes at least the following steps:

adapting at least one connection parameter in the SDP (Session Description Protocol) of the received SIP invite message,

adapting at least one connection parameter in the SDP (Session Description Protocol) of the received SIP response message.

The computer program could also be programmed to perform all steps of the method as described above.

[0057] Within an IP network one, two, or more SIP proxy servers could be used, one, two, or more SIP interception proxy servers could be used, one, two, or more RTP proxy servers could be used, and one, two, or more RTP interception proxy servers could be used.

[0058] The IP network could be a wireline network, a

wireless network, or a combination of both.

List of abbreviations:

5	[0059]	
	3G	Third Generation
	API	Application Programmer Interface
	AMR	Adaptive Multi-Rate
10	AMR-WB	AMR-Wideband
	DTMF	Dual-Tone Multi-Frequency
	FEC	Forward Error Correction
	H248	ITU standard
	H261	ITU standard
15	H320	ITU standard
	H323	ITU standard
	IETF	Internet Engineering Task Force
	IP	Internet Protocol
	ISDN	Integrated Services Digital Network
20	LDAP	Lightweight Directory Access Protocol
	MEGACO	Media Gateway Controller
	MCU	Multipoint Control Unit
	MPEG	Motion Picture Expert Group
	MGC	Media Gateway Controller
25	NGN	Next Generation Network
	PSTN	Public Switched Telephone Network
	PLMN	Public Land Mobile Network
	QoS	Quality of Service
	RTCP	Real-time Transport Control Protocol
30	RTP	Real-time Transport Protocol
	SDP	Session Description Protocol
	SIP	Session Initiation Protocol
	TCP	Transmission Control Protocol
	UAC	User Agent Client
35	UDP	User Datagram Protocol
	UMTS	Universal Mobile Transmission System
	VoIP	Voice over IP
	XML	extensible Markup Language

40 Claims

1. Lawful interception device including a SIP (Session Initiation Protocol) proxy server or a MGC (Media Gateway Controller) to detect information in the signalling information being transmitted between two IP (Internet Protocol) parties and to generate instructions out of the detected signalling information for instructing a RTP (Real-time Transport Protocol) proxy server to create channels to bypass a media stream to be intercepted via an intermediate storage medium.
2. SIP interception proxy server to detect information in the signalling information being transmitted between two IP (Internet Protocol) parties and to generate instructions out of the detected signalling information for instructing a RTP (Real-time Trans-

port Protocol) proxy server to create channels to bypass a media stream to be intercepted via an intermediate storage medium.

3. Interception MGC to detect information in the signalling information being transmitted between two IP (Internet Protocol) parties and to generate instructions out of the detected signalling information for instructing a RTP (Real-time Transport Protocol) proxy server to create channels to bypass a media stream to be intercepted via an intermediate storage medium. 5
10
4. Method for performing SIP signaling for a media stream, including the following steps: 15
 - receiving a SIP invite message of a first IP party,
 - adapting at least one connection parameter in the SDP (Session Description Protocol) of the received SIP invite message, 20
 - transmitting the adapted SIP invite message to a second IP party, 25
 - receiving a SIP response message of the second IP party,
 - adapting at least one connection parameter in the SDP (Session Description Protocol) of the received SIP response message, 30
 - transmitting the adapted SIP response message to the first IP party. 35
5. Method according to claim 4, wherein at least one connection parameter includes information about a bypass channel, an address, or a port.
6. Method according to claim 4, wherein the connection parameters sent to both IP parties differ from each other. 40
7. Computer program for performing at least part of the steps of the method according to claim 4, including the following steps: 45
 - adapting at least one connection parameter in the SDP (Session Description Protocol) of the received SIP invite message, 50
 - adapting at least one connection parameter in the SDP (Session Description Protocol) of the received SIP response message. 55

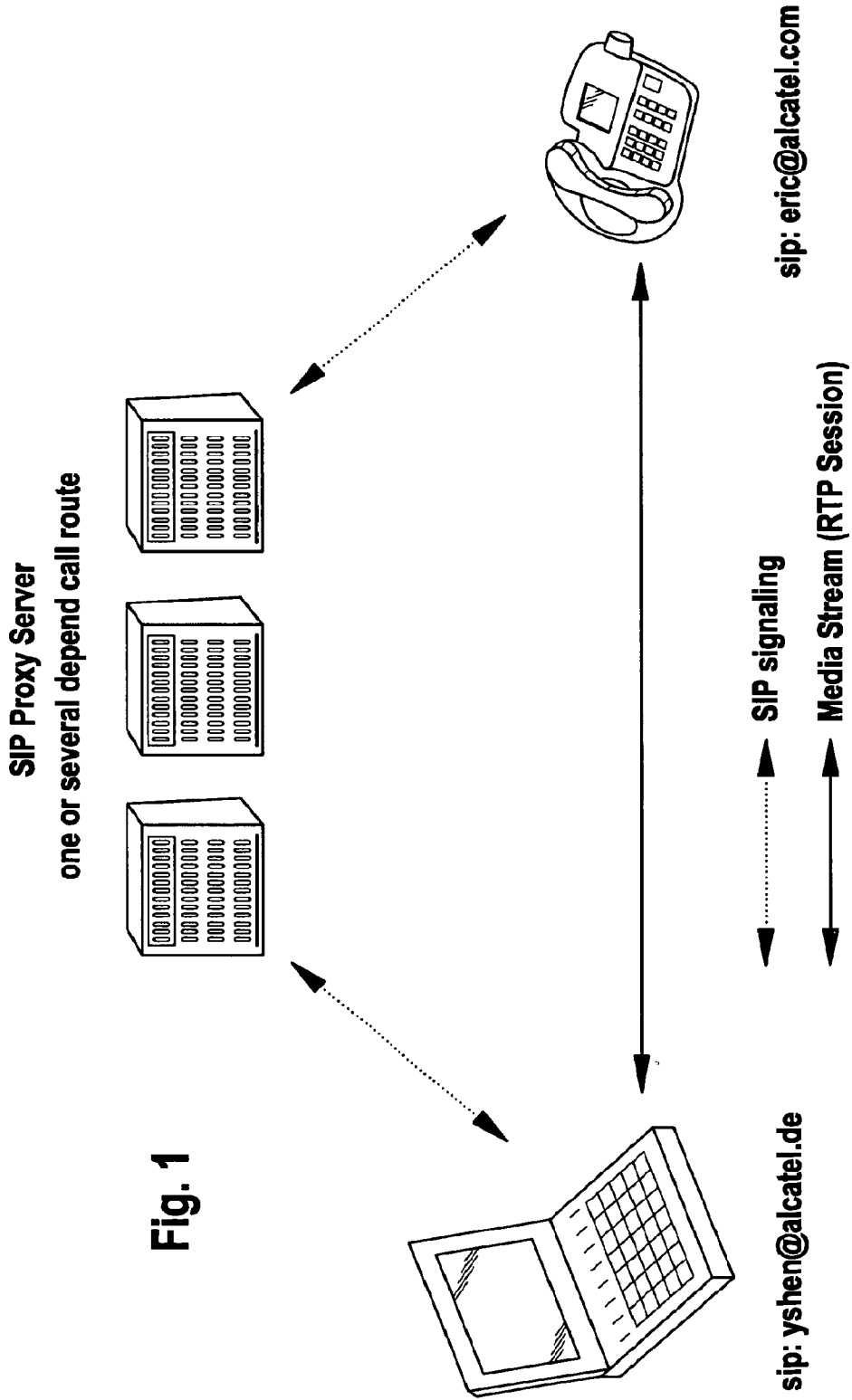

Fig. 1

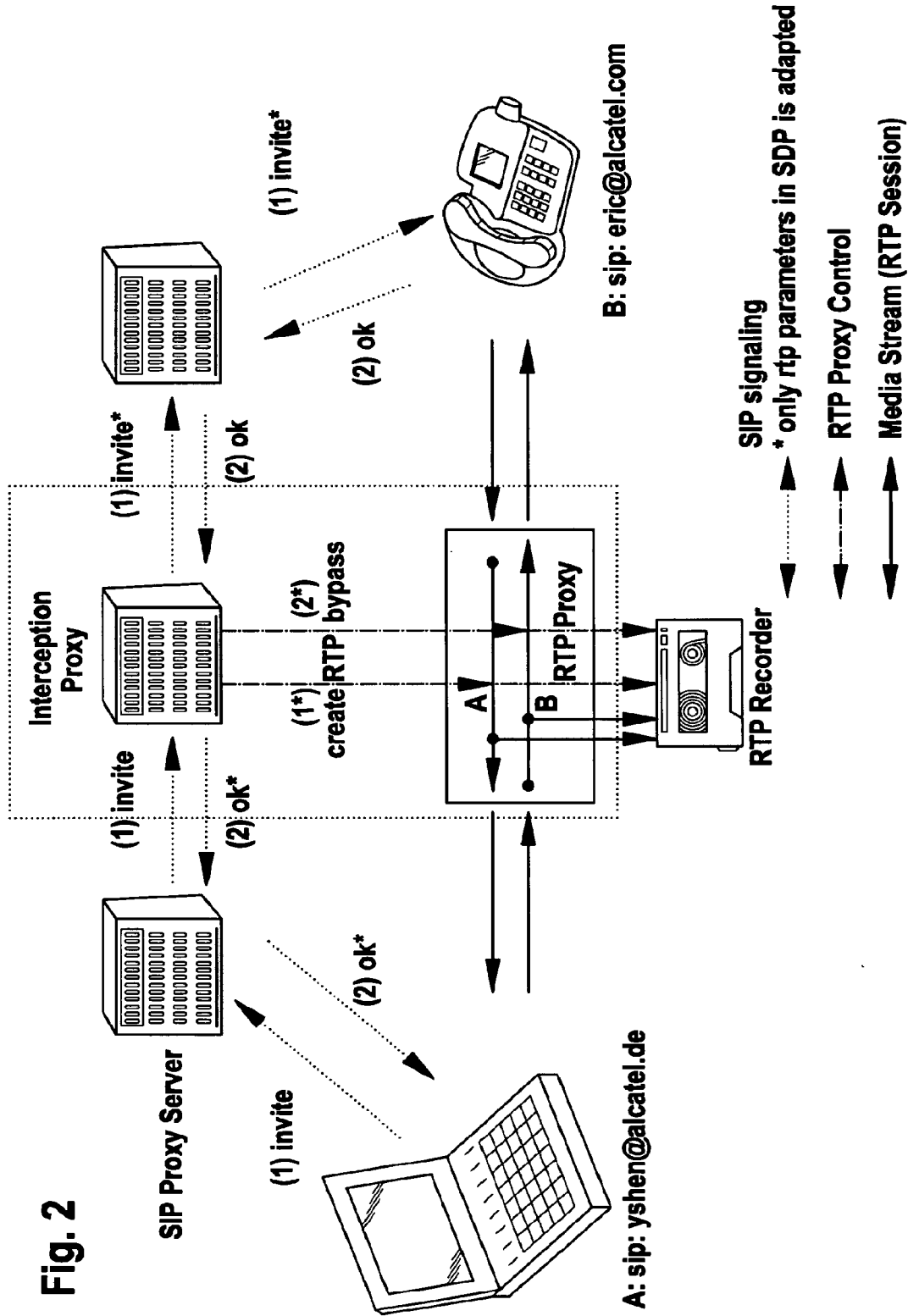

Fig. 2



European Patent
Office

EUROPEAN SEARCH REPORT

Application Number
EP 02 36 0235

DOCUMENTS CONSIDERED TO BE RELEVANT			
Category	Citation of document with indication, where appropriate, of relevant passages	Relevant to claim	CLASSIFICATION OF THE APPLICATION (Int.Cl.7)
X	THERNELIUS F: "SIP, NAT, and Firewalls" MASTER'S THESIS, KUNGST TEKNISKA HOGSKOLAN, DEPARTMENT OF TELEINFORMATICS - ERICSSON, May 2000 (2000-05), XP002209773 * page 14; figure 11 * * page 31, line 36 - line 48; figure 32 * * page 33, line 1 - page 34, line 33; table 5 * ---	4-7	H04L29/06 H04M7/00
X	WO 02 15627 A (PARANTAINEN JANNE ;EINOLA HEIKKI (FI); HAMITI SHKUMBIN (FI); HURTT) 21 February 2002 (2002-02-21) * page 14, line 7 - page 15, line 31 * ---	4,7	
A	EP 1 111 892 A (NORTEL NETWORKS LTD) 27 June 2001 (2001-06-27) * abstract * * page 4, column 5, paragraph 18 - page 5, column 7, paragraph 25 * * page 9, column 16, paragraph 57 - page 11, column 19, line 11 * ---	1-7	
			TECHNICAL FIELDS SEARCHED (Int.Cl.7)
A	WO 01 89145 A (ERICSSON TELEFON AB L M) 22 November 2001 (2001-11-22) * abstract * * page 3, line 20 - page 4, line 2 * * page 4, line 27 - page 5, line 2 * * page 6, line 10 - page 7, line 27 * ---	1-7	H04L H04M H04Q
A	WO 99 17499 A (NOKIA TELECOMMUNICATIONS OY ;HAUMONT SERGE (FI)) 8 April 1999 (1999-04-08) * page 9, line 18 - line 31 * * abstract * * page 10, line 9 - line 29 * * claims 1,3,4,7-9 * -----	1-7	
The present search report has been drawn up for all claims			
Place of search THE HAGUE		Date of completion of the search 16 January 2003	Examiner Karavassilis, N
CATEGORY OF CITED DOCUMENTS X : particularly relevant if taken alone Y : particularly relevant if combined with another document of the same category A : technological background O : non-written disclosure P : intermediate document T : theory or principle underlying the invention E : earlier patent document, but published on, or after the filing date D : document cited in the application L : document cited for other reasons & : member of the same patent family, corresponding document			

EPO FORM 1503 03.02 (P04-C01)

**ANNEX TO THE EUROPEAN SEARCH REPORT
ON EUROPEAN PATENT APPLICATION NO.**

EP 02 36 0235

This annex lists the patent family members relating to the patent documents cited in the above-mentioned European search report. The members are as contained in the European Patent Office EDP file on The European Patent Office is in no way liable for these particulars which are merely given for the purpose of information.

16-01-2003

Patent document cited in search report	Publication date	Patent family member(s)	Publication date
WO 0215627 A	21-02-2002	WO 0215625 A1	21-02-2002
		AU 6701800 A	25-02-2002
		AU 8767601 A	25-02-2002
		WO 0215627 A1	21-02-2002
EP 1111892 A	27-06-2001	EP 1111892 A2	27-06-2001
WO 0189145 A	22-11-2001	AU 5690501 A	26-11-2001
		WO 0189145 A2	22-11-2001
WO 9917499 A	08-04-1999	FI 973806 A	27-03-1999
		AU 9351598 A	23-04-1999
		CA 2304172 A1	08-04-1999
		CN 1277771 T	20-12-2000
		EP 1018241 A2	12-07-2000
		WO 9917499 A2	08-04-1999
		JP 2001518744 T	16-10-2001
		TW 429710 B	11-04-2001

EPC FORM P0458

For more details about this annex : see Official Journal of the European Patent Office, No. 12/82

INFORMATION DISCLOSURE STATEMENT

Applicant : Clay Perreault et al.
App. No : 12/513147
Filed : March 1, 2010
For : PRODUCING ROUTING MESSAGES
FOR VOICE OVER IP
COMMUNICATIONS
Examiner : Curtis A. Kuntz
Art Unit : 2614
Conf No. : 9611

Mail Stop Amendment
Commissioner for Patents
P.O. Box 1450
Alexandria, VA 22313-1450

Dear Sir:

Enclosed for filing in the above-identified application is a PTO/SB/08 Equivalent listing 15 references, of which 9 are enclosed/submitted.

This Information Disclosure Statement is being filed before the receipt of a first Office Action on the merits, and presumably no fee is required. If a first Office Action on the merits was mailed before the mailing date of this Statement, the Commissioner is authorized to charge the fee set forth in 37 C.F.R. § 1.17(p) to Deposit Account No. 11-1410.

Respectfully submitted,
KNOBBE, MARTENS, OLSON & BEAR, LLP

Dated: 5/5/11

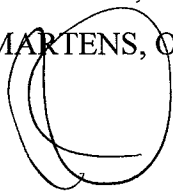
By: 
John M. Carson
Registration No. 34,303
Attorney of Record
Customer No. 20995
(858) 836-9000

SUPPLEMENTAL APPLICATION DATA SHEET

Application Information

Application Number: 12/513147
Filing Date: ~~04/30/2009~~ March 1, 2010
Application Type: Nonprovisional
Subject Matter: Utility
Title: PRODUCING ROUTING MESSAGES FOR VOICE
OVER IP COMMUNICATIONS
Attorney Docket Number: SMARB19.001APC
Request for Early Publication? NO
Request for Non-Publication? NO
Total Drawing Sheets: 32
Small Entity? YES

Inventor Information

Applicant Authority Type: Inventor
Primary Citizenship Country: UK
Given Name: Clay
Family Name: PERREAULT
City of Residence: Panama City
State or Prov. of Residence: Panama
Country of Residence: Panama
Street: 340a Corozal West
City: Panama City
State or Province: Panama
Country: Panama
Postal or Zip Code: N/A

Applicant Authority Type: Inventor
Primary Citizenship Country: NZ
Given Name: Steve
Family Name: NICHOLSON
City of Residence: Hamilton
Country of Residence: NZ
Street: 423 Tauwhare Road, RD 3
City: Hamilton
Country: NZ
Postal or Zip Code: 3283

Applicant Authority Type: Inventor
Primary Citizenship Country: CA
Given Name: Rod
Family Name: THOMSON
City of Residence: North Vancouver, ~~British Columbia~~
Country of Residence: CA
Street: 3320 Garabaldi Drive
City: North Vancouver, ~~British Columbia~~
State or Province: BC
Country: CA
Postal or Zip Code: V7H 2N9

Applicant Authority Type: Inventor
Primary Citizenship Country: ~~CA~~ SE
Given Name: Johan
Middle Name: Emil ~~Vietor~~ Viktor
Family Name: BJORSELL
City of Residence: Vancouver, ~~British Columbia~~

Country of Residence: CA
Street: P.O. Box 29164 RPO South Granville Post
City: Vancouver, ~~British Columbia~~
State or Province: BC
Country: CA
Postal or Zip Code: V6J 0A6

Applicant Authority Type: Inventor
Primary Citizenship Country: CA
Given Name: Fuad
Family Name: ARAFA
City of Residence: Vancouver, ~~British Columbia~~
Country of Residence: CA
Street: 782 West 22nd Street
City: Vancouver, ~~British Columbia~~
State or Province: BC
Country: CA
Postal or Zip Code: V5Z 17Z

Correspondence Information

Correspondence Customer Number: 20,995
E-Mail Address: efilings@kmob.com

Representative Information

Representative Customer Number: 20995

Domestic Priority Information

Application:	Continuity Type:	Parent Application:	Parent Filing Date:
This Application	a 371 of international	PCT/CA2007001956	2007-11-01
PCT/CA2007001956	non provisional of	60856212	2006-11-02

Foreign Priority Information

Country:	Application Number:	Filing Date:	Priority Claimed:
N/A	N/A	N/A	N/A

Assignment Information

Assignee Name: DIGIFONICA (INTERNATIONAL) LIMITED
 Street: Suite 890, 990 West Hastings Street
 City: Vancouver
 State or Province: British Columbia
 Country: CA
 Postal or Zip Code: V6C 2W2

Dated: 9/9/10

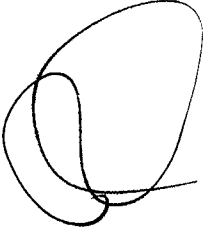
By: 
 John M. Carson
 Registration No. 34,303
 Attorney of Record
 Customer No. 20995
 (858) 836-9000

9498429\cey
 081110

Electronic Acknowledgement Receipt

EFS ID:	8387009
Application Number:	12513147
International Application Number:	
Confirmation Number:	9611
Title of Invention:	PRODUCING ROUTING MESSAGES FOR VOICE OVER IP COMMUNICATIONS
First Named Inventor/Applicant Name:	Clay Perreault
Customer Number:	20995
Filer:	John M Carson/Sabrina Jacob
Filer Authorized By:	John M Carson
Attorney Docket Number:	SMARB19.001APC
Receipt Date:	09-SEP-2010
Filing Date:	01-MAR-2010
Time Stamp:	17:58:09
Application Type:	U.S. National Stage under 35 USC 371

Payment information:

Submitted with Payment	no
------------------------	----

File Listing:

Document Number	Document Description	File Name	File Size(Bytes)/ Message Digest	Multi Part /.zip	Pages (if appl.)
1	Application Data Sheet	SMARB19_001APC_SUPPADS. pdf	87288 <small>2ddb92ea63bddb401cd69e34bf8788f8497 f1f1d</small>	no	4

Warnings:

Information:

PETITIONER APPLE INC. EX. 1002-347

Total Files Size (in bytes):

87288

This Acknowledgement Receipt evidences receipt on the noted date by the USPTO of the indicated documents, characterized by the applicant, and including page counts, where applicable. It serves as evidence of receipt similar to a Post Card, as described in MPEP 503.

New Applications Under 35 U.S.C. 111

If a new application is being filed and the application includes the necessary components for a filing date (see 37 CFR 1.53(b)-(d) and MPEP 506), a Filing Receipt (37 CFR 1.54) will be issued in due course and the date shown on this Acknowledgement Receipt will establish the filing date of the application.

National Stage of an International Application under 35 U.S.C. 371

If a timely submission to enter the national stage of an international application is compliant with the conditions of 35 U.S.C. 371 and other applicable requirements a Form PCT/DO/EO/903 indicating acceptance of the application as a national stage submission under 35 U.S.C. 371 will be issued in addition to the Filing Receipt, in due course.

New International Application Filed with the USPTO as a Receiving Office

If a new international application is being filed and the international application includes the necessary components for an international filing date (see PCT Article 11 and MPEP 1810), a Notification of the International Application Number and of the International Filing Date (Form PCT/RO/105) will be issued in due course, subject to prescriptions concerning national security, and the date shown on this Acknowledgement Receipt will establish the international filing date of the application.



UNITED STATES PATENT AND TRADEMARK OFFICE

UNITED STATES DEPARTMENT OF COMMERCE
United States Patent and Trademark Office
Address: COMMISSIONER FOR PATENTS
P.O. Box 1450
Alexandria, Virginia 22313-1450
www.uspto.gov

Table with 4 columns: APPLICATION NUMBER (12/513,147), FILING OR 371(C) DATE (03/01/2010), FIRST NAMED APPLICANT (Clay Perreault), ATTY. DOCKET NO./TITLE (SMARB19.001APC)

CONFIRMATION NO. 9611

PUBLICATION NOTICE



20995
KNOBBE MARTENS OLSON & BEAR LLP
2040 MAIN STREET
FOURTEENTH FLOOR
IRVINE, CA 92614

Title:PRODUCING ROUTING MESSAGES FOR VOICE OVER IP COMMUNICATIONS

Publication No.US-2010-0150328-A1
Publication Date:06/17/2010

NOTICE OF PUBLICATION OF APPLICATION

The above-identified application will be electronically published as a patent application publication pursuant to 37 CFR 1.211, et seq. The patent application publication number and publication date are set forth above.

The publication may be accessed through the USPTO's publically available Searchable Databases via the Internet at www.uspto.gov. The direct link to access the publication is currently http://www.uspto.gov/patft/.

The publication process established by the Office does not provide for mailing a copy of the publication to applicant. A copy of the publication may be obtained from the Office upon payment of the appropriate fee set forth in 37 CFR 1.19(a)(1). Orders for copies of patent application publications are handled by the USPTO's Office of Public Records. The Office of Public Records can be reached by telephone at (703) 308-9726 or (800) 972-6382, by facsimile at (703) 305-8759, by mail addressed to the United States Patent and Trademark Office, Office of Public Records, Alexandria, VA 22313-1450 or via the Internet.

In addition, information on the status of the application, including the mailing date of Office actions and the dates of receipt of correspondence filed in the Office, may also be accessed via the Internet through the Patent Electronic Business Center at www.uspto.gov using the public side of the Patent Application Information and Retrieval (PAIR) system. The direct link to access this status information is currently http://pair.uspto.gov/. Prior to publication, such status information is confidential and may only be obtained by applicant using the private side of PAIR.

Further assistance in electronically accessing the publication, or about PAIR, is available by calling the Patent Electronic Business Center at 1-866-217-9197.

Office of Data Management, Application Assistance Unit (571) 272-4000, or (571) 272-4200, or 1-888-786-0101

INFORMATION DISCLOSURE STATEMENT BY APPLICANT

Application No.	12/513,147
Filing Date	March 1, 2010
First Named Inventor	Clay Perreault
Art Unit	2614
Examiner	Unassigned
Attorney Docket No.	SMARB19.001APC

(Multiple sheets used when necessary)

SHEET 1 OF 6

U.S. PATENT DOCUMENTS

Examiner Initials	Cite No.	Document Number Number - Kind Code (if known) Example: 1,234,567 B1	Publication Date MM-DD-YYYY	Name of Patentee or Applicant	Pages, Columns, Lines Where Relevant Passages or Relevant Figures Appear
	1	2002/0051518 A1	05-02-2002	Bondy et al.	
	2	2002/0116464 A1	08-22-2002	Mak	
	3	2003/0219103 A1	11-27-2003	Rao et al.	
	4	2004/0157629 A1	08-12-2004	Kallio et al.	
	5	2004/0165709 a1	08-26-2004	Pence et al.	
	6	2004/0181599 A1	09-16-2004	Kreusch et al.	
	7	2004/0202295 A1	10-14-2004	Shen et al.	
	8	2004/0255126 A1	12-16-2004	Reith	
	9	2005/0083911 A1	04-21-2005	Grabelsky et al.	
	10	2005/0094651 A1	05-05-2005	Lutz et al.	
	11	2005/0169248 A1	08-04-2005	Truesdale et al.	
	12	2005/0174937 A1	08-11-2005	Scoggins et al.	
	13	2005/0177843 A1	08-11-2005	Williams	
	14	2006/0072547 A1	04-06-2006	Florkey et al.	
	15	2006/0111116 A1	05-25-2006	Palmer et al.	
	16	2006/0160565 A1	07-20-2006	Singh et al.	
	17	2006/0177035 A1	08-10-2006	Cope et al.	
	18	2006/0209768 A1	09-21-2006	Yan et al.	
	19	2008/0037715 A1	02-14-2008	Prozeniuk et al.	

Examiner Signature	Date Considered
<p>*Examiner: Initial if reference considered, whether or not citation is in conformance with MPEP 609. Draw line through citation if not in conformance and not considered. Include copy of this form with next communication to applicant.</p>	

INFORMATION DISCLOSURE STATEMENT BY APPLICANT	Application No.	12/513,147
	Filing Date	March 1, 2010
	First Named Inventor	Clay Perreault
	Art Unit	2614
<i>(Multiple sheets used when necessary)</i>	Examiner	Unassigned
SHEET 2 OF 6	Attorney Docket No.	SMARB19.001APC

U.S. PATENT DOCUMENTS

Examiner Initials	Cite No.	Document Number Number - Kind Code (if known) Example: 1,234,567 B1	Publication Date MM-DD-YYYY	Name of Patentee or Applicant	Pages, Columns, Lines Where Relevant Passages or Relevant Figures Appear
	20	2008/0063153 A1	03-13-2008	Krivorot et al.	
	21	4,916,491	04-10-1990	Katoh	
	22	5,146,491	09-08-1992	Silver et al.	
	23	5,247,571	09-21-1993	Kay et al .	
	24	5,303,297	04-12-1994	Hillis	
	25	5,359,642	10-25-1994	Castro	
	26	5,425,085	06-13-1995	Weinberger et al.	
	27	5,440,621	08-08-1995	Castro	
	28	5,469,497	11-21-1995	Pierce et al.	
	29	5,506,893	04-09-1996	Buscher et al.	
	30	5,519,769	05-21-1996	Weinberger et al.	
	31	5,559,871	09-24-1996	Smith	
	32	5,590,133	12-31-1996	Billstrom et al.	
	33	5,608,786	05-04-1997	Gordon	
	34	5,621,787	04-15-1997	McKoy et al.	
	35	5,661,790	08-26-1997	Hsu	
	36	5,712,907	01-27-1998	Wegner et al.	
	37	5,724,355	05-03-1998	Bruno et al.	
	38	5,726,984	05-10-1998	Kubler et al.	

Examiner Signature	Date Considered
*Examiner: Initial if reference considered, whether or not citation is in conformance with MPEP 609. Draw line through citation if not in conformance and not considered. Include copy of this form with next communication to applicant.	

INFORMATION DISCLOSURE STATEMENT BY APPLICANT	Application No.	12/513,147
	Filing Date	March 1, 2010
	First Named Inventor	Clay Perreault
	Art Unit	2614
<i>(Multiple sheets used when necessary)</i>	Examiner	Unassigned
SHEET 3 OF 6	Attorney Docket No.	SMARB19.001APC

U.S. PATENT DOCUMENTS

Examiner Initials	Cite No.	Document Number Number - Kind Code (if known) Example: 1,234,567 B1	Publication Date MM-DD-YYYY	Name of Patentee or Applicant	Pages, Columns, Lines Where Relevant Passages or Relevant Figures Appear
	39	5,737,414	04-07-1998	Walker et al.	
	40	5,751,961	05-12-1998	Smyk	
	41	5,793,762	08-11-1998	Penners et al.	
	42	5,799,072	08-25-1998	Vulcan et al.	
	43	5,802,502	09-01-1998	Gell et al.	
	44	5,825,863	10-20-1998	Walker	
	45	5,828,740	10-27-1998	Khuc et al.	
	46	5,838,682	11-17-1998	Dekelbaum et al.	
	47	5,845,267	12-01-1998	Ronen	
	48	5,850,433	12-15-1998	Rondeau	
	49	5,864,610	01-26-1999	Ronen	
	50	5,867,495	02-02-1999	Elliott et al.	
	51	5,883,891	05-16-1999	Williams et al.	
	52	5,889,774	05-30-1999	Mirashrafi et al.	
	53	5,905,736	05-18-1999	Ronen et al.	
	54	5,907,547	05-25-1999	Foladare et al.	
	55	5,910,946	06-08-1999	Csapo	
	56	5,915,005	06-22-1999	He	
	57	5,923,659	01-30-2001	Curry et al.	

Examiner Signature	Date Considered
*Examiner: Initial if reference considered, whether or not citation is in conformance with MPEP 609. Draw line through citation if not in conformance and not considered. Include copy of this form with next communication to applicant.	

INFORMATION DISCLOSURE STATEMENT BY APPLICANT	Application No.	12/513,147
	Filing Date	March 1, 2010
	First Named Inventor	Clay Perreault
	Art Unit	2614
<i>(Multiple sheets used when necessary)</i>	Examiner	Unassigned
SHEET 4 OF 6	Attorney Docket No.	SMARB19.001APC

U.S. PATENT DOCUMENTS

Examiner Initials	Cite No.	Document Number Number - Kind Code (if known) Example: 1,234,567 B1	Publication Date MM-DD-YYYY	Name of Patentee or Applicant	Pages, Columns, Lines Where Relevant Passages or Relevant Figures Appear
	58	5,930,343	07-27-1999	Vasquez	
	59	5,937,045	08-10-1999	Yaoya et al.	
	60	5,940,598	08-17-1999	Strauss et al.	
	61	5,953,504	09-14-1999	Sokal et al.	
	62	5,956,391	09-21-1999	Melen et al.	
	63	5,970,477	10-19-1999	Roden	
	64	5,974,043	10-26-1999	Solomon	
	65	5,991,291	11-23-1999	Asai et al.	
	66	6,005,926	12-21-1999	Mashinsky	
	67	6,014,379	01-11-2000	White et al.	
	68	6,021,126	02-01-2000	White et al.	
	69	6,052,445	10-28-2003	Bashoura et al.	
	70	6,058,300	05-02-2000	Hanson	
	71	6,069,890	05-30-2000	White et al.	
	72	6,073,013	06-06-2000	Agre et al.	
	73	6,104,704	08-15-2000	Buhler et al.	
	74	6,104,711	08-15-2000	Voit	
	75	6,115,737	09-05-2000	Ely et al.	
	76	6,128,304	10-03-2000	Gardell et al.	

Examiner Signature	Date Considered
<p>*Examiner: Initial if reference considered, whether or not citation is in conformance with MPEP 609. Draw line through citation if not in conformance and not considered. Include copy of this form with next communication to applicant.</p>	

INFORMATION DISCLOSURE STATEMENT BY APPLICANT	Application No.	12/513,147
	Filing Date	March 1, 2010
	First Named Inventor	Clay Perreault
	Art Unit	2614
<i>(Multiple sheets used when necessary)</i>	Examiner	Unassigned
SHEET 5 OF 6	Attorney Docket No.	SMARB19.001APC

U.S. PATENT DOCUMENTS

Examiner Initials	Cite No.	Document Number Number - Kind Code (if known) Example: 1,234,567 B1	Publication Date MM-DD-YYYY	Name of Patentee or Applicant	Pages, Columns, Lines Where Relevant Passages or Relevant Figures Appear
	77	6,137,869	10-24-2000	Voit et al	
	78	6,141,404	10-31-2000	Westerlage et al.	
	79	6,188,752 B1	02-13-2001	Lesley	
	80	6,282,574	08-28-2001	Voit	
	81	6,298,062	10-02-2001	Gardell et al.	
	82	6,351,464	02-26-2002	Galvin et al.	
	83	6,359,880	05-19-2002	Curry et al.	
	84	6,430,275	08-06-2002	Voit et al	
	85	6,507,644 B1	01-14-2003	Henderson et al.	
	86	6,766,159 B2	07-20-2004	Lindholm	
	87	6,819,929 B2	11-16-2004	Antonucci et al.	
	88	6,954,453	10-11-2005	Schindler	
	89	7,068,772	06-27-2006	Widger et al.	
	90	7,120,682 B1	10-10-2006	Salama	
	91	7,212,522 B1	05-01-2007	Shankar et al.	

FOREIGN PATENT DOCUMENTS

Examiner Initials	Cite No.	Foreign Patent Document Country Code-Number-Kind Code Example: JP 1234567 A1	Publication Date MM-DD-YYYY	Name of Patentee or Applicant	Pages, Columns, Lines Where Relevant Passages or Relevant Figures Appear	T ¹
	92	CA 2,249,668	04-07-1999	Bruno et al.		
	93	EP 1 389 862 A1	02-18-2004	Shen et al.		

Examiner Signature	Date Considered
--------------------	-----------------

***Examiner:** Initial if reference considered, whether or not citation is in conformance with MPEP 609. Draw line through citation if not in conformance and not considered. Include copy of this form with next communication to applicant.

INFORMATION DISCLOSURE STATEMENT BY APPLICANT	Application No.	12/513,147	
	Filing Date	March 1, 2010	
	First Named Inventor	Clay Perreault	
	Art Unit	2614	
<i>(Multiple sheets used when necessary)</i>		Examiner	Unassigned
SHEET 6 OF 6		Attorney Docket No.	SMARB19.001APC

FOREIGN PATENT DOCUMENTS

Examiner Initials	Cite No.	Foreign Patent Document Country Code-Number-Kind Code Example: JP 1234567 A1	Publication Date MM-DD-YYYY	Name of Patentee or Applicant	Pages, Columns, Lines Where Relevant Passages or Relevant Figures Appear	T ¹
	94	WO 2007/044454 A2	04-19-2007	Croy et al.		
	95	WO 2008/052340 A1	05-08-2008	Perreault et al.		
	96	WO 2008/064481 A1	06-05-2008	Bjorsell et al.		
	97	WO 2008/116296 A1	10-02-2008	Bjorsell et al.		

NON PATENT LITERATURE DOCUMENTS

Examiner Initials	Cite No.	Include name of the author (in CAPITAL LETTERS), title of the article (when appropriate), title of the item (book, magazine, journal, serial, symposium, catalog, etc.), date, page(s), volume-issue number(s), publisher, city and/or country where published.	T ¹
	98	F. Baker et al. "RFC 3924 - Cisco Architecture for Lawful Intercept in IP Networks." October 2004.	
	99	Cisco. "Lawful Intercept Requirements Summary." http://www.faqs.org/rfcs/rfc3924.html . November 8, 2006.	
	100	Sippy SIP B2BUA. "About Sippy RTPproxy." http://www.rtpproxy.org . July 15, 2009.	
	101	ETSI Technical Specification. "Lawful Interception (LI); Handover Interface and Service-Specific Details (SSD) for IP delivery; Part 5: Service-specific details for IP Multimedia Services." Apr 2008, 25 pgs, v.2.3.1, France.	
	102	M. Handley et al. "RFC 2543 - SIP: Session Initiation Protocol." March 1999.	
	103	A copy of the International Search Report and Written Opinion of the International Searching Authority completed June 6, 2008 for related PCT/CA2008/000545.	
	104	A copy of the International Search Report and Written Opinion of the International Searching Authority completed February 6, 2008 for corresponding PCT/CA2007/001956.	
	105	A copy of the International Preliminary Report on Patentability mailed May 14, 2009 for corresponding PCT/CA2007/001956.	
	106	A copy of the International Search Report and Written Opinion of the International Searching Authority completed March 3, 2008 for related PCT/CA2007/002150.	
	107	A copy of the International Preliminary Report on Patentability mailed February 13, 2009 for related PCT/CA2007/002150.	

8659055\cey
030410

Examiner Signature	Date Considered
* Examiner: Initial if reference considered, whether or not citation is in conformance with MPEP 609. Draw line through citation if not in conformance and not considered. Include copy of this form with next communication to applicant.	

T¹ - Place a check mark in this area when an English language PATE... APPLE INC. EX. 1002-355

Electronic Acknowledgement Receipt

EFS ID:	7264530
Application Number:	12513147
International Application Number:	
Confirmation Number:	9611
Title of Invention:	PRODUCING ROUTING MESSAGES FOR VOICE OVER IP COMMUNICATIONS
First Named Inventor/Applicant Name:	Clay Perreault
Customer Number:	20995
Filer:	John M Carson/Chelsea Pearsall
Filer Authorized By:	John M Carson
Attorney Docket Number:	SMARB19.001APC
Receipt Date:	23-MAR-2010
Filing Date:	01-MAR-2010
Time Stamp:	18:21:58
Application Type:	U.S. National Stage under 35 USC 371

Payment information:

Submitted with Payment	no
------------------------	----

File Listing:

Document Number	Document Description	File Name	File Size(Bytes)/ Message Digest	Multi Part /.zip	Pages (if appl.)
1	NPL Documents	Baker.pdf	667164 1471e458f1c9e4b6ac12bd46159b5d0f5dd a26ff	no	17

Warnings:

Information:

PETITIONER APPLE INC. EX. 1002-356

2	Foreign Reference	CA2249668.pdf	1174725	no	40
			d4aaacc5e455ccdf137a946905bdea8d83076b90		
Warnings:					
Information:					
3	NPL Documents	Cisco.pdf	68163	no	3
			91d138106dfdd1b1fab6eedc25af5e04d6695f79		
Warnings:					
Information:					
4	Foreign Reference	EP_1389862.pdf	587495	no	11
			4ea93d27029a7a2ccd13c0a9b96a7dea71d323f6		
Warnings:					
Information:					
5	NPL Documents	ETSI.pdf	1168640	no	25
			ffc7b9dd1209a2f525970e82c3383e138b1503dc		
Warnings:					
Information:					
6	NPL Documents	Handley.pdf	543780	no	143
			cc94c33f37fe2135b3a8bb510cc781bc37c38708		
Warnings:					
Information:					
7	NPL Documents	IPRP_PCT_CA2007_001956.pdf	535190	no	10
			50b674114b078f2c665d9e060a0eb18335273e69		
Warnings:					
Information:					
8	NPL Documents	IPRP_PCT_CA2007_002150.pdf	1138415	no	27
			ac7f2a930f363ff846c404dfb423e748360f67b3		
Warnings:					
Information:					
9	NPL Documents	ISR_PCT_CA2007_001956.pdf	703721	no	12
			f9277a31dd1e5e1f8593ab3faa963fa6ef100cb5		
Warnings:					
Information:					
10	NPL Documents	ISR_PCT_CA2007_002150.pdf	772250	no	12
			46225a5684736c59ee6ad21f7f6200e0712565		
Warnings:					
Information:					
PETITIONER APPLE INC. EX. 1002-357					

11	NPL Documents	ISR_PCT_CA2008_000545.pdf	465629 73e1c60478b6c0911685c4bc4120f9798f2a74b7	no	9
Warnings:					
Information:					
12	NPL Documents	Sippy.pdf	100886 cf5621fd013d1dd2467e249586f59380e919c175	no	2
Warnings:					
Information:					
13	Foreign Reference	WO_2007_044454.pdf	1043708 115ae967479afe4a10afb4833cbc63f57fe4af71	no	27
Warnings:					
Information:					
14	Foreign Reference	WO_2008_052340.pdf	4979083 8a625f700c9166971f8e24354fca1cf84438f6e5	no	138
Warnings:					
Information:					
15	Foreign Reference	wo_2008_064481.pdf	4164466 451841c647c0f93044680149525b32ed349b6d32	no	109
Warnings:					
Information:					
16	Foreign Reference	WO_2008_116296.pdf	3463876 df82ffba8cc7eba62a7596d8924acdffc91854e	no	89
Warnings:					
Information:					
17		SMARB19_001APC.pdf	387605 97a341141f102f2987f786254609613a553357bb	yes	7
	Multipart Description/PDF files in .zip description				
	Document Description		Start	End	
	Transmittal Letter		1	1	
	Information Disclosure Statement (IDS) Filed (SB/08)		2	7	
Warnings:					
Information:					
Total Files Size (in bytes):			21964796		

This Acknowledgement Receipt evidences receipt on the noted date by the USPTO of the indicated documents, characterized by the applicant, and including page counts, where applicable. It serves as evidence of receipt similar to a Post Card, as described in MPEP 503.

New Applications Under 35 U.S.C. 111

If a new application is being filed and the application includes the necessary components for a filing date (see 37 CFR 1.53(b)-(d) and MPEP 506), a Filing Receipt (37 CFR 1.54) will be issued in due course and the date shown on this Acknowledgement Receipt will establish the filing date of the application.

National Stage of an International Application under 35 U.S.C. 371

If a timely submission to enter the national stage of an international application is compliant with the conditions of 35 U.S.C. 371 and other applicable requirements a Form PCT/DO/EO/903 indicating acceptance of the application as a national stage submission under 35 U.S.C. 371 will be issued in addition to the Filing Receipt, in due course.

New International Application Filed with the USPTO as a Receiving Office

If a new international application is being filed and the international application includes the necessary components for an international filing date (see PCT Article 11 and MPEP 1810), a Notification of the International Application Number and of the International Filing Date (Form PCT/RO/105) will be issued in due course, subject to prescriptions concerning national security, and the date shown on this Acknowledgement Receipt will establish the international filing date of the application.

(12)

(21) 2 249 668

(51) Int. Cl.⁶: H04L 12/56, H04L 12/46

(22) 05.10.1998

(30) 08/946,175 US 07.10.1997

(73)

AT&T CORP.
32 Avenue of the Americas NEW YORK XX (US).

ROSEN, KENNETH H. (US).
BRUNO, RICHARD FRANK (US).
MARKOWITZ, ROBERT EDWARD (US).
ROBINSON, BETHANY SCOTT (US).
KATSEFF, HOWARD PAUL (US).

(72)

(74)

KIRBY EADES GALE BAKER

(54) METHODES ET SYSTEMES DE GESTION DYNAMIQUE DU ROUTAGE D'INFORMATION SUR UN RESEAU UNIVERSEL INTEGRE DE COMMUNICATION

(54) METHODS AND SYSTEMS FOR DYNAMICALLY MANAGING THE ROUTING OF INFORMATION OVER AN INTEGRATED GLOBAL COMMUNICATION NETWORK

(57)

Methods and systems for routing information in an integrated global communications network comprising a signalling system interconnecting a source router, a plurality of intermediate routers, a destination router and a routing processor for routing the multimedia information. The source router receives the information including the routing requirements associated with the information and transmits a routing query signal to the routing processor. The routing processor evaluates the routing requirements, determines which routers and communication paths are capable and available to route the information, evaluates the statistical availability of such routers and selects an optimal routing path comprising select ones of the available routers and communication paths.

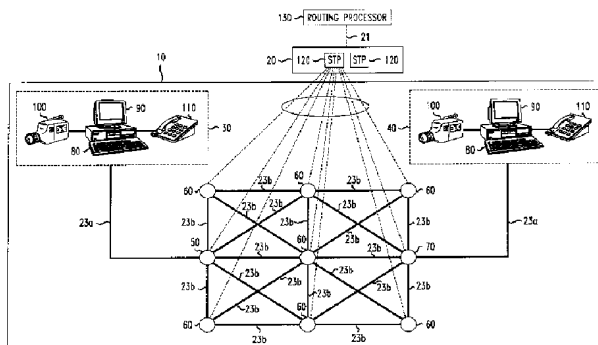



(22) **Date de dépôt/Filing Date:** 1998/10/05
 (41) **Mise à la disp. pub./Open to Public Insp.:** 1999/04/07
 (45) **Date de délivrance/Issue Date:** 2003/12/23
 (30) **Priorité/Priority:** 1997/10/07 (08/946,175) US

(51) **Cl.Int.⁶/Int.Cl.⁶** H04L 12/56, H04L 12/46

(72) **Inventeurs/Inventors:**
 BRUNO, RICHARD FRANK, US;
 KATSEFF, HOWARD PAUL, US;
 MARKOWITZ, ROBERT EDWARD, US;
 ROBINSON, BETHANY SCOTT, US;
 ROSEN, KENNETH H., US

(73) **Propriétaire/Owner:**
 AT&T CORP., US

(74) **Agent:** KIRBY EADES GALE BAKER

(54) **Titre :** METHODES ET SYSTEMES DE GESTION DYNAMIQUE DU ROUTAGE D'INFORMATION SUR UN RESEAU UNIVERSEL INTEGRE DE COMMUNICATION
 (54) **Title:** METHODS AND SYSTEMS FOR DYNAMICALLY MANAGING THE ROUTING OF INFORMATION OVER AN INTEGRATED GLOBAL COMMUNICATION NETWORK

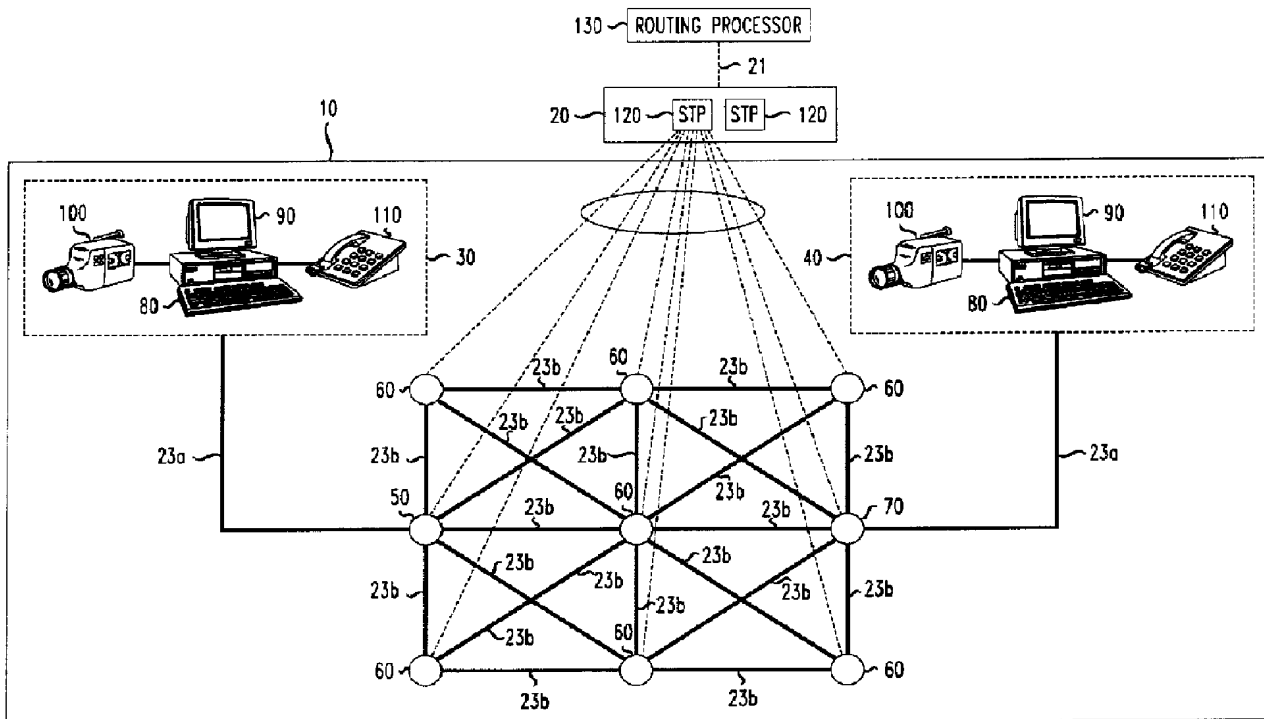

(57) **Abrégé/Abstract:**

Methods and systems for routing information in an integrated global communications network comprising a signalling system interconnecting a source router, a plurality of intermediate routers, a destination router and a routing processor for routing the multimedia information. The source router receives the information including the routing requirements associated with the



(57) Abrégé(suite)/Abstract(continued):

information and transmits a routing query signal to the routing processor. The routing processor evaluates the routing requirements, determines which routers and communication paths are capable and available to route the information, evaluates the statistical availability of such routers and selects an optimal routing path comprising select ones of the available routers and communication paths.

**Methods And Systems For Dynamically Managing The Routing Of
Information Over An Integrated Global Communication Network**

5

ABSTRACT

10

15

Methods and systems for routing information in an integrated global communications network comprising a signalling system interconnecting a source router, a plurality of intermediate routers, a destination router and a routing processor for routing the multimedia information. The source router receives the information including the routing requirements associated with the information and transmits a routing query signal to the routing processor. The routing processor evaluates the routing requirements, determines which routers and communication paths are capable and available to route the information, evaluates the statistical availability of such routers and selects an optimal routing path comprising select ones of the available routers and communication paths.

5

**METHODS AND SYSTEMS FOR DYNAMICALLY
MANAGING THE ROUTING OF INFORMATION OVER
AN INTEGRATED GLOBAL COMMUNICATION
NETWORK**

10

FIELD OF THE INVENTION

15

The present invention relates generally to the field of managing the routing of information over an integrated global communication network, such as the Internet, and, more particularly, to the methods and systems for reserving routing paths for routing information over the network.

BACKGROUND OF THE INVENTION

20

As is well known, the Internet is a vast collection of computers that communicate over a packet network via high-speed communication paths ranging from ISDN to T1, T3, FDDI, SONET, SMDS, OT1, etc. A personal computer typically accesses the Internet through a modem on a user's "Plain Old Telephone Service" (POTS) line or through a switched ISDN.

25

Alternatively, a personal computer can access the Internet through a X.25, Frame Relay (FR) or Asynchronous Transfer Mode (ATM) connection on a high-speed local area network (LAN) or wide area network (WAN).

Connecting a personnel computer to the LAN requires a card known as a LAN adapter that plugs into the computer's expansion bus. Once Internet access is

established, the Internet communicates information from the source computer to a destination over a routing path using any one of a number of protocols, such as the Internet Protocol (IP).

5 With the increased routing of multimedia (voice, video and data) calls over the Internet, there continues to be a growing demand for modifications to the routing component of the Internet infrastructure to support real-time quality transmission of information. For example, video applications have characteristics including file size, flow rate and sensitivity to delay that distinguish them from other applications that share the same
10 network. A single video file can be hundreds of megabytes or gigabytes long, whereas traditional data is significantly shorter. Further, a traditional data application is sent over a network as a burst of packets, whereas a video application is sent as a continuous stream of data which must be delivered quickly and regularly. When packetized, transmission delays must not vary by
15 more than a few milliseconds. Data that arrives too late is discarded resulting in diminished quality of display. Moreover, the frames occupy space in queues, delaying the rest of the traffic and possibly causing such traffic to be discarded as well. Thus, the key requirement is to reduce the end-to-end packet delays (e.g. jitter) in order to satisfy real-time delivery constraints and
20 achieve the necessary high nodal throughput (e.g. message latency) for the transfer of real-time voice and video.

Currently, the management of routing between the Internet and

the various routers are commonly performed over a signalling network, such as Resource Reservation Protocol (RSVP), which visits routers in the network and attempts to make a resource reservation to obtain routes that are capable of routing particular multimedia information.

5 The current Internet routing structure, however, lacks the ability to provide advanced reservation of optimal routing paths for such real-time multimedia information. Such advanced reservation is desirable in reducing jitter and achieving high message latency in the transmission of such information. It is therefore desirable to improve the routing of multimedia
10 information through the integrated global communication network such that the desired transmission is achieved.

SUMMARY OF THE INVENTION

In one aspect, the invention features a system for managing the routing of information to a destination through a packet network that includes a
15 plurality of routers, wherein each router in the packet network is linked to at least one other router by a first communication medium. The system comprises a routing processor for receiving a routing query specifying a destination to which the information will be routed and a memory for storing at least one characteristic of each of the routers in the packet network, wherein the
20 characteristic includes statistical information. The processor has direct access to the characteristic information of the routers and determines a route for the transmission of the information based on the routing query and on the characteristics stored in the memory, wherein the route comprises at least two of the routers. The system also comprises a second communication medium for
25 transmitting signals from the processor to the router, wherein the second

communication medium differs from the first communication medium.

In another aspect of the invention, the invention features a system for routing information to a destination, which comprises a packet network and a routing processor. The packet network includes a plurality of routers, wherein each router is linked to at least one other router by a communication medium. The routing processor receives a routing query signal from a first one of the routers and information concerning at least one characteristic of each of the remaining routers. The routing processor then determines a transmission path for routing the information through the packet network based on the routing query and on the characteristics stored in the memory, wherein the route comprises at least two of the routers.

In accordance with one aspect of the present invention there is provided a system for managing the routing of information to a destination through a packet network that includes a plurality of routers, each router being linked to at least one other router by a first communication medium, said system comprising: a routing processor for receiving a routing query specifying a destination to which said information will be routed; a memory for storing at least one characteristic of each of said routers in said packet network, said characteristic including statistical information; wherein said processor has direct access to said characteristic of said routers and determines a route for the transmission of said information based on said routing query and on said characteristics stored in said memory, said route comprising at least two of said routers; and a second communication medium for transmitting signals from said processor to said routers, wherein the second communication medium differs from the first communication medium.

In accordance with another aspect of the present invention there is provided a method for managing the routing of information to a destination through a packet network, wherein said network includes a plurality of routers, each router being linked to at least one other router by a first communication medium, said method comprising the steps of: receiving a routing query specifying a destination to which said information will be routed at a routing processor; storing at least one characteristic of each of said routers, said characteristic including statistical information, wherein said characteristic of said routers may be directly accessed by said processor; determining a route for the transmission of said information based on said routing query and on said stored characteristics, said route comprising at least two of the routers; and transmitting said route from said processor to said routers via a second communication medium, wherein the second communication medium differs from the first communication medium.

In yet another aspect of the invention, the invention features a method for managing the routing of information to a destination in a packet network that includes a plurality of routers, wherein each router is linked to at least one other router by a communication medium. The method comprises the steps of receiving a routing query signal from a first one of the routers and information concerning at least one characteristic of each of the remaining routers and determining a transmission path for routing the information through the packet network. The transmission path comprises at least one router in addition to the first router. Such routing can be implemented for both Internet and Intranet traffic.

5a

BRIEF DESCRIPTION OF THE DRAWINGS

FIG. 1 is a block diagram illustrating a system for managing the routing of information over an integrated global communication network in accordance with one embodiment of the present invention;

5 FIG. 2 is a functional block diagram of a method for managing the routing of information over an integrated global communication network using the system of FIG. 1;

FIG. 3 is a block diagram illustrating an embodiment of the routing processor of FIG. 1;

10 FIG. 4 is a block diagram illustrating an embodiment of the

routers of FIG 1.

DESCRIPTION OF THE PREFERRED EMBODIMENTS

FIG. 1 shows a simplified integrated global data communication network suitable for use in accordance with an embodiment of the present invention. It will of course be recognized that the network of FIG. 1 includes other known elements, but those elements have been omitted for simplicity.

Referring to FIG. 1, there is illustrated an integrated global communication network **10**, such as the Internet, that uses a signalling system **20** for communicating messages. The network **10** includes plural multimedia terminals **30** and **40**, communication paths **23a** and **23b**, a source router **50**, a plurality of intermediate routers **60** and a destination router **70**. Of course, an actual network could include many more such terminals, paths and routers.

As shown, multimedia terminals **30** and **40** each include a processing unit **80**, a CRT **90**, and a camera **100**. The terminals **30** and **40** are used merely as an example and may include a variety of other communication devices, including but not limited to an associated telephone **110** located external to each of the processing units **80** for purposes of dialing another terminal's telephone number when the processing units **80** are incapable of doing so directly. Because of the numerous types of multimedia capable devices which may be utilized in connection with the invention, the integrated global communication network **10** may also include additional processing equipment (not shown) at the destination, for example, a cable converter,

satellite transmission converter or personal computer may be necessary to convert a message to a format compatible with that destination. A more detailed general background on multimedia communication, and particularly, desktop videoconferencing and collaborative video equipment may be found in Don Labriola, Meeting on the Edge, Windows Sources, Sept. 1994, p. 96 et seq.

Each of the processing units **80** may be a general purpose computer with multimedia capable equipment and/or packetized voice hardware and/or software incorporated therein. A more detailed description of the construction and operation of the Vistium video system may be found in Andrew W. Davis, VISTIUM: AT&T's Board-Level Videoconferencing at the Desktop, Advanced Imaging, Sept. 1994, p. 46 et seq. Alternatively, the processing unit may be any multimedia specific device.

The signalling system **20** interconnects the various components of the network **10**, including source router **50**, intermediate routers **60**, and destination router **70** to routing processor **130**. Preferably, the signalling system **20** used by the network is an SS7 network of interconnected STPs **120**. As is well known, the SS7 network utilizes a SS7 protocol which consists of four basic sub-protocols. These sub-protocols are: message transfer part (MTP) which provides the function of basic routing of signalling messages between signalling points; a signalling connection control part (SCCP) which

provides additional routing and management functions for transfer of messages other than call set-up between the signaling points; an integrated services digital network (ISDN) user part (ISUP) which transfers call set-up signaling information between signaling points; and a transaction capabilities part (TCAP) which transfers non-circuit related information between the signaling points.

The signalling system **20** illustrated in FIG. 1 includes the preferred SS7 network of interconnected STPs **120**. Those skilled in the art will recognize that STP **120** is a multi-port, high speed packet switch that directs traffic among entities on a network. It should be noted that signal transfer point devices such as STP **120** are conventionally installed in redundant pairs within a network, as illustrated, so that if one device fails, its mate takes over until the first STP **120** is able to return to service.

As is illustrated in FIG. 1, STP **120** is connected to routing processor **130** by communication path **21** and the source router **50**, the intermediate routers **60**, and the destination router **70** are connected to STP **120** by communication path **22**. It should be noted that separate paths are provided for communication paths **21** and **22**, that communicate routing message signals, and communication paths **23a** and **23b**, that actually communicate the information. Communication paths **21** and **22** are preferably high digital serial A-links, which transfer routing message signals between elements **50**, **60**, **70**, **120**, and **130** using out-of-band signaling with other

communications protocols. It is understood that communication paths **21** and **22** are logical paths, although the communication paths could be physical paths.

5 After the signalling system **20** completes sending the routing message signals via STP **120** through communication paths **21** and **22**, communication paths **23a** and **23b** transfer the multimedia information from terminal **30** to terminal **40** through a routing path including source router **50**, select intermediate routers **60**, and destination router **70** over communication paths **23a** and select communication paths **23b**. In most instances, the
10 multimedia information will be routed from multimedia terminal **30** to source router **50** and destination router **70** to terminal **40**, through communication paths **23a** via an LEC (not shown) in a public switched network or via a private switched network (not shown) and through intermediate routers **60** via communication paths **23b**. Communication paths **23a** and **23b** comprise
15 digital links, which are preferably high speed (1.544 Mbps) T-1 span over which information is transmitted using in-band-signaling in a serial fashion. Other known communication paths, besides the preferred T-1 links, which are also suitable for use in conjunction with this invention include, for example, Feature Group D Data Trunks (sometimes referred to as "FG-D"), as well as
20 ATM, FR, ISDN BRI, ISDN PRI, T1, Switched 56 (SW56), 45Kbps DS-3/Datapath, 56 Kbps DDS/Datapath, or nxDS-0 paths.

It will be recognized that the types and combinations of

communication paths **23a** and **23b** which may be employed are too numerous to discuss in detail. It should therefore be recognized that the preferred embodiment will work with communication paths **23a** and **23b** that are capable of supporting packetized voice and/or a combination of single or multi-channel video, audio or data requiring different sizes of bandwidth. By way of example, where the path is an ISDN path it should support about 64 Kbps access for combinations of single channel video, audio and data or about 128 Kbps access for combinations of two channel video, audio and data. Where the path is T1 it should support about 1.5 Mbps access for combinations of single channel video, audio and data or about 3 Mbps access for combinations of two channel video, audio and data. Where the path is switched 56 it should support about 56 Kbps access for combinations of single channel video, audio and data or about 112 Kbps access for combinations of two channel video, audio and data. Where the path is DS-3 it should support about 45 Kbps access for combinations of single channel video, audio and data or about 90 Kbps access for combinations of two channel video, audio and data. Where the path is $n \times DS-0$, the path should support $n \times 64$ Kbps access, where n is the number of channels.

In the embodiment illustrated in FIG. 1, the source router **50**, intermediate routers **60**, and destination router **70** could be any number of conventional routers capable of routing information over the network **10** and processing signalling messages over signalling system **20**. Similarly, the

routing processor **130** is illustratively shown as and may be implemented using a 2NCP processor also available from Lucent Technologies Inc., but could otherwise be any processing means capable of processing signalling messages communicated over the signalling system **20**. The routing processor **130** is
5 utilized to control routing of multimedia (i.e, real-time video or audio) information associated with a network subscriber.

While only a specific number of intermediate routers **60**, STPs **120** and routing processor **130** are illustrated in FIG. 1, it is understood that the communication network **10** may include additional routers, STPs and/or
10 routing processors to process and complete such multimedia information over the network **10**. It is also understood that various trunks and other channels may be provided in the network **10** to connect, for instance, two or more routers to one another. It is further understood that various modifications may be made to the network **10** without departing from the scope of the invention.

15 Referring to FIG. 2, there is illustrated a block flowchart of the preferred method of using the system illustrated in FIG. 1, in which routing processor **130** controls the routing of multimedia information from multimedia terminal **30** to multimedia terminal **40** in network **10**.

20 In step **200**, source router **50** begins receiving a plurality of information packets that form a multimedia session from multimedia terminal **30**. Preferably, the packets are sent to source router **50** using Internet IP addressing and UDP protocol. Upon receiving the first packets, which include

the source and destination addresses and routing requirement information (e.g. bandwidth and time limitations on information transfer), the source router **50** sends a flow control ON message to the multimedia terminal **30** to hold further transmission of the remaining information packets that form the session. As is
5 known in the art, upon receiving the packet, the source router **50** translates the destination network address to a physical address in the Internet network.

In step **201**, the source router **50** sends a routing query to the service processor **130** via STP **120**. The routing query includes the source and destination addresses as well as routing requirements (e.g. bandwidth
10 requirements). The routing query is preferably a routing TCAP query message.

In step **202**, the routing processor **130** evaluates the list of intermediate routers **60** and corresponding communication paths **23b**, in Router Table **140** and Inventory Control Table **150**, and identifies intermediate
15 routers **60** (including any backup or secondary intermediate routers) and communication paths **23b** connected therebetween that have the appropriate bandwidth capability to route particular multimedia information.

In step **203**, the routing processor **130** identifies each intermediate router **60** in the list of intermediate routers **60** and corresponding
20 communication paths **23b**, previously identified by the routing processor **130** in step **202**, that is capable of processing the information to determine which routers are currently available.

Specifically, in step **203**, the routing processor **130** uses a pointer in a list of intermediate routers identified by the routing processor **130** to consider each router. The routing processor **130** determines whether the router, on the list to which the pointer is directed, is available. The routing processor **130** will then point to the "next" router in the list and repeat the process until the routing processor **130** has checked all of the routers in the list to ascertain their respective availability conditions. Once all of the routers in the list have been considered and the pointer is incremented back to the first router then the routing processor **130** proceeds to step **204**.

If the routing processor **130** determines in step **203** that all or some of the intermediate routers **60** in the list of routers **60** capable of routing particular multimedia information are available, then the routing processor **130** provides such router **60** and communication path **23b** information to its optimal route program **160** for determining the optimal routing path of intermediate routers **60** and communication paths **23b** between the source router **50** and the destination router **70** and its statistical program **170** for determining the frequency of use of such intermediate routers **60** (step **204**).

The optimal routing program **160**, discussed in more detail below in the description of FIG. 3, provides intelligence or decision making capabilities based upon stored programs and data which is available either in the **140** or Inventory Control Table **150** (see FIG. 3) or obtained from other data sources such as local dynamic routing databases **225** in individual routers

60 to calculate the optimal route. The optimal routing program **160** may for example be the Real-Time Network Routing (RTNR) program described in Ash et al. United States Patent Number 5,101,451.

5 The statistical program **170**, discussed in more detail below in the description of FIG. 3, utilizes the status information stored in the Inventory Control Table **150** to maintain a statistical record of performance of the system. The statistical program **160** and the optimal routing program **170** are both used by the routing processor **130** in determining several routing paths including an optimal routing path (step **204**).

10 After the routing paths are determined, the routing processor **130** selects a routing path (preferably, the optimal routing path, discussed in more detail below in the description of the optimal routing program **160** of FIG. 3) and the routing processor **130** retrieves from the Router Table **140** the SS7 network address of the desired routers **60** (step **206**). The routing processor **130**
15 also creates and transmits "Reserve" messages, preferably SS7 messages, instructing each of the intermediate routers **60** on this path to reserve a routing path including communication paths **23b** with the specific bandwidth and length capabilities to provide the requested quality of service. The intermediate routers **60** then send "Acknowledgement" messages to routing processor **130** (step
20 **206**).

Routing processor **130** transmits a "Proceed" message to the

source router **50** identifying the reserved router path and instructing the source router **50** to proceed to route the information within the network **10** (step **207**).

Source router **50** sends a flow control OFF message to terminal **30** instructing terminal **30** to continue to transmit the remaining information packets (step **208**). Terminal **30** then sends the remaining packets to source router **50** which forwards such packets to destination router **70** through intermediate router(s) **60** and communication paths **23b** on the reserved router path. (step **209**). In the preferred embodiment, the reserved routing path forms a permanent virtual connection, which will remain up even if the session is disconnected in error.

When terminal **40** receives all the information, either terminal **30** or terminal **40** transmit a "Disconnect" message to source router **50** or destination router **70**, respectively. (step **210**). Router **50** or **70** then forward this "Disconnect" message to all intermediate routers **60** on the reserved routing path, thereby disconnecting the session and ensuring that the session status is correct. (step **210**).

The routing processor **130** then updates its **140** and Inventory Control Table **150** changing the status of the intermediate routers **60** and communication paths **23b** in its lists from unavailable to spare. (step **211**).

Preferably, the routing processor then sends this information to the reserved intermediate routers **60** which update their local dynamic routing databases **225** from unavailable to spare. (step **212**).

Referring to FIG. 3, there is illustrated an embodiment of the routing processor 130 as shown in FIG. 1. The routing processor 130 includes an optimal routing program 160 and statistical program 170 each comprising a microprocessing unit (MPU) and each operating under program control as supported by a ROM, a RAM, an input keyboard, an output display monitor, and an input/output interface device which provide communication capability, i.e. transmission and reception, of information and commands to other elements of the routing processor 130 such as the Router Table 140 and Inventory Control Table 150 and routers 60 such as local dynamic database 225. The MPU is also supported by a non-volatile data storage device, such as a hard disk, which provides general storage of program controlled instructions and data which is utilized in decision making carried out by the optimal routing program 160 and statistical program 170. Each of the storage devices can be considered as storing data associated with different databases, Router Table 140 and Inventory Control Table 150. The routing processor 130 also includes an input/output module 190 which accommodates communication with the illustrated source router 50, intermediate routers 60 and destination router 70 via STPs 120.

The Router Table 140, in the illustrative embodiment is preferably stored within a database of the routing processor 130 and is utilized by the routing processor 130 to determine the SS7 network routing information associated with one or more intermediate routers 60 capable of

routing the information in accordance with the present invention. The Router Table **140** illustrated in FIG. 3 preferably comprises at least three columns. For example, the first column of the Router Table **140** identifies the routers **50, 60, 70** and corresponding communication paths **23a** and **23b**. The second column of the Router Table **140** contains each router Internet address and corresponding SS7 network address. Various router SS7 network addresses may be utilized to reach a router **60** capable of routing the information. The third column of the Router Table **140** contains the status of each router (e.g., available). The status of the router SS7 address is determined dynamically based on its SS7 network routing status.

The Inventory Control Table **150**, in the illustrative embodiment, stores logical, physical, and statistical information relating to intermediate router(s) **60** and communication paths **23b** (e.g. bandwidth and distance between routers **60**). For example, assuming the total bandwidth for the T-1 transport sections of intermediate router communication paths **23b** is 15.44 Mbps and that the bandwidth is divided into chunks of 8 Kbps. This bandwidth segment information is placed in the Inventory Control Table **150**.

The Inventory Control Table **150** also stores information relating to the availability and bandwidth consumption status of intermediate routers **60** and communication paths **23b** such routers **60**. One feature of the preferred embodiment is the capability of routing information based on current router availability. In order to minimize multimedia information-processing

time, it is desirable to have real-time status information concerning the availability of a router to accept incoming information. As used herein, "real-time" information means information available in a short time, e.g., a few seconds, as opposed to longer delays. Such real-time information
5 concerning each of routers **60** and communication paths **23b** availability is preferably stored in the Inventory Control Table **150**. Preferably, the higher speed communication paths **21** and **22** are utilized in order to provide the most current real-time status of each router **60** and communication path **23b** for utilization by routing processor **130**. Specifically, the stored information
10 includes records based on time of day routing, day of week routing, location routing, bandwidth consumption routing, and alternate routing in cases of busy conditions.

The Inventory Control Table **150** preferably, also contains data which reflects the availability of each router and contains corresponding time
15 data. For example, this database information can permit routers to be selected based upon the router that has been available for the longest time.

The optimal routing program **160**, in the illustrative embodiment, preferably determines the optimum routing path required to minimize the number of routing hops involved in completing the multimedia
20 call across the network and thus, results in reduced jitter. For example, assuming that each router introduces 50 milliseconds of delay, the optimal routing path used to transport voice over the integrated global communication

network should include no more than three router hops. Further, in computing the optimal path, the optimal routing program **160** takes into consideration the bandwidth required for the call and selects routers and associated communication paths that are capable of providing the best high nodal throughput for the call. For example, assuming the call requires bandwidth of about 1.5 Mbps the optimization will consider all routers **60** and associated communication paths **23b**, identified in the routing processor's **130** Routing Table **140** and Inventory Control Table **150**, with this bandwidth capability and then determine the optimal path utilizing select ones of these routers **60** and associated communication paths **23b**.

The statistical program **170**, in the illustrative embodiment, reviews the components of the network (i.e. has a global view of the network and the routers and the corresponding communication paths included therein) stored in the routing processor's **130** Routing Table **140** and Inventory Control Table **150** and determines the percentage of time each router is available or busy. The statistical program **170** also determines the percentage of time the corresponding communication paths are available to provide the requested bandwidth. Such statistical calculations are computed at different times of days and on different days of the week and the results of such calculations are then stored in the Inventory Control Table **150**.

Referring to FIG. 4, there is illustrated a block diagram of an embodiment of routers **50**, **60**, and **70** illustrated in FIG. 1. For discussion

purposes, the router is marked as an intermediate router **60**. Router **60** includes a packet scheduler **215** to hold information packets in a queue, a routing protocol **220** to store handling instructions and decision making processes for routing information based on the specific routing requirements, a
5 local dynamic routing data base **225** to store individual router information including bandwidth consumption and communication path **23b** information and a local route selection **230** which is used by the router in determining which communication paths **23b** are capable of routing multimedia information. Router **60** routes information over communication paths, such as
10 communication path **23b**, as discussed above. These existing routers can be modified, however, to also include input/output module (I/O) **190** to accommodate communication of routing message signals between such routers and the routing processor **130** through communication paths **22** via STPs **120**.

15 Although an illustrative preferred embodiment has been described herein in detail, it should be noted and will be appreciated by those skilled in the art that numerous variations may be made within the scope of this invention without departing from the principle of this invention and without sacrificing its chief advantages. For instance, it is understood that,
20 while the present invention has been described above with respect to "SS7" messaging over a signalling system, other types of signalling systems may be utilized to interconnect and communicate signalling messages between the

various components of the integrated global communication network. The terms and expressions have been used herein as terms of description and not terms of limitation. There is no intention to use the terms or expressions to exclude any equivalents of features shown and described or portions thereof and this invention should be defined in accordance with the claims which follow.

5

CLAIMS:

1. A system for managing the routing of information to a destination through a packet network that includes a plurality of routers, each router being linked to at least one other router by a first communication medium, said system comprising:

5

a routing processor for receiving a routing query specifying a destination to which said information will be routed;

a memory for storing at least one characteristic of each of said routers in said packet network, said characteristic including statistical information:

10

wherein said processor has direct access to said characteristic of said routers and determines a route for the transmission of said information based on said routing query and on said characteristics stored in said memory, said route comprising at least two of said routers; and

15

a second communication medium for transmitting signals from said processor to said routers, wherein the second communication medium differs from the first communication medium.

2. The system according to claim 1, wherein said characteristic includes information relating to the bandwidth of said communication medium.

20

3. The system according to claim 1, wherein said characteristic includes statistical information relating to the availability of each of said routers.

4. The system according to claim 3, wherein said statistical information includes information relating to the availability of each of said routers at specific times of day.

5. The system according to claim 3, wherein said statistical information includes information relating to the availability of each of said routers on specific days of the week.

6. A system for routing information to a destination, said system comprising:

a packet network that includes a plurality of routers, wherein each router is linked to at least one other router by a first communication medium;

a routing processor for receiving a routing query signal from a first one of said routers and information concerning at least one characteristic of each of said remaining routers, said characteristic including statistical information, said routing processor determining a transmission path for routing said information through said packet network, said transmission path comprising at least one router in addition to said first router;

wherein said routing processor has direct access to said characteristic of said routers and determines said transmission path based on said routing query signal and on said received characteristics; and

a second communication medium for transmitting signals from said processor to said routers, wherein the second communication medium differs from the first communication medium.

7. The system according to claim 6, wherein said routing processor transmits reservation signals to each of said routers on said transmission path.

8. The system according to claim 6, wherein said characteristic includes at least one address for each of said routers.

9. The system according to claim 6, wherein said characteristic includes information relating to the bandwidth of said communication medium.

10. The system according to claim 6, wherein said characteristic includes statistical information relating to the availability of each of said router.

11. The system according to claim 10, wherein said statistical information includes information relating to the availability of each of said routers at specific times of day.

12. The system according to claim 10, wherein said statistical information includes information relating to the availability of each of said routers on specific days of the week.

13. The system according to claim 6, wherein said routing processor includes a program for calculating statistical information about each of said routers based on characteristics stored in memory.

14. A system for managing the routing of information to a destination, said system comprising:

a packet network that includes a plurality of routers, wherein each router is linked to at least one other router by a first communication medium; and

a router processor in communication with said routers through a signalling system, wherein said signalling system transmits signals using a second communication medium that differs from the first communication medium;

wherein said routing processor receives a routing query signal from a first one of said routers and information concerning at least one characteristic of each of said remaining routers through said signalling system, said characteristic including statistical information, said routing processor
5 determining a transmission path for routing said information through said packet network, said transmission path comprising at least one router in addition to said first router;

wherein said routing processor has direct access to said characteristic of said routers and determines said transmission path based on
10 said routing query signal and on said received characteristics.

15. The system according to claim 14, wherein said routing processor transmits reservation signals to each of said routers on said transmission path.

16. The system according to claim 14, wherein said
15 characteristic includes at least one address for each of said routers.

17. The system according to claim 14, wherein said characteristic includes information relating to the bandwidth of said communication medium.

18. The system according to claim 14, wherein said
20 characteristic includes statistical information relating to the availability of each of said routers.

19. The system according to claim 18, wherein said statistical information includes information relating to the availability of each of said routers at specific times of day.

20. The system according to claim 18, wherein said statistical information includes information relating to the availability of each of said routers on specific days of the week.

5 21. The system according to claim 14, wherein said routing processor includes a program for calculating statistical information about each of said routers based on characteristics stored in memory.

22. The system according to claim 14, wherein said signalling system utilizes SS7 messaging capabilities.

10 23. The system according to claim 14, wherein said signalling system includes at least one signal transfer point.

24. A system for managing the routing of multimedia information to a destination, said system comprising:

15 a packet network that includes a plurality of routers, wherein each router is linked to at least one other router by a first communication medium; and

a routing processor in communication with said routers through a signalling system, wherein said signalling system transmits signals using a second communication medium that differs from the first communication medium;

20 wherein said routing processor receives a routing query signal including routing requirements from a first one of said routers and information concerning at least one characteristic of each of said remaining routers through said signalling system, said characteristic including statistical information, said router processor identifies a plurality of routers that are capable of routing said
25 information, said routing processor has direct access to said characteristic of

said routers and determines a transmission path for routing said information based on said routing query and on said characteristic, through said packet network, said transmission path comprising at least one router in addition to said first router.

5 25. The system according to claim 24, wherein said routing processor transmits reservation signals to each of said routers on said transmission path.

 26. The system according to claim 24, wherein said signalling system utilizes SS7 messaging capabilities.

10 27. The system according to claim 24, wherein said signalling system includes at least one signal transfer point.

 28. A method for managing the routing of information to a destination through a packet network, wherein said network includes a plurality of routers, each router being linked to at least one other router by a first communication medium, said method comprising the steps of:

15 receiving a routing query specifying a destination to which said information will be routed at a routing processor;

 storing at least one characteristic of each of said routers, said characteristic including statistical information, wherein said characteristic of said routers may be directly accessed by said processor;

20 determining a route for the transmission of said information based on said routing query and on said stored characteristics, said route comprising at least two of the routers; and

 transmitting said route from said processor to said routers via a second communication medium, wherein the second communication medium
25 differs from the first communication medium.

29. The method according to claim 28, wherein said step of storing characteristics includes the step of storing at least one address for each of said routers.

5 30. The method according to claim 28, wherein said step of storing characteristics includes the step of storing information relating to the bandwidth of said communication medium.

31. The method according to claim 28, wherein said step of storing characteristics includes the step of storing statistical information relating to the availability of each of said routers.

10 32. The method according to claim 31, wherein said step of storing statistical information further includes the step of storing information relating to the availability of each of said routers at specific times of day.

15 33. The method according to claim 31, wherein said step of storing statistical information further includes the step of storing information relating to the availability of each of said routers on specific days of the week.

34. A method for managing the routing of information to a destination in a packet network that includes a plurality of routers, wherein each router is linked to at least one other router by a first communication medium, said method comprising the steps of:

20 receiving a routing query signal from a first one of said routers and information concerning at least one characteristic of each of said remaining routers, said characteristic including statistical information, wherein said characteristic of said routers may be directly accessed by said processor;

25 determining a transmission path for routing said information through said packet network, said transmission path comprising at least one

router in addition to said first router, wherein said step of determining is based on said received routing query and on said received characteristics; and

transmitting said transmission path from said processor to said routers via a second communication medium, wherein the second communication medium differs from the first communication medium.

5

35. The method according to claim 34, further including the step of transmitting reservation signals to each of said routers on said transmission path.

36. The method according to claim 34, wherein said step of determining a transmission path includes the step of evaluating the bandwidth of said communication medium.

10

37. The method according to claim 34, wherein said step of determining a transmission path includes the step of evaluating the availability of each of said routers.

38. The method according to claim 34, wherein the step of determining a transmission path includes the step of calculating statistical information about each of said routers based on characteristics stored in memory.

15

39. The method according to claim 38, wherein said step of calculating statistical information includes the step of evaluating the availability of each of said routers at specific times of day.

20

40. The method according to claim 38, wherein said step of calculating statistical information includes the step of evaluating the availability of each of said routers on specific days of the week.

41. A method for managing the routing of information to a destination in a packet network that includes a plurality of routers, wherein each router is linked to at least one other router by a first communication medium, said method comprising the steps of:

5 receiving a routing query signal including routing requirements from a first one of said routers and information concerning at least one characteristic of each of said remaining router at a routing processor over a signalling system, wherein said signalling system transmits signals using a second communication medium that differs from the first communication
10 medium, said characteristic including statistical information, wherein said characteristic of said routers may be directly accessed by said processor;

identifying a plurality of routers that are capable of routing said information;

determining the availability of said identified routers; and
15 determining a transmission path for routing said information through said packet network based on said routing query and on said characteristic, wherein said transmission path comprises at least one of said identified routers in addition to said first router.

42. The method according to claim 41, wherein said step of
20 determining a transmission path includes the step of evaluating the bandwidth of said communication medium.

43. The method according to claim 41, wherein said step of determining a transmission path includes the step of evaluating the availability of each of said routers.

44. The method according to claim 41, wherein the step of determining a transmission path includes the step of calculating statistical information about each of said routers based on characteristics stored in memory.

5 45. The method according to claim 44, wherein said step of calculating statistical information includes the step of evaluating the availability of each of said routers at specific times of day.

46. The method according to claim 44, wherein said step of calculating statistical information includes the step of evaluating the availability
10 of each of said routers on specific days of the week.

47. A method for managing the routing of multimedia information to a destination in a packet network that includes a plurality of routers, wherein each router is linked to at least one other router by a first communication medium, said method comprising the steps of:

15 receiving a routing query signal including routing requirements from a first one of said routers and information concerning at least one characteristic of each of said remaining router at a routing processor over a signalling system, wherein said signalling system transmits signals using a second communication medium that differs from the first communication
20 medium, said characteristic including statistical information, wherein said characteristic of said routers may be directly accessed by said processor;

identifying a plurality of routers that are capable of routing said information;

determining the availability of each of said identified routers;

determining a plurality of transmission paths for routing said information through said packet network based on said routing query and on said characteristic, each of said transmission paths comprising at least one of said identified routers in addition to said first router, wherein said step of

5 determining each of said transmission paths is based on said routing query;

selecting one of said transmission paths for routing said information through said packet network;

sending reservation signals from said routing processor to said routers on said select routing path over said signalling system;

10 sending a routing response signal from said routing processor to said first router over said signalling system; and

routing said multimedia information over said select path.

FIG. 1

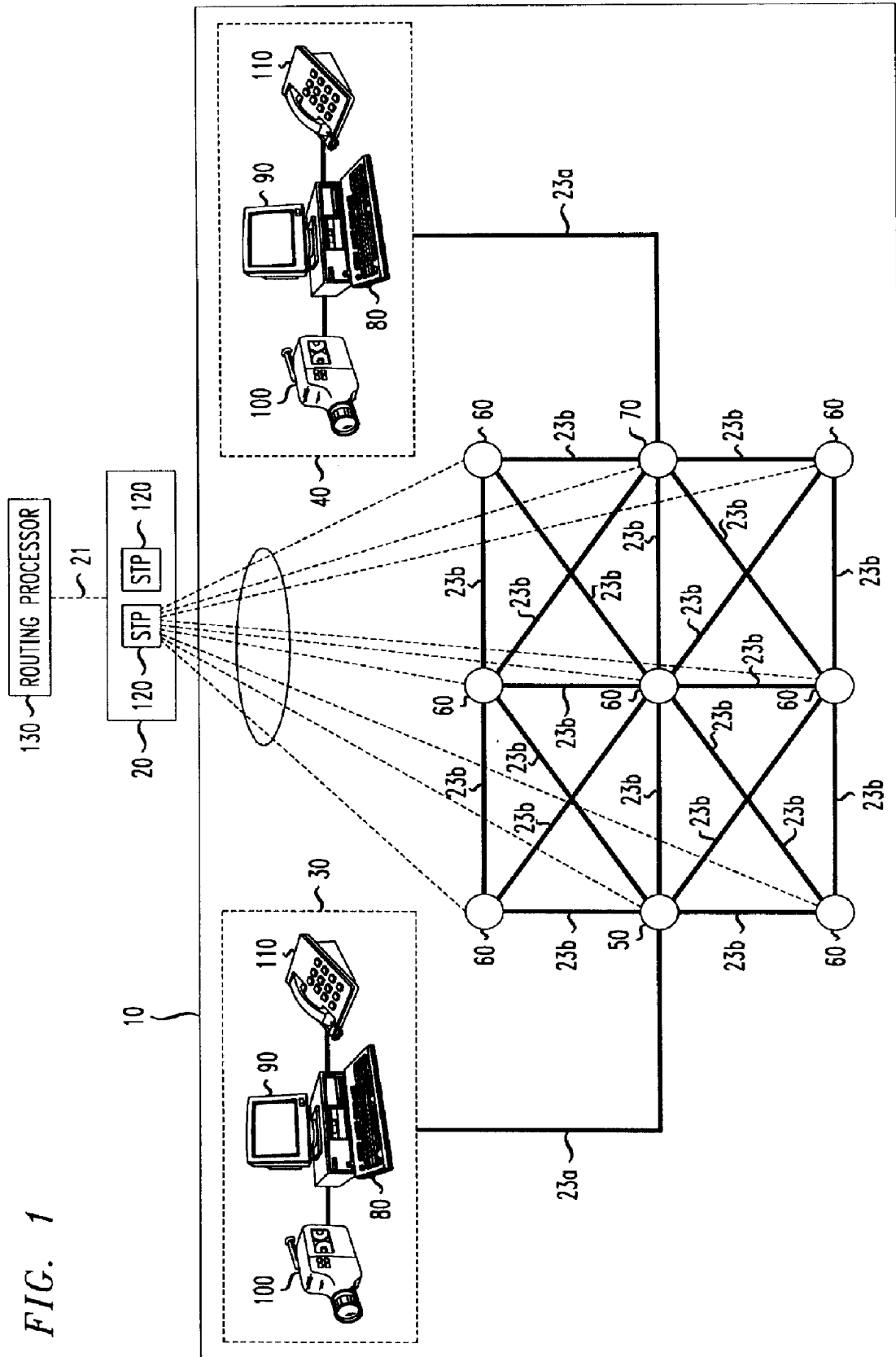

FIG. 2

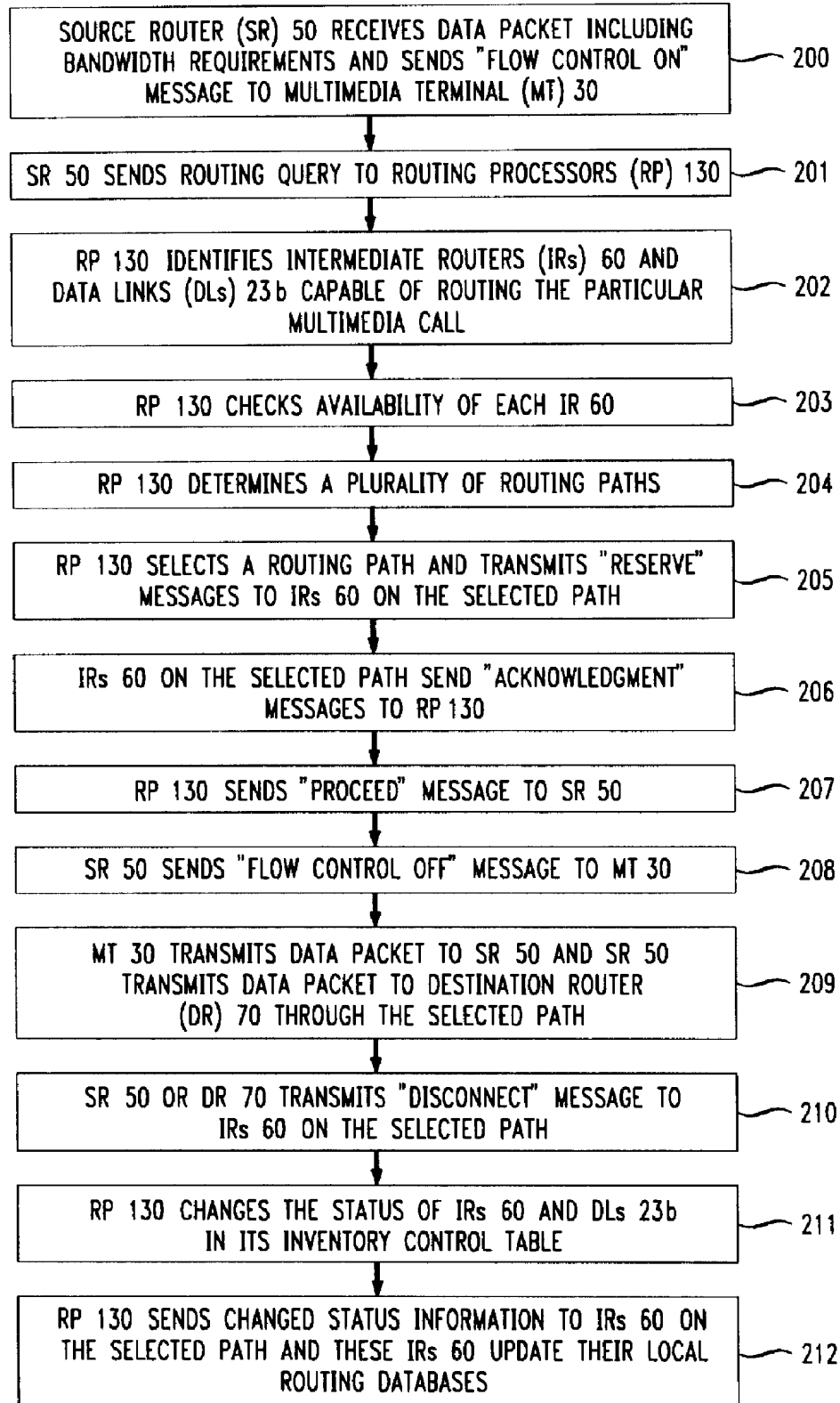

FIG. 3

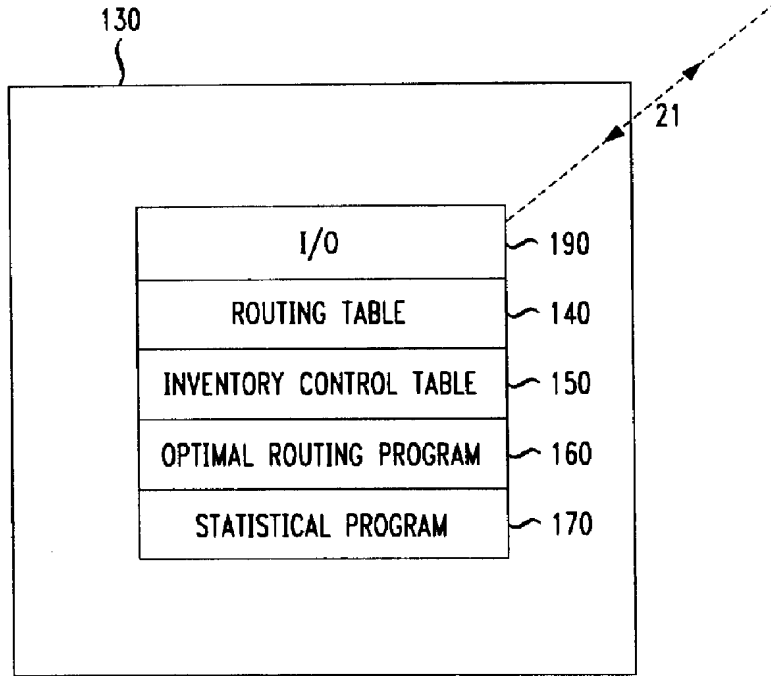
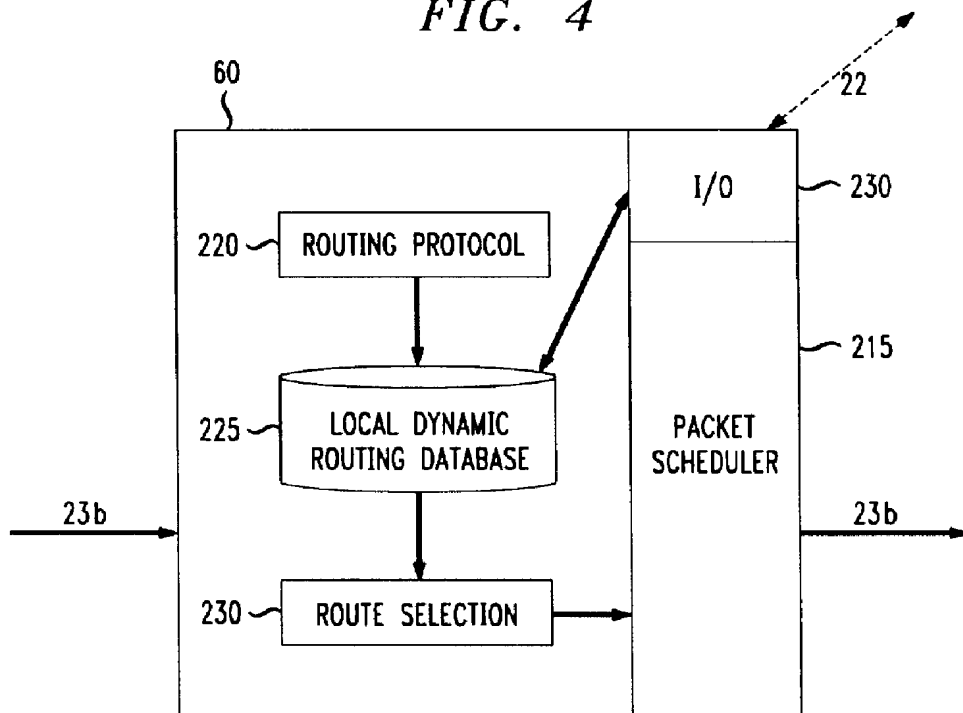

FIG. 4





(12) **EUROPEAN PATENT APPLICATION**

(43) Date of publication:
18.02.2004 Bulletin 2004/08

(51) Int Cl.7: **H04L 29/06, H04M 7/00**

(21) Application number: **02360235.2**

(22) Date of filing: **08.08.2002**

(84) Designated Contracting States:
AT BE BG CH CY CZ DE DK EE ES FI FR GB GR
IE IT LI LU MC NL PT SE SK TR
 Designated Extension States:
AL LT LV MK RO SI

• **Gorges, Thomas**
71638 Ludwigsburg (DE)

(74) Representative:
Menziotti, Domenico, Dipl.-Ing et al
Alcatel
Intellectual Property Department, Stuttgart
70430 Stuttgart (DE)

(71) Applicant: **ALCATEL**
75008 Paris (FR)

(72) Inventors:
 • **Shen, Yuzhong**
70499 Stuttgart (DE)

(54) **Lawful interception for VoIP calls in IP based networks**

(57) The lawful interception device to monitor media streams of two IP parties includes a SIP (Session Initiation Protocol) proxy server or a MGC (Media Gateway Controller) to detect information in the signalling information being transmitted between the two IP (Internet Protocol) parties and to generate instructions out of the

detected signalling information for instructing a RTP (Real-time Transport Protocol) proxy server to create channels to bypass a media stream to be intercepted via an intermediate storage medium. Due to adaptation of connection parameters in the SDP part of the SIP messages sent to the IP parties the interception is transparent to the IP parties.

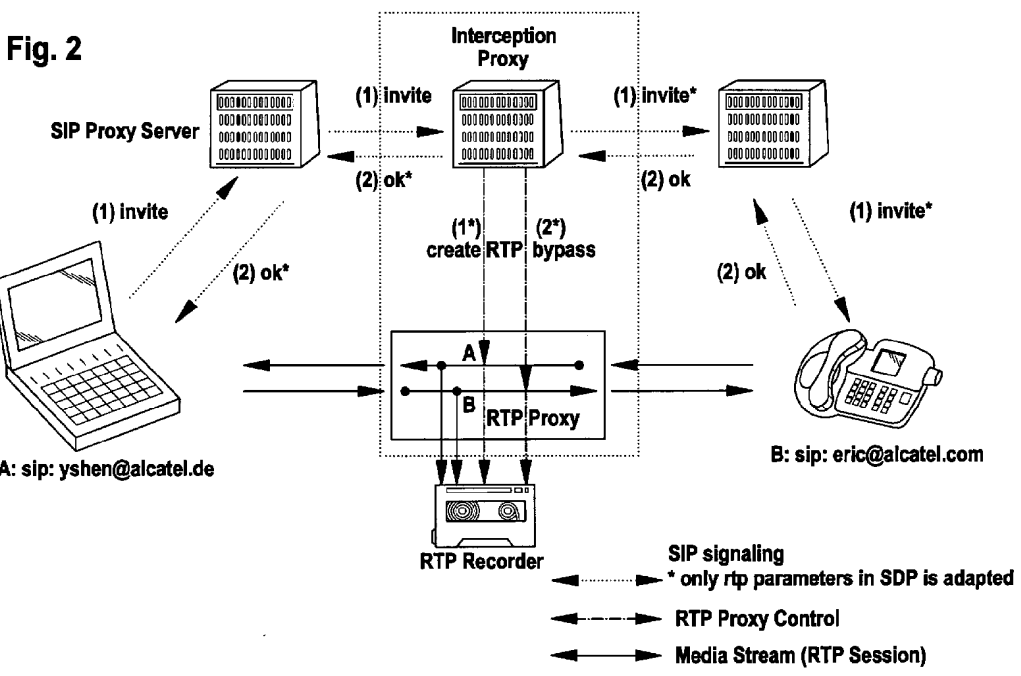

EP 1 389 862 A1

Description

TECHNICAL FIELD OF THE INVENTION

[0001] This invention is related in general to the field of telecommunications systems. More particularly, the invention is related to a lawful interception device for media streams, in particular VoIP calls in IP based networks.

BACKGROUND OF THE INVENTION

[0002] Current lawful interceptions are deployed in class4/class5 switches of PSTN/PLMN networks. In 3G/UMTS or next generation networks, a connection may be IP end to end. No traffics will go through class 5/class4 switches. That means current lawful interception solutions cannot be used here. One solution may undertake an analysis of IP packets in a related network node, but it's difficult to know which route a call (media stream) will take through the network.

SUMMARY OF THE INVENTION

[0003] It is an object of the invention to provide a lawful interception device for VoIP calls in IP based networks.

[0004] The inventive lawful interception device detects information in the signalling information being transmitted between two IP parties and generates instructions out of the detected signalling information for instructing a RTP (Real-time Transport Protocol) proxy server to create channels to bypass a VoIP call to be intercepted via an intermediate storage medium. Instead of voice each media stream could be intercepted, e.g. data, internet access, e-mail, video, real-time pictures, etc.

[0005] In a SIP (Session Initiation Protocol) interception proxy server, where interception should be controlled, applications for interception are running to chose calls for interception. If a call should be monitored, the SIP proxy server has first to hold the invite message from A party. There are listening information in SDP (session description protocol) part of invite message.

[0006] SIP proxy server then instructs a RTP proxy server via a RTP proxy control interface to allocate a bypass channel for monitoring the media stream (A channel: sending to A party). The RTP information of this bypass channel (listening part: ip and port) is included in SDP part in the SIP invite message and passed to its destination.

[0007] When SIP proxy server has received a response of B party, he instructs RTP proxy via RTP proxy control interface to allocate another bypass channel for monitoring the media stream (B channel: sending to B party). The RTP information of this second bypass channel (listening part: ip and port) is included in SDP part in SIP ok message and send to its origination (A party).

[0008] After session setup, both parties will start RTP connections to RTP proxy server depending on connection parameters in its received SIP messages. But those are transparent to A and B. They do not know they are connected to a RTP proxy.

[0009] The RTP proxy can start record both media channels (A and B). At the end of this call, e.g. a media file with two sound tracks will be created by RTP proxy.

[0010] Advantages:

- centralized network node to intercept media streams,
- low cost of deployment,
- transparent to end users,
- the RTP proxy can also be used in the same way as above in a media gateway control (MEGACO, H.248) based network or H.323 network.

BRIEF DESCRIPTION OF THE DRAWINGS

[0011] For a better understanding of the present invention, reference is made to the accompanying drawings, in which:

FIG. 1 is a simplified block diagram of a portion of an exemplary telecommunications network according to the teachings of the prior art;

FIG. 2 is a simplified block diagram of a portion of an exemplary telecommunications network according to the teachings of the present invention.

DETAILED DESCRIPTION OF THE INVENTION

[0012] FIG. 1 shows a portion of an exemplary telecommunications network according to the teachings of the prior art.

[0013] Two IP parties, e.g. yshen@alcatel.de and eric@alcatel.com, are interconnected via two networks: a SIP signaling network and a transmission network. Via the SIP signaling network signaling is performed, e.g. a connection is established between the two IP parties. Via the transmission network the information to be transmitted, e.g. voice, data, etc. is transmitted in media streams (RTP session).

[0014] In the SIP based network, each SIP proxy server is responsible for signaling and session monitoring. The media stream will go from one IP endpoint to another IP endpoint. There is no need of a centralized media path like in PSTN network. A lawful interception of media stream could be done only in the network layer.

[0015] Recording media stream by analyzing network traffics for lawful interception is very expensive, due to the packet route through the IP network could change. Therefore the recording could only be done very closely to the endpoints. Additionally a resembling of recorded packets is needed. A playing in real time will be difficult.

[0016] In the following definition and background information is provided regarding SIP, proxy server, RTP, SDP, etc.

SIP:

[0017] The Session Initiation Protocol (SIP) is an application-layer control (signaling) protocol for creating, modifying and terminating sessions with one or more participants. These sessions include Internet multimedia conferences, Internet telephone calls and multimedia distribution. Members in a session can communicate via multicast or via a mesh of unicast relations, or a combination of these.

[0018] SIP invitations used to create sessions carry session descriptions which allow participants to agree on a set of compatible media types. SIP supports user mobility by proxying and redirecting requests to the user's current location. Users can register their current location. SIP is not tied to any particular conference control protocol. SIP is designed to be independent of the lower-layer transport protocol and can be extended with additional capabilities.

[0019] The Session Initiation Protocol (SIP) is an application-layer control protocol that can establish, modify and terminate multimedia sessions or calls. These multimedia sessions include multimedia conferences, distance learning, Internet telephony and similar applications. SIP can invite both persons and "robots", such as a media storage service. SIP can invite parties to both unicast and multicast sessions; the initiator does not necessarily have to be a member of the session to which it is inviting. Media and participants can be added to an existing session.

[0020] SIP can be used to initiate sessions as well as invite members to sessions that have been advertised and established by other means. Sessions can be advertised using multicast protocols such as electronic mail, news groups, web pages or directories (LDAP), among others.

[0021] SIP transparently supports name mapping and redirection services, allowing the implementation of IS-DN and Intelligent Network telephony subscriber services. These facilities also enable personal mobility. In the parlance of telecommunications intelligent network services, this is defined as: "Personal mobility is the ability of end users to originate and receive calls and access subscribed telecommunication services on any terminal in any location, and the ability of the network to identify end users as they move. Personal mobility is based on the use of a unique personal identity (i.e., personal number)." Personal mobility complements terminal mobility, i.e., the ability to maintain communications when moving a single end system from one subnet to another.

[0022] SIP supports five facets of establishing and terminating multimedia communications:

User location: determination of the end system to

be used for communication;

User capabilities: determination of the media and media parameters to be used;

User availability: determination of the willingness of the called party to engage in communications;

Call setup: "ringing", establishment of call parameters at both called and calling party;

Call handling: including transfer and termination of calls.

5

10

15

20

25

30

35

40

45

50

55

[0023] SIP can also initiate multi-party calls using a multipoint control unit (MCU) or fully-meshed interconnection instead of multicast.

Internet telephony gateways that connect Public Switched Telephone Network (PSTN) parties can also use SIP to set up calls between them.

[0024] SIP is designed as part of the overall IETF multimedia data and control architecture currently incorporating protocols such as the real-time transport protocol (RTP) for transporting real-time data and providing QoS feedback.

[0025] A request and a response form together a transaction. SIP uses e.g. invite and ack messages to build up connections. Other messages used are e.g. ok, bye, options, register, cancel. SIP parties are identified via a SIP-ULR, e.g.: sip:cfientname@hostaddress. Each client may transmit requests to a proxy server or directly to an IP address.

[0026] An establishment of a connection is performed in three steps: sending an invite (request) message from a first IP party to a second IP party, sending an ok (response) message from the second IP party to the first IP party, sending an ack (response) message from the first IP party to the second IP party. The invite message includes as much information as needed to allow the second IP party to judge whether a connection is wanted or not. The ack message is an acknowledgement, which serves to increase safety of the connection. SIP is thus not dependent on TCP or UDP.

[0027] The SIP according to the invention is the SIP currently standardized and modifications thereof and equivalents thereof.

RTP:

[0028] The Audio/Video Transport Working Group of IETF was formed to specify a protocol for real-time transmission of audio and video over UDP and IP multicast. This is the Real-time Transport Protocol, RTP, together with its associated profile for audio/video conferences and payload format documents. The payload formats currently under discussion include a number of media specific formats (MPEG-4, DTMF, PureVoice) and FEC techniques applicable to multiple formats (par-

ity FEC, Reed-Solomon coding). RTP is used to replace a normal circuit-switched trunk between two nodes.

[0029] The real-time transport protocol (RTP) is a payload format to be used for e.g. Adaptive Multi-Rate (AMR) and Adaptive Multi-Rate Wideband (AMR-WB) encoded speech signals. RTP provides end-to-end network transport functions suitable for applications transmitting real-time data, such as audio, video or simulation data, over multicast or unicast network services. RTP does not address resource reservation and does not guarantee quality-of-service for real-time services. The data transport is e.g. augmented by the control protocol RTCP (Real-time Transport Control Protocol) to allow monitoring of the data delivery in a manner scalable to large multicast networks, and to provide minimal control and identification functionality. RTP and RTCP are designed to be independent of the underlying transport and network layers. The protocol supports the use of RTP-level translators and mixers. The data transported by RTP in a packet, for example audio samples or compressed video data. A data packet includes e.g. the fixed RTP header, a possibly empty list of contributing sources, and the payload data.

[0030] The RTP according to the invention is the RTP currently under discussion and modifications thereof and equivalents thereof. RTP may be a protocol for both audio and video, or audio only, or video only, or audio, video and data, or audio and data, etc. One modification of RTP is e.g. RTP/I, an application level real-time protocol for distributed interactive media. Typical examples of distributed interactive media are shared whiteboards, networked computer games and distributed virtual environments. RTP/I defines a standardized framing for the transmission of data and provides mechanisms that are universally needed for this media class. Thereby RTP/I enables the development of reusable functionality and generic services that can be employed for multiple distributed interactive media. Examples for this kind of functionality are the ability to record sessions, to support late coming participants, and to provide security services. PTP/I is a protocol that follows the ideas of application level framing and integrated layer processing. It has been designed to be independent of the underlying network and transport layers. Thus RTP/I as a modified RTP protocol that reuses many aspects of RTP while it is thoroughly adapted to the specific needs of distributed interactive media.

Proxy, proxy server:

[0031] An intermediary program that acts as both a server and a client for the purpose of making requests on behalf of other clients. Requests are serviced internally or by passing them on, possibly after translation, to other servers. A proxy interprets, and, if necessary, rewrites a request message before forwarding it.

Server:

[0032] A server is an application program that accepts requests in order to service requests and sends back responses to those requests. Servers are either proxy, redirect or user agent servers or registrars.

User agent client (UAC), calling user agent:

[0033] A user agent client is a client application that initiates the SIP request.

SDP:

[0034] The Session Description Protocol (SDP) is intended for describing multimedia sessions for the purposes of session announcement, session invitation, and other forms of multimedia session initiation.

[0035] The purpose of SDP is to convey information about media streams in multimedia sessions to allow the recipients of a session description to participate in the session. SDP is primarily intended for use in an inter-network, although it is sufficiently general that it can describe conferences in other network environments.

[0036] A multimedia session, for these purposes, is defined as a set of media streams that exist for some duration of time. Media streams can be many-to-many. The times during which the session is active need not be continuous.

[0037] Thus far, multicast based sessions on the Internet have differed from many other forms of conferencing in that anyone receiving the traffic can join the session (unless the session traffic is encrypted). In such an environment, SDP serves two primary purposes. It is a means to communicate the existence of a session, and is a means to convey sufficient information to enable joining and participating in the session. In a unicast environment, only the latter purpose is likely to be relevant.

[0038] Thus SDP includes:

- o Session name and purpose
- o Time(s) the session is active
- o The media comprising the session
- o Information to receive those media (addresses, ports, formats and so on)

[0039] As resources necessary to participate in a session may be limited, some additional information may also be desirable:

- o Information about the bandwidth to be used by the conference
- o Contact information for the person responsible for the session

[0040] In general, SDP must convey sufficient information to be able to join a session (with the possible

exception of encryption keys) and to announce the resources to be used to non-participants that may need to know.

[0041] SDP includes:

- o The type of media (video, audio, etc)
- o The transport protocol (RTP/UDP/IP, H.320, etc)
- o The format of the media (H.261 video, MPEG video, etc)

[0042] For an IP multicast session, the following are also conveyed:

- o Multicast address for media
- o Transport Port for media

[0043] This address and port are the destination address and destination port of the multicast stream, whether being sent, received, or both.

[0044] For an IP unicast session, the following are conveyed:

- o Remote address for media
- o Transport port for contact address

[0045] The semantics of this address and port depend on the media and transport protocol defined. By default, this is the remote address and remote port to which data is sent, and the remote address and local port on which to receive data. However, some media may define to use these to establish a control channel for the actual media flow.

[0046] The SDP according to the invention is the SDP currently standardized and modifications thereof and equivalents thereof.

[0047] FIG. 2 shows a portion of an exemplary telecommunications network according to the teachings of the present invention.

[0048] Like in fig. 1 two IP parties, e.g. yshen@alcatel.de and eric@alcatel.com, are interconnected via two networks: a SIP signaling network and a transmission network. Via the SIP signaling network signaling is performed, e.g. a connection is established between the two IP parties. Via the transmission network the information to be transmitted, e.g. voice, data, etc. is transmitted in media streams (RTP session).

[0049] Different from fig. 1 a lawful interception device is included in fig. 2. The lawful interception device is e.g. a processor with particular software. The processor is e.g. a digital signal processor, a controller, a micro-processor or the like. Instead of one processor two or more processors could be used. Two or more processors could be located at different sites. One processor could be used to perform SIP proxy server operations and another processor could be used to perform RTP proxy server operations. In general, one, two or more hardwares could be used to run one, two, or more softwares. Each software could in addition be run in parts

on different hardware.

[0050] The lawful interception device includes a SIP (Session Initiation Protocol) proxy server or a MGC (Media Gateway Controller) to detect information in the signalling information being transmitted between two IP (Internet Protocol) parties and to generate instructions out of the detected signalling information for instructing a RTP (Real-time Transport Protocol) proxy server to create channels to bypass a media stream to be intercepted via an intermediate storage medium. Media streams are e.g. VoIP, data, internet access, e-mail, video, real-time pictures, music, video clips, video games, etc. The storage medium could be a compact disk, a magnetic storage medium, a read access memory, or the like.

[0051] The method for performing SIP signaling for a media stream includes the following steps:

receiving a SIP invite message of a first IP party,

adapting at least one connection parameter in the SDP (Session Description Protocol) of the received SIP invite message,

transmitting the adapted SIP invite message to a second IP party,

receiving a SIP response message of the second IP party,

adapting at least one connection parameter in the SDP (Session Description Protocol) of the received SIP response message,

transmitting the adapted SIP response message to the first IP party.

[0052] At least one RTP parameter includes information about a bypass channel, an address, or a port. The RTP parameters sent to both IP parties differ from each other.

[0053] After receipt of the SIP invite message of the first IP party the SIP interception proxy server sends a request to the RTP interception proxy server to assign at least two channels for bothway communication. The interface used to communicate between SIP interception proxy server and RTP interception proxy server is a XML based API. The number of channels to be assigned may vary dependent of the amount of data to be transmitted, of the bandwidth requested, of the quality of service requested, of the kind of information to be transmitted, e.g. voice, voice and data, voice and video, etc. At least one channel is assigned to transmit information between the RTP interception proxy server and the terminal of the first IP party. The terminal could be a phone, a laptop, a personal computer, a screenphone, a mobile phone, etc. At least one other channel is assigned to transmit information between the RTP interception proxy server and the terminal of the second IP party.

[0054] Assume channel A at the RTP interception proxy server is assigned to transmit information between the second IP terminal and the terminal of the first IP party, and channel B is assigned to transmit information between the terminal of the first IP party and the second IP terminal. Then the RTP interception proxy server sends information about the assignment of channels A and B to the SIP interception proxy server. The SIP interception proxy server includes information about channel A in the invite message to be send to the second IP party. The information about channel A is advantageously included in the connection parameter information to be included in the SDP of the SIP invite message. After receipt of the SIP response message of the second IP party, which corresponds to an ok message stating that a connection to the first IP party is desired, the SIP interception proxy server exchanges the connection parameter included in the SDP part of the ok message by the information about channel B. The modified ok message including the information about channel B is send to the first IP party.

[0055] Thus the first IP party will send data to channel B and receive data via channel A of the RTP interception proxy server. The second IP party will send data to channel A and receive data via channel B of the RTP interception proxy server. Within the lawful interception device the intermediate storage medium is connected to both channel A and B. Thus the information flow between both IP parties will transfer the intermediate storage medium and thus interception is enabled. The first party is not aware on which channel the second party is sending, and the second party is not aware on which channel the first party is sending. Thus interception is transparent regarding the two IP parties.

[0056] A computer program for performing at least part of the steps of the inventive method could be used as an upgrade software, which is sold e.g. to service providers, which will upgrade one or more SIP proxy server thus enabling a usual SIP proxy server having the functionality of an SIP interception proxy server. The computer program includes at least the following steps:

adapting at least one connection parameter in the SDP (Session Description Protocol) of the received SIP invite message,

adapting at least one connection parameter in the SDP (Session Description Protocol) of the received SIP response message.

The computer program could also be programmed to perform all steps of the method as described above.

[0057] Within an IP network one, two, or more SIP proxy servers could be used, one, two, or more SIP interception proxy servers could be used, one, two, or more RTP proxy servers could be used, and one, two, or more RTP interception proxy servers could be used.

[0058] The IP network could be a wireline network, a

wireless network, or a combination of both.

List of abbreviations:

5	[0059]	
	3G	Third Generation
	API	Application Programmer Interface
	AMR	Adaptive Multi-Rate
10	AMR-WB	AMR-Wideband
	DTMF	Dual-Tone Multi-Frequency
	FEC	Forward Error Correction
	H248	ITU standard
	H261	ITU standard
15	H320	ITU standard
	H323	ITU standard
	IETF	Internet Engineering Task Force
	IP	Internet Protocol
	ISDN	Integrated Services Digital Network
20	LDAP	Lightweight Directory Access Protocol
	MEGACO	Media Gateway Controller
	MCU	Multipoint Control Unit
	MPEG	Motion Picture Expert Group
	MGC	Media Gateway Controller
25	NGN	Next Generation Network
	PSTN	Public Switched Telephone Network
	PLMN	Public Land Mobile Network
	QoS	Quality of Service
	RTCP	Real-time Transport Control Protocol
30	RTP	Real-time Transport Protocol
	SDP	Session Description Protocol
	SIP	Session Initiation Protocol
	TCP	Transmission Control Protocol
	UAC	User Agent Client
35	UDP	User Datagram Protocol
	UMTS	Universal Mobile Transmission System
	VoIP	Voice over IP
	XML	extensible Markup Language

40 Claims

- 45
50
1. Lawful interception device including a SIP (Session Initiation Protocol) proxy server or a MGC (Media Gateway Controller) to detect information in the signalling information being transmitted between two IP (Internet Protocol) parties and to generate instructions out of the detected signalling information for instructing a RTP (Real-time Transport Protocol) proxy server to create channels to bypass a media stream to be intercepted via an intermediate storage medium.
- 55
2. SIP interception proxy server to detect information in the signalling information being transmitted between two IP (Internet Protocol) parties and to generate instructions out of the detected signalling information for instructing a RTP (Real-time Trans-

port Protocol) proxy server to create channels to bypass a media stream to be intercepted via an intermediate storage medium.

3. Interception MGC to detect information in the signalling information being transmitted between two IP (Internet Protocol) parties and to generate instructions out of the detected signalling information for instructing a RTP (Real-time Transport Protocol) proxy server to create channels to bypass a media stream to be intercepted via an intermediate storage medium. 5
10
4. Method for performing SIP signaling for a media stream, including the following steps: 15
 - receiving a SIP invite message of a first IP party,
 - adapting at least one connection parameter in the SDP (Session Description Protocol) of the received SIP invite message, 20
 - transmitting the adapted SIP invite message to a second IP party, 25
 - receiving a SIP response message of the second IP party,
 - adapting at least one connection parameter in the SDP (Session Description Protocol) of the received SIP response message, 30
 - transmitting the adapted SIP response message to the first IP party. 35
5. Method according to claim 4, wherein at least one connection parameter includes information about a bypass channel, an address, or a port.
6. Method according to claim 4, wherein the connection parameters sent to both IP parties differ from each other. 40
7. Computer program for performing at least part of the steps of the method according to claim 4, including the following steps: 45
 - adapting at least one connection parameter in the SDP (Session Description Protocol) of the received SIP invite message, 50
 - adapting at least one connection parameter in the SDP (Session Description Protocol) of the received SIP response message. 55

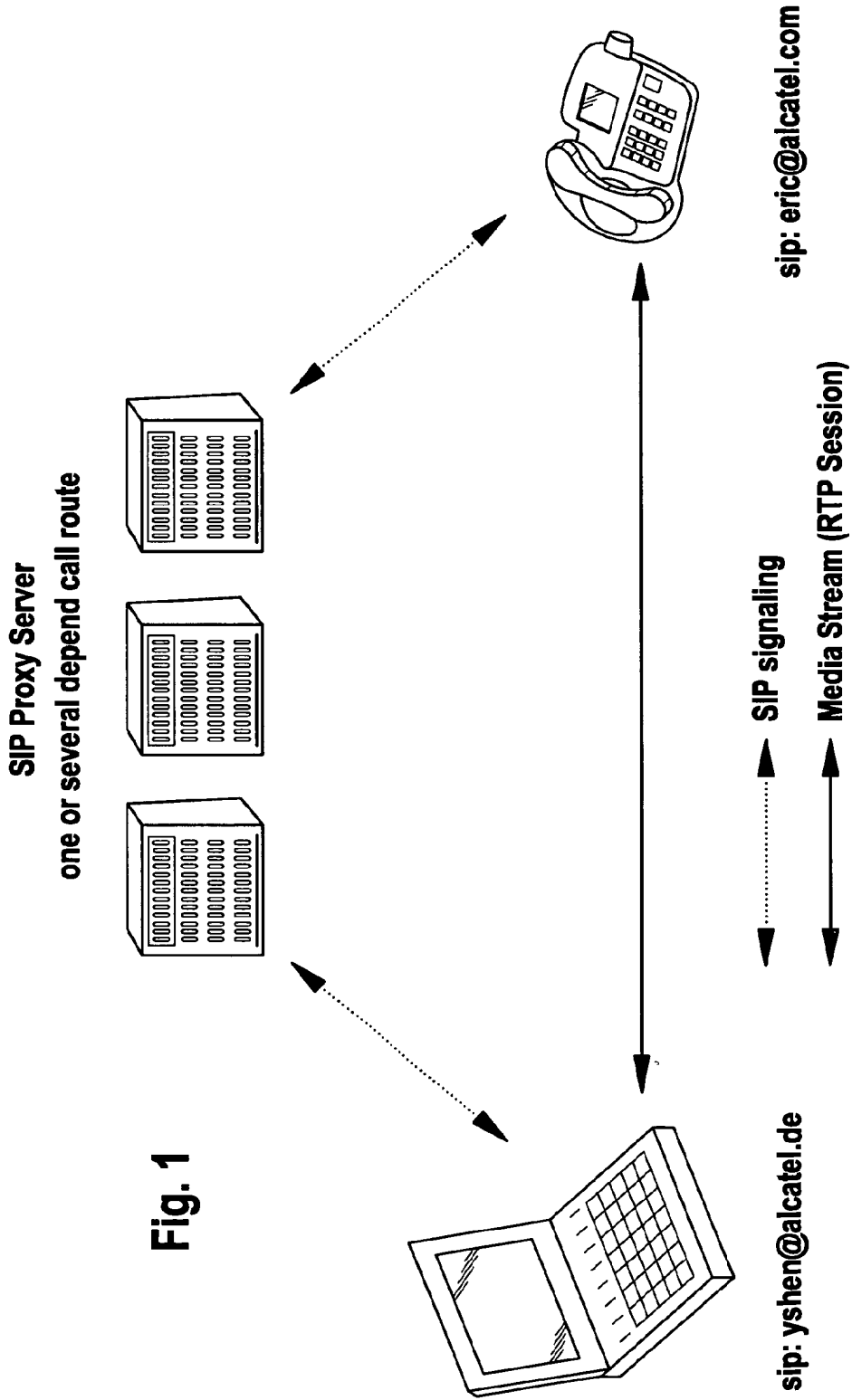

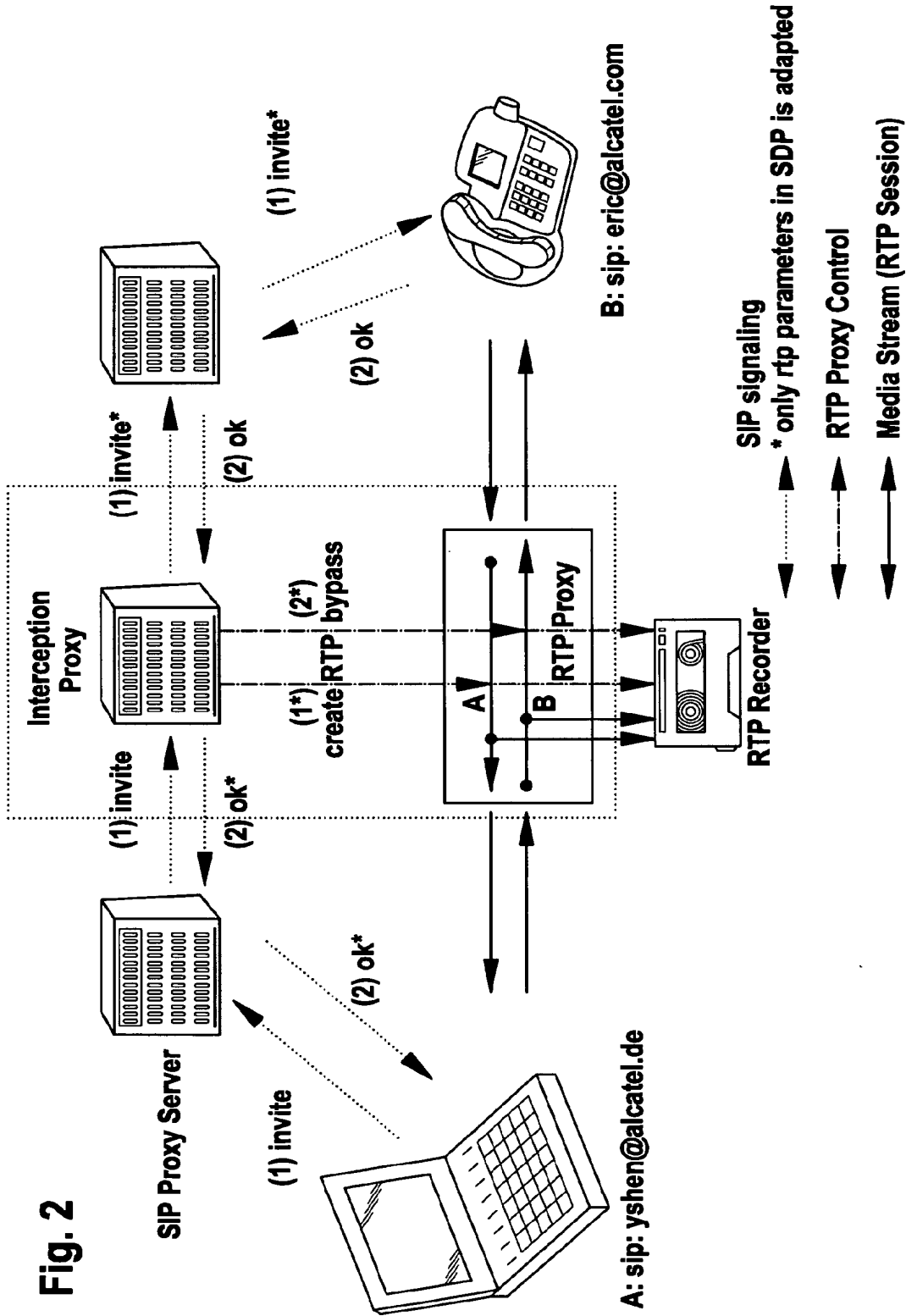

Fig. 2



European Patent
Office

EUROPEAN SEARCH REPORT

Application Number
EP 02 36 0235

DOCUMENTS CONSIDERED TO BE RELEVANT			
Category	Citation of document with indication, where appropriate, of relevant passages	Relevant to claim	CLASSIFICATION OF THE APPLICATION (Int.Cl.7)
X	THERNELIUS F: "SIP, NAT, and Firewalls" MASTER'S THESIS, KUNGST TEKNISKA HÖGSKOLAN, DEPARTMENT OF TELEINFORMATICS - ERICSSON, May 2000 (2000-05), XP002209773 * page 14; figure 11 * * page 31, line 36 - line 48; figure 32 * * page 33, line 1 - page 34, line 33; table 5 * ---	4-7	H04L29/06 H04M7/00
X	WO 02 15627 A (PARANTAINEN JANNE ;EINOLA HEIKKI (FI); HAMITI SHKUMBIN (FI); HURTT) 21 February 2002 (2002-02-21) * page 14, line 7 - page 15, line 31 * ---	4,7	
A	EP 1 111 892 A (NORTEL NETWORKS LTD) 27 June 2001 (2001-06-27) * abstract * * page 4, column 5, paragraph 18 - page 5, column 7, paragraph 25 * * page 9, column 16, paragraph 57 - page 11, column 19, line 11 * ---	1-7	TECHNICAL FIELDS SEARCHED (Int.Cl.7)
A	WO 01 89145 A (ERICSSON TELEFON AB L M) 22 November 2001 (2001-11-22) * abstract * * page 3, line 20 - page 4, line 2 * * page 4, line 27 - page 5, line 2 * * page 6, line 10 - page 7, line 27 * ---	1-7	H04L H04M H04Q
A	WO 99 17499 A (NOKIA TELECOMMUNICATIONS OY ;HAUMONT SERGE (FI)) 8 April 1999 (1999-04-08) * page 9, line 18 - line 31 * * abstract * * page 10, line 9 - line 29 * * claims 1,3,4,7-9 * -----	1-7	
The present search report has been drawn up for all claims			
Place of search THE HAGUE		Date of completion of the search 16 January 2003	Examiner Karavassilis, N
CATEGORY OF CITED DOCUMENTS			
X : particularly relevant if taken alone Y : particularly relevant if combined with another document of the same category A : technological background O : non-written disclosure P : intermediate document			T : theory or principle underlying the invention E : earlier patent document, but published on, or after the filing date D : document cited in the application L : document cited for other reasons & : member of the same patent family, corresponding document

EPO FORM 1503 03.02 (P04001)

**ANNEX TO THE EUROPEAN SEARCH REPORT
ON EUROPEAN PATENT APPLICATION NO.**

EP 02 36 0235

This annex lists the patent family members relating to the patent documents cited in the above-mentioned European search report. The members are as contained in the European Patent Office EDP file on
The European Patent Office is in no way liable for these particulars which are merely given for the purpose of information.

16-01-2003

Patent document cited in search report		Publication date	Patent family member(s)	Publication date
WO 0215627	A	21-02-2002	WO 0215625 A1	21-02-2002
			AU 6701800 A	25-02-2002
			AU 8767601 A	25-02-2002
			WO 0215627 A1	21-02-2002

EP 1111892	A	27-06-2001	EP 1111892 A2	27-06-2001

WO 0189145	A	22-11-2001	AU 5690501 A	26-11-2001
			WO 0189145 A2	22-11-2001

WO 9917499	A	08-04-1999	FI 973806 A	27-03-1999
			AU 9351598 A	23-04-1999
			CA 2304172 A1	08-04-1999
			CN 1277771 T	20-12-2000
			EP 1018241 A2	12-07-2000
			WO 9917499 A2	08-04-1999
			JP 2001518744 T	16-10-2001
			TW 429710 B	11-04-2001

EPC FORM P0458

For more details about this annex : see Official Journal of the European Patent Office, No. 12/82

From the INTERNATIONAL BUREAU

PCT

NOTIFICATION CONCERNING
TRANSMITTAL OF COPY OF INTERNATIONAL
PRELIMINARY REPORT ON PATENTABILITY
(CHAPTER I OF THE PATENT COOPERATION
TREATY)

(PCT Rule 44bis.1(c))

To:

KNOX, John, W.
SMART & BIGGAR
Box 11560, Vancouver Centre
650 West Georgia Street
Suite 2200
Vancouver, British Columbia V6B 4N8
CANADA

RECEIVED

2009 MAY 26 A 10:00

650-650 WEST GEORGIA ST.
VANCOUVER, B.C.

Date of mailing (<i>day/month/year</i>) 14 May 2009 (14.05.2009)		
Applicant's or agent's file reference 83636-16		IMPORTANT NOTICE
International application No. PCT/CA2007/001956	International filing date (<i>day/month/year</i>) 01 November 2007 (01.11.2007)	Priority date (<i>day/month/year</i>) 02 November 2006 (02.11.2006)
Applicant DIGIFONICA (INTERNATIONAL) LIMITED et al		

The International Bureau transmits herewith a copy of the international preliminary report on patentability (Chapter I of the Patent Cooperation Treaty)

The International Bureau of WIPO 34, chemin des Colombettes 1211 Geneva 20, Switzerland Facsimile No. +41 22 338 82 70	Authorized officer Athina Nickitas-Etienne e-mail: pt04.pct@wipo.int
---	--

PATENT COOPERATION TREATY

PCT

INTERNATIONAL PRELIMINARY REPORT ON PATENTABILITY

(Chapter I of the Patent Cooperation Treaty)

(PCT Rule 44bis)

RECEIVED

2009 MAY 26 A 10:00

See item 4 below
WEST GEORGIA ST
VANCOUVER, B.C.

Applicant's or agent's file reference 83636-16	FOR FURTHER ACTION	
International application No. PCT/CA2007/001956	International filing date (<i>day/month/year</i>) 01 November 2007 (01.11.2007)	Priority date (<i>day/month/year</i>) 02 November 2006 (02.11.2006)
International Patent Classification (8th edition unless older edition indicated) See relevant information in Form PCT/ISA/237		
Applicant DIGIFONICA (INTERNATIONAL) LIMITED		

1. This international preliminary report on patentability (Chapter I) is issued by the International Bureau on behalf of the International Searching Authority under Rule 44 *bis*.1(a).

2. This REPORT consists of a total of 8 sheets, including this cover sheet.

In the attached sheets, any reference to the written opinion of the International Searching Authority should be read as a reference to the international preliminary report on patentability (Chapter I) instead.

3. This report contains indications relating to the following items:

<input checked="" type="checkbox"/>	Box No. I	Basis of the report
<input type="checkbox"/>	Box No. II	Priority
<input type="checkbox"/>	Box No. III	Non-establishment of opinion with regard to novelty, inventive step and industrial applicability
<input checked="" type="checkbox"/>	Box No. IV	Lack of unity of invention
<input checked="" type="checkbox"/>	Box No. V	Reasoned statement under Article 35(2) with regard to novelty, inventive step or industrial applicability; citations and explanations supporting such statement
<input type="checkbox"/>	Box No. VI	Certain documents cited
<input type="checkbox"/>	Box No. VII	Certain defects in the international application
<input checked="" type="checkbox"/>	Box No. VIII	Certain observations on the international application

4. The International Bureau will communicate this report to designated Offices in accordance with Rules 44*bis*.3(c) and 93*bis*.1 but not, except where the applicant makes an express request under Article 23(2), before the expiration of 30 months from the priority date (Rule 44*bis* .2).

The International Bureau of WIPO 34, chemin des Colombettes 1211 Geneva 20, Switzerland Facsimile No. +41 22 338 82 70	Date of issuance of this report 05 May 2009 (05.05.2009)
	Authorized officer Athina Nickitas-Etienne e-mail: pt04.pct@wipo.int

Form PCT/IB/373 (January 2004)

PATENT COOPERATION TREATY

From the
INTERNATIONAL SEARCHING AUTHORITY

To: SMART & BIGGAR Box 11560 Vancouver Centre 2200 - 650 W. Georgia Street VANCOUVER, British Columbia Canada, V6B 4N8		RECEIVED PCT 2008 MAY 26 A 10:00 WRITTEN OPINION OF THE INTERNATIONAL SEARCHING AUTHORITY VANCOUVER, B.C. (PCT Rule 43bis.1)																									
		Date of mailing 20 February 2008 (20-02-2008) (day/month/year)																									
Applicant's or agent's file reference 83636-16		FOR FURTHER ACTION See paragraph 2 below																									
International application No. PCT/CA2007/001956	International filing date (day/month/year) 01 November 2007 (01-11-2007)	Priority date (day/month/year) 02 November 2006 (02-11-2006)																									
International Patent Classification (IPC) or both national classification and IPC IPC: <i>H04L 12/66</i> (2006.01), <i>H04L 12/14</i> (2006.01), <i>H04M 11/06</i> (2006.01), <i>H04M 15/00</i> (2006.01), <i>H04Q 3/64</i> (2006.01)																											
Applicant DIGIFONICA (INTERNATIONAL) LIMITED ET AL																											
1. This opinion contains indications relating to the following items : <table style="width: 100%; border: none;"> <tr> <td style="width: 15%;"><input checked="" type="checkbox"/></td> <td style="width: 35%;">Box No. I</td> <td>Basis of the opinion</td> </tr> <tr> <td><input type="checkbox"/></td> <td>Box No. II</td> <td>Priority</td> </tr> <tr> <td><input type="checkbox"/></td> <td>Box No. III</td> <td>Non-establishment of opinion with regard to novelty, inventive step and industrial applicability</td> </tr> <tr> <td><input checked="" type="checkbox"/></td> <td>Box No. IV</td> <td>Lack of unity of invention</td> </tr> <tr> <td><input checked="" type="checkbox"/></td> <td>Box No. V</td> <td>Reasoned statement under Rule 43bis.1(a)(i) with regard to novelty, inventive step or industrial applicability, citations and explanations supporting such statement</td> </tr> <tr> <td><input type="checkbox"/></td> <td>Box No. VI</td> <td>Certain documents cited</td> </tr> <tr> <td><input type="checkbox"/></td> <td>Box No. VII</td> <td>Certain defects in the international application</td> </tr> <tr> <td><input checked="" type="checkbox"/></td> <td>Box No. VIII</td> <td>Certain observations on the international application</td> </tr> </table>				<input checked="" type="checkbox"/>	Box No. I	Basis of the opinion	<input type="checkbox"/>	Box No. II	Priority	<input type="checkbox"/>	Box No. III	Non-establishment of opinion with regard to novelty, inventive step and industrial applicability	<input checked="" type="checkbox"/>	Box No. IV	Lack of unity of invention	<input checked="" type="checkbox"/>	Box No. V	Reasoned statement under Rule 43bis.1(a)(i) with regard to novelty, inventive step or industrial applicability, citations and explanations supporting such statement	<input type="checkbox"/>	Box No. VI	Certain documents cited	<input type="checkbox"/>	Box No. VII	Certain defects in the international application	<input checked="" type="checkbox"/>	Box No. VIII	Certain observations on the international application
<input checked="" type="checkbox"/>	Box No. I	Basis of the opinion																									
<input type="checkbox"/>	Box No. II	Priority																									
<input type="checkbox"/>	Box No. III	Non-establishment of opinion with regard to novelty, inventive step and industrial applicability																									
<input checked="" type="checkbox"/>	Box No. IV	Lack of unity of invention																									
<input checked="" type="checkbox"/>	Box No. V	Reasoned statement under Rule 43bis.1(a)(i) with regard to novelty, inventive step or industrial applicability, citations and explanations supporting such statement																									
<input type="checkbox"/>	Box No. VI	Certain documents cited																									
<input type="checkbox"/>	Box No. VII	Certain defects in the international application																									
<input checked="" type="checkbox"/>	Box No. VIII	Certain observations on the international application																									
2. FURTHER ACTION If a demand for international preliminary examination is made, this opinion will be considered to be a written opinion of the International Preliminary Examining Authority ("IPEA") except that this does not apply where the applicant chooses an Authority other than this one to be the IPEA and the chosen IPEA has notified the International Bureau under Rule 66.1bis(b) that written opinions of this International Searching Authority will not be so considered. If this opinion is, as provided above, considered to be a written opinion of the IPEA, the applicant is invited to submit to the IPEA a written reply together, where appropriate, with amendments, before the expiration of 3 months from the date of mailing of Form PCT/ISA/220 or before the expiration of 22 months from the priority date, whichever expires later. For further options, see Form PCT/ISA/220.																											
3. For further details, see notes to Form PCT/ISA/220.																											
Name and mailing address of the ISA/CA Canadian Intellectual Property Office Place du Portage I, C114 - 1st Floor, Box PCT 50 Victoria Street Gatineau, Quebec K1A 0C9 Facsimile No.: 001-819-953-2476		Date of completion of this opinion 7 February 2008 (07-02-2008)	Authorized officer Arthur Smith 819-953-1360																								

WRITTEN OPINION OF THE
INTERNATIONAL SEARCHING AUTHORITY

International application No.
PCT/CA2007/001956

Box No. I Basis of this opinion

1. With regard to the **language**, this opinion has been established on the basis of:
 - the international application in the language in which it was filed
 - a translation of the international application into _____, which is the language of a translation furnished for the purposes of international search (Rules 12.3(a) and 23.1(b)).
2. This opinion has been established taking into account the **rectification of an obvious mistake** authorized by or notified to this Authority under Rule 91 (Rule 43bis.1(a))
3. With regard to any **nucleotide and/or amino acid sequence** disclosed in the international application and necessary to the claimed invention, this opinion has been established on the basis of:
 - a. type of material
 - a sequence listing
 - table(s) related to the sequence listing
 - b. format of material
 - on paper
 - in electronic form
 - c. time of filing/furnishing
 - contained in the international application as filed.
 - filed together with the international application in electronic form
 - furnished subsequently to this Authority for the purposes of search.
4. In addition, in the case that more than one version or copy of a sequence listing and/or table(s) relating thereto has been filed or furnished, the required statements that the information in the subsequent or additional copies is identical to that in the application as filed or does not go beyond the application as filed, as appropriate, were furnished.
5. Additional comments :

Box No. IV Lack of unity of invention

1. In response to the invitation (Form PCT/ISA/206) to pay additional fees the applicant has, within the applicable time limit :

- paid additional fees
- paid additional fees under protest and, where applicable, the protest fee
- paid additional fees under protest but the applicable protest fee was not paid
- not paid additional fees

2. This Authority found that the requirement of unity of invention is not complied with and chose not to invite the applicant to pay additional fees.

3. This Authority considers that the requirement of unity of invention in accordance with Rules 13.1, 13.2 and 13.3 is

- complied with
- not complied with for the following reasons :

This International Searching Authority considers that there are four inventions claimed in the international application covered by the claims indicated below:

- I Claims 1-59
- II Claims 60, 61
- III Claims 62-84
- IV Claims 85-107

The claims of Group I have in common a call routing controller for facilitating communications between callers and callees in a communications system comprising a plurality of nodes in which, in response to initiation of a call, uses call classification criteria to classify the call as a public network call or a private network call, and produces accordingly a routing message.

The claims of Group II have in common a data structure for access by an apparatus for producing a routing message for use by a call routing controller in a communications system.

The claims of Group III have in common determining a time to permit a communication session to be conducted, the determination based on calculating a cost per unit time, a participant's billing pattern, and the quotient of a funds balance held by the participant.

The claims of Group IV have in common attributing charges for communications services by determining chargeable times and changing account balances of both user and communications services reseller.

Groups I and II have in common the call routing controller; however, call routing controllers are well known in the art so the claims of Groups I and II lack unity *a posteriori*.

Because the remainder of the claims of Groups I, II, III, and IV have no elements in common and would require separate searches by the examiner, these groups lack unity *a priori*.

4. Consequently, this opinion has been established in respect of the following parts of the international application :

- all parts
- the parts relating to claim Nos.

**WRITTEN OPINION OF THE
INTERNATIONAL SEARCHING AUTHORITY**

International application No.
PCT/CA2007/001956

Box No. V Reasoned statement under Rule 43bis.1(a)(i) with regard to novelty, inventive step or industrial applicability; citations and explanations supporting such statement

1. Statement

Novelty (N)	Claims <u>1-107</u>	YES
	Claims <u>None</u>	NO
Inventive step (IS)	Claims <u>1-61, 64-72, 76-107</u>	YES
	Claims <u>62, 63, 73-75</u>	NO
Industrial applicability (IA)	Claims <u>1-107</u>	YES
	Claims <u>None</u>	NO

2. Citations and explanations :

Group I (Claims 1-59)

The following document is referred to in this communication:

D1 CA 2249668

D1 is considered to form the closest prior art. D1 discloses routing information in an integrated global communications network in which a central routing processor collects routing capabilities of network nodes for which it has responsibility. The routing processor evaluates the routing requirements of a routing query signal transmitted by a source router, determines which routers and communication paths within the network are capable and available to route the information, evaluates the statistical availability of such routers, and selects an optimal routing path to a destination router.

Novelty

D1 fails to individually disclose all the elements of claims 1-59; therefore, claims 1-59 **are considered to be novel** in accordance with Article 33(2) PCT.

Inventive Step

Independent claims 1, 30, and 31 each claim operating a call routing controller to facilitate communication between callers and callees in a system or network comprising a plurality of nodes in which call classification criteria associated with a caller identifier is used to classify the call as a public network call or a private network call, and producing a routing message in accordance with the classification. D1 teaches facilitation of communication between callers and callees within a private network, including producing a routing message for a private network call. However, D1 fails to teach classification of a call as a public network call, and fails to teach producing an appropriate routing message for a public network call.

Claims 2-29 and 32-59 depend on independent claims 1 and 31, respectively.

Therefore, claims 1-59 **are considered to have an inventive step** in accordance with Article 33(3) PCT.

Industrial Applicability

Routing IP phone calls through a communication network including both private and public aspects finds use in telecommunications, and, thus, claims 1-59 **are industrially applicable** in accordance with Article 33(4) PCT.

Group II (Claims 60, 61)

The following documents are referred to in this communication:

D2 US7,068,772

D3 US2006/0209768

D2 and D3 are considered to form the closest prior art. D2 discloses a call processing system and method for providing one-number telecommunication services, wherein a data structure of a subscriber record for access by an apparatus for producing a routing message, the data structure comprising the subscriber's various profiles and the associated 1-800 number or address that the subscriber may be contacted.

Box No. VIII Certain observations on the international application

The following observations on the clarity of the claims, description, and drawings or on the question whether the claims are fully supported by the description, are made :

Claim-Related Objections

Claim 60 is unclear and does not comply with Article 6 of the PCT. The following terms lack a proper antecedent basis:

- “the subscriber” (claim 60, page 83, line 16)
- “subscriber name” (claim 60, page 83, line 17)

Claim 60 is unclear and does not comply with Article 6 of the PCT. The double inclusion of any element renders the claims indefinite. The following expressions have already been defined previously in the claims and should therefore be referred to using a definite article:

- “a user domain” (claim 60, page 83, lines 14, 17)
- “a direct-in-dial number” (claim 60, page 83, line 18)

Claim 60 is indefinite and does not comply with Article 6 of the PCT. The terms “a subscriber user name” (claim 60, page 82, line 32) and “subscriber name” (claim 60, page 83, lines 14, 15, 16-17, 17) cause ambiguity. It is not clear whether they are the same or different.

Claim 61 is indefinite and does not comply with Article 6 of the PCT. The term “master list records” (page 83, line 27) causes ambiguity. It should read “said master list records”.

Claim 61 is indefinite and does not comply with Article 6 of the PCT. The term “aid” (page 83, line 28) causes ambiguity. It should read “said aid”.

Claim 61 is indefinite and does not comply with Article 6 of the PCT. The term “dialing codes” (page 84, line 8) causes ambiguity. It should read “said dialing codes”.

Supplemental Box

In case the space in any of the preceding boxes is not sufficient.

Continuation of: Box V

D3 discloses a system for managing address allocation of a mobile terminal in wireless LAN (WLAN) to inter-work with another WLAN or a public cellular network, wherein a data structure comprises: Message_Type, Message_Length, Domain_Name, MT_ID, Service_Request, Session_ID, Address_Request, Tunnel_Request, WLAN_ID and Security_Field.

Novelty

The subject matter of claim 60 is considered to be novel and complies with the requirement of **Article 33(2) of the PCT**. The cited references, when taken alone, fail to disclose a data structure for access by an apparatus for producing a routing message for use by a call routing controller in a communications system, the data structure comprising: dialing profile records comprising fields for associating with respective subscribers to the system: a subscriber user name; direct-in-dial records comprising fields for associating with respective subscriber usernames: a user domain; and a direct-in-dial number; prefix to node records comprising fields for associating with at least a portion of said respective subscriber usernames: a node address of a node in said system, whereby a subscriber name can be used to find a user domain, at least a portion of said subscriber name can be used to find a node with which the subscriber identified by the subscriber name is associated, and a user domain and subscriber name can be located in response to a direct-in-dial number.

The subject matter of claim 61 is considered to be novel and complies with the requirement of **Article 33(2) of the PCT**. The cited references, when taken alone, fail to disclose a data structure for access by an apparatus for producing a routing message for use by a call routing controller in a communications system, the data structure comprising: master list records comprising fields for associating a dialing code with respective master list identifiers; and supplier list records linked to master list records by said master list identifiers, said supplier list records comprising fields for associating with a communications service supplier: a supplier id; a master list id; a route identifier; and a billing rate code, whereby communications services suppliers are associated with dialing codes, such that dialing codes can be used to locate suppliers capable of providing a communications link associated with a given dialing code.

Inventive Step

The subject matter of claim 60 is considered to involve an inventive step and does comply with **Article 33(3) of the PCT**. The prior art, D2 and D3, alone or in combination, does not fairly suggest a data structure comprising: dialing profile records; direct-in-dial records; prefix to node records, whereby a subscriber name can be used to find a user domain, at least a portion of said subscriber name can be used to find a node with which the subscriber identified by the subscriber name is associated, and a user domain and subscriber name can be located in response to a direct-in-dial number.

The subject matter of claim 61 is considered to involve an inventive step and does comply with **Article 33(3) of the PCT**. The prior art, D2 and D3, alone or in combination, does not fairly suggest a data structure comprising: master list records; and supplier list records linked to master list records, said supplier list records comprising fields for associating with a communications service supplier, whereby communications services suppliers are associated with dialing codes, such that dialing codes can be used to locate suppliers capable of providing a communications link associated with a given dialing code.

Industrial Applicability

Claims 60 and 61 are considered to be industrially applicable and do comply with **Article 33(4) of the PCT**.

Group III (Claims 62-84)

The following documents are referred to in this communication:

D4 US 6058300
D5 US 2005/0177843 A1

D4 discloses, in part, a calculation of a maximum call duration in response to a customer account balance for a prepay telecommunications system.

D5 discloses, in part, calculation of a maximum call duration to a specific callee in response to a caller request to make a call in a prepay telecommunications system. If the maximum call duration is sufficient, the system permits the call to take place.

Novelty

Each of D4 and D5 fail to individually disclose all the elements of claims 62-84; therefore, claims 62-84 are considered to be novel in accordance with Article 33(2) PCT.

(Continued in next Supplemental Box)

Supplemental Box

In case the space in any of the preceding boxes is not sufficient.

Continuation of: Previous Supplemental Box

Inventive Step

Claim 62 claims a method of determining a time to permit a communications session to be conducted (ie, a maximum call duration). Either of D4 or D5 disclose determination of a maximum call duration and cause claim 62 to lack an inventive step. Both of D4 and D5 teach determination of a cost per unit time (D4: "rate per minute" (col. 5, line 58); D5: "call credits" (para. 65)), calculating a first time value as a sum of a free time attributed to a participant in the communication session and the quotient of a funds balance held by the participant to the cost per unit time value (D4: col. 5, lines 61 - 65; D5: para. 67), and producing a second time value in response to the first time value and a billing pattern (D4: roaming or not roaming; D5: "call history"), the second time value being the time to permit a communications session to be conducted. Additional differences between claim 62 and either D4 or D5 such as "free time", "cost per unit time" and "billing pattern" also lack inventive step. Thus claim 62 is considered to **lack an inventive step** in accordance with Article 33(3) PCT.

As claims 73 and 74 are apparatus for carrying out methods steps similar or identical to those of claim 62, these claims **lack an inventive step** in accordance with Article 33(3) PCT for the same reasons as listed above.

Claim 63 and 75 lack an inventive step in view of either of D4 or D5 in that D4 and D5 disclose retrieving a record associated with said participant (D4: "customer's account" (col. 5, lines 63-64); D5: "certificate information" (para. 67)) and obtaining from said record said funds balance (D4: col. 5, line 63; D5: para. 67). To also obtain a participant's free time also lack an inventive step. Thus, claims 63 and 75 **lack an inventive step** in accordance with Article 33(3) PCT.

Claims 64-72 and 76-84 are found to be inventive since no combination of prior art documents were found which disclose the subject matter as set forth in claims 64-72 and 76-84 in accordance with Article 33(3) PCT.

Industrial Applicability

Determination of maximum time for a communication session finds application within Internet telephony; thus, claims 62-84 are considered to **have industrial applicability** in accordance with Article 33(4) PCT.

Group IV (Claims 85-107)

The following document is referred to in this communication:

D6 US 6188752

D6 is considered to form the closest prior art. D6 discloses provision of prepaid telecommunications services by a telecommunications network. A database record includes subscriber information fields such as account numbers, prepaid account information, and a current prepayment monetary amounts. Once a call or communication session has been established, the network monitors parameters related to any fee to be charged for the service such as start time, elapsed time, origination and destination locations, and rate information (ie, billing pattern) preferably in real time. D6 further discloses determining the cost of the call and debiting the account balance associated with the subscriber.

Novelty

D6 fails to individually disclose all the elements of claims 85-107; therefore, claims 85-107 **are considered to be novel** in accordance with Article 33(2) PCT.

Inventive Step

Independent claims 85, 96, and 97 each claim attributing charges for communications services including determining a chargeable time in response to a communication session time and a pre-defined billing pattern, determining a user cost value, and changing account balances associated with the user, reseller, and operator of the communications services. D6 teaches attributing charges for communications services, determining a chargeable time in response to a communication session time and a pre-defined billing pattern, determining a user cost value in response to said first chargeable time associated with a user of said communications services, and changing an account balance associated with said user in response to a user cost per unit time. However, D6 fails to suggest a free time value, nor does D6 teach changing the account balances of either a reseller or an operator of said communications services.

Claims 86-95 and 98-107 depend on independent claims 85 and 97, respectively.

Therefore, claims 85-107 **are considered to have an inventive step** in accordance with Article 33(3) PCT.

Industrial Applicability

Billing or attributing charges for communications services finds use in telecommunications, and, thus, claims 85-107 are considered to

PATENT COOPERATION TREATY

from the
INTERNATIONAL PRELIMINARY EXAMINING AUTHORITY

RECEIVED

PCT

To:
SMART & BIGGAR
Box 11560 Vancouver Centre
2200 - 650 W. Georgia Street
VANCOUVER, British Columbia
Canada, V6B 4N8

2009 FEB 19 A 9:35
2200-650 WEST GEORGIA ST.
VANCOUVER, B.C.

NOTIFICATION OF TRANSMITTAL OF
INTERNATIONAL PRELIMINARY
REPORT ON PATENTABILITY
(Chapter II of the Patent Cooperation Treaty)

(PCT Rule 71.1)

Date of mailing 13 February 2009 (13-02-2009)
(day/month/year)

Applicant's or agent's file reference
83636-13

IMPORTANT NOTIFICATION

International application No.
PCT/CA2007/002150

International filing date (day/month/year)
29 November 2007 (29-11-2007)

Priority date (day/month/year)
29 November 2006 (29-11-2006)

Applicant
DIGIFONICA (INTERNATIONAL) LIMITED ET AL

1. The applicant is hereby notified that this International Preliminary Examining Authority transmits herewith the international preliminary report on patentability and its annexes, if any, established on the international application.
2. A copy of the report and its annexes, if any, is being transmitted to the International Bureau for communication to all the elected Offices.
3. Where required by any of the elected Offices, the International Bureau will prepare an English translation of the report (but not of any annexes) and will transmit such translation to those Offices.

4. REMINDER

The applicant must enter the national phase before each elected Office by performing certain acts (filing translations and paying national fees) within 30 months from the priority date (or later in some Offices) (Article 39(1)) (see also the reminder sent by the International Bureau with Form PCT/IB/301).

Where a translation of the international application must be furnished to an elected Office, that translation must contain a translation of any annexes to the international preliminary report on patentability. It is the applicant's responsibility to prepare and furnish such translation directly to each elected Office concerned.

For further details on the applicable time limits and requirements of the elected Offices, see Volume II of the *PCT Applicant's Guide*.

The applicant's attention is drawn to Article 33(5), which provides that the criteria of novelty, inventive step and industrial applicability described in Article 33(2) to (4) merely serve the purposes of international preliminary examination and that "any Contracting State may apply additional or different criteria for the purposes of deciding whether, in that State, the claimed invention is patentable or not" (see also Article 27(5)). Such additional criteria may relate, for example, to exemptions from patentability, requirements for enabling disclosure, clarity and support for the claims.

Name and mailing address of the IPEA/CA
Canadian Intellectual Property Office
Place du Portage I, C114 - 1st Floor, Box PCT
50 Victoria Street
Gatineau, Quebec K1A 0C9
Facsimile No.: 001-819-953-2476

Authorized officer

Maureen Matheson 819- 953-1495

Form PCT/IPEA/416 (January 2004)

PATENT COOPERATION TREATY

PCT

INTERNATIONAL PRELIMINARY REPORT ON PATENTABILITY
(Chapter II of the Patent Cooperation Treaty)

RECEIVED

(PCT Article 36 and Rule 70)

2009 FEB 19 A 9:35

Applicant's or agent's file reference 83636-13	<p style="text-align: right;">2200-850 WEST GEORGIA ST. VICTORIA, B.C.</p> FOR FURTHER ACTION See Form PCT/IPEA/416	
International application No. PCT/CA2007/002150	International filing date (day/month/year) 29 November 2007 (29-11-2007)	Priority date (day/month/year) 29 November 2006 (29-11-2006)
International Patent Classification (IPC) or national classification and IPC IPC: <i>H04L 12/26</i> (2006.01), <i>H04L 12/66</i> (2006.01), <i>H04M 11/06</i> (2006.01), <i>H04M 3/22</i> (2006.01)		
Applicant DIGIFONICA (INTERNATIONAL) LIMITED ET AL		
<p>1. This report is the international preliminary examination report, established by this International Preliminary Examining Authority under Article 35 and transmitted to the applicant according to Article 36.</p> <p>2. This REPORT consists of a total of <u>3</u> sheets, including this cover sheet.</p> <p>3. This report is also accompanied by ANNEXES, comprising:</p> <p style="margin-left: 20px;">a. <input checked="" type="checkbox"/> (sent to the applicant and to the International Bureau) a total of <u>23</u> sheets, as follows:</p> <p style="margin-left: 40px;"><input checked="" type="checkbox"/> sheets of the description, claims and/or drawings which have been amended and are the basis of this report and/or sheets containing rectifications authorized by this Authority (see Rule 70.16 and Section 607 of the Administrative Instructions).</p> <p style="margin-left: 40px;"><input type="checkbox"/> sheets which supersede earlier sheets, but which this Authority considers contain an amendment that goes beyond the disclosure in the international application as filed, as indicated in item 4 of Box No. 1 and the Supplemental Box.</p> <p style="margin-left: 20px;">b. <input type="checkbox"/> (sent to the International Bureau only) a total of (indicate type and number of electronic carrier(s)) _____, containing a sequence listing and/or tables related thereto, in electronic form only, as indicated in the Supplemental Box Relating to Sequence Listing (see Section 802 of the Administrative Instructions).</p>		
<p>4. This report contains indications relating to the following items:</p> <p><input checked="" type="checkbox"/> Box No. I Basis of the report</p> <p><input type="checkbox"/> Box No. II Priority</p> <p><input type="checkbox"/> Box No. III Non-establishment of opinion with regard to novelty, inventive step and industrial applicability</p> <p><input type="checkbox"/> Box No. IV Lack of unity of invention</p> <p><input checked="" type="checkbox"/> Box No. V Reasoned statement under Article 35(2) with regard to novelty, inventive step or industrial applicability; citations and explanations supporting such statement</p> <p><input type="checkbox"/> Box No. VI Certain documents cited</p> <p><input type="checkbox"/> Box No. VII Certain defects in the international application</p> <p><input type="checkbox"/> Box No. VIII Certain observations on the international application</p>		
Date of submission of the demand 13 May 2008 (13-05-2008)	Date of completion of this report 13 February 2009 (13-02-2009)	
Name and mailing address of the IPEA/CA Canadian Intellectual Property Office Place du Portage I, C114 - 1st Floor, Box PCT 50 Victoria Street Gatineau, Quebec K1A 0C9 Facsimile No.: 001-819-953-2476	Authorized officer Daniela Savin 819- 934-4890	

Box No. I Basis of the report

1. With regard to the **language**, this report is based on:
 - the international application in the language in which it was filed
 - a translation of the international application into _____, which is the language of a translation furnished for the purposes of:
 - international search (Rules 12.3(a) and 23.1(b))
 - publication of the international application (Rule 12.4(a))
 - international preliminary examination (Rules 55.2(a) and/or 55.3(a))

2. With regard to the **elements** of the international application, this report is based on (*replacement sheets which have been furnished to the receiving Office in response to an invitation under Article 14 are referred to in this report as "originally filed" and are not annexed to this report*):
 - the international application as originally filed/furnished
 - the description:

pages	2-23, 25-54, 56-62	as originally filed/furnished
pages*	1	received by this Authority on <u>13 May 2008 (13-05-2008)</u>
pages*	24, 55	received by this Authority on <u>22 January 2009 (22-01-2009)</u>
 - the claims:

pages	_____	as originally filed/furnished
pages*	_____	as amended (together with any statement) under Article 19
pages*	63-70	received by this Authority on <u>05 February 2009 (05-02-2009)</u>
pages*	_____	received by this Authority on _____
 - the drawings:

pages	1/29-5/29, 10/29-12/29, 14/29, 17/29, 19/29-22/29, 24/29, 27/29, 29/29	as originally filed/furnished
pages*	6/29-9/29, 13/29, 15/29-16/29	received by this Authority on <u>22 January 2009 (22-01-2009)</u>
pages*	18/29, 23/29, 25/29-26/29, 28/29	received by this Authority on <u>22 January 2009 (22-01-2009)</u>
 - a sequence listing and/or any related table(s) - see Supplemental Box Relating to Sequence Listing.

3. The amendments have resulted in the cancellation of:
 - the description, pages _____
 - the claims, Nos. _____
 - the drawings, sheets/figs _____
 - the sequence listing (*specify*): _____
 - any table(s) related to sequence listing (*specify*): _____

4. This report has been established as if (some of) the amendments annexed to this report and listed below had not been made, since they have been considered to go beyond the disclosure as filed, as indicated in the Supplemental Box (Rule 70.2(c)).
 - the description, pages _____
 - the claims, Nos. _____
 - the drawings, sheets/figs _____
 - the sequence listing (*specify*): _____
 - any table(s) related to sequence listing (*specify*): _____

5. This opinion has been established taking into account the **rectification of an obvious mistake** authorized by or notified to this Authority under Rule 91 (Rule 66.1(d-bis))

6. Supplementary international search report(s) from Authority(ies) _____ have been received and taken into account in drawing up this report (Rule 45bis.8(b) and (c)).

**If item 4 applies, some or all of those sheets may be marked "superseded."*

Box No. V Reasoned statement under Article 35(2) with regard to novelty, inventive step or industrial applicability; citations and explanations supporting such statement

1. Statement

Novelty (N)	Claims	1-26	YES
	Claims	None	NO
Inventive step (IS)	Claims	1-26	YES
	Claims	None	NO
Industrial applicability (IA)	Claims	1-26	YES
	Claims	None	NO

2. Citations and explanations (Rule 70.7)

Reference is made to the following document cited in the International Search Report:
D1: US 2004/0181599 A1 (Kreusch et al.) 16 September 2004 (16-09-2004)

The following is a review of how the subject matter described by the claims relates to the prior art of record.

Claims 1-26 are directed to a method and apparatus for intercepting communications in an IP network, in which communications between a subscriber and another party occur through a media relay. The aforementioned claims recite a methodology for intercepting IP communications comprising the following: determining whether determination information associated with a subscriber dialing profile meets intercept criteria; when said determination information meets said intercept criteria, causing the same media relay through which communications between said subscriber and said another party are relayed to produce a copy of said communications between said subscriber and said another party, while said same media relay relays communications between said subscriber and said another party; and causing said same media relay to send said copy to a mediation device identified by destination information associated with said subscriber dialing profile. Associating intercept information with a subscriber dialing profile happens when communications involving the subscriber are not in progress, as well as when the communications are in progress.

D1 is considered to be the prior art closest to claims 1-26. D1 describes a method for monitoring an IP data flow between at least two telecommunications terminals, which are connected to a data network via at least one access server. When monitoring takes place, the data flow is rerouted from the access server to a monitoring server, which makes a copy of the data flow and further transmits the copy to an evaluation unit (*see D1: abstract; paragraphs [0011]-[0015], [0019]-[0022], [0028], [0034]-[0036], [0048]-[0053], [0055]-[0061], [0067], [0072]-[0074], [0078]-[0083]; Figs. 1, 2a-2b; claims 1-3, 7-8, 25-26*).

However, D1 does not describe the same features as are found in independent claims 1 and 14. Specifically, the prior art of reference does not show that communications between a subscriber of an IP network and another party occur through a media relay only, and not through a gateway, an access server and eventually a monitoring server. Moreover, the same media relay through which communications between the subscriber and the other party are relayed, produces a copy of the communications when determination information meets intercept criteria, while continuing to relay the communications. This is in contrast with the intercept method disclosed in prior art, which diverts the communications to a monitoring server in order to make a copy of the data flow, since the monitoring server is not part of the normal communications flow, and it is only used when the communications need to be intercepted. Thus, the present application describes a methodology for intercepting IP communications directly at layer 3 of the OSI model, using only a media relay that relays communications between two telecommunications terminals and also makes copies of the communications, without the need of a dedicated monitoring server.

2.1 Novelty

Claims 1-26 are novel under Article 33(2) of the PCT, as the features of these claims are not explicitly shown in the prior art.

2.2 Inventive Step

Claims 1-26 involve an inventive step over the prior art, and therefore they comply with PCT Article 33(3).

2.3 Industrial Applicability

Claims 1-26 are considered to be industrially applicable as per PCT Article 33(4).

INTERCEPTING VOICE OVER IP COMMUNICATIONS AND OTHER DATA COMMUNICATIONS

BACKGROUND OF THE INVENTION

5 **1. Field of Invention**

This invention relates to data communications and methods and apparatus for intercepting data communications, particularly voice over IP data communications, in an IP network.

10 **2. Description of Related Art**

The term "lawful intercept" is used to describe a procedure which allows law enforcement agencies to perform electronic surveillance of telecommunications. Lawful intercept of telecommunications, particularly phone calls, is premised on a notion that a law enforcement agency has identified a person of interest, obtained a legal authorization for the surveillance (for example, a judicial or administrative warrant), and then contacted the person's telecommunications service provider that will be required to provide the law enforcement agency with a real-time copy of the person's communications. This real-time copy can then be used by the law enforcement agency to monitor or record the person's communications. Within the framework of traditional telecommunications networks, such as, for example, the Public Switched Telephone Network (PSTN) or cellular networks, lawful intercept generally presents a purely economic problem for the service providers that have to ensure that sufficient interception equipment and dedicated links to the law enforcement agencies have been deployed to satisfy lawful intercept requirements mandated by law. However, in the context of Voice over Internet Protocol (VoIP) communications, in addition to the economic problems mentioned above, lawful intercept presents

AMENDED SHEET

22 JANUARY 2009 22.01.09

-24-

Routing Controller

Referring to Figure 7, the routing controller **16** is shown in greater detail and includes a routing controller processor circuit shown generally at **200**. The RC processor circuit **200** includes a microprocessor **202**, program memory **204**, a
5 table memory **206** and an I/O interface **208**, all in communication with the processor. There may be a plurality of processor circuits (**202**), memories (**204**), etc.

The I/O interface **208** includes a database output port **210** through which a
10 request to the database **18** (Figure 1) can be made and includes a database response port **212** for receiving a reply from the database. The I/O interface **208** further includes an RC Request message input **214** for receiving the RC Request message from the call controller **14** and includes a routing message output **216** for sending a routing message back to the call controller **14**.

The program memory **204** includes blocks of codes for directing the RC processor circuit **200** to carry out various functions of the routing controller **16**. One of these blocks implements an RC Request message handler process **250** which directs the RC to produce a routing message in response to a
20 received RC Request message of the type shown at **150** in Figure 6. Referring back to Figure 7, the program memory **204** further includes a Law Enforcement Authority (LEA) request message handler **1400** and an in-call intercept shut down routine **1500**.

The RC Request message handler process **250** is shown in greater detail in
25 Figures **8A** through **8D**.

RC Request Message Handler

Referring to Figure **8A**, the RC Request message handler process **250** begins
30 with a first block **252** that directs the RC processor circuit **200** (Figure 7) to store the contents of the RC Request message **150** (Figure 6) in buffers. Block **254** then directs the RC processor circuit **200** to use the contents of the

AMENDED SHEET

the IP/UDP port address to which the audio data received at the caller and callee IP/UDP port addresses were being copied.

5 It will be appreciated that in the foregoing description, the components described cooperate to detect a requirement for intercept at the time a call is set up. In the following description an explanation is provided to describe how to intercept a call while the call is in progress.

Intercepting a Call in Progress

10 Referring back to Figure 1, to intercept a call while the call is in progress, the law enforcement authority **293** may communicate with a mediation device, or may communicate with the call controller or may communicate with the routing controller or may communicate with a handover interface that communicates with any of the foregoing components to cause the routing
15 controller to receive a law enforcement authority (LEA) intercept request message including intercept information, such as that which would be associated with fields **702-710** in Figure 9, for example.

20 In response to receipt of a LEA intercept request message, the routing controller LEA request message handler shown at **1400** in Figure 44 is invoked.

25 The LEA request message handler **1400** begins with a first block **1402** that directs the routing controller processor circuit to communicate with the database **18** in which dialing profile records of the type shown in Figure 9 are stored to find a dialing profile associated with the user whose calls are to be monitored.

30 If the username is not known, but a DID number (i.e. a PSTN number) is known, the routing controller may cause a search through the DID bank table records of the type shown in Figure 13, for example to find a username associated with a DID number. If the username is not known but a name and

AMENDED SHEET

What is claimed is:

1. A method for intercepting communications in an Internet Protocol (IP) network system in which communications between a subscriber of said system and another party occur through a media relay to which said subscriber and said another party address their communications destined for each other and which relays said communications between said subscriber and said another party, the method comprising:

5

10

determining whether determination information associated with a subscriber dialing profile associated with said subscriber meets intercept criteria;

15

when said determination information meets said intercept criteria, causing the same media relay through which communications between said subscriber and said another party are relayed to produce a copy of said communications between said subscriber and said another party, while said same media relay relays communications between said subscriber and said another party; and

20

causing said same media relay to send said copy to a mediation device identified by destination information associated with said subscriber dialing profile.

25

2. The method of claim 1 further comprising associating said determination information and said destination information with said dialing profile when communications involving said subscriber are not in progress.

30

~~AMENDED SHEET~~

- 5
3. The method of claim 1 further comprising associating said determination information and said destination information with said subscriber dialing profile when communications involving said subscriber are in progress.
- 10
4. The method of claim 2 or 3 wherein associating said determination information and said destination information comprises populating intercept information fields in said dialing profile of a subscriber whose communications are to be monitored.
- 15
5. The method of claim 1 further comprising producing a routing message for routing communications involving the subscriber through components of the IP network and determining whether said determination information meets said intercept criteria prior to producing said routing message and including at least some of said determination information and said destination information in said routing message when said determination information meets said intercept criteria.
- 20
6. The method of claim 5 wherein determining whether said determination information meets said intercept criteria comprises determining whether a current date and time is within a range specified by said determination information.
- 25
7. The method of claim 6 wherein producing a routing message comprises identifying a media relay through which communications involving said subscriber will be conducted and including an identification of said media relay in said routing message such that said media relay acts as said same media relay through which
- 30
- communications between said subscriber and said another party are relayed.

AMENDED SHEET

5 8. The method of claim 7 further comprising pre-associating at least one media relay with said dialing profile associated with the subscriber whose communications are to be monitored and wherein identifying said media relay comprises identifying the media relay pre-associated with said subscriber whose communications are to be monitored.

10 9. The method of claim 8 wherein pre-associating comprises populating media relay fields in said dialing profile with an identification of said at least one media relay.

15 10. The method of claim 3 wherein associating said determination information and said destination information comprises associating said determination information and said destination information with said dialing profile of the subscriber whose communications are to be monitored, in response to receipt of an intercept request message, wherein said intercept request message comprises said determination information and said destination information.

20 11. The method of claim 10 further comprising invoking an intercept request message handler to:
a) find a dialing profile associated with the subscriber whose communications are to be monitored;
b) perform the step of associating said determination information and said destination information with said dialing profile;
25 c) determine whether said intercept criteria are met; and
d) identify a media relay through which said communications are being conducted such that said media relay can be caused to send said copy to said mediation device.
30

AMENDED SHEET

5 12. The method of claim 11 wherein said dialing profile includes a username identifier and further comprising maintaining active call records for communications in progress, said active call records comprising a username identifier and a media relay identifier identifying the media relay through which said communications are being conducted and wherein identifying the media relay comprises locating an active call record associated with communications of the subscriber whose communication are to be monitored to identify the media relay associated with said communications.

10 13. The method of claim 12 further comprising maintaining direct-in-dial (DID) records associating PST telephone numbers with usernames of users subscribing to said IP network, and wherein finding a dialing profile associated with the subscriber whose communications are to be monitored comprises finding a username in a DID record bearing a PSTN number associated with the subscriber whose communications are to be monitored and using said username to locate a dialing profile associated with said username.

20 14. An apparatus for intercepting communications in an Internet Protocol (IP) network, the apparatus comprising:

25 means for accessing dialing profiles associated with respective subscribers of the IP network, at least one of said dialing profiles being associated with a subscriber whose communications are to be monitored, the dialing profile of the subscriber whose communications are to be monitored including intercept information including determination information for determining
30 whether to intercept a communication involving said subscriber, and destination information identifying a mediation device to which intercepted communications involving said subscriber are to be sent;

AMENDED SHEET

means for determining whether said determination information meets intercept criteria;

5

means for causing the same media relay through which communications between said subscriber and said another party are relayed to produce a copy of said communications between said subscriber and said another party, while said media relay relays communications between said subscriber and said another party;

10

means for communicating with said same media relay to cause said same media relay to send said copy of said communications to a mediation device specified by said destination information, when said determination information meets said intercept criteria.

15

15. The apparatus of claim **14** further comprising means for associating said intercept information with said dialing profile when communications involving said subscriber are not in progress.

20

16. The apparatus of claim **14** further comprising means for associating said intercept information with said dialing profile when communications involving said subscriber are in progress.

25

17. The apparatus of claim **15** or **16** wherein said means for associating said intercept information is operably configured to populate intercept information fields in said dialing profile of the subscriber whose communications are to be monitored.

30

18. The apparatus of claim **14** further comprising means for producing a routing message for routing communications involving the subscriber through components of the IP network and means for determining

AMENDED SHEET

5 whether said determination information meets said intercept criteria prior to producing said routing message and wherein said means for producing said routing message is operably configured to include at least some of said intercept information in said routing message when said determination information meets said intercept criteria.

10 19. The apparatus of claim 18 wherein said means for determining whether said determination information meets said intercept criteria is operably configured to determine whether a current date and time is within a range specified by said determination information.

15 20. The apparatus of claim 19 wherein said means for producing said routing message is operably configured to identify a media relay through which communications involving said subscriber will be conducted and to include an identification of said media relay in said routing message such that said media relay acts as said same media relay through which communications between said subscriber and said another party are relayed.

20 21. The apparatus of claim 20 further comprising means for pre-associating at least one media relay with said dialing profile of the subscriber whose communications are to be monitored and wherein said routing means is operably configured to identify from said dialing profile the media relay pre-associated with said subscriber whose communications are to be monitored.

25 22. The apparatus of claim 21 wherein said means for pre-associating is operably configured to populate media relay fields in said dialing profile with an identification of at said least one media relay.

30 23. The apparatus of claim 16 wherein said means for associating said intercept information is operably configured to associate said intercept information associated with said dialing profile of the subscriber whose

AMENDED SHEET

communications are to be monitored, in response to receipt of an intercept request message, wherein said intercept request message comprises said intercept information.

5 **24.** The apparatus of claim **23** further comprising means for handling an intercept request message, said means for handling said intercept request message comprising:

10 a) means for finding a dialing profile associated with the subscriber whose communications are to be monitored, said means for finding a dialing profile cooperating with said means for associating said intercept information with said dialing profile to cause said intercept information to be associated with said dialing profile;

15 b) means for determining whether said intercept criteria are met; and

20 c) means for identifying a media relay through which said communications are being conducted such that said media relay can be caused to send said copy to said mediation device.

25 **25.** The apparatus of claim **24** wherein said dialing profile includes a username identifier and further comprising means for maintaining active call records for communications in progress, said active call records comprising a username identifier and a media relay identifier identifying a media relay through which said communications are being conducted and wherein said means for identifying the media relay is operably configured to locate an active call record associated with communications of the subscriber whose communications are to be monitored to identify the media relay associated with said
30 communications.

AMENDED SHEET

- 5 26. The apparatus of claim 25 further comprising means for maintaining direct-in-dial (DID) records associating PST telephone numbers with usernames of users subscribing to said IP network, and wherein said means for finding a dialing profile associated with the subscriber whose communications are to be monitored is operably configured to find a username in a DID record bearing a PSTN number associated with the subscriber whose communications are to be monitored and use said username to locate a dialing profile associated with said username.

AMENDED SHEET

6/29

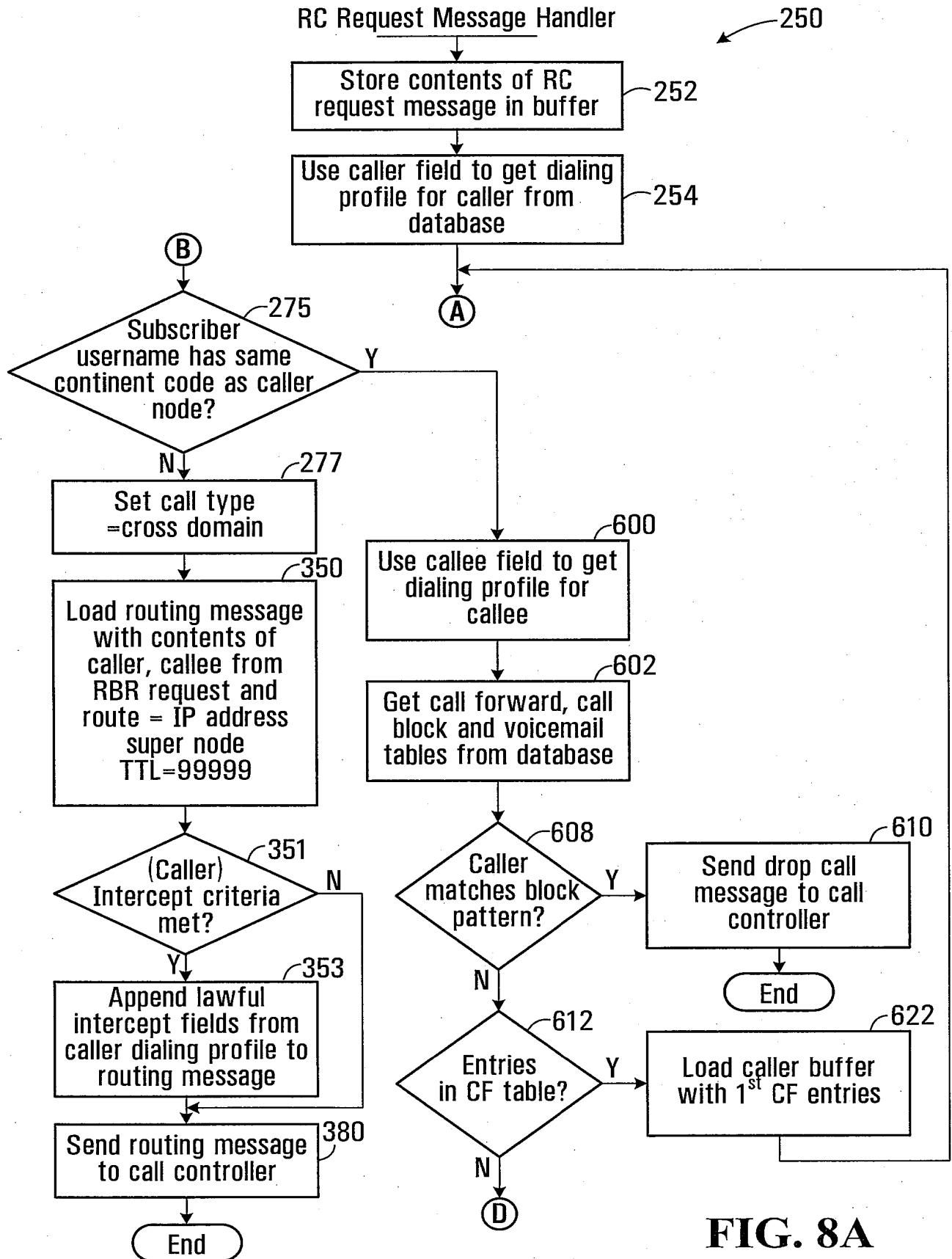

FIG. 8A

7/29

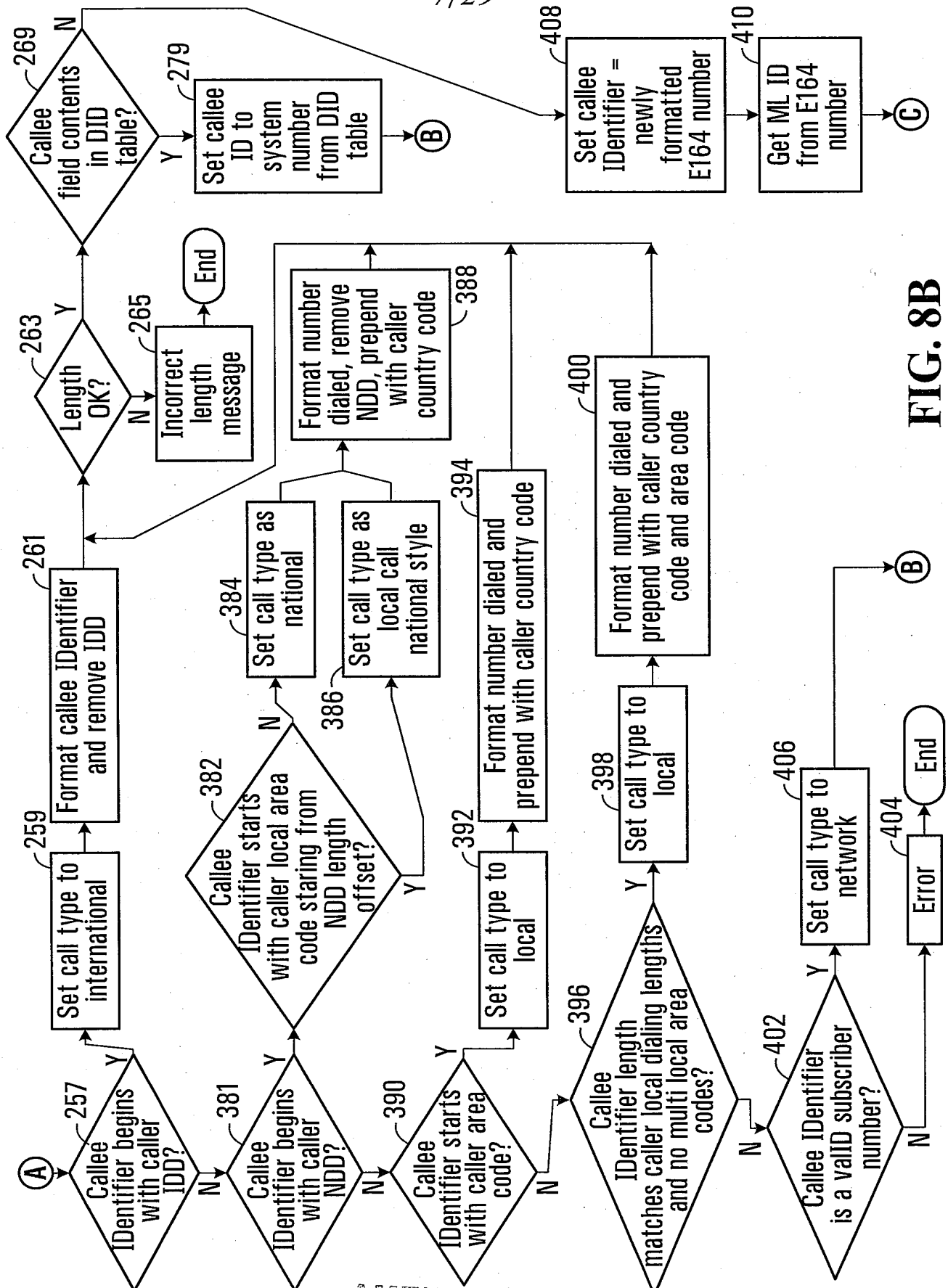

FIG. 8B

8/29

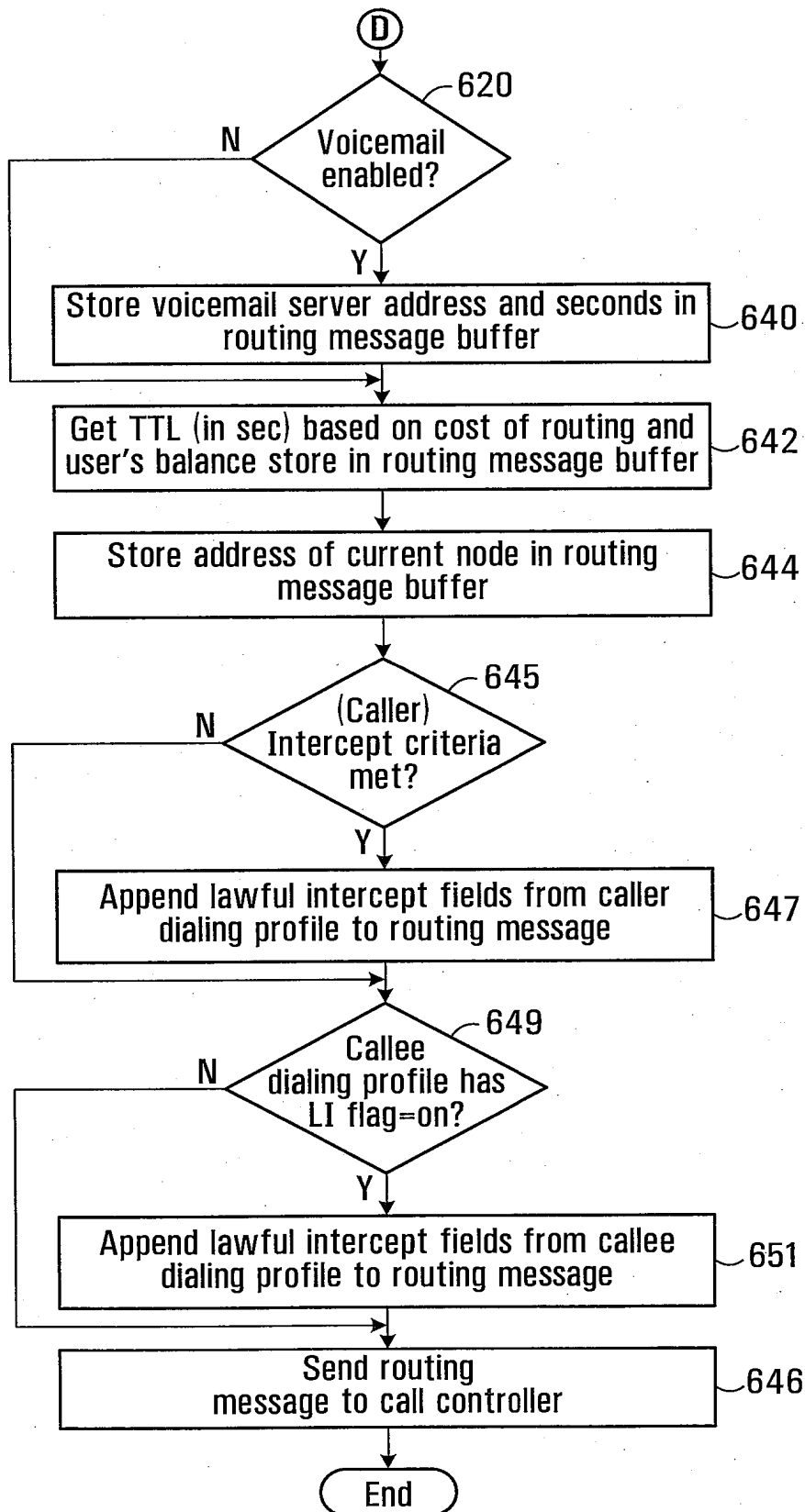

FIG. 8C

ASSEMBLY SHEET

9/29

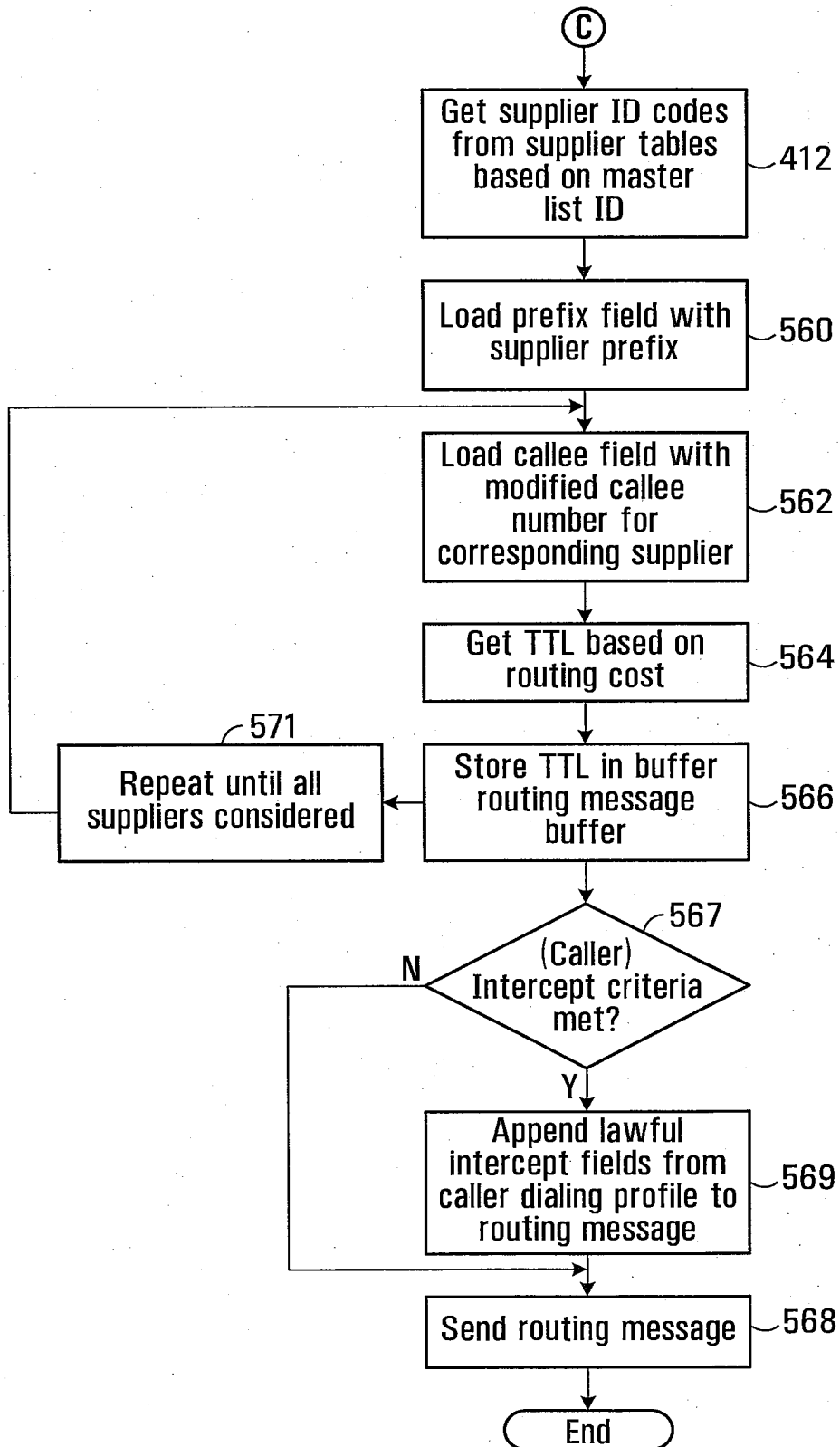

FIG. 8D

13/29

352

Routing Message Format

354	Supplier Prefix (optional)	Code identifying supplier traffic
356	Delimiter	Symbol separating fields
358	Callee	PSTN compatible number or Digifonica number
360	Route	Domain name and IP address
362	Time to Live(TTL)	In seconds
364	Other	TBD

FIG. 15

366

Routing Message - Different Node

440110624444@sp.lhr.digifonica.com;tll=9999

358
360
362

1152 Media Relays (optional)

FIG. 16

Routing Message - Different Node with lawful intercept fields

440110624444@sp.lhr.digifonica.com;tll=999;Liflag=on;MDaddress=192.168.1.10;
 WarrantID=20060515142;
 Lstart=2006 05 16 00:00:00
 Lstop=2006 12 31 23:59:59;

1152 Media Relays (optional)

FIG. 16A

370

Prefix to Supernode Table Record Format

372	Prefix	First n digits of callee identifier
374	Supernode Address	IP address or fully qualified domain name

FIG. 17

Prefix to Supernode Table Record for London Subscriber

Prefix	4
Supernode Address	sp.lhr.digifonica.com

FIG. 18

15/29

Suppliers List Record Format

540	Sup_ID	Name code
542	Route_ID	Numeric code
544	Prefix (optional)	String identifying supplier's traffic #
546	Route	IP address
548	NDD/IDD rewrite	
550	Rate	Cost per second to Digifonica to use this route

FIG. 21**Telus Supplier Record**

	Sup_ID	2010 (Telus)
	Route_ID	1019
	Prefix (optional)	4973#
546	Route	72.64.39.58
	NDD/IDD rewrite	011
550	Rate	\$0.02/min

FIG. 22**Shaw Supplier Record**

	Sup_ID	2011 (Shaw)
	Route_ID	1019
	Prefix (optional)	4974#
	Route	73.65.40.59
	NDD/IDD rewrite	011
550	Rate	\$0.025/min

FIG. 23**Sprint Supplier Record**

	Sup_ID	2012 (Sprint)
	Route_ID	1019
	Prefix (optional)	4975#
	Route	74.66.41.60
	NDD/IDD rewrite	011
550	Rate	\$0.03/min

FIG. 24

22 JANUARY 2009 22.01.09

16/29

Routing Message Buffer for Gateway Call

4973#0116048675309@72.64.39.58;tll=3600 ~ 570
 4974#0116048675309@73.65.40.59;tll=3600 ~ 572
 4975#0116048675309@74.66.41.60;tll=3600 ~ 574
 Media Relays (optional) ~ 1152

FIG. 25**Routing Message Buffer for Gateway Call with Lawful Intercept Fields**

4973#0116048675309@72.64.39.58;tll=3600
 4974#0116048675309@73.65.40.59;tll=3600
 4975#0116048675309@74.66.41.60;tll=3600
 LIflag=on;MDaddress=192.168.1.10;WarrantID=20060515142;
 LIstart=2006051600:00:00;LIstop=2006123123:59:59
 Media Relays (optional) ~ 1152

FIG. 25A**Call Block Record Format**

604 ~ Username Digifonica #
 606 ~ Block Pattern PSTN compatible or Digifonica #

FIG. 26**Call Block Record for Calgary Callee**

604 ~ Username of Callee 2001 1050 2222
 606 ~ Block Pattern 2001 1050 8664

FIG. 27**Call Forwarding Record Format for Callee**

614 ~ Username of Callee Digifonica #
 616 ~ Destination Number Digifonica #
 618 ~ Sequence Number Integer indicating order to try this

FIG. 28

18/29

Routing Message Buffer for CF/VM Routing Message

650 ~ 200110502222@sp.yvr.digifonica.com;ttl=3600
 652 ~ 200110552223@sp.yvr.digifonica.com;ttl=3600
 654 ~ vm.yvr.digifonica.com;20;ttl=60
 656 ~ sp.yvr.digifonica.com
 1152 ~ Media Relays (optional)

FIG. 32**Routing Message Buffer for CF/VM Routing Message with Caller Lawful Intercept Fields**

200110502222@sp.yvr.digifonica.com;ttl=3600
 200110552223@sp.yvr.digifonica.com;ttl=3600
 vm.yvr.digifonica.com;20;ttl=60
 sp.yvr.digifonica.com
 LIflag=on;MDaddress=192.168.1.10;WarrantID=20060615142;
 LIstart=2006061500:00:00;LIstop=2006123123:59:59
 Media Relays (optional) ~ 1152

FIG. 32A**Routing Message Buffer for CF/VM Routing Message with Caller and Callee Lawful Intercept Fields**

200110502222@sp.yvr.digifonica.com;ttl=3600
 200110552223@sp.yvr.digifonica.com;ttl=3600
 vm.yvr.digifonica.com;20;ttl=60
 sp.yvr.digifonica.com
 LI1flag=on;Mdaddress=192.168.1.10;WarrantID=20060515142;
 LI1start=2006051600:00:00;LI1stop=2006123123:59:59
 LI2flag=0;MD2address=192.168.1.20;WarrantID=20060615142;
 LI2start=2006061500:00:00;LI2stop=2006123123:59:59
 Media Relays (optional) ~ 1152

FIG. 32B

AMENDED SHEET

23/29

900

SIP Bye Message

902 ~	Caller	Username
904 ~	Callee	PSTN compatible # or Username
906 ~	Call ID	unique call identifier (hexadecimal string@IP)

FIG. 39

908

SIP Bye Message

902 ~	Caller	2001 1050 8667
904 ~	Callee	2001 1050 2222
906 ~	Call ID	FA10@192.168.0.20

FIG. 40

AMENDED SHEET

22 JANUARY 2009 22.01.09

25/29

RC Call Stop Message

1000
↙

1002	Caller	Username
1004	Callee	PSTN compatible # or Username
1006	Call ID	unique call identifier (hexadecimal string@IP)
1008	Acct Start Time	start time of call
1010	Acct Stop Time	time the call ended
1012	Acct Session Time	start time-stop time (in seconds)
1014	Route	IP address for gateway, where a gateway is used

FIG. 42**RC Call Stop Message for Calgary Callee**

1021
↙

1002	Caller	2001 1050 8667
1004	Callee	2001 1050 2222
1006	Call ID	FA10@192.168.0.20
1008	Acct Start Time	2006-12-30 12:12:12
1010	Acct Stop Time	2006-12-30 12:12:14
1012	Acct Session Time	2
1014	Route	(72.64.39.58 if Telus gateway is used)

FIG. 43

AMENDED SHEET

26/29

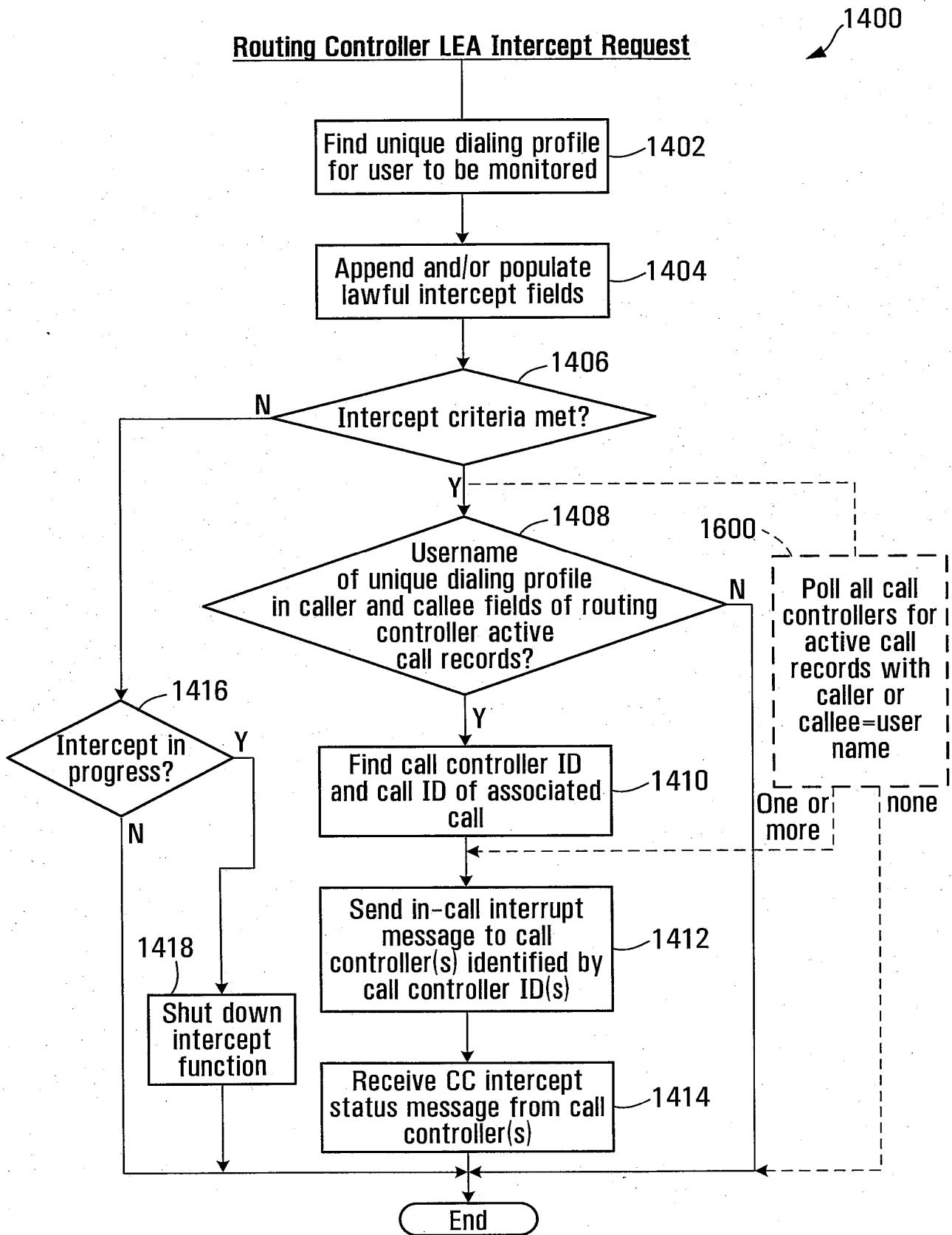

FIG. 44

28/29

1500

Routing Controller In-Call Intercept Shut Down Routine

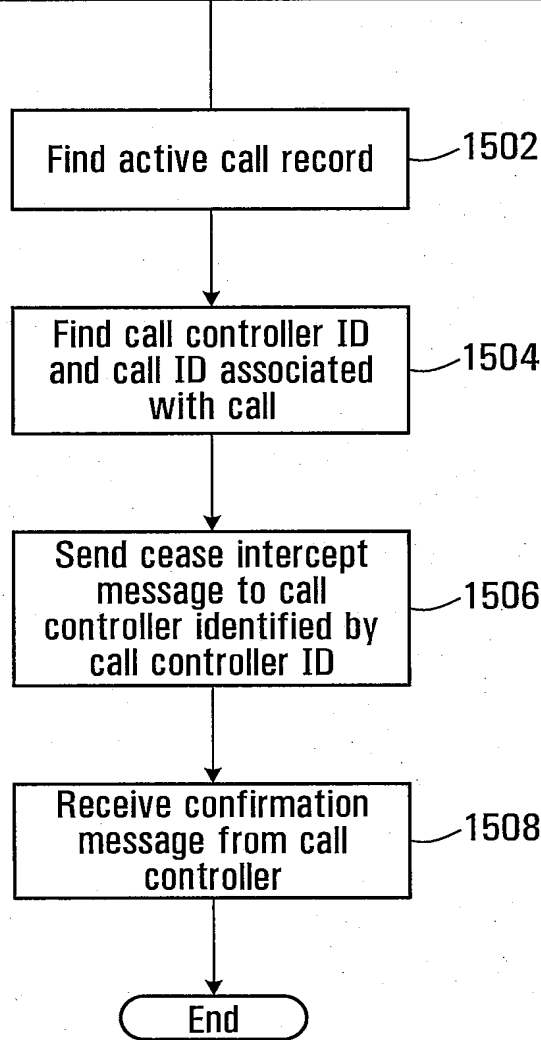

FIG. 46

AMENDED SHEET

PATENT COOPERATION TREATY
PCT

INTERNATIONAL SEARCH REPORT
(PCT Article 18 and Rules 43 and 44)

RECEIVED

Applicant's or agent's file reference 83636-16	FOR FURTHER ACTION	7588 Form PCT/ISA/210: 26 as well as, where applicable, item 5 below 600 WEST GEORGIA ST. ATLANTA, GA 30308-3903 UNITED STATES OF AMERICA
International application No. PCT/CA2007/001956	International filing date (day/month/year) 01 November 2007 (01-11-2007)	(Earliest) Priority date (day/month/year) 02 November 2006 (02-11-2006)
Applicant DIGIFONICA (INTERNATIONAL) LIMITED ET AL		

This international search report has been prepared by this International Searching Authority and is transmitted to the applicant according to Article 18. A copy is being transmitted to the International Bureau.

This international search report consists of a total of 5 sheets.

It is also accompanied by a copy of each prior art document cited in this report.

1. Basis of the report

a. With regard to the **language**, the international search was carried out on the basis of:

the international application in the language in which it was filed

a translation of the international application into _____, which is the language of a translation furnished for the purposes of international search (Rules 12.3(a) and 23.1(b))

b. This international search report has been established taking into account the **rectification of an obvious mistake** authorized by or notified to this Authority under Rule 91 (Rule 43.6bis(a)).

c. With regard to any **nucleotide and/or amino acid sequence** disclosed in the international application, see Box No. I

2. **Certain claims were found unsearchable** (see Box No. II)

3. **Unity of invention is lacking** (see Box No. III)

4. With regard to the **title**,

the text is approved as submitted by the applicant

the text has been established by this Authority to read as follows :

5. With regard to the **abstract**,

the text is approved as submitted by the applicant

the text has been established, according to Rule 38.2, by this Authority as it appears in Box No. IV. The applicant may, within one month from the date of mailing of this international search report, submit comments to this Authority

6. With regard to the **drawings**,

a. the figure of the **drawings** to be published with the abstract is Figure No. 1

as suggested by the applicant

as selected by this Authority, because the applicant failed to suggest a figure

as selected by this Authority, because this figure better characterizes the invention

b. none of the figures is to be published with the abstract



DOC
JLE
JWK

Box No. II Observations where certain claims were found unsearchable (Continuation of item 2 of the first sheet)

This international search report has not been established in respect of certain claims under Article 17(2)(a) for the following reasons :

1. Claim Nos. :
because they relate to subject matter not required to be searched by this Authority, namely :

2. Claim Nos. :
because they relate to parts of the international application that do not comply with the prescribed requirements to such an extent that no meaningful international search can be carried out, specifically :

3. Claim Nos. :
because they are dependant claims and are not drafted in accordance with the second and third sentences of Rule 6.4(a).

Box No. III Observations where unity of invention is lacking (Continuation of item 3 of first sheet)

This International Searching Authority found multiple inventions in this international application, as follows :

Group I	Claims 1-59
Group II	Claims 60, 61
Group III	Claims 62-84
Group IV	Claims 85-107

1. As all required additional search fees were timely paid by the applicant, this international search report covers all searchable claims.
2. As all searchable claims could be searched without effort justifying additional fees, this Authority did not invite payment of additional fees.
3. As only some of the required additional search fees were timely paid by the applicant, this international search report covers only those claims for which fees were paid, specifically claim Nos. :
4. No required additional search fees were timely paid by the applicant. Consequently, this international search report is restricted to the invention first mentioned in the claims; it is covered by claim Nos. :

Remark on Protest The additional search fees were accompanied by the applicant's protest and, where applicable, the payment of a protest fee.

The additional search fees were accompanied by the applicant's protest but the applicable protest fee was not paid within the time limit specified in the invitation.

No protest accompanied the payment of additional search fees.

INTERNATIONAL SEARCH REPORT

International application No.
PCT/CA2007/001956

A. CLASSIFICATION OF SUBJECT MATTER
 IPC: *H04L 12/66* (2006.01), *H04L 12/14* (2006.01), *H04M 11/06* (2006.01), *H04M 15/00* (2006.01),
H04Q 3/64 (2006.01)
 According to International Patent Classification (IPC) or to both national classification and IPC

B. FIELDS SEARCHED

Minimum documentation searched (classification system followed by classification symbols)
 IPC: H04L (2006.01), H04M (2006.01), H04Q (2006.01); US classes: 370, 379 in combination with keywords

Documentation searched other than minimum documentation to the extent that such documents are included in the fields searched

Electronic database(s) consulted during the international search (name of database(s) and, where practicable, search terms used)
 Canadian Patent Database, USPTO West, Delphion. Keywords: public network, private network, routing message, instant messaging, ip phone, voip, routing controller, sip, gateway, tfl, metric, skype, data structure, routing message, billing, communication session, prepaid

C. DOCUMENTS CONSIDERED TO BE RELEVANT

Category*	Citation of document, with indication, where appropriate, of the relevant passages	Relevant to claim No.
A	CA2249668 C (Bruno et al.) 7 April 1999 (07-04-1999) * Page 9, line 4 to page 14, line 18; Figs 1, 2 *	1-59
A	US7120682 B1 (Salama) 10 October 2006 (10-10-2006) * Col. 1, line 47 to col. 4, line 67 *	1-59
A	US2006/0160565 A1 (Singh et al.) 20 July 2006 (20-07-2006) * Paragraphs 14, 15, 18; Figs 1, 2 *	1-59
A	US2006/0177035 A1 (Cope et al.) 10 August 2006 (10-08-2006) * Paragraphs 5, 6, 12 *	1-59
A, P	US7212522 B1 (Shankar et al.) 1 May 2007 (01-05-2007) * Col. 4, line 47 to col. 5, line 11; Fig. 1 *	1-59

Further documents are listed in the continuation of Box C.

See patent family annex.

* Special categories of cited documents :

"A" document defining the general state of the art which is not considered to be of particular relevance
 "E" earlier application or patent but published on or after the international filing date
 "L" document which may throw doubts on priority claim(s) or which is cited to establish the publication date of another citation or other special reason (as specified)
 "O" document referring to an oral disclosure, use, exhibition or other means
 "P" document published prior to the international filing date but later than the priority date claimed

"T" later document published after the international filing date or priority date and not in conflict with the application but cited to understand the principle or theory underlying the invention
 "X" document of particular relevance; the claimed invention cannot be considered novel or cannot be considered to involve an inventive step when the document is taken alone
 "Y" document of particular relevance; the claimed invention cannot be considered to involve an inventive step when the document is combined with one or more other such documents, such combination being obvious to a person skilled in the art
 "&" document member of the same patent family

Date of the actual completion of the international search

6 February 2008 (06-02-2008)

Date of mailing of the international search report

20 February 2008 (20-02-2008)

Name and mailing address of the ISA/CA
 Canadian Intellectual Property Office
 Place du Portage I, C114 - 1st Floor, Box PCT
 50 Victoria Street
 Gatineau, Quebec K1A 0C9
 Facsimile No.: 001-819-953-2476

Authorized officer

Arthur Smith 819-953-1360

INTERNATIONAL SEARCH REPORT

International application No.
PCT/CA2007/001956

C (Continuation). DOCUMENTS CONSIDERED TO BE RELEVANT

Category*	Citation of document, with indication, where appropriate, of the relevant passages	Relevant to claim No.
A	US7068772 (Widger et al.) 27 June 2006 (27-06-2006) * Col. 12, line 49 to col. 14, line 44; col. 15, line 26 to col. 16, line 30 Figs. 3, 5 *	60, 61
A	US2006/0209768 A1 (Yan et al.) 21 September 2006 (21-09-2006) * Paras. 71-99, 111-118, 128-141, 179-188; Figs. 3, 4, 7-9 *	60, 61
X	US6058300 (Hanson) 2 May 2000 (02-05-2000) * Col. 2, lines 9-13; col. 5, line 55 to col. 6, line 23; col. 6, line 55 to col. 7, line 18 *	62, 63, 73-75
A		64-72, 76-84
X	US2005/0177843 A1 (Williams) 11 August 2005 (11-08-2005) * Paragraphs 64 - 69 *	62, 63, 73-75
A		64-72, 76-84
A	US6188752 B1 (Lesley) 13 February 2001 (13-02-2001) * Col. 4, line 24 to col. 9, line 6; Figs 1, 3 *	85-107
A	US6507644 B1 (Henderson et al.) 14 January 2003 (14-01-2003) * Col. 1, line 51 to col. 6, line 28 *	85-107
A	US5359642 (Castro) 25 October 1994 (25-10-1994) * Abstract; Col. 5, lines 7-12, col. 6, line 5 to col. 8, line 38; col. 10, line 10 to col. 12, line 68 *	85-107

INTERNATIONAL SEARCH REPORT
Information on patent family members

International application No.
PCT/CA2007/001956

Patent Document Cited in Search Report	Publication Date	Patent Family Member(s)	Publication Date
CA2249668	07-04-1999	EP0915594 A2 US6614765 B1	12-05-1999 02-09-2003
US7120682	10-10-2006	NONE	
US2006160565	20-07-2006	NONE	
US2006177035	10-08-2006	CA2595429 A1 WO2006081115 A1	03-08-2006 03-08-2006
US7212522	01-05-2007	US6570869 B1 US6658022 B1 US6768733 B1	27-05-2003 02-12-2003 27-07-2004
US7068772	27-06-2006	NONE	
US2006209768	21-09-2006	CA2512959 A1 CN1762129 A EP1585270 A1 JP2004266310 A KR20050092405 A WO2004077754 A1	10-09-2004 19-04-2006 12-10-2005 24-09-2004 21-09-2005 10-09-2004
US6058300	02-05-2000	AU6142498 A CA2250845 A1 US6029062 A US6208851 B1 US6625438 B2 US7162220 B2 WO9834393 A2	25-08-1998 06-08-1998 22-02-2000 27-03-2001 23-09-2003 09-01-2007 06-08-1998
US2005177843	11-08-2005	AU2002351582 A1 CA2469959 A1 CA2471113 A1 US2003120553 A1 US2006190353 A1 WO03056803 A2	15-07-2003 10-07-2003 10-07-2003 26-06-2003 24-08-2006 10-07-2003
US6188752	13-02-2001	AU730021B B2 AU5073398 A BR9713025 A CA2271311 A1 CN1244987 A DE69732526D D1 DE69732526T T2 EP0944994 A1 ES2237791T T3 JP2001504299T T KR20000053241 A NO992280 A US6333976 B2 WO9821874 A1	22-02-2001 03-06-1998 25-01-2000 22-05-1998 16-02-2000 24-03-2005 28-07-2005 29-09-1999 01-08-2005 27-03-2001 25-08-2000 12-07-1999 25-12-2001 22-05-1998
US6507644	14-01-2003	NONE	
US5359642	25-10-1994	NONE	

PATENT COOPERATION TREATY

From the
INTERNATIONAL SEARCHING AUTHORITY

To:
SMART & BIGGAR
Box 11560 Vancouver Centre
2200 - 650 W. Georgia Street
VANCOUVER, British Columbia
Canada, V6B 4N8

RECEIVED REPTIVED

2008 FEB 26 A 10:27 AM
INTERNATIONAL SEARCHING AUTHORITY
2200 - 650 WEST GEORGIA ST. VANCOUVER, B.C.
WEST GEORGIA ST. VANCOUVER, B.C.
(PCT Rule 43bis)

Date of mailing (day/month/year) 20 February 2008 (20-02-2008)

Applicant's or agent's file reference
83636-16

FOR FURTHER ACTION
See paragraph 2 below

International application No.
PCT/CA2007/001956

International filing date (day/month/year)
01 November 2007 (01-11-2007)

Priority date (day/month/year)
02 November 2006 (02-11-2006)

International Patent Classification (IPC) or both national classification and IPC
IPC: *H04L 12/66* (2006.01), *H04L 12/14* (2006.01), *H04M 11/06* (2006.01), *H04M 15/00* (2006.01),
H04Q 3/64 (2006.01)

Applicant
DIGIFONICA (INTERNATIONAL) LIMITED ET AL

NKS
Written Opinion
due Sep 2/08
DOCKET
dock: Sep 1/08

1. This opinion contains indications relating to the following items :

- Box No. I Basis of the opinion
- Box No. II Priority
- Box No. III Non-establishment of opinion with regard to novelty, inventive step and industrial applicability
- Box No. IV Lack of unity of invention
- Box No. V Reasoned statement under Rule 43bis.1(a)(i) with regard to novelty, inventive step or industrial applicability; citations and explanations supporting such statement
- Box No. VI Certain documents cited
- Box No. VII Certain defects in the international application
- Box No. VIII Certain observations on the international application

2. FURTHER ACTION

If a demand for international preliminary examination is made, this opinion will be considered to be a written opinion of the International Preliminary Examining Authority ("IPEA") except that this does not apply where the applicant chooses an Authority other than this one to be the IPEA and the chosen IPEA has notified the International Bureau under Rule 66.1bis(b) that written opinions of this International Searching Authority will not be so considered.

If this opinion is, as provided above, considered to be a written opinion of the IPEA, the applicant is invited to submit to the IPEA a written reply together, where appropriate, with amendments, before the expiration of 3 months from the date of mailing of Form PCT/ISA/220 or before the expiration of 22 months from the priority date, whichever expires later.

For further options, see Form PCT/ISA/220.

3. For further details, see notes to Form PCT/ISA/220.

Name and mailing address of the ISA/CA
Canadian Intellectual Property Office
Place du Portage I, C114 - 1st Floor, Box PCT
50 Victoria Street
Gatineau, Quebec K1A 0C9
Facsimile No.: 001-819-953-2476

Date of completion of this opinion
7 February 2008 (07-02-2008)

Authorized officer
Arthur Smith 819-953-1360

Form PCT/ISA/237 (cover sheet) (April 2007)

Page 1 of 7

Doc
JCC
JWW

WRITTEN OPINION OF THE
INTERNATIONAL SEARCHING AUTHORITY

International application No.
PCT/CA2007/001956

Box No. I Basis of this opinion

1. With regard to the **language**, this opinion has been established on the basis of:
 - the international application in the language in which it was filed
 - a translation of the international application into _____, which is the language of a translation furnished for the purposes of international search (Rules 12.3(a) and 23.1(b)).
2. This opinion has been established taking into account the **rectification of an obvious mistake** authorized by or notified to this Authority under Rule 91 (Rule 43bis.1(a))
3. With regard to any **nucleotide and/or amino acid sequence** disclosed in the international application and necessary to the claimed invention, this opinion has been established on the basis of:
 - a. type of material
 - a sequence listing
 - table(s) related to the sequence listing
 - b. format of material
 - on paper
 - in electronic form
 - c. time of filing/furnishing
 - contained in the international application as filed.
 - filed together with the international application in electronic form
 - furnished subsequently to this Authority for the purposes of search.
4. In addition, in the case that more than one version or copy of a sequence listing and/or table(s) relating thereto has been filed or furnished, the required statements that the information in the subsequent or additional copies is identical to that in the application as filed or does not go beyond the application as filed, as appropriate, were furnished.
5. Additional comments :

WRITTEN OPINION OF THE
INTERNATIONAL SEARCHING AUTHORITY

International application No.
PCT/CA2007/001956

Box No. IV Lack of unity of invention

1. In response to the invitation (Form PCT/ISA/206) to pay additional fees the applicant has, within the applicable time limit :
- paid additional fees
 - paid additional fees under protest and, where applicable, the protest fee
 - paid additional fees under protest but the applicable protest fee was not paid
 - not paid additional fees

2. This Authority found that the requirement of unity of invention is not complied with and chose not to invite the applicant to pay additional fees.

3. This Authority considers that the requirement of unity of invention in accordance with Rules 13.1, 13.2 and 13.3 is

complied with

not complied with for the following reasons :

This International Searching Authority considers that there are four inventions claimed in the international application covered by the claims indicated below:

- I Claims 1-59
- II Claims 60, 61
- III Claims 62-84
- IV Claims 85-107

The claims of Group I have in common a call routing controller for facilitating communications between callers and callees in a communications system comprising a plurality of nodes in which, in response to initiation of a call, uses call classification criteria to classify the call as a public network call or a private network call, and produces accordingly a routing message.

The claims of Group II have in common a data structure for access by an apparatus for producing a routing message for use by a call routing controller in a communications system.

The claims of Group III have in common determining a time to permit a communication session to be conducted, the determination based on calculating a cost per unit time, a participant's billing pattern, and the quotient of a funds balance held by the participant.

The claims of Group IV have in common attributing charges for communications services by determining chargeable times and changing account balances of both user and communications services reseller.

Groups I and II have in common the call routing controller; however, call routing controllers are well known in the art so the claims of Groups I and II lack unity *a posteriori*.

Because the remainder of the claims of Groups I, II, III, and IV have no elements in common and would require separate searches by the examiner, these groups lack unity *a priori*.

4. Consequently, this opinion has been established in respect of the following parts of the international application :

all parts

the parts relating to claim Nos.

WRITTEN OPINION OF THE
INTERNATIONAL SEARCHING AUTHORITY

International application No.
PCT/CA2007/001956

Box No. V Reasoned statement under Rule 43bis.1(a)(i) with regard to novelty, inventive step or industrial applicability; citations and explanations supporting such statement

1. Statement

Novelty (N)	Claims <u>1-107</u>	YES
	Claims <u>None</u>	NO
Inventive step (IS)	Claims <u>1-61, 64-72, 76-107</u>	YES
	Claims <u>62, 63, 73-75</u>	NO
Industrial applicability (IA)	Claims <u>1-107</u>	YES
	Claims <u>None</u>	NO

2. Citations and explanations :

Group I (Claims 1-59)

The following document is referred to in this communication:

D1 CA 2249668

D1 is considered to form the closest prior art. D1 discloses routing information in an integrated global communications network in which a central routing processor collects routing capabilities of network nodes for which it has responsibility. The routing processor evaluates the routing requirements of a routing query signal transmitted by a source router, determines which routers and communication paths within the network are capable and available to route the information, evaluates the statistical availability of such routers, and selects an optimal routing path to a destination router.

Novelty

D1 fails to individually disclose all the elements of claims 1-59; therefore, claims 1-59 are considered to be novel in accordance with Article 33(2) PCT.

Inventive Step

Independent claims 1, 30, and 31 each claim operating a call routing controller to facilitate communication between callers and callees in a system or network comprising a plurality of nodes in which call classification criteria associated with a caller identifier is used to classify the call as a public network call or a private network call, and producing a routing message in accordance with the classification. D1 teaches facilitation of communication between callers and callees within a private network, including producing a routing message for a private network call. However, D1 fails to teach classification of a call as a public network call, and fails to teach producing an appropriate routing message for a public network call.

Claims 2-29 and 32-59 depend on independent claims 1 and 31, respectively.

Therefore, claims 1-59 are considered to have an inventive step in accordance with Article 33(3) PCT.

Industrial Applicability

Routing IP phone calls through a communication network including both private and public aspects finds use in telecommunications, and, thus, claims 1-59 are industrially applicable in accordance with Article 33(4) PCT.

Group II (Claims 60, 61)

The following documents are referred to in this communication:

D2 US7,068,772

D3 US2006/0209768

D2 and D3 are considered to form the closest prior art. D2 discloses a call processing system and method for providing one-number telecommunication services, wherein a data structure of a subscriber record for access by an apparatus for producing a routing message, the data structure comprising the subscriber's various profiles and the associated 1-800 number or address that the subscriber may be contacted.

(Continued in Supplemental Box)

Box No. VIII **Certain observations on the international application**

The following observations on the clarity of the claims, description, and drawings or on the question whether the claims are fully supported by the description, are made :

Claim-Related Objections

Claim 60 is unclear and does not comply with Article 6 of the PCT. The following terms lack a proper antecedent basis:

- “the subscriber” (claim 60, page 83, line 16)
- “subscriber name” (claim 60, page 83, line 17)

Claim 60 is unclear and does not comply with Article 6 of the PCT. The double inclusion of any element renders the claims indefinite. The following expressions have already been defined previously in the claims and should therefore be referred to using a definite article:

- “a user domain” (claim 60, page 83, lines 14, 17)
- “a direct-in-dial number” (claim 60, page 83, line 18)

Claim 60 is indefinite and does not comply with Article 6 of the PCT. The terms “a subscriber user name” (claim 60, page 82, line 32) and “subscriber name” (claim 60, page 83, lines 14, 15, 16-17, 17) cause ambiguity. It is not clear whether they are the same or different.

Claim 61 is indefinite and does not comply with Article 6 of the PCT. The term “master list records” (page 83, line 27) causes ambiguity. It should read “said master list records”.

Claim 61 is indefinite and does not comply with Article 6 of the PCT. The term “aid” (page 83, line 28) causes ambiguity. It should read “said aid”.

Claim 61 is indefinite and does not comply with Article 6 of the PCT. The term “dialing codes” (page 84, line 8) causes ambiguity. It should read “said dialing codes”.

Supplemental Box

In case the space in any of the preceding boxes is not sufficient.

Continuation of: Box V

D3 discloses a system for managing address allocation of a mobile terminal in wireless LAN (WLAN) to inter-work with another WLAN or a public cellular network, wherein a data structure comprises: Message_Type, Message_Length, Domain_Name, MT_ID, Service_Request, Session_ID, Address_Request, Tunnel_Request, WLAN_ID and Security_Field.

Novelty

The subject matter of claim 60 is considered to be novel and complies with the requirement of **Article 33(2) of the PCT**. The cited references, when taken alone, fail to disclose a data structure for access by an apparatus for producing a routing message for use by a call routing controller in a communications system, the data structure comprising: dialing profile records comprising fields for associating with respective subscribers to the system: a subscriber user name; direct-in-dial records comprising fields for associating with respective subscriber usernames: a user domain; and a direct-in-dial number; prefix to node records comprising fields for associating with at least a portion of said respective subscriber usernames: a node address of a node in said system, whereby a subscriber name can be used to find a user domain, at least a portion of said subscriber name can be used to find a node with which the subscriber identified by the subscriber name is associated, and a user domain and subscriber name can be located in response to a direct-in-dial number.

The subject matter of claim 61 is considered to be novel and complies with the requirement of **Article 33(2) of the PCT**. The cited references, when taken alone, fail to disclose a data structure for access by an apparatus for producing a routing message for use by a call routing controller in a communications system, the data structure comprising: master list records comprising fields for associating a dialing code with respective master list identifiers; and supplier list records linked to master list records by said master list identifiers, said supplier list records comprising fields for associating with a communications service supplier: a supplier id; a master list id; a route identifier; and a billing rate code, whereby communications services suppliers are associated with dialing codes, such that dialing codes can be used to locate suppliers capable of providing a communications link associated with a given dialing code.

Inventive Step

The subject matter of claim 60 is considered to involve an inventive step and does comply with **Article 33(3) of the PCT**. The prior art, D2 and D3, alone or in combination, does not fairly suggest a data structure comprising: dialing profile records; direct-in-dial records; prefix to node records, whereby a subscriber name can be used to find a user domain, at least a portion of said subscriber name can be used to find a node with which the subscriber identified by the subscriber name is associated, and a user domain and subscriber name can be located in response to a direct-in-dial number.

The subject matter of claim 61 is considered to involve an inventive step and does comply with **Article 33(3) of the PCT**. The prior art, D2 and D3, alone or in combination, does not fairly suggest a data structure comprising: master list records; and supplier list records linked to master list records, said supplier list records comprising fields for associating with a communications service supplier, whereby communications services suppliers are associated with dialing codes, such that dialing codes can be used to locate suppliers capable of providing a communications link associated with a given dialing code.

Industrial Applicability

Claims 60 and 61 are considered to be industrially applicable and do comply with **Article 33(4) of the PCT**.

Group III (Claims 62-84)

The following documents are referred to in this communication:

D4 US 6058300
D5 US 2005/0177843 A1

D4 discloses, in part, a calculation of a maximum call duration in response to a customer account balance for a prepaid telecommunications system.

D5 discloses, in part, calculation of a maximum call duration to a specific callee in response to a caller request to make a call in a prepaid telecommunications system. If the maximum call duration is sufficient, the system permits the call to take place.

Novelty

Each of D4 and D5 fail to individually disclose all the elements of claims 62-84; therefore, claims 62-84 are considered to be novel in accordance with Article 33(2) PCT.

(Continued in next Supplemental Box)

Supplemental Box

In case the space in any of the preceding boxes is not sufficient.

Continuation of: Previous Supplemental Box

Inventive Step

Claim 62 claims a method of determining a time to permit a communications session to be conducted (ie, a maximum call duration). Either of D4 or D5 disclose determination of a maximum call duration and cause claim 62 to lack an inventive step. Both of D4 and D5 teach determination of a cost per unit time (D4: "rate per minute" (col. 5, line 58); D5: "call credits" (para. 65)), calculating a first time value as a sum of a free time attributed to a participant in the communication session and the quotient of a funds balance held by the participant to the cost per unit time value (D4: col. 5, lines 61 - 65; D5: para. 67), and producing a second time value in response to the first time value and a billing pattern (D4: roaming or not roaming; D5: "call history"), the second time value being the time to permit a communications session to be conducted. Additional differences between claim 62 and either D4 or D5 such as "free time", "cost per unit time" and "billing pattern" also lack inventive step. Thus claim 62 is considered to **lack an inventive step** in accordance with Article 33(3) PCT.

As claims 73 and 74 are apparatus for carrying out methods steps similar or identical to those of claim 62, these claims **lack an inventive step** in accordance with Article 33(3) PCT for the same reasons as listed above.

Claim 63 and 75 lack an inventive step in view of either of D4 or D5 in that D4 and D5 disclose retrieving a record associated with said participant (D4: "customer's account" (col. 5, lines 63-64); D5: "certificate information" (para. 67)) and obtaining from said record said funds balance (D4: col. 5, line 63; D5: para. 67). To also obtain a participant's free time also lack an inventive step. Thus, claims 63 and 75 **lack an inventive step** in accordance with Article 33(3) PCT.

Claims 64-72 and 76-84 are found to be inventive since no combination of prior art documents were found which disclose the subject matter as set forth in claims 64-72 and 76-84 in accordance with Article 33(3) PCT.

Industrial Applicability

Determination of maximum time for a communication session finds application within Internet telephony; thus, claims 62-84 are considered to **have industrial applicability** in accordance with Article 33(4) PCT.

Group IV (Claims 85-107)

The following document is referred to in this communication:

D6 US 6188752

D6 is considered to form the closest prior art. D6 discloses provision of prepaid telecommunications services by a telecommunications network. A database record includes subscriber information fields such as account numbers, prepaid account information, and a current prepayment monetary amounts. Once a call or communication session has been established, the network monitors parameters related to any fee to be charged for the service such as start time, elapsed time, origination and destination locations, and rate information (ie, billing pattern) preferably in real time. D6 further discloses determining the cost of the call and debiting the account balance associated with the subscriber.

Novelty

D6 fails to individually disclose all the elements of claims 85-107; therefore, claims 85-107 **are considered to be novel** in accordance with Article 33(2) PCT.

Inventive Step

Independent claims 85, 96, and 97 each claim attributing charges for communications services including determining a chargeable time in response to a communication session time and a pre-defined billing pattern, determining a user cost value, and changing account balances associated with the user, reseller, and operator of the communications services. D6 teaches attributing charges for communications services, determining a chargeable time in response to a communication session time and a pre-defined billing pattern, determining a user cost value in response to said first chargeable time associated with a user of said communications services, and changing an account balance associated with said user in response to a user cost per unit time. However, D6 fails to suggest a free time value, nor does D6 teach changing the account balances of either a reseller or an operator of said communications services.

Claims 86-95 and 98-107 depend on independent claims 85 and 97, respectively.

Therefore, claims 85-107 **are considered to have an inventive step** in accordance with Article 33(3) PCT.

Industrial Applicability

Billing or attributing charges for communications services finds use in telecommunications, and, thus, claims 85-107 are considered to **have industrial applicability** in accordance with Article 33(4) PCT.

PATENT COOPERATION TREATY

From the INTERNATIONAL SEARCHING AUTHORITY

<p>To: SMART & BIGGAR Box 11560 Vancouver Centre 2200 - 650 W. Georgia Street VANCOUVER, British Columbia Canada, V6B 4N8</p>	<p>INFO TO BE FILED DUE ON 14/08 DOCKET JMU</p>	<p>PCT RECEIVED NOTIFICATION OF TRANSMITTAL OF THE INTERNATIONAL SEARCH REPORT AND THE WRITTEN OPINION OF THE INTERNATIONAL SEARCHING AUTHORITY, OR THE DECLARATION OF ABANDONMENT. (PCT Rule 44.1)</p>
	<p>AMENDS UNDER ARTICLE 19 DUE: MAY 14/08 DOCKET JMU</p>	<p>Date of mailing (day/month/year) 14 March 2008 (14-03-2008)</p>
<p>Applicant's or agent's file reference 83636-13</p>		<p>FOR FURTHER ACTION See paragraphs 1 and 4 below</p>
<p>International application No. PCT/CA2007/002150</p>		<p>International filing date (day/month/year) 29 November 2007 (29-11-2007)</p>
<p>Applicant DIGIFONICA (INTERNATIONAL) LIMITED ET AL</p>		
<p>1. <input checked="" type="checkbox"/> The applicant is hereby notified that the international search report and the written opinion of the International Searching Authority have been established and are transmitted herewith.</p> <p>Filing of amendments and statement under Article 19 : The applicant is entitled, if he so wishes, to amend the claims of the international application (see Rule 46) :</p> <p>When? The time limit for filing such amendments is normally two months from the date of transmittal of the international search report.</p> <p>Where? Directly to the International Bureau of WIPO, 34 chemin des Colombettes 1211 Geneva 20, Switzerland, Facsimile No.: +41 22 338 82 70</p> <p>For more detailed instructions, see the notes on the accompanying sheet.</p> <p>2. <input type="checkbox"/> The applicant is hereby notified that no international search report will be established and that the declaration under Article 17(2)(a) to that effect and the written opinion of the International Searching Authority are transmitted herewith.</p> <p>3. <input type="checkbox"/> With regard to the protest against payment of (an) additional fee(s) under Rule 40.2, the applicant is notified that :</p> <p><input type="checkbox"/> the protest together with the decision thereon has been transmitted to the International Bureau together with the applicant's request to forward the texts of both the protest and the decision thereon to the designated Offices.</p> <p><input type="checkbox"/> no decision has been made yet on the protest; the applicant will be notified as soon as a decision is made.</p> <p>4. Reminders</p> <p>Shortly after the expiration of 18 months from the priority date, the international application will be published by the International Bureau. If the applicant wishes to avoid or postpone publication, a notice of withdrawal of the international application, or of the priority claim, must reach the International Bureau as provided in Rules 90bis.1 and 90bis.3, respectively, before the completion of the technical preparations for the international publication.</p> <p>The applicant may submit comments on an informal basis on the written opinion of the International Searching Authority if a preliminary examination report has been or is to be established. These comments would also be made available to the public out not before the expiration of 30 months from the priority date.</p> <p>Within 19 months from the priority date, but only in respect of some designated Offices, a demand for international preliminary examination must be filed if the applicant wishes to postpone the entry into the national phase until 30 months from the priority date (in some Offices even later); otherwise, the applicant must, within 20 months from the priority date, perform the prescribed acts for entry into the national phase before those designated Offices.</p> <p>In respect of other designated Offices, the time limit of 30 months (or later) will apply even if no demand is filed within 19 months.</p> <p>See the Annex to Form PCT/IB/301 and, for details about the applicable time limits, Office by Office, see the <i>PCT Applicant's Guide</i>, Volume II, National Chapters and the WIPO Internet site.</p>		
<p>Name and mailing address of the ISA/CA Canadian Intellectual Property Office Place du Portage I, C114 - 1st Floor, Box PCT 50 Victoria Street Gatineau, Quebec K1A 0C9 Facsimile No.: 001-819-953-2476</p>	<p>Authorized officer Donna Daly 819- 953-8972</p>	

Form PCT/ISA/220 (October 2005)

(See notes on accompanying sheet)

Doc
 JLG
 JMK

PETITIONER APPLE INC. EX. 1002-460

NOTES TO FROM PCT/ISA/220

These Notes are intended to give instructions concerning the filing of amendments under Article 19. The Notes are based on the requirements of the Patent Cooperation Treaty, the Regulations and the Administrative Instructions under that Treaty. In case of discrepancy between these Notes and those requirements, the latter are applicable. For more detailed information, see also the *PCT Applicant's Guide*, a publication of WIPO.

In these Notes, "Article," "Rule" and "Section" refer to the provisions of the PCT, the PCT Regulations and the PCT Administrative Instructions, respectively.

INSTRUCTIONS CONCERNING AMENDMENTS UNDER ARTICLE 19

The applicant has, after having received the international search report and the written opinion of the International Searching Authority, one opportunity to amend the claims of the international application. It should however be emphasized that, since all parts of the international application (claims, description and drawings) may be amended during the international preliminary examination procedure, there is usually no need to file amendments of the claims under Article 19 except where, e.g. the applicant wants the latter to be published for the purposes of provisional protection or has another reason for amending the claims before international publication. Furthermore, it should be emphasized that provisional protection is available in some States only (see *PCT Applicant's Guide*, Volume I/A, Annexes B1 and B2).

The attention of the applicant is drawn to the fact that amendments to the claims under Article 19 are not allowed where the International Searching Authority has declared, under Article 17(2), that no international search report would be established (see *PCT Applicant's Guide*, Volume I/A, paragraph 296).

What parts of the international application may be amended?

Under Article 19, only the claims may be amended.

During the international phase, the claims may also be amended (or further amended) under Article 34 before the International Preliminary Examining Authority. The description and drawings may only be amended under Article 34 before the International Preliminary Examining Authority.

Upon entry into the national phase, all parts of the international application may be amended under Article 28 or, where applicable, Article 41.

When? Within 2 months from the date of transmittal of the international search report or 16 months from the priority date, whichever time limit expires later. It should be noted, however, that the amendments will be considered as having been received on time if they are received by the International Bureau after the expiration of the applicable time limit but before the completion of the technical preparations for international publication (Rule 46.1).

Where not to file the amendments?

The amendments may only be filed with the International Bureau and not with the receiving Office or the International Searching Authority (Rule 46.2).

Where a demand for international preliminary examination has been/is filed, see below.

How? Either by cancelling one or more entire claims, by adding one or more new claims or by amending the text of one or more of the claims as filed.

A replacement sheet must be submitted for each sheet of the claims which, on account of an amendment or amendments, differs from the sheet originally filed.

All the claims appearing on a replacement sheet must be numbered in Arabic numerals. Where a claim is cancelled, no renumbering of the other claims is required. In all cases where claims are renumbered, they must be renumbered consecutively (Section 205(b)).

The amendments must be made in the language in which the international application is to be published.

What documents must/may accompany the amendments?

Letter (Section 205(b)) :

The amendments must be submitted with a letter.

The letter will not be published with the international application and the amended claims. It should not be confused with the "Statement under Article 19(1)" (see below, under "Statement under Article 19(1)").

The letter must be in English or French, at the choice of the applicant. However, if the language of the international application is English, the letter must be in English; if the language of the international application is French, the letter must be in French.

NOTES TO FORM PCT/ISA/220 (continued)

The letter must indicate the differences between the claims as filed and the claims as amended. It must, in particular, indicate, in connection with each claim appearing in the international application (it being understood that identical indications concerning several claims may be grouped), whether

- (i) the claim is unchanged;
- (ii) the claim is cancelled;
- (iii) the claim is new;
- (iv) the claim replaces one or more claims as filed;
- (v) the claim is the result of the division of a claim as filed.

The following examples illustrate the manner in which amendments must be explained in the accompanying letter :

1. [Where originally there were 48 claims and after amendment of some claims there are 51]:
"Claims 1 to 29, 31, 32, 34, 35, 37 to 48 replaced by amended claims bearing the same numbers; claims 30, 33 and 36 unchanged; new claims 49 to 51 added."
2. [Where originally there were 15 claims and after amendment of all claims there are 11]:
"Claims 1 to 15 replaced by amended claims 1 to 11."
3. [Where originally there were 14 claims and the amendments consist in cancelling some claims and in adding new claims]:
"Claims 1 to 6 and 14 unchanged; claims 7 to 13 cancelled; new claims 15, 16 and 17 added." or
"Claims 7 to 13 cancelled; new claims 15, 16 and 17 added; all other claims unchanged."
4. [Where various kinds of amendments are made]:
"Claims 1-10 unchanged; claims 11 to 13, 18 and 19 cancelled; claims 14, 15 and 16 replaced by amended claim 14; claim 17 subdivided into amended claims 15, 16 and 17; new claims 20 and 21 added."

"Statement under Article 19(1)" (Rule 46.4)

The amendments may be accompanied by a statement explaining the amendments and indicating any impact that such amendments might have on the description and the drawings (which cannot be amended under Article 19(1)).

The statement will be published with the international application and the amended claims.

It must be in the language in which the international application is to be published.

It must be brief, not exceeding 500 words if in English or if translated into English.

It should not be confused with and does not replace the letter indicating the differences between the claims as filed and as amended. It must be filed on a separate sheet and must be identified as such by a heading, preferably by using the words "Statement under Article 19(1)."

It may not contain any disparaging comments on the international search report or the relevance of citations contained in that report. Reference to citations, relevant to a given claim, contained in the international search report may be made only in connection with an amendment of that claim.

Consequence if a demand for international preliminary examination has already been filed

If, at the time of filing any amendments and any accompanying statement, under Article 19, a demand for international preliminary examination has already been submitted, the applicant must preferably, at the time of filing the amendments (and any statement) with the International Bureau, also file with the International Preliminary Examining Authority a copy of such amendments (and of any statement) and, where required, a translation of such amendments for the procedure before that Authority (see Rules 55.3(a) and 62.2, first sentence). For further information, see the Notes to the demand form (PCT/IPEA/401).

If a demand for international preliminary examination is made, the written opinion of the International Searching Authority will, except in certain cases where the International Preliminary Examining Authority did not act as International Searching Authority and where it has notified the International Bureau under Rule 66.1bis(b), be considered to be a written opinion of the International Preliminary Examining Authority. If a demand is made, the applicant may submit to the International Preliminary Examining Authority a re- to the written opinion together, where appropriate, with amendments before the expiration of 3 months from the date of mailing of For... PCT/ISA/220 or before the expiration of 22 months from the priority date, whichever expires later (Rule 43bis.1(c)).

Consequence with regard to translation of the international application for entry into the national phase

The applicant's attention is drawn to the fact that, upon entry into the national phase, a translation of the claims as amended under Article 19 may have to be furnished to the designated/elected Offices, instead of, or in addition to, the translation of the claims as filed.

For further details on the requirements of each designated/elected Office, see the *PCT Applicant's Guide*, Volume II.

PATENT COOPERATION TREATY
PCT
INTERNATIONAL SEARCH REPORT
(PCT Article 18 and Rules 43 and 44)

RECEIVED

Applicant's or agent's file reference 83636-13	FOR FURTHER ACTION	see Form PCT/ISA/220 9:55 as well as, where applicable, item 5 below
International application No. PCT/CA2007/002150	International filing date (<i>day/month/year</i>) 29 November 2007 (29-11-2007)	(Earliest) Priority date (<i>day/month/year</i>) 29 November 2006 (29-11-2006)

Applicant
DIGIFONICA (INTERNATIONAL) LIMITED ET AL

This international search report has been prepared by this International Searching Authority and is transmitted to the applicant according to Article 18. A copy is being transmitted to the International Bureau.

This international search report consists of a total of 4 sheets.

It is also accompanied by a copy of each prior art document cited in this report.

1. Basis of the report

a. With regard to the **language**, the international search was carried out on the basis of:

the international application in the language in which it was filed

a translation of the international application into _____, which is the language of a translation furnished for the purposes of international search (Rules 12.3(a) and 23.1(b))

b. This international search report has been established taking into account the **rectification of an obvious mistake** authorized by or notified to this Authority under Rule 91 (Rule 43.6*bis*(a)).

c. With regard to any **nucleotide and/or amino acid sequence** disclosed in the international application, see Box No. I

2. **Certain claims were found unsearchable** (see Box No. II)

3. **Unity of invention is lacking** (see Box No. III)

4. With regard to the **title**,

the text is approved as submitted by the applicant

the text has been established by this Authority to read as follows :

5. With regard to the **abstract**,

the text is approved as submitted by the applicant

the text has been established, according to Rule 38.2, by this Authority as it appears in Box No. IV. The applicant may, within one month from the date of mailing of this international search report, submit comments to this Authority

6. With regard to the **drawings**,

a. the figure of the **drawings** to be published with the abstract is Figure No. 1

as suggested by the applicant

as selected by this Authority, because the applicant failed to suggest a figure

as selected by this Authority, because this figure better characterizes the invention

b. none of the figures is to be published with the abstract

Doc
JLG
TWW

[Handwritten signatures]

INTERNATIONAL SEARCH REPORT

International application No.
PCT/CA2007/002150

A. CLASSIFICATION OF SUBJECT MATTER IPC: <i>H04L 12/26</i> (2006.01), <i>H04L 12/66</i> (2006.01), <i>H04M 11/06</i> (2006.01), <i>H04M 3/22</i> (2006.01) According to International Patent Classification (IPC) or to both national classification and IPC		
B. FIELDS SEARCHED Minimum documentation searched (classification system followed by classification symbols) IPC: <i>H04L 12/26</i> (2006.01), <i>H04L 12/66</i> (2006.01), <i>H04M 11/06</i> (2006.01), <i>H04M 3/22</i> (2006.01) Documentation searched other than minimum documentation to the extent that such documents are included in the fields searched Electronic database(s) consulted during the international search (name of database(s) and, where practicable, search terms used) West, Delphion, Canadian Patents Database, IEEEXplore, Google Keywords: lawful intercept, (monitor* OR record* or intercept*) near (communicat* OR voip OR phone call* OR audio OR video), electronic surveillance, intercept* near device*, intercept* same IP network*, record* same IP network*, intercept* same voip, record* same voip, media relay, mediation device, (intercept* field OR flag) same profile		
C. DOCUMENTS CONSIDERED TO BE RELEVANT		
Category*	Citation of document, with indication, where appropriate, of the relevant passages	Relevant to claim No.
X Y	US 2004/0181599 A1 (Kreusch et al.) 16 September 2004 (16-09-2004) *paragraphs [0011]-[0015], [0019]-[0022], [0028], [0034]-[0036], [0048]-[0053], [0055]-[0061], [0067], [0072]-[0074], [0078]-[0083]; Figs. 1, 2a-2b; claims 1-3, 7-8, 25-26*	1-2, 4-5, 10-15, 17-18, 23-26 3, 6-9, 16, 19-22
X	US 2003/0219103 A1 (Rao et al.) 27 November 2003 (27-11-2003) *Abstract; paragraphs [0005], [0026]-[0037], [0051]-[0062], [0071]-[0079], [0086]-[0090]; Figs. 1-9*	1, 14
Y	US 2002/0051518 A1 (Bondy et al.) 2 May 2002 (02-05-2002) *Abstract; paragraphs [0030]-[0032], [0036]-[0037], [0039], [0044]-[0052], [0055]-[0057], [0060]; Figs 1, 3, 5; claims 1-5*	3, 6-9, 16, 19-22
A	EP 1 389 862 B1 (Shen et al.) 3 November 2004 (03-11-2004) *paragraphs [0007]-[0014], [0051]-[0060]; Fig. 2; claim 1*	1-3, 14-16
A	US 2004/0165709 A1 (Pence et al.) 26 August 2004 (26-08-2004) *whole document*	1-26
<input checked="" type="checkbox"/> Further documents are listed in the continuation of Box C.		<input checked="" type="checkbox"/> See patent family annex.
* Special categories of cited documents :		"T" later document published after the international filing date or priority date and not in conflict with the application but cited to understand the principle or theory underlying the invention
"A" document defining the general state of the art which is not considered to be of particular relevance		"X" document of particular relevance; the claimed invention cannot be considered novel or cannot be considered to involve an inventive step when the document is taken alone
"E" earlier application or patent but published on or after the international filing date		"Y" document of particular relevance; the claimed invention cannot be considered to involve an inventive step when the document is combined with one or more other such documents, such combination being obvious to a person skilled in the art
"L" document which may throw doubts on priority claim(s) or which is cited to establish the publication date of another citation or other special reason (as specified)		"&" document member of the same patent family
"O" document referring to an oral disclosure, use, exhibition or other means		
"P" document published prior to the international filing date but later than the priority date claimed		
Date of the actual completion of the international search 3 March 2008 (03-03-2008)	Date of mailing of the international search report 14 March 2008 (14-03-2008)	
Name and mailing address of the ISA/CA Canadian Intellectual Property Office Place du Portage I, C114 - 1st Floor, Box PCT 50 Victoria Street Gatineau, Quebec K1A 0C9 Facsimile No.: 001-819-953-2476	Authorized officer Daniela Savin 819- 934-4890	

INTERNATIONAL SEARCH REPORT

International application No.
PCT/CA2007/002150

C (Continuation). DOCUMENTS CONSIDERED TO BE RELEVANT		
Category*	Citation of document, with indication, where appropriate, of the relevant passages	Relevant to claim No.
A	US 2004/0255126 A1 (Reith) 16 December 2004 (16-12-2004) *paragraphs [0010]-[0014], [0020]-[0031], [0041]-[0046]; Figs. 1-2, 4-6; claims 1, 6-10*	1-26
A	US 2004/0157629 A1 (Kallio et al.) 12 August 2004 (12-08-2004) *paragraphs [0006]-[0021], [0050]-[0057], [0080]-[0109]; Figs. 1-12; claims 1, 7-23, 29-43*	1-26
A	US 2005/0174937 A1 (Scoggins et al.) 11 August 2005 (11-08-2005) *paragraphs [0068]-[0089], [0112]-[0138], [0153]-[0156], [0173]-[0176], [0184]-[0193]; Figs. 1-11; claims 1-2*	1-26

PATENT COOPERATION TREATY

From the
INTERNATIONAL SEARCHING AUTHORITY

To:
SMART & BIGGAR
Box 11560 Vancouver Centre
2200 - 650 W. Georgia Street
VANCOUVER, British Columbia
Canada, V6B 4N8

PCT RECEIVED

WRITTEN OPINION OF THE
INTERNATIONAL SEARCHING AUTHORITY
A 9:54
(PCT Rule 43bis.1)
100 WEST GEORGIA ST.
VANCOUVER, B.C.

Date of mailing (day/month/year) 14 March 2008 (14-03-2008)

Applicant's or agent's file reference
83636-13

FOR FURTHER ACTION
See paragraph 2 below

International application No.
PCT/CA2007/002150

International filing date (day/month/year)
29 November 2007 (29-11-2007)

Priority date (day/month/year)
29 November 2006 (29-11-2006)

International Patent Classification (IPC) or both national classification and IPC
IPC: *H04L 12/26* (2006.01), *H04L 12/66* (2006.01), *H04M 11/06* (2006.01), *H04M 3/22* (2006.01)

Applicant
DIGIFONICA (INTERNATIONAL) LIMITED ET AL

WRITTEN OPINION
DUE: ON 29/08
DOCK: SEP 26/08
DOCKET
JML

1. This opinion contains indications relating to the following items :

- Box No. I Basis of the opinion
- Box No. II Priority
- Box No. III Non-establishment of opinion with regard to novelty, inventive step and industrial applicability
- Box No. IV Lack of unity of invention
- Box No. V Reasoned statement under Rule 43bis.1(a)(i) with regard to novelty, inventive step or industrial applicability; citations and explanations supporting such statement
- Box No. VI Certain documents cited
- Box No. VII Certain defects in the international application
- Box No. VIII Certain observations on the international application

2. FURTHER ACTION

If a demand for international preliminary examination is made, this opinion will be considered to be a written opinion of the International Preliminary Examining Authority ("IPEA") except that this does not apply where the applicant chooses an Authority other than this one to be the IPEA and the chosen IPEA has notified the International Bureau under Rule 66.1bis(b) that written opinions of this International Searching Authority will not be so considered.

If this opinion is, as provided above, considered to be a written opinion of the IPEA, the applicant is invited to submit to the IPEA a written reply together, where appropriate, with amendments, before the expiration of 3 months from the date of mailing of Form PCT/ISA/220 or before the expiration of 22 months from the priority date, whichever expires later.

For further options, see Form PCT/ISA/220.

3. For further details, see notes to Form PCT/ISA/220.

Name and mailing address of the ISA/CA
Canadian Intellectual Property Office
Place du Portage I, C114 - 1st Floor, Box PCT
50 Victoria Street
Gatineau, Quebec K1A 0C9
Facsimile No.: 001-819-953-2476

Date of completion of this opinion
04 March 2008 (04-03-2008)

Authorized officer
Daniela Savin 819- 934-4890

DOC
JLL
Trnk

PETITIONER APPLE INC. EX. 1002-466

WRITTEN OPINION OF THE
INTERNATIONAL SEARCHING AUTHORITY

International application No.
PCT/CA2007/002150

Box No. I Basis of this opinion

1. With regard to the language, this opinion has been established on the basis of:

the international application in the language in which it was filed

a translation of the international application into _____, which is the language of a translation furnished for the purposes of international search (Rules 12.3(a) and 23.1(b)).

2. This opinion has been established taking into account the rectification of an obvious mistake authorized by or notified to this Authority under Rule 91 (Rule 43bis.1(a))

3. With regard to any nucleotide and/or amino acid sequence disclosed in the international application and necessary to the claimed invention, this opinion has been established on the basis of:

a. type of material

a sequence listing

table(s) related to the sequence listing

b. format of material

on paper

in electronic form

c. time of filing/furnishing

contained in the international application as filed.

filed together with the international application in electronic form

furnished subsequently to this Authority for the purposes of search.

4. In addition, in the case that more than one version or copy of a sequence listing and/or table(s) relating thereto has been filed or furnished, the required statements that the information in the subsequent or additional copies is identical to that in the application as filed or does not go beyond the application as filed, as appropriate, were furnished.

5. Additional comments :

WRITTEN OPINION OF THE
INTERNATIONAL SEARCHING AUTHORITY

International application No.
PCT/CA2007/002150

Box No. V Reasoned statement under Rule 43bis.1(a)(i) with regard to novelty, inventive step or industrial applicability; citations and explanations supporting such statement

1. Statement

Novelty (N)	Claims <u>3, 6-9, 12-13, 16, 19-22, 25-26</u>	YES
	Claims <u>1-2, 4-5, 10-11, 14-15, 17-18, 23-24</u>	NO
Inventive step (IS)	Claims <u>None</u>	YES
	Claims <u>1-26</u>	NO
Industrial applicability (IA)	Claims <u>1-26</u>	YES
	Claims <u>None</u>	NO

2. Citations and explanations :

Reference is made to the following documents cited in the International Search Report:

D1: US 2004/0181599 A1 (Kreusch et al.) 16 September 2004 (16-09-2004)

D2: US 2003/0219103 A1 (Rao et al.) 27 November 2003 (27-11-2003)

D3: US 2002/0051518 A1 (Bondy et al.) 2 May 2002 (02-05-2002)

2.1 Novelty

a) **Claims 1 and 14 do not comply with PCT Article 33(2).** D1 or D2 disclosed the claimed subject matter before the claim date.

Using the wording of **claim 1**, D1 or D2 each discloses (*references in parenthesis apply to D1 or D2*):

A method for intercepting communications in an Internet Protocol network, the method comprising (*see D1: paragraphs [0011], [0022]; Fig. 1; claims 1-3; or see D2: Abstract; Figs. 1-9*):

maintaining dialing profiles for respective subscribers to the IP network, each said dialing profile including a username associated with the corresponding subscriber (*see D1: paragraphs [0019]-[0021], [0034]-[0036], [0053]; claims 7-8; or see D2: paragraphs [0027], [0029]*);

associating intercept information with the dialing profile of a subscriber whose communications are to be monitored, said intercept information including determination information for determining whether to intercept a communication involving said subscriber, and destination information identifying a device to which intercepted communications involving said subscriber are to be sent (*see D1: paragraphs [0055], [0067], [0078]; Figs. 2a-2b; or see D2: paragraphs [0027], [0029], [0052], [0072]*); and

when said determination information meets intercept criteria, communicating with a media relay through which said communications involving said subscriber will be conducted or are being conducted to cause said media relay to send a copy of said communications to a mediation device specified by said destination information (*see D1: paragraphs [0012], [0015], [0019], [0022], [0028], [0053], [0055], [0060]-[0061], [0081]-[0083]; claim 7; or see D2: paragraphs [0026]-[0037], [0051]-[0062], [0071]-[0079]; [0086]-[0090]; Figs. 1-9*).

Since the language of **claim 1** reads on the prior art represented by D1 or D2, the subject matter of this claim is considered to lack novelty.

As **independent claim 14** is of the same scope as **claim 1**, it is similarly considered to lack novelty, for the same reasons indicated above for **claim 1**.

b) **Claims 2, 4-5, 10-11, 15, 17-18 and 23-24 do not comply with PCT Article 33(2).** D1 disclosed the claimed subject matter before the claim date.

Regarding **claim 2**, D1 discloses associating intercept information with the subscriber profile at login time, when communications involving the subscriber are not in progress (*see D1: paragraphs [0048]-[0053], [0072]-[0074]*).

Box No. VIII Certain observations on the international application

The following observations on the clarity of the claims, description, and drawings or on the question whether the claims are fully supported by the description, are made :

The description does not comply with Article 5 of the PCT. All documents referred to in the description of an application must be available to the public. Reference to the document on page 1, lines 5-6 must be deleted or replaced by its corresponding patent number or publication number.

Claims 1 and 14 are indefinite and do not comply with PCT Article 6. The following terms have no antecedents: "dialing profile" (claim 1, line 6; claim 14, line 8), "intercept information" (claim 1, line 10; claim 14, line 12) and "intercept criteria" (claim 1, line 18; claim 14, line 25).

Claims 1 and 14 are indefinite and do not comply with PCT Article 6. The inclusion of "... identifying a device to which intercepted communications ..." (claim 1, lines 14-15; claim 14, lines 17-18) causes ambiguity. It is not clear whether "a device" refers to a mediation device or any other type of device.

Claims 2-3 and 15-16 are indefinite and do not comply with PCT Article 6. The inclusion of "method of claim 1" and "apparatus of claim 14" causes ambiguity. The applicant likely meant "method of claim 1" and "apparatus of claim 14".

Claim 11 is unclear and does not comply with PCT Article 6. The inclusion of "... identify a media relay ..." causes ambiguity. It is not clear whether the media relay is identified by the intercept request message handler as recited by claim 11, or in response to the routing message, as recited by claim 7. The same comment applies to claim 24 (but in regards to routing message recited by claim 20), since claim 24 is of the same scope as claim 11.

Claim 12 is unclear and does not comply with PCT Article 6. The inclusion of "maintaining a active call records" causes ambiguity, as the aforementioned expression is not grammatically correct.

Claim 24 is unclear and does not comply with PCT Article 6. The inclusion of "a means for find ..." causes ambiguity. It is suggested that "means for find ..." should read "means for finding ...", in order to be consistent with the tense used for the other verbs in claim 24.

diff
claim 1
border

7
11
10
1

10
19
20
24
23
24

Supplemental Box

In case the space in any of the preceding boxes is not sufficient.

Continuation of: Box V

Regarding claim 4, D1 discloses populating the intercept information fields in the hidden database, which is similar to the dialing profile recited by this claim (see D1: paragraph [0079]; claims 7-8, 25-26).

As claim 17 is of the same scope as claim 4, it is similarly considered to lack novelty, for the same reasons indicated above for claim 4.

Regarding claim 5, D1 discloses the routing message containing at least part of the intercept information, when determination information meets intercept criteria (see D1: paragraphs [0055]-[0060], [0067], [0072], [0081]; Figs. 2a-2b).

As claim 18 is of the same scope as claim 5, it is similarly considered to lack novelty, for the same reasons indicated above for claim 5.

Regarding claims 10-11, D1 discloses that in response to receipt of an intercept request message, the corresponding message handler finds the dialing profile associated with the subscriber whose communications are to be monitored, associates the intercept information with the dialing profile, determines whether the intercept criteria are met and identifies the media relay through which communications are being conducted (see D1: paragraphs [0019], [0067], [0072], [0079]).

As claims 23-24 are of the same scope as claims 10-11, they are similarly considered to lack novelty, for the same reasons indicated above for claims 10-11.

However, claims 3, 6-9, 12-13, 16, 19-22 and 25-26 appear to be novel and are deemed to comply with PCT Article 33(2) since the search of the prior art has not revealed a single document disclosing the claimed subject matter.

2.2 Inventive Step

c) Claims 1 and 14 do not involve an inventive step over D1 or D2 since they are not novel over D1 or D2, and therefore they do not comply with PCT Article 33(3). Claims 2, 4-5, 10-11, 15, 17-18 and 23-24 do not involve an inventive step over D1 since they are not novel over D1, and therefore they do not comply with PCT Article 33(3).

e) Claim 3 does not comply with PCT Article 33(3). The subject matter of this claim does not appear to involve an inventive step in view of D1 and D3. D1 does not specifically disclose associating the intercept information with the dialing profile when communications involving the subscriber are in progress. D1 mentions that the interception is possible even when the interception subject is mobile and changes location (see D1: paragraph [0013]). D3, however complements the teachings of D1 by disclosing the interception happening not only at login or call origination, but also for any service invocation during the call, such as call waiting, conference call, call forwarding or message retrieval (see D3: paragraph [0030]; claims 4-5).

As claim 16 is of the same scope as claim 3, it is similarly considered to lack an inventive step in view of D1 and D3.

f) Claim 6 does not comply with PCT Article 33(3). The subject matter of this claim does not appear to involve an inventive step in view of D1 and D3. D1 does not specifically disclose determining whether a current date and time is within a range specified by the determination information. However, D3 discloses the interception information containing the start and stop time for the interception (see D3: paragraph [0039]; claim 3), and it would have been obvious for someone skilled in the art to add these start and stop times to the determination information taught by D1, in order to determine whether to intercept a call or not, depending on the current time.

As claim 19 is of the same scope as claim 6, it is similarly considered to lack an inventive step in view of D1 and D3.

g) Claims 7-9 do not comply with PCT Article 33(3). The subject matter of these claims does not appear to involve an inventive step in view of D1 and D3. D1 does not specifically disclose the routing message containing an identification of the media relay through which communications and interception will be conducted, and pre-associating this media relay with the dialing profile. However, the inclusion of the media relay address in the routing message is a normal design procedure, since no communication would be possible without the presence of the media relay. Moreover, D3 discloses the surveillance information containing all the entities comprising the surveillance path, including the identification of the media relay, and it would have been obvious for someone skilled in the art to include this identification to the monitoring information stored in the hidden database taught by D1 (see D3: paragraphs [0032], [0044], [0051]-[0052], [0057], [0060]; claims 1-3).

As claims 20-22 are of the same scope as claims 7-9, they are similarly considered to lack an inventive step in view of D1 and D3.

Supplemental Box

In case the space in any of the preceding boxes is not sufficient.

Continuation of: Supplemental sheet on page 5

h **Claims 12-13 do not comply with PCT Article 33(3).** The subject matter of these claims does not appear to involve an inventive step in view of D1 and the common knowledge in the art. D1 does not specifically disclose maintaining a list of all the active call records, linking the username with the corresponding media relay identifier, and another list that associates every PST telephone number with its corresponding username, for all the subscribers in the network. However, creating and maintaining these lists would have been an obvious design alternative on the claim date to a person skilled in the art having regards to D1, since keeping a record of all the calls in progress is a standard functionality of any generic network management entity.

As **claims 25-26** are of the same scope as claims 12-13, they are similarly considered to lack an inventive step in view of D1 and the common knowledge in the art.

2.3 Industrial Applicability

Claims 1-26 are considered to be industrially applicable as per PCT Article 33(4).

PATENT COOPERATION TREATY

From the INTERNATIONAL SEARCHING AUTHORITY

PCT

To:
 SMART & BIGGAR
 Box 11560 Vancouver Centre
 2200 - 650 W. Georgia Street
 VANCOUVER, British Columbia
 Canada, V6B 4N8

RECEIVED
 INFO TO BE FILED
 JUN 25 A 9 14
 ME 8020 10
 DOCK
 DOCKED

NOTIFICATION OF TRANSMITTAL OF
 THE INTERNATIONAL SEARCH REPORT AND
 THE WRITTEN OPINION OF THE INTERNATIONAL
 SEARCHING AUTHORITY, OR THE DECLARATION

(PCT Rule 44.1)

Date of mailing 20 June 2008 (20-06-2008)
 (day/month/year)

Applicant's or agent's file reference
 83636-18

FOR FURTHER ACTION See paragraphs 1 and 4 below

International application No.
 PCT/CA2008/000545

International filing date 20 March 2008 (20-03-2008)
 (day/month/year)

Applicant
 DIGIFONICA (INTERNATIONAL) LIMITED ET AL

1. The applicant is hereby notified that the international search report and the written opinion of the International Searching Authority have been established and are transmitted herewith.

Filing of amendments and statement under Article 19 :

The applicant is entitled, if he so wishes, to amend the claims of the international application (see Rule 46) :

When? The time limit for filing such amendments is normally two months from the date of transmittal of the international search report.

Where? Directly to the International Bureau of WIPO, 34 chemin des Colombettes
 1211 Geneva 20, Switzerland, Facsimile No.: +41 22 338 82 70

For more detailed instructions, see the notes on the accompanying sheet.

2. The applicant is hereby notified that no international search report will be established and that the declaration under Article 17(2)(a) to that effect and the written opinion of the International Searching Authority are transmitted herewith.

3. With regard to the protest against payment of (an) additional fee(s) under Rule 40.2, the applicant is notified that :

the protest together with the decision thereon has been transmitted to the International Bureau together with the applicant's request to forward the texts of both the protest and the decision thereon to the designated Offices.

no decision has been made yet on the protest; the applicant will be notified as soon as a decision is made.

4. Reminders

Shortly after the expiration of **18 months** from the priority date, the international application will be published by the International Bureau. If the applicant wishes to avoid or postpone publication, a notice of withdrawal of the international application, or of the priority claim, must reach the International Bureau as provided in Rules 90bis.1 and 90bis.3, respectively, before the completion of the technical preparations for the international publication.

The applicant may submit comments on an informal basis on the written opinion of the International Searching Authority to the International Bureau. The International Bureau will send a copy of such comments to all designated Offices unless an international preliminary examination report has been or is to be established. These comments would also be made available to the public but not before the expiration of 30 months from the priority date.

Within **19 months** from the priority date, but only in respect of some designated Offices, a demand for international preliminary examination must be filed if the applicant wishes to postpone the entry into the national phase **until 30 months** from the priority date (in some Offices even later); otherwise, the applicant must, **within 20 months** from the priority date, perform the prescribed acts for entry into the national phase before those designated Offices.

In respect of other designated Offices, the time limit of **30 months** (or later) will apply even if no demand is filed within 19 months.

See the Annex to Form PCT/IB/301 and, for details about the applicable time limits, Office by Office, see the *PCT Applicant's Guide*, Volume II, National Chapters and the WIPO Internet site.

Name and mailing address of the ISA/CA
 Canadian Intellectual Property Office
 Place du Portage I, C114 - 1st Floor, Box PCT
 50 Victoria Street
 Gatineau, Quebec K1A 0C9
 Facsimile No.: 001-819-953-2476

Authorized officer
 Donna Daly 819-953-8972

(Handwritten signature)

Form PCT/ISA/220 (October 2005)

(See notes on accompanying sheet)

*Doc
 JWK*

PETITIONER APPLE INC. EX. 1002-472

NOTES TO FORM PCT/ISA/220 (continued)

The letter must indicate the differences between the claims as filed and the claims as amended. It must, in particular, indicate, in connection with each claim appearing in the international application (it being understood that identical indications concerning several claims may be grouped), whether

- (i) the claim is unchanged;
- (ii) the claim is cancelled;
- (iii) the claim is new;
- (iv) the claim replaces one or more claims as filed;
- (v) the claim is the result of the division of a claim as filed.

The following examples illustrate the manner in which amendments must be explained in the accompanying letter :

1. [Where originally there were 48 claims and after amendment of some claims there are 51]:
"Claims 1 to 29, 31, 32, 34, 35, 37 to 48 replaced by amended claims bearing the same numbers; claims 30, 33 and 36 unchanged; new claims 49 to 51 added."
2. [Where originally there were 15 claims and after amendment of all claims there are 11]:
"Claims 1 to 15 replaced by amended claims 1 to 11."
3. [Where originally there were 14 claims and the amendments consist in cancelling some claims and in adding new claims]:
"Claims 1 to 6 and 14 unchanged; claims 7 to 13 cancelled; new claims 15, 16 and 17 added."
"Claims 7 to 13 cancelled; new claims 15, 16 and 17 added; all other claims unchanged."
4. [Where various kinds of amendments are made]:
"Claims 1-10 unchanged; claims 11 to 13, 18 and 19 cancelled; claims 14, 15 and 16 replaced by amended claim 14; claim 17 subdivided into amended claims 15, 16 and 17; new claims 20 and 21 added."

"Statement under Article 19(1)" (Rule 46.4)

The amendments may be accompanied by a statement explaining the amendments and indicating any impact that such amendments might have on the description and the drawings (which cannot be amended under Article 19(1)).

The statement will be published with the international application and the amended claims.

It must be in the language in which the international application is to be published.

It must be brief, not exceeding 500 words if in English or if translated into English.

It should not be confused with and does not replace the letter indicating the differences between the claims as filed and as amended. It must be filed on a separate sheet and must be identified as such by a heading, preferably by using the words "Statement under Article 19(1)."

It may not contain any disparaging comments on the international search report or the relevance of citations contained in that report. Reference to citations, relevant to a given claim, contained in the international search report may be made only in connection with an amendment of that claim.

Consequence if a demand for international preliminary examination has already been filed

If, at the time of filing any amendments and any accompanying statement, under Article 19, a demand for international preliminary examination has already been submitted, the applicant must preferably, at the time of filing the amendments (and any statement) with the International Bureau, also file with the International Preliminary Examining Authority a copy of such amendments (and of any statement) and, where required, a translation of such amendments for the procedure before that Authority (see Rules 55.3(a) and 62.2, first sentence). For further information, see the Notes to the demand form (PCT/IPEA/401).

If a demand for international preliminary examination is made, the written opinion of the International Searching Authority will, except in certain cases where the International Preliminary Examining Authority did not act as International Searching Authority and where it has notified the International Bureau under Rule 66.1bis(b), be considered to be a written opinion of the International Preliminary Examining Authority. If a demand is made, the applicant may submit to the International Preliminary Examining Authority a reply to the written opinion together, where appropriate, with amendments before the expiration of 3 months from the date of mailing of Form PCT/ISA/220 or before the expiration of 22 months from the priority date, whichever expires later (Rule 43bis.1(c)).

Consequence with regard to translation of the international application for entry into the national phase

The applicant's attention is drawn to the fact that, upon entry into the national phase, a translation of the claims as amended under Article 19 may have to be furnished to the designated/elected Offices, instead of, or in addition to, the translation of the claims as filed.

For further details on the requirements of each designated/elected Office, see the *PCT Applicant's Guide*, Volume II.

PATENT COOPERATION TREATY
PCT
INTERNATIONAL SEARCH REPORT

(PCT Article 18 and Rules 43 and 44)

RECEIVED

Applicant's or agent's file reference 83636-18	FOR FURTHER ACTION	2008 Form PCT/ISA/220 as well as, where applicable, item 5 below 2008 JUN 25 A 8:40 2200 GSW WEST GEORGIA ST ATLANTA, GA 30335 (Earliest) Priority date (day/month/year) 26 March 2007 (26-03-2007)
International application No. PCT/CA2008/000545	International filing date (day/month/year) 20 March 2008 (20-03-2008)	(Earliest) Priority date (day/month/year) 26 March 2007 (26-03-2007)
Applicant DIGIFONICA (INTERNATIONAL) LIMITED ET AL		

This international search report has been prepared by this International Searching Authority and is transmitted to the applicant according to Article 18. A copy is being transmitted to the International Bureau.

This international search report consists of a total of 3 sheets.

It is also accompanied by a copy of each prior art document cited in this report.

1. Basis of the report

a. With regard to the **language**, the international search was carried out on the basis of:

the international application in the language in which it was filed

a translation of the international application into _____, which is the language of a translation furnished for the purposes of international search (Rules 12.3(a) and 23.1(b))

b. This international search report has been established taking into account the **rectification of an obvious mistake** authorized by or notified to this Authority under Rule 91 (Rule 43.6bis(a)).

c. With regard to any **nucleotide and/or amino acid sequence** disclosed in the international application, see Box No. I

2. **Certain claims were found unsearchable** (see Box No. II)

3. **Unity of invention is lacking** (see Box No. III)

4. With regard to the **title**,

the text is approved as submitted by the applicant

the text has been established by this Authority to read as follows :

5. With regard to the **abstract**,

the text is approved as submitted by the applicant

the text has been established, according to Rule 38.2, by this Authority as it appears in Box No. IV. The applicant may, within one month from the date of mailing of this international search report, submit comments to this Authority

6. With regard to the **drawings**,

a. the figure of the **drawings** to be published with the abstract is Figure No. 1

as suggested by the applicant

as selected by this Authority, because the applicant failed to suggest a figure

as selected by this Authority, because this figure better characterizes the invention

b. none of the figures is to be published with the abstract

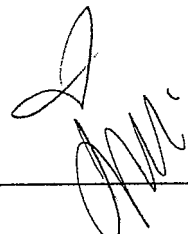

Doc
JWK

A. CLASSIFICATION OF SUBJECT MATTER
 IPC: *H04L 12/66* (2006.01), *H04M 11/06* (2006.01), *H04M 3/42* (2006.01), *H04Q 3/00* (2006.01),
H04Q 3/64 (2006.01)
 According to International Patent Classification (IPC) or to both national classification and IPC

B. FIELDS SEARCHED

Minimum documentation searched (classification system followed by classification symbols)
 IPC: H04L (2006.01), H04M (2006.01), H04Q (2006.01); US classes: 379/45, 370 in combination with keywords

Documentation searched other than minimum documentation to the extent that such documents are included in the fields searched

Electronic database(s) consulted during the international search (name of database(s) and, where practicable, search terms used)
 Canadian Patent Database, USPTO West, Delphion. Keywords: pbx, inward dialing, dial-in, voip, sip, psap, etc, ali, flag and variations thereof.

C. DOCUMENTS CONSIDERED TO BE RELEVANT

Category*	Citation of document, with indication, where appropriate, of the relevant passages	Relevant to claim No.
X, P	US 2008/0063153 A1 (Krivorot et al.) 13 March 2008 (13-03-2008) * Para. [0004] - [0024], [0042] - [0082]; Fig. 1 *	1, 15, 29, 43
A, P		2-14, 16-28, 30-42
A	US 2005/0083911 A1 (Grabelsky et al.) 21 April 2005 (21-04-2005) * Para. [0041] - [0055], [0060] - [0138]; Fig. 1, 2 *	1-43
A	US 2005/0169248 A1 (Truesdale et al.) 4 August 2005 (04-08-2005) * Para. [0013] - [0050] *	1-43
A, P	US 2008/0037715 A1 (Prozeniuk et al.) 14 February 2008 (14-02-2008) * Entire document *	1-43
A, P	WO 2007/044454 A2 (Croy et al.) 19 April 2007 (19-04-2007) * Entire document *	1-43

Further documents are listed in the continuation of Box C.

See patent family annex.

* Special categories of cited documents :	"T" later document published after the international filing date or priority date and not in conflict with the application but cited to understand the principle or theory underlying the invention
"A" document defining the general state of the art which is not considered to be of particular relevance	"X" document of particular relevance; the claimed invention cannot be considered novel or cannot be considered to involve an inventive step when the document is taken alone
"E" earlier application or patent but published on or after the international filing date	"Y" document of particular relevance; the claimed invention cannot be considered to involve an inventive step when the document is combined with one or more other such documents, such combination being obvious to a person skilled in the art
"L" document which may throw doubts on priority claim(s) or which is cited to establish the publication date of another citation or other special reason (as specified)	"&" document member of the same patent family
"O" document referring to an oral disclosure, use, exhibition or other means	
"P" document published prior to the international filing date but later than the priority date claimed	

Date of the actual completion of the international search

6 June 2008 (06-06-2008)

Date of mailing of the international search report

20 June 2008 (20-06-2008)

Name and mailing address of the ISA/CA
 Canadian Intellectual Property Office
 Place du Portage I, C114 - 1st Floor, Box PCT
 50 Victoria Street
 Gatineau, Quebec K1A 0C9
 Facsimile No.: 001-819-953-2476

Authorized officer

Arthur Smith 819-953-1360

INTERNATIONAL SEARCH REPORT
Information on patent family members

International application No.
PCT/CA2008/000545

Patent Document Cited in Search Report	Publication Date	Patent Family Member(s)	Publication Date
US2008063153	13-03-2008	CA2598200 A1	21-02-2008
US2005083911	21-04-2005	EP1526697 A2	27-04-2005
US2005169248	04-08-2005	NONE	
US2008037715	14-02-2008	NONE	
WO2007044454	19-04-2007	US2007091831 A1	26-04-2007
		US2007091906 A1	26-04-2007
		US2007092070 A1	26-04-2007
		WO2007044455 A2	19-04-2007
		WO2007055971 A2	18-05-2007

PATENT COOPERATION TREATY

From the
INTERNATIONAL SEARCHING AUTHORITY

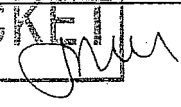
To: SMART & BIGGAR Box 11560 Vancouver Centre 2200 - 650 W. Georgia Street VANCOUVER, British Columbia Canada, V6B 4N8		RECEIVED 2008 JUN 25 A 9:48 2200-650 WEST GEORGIA ST. VANCOUVER, B.C.	PCT WRITTEN OPINION OF THE INTERNATIONAL SEARCHING AUTHORITY (PCT Rule 43bis.1)
Applicant's or agent's file reference 83636-18		Date of mailing (day/month/year) 20 June 2008 (20-06-2008)	
International application No. PCT/CA2008/000545		International filing date (day/month/year) 20 March 2008 (20-03-2008)	Priority date (day/month/year) 26 March 2007 (26-03-2007)
International Patent Classification (IPC) or both national classification and IPC IPC: H04L 12/66 (2006.01), H04M 11/06 (2006.01), H04M 3/42 (2006.01), H04Q 3/00 (2006.01), H04Q 3/64 (2006.01)			
Applicant DIGIFONICA (INTERNATIONAL) LIMITED ET AL		WRITTEN OPINION DUE: JAN 26/09 DUE: JAN 23/09 DOCKET 	
1. This opinion contains indications relating to the following items :			
<input checked="" type="checkbox"/>	Box No. I	Basis of the opinion	
<input type="checkbox"/>	Box No. II	Priority	
<input type="checkbox"/>	Box No. III	Non-establishment of opinion with regard to novelty, inventive step and industrial applicability	
<input type="checkbox"/>	Box No. IV	Lack of unity of invention	
<input checked="" type="checkbox"/>	Box No. V	Reasoned statement under Rule 43bis.1(a)(i) with regard to novelty, inventive step or industrial applicability, citations and explanations supporting such statement	
<input type="checkbox"/>	Box No. VI	Certain documents cited	
<input checked="" type="checkbox"/>	Box No. VII	Certain defects in the international application	
<input checked="" type="checkbox"/>	Box No. VIII	Certain observations on the international application	
2. FURTHER ACTION If a demand for international preliminary examination is made, this opinion will be considered to be a written opinion of the International Preliminary Examining Authority ("IPEA") except that this does not apply where the applicant chooses an Authority other than this one to be the IPEA and the chosen IPEA has notified the International Bureau under Rule 66.1bis(b) that written opinions of this International Searching Authority will not be so considered. If this opinion is, as provided above, considered to be a written opinion of the IPEA, the applicant is invited to submit to the IPEA a written reply together, where appropriate, with amendments, before the expiration of 3 months from the date of mailing of Form PCT/ISA/220 or before the expiration of 22 months from the priority date, whichever expires later. For further options, see Form PCT/ISA/220.			
3. For further details, see notes to Form PCT/ISA/220.			
Name and mailing address of the ISA/CA Canadian Intellectual Property Office Place du Portage I, C114 - 1st Floor, Box PCT 50 Victoria Street Gatineau, Quebec K1A 0C9 Facsimile No.: 001-819-953-2476		Date of completion of this opinion 13 June 2008 (13-06-2008)	Authorized officer Arthur Smith 819-953-1360

Form PCT/ISA/237 (cover sheet) (April 2007)

Page 1 of 5

DEC
JMK

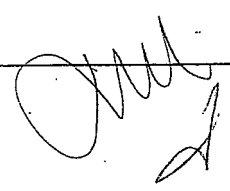

WRITTEN OPINION OF THE
INTERNATIONAL SEARCHING AUTHORITY

International application No.
PCT/CA2008/000545

Box No. V Reasoned statement under Rule 43bis.1(a)(i) with regard to novelty, inventive step or industrial applicability; citations and explanations supporting such statement

1. Statement

Novelty (N)	Claims	<u>1-43</u>	YES
	Claims	<u>None</u>	NO
Inventive step (IS)	Claims	<u>1-43</u>	YES
	Claims	<u>None</u>	NO
Industrial applicability (IA)	Claims	<u>1-43</u>	YES
	Claims	<u>None</u>	NO

2. Citations and explanations :

The following document is referred to in this communication:

D1 US2005/0083911 A1

D1 is considered to form the closest prior art. D1 describes providing E911 emergency services to an IP telephony-based PBX or similar system by establishing a 911 Location Server Database comprising an Emergency Response Location (ERL) database and a Phone Location database. The location of a caller stored in the ERL database is used to route an emergency call to an end-office switch corresponding to the nearest Public Safety Answering Point (PSAP). The Phone Location database stores one record for each registered phone in the system.

Novelty

D1 fails to disclose all the elements of independent claims 1, 15, 29, and 43. In particular, D1 fails to teach a direct inward dialing (DID) identifier or producing a DID identifier for a caller identifier that has no pre-associated DID identifier. Claims 2-14, 16-28 and 30-42 depend on the above independent claims, respectively.

Thus, claims 1-43 are considered to be novel in accordance with Article 33(2) PCT.

Inventive Step

D1 fails to teach or suggest producing a routing message including an emergency response center identifier and temporary DID identifier for establishing a route between a caller and an emergency response center as claimed in independent claims 1, 15, 29, and 43. Claims 2-14, 16-28, and 30-42 depend on the above independent claims, respectively.

Thus, claims 1-43 are considered to have inventive step in accordance with Article 33(3) PCT.

Industrial Applicability

Including location information for emergency VoIP callers located behind a VoIP PBX finds application in IP telephony networks. Thus, claims 1-43 are industrially applicable in accordance with Article 33(4) PCT.

Box No. VII Certain defects in the international application

The following defects in the form or contents of the international application have been noted :

Description-Related Deficiencies

On page 1, line 19, of the description, the term "presended" (sic) is misspelled. Applicant may have intended "presented to".

Box No. VIII **Certain observations on the international application**

The following observations on the clarity of the claims, description, and drawings or on the question whether the claims are fully supported by the description, are made :

Claims-Related Deficiencies

Claims 1 and 22 do not comply with PCT Article 6. In claim 1, the term "the method" (line 3) lacks an antecedent and in claim 22, the term "said pool" (line 15) lacks an antecedent.

(19) World Intellectual Property Organization
International Bureau



(43) International Publication Date
19 April 2007 (19.04.2007)

PCT

(10) International Publication Number
WO 2007/044454 A2

(51) International Patent Classification:
H04M 11/04 (2006.01)

(21) International Application Number:
PCT/US2006/038946

(22) International Filing Date: 4 October 2006 (04.10.2006)

(25) Filing Language: English

(26) Publication Language: English

(30) Priority Data:
60/723,961 6 October 2005 (06.10.2005) US
11/503,912 15 August 2006 (15.08.2006) US

(71) Applicant (for all designated States except US):
TELECOMMUNICATION SYSTEMS, INC. [US/US];
275 WEST STREET, Suite 400, Annapolis, MD 21401
(US).

(72) Inventors: CROY, Jon; 3019 24th Avenue W, Seattle,
WA 98199 (US). HINES, John, Gordon; 120 10th Street,
Kirkland, WA 98033 (US). JOHNSON, Darrin; 16447
169th Street SE, Monroe, WA 98272 (US).

(74) Agent: BOLLMAN, William, H.; Manelli Denison &
Selter PLLC, 2000 M Street, NW, 7th Floor, Washington,
DC 20036 (US).

(81) Designated States (unless otherwise indicated, for every kind of national protection available): AE, AG, AL, AM, AT, AU, AZ, BA, BB, BG, BR, BW, BY, BZ, CA, CH, CN, CO, CR, CU, CZ, DE, DK, DM, DZ, EC, EE, EG, ES, FI, GB, GD, GE, GH, GM, HN, HR, HU, ID, IL, IN, IS, JP, KE, KG, KM, KN, KP, KR, KZ, LA, LC, LK, LR, LS, LT, LU, LV, LY, MA, MD, MG, MK, MN, MW, MX, MY, MZ, NA, NG, NI, NO, NZ, OM, PG, PH, PL, PT, RO, RS, RU, SC, SD, SE, SG, SK, SL, SM, SV, SY, TJ, TM, TN, TR, TT, TZ, UA, UG, US, UZ, VC, VN, ZA, ZM, ZW.

(84) Designated States (unless otherwise indicated, for every kind of regional protection available): ARIPO (BW, GH, GM, KE, LS, MW, MZ, NA, SD, SL, SZ, TZ, UG, ZM, ZW), Eurasian (AM, AZ, BY, KG, KZ, MD, RU, TJ, TM), European (AT, BE, BG, CH, CY, CZ, DE, DK, EE, ES, FI, FR, GB, GR, HU, IE, IS, IT, LT, LU, LV, MC, NL, PL, PT, RO, SE, SI, SK, TR), OAPI (BF, BJ, CF, CG, CI, CM, GA, GN, GQ, GW, ML, MR, NE, SN, TD, TG).

Published:

— without international search report and to be republished upon receipt of that report

For two-letter codes and other abbreviations, refer to the "Guidance Notes on Codes and Abbreviations" appearing at the beginning of each regular issue of the PCT Gazette.

(54) Title: VOICE OVER INTERNET PROTOCOL (VOIP) LOCATION BASED 911 CONFERENCING

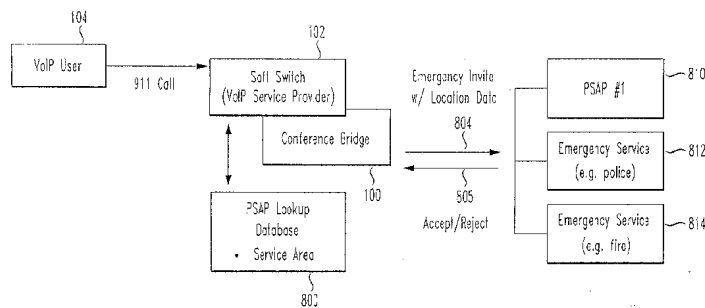

(57) Abstract: Voice Over Internet Protocol (VoIP) emergency calls to an Emergency Response Center (ERC) are handled through a VoIP conference bridge on a VoIP service provider's soft switch. The soft switch works with a VoIP positioning center (VPC) to obtain location information, which is compared against a PSAP database to find an initial best-appropriate PSAP for the location of the emergency caller. The PSAP is issued an Invite message to join the conference, establishing an emergency call. Third parties such as police, ambulance may be issued Invite messages to join the conference. Cold transfers are avoided by Inviting participants to join a single emergency conference rather than passing an emergency call from party to party (e.g., from PSAP to police to ambulance, etc.). The PSAP, other emergency responders, and even the initial VoIP emergency caller may leave and rejoin the VoIP conference without dropping the conference between the others.



WO 2007/044454 A2

VOICE OVER INTERNET PROTOCOL (VoIP) LOCATION BASED 911 CONFERENCING

This application is related to and claims priority from a co-pending
5 U.S. Provisional Application No. 60/723,960, entitled "Voice Over Internet
Protocol (VoIP) Location Based Conferencing", filed on October 6, 2005; U.S.
Provisional Application No. 60/733,789, entitled "Voice Over Internet Protocol
(VoIP) Multi-User Conferencing", filed on November 7, 2005; and U.S.
Provisional Application No. 60/723,961, entitled "Voice Over Internet Protocol
10 (VoIP) Location Based 911 Conferencing", filed on October 6, 2005; the entirety
of all three of which are expressly incorporated herein by reference.

BACKGROUND OF THE INVENTION

1. Field of the Invention

15 This invention relates generally to Voice Over Internet (VoIP)
protocols and architectures. More particularly, it relates to location based
services for the provision of 911 emergency services using VoIP protocols and
architectures.

20 2. Background of the Related Art

911 is a phone number widely recognized in North America as an
emergency phone number that is used by emergency dispatch personnel, among
other things, to determine a location of a caller. Enhanced 911 (E911) is defined
by the transmission of callback number and location information. E911 may be
25 implemented for landline and/or wireless devices.

A Public Safety Answering Point (PSAP) is a dispatch office that
receives 9-1-1 calls from the public. A PSAP may be a local, fire or police
department, an ambulance service or a regional office covering all services. A 9-
1-1 ("911") service becomes E-9-1-1 ("E911") when automatic number
30 identification and automatic location information from a communications device
(e.g. wireless phone, VoIP Phone, etc.) is provided to the 911 operator.

Voice-Over-Internet Protocol (VoIP) is a technology that emulates a phone call, but instead of using a circuit based system such as the telephone network, utilizes packetized data transmission techniques most notably implemented in the Internet. 911 calls made using VoIP technology must reach
5 the correct PSAP, but there currently is no uniform interface to the various PSAPs for call delivery because the technology for connecting calls varies. For instance, not all PSAPs are Internet Protocol (IP) capable. Some PSAPs are accessed via ordinary public switched telephone network (PSTN) telephone lines. Some PSAPs are accessed through selective routing such as direct
10 trunks. Still other PSAPs are accessed using IP connections. There is no uniformity among the thousands of different PSAPs.

Moreover, some Public Safety Access Points (PSAPs) are not enhanced, and thus do not receive the callback or location information at all from any phone, landline or wireless.

15 The use of VoIP technology is growing quickly. As people adopt voice-over-IP (VoIP) technology for routine communications, the inventors herein recognize that there is a growing need to access E911 services including provision of location information from a VoIP device.

The existing E911 infrastructure is built upon copper wire line voice
20 technology and is not fully compatible with VoIP. Given VoIP technology, there are at least three VoIP scenarios:

- 25 1. A VoIP UA that is physically connected to a static data cable at a "home" address. For instance, an Analog Telephone Adapter (ATA) that is connected to the "home" data cable and uses traditional telephone devices.
2. A VoIP UA that is physically connected to a data cable at a location different than its "home" address. For instance, a laptop computer device utilized away from home as a VoIP software telephone would be a VoIP 'visitor' device as described by this scenario.
- 30 3. A VoIP UA that is wireless, physically disconnected from any data cable. In this situation, the VoIP UA connects to the VoIP service provider via

either a wide-area wireless technology (e.g., cellular, PCS, WiMAX) or via a local-area wireless technology (e.g., Wireless Fidelity (WiFi), UWB, etc.) using a laptop computer or handheld device.

VoIP phone calls are routed to a VoIP voice gateway, from which
5 they are passed on to their destination. A VoIP voice gateway or soft switch is a programmable network switch that can process the signaling for all types of packet protocols. Also known as a 'media gateway controller,' 'call agent,' or 'call server, such devices are used by carriers that support converged
10 communications services by integrating SS7 telephone signaling with packet networks. Softswitches can support, e.g., IP, DSL, ATM and frame relay.

The challenges evident with respect to determining the location of a calling VoIP telephone is perhaps most evident with respect to its use to make an emergency call (e.g., a 911 call). Nevertheless, VoIP telephone technology is quickly replacing conventional switched telephone technology. However,
15 because VoIP is Internet Protocol (IP) based, call related information such as CallerID type services may not be available or accurate. A location of a given VoIP device may be provisioned to be at a given geographic location, or queried from a home location register (HLR) in a mobile system.

In addition, some Public Safety Access Points (PSAPs) are not
20 enhanced, and thus do not receive the callback or location information at all from any phone; landline, cellular or VoIP.

Moreover, there is complexity in public access to Public Safety Answering Points due to lack of a Session Initiation Protocol (SIP) Uniform Resource Identifier (URI) for all PSAPs. (SIP is the IP-based protocol defined in
25 IETF RFCs 3261 and 2543.) SIP is one of two dominant protocols used by the VoIP industry. URI is the addressing technology for identifying resources on the Internet or a private intranet. URIs were originally defined as two types: Uniform Resource Locators (URLs) which are addresses with network location, and Uniform Resource Names (URNs) which are persistent names that are address
30 independent. Today, a URI is defined by its purpose rather than the URL vs. URN classification.) Some PSAPs are accessed only by conventional telephone

line, others only by direct telephone trunk lines. Not all PSAPs are accessible via the Internet.

Fig. 5 shows basic conventional VoIP elements required to interconnect a VoIP emergency E911 caller to a relevant public safety access point (PSAP).
5

In particular, as shown in Fig. 5, VoIP telephone devices **102a**, **102b**, **102c** (collectively referred to as **102**) are connected to respective VoIP Service Provider (VSP) soft switches **104a**, **104b**, **104c** (collectively referred to as **104**) using an Internet Protocol (IP) connection, most commonly over the Internet. The VoIP service provider's soft switch **104** in turn communicates with a respective VoIP Positioning Center (VPC) **106a**, **106b**, **106c** (collectively referred to as **106**) using an appropriate IP connection. Each VSP requires use of their own VPC, as depicted in Fig. 5.
10

Fig. 6 shows in more detail conventional VoIP elements required by a VPC to interconnect a VoIP emergency E911 caller to a relevant public safety access point (PSAP).
15

In particular, as shown in Fig. 6, each VPC **106** comprises its own respective route determination module **404**, call delivery module **406**, and provisioning list **408**.

A respective location information server (LIS) **108** services each of the VPCs **106**. The LIS **108** is responsible for storing and providing access to the subscriber location information needed for E9-1-1 call processing (as defined by the NENA VoIP Location Working Group).
20

A conventional VoIP Positioning Center (VPC) **106** is a system that attempts to determine the appropriate or correct PSAP **114** that a VoIP emergency E911 call should be routed to based on the VoIP subscriber's position. The conventional VPC **106** also returns associated routing instructions to the VoIP network. The conventional VPC **106** additionally provides the caller's location and the callback number to the relevant PSAP through the automatic location identifier (ALI) (The ALI is a database that accepts a PSAP query, and using that relates a specific telephone number to a street address. In the case of
25
30

an Emergency Services Query Key (ESQK), the ALI database steers the query to the appropriate VPC and steers the response back to the PSAP. An ALI is typically owned by a LEC or a PSAP.)

Further as shown in Fig. 6, each VSP route the emergency 9-1-1 call, without location object added, to their VPC **106**. The VPC must determine the correct PSAP **114** (collectively represented by PSAP **114a**, **114b** and **114c**) and route to it using the appropriate technology.

In a first scenario, the VPC **106** passes the 9-1-1 call to the PSAP **114a** using an INVITE telephone number message, via a media gateway **110** that translates between the IP protocol of the INVITE message and a telephone line interface, and interfaces with the public switched telephone network (PSTN) **112**.

In a second scenario, the VPC **106** passes the 9-1-1 call to the PSAP **114b** using an INVITE S/R message, via an ESGW **120** and selective router **122**. In this scenario, the selective router **122** is connected to the relevant PSAP **114b** via direct trunks.

In a third scenario, the VPC **106** passes the 9-1-1 call to the PSAP **114c** using an INVITE PSAP message, via IP, to the PSAP **114c**.

In the second and third scenario, the ALI **126** must be inter-connected with each VPC **106** (a,b,c). Furthermore, each VPC is burdened with supporting all the various ALI protocols: ve2, e2, PAM, legacy NENA, etc.

Thus, as can be appreciated, an Emergency call (e.g., 911, E911) may require the involvement of one or more Response Centers (RCs), e.g., Public Safety Access Point (PSAP) in addition to the RC that initially receives the emergency call. This is because there is a possibility that the emergency call is received by a PSAP other than that which is assigned to the geographic region that the caller is currently located in.

Accordingly, the PSAP that initially answers the call may need to transfer the emergency call to the correct PSAP. During transfer of the emergency VoIP call, the original RC may or may not remain on the line, but for safety purposes will not likely want to disconnect or cold transfer the emergency

call. This is because errors may occur in the transfer, resulting in valuable time lost. One cause of a faulty transfer of the E911 call would be that the VoIP user has not updated the location stored by the VPC, or quite simply that bad routing has occurred. Another cause would be that the nature of the emergency requires
5 multiple parties to be involved (e.g., fire/police, police/FBI, ambulance/CDC, etc.).

Conventional solutions are based on tools that can be used to find the phone numbers of other emergency response centers. The ERC receiving the call initially will perform a look-up for the correct response center, and may dial the identified correct response center, agency, etc., and transfer the call via
10 direct dial/public switched telephone network (PSTN).

One exemplary conventional solution is called an Intelligent Emergency Network (IEN), available from Intrado Inc. of Longmont, Colorado. However, such conventional solutions typically require the emergency response center to know the direct dial lines of every PSAP, ESP, ERC, etc. nationally.
15 Moreover, those lines may not always be staffed. Other potential problems would be caused if no automatic location identification (ALI) information is accessible or available.

There is a need for an architecture and methodology that both simplifies the complexity of a VoIP call transfers with respect to an emergency
20 response center such as a public safety access point (PSAP).

SUMMARY OF THE INVENTION

In accordance with the principles of the present invention, a method of connecting an emergency caller with an emergency response center
25 comprises establishing an emergency call conference. The emergency caller is added to the established emergency call conference, and the emergency response center is added to the emergency call conference. The emergency call is established after the emergency caller and the emergency response center are both added to the emergency call conference.

30

BRIEF DESCRIPTION OF THE DRAWINGS

Fig. 1 shows an exemplary architecture of a VoIP emergency call conference bridge application operating in a VoIP soft switch of a VoIP provider to provide VoIP emergency call conferencing, in accordance with the principles of the present invention.

Fig. 2 shows an exemplary message flow diagram of VoIP location based 911 conferencing, in accordance with the principles of the present invention.

Fig. 3 shows an exemplary architecture of a VoIP conference bridge application operating in a VoIP soft switch of a VoIP provider to provide VoIP emergency call conferencing, in accordance with the principles of the present invention.

Fig. 4 shows an exemplary message flow diagram for establishing a VoIP location based conference, in accordance with the principles of the present invention.

Fig. 5 shows basic conventional VoIP elements required to interconnect a VoIP emergency E911 caller to a relevant public safety access point (PSAP).

Fig. 6 shows in more detail conventional VoIP elements required to interconnect a VoIP emergency E911 caller to a relevant public safety access point (PSAP).

DETAILED DESCRIPTION OF ILLUSTRATIVE EMBODIMENTS

The present invention handles emergency calls through the use of a conference bridge on a VoIP service provider's soft switch. The soft switch works with a VoIP positioning center (VPC) to obtain location information, which may be gathered or confirmed by the initial recipient of the call, to ensure that appropriate participants to the emergency conference call are invited to join the call. With the present invention in place, any number of emergency calls can be made, including any number of ERCs, PSAPs, ERPs, etc., (limited only by the number of conference bridges that can be established in provisioned equipment,

e.g., in the VoIP service provider's soft switch). Cold transfers can be avoided by inviting participants to join a single emergency conference rather than passing an original call from party to party (e.g., from PSAP to police to ambulance, etc.) Moreover, the emergency call can survive as long as a participant remains in the emergency conference call, even after the original emergency caller hangs up.

Fig. 1 shows an exemplary architecture of a VoIP emergency call conference bridge application operating in a VoIP soft switch of a VoIP provider to provide VoIP emergency call conferencing, in accordance with the principles of the present invention.

In particular, as shown in Fig. 1, a user of a VoIP communications device **104** makes an emergency call (e.g., a 911 call). The VoIP service provider of the VoIP communications device **104** receives the 911 call, and assigns it to an available VoIP emergency conference call bridge **100**. The soft switch **102** obtains location information relating to the VoIP communications device **104**, either directly from the VoIP communications device **104** itself (e.g., if it includes a GPS device) or from a VoIP positioning center (VPC). The VoIP soft switch **102** compares the location information in a PSAP lookup database **800** to determine an initial PSAP for the service area responsible for the location of the VoIP communications device **104**. The PSAP lookup database provides an appropriate URL or other address information of the initial PSAP to the VoIP soft switch **102**, which in turn addresses an Invite message **804** (preferably including location information relating to the location of the VoIP communications device **104**). The PSAP **810**, in response, sends either an Accept message or a Reject message to the soft switch **102** in response to the Invite message **804**. Additional emergency services departments (e.g., police **812**, fire **814**, etc.) may be subsequently sent an Invite message to join the same VoIP emergency conference call.

Thus, the VoIP communication device **104** dials the appropriate emergency number (e.g., 911), and in response the VoIP service provider's soft switch **102** otherwise responsible for routing the user's calls instead establishes a

VoIP conference bridge **100** and places the incoming emergency call into the VoIP conference bridge **100**.

Although the initial emergency VoIP communication device **104** is a VoIP device, the soft switch **102** may additionally include interfaces to the Public
5 Switched Telephone Network (PSTN) to permit non-VoIP emergency service provider's to join into the VoIP conference bridge.

Alternatively, instead of automatically placing the initial VoIP emergency caller **104** into the established VoIP conference bridge **100**, the VoIP soft switch **102** may instead Invite the initial VoIP emergency caller **104** to join
10 the conference call via the VoIP conference bridge **100**. In response, the initial VoIP emergency caller **104** presumably accepts the Invite message and joins the VoIP conference bridge **100**.

At this point, the soft switch **102** may confirm location with the initial VoIP emergency caller **104** (if location information was provided with the initial
15 call from the VoIP communication device **104**), or determines location from the subscriber's VPC, and captures the Location Object (LO).

The initial VoIP emergency caller **104** sends the LO and a 911 Invite message with an RC type (e.g., Fire Department, Homeland Security, etc.) to the soft switch **102** managing the VoIP conference bridge **100**.

20 The soft switch **102** sends the LO and Invite information to the VPC, which identifies the proper additional conference participant(s) (e.g., a PSAP, RC, first responder, other interested party, etc.) and corresponding contact information, and invites the proper participants to join the call.

The invited participant(s) can also invite other entities to join the
25 VoIP emergency conference. While it is presumed that all participants in the VoIP emergency conference call may participate in the call, it is possible to include 'listen only' participants. For instance, a voice and/or data recording line may be invited to the VoIP emergency conference call to record any data and/or voice conversation.

Fig. 2 shows an exemplary message flow diagram of VoIP location based 911 conferencing, in accordance with the principles of the present invention.

5 In particular, as shown in Fig. 2, an emergency call **712** (e.g., 911) is placed from VoIP communications device **104**.

In response, the VoIP soft switch establishing the VoIP emergency conference call bridge transmits an emergency VoIP conference call Invite message (with or without a location object) **714** (or other location request) to the VoIP Positioning Center (VPC) **701**. Based on the location of the initiating VoIP emergency caller **104**, the VPC pass at least one Invite message using Internet Protocol (e.g., over the Internet) to interested third parties such as an initially contacted RC-1/PSAP **702**, PSAP-2 **703**, PSAP-n **704**, etc. The first emergency center contacted (RC-1/PSAP **702**) responds by verifying the location object and passing the same, along with the Invite RC Type, to the soft switch **718**.

15 As the emergency call progresses, other emergency responders may be brought into the VoIP emergency conference call. For instance, the soft switch that manages the VoIP conference call bridge **100** initiates an Invite message with location object to the VPC **701**, which in turn transmits an Invite message **722** to a subsequent emergency response center (e.g., PSAP-2 **703**).
20 That subsequent emergency response center **703** responds by verifying/modifying the location object, and the Invite RC Type, as shown in message **724**.

The VoIP soft switch **102** may continue to invite additional emergency responders (or other parties) by passing an Invite message with location object through the VPC **701**, which passes an Invite with location object to the relevant other emergency responders **704**.

As an example to explain advantages of the present invention, the scenario is given where an emergency 9-1-1 call is routed to a PSAP based on a presumed or default location of the VoIP caller, but in fact it turns out that the PSAP that receives the VoIP call is not the correct entity to handle emergency calls from the particular location that the VoIP caller is currently at. Such errors
30

may occur, e.g., due to the user not updating the SLDB, bad routing, etc. In this scenario, the initial VoIP communications device dials 9-1-1, a conference line is initiated by the soft switch, an initially determined PSAP receives an Invite message to join the VoIP emergency conference bridge. The PSAP
5 confirms/determines the user's location, and in the given scenario would determine that another PSAP is needed instead of or in addition to the PSAP on the line. In particular, the initial PSAP captures the Location Object (LO) and either rejects the Invite to join the VoIP emergency conference call (and is then removed from the conference bridge) or continues to participate in the VoIP
10 emergency conference call (and so then stays on the conference bridge). Either way, a 911 emergency call Invite message is sent with the LO to the soft switch managing the VoIP emergency conference bridge. The VoIP soft switch sends the LO to the VPC, which then identifies the proper PSAP based on the LO and initiates an Invite message addressed over IP to the proper PSAP to join into the
15 VoIP emergency conference call through the soft switch.

The VoIP conference bridge then joins the proper PSAP to the VoIP emergency conference call with the initial VoIP emergency caller (and with the initially contacted PSAP, if the initially contacted PSAP continues to participate in the call). In this manner, the initial VoIP emergency caller is kept
20 on the line throughout the process, with preferably no additional manual action or key entry required from the initial emergency caller.

At the conclusion of the VoIP emergency call, the VoIP conference bridge is closed.

In cases where the initial routing of the VoIP emergency call was
25 correct, the VoIP conference bridge would still be used, and the initial two parties would participate in the VoIP emergency conference call (e.g., the initial VoIP emergency caller and the initially Invited RC or PSAP). If no other parties are invited, additional queries to the VoIP Positioning Center (VPC) would not be necessary. If additional parties are invited, the soft switch would use location
30 information and RC Type information from the initial RC or PSAP to determine the identity of other relevant RCs and/or PSAPs.

In general principle, Fig. 3 shows an exemplary architecture of a VoIP conference bridge application operating in a VoIP soft switch of a VoIP provider to provide VoIP call conferencing, in accordance with the principles of the present invention.

5 In particular, as shown in Fig. 3, a VoIP communications device **104** is serviced by their service provider's soft switch **102**. A positioning center **106** provides location data upon request from the soft switch **102**. Other VoIP users **110**, **112**, **114** etc. are potential members of any given conference.

 Conference bridges **100** are implemented on the VoIP soft switch
10 **102** located, e.g., at the VoIP service provider's VoIP network.

 While the VoIP soft switch **102** is preferably capable of being provisioned with as many VoIP conference bridges **100** as are required in any particular application, only one conference bridge **100** is shown in Fig. 3 for simplicity of explanation.

15 Also, while the conference bridge **100** is shown implemented in the soft switch **102**, it can be embodied within another suitable network element having an Internet Protocol (IP) type connection (e.g., TCP/IP) with the initial user **104** as well as with the potential conferees **110**, **112**, **114**.

 In accordance with the principles of the present invention, location
20 information relating to the initial VoIP user **104** is passed to the VoIP conference bridge **100**, either from the user's VoIP communication device **104** or from their respective location server **106**. The location information is then compared by the VoIP soft switch **102** to find an initial desired PSAP.

 The VoIP soft switch **102** makes use of the location information and
25 other existing data or user input (e.g., existing preferences on file on the Soft Switch **102**, user entry through the keypad of the communications device **104**, or voice response). Based on the location and user input, the VoIP conference bridge **100** identifies the desired PSAP to be asked or Invited to join the conference currently established by the initial VoIP user **104** on the conference
30 bridge **100**, and outputs an Invite or request message **204** to join that conference **100** to the specific URL(s), phone number(s) and/or other identifying address

information relating to VoIP communications equipment **110, 112, 114** of the relevant PSAP.

The soft switch **102** may also maintain the attributes and rules from other VoIP communication devices **110, 112, 114** etc. for receiving conference
5 bridge calls, as well as the fixed location (e.g., a place of business) or the ability to query for a current location (e.g., for mobile communication devices such as mobile phones) for each device. Based on this information, with or without other user input (e.g., to select or prioritize among a list of available third parties), the soft switch **102** invites one or more other communication devices **110, 112, 114,**
10 etc. to join the conference bridge. This creates a voice link between the first user **104** and the other third parties **110, 112, 114** without requiring the first user **104** to know the contact information or name of the third parties **110, 112, 114**.

Fig. 4 shows an exemplary message flow diagram for establishing a VoIP location based conference, in accordance with the principles of the
15 present invention.

In particular, as shown in Fig. 4, the initial VoIP user **104** sends a request for conference bridge call to the soft switch **102**. Preferably the initial VoIP user **104** includes location information with the conference request call **201**. However, as depicted in Fig. 3, location information can be obtained from an
20 appropriate positioning server **106** if not available from the initial VoIP user **104**.

Subsequent to the incoming conference call **201**, a suitable PSAP (and/or other emergency services, including a recorder line) is determined and invited with respective invite messages **204, 206**.

In operation, the user's VoIP communication device **104** dials a pre-
25 determined phone number (or URL) of the emergency service (e.g., 911) to initiate a VoIP emergency conference bridge **100** on the relevant VoIP soft switch **102**.

Fig. 3 shows use of a VoIP positioning center (VPC) **106**. The VoIP soft switch **102** may receive the user's location information either from each of
30 the VoIP communication devices **104, 110, 112, 114** etc., or from the VPC **106**.

The VoIP soft switch **102** preferably uses both the location information of the initiating VoIP user **104**, together with any profile criteria set for a given conference bridge **100**, to determine a suitable PSAP or other emergency services entity to be sent INVITE messages inviting them to join the established VoIP emergency conference bridge **100**.

The VoIP soft switch **102** invites one or more other VoIP communication devices **110, 112, 114**, (relating to emergency services) to join the VoIP emergency conference bridge **100**. This creates a voice link between the initiating VoIP user **104** that initially called into the VoIP emergency conference bridge **100**, and the other potential, third party conferees **110, 112, 114**, etc., without requiring the initiating VoIP user **104** to know the name or even the contact information of the other potential, third party emergency conferees **110, 112, 114**, etc.

Upon receipt of an invite to a VoIP conference bridge **204, 206**, the potential other VoIP users **110, 112, 114**, etc. (PSAPs) are preferably notified similar to an incoming telephone call, e.g. with a ring signal, though it may be customized to be distinguished from the sound of an otherwise ordinary incoming phone call. For instance, a given unique phone tone may be activated upon receipt of an invite **204, 206** to a conference bridge **100**.

In accordance with the principles of the present invention, the VoIP communication device(s) **110, 112, 114** receiving invitations to join a VoIP emergency call conference **100** may be provided with a filter that automatically rejects any/all invite requests not meeting their own specific criteria (e.g., the first invited participant to accept the Invite message) maintained on their VoIP devices **110, 112, 114** themselves, though such filtering may alternatively be performed at a network level, e.g., at the VoIP soft switch **102** or other centralized location.

Benefits of the invention include that there is no effective limit to the number of participants in the VoIP emergency conference call, there are no cold transfers of a call as VoIP invitees enter or leave the conference bridge **100**, and

there is the ability to continue the conference call even after the initial VoIP user **104** making the emergency call disconnects.

The present invention has particular applicability with any/all VoIP users, VoIP service providers, and Public Safety Access Points (PSAPs).

5 The invited VoIP users **110, 112, 114** may include a filter allowing through only acceptable Invite messages based on criteria established by or on the receiving VoIP communication devices **110, 112, 114**.

10 The present invention allows VoIP users to efficiently and quickly find and invite their most appropriate responder to their emergency, with minimal user interaction. This is particularly helpful for mobile VoIP users (e.g., while driving, walking, etc.) Moreover, there is no effective limit to the number of participants in the conference call (within network hardware limits of the conference bridge itself). There is also no risk of cold transfers of a VoIP telephone call as participants aren't handled in point-to-point connections that are
15 transferred but rather join or exit an established conference at will. Furthermore, emergency personnel from various departments and locations in the conference call can continue in the conference even after the initial emergency caller disconnects.

20 Potential markets for the present invention include VoIP service providers who may implement the inventive VoIP emergency conference calling as a value added services for users. VoIP location based conferencing in accordance with the principles of the present invention has particular applicability with any/all VoIP users, VoIP service providers, and Public Safety Access Points (PSAPs).

25 While the invention has been described with reference to the exemplary embodiments thereof, those skilled in the art will be able to make various modifications to the described embodiments of the invention without departing from the true spirit and scope of the invention.

CLAIMS

What is claimed is:

1. A method of connecting an emergency caller with an emergency response center, comprising:

5 establishing an emergency call conference;
 adding said emergency caller to said established emergency call conference; and

 adding said emergency response center to said emergency call conference;

10 wherein said emergency call is established after said emergency caller and said emergency response center are both added to said emergency call conference.

2. The method of connecting an emergency caller with an emergency response center according to claim 1, further comprising:

15 adding a third party to said emergency call conference;

3. The method of connecting an emergency caller with an emergency response center according to claim 1, wherein:

20 at least three parties are present in said emergency call conference at least at a beginning of said emergency call.

4. The method of connecting an emergency caller with an emergency response center according to claim 1, wherein said emergency response center comprises:

25 a public safety access point (PSAP).

5. The method of connecting an emergency caller with an emergency response center according to claim 2, wherein said third party comprises:

30 a police dispatcher.

6. The method of connecting an emergency caller with an emergency response center according to claim 2, wherein said third party comprises:

5 a fire department.

7. The method of connecting an emergency caller with an emergency response center according to claim 2, wherein said third party comprises:

10 an ambulance company.

8. The method of connecting an emergency caller with an emergency response center according to claim 1, wherein:

15 said emergency caller is added to said emergency call conference after said emergency response center is added to said emergency call conference.

9. The method of connecting an emergency caller with an emergency response center according to claim 1, wherein:

20 said emergency response center is added to said emergency call conference after said emergency caller is added to said emergency call conference.

10. Apparatus for connecting an emergency caller with an emergency response center, comprising:

means for establishing an emergency call conference;

5 means for adding said emergency caller to said established emergency call conference; and

means for adding said emergency response center to said emergency call conference;

10 wherein said emergency call is established after said emergency caller and said emergency response center are both added to said emergency call conference.

11. Apparatus for connecting an emergency caller with an emergency response center according to claim 10, further comprising:

15 means for adding a third party to said emergency call conference;

12. The apparatus for connecting an emergency caller with an emergency response center according to claim 10, wherein:

20 at least three parties are present in said emergency call conference at least at a beginning of said emergency call.

13. The apparatus for connecting an emergency caller with an emergency response center according to claim 10, wherein said emergency response center comprises:

25 a public safety access point (PSAP).

14. The apparatus for connecting an emergency caller with an emergency response center according to claim 11, wherein said third party comprises:

30 a police dispatcher.

15. The apparatus for connecting an emergency caller with an emergency response center according to claim 11, wherein said third party comprises:

a fire department.

5

16. The apparatus for connecting an emergency caller with an emergency response center according to claim 11, wherein said third party comprises:

an ambulance company.

10

1/7

FIG. 1

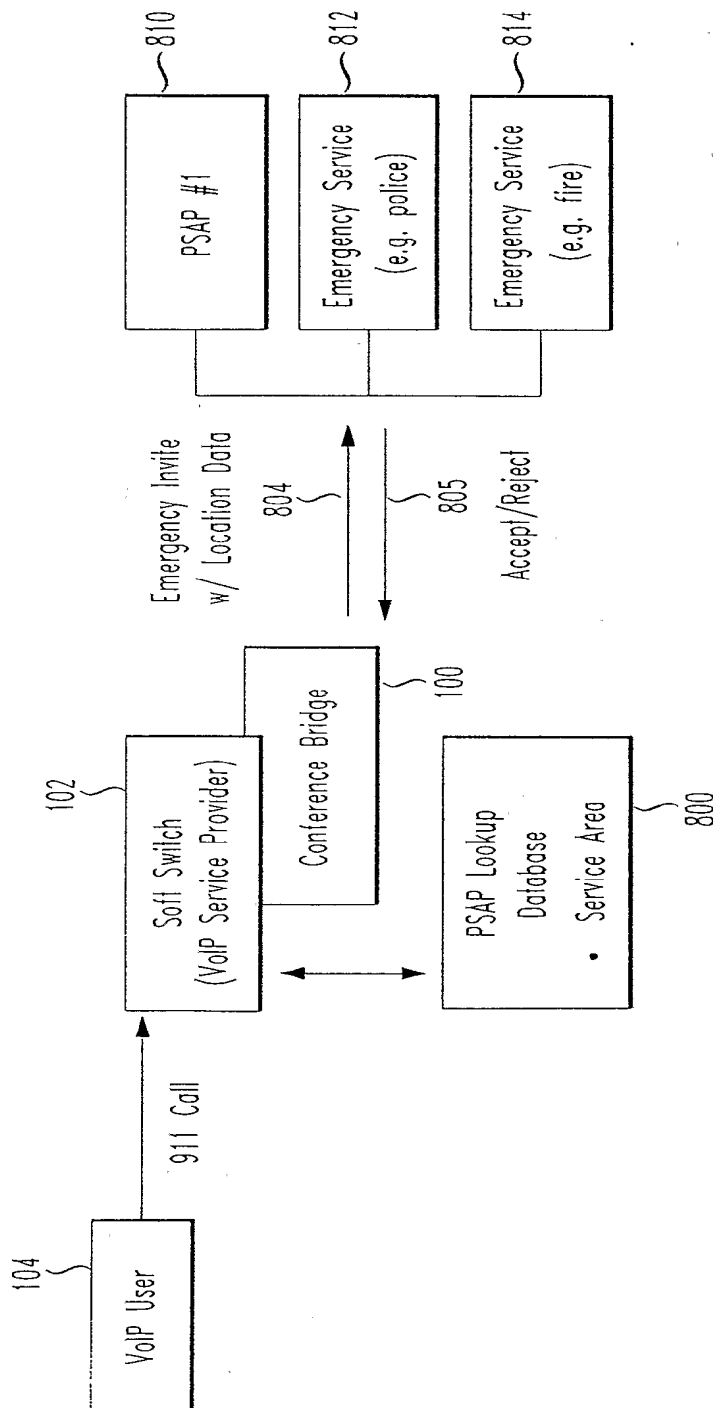

FIG. 2

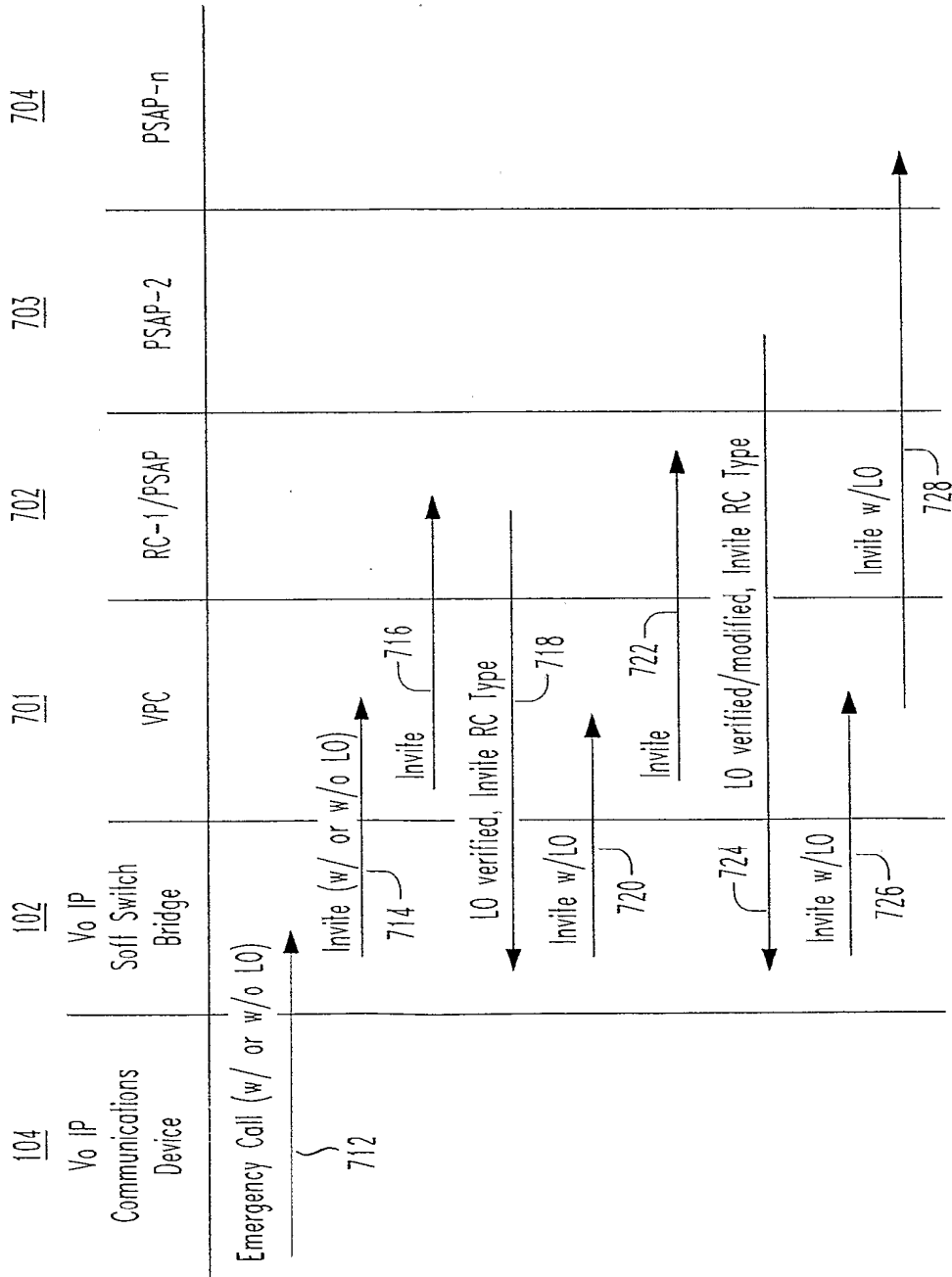

FIG. 3

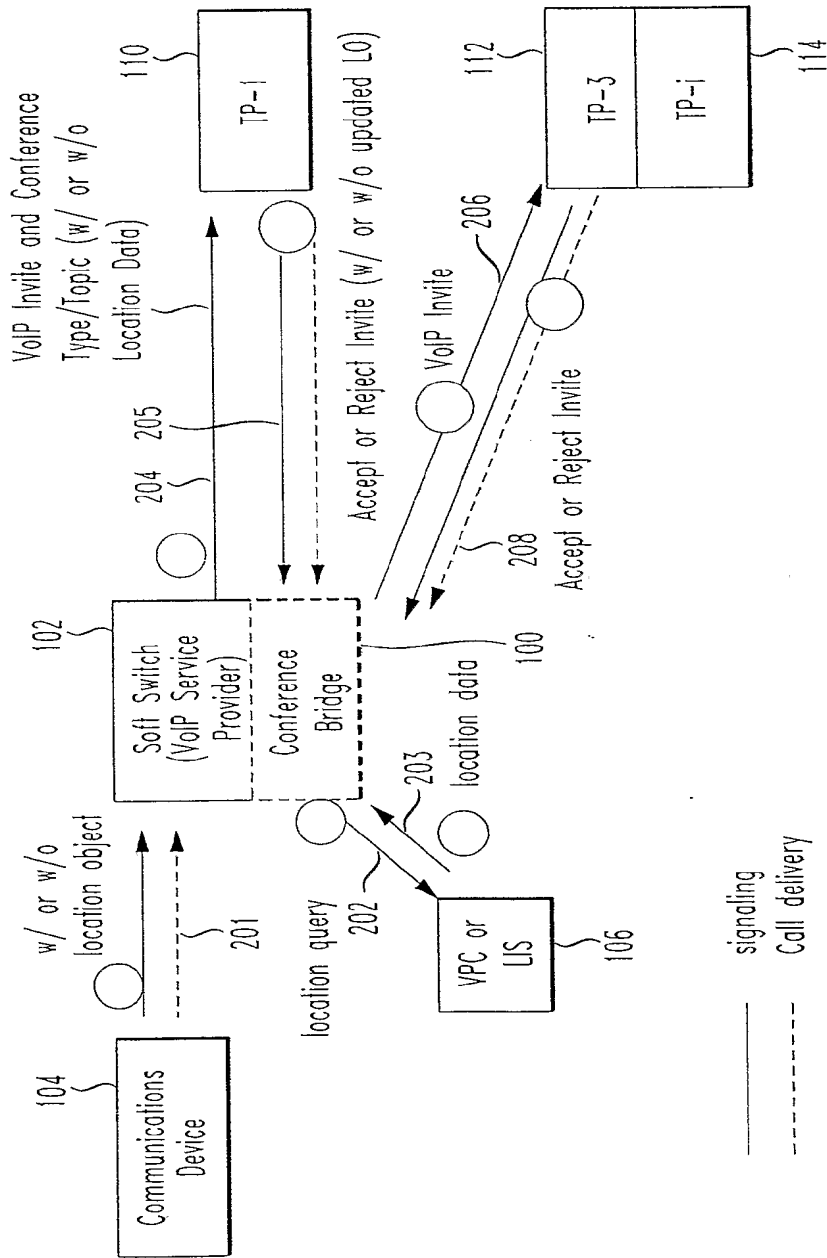

FIG. 4

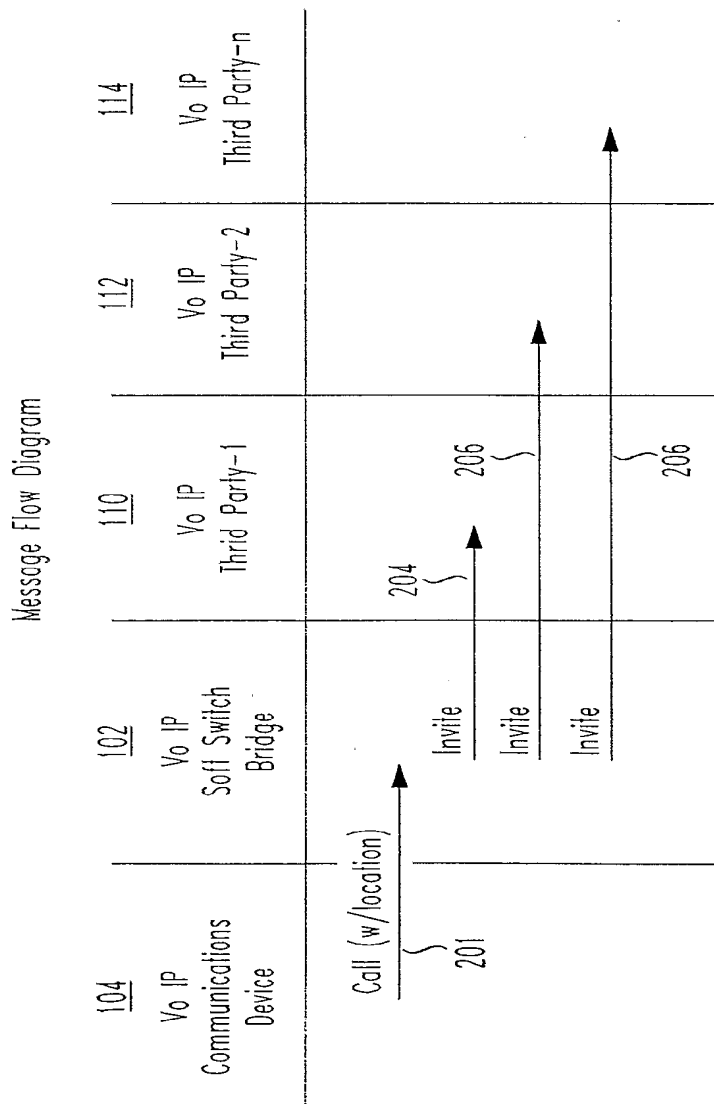

FIG. 5

(PRIOR ART)

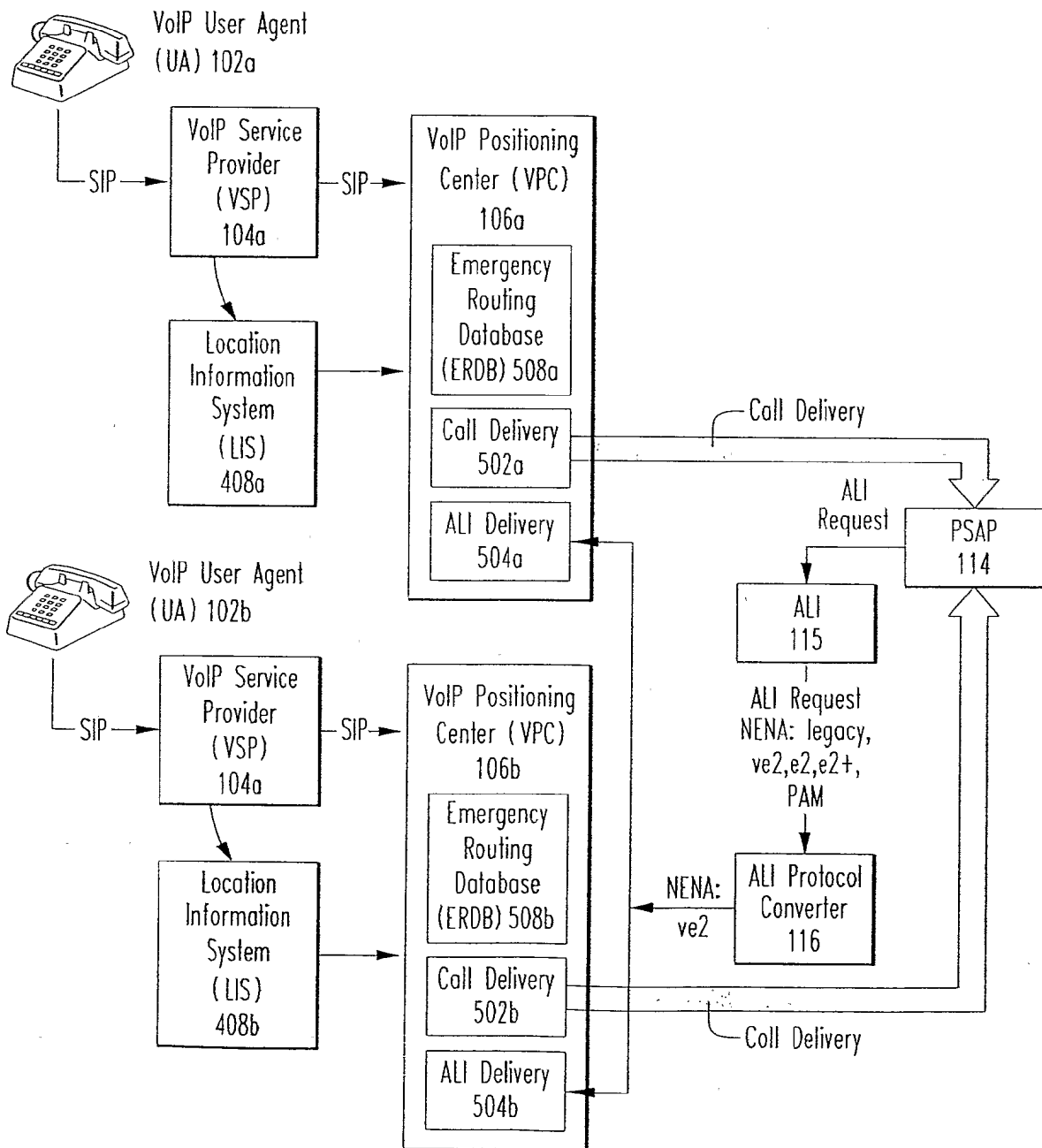

FIG. 6
(PRIOR ART)

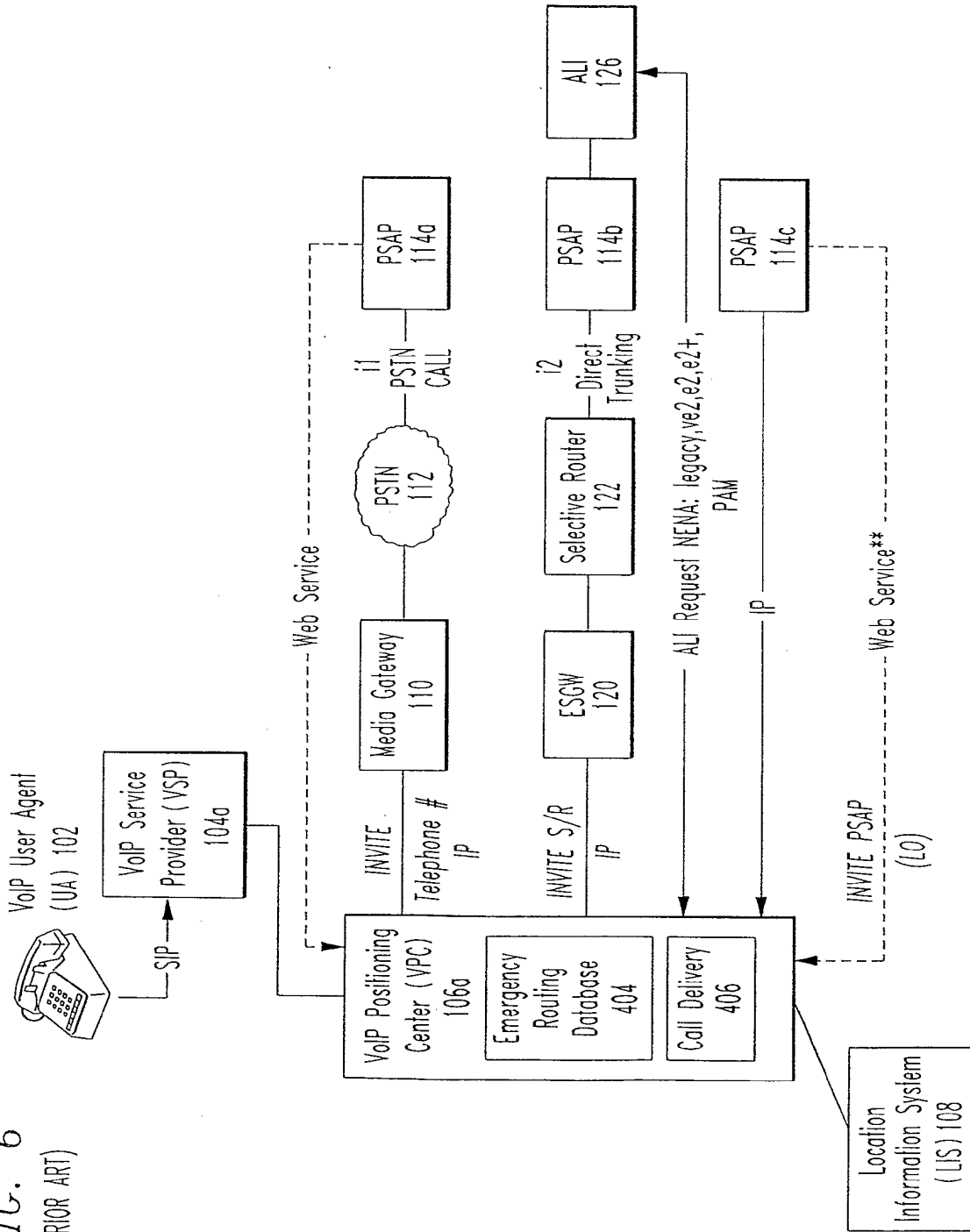
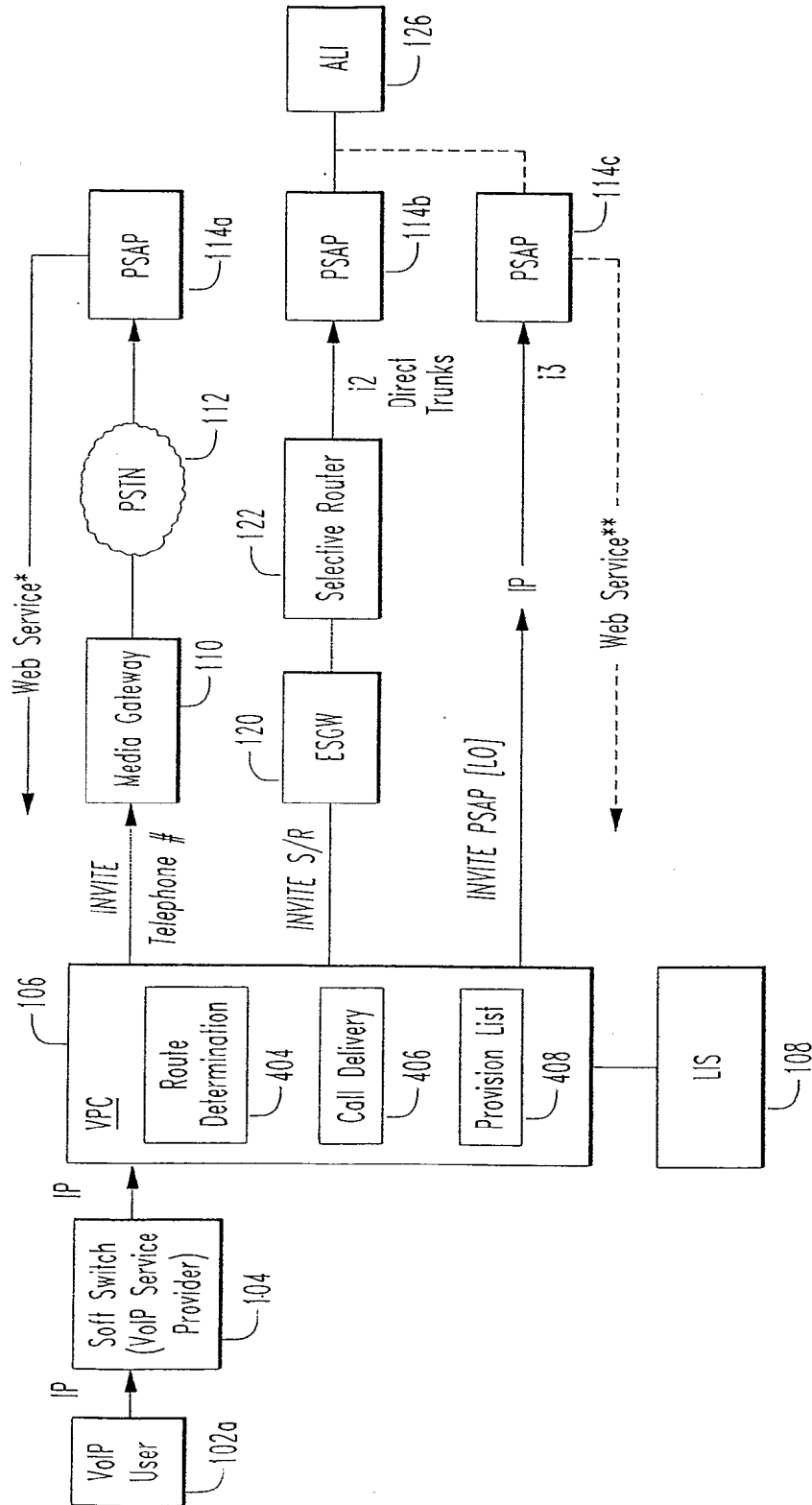

FIG. 7
(PRIOR ART)



7/7

(19) World Intellectual Property Organization
International Bureau



(43) International Publication Date
8 May 2008 (08.05.2008)

(10) International Publication Number
WO 2008/052340 A1

(51) International Patent Classification:

H04L 12/66 (2006.01) H04M 15/00 (2006.01)
H04L 12/14 (2006.01) H04Q 3/64 (2006.01)
H04M 11/06 (2006.01)

(21) International Application Number:

PCT/CA2007/001956

(22) International Filing Date:

1 November 2007 (01.11.2007)

(25) Filing Language:

English

(26) Publication Language:

English

(30) Priority Data:

60/856,212 2 November 2006 (02.11.2006) US

(71) Applicant (for all designated States except US): DIGIFONICA (INTERNATIONAL) LIMITED [CA/CA]; Suite 1401, 4710 Kingsway Avenue, Burnaby, British Columbia V5H 4M2 (CA).

(72) Inventors; and

(75) Inventors/Applicants (for US only): PERREAULT, Clay [CA/GB]; Suite #5 Keats Avenue, London, E161TW (GB). NICHOLSON, Steve [CA/CA]; Suite #5 Keats Avenue, London, E161TW (CA). THOMSON, Rod [CA/CA]; 3320 Garabaldi Drive, North Vancouver, British

Columbia V7H 2N9 (CA). BJORSELL, Johan Emil Victor [SE/CA]; 273 West 5th Street, North Vancouver, British Columbia V7M 1J9 (CA). ARAFA, Fuad [CA/CA]; 305 - 3199 Willow Street, Vancouver, British Columbia V5Z 4L5 (CA).

(74) Agents: KNOX, John, W. et al.; SMART & BIGGAR, Box 11560, Vancouver Centre, 650 West Georgia Street, Suite 2200, Vancouver, British Columbia V6B 4N8 (CA).

(81) Designated States (unless otherwise indicated, for every kind of national protection available): AE, AG, AL, AM, AT, AU, AZ, BA, BB, BG, BH, BR, BW, BY, BZ, CA, CH, CN, CO, CR, CU, CZ, DE, DK, DM, DO, DZ, EC, EE, EG, ES, FI, GB, GD, GE, GH, GM, GT, HN, HR, HU, ID, IL, IN, IS, JP, KE, KG, KM, KN, KP, KR, KZ, LA, LC, LK, LR, LS, LT, LU, LY, MA, MD, ME, MG, MK, MN, MW, MX, MY, MZ, NA, NG, NI, NO, NZ, OM, PG, PH, PL, PT, RO, RS, RU, SC, SD, SE, SG, SK, SL, SM, SV, SY, TJ, TM, TN, TR, TT, TZ, UA, UG, US, UZ, VC, VN, ZA, ZM, ZW.

(84) Designated States (unless otherwise indicated, for every kind of regional protection available): ARIPO (BW, GH, GM, KE, LS, MW, MZ, NA, SD, SL, SZ, TZ, UG, ZM, ZW), Eurasian (AM, AZ, BY, KG, KZ, MD, RU, TJ, TM), European (AT, BE, BG, CH, CY, CZ, DE, DK, EE, ES, FI, FR, GB, GR, HU, IE, IS, IT, LT, LU, LV, MC, MT, NL, PL,

[Continued on next page]

(54) Title: PRODUCING ROUTING MESSAGES FOR VOICE OVER IP COMMUNICATIONS

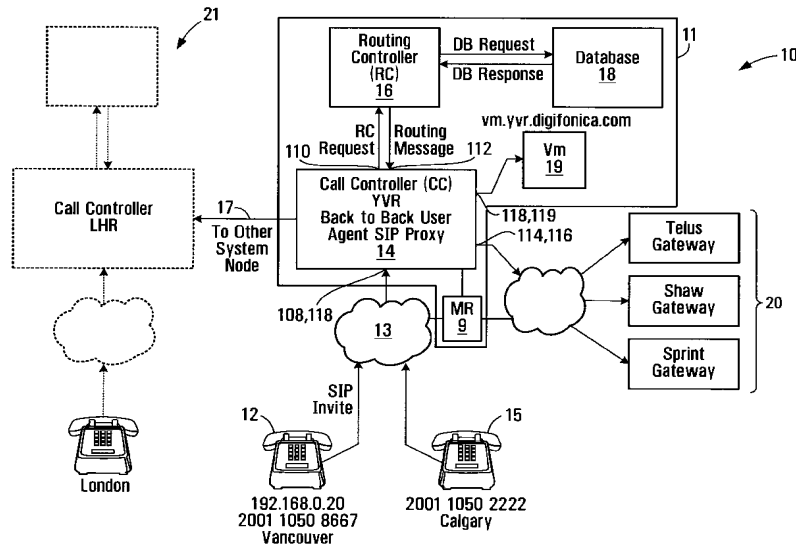

(57) Abstract: A process and apparatus to facilitate communication between callers and callees in a system comprising a plurality of nodes with which callers and callees are associated is disclosed. In response to initiation of a call by a calling subscriber, a caller identifier and a callee identifier are received. Call classification criteria associated with the caller identifier are used to classify the call as a public network call or a private network call. A routing message identifying an address, on the private network, associated with the callee is produced when the call is classified as a private network call and a routing message identifying a gateway to the public network is produced when the call is classified as a public network call.

WO 2008/052340 A1



PT, RO, SE, SI, SK, TR), OAPI (BF, BJ, CF, CG, CI, CM,
GA, GN, GQ, GW, ML, MR, NE, SN, TD, TG).

Published:

- *with international search report*
- *with amended claims*

-1-

PRODUCING ROUTING MESSAGES FOR VOICE OVER IP COMMUNICATIONS

BACKGROUND OF THE INVENTION

5 1. Field of Invention

This invention relates to voice over IP communications and methods and apparatus for routing and billing.

2. Description of Related Art

10 Internet protocol (IP) telephones are typically personal computer (PC) based telephones connected within an IP network, such as the public Internet or a private network of a large organization. These IP telephones have installed "voice-over-IP" (VoIP) software enabling them to make and receive voice calls and send and receive information in data and video formats.

15 IP telephony switches installed within the IP network enable voice calls to be made within or between IP networks, and between an IP network and a switched circuit network (SCN), such as the public switched telephone network (PSTN). If the IP switch supports the Signaling System 7 (SS7)
20 protocol, the IP telephone can also access PSTN databases.

The PSTN network typically includes complex network nodes that contain all information about a local calling service area including user authentication and call routing. The PSTN network typically aggregates all information and
25 traffic into a single location or node, processes it locally and then passes it on to other network nodes, as necessary, by maintaining route tables at the node. PSTN nodes are redundant by design and thus provide reliable service, but if a node should fail due to an earthquake or other natural disaster, significant, if not complete service outages can occur, with no other nodes
30 being able to take up the load.

-2-

Existing VoIP systems do not allow for high availability and resiliency in delivering Voice Over IP based Session Initiation Protocol (SIP) Protocol service over a geographically dispersed area such as a city, region or continent. Most resiliency originates from the provision of IP based telephone services to one location or a small number of locations such as a single office or network of branch offices.

SUMMARY OF THE INVENTION

In accordance with one aspect of the invention, there is provided a process for operating a call routing controller to facilitate communication between callers and callees in a system comprising a plurality of nodes with which callers and callees are associated. The process involves, in response to initiation of a call by a calling subscriber, receiving a caller identifier and a callee identifier. The process also involves using call classification criteria associated with the caller identifier to classify the call as a public network call or a private network call. The process further involves producing a routing message identifying an address, on the private network, associated with the callee when the call is classified as a private network call. The process also involves producing a routing message identifying a gateway to the public network when the call is classified as a public network call.

The process may involve receiving a request to establish a call, from a call controller in communication with a caller identified by the callee identifier.

Using the call classification criteria may involve searching a database to locate a record identifying calling attributes associated with a caller identified by the caller identifier.

Locating a record may involve locating a caller dialing profile comprising a username associated with the caller, a domain associated with the caller, and at least one calling attribute.

-3-

Using the call classification criteria may involve comparing calling attributes associated with the caller dialing profile with aspects of the callee identifier.

5 Comparing may involve determining whether the callee identifier includes a portion that matches an IDD associated with the caller dialing profile.

Comparing may involve determining whether the callee identifier includes a portion that matches an NDD associated with the caller dialing profile.

10 Comparing may involve determining whether the callee identifier includes a portion that matches an area code associated with the caller dialing profile.

Comparing may involve determining whether the callee identifier has a length within a range specified in the caller dialing profile.

15 The process may involve formatting the callee identifier into a pre-defined digit format to produce a re-formatted callee identifier.

20 Formatting may involve removing an international dialing digit from the callee identifier, when the callee identifier begins with a digit matching an international dialing digit specified by the caller dialing profile associated with the caller.

25 Formatting may involve removing a national dialing digit from the callee identifier and prepending a caller country code to the callee identifier when the callee identifier begins with a national dialing digit.

30 Formatting may involve prepending a caller country code to the callee identifier when the callee identifier begins with digits identifying an area code specified by the caller dialing profile.

-4-

5 Formatting may involve prepending a caller country code and an area code to the callee identifier when the callee identifier has a length that matches a caller dialing number format specified by the caller dialing profile and only one area code is specified as being associated with the caller in the caller dialing profile.

The process may involve classifying the call as a private network call when the re-formatted callee identifier identifies a subscriber to the private network.

10 The process may involve determining whether the callee identifier complies with a pre-defined username format and if so, classifying the call as a private network call.

15 The process may involve causing a database of records to be searched to locate a direct in dial (DID) bank table record associating a public telephone number with the reformatted callee identifier and if the DID bank table record is found, classifying the call as a private network call and if a DID bank table record is not found, classifying the call as a public network call.

20 Producing the routing message identifying a node on the private network may involve setting a callee identifier in response to a username associated with the DID bank table record.

25 Producing the routing message may involve determining whether a node associated with the reformatted callee identifier is the same as a node associated the caller identifier.

30 Determining whether a node associated with the reformatted callee identifier is the same as a node associated the caller identifier may involve determining whether a prefix of the re-formatted callee identifier matches a corresponding prefix of a username associated with the caller dialing profile.

-5-

When the node associated with the caller is not the same as the node associated with the callee, the process involves producing a routing message including the caller identifier, the reformatted callee identifier and an identification of a private network node associated with the callee and communicating the routing message to a call controller.

5

When the node associated with the caller is the same as the node associated with the callee, the process involves determining whether to perform at least one of the following: forward the call to another party, block the call and direct the caller to a voicemail server associated with the callee.

10

Producing the routing message may involve producing a routing message having an identification of at least one of the callee identifier, an identification of a party to whom the call should be forwarded and an identification of a voicemail server associated with the callee.

15

The process may involve communicating the routing message to a call controller.

20

Producing a routing message identifying a gateway to the public network may involve searching a database of route records associating route identifiers with dialing codes to find a route record having a dialing code having a number pattern matching at least a portion of the reformatted callee identifier.

25

The process may involve searching a database of supplier records associating supplier identifiers with the route identifiers to locate at least one supplier record associated with the route identifier associated with the route record having a dialing code having a number pattern matching at least a portion of the reformatted callee identifier.

30

The process may involve loading a routing message buffer with the reformatted callee identifier and an identification of specific routes associated

-6-

respective ones of the supplier records associated with the route record and loading the routing message buffer with a time value and a timeout value.

5 The process may involve communicating a routing message involving the contents of the routing message buffer to a call controller.

10 The process may involve causing the dialing profile to include a maximum concurrent call value and a concurrent call count value and causing the concurrent call count value to be incremented when the user associated with the dialing profile initiates a call and causing the concurrent call count value to be decremented when a call with the user associated with the dialing profile is ended.

15 In accordance with another aspect of the invention, there is provided a call routing apparatus for facilitating communications between callers and callees in a system comprising a plurality of nodes with which callers and callees are associated. The apparatus includes receiving provisions for receiving a caller identifier and a callee identifier, in response to initiation of a call by a calling subscriber. The apparatus also includes classifying provisions for classifying
20 the call as a private network call or a public network call according to call classification criteria associated with the caller identifier. The apparatus further includes provisions for producing a routing message identifying an address, on the private network, associated with the callee when the call is classified as a private network call. The apparatus also includes provisions for
25 producing a routing message identifying a gateway to the public network when the call is classified as a public network call.

30 The receiving provisions may be operably configured to receive a request to establish a call, from a call controller in communication with a caller identified by the callee identifier.

-7-

The apparatus may further include searching provisions for searching a database including records associating calling attributes with subscribers to the private network to locate a record identifying calling attributes associated with a caller identified by the caller identifier.

5

The records may include dialing profiles each including a username associated with the subscriber, an identification of a domain associated with the subscriber, and an identification of at least one calling attribute associated with the subscriber.

10

The call classification provisions may be operably configured to compare calling attributes associated with the caller dialing profile with aspects of the callee identifier.

15

The calling attributes may include an international dialing digit and call classification provisions may be operably configured to determine whether the callee identifier includes a portion that matches an IDD associated with the caller dialing profile.

20

The calling attributes may include an national dialing digit and the call classification provisions may be operably configured to determine whether the callee identifier includes a portion that matches an NDD associated with the caller dialing profile.

25

The calling attributes may include an area code and the call classification provisions may be operably configured to determine whether the callee identifier includes a portion that matches an area code associated with the caller dialing profile.

30

The calling attribute may include a number length range and the call classification provisions may be operably configured to determine whether the

-8-

callee identifier has a length within a number length range specified in the caller dialing profile.

5 The apparatus may further include formatting provisions for formatting the callee identifier into a pre-defined digit format to produce a re-formatted callee identifier.

10 The formatting provisions may be operably configured to remove an international dialing digit from the callee identifier, when the callee identifier begins with a digit matching an international dialing digit specified by the caller dialing profile associated with the caller.

15 The formatting provisions may be operably configured to remove a national dialing digit from the callee identifier and prepend a caller country code to the callee identifier when the callee identifier begins with a national dialing digit.

20 The formatting provisions may be operably configured to prepend a caller country code to the callee identifier when the callee identifier begins with digits identifying an area code specified by the caller dialing profile.

25 The formatting provisions may be operably configured to prepend a caller country code and area code to the callee identifier when the callee identifier has a length that matches a caller dialing number format specified by the caller dialing profile and only one area code is specified as being associated with the caller in the caller dialing profile.

30 The classifying provisions may be operably configured to classify the call as a private network call when the re-formatted callee identifier identifies a subscriber to the private network.

The classifying provisions may be operably configured to classify the call as a private network call when the callee identifier complies with a pre-defined username format.

5 The apparatus may further include searching provisions for searching a database of records to locate a direct in dial (DID) bank table record associating a public telephone number with the reformatted callee identifier and the classifying provisions may be operably configured to classify the call as a private network call when the DID bank table record is found and to
10 classify the call as a public network call when a DID bank table record is not found

The private network routing message producing provisions may be operably configured to produce a routing message having a callee identifier set
15 according to a username associated with the DID bank table record.

The private network routing message producing provisions may be operably configured to determine whether a node associated with the reformatted callee identifier is the same as a node associated the caller identifier.
20

The private network routing provisions may include provisions for determining whether a prefix of the re-formatted callee identifier matches a corresponding prefix of a username associated with the caller dialing profile.

25 The private network routing message producing provisions may be operably configured to produce a routing message including the caller identifier, the reformatted callee identifier and an identification of a private network node associated with the callee and to communicate the routing message to a call controller.

30 The private network routing message producing provisions may be operably configured to perform at least one of the following forward the call to another

-10-

party, block the call and direct the caller to a voicemail server associated with the callee, when the node associated with the caller is the same as the node associated with the callee.

5 The provisions for producing the private network routing message may be operably configured to produce a routing message having an identification of at least one of the callee identifier, an identification of a party to whom the call should be forwarded and an identification of a voicemail server associated with the callee.

10

The apparatus further includes provisions for communicating the routing message to a call controller.

15

The provisions for producing a public network routing message identifying a gateway to the public network may include provisions for searching a database of route records associating route identifiers with dialing codes to find a route record having a dialing code having a number pattern matching at least a portion of the reformatted callee identifier.

20

The apparatus further includes provisions for searching a database of supplier records associating supplier identifiers with the route identifiers to locate at least one supplier record associated with the route identifier associated with the route record having a dialing code having a number pattern matching at least a portion of the reformatted callee identifier.

25

The apparatus further includes a routing message buffer and provisions for loading the routing message buffer with the reformatted callee identifier and an identification of specific routes associated respective ones of the supplier records associated with the route record and loading the routing message buffer with a time value and a timeout value.

30

-11-

The apparatus further includes provisions for communicating a routing message including the contents of the routing message buffer to a call controller.

5 The apparatus further includes means for causing said dialing profile to include a maximum concurrent call value and a concurrent call count value and for causing said concurrent call count value to be incremented when the user associated with said dialing profile initiates a call and for causing said concurrent call count value to be decremented when a call with said user
10 associated with said dialing profile is ended.

In accordance with another aspect of the invention, there is provided a data structure for access by an apparatus for producing a routing message for use by a call routing controller in a communications system. The data structure
15 includes dialing profile records comprising fields for associating with respective subscribers to the system, a subscriber user name, direct-in-dial records comprising fields for associating with respective subscriber usernames, a user domain and a direct-in-dial number, prefix to node records comprising fields for associating with at least a portion of the respective
20 subscriber usernames, a node address of a node in the system, whereby a subscriber name can be used to find a user domain, at least a portion of the a subscriber name can be used to find a node with which the subscriber identified by the subscriber name is associated, and a user domain and subscriber name can be located in response to a direct-in-dial number.

25 In accordance with another aspect of the invention, there is provided a data structure for access by an apparatus for producing a routing message for use by a call routing controller in a communications system. The data structure includes master list records comprising fields for associating a dialing code
30 with respective master list identifiers and supplier list records linked to master list records by the master list identifiers, said supplier list records comprising fields for associating with a communications services supplier, a supplier id, a

-12-

master list id, a route identifier and a billing rate code, whereby communications services suppliers are associated with dialing codes, such that dialing codes can be used to locate suppliers capable of providing a communications link associated with a given dialing code.

5

In accordance with another aspect of the invention, there is provided a method for determining a time to permit a communication session to be conducted. The method involves calculating a cost per unit time, calculating a first time value as a sum of a free time attributed to a participant in the communication session and the quotient of a funds balance held by the participant to the cost per unit time value and producing a second time value in response to the first time value and a billing pattern associated with the participant, the billing pattern including first and second billing intervals and the second time value being the time to permit a communication session to be conducted.

10

15

Calculating the first time value may involve retrieving a record associated with the participant and obtaining from the record at least one of the free time and the funds balance.

20

Producing the second time value may involve producing a remainder value representing a portion of the second billing interval remaining after dividing the second billing interval into a difference between the first time value and the first billing interval.

25

Producing the second time value may involve setting a difference between the first time value and the remainder as the second time value.

30

The method may further involve setting the second time value to zero when the remainder is greater than zero and the first time value is less than the free time associated with the participant.

-13-

Calculating the cost per unit time may involve locating a record in a database, the record comprising a markup type indicator, a markup value and a billing pattern and setting a reseller rate equal to the sum of the markup value and the buffer rate.

5

Locating the record in a database may involve locating at least one of a record associated with a reseller and a route associated with the reseller, a record associated with the reseller and a default reseller markup record.

10

Calculating the cost per unit time value further may involve locating at least one of an override record specifying a route cost per unit time amount associated with a route associated with the communication session, a reseller record associated with a reseller of the communications session, the reseller record specifying a reseller cost per unit time associated with the reseller for the communication session, a default operator markup record specifying a default cost per unit time.

15

The method may further involve setting as the cost per unit time the sum of the reseller rate and at least one of the route cost per unit time, the reseller cost per unit time and the default cost per unit time.

20

The method may further involve receiving a communication session time representing a duration of the communication session and incrementing a reseller balance by the product of the reseller rate and the communication session time.

25

The method may further involve receiving a communication session time representing a duration of the communication session and incrementing a system operator balance by a product of the buffer rate and the communication session time.

30

-14-

In accordance with another aspect of the invention, there is provided an apparatus for determining a time to permit a communication session to be conducted. The apparatus includes a processor circuit, a computer readable medium coupled to the processor circuit and encoded with instructions for directing the processor circuit to calculate a cost per unit time for the communication session, calculate a first time value as a sum of a free time attributed to a participant in the communication session and the quotient of a funds balance held by the participant to the cost per unit time value and produce a second time value in response to the first time value and a billing pattern associated with the participant, the billing pattern including first and second billing intervals and the second time value being the time to permit a communication session to be conducted.

The instructions may include instructions for directing the processor circuit to retrieve a record associated with the participant and obtain from the record at least one of the free time and the funds balance.

The instructions may include instructions for directing the processor circuit to produce the second time value by producing a remainder value representing a portion of the second billing interval remaining after dividing the second billing interval into a difference between the first time value and the first billing interval.

The instructions may include instructions for directing the processor circuit to produce the second time value comprises setting a difference between the first time value and the remainder as the second time value.

The instructions may include instructions for directing the processor circuit to set the second time value to zero when the remainder is greater than zero and the first time value is less than the free time associated with the participant.

-15-

5 The instructions for directing the processor circuit to calculate the cost per unit time may include instructions for directing the processor circuit to locate a record in a database, the record comprising a markup type indicator, a markup value and a billing pattern and set a reseller rate equal to the sum of the markup value and the buffer rate.

10 The instructions for directing the processor circuit to locate the record in a database may include instructions for directing the processor circuit to locate at least one of a record associated with a reseller and a route associated with the reseller, a record associated with the reseller, and a default reseller markup record. The instructions for directing the processor circuit to calculate the cost per unit time value may further include instructions for directing the processor circuit to locate at least one of an override record specifying a route cost per unit time amount associated with a route associated with the communication session, a reseller record associated with a reseller of the communications session, the reseller record specifying a reseller cost per unit time associated with the reseller for the communication session, a default operator markup record specifying a default cost per unit time.

20 The instructions may include instructions for directing the processor circuit to set as the cost per unit time the sum of the reseller rate and at least one of the route cost per unit time, the reseller cost per unit time and the default cost per unit time.

25 The instructions may include instructions for directing the processor circuit to receive a communication session time representing a duration of the communication session and increment a reseller balance by the product of the reseller rate and the communication session time.

30 The instructions may include instructions for directing the processor circuit to receive a communication session time representing a duration of the

-16-

communication session and increment a system operator balance by a product of the buffer rate and the communication session time.

5 In accordance with another aspect of the invention, there is provided a process for attributing charges for communications services. The process involves determining a first chargeable time in response to a communication session time and a pre-defined billing pattern, determining a user cost value in response to the first chargeable time and a free time value associated with a user of the communications services, changing an account balance associated with the user in response to a user cost per unit time. The process may further involve changing an account balance associated with a reseller of the communications services in response to a reseller cost per unit time and the communication session time and changing an account balance associated with an operator of the communications services in response to an operator cost per unit time and the communication session time.

20 Determining the first chargeable time may involve locating at least one of an override record specifying a route cost per unit time and billing pattern associated with a route associated with the communication session, a reseller record associated with a reseller of the communications session, the reseller record specifying a reseller cost per unit time and billing pattern associated with the reseller for the communication session and a default record specifying a default cost per unit time and billing pattern and setting as the pre-defined billing pattern the billing pattern of the record located. The billing pattern of the record located may involve a first billing interval and a second billing interval.

25 Determining the first chargeable time may involve setting the first chargeable time equal to the first billing interval when the communication session time is less than or equal to the first billing interval.

30

-17-

5 Determining the first chargeable time may involve producing a remainder value representing a portion of the second billing interval remaining after dividing the second billing interval into a difference between communication session time and the first interval when the communication session time is greater than the communication session time and setting the first chargeable time to a difference between the communication session time and the remainder when the remainder is greater than zero and setting the first chargeable time to the communication session time when the remainder is not greater than zero.

10

The process may further involve determining a second chargeable time in response to the first chargeable time and the free time value associated with the user of the communications services when the first chargeable time is greater than or equal to the free time value associated with the user of the communications services.

15

Determining the second chargeable time may involve setting the second chargeable time to a difference between the first chargeable time.

20

The process may further involve resetting the free time value associated with the user to zero when the first chargeable time is greater than or equal to the free time value associated with the user of the communications services.

25

Changing an account balance associated with the user may involve calculating a user cost value in response to the second chargeable time and the user cost per unit time.

30

The process may further involve changing a user free cost balance in response to the user cost value.

The process may further involve setting the user cost to zero when the first chargeable time is less than the free time value associated with the user.

-18-

The process may further involve changing a user free time balance in response to the first chargeable time.

5 In accordance with another aspect of the invention, there is provided an apparatus for attributing charges for communications services. The apparatus includes a processor circuit, a computer readable medium in communication with the processor circuit and encoded with instructions for directing the processor circuit to determine a first chargeable time in response to a
10 communication session time and a pre-defined billing pattern, determine a user cost value in response to the first chargeable time and a free time value associated with a user of the communications services, change an account balance associated with the user in response to a user cost per unit time.

15 The instructions may further include instructions for changing an account balance associated with a reseller of the communications services in response to a reseller cost per unit time and the communication session time and changing an account balance associated with an operator of the communications services in response to an operator cost per unit time and
20 the communication session time.

The instructions for directing the processor circuit to determine the first chargeable time may further include instructions for causing the processor circuit to communicate with a database to locate at least one of an override
25 record specifying a route cost per unit time and billing pattern associated with a route associated with the communication session, a reseller record associated with a reseller of the communications session, the reseller record specifying a reseller cost per unit time and billing pattern associated with the reseller for the communication session and a default record specifying a
30 default cost per unit time and billing pattern and instructions for setting as the pre-defined billing pattern the billing pattern of the record located. The billing

-19-

pattern of the record located may include a first billing interval and a second billing interval.

5 The instructions for causing the processor circuit to determine the first chargeable time may include instructions for directing the processor circuit to set the first chargeable time equal to the first billing interval when the communication session time is less than or equal to the first billing interval.

10 The instructions for causing the processor circuit to determine the first chargeable time may include instructions for producing a remainder value representing a portion of the second billing interval remaining after dividing the second billing interval into a difference between communication session time and the first interval when the communication session time is greater than the communication session time and instructions for causing the
15 processor circuit to set the first chargeable time to a difference between the communication session time and the remainder when the remainder is greater than zero and instructions for causing the processor circuit to set the first chargeable time to the communication session time when the remainder is not greater than zero.

20 The instructions may further include instructions for causing the processor circuit to determine a second chargeable time in response to the first chargeable time and the free time value associated with the user of the communications services when the first chargeable time is greater than or
25 equal to the free time value associated with the user of the communications services.

The instructions for causing the processor circuit to determine the second chargeable time may include instructions for causing the processor circuit to
30 set the second chargeable time to a difference between the first chargeable time.

-20-

The instructions may further include instructions for causing the processor circuit to reset the free time value associated with the user to zero when the first chargeable time is greater than or equal to the free time value associated with the user of the communications services.

5

The instructions for causing the processor circuit to change an account balance associated with the user may include instructions for causing the processor circuit to calculate a user cost value in response to the second chargeable time and the user cost per unit time.

10

The instructions may further include instructions for causing the processor circuit to change a user free cost balance in response to the user cost value.

15

The instructions may further include instructions for causing the processor circuit to set the user cost to zero when the first chargeable time is less than the free time value associated with the user.

20

The instructions may further include instructions for causing the processor circuit to change a user free time balance in response to the first chargeable time.

25

In accordance with another aspect of the invention, there is provided a computer readable medium encoded with codes for directing a processor circuit to execute one or more of the methods described above and/or variants thereof.

30

Other aspects and features of the present invention will become apparent to those ordinarily skilled in the art upon review of the following description of specific embodiments of the invention in conjunction with the accompanying figures.

BRIEF DESCRIPTION OF THE DRAWINGS

In drawings which illustrate embodiments of the invention,

- 5 **Figure 1** is a block diagram of a system according to a first embodiment of the invention;
- Figure 2** is a block diagram of a caller telephone according to the first embodiment of the invention;
- 10 **Figure 3** is a schematic representation of a SIP invite message transmitted between the caller telephone and a controller shown in Figure 1;
- Figure 4** is a block diagram of a call controller shown in Figure 1;
- 15 **Figure 5** is a flowchart of a process executed by the call controller shown in Figure 1;
- Figure 6** is a schematic representation of a routing, billing and rating (RC) request message produced by the call controller shown in Figure
- 20 **1;**
- Figure 7** is a block diagram of a processor circuit of a routing, billing, rating element of the system shown in Figure 1;
- 25 **Figures 8A-8D** is a flowchart of a RC request message handler executed by the RC processor circuit shown in Figure 7;
- Figure 9** is a tabular representation of a dialing profile stored in a database accessible by the RC shown in Figure 1;
- 30 **Figure 10** is a tabular representation of a dialing profile for a caller using the caller telephone shown in Figure 1;

-22-

- Figure 11 is a tabular representation of a callee profile for a callee located in Calgary;
- 5 Figure 12 is a tabular representation of a callee profile for a callee located in London;
- Figure 13 is a tabular representation of a Direct-in-Dial (DID) bank table record stored in the database shown in Figure 1;
- 10 Figure 14 is a tabular representation of an exemplary DID bank table record for the Calgary callee referenced in Figure 11;
- Figure 15 is a tabular representation of a routing message transmitted from the RC to the call controller shown in Figure 1;
- 15 Figure 16 is a schematic representation of a routing message buffer holding a routing message for routing a call to the Calgary callee referenced in Figure 11;
- 20 Figure 17 is a tabular representation of a prefix to supernode table record stored in the database shown in Figure 1;
- Figure 18 is a tabular representation of a prefix to supernode table record that would be used for the Calgary callee referenced in Figure 11;
- 25 Figure 19 is a tabular representation of a master list record stored in a master list table in the database shown in Figure 1;
- 30 Figure 20 is a tabular representation of a populated master list record;

-23-

- Figure 21 is a tabular representation of a suppliers list record stored in the database shown in Figure 1;
- 5 Figure 22 is a tabular representation of a specific supplier list record for a first supplier;
- Figure 23 is a tabular representation of a specific supplier list record for a second supplier;
- 10 Figure 24 is a tabular representation of a specific supplier list record for a third supplier;
- Figure 25 is a schematic representation of a routing message, held in a routing message buffer, identifying to the controller a plurality of possible suppliers that may carry the call;
- 15 Figure 26 is a tabular representation of a call block table record;
- Figure 27 is a tabular representation of a call block table record for the Calgary callee;
- 20 Figure 28 is a tabular representation of a call forwarding table record;
- Figure 29 is a tabular representation of a call forwarding table record specific for the Calgary callee;
- 25 Figure 30 is a tabular representation of a voicemail table record specifying voicemail parameters to enable the caller to leave a voicemail message for the callee;
- 30 Figure 31 is a tabular representation of a voicemail table record specific to the Calgary callee;

Figure 32 is a schematic representation of an exemplary routing message, held in a routing message buffer, indicating call forwarding numbers and a voicemail server identifier;

5

Figures 33A and 33B are respective portions of a flowchart of a process executed by the RC processor for determining a time to live value;

Figure 34 is a tabular representation of a subscriber bundle table record;

10

Figure 35 is a tabular representation of a subscriber bundle record for the Vancouver caller;

Figure 36 is a tabular representation of a bundle override table record;

15

Figure 37 is a tabular representation of bundle override record for a located master list ID;

Figure 38 is a tabular representation of a subscriber account table record;

20

Figure 39 is a tabular representation of a subscriber account record for the Vancouver caller;

Figure 40 is a flowchart of a process for producing a second time value executed by the RC processor circuit shown in Figure 7;

25

Figure 41 is a flowchart for calculating a call cost per unit time;

Figure 42 is a tabular representation of a system operator special rates table record;

30

-25-

Figure 43 is a tabular representation of a system operator special rates table record for a reseller named Klondike;

5 Figure 44 is a tabular representation of a system operator mark-up table record;

Figure 45 is a tabular representation of a system operator mark-up table record for the reseller Klondike;

10 Figure 46 is a tabular representation of a default system operator mark-up table record;

Figure 47 is a tabular representation of a reseller special destinations table record;

15

Figure 48 is a tabular representation of a reseller special destinations table record for the reseller Klondike;

Figure 49 is a tabular representation of a reseller global mark-up table record;

20

Figure 50 is a tabular representation of a reseller global mark-up table record for the reseller Klondike;

25 Figure 51 is a tabular representation of a SIP bye message transmitted from either of the telephones shown in Figure 1 to the call controller;

Figure 52 is a tabular representation of a SIP bye message sent to the controller from the Calgary callee;

30

-26-

Figure 53 is a flowchart of a process executed by the call controller for producing a RC stop message in response to receipt of a SIP bye message;

5 Figure 54 is a tabular representation of an exemplary RC call stop message;

Figure 55 is a tabular representation of an RC call stop message for the Calgary callee;

10 Figures 56A and 56B are respective portions of a flowchart of a RC call stop message handling routine executed by the RC shown in Figure 1;

Figure 57 is a tabular representation of a reseller accounts table record;

15

Figure 58 is a tabular representation of a reseller accounts table record for the reseller Klondike;

Figure 59 is a tabular representation of a system operator accounts table record; and

20

Figure 60 is a tabular representation of a system operator accounts record for the system operator described herein.

25

DETAILED DESCRIPTION

Referring to Figure 1, a system for making voice over IP telephone/videophone calls is shown generally at 10. The system includes a first super node shown generally at 11 and a second super node shown generally at 21. The first super node 11 is located in geographical area, such as Vancouver, B.C., Canada for example and the second super node 21 is located in London, England, for example. Different super nodes may be located in different geographical regions throughout the world to provide

30

-27-

5 telephone/videophone service to subscribers in respective regions. These super nodes may be in communication with each other by high speed/ high data throughput links including optical fiber, satellite and/or cable links, forming a backbone to the system. These super nodes may alternatively or, in addition, be in communication with each other through conventional internet services.

10 In the embodiment shown, the Vancouver supernode **11** provides telephone/videophone service to western Canadian customers from Vancouver Island to Ontario. Another node (not shown) may be located in Eastern Canada to provide services to subscribers in that area.

15 Other nodes of the type shown may also be employed within the geographical area serviced by a supernode, to provide for call load sharing, for example within a region of the geographical area serviced by the supernode. However, in general, all nodes are similar and have the properties described below in connection with the Vancouver supernode **11**.

20 In this embodiment, the Vancouver supernode includes a call controller (C) **14**, a routing controller (RC) **16**, a database **18** and a voicemail server **19** and a media relay **9**. Each of these may be implemented as separate modules on a common computer system or by separate computers, for example. The voicemail server **19** need not be included in the node and can be provided by an outside service provider.

25
30 Subscribers such as a subscriber in Vancouver and a subscriber in Calgary communicate with the Vancouver supernode using their own internet service providers which route internet traffic from these subscribers over the internet shown generally at **13** in Figure 1. To these subscribers the Vancouver supernode is accessible at a pre-determined internet protocol (IP) address or a fully qualified domain name that can be accessed in the usual way through a subscriber's internet service provider. The subscriber in Vancouver uses a

-28-

telephone **12** that is capable of communicating with the Vancouver supernode **11** using Session Initiation Protocol (SIP) messages and the Calgary subscriber uses a similar telephone **15**, in Calgary AB.

5 It should be noted that throughout the description of the embodiments of this invention, the IP/UDP addresses of all elements such as the caller and callee telephones, call controller, media relay, and any others, will be assumed to be valid IP/UDP addresses directly accessible via the Internet or a private IP network, for example, depending on the specific implementation of the
10 system. As such, it will be assumed, for example, that the caller and callee telephones will have IP/UDP addresses directly accessible by the call controllers and the media relays on their respective supernodes, and those addresses will not be obscured by Network Address Translation (NAT) or similar mechanisms. In other words, the IP/UDP information contained in SIP
15 messages (for example the SIP Invite message or the RC Request message which will be described below) will match the IP/UDP addresses of the IP packets carrying these SIP messages.

It will be appreciated that in many situations, the IP addresses assigned to
20 various elements of the system may be in a private IP address space, and thus not directly accessible from other elements. Furthermore, it will also be appreciated that NAT is commonly used to share a "public" IP address between multiple devices, for example between home PCs and IP telephones sharing a single Internet connection. For example, a home PC may be
25 assigned an IP address such as **192.168.0.101** and a Voice over IP telephone may be assigned an IP address of **192.168.0.103**. These addresses are located in so called "non-routable" (IP) address space and cannot be accessed directly from the Internet. In order for these devices to communicate with other computers located on the Internet, these IP addresses have to be
30 converted into a "public" IP address, for example **24.10.10.123** assigned by the Internet Service Provider to the subscriber, by a device performing NAT, typically a home router. In addition to translating the IP addresses, NAT

-29-

typically also translates UDP port numbers, for example an audio path originating at a VoIP telephone and using a UDP port **12378** at its private IP address, may have be translated to a UDP port **23465** associated with the public IP address of the NAT device. In other words, when a packet
5 originating from the above VoIP telephone arrives at an Internet-based supernode, the source IP/UDP address contained in the IP packet header will be **24.10.10.1:23465**, whereas the source IP/UDP address information contained in the SIP message inside this IP packet will be
10 **192.168.0.103:12378**. The mismatch in the IP/UDP addresses may cause a problem for SIP-based VoIP systems because, for example, a supernode will attempt to send messages to a private address of a telephone but the messages will never get there.

Referring to Figure 1, in an attempt to make a call by the Vancouver
15 telephone/videophone **12** to the Calgary telephone/videophone **15**, the Vancouver telephone/videophone sends a SIP invite message to the Vancouver supernode **11** and in response, the call controller **14** sends an RC request message to the RC **16** which makes various enquiries of the database **18** to produce a routing message which is sent back to the call
20 controller **14**. The call controller **14** then communicates with the media relay **9** to cause a communications link including an audio path and a videophone (if a videopath call) to be established through the media relay to the same node, a different node or to a communications supplier gateway as shown generally
25 at **20** to carry audio, and where applicable, video traffic to the call recipient or callee.

Generally, the RC **16** executes a process to facilitate communication between callers and callees. The process involves, in response to initiation of a call by
30 a calling subscriber, receiving a callee identifier from the calling subscriber, using call classification criteria associated with the calling subscriber to classify the call as a public network call or a private network call and producing a routing message identifying an address on the private network,

-30-

associated with the callee when the call is classified as a private network call and producing a routing message identifying a gateway to the public network when the call is classified as a public network call.

5 Subscriber Telephone

In greater detail, referring to Figure 2, in this embodiment, the telephone/videophone 12 includes a processor circuit shown generally at 30 comprising a microprocessor 32, program memory 34, an input/output (I/O) port 36, parameter memory 38 and temporary memory 40. The program
10 memory 34, I/O port 36, parameter memory 38 and temporary memory 40 are all in communication with the microprocessor 32. The I/O port 36 has a dial input 42 for receiving a dialled telephone/videophone number from a keypad, for example, or from a voice recognition unit or from pre-stored telephone/videophone numbers stored in the parameter memory 38, for
15 example. For simplicity, in Figure 2 a box labelled dialing functions 44 represents any device capable of informing the microprocessor 32 of a callee identifier, e.g., a callee telephone/videophone number.

The processor 32 stores the callee identifier in a dialled number buffer 45. In
20 this case, assume the dialled number is 2001 1050 2222 and that it is a number associated with the Calgary subscriber. The I/O port 36 also has a handset interface 46 for receiving and producing signals from and to a handset that the user may place to his ear. This interface 46 may include a BLUETOOTH™ wireless interface, a wired interface or speaker phone, for
25 example. The handset acts as a termination point for an audio path (not shown) which will be appreciated later. The I/O port 36 also has an internet connection 48 which is preferably a high speed internet connection and is operable to connect the telephone/videophone to an internet service provider. The internet connection 48 also acts as a part of the voice path, as will be
30 appreciated later. It will be appreciated that where the subscriber device is a videophone, a separate video path is established in the same way an audio path is established. For simplicity, the following description refers to a

-31-

telephone call, but it is to be understood that a videophone call is handled similarly, with the call controller causing the media relay to facilitate both an audio path and a video path instead of only an audio path.

5 The parameter memory **38** has a username field **50**, a password field **52** an IP address field **53** and a SIP proxy address field **54**, for example. The user name field **50** is operable to hold a user name, which in this case is **2001 1050 8667**. The user name is assigned upon subscription or registration into the system and, in this embodiment, includes a twelve digit number having a
10 continent code **61**, a country code **63**, a dealer code **70** and a unique number code **74**. The continent code **61** is comprised of the first or left-most digit of the user name in this embodiment. The country code **63** is comprised of the next three digits. The dealer code **70** is comprised of the next four digits and the unique number code **74** is comprised of the last four digits. The password
15 field **52** holds a password of up to **512** characters, in this example. The IP address field **53** stores an IP address of the telephone, which for this explanation is **192.168.0.20**. The SIP proxy address field **54** holds an IP protocol compatible proxy address which may be provided to the telephone through the internet connection **48** as part of a registration procedure.

20

The program memory **34** stores blocks of codes for directing the processor **32** to carry out the functions of the telephone, one of which includes a firewall block **56** which provides firewall functions to the telephone, to prevent access by unauthorized persons to the microprocessor **32** and memories **34**, **38** and
25 **40** through the internet connection **48**. The program memory **34** also stores codes **57** for establishing a call ID. The call ID codes **57** direct the processor **32** to produce a call identifier having a format comprising a hexadecimal string at an IP address, the IP address being the IP address of the telephone. Thus, an exemplary call identifier might be **FF10@192.168.0.20**.

30

Generally, in response to picking up the handset interface **46** and activating a dialing function **44**, the microprocessor **32** produces and sends a SIP invite

-32-

message as shown in Figure 3, to the routing controller 16 shown in Figure 1. This SIP invite message is essentially to initiate a call by a calling subscriber.

5 Referring to Figure 3, the SIP invite message includes a caller ID field 60, a
callee identifier field 62, a digest parameters field 64, a call ID field 65 an IP
address field 67 and a caller UDP port field 69. In this embodiment, the caller
ID field 60 includes the user name 2001 1050 8667 that is the Vancouver user
name stored in the user name field 50 of the parameter memory 38 in the
telephone 12 shown in Figure 2. In addition, referring back to Figure 3, the
10 callee identifier field 62 includes a callee identifier which in this embodiment is
the user name 2001 1050 2222 that is the dialled number of the Calgary
subscriber stored in the dialled number buffer 45 shown in Figure 2. The
digest parameters field 64 includes digest parameters and the call ID field 65
includes a code comprising a generated prefix code (FF10) and a suffix which
15 is the Internet Protocol (IP) address of the telephone 12 stored in the IP
address field 53 of the telephone. The IP address field 67 holds the IP
address assigned to the telephone, in this embodiment 192.168.0.20, and the
caller UDP port field 69 includes a UDP port identifier identifying a UDP port
at which the audio path will be terminated at the caller's telephone.

Call Controller

20 Referring to Figure 4, a call controller circuit of the call controller 14 (Figure 1)
is shown in greater detail at 100. The call controller circuit 100 includes a
microprocessor 102, program memory 104 and an I/O port 106. The circuit
25 100 may include a plurality of microprocessors, a plurality of program
memories and a plurality of I/O ports to be able to handle a large volume of
calls. However, for simplicity, the call controller circuit 100 will be described as
having only one microprocessor 102, program memory 104 and I/O port 106,
it being understood that there may be more.

30 Generally, the I/O port 106 includes an input 108 for receiving messages such
as the SIP invite message shown in Figure 3, from the telephone shown in

-33-

Figure 2. The I/O port **106** also has an RC request message output **110** for transmitting an RC request message to the RC **16** of Figure 1, an RC message input **112** for receiving routing messages from the RC **16**, a gateway output **114** for transmitting messages to one of the gateways **20** shown in Figure 1 to advise the gateway to establish an audio path, for example, and a gateway input **116** for receiving messages from the gateway. The I/O port **106** further includes a SIP output **118** for transmitting messages to the telephone **12** to advise the telephone of the IP addresses of the gateways which will establish the audio path. The I/O port **106** further includes a voicemail server input and output **117, 119** respectively for communicating with the voicemail server **19** shown in Figure 1.

While certain inputs and outputs have been shown as separate, it will be appreciated that some may be a single IP address and IP port. For example, the messages sent to the RC **16** and received from the RC **16** may be transmitted and received on the same single IP port.

The program memory **104** includes blocks of code for directing the microprocessor **102** to carry out various functions of the call controller **14**. For example, these blocks of code include a first block **120** for causing the call controller circuit **100** to execute a SIP invite to RC request process to produce an RC request message in response to a received SIP invite message. In addition, there is a routing message to gateway message block **122** which causes the call controller circuit **100** to produce a gateway query message in response to a received routing message from the RC **16**.

Referring to Figure 5, the SIP invite to RC request process is shown in more detail at **120**. On receipt of a SIP invite message of the type shown in Figure 3, block **122** of Figure 5 directs the call controller circuit **100** of Figure 4 to authenticate the user. This may be done, for example, by prompting the user for a password, by sending a message back to the telephone **12** which is interpreted at the telephone as a request for a password entry or the

-34-

password may automatically be sent to the call controller **14** from the telephone, in response to the message. The call controller **14** may then make enquiries of databases to which it has access, to determine whether or not the user's password matches a password stored in the database. Various functions may be used to pass encryption keys or hash codes back and forth to ensure that the transmittal of passwords is secure.

Should the authentication process fail, the call controller circuit **100** is directed to an error handling routine **124** which causes messages to be displayed at the telephone **12** to indicate there was an authentication problem. If the authentication procedure is passed, block **121** directs the call controller circuit **100** to determine whether or not the contents of the caller ID field **60** of the SIP invite message received from the telephone is an IP address. If it is an IP address, then block **123** directs the call controller circuit **100** to set the contents of a type field variable maintained by the microprocessor **102** to a code representing that the call type is a third party invite. If at block **121** the caller ID field contents do not identify an IP address, then block **125** directs the microprocessor to set the contents of the type field to a code indicating that the call is being made by a system subscriber. Then, block **126** directs the call controller circuit to read the call identifier **65** provided in the SIP invite message from the telephone **12**, and at block **128** the processor is directed to produce an RC request message that includes that call ID. Block **129** then directs the call controller circuit **100** to send the RC request to the RC **16**.

Referring to Figure **6**, an RC request message is shown generally at **150** and includes a caller field **152**, a callee field **154**, a digest field **156**, a call ID field **158** and a type field **160**. The caller, callee, digest call ID fields **152**, **154**, **156** and **158** contain copies of the caller, callee, digest parameters and call ID fields **60**, **62**, **64** and **65** of the SIP invite message shown in Figure **3**. The type field **160** contains the type code established at blocks **123** or **125** of Figure **5** to indicate whether the call is from a third party or system subscriber,

-35-

respectively. The caller identifier field may include a PSTN number or a system subscriber username as shown, for example.

Routing Controller (RC)

5 Referring to Figure 7, the RC **16** is shown in greater detail and includes an RC processor circuit shown generally at **200**. The RC processor circuit **200** includes a processor **202**, program memory **204**, a table memory **206**, buffer memory **207**, and an I/O port **208**, all in communication with the processor **202**. (As earlier indicated, there may be a plurality of processor circuits (**202**),
10 memories (**204**), etc.)

The buffer memory **207** includes a caller id buffer **209** and a callee id buffer **211**.

15 The I/O port **208** includes a database request port **210** through which a request to the database (**18** shown in Figure 1) can be made and includes a database response port **212** for receiving a reply from the database **18**. The I/O port **208** further includes an RC request message input **214** for receiving the RC request message from the call controller (**14** shown in Figure 1) and
20 includes a routing message output **216** for sending a routing message back to the call controller **14**. The I/O port **208** thus acts to receive caller identifier and a callee identifier contained in the RC request message from the call controller, the RC request message being received in response to initiation of a call by a calling subscriber.

25 The program memory **204** includes blocks of codes for directing the processor **202** to carry out various functions of the RC (**16**). One of these blocks includes an RC request message handler **250** which directs the RC to produce a routing message in response to a received RC request message.
30 The RC request message handler process is shown in greater detail at **250** in Figures **8A** through **8D**.

-36-

RC Request Message Handler

Referring to Figure 8A, the RC request message handler begins with a first block 252 that directs the RC processor circuit (200) to store the contents of the RC request message (150) in buffers in the buffer memory 207 of Figure 7, one of which includes the caller ID buffer 209 of Figure 7 for separately storing the contents of the callee field 154 of the RC request message. Block 254 then directs the RC processor circuit to use the contents of the caller field 152 in the RC request message shown in Figure 6, to locate and retrieve from the database 18 a record associating calling attributes with the calling subscriber. The located record may be referred to as a dialing profile for the caller. The retrieved dialing profile may then be stored in the buffer memory 207, for example.

Referring to Figure 9, an exemplary data structure for a dialing profile is shown generally at 253 and includes a user name field 258, a domain field 260, and calling attributes comprising a national dialing digits (NDD) field 262, an international dialing digits (IDD) field 264, a country code field 266, a local area codes field 267, a caller minimum local length field 268, a caller maximum local length field 270, a reseller field 273, a maximum number of concurrent calls field 275 and a current number of concurrent calls field 277. Effectively the dialing profile is a record identifying calling attributes of the caller identified by the caller identifier. More generally, dialing profiles represent calling attributes of respective subscribers.

An exemplary caller profile for the Vancouver subscriber is shown generally at 276 in Figure 10 and indicates that the user name field 258 includes the user name (2001 1050 8667) that has been assigned to the subscriber and is stored in the user name field 50 in the telephone as shown in Figure 2.

Referring back to Figure 10, the domain field 260 includes a domain name as shown at 282, including a node type identifier 284, a location code identifier 286, a system provider identifier 288 and a domain portion 290. The domain

-37-

field **260** effectively identifies a domain or node associated with the user identified by the contents of the user name field **258**.

5 In this embodiment, the node type identifier **284** includes the code "sp" identifying a supernode and the location identifier **286** identifies the supernode as being in Vancouver (YVR). The system provider identifier **288** identifies the company supplying the service and the domain portion **290** identifies the "com" domain.

10 The national dialled digit field **262** in this embodiment includes the digit "1" and, in general, includes a number specified by the International Telecommunications Union (ITU) Telecommunications Standardization Sector (ITU-T) E. **164** Recommendation which assigns national dialing digits to countries.

15 The international dialing digit field **264** includes a code also assigned according to the ITU-T according to the country or location of the user.

20 The country code field **266** also includes the digit "1" and, in general, includes a number assigned according to the ITU-T to represent the country in which the user is located.

25 The local area codes field **267** includes a list of area codes that have been assigned by the ITU-T to the geographical area in which the subscriber is located. The caller minimum and maximum local number length fields **268** and **270** hold numbers representing minimum and maximum local number lengths permitted in the area code(s) specified by the contents of the local area codes field **267**. The reseller field **273** is optional and holds a code identifying a retailer of the services, in this embodiment "Klondike". The maximum number of concurrent calls field **275** holds a code identifying the maximum number of
30 concurrent calls that the user is entitled to cause to concurrently exist. This permits more than one call to occur concurrently while all calls for the user are

-38-

billed to the same account. The current number of concurrent calls field **277** is initially **0** and is incremented each time a concurrent call associated with the user is initiated and is decremented when a concurrent call is terminated.

5 The area codes associated with the user are the area codes associated with the location code identifier **286** of the contents of the domain field **260**.

A dialing profile of the type shown in Figure **9** is produced whenever a user registers with the system or agrees to become a subscriber to the system.
10 Thus, for example, a user wishing to subscribe to the system may contact an office maintained by a system operator and personnel in the office may ask the user certain questions about his location and service preferences, whereupon tables can be used to provide office personnel with appropriate information to be entered into the user name **258**, domain **260**, NDD **262**, IDD
15 **264**, country code **266**, local area codes **267**, caller minimum and maximum local length fields **268** and **270** reseller field **273** and concurrent call fields **275** and **277** to establish a dialing profile for the user.

Referring to Figures **11** and **12**, callee dialing profiles for users in Calgary and
20 London, respectively for example, are shown.

In addition to creating dialing profiles when a user registers with the system, a direct-in-dial (DID) record of the type shown at **278** in Figure **13** is added to a direct-in-dial bank table in the database (**18** in Figure **1**) to associate the
25 username and a host name of the supernode with which the user is associated, with an E.164 number associated with the user on the PSTN network.

An exemplary DID table record entry for the Calgary callee is shown generally
30 at **300** in Figure **14**. The user name field **281** and user domain field **272** are analogous to the user name and user domain fields **258** and **260** of the caller dialing profile shown in Figure **10**. The contents of the DID field **274** include a

-39-

5 E.164 public telephone number including a country code **283**, an area code **285**, an exchange code **287** and a number **289**. If the user has multiple telephone numbers, then multiple records of the type shown at **300** would be included in the DID bank table, each having the same user name and user domain, but different DID field **274** contents reflecting the different telephone numbers associated with that user.

10 In addition to creating dialing profiles as shown in Figure **9** and DID records as shown in Figure **13** when a user registers with the system, call blocking records of the type shown in Figure **26**, call forwarding records of the type shown in Figure **28** and voicemail records of the type shown in Figure **30** may be added to the database **18** when a new subscriber is added to the system.

15 Referring back to Figure **8A**, after retrieving a dialing profile for the caller, such as shown at **276** in Figure **10**, the RC processor circuit **200** is directed to block **256** which directs the processor circuit (**200**) to determine whether the contents of the concurrent call field **277** are less than the contents of the maximum concurrent call field **275** of the dialing profile for the caller and, if so, block **271** directs the processor circuit to increment the contents of the concurrent call field **277**. If the contents of concurrent call field **277** are equal to or greater than the contents of the maximum concurrent call field **275**, block **259** directs the processor circuit **200** to send an error message back to the call controller (**14**) to cause the call controller to notify the caller that the maximum number of concurrent calls has been reached and no further calls can exist concurrently, including the presently requested call.

20 Assuming block **256** allows the call to proceed, the RC processor circuit **200** is directed to perform certain checks on the callee identifier provided by the contents of the callee field **154** in Figure **6**, of the RC request message **150**.
30 These checks are shown in greater detail in Figure **8B**.

-40-

Referring to Figure 8B, the processor (202 in Figure 7) is directed to a first block 257 that causes it to determine whether a digit pattern of the callee identifier (154) provided in the RC request message (150) includes a pattern that matches the contents of the international dialing digits (IDD) field 264 in the caller profile shown in Figure 10. If so, then block 259 directs the processor (202) to set a call type code identifier variable maintained by the processor to indicate that the call is an international call and block 261 directs the processor to produce a reformatted callee identifier by reformatting the callee identifier into a predefined digit format. In this embodiment, this is done by removing the pattern of digits matching the IDD field contents 264 of the caller dialing profile to effectively shorten the callee identifier. Then, block 263 directs the processor 202 to determine whether or not the callee identifier has a length which meets criteria establishing it as a number compliant with the E.164 Standard set by the ITU. If the length does not meet this criteria, block 265 directs the processor 202 to send back to the call controller (14) a message indicating the length is not correct. The process is then ended. At the call controller 14, routines (not shown) stored in the program memory 104 may direct the processor (102 of Figure 4) to respond to the incorrect length message by transmitting a message back to the telephone (12 shown in Figure 1) to indicate that an invalid number has been dialled.

Still referring to Figure 8B, if the length of the amended callee identifier meets the criteria set forth at block 263, block 269 directs the processor (202 of Figure 7) to make a database request to determine whether or not the amended callee identifier is found in a record in the direct-in-dial bank (DID) table. Referring back to Figure 8B, at block 269, if the processor 202 receives a response from the database indicating that the reformatted callee identifier produced at block 261 is found in a record in the DID bank table, then the callee is a subscriber to the system and the call is classified as a private network call by directing the processor to block 279 which directs the processor to copy the contents of the corresponding user name field (281 in Figure 14) from the callee DID bank table record (300 in Figure 14) into the

-41-

callee ID buffer (211 in Figure 7). Thus, the processor 202 locates a subscriber user name associated with the reformatted callee identifier. The processor 202 is then directed to point B in Figure 8A.

5 Subscriber to Subscriber Calls Between Different Nodes

Referring to Figure 8A, block 280 directs the processor (202 of Figure 7) to execute a process to determine whether or not the node associated with the reformatted callee identifier is the same node that is associated with the caller identifier. To do this, the processor 202 determines whether or not a prefix (e.g., continent code 61) of the callee name held in the callee ID buffer (211 in Figure 7), is the same as the corresponding prefix of the caller name held in the username field 258 of the caller dialing profile shown in Figure 10. If the corresponding prefixes are not the same, block 302 in Figure 8A directs the processor (202 in Figure 7) to set a call type flag in the buffer memory (207 in Figure 7) to indicate the call is a cross-domain call. Then, block 350 of Figure 8A directs the processor (202 of Figure 7) to produce a routing message identifying an address on the private network with which the callee identified by the contents of the callee ID buffer is associated and to set a time to live for the call at a maximum value of 99999, for example.

20

Thus the routing message includes a caller identifier, a call identifier set according to a username associated with the located DID bank table record and includes an identifier of a node on the private network with which the callee is associated.

25

The node in the system with which the callee is associated is determined by using the callee identifier to address a supernode table having records of the type as shown at 370 in Figure 17. Each record 370 has a prefix field 372 and a supernode address field 374. The prefix field 372 includes the first n digits of the callee identifier. In this embodiment n=2. The supernode address field 374 holds a code representing the IP address or a fully qualified domain name of the node associated with the code stored in the callee identifier prefix field

30

-42-

372. Referring to Figure 18, for example, if the prefix is **20**, the supernode address associated with that prefix is sp.yvr.digifonica.com.

5 Referring to Figure 15, a generic routing message is shown generally at **352** and includes an optional supplier prefix field **354**, and optional delimiter field **356**, a callee user name field **358**, at least one route field **360**, a time to live field **362** and other fields **364**. The optional supplier prefix field **354** holds a code for identifying supplier traffic. The optional delimiter field **356** holds a symbol that delimits the supplier prefix code from the callee user name field **358**. In this embodiment, the symbol is a number sign (#). The route field **360** holds a domain name or IP address of a gateway or node that is to carry the call, and the time to live field **362** holds a value representing the number of seconds the call is permitted to be active, based on subscriber available minutes and other billing parameters.

10 Referring to Figure 8A and Figure 16, an example of a routing message produced by the processor at block **350** for a caller associated with a different node than the caller is shown generally at **366** and includes only a callee field **359**, a route field **361** and a time to live field **362**.

15 Referring to Figure 8A, having produced a routing message as shown in Figure 16, block **381** directs the processor (**202** of Figure 7) to send the routing message shown in Figure 16 to the call controller **14** shown in Figure 1.

20 Referring back to Figure 8B, if at block **257**, the callee identifier stored in the callee id buffer (**211** in Figure 7) does not begin with an international dialing digit, block **380** directs the processor (**202**) to determine whether or not the callee identifier begins with the same national dial digit code as assigned to the caller. To do this, the processor (**202**) is directed to refer to the retrieved caller dialing profile as shown in Figure 10. In Figure 10, the national dialing

25

30

-43-

digit code **262** is the number **1**. Thus, if the callee identifier begins with the number **1**, then the processor (**202**) is directed to block **382** in Figure **8B**.

5 Block **382** directs the processor (**202** of Figure **7**) to examine the callee identifier to determine whether or not the digits following the NDD digit identify an area code that is the same as any of the area codes identified in the local area codes field **267** of the caller dialing profile **276** shown in Figure **10**. If not, block **384** of Figure **8B** directs the processor **202** to set the call type flag to indicate that the call is a national call. If the digits following the NDD digit
10 identify an area code that is the same as a local area code associated with the caller as indicated by the caller dialing profile, block **386** directs the processor **202** to set the call type flag to indicate a local call, national style. After executing blocks **384** or **386**, block **388** directs the processor **202** to format the callee identifier into a pre-defined digit format to produce a re-
15 formatted callee identifier by removing the national dialled digit and prepending a caller country code identified by the country code field **266** of the caller dialing profile shown in Figure **10**. The processor (**202**) is then directed to block **263** of Figure **8B** to perform other processing as already described above.

20 If at block **380**, the callee identifier does not begin with a national dialled digit, block **390** directs the processor (**202**) to determine whether the callee identifier begins with digits that identify the same area code as the caller. Again, the reference for this is the retrieved caller dialing profile shown in
25 Figure **10**. The processor (**202**) determines whether or not the first few digits of the callee identifier identify an area code corresponding to the local area code field **267** of the retrieved caller dialing profile. If so, then block **392** directs the processor **202** to set the call type flag to indicate that the call is a local call and block **394** directs the processor (**202**) to format the callee
30 identifier into a pre-defined digit format to produce a reformatted callee identifier by prepending the caller country code to the callee identifier, the caller country code being determined from the country code field **266** of the

-44-

retrieved caller dialing profile shown in Figure 10. The processor (202) is then directed to block 263 for further processing as described above.

5 Referring back to Figure 8B, at block 390, the callee identifier does not start with the same area code as the caller, block 396 directs the processor (202 of Figure 7) to determine whether the number of digits in the callee identifier, i.e. the length of the callee identifier, is within the range of digits indicated by the caller minimum local number length field 268 and the caller maximum local number length field 270 of the retrieved caller dialing profile shown in Figure 10. If so, then block 398 directs the processor (202) to set the call type flag to indicate a local call and block 400 directs the processor (202) to format the callee identifier into a pre-defined digit format to produce a reformatted callee identifier by prepending to the callee identifier the caller country code (as indicated by the country code field 266 of the retrieved caller dialing profile shown in Figure 10) followed by the caller area code (as indicated by the local area code field 267 of the caller profile shown in Figure 10). The processor (202) is then directed to block 263 of Figure 8B for further processing as described above.

20 Referring back to Figure 8B, if at block 396, the callee identifier has a length that does not fall within the range specified by the caller minimum local number length field (268 in Figure 10) and the caller maximum local number length field (270 in Figure 10), block 402 directs the processor 202 of Figure 7 to determine whether or not the callee identifier identifies a valid user name. To do this, the processor 202 searches through the database (18 of Figure 10 of dialing profiles to find a dialing profile having user name field contents (258 in Figure 10) that match the callee identifier. If no match is found, block 404 directs the processor (202) to send an error message back to the call controller (14). If at block 402, a dialing profile having a user name field 258 that matches the callee identifier is found, block 406 directs the processor 202 to set the call type flag to indicate that the call is a private network call and then the processor is directed to block 280 of Figure 8A. Thus, the call is

-45-

classified as a private network call when the callee identifier identifies a subscriber to the private network.

5 From Figure 8B, it will be appreciated that there are certain groups of blocks of codes that direct the processor 202 in Figure 7 to determine whether the callee identifier has certain features such as an international dialing digit, a national dialing digit, an area code and a length that meet certain criteria, and cause the processor 202 to reformat the callee identifier stored in the callee id buffer 211, as necessary into a predetermined target format including only a
10 country code, area code, and a normal telephone number, for example, to cause the callee identifier to be compatible with the E.164 number plan standard in this embodiment. This enables block 269 in Figure 8B to have a consistent format of callee identifiers for use in searching through the DID bank table records of the type shown in Figure 13 to determine how to route
15 calls for subscriber to subscriber calls on the same system. Effectively, therefore blocks 257, 380, 390, 396 and 402 establish call classification criteria for classifying the call as a public network call or a private network call. Block 269 classifies the call, depending on whether or not the formatted callee identifier has a DID bank table record and this depends on how the call
20 classification criteria are met and block 402 directs the processor 202 of Figure 7 to classify the call as a private network call when the callee identifier complies with a pre-defined format, i.e. is a valid user name and identifies a subscriber to the private network, after the callee identifier has been subjected to the classification criteria of blocks 257, 380, 390 and 396.

25

Subscriber to Non-Subscriber Calls

30 Not all calls will be subscriber to subscriber calls and this will be detected by the processor 202 of Figure 7 when it executes block 269 in Figure 8B, and does not find a DID bank table record that is associated with the callee, in the DID bank table. When this occurs, the call is classified as a public network

-46-

call by directing the processor **202** to block **408** of Figure **8B** which causes it to set the contents of the callee id buffer **211** of Figure **7** equal to the newly formatted callee identifier, i.e., a number compatible with the E.164 standard. Then, block **410** of Figure **8B** directs the processor (**202**) to search a database of route or master list records associating route identifiers with dialing codes shown in Figure **19** to locate a router having a dialing code having a number pattern matching at least a portion of the reformatted callee identifier.

Referring to Figure **19**, a data structure for a master list or route list record is shown. Each master list record includes a master list ID field **500**, a dialing code field **502**, a country code field **504**, a national sign number field **506**, a minimum length field **508**, a maximum length field **510**, a national dialled digit field **512**, an international dialled digit field **514** and a buffer rate field **516**.

The master list ID field **500** holds a unique code such as **1019**, for example, identifying the record. The dialing code field **502** holds a predetermined number pattern that the processor **202** of Figure **7** uses at block **410** in Figure **8B** to find the master list record having a dialing code matching the first few digits of the amended callee identifier stored in the callee id buffer **211**. The country code field **504** holds a number representing the country code associated with the record and the national sign number field **506** holds a number representing the area code associated with the record. (It will be observed that the dialing code is a combination of the contents of the country code field **504** and the national sign number field **506**.) The minimum length field **508** holds a number representing the minimum length of digits associated with the record and the maximum length field **51** holds a number representing the maximum number of digits in a number with which the record may be compared. The national dialled digit (NDD) field **512** holds a number representing an access code used to make a call within the country specified by the country code, and the international dialled digit (IDD) field **514** holds a

-47-

number representing the international prefix needed to dial a call from the country indicated by the country code.

5 Thus, for example, a master list record may have a format as shown in Figure 20 with exemplary field contents as shown.

10 Referring back to Figure 8B, using the country code and area code portions of the reformatted callee identifier stored in the callee id buffer 211, block 410 directs the processor 202 of Figure 7 to find a master list record such as the one shown in Figure 20 having a dialing code that matches the country code (1) and area code (604) of the callee identifier. Thus, in this example, the processor (202) would find a master list record having an ID field containing the number 1019. This number may be referred to as a route ID. Thus, a route ID number is found in the master list record associated with a predetermined number pattern in the reformatted callee identifier.

15 After executing block 410 in Figure 8B, the process continues as shown in Figure 8D. Referring to Figure 8D, block 412 directs the processor 202 of Figure 7 to use the route ID number to search a database of supplier records associating supplier identifiers with route identifiers to locate at least one supplier record associated with the route identifier to identify at least one supplier operable to supply a communications link for the route.

20 Referring to Figure 21, a data structure for a supplier list record is shown. Supplier list records include a supplier ID field 540, a master list ID field 542, an optional prefix field 544, a specific route identifier field 546, a NDD/IDD rewrite field 548, a rate field 550, and a timeout field 551. The supplier ID field 540 holds a code identifying the name of the supplier and the master list ID field 542 holds a code for associating the supplier record with a master list record. The prefix field 544 holds a string used to identify the supplier traffic and the specific route identifier field 546 holds an IP address of a gateway operated by the supplier indicated by the supplier ID field 540. The NDD/IDD

30

-48-

rewrite field **548** holds a code representing a rewritten value of the NDD/IDD associated with this route for this supplier, and the rate field **550** holds a code indicating the cost per second to the system operator to use the route provided by the gateway specified by the contents of the route identifier field **546**. The timeout field **551** holds a code indicating a time that the call controller should wait for a response from the associated gateway before giving up and trying the next gateway. This time value may be in seconds, for example. Exemplary supplier records are shown in Figures **22**, **23** and **24** for the exemplary suppliers shown at **20** in Figure **1**, namely Telus, Shaw and Sprint.

Referring back to Figure **8D**, at block **412** the processor **202** finds all supplier records that identify the master list ID found at block **410** of Figure **8B**.

Referring back to Figure **8D**, block **560** directs the processor **202** of Figure **7** to begin to produce a routing message of the type shown in Figure **15**. To do this, the processor **202** loads a routing message buffer as shown in Figure **25** with a supplier prefix of the least costly supplier where the least costly supplier is determined from the rate fields **550** of Figure **21** of the records associated with respective suppliers.

Referring to Figures **22-24**, in the embodiment shown, the supplier "Telus" has the lowest number in the rate field **550** and therefore the prefix **4973** associated with that supplier is loaded into the routing message buffer shown in Figure **25** first.

Block **562** in Figure **8D** directs the processor to delimit the prefix **4973** by the number sign (#) and to next load the reformatted callee identifier into the routing message buffer shown in Figure **25**. At block **563** of Figure **8D**, the contents of the route identifier field **546** of Figure **21** of the record associated with the supplier "Telus" are added by the processor **202** of Figure **7** to the routing message buffer shown in Figure **25** after an @ sign delimiter, and then

-49-

block **564** in Figure **8D** directs the processor to get a time to live value, which in one embodiment may be **3600** seconds, for example. Block **566** then directs the processor **202** to load this time to live value and the timeout value (**551**) in Figure **21** in the routing message buffer of Figure **25**. Accordingly, a first part of the routing message for the Telus gateway is shown generally at **570** in Figure **25**.

Referring back to Figure **8D**, block **571** directs the processor **202** back to block **560** and causes it to repeat blocks **560**, **562**, **563**, **564** and **566** for each successive supplier until the routing message buffer is loaded with information pertaining to each supplier identified by the processor at block **412**. Thus, a second portion of the routing message as shown at **572** in Figure **25** relates to the second supplier identified by the record shown in Figure **23**. Referring back to Figure **25**, a third portion of the routing message as shown at **574** and is associated with a third supplier as indicated by the supplier record shown in Figure **24**.

Consequently, referring to Figure **25**, the routing message buffer holds a routing message identifying a plurality of different suppliers able to provide gateways to the public telephone network (i.e. specific routes) to establish at least part of a communication link through which the caller may contact the callee. In this embodiment, each of the suppliers is identified, in succession, according to rate. Other criteria for determining the order in which suppliers are listed in the routing message may include preferred supplier priorities which may be established based on service agreements, for example.

Referring back to Figure **8D**, block **568** directs the processor **202** of Figure **7** to send the routing message shown in Figure **25** to the call controller **14** in Figure **1**.

Subscriber to Subscriber Calls Within the Same Node

-50-

Referring back to Figure 8A, if at block 280, the callee identifier received in the RC request message has a prefix that identifies the same node as that associated with the caller, block 600 directs the processor 202 to use the callee identifier in the callee id buffer 211 to locate and retrieve a dialing profile for the callee. The dialing profile may be of the type shown in Figure 11 or 12, for example. Block 602 of Figure 8A then directs the processor 202 of Figure 7 to get call block, call forward and voicemail records from the database 18 of Figure 1 based on the user name identified in the callee dialing profile retrieved by the processor at block 600. Call block, call forward and voicemail records may be as shown in Figures 26, 27, 28 and 30 for example.

Referring to Figure 26, the call block records include a user name field 604 and a block pattern field 606. The user name field holds a user name corresponding to the user name in the user name field (258 in Figure 10) of the callee profile and the block pattern field 606 holds one or more E.164-compatible numbers or user names identifying PSTN numbers or system subscribers from whom the subscriber identified in the user name field 604 does not wish to receive calls.

Referring to Figure 8A and Figure 27, block 608 directs the processor 202 of Figure 7 to determine whether or not the caller identifier received in the RC request message matches a block pattern stored in the block pattern field 606 of the call block record associated with the callee identified by the contents of the user name field 604 in Figure 26. If the caller identifier matches a block pattern, block 610 directs the processor to send a drop call or non-completion message to the call controller (14) and the process is ended. If the caller identifier does not match a block pattern associated with the callee, block 609 directs the processor to store the username and domain of the callee, as determined from the callee dialing profile, and a time to live value in the routing message buffer as shown at 650 in Figure 32. Referring back to

-51-

Figure 8A, block 612 then directs the processor 202 to determine whether or not call forwarding is required.

5 Referring to Figure 28, the call forwarding records include a user name field 614, a destination number field 616, and a sequence number field 618. The user name field 614 stores a code representing a user with which the record is associated. The destination number field 616 holds a user name representing a number to which the current call should be forwarded, and the sequence number field 618 holds an integer number indicating the order in
10 which the user name associated with the corresponding destination number field 616 should be attempted for call forwarding. The call forwarding table may have a plurality of records for a given user. The processor 202 of Figure 7 uses the contents of the sequence number field 618 to place the records for a given user in order. As will be appreciated below, this enables the call
15 forwarding numbers to be tried in an ordered sequence.

Referring to Figure 8A and Figure 29, if at block 612, the call forwarding record for the callee identified by the callee identifier contains no contents in the destination number field 616 and accordingly no contents in the sequence
20 number field 618, there are no call forwarding entries for this callee, and the processor 202 is directed to block 620 in Figure 8C. If there are entries in the call forwarding table 27, block 622 in Figure 8A directs the processor 202 to search the dialing profile table to find a dialing profile record as shown in Figure 9, for the user identified by the destination number field 616 of the call
25 forward record shown in Figure 28. The processor 202 of Figure 7 is further directed to store the username and domain for that user and a time to live value in the routing message buffer as shown at 652 in Figure 32, to produce a routing message as illustrated. This process is repeated for each call forwarding record associated with the callee identified by the callee id buffer
30 211 in Figure 7 to add to the routing message buffer all call forwarding usernames and domains associated with the callee.

-52-

Referring back to Figure 8A, if at block 612 there are no call forwarding records, then at block 620 in Figure 8C the processor 202 is directed to determine whether or not the user identified by the callee identifier has paid for voicemail service. This is done by checking to see whether or not a flag is set in a voicemail record of the type shown in Figure 30 in a voicemail table stored in the database 18 shown in Figure 1.

Referring to Figure 30, voicemail records in this embodiment may include a user name field 624, a voicemail server field 626, a seconds to voicemail field 628 and an enable field 630. The user name field 624 stores the user name of the callee. The voicemail server field 626 holds a code identifying a domain name of a voicemail server associated with the user identified by the user name field 624. The seconds to voicemail field 628 holds a code identifying the time to wait before engaging voicemail, and the enable field 630 holds a code representing whether or not voicemail is enabled for the user. Referring back to Figure 8C, at block 620 if the processor 202 of Figure 7 finds a voicemail record as shown in Figure 30 having user name field 624 contents matching the callee identifier, the processor is directed to examine the contents of the enabled field 630 to determine whether or not voicemail is enabled. If voicemail is enabled, then block 640 in Figure 8C directs the processor 202 to Figure 7 to store the contents of the voicemail server field 626 and the contents of the seconds to voicemail field 628 in the routing message buffer, as shown at 654 in Figure 32. Block 642 then directs the processor 202 to get time to live values for each path specified by the routing message according to the cost of routing and the user's balance. These time to live values are then appended to corresponding paths already stored in the routing message buffer.

Referring back to Figure 8C, block 644 then directs the processor 202 of Figure 7 to store the IP address of the current node in the routing message buffer as shown at 656 in Figure 32. Block 646 then directs the processor 202 to send the routing message shown in Figure 32 to the call controller 14 in

-53-

Figure 1. Thus in the embodiment described the routing controller will produce a routing message that will cause at least one of the following: forward the call to another party, block the call and direct the caller to a voicemail server.

5 Referring back to Figure 1, the routing message whether of the type shown in Figures 16, 25 or 32, is received at the call controller 14 and the call controller interprets the receipt of the routing message as a request to establish a call.

10 Referring to Figure 4, the program memory 104 of the call controller 14 includes a routing to gateway routine depicted generally at 122.

15 Where a routing message of the type shown in Figure 32 is received by the call controller 14, the routing to gateway routine 122 shown in Figure 4 may direct the processor 102 cause a message to be sent back through the internet 13 shown in Figure 1 to the callee telephone 15, knowing the IP address of the callee telephone 15 from the user name.

20 Alternatively, if the routing message is of the type shown in Figure 16, which identifies a domain associated with another node in the system, the call controller may send a SIP invite message along the high speed backbone 17 connected to the other node. The other node functions as explained above, in response to receipt of a SIP invite message.

25 If the routing message is of the type shown in Figure 25 where there are a plurality of gateway suppliers available, the call controller sends a SIP invite message to the first supplier, in this case Telus, using a dedicated line or an internet connection to determine whether or not Telus is able to handle the call. If the Telus gateway returns a message indicating it is not able to handle the call, the call controller 14 then proceeds to send a SIP invite message to
30 the next supplier, in this case Shaw. The process is repeated until one of the suppliers responds indicating that it is available to carry the call. Once a supplier responds indicating that it is able to carry the call, the supplier sends

-54-

back to the call controller **14** an IP address for a gateway provided by the supplier through which the call or audio path of the call will be carried. This IP address is sent in a message from the call controller **14** to the media relay **9** which responds with a message indicating an IP address to which the caller telephone should send its audio/video, traffic and an IP address to which the gateway should send its audio/video for the call. The call controller conveys the IP address at which the media relay expects to receive audio/video from the caller telephone, to the caller telephone **12** in a message. The caller telephone replies to the call controller with an IP address at which it would like to receive audio/video and the call controller conveys that IP address to the media relay. The call may then be conducted between the caller and callee through the media relay and gateway.

Referring back to Figure **1**, if the call controller **14** receives a routing message of the type shown in Figure **32**, and which has at least one call forwarding number and/or a voicemail number, the call controller attempts to establish a call to the callee telephone **15** by seeking from the callee telephone a message indicating an IP address to which the media relay should send audio/video. If no such message is received from the callee telephone, no call is established. If no call is established within a pre-determined time, the call controller **14** attempts to establish a call with the next user identified in the call routing message in the same manner. This process is repeated until all call forwarding possibilities have been exhausted, in which case the call controller communicates with the voicemail server **19** identified in the routing message to obtain an IP address to which the media relay should send audio/video and the remainder of the process mentioned above for establishing IP addresses at the media relay **9** and the caller telephone is carried out to establish audio/video paths to allowing the caller to leave a voicemail message with the voicemail server.

When an audio/video path through the media relay is established, a call timer maintained by the call controller **14** logs the start date and time of the call and

-55-

logs the call ID and an identification of the route (i.e., audio/video path IP address) for later use in billing.

Time to Live

5 Referring to Figures **33A** and **33B**, a process for determining a time to live value for any of blocks **642** in Figure **8C**, **350** in Figure **8A** or **564** in Figure **8D** above is described. The process is executed by the processor **202** shown in Figure **7**. Generally, the process involves calculating a cost per unit time, calculating a first time value as a sum of a free time attributed to a participant
10 in the communication session and the quotient of a funds balance held by the participant to the cost per unit time value and producing a second time value in response to the first time value and a billing pattern associated with the participant, the billing pattern including first and second billing intervals and the second time value being the time to permit a communication session to be
15 conducted.

Referring to Figure **33A**, in this embodiment, the process begins with a first block **700** that directs the RC processor to determine whether or not the call type set at block **302** in Figure **8A** indicates the call is a network or cross-domain call. If the call is a network or cross-domain call, block **702** of Figure
20 **33A** directs the RC processor to set the time to live equal to **99999** and the process is ended. Thus, the network or cross-domain call type has a long time to live. If at block **700** the call type is determined not to be a network or cross-domain type, block **704** directs the RC processor to get a subscriber bundle table record from the database **18** in Figure **1** and store it locally in the
25 subscriber bundle record buffer at the RC **14**.

Referring to Figure **34**, a subscriber bundle table record is shown generally at **706**. The record includes a user name field **708** and a services field **710**. The
30 user name field **708** holds a code identifying the subscriber user name and the services field **710** holds codes identifying service features assigned to the subscriber, such as free local calling, call blocking and voicemail, for example.

-56-

Figure 35 shows an exemplary subscriber bundle record for the Vancouver caller. In this record the user name field 708 is loaded with the user name 2001 1050 8667 and the services field 710 is loaded with codes 10, 14 and 16 corresponding to free local calling, call blocking and voicemail, respectively. Thus, user 2001 1050 8667 has free local calling, call blocking and voicemail features.

Referring back to Figure 33A, after having loaded a subscriber bundle record into the subscriber bundle record buffer, block 712 directs the RC processor to search the database (18) determine whether or not there is a bundle override table record for the master list ID value that was determined at block 410 in Figure 8B. An exemplary bundle override table record is shown at 714 in Figure 36. The bundle table record includes a master list ID field 716, an override type field 718, an override value field 720 a first interval field 722 and a second interval field 724. The master list ID field 716 holds a master list ID code. The override type field 718 holds an override type code indicating a fixed, percent or cent amount to indicate the amount by which a fee will be increased. The override value field 720 holds a real number representing the value of the override type. The first interval field 722 holds a value indicating the minimum number of seconds for a first level of charging and the second interval field 724 holds a number representing a second level of charging.

Referring to Figure 37, a bundle override record for the located master list ID code is shown generally at 726 and includes a master list ID field 716 holding the code 1019 which was the code located in block 410 of Figure 8B. The override type field 718 includes a code indicating the override type is a percentage value and the override value field 720 holds the value 10.0 indicating that the override will be 10.0% of the charged value. The first interval field 722 holds a value representing 30 seconds and the second interval field 724 holds a value representing 6 seconds. The 30 second value in the first interval field 722 indicates that charges for the route will be made at

-57-

a first rate for **30** seconds and thereafter the charges will be made at a different rate in increments of **6** seconds, as indicated by the contents of the second interval field **724**.

5 Referring back to Figure **33A**, if at block **712** the processor finds a bundle
override record of the type shown in Figure **37**, block **728** directs the
processor to store the bundle override record in local memory. In the
embodiment shown, the bundle override record shown in Figure **37** is stored
10 in the bundle override record buffer at the RC as shown in Figure **7**. Still
referring to Figure **33A**, block **730** then directs the RC processor to determine
whether or not the subscriber bundle table record **706** in Figure **35** has a
services field including a code identifying that the user is entitled to free local
calling and also directs the processor to determine whether or not the call type
15 is not a cross domain cell, i.e. it is a local or local/national style. If both of
these conditions are satisfied, block **732** directs the processor to set the time
to live equal to **99999**, giving the user a long period of time for the call. The
process is then ended. If the conditions associated with block **730** are not
satisfied, block **734** of Figure **33B** directs the RC processor to retrieve a
subscriber account record associated with a participant in the call. This is
20 done by copying and storing in the subscriber account record buffer a
subscriber account record for the caller.

Referring to Figure **38**, an exemplary subscriber account table record is
shown generally at **736**. The record includes a user name field **738**, a funds
25 balance field **740** and a free time field **742**. The user name field **738** holds a
subscriber user name, the funds balance field **740** holds a real number
representing the dollar value of credit available to the subscriber and the free
time field **742** holds an integer representing the number of free seconds that
the user is entitled to.

30

An exemplary subscriber account record for the Vancouver caller is shown
generally at **744** in Figure **39**, wherein the user name field **738** holds the user

-58-

name **2001 1050 8667**, the funds balance field **740** holds the value **\$10.00**, and the free time field **742** holds the value **100**. The funds balance field holding the value of **\$10.00** indicates the user has **\$10.00** worth of credit and the free time field having the value of **100** indicates that the user has a balance of **100** free seconds of call time.

5

Referring back to Figure **33B**, after copying and storing the subscriber account record shown in Figure **39** from the database to the subscriber account record buffer RC, block **746** directs the processor to determine whether or not the subscriber account record funds balance field **740** or free time field **742** are greater than zero. If they are not greater than zero, block **748** directs the processor to set the time to live equal to zero and the process is ended. The RC then sends a message back to the call controller to cause the call controller to deny the call to the caller. If the conditions associated with block **746** are satisfied, block **750** directs the processor to calculate the call cost per unit time. A procedure for calculating the call cost per unit time is described below in connection with Figure **41**.

10

15

Assuming the procedure for calculating the cost per second returns a number representing the call cost per second, block **752** directs the processor **202** in Figure **7** to determine whether or not the cost per second is equal to zero. If so, block **754** directs the processor to set the time to live to **99999** to give the caller a very long length of call and the process is ended.

20

If at block **752** the call cost per second is not equal to zero, block **756** directs the processor **202** in Figure **7** to calculate a first time to live value as a sum of a free time attributed to the participant in the communication session and the quotient of the funds balance held by the participant to the cost per unit time value. To do this, the processor **202** of Figure **7** is directed to set a first time value or temporary time to live value equal to the sum of the free time provided in the free time field **742** of the subscriber account record shown in Figure **39** and the quotient of the contents of the funds balance field **740** in the

25

30

-59-

subscriber account record for the call shown in Figure 39 and the cost per second determined at block 750 of Figure 33B. Thus, for example, if at block 750 the cost per second is determined to be three cents per second and the funds balance field holds the value \$10.00, the quotient of the funds balance and cost per second is 333 seconds and this is added to the contents of the free time field 742, which is 100, resulting in a time to live of 433 seconds.

Block 758 then directs the RC processor to produce a second time value in response to the first time value and the billing pattern associated with the participant as established by the bundle override record shown in Figure 37. This process is shown in greater detail at 760 in Figure 40 and generally involves producing a remainder value representing a portion of the second billing interval remaining after dividing the second billing interval into a difference between the first time value and the first billing interval.

Referring to Figure 40, the process for producing the second time value begins with a first block 762 that directs the processor 202 in Figure 7 to set a remainder value equal to the difference between the time to live value calculated at block 756 in Figure 33B and the contents of the first interval field 722 of the record shown in Figure 37, multiplied by the modulus of the contents of the second interval field 724 of Figure 37. Thus, in the example given, the difference between the time to live field and the first interval field is 433 minus 30, which is 403 and therefore the remainder produced by the mod of 403 divided by 6 is 0.17. Block 764 then directs the processor to determine whether or not this remainder value is greater than zero and, if so, block 766 directs the processor to subtract the remainder from the first time value and set the difference as the second time value. To do this the processor is directed to set the time to live value equal to the current time to live of 403 minus the remainder of 1, i.e., 402 seconds. The processor is then returned back to block 758 of Figure 33B.

-60-

Referring back to Figure 40, if at block 764 the remainder is not greater than zero, block 768 directs the processor 202 of Figure 7 to determine whether or not the time to live is less than the contents of the first interval field 722 in the record shown in Figure 37. If so, then block 770 of Figure 40 directs the processor to set the time to live equal to zero. Thus, the second time value is set to zero when the remainder is greater than zero and the first time value is less than the free time associated with the participant in the call. If at block 768 the conditions of that block are not satisfied, the processor returns the first time to live value as the second time to live value.

Thus, referring to Figure 33B, after having produced a second time to live value, block 772 directs the processor to set the time to live value for use in blocks 342, 350 or 564.

Cost per Second

Referring back to Figure 33B, at block 750 it was explained that a call cost per unit time is calculated. The following explains how that call cost per unit time value is calculated.

Referring to Figure 41, a process for calculating a cost per unit time is shown generally at 780. The process is executed by the processor 202 in Figure 7 and generally involves locating a record in a database, the record comprising a markup type indicator, a markup value and a billing pattern and setting a reseller rate equal to the sum of the markup value and the buffer rate, locating at least one of an override record specifying a route cost per unit time amount associated with a route associated with the communication session, a reseller record associated with a reseller of the communications session, the reseller record specifying a reseller cost per unit time associated with the reseller for the communication session and a default operator markup record specifying a default cost per unit time and setting as the cost per unit time the sum of the reseller rate and at least one of the route cost per unit time, the reseller cost per unit time and the default cost per unit time.

-61-

5 The process begins with a first set of blocks **782**, **802** and **820** which direct the processor **202** in Figure **7** to locate at least one of a record associated with a reseller and a route associated with the reseller, a record associated with the reseller, and a default reseller mark-up record. Block **782**, in particular, directs the processor to address the database **18** to look for a record associated with a reseller and a route with the reseller by looking for a special rate record based on the master list ID established at block **410** in Figure **8C**.

10 Referring to Figure **42**, a system operator special rate table record is shown generally at **784**. The record includes a reseller field **786**, a master list ID field **788**, a mark-up type field **790**, a mark-up value field **792**, a first interval field **794** and a second interval field **796**. The reseller field **786** holds a reseller ID code and the master list ID field **788** holds a master list ID code. The mark-up type field **790** holds a mark-up type such as fixed percent or cents and the mark-up value field **792** holds a real number representing the value corresponding to the mark-up type. The first interval field **794** holds a number representing a first level of charging and the second interval field **796** holds a number representing a second level of charging.

15 An exemplary system operator special rate table for a reseller known as "Klondike" is shown at **798** in Figure **43**. In this record, the reseller field **786** holds a code indicating the retailer ID is Klondike, the master list ID field **788** holds the code **1019** to associate the record with the master list ID code **1019**. The mark-up type field **790** holds a code indicating the mark-up type is cents and the mark-up value field **792** holds a mark-up value indicating **1/10** of one cent. The first interval field **794** holds the value **30** and the second interval field **796** holds the value **6**, these two fields indicating that the operator allows **30** seconds for free and then billing is done in increments of **6** seconds after that.

-62-

Referring back to Figure 41, if at block 782 a record such as the one shown in Figure 43 is located in the system operator special rates table, the processor is directed to block 800 in Figure 41. If such a record is not found in the system operator special rates table, block 802 directs the processor to address the database 18 to look in a system operator mark-up table for a mark-up record associated with the reseller.

Referring to Figure 44, an exemplary system operator mark-up table record is shown generally at 804. The record includes a reseller field 806, a mark-up type field 808, a mark-up value field 810, a first interval field 812 and a second interval field 814. The reseller mark-up type, mark-up value, first interval and second interval fields are as described in connection with the fields by the same names in the system operator special rates table shown in Figure 42.

Figure 45 provides an exemplary system operator mark-up table record for the reseller known as Klondike and therefore the reseller field 806 holds the value "Klondike", the mark-up type field 808 holds the value cents, the mark-up value field holds the value 0.01, the first interval field 812 holds the value 30 and the second interval field 814 holds the value 6. This indicates that the reseller "Klondike" charges by the cent at a rate of one cent per minute. The first 30 seconds of the call are free and billing is charged at the rate of one cent per minute in increments of 6 seconds.

Figure 46 provides an exemplary system operator mark-up table record for cases where no specific system operator mark-up table record exists for a particular reseller, i.e., a default reseller mark-up record. This record is similar to the record shown in Figure 45 and the reseller field 806 holds the value "all", the mark-up type field 808 is loaded with a code indicating mark-up is based on a percentage, the mark-up value field 810 holds the percentage by which the cost is marked up, and the first and second interval fields 812 and 814 identify first and second billing levels.

-63-

Referring back to Figure 41, if at block 802 a specific mark-up record for the reseller identified at block 782 is not located, block 820 directs the processor to get the mark-up record shown in Figure 46, having the "all" code in the reseller field 806. The processor is then directed to block 800.

5

Referring back to Figure 41, at block 800, the processor 202 of Figure 7 is directed to set a reseller rate equal to the sum of the mark-up value of the record located by blocks 782, 802 or 820 and the buffer rate specified by the contents of the buffer rate field 516 of the master list record shown in Figure 20. To do this, the RC processor sets a variable entitled "reseller cost per second" to a value equal to the sum of the contents of the mark-up value field (792, 810) of the associated record, plus the contents of the buffer rate field (516) from the master list record associated with the master list ID. Then, block 822 directs the processor to set a system operator cost per second variable equal to the contents of the buffer rate field (516) from the master list record. Block 824 then directs the processor to determine whether the call type flag indicates the call is local or national/local style and whether the caller has free local calling. If both these conditions are met, then block 826 sets the user cost per second variable equal to zero and sets two increment variables equal to one, for use in later processing. The cost per second has thus be calculated and the process shown in Figure 41 is ended.

10

15

20

If at block 824 the conditions of that block are not met, the processor 202 of Figure 7 is directed to locate at least one of a bundle override table record specifying a route cost per unit time associated with a route associated with the communication session, a reseller special destinations table record associated with a reseller of the communications session, the reseller record specifying a reseller cost per unit time associated with the reseller for the communication session and a default reseller global markup record specifying a default cost per unit time.

25

30

-64-

To do this block **828** directs the processor **202** of Figure **7** to determine whether or not the bundle override record **726** in Figure **37** located at block **712** in Figure **33A** has a master list ID equal to the stored master list ID that was determined at block **410** in Figure **8B**. If not, block **830** directs the processor to find a reseller special destinations table record in a reseller special destinations table in the database (**18**), having a master list ID code equal to the master list ID code of the master list ID that was determined at block **410** in Figure **8B**. An exemplary reseller special destinations table record is shown in Figure **47** at **832**. The reseller special destinations table record includes a reseller field **834**, a master list ID field **836**, a mark-up type field **838**, a mark-up value field **840**, a first interval field **842** and a second interval field **844**. This record has the same format as the system operator special rates table record shown in Figure **42**, but is stored in a different table to allow for different mark-up types and values and time intervals to be set according to resellers' preferences. Thus, for example, an exemplary reseller special destinations table record for the reseller "Klondike" is shown at **846** in Figure **48**. The reseller field **834** holds a value indicating the reseller as the reseller "Klondike" and the master list ID field holds the code **1019**. The mark-up type field **838** holds a code indicating the mark-up type is percent and the mark-up value field **840** holds a number representing the mark-up value as 5%. The first and second interval fields identify different billing levels used as described earlier.

Referring back to Figure **41**, the record shown in Figure **48** may be located at block **830**, for example. If at block **830** such a record is not found, then block **832** directs the processor to get a default operator global mark-up record based on the reseller ID.

Referring to Figure **49**, an exemplary default reseller global mark-up table record is shown generally at **848**. This record includes a reseller field **850**, a mark-up type field **852**, a mark-up value field **854**, a first interval field **856** and a second interval field **858**. The reseller field **850** holds a code identifying the

-65-

reseller. The mark-up type field **852**, the mark-up value field **854** and the first and second interval fields **856** and **858** are of the same type as described in connection with fields of the same name in Figure **47**, for example. The contents of the fields of this record **860** may be set according to system operator preferences, for example.

Referring to Figure **50**, an exemplary reseller global mark-up table record is shown generally at **860**. In this record, the reseller field **850** holds a code indicating the reseller is "Klondike", the mark-up type field **852** holds a code indicating the mark-up type is percent, the mark-up value field **854** holds a value representing **10%** as the mark-up value, the first interval field **856** holds the value **30** and the second interval field **858** holds the values **30** and **6** respectively to indicate the first **30** seconds are free and billing is to be done in **6** second increments after that.

Referring back to Figure **41**, should the processor get to block **832**, the reseller global mark-up table record as shown in Figure **50** is retrieved from the database and stored locally at the RC. As seen in Figure **41**, it will be appreciated that if the conditions are met in blocks **828** or **830**, or if the processor executes block **832**, the processor is then directed to block **862** which causes it to set an override value equal to the contents of the mark-up value field of the located record, to set the first increment variable equal to the contents of the first interval field of the located record and to set the second increment variable equal to the contents of the second interval field of the located record. (The increment variables were alternatively set to specific values at block **826** in Figure **41**.)

It will be appreciated that the located record could be a bundle override record of the type shown in Figure **37** or the located record could be a reseller special destination record of the type shown in Figure **48** or the record could be a reseller global mark-up table record of the type shown in Figure **50**. After the override and first and second increment variables have been set at block

-66-

5 **862**, the processor **202** if Figure **7** is directed to set as the cost per unit time the sum of the reseller rate and at least one of the route cost per unit time, the reseller cost per unit time and the default cost per unit time, depending on which record was located. To do this, block **864** directs the processor to set the cost per unit time equal to the sum of the reseller cost set at block **800** in Figure **41**, plus the contents of the override variable calculated in block **862** in Figure **41**. The cost per unit time has thus been calculated and it is this cost per unit time that is used in block **752** of Figure **33B**, for example.

10 Terminating the Call

15 In the event that either the caller or the callee terminates a call, the telephone of the terminating party sends a SIP bye message to the controller **14**. An exemplary SIP bye message is shown at **900** in Figure **51** and includes a caller field **902**, a callee field **904** and a call ID field **906**. The caller field **902** holds a twelve digit user name, the callee field **904** holds a PSTN compatible number or user name, and the call ID field **906** holds a unique call identifier field of the type shown in the call ID field **65** of the SIP invite message shown in Figure **3**.

20 Thus, for example, referring to Figure **52**, a SIP bye message for the Calgary callee is shown generally at **908** and the caller field **902** holds a user name identifying the caller, in this case **2001 1050 8667**, the callee field **904** holds a user name identifying the Calgary callee, in this case **2001 1050 2222**, and the call ID field **906** holds the code **FA10 @ 192.168.0.20**, which is the call ID
25 for the call.

30 The SIP bye message shown in Figure **52** is received at the call controller **14** and the call controller executes a process as shown generally at **910** in Figure **53**. The process includes a first block **912** that directs the call controller processor **202** of Figure **7** to copy the caller, callee and call ID field contents from the SIP bye message received from the terminating party to corresponding fields of an RC stop message buffer (not shown). Block **914**

-67-

then directs the processor to copy the call start time from the call timer and to obtain a call stop time from the call timer. Block **916** then directs the call controller to calculate a communication session time by determining the difference in time between the call start time and the call stop time. This session time is then stored in a corresponding field of the RC call stop message buffer. Block **917** then directs the processor to decrement the contents of the current concurrent call field **277** of the dialing profile for the caller as shown in Figure **10**, to indicate that there is one less concurrent call in progress. A copy of the amended dialing profile for the caller is then stored in the database **18** of Figure **1**. Block **918** then directs the processor to copy the route from the call log. An RC call stop message produced as described above is shown generally at **1000** in Figure **54**. An RC call stop message specifically associated with the call made to the Calgary callee is shown generally at **1020** in Figure **55**.

Referring to Figure **54**, the RC stop call message includes a caller field **1002**, callee field **1004**, a call ID field **1006**, an account start time field **1008**, an account stop time field **1010**, a communication session time **1012** and a route field **1014**. The caller field **1002** holds a username, the callee field **1004** holds a PSTN-compatible number or system number, the call ID field **1006** hold the unique call identifier received from the SIP invite message shown in Figure **3**, the account start time field **1008** holds the date and start time of the call, the account stop time field **1010** holds the date and time the call ended, the communication session time field **1012** holds a value representing the difference between the start time and the stop time, in seconds, and the route field **1014** holds the IP address for the communications link that was established.

Referring to Figure **55**, an exemplary RC stop call message for the Calgary callee is shown generally at **1020**. In this example the caller field **1002** holds the user name **2001 1050 8667** identifying the Vancouver-based caller and the callee field **1004** holds the user name **2001 1050 2222** identifying the

-68-

Calgary callee. The contents of the call ID field **1006** are **FA10 @ 192.168.0.20**. The contents of the account start time field **1008** are **2006-12-30 12:12:12** and the contents of the account stop time field are **2006-12-30 12:12:14**. The contents of the communication session time field **1012** are **2** to indicate **2** seconds call duration and the contents of the route field are **72.64.39.58**.

Referring back to Figure **53**, after having produced an RC call stop message, block **920** directs the processor **202** in Figure **7** to send the RC stop message compiled in the RC call stop message buffer to the RC **16** of Figure **1**. Block **922** directs the call controller **14** to send a “bye” message back to the party that did not terminate the call.

The RC **16** of Figure **1** receives the call stop message and an RC call stop message process is invoked at the RC, the process being shown at **950** in Figures **56A**, **56B** and **56C**. Referring to Figure **56A**, the RC stop message process **950** begins with a first block **952** that directs the processor **202** in Figure **7** to determine whether or not the communication session time is less than or equal to the first increment value set by the cost calculation routine shown in Figure **41**, specifically blocks **826** or **862** thereof. If this condition is met, then block **954** of Figure **56A** directs the RC processor to set a chargeable time variable equal to the first increment value set at block **826** or **862** of Figure **41**. If at block **952** of Figure **56A** the condition is not met, block **956** directs the RC processor to set a remainder variable equal to the difference between the communication session time and the first increment value mod the second increment value produced at block **826** or **862** of Figure **41**. Then, the processor is directed to block **958** of Figure **56A** which directs it to determine whether or not the remainder is greater than zero. If so, block **960** directs the RC processor to set the chargeable time variable equal to the difference between the communication session time and the remainder value. If at block **958** the remainder is not greater than zero, block **962** directs the RC processor to set the chargeable time variable equal to the contents of the

-69-

communication session time from the RC stop message. The processor is then directed to block **964**. In addition, after executing block **954** or block **960**, the processor is directed to block **964**.

5 Block **964** directs the processor **202** of Figure **7** to determine whether or not the chargeable time variable is greater than or equal to the free time balance as determined from the free time field **742** of the subscriber account record shown in Figure **39**. If this condition is satisfied, block **966** of Figure **56A** directs the processor to set the free time field **742** in the record shown in
10 Figure **39**, to zero. If the chargeable time variable is not greater than or equal to the free time balance, block **968** directs the RC processor to set a user cost variable to zero and Block **970** then decrements the free time field **742** of the subscriber account record for the caller by the chargeable time amount determined by block **954**, **960** or **962**.

15

If at Block **964** the processor **202** of Figure **7** was directed to Block **966** which causes the free time field (**742** of Figure **39**) to be set to zero, referring to Figure **56B**, Block **972** directs the processor to set a remaining chargeable time variable equal to the difference between the chargeable time and the
20 contents of the free time field (**742** of Figure **39**). Block **974** then directs the processor to set the user cost variable equal to the product of the remaining chargeable time and the cost per second calculated at Block **750** in Figure **33B**. Block **976** then directs the processor to decrement the funds balance field (**740**) of the subscriber account record shown in Figure **39** by the
25 contents of the user cost variable calculated at Block **974**.

After completing Block **976** or after completing Block **970** in Figure **56A**, block **978** of Figure **56B** directs the processor **202** of Figure **7** to calculate a reseller cost variable as the product of the reseller rate as indicated in the
30 mark-up value field **810** of the system operator mark-up table record shown in Figure **45** and the communication session time determined at Block **916** in Figure **53**. Then, Block **980** of Figure **56B** directs the processor to add the

-70-

reseller cost to the reseller balance field **986** of a reseller account record of the type shown in Figure **57** at **982**.

5 The reseller account record includes a reseller ID field **984** and the aforementioned reseller balance field **986**. The reseller ID field **984** holds a reseller ID code, and the reseller balance field **986** holds an accumulated balance of charges.

10 Referring to Figure **58**, a specific reseller accounts record for the reseller "Klondike" is shown generally at **988**. In this record the reseller ID field **984** holds a code representing the reseller "Klondike" and the reseller balance field **986** holds a balance of **\$100.02**. Thus, the contents of the reseller balance field **986** in Figure **58** are incremented by the reseller cost calculated at block **978** of Figure **56B**.

15 Still referring to Figure **56B**, after adding the reseller cost to the reseller balance field as indicated by Block **980**, Block **990** directs the processor to **202** of Figure **7** calculate a system operator cost as the product of the system operator cost per second, as set at block **822** in Figure **41**, and the communication session time as determined at Block **916** in Figure **53**. Block **992** then directs the processor to add the system operator cost value calculated at Block **990** to a system operator accounts table record of the type shown at **994** in Figure **59**. This record includes a system operator balance field **996** holding an accumulated charges balance. Referring to Figure **60** in the embodiment described, the system operator balance field **996** may hold the value **\$1,000.02** for example, and to this value the system operator cost calculated at Block **990** is added when the processor executes Block **992** of Figure **56B**.

25
30 Ultimately, the final reseller balance **986** in Figure **58** holds a number representing an amount owed to the reseller by the system operator and the

-71-

system operator balance **996** of Figure **59** holds a number representing an amount of profit for the system operator.

5 While specific embodiments of the invention have been described and illustrated, such embodiments should be considered illustrative of the invention only and not as limiting the invention as construed in accordance with the accompanying claims.

-72-

What is claimed is:

- 5 1. A process for operating a call routing controller to facilitate communication between callers and callees in a system comprising a plurality of nodes with which callers and callees are associated, the process comprising:

10 in response to initiation of a call by a calling subscriber, receiving a caller identifier and a callee identifier;

15 using call classification criteria associated with the caller identifier to classify the call as a public network call or a private network call;

20 producing a routing message identifying an address, on the private network, associated with the callee when the call is classified as a private network call; and

25 producing a routing message identifying a gateway to the public network when the call is classified as a public network call.

- 30 2. The process of claim 1 further comprising receiving a request to establish a call, from a call controller in communication with a caller identified by said callee identifier.

- 35 3. The process of claim 1 wherein using said call classification criteria comprises searching a database to locate a record identifying calling attributes associated with a caller identified by said caller identifier.

- 40 4. The process of claim 3 wherein locating a record comprises locating a caller dialing profile comprising a username associated with said caller, a domain associated with said caller, and at least one calling attribute.

-73-

- 5
6. The process of claim 4 wherein comparing comprises determining whether said callee identifier includes a portion that matches an IDD associated with said caller dialing profile.
- 10
7. The process of claim 4 wherein comparing comprises determining whether said callee identifier includes a portion that matches an NDD associated with said caller dialing profile.
- 15
8. The process of claim 4 wherein comparing comprises determining whether said callee identifier includes a portion that matches an area code associated with said caller dialing profile.
- 20
9. The process of claim 4 wherein comparing comprises determining whether said callee identifier has a length within a range specified in said caller dialing profile.
- 25
10. The process of claim 4 further comprising formatting said callee identifier into a pre-defined digit format to produce a re-formatted callee identifier.
- 30
11. The process of claim 10 wherein formatting comprises removing an international dialing digit from said callee identifier, when said callee identifier begins with a digit matching an international dialing digit specified by said caller dialing profile associated with said caller.
12. The process of claim 10 wherein formatting comprises removing a national dialing digit from said callee identifier and prepending a caller

-74-

country code to said callee identifier when said callee identifier begins with a national dialing digit.

- 5 **13.** The process of claim **10** wherein formatting comprises prepending a caller country code to said callee identifier when said callee identifier begins with digits identifying an area code specified by said caller dialing profile.
- 10 **14.** The process of claim **10** wherein formatting comprises prepending a caller country code and area code to said callee identifier when said callee identifier has a length that matches a caller dialing number format specified by said caller dialing profile and only one area code is specified as being associated with said caller in said caller dialing profile.
- 15 **15.** The process of claim **10** further comprising classifying said call as a private network call when said re-formatted callee identifier identifies a subscriber to the private network.
- 20 **16.** The process of claim **10** further comprising determining whether said callee identifier complies with a pre-defined username format and if so classifying the call as a private network call.
- 25 **17.** The process of claim **10** further comprising causing a database of records to be searched to locate a direct in dial (DID) bank table record associating a public telephone number with said reformatted callee identifier and if said DID bank table record is found classifying the call as a private network call and if a DID bank table record is not found classifying the call as a public network call.
- 30 **18.** The process of claim **17** wherein producing said routing message identifying a node on the private network comprises setting a callee

-75-

identifier in response to a username associated with said DID bank table record.

- 5 **19.** The process of claim **18** wherein producing said routing message comprises determining whether a node associated with the reformatted callee identifier is the same as a node associated the caller identifier.
- 10 **20.** The process of claim **19** wherein determining whether a node associated with the reformatted callee identifier is the same as a node associated the caller identifier comprises determining whether a prefix of said re-formatted callee identifier matches a corresponding prefix of a username associated with said caller dialing profile.
- 15 **21.** The process of claim **20** wherein when said node associated with said caller is not the same as the node associated with the callee, producing a routing message including said caller identifier, said reformatted callee identifier and an identification of a private network node associated with said callee and communicating said routing message to a call controller.
- 20 **22.** The process of claim **19** wherein when said node associated with said caller is the same as the node associated with said callee, determining whether to perform at least one of the following: forward said call to another party, block the call and direct the caller to a voicemail server associated with the callee.
- 25 **23.** The process of claim **22** wherein producing said routing message comprises producing a routing message having an identification of at least one of the callee identifier, an identification of a party to whom the call should be forwarded and an identification of a voicemail server associated with the callee.
- 30

-76-

24. The process of claim **23** further comprising communicating said routing message to a call controller.
- 5 25. The process of claim **10** wherein producing a routing message identifying a gateway to the public network comprises searching a database of route records associating route identifiers with dialing codes to find a route record having a dialing code having a number pattern matching at least a portion of said reformatted callee identifier.
- 10 26. The process of claim **25** further comprising searching a database of supplier records associating supplier identifiers with said route identifiers to locate at least one supplier record associated with said route identifier associated with said route record having a dialing code having a number pattern matching at least a portion of said reformatted
- 15 callee identifier.
- 20 27. The process of claim **26** further comprising loading a routing message buffer with the reformatted callee identifier and an identification of specific routes associated respective ones of the supplier records associated with said route record and loading said routing message buffer with a time value and a timeout value.
- 25 28. The process of claim **27** further comprising communicating a routing message comprising the contents of said routing message buffer to a call controller.
- 30 29. The process of claim **4** further comprising causing said dialing profile to include a maximum concurrent call value and a concurrent call count value and causing said concurrent call count value to be incremented when the user associated with said dialing profile initiates a call and causing said concurrent call count value to be decremented when a call with said user associated with said dialing profile is ended.

-77-

30. A computer readable medium encoded with codes for directing a processor to execute the method of any one of claims **1-29**.

5 **31.** A call routing apparatus for facilitating communications between callers and callees in a system comprising a plurality of nodes with which callers and callees are associated, the apparatus comprising:

10 receiving means for receiving a caller identifier and a callee identifier, in response to initiation of a call by a calling subscriber;

15 classifying means for classifying the call as a private network call or a public network call according to call classification criteria associated with the caller identifier;

20 means for producing a routing message identifying an address, on the private network, associated with the callee when the call is classified as a private network call; and

25 means for producing a routing message identifying a gateway to the public network if the call is classified as a public network call.

32. The apparatus of claim **31** wherein said receiving means is operably configured to receive a request to establish a call, from a call controller in communication with a caller identified by said callee identifier.

30 **33.** The apparatus of claim **31** further comprising searching means for searching a database comprising records associating calling attributes with subscribers to said private network to locate a record identifying calling attributes associated with a caller identified by said caller identifier.

-78-

- 5 **34.** The apparatus of claim **33** wherein said records include dialing profiles each comprising a username associated with said subscriber, an identification of a domain associated with said subscriber, and an identification of at least one calling attribute associated with said subscriber.
- 10 **35.** The apparatus of claim **34** wherein said call classification means is operably configured to compare calling attributes associated with said caller dialing profile with aspects of said callee identifier.
- 15 **36.** The apparatus of claim **35** wherein said calling attributes include an international dialing digit and wherein said call classification means is operably configured to determine whether said callee identifier includes a portion that matches an IDD associated with said caller dialing profile.
- 20 **37.** The apparatus of claim **34** wherein said calling attributes include an national dialing digit and wherein said call classification means is operably configured to determine whether said callee identifier includes a portion that matches an NDD associated with said caller dialing profile.
- 25 **38.** The apparatus of claim **34** wherein said calling attributes include an area code and wherein said call classification means is operably configured to determine whether said callee identifier includes a portion that matches an area code associated with said caller dialing profile.
- 30 **39.** The apparatus of claim **34** wherein said calling attribute include a number length range and wherein said call classification means is operably configured to determine whether said callee identifier has a length within a range specified in said caller dialing profile.

-79-

40. The apparatus of claim **34** further comprising formatting means for formatting said callee identifier into a pre-defined digit format to produce a re-formatted callee identifier.

5

41. The apparatus of claim **40** wherein said formatting means is operably configured to remove an international dialing digit from said callee identifier, when said callee identifier begins with a digit matching an international dialing digit specified by said caller dialing profile associated with said caller.

10

42. The apparatus of claim **40** wherein said formatting means is operably configured to remove a national dialing digit from said callee identifier and prepend a caller country code to said callee identifier when said callee identifier begins with a national dialing digit.

15

43. The apparatus of claim **40** wherein said formatting means is operably configured to prepend a caller country code to said callee identifier when said callee identifier begins with digits identifying an area code specified by said caller dialing profile.

20

44. The apparatus of claim **40** wherein said formatting means is operably configured to prepend a caller country code and area code to said callee identifier when said callee identifier has a length that matches a caller dialing number format specified by said caller dialing profile and only one area code is specified as being associated with said caller in said caller dialing profile.

25

45. The apparatus of claim **40** wherein said classifying means is operably configured to classifying said call as a private network call when said re-formatted callee identifier identifies a subscriber to the private network.

30

-80-

- 5
46. The apparatus of claim **40** wherein said classifying means is operably configured to classify the call as a private network call when said callee identifier complies with a pre-defined username format.
- 10
47. The apparatus of claim **40** further comprising searching means for searching a database of records to locate a direct in dial (DID) bank table record associating a public telephone number with said reformatted callee identifier and wherein said classifying means is operably configured to classify the call as a private network call when said DID bank table record is found and to classify the call as a public network call when a DID bank table record is not found
- 15
48. The apparatus of claim **47** wherein said private network routing message producing means is operably configured to produce a routing message having a callee identifier set according to a username associated with said DID bank table record.
- 20
49. The apparatus of claim **48** wherein said private network routing message producing means is operably configured to determine whether a node associated with the reformatted callee identifier is the same as a node associated the caller identifier.
- 25
50. The apparatus of claim **49** wherein said private network routing means includes means for determining whether a prefix of said re-formatted callee identifier matches a corresponding prefix of a username associated with said caller dialing profile.
- 30
51. The apparatus of claim **50** wherein said private network routing message producing means is operably configured to produce a routing message including said caller identifier, said reformatted callee identifier and an identification of a private network node associated with

-81-

said callee and communicating said routing message to a call controller.

- 5
- 52.** The apparatus of claim **49** wherein said private network routing message producing means is operably configured to perform at least one of the following: forward said call to another party, block the call and direct the caller to a voicemail server associated with the callee, when said node associated with said caller is the same as the node associated with said callee.
- 10
- 53.** The apparatus of claim **52** wherein said means for producing said private network routing message is operably configured to produce a routing message having an identification of at least one of the callee identifier, an identification of a party to whom the call should be forwarded and an identification of a voicemail server associated with the callee.
- 15
- 54.** The apparatus of claim **53** further comprising means for communicating said routing message to a call controller.
- 20
- 55.** The apparatus of claim **40** wherein said means for producing a public network routing message identifying a gateway to the public network comprises means for searching a database of route records associating route identifiers with dialing codes to find a route record having a dialing code having a number pattern matching at least a portion of said reformatted callee identifier.
- 25
- 56.** The apparatus of claim **55** further comprising means for searching a database of supplier records associating supplier identifiers with said route identifiers to locate at least one supplier record associated with said route identifier associated with said route record having a dialing
- 30

-82-

code having a number pattern matching at least a portion of said reformatted callee identifier.

5 **57.** The apparatus of claim **56** further comprising a routing message buffer and means for loading said routing message buffer with the reformatted callee identifier and an identification of specific routes associated respective ones of the supplier records associated with said route record and loading said routing message buffer with a time value and a timeout value.

10 **58.** The apparatus of claim **57** further comprising means for communicating a routing message comprising the contents of said routing message buffer to a call controller.

15 **59.** The apparatus of claim **34** further comprising means for causing said dialing profile to include a maximum concurrent call value and a concurrent call count value and for causing said concurrent call count value to be incremented when the user associated with said dialing profile initiates a call and for causing said concurrent call count value to be decremented when a call with said user associated with said dialing profile is ended.

Data Structure

25 **60.** A data structure for access by an apparatus for producing a routing message for use by a call routing controller in a communications system, the data structure comprising:

30 dialing profile records comprising fields for associating with respective subscribers to the system:

 a subscriber user name

-83-

direct-in-dial records comprising fields for associating with respective subscriber usernames:

5 a user domain; and

a direct-in-dial number;

10 prefix to node records comprising fields for associating with at least a portion of said respective subscriber usernames:

a node address of a node in said system,

15 whereby a subscriber name can be used to find a user domain, at least a portion of said a subscriber name can be used to find a node with which the subscriber identified by the subscriber name is associated, and a user domain and subscriber name can be located in response to a direct-in-dial number.

20 **61.** A data structure for access by an apparatus for producing a routing message for use by a call routing controller in a communications system, the data structure comprising:

25 master list records comprising fields for associating a dialing code with respective master list identifiers; and

supplier list records linked to master list records by said master list identifiers, aid supplier list records comprising fields for associating with a communications services supplier:

30 a supplier id;

a master list id;

a route identifier; and

5 a billing rate code,

whereby communications services suppliers are associated with dialing codes, such that dialing codes can be used to locate suppliers capable of providing a communications link associated with a given dialing code.

10

62. A method of determining a time to permit a communication session to be conducted, the method comprising:

15 calculating a cost per unit time;

calculating a first time value as a sum of a free time attributed to a participant in the communication session and the quotient of a funds balance held by said participant to said cost per unit time value; and

20

producing a second time value in response to said first time value and a billing pattern associated with said participant, said billing pattern including first and second billing intervals and said second time value being said time to permit a communication session to be conducted.

25

63. The method of claim **62** wherein calculating said first time value comprises retrieving a record associated with said participant and obtaining from said record at least one of said free time and said funds balance.

30

-85-

5 **64.** The method of claim **62** wherein producing said second time value comprises producing a remainder value representing a portion of said second billing interval remaining after dividing said second billing interval into a difference between said first time value and said first billing interval.

10 **65.** The method of claim **64** wherein producing said second time value comprises setting a difference between said first time value and said remainder as said second time value.

15 **66.** The method of claim **62** further comprising setting said second time value to zero when said remainder is greater than zero and said first time value is less than said free time associated with said participant.

20 **67.** The method of claim **62** wherein calculating said cost per unit time comprises:

 locating a record in a database, said record comprising a markup type indicator, a markup value and a billing pattern;

 and

 setting a reseller rate equal to the sum of said markup value and said buffer rate.

25 **68.** The method of claim **67** wherein locating said record in a database comprises locating at least one of:

30 a record associated with a reseller and a route associated with the reseller;

 a record associated with the reseller; and

a default reseller markup record.

5 **69.** The method of claim **67** wherein calculating said cost per unit time value further comprises locating at least one of:

10 an override record specifying a route cost per unit time amount associated with a route associated with the communication session;

15 a reseller record associated with a reseller of said communications session, said reseller record specifying a reseller cost per unit time associated with said reseller for the communication session;

 a default operator markup record specifying a default cost per unit time.

20 **70.** The method of claim **69** further comprising setting as said cost per unit time the sum of said reseller rate and at least one of said route cost per unit time, said reseller cost per unit time and said default cost per unit time.

25 **71.** The method of claim **69** further comprising receiving a communication session time representing a duration of said communication session and incrementing a reseller balance by the product of said reseller rate and said communication session time.

30 **72.** The method of claim **69** further comprising receiving a communication session time representing a duration of said communication session and incrementing a system operator balance by a product of said buffer rate and said communication session time.

-87-

73. A computer readable medium encoded with instructions for directing a processor circuit to execute the method of any one of claims **62-72**.

5 **74.** An apparatus for determining a time to permit a communication session to be conducted, the apparatus comprising:

a processor circuit;

10 a computer readable medium coupled to the processor circuit and encoded with instructions for directing the processor circuit to:

calculate a cost per unit time for the communication session;

15

calculate a first time value as a sum of a free time attributed to a participant in the communication session and the quotient of a funds balance held by said participant to said cost per unit time value; and

20

produce a second time value in response to said first time value and a billing pattern associated with said participant, said billing pattern including first and second billing intervals and said second time value being said time to permit a communication session to be conducted.

25

75. The apparatus of claim **74** wherein said instructions include instructions for directing the processor circuit to retrieve a record associated with said participant and obtain from said record at least one of said free time and said funds balance.

30

- 5 **76.** The apparatus of claim **74** wherein said instructions include instructions for directing the processor circuit to produce said second time value by producing a remainder value representing a portion of said second billing interval remaining after dividing said second billing interval into a difference between said first time value and said first billing interval.
- 10 **77.** The apparatus of claim **76** wherein said instructions include instructions for directing the processor circuit to produce said second time value comprises setting a difference between said first time value and said remainder as said second time value.
- 15 **78.** The apparatus of claim **74** wherein said instructions include instructions for directing the processor circuit to set said second time value to zero when said remainder is greater than zero and said first time value is less than said free time associated with said participant.
- 20 **79.** The apparatus of claim **74** wherein said instructions for directing said processor circuit to calculate said cost per unit time comprises instructions for directing the processor circuit to:
- 25 locate a record in a database, said record comprising a markup type indicator, a markup value and a billing pattern;
- and
- set a reseller rate equal to the sum of said markup value and said buffer rate.

30

-89-

80. The apparatus of claim **79** wherein said instructions for directing the processor circuit to locate said record in a database comprises instruction for directing the processor circuit to locate at least one of:

5 a record associated with a reseller and a route associated with the reseller;

 a record associated with the reseller;

10 a default reseller markup record;

81. The apparatus of claim **79** wherein said instructions for directing the processor circuit to calculate said cost per unit time value further comprises instructions for directing the processor circuit to locate at least one of:

15

 an override record specifying a route cost per unit time amount associated with a route associated with the communication session;

20

 a reseller record associated with a reseller of said communications session, said reseller record specifying a reseller cost per unit time associated with said reseller for the communication session;

25

 a default operator markup record specifying a default cost per unit time.

82. The apparatus of claim **81** wherein said instructions include instructions for directing the processor circuit to set as said cost per unit time the sum of said reseller rate and at least one of said route

30

-90-

cost per unit time, said reseller cost per unit time and said default cost per unit time.

5 **83.** The apparatus of claim **81** wherein said instructions include instructions for directing the processor circuit to receive a communication session time representing a duration of said communication session and increment a reseller balance by the product of said reseller rate and said communication session time.

10 **84.** The apparatus of claim **81** wherein said instructions include instructions for directing the processor circuit to receive a communication session time representing a duration of said communication session and increment a system operator balance by a product of said buffer rate and said communication session time.

15 **Attributing Charges to a User**

20 **85.** A process for attributing charges for communications services, the process comprising:

determining a first chargeable time in response to a communication session time and a pre-defined billing pattern;

25 determining a user cost value in response to said first chargeable time and a free time value associated with a user of said communications services;

30 changing an account balance associated with said user in response to a user cost per unit time.

changing an account balance associated with a reseller of said communications services in response to a reseller cost per unit time and said communication session time; and

5 changing an account balance associated with an operator of said communications services in response to an operator cost per unit time and said communication session time.

10 **86.** The process of claim **85** wherein determining said first chargeable time comprises:

locating at least one of:

15 an override record specifying a route cost per unit time and billing pattern associated with a route associated with the communication session;

20 a reseller record associated with a reseller of said communications session, said reseller record specifying a reseller cost per unit time and billing pattern associated with said reseller for the communication session; and

25 a default record specifying a default cost per unit time and billing pattern; and

setting as said pre-defined billing pattern the billing pattern of the record located,

30 wherein the billing pattern of the record located comprises a first billing interval and a second billing interval.

-92-

5 **87.** The process of claim **85** wherein determining said first chargeable time comprises setting said first chargeable time equal to said first billing interval when said communication session time is less than or equal to said first billing interval.

10 **88.** The process of claim **86** wherein determining said first chargeable time comprises producing a remainder value representing a portion of said second billing interval remaining after dividing said second billing interval into a difference between communication session time and said first interval when said communication session time is greater than said communication session time; and

15 setting said first chargeable time to a difference between said communication session time and said remainder when said remainder is greater than zero; and

 setting said first chargeable time to said communication session time when said remainder is not greater than zero.

20 **89.** The process of claim **88** further comprising determining a second chargeable time in response to said first chargeable time and said free time value associated with said user of said communications services when said first chargeable time is greater than or equal to said free time value associated with said user of said communications services.

25 **90.** The process of claim **89** wherein determining said second chargeable time comprises setting said second chargeable time to a difference between said first chargeable time.

30 **91.** The process of claim **89** further comprising resetting said free time value associated with the user to zero when said first chargeable time

-93-

is greater than or equal to said free time value associated with said user of said communications services.

- 5 **92.** The process of claim **90** wherein changing an account balance associated with the user comprises calculating a user cost value in response to said second chargeable time and said user cost per unit time.
- 10 **93.** The process of claim **92** further comprising changing a user free cost balance in response to said user cost value.
- 15 **94.** The process of claim **85** further comprising setting said user cost to zero when said first chargeable time is less than said free time value associated with the user.
- 95.** The process of claim **85** further comprising changing a user free time balance in response to said first chargeable time.
- 20 **96.** A computer readable medium encoded with instructions for directing a processor circuit to execute the process of any one of claims **85-95**.
- 97.** An apparatus for attributing charges for communications services, the apparatus comprising:
- 25 a processor circuit;
- a computer readable medium in communication with the processor circuit and encoded with instructions for directing said processor circuit to;
- 30 determine a first chargeable time in response to a communication session time and a pre-defined billing pattern;

-94-

determine a user cost value in response to said first chargeable time and a free time value associated with a user of said communications services;

5

change an account balance associated with said user in response to a user cost per unit time.

change an account balance associated with a reseller of said communications services in response to a reseller cost per unit time and said communication session time; and

10

change an account balance associated with an operator of said communications services in response to an operator cost per unit time and said communication session time.

15

98. The apparatus of claim **97** wherein said instructions for directing the processor circuit to determine said first chargeable time comprises:

20

instructions for causing said processor circuit to communicate with a database to locate at least one of:

an override record specifying a route cost per unit time and billing pattern associated with a route associated with the communication session;

25

a reseller record associated with a reseller of said communications session, said reseller record specifying a reseller cost per unit time and billing pattern associated with said reseller for the communication session; and

30

-95-

a default record specifying a default cost per unit time and billing pattern; and

5

instructions for setting as said pre-defined billing pattern the billing pattern of the record located,

wherein the billing pattern of the record located comprises a first billing interval and a second billing interval.

10

99. The apparatus of claim **97** wherein said instructions causing the processor circuit to determine said first chargeable time comprises instructions for directing the processor circuit to set said first chargeable time equal to said first billing interval when said communication session time is less than or equal to said first billing interval.

15

100. The apparatus of claim **98** wherein said instructions for causing the processor circuit to determine said first chargeable time comprises instructions for producing a remainder value representing a portion of said second billing interval remaining after dividing said second billing interval into a difference between communication session time and said first interval when said communication session time is greater than said communication session time; and

20

25

instructions for causing the processor circuit to set said first chargeable time to a difference between said communication session time and said remainder when said remainder is greater than zero; and

30

instructions for causing the processor circuit to set said first chargeable time to said communication session time when said remainder is not greater than zero.

-96-

- 5 **101.** The apparatus of claim **100** wherein the computer readable medium is further encoded with instructions for causing the processor circuit to determine a second chargeable time in response to said first chargeable time and said free time value associated with said user of said communications services when said first chargeable time is greater than or equal to said free time value associated with said user of said communications services.
- 10 **102.** The apparatus of claim **101** wherein said instructions for causing the processor circuit to determine said second chargeable time comprises instructions for causing the processor circuit to set said second chargeable time to a difference between said first chargeable time.
- 15 **103.** The apparatus of claim **101** wherein the computer readable medium is further encoded with instructions for causing the processor circuit to reset said free time value associated with the user to zero when said first chargeable time is greater than or equal to said free time value associated with said user of said communications services.
- 20 **104.** The apparatus of claim **102** wherein said instructions for causing the processor circuit to change an account balance associated with the user comprises instructions for causing the processor circuit to calculate a user cost value in response to said second chargeable time and said user cost per unit time.
- 25 **105.** The apparatus of claim **104** wherein the computer readable medium is further encoded with instructions for causing the processor circuit to change a user free cost balance in response to said user cost value.
- 30 **106.** The apparatus of claim **97** wherein the computer readable medium is further encoded with instructions for causing the processor circuit to

-97-

set said user cost to zero when said first chargeable time is less than said free time value associated with the user.

- 5 **107.** The apparatus of claim **97** wherein the computer readable medium is further encoded with instructions for causing the processor circuit to change a user free time balance in response to said first chargeable time.

AMENDED CLAIMS**received by the International Bureau on 18 April 2008 (18.04.08)**

code having a number pattern matching at least a portion of said reformatted callee identifier.

5 **57.** The apparatus of claim **56** further comprising a routing message buffer and means for loading said routing message buffer with the reformatted callee identifier and an identification of specific routes associated respective ones of the supplier records associated with said route record and loading said routing message buffer with a time value and a timeout value.

10 **58.** The apparatus of claim **57** further comprising means for communicating a routing message comprising the contents of said routing message buffer to a call controller.

15 **59.** The apparatus of claim **34** further comprising means for causing said dialing profile to include a maximum concurrent call value and a concurrent call count value and for causing said concurrent call count value to be incremented when the user associated with said dialing profile initiates a call and for causing said concurrent call count value to be decremented when a call with said user associated with said dialing
20 profile is ended.

Data Structure

25 **60.** A data structure for access by an apparatus for producing a routing message for use by a call routing controller in a communications system, the data structure comprising:

30 dialing profile records comprising fields for associating a subscriber username with respective subscribers to the system;

direct-in-dial records comprising fields for associating a user domain and a direct-in-dial number with respective subscriber usernames;

5 prefix to node records comprising fields for associating a node address of a node in said system with at least a portion of said respective subscriber usernames:

10 whereby said subscriber username can be used to find said user domain, at least a portion of said subscriber username can be used to find said node with which a subscriber identified by said subscriber user name is associated, and said user domain and said subscriber username can be located in response to said direct-in-dial number.

15

61. A data structure for access by an apparatus for producing a routing message for use by a call routing controller in a communications system, the data structure comprising:

20 master list records comprising fields for associating a dialing code with respective master list identifiers; and

25 supplier list records linked to said master list records by said master list identifiers, said supplier list records comprising fields for associating with a communications services supplier:

a supplier id;

30 a master list id;

30

a route identifier; and

a billing rate code,

5 whereby at least one communications service supplier is associated with said dialing code, such that said dialing code can be used to locate suppliers capable of providing a communications link associated with a given dialing code.

62. A method of determining a time to permit a communication session to be conducted, the method comprising:

10

calculating a cost per unit time;

15

calculating a first time value as a sum of a free time attributed to a participant in the communication session and the quotient of a funds balance held by said participant to said cost per unit time value; and

20

producing a second time value in response to said first time value and a billing pattern associated with said participant, said billing pattern including first and second billing intervals and said second time value being said time to permit a communication session to be conducted.

25

63. The method of claim 62 wherein calculating said first time value comprises retrieving a record associated with said participant and obtaining from said record at least one of said free time and said funds balance.

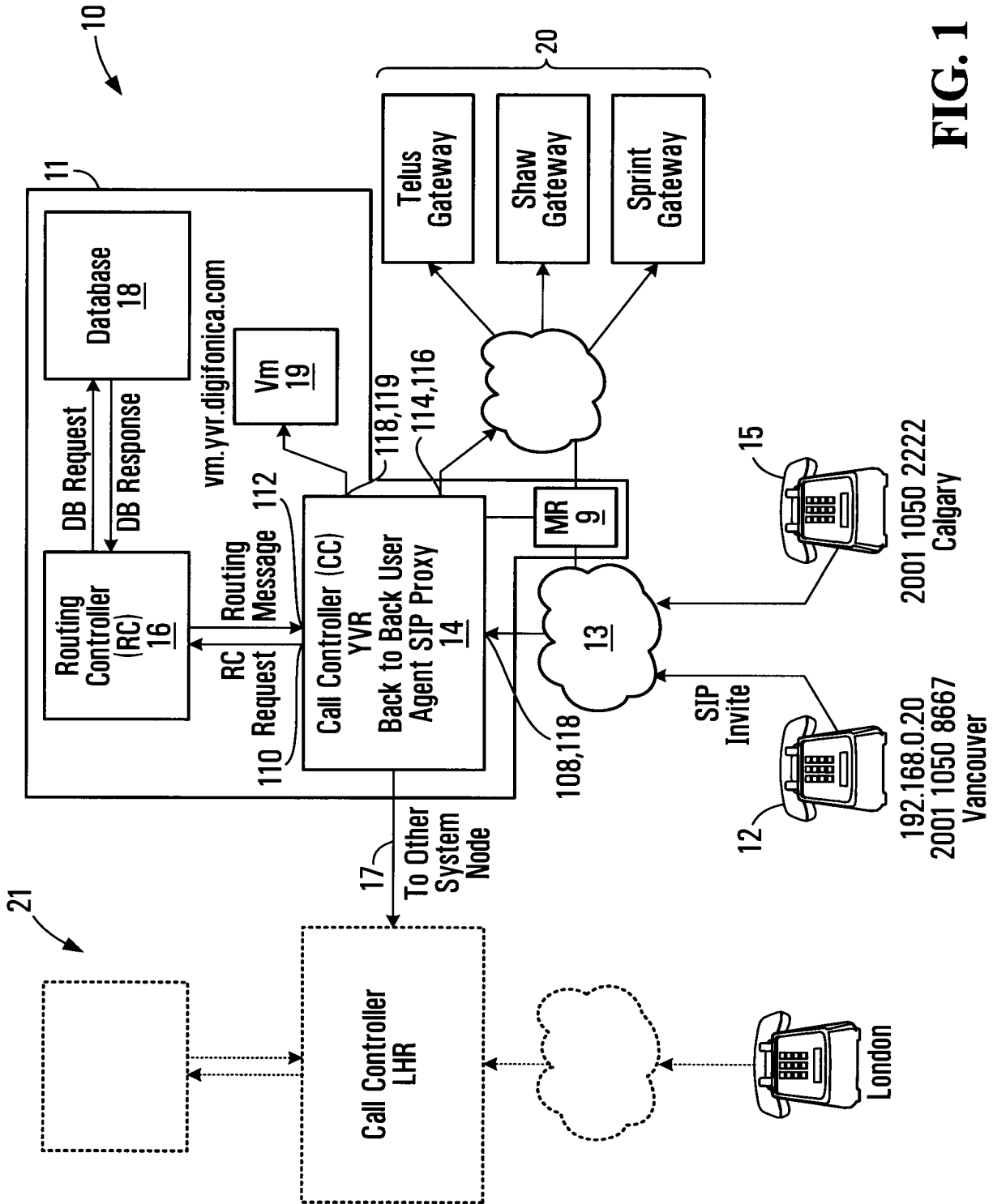

FIG. 1

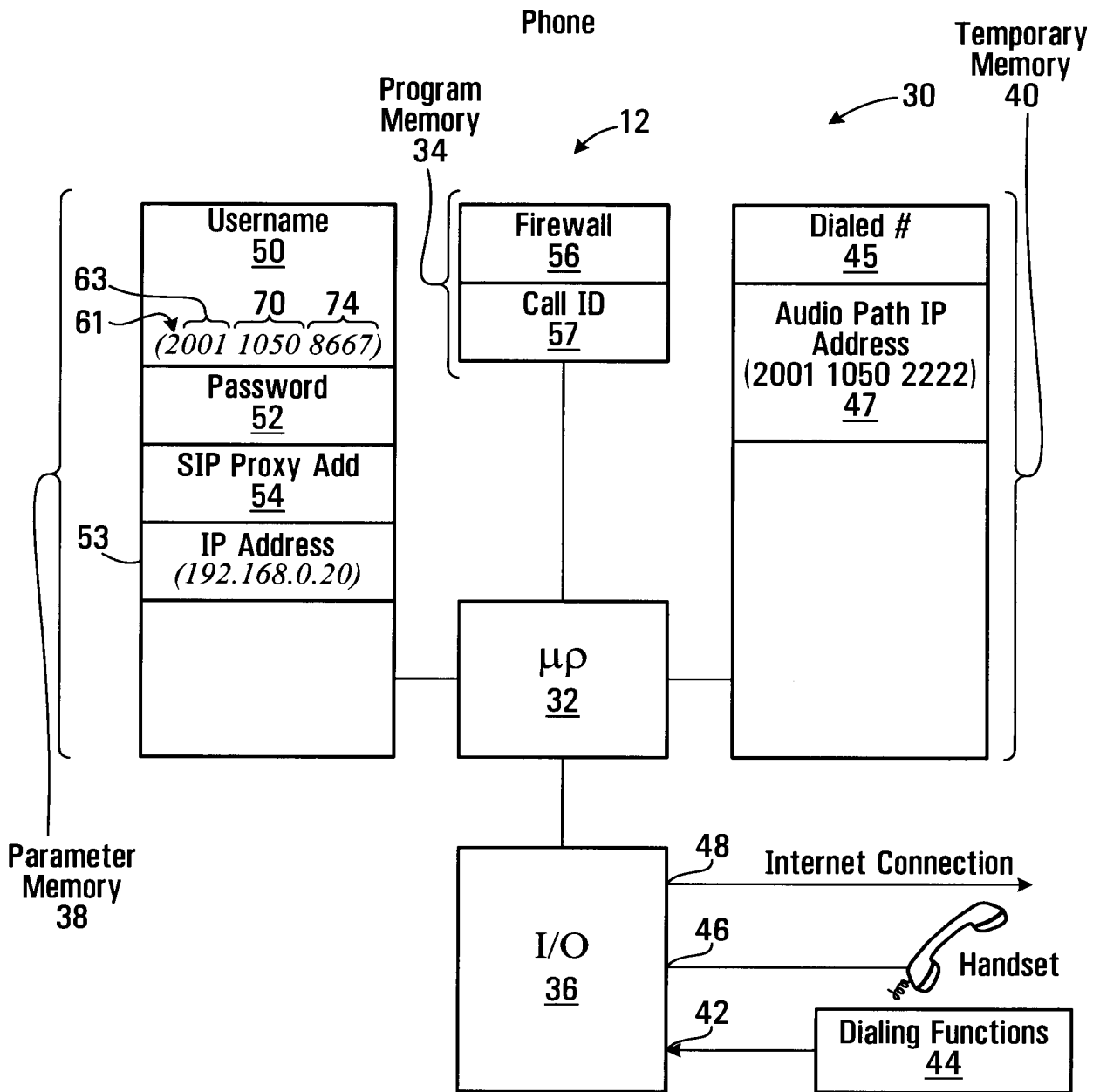

FIG. 2

3/32

SIP Invite Message

60 ~ Caller 2001 1050 8667
62 ~ Callee 2001 1050 2222
64 ~ Digest Parameters XXXXXXX
65 ~ Call ID FF10@ 192.168.0.20
67 ~ IP Address 192.168.0.20
69 ~ Caller UDP Port 1

FIG. 3

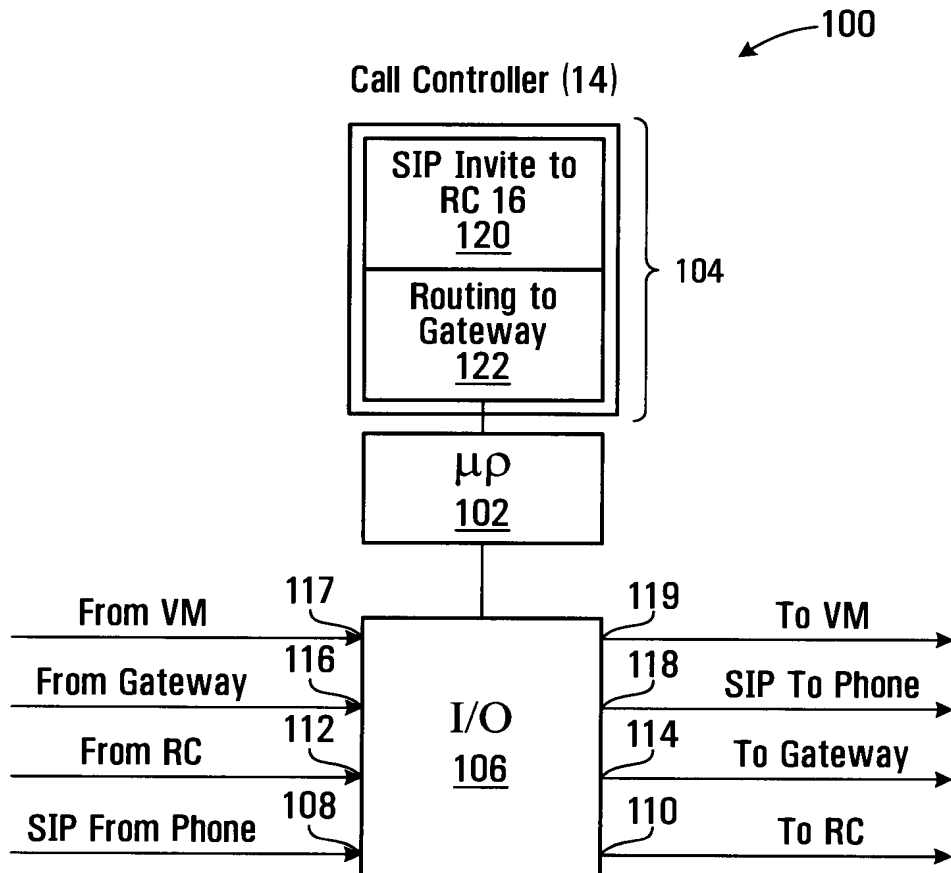

FIG. 4

4/32

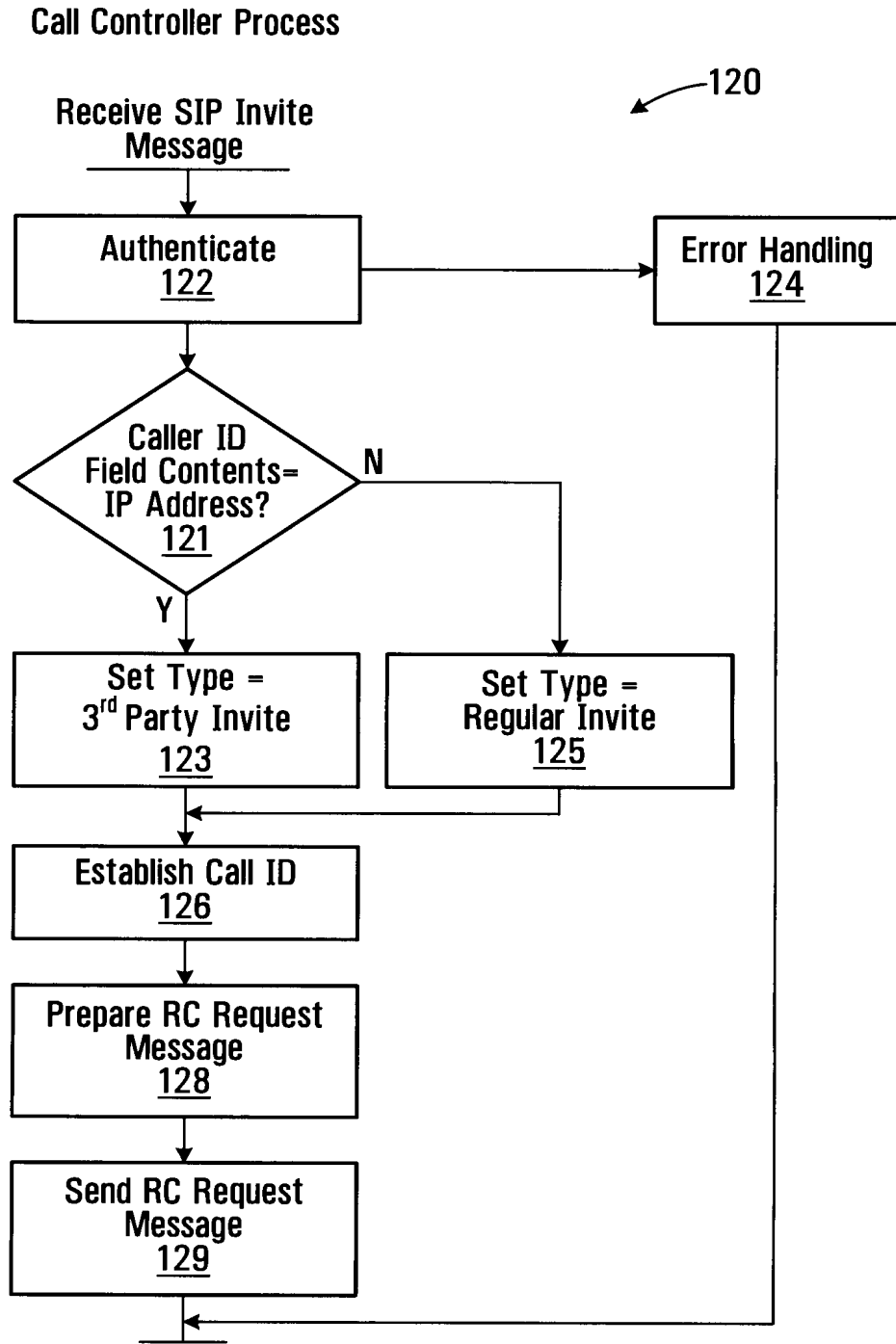

FIG. 5

5/32

150

RC Request Message

152 ~ Caller 2001 1050 8667
 154 ~ Callee 2001 1050 2222
 156 ~ Digest XXXXXXX
 158 ~ Call ID FF10@ 192.168.0.20
 160 ~ Type Subscriber

FIG. 6

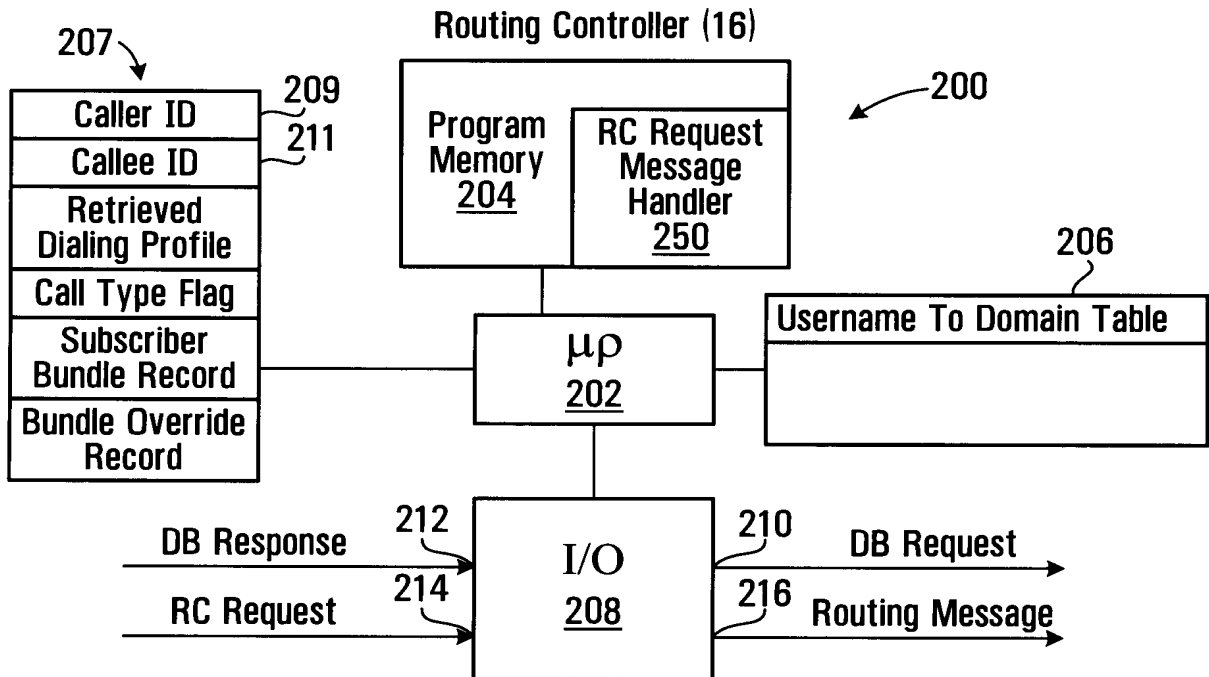

FIG. 7

6/32

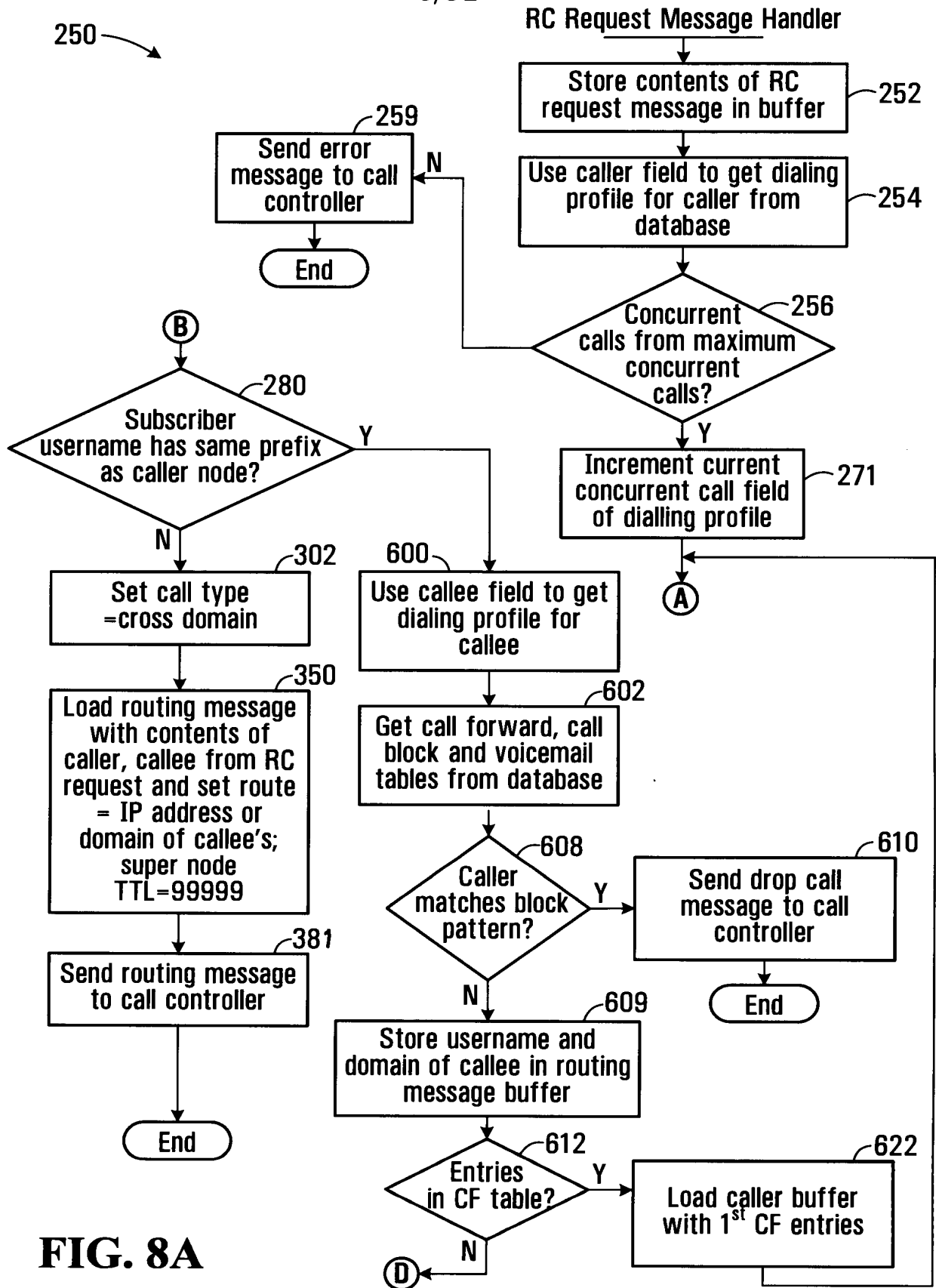
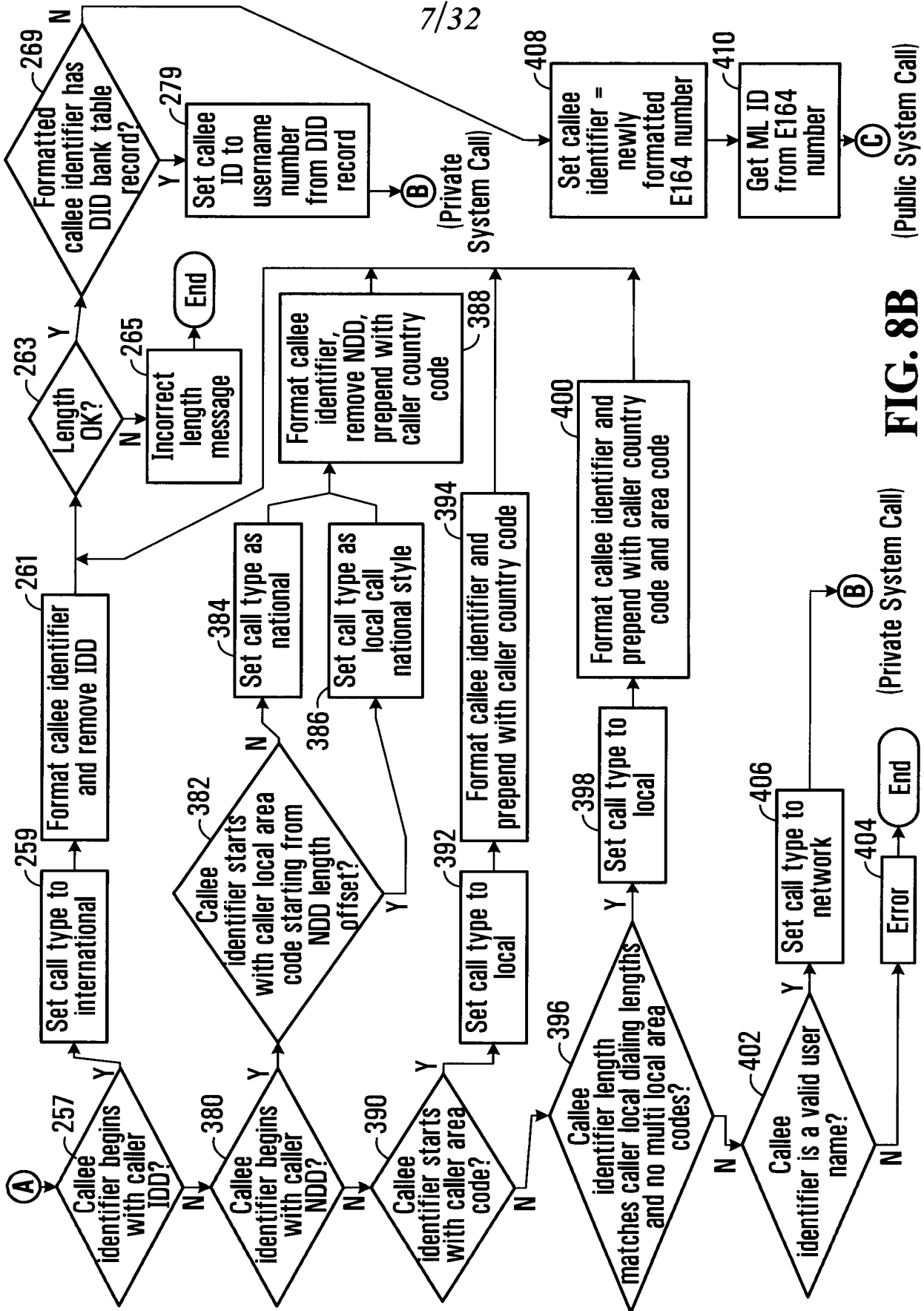

FIG. 8A

7/32



(Public System Call)

(Private System Call)

FIG. 8B

8/32

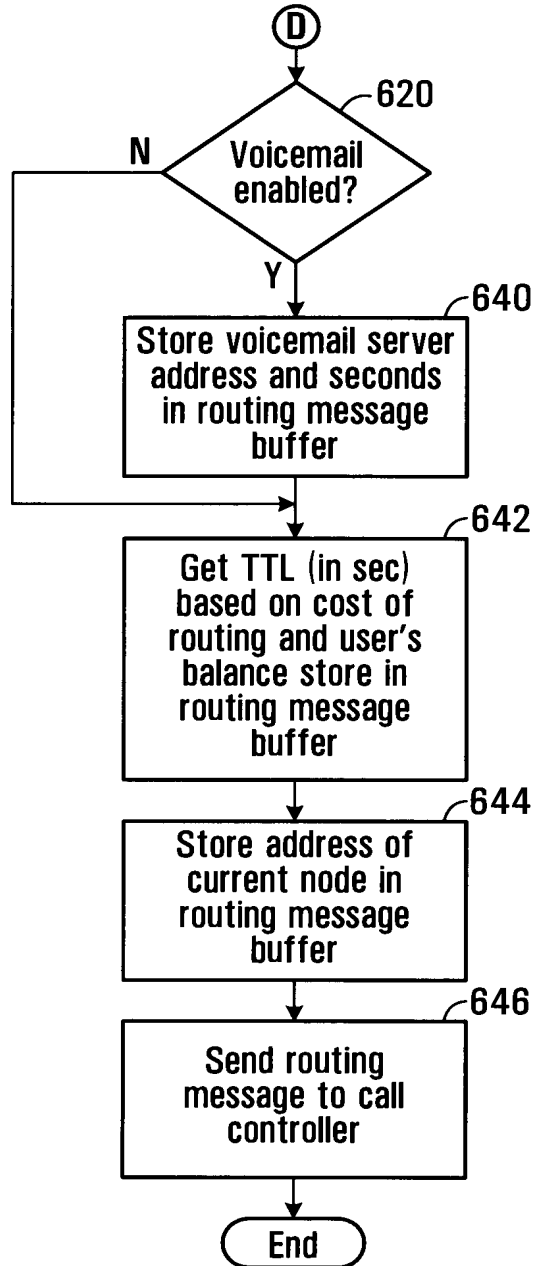

FIG. 8C

9/32

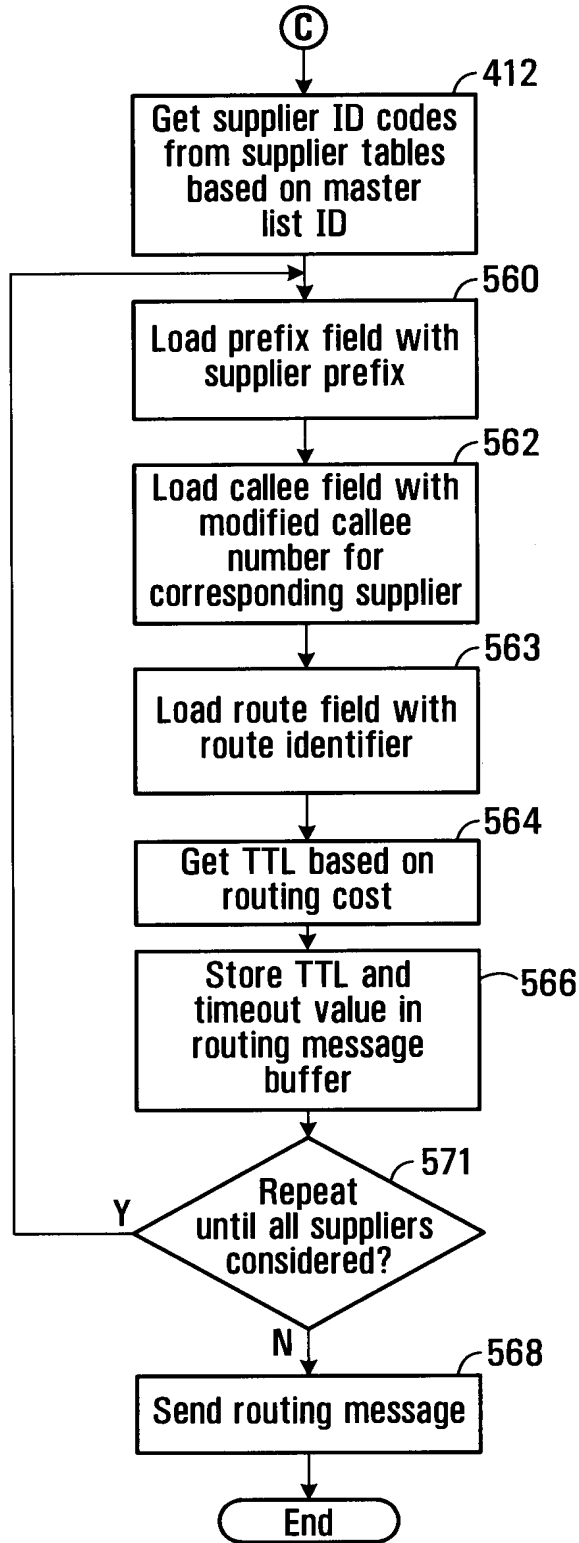

FIG. 8D

10/32

↖ 253

Dialing Profile for a User

258 ~ Username	Assigned on Subscription
260 ~ Domain	Domain Associated with User
262 ~ NDD	1
264 ~ IDD	011
266 ~ Country Code	1
267 ~ Local Area Codes	604;778
268 ~ Caller Minimum Local Length	10
270 ~ Caller Maximum Local Length	10
273 ~ Reseller	Retailer
275 ~ Maximum # of concurrent calls	Assigned on Subscription
277 ~ Current # of concurrent calls	Assigned on Subscription

FIG. 9

Dialing Profile for Caller (Vancouver Subscriber)

258 ~ Username	2001 1050 8667
260 ~ Domain	sp.yvr.digifonica.com
262 ~ NDD	1
264 ~ IDD	011 286 288 290
266 ~ Country Code	1
267 ~ Local Area Codes	604;778 (Vancouver)
268 ~ Caller Minimum Local Length	10
270 ~ Caller Maximum Local Length	10
273 ~ Reseller	Klondike
275 ~ Maximum # of concurrent calls	5
277 ~ Current # of concurrent calls	0

↖ 276

FIG. 10

11/32

Callee Profile for Calgary Subscriber

Username	2001 1050 2222
Domain	sp.yvr.digifonica.com
NDD	1
IDD	011
Country Code	1
Local Area Codes	403 (Calgary)
Caller Minimum Local Length	7
Caller Maximum Local Length	10
Reseller	Deerfoot
Maximum # of concurrent calls	5
Current # of concurrent calls	0

FIG. 11**Callee Profile for London Subscriber**

Username	4401 1062 4444
Domain	sp.lhr.digifonica.com
NDD	0
IDD	00
Country Code	44
Local Area Codes	20 (London)
Caller Minimum Local Length	10
Caller Maximum Local Length	11
Reseller	Marble Arch
Maximum # of concurrent calls	5
Current # of concurrent calls	0

FIG. 12

12/32

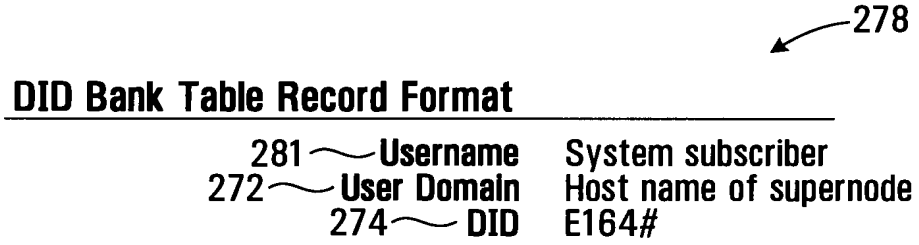

FIG. 13

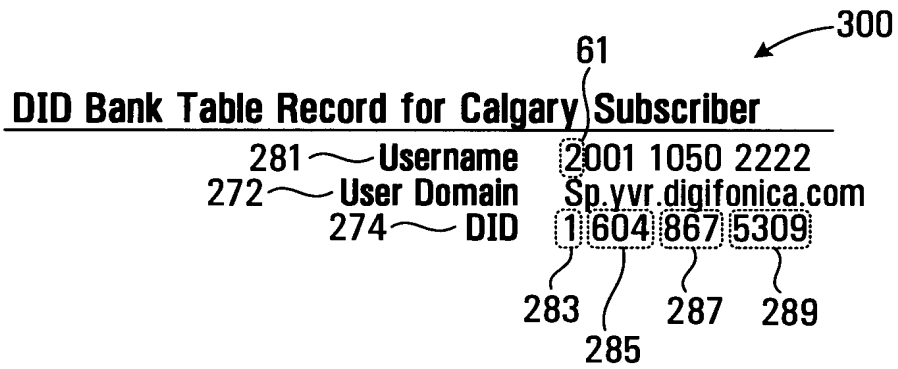

FIG. 14

13/32

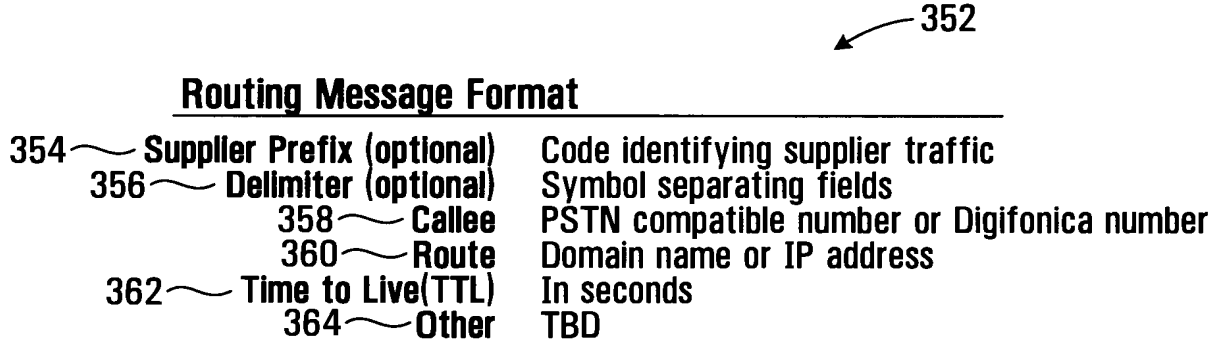

FIG. 15



FIG. 16



FIG. 17



FIG. 18

Master List Record Format

500 ~	ml_id	Alphanumeric
502 ~	Dialing code	Number Sequence
504 ~	Country code	The country code is the national prefix to be used when dialing TO a particular country FROM another country.
506 ~	Nat Sign #(Area Code)	Number Sequence
508 ~	Min Length	Numeric
510 ~	Max Length	Numeric
512 ~	NDD	The NDD prefix is the access code used to make a call WITHIN that country from one city to another (when calling another city in the same vicinity, this may not be necessary).
514 ~	IDD	The IDD prefix is the international prefix needed to dial a call FROM the country listed TO another country.
516 ~	Buffer rate	Safe change rate above the highest rate charged by suppliers

FIG. 19

Example: Master List Record with Populated Fields

ml_id	1019
Dialing code	1604
Country code	1
Nat Sign #(Area Code)	604
Min Length	7
Max Length	7
NDD	1
IDD	011
Buffer rate	\$0.009/min

FIG. 20

15/32

Suppliers List Record Format

540 ~	Sup_id	Name code
542 ~	MI_id	Numeric code
544 ~	Prefix (optional)	String identifying supplier's traffic #
546 ~	Specific Route	IP address
548 ~	NDD/IDD rewrite	
550 ~	Rate	Cost per second to Digifonica to use this route
551 ~	Timeout	Maximum time to wait for a response when requesting this gateway

FIG. 21

Telus Supplier Record

Sup_id	2010 (Telus)
MI_id	1019
Prefix (optional)	4973#
Specific Route	72.64.39.58
NDD/IDD rewrite	011
Rate	\$0.02/min
Timeout	20

FIG. 22

Shaw Supplier Record

Sup_id	2011 (Shaw)
MI_id	1019
Prefix (optional)	4974#
Specific Route	73.65.40.59
NDD/IDD rewrite	011
Rate	\$0.025/min
Timeout	30

FIG. 23

Sprint Supplier Record

Sup_id	2012 (Sprint)
MI_id	1019
Prefix (optional)	4975#
Specific Route	74.66.41.60
NDD/IDD rewrite	011
Rate	\$0.03/min
Timeout	40

FIG. 24

16/32

Routing Message Buffer for Gateway Call

4973#0116048675309@72.64.39.58;tll=3600;to=20 ~ 570
 4974#0116048675309@73.65.40.59;tll=3600;to=30 ~ 572
 4975#0116048675309@74.66.41.60;tll=3600;to=40 ~ 574

FIG. 25

Call Block Table Record Format

604 ~ Username Digifonica #
 606 ~ Block Pattern PSTN compatible or Digifonica #

FIG. 26

Call Block Table Record for Calgary Callee

604 ~ Username of Callee 2001 1050 2222
 606 ~ Block Pattern 2001 1050 8664

FIG. 27

Call Forwarding Table Record Format for Callee

614 ~ Username of Callee Digifonica #
 616 ~ Destination Number Digifonica #
 618 ~ Sequence Number Integer indicating order to try this

FIG. 28

Call Forwarding Table Record for Calgary Callee

614 ~ Username of Callee 2001 1050 2222
 616 ~ Destination Number 2001 1055 2223
 618 ~ Sequence Number 1

FIG. 29

17/32

Voicemail Table Record Format

624 ~	Username of Callee	Digifonica #
626 ~	Vm Server	domain name
628 ~	Seconds to Voicemail	time to wait before engaging voicemail
630 ~	Enabled	yes/no

FIG. 30

Voicemail Table Record for Calgary Callee

Username of Callee	2001 1050 2222
Vm Server	vm.yvr.digifonica.com
Seconds to Voicemail	20
Enabled	1

FIG. 31

Routing Message Buffer - Same Node

650 ~	200110502222@sp.yvr.digifonica.com;ttl=3600
652 ~	200110552223@sp.yvr.digifonica.com;ttl=3600
654 ~	vm.yvr.digifonica.com;20;ttl=60
656 ~	sp.yvr.digifonica.com

FIG. 32

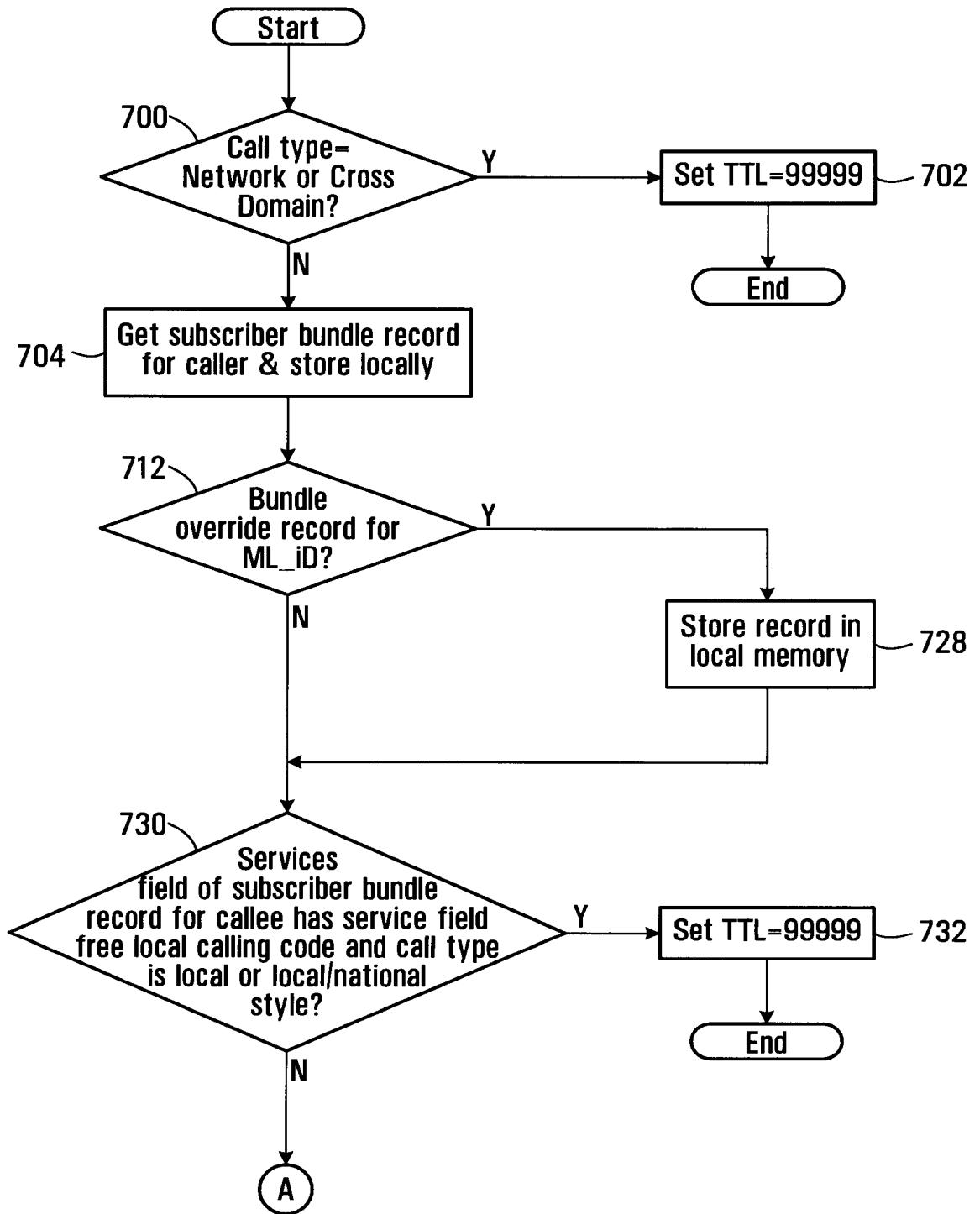

FIG. 33A

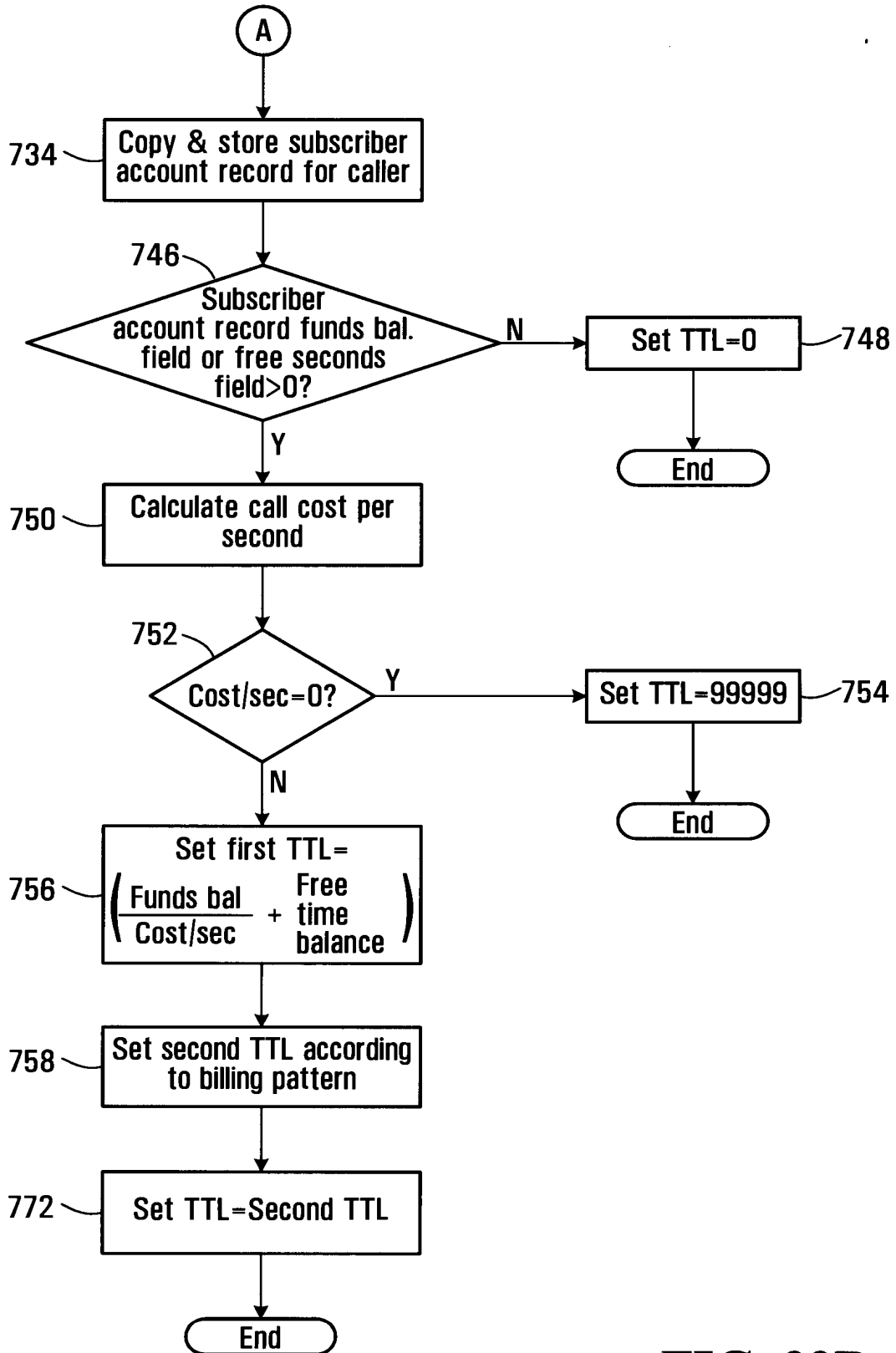

FIG. 33B

20/32

Subscriber Bundle Table Record

706
↙

708 ~	Username	Subscriber username
710 ~	Services	Codes identifying service features (e.g. Free local calling; call blocking, voicemail)

FIG. 34

Subscriber Bundle Record for Vancouver Caller

708 ~	Username	2001 1050 8667
710 ~	Services	10; 14; 16

FIG. 35

Bundle Override Table Record

714
↙

716 ~	ML_Id	Master list ID code
718 ~	Override type	Fixed; percent; cents
720 ~	Override value	real number representing value of override type
722 ~	Inc1	first level of charging (minimum # of seconds) charge
724 ~	Inc2	second level of charging

FIG. 36

Bundle Override Record for Located ML_id

726
↙

716 ~	ML_Id	1019
718 ~	Override type	percent
720 ~	Override value	10.0
722 ~	Inc1	30 seconds
724 ~	Inc2	6 seconds

FIG. 37

21/32

736 ↙

Subscriber Account Table Record

738 ~	Username	Subscriber username
740 ~	Funds balance	real number representing \$ value of credit
742 ~	Free time balance	integer representing # of free seconds

FIG. 38

744 ↙

Subscriber Account Record for Vancouver Caller

738 ~	Username	2001 1050 8667
740 ~	Funds balance	\$10.00
742 ~	Free time balance	100

FIG. 39

22/32

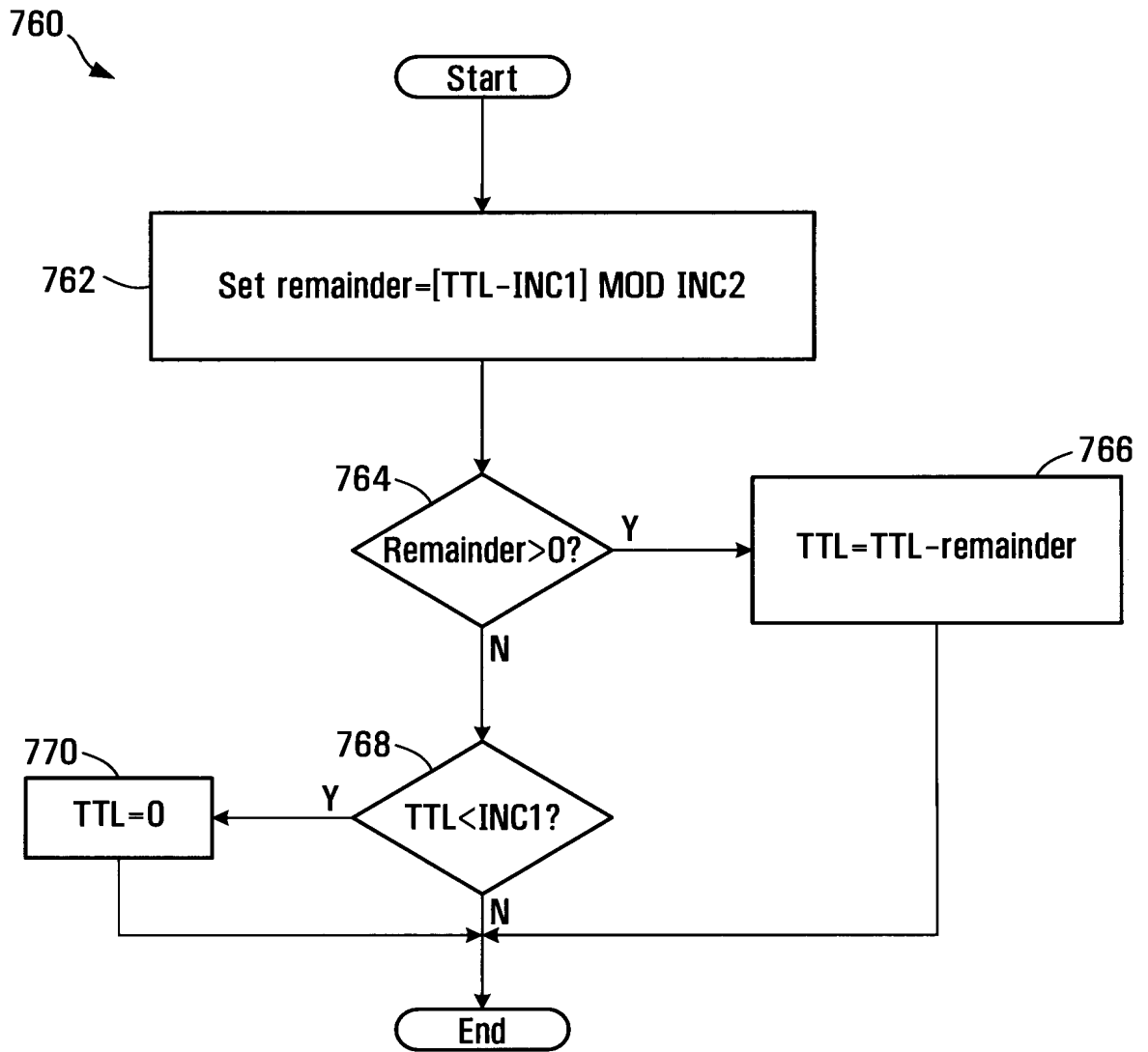

FIG. 40

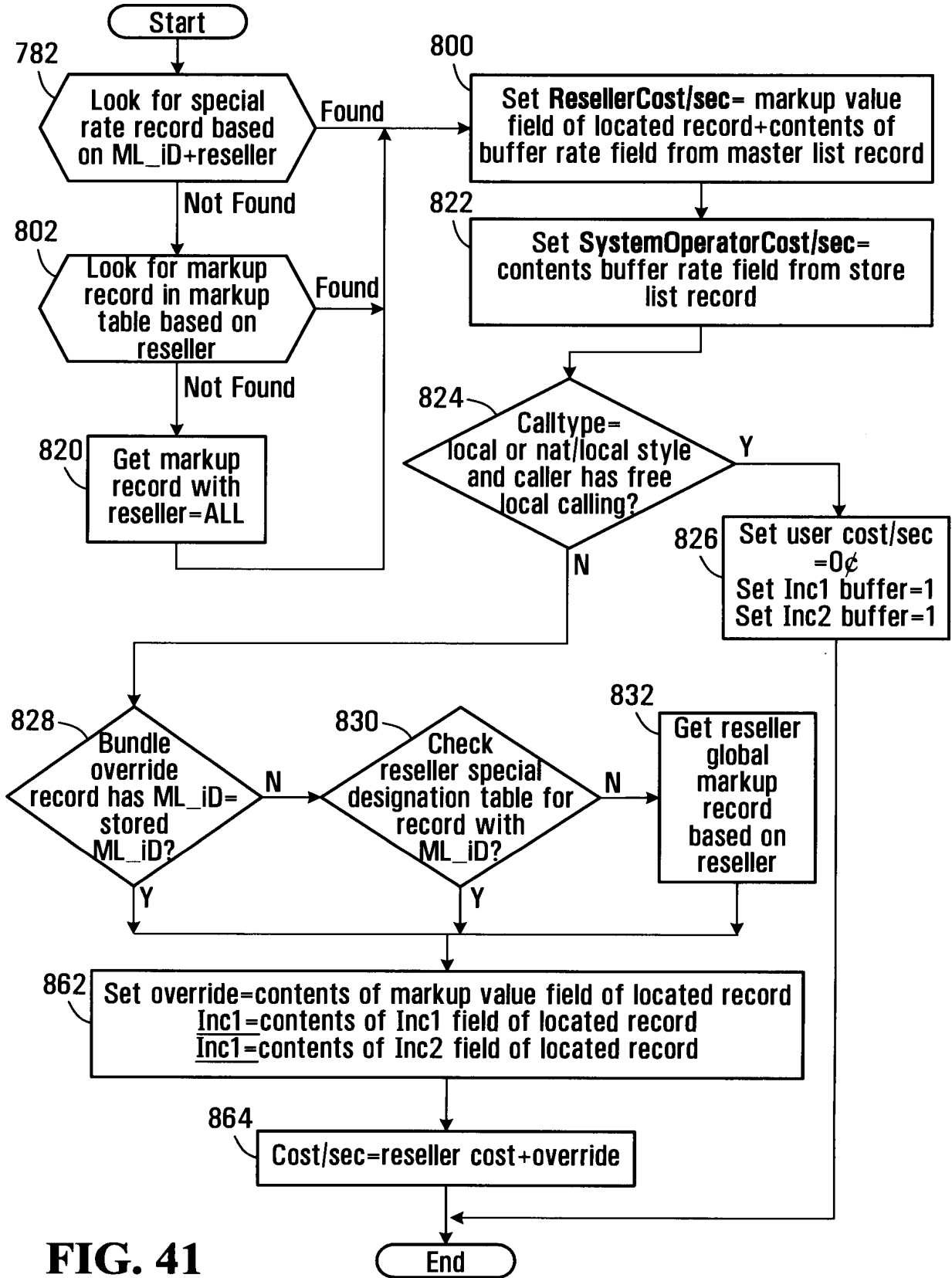

FIG. 41

784
↙

System Operator Special Rates Table Record

786	Reseller	retailer id
788	ML_Id	master list id
790	Markup Table	fixed; percent; cents
792	Markup Value	real number representing value of markup type
794	Inc1	first level of charging (minimum # of seconds) charge
796	Inc2	second level of charging

FIG. 42

798
↙

System Operator Special Rates Table Record for Klondike

786	Reseller	Klondike
788	ML_Id	1019
790	Markup Table	cents
792	Markup Value	\$0.001
794	Inc1	30
796	Inc2	6

FIG. 43

25/32

System Operator Markup Table Record

804
↙

806	Reseller	reseller id code
808	Markup Table	fixed; percent; cents
810	Markup Value	real number representing value of markup type
812	Inc1	first level of charging (minimum # of seconds) charge
814	Inc2	second level of charging

FIG. 44

System Operator Markup Table Record for the Reseller Klondike

806	Reseller	Klondike
808	Markup Table	cents
810	Markup Value	\$0.01
812	Inc1	30
814	Inc2	6

FIG. 45

System Operator Markup Table Record

806	Reseller	all
808	Markup Table	percent
810	Markup Value	1.0
812	Inc1	30
814	Inc2	6

FIG. 46

26/32

Reseller Special Destinations Table Record

832

834	Reseller	reseller id code
836	ML_id	Master List ID code
838	Markup Table	fixed; percent; cents
840	Markup Value	real number representing value of markup type
842	Inc1	first level of charging (minimum # of seconds) charge
844	Inc2	second level of charging

FIG. 47

Reseller Special Destinations Table Record for the Reseller Klondike

846

834	Reseller	Klondike
836	ML_id	1019
838	Markup Table	percent
840	Markup Value	5%
842	Inc1	30
844	Inc2	6

FIG. 48

Reseller Global Markup Table Record

848

850	Reseller	reseller id code
852	Markup Table	fixed; percent; cents
854	Markup Value	real number representing value of markup type
856	Inc1	first level of charging (minimum # of seconds) charge
858	Inc2	second level of charging

FIG. 49

Reseller Global Markup Table Record for the Reseller Klondike

860

850	Reseller	Klondike
852	Markup Table	percent
854	Markup Value	10%
856	Inc1	30
858	Inc2	6

FIG. 50

27/32

900
↙

SIP Bye Message

902 ~	Caller	Username
904 ~	Callee	PSTN compatible # or Username
906 ~	Call ID	unique call identifier (hexadecimal string@IP)

FIG. 51

908
↙

SIP Bye Message

902 ~	Caller	2001 1050 8667
904 ~	Callee	2001 1050 2222
906 ~	Call ID	<u>FA10@192.168.0.20</u>

FIG. 52

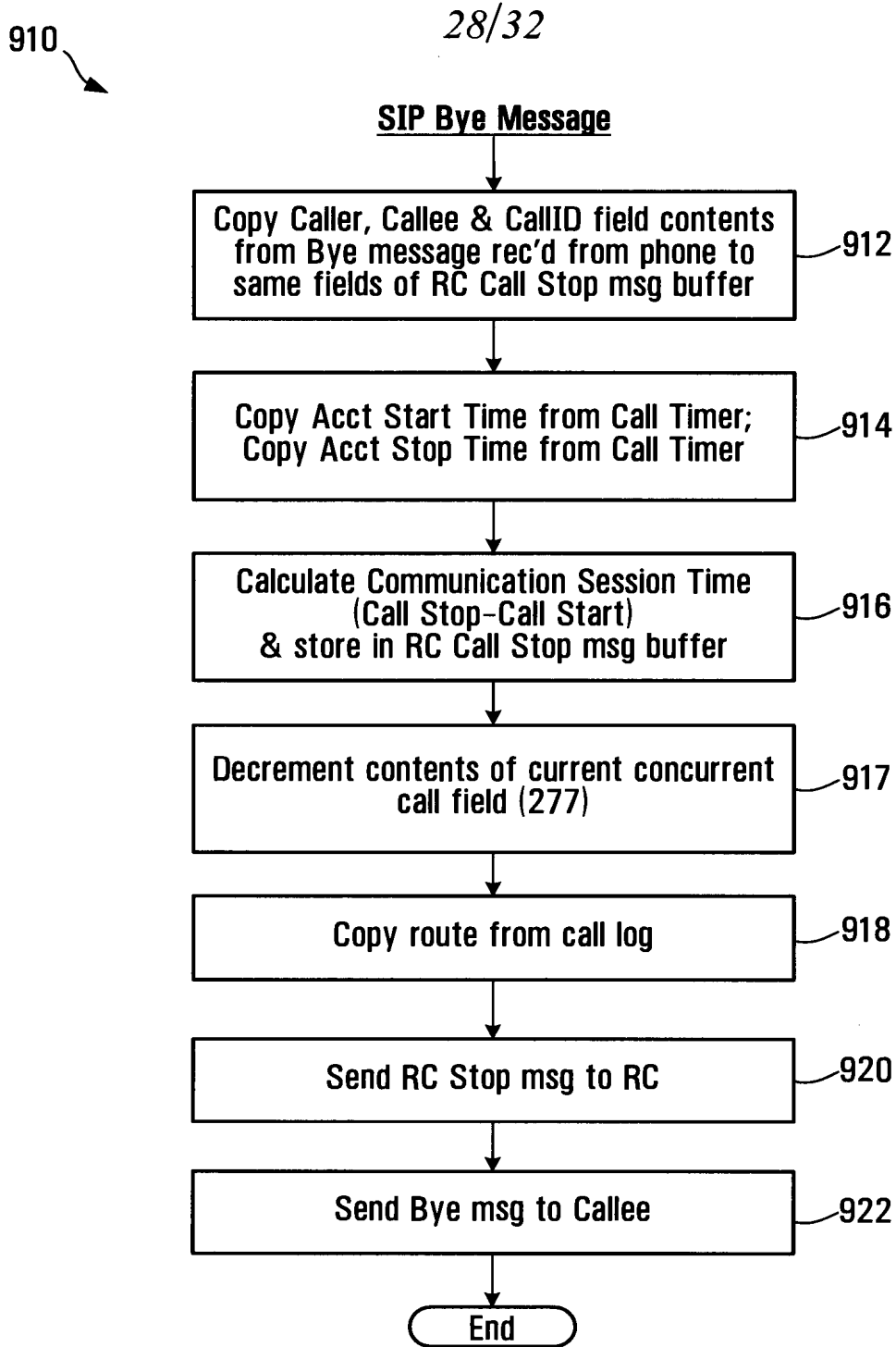

FIG. 53

29/32

RC Call Stop Message

1000
↙

1002	Caller	Username
1004	Callee	PSTN compatible # or Username
1006	Call ID	unique call identifier (hexadecimal string@IP)
1008	Acct Start Time	start time of call
1010	Acct Stop Time	time the call ended
1012	Acct Session Time	start time-stop time (in seconds)
1014	Route	IP address for the communications link that was established

FIG. 54

RC Call Stop Message for Calgary Callee

1020
↙

1002	Caller	2001 1050 8667
1004	Callee	2001 1050 2222
1006	Call ID	FA10@192.168.0.20
1008	Acct Start Time	2006-12-30 12:12:12
1010	Acct Stop Time	2006-12-30 12:12:14
1012	Acct Session Time	2
1014	Route	72.64.39.58

FIG. 55

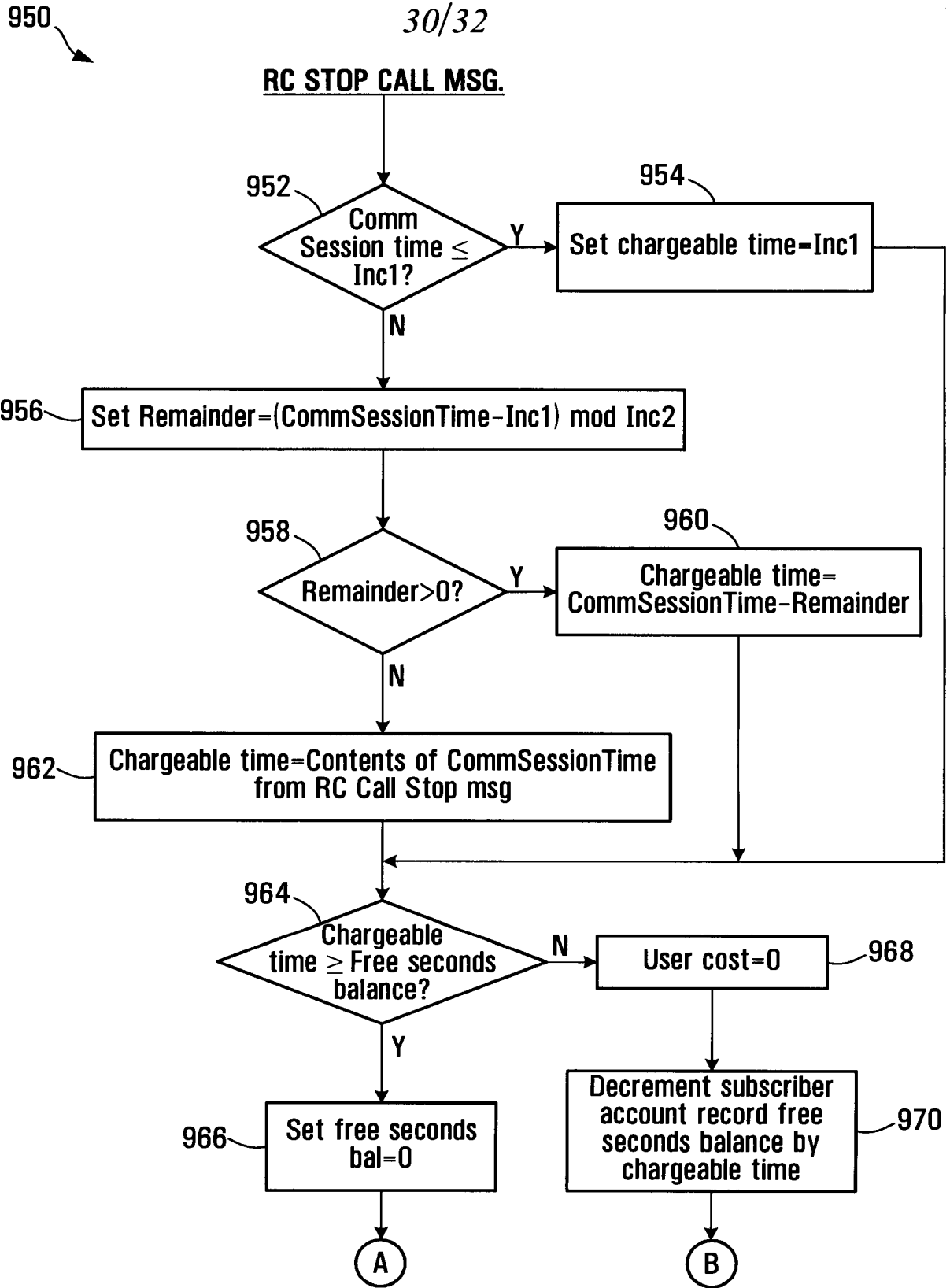

FIG. 56A

31/32

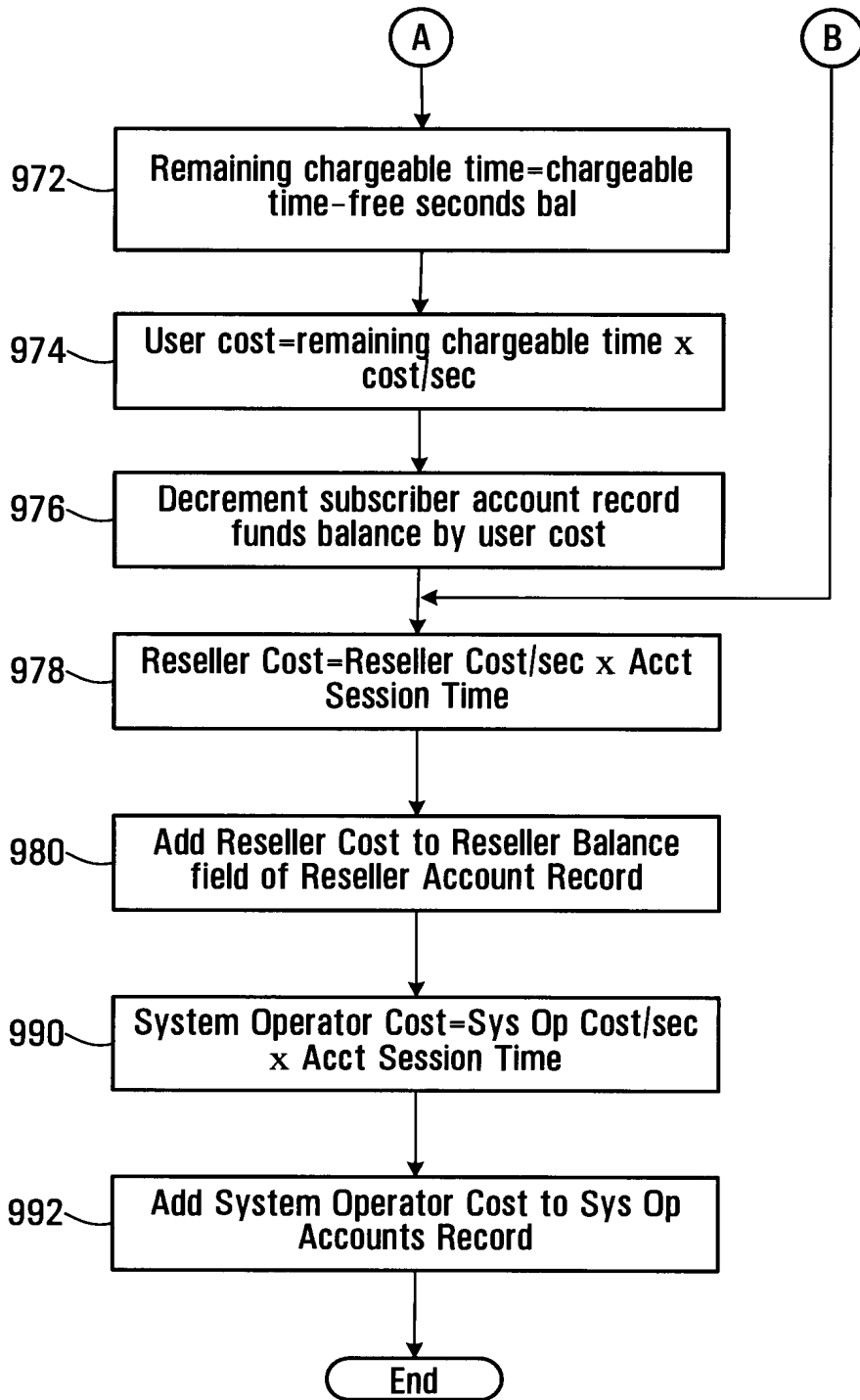

FIG. 56B

32/32

Reseller Accounts Table Record

982
↙

984 ~ Reseller ID reseller id code
986 ~ Reseller balance accumulated balance of charges

FIG. 57

Reseller Accounts Table Record for Klondike

988
↙

984 ~ Reseller ID Klondike
986 ~ Reseller balance \$100.02

FIG. 58

System Operator Accounts Table Record

994
↙

996 ~ System Operator balance accumulated balance of charges

FIG. 59

System Operator Accounts Record for this System Operator

996 ~ System Operator balance \$1000.02

FIG. 60

INTERNATIONAL SEARCH REPORT

International application No.
PCT/CA2007/001956

<p>A. CLASSIFICATION OF SUBJECT MATTER IPC: H04L 12/66 (2006.01) , H04L 12/14 (2006.01) , H04M 11/06 (2006.01) , H04M 15/00 (2006.01) , H04Q 3/64 (2006.01) According to International Patent Classification (IPC) or to both national classification and IPC</p>																				
<p>B. FIELDS SEARCHED</p> <p>Minimum documentation searched (classification system followed by classification symbols) IPC: H04L (2006.01), H04M (2006.01), H04Q (2006.01); US classes: 370, 379 in combination with keywords</p> <p>Documentation searched other than minimum documentation to the extent that such documents are included in the fields searched</p> <p>Electronic database(s) consulted during the international search (name of database(s) and, where practicable, search terms used) Canadian Patent Database, USPTO West, Delphion. Keywords: public network, private network, routing message, instant messaging, ip phone, voip, routing controller, sip, gateway, ttl, metric, skype, data structure, routing message, billing, communication session, prepaid</p>																				
<p>C. DOCUMENTS CONSIDERED TO BE RELEVANT</p> <table border="1"> <thead> <tr> <th>Category*</th> <th>Citation of document, with indication, where appropriate, of the relevant passages</th> <th>Relevant to claim No.</th> </tr> </thead> <tbody> <tr> <td>A</td> <td>CA2249668 C (Bruno et al.) 7 April 1999 (07-04-1999) * Page 9, line 4 to page 14, line 18; Figs 1, 2 *</td> <td>1-59</td> </tr> <tr> <td>A</td> <td>US7120682 B1 (Salama) 10 October 2006 (10-10-2006) * Col. 1, line 47 to col. 4, line 67 *</td> <td>1-59</td> </tr> <tr> <td>A</td> <td>US2006/0160565 A1 (Singh et al.) 20 July 2006 (20-07-2006) * Paragraphs 14, 15, 18; Figs 1, 2 *</td> <td>1-59</td> </tr> <tr> <td>A</td> <td>US2006/0177035 A1 (Cope et al.) 10 August 2006 (10-08-2006) * Paragraphs 5, 6, 12 *</td> <td>1-59</td> </tr> <tr> <td>A, P</td> <td>US7212522 B1 (Shankar et al.) 1 May 2007 (01-05-2007) * Col. 4, line 47 to col. 5, line 11; Fig. 1 *</td> <td>1-59</td> </tr> </tbody> </table>			Category*	Citation of document, with indication, where appropriate, of the relevant passages	Relevant to claim No.	A	CA2249668 C (Bruno et al.) 7 April 1999 (07-04-1999) * Page 9, line 4 to page 14, line 18; Figs 1, 2 *	1-59	A	US7120682 B1 (Salama) 10 October 2006 (10-10-2006) * Col. 1, line 47 to col. 4, line 67 *	1-59	A	US2006/0160565 A1 (Singh et al.) 20 July 2006 (20-07-2006) * Paragraphs 14, 15, 18; Figs 1, 2 *	1-59	A	US2006/0177035 A1 (Cope et al.) 10 August 2006 (10-08-2006) * Paragraphs 5, 6, 12 *	1-59	A, P	US7212522 B1 (Shankar et al.) 1 May 2007 (01-05-2007) * Col. 4, line 47 to col. 5, line 11; Fig. 1 *	1-59
Category*	Citation of document, with indication, where appropriate, of the relevant passages	Relevant to claim No.																		
A	CA2249668 C (Bruno et al.) 7 April 1999 (07-04-1999) * Page 9, line 4 to page 14, line 18; Figs 1, 2 *	1-59																		
A	US7120682 B1 (Salama) 10 October 2006 (10-10-2006) * Col. 1, line 47 to col. 4, line 67 *	1-59																		
A	US2006/0160565 A1 (Singh et al.) 20 July 2006 (20-07-2006) * Paragraphs 14, 15, 18; Figs 1, 2 *	1-59																		
A	US2006/0177035 A1 (Cope et al.) 10 August 2006 (10-08-2006) * Paragraphs 5, 6, 12 *	1-59																		
A, P	US7212522 B1 (Shankar et al.) 1 May 2007 (01-05-2007) * Col. 4, line 47 to col. 5, line 11; Fig. 1 *	1-59																		
<p><input checked="" type="checkbox"/> Further documents are listed in the continuation of Box C.</p>		<p><input checked="" type="checkbox"/> See patent family annex.</p>																		
<p>* Special categories of cited documents :</p> <p>"A" document defining the general state of the art which is not considered to be of particular relevance</p> <p>"E" earlier application or patent but published on or after the international filing date</p> <p>"L" document which may throw doubts on priority claim(s) or which is cited to establish the publication date of another citation or other special reason (as specified)</p> <p>"O" document referring to an oral disclosure, use, exhibition or other means</p> <p>"P" document published prior to the international filing date but later than the priority date claimed</p>		<p>"T" later document published after the international filing date or priority date and not in conflict with the application but cited to understand the principle or theory underlying the invention</p> <p>"X" document of particular relevance; the claimed invention cannot be considered novel or cannot be considered to involve an inventive step when the document is taken alone</p> <p>"Y" document of particular relevance; the claimed invention cannot be considered to involve an inventive step when the document is combined with one or more other such documents, such combination being obvious to a person skilled in the art</p> <p>"&" document member of the same patent family</p>																		
<p>Date of the actual completion of the international search 6 February 2008 (06-02-2008)</p>		<p>Date of mailing of the international search report 20 February 2008 (20-02-2008)</p>																		
<p>Name and mailing address of the ISA/CA Canadian Intellectual Property Office Place du Portage I, C114 - 1st Floor, Box PCT 50 Victoria Street Gatineau, Quebec K1A 0C9 Facsimile No.: 001-819-953-2476</p>		<p>Authorized officer Arthur Smith 819-953-1360</p>																		

INTERNATIONAL SEARCH REPORT

International application No.
PCT/CA2007/001956

Box No. II Observations where certain claims were found unsearchable (Continuation of item 2 of the first sheet)

This international search report has not been established in respect of certain claims under Article 17(2)(a) for the following reasons :

1. Claim Nos. :
because they relate to subject matter not required to be searched by this Authority, namely :

2. Claim Nos. :
because they relate to parts of the international application that do not comply with the prescribed requirements to such an extent that no meaningful international search can be carried out, specifically :

3. Claim Nos. :
because they are dependant claims and are not drafted in accordance with the second and third sentences of Rule 6.4(a).

Box No. III Observations where unity of invention is lacking (Continuation of item 3 of first sheet)

This International Searching Authority found multiple inventions in this international application, as follows :

Group I Claims 1-59
Group II Claims 60, 61
Group III Claims 62-84
Group IV Claims 85-107

1. As all required additional search fees were timely paid by the applicant, this international search report covers all searchable claims.
2. As all searchable claims could be searched without effort justifying additional fees, this Authority did not invite payment of additional fees.
3. As only some of the required additional search fees were timely paid by the applicant, this international search report covers only those claims for which fees were paid, specifically claim Nos. :
4. No required additional search fees were timely paid by the applicant. Consequently, this international search report is restricted to the invention first mentioned in the claims, it is covered by claim Nos. :

- Remark on Protest** The additional search fees were accompanied by the applicant's protest and, where applicable, the payment of a protest fee.
- The additional search fees were accompanied by the applicant's protest but the applicable protest fee was not paid within the time limit specified in the invitation.
- No protest accompanied the payment of additional search fees.

INTERNATIONAL SEARCH REPORT

International application No.
PCT/CA2007/001956

C (Continuation). DOCUMENTS CONSIDERED TO BE RELEVANT		
Category*	Citation of document, with indication, where appropriate, of the relevant passages	Relevant to claim No.
A	US7068772 (Widger et al.) 27 June 2006 (27-06-2006) * Col. 12, line 49 to col. 14, line 44; col. 15, line 26 to col. 16, line 30 Figs. 3, 5 *	60, 61
A	US2006/0209768 A1 (Yan et al.) 21 September 2006 (21-09-2006) * Paras. 71-99, 111-118, 128-141, 179-188; Figs. 3, 4, 7-9 *	60, 61
X	US6058300 (Hanson) 2 May 2000 (02-05-2000) * Col. 2, lines 9-13; col. 5, line 55 to col. 6, line 23; col. 6, line 55 to	62, 63, 73-75
A	col. 7, line 18 *	64-72, 76-84
X	US2005/0177843 A1 (Williams) 11 August 2005 (11-08-2005) * Paragraphs 64 - 69 *	62, 63, 73-75
A		64-72, 76-84
A	US6188752 B1 (Lesley) 13 February 2001 (13-02-2001) * Col. 4, line 24 to col. 9, line 6; Figs 1, 3 *	85-107
A	US6507644 B1 (Henderson et al.) 14 January 2003 (14-01-2003) * Col. 1, line 51 to col. 6, line 28 *	85-107
A	US5359642 (Castro) 25 October 1994 (25-10-1994) * Abstract; Col. 5, lines 7-12, col. 6, line 5 to col. 8, line 38; col. 10, line 10 to col. 12, line 68 *	85-107

INTERNATIONAL SEARCH REPORT
Information on patent family members

International application No.
PCT/CA2007/001956

Patent Document Cited in Search Report	Publication Date	Patent Family Member(s)	Publication Date
CA2249668	07-04-1999	EP0915594 A2 US6614765 B1	12-05-1999 02-09-2003
US7120682	10-10-2006	NONE	
US2006160565	20-07-2006	NONE	
US2006177035	10-08-2006	CA2595429 A1 WO2006081115 A1	03-08-2006 03-08-2006
US7212522	01-05-2007	US6570869 B1 US6658022 B1 US6768733 B1	27-05-2003 02-12-2003 27-07-2004
US7068772	27-06-2006	NONE	
US2006209768	21-09-2006	CA2512959 A1 CN1762129 A EP1585270 A1 JP2004266310 A KR20050092405 A WO2004077754 A1	10-09-2004 19-04-2006 12-10-2005 24-09-2004 21-09-2005 10-09-2004
US6058300	02-05-2000	AU6142498 A CA2250845 A1 US6029062 A US6208851 B1 US6625438 B2 US7162220 B2 WO9834393 A2	25-08-1998 06-08-1998 22-02-2000 27-03-2001 23-09-2003 09-01-2007 06-08-1998
US2005177843	11-08-2005	AU2002351582 A1 CA2469959 A1 CA2471113 A1 US2003120553 A1 US2006190353 A1 WO03056803 A2	15-07-2003 10-07-2003 10-07-2003 26-06-2003 24-08-2006 10-07-2003
US6188752	13-02-2001	AU730021B B2 AU5073398 A BR9713025 A CA2271311 A1 CN1244987 A DE69732526D D1 DE69732526T T2 EP0944994 A1 ES2237791T T3 JP2001504299T T KR20000053241 A NO992280 A US6333976 B2 WO9821874 A1	22-02-2001 03-06-1998 25-01-2000 22-05-1998 16-02-2000 24-03-2005 28-07-2005 29-09-1999 01-08-2005 27-03-2001 25-08-2000 12-07-1999 25-12-2001 22-05-1998
US6507644	14-01-2003	NONE	
US5359642	25-10-1994	NONE	

(19) World Intellectual Property Organization
International Bureau



(43) International Publication Date
5 June 2008 (05.06.2008)

PCT

(10) International Publication Number
WO 2008/064481 A1

(51) International Patent Classification:

H04L 12/26 (2006.01) H04M 11/06 (2006.01)
H04L 12/66 (2006.01) H04M 3/22 (2006.01)

(74) Agent: SMART & BIGGAR; Box 11560 Vancouver Center, 2200 - 650 West Georgia Street, Vancouver, British Columbia V6B 4N8 (CA).

(21) International Application Number:

PCT/CA2007/002150

(81) Designated States (unless otherwise indicated, for every kind of national protection available):

AE, AG, AL, AM, AT, AU, AZ, BA, BB, BG, BH, BR, BW, BY, BZ, CA, CH, CN, CO, CR, CU, CZ, DE, DK, DM, DO, DZ, EC, EE, EG, ES, FI, GB, GD, GE, GH, GM, GT, HN, HR, HU, ID, IL, IN, IS, JP, KE, KG, KM, KN, KP, KR, KZ, LA, LC, LK, LR, LS, LT, LU, LY, MA, MD, ME, MG, MK, MN, MW, MX, MY, MZ, NA, NG, NI, NO, NZ, OM, PG, PH, PL, PT, RO, RS, RU, SC, SD, SE, SG, SK, SL, SM, SV, SY, TJ, TM, TN, TR, TT, TZ, UA, UG, US, UZ, VC, VN, ZA, ZM, ZW.

(22) International Filing Date:

29 November 2007 (29.11.2007)

(25) Filing Language:

English

(26) Publication Language:

English

(30) Priority Data:

60/861,431 29 November 2006 (29.11.2006) US

(71) Applicant (for all designated States except US): DIGIFONICA (INTERNATIONAL) LIMITED [CA/CA]; Suite 1401, 4710 Kingsway Avenue, Burnaby, British Columbia V5H 4M2 (CA).

(84) Designated States (unless otherwise indicated, for every kind of regional protection available):

ARIPO (BW, GH, GM, KE, LS, MW, MZ, NA, SD, SL, SZ, TZ, UG, ZM, ZW), Eurasian (AM, AZ, BY, KG, KZ, MD, RU, TJ, TM), European (AT, BE, BG, CH, CY, CZ, DE, DK, EE, ES, FI, FR, GB, GR, HU, IE, IS, IT, LT, LU, LV, MC, MT, NL, PL, PT, RO, SE, SI, SK, TR), OAPI (BF, BJ, CF, CG, CI, CM, GA, GN, GQ, GW, ML, MR, NE, SN, TD, TG).

(72) Inventors; and

(75) Inventors/Applicants (for US only): BJORSELL, Johan Emil Victor [SE/CA]; 273 West 5th Street, North Vancouver, British Columbia V7M 1J9 (CA). SOBOLYEV, maksym [UA/CA]; 307-265 Tenth Street, New Westminster, BC, V3M 3Y1 (CA).

Published:

- with international search report
- with amended claims

(54) Title: INTERCEPTING VOICE OVER IP COMMUNICATIONS AND OTHER DATA COMMUNICATIONS

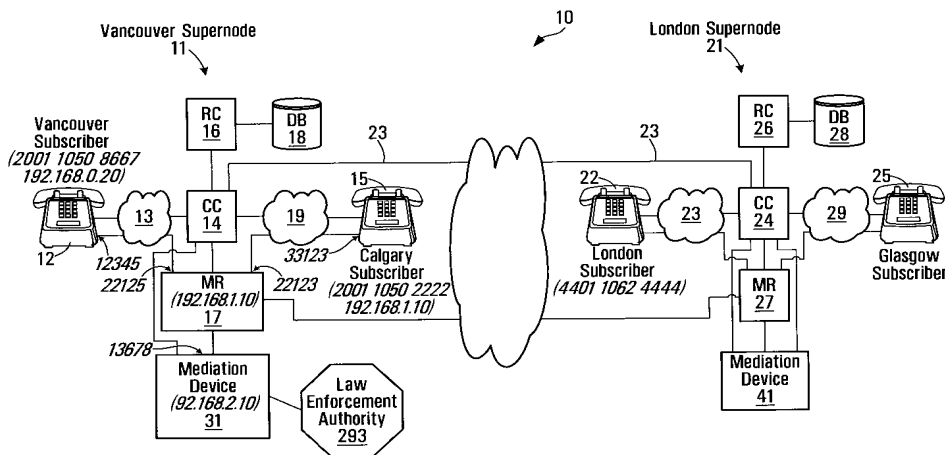

(57) Abstract: Methods and apparatus for intercepting communications in an Internet Protocol (IP) network involve maintaining dialing profiles for respective subscribers to the IP network, each dialing profile including a username associated with the corresponding subscriber, and associating intercept information with the dialing profile of a subscriber whose communications are to be monitored. Intercept information will include determination information for determining whether to intercept a communication involving the subscriber, and destination information identifying a device to which intercepted communications involving the subscriber are to be sent. When the determination information meets intercept criteria communications are established with a media relay through which communications involving the subscriber will be conducted or are being conducted to cause the media relay to send a copy of the communications involving the subscriber to a mediation device specified by the destination information.

WO 2008/064481 A1

INTERCEPTING VOICE OVER IP COMMUNICATIONS AND OTHER DATA COMMUNICATIONS

CROSS REFERENCE TO RELATED APPLICATIONS

5 This application claims the benefit of U.S. Provisional Application No. 60/861,431 filed November 29, 2006.

BACKGROUND OF THE INVENTION

1. Field of Invention

10 This invention relates to data communications and methods and apparatus for intercepting data communications, particularly voice over IP data communications, in an IP network.

2. Description of Related Art

15 The term "lawful intercept" is used to describe a procedure which allows law enforcement agencies to perform electronic surveillance of telecommunications. Lawful intercept of telecommunications, particularly phone calls, is premised on a notion that a law enforcement agency has identified a person of interest, obtained a legal authorization for the surveillance (for example, a judicial or administrative warrant), and then
20 contacted the person's telecommunications service provider that will be required to provide the law enforcement agency with a real-time copy of the person's communications. This real-time copy can then be used by the law enforcement agency to monitor or record the person's communications.
25 Within the framework of traditional telecommunications networks, such as, for example, the Public Switched Telephone Network (PSTN) or cellular networks, lawful intercept generally presents a purely economic problem for the service providers that have to ensure that sufficient interception equipment and dedicated links to the law enforcement agencies have been
30 deployed to satisfy lawful intercept requirements mandated by law. However, in the context of Voice over Internet Protocol (VoIP) communications, in addition to the economic problems mentioned above, lawful intercept presents

-2-

significant technological challenges which often makes compliance with legally mandated lawful intercept requirements exceedingly difficult.

5 The problem lies in the very nature of the VoIP technology and the Internet Protocol (IP) networks (for example, the Internet) that underlie it.

10 Traditional telecommunications networks are "connection-oriented" or "circuit-switched". Communications over such networks occur via dedicated "circuits". Although the networks typically comprise a plurality of available parallel paths, when a circuit is established, only a single one of the available paths is picked. In situations where a circuit has failure protection, a redundant path, also determined at the time of the circuit establishment, can also be reserved. Once the circuit is established, all communications traverse from end to end. Interception of such communications is easy as the service provider can "tap" the circuit at any point in the network that is under its lawful control.

20 In contrast to circuit-switched networks, IP-based networks are "connectionless" by design. A connectionless IP network essentially comprises a plurality of interconnected network devices (routers) which establish a plurality of paths from any point on the network to any other point. Information that needs to traverse an IP network is divided into small "packets", each one comprising an IP header containing source and destination addressing information, and service flags; and user payload. The specific path that each packet in a communication between parties takes across an IP network is not determined in advance such as in a circuit-switched network. The path is defined on a hop-by-hop basis (router-by-router), each router at which the packet arrives examines the source and destination addresses contained in the IP header and applies a number of service variables such as hop-count (number of routers between the current router and the destination), latency and bandwidth of available links, and administrative considerations such as inter-provider agreements, to determine

30

-3-

the next hop to which the packet will be forwarded. Because the service variables change dynamically, for example in response to a failure of a link in the network, the available paths may change significantly and it is impossible to reliably predict the path or paths that the packets that comprise a specific communication will traverse. Furthermore, it is not even possible to predict the order in which the packets will arrive at their destination as the different paths taken may have different latency. While the plurality of available paths and out-of-order arrivals present no problems to IP-based applications that usually keep track of the packet sequence to reassemble the communication, the same factors present formidable problems for the lawful intercept of communication over IP networks, particularly lawful intercept of VoIP calls.

The problem of lawful intercept in VoIP systems is further exacerbated by the distributed technologies often utilized in such systems. While a VoIP caller typically communicates with a VoIP call controller to facilitate the connection to the VoIP callee, the actual communication between the parties typically occurs by establishing a direct IP connection between them using the User Datagram Protocol (UDP) to encapsulate audio information into IP packets. These packets may take any available path across the IP network as described above. Even if a service provider could place an interception device at every point in the network through which a subscriber's packet could traverse, in order to provide a useful copy of the communication to a law enforcement agency, the service provider would have to reassemble all of the intercepted packets at a single device and only then pass the result to the law enforcement agency. In essence, the service provider would have to mirror the functions of the callee VoIP telephone, except the packets that comprise the communication would have to be collected from multiple points in the network. The technological challenges and economic costs associated with this proposition have thus far resulted in lack of meaningful lawful intercept capabilities in VoIP systems.

-4-

SUMMARY OF THE INVENTION

In accordance with one aspect of the invention, there is provided a method for intercepting communications in an Internet Protocol (IP) network. The method involves maintaining dialing profiles for respective subscribers to the IP network, each dialing profile including a username associated with the corresponding subscriber. The method also involves associating intercept information with the dialing profile of a subscriber whose communications are to be monitored, the intercept information including determination information for determining whether to intercept a communication involving the subscriber, and destination information identifying a device to which intercepted communications involving the subscriber are to be sent. The method further involves, when the determination information meets intercept criteria, communicating with a media relay through which the communications involving the subscriber will be conducted or are being conducted to cause the media relay to send a copy of the communications to a mediation device specified by the destination information.

Associating intercept information may involve associating the intercept information with the dialing profile when communications involving the subscriber are not in progress.

Associating intercept information may involve associating the intercept information when communications involving the subscriber are in progress.

Associating the intercept information may involve populating intercept information fields in the dialing profile of the subscriber whose communications are to be monitored.

The method may involve producing a routing message for routing communications involving the subscriber through components of the IP network and determining whether the determination information meets the

-5-

intercept criteria prior to producing the routing message and including at least some of the intercept information in the routing message when the determination information meets the intercept criteria.

5 Determining whether the determination information meets the intercept criteria may involve determining whether a current date and time is within a range specified by the determination information.

10 The method may involve identifying a media relay through which communications involving the subscriber will be conducted in response to the routing message.

15 The method may involve pre-associating at least one media relay with the dialing profile of the subscriber whose communications are to be monitored and identifying the media relay may involve identifying the media relay pre-associated with the subscriber whose communications are to be monitored.

20 Pre-associating may involve populating media relay fields in the dialing profile with an identification of at least one media relay.

The intercept information may be associated with the dialing profile of the subscriber whose communications are to be monitored, in response to receipt of an intercept request message, and the intercept request message may include the intercept information.

25 The method may involve invoking an intercept request message handler to find a dialing profile associated with the subscriber whose communications are to be monitored, and to perform the step of associating the intercept information with the dialing profile, and to determine whether the intercept
30 criteria are met, and identify a media relay through which the communications are being conducted.

-6-

5 The method may involve maintaining active call records for communications in progress, and the active call records may include a username identifier and a media relay identifier identifying the media relay through which the communications are being conducted and identifying a media relay through which the communications are being conducted may involve locating an active call record associated with communications of the subscriber whose communication are to be monitored to find the media relay associated with the communications.

10 The method may involve maintaining direct-inward-dialing (DID) records associating PST telephone numbers with usernames of users subscribing to the IP network, and finding a dialing profile associated with the subscriber whose communications are to be monitored may involve finding a username in a DID record bearing a PSTN number associated with the subscriber
15 whose communications are to be monitored. The username may be used to locate a dialing profile associated with the username.

In accordance with another aspect of the invention, there is provided an apparatus for intercepting communications in an Internet Protocol (IP)
20 network. The apparatus includes provisions for maintaining dialing profiles for respective subscribers to the IP network, each dialing profile including a username associated with the corresponding subscriber. The apparatus also includes provisions for associating intercept information with the dialing profile of a subscriber whose communications are to be monitored, the intercept
25 information including determination information for determining whether to intercept a communication involving the subscriber, and destination information identifying a device to which intercepted communications involving the subscriber are to be sent. The apparatus further includes provisions for communicating with a media relay through which the communications
30 involving the subscriber will be conducted or are being conducted to cause the media relay to send a copy of the communications to a mediation device

-7-

specified by the destination information, when the determination information meets intercept criteria.

5 The provisions for associating intercept information may be operably configured to associate the intercept information with the dialing profile when communications involving the subscriber are not in progress.

10 The provisions for associating intercept information may be operably configured to associate the intercept information when communications involving the subscriber are in progress.

15 The provisions for associating the intercept information may be operably configured to populate intercept information fields in the dialing profile of the subscriber whose communications are to be monitored.

20 The apparatus may further include provisions for producing a routing message for routing communications involving the subscriber through components of the IP network and provisions for determining whether the determination information meets the intercept criteria prior to producing the routing message and the provisions for producing the routing message may be operably configured to include at least some of the intercept information in the routing message when the determination information meets the intercept criteria.

25 The provisions for determining whether the determination information meets the intercept criteria may be operably configured to determine whether a current date and time is within a range specified by the determination information.

30 The apparatus may further include provisions for identifying a media relay through which communications involving the subscriber will be conducted in response to the routing message.

-8-

5 The apparatus may further include provisions for pre-associating at least one media relay with the dialing profile of the subscriber whose communications are to be monitored and the routing provisions may be operably configured to identify from the dialing profile the media relay pre-associated with the subscriber whose communications are to be monitored.

10 The provisions for pre-associating may be operably configured to populate media relay fields in the dialing profile with an identification of at least one media relay.

15 Provisions for associating the intercept information may be operably configured to associate the intercept information associated with the dialing profile of the subscriber whose communications are to be monitored, in response to receipt of an intercept request message, wherein the intercept request message comprises the intercept information.

20 The apparatus may further include provisions for handling an intercept request message. The provisions for handling an intercept request message may include provisions for finding a dialing profile associated with the subscriber whose communications are to be monitored. The provisions for finding a dialing profile may cooperate with the provisions for associating the intercept information with the dialing profile to cause the intercept information to be associated with the dialing profile. The provisions for handling an intercept request message may include provisions for determining whether the intercept criteria are met and provisions for identifying a media relay through which the communications are being conducted.

30 The apparatus may further include provisions for maintaining active call records for communications in progress, the active call records including a username identifier and a media relay identifier identifying the media relay through which the communications are being conducted and the provisions for

-9-

identifying a media relay through which the communications are being conducted may be operably configured to locate an active call record associated with communications of the subscriber whose communication are to be monitored to find the media relay associated with the communications.

5

The apparatus may further include provisions for maintaining direct-inward-dialing (DID) records associating PST telephone numbers with usernames of users subscribing to the IP network, and the provisions for finding a dialing profile associated with the subscriber whose communications are to be monitored may be operably configured to find a username in a DID record bearing a PSTN number associated with the subscriber whose communications are to be monitored and use the username to locate a dialing profile associated with the username.

10

15

By employing a media replay, all VoIP communications traverse a point in the VoIP system that is under a provider's control and at which the communications can be copied in real-time to a mediation device that passes the intercepted communication to a law enforcement agency.

20

By maintaining dialing profiles for respective subscribers and associating intercept information of the type described, with the dialing profiles of subscribers whose communications are to be monitored, the dialing profile can serve as the source of determination information for determining whether or not communications involving the subscriber will be monitored and for providing destination information for specifying where the copy of the communications is to be sent. Use of the dialing profile in this manner easily facilitates the dialing profile to be considered a respository for intercept information for a given subscriber and this respository can be addressed whether a call is being initiated or in progress, thereby simplifying control algorithms because they can cooperate with a common source and format of data in the dialing profile.

25

30

-10-

Other aspects and features of the present invention will become apparent to those ordinarily skilled in the art upon review of the following description of specific embodiments of the invention in conjunction with the accompanying figures.

5

BRIEF DESCRIPTION OF THE DRAWINGS

In drawings which illustrate embodiments of the invention,

- 10 Figure 1 is a block diagram of a system according to a first embodiment of the invention;
- Figure 2 is a block diagram of a caller VoIP telephone according to the first embodiment of the invention;
- 15 Figure 3 is a schematic representation of a SIP Invite message transmitted between the caller telephone and a call controller (CC) shown in Figure 1;
- Figure 4 is a block diagram of the call controller shown in Figure 1;
- 20 Figure 5 is a flowchart of a process executed by the call controller shown in Figure 1;
- Figure 6 is a schematic representation of a routing controller (RC) request message produced by the call controller shown in Figure 1;
- 25 Figure 7 is a block diagram of a routing controller (RC) processor circuit of the system shown in Figure 1;
- 30 Figures 8A-8D are flowcharts of a RC Request message handler executed by the RC processor circuit shown in Figure 7;

-11-

Figure 9 is a tabular representation of a dialing profile stored in a database accessible by the RC shown in Figure 1;

5 Figure 10 is a tabular representation of a dialing profile for a Vancouver subscriber ;

Figure 11 is a tabular representation of a dialing profile for a Calgary subscriber;

10 Figure 12 is a tabular representation of a dialing profile for a London subscriber;

Figure 13 is a tabular representation of a direct-inward-dialing (DID) bank table record stored in the database shown in Figure 1;

15

Figure 14 is a tabular representation of an exemplary DID bank table record for the London subscriber referenced in Figure 12;

20 Figure 15 is a tabular representation of a routing message transmitted from the routing controller to the call controller shown in Figure 1;

Figure 16 is a tabular representation of a routing message buffer holding a routing message for routing a call to the London callee referenced in Figure 12;

25

Figure 16A is a tabular representation of a routing message buffer holding a message for routing a call to the London callee and to a law enforcement agency for the purpose of lawful intercept;

30 Figure 17 is a tabular representation of a prefix to supernode table record stored in the database shown in Figure 1;

-12-

Figure 18 is a tabular representation of a prefix to supernode table record that would be used for the Calgary callee referenced in Figure 11;

5 Figure 19 is a tabular representation of a master list record stored in a master list table in the database shown in Figure 1;

Figure 20 is a tabular representation of an exemplary populated master list record;

10 Figure 21 is a tabular representation of a suppliers list record stored in the database shown in Figure 1;

Figure 22 is a tabular representation of a specific supplier list record for a first supplier;

15 Figure 23 is a tabular representation of a specific supplier list record for a second supplier;

20 Figure 24 is a tabular representation of a specific supplier list record for a third supplier;

Figure 25 is a tabular representation of a routing message, held in a routing message buffer, identifying to the routing controller a plurality of possible suppliers that may carry the call;

25 Figure 25A is a tabular representation of a routing message held in a routing message buffer, with lawful intercept fields appended;

Figure 26 is a tabular representation of a call block table record;

30 Figure 27 is a tabular representation of a call block table record for the Calgary callee;

Figure 28 is a tabular representation of a call forwarding table record;

5 Figure 29 is a tabular representation of an exemplary call forwarding table record specific for the Calgary callee;

10 Figure 30 is a tabular representation of a voicemail table record specifying voicemail parameters to enable the caller to leave a voicemail message for the callee;

Figure 31 is a tabular representation of an exemplary voicemail table record for the Calgary callee;

15 Figure 32 is a tabular representation of an exemplary routing message, held in a routing message buffer, indicating call forwarding numbers and a voicemail server identifier;

20 Figure 32A is a tabular representation of an exemplary routing message, held in a routing message buffer, indicating call forwarding numbers and a voicemail server identifier with caller lawful intercept fields appended;

25 Figure 32B is a tabular representation of an exemplary routing message, held in a routing message buffer, indicating call forwarding numbers and a voicemail server identifier with caller and callee lawful intercept fields appended;

30 Figure 33 is a flowchart of a routing message handler process executed by the call controller.

-14-

- Figure 34 is a schematic representation of messages exchanged during execution of process for establishing audio paths between telephones and a media relay;
- 5 Figure 35 is a tabular representation of an active call record maintained by the call controller of Figure 1;
- Figure 36 is a tabular representation of an active call record maintained by the routing controller of Figure 1;
- 10 Figure 37 is a tabular representation of a SIP Invite message transmitted from the call controller to the mediation device;
- Figure 38 is a tabular representation of a SIP OK message transmitted from the mediation device to the call controller.
- 15 Figure 39 is a tabular representation of a SIP Bye message transmitted from either of the telephones shown in Figure 1 to the call controller;
- 20 Figure 40 is a tabular representation of a SIP Bye message sent to the call controller from the Calgary callee;
- Figure 41 is a flowchart of a process executed by the call controller for producing a RC stop message in response to receipt of a SIP Bye message;
- 25 Figure 42 is a tabular representation of an exemplary RC Call Stop message;
- 30 Figure 43 is a tabular representation of an exemplary RC Call Stop message for the Calgary callee;

-15-

Figure 44 is a flowchart of a routing controller Law Enforcement Authority request message handler executed by the routing controller shown in Figure 1;

5 Figure 45 is a flowchart of a call controller in-call intercept message handler executed by the call controller shown in Figure 1;

Figure 46 is a flowchart of a routing controller in-call intercept shut down routine executed by the routing controller shown in Figure 1;

10

Figure 47 is a flowchart of a call controller cease intercept message handler routing executed by the call controller shown in Figure 1.

DETAILED DESCRIPTION

15

Referring to Figure 1, a system for making voice over IP telephone calls is shown generally at 10. The system includes a first supernode shown generally at 11 and a second supernode shown generally at 21. The first supernode 11 is located in a geographical area, such as Vancouver B.C., for example and the second supernode 21 is located in London England, for example. Different supernodes may be located in different geographical regions throughout the world to provide telephone service to subscribers in respective regions. These supernodes may be in communication with each other through high speed / high data throughput links including optical fiber, satellite and/or cable links, for example, forming a system backbone. These supernodes may alternatively or in addition be in communication with each other through conventional Internet services. In the embodiment shown, data communication media for providing for data communications between the first and second supernodes 11 and 21 are shown generally at 23 and may include very high speed data links, for example.

20

25

30

In the embodiment shown, the Vancouver supernode 11 provides telephone service to a geographical region comprising Western Canadian customers

-16-

from Vancouver Island to Ontario and includes a Vancouver subscriber and a Calgary subscriber. Another supernode (not shown) may be located in Eastern Canada to provide services to subscribers in that area.

5 Other, smaller supernodes similar to the type shown may also be employed within the geographical area serviced by a supernode, to provide for call load sharing, for example within a region of the geographical area serviced by the supernode. However, in general, all supernodes are similar and have the properties described below in connection with the Vancouver supernode **11**.

10

In this embodiment, the Vancouver supernode includes a call controller (CC) **14**, a routing controller (RC) **16**, a database **18**, a media relay **17** and one or more mediation devices (MD), only one of which is shown at **31**. Subscribers such as the Vancouver subscriber and the Calgary subscriber communicate with the Vancouver supernode **11** using their own Internet Service Providers (ISPs) **13** and **19** which route Internet traffic from these subscribers over the Internet. To these subscribers the Vancouver supernode **11** is accessible at a pre-determined IP address or a fully qualified domain name (FQDN) so that it can be accessed in the usual way through a subscriber's ISP. The subscriber in the city of Vancouver uses a telephone **12** that is capable of communicating with the Vancouver supernode **11** using Session Initiation Protocol (SIP) messages and the Calgary subscriber uses a similar telephone **15**, to communicate with the Vancouver supernode from Calgary, AB.

15

25 It should be noted that throughout the description of the embodiments of this invention, the IP/UDP addresses of all elements such as the caller and callee telephones, call controller, media relay, and any others, will be assumed to be valid IP/UDP addresses directly accessible via the Internet or a private IP network, for example, depending on the specific implementation of the system. As such, it will be assumed, for example, that the caller and callee telephones will have IP/UDP addresses directly accessible by the call controllers and the media relays on their respective supernodes, and that will

30

-17-

not be obscured by Network Address Translation (NAT) or similar mechanisms. In other words, the IP/UDP information contained in SIP messages (for example the SIP Invite message or the RC Request message which will be described below) will match the IP/UDP addresses of the IP packets carrying these SIP messages.

It will be appreciated that in many situations, the IP addresses assigned to various elements of the system may be in a private IP address space, and thus not directly accessible from other elements. Furthermore, it will also be appreciated that NAT is commonly used to share a “public” IP address between multiple devices, for example between home PCs and IP telephones sharing a single Internet connection. For example, a home PC may be assigned an IP address such as **192.168.0.101** and a Voice over IP telephone may be assigned an IP address of **192.168.0.103**. These addresses are located in so called “non-routable” address space and cannot be accessed directly from the Internet. In order for these devices to communicate with other computers located on the Internet, these IP addresses have to be converted into a “public” IP address, for example **24.10.10.123** assigned to the subscriber by the Internet Service Provider, by a device performing NAT, typically a home router. In addition to translating the IP addresses, the NAT typically also translates UDP port numbers, for example an audio path originating at an IP telephone and using a UDP port **12378** at its private IP address may have been translated to a UDP port **23465** associated with the public IP address of the NAT device. In other words, when a packet originating from the above IP telephone arrives at an Internet-based supernode, the source IP/UDP address contained in the IP packet header will be **24.10.10.1:23465**, whereas the source IP/UDP address information contained in the SIP message inside this IP packet will be **192.168.0.103:12378**. The mismatch in the IP/UDP addresses may cause a problem for SIP-based systems because, for example, a supernode will attempt to send messages to a private address of a telephone – the messages will never get there.

-18-

It will be appreciated that a number of methods are available to overcome this problem. For example, the SIP NATHelper open source software module may run on the supernode to correlate public IP/UDP address contained in the headers of the IP packets arriving from SIP devices with private IP/UDP addresses in the SIP messages contained in these packets. Therefore, the embodiments of the invention described below will function whether or not any of the elements of the system are located behind NAT devices that obscure their real IP/UDP addresses.

Referring to Figure 1, in an attempt to make a call by the Vancouver telephone 12 to the Calgary telephone 15, for example, the Vancouver telephone sends a SIP Invite message to the Vancouver supernode 11 and in response, the call controller 14 sends an RC Request message to the routing controller 16 which makes various enquiries of the database 18 to produce a routing message which is sent to the call controller 14. The call controller 14 then causes a communications link including audio paths to be established through the media relay 17 which may include the same Vancouver supernode 11, a different supernode or a communications supplier gateway, for example, to carry voice traffic to and from the call recipient or callee. Subject to certain conditions being satisfied, as will be described below, when lawful intercept of data is to occur, data on the audio paths is copied to the mediation device 31 which may provide for real time listening of the audio data or recording of same.

Subscriber Telephone

Referring to Figure 2, in this embodiment, the telephones 12, 15, 22 and 25 each includes a processor circuit shown generally at 30 comprising a microprocessor 32, program memory 34, an input/output (I/O) interface 36, parameter memory 38 and temporary memory 40. The program memory 34, I/O interface 36, parameter memory 38 and temporary memory 40 are all in communication with the microprocessor 32. The I/O interface 36 has a dial

-19-

input **42** for receiving a dialed telephone number from a keypad, for example, or from a voice recognition unit or from pre-stored telephone numbers stored in the parameter memory **38**, for example. For simplicity, a box labelled dialing functions **44** represents any device capable of informing the
5 microprocessor **32** of a callee identifier, e.g., a callee telephone number.

The microprocessor **32** stores the callee identifier in a dialed number buffer **41**. In the case of the Vancouver subscriber for example, the dialed number may be **2001 1050 2222**, identifying the Calgary subscriber or the dialed
10 number may be a PSTN number, for example. The I/O interface **36** also has a handset interface **46** for receiving and producing signals from and to a handset **45** that the user may place to his ear. The handset interface **46** may include a BLUETOOTH™ wireless interface, a wired interface or speakerphone, for example. The handset **45** acts as a termination point for an
15 audio path (not shown) which will be appreciated later.

The I/O interface **36** also has a network interface **48** to an IP network which may provide a high speed Internet connection, for example, and is operable to connect the telephone to an ISP. The network interface **48** also acts as a part
20 of the audio path, as will be appreciated later.

The parameter memory **38** has a username field **50**, a password field **52** an IP address field **53** and a SIP proxy address field **54**. The username field **50** is operable to hold a username, which, for the Vancouver subscriber, is **2001**
25 **1050 8667**. The username is assigned upon subscription or registration into the system and, in this embodiment includes a twelve digit number having a continent code **61**, a country code **63**, a dealer code **70** and a unique number code **74**. The continent code **61** is comprised of the first or left-most digit of the username in this embodiment. The country code **63** is comprised of the
30 next three digits. The dealer code **70** is comprised of the next four digits and the unique number code **74** is comprised of the last four digits. The password field **52** holds a password of up to **512** characters, in this example. The IP

-20-

address field **53** stores an IP address and UDP port number of the telephone **12**, which, for this explanation, is **192.168.0.20:12345**. The SIP proxy address field **54** stores an IP address of a SIP proxy which may be provided to the telephone **12** through the network interface **48** as part of a registration procedure.

5

The program memory **34** stores blocks of codes for directing the microprocessor **32** to carry out the functions of the telephone, one of which includes a firewall block **56** which provides firewall functions to the telephone, to prevent unauthorized access through the network connection to the microprocessor **32** and memories **34**, **38** and **40**. The program memory **34** also stores call ID codes **57** for establishing a call ID. The call ID codes **57** direct the microprocessor **32** to produce call identifiers having the format of a hexadecimal string and an IP address of the telephone stored in the IP address field **53**. Thus, an exemplary call identifier for a call might be **FF10@192.168.0.20**.

10

15

Generally, in response to activating the handset **45** and using the dialing function **44**, the microprocessor **32** produces and sends a SIP Invite message as shown in Figure **3**, to the call controller **14** shown in Figure **1**.

20

Referring to Figure **3**, the SIP Invite message includes a caller identifier field **60**, a callee identifier field **62**, a digest parameters field **64**, a call identifier field **65**, a caller IP address field **67** and a caller UDP port field **69**. In this embodiment, the caller identifier field **60** includes the username **2001 1050 8667**, which is the username stored in the username field **50** of the parameter memory **38** in the Vancouver telephone **12** shown in Figure **2**. In addition, as an example, referring back to Figure **3**, the callee identifier field **62** includes the username **2001 1050 2222** which is the dialed number of the Calgary subscriber stored in the dialed number buffer **41** shown in Figure **2**. The digest parameters field **64** includes digest parameters and the call identifier field **65** includes a code comprising a generated prefix code (**FF10**) and a

25

30

-21-

suffix which is the IP address of the telephone **12** stored in the IP address field **53**. The caller IP address field **67** holds the IP address assigned to the telephone, in this embodiment **192.168.0.20**, and the caller UDP port field **69** includes a UDP port identifier identifying a UDP port to which audio data is to be sent for reception by the caller's telephone.

Call Controller

Referring to Figure **4**, a call controller circuit of the call controller **14** (Figure **1**) is shown in greater detail at **100**. The call controller circuit **100** includes a microprocessor **102**, program memory **104** and an I/O interface **106**. The call controller circuit **100** may include a plurality of microprocessors, a plurality of program memories and a plurality of I/O interfaces to be able to handle a large volume of calls. However, for simplicity, the call controller circuit **100** will be described as having only one microprocessor, program memory and I/O interface, it being understood that there may be more.

Generally, the I/O interface **106** includes an input **108** for receiving messages, such as the SIP Invite message shown in Figure **3**, from the telephone shown in Figure **2**. The I/O interface **106** also has an RC Request message output **110** for transmitting an RC Request message to the routing controller **16** of Figure **1**, an RC message input **112** for receiving routing messages from the routing controller **16** (Figure **1**), a media relay (MR) output **114** for transmitting messages to the media relay (Figure **1**) to advise the media relay to establish an audio path, and a MR input **116** for receiving messages from the media relay to which a message has been sent to attempt to establish the audio path. The I/O interface **106** further includes a SIP output **118** for transmitting SIP messages to the telephone **12** (Figure **1**) to advise the telephone of the IP address of the media relay **17** (Figure **1**) which will establish the audio path. The I/O interface **106** further includes mediation device input **119** and output **121** for communicating with the mediation device **31** (Figure **1**).

While certain inputs and outputs have been shown as separate, it will be appreciated that some may be associated with a single IP address and TCP or UDP port. For example, the messages sent and received from the routing controller **16** may be transmitted and received at the same single IP address and TCP or UDP port.

The program memory **104** of the call controller circuit **100** includes blocks of code for directing the microprocessor **102** to carry out various functions of the call controller **14**. For example, these blocks of code include a first block **120** for causing the call controller circuit **100** to execute a SIP Invite-to-RC request process to produce an RC Request message in response to a received SIP Invite message. In addition, there is a Routing Message Handler block **122** which causes the call controller circuit **100** to engage the mediation device and/or execute a call handling routine to establish audio paths through a media relay to establish the call. The program memory **104** further includes an in-call intercept message handler **1450** for intercepting a call in progress and a cease intercept message handler **1520** for ceasing the interception of a call in progress.

Referring to Figure **5**, the SIP Invite-to-RC Request process is shown in more detail at **120**. On receipt of a SIP Invite message of the type shown in Figure **3**, block **132** of Figure **5** directs the call controller circuit **100** of Figure **4** to authenticate the user operating the telephone from which the SIP Invite message originated. This may be done, for example, by prompting the user for a password, by sending a message back to the telephone **12** which is interpreted at the telephone as a request for password entry or the password may automatically be sent to the call controller **14** from the telephone, in response to the message. The call controller **14** may then make enquiries of databases to which it has access, to determine whether or not the user's password matches a password stored in the database. Various functions may be used to pass encryption keys or hash codes back and forth to ensure the secure transmission of passwords.

-23-

Should the authentication process fail, the call controller circuit **100** is directed to an error handling block **134** which causes messages to be displayed at the telephone **12** to indicate that there was an authentication error. If the authentication process is successful, block **131** directs the call controller circuit **100** to determine whether or not the contents of the caller identifier field **60** of the SIP Invite message is a validly formatted IP address. If it is a valid IP address, then block **133** directs the call controller circuit **100** to associate a type code with the call to indicate that the call type is a third party invite.

If at block **131** the caller identifier field **60** contents do not identify an IP address, then block **135** directs the call controller circuit **100** to associate a type code with the call to indicate the call type is a regular SIP Invite message. Then, block **136** directs the call controller circuit **100** to establish a call ID by assigning the call ID provided in the call identifier field **65** of the SIP Invite message from the telephone **12**, and at block **138** the call controller circuit is directed to produce an RC Request message of the type shown in Figure **6** that includes that call ID. Referring back to Figure **5**, block **139** then directs the call controller circuit **100** to send the RC Request message to the routing controller **16**.

Referring to Figure **6**, an RC Request message is shown generally at **150** and includes a caller identifier field **152**, a callee identifier field **154**, a digest field **156**, a call ID field **158** and a type field **160**. The caller, callee, digest, and call identifier fields **152**, **154**, **156** and **158** contain copies of the caller, callee, digest parameters and call ID fields **60**, **62**, **64** and **65** of the SIP Invite message **59** shown in Figure **3**. The type field **160** contains the type code established at block **133** or **135** of Figure **5** to indicate whether the call is from a third party or system subscriber, respectively. The callee identifier field **154** may include a PSTN number or a system subscriber username as shown, for example.

-24-

Routing Controller

Referring to Figure 7, the routing controller 16 is shown in greater detail and includes a routing controller processor circuit shown generally at 200. The RC processor circuit 200 includes a microprocessor 202, program memory 204, a table memory 206 and an I/O interface 208, all in communication with the processor. There may be a plurality of processor circuits (202), memories (204), etc.

The I/O interface 208 includes a database output port 210 through which a request to the database 18 (Figure 1) can be made and includes a database response port 212 for receiving a reply from the database. The I/O interface 208 further includes an RC Request message input 214 for receiving the RC Request message from the call controller 14 and includes a routing message output 216 for sending a routing message back to the call controller 14.

The program memory 204 includes blocks of codes for directing the RC processor circuit 200 to carry out various functions of the routing controller 16. One of these blocks implements an RC Request message handler process 250 which directs the RC to produce a routing message in response to a received RC Request message of the type shown at 150 in Figure 6. Referring back to Figure 7, the program memory 204 further includes a Law Enforcement Authority (LEA) request message handler 1400 and an in-call intercept shut down route 1500.

The RC Request message handler process 250 is shown in greater detail in Figures 8A through 8D.

RC Request Message Handler

Referring to Figure 8A, the RC Request message handler process 250 begins with a first block 252 that directs the RC processor circuit 200 (Figure 7) to store the contents of the RC Request message 150 (Figure 6) in buffers. Block 254 then directs the RC processor circuit 200 to use the contents of the

-25-

caller identifier field **152** in the RC Request message shown in Figure **6**, to locate and retrieve a dialing profile for the caller from the database **18**.

5 The routing controller maintains, in the database, a dialing profile for each subscriber to the system. Referring to Figure **9**, an exemplary dialing profile is shown generally at **256** and includes system fields including a username field **258**, a domain field **260**, a national dialing digits (NDD) field **262**, an IDD (IDD) field **264**, a country code field **266**, a local area codes field **267**, a caller minimum local length field **268**, a caller maximum local length field **270** and a reseller field **273**.

10 The exemplary dialing profile further includes lawful intercept related fields including a lawful intercept (LI) flag field **702**, at least one mediation device field **704**, at least one warrant ID field **706**, and intercept period start and stop date/time fields **708** and **710**. The LI flag field **702**, the warrant ID filed **706** and the LI start/stop fields **708** and **710** may be regarded as determination information fields for determining whether to intercept a communication involving the subscriber and the MD1 address field **704** may be regarded as a destination information field for identifying a device to which intercepted communications involving the subscriber are to be sent.

20 The system fields (**258, 260, 262, 264, 266, 267, 268, 270, 273**) are assigned values by a system operator or are assigned automatically according to pre-defined algorithms (not shown) when a user registers with the system to become a subscriber. The lawful intercept fields (**702, 704, 706, 708, 710**) are assigned values in response to communications with one or more authorized devices and may be populated at any time regardless of whether or not communications involving the subscriber are in progress.

30 For example, referring back to Figure **1** the mediation device **31** may be regarded as an authorized device operated by a law enforcement authority **293**. A communications channel between the call controller **14** and the

-26-

mediation device **31** may be established to permit the mediation device to communicate with the call controller to cause the call controller to communicate with the routing controller **16** to find a subscriber record in the database **18** which is associated with a subscriber for which a warrant for lawful intercept has been obtained. For example, once a warrant identifying a user and permitting lawful intercept of that user's communications has been received by the law enforcement authority **293**, that authority can use its own computers to communicate with the mediation device **31** to cause the mediation device to communicate with the call controller **14** to cause the call controller to interact with the routing controller **16** to access a dialing profile (Figure **9**) for the user specified in the warrant and load the lawful intercept fields (**702, 704, 706, 708, 710**) with data that sets the lawful intercept flag field **702** to "on", stores an IP address of the mediation device **31** in the MD1 address field **704**, loads the warrant ID field **706** with an identifier of the warrant and loads the start and stop fields **708** and **710** with start and stop dates and times to specify a period during which lawful intercept of communications of the identified user may occur according to the warrant. Thus, intercept information is associated with the dialing profile by the routing controller, in response to information it receives from the call controller.

A plurality of groups of lawful intercept fields of the type shown may be added, each group being added by a different authorized device, for example, if several different law enforcement agencies operating the same or different mediation devices have warrants to monitor communications of a user. Alternatively the authorized device may include a handover interface operable to communicate with the call controller or routing controller to access the database to load the lawful intercept fields associated with a subscriber of interest.

An exemplary dialing profile for the Vancouver subscriber is shown generally at **276** in Figure **10** and indicates that the username field includes the

-27-

username **2001 1050 8667** which is the same as the contents of the username field **50** in the Vancouver telephone **12** shown in Figure 2.

5 Referring back to Figure **10**, the domain field **260** includes a domain name as shown at **282**, including a supernode type identifier **284**, a location code identifier **286**, a system provider identifier **288** and a top level domain identifier **290**, identifying a domain or supernode associated with the user identified by the contents of the username field **258**.

10 In this embodiment, the supernode type identifier **284** includes the code “sp” identifying a supernode and the location code identifier **286** identifies the supernode as being in Vancouver (YVR). The system provider identifier **288** identifies the company supplying the service and the top level domain identifier **290** identifies the “com” domain.

15 The national dialing digit (NDD) field **262** in this embodiment includes the digit “1” and, in general, includes a digit specified by the International Telecommunications Union – Telecommunications Standardization Sector (ITU-T) E.164 Recommendation which assigns national dialing digits to
20 certain countries. Herein numbering sequences compliant with this standard will be regarded as “E.164” numbers.

The International Dialing Digit (IDD) field **264** includes the code **011** and in
25 general includes a code assigned by the ITU-T according to the country or geographical location of the user.

The country code field **266** includes the digit “1” and in general includes a
number assigned by the ITU-T to represent the country in which the user is
located.

30 The local area codes field **267** includes the numbers **604** and **778** and generally includes a list of area codes that have been assigned by the ITU-T

-28-

to the geographical area in which the subscriber is located. The caller minimum and maximum local number length fields **268** and **270** hold the number **10** representing minimum and maximum local number lengths permitted in the area code(s) specified by the contents of the local area codes field **267**. The reseller field **273** holds a code identifying a retailer of the telephone services, and in the embodiment shown, the retailer is "Klondike".

Initially, the lawful intercept fields shown in Figure **9** might not be included in the dialing profile and may be added as described above, by the mediation device **31**, in the event a warrant is obtained to intercept the user's calls. Alternatively, the lawful intercept fields may be included, but populated with null values until modified by a mediation device **31**.

A dialing profile of the type shown at **256** in Figure **9** is produced whenever a user registers with the system or agrees to become a subscriber to the system. Thus, for example, a user wishing to subscribe to the system may contact an office maintained by a system operator and personnel in the office may ask the user certain questions about his location and service preferences, whereupon tables can be used to provide office personnel with appropriate information to be entered into the username, domain, NDD, IDD, country code, local area codes and caller minimum and maximum local length fields **258**, **260**, **262**, **264**, **266**, **267**, **268**, **270** to establish a dialing profile for the user.

Referring to Figures **11** and **12**, dialing profiles for subscribers in Calgary and London, respectively for example, are shown.

In addition to creating dialing profiles, optionally when a user registers with the system, a direct inward dialing (DID) record of the type shown at **268** in Figure **13** is added to a direct inward dialing table in the database **18** to associate the username with a host name of the supernode with which the user is associated and with an E.**164** number on the PSTN network.

-29-

In this embodiment, the DID bank table records include a username field **281**, a user domain field **272** and a DID field **274**, for holding the username, hostname of the supernode, and an E.**164** number respectively.

5

A DID bank table record for the London subscriber is shown generally at **291** in Figure **14**.

10 In addition to creating dialing profiles and DID records when a user registers with the system, call blocking records of the type shown in Figure **26**, call forwarding records of the type shown in Figure **28** and voicemail records of the type shown in Figure **30** may be stored in the database **18** when a new subscriber is added to the system.

15 Referring back to Figure **8A**, after being directed at block **254** to retrieve a dialing profile for the caller, a dialing profile such as shown at **276** in Figure **10** is retrieved and the RC processor circuit **200** is directed to perform certain checks on the callee identifier provided by the contents of the callee identifier field **154** of the RC Request message shown in Figure **6**. These checks are
20 shown in greater detail in Figure **8B**.

Referring to Figure **8B**, the RC processor circuit **200** is directed to a first block **257** that causes it to determine whether a digit pattern of the callee identifier **154** provided in the RC Request message includes a pattern that matches the
25 contents of the IDD field **264** in the caller dialing profile **276** shown in Figure **10**. If so, then block **259** directs the RC processor circuit **200** to set a call type code identifier (not shown) to indicate that the call is a long distance call, e.g., from the Vancouver subscriber to the London subscriber, and block **261** directs the RC processor circuit **200** to produce a reformatted callee identifier
30 by reformatting the callee identifier into a predetermined target format. In this embodiment, this is done by removing the pattern of digits matching the IDD field contents **264** of the caller dialing profile **276** to effectively shorten the

-30-

number. Then, block **263** directs the RC processor circuit **200** to determine whether or not the reformatted callee identifier meets criteria establishing it as a number compliant with the E.164 Recommendation set by the ITU-T and if the length does not meet this criteria, block **265** directs the RC processor circuit **200** to send back to the call controller **14** a message indicating that the length of the call identifier is not correct. The process **250** is then ended. At the call controller **14**, routines may respond to the incorrect length message by transmitting a message back to the telephone **12** to indicate that an invalid number has been dialed.

Still referring to Figure **8B**, if the length of the reformatted callee identifier meets the criteria set forth at block **263**, block **269** directs the RC processor circuit **200** to determine whether or not the reformatted callee identifier is associated with a direct inward dialing (DID) bank table record such as shown at **268** in Figure **13**.

An exemplary DID bank table record entry for the London callee is shown generally at **291** in Figure **14**. The username field **281** and user domain field **272** are as specified in the username and user domain fields **258** and **260** of the dialing profile **276** shown in Figure **12**. The contents of the DID field **274** include an E.164 telephone number including a country code **283**, an area code **285**, an exchange code **287** and a number **289**. If the user has multiple telephone numbers, then multiple records of the type shown at **291** would be included in the DID bank table in the database **18**, each having the same username and user domain, but different DID field **274** contents reflecting the different telephone numbers associated with that user.

Referring back to Figure **8B**, at block **269**, if the RC processor circuit **200** finds that the reformatted callee identifier produced at block **261** is found in a record in the DID bank table, then the callee is a subscriber to the system and block **279** directs the RC processor circuit **200** to copy the contents of the corresponding username field **270** into a callee ID buffer (not shown). Thus,

-31-

the RC processor circuit **200** locates a subscriber username associated with the reformatted callee identifier. The processor is then directed to block **275** at point B in Figure **8A**.

5 Subscriber to Subscriber Calls Between Different Nodes

Referring back to Figure **8A**, block **275** then directs the RC processor circuit **200** to determine whether or not the subscriber username is associated with the same supernode as the caller. To do this, the RC processor circuit **200** determines whether or not the continent code (**61**) of the username stored in the callee ID buffer is the same as the continent code (**61**) of the username of the caller specified by the caller identifier field **152** of the RC Request message shown in Figure **6**. If they are not the same, block **277** directs the RC processor circuit **200** to set a call type flag (not shown) to indicate that the call is a cross-domain call. Then, block **350** directs the RC processor circuit **200** to produce a routing message identifying the supernode in the system with which the callee is associated and to set a TTL for the call to the maximum value of **99999**. The supernode in the system, with which the callee is associated, is determined by using the callee username stored in the callee ID buffer to address a supernode table having records of the type as shown at **370** in Figure **17**.

Referring to Figure **17**, each prefix to supernode table record **370** has a prefix field **372** and a supernode address field **374**. The prefix field **372** includes the first n digits of the callee identifier. In this case n=1. The supernode address field **374** holds a code representing the IP address or a fully qualified domain name of the supernode associated with the code stored in the prefix field **372**. Referring to Figure **18**, for example, if the prefix is **4**, the supernode address associated with that prefix is sp.lhr.digifonica.com, identifying the London supernode **21**, for example.

30 Referring to Figure **15**, a generic routing message is shown generally at **352** and includes a supplier prefix field **354**, a delimiter field **356**, a callee field **358**,

-32-

at least one route field **360**, a time-to-live (TTL) field **362** and other fields **364**. The supplier prefix field **354** holds a code for identifying supplier traffic. The delimiter field holds a symbol that delimits the supplier prefix code from the callee field **358** and in this embodiment, the symbol is a number sign (#). The route field **360** holds a domain name or an IP address of a gateway or supernode that is to carry the call and the TTL field **362** holds a value representing the number of seconds the call is permitted to be active, based on subscriber available minutes and other billing parameters, for example.

Referring to Figure **8A** and Figure **16**, in this example the routing message produced by the RC processor circuit **200** at block **350** is shown generally at **366** and includes only a callee field **358**, a route field **360** and a TTL field **362**.

The callee field **358** holds the full username of the callee and the route field **360**, shown in Figure **15**, contains the identification of the domain with which the callee is associated, i.e., sp.lhr.digifonica.com.

Having produced the routing message **366** as shown in Figure **16A**, referring back to Figure **8A**, block **351** then directs the RC processor circuit **200** to check the caller dialing profile (see Figure **9**) to determine whether or not it contains lawful intercept fields (**702**, **704**, **706**, **708**, **710**) and if so, to determine whether or not the determination information contained therein meets intercept criteria. The intercept criteria may be that the lawful intercept flag field **702** (Figure **9**) contains a flag indicating lawful intercept is enabled and whether the current date and time is within the period specified by the LI start date/time field contents **708** and the LI stop date/time field contents **710**, for example. If the intercept criteria are met, block **353** directs the RC processor circuit **200** to append the contents of the lawful intercept fields **702**, **704**, **706**, **708**, **710** to the routing message produced at block **350** to produce a routing message as shown in Figure **16A**. Generally, the determination of whether or not the destination information meets intercept criteria is done prior to producing the routing message so that when the intercept criteria are met,

-33-

at least some of the intercept information, in this embodiment all of it, can be included in the routing message.

5 If at block **351** in Figure **8A**, it is determined there are no lawful intercept fields associated with the caller dialing profile or that the intercept criteria are not met, the processor does not append any lawful intercept fields to the routing message produced at block **350** in Figure **8A** and the routing message shown in Figure **16** is sent to the call controller **14** as shown at block **380**. If the lawful intercept fields have been appended, block **380** directs the RC processor circuit **200** to send the routing message shown in Figure **16A** to the call controller **14** (Figure **1**).

15 Referring back to Figure **8B**, if at block **257**, the callee identifier specified by the contents of the callee field **154** of the RC Request message shown in Figure **6** does not begin with an IDD, block **381** directs the RC processor circuit **200** to determine whether or not the callee identifier begins with the same national dial digit code as assigned to the caller. To do this, the processor is directed to refer to the caller dialing profile shown in Figure **10**. In the embodiment shown, the NDD code **262** is the digit **1**. Thus, if the callee identifier begins with the digit **1**, the RC processor circuit **200** is directed to block **382** in Figure **8B**.

25 Block **382** directs the RC processor circuit **200** to examine the callee identifier to determine whether or not digits following the NDD code identify an area code that is the same as any of the area codes identified in the local area codes field **267** of the caller dialing profile **276** shown in Figure **10**. If not, block **384** directs the RC processor circuit **200** to set a call type variable (not shown) to a code indicating the call is a national code. If the digits identify an area code that is the same as a local area code associated with the caller, block **386** directs the RC processor circuit **200** to set the call type variable to indicate that the call type is a local call, national style. After executing blocks **384** or **386**, block **388** directs the RC processor circuit **200** to format the

30

-34-

number dialed by removing the national dial digit (NDD) and prepending a caller country code identified by the country code field **266** of the caller dialing profile shown in Figure **10**. The RC processor circuit **200** is then directed to block **263** to perform the processes described above beginning at block **263**.

5

If at block **381**, the callee identifier does not begin with an NDD code, block **390** directs the RC processor circuit **200** to determine whether the callee identifier begins with digits that identify the same area code as the caller. Again, the reference for this is the caller profile shown in Figure **10** and the RC processor circuit **200** determines whether or not the first few digits in the callee identifier identify an area code identified by the local area code field **267** of the caller profile. If so, then block **392** directs the RC processor circuit **200** to set the call type to a code indicating the call is a local call and block **394** directs the RC processor circuit **200** to prepend the caller country code to the callee identifier, the caller country code being determined from the country code field **266** in the caller profile shown in Figure **10**. The RC processor circuit **200** is then directed to block **263** for processing as described above beginning at block **263**.

10

15

20

If at block **390**, the callee identifier does not have the same area code as the caller, block **396** directs the RC processor circuit **200** to determine whether the callee identifier has the same number of digits as the number of digits indicated in either the caller minimum local number length field **268** or the caller maximum local number length field **270** of the caller profile shown in Figure **10**. If so, then block **398** directs the RC processor circuit **200** to set the call type to local and block **400** directs the processor to prepend to the callee identifier the caller country code as indicated by the country code field **266** of the caller profile shown in Figure **10** followed by the caller area code as indicated by the local area code field **267** of the caller profile shown in Figure **10**. The RC processor circuit **200** is then directed to block **263** for further processing as described above beginning at block **263**.

25

30

-35-

If at block **396**, the callee identifier has a length that does not match the length specified by the contents of the caller minimum local number length field **268** or the caller maximum local number length field **270**, block **402** directs the RC processor circuit **200** to determine whether or not the callee identifier identifies a valid username. To do this, the RC processor circuit **200** searches through the database of dialing profiles to find a dialing profile having username field contents **258** that match the callee identifier. If no match is found, block **404** directs the RC processor circuit **200** to send an error message back to the call controller (**14**). If at block **402**, a dialing profile having a username field **258** that matches the callee identifier is found, block **406** directs the RC processor circuit **200** to set the call type to a code indicating the call is a network call and the processor is directed to block **275** of Figure **8A**, to continue processing the RC message handler process **250**.

From Figure **8B**, it will be appreciated that there are certain groups of blocks of codes that direct the RC processor circuit **200** to determine whether the callee identifier has certain features such as an IDD code, a NDD code, an area code and a length that meet certain criteria and to reformat the callee identifier as necessary into a predetermined target format including only a country code, area code, and a normal telephone number, for example, to cause the callee identifier to be compatible with the E.164 number plan standard, in this embodiment. This enables the RC processor circuit **200** directed by block **279** to have a consistent format of callee identifiers for use in searching through the DID bank table records of the type shown in Figure **13** to determine how to route calls for subscriber to subscriber calls on the same system.

Subscriber to Non-Subscriber Calls

Not all calls will be subscriber-to-subscriber calls and this will be detected by the RC processor circuit **200** when it executes block **269** of Figure **8B**, and does not find a record that is associated with the callee in the DID bank table. When this occurs, the RC processor circuit **200** is directed to block **408** which

-36-

causes it to set the callee identifier equal to the reformatted callee identifier, i.e., the number compatible with the E.164 standard. Then, block **410** directs the RC processor circuit **200** to address a master list having records of the type shown in Figure **19**.

5

Each master list record includes a master list ID field **500**, a dialing code field **502**, a country code field **504**, a national sign number field **506**, a minimum length field **508**, a maximum length field **510**, a NDD field **512**, an IDD field **514** and a buffer rate field **516**.

10

The master list ID field **500** holds a unique code such as **1019**, for example, identifying a route identification (route ID). The dialing code field **502** holds a predetermined number pattern which the RC processor circuit **200** uses at block **410** in Figure **8B** to find the master list record having a dialing code matching the first few digits of the reformatted callee identifier. The country code field **504** holds a number representing the country code associated with the record and the national sign number field **506** holds a number representing the area code associated with the record. (It will be observed that the dialing code is a combination of the contents of the country code field **504** and the national sign number field **506**.) The minimum length field **508** holds a number representing the minimum number of digits that can be associated with the record and the maximum length field **51** holds a number representing the maximum number of digits in a number with which the record may be compared. The NDD field **512** holds a number representing an access code used to make a call within the country specified by the contents of the country code field **504** and the IDD field **514** holds a number representing the international prefix needed to dial a call from the country indicated by the country code.

15

20

25

30

Thus, for example, a master list record may have a format as shown in Figure **20** with exemplary field contents as shown.

-37-

Referring back to Figure 8B, using the country code and area code portions of the reformatted callee identifier that has been formatted for compatibility with the E.164 standard, block 410 directs the RC processor circuit 200 to find a master list record such as the one shown in Figure 20 having a dialing code that matches the country code and area code of the callee identifier. Thus, in this example, the RC processor circuit 200 would find a master list record having an ID field with the number 1019. This number may be also referred to as a route ID. Thus, a route ID number is found in the master list record associated with a predetermined number pattern in the reformatted callee identifier.

After execution of block 410 in Figure 8B, the process 250 continues as shown in Figure 8D. Referring to Figure 8D, block 412 directs the RC processor circuit 200 to use the route ID number to locate at least one supplier record identifying a supplier operable to supply a communications link for this route. To do this, block 412 directs the RC processor circuit 200 to search a supplier ID table having records of the type shown in Figure 21.

Referring to Figure 21, the supplier list records include a supplier ID field 540, a route ID field 542, an optional prefix field 544, a route identifier field 546, a NDD/IDD rewrite field 548 and a rate field 550. The supplier ID field 540 holds a code identifying the name of the supplier and the route ID field 542 holds a code for associating the supplier record with a route, and hence with a master list record. The prefix field 544 holds a string used to identify the supplier traffic and the route identifier field 546 holds an IP address of a gateway operated by the supplier indicated by the supplier ID field 540. The NDD/IDD rewrite field 548 holds a code and the rate field 550 holds a code indicating the cost per second to the system operator to use the route provided by the gateway specified by the contents of the route identifier field 546. Exemplary supplier records are shown in Figures 22, 23 and 24 for the suppliers shown in Figure 1 which may include Telus, Shaw and Sprint, respectively, for example.

-38-

Referring back to Figure 8D, at block 412 the RC processor circuit 200 finds all supplier records that identify the route ID found at block 410 of Figure 8B.

5 Referring back to Figure 8D, block 560 directs the RC processor circuit 200 to begin to produce routing messages of the type shown in Figure 16. To do this, the RC processor circuit 200 loads a routing message buffer as shown in Figure 25 with a supplier prefix of the least costly supplier where the least
10 costly supplier is determined from the rate fields 550 of the records associated with respective suppliers.

Referring to Figures 22-24, in the embodiment shown, the supplier "Telus" has the lowest number in the rate field 550 and therefore the prefix 4973 associated with that supplier is loaded into the routing message buffer shown
15 in Figure 25 first. The prefix 4973 is then delimited by the number sign and the reformatted callee identifier is next loaded into the routing message buffer. Then, the contents of the route identifier field 546 of the record associated with the supplier Telus are added to the message after an @ sign delimiter and then block 564 in Figure 8D directs the RC processor circuit 200 to get a
20 TTL value, which in this embodiment may be 3600 seconds, for example. Block 566 then directs the RC processor circuit 200 to load this TTL value in the routing message buffer shown in Figure 25. Accordingly, the first part of the routing message is shown generally at 570 in Figure 25.

25 Referring back to Figure 8D, block 568 directs the RC processor circuit 200 back to block 560 and causes it to repeat blocks 560, 562, 564 and 566 for each successive supplier until the routing message buffer is loaded with information pertaining to each supplier. Thus, the second portion of the routing message is shown at 572 in Figure 25 and this second portion relates
30 to the second supplier identified by the record shown in Figure 23 and referring back to Figure 25, the third portion of the routing message is shown at 574 which is associated with a third supplier as indicated by the supplier

-39-

record shown in Figure **24**. Consequently, referring to Figure **25**, the routing message buffer holds a routing message identifying a plurality of different suppliers able to provide gateways to establish a communication link to permit the caller to contact the callee. Each of the suppliers is identified, in ascending order according to the rates contained in the rate fields **550** of the supplier list records shown in Figures **22-24**, in this embodiment. Other criteria for determining the order in which suppliers are listed in the routing message may include preferred supplier priorities which may be established based on service agreements, for example. In this case additional fields may be provided in respective supplier records to hold values representing supplier priority.

After the routing message buffer has been loaded as shown in Figure **25**, block **567** directs the RC processor circuit **200** to check the caller dialing profile shown in Figure **10** to determine whether or not it contains lawful intercept fields as shown in Figure **9**, and if so, to determine whether or not the intercept criteria are met by checking whether the lawful intercept flag field **702** contains a flag indicating that lawful intercept is enabled and checking whether the current date and time are within the period specified by the LI start date/time field contents **708** and the LI stop date/time field contents **710**. If the intercept criteria are met, block **569** directs the RC processor circuit **200** to append the contents of the lawful intercept fields **702**, **704**, **706**, **708**, **710** to the routing message stored in the routing message buffer, as shown in Figure **25A**. Again, the determination of whether or not the destination information meets intercept criteria is done prior to producing the routing message so that when the intercept criteria are met, at least some of the intercept information, in this embodiment all of it, can be included in the routing message.

If at block **567**, it is determined there are no lawful intercept fields associated with the caller dialing profile shown in Figure **10** or that the intercept criteria are not met, the RC processor circuit **200** does not append any lawful

-40-

intercept fields to the routing message stored in the routing message buffer shown in Figure 25.

5 Block 568 then directs the RC processor circuit 200 to send the contents of the routing message buffer, i.e. the routing message shown in Figure 25 or 25A, to the call controller 14 in Figure 1.

Subscriber to Subscriber Calls Within the Same Node

10 Referring back to Figure 8A, if at block 275, the callee identifier stored in the callee ID buffer has a prefix that identifies the same supernode as that associated with the caller, block 600 directs the RC processor circuit 200 to use the callee identifier to locate and retrieve a dialing profile for the callee identified by the callee identifier. The dialing profile is of the type shown in Figure 9, and may contain data as shown in Figure 11, for example. Block 602

15 of Figure 8A directs the RC processor circuit 200 to get call block, call forward and voicemail tables from the database 18 based on the username identified in the callee profile retrieved by the RC processor circuit at block 600. Call block, call forward and voicemail tables have records as shown in Figures 26, 28 and 30 for example.

20 Referring to Figure 26, the call block records include a username field 604 and a block pattern field 606. The username field holds a username matching the username in the username field 258 of the dialing profile associated with the callee and the block pattern field 606 holds one or more E.164-compatible

25 numbers or usernames identifying PSTN numbers or system subscribers from whom the subscriber identified by the contents of the username field 604 does not wish to receive calls.

30 Referring back to Figure 8A and referring to Figure 27, block 608 directs the RC processor circuit 200 to determine whether or not the caller identifier matches a block pattern stored in the block pattern field 606 of the call block record associated with the callee identified by the contents of the username

-41-

field **604** in Figure **26**. If the caller identifier matches a block pattern stored in the block pattern field **606**, block **610** directs the RC processor circuit **200** to send a drop call or non-completion message to the call controller (**14**) and the process is ended. If the caller identifier does not match a block pattern associated with the callee, block **612** directs the RC processor circuit **200** to determine whether or not call forwarding is required.

Referring to Figure **28**, records in the call forwarding table include a username field **614**, a destination number field **616**, a destination number field **616** and a sequence number field **618**. The username field **614** stores a code representing a subscriber with which the record is associated. The destination number field **616** holds a username or number representing a number to which the current call should be forwarded and the sequence number field **618** holds an integer number indicating the order in which the username associated with the corresponding destination number field **616** should be attempted for call forwarding. The call forwarding table may have a plurality of records for a given user. The RC processor circuit **200** uses the contents of the sequence number field **618** to consider the records for a given subscriber in order. As will be appreciated below, this enables the call forwarding numbers to be tried in a ordered sequence.

Referring back to Figure **8A** and referring to Figure **28**, if at block **612** in Figure **8A**, the call forwarding record for the callee identified by the callee identifier contains no contents in the destination number field **616** and accordingly no contents in the sequence number field **618**, there are no call forwarding entries and the RC processor circuit **200** is directed to load the routing message buffer shown in Figure **32** with the callee username and domain, as shown at **650** in Figure **32**. The processor is then directed to block **620** in Figure **8C**.

If there are contents in the destination number field of the call forwarding record as shown in Figure **29**, block **622** shown in Figure **8A** directs the RC

-42-

processor circuit **200** to search the dialing profile table to find a dialing profile record of the type shown in Figure **9**, for the user identified in the destination number field **616** in the call forwarding table record of Figure **29** and to store the contents of the destination number field in the routing message buffer shown in Figure **32**. The RC processor circuit **200** is then directed to load the contents of the domain field **260** shown in Figure **9** associated with the username specified by the contents of the destination number field **616** of Figure **29** into the routing message buffer as shown at **652** in Figure **32**. This process is repeated for each call forwarding record associated with the callee identified by the callee identifier to add to the routing message buffer all call forwarding usernames and domains associated with the callee.

Referring to Figure **8C**, at block **620** the processor is directed to determine whether or not the user identified by the callee identifier has paid for voicemail service and this is done by checking to see whether or not a flag is set in a voicemail record of the type shown in Figure **30** in a voicemail table stored in the database **18** in Figure **1**.

Referring to Figure **30**, voicemail table records include a username field **624**, a voicemail server field **626**, a seconds-to-voicemail field **628** and an enable field **630**. The username field **624** stores the username of the subscriber who purchased the service. The voicemail server field **626** holds a code identifying an IP address or a fully qualified domain name (FQDN) of a voicemail server associated with the subscriber identified by the username field **624**. The seconds-to-voicemail field **628** holds a code identifying the time to wait before engaging voicemail and the enable field **630** holds a code representing whether or not voicemail is enabled for the user identified by the contents of the username field **624**. Therefore, referring back to Figure **8C**, at block **620** the processor searches for a voicemail record as shown in Figure **31** having username field **624** contents matching the callee identifier and looks at the contents of the enabled field **630** to determine whether or not voicemail is enabled. If voicemail is enabled, then block **640** in Figure **8C** directs the

-43-

processor to store the contents of the voicemail server field **626** of Figure **31** and the contents of the seconds to voicemail field **628** of Figure **31** in the routing message buffer as shown at **654** in Figure **32**. Referring back to Figure **8C**, block **642** then directs the processor to get time to live (TTL) values for each route specified by the routing message according to any of a plurality of criteria such as, for example, the cost of routing and the user's account balance. These TTL values are then appended to corresponding routes already stored in the routing message buffer.

5

Block **644** of Figure **8C** then directs the RC processor circuit **200** to store the IP address of the current supernode in the routing message buffer as shown at **656** in Figure **32**. An exemplary routing message is shown in the routing message buffer shown in Figure **32**.

10

Block **645** of Figure **8C** then directs the processor to check the caller dialing profile shown in Figure **10** to determine whether or not it contains lawful intercept fields of the type shown in Figure **9** and if so, to determine whether or not the intercept criteria are met. In this embodiment, this includes determining whether the lawful intercept flag field **702** contains a flag indicating that lawful intercept is enabled and checking whether the current date and time is within the period specified by the LI start date/time field contents **708** and the LI stop date/time field contents **710**. If the intercept criteria are met, block **647** directs the RC processor circuit **200** to append the contents of the lawful intercept fields **702**, **704**, **706**, **708**, **710** to the routing message shown in Figure **32A** to produce a routing message with lawful intercept field contents, as shown in Figure **32A**. Again, the determination of whether or not the destination information meets intercept criteria is done prior to producing the routing message so that when the intercept criteria are met, at least some of the intercept information, in this embodiment all of it, can be included in the routing message.

15

20

25

30

-44-

Referring back to Figure 8C, if at block 645, it is determined there are no lawful intercept fields associated with the caller dialing profile of Figure 10 or that the intercept criteria are not met after producing the routing message shown in Figure 32A the processor is directed to block 649 which causes the processor to check the callee dialing profile shown in Figure 11 to determine whether or not it contains lawful intercept fields of the type shown in Figure 9 and if so, to determine whether or not the intercept criteria are met by checking whether the current date and time is within the period specified by the LI start date/time field contents 708 and the LI stop date/time field contents 710 of the callee dialing profile. If the intercept criteria are met, block 651 directs the RC processor circuit 200 to append the contents of the lawful intercept fields 702, 704, 706, 708, 710 associated with the callee dialing profile to the routing message shown in Figure 32A to produce a routing message. If at block 649 of Figure 8C, it is determined there are no lawful intercept fields associated with the callee dialing profile or that the intercept criteria are not met, no lawful intercept fields associated with the callee are appended to the routing message shown in Figure 32 or 32A. Referring back to Figure 8C, block 646 then directs the RC processor circuit 200 to send the routing message to the call controller 14.

Response to Routing Message

Referring back to Figure 1, the routing message, whether of the type shown in Figures 16, 16A, 25, 25A, 32, 32A or 32B, is received at the call controller 14. Referring to Figure 33, when a routing message is received at the call controller, the routing message handler 122 is invoked at the call controller. The routing message handler is shown in detail in Figure 33.

Referring to Figure 33, the routing message handler begins with a first block 1200 that directs the processor circuit to determine whether the routing message includes lawful intercept fields. If not, the processor is directed to block 1206 which causes it to invoke a call handling routine shown in Figure 34. Referring to Figure 34, as a first step in the call handling routine, a

-45-

message **1100** is sent from the call controller **14** to the media relay **17**, the message including the caller telephone IP address and UDP port as determined from the caller IP address field **67** and caller UDP port field **69** in the SIP Invite message shown in Figure **3**.

5

The specific media relay **17** to which the message **1100** is sent may be selected from a pool of available media relays and such media relays may be at any geographical location. The purpose of the message **1100** is to advise the media relay that a call is desired to be set up to communicate with the IP address and UDP number of the caller telephone.

10

A media relay selected from media relays located at a geographical location that facilitates communication at a desired quality of service between the media relay **17** and the caller telephone **12** and callee telephone **15** may provide the best service. Alternatively, media relays may be pre-assigned or pre-associated with users by including and populating media relay fields of the dialing profiles of users, such as shown at **1150** in Figure **9**, identifying one or more media relays through which calls associated with the associated user are to be directed. In this case, the identifications of possible media relays obtained from the media relay fields **1150** may be sent to the call controller in additional fields in the routing message. These media relay fields are shown at **1152** in Figures **16**, **16A**, **25**, **25A**, **32**, **32A** and **32B**. In essence, the media relay through which communications involving the communications involving the subscriber will be conducted is identified in response to the routing message.

15

20

25

Referring back to Figure **34**, in this case, the message **1100** may be sent in a polling fashion to all media relays identified by the media relay fields **1150**, until one responds. Alternatively, the message **1100** may be sent simultaneously to all of the media relays.

30

-46-

In response, in the case where the media relay is known or is involved in polling as described above, the media relay **17** to which the message **1100** is sent sends a media relay status message **1102** back to the call controller **14**, the message including a media relay IP address and UDP port number at which the media relay will establish a UDP connection to the callee telephone **15**. Audio data to/from the callee telephone **15** will be transmitted over this connection. In the case where the message **1100** is sent to a plurality of media relays, the first one to respond with a media relay status message is the one through which the call will be carried. Media relay status messages from the remaining media relays can be ignored.

After the media relay status message **1102** is received at the call controller, the call controller **14** then sends a SIP Invite message **1104** of the type shown in Figure **3** to the callee telephone **15**, including the contents of the caller and callee identifier fields (**60** and **62**), the call identifier field (**65**) and the media relay IP address and the media relay UDP port number assigned to the audio path connection with the callee telephone **15**, to invite the callee telephone to establish a connection with the media relay **17**.

The purpose of the SIP Invite message **1104**, is to advise the callee telephone of the caller and call ID and of the IP address and UDP port number of the media relay through which the callee telephone should send and receive audio data.

The callee telephone **15** stores the media relay IP address and assigned UDP port number in the audio path IP address buffer **47** shown in Figure **2** and configures itself to create a socket between the media relay IP/UDP address and the callee telephone IP address and a UDP port number that the callee telephone **15** desires to use as an audio path to the caller telephone. Instead of being sent or received directly to or from the caller telephone, the callee telephone **15** will send and receive audio data from the media relay. To indicate this, the callee telephone **15** sends a SIP OK message **1106** back to

-47-

the call controller **14**, the message including the callee IP address and UDP port number from its IP address field (**53** in Figure **3**) at which the callee telephone **15** will establish an audio path connection with the media relay **17**. The purpose of this SIP OK message **1106** is to advise the call controller of the IP address and UDP port number through which the media relay should send and receive audio data to and from the callee telephone.

The call controller **14** then sends a message **1108** to the media relay **17** including the IP address and UDP port number that the callee telephone **15** will use for the audio path connection with the media relay. The purpose of the message **1108** is to advise the media relay of the IP address and UDP port number through which it should send and receive audio data to and from the callee telephone.

The media relay **17** then determines a UDP port through which it will carry audio data to and from the caller telephone **12** and sends a message **1110** to the call controller (**14**), the message including the media relay IP address and the media relay UDP port number the media relay will use to carry audio to and from the caller telephone **12**. The purpose of this message **1110** is to advise the call controller **14** of the IP address and UDP port number through which it expects to transfer audio data to and from the caller telephone.

The call controller **14** then sends a SIP OK message **1112** to the caller telephone **12** to indicate that the call may now proceed. The SIP OK message includes the caller and callee usernames, the call ID and the media relay **17** IP address and the UDP port number assigned to the audio connection with the caller telephone **12**. The purpose of this SIP OK message **1112** is to advise the caller telephone **12** of the IP address and UDP port number through which it should exchange audio data with the media relay **17**.

If the routing message is of the type shown in Figure **25** where there are a plurality of suppliers available, the call handling routine proceeds as described

-48-

above with the exception that instead of communicating with the callee telephone directly, the call controller **14** communicates with a gateway provided by a supplier. If a SIP OK message is not received back from the first gateway, the processor is directed to send the SIP Invite message **1104** to a gateway of the next indicated supplier. For example, the call controller **14** sends the SIP Invite message **1104** to the first supplier, in this case Telus, to determine whether or not Telus is able to handle the call. If Telus does not send back a SIP OK message **1106** within a specified time or sends a message indicating that it is not able to handle the call, the call controller proceeds to send a SIP Invite message **1104** to the next supplier, in this case Shaw. The process is repeated until one of the suppliers responds with a SIP OK message **1106** indicating that it is available to carry the call and the process proceeds as shown in connection with messages **1108**, **1110** and **1112**. For example, the supplier "Telus" sends back a SIP OK message and thus provides a gateway to the PSTN at IP address **72.64.39.58** as provided by the routing message from the contents of the route identifier field **546** of the corresponding supplier record shown in Figure **22**.

Referring back to Figure **1**, if the call controller **14** receives a message of the type shown in Figure **32**, i.e., a type that has one call forwarding number and/or a voicemail number, the call controller attempts to establish a call (using SIP Invite message **1104**) to the callee telephone **15** and if no call is established (i.e., message **1106** is not received) within a pre-determined time, the call controller **14** attempts to establish a call with the next user identified in the call routing message, by sending a SIP invite message like message **1104** to the next user. This process is repeated until all call forwarding possibilities have been exhausted, in which case an audio path is established with the voicemail server **19** identified in the routing message. The voicemail server **19** sends the SIP OK message **1106** in response to receipt of the SIP invite message **1104** and functions as described above in connection with the callee telephone **15** to permit an outgoing audio message provided by the voicemail

-49-

server to be heard by the caller and to permit the caller to record an audio message on the voicemail server.

5 When audio paths are established, a call timer (not shown) maintained by the call controller logs the start date and time of the call and logs the call ID and adds an active call record of the type shown in Figure 35 to an active call list, maintained by the call controller.

10 In this embodiment, the call controller active call record shown in Figure 35 includes a call ID field 1300, a caller IP address field 1302, a caller port field 1304, a callee IP address field 1306, a callee port field 1308, a media relay ID field 1310, a media relay caller port field 1312 and a media relay callee port field 1314. The contents of the call ID field 1300 are established at block 136 in Figure 5. The contents of the caller IP address field 1302 are established
15 from the contents of the caller IP address field 67 of the SIP invite message shown in Figure 3. The contents of the caller port field 1304 are established from the caller UDP port field 69 of the SIP invite message shown in Figure 3. The contents of the callee IP address field 1306 and callee port field 1308 are established from the SIP OK message 1106 shown in Figure 34.

20 The media relay ID field 1310 is populated with an identification of the media relay handling the call. In the example shown, the media relay is number 42. The contents of the media relay caller port field are obtained from the message 1110 shown in Figure 34 and the contents in the media relay callee
25 port field 1314 are obtained from the media relay status message 1102 shown in Figure 34. Each time a call is established, an active call record of the type shown in Figure 35 is added to an active call log maintained by the call controller.

30 The routing controller also maintains an active call log containing active call records however the active call records maintained by the routing controller are different from the active call records held by the call controller. For

-50-

example, referring to Figure 36, an active call record held by the routing controller includes a call ID field 1316, a caller field 1318, a callee field 1320 and a call controller ID field 1322. Information for populating these fields may be received in a message (not shown) transmitted from the call controller to the routing controller after an active call record has been entered into the active call log of the call controller.

The message from the call controller 14 to the routing controller 16, indicating that an active call has been established may include the contents of the call ID field 1300 shown in Figure 35 and a call controller unique ID number held by the call controller. The routing controller 16 matches the call ID with the caller and callee user names contained in the original call routing message (Fig 16, 16A, 25, 25A, 32, 32A, 32B) that caused the call controller 14 to route the call, to populate the caller and callee fields 1318 and 1320 shown in Figure 36, respectively. It will be appreciated that a plurality of call controllers may be associated with a single routing controller, in which case the call controller ID allows the routing controller to uniquely identify the call controller associated with the call ID indicated by the contents of the call ID field 1316. In the example shown, the call controller is number 61.

The active call records facilitate intercepting a call already in progress, as will be described below.

Referring back to Figure 33, if at block 1200 it is determined that the routing message has lawful intercept fields, block 1202 directs the call controller circuit 100 (Figure 4) to send a SIP Invite message as shown in Figure 37 to a mediation device identified by the mediation device IP address in the routing message as obtained from the user dialing profile MD1 address field 704 as shown at 256 in Figure 9. Referring to Figure 37, the SIP Invite message includes caller and callee identifier fields 1020, 1022, a call ID field 1024, a warrant ID field 1026 and other intercept related information fields 1028, if desired. The caller, callee and call ID field contents 1020, 1022, and 1024 are

-51-

obtained from the original SIP Invite message shown in Figure 6. The contents of the warrant ID field **1026** and intercept related info fields **1028** are obtained from the routing message which would be of the type shown in Figures **16A**, **25A**, **32A** or **32B**.

5

Referring back to Figure **33**, block **1204** then directs the call controller **14** to receive a reply message, as shown in Figure **38**, from the mediation device **31**. The reply message is a SIP OK message that includes caller, callee, and call ID fields **1040**, **1042**, **1044** as described above and further includes a mediation device IP address field **1046** and a mediation device UDP caller port number field **1048** and a UDP callee port number field **1050** identifying UDP ports at the mediation device IP address to which the media relay is to send copies of audio data streams received from the caller and callee telephones respectively. Block **1206** then directs the call controller to execute the call handling routine shown in Figure **34** with the exception that the message **1100** additionally includes the contents of the mediation device IP address field **1046**, the mediation device UDP caller port number field **1048** and the UDP callee port number field **1050** of the SIP OK message shown in Figure **38**.

10

15

20

All other messages are the same as described above in connection with the call handling routine as shown in Figure **34**, but in response to receiving the additional information in the message **1100**, the media relay automatically configures itself to provide for copying the audio data received from both the caller telephone and the callee telephone to the mediation device IP address and the UDP caller port number and the UDP callee port number respectively.

25

30

Referring back to Figure **1**, as audio data originating at the caller telephone **12** and callee telephone **15** passes through the media relay **17**, this data is copied to the mediation device UDP port for the caller and the mediation device UDP port for the callee, as indicated by the SIP invite message **1100**. This enables law enforcement agencies to monitor audio communications

-52-

between the caller and callee and/or to record such communications at the mediation device.

Thus, when the determination information in the dialing profile meets intercept
5 criteria, the call controller communicates with the media relay through which
communications involving the subscriber whose communications are to be
monitored will be handled to cause the media relay to send a copy of such
communications to a mediation device specified by the destination information
10 included in the intercept information associated with the dialing profile
associated with the subscriber whose communications are to be monitored.

Terminating the Call

In the event that either the caller or the callee terminates a call, the telephone
of the terminating party sends a SIP Bye message to the call controller **14**. An
15 exemplary SIP Bye message is shown at **900** in Figure **39** and includes a
caller field **902**, a callee field **904** and a call ID field **906**. The caller field **902**
holds the caller username, the callee field **904** holds a PSTN compatible
number or username, and the call ID field **906** holds a unique call identifier
field of the type shown in the call identifier field **65** of the SIP Invite message
20 shown in Figure **3**.

Thus, for example, referring to Figure **40**, a SIP Bye message for the Calgary
callee is shown generally at **908** and the caller field **902** holds a username
identifying the Vancouver caller, in this case **2001 1050 8667**, the callee field
25 **904** holds a username identifying the Calgary callee, in this case **2001 1050**
2222, and the call ID field **906** holds the code **FA10@192.168.0.20**, which is
the call ID for the call.

The SIP Bye message shown in Figure **40** is received at the call controller **14**
30 and the call controller executes a process as shown generally at **910** in Figure
41. The process includes a first block **912** that directs the call controller circuit
(**100**) to copy the caller, callee and call ID field contents from the SIP Bye

-53-

message **900** shown in Figure **39** received from the terminating party to corresponding fields of an RC stop message buffer (not shown). Block **914** then directs the call controller circuit **100** to copy the call start time from the call timer and to obtain a Call Stop time from the call timer. Block **916** then directs the call controller to calculate a communication session time by determining the difference in time between the call start time and the Call Stop time. This communication session time is then stored in a corresponding field of the RC Call Stop message buffer. Block **918** then directs the call controller circuit **100** to populate the route field with the IP address of the gateway supplier, if any. An RC Call Stop message produced as described above is shown generally at **1000** in Figure **42**. An RC Call Stop message specifically associated with the call made to the Calgary callee is shown generally at **1021** in Figure **43**.

Referring to Figure **42**, the RC call stop message **1000** includes a caller field **1002**, callee field **1004**, a call ID field **1006**, an account start time field **1008**, an account stop time field **1010**, a communication session time field **1012** and a route field **1014**. The caller field **1002** holds a username, the callee field **1004** holds a PSTN-compatible number or system number, the call ID field **1006** holds the unique call identifier received from the SIP Invite message shown in Figure **3**, the account start time field **1008** holds the date and start time of the call, the account stop time field **1010** holds the date and time the call ended, the communication session time field **1012** holds a value representing the difference between the start time and the stop time, in seconds, and the route field **1014** holds the IP address for a gateway, if a gateway is used to establish the call.

Referring to Figure **43**, an exemplary RC call stop message for the Calgary callee is shown generally at **1021**. In this example the caller field **1002** holds the username **2001 1050 8667** identifying the Vancouver caller and the callee field **1004** holds the username **2001 1050 2222** identifying the Calgary callee. The contents of the call ID field **1006** are **FA10@192.168.0.20**. The contents

-54-

of the account start time field **1008** are **2006-12-30 12:12:12** and the contents of the account stop time field **1010** are **2006-12-30 12:12:14**. The contents of the communication session time field **1012** are **2** to indicate **2** seconds call duration and the contents of the route field are blank but would be **72.64.39.58** if the "Telus" gateway were used, for example.

Referring back to Figure **41**, after having produced an RC Call Stop message, block **920** directs the call controller circuit **100** to send the RC stop message contained in the RC Call Stop message buffer to the routing controller (**16**).

The RC (**16**) receives the Call Stop message and an routing controller Call Stop message process (not shown) is invoked at the routing controller to deal with charges and billing for the call.

Block **922** directs the call controller circuit **100** to send a Bye message to the party that did not terminate the call i.e. to the non-terminating party.

Block **924** then directs the call controller circuit **100** to send a SIP Bye message of the type shown in Figure **39** to the media relay **17** to cause the media relay to disconnect the audio path sockets associated with the caller telephone IP/UDP address and the callee telephone IP/UDP address. In disconnecting these communication sockets, the media relay **17** deletes associations between the caller telephone IP/UDP address media relay caller IP/UDP address and between the caller telephone IP/UDP address and media relay callee IP/UDP address.

If the media relay (**17**) was configured for lawful intercept, block **926** of Figure **41** then directs the call controller circuit **100** to send a SIP Bye message of the type shown in Figure **39** to the mediation device **31** to inform the mediation device that the call has ended and to disconnect communication sockets between the media relay caller and callee IP/UDP port addresses and

-55-

the IP/UDP port address to which the audio data received at the caller and callee IP/UDP port addresses were being copied.

5 It will be appreciated that in the foregoing description, the components described cooperate to detect a requirement for intercept at the time a call is set up. In the following description an explanation is provided to describe how to intercept a call while the call is in progress.

Intercepting a Call in Progress

10 Referring back to Figure 1, to intercept a call while the call is in progress, the law enforcement authority **293** may communicate with a mediation device, or may communicate with the call controller or may communicate with the routing controller or may communicate with a handover interface that
15 communicates with any of the foregoing components to cause the routing controller to receive a law enforcement authority (LEA) intercept request message including intercept information. Such as that which would be associated with fields **702-710** in Figure 9, for example..

20 In response to receipt of a, LEA intercept request message, the routing controller LEA request message handler shown at **1400** in Figure 44 is invoked.

25 The LEA request message handler **1400** begins with a first block **1402** that directs the routing controller processor circuit to communicate with the database **18** in which dialing profile records of the type shown in Figure 9 are stored to find a dialing profile associated with the user whose calls are to be monitored.

30 If the username is not known, but a DID number (i.e. a PSTN number) is known, the routing controller may cause a search through the DID bank table records of the type shown in Figure 13, for example to find a username associated with a DID number. If the username is not known but a name and

-56-

address is known, other records such as billing records (not shown) associating names and addresses with usernames may be searched to find a username associated with a given name and/or address of a person whose calls are to be intercepted. Regardless of the information available, to facilitate call interception any way of finding the unique dialing profile associated with the user whose calls are to be intercepted is a first step to facilitating call interception, in this embodiment.

Once the dialing profile is located, block **1404** directs the routing controller processor circuit to associate the intercept information with the dialing profile by appending and/or populating the lawful intercept fields of the dialing profile with such information as provided in the LEA intercept request message..

Block **1406** then directs the routing controller processor circuit to determine whether the intercept criteria are met by the intercept information now included in the dialing profile. This is done by determining whether the LI flag (**702**) is on, and the current date and time is within the LI start stop date/time ranges. If the intercept criteria are not met, the process is ended. Otherwise the processor is directed to block **1408**.

Block **1408** directs the routing controller processor circuit to use the username of the dialing profile found at block **1402** to search caller and callee fields of routing controller active call records shown in Figure **36** that have contents matching the username associated with the dialing profile. If no such record is found, the user is not currently engaged in a call and the process is ended. If the user is engaged in a call, the routing controller active call record will be found. Block **1410** then directs the routing controller processor circuit to find the call controller id and call id of the associated call, from the routing controller active call record shown in Figure **36**.

Block **1412** then directs the routing controller processor circuit to transmit an in-call intercept message to the call controller identified by the contents of the

-57-

5 call controller id field **1322** of the routing controller active call record. The in-call intercept message includes the call id as determined from the routing controller active call record and the IP address of the mediation device associated with the law enforcement authority interested in intercepting the call. The IP address of the mediation device may be obtained from the law enforcement authority request message, or the dialing profile, for example.

10 Block **1414** then directs the routing controller processor circuit to wait a specified time to receive a call controller intercept status message back from the call controller indicating whether or not the intercept function has been activated.

15 Referring to Figure **45**, upon receipt of an in-call intercept message at the call controller (**14**) the call controller executes an in-call intercept message handler shown generally at **1450**. The in-call intercept message handler **1450** begins with a first block **1452** that directs the call controller processor circuit to send a SIP invite message to the mediation device associated with the IP address of the mediation device, received in the in-call intercept message.

20 Block **1454** then directs the call controller processor circuit to receive an IP address and callee and caller UDP port numbers from the mediation device, where this IP address and UDP port numbers are network locations at which the mediation device will expect to receive audio data streams from the media relay through which the call is carried.

25 Block **1456** then directs the call controller processor circuit to identify a media relay through which communications to be monitored are being conducted by using the username of the subscriber whose communications are to be monitored to locate an active call record in the call controller active call list to locate a media relay identifier such as the IP address of the media relay indicated by the contents of the media relay ID field **1310** of the call controller active call record shown in Figure **35**. The call controller processor circuit is

30

-58-

then directed to send an intercept request message to the media relay (17) that is handling the call. The intercept request message includes the mediation device IP address and caller and callee UDP port numbers to identify to the media relay (17) the mediation device IP address and UDP port number(s) at which it expects to receive a copy of the audio data stream from the caller and callee respectively.

In response, the media relay establishes internal connections between the caller and callee IP addresses and UDP ports and callee IP address and UDP port of the mediation device. Then, the media relay sends a media relay status message back to the call controller indicating whether or not internal connections have been established and that call intercept has been initiated.

As seen at block 1458, the call controller processor circuit is directed to receive the media relay status message and block 1460 directs the call controller processor circuit to send a call controller intercept status message back to the routing controller to indicate that the call intercept function has been established. The routing controller may communicate this status back to the law enforcement authority that issued the law enforcement authority request message. In the meantime, communications involving the caller or callee whose communications are to be monitored, which travel through the media relay, are copied and sent to the mediation device.

Thus, after associating intercept information with the dialing profile of the subscriber whose communications are to be monitored, when the determination information included in the intercept information meets intercept criteria, the call controller communicates with the media relay through which the communications of the subscriber whose communications are to be monitored to cause such media relay to send a copy of such communications to a mediation device specified by the destination information included in the intercept information.

-59-

When the call is ended, the call is shut down in the same way as described above.

5 Should the law enforcement authority desire to cease interception of the call during the call, an LEA request message requesting that the intercept function be stopped is sent to the routing controller from the law enforcement authority through any of the paths described above. This invokes the LEA request message handler such as shown in Figure 44 which causes the routing controller processor circuit to execute blocks 1402, 1404. At block 1404, the
10 routing controller processor circuit is directed to change the contents of the lawful intercept fields to at least set the lawful intercept flag (702 in Figure 9) inactive.

15 Then, at block 1406, the intercept criteria are not met and the processor is directed to block 1416, which causes the routing controller processor circuit to determine whether or not an interception function is in progress. This can be determined, for example, by maintaining evidence of the receipt of the confirmation message from the call controller, received at block 1414 of the LEA request message handler 1400.

20

If an intercept is not in progress, the LEA request message handler 1400 is ended.

25 If an intercept is in progress, block 1418 directs the routing controller processor circuit to execute an in-call intercept shut down routine as shown at 1500 in Figure 46. The in-call intercept shut down routine begins with a first block 1502 which directs the routing controller processor circuit to locate the routing controller active call record having caller or callee field contents equal to the username indicated in the dialing profile found at block 1402 of the LEA request message handler 1400 shown in Figure 44. Having found the active
30 call record, block 1504 directs the routing controller processor circuit to find, in the routing controller active call record shown in Figure 36, the call

-60-

controller id (**1322**) and the call id (**1316**) associated with the call. Block **1506** then directs the routing controller processor circuit to send a cease intercept message (not shown) to the call controller identified by the call controller id determined at block **1504**. This cease intercept message includes the call id
5 determined at block **1504** and an identification of the mediation device, the identification being obtained from the MD1 address field (**704** in Figure **9**) of the dialing profile for the user whose calls are currently being intercepted. Block **1508** then directs the routing controller processor circuit to wait a specified time to receive a confirmation message from the call controller to
10 indicate that the intercept function has been shut down.

Referring to Figure **47**, upon receipt of the cease intercept message at the call controller (**14**), a cease intercept message handler **1520** is invoked at the call controller. The cease intercept message handler **1520** begins with a first
15 block **1522** that directs the call controller processor circuit to send a SIP stop message to the mediation device identified in the cease intercept message received from the routing controller. In response to the SIP stop message, the mediation device stops receiving audio data and sends a confirmation message back to the call controller.

20 Block **1524** directs the call controller processor circuit to receive the confirmation message back from the mediation device.

Block **1526** then directs the call controller processor circuit to send a stop
25 intercept message to the media relay **17** identified by the contents of the media relay ID field **1310** of the active call record shown in Figure **35**. The stop intercept message includes the contents of the media relay caller port ID field **1312** and media relay callee port field **1314** included in the active call record and identifies to the media relay which ports to shut down. In response
30 to the stop intercept message, the media relay **17** disconnects the connections between the media relay caller port and the mediation device port that was receiving the audio data from the caller and the connection between

-61-

the media relay callee port and the mediation device port that was receiving audio data from the callee. The media relay then sends an MR stop status message to the call controller.

5 Block **1528** directs the call controller processor circuit to receive the MR stop status message and block **1530** directs the call controller to send a stop status message to the routing controller **16**.

10 In an alternative embodiment, the routing controller does not maintain active call records but each call controller does. In such an embodiment, blocks **1408** and **1410** of Figure **44** are replaced with a single block **1600** that directs the routing controller processor circuit to poll each call controller to determine whether or not its active call list contains an entry having caller or callee field contents equal to the username determined from the dialing profile located at
15 block **1402**.

If any of the polled call controllers has such a record, that call controller transmits a response message back to the routing controller, the response message including a call controller ID identifying that call controller. More than
20 one call controller may have an active call record having caller or callee field contents equal to the username determined from the user profile. Such would be the case in a conference call, for example.

The routing controller processor circuit then executes blocks **1412** and **1414**
25 as described above or the process is ended if none of the polled call controllers contains a call record with caller and callee field contents matching the username determined from the dialing profile located at block **1402**.

In effect therefore, block **1600** provides an alternate way of finding call
30 controllers that are currently carrying a call associated with the user of interest.

-62-

In another embodiment, an interface to the routing controller and/or the call controller may be provided to enable law enforcement authorities to have direct access or a copy of the active call list maintained by the call controller and/or routing controller.

5

From the foregoing, it will be appreciated that indications of whether or not communications of a subscriber to the system are to be monitored are provided by law enforcement agencies directly into a subscriber dialing profile shown in Figure 9. This dialing profile is used to route a call involving the subscriber and is checked for lawful intercept requirements to determine whether or not the media relay should copy audio data associated with the call to a mediation device for lawful monitoring and/or recording purposes.

10

While the system has been described in connection with the monitoring of audio streams, it may similarly be used for monitoring any other data streams such as pure data and/or video or multimedia data, for example, between subscribers to the system or between a subscriber and a non-subscriber to the system.

15

While specific embodiments of the invention have been described and illustrated, such embodiments should be considered illustrative of the invention only and not as limiting the invention as construed in accordance with the accompanying claims.

20

What is claimed is:

1. A method for intercepting communications in an Internet Protocol (IP) network, the method comprising:

5

maintaining dialing profiles for respective subscribers to the IP network, each said dialing profile including a username associated with the corresponding subscriber;

10

associating intercept information with the dialing profile of a subscriber whose communications are to be monitored, said intercept information including determination information for determining whether to intercept a communication involving said subscriber, and destination information identifying a device to which intercepted communications involving said subscriber are to be sent; and

15

when said determination information meets intercept criteria, communicating with a media relay through which said communications involving said subscriber will be conducted or are being conducted to cause said media relay to send a copy of said communications to a mediation device specified by said destination information.

20

25

2. The method of clam 1 wherein associating intercept information comprises associating said intercept information with said dialing profile when communications involving said subscriber are not in progress.

30

3. The method of clam 1 wherein associating intercept information comprises associating said intercept information when communications involving said subscriber are in progress.

-64-

- 5 4. The method of claim 2 or 3 wherein associating said intercept information comprises populating intercept information fields in said dialing profile of the subscriber whose communications are to be monitored.
- 10 5. The method of claim 1 further comprising producing a routing message for routing communications involving the subscriber through components of the IP network and determining whether said determination information meets said intercept criteria prior to producing said routing message and including at least some of said intercept information in said routing message when said determination information meets said intercept criteria.
- 15 6. The method of claim 5 wherein determining whether said determination information meets said intercept criteria comprises determining whether a current date and time is within a range specified by said determination information.
- 20 7. The method of claim 6 further comprising identifying a media relay through which communications involving said subscriber will be conducted in response to said routing message.
- 25 8. The method of claim 7 further comprising pre-associating at least one media relay with said dialing profile of the subscriber whose communications are to be monitored and wherein identifying said media relay comprises identifying the media relay pre-associated with said subscriber whose communications are to be monitored.
- 30 9. The method of claim 8 wherein pre-associating comprises populating media relay fields in said dialing profile with an identification of at least one media relay.

-65-

- 5 **10.** The method of claim **1** wherein said intercept information is associated with said dialing profile of the subscriber whose communications are to be monitored, in response to receipt of an intercept request message, wherein said intercept request message comprises said intercept information.
- 10 **11.** The method of claim **10** further comprising invoking an intercept request message handler to:
- a) find a dialing profile associated with the subscriber whose communications are to be monitored;
- b) perform the step of associating said intercept information with said dialing profile;
- 15 c) determine whether said intercept criteria are met; and
- d) identify a media relay through which said communications are being conducted.
- 20 **12.** The method of claim **11** further comprising maintaining a active call records for communications in progress, said active call records comprising a username identifier and a media relay identifier identifying the media relay through which said communications are being conducted and wherein identifying a media relay through which said communications are being conducted comprises locating an active call record associated with communications of the subscriber whose communication are to be monitored to find the media relay associated with said communications.
- 25 **13.** The method of claim **12** further comprising maintaining direct inward dialing (DID) records associating PST telephone numbers with usernames of users subscribing to said IP network, and wherein finding a dialing profile associated with the subscriber whose communications are to be monitored comprises finding a username in a DID record
- 30

-66-

bearing a PSTN number associated with the subscriber whose communications are to be monitored and using said username to locate a dialing profile associated with said username.

- 5 **14.** An apparatus for intercepting communications in an Internet Protocol (IP) network, the apparatus comprising:

10 means for maintaining dialing profiles for respective subscribers to the IP network, each said dialing profile including a username associated with the corresponding subscriber;

15 means for associating intercept information with the dialing profile of a subscriber whose communications are to be monitored, said intercept information including determination information for determining whether to intercept a communication involving said subscriber, and destination information identifying a device to which intercepted communications involving said subscriber are to be sent; and

20 means for communicating with a media relay through which said communications involving said subscriber will be conducted or are being conducted to cause said media relay to send a copy of said communications to a mediation device specified by said destination information, when said determination information
25 meets intercept criteria.

- 30 **15.** The apparatus of clam **14** wherein said means for associating intercept information is operably configured to associate said intercept information with said dialing profile when communications involving said subscriber are not in progress.

-67-

16. The apparatus of claim **14** wherein said means for associating intercept information is operably configured to associate said intercept information when communications involving said subscriber are in progress.

5

17. The apparatus of claim **15** or **16** wherein said means for associating said intercept information is operably configured to populate intercept information fields in said dialing profile of the subscriber whose communications are to be monitored.

10

18. The apparatus of claim **14** further comprising means for producing a routing message for routing communications involving the subscriber through components of the IP network and means for determining whether said determination information meets said intercept criteria prior to producing said routing message and wherein said means for producing said routing message is operably configured to include at least some of said intercept information in said routing message when said determination information meets said intercept criteria.

15

19. The apparatus of claim **18** wherein said means for determining whether said determination information meets said intercept criteria is operably configured to determine whether a current date and time is within a range specified by said determination information.

20

20. The apparatus of claim **19** further comprising means for identifying a media relay through which communications involving said subscriber will be conducted in response to said routing message.

25

21. The apparatus of claim **20** further comprising means for pre-associating at least one media relay with said dialing profile of the subscriber whose communications are to be monitored and wherein said routing means is operably configured to identify from said dialing

30

-68-

profile the media relay pre-associated with said subscriber whose communications are to be monitored.

- 5 **22.** The apparatus of claim **21** wherein said means for pre-associating is operably configured to populate media relay fields in said dialing profile with an identification of at least one media relay.
- 10 **23.** The apparatus of claim **14** wherein means for associating said intercept information is operably configured to associate said intercept information associated with said dialing profile of the subscriber whose communications are to be monitored, in response to receipt of an intercept request message, wherein said intercept request message comprises said intercept information.
- 15 **24.** The apparatus of claim **23** further comprising means for handling an intercept request message, said means for handling an intercept request message comprising:
- 20 a) means for find a dialing profile associated with the subscriber whose communications are to be monitored, said means for finding a dialing profile cooperating with said means for associating said intercept information with said dialing profile to cause said intercept information to be associated with said dialing profile;
- 25 b) means for determining whether said intercept criteria are met; and
- c) means for identifying a media relay through which said communications are being conducted.
- 30 **25.** The apparatus of claim **24** further comprising means for maintaining active call records for communications in progress, said active call records comprising a username identifier and a media relay identifier identifying the media relay through which said communications are

-69-

being conducted and wherein said means for identifying a media relay through which said communications are being conducted is operably configured to locate an active call record associated with communications of the subscriber whose communication are to be monitored to find the media relay associated with said communications.

5

- 26.** The apparatus of claim **25** further comprising means for maintaining direct inward dialing (DID) records associating PST telephone numbers with usernames of users subscribing to said IP network, and wherein said means for finding a dialing profile associated with the subscriber whose communications are to be monitored is operably configured to find a username in a DID record bearing a PSTN number associated with the subscriber whose communications are to be monitored and use said username to locate a dialing profile associated with said username.

10

15

**AMENDED CLAIMS received by the International Bureau on 14 May 2008
(14/05/08)**

What is claimed is:

1. A method for intercepting communications in an Internet Protocol (IP) network, the method comprising:

5

maintaining dialing profiles for respective subscribers to the IP network, each said dialing profile including a username associated with the corresponding subscriber;

10

associating intercept information with a dialing profile of a subscriber whose communications are to be monitored, said intercept information including determination information for determining whether to intercept a communication involving said subscriber, and destination information identifying a mediation device to which intercepted communications involving said subscriber are to be sent; and

15

selecting a media relay through which communications involving said subscriber and a callee or caller of said subscriber will be conducted, by selecting a media relay from a pool of media relays at any of a plurality of geographical locations to identify a selected media relay;

20

when said determination information meets intercept criteria, communicating with said selected media relay through which said communications involving said subscriber will be conducted or are being conducted to cause said selected media relay to send a copy of said communications to a mediation device specified by said destination information.

25

30

2. The method of claim 1 wherein associating intercept information comprises associating said intercept information with said dialing

profile when communications involving said subscriber are not in progress.

- 5
3. The method of claim 1 wherein associating intercept information comprises associating said intercept information when communications involving said subscriber are in progress.
- 10
4. The method of claim 2 or 3 wherein associating said intercept information comprises populating intercept information fields in said dialing profile of the subscriber whose communications are to be monitored.
- 15
5. The method of claim 1 further comprising producing a routing message for routing communications involving the subscriber through components of the IP network and determining whether said determination information meets said intercept criteria prior to producing said routing message and including at least some of said intercept information in said routing message when said determination information meets said intercept criteria.
- 20
6. The method of claim 5 wherein determining whether said determination information meets said intercept criteria comprises determining whether a current date and time is within a range specified by said determination information.
- 25
7. The method of claim 6 wherein producing a routing message comprises identifying a media relay through which communications involving said subscriber will be conducted and including an identification of said media relay in said routing message.
- 30
8. The method of claim 7 further comprising pre-associating at least one media relay with said dialing profile of the subscriber whose

communications are to be monitored and wherein identifying said media relay comprises identifying the media relay pre-associated with said subscriber whose communications are to be monitored.

- 5 **9.** The method of claim 8 wherein pre-associating comprises populating media relay fields in said dialing profile with an identification of at least one media relay.
- 10 **10.** The method of claim 1 wherein said intercept information is associated with said dialing profile of the subscriber whose communications are to be monitored, in response to receipt of an intercept request message, wherein said intercept request message comprises said intercept information.
- 15 **11.** The method of claim 10 further comprising invoking an intercept request message handler to:
- a) find a dialing profile associated with the subscriber whose communications are to be monitored;
 - b) perform the step of associating said intercept information with said dialing profile;
 - c) determine whether said intercept criteria are met; and
 - d) identify a media relay through which said communications are being conducted.
- 20
- 25 **12.** The method of claim 11 further comprising maintaining active call records for communications in progress, said active call records comprising a username identifier and a media relay identifier identifying the media relay through which said communications are being conducted and wherein identifying a media relay through which said communications are being conducted comprises locating an active call record associated with communications of the subscriber whose
- 30

communication are to be monitored to find the media relay associated with said communications.

5 13. The method of claim 12 further comprising maintaining direct-in-dial (DID) records associating PST telephone numbers with usernames of users subscribing to said IP network, and wherein finding a dialing profile associated with the subscriber whose communications are to be monitored comprises finding a username in a DID record bearing a PSTN number associated with the subscriber whose communications are to be monitored and using said username to locate a dialing profile associated with said username.

10

14. An apparatus for intercepting communications in an Internet Protocol (IP) network, the apparatus comprising:

15

means for maintaining dialing profiles for respective subscribers to the IP network, each said dialing profile including a username associated with the corresponding subscriber;

20

means for associating intercept information with a dialing profile of a subscriber whose communications are to be monitored, said intercept information including determination information for determining whether to intercept a communication involving said subscriber, and destination information identifying a mediation device to which intercepted communications involving said subscriber are to be sent; and

25

means for selecting a media relay through which communications involving said subscriber and a callee or caller of said subscriber will be conducted, by selecting a media relay

30

from a pool of media relays at any of a plurality of geographical locations to identify a selected media relay;

5 means for communicating with said selected media relay through which said communications involving said subscriber will be conducted or are being conducted to cause said selected media relay to send a copy of said communications to a mediation device specified by said destination information, when
10 said determination information meets intercept criteria.

15 **15.** The apparatus of claim 14 wherein said means for associating intercept information is operably configured to associate said intercept information with said dialing profile when communications involving said subscriber are not in progress.

20 **16.** The apparatus of claim 14 wherein said means for associating intercept information is operably configured to associate said intercept information when communications involving said subscriber are in progress.

25 **17.** The apparatus of claim 15 or 16 wherein said means for associating said intercept information is operably configured to populate intercept information fields in said dialing profile of the subscriber whose communications are to be monitored.

30 **18.** The apparatus of claim 14 further comprising means for producing a routing message for routing communications involving the subscriber through components of the IP network and means for determining whether said determination information meets said intercept criteria prior to producing said routing message and wherein said means for producing said routing message is operably configured to include at

least some of said intercept information in said routing message when said determination information meets said intercept criteria.

- 5
- 19.** The apparatus of claim **18** wherein said means for determining whether said determination information meets said intercept criteria is operably configured to determine whether a current date and time is within a range specified by said determination information.
- 10
- 20.** The apparatus of claim **19** wherein said means for producing said routing message is operably configured to identify a media relay through which communications involving said subscriber will be conducted and to include ng an identification of said media relay in said routing message.
- 15
- 21.** The apparatus of claim **20** further comprising means for pre-associating at least one media relay with said dialing profile of the subscriber whose communications are to be monitored and wherein said routing means is operably configured to identify from said dialing profile the media relay pre-associated with said subscriber whose
- 20
- communications are to be monitored.
- 22.** The apparatus of claim **21** wherein said means for pre-associating is operably configured to populate media relay fields in said dialing profile with an identification of at least one media relay.
- 25
- 23.** The apparatus of claim **14** wherein means for associating said intercept information is operably configured to associate said intercept information associated with said dialing profile of the subscriber whose communications are to be monitored, in response to receipt of an intercept request message, wherein said intercept request message
- 30
- comprises said intercept information.

24. The apparatus of claim 23 further comprising means for handling an intercept request message, said means for handling an intercept request message comprising:

5

a) means for finding a dialing profile associated with the subscriber whose communications are to be monitored, said means for finding a dialing profile cooperating with said means for associating said intercept information with said dialing profile to cause said intercept information to be associated with said dialing profile;

10

b) means for determining whether said intercept criteria are met; and

c) means for identifying a media relay through which said communications are being conducted.

15

25. The apparatus of claim 24 further comprising means for maintaining active call records for communications in progress, said active call records comprising a username identifier and a media relay identifier identifying the media relay through which said communications are being conducted and wherein said means for identifying a media relay through which said communications are being conducted is operably configured to locate an active call record associated with communications of the subscriber whose communication are to be monitored to find the media relay associated with said communications.

20

25

26. The apparatus of claim 25 further comprising means for maintaining direct-in-dial (DID) records associating PST telephone numbers with usernames of users subscribing to said IP network, and wherein said means for finding a dialing profile associated with the subscriber whose communications are to be monitored is operably configured to find a username in a DID record bearing a PSTN number associated with the subscriber whose communications are to be monitored and use said username to locate a dialing profile associated with said username.

30

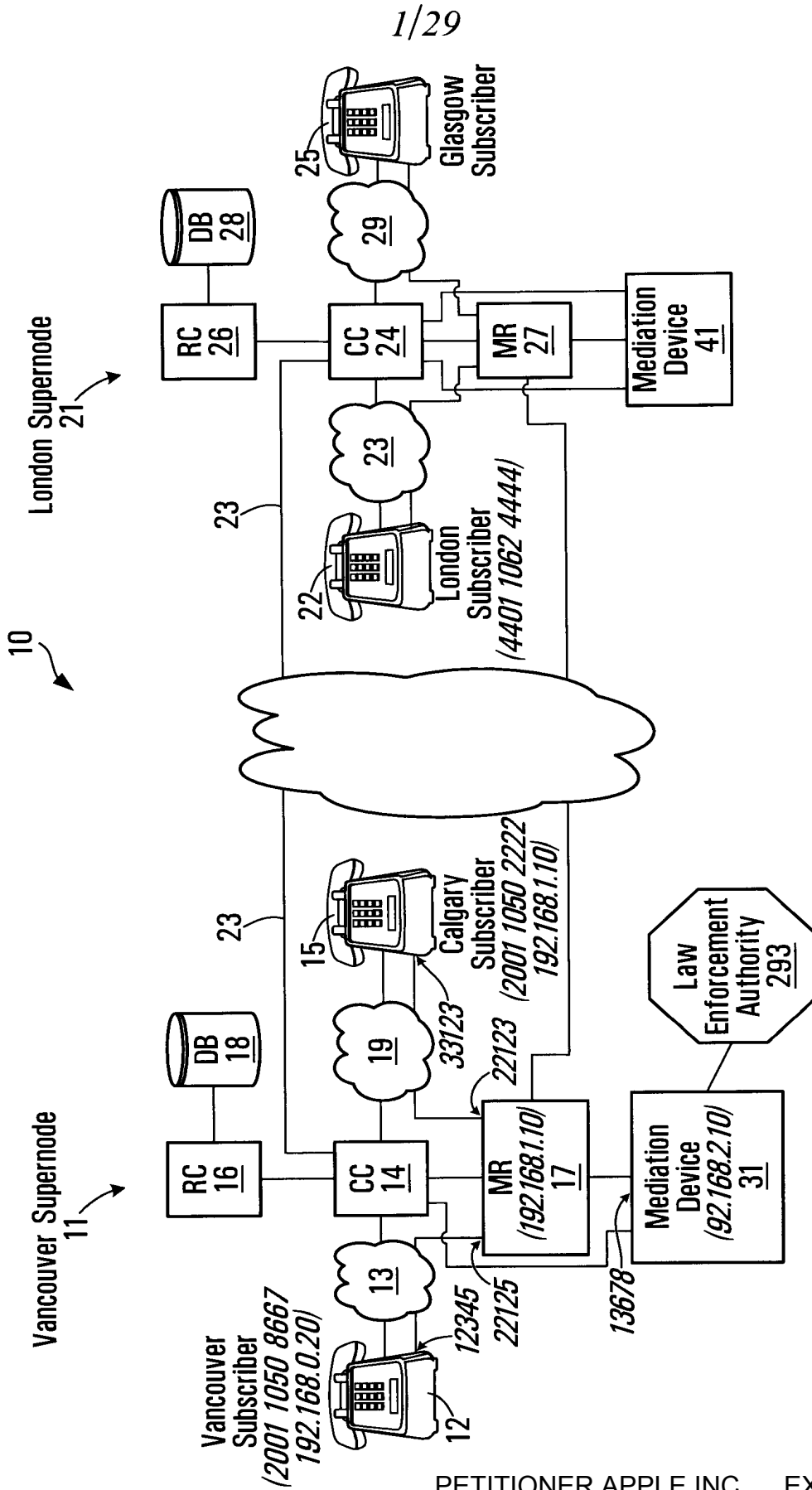

FIG. 1

2/29

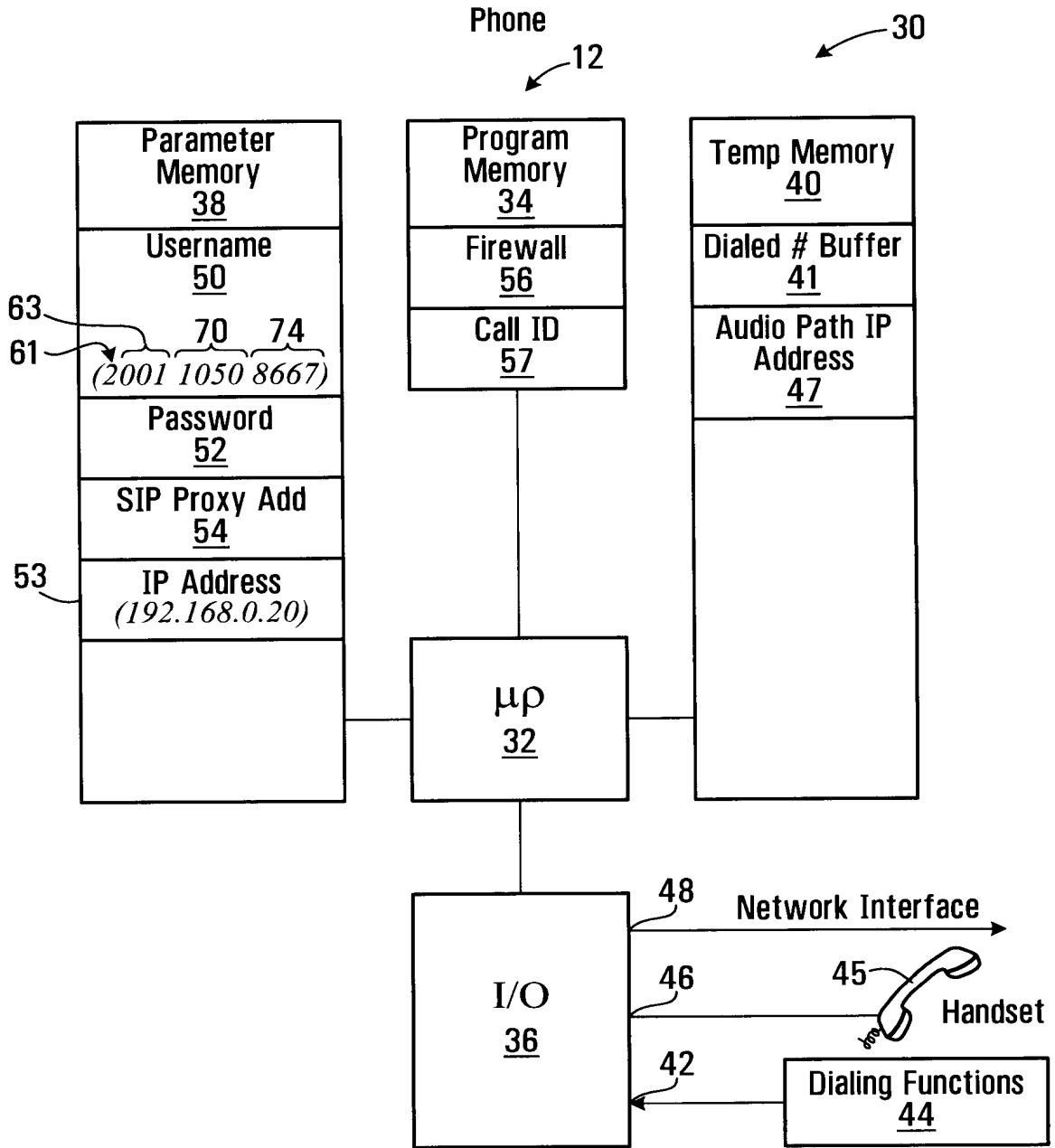

FIG. 2

3/29

SIP Invite Message

60 ~ Caller 2001 1050 8667
62 ~ Callee 2001 1050 2222
64 ~ Digest Parameters XXXXXX
65 ~ Call ID FF10@ 192.168.0.20
67 ~ Caller IP Address 192.168.0.20
69 ~ Caller UDP port 12345

FIG. 3

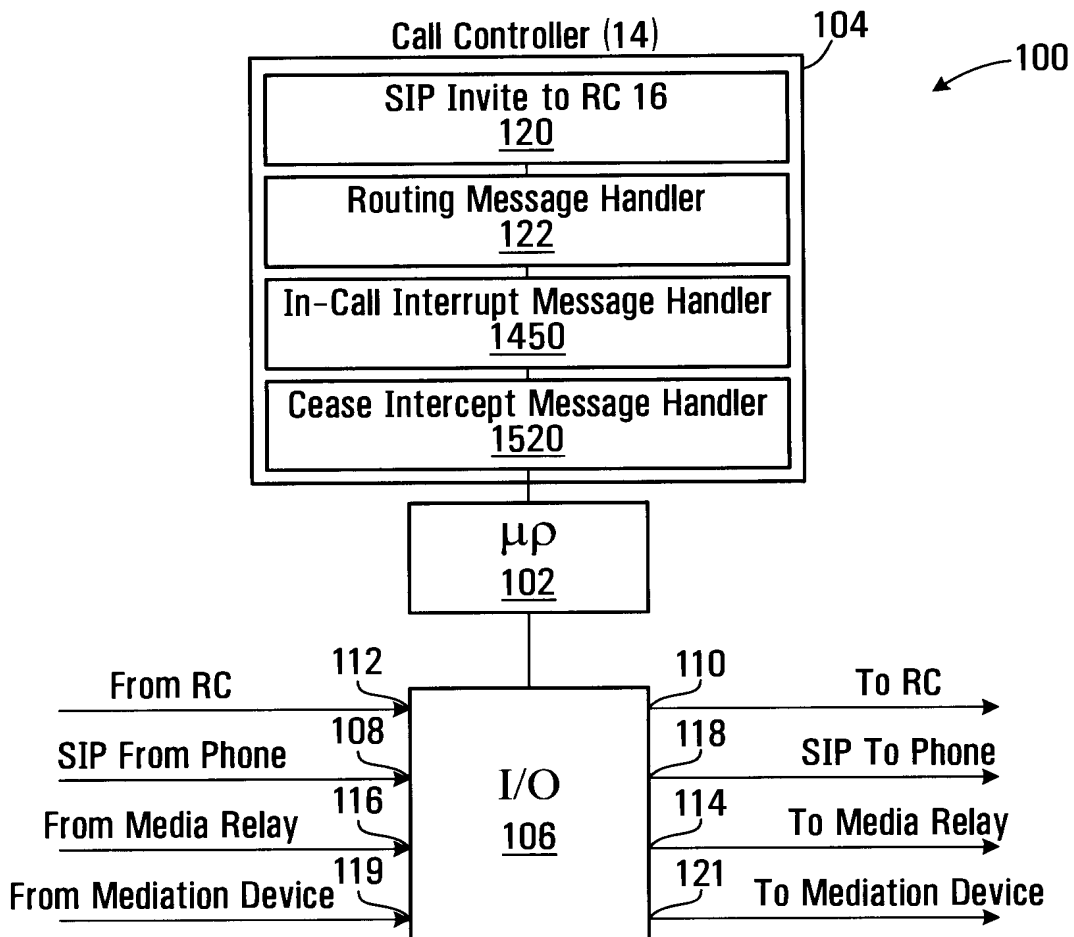

4/29

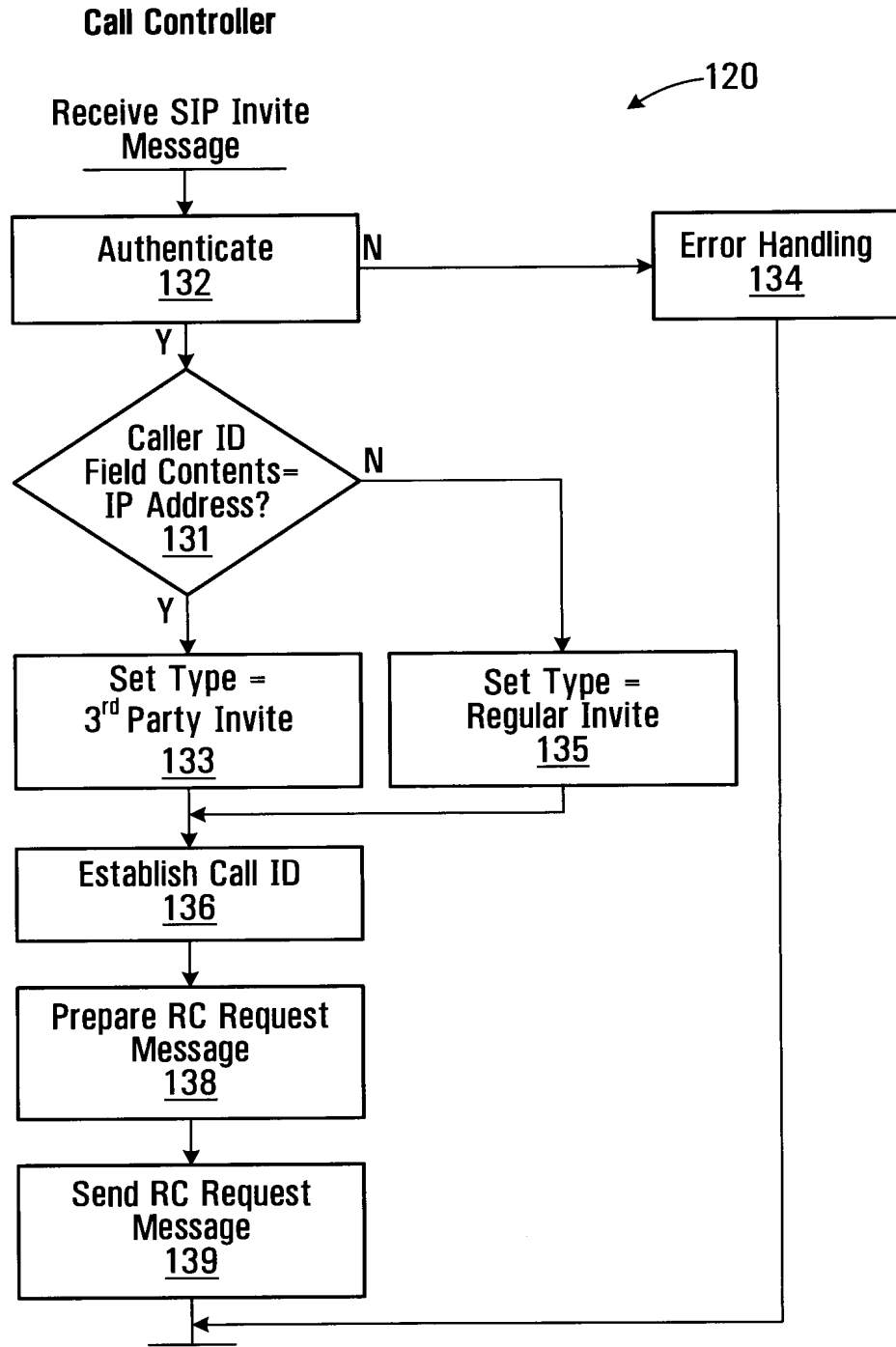

FIG. 5

5/29

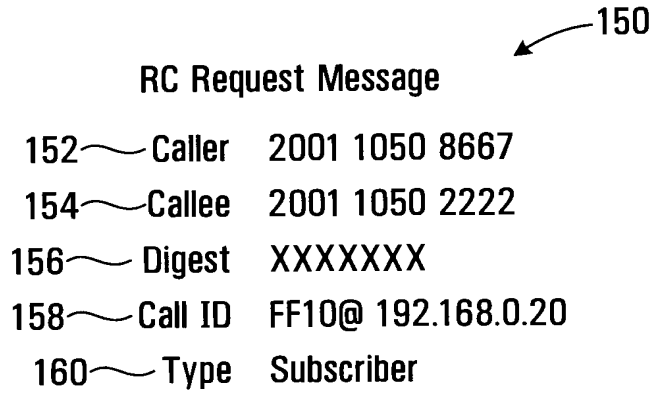

FIG. 6

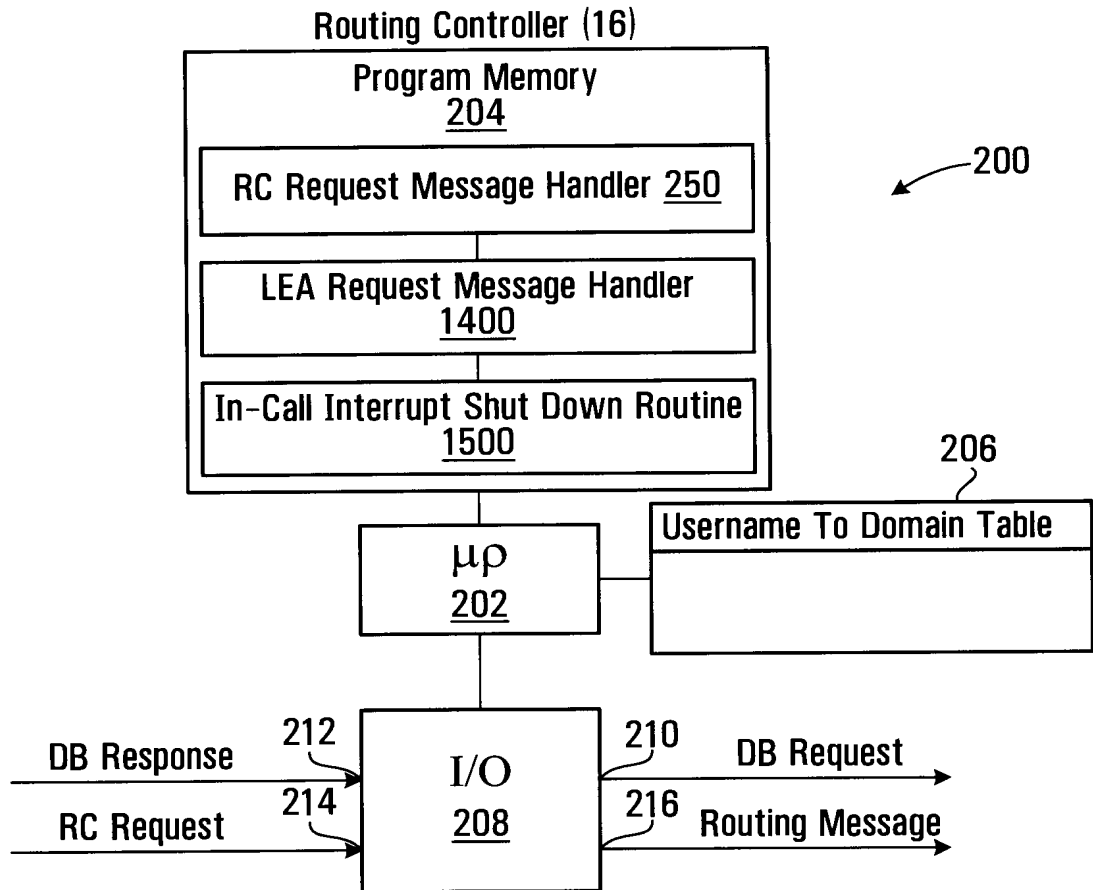

FIG. 7

6/29

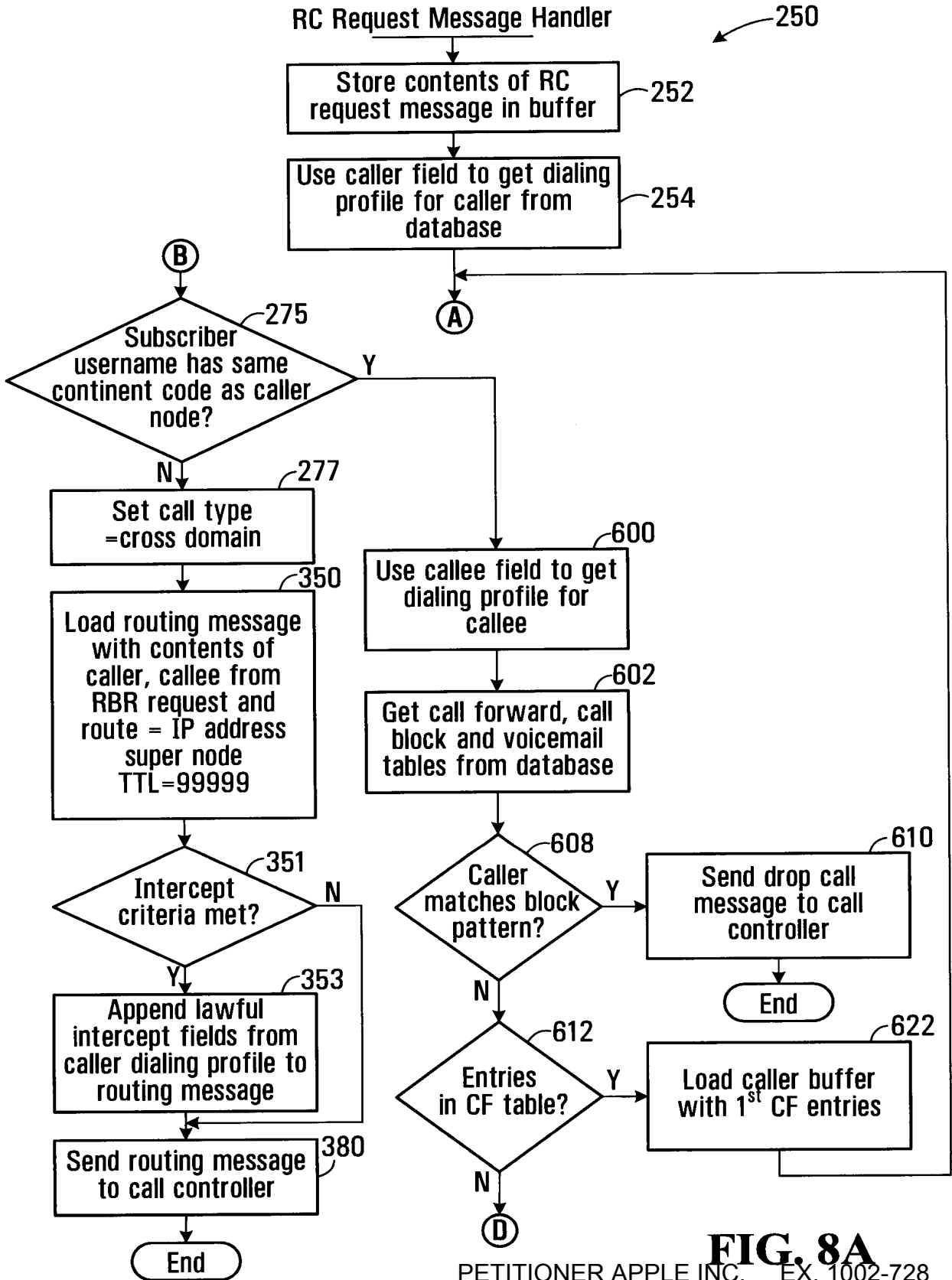

FIG. 8A

7/29

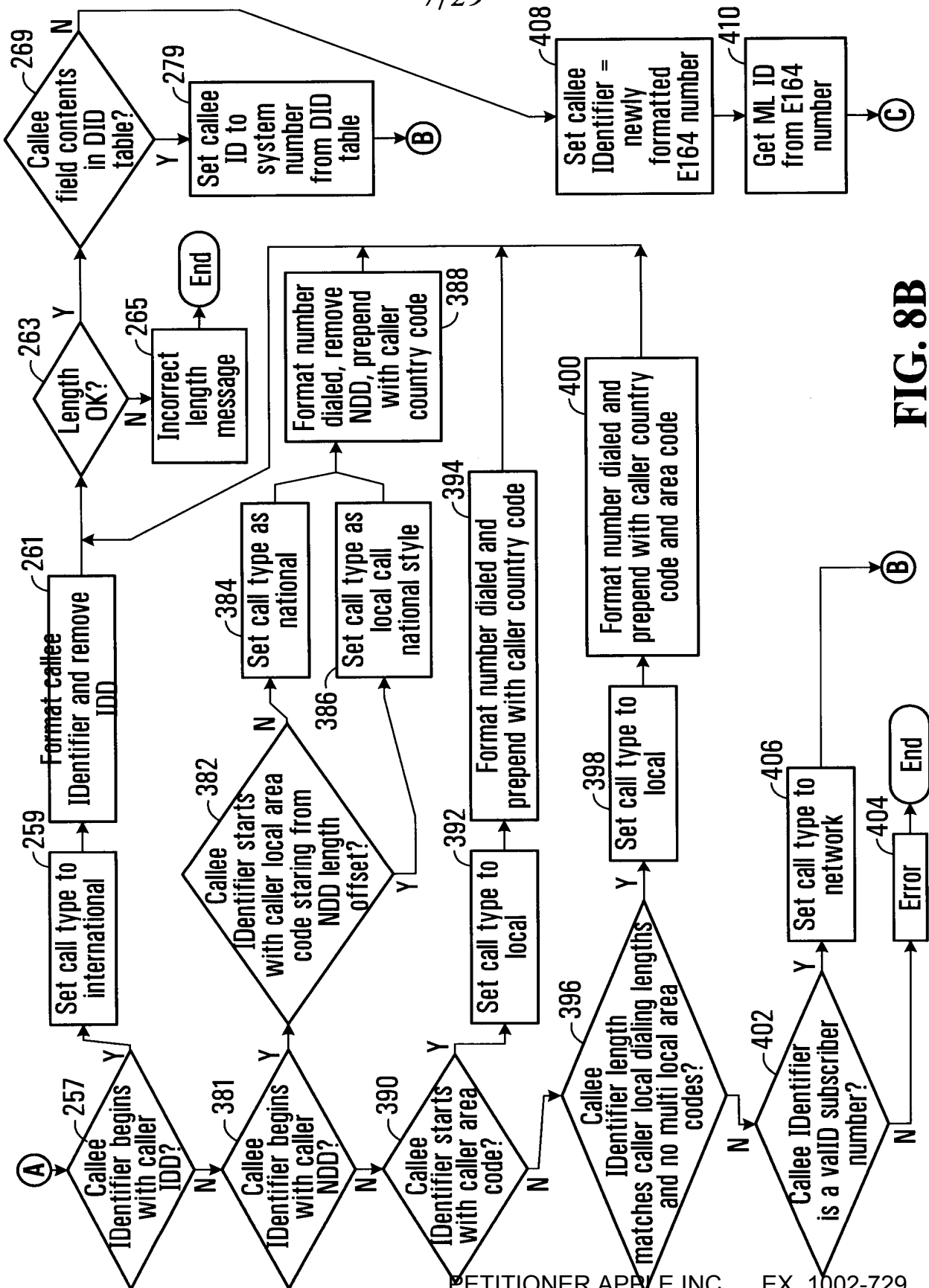

FIG. 8B

8/29

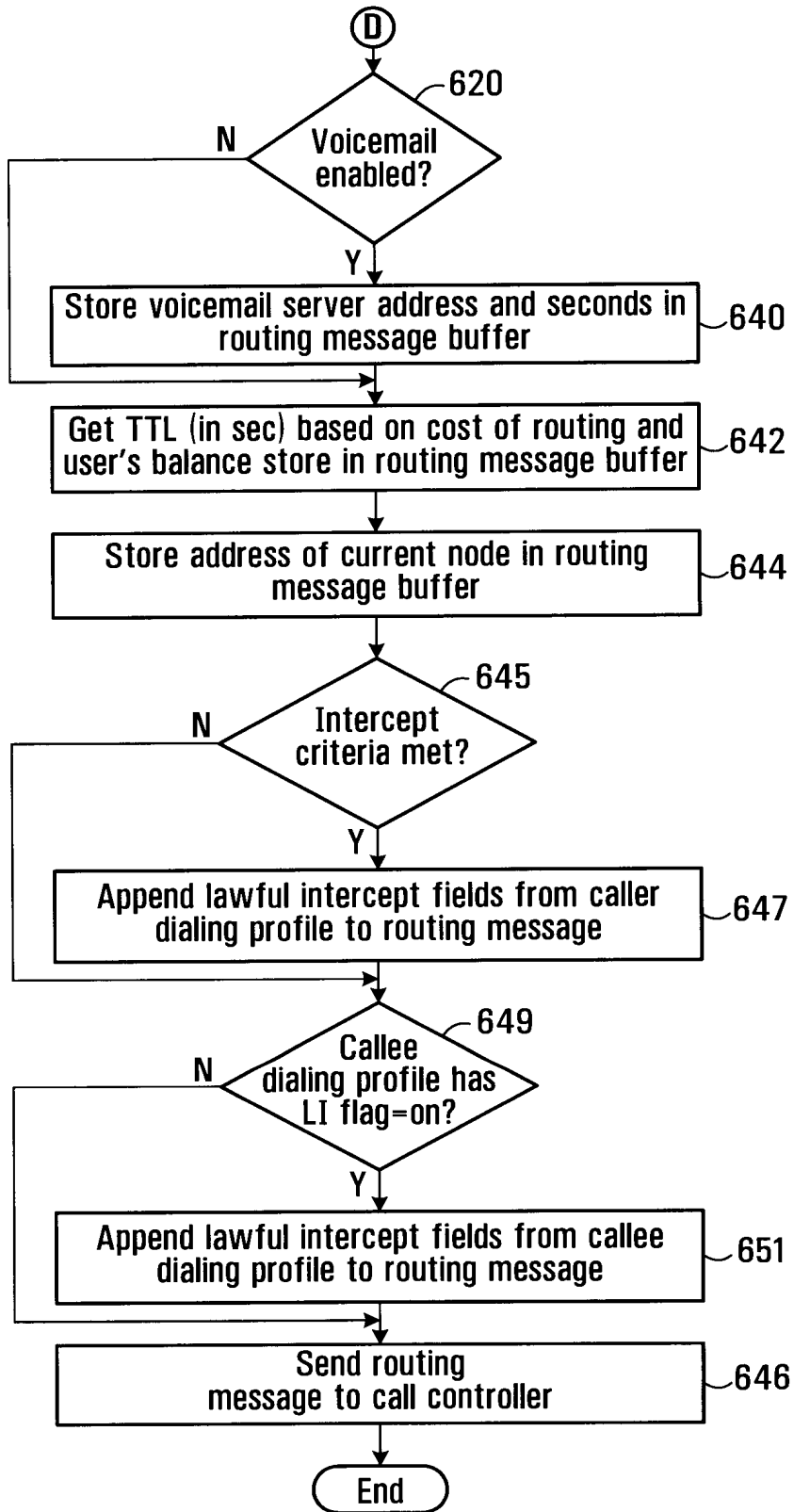

FIG. 8C

9/29

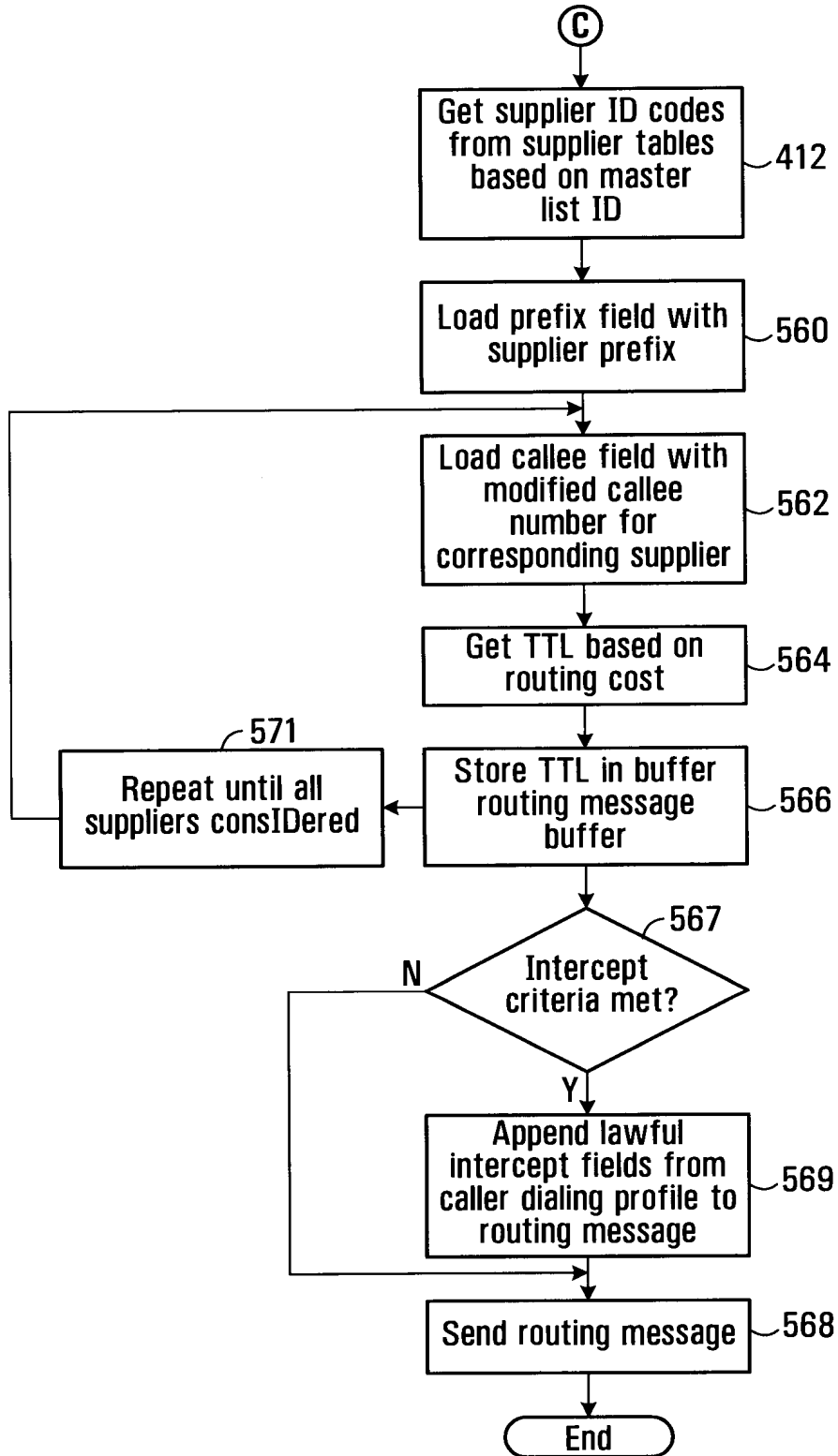

FIG. 8D

10/29

↖ 256

Dialing Profile for a User

258 ~ Username	Assigned on Subscription
260 ~ Domain	Domain Associated with User
262 ~ NDD	National Dialing Digit Code
264 ~ IDD	International Dialing Digit Code
266 ~ Country Code	Country Dependant Code
267 ~ Local Area Codes	Numeric
268 ~ Caller Minimum Local Length	Numeric
270 ~ Caller Maximum Local Length	Numeric
273 ~ Reseller	Retailer
1150 ~ Media Relay 1	Optional Media relay IDentifier #1
1150 ~ Media Relay n	Optional Media relay IDentifier #2
702 ~ LI flag	on or off
704 ~ MD1 Address	Address of First Mediation Device
706 ~ Warrant ID	From Law Enforcement Agency
708 ~ LI-Start Date/Time	When to Begin Monitoring Period
710 ~ LI-Stop Date/Time	When to End Monitoring Period

FIG. 9

Dialing Profile for Vancouver Subscriber

258 ~ Username	2001 1050 8667	↖ 276
260 ~ Domain	sp.yvr.digifonica.com	← 282
262 ~ NDD	1	
264 ~ IDD	011	
266 ~ Country Code	1	
267 ~ Local Area Codes	604;778 (Vancouver)	
268 ~ Caller Minimum Local Length	10	
270 ~ Caller Maximum Local Length	10	
273 ~ Reseller	Klondike	
MR 1	192.168.1.10	
⋮		
MR N	192.168.2.59	

Annotations: 61 points to 2001, 63 to 1050, 70 to 8667, 74 to 8667. 284 points to 2001. 286 points to 011, 288 to 604, 290 to 778.

FIG. 10

11/29

Dialing Profile for Calgary Subscriber

Username	2001 1050 2222
Domain	sp.yvr.digifonica.com
NDD	1
IDD	011
Country Code	1
Local Area Codes	403 (Calgary)
Caller Minimum Local Length	7
Caller Maximum Local Length	10
Reseller	ABC
MR1	192.168.3.60
⋮	
MRn	192.168.4.69

FIG. 11**Dialing Profile for London Subscriber**

Username	4401 1062 4444
Domain	sp.lhr.digifonica.com
NDD	0
IDD	00
Country Code	44
Local Area Codes	20 (London)
Caller Minimum Local Length	10
Caller Maximum Local Length	11
Reseller	DEF
MR1	192.168.5.70
⋮	
MRn	192.168.6.79

FIG. 12

12/29

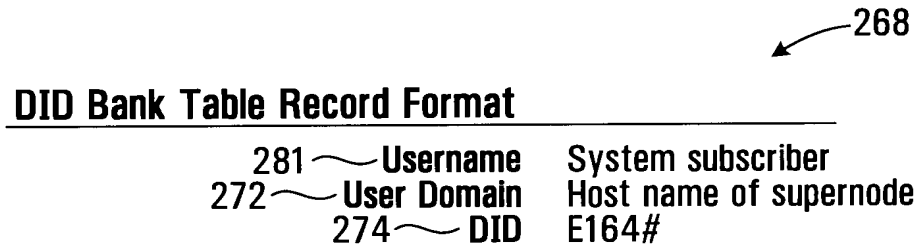

FIG. 13

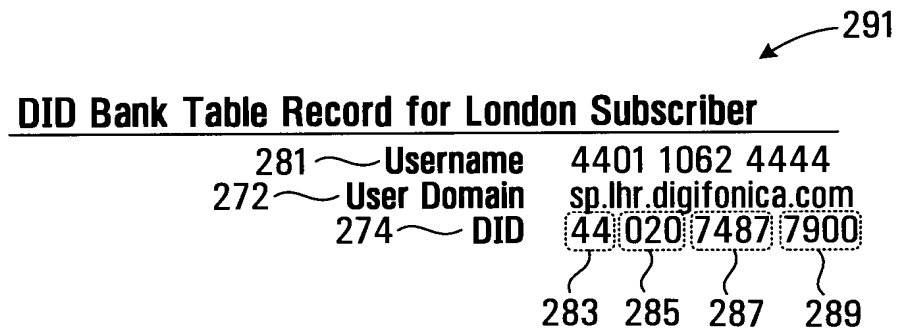

FIG. 14

13/29

352

Routing Message Format

354	Supplier Prefix (optional)	Code IDentifying supplier traffic
	356 Delimiter	Symbol separating fields
	358 Callee	PSTN compatible number or Digifonica number
	360 Route	Domain name and IP address
362	Time to Live(TTL)	In seconds
	364 Other	TBD

FIG. 15

366

Routing Message - Different Node

	440110624444@sp.lhr.digifonica.com;tll=9999		
	358	360	362
1152	Media Relays (optional)		

FIG. 16

Routing Message - Different Node with lawful intercept fields

	440110624444@sp.lhr.digifonica.com;tll=999;LIflag=on;MDaddress=192.168.1.10;		
	WarrantID=20060515142;		
	LIstart=2006 05 16 00:00:00		
	LIstop=2006 12 31 23:59:59;		
1152	Media Relays (optional)		

FIG. 16A

370

Prefix to Supernode Table Record Format

	372	Prefix	First n digits of callee IDentifier
374	Supernode Address		IP address or fully qualified domain name

FIG. 17

Prefix to Supernode Table Record for London Subscriber

	Prefix	4
	Supernode Address	sp.lhr.digifonica.com

FIG. 18

14/29

Master List Record Format

500	~	ml_ID	1019
502	~	Dialing code	1604
504	~	Country code	The country code is the national prefix to be used when dialing TO a particular country FROM another country.
506	~	Nat Sign #(Area Code)	Numeric
508	~	Min Length	Numeric
510	~	Max Length	Numeric
512	~	NDD	The NDD prefix is the access code used to make a call WITHIN that country from on city to another (when calling another city in the same vicinity, this may not be necessary).
514	~	IDD	The IDD prefix is the international prefix needed to dial a call FROM the country listed TO another country.
516	~	Buffer rate	Safe charge rate above the highest rate charged by suppliers

FIG. 19

Example: Master List Record with Populated Fields

Route_ID	1019
Dialing code	1604
Country code	1
Nat Sign #(Area Code)	604
Min Length	7
Max Length	7
NDD	1
IDD	011
Buffer rate	\$0.009/min

FIG. 20

15/29

Suppliers List Record Format

540 ~	Sup_ID	Name code
542 ~	Route_ID	Numeric code
544 ~	Prefix (optional)	String IDentifying supplier's traffic #
546 ~	Route	IP address
548 ~	NDD/IDD rewrite	
550 ~	Rate	Cost per second to Digifonica to use this route

FIG. 21

Telus Supplier Record

	Sup_ID	2010 (Telus)
	Route_ID	1019
	Prefix (optional)	4973#
546 ~	Route	72.64.39.58
	NDD/IDD rewrite	011
550 ~	Rate	\$0.02/min

FIG. 22

Shaw Supplier Record

	Sup_ID	2011 (Shaw)
	Route_ID	1019
	Prefix (optional)	4974#
	Route	73.65.40.59
	NDD/IDD rewrite	011
550 ~	Rate	\$0.025/min

FIG. 23

Sprint Supplier Record

	Sup_ID	2012 (Sprint)
	Route_ID	1019
	Prefix (optional)	4975#
	Route	74.66.41.60
	NDD/IDD rewrite	011
550 ~	Rate	\$0.03/min

FIG. 24

16/29

Routing Message Buffer for Gateway Call

4973#0116048675309@72.64.39.58;ttl=3600 ~ 570
 4974#0116048675309@73.65.40.59;ttl=3600 ~ 572
 4975#0116048675309@74.66.41.60;ttl=3600 ~ 574
 Media Relays (optional) ~ 1152

FIG. 25

Routing Message Buffer for Gateway Call with Lawful Intercept Fields

4973#0116048675309@72.64.39.58;ttl=3600
 4974#0116048675309@73.65.40.59;ttl=3600
 4975#0116048675309@74.66.41.60;ttl=3600
 LIflag=on;MAddress=192.168.1.10;WarrantID=20060515142;
 LIstart=2006051600:00:00;LIstop=2006123123:59:59
 Media Relays (optional) ~ 1152

FIG. 25A

Call Block Record Format

604 ~ Username Digifonica #
 606 ~ Block Pattern PSTN compatible or Digifonica #

FIG. 26

Call Block Record for Calgary Callee

604 ~ Username of Callee 2001 1050 2222
 606 ~ Block Pattern 2001 1050 8664

FIG. 27

Call Forwarding Record Format for Callee

614 ~ Username of Callee Digifonica #
 616 ~ Destination Number Digifonica #
 618 ~ Sequence Number Integer indicating order to try this

FIG. 28

17/29

Call Forwarding Table Record for Calgary Callee

614	Username of Callee	2001 1050 2222
616	Destination Number	2001 1055 2223
618	Sequence Number	1

FIG. 29**Voicemail Table Record Format**

624	Username of Callee	Digifonica #
626	Vm Server	domain name
628	Seconds to Voicemail	time to wait before engaging voicemail
630	Enabled	yes/no

FIG. 30**Voicemail Table Record for Calgary Callee**

624	Username of Callee	2001 1050 2222
626	Vm Server	vm.yvr.digifonica.com
628	Seconds to Voicemail	20
630	Enabled	1

FIG. 31

18/29

Routing Message Buffer for CF/VM Routing Message

650 ~ 200110502222@sp.yvr.digifonica.com;ttl=3600
 652 ~ 200110552223@sp.yvr.digifonica.com;ttl=3600
 654 ~ vm.yvr.digifonica.com;20;ttl=60
 656 ~ sp.yvr.digifonica.com
 1152 ~ Media Relays (optional)

FIG. 32**Routing Message Buffer for CF/VM Routing Message with Caller Lawful Interrupt Fields**

200110502222@sp.yvr.digifonica.com;ttl=3600
 200110552223@sp.yvr.digifonica.com;ttl=3600
 vm.yvr.digifonica.com;20;ttl=60
 sp.yvr.digifonica.com
 LIflag=on;MDaddress=192.168.1.10;WarrantID=20060615142;
 LIstart=2006061500:00:00;LIstop=2006123123:59:59
 Media Relays (optional) ~ 1152

FIG. 32A**Routing Message Buffer for CF/VM Routing Message with Caller and Callee Lawful Interrupt Fields**

200110502222@sp.yvr.digifonica.com;ttl=3600
 200110552223@sp.yvr.digifonica.com;ttl=3600
 vm.yvr.digifonica.com;20;ttl=60
 sp.yvr.digifonica.com
 LI1flag=on;Mdaddress=192.168.1.10;WarrantID=20060515142;
 LI1start=2006051600:00:00;LI1stop=2006123123:59:59
 LI2flag=0;MD2address=192.168.1.20;WarrantID=20060615142;
 LI2start=2006061500:00:00;LI2stop=2006123123:59:59
 Media Relays (optional) ~ 1152

FIG. 32B

19/29

Routing Message Handler
Executed by Call Controller

122

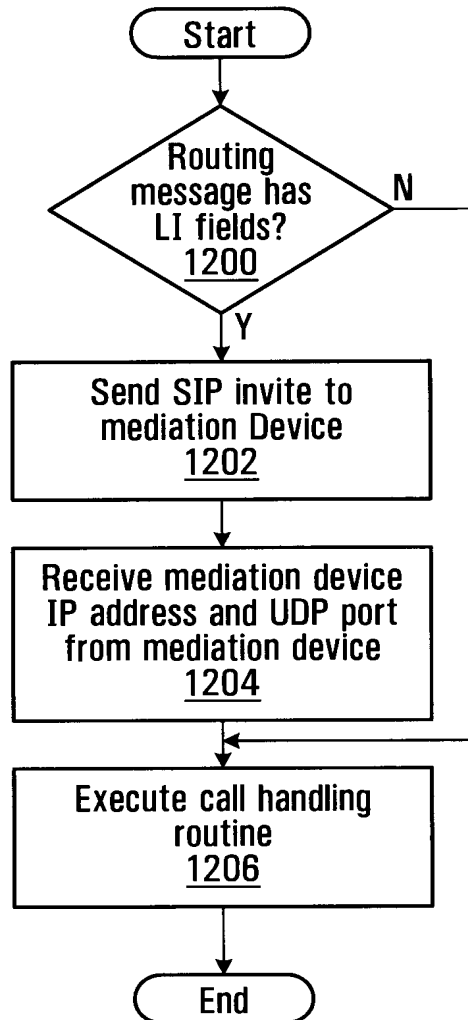

FIG. 33

20/29

123

Call Handling Routine

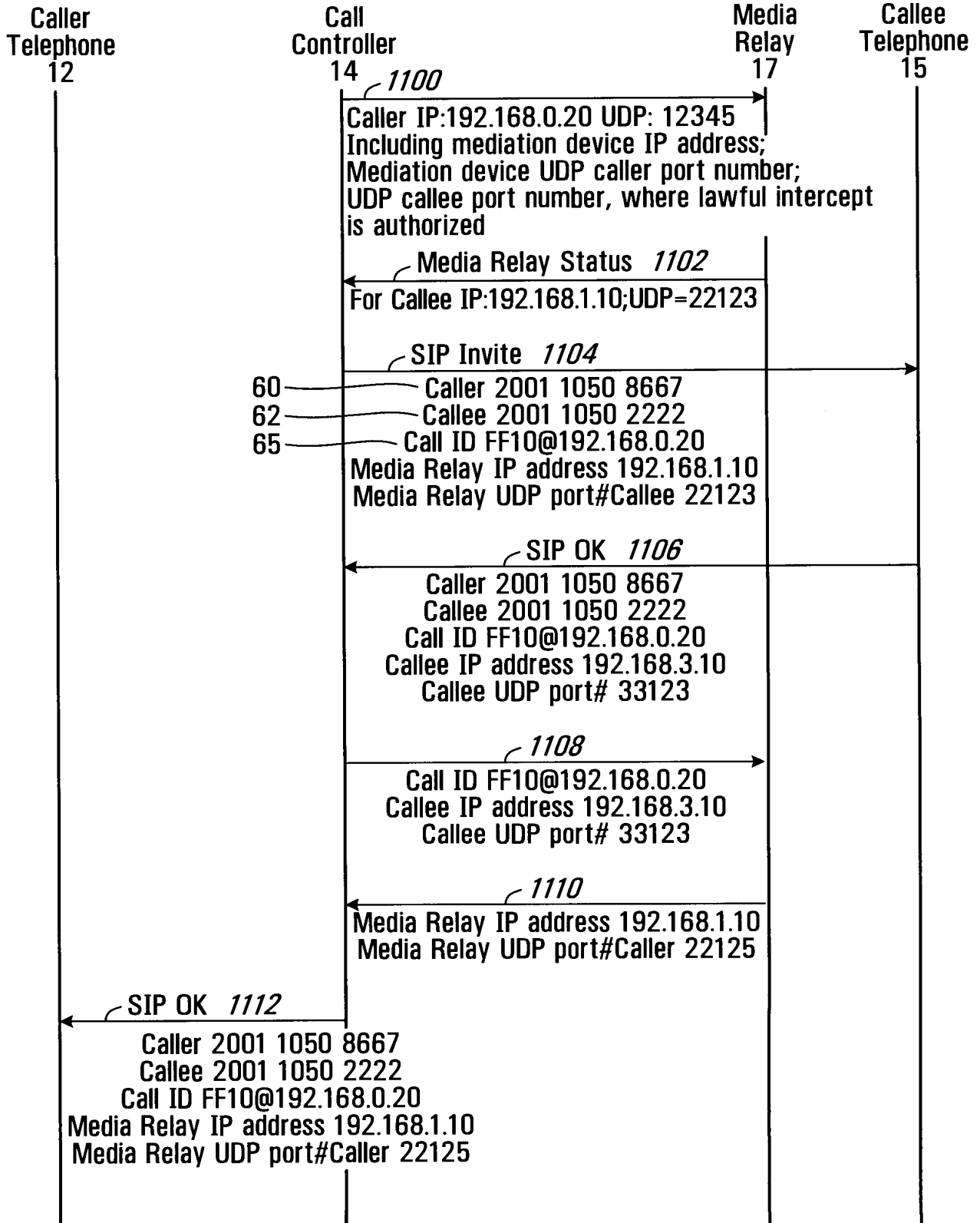

FIG. 34

21/29

Call Controller Active Call Record

1300	Call ID	FF10@192.168.0.20
1302	Caller IP Address	192.168.0.20
1304	Caller Port	12345
1306	Callee IP Address	192.168.3.10
1308	Callee Port	33123
1310	Media Relay ID	42
1312	Media Relay Caller Port	22125
1314	Media Relay Callee Port	22123

FIG. 35**Routing Controller Active Call Record**

1316	Call ID	FF10@192.168.0.20
1318	Caller	2001 1050 8667
1320	Callee	2001 1050 2222
1322	Call Controller ID	61

FIG. 36

22/29

Message from Call Controller to Mediation Device - SIP Invite

1020	~	Caller	2001 1050 8667
1022	~	Callee	2001 1050 2222
1024	~	Call ID	FF10@192.168.0.20
1026	~	Warrant ID	12345678
1028	~	Intercept Related Info	XXXXXXXXXX

FIG. 37

Reply Message from Mediation Device - SIP Ok

1040	~	Caller	2001 1050 8667
1042	~	Callee	2001 1050 2222
1044	~	Call ID	FF10@192.168.0.20
1046	~	Mediation Device IP Address	192.138.2.10
1048	~	Mediation Device UDP Port # Caller	13678
1050	~	Mediation Device UDP Port # Callee	13679

FIG. 38

23/29

900
↙

SIP Bye Message

902 ~	Caller	Username
904 ~	Callee	PSTN compatible # or Username
906 ~	Call ID	unique call IDentifier (hexadecimal string@IP))

FIG. 39

908
↙

SIP Bye Message

902 ~	Caller	2001 1050 8667
904 ~	Callee	2001 1050 2222
906 ~	Call ID	FA10@192.168.0.20

FIG. 40

24/29

910 ↘

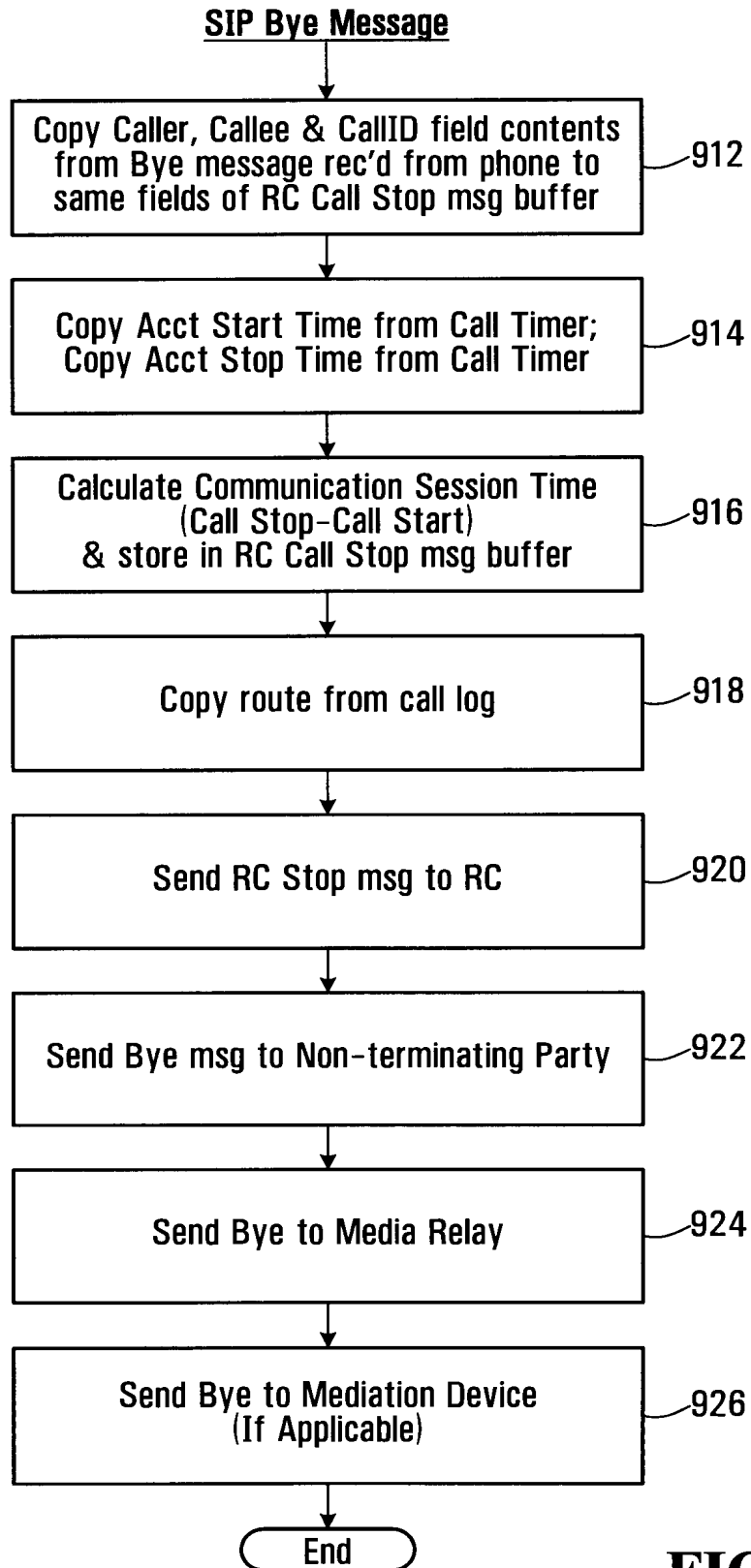

25/29

1000

RC Call Stop Message

1002	Caller	Username
1004	Callee	PSTN compatible # or Username
1006	Call ID	unique call IDentifier (hexadecimal string@IP)
1008	Acct Start Time	start time of call
1010	Acct Stop Time	time the call ended
1012	Acct Session Time	start time-stop time (in seconds)
1014	Route	IP address for gateway, where a gateway is used

FIG. 42

1021

RC Call Stop Message for Calgary Callee

1002	Caller	2001 1050 8667
1004	Callee	2001 1050 2222
1006	Call ID	FA10@192.168.0.20
1008	Acct Start Time	2006-12-30 12:12:12
1010	Acct Stop Time	2006-12-30 12:12:14
1012	Acct Session Time	2
1014	Route	(72.64.39.58 if Telus gateway is used)

FIG. 43

26/29

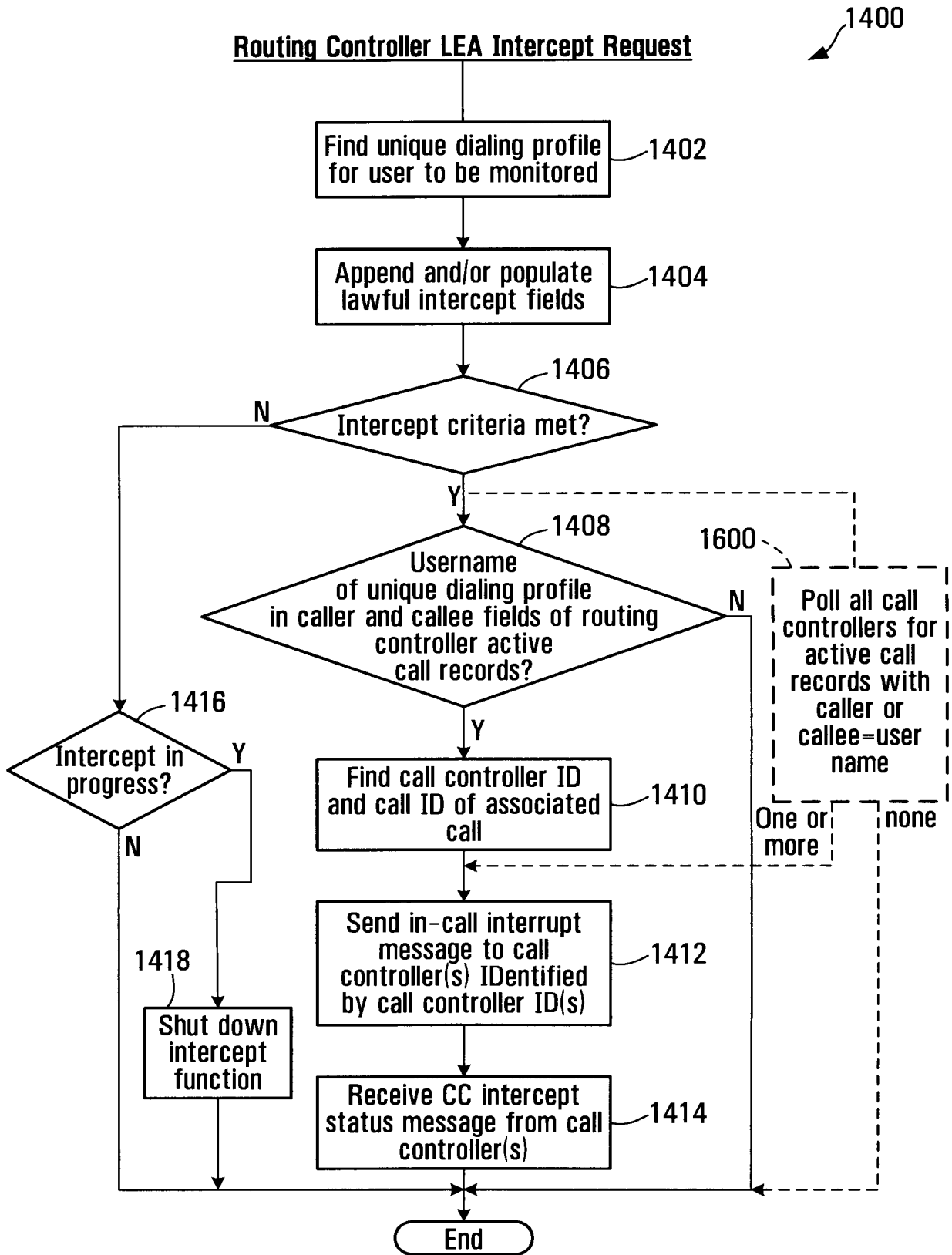

FIG. 44

27/29

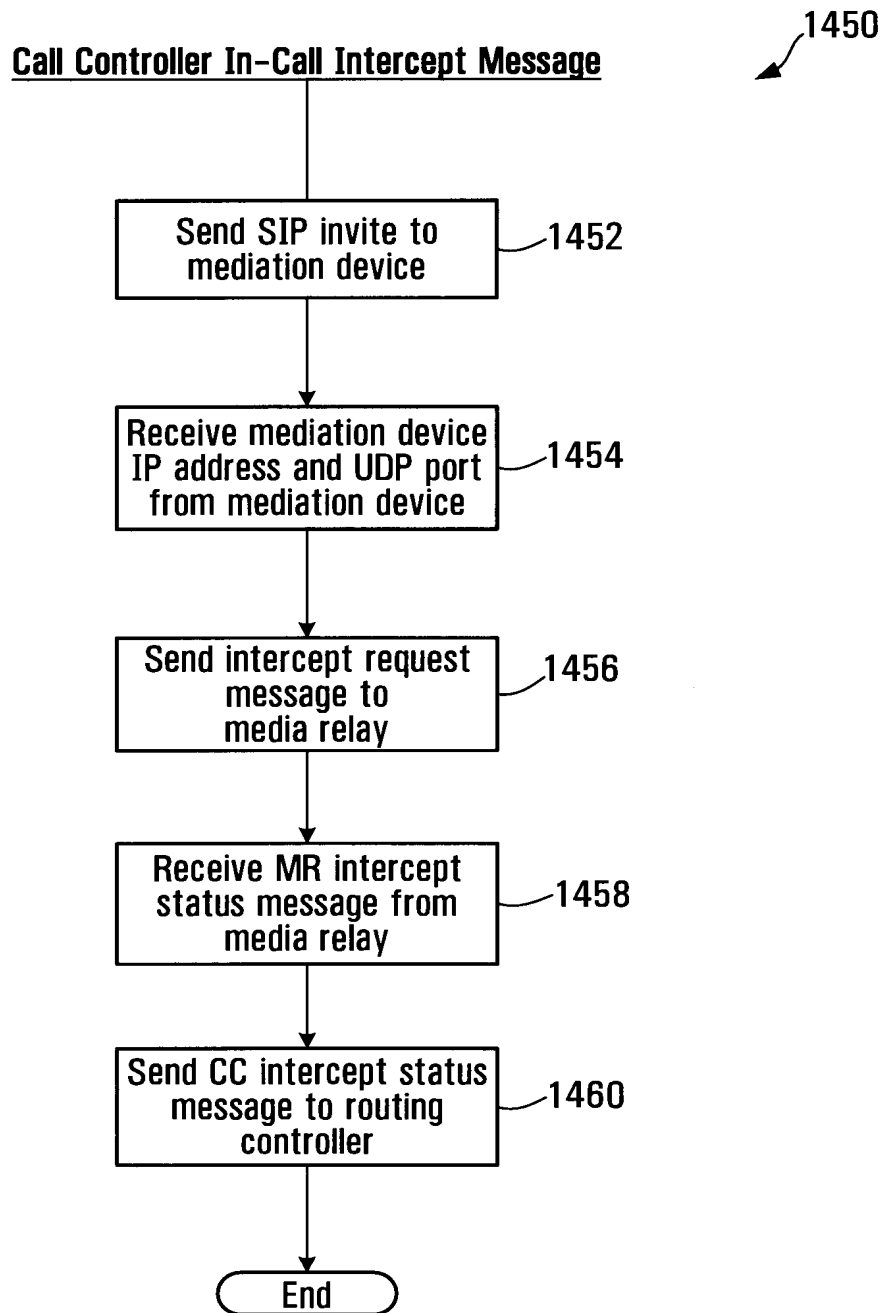

FIG. 45

28/29

1500

Routing Controller In-Call Intercept Shut Down Routine

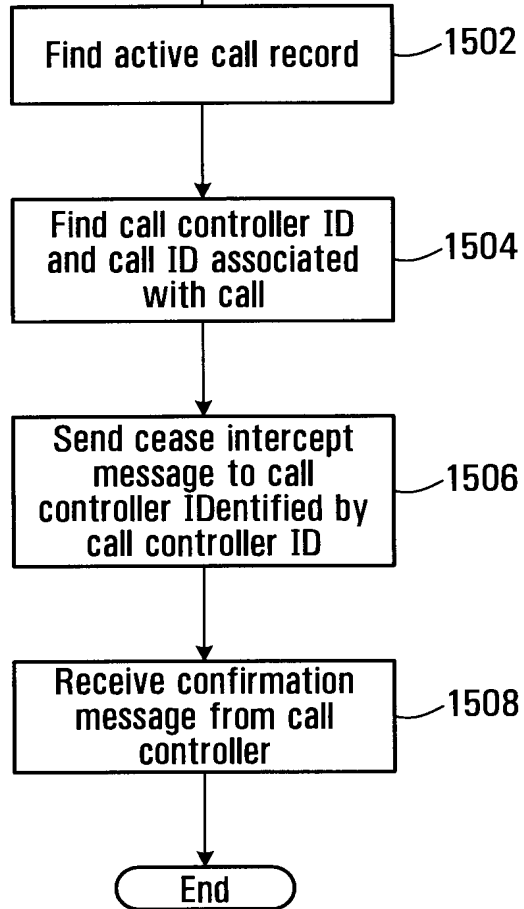

FIG. 46

29/29

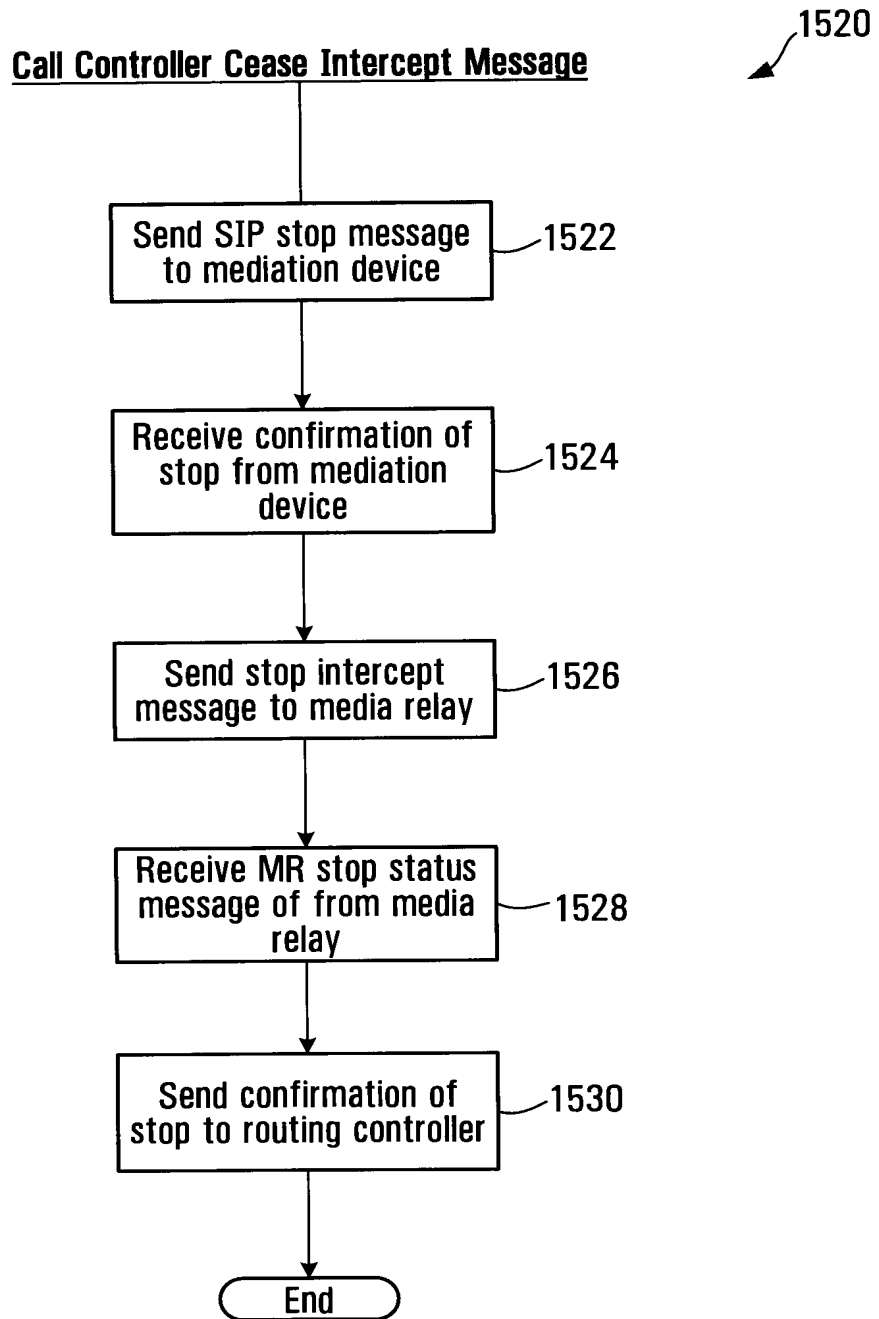

FIG. 47

INTERNATIONAL SEARCH REPORT

International application No.
PCT/CA2007/002150

<p>A. CLASSIFICATION OF SUBJECT MATTER IPC: H04L 12/26 (2006.01) , H04L 12/66 (2006.01) , H04M 11/06 (2006.01) , H04M 3/22 (2006.01) According to International Patent Classification (IPC) or to both national classification and IPC</p>																				
<p>B. FIELDS SEARCHED</p> <p>Minimum documentation searched (classification system followed by classification symbols) IPC: H04L 12/26 (2006.01) , H04L 12/66 (2006.01) , H04M 11/06 (2006.01) , H04M 3/22 (2006.01)</p> <p>Documentation searched other than minimum documentation to the extent that such documents are included in the fields searched</p> <p>Electronic database(s) consulted during the international search (name of database(s) and, where practicable, search terms used) West, Delphion, Canadian Patents Database, IEEEXplore, Google Keywords: lawful intercept, (monitor* OR record* or intercept*) near (communicat* OR voip OR phone call* OR audio OR video), electronic surveillance, intercept* near device*, intercept* same IP network*, record* same IP network*, intercept* same voip, record*</p>																				
<p>C. DOCUMENTS CONSIDERED TO BE RELEVANT</p> <table border="1"> <thead> <tr> <th>Category*</th> <th>Citation of document, with indication, where appropriate, of the relevant passages</th> <th>Relevant to claim No.</th> </tr> </thead> <tbody> <tr> <td>X Y</td> <td>US 2004/0181599 A1 (Kreusch et al.) 16 September 2004 (16-09-2004) *paragraphs [0011]-[0015], [0019]-[0022], [0028], [0034]-[0036], [0048]-[0053], [0055]-[0061], [0067], [0072]-[0074], [0078]-[0083]; Figs. 1, 2a-2b; claims 1-3, 7-8, 25-26*</td> <td>1-2, 4-5, 10-15, 17-18, 23-26 3, 6-9, 16, 19-22</td> </tr> <tr> <td>X</td> <td>US 2003/0219103 A1 (Rao et al.) 27 November 2003 (27-11-2003) *Abstract; paragraphs [0005], [0026]-[0037], [0051]-[0062], [0071]-[0079], [0086]-[0090]; Figs. 1-9*</td> <td>1, 14</td> </tr> <tr> <td>Y</td> <td>US 2002/0051518 A1 (Bondy et al.) 2 May 2002 (02-05-2002) *Abstract; paragraphs [0030]-[0032], [0036]-[0037], [0039], [0044]-[0052], [0055]-[0057], [0060]; Figs 1, 3, 5; claims 1-5*</td> <td>3, 6-9, 16, 19-22</td> </tr> <tr> <td>A</td> <td>EP 1 389 862 B1 (Shen et al.) 3 November 2004 (03-11-2004) *paragraphs [0007]-[0014], [0051]-[0060]; Fig. 2; claim 1*</td> <td>1-3, 14-16</td> </tr> <tr> <td>A</td> <td>US 2004/0165709 A1 (Pence et al.) 26 August 2004 (26-08-2004) *whole document*</td> <td>1-26</td> </tr> </tbody> </table>			Category*	Citation of document, with indication, where appropriate, of the relevant passages	Relevant to claim No.	X Y	US 2004/0181599 A1 (Kreusch et al.) 16 September 2004 (16-09-2004) *paragraphs [0011]-[0015], [0019]-[0022], [0028], [0034]-[0036], [0048]-[0053], [0055]-[0061], [0067], [0072]-[0074], [0078]-[0083]; Figs. 1, 2a-2b; claims 1-3, 7-8, 25-26*	1-2, 4-5, 10-15, 17-18, 23-26 3, 6-9, 16, 19-22	X	US 2003/0219103 A1 (Rao et al.) 27 November 2003 (27-11-2003) *Abstract; paragraphs [0005], [0026]-[0037], [0051]-[0062], [0071]-[0079], [0086]-[0090]; Figs. 1-9*	1, 14	Y	US 2002/0051518 A1 (Bondy et al.) 2 May 2002 (02-05-2002) *Abstract; paragraphs [0030]-[0032], [0036]-[0037], [0039], [0044]-[0052], [0055]-[0057], [0060]; Figs 1, 3, 5; claims 1-5*	3, 6-9, 16, 19-22	A	EP 1 389 862 B1 (Shen et al.) 3 November 2004 (03-11-2004) *paragraphs [0007]-[0014], [0051]-[0060]; Fig. 2; claim 1*	1-3, 14-16	A	US 2004/0165709 A1 (Pence et al.) 26 August 2004 (26-08-2004) *whole document*	1-26
Category*	Citation of document, with indication, where appropriate, of the relevant passages	Relevant to claim No.																		
X Y	US 2004/0181599 A1 (Kreusch et al.) 16 September 2004 (16-09-2004) *paragraphs [0011]-[0015], [0019]-[0022], [0028], [0034]-[0036], [0048]-[0053], [0055]-[0061], [0067], [0072]-[0074], [0078]-[0083]; Figs. 1, 2a-2b; claims 1-3, 7-8, 25-26*	1-2, 4-5, 10-15, 17-18, 23-26 3, 6-9, 16, 19-22																		
X	US 2003/0219103 A1 (Rao et al.) 27 November 2003 (27-11-2003) *Abstract; paragraphs [0005], [0026]-[0037], [0051]-[0062], [0071]-[0079], [0086]-[0090]; Figs. 1-9*	1, 14																		
Y	US 2002/0051518 A1 (Bondy et al.) 2 May 2002 (02-05-2002) *Abstract; paragraphs [0030]-[0032], [0036]-[0037], [0039], [0044]-[0052], [0055]-[0057], [0060]; Figs 1, 3, 5; claims 1-5*	3, 6-9, 16, 19-22																		
A	EP 1 389 862 B1 (Shen et al.) 3 November 2004 (03-11-2004) *paragraphs [0007]-[0014], [0051]-[0060]; Fig. 2; claim 1*	1-3, 14-16																		
A	US 2004/0165709 A1 (Pence et al.) 26 August 2004 (26-08-2004) *whole document*	1-26																		
<p><input checked="" type="checkbox"/> Further documents are listed in the continuation of Box C. <input checked="" type="checkbox"/> See patent family annex.</p> <table border="1"> <tbody> <tr> <td>* Special categories of cited documents :</td> <td>"T" later document published after the international filing date or priority date and not in conflict with the application but cited to understand the principle or theory underlying the invention</td> </tr> <tr> <td>"A" document defining the general state of the art which is not considered to be of particular relevance</td> <td>"X" document of particular relevance; the claimed invention cannot be considered novel or cannot be considered to involve an inventive step when the document is taken alone</td> </tr> <tr> <td>"E" earlier application or patent but published on or after the international filing date</td> <td>"Y" document of particular relevance; the claimed invention cannot be considered to involve an inventive step when the document is combined with one or more other such documents, such combination being obvious to a person skilled in the art</td> </tr> <tr> <td>"L" document which may throw doubts on priority claim(s) or which is cited to establish the publication date of another citation or other special reason (as specified)</td> <td>"&" document member of the same patent family</td> </tr> <tr> <td>"O" document referring to an oral disclosure, use, exhibition or other means</td> <td></td> </tr> <tr> <td>"P" document published prior to the international filing date but later than the priority date claimed</td> <td></td> </tr> </tbody> </table>			* Special categories of cited documents :	"T" later document published after the international filing date or priority date and not in conflict with the application but cited to understand the principle or theory underlying the invention	"A" document defining the general state of the art which is not considered to be of particular relevance	"X" document of particular relevance; the claimed invention cannot be considered novel or cannot be considered to involve an inventive step when the document is taken alone	"E" earlier application or patent but published on or after the international filing date	"Y" document of particular relevance; the claimed invention cannot be considered to involve an inventive step when the document is combined with one or more other such documents, such combination being obvious to a person skilled in the art	"L" document which may throw doubts on priority claim(s) or which is cited to establish the publication date of another citation or other special reason (as specified)	"&" document member of the same patent family	"O" document referring to an oral disclosure, use, exhibition or other means		"P" document published prior to the international filing date but later than the priority date claimed							
* Special categories of cited documents :	"T" later document published after the international filing date or priority date and not in conflict with the application but cited to understand the principle or theory underlying the invention																			
"A" document defining the general state of the art which is not considered to be of particular relevance	"X" document of particular relevance; the claimed invention cannot be considered novel or cannot be considered to involve an inventive step when the document is taken alone																			
"E" earlier application or patent but published on or after the international filing date	"Y" document of particular relevance; the claimed invention cannot be considered to involve an inventive step when the document is combined with one or more other such documents, such combination being obvious to a person skilled in the art																			
"L" document which may throw doubts on priority claim(s) or which is cited to establish the publication date of another citation or other special reason (as specified)	"&" document member of the same patent family																			
"O" document referring to an oral disclosure, use, exhibition or other means																				
"P" document published prior to the international filing date but later than the priority date claimed																				
<p>Date of the actual completion of the international search 3 March 2008 (03-03-2008)</p>		<p>Date of mailing of the international search report 14 March 2008 (14-03-2008)</p>																		
<p>Name and mailing address of the ISA/CA Canadian Intellectual Property Office Place du Portage I, C114 - 1st Floor, Box PCT 50 Victoria Street Gatineau, Quebec K1A 0C9 Facsimile No.: 001-819-953-2476</p>		<p>Authorized officer Daniela Savin 819- 934-4890</p>																		

INTERNATIONAL SEARCH REPORT

International application No.
PCT/CA2007/002150

C (Continuation). DOCUMENTS CONSIDERED TO BE RELEVANT

Category*	Citation of document, with indication, where appropriate, of the relevant passages	Relevant to claim No.
A	US 2004/0255126 A1 (Reith) 16 December 2004 (16-12-2004) *paragraphs [0010]-[0014], [0020]-[0031], [0041]-[0046]; Figs. 1-2, 4-6; claims 1, 6-10*	1-26
A	US 2004/0157629 A1 (Kallio et al.) 12 August 2004 (12-08-2004) *paragraphs [0006]-[0021], [0050]-[0057], [0080]-[0109]; Figs. 1-12; claims 1, 7-23, 29-43*	1-26
A	US 2005/0174937 A1 (Scoggins et al.) 11 August 2005 (11-08-2005) *paragraphs [0068]-[0089], [0112]-[0138], [0153]-[0156], [0173]-[0176], [0184]-[0193]; Figs. 1-11; claims 1-2*	1-26

INTERNATIONAL SEARCH REPORT
Information on patent family members

International application No.
PCT/CA2007/002150

Patent Document Cited in Search Report	Publication Date	Patent Family Member(s)	Publication Date
US2004181599	16-09-2004	BR0208272 A	09-03-2004
		CN1274114 C	06-09-2006
		DE50211291 D1	10-01-2008
		EP1244250 A1	25-09-2002
		EP1371173 A1	17-12-2003
		RU2280331 C2	20-07-2006
		WO02082728 A1	17-10-2002
US2003219103	27-11-2003	NONE	
US2002051518	02-05-2002	US7006508 B2	28-02-2006
		US2001052081 A1	13-12-2001
		US2002009973 A1	24-01-2002
EP1389862	03-11-2004	AT281734 T	15-11-2004
		DE60201827 D1	09-12-2004
		DE60201827 T2	10-11-2005
		ES2229073 T3	16-04-2005
		US2004202295 A1	14-10-2004
US2004165709	26-08-2004	NONE	
US2004255126	16-12-2004	DE602004003518 D1	18-01-2007
		EP1484892 A2	08-12-2004
US2004157629	12-08-2004	EP1396113 A1	10-03-2004
		WO02093838 A1	21-11-2002
US2005174937	11-08-2005	US2006212933 A1	21-09-2006

(19) World Intellectual Property Organization
International Bureau



(43) International Publication Date
2 October 2008 (02.10.2008)

PCT

(10) International Publication Number
WO 2008/116296 A1

(51) International Patent Classification:

H04L 12/66 (2006.01) H04Q 3/00 (2006.01)
H04M 11/06 (2006.01) H04Q 3/64 (2006.01)
H04M 3/42 (2006.01)

(74) Agents: KNOX, John, W. et al.; Smart & Biggar, 2200
- 650 West Georgia Street Box 11560, Vancouver Centre,
Vancouver, British Columbia V6B 4N8 (CA).

(21) International Application Number:

PCT/CA2008/000545

(22) International Filing Date: 20 March 2008 (20.03.2008)

(25) Filing Language: English

(26) Publication Language: English

(30) Priority Data:

60/907,224 26 March 2007 (26.03.2007) US

(81) Designated States (unless otherwise indicated, for every
kind of national protection available): AE, AG, AL, AM,
AO, AT, AU, AZ, BA, BB, BG, BH, BR, BW, BY, BZ, CA,
CH, CN, CO, CR, CU, CZ, DE, DK, DM, DO, DZ, EC, EE,
EG, ES, FI, GB, GD, GE, GH, GM, GT, HN, HR, HU, ID,
IL, IN, IS, JP, KE, KG, KM, KN, KP, KR, KZ, LA, LC,
LK, LR, LS, LT, LU, LY, MA, MD, ME, MG, MK, MN,
MW, MX, MY, MZ, NA, NG, NI, NO, NZ, OM, PG, PH,
PL, PT, RO, RS, RU, SC, SD, SE, SG, SK, SL, SM, SV,
SY, TJ, TM, TN, TR, TT, TZ, UA, UG, US, UZ, VC, VN,
ZA, ZM, ZW.

(71) Applicant (for all designated States except US): DIGI-
FONICA (INTERNATIONAL) LIMITED [CA/CA];
Suite 1401, 4710 Kingsway, Burnaby, British Columbia
V5H 4M2 (CA).

(84) Designated States (unless otherwise indicated, for every
kind of regional protection available): ARIPO (BW, GH,
GM, KE, LS, MW, MZ, NA, SD, SL, SZ, TZ, UG, ZM,
ZW), Eurasian (AM, AZ, BY, KG, KZ, MD, RU, TJ, TM),
European (AT, BE, BG, CH, CY, CZ, DE, DK, EE, ES, FI,
FR, GB, GR, HR, HU, IE, IS, IT, LT, LU, LV, MC, MT, NL,
NO, PL, PT, RO, SE, SI, SK, TR), OAPI (BF, BJ, CF, CG,
CI, CM, GA, GN, GQ, GW, ML, MR, NE, SN, TD, TG).

(72) Inventors; and

(75) Inventors/Applicants (for US only): BJORSELL,
Johan, Emil, Viktor [SE/CA]; 203 - 2288 Broadway
West, Vancouver, British Columbia V6K 0B3 (CA).
SOBOLYEV, Maksym [RU/CA]; 307 - 265 Tenth Street,
New Westminster, British Columbia V3M 3Y1 (CA).

Published:
— with international search report

(54) Title: EMERGENCY ASSISTANCE CALLING FOR VOICE OVER IP COMMUNICATIONS SYSTEMS

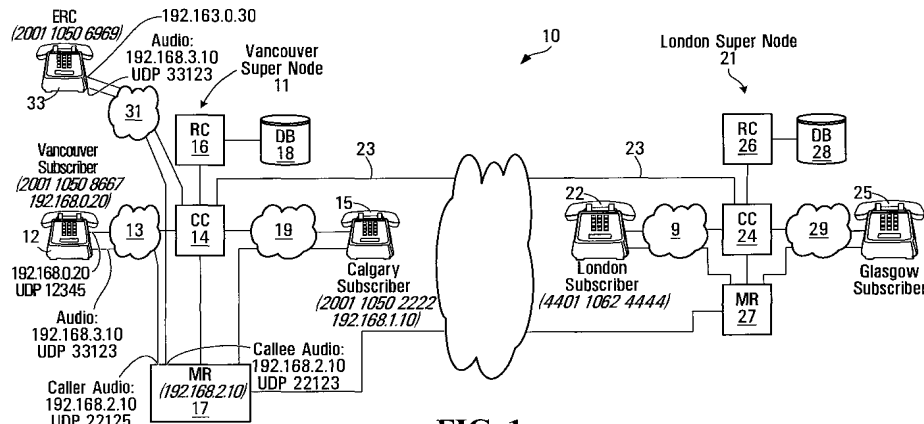

FIG. 1

(57) Abstract: In accordance with one aspect of the invention there is provided a process for handling emergency calls from a caller in a voice over IP system. The process involves receiving a routing request message including a caller identifier and a callee identifier. The process also involves setting an emergency call flag active in response to the callee identifier matching an emergency call identifier pre-associated with the caller. The process further involves producing an emergency response center identifier in response to the emergency call identifier. The process also involves determining whether the caller identifier is associated with a pre-associated direct inward dialing (DID) identifier. The process further involves producing a direct inward dialing (DID) identifier for the caller by associating a temporary DID identifier with the caller identifier when the emergency call flag is active and it is determined that the caller has no pre-associated DID. The process also involves producing a routing message including the emergency response center identifier and the temporary DID identifier for receipt by a routing controller operable to cause a route to be established between the caller and the emergency response center.



WO 2008/116296 A1

-1-

EMERGENCY ASSISTANCE CALLING FOR VOICE OVER IP COMMUNICATIONS SYSTEMS

BACKGROUND OF THE INVENTION

5 Field of Invention

This invention relates to emergency assistance calling, voice over internet protocol communications and methods and apparatus for emergency assistance calling for voice over IP data communications.

10 An essential feature of traditional telephone systems (PSTN) is the ability of its subscribers to dial a universal emergency number (911 in North America) to access a host of emergency services such as fire, police and ambulance. Because of the hierarchical nature of telephone networks and numbering schemes, a call coming from a specific telephone number on the PSTN
15 network is automatically routed to a nearest Emergency Response Center (ERC) based on the area code and exchange code contained in the specific telephone number. Normally, the specific telephone number will be compliant with the E.164 standard set by the International Telecommunication Union. When the call comes into the ERC, call information presented the ERC
20 operator includes the phone number, and where available, the address associated with this phone number.

Since the late 1990s, an enhanced emergency service (E911) was mandated for PSTN and cellular carriers in North America and elsewhere. In particular,
25 with this enhanced service the information automatically provided to the ERC includes the physical location of the person calling, even where the caller is using a cellular telephone. Moreover, a callback functionality is integrated into E911-compliant systems allowing an ERC operator to call back the person who placed the emergency call even if the original phone call was
30 disconnected or if the calling line became busy.

-2-

In the realm of VoIP networks, implementation of **911** and **E911** services often presents significant problems.

5 Even to provide basic **911** services, VoIP systems present a number of problems because they do not employ hierarchical numbering schemes, and the phone numbers assigned to VoIP system subscribers, while still in the **E.164** format, do not actually reflect the subscribers physical location via area code and exchange codes. As a result, a VoIP provider is not able to automatically route an emergency call to an ERC nearest to the subscriber.
10 Because VoIP subscriber phone numbers are assigned from a bulk of phone numbers that VoIP providers purchase from wireline PSTN carriers, a VoIP **911** emergency services call coming into the ERC is not associated with a subscriber address that can be accessed by the ERC operator.

15 In addition, because VoIP systems are not based on the Signaling System 7 (SS7) protocol, they do not natively support special short phone numbers such as **911**. In particular, they do not natively support variable length phone number dialing, or dynamic translation of dialed universal phone numbers into actual destination phone numbers based on user attributes such as location
20 or service type.

VoIP systems are also typically not able to comply with **E911** service requirements, for the same reasons they are not able to comply with regular **911** services.

25
In accordance with one aspect of the invention, there is provided a process for handling emergency calls from a caller in a voice over IP system. The method involves receiving a routing request message including a caller identifier and a callee identifier. The method also involves setting an emergency call flag
30 active in response to the callee identifier matching an emergency call identifier pre-associated with the caller. The method further involves producing an emergency response center identifier in response to the emergency call

-3-

5 identifier. The method also involves determining whether the caller identifier is associated with a pre-associated direct inward dialing (DID) identifier. The method further involves producing a direct inward dialing (DID) identifier for the caller by associating a temporary DID identifier with the caller identifier when the emergency call flag is active and it is determined that the caller has no pre-associated DID identifier. The method also involves producing a routing message including the emergency response center identifier and the temporary DID identifier for receipt by a routing controller operable to cause a route to be established between the caller and the emergency response center.

10 Setting the emergency call flag active may involve retrieving a dialing profile associated with the caller and setting the emergency call flag active when the contents of an emergency call identifier field of the dialing profile match the callee identifier.

15 Determining whether the caller identifier is associated with a pre-associated DID identifier may involve searching a database for a DID record associating a DID identifier with the caller and determining that the caller identifier is associated with a pre-associated DID identifier when the record associating a DID identifier with the caller is found.

20 Associating a pre-assigned DID identifier with the caller identifier may involve copying the pre-associated DID identifier from the DID record to a DID identifier buffer.

25 Producing the routing message may involve causing the contents of the DID identifier buffer to define the DID identifier in the routing message.

30 Determining whether the caller identifier is associated with a pre-associated DID identifier may involve searching a database for a DID record associating a DID identifier with the caller and determining that the caller identifier is not

-4-

associated with a pre-associated DID identifier when a record associating a DID identifier with the caller is not found.

5 Associating a temporary DID identifier with the caller identifier may involve associating with the caller identifier a DID identifier from a pool of pre-determined DID identifiers.

10 Associating the DID identifier from the pool may involve associating a temporary DID record with the caller, the temporary DID record having a DID identifier field populated with the DID identifier from the pool.

Associating the DID identifier from the pool may involve copying the DID identifier from the temporary DID record to a DID identifier buffer.

15 The method may involve canceling the temporary DID record after a pre-defined period of time.

20 Producing the emergency response center identifier may involve obtaining an emergency response center identifier from an emergency response center field of the dialing profile associated with the caller.

25 Obtaining may involve copying an emergency response center identifier from the dialing profile associated with the caller to a routing message buffer such that the emergency response center identifier is included in the routing message.

30 Producing the routing message may involve causing the routing message to specify a maximum call time for the emergency call, the maximum call time exceeding a duration of an average non-emergency telephone call.

In accordance with another aspect of the invention, there is provided an apparatus for handling emergency calls from a caller in a voice over IP

-5-

5 system. The apparatus includes provisions for receiving a routing request message including a caller identifier and a callee identifier. The apparatus also includes setting provisions for setting an emergency call flag active in response to the callee identifier matching an emergency call identifier pre-associated with the caller. The apparatus further includes provisions for producing an emergency response center identifier in response to the emergency call identifier. The apparatus also includes provisions for determining whether the caller identifier is associated with a pre-associated direct inward dialing (DID) identifier. The apparatus further includes provisions for producing a direct inward dialing (DID) identifier for the caller including provisions for associating a temporary DID identifier with the caller identifier in response to the emergency call flag being active and the caller identifier not being pre-associated with direct inward dialing identifier. The provisions for producing a direct inward dialing (DID) identifier for the caller further include provisions for associating a pre-assigned DID identifier with the caller identifier when the caller identifier has no pre-associated direct inward dialing identifier. The apparatus also includes provisions for producing a routing message including the emergency response center identifier and the temporary DID identifier for receipt by a routing controller operable to cause a route to be established between the caller and the emergency response center.

25 The apparatus may further include provisions for accessing a database of dialing profiles associated with respective subscribers to the system, each of the dialing profiles including an emergency call identifier field and an emergency call center field and the setting provisions may comprise provisions for retrieving a dialing profile associated with the caller and for setting the emergency call flag active when the contents of the emergency call identifier field of the dialing profile match the callee identifier.

30 The apparatus may further include database accessing provisions for accessing a database including direct inward dialing (DID) records associated

-6-

with at least some subscribers to the system, each of the direct inward dialing records comprising a system username and a direct inward dialing number, and wherein the determining provisions comprise searching provisions for searching a database for a DID record associating a DID identifier with the caller. The determining provisions may be operably configured to determine that the caller identifier is associated with a pre-associated DID identifier when a record associating a DID identifier with the caller is found.

The apparatus may further include a DID identifier buffer and the provisions for associating a pre-assigned DID identifier with the caller identifier may comprise provisions for copying the pre-associated DID identifier from the DID record to the DID identifier buffer.

The provisions for producing the routing message may include provisions for causing the contents of the DID identifier buffer to define the DID identifier in the routing message.

The apparatus may further include database accessing provisions for accessing a database including direct inward dialing records associated with at least some subscribers to the system, each of the direct inward dialing records comprising a system username and a direct inward dialing number and the determining provisions may comprise searching provisions for searching a database for a DID record associating a DID identifier with the caller and wherein the determining provisions may be operably configured to determine that the caller identifier is not associated with a pre-associated DID identifier when a record associating a DID identifier with the caller is not found.

The apparatus may further include provisions for accessing a pool of pre-determined DID identifiers and the provisions for associating a temporary DID identifier with the caller identifier may comprise provisions for associating a

-7-

DID identifier from the pool of pre-determined DID identifiers with the caller identifier.

5 The provisions for associating the DID identifier from the pool may include provisions for associating a temporary DID record with the caller, the temporary DID record having a DID identifier field populated with the DID identifier from the pool.

10 The provisions for associating the DID identifier may include provisions for copying the DID identifier from the temporary DID record to a DID identifier buffer.

15 The apparatus may further include provisions for canceling the temporary DID record after a period of time.

20 The provisions for producing the emergency response center identifier may include provisions for obtaining an emergency response center identifier from an emergency response center field of the dialing profile associated with the caller.

25 The apparatus may include a routing message buffer and the provisions for obtaining may include provisions for copying the contents of the emergency response center field of the dialing profile associated with the caller to the routing message buffer such that the contents of the emergency response center field are included in the routing message.

30 The provisions for producing the routing message may include provisions for causing the routing message to include a maximum call time for the emergency call, the maximum call time exceeding a duration of an average non-emergency telephone call.

-8-

In accordance with another aspect of the invention, there is provided an apparatus for handling emergency calls from a caller in a voice over IP system. The apparatus includes an processor circuit operably configured to receive a routing request message including a caller identifier and a callee identifier. The processor circuit is also operably configured to set an emergency call flag active in response to the callee identifier matching an emergency call identifier pre-associated with the caller. The processor circuit is further operably configured to produce an emergency response center identifier in response to the emergency call identifier and to determine whether the caller identifier is associated with a pre-associated direct inward dialing (DID) identifier. The processor circuit is also operably configured to produce a direct inward dialing (DID) identifier for the caller by associating a temporary DID identifier with the caller identifier when the emergency call flag is active and it is determined that the caller identifier has no pre-associated DID identifier. The processor circuit is further operably configured to produce a routing message including the emergency response center identifier and the temporary DID identifier for receipt by a routing controller operable to cause a route to be established between the caller and the emergency response center.

The processor circuit may be operably configured to retrieve a dialing profile associated with the caller and to set the emergency call flag active when the contents of an emergency call identifier field of the dialing profile match the callee identifier.

The processor circuit may be operably configured to search a database for a DID record associating a DID identifier with the caller and to determine that the caller identifier is associated with a pre-associated DID identifier when the record associating a DID identifier with the caller is found.

The processor circuit may be operably configured to copy the pre-associated DID identifier from the DID record to a DID identifier buffer.

The processor circuit may be operably configured to cause the contents of the DID identifier buffer to define the DID identifier in the routing message.

5 The processor circuit may be operably configured to search a database for a DID record associating a DID identifier with the caller and to determine that the caller identifier is not associated with a pre-associated DID identifier when a record associating a DID identifier with the caller is not found.

10 The processor circuit may be operably configured to associate with the caller identifier a DID identifier from a pool of pre-determined DID identifiers.

The processor circuit may be operably configured to associate a temporary DID record with the caller, the temporary DID record having a DID identifier field populated with the DID identifier from the pool.

15

The processor circuit may be operably configured to copy the DID identifier from the temporary DID record to a DID buffer.

20 The processor circuit may be operably configured to cancel the temporary DID record after a period of time.

The processor circuit may be operably configured to obtain an emergency response center identifier from an emergency response center field of the dialing profile associated with the caller.

25

The apparatus may further a routing message buffer and the processor circuit may be operably configured to copy an emergency response center identifier from the dialing profile associated with the caller to the routing message buffer such that the emergency response center identifier is included in the routing message.

30

-10-

The processor circuit may be operably configured to cause the routing message to include a maximum call time for the emergency call, the maximum call time exceeding a duration of an average non-emergency telephone call.

5

In accordance with another aspect of the invention, there is provided a computer readable medium encoded with codes for directing a processor circuit to handle emergency calls from callers in a voice over IP system. The codes direct the processor circuit to receive a routing request message including a caller identifier and a callee identifier. The codes also direct the processor circuit to set an emergency call flag active in response to the callee identifier matching an emergency call identifier pre-associated with the caller. The codes further direct the processor circuit to produce an emergency response center identifier in response to the emergency call identifier. The codes also direct the processor circuit to determine whether the caller identifier is associated with a pre-associated direct inward dialing (DID) identifier. The codes further direct the processor circuit to produce a direct inward dialing (DID) identifier for the caller by associating a temporary DID identifier with the caller identifier when the emergency call flag is active and it is determined that the caller identifier has no pre-associated DID identifier. The codes also direct the processor circuit to produce a routing message including the emergency response center identifier and the temporary DID identifier for receipt by a routing controller operable to cause a route to be established between the caller and the emergency response center.

25

BRIEF DESCRIPTION OF THE DRAWINGS

In drawings which illustrate embodiments of the invention,

Figure 1 is a block diagram of a system according to a first embodiment of the invention;

30

-11-

- Figure 2 is a block diagram of a caller VoIP telephone according to the first embodiment of the invention;
- 5 Figure 3 is a schematic representation of a SIP Invite message transmitted between the caller telephone and a call controller (CC) shown in Figure 1;
- Figure 4 is a block diagram of the call controller shown in Figure 1;
- 10 Figure 5 is a flowchart of a process executed by the call controller shown in Figure 1;
- Figure 6 is a schematic representation of a routing controller (RC) Request message produced by the call controller shown in Figure 1;
- 15 Figure 7 is a block diagram of a routing controller (RC) processor circuit of the routing controller shown in Figure 1;
- Figures 8A-8D are flowcharts of a RC Request message handler executed by the RC processor circuit shown in Figure 7;
- 20 Figure 9 is a tabular representation of a dialling profile stored in a database accessible by the RC shown in Figure 1;
- 25 Figure 10 is a tabular representation of a dialling profile for a Vancouver caller using the caller telephone shown in Figure 1;
- Figure 10A is a tabular representation of a dialling profile for the Emergency Response Center subscriber shown in Figure 1;
- 30 Figure 11 is a tabular representation of a dialling profile for the Calgary subscriber shown in Figure 1;

-12-

- Figure 12 is a tabular representation of a dialing profile for the London subscriber shown in Figure 1;
- 5 Figure 13 is a tabular representation of a DID bank table record stored in the database shown in Figure 1;
- Figure 13A is a tabular representation of an exemplary DID bank table record for the Vancouver subscriber;
- 10 Figure 13B is a tabular representation of an exemplary DID bank table record for the Calgary subscriber;
- Figure 14 is a tabular representation of an exemplary DID bank table record for the London subscriber;
- 15 Figure 15 is a tabular representation of a routing message buffer for holding a routing message to be transmitted from the RC to the call controller shown in Figure 1;
- 20 Figure 16 is a tabular representation of a routing message for routing a call to the Emergency Response Center;
- Figure 16A is a tabular representation of a routing message for routing a call to the London subscriber;
- 25 Figure 17 is a tabular representation of a prefix to supernode table record stored in the database shown in Figure 1;
- 30 Figure 18 is a tabular representation of a prefix to supernode table record that would be used for the London subscriber;

-13-

- Figure 19 is a tabular representation of a master list record stored in a master list table in the database shown in Figure 1;
- 5 Figure 20 is a tabular representation of an exemplary populated master list record;
- Figure 21 is a tabular representation of a suppliers list record stored in the database shown in Figure 1;
- 10 Figure 22 is a tabular representation of a specific supplier list record for a first supplier;
- Figure 23 is a tabular representation of a specific supplier list record for a second supplier;
- 15 Figure 24 is a tabular representation of a specific supplier list record for a third supplier;
- Figure 25 is a tabular representation of a routing message buffer for holding a routing message identifying a plurality of possible suppliers that may carry the call;
- 20 Figure 26 is a tabular representation of a call block table record;
- Figure 27 is a tabular representation of a call block table record for the Calgary subscriber;
- 25 Figure 28 is a tabular representation of a call forwarding table record;
- Figure 29 is a tabular representation of an exemplary call forwarding table record specific to the Calgary subscriber;
- 30

-14-

- Figure 30 is a tabular representation of a voicemail table record specifying voicemail parameters to enable the caller to leave a voicemail message for the callee;
- 5 Figure 31 is a tabular representation of an exemplary voicemail table record for the Calgary subscriber;
- Figure 32 is a tabular representation of an exemplary routing message, held in a routing message buffer, indicating call forwarding numbers and a voicemail server identifier;
- 10 Figure 33 is a tabular representation of a SIP Bye message transmitted from any of the telephones to the call controller;
- 15 Figure 34 is a tabular representation of a SIP Bye message sent to the call controller from the callee or caller gateway;
- Figure 35 is a flowchart of a process executed by the call controller for producing a RC Call Stop message in response to receipt of a SIP Bye message;
- 20 Figure 36 is a tabular representation of an exemplary RC Call Stop message;
- 25 Figure 37 is a tabular representation of an exemplary RC Call Stop message for the Calgary subscriber;
- Figure 38 is a schematic representation of messages exchanged during a process for establishing audio paths between telephones and a media relay.
- 30

-15-

DETAILED DESCRIPTION

Referring to Figure 1, a system for making voice over IP telephone calls including emergency calls is shown generally at **10**. The system includes a first supernode shown generally at **11** and a second supernode shown generally at **21**. The first supernode **11** is located in a geographical area, such as Vancouver B.C., for example and the second supernode **21** is located in London, England, for example. Different supernodes may be located in different geographical regions throughout the world to provide telephone service to subscribers in respective regions. These supernodes may be in communication with each other through high speed / high data throughput links including optical fiber, satellite and/or cable links, for example, forming a system backbone. These supernodes may alternatively or in addition be in communication with each other through conventional Internet services. In the embodiment shown, data communication media for providing for data communications between the first and second supernodes **11** and **21** are shown generally at **23** and may include very high speed data links, for example.

In the embodiment shown, the Vancouver supernode **11** provides telephone service to a geographical region comprising Western Canadian customers from Vancouver Island to Ontario and includes a Vancouver subscriber, a Calgary subscriber and an emergency response center (ERC) that is also a subscriber. The second supernode **21** may be located in London, England, for example, to service London and Glasgow subscribers, **22** and **25**, for example through their own service providers **9** and **29**. As will be seen below however, the emergency response center need not be a subscriber.

Other supernodes similar to the type shown may also be employed within the geographical area serviced by a supernode, to provide for call load sharing, for example within a region of the geographical area serviced by the supernode. However, in general, all supernodes are similar and have the properties described below in connection with the Vancouver supernode **11**.

-16-

In this embodiment, the Vancouver supernode includes a call controller (CC) **14**, a routing controller (RC) **16**, a database **18** and a media relay (MR) **17**. Subscribers such as the Vancouver subscriber, the Calgary subscriber and the Emergency Response Center subscriber communicate with the Vancouver supernode **11** using their own Internet Service Providers (ISPs) **13**, **19** and **31** respectively which route Internet Protocol (IP) traffic from these subscribers to the Vancouver Supernode over the Internet. To these subscribers the Vancouver supernode **11** is accessible through their ISP at a pre-determined IP address or a fully qualified domain name (FQDN). The subscriber in the city of Vancouver uses a telephone **12** that is capable of communicating with the Vancouver supernode **11** using Session Initiation Protocol (SIP) messages, and the Calgary and Emergency Response Center subscribers use similar telephones **15** and **33** respectively, to communicate with the Vancouver supernode from their locations. The London supernode **21** also has a call controller **24**, a routing controller **26** and a database **28** and functions in a manner similar to the Vancouver supernode **11**.

It should be noted that throughout the description of the embodiments of this invention, the IP/UDP addresses of all elements such as the caller and callee telephones, call controller, media relay, and any others, will be assumed to be valid IP/UDP addresses directly accessible via the Internet or a private IP network, for example, depending on the specific implementation of the system. As such, it will be assumed, for example, that the caller and callee telephones will have IP/UDP addresses directly accessible by the call controllers and the media relays on their respective supernodes, and those addresses will not be obscured by Network Address Translation (NAT) or similar mechanisms. In other words, the IP/UDP information contained in SIP messages (for example the SIP Invite message or the RC Request message which will be described below) will match the IP/UDP addresses of the IP packets carrying these SIP messages.

-17-

It will be appreciated that in many situations, the IP addresses assigned to various elements of the system may be in a private IP address space, and thus not directly accessible from other elements. Furthermore, it will also be appreciated that NAT is commonly used to share a “public” IP address between multiple devices, for example between home PCs and IP telephones sharing a single Internet connection. For example, a home PC may be assigned an IP address such as **192.168.0.101** and a Voice over IP telephone may be assigned an IP address of **192.168.0.103**. These addresses are located in so called “non-routable” (IP) address space and cannot be accessed directly from the Internet. In order for these devices to communicate with other computers located on the Internet, these IP addresses have to be converted into a “public” IP address, for example **24.10.10.123** assigned by the Internet Service Provider to the subscriber, by a device performing NAT, typically a home router. In addition to translating the IP addresses, NAT typically also translates UDP port numbers, for example an audio path originating at a VoIP telephone and using a UDP port **12378** at its private IP address, may have been translated to UDP port **23465** associated with the public IP address of the NAT device. In other words, when a packet originating from the above VoIP telephone arrives at an Internet-based supernode, the source IP/UDP address contained in the IP packet header will be **24.10.10.123:23465**, whereas the source IP/UDP address information contained in the SIP message inside this IP packet will be **192.168.0.103:12378**. The mismatch in the IP/UDP addresses may cause a problem for SIP-based VoIP systems because, for example, a supernode will attempt to send messages to a private address of a telephone – the messages will never get there.

It will be appreciated that a number of methods are available to overcome this problem. For example, the SIP NATHelper open source software module may run on the supernode to correlate public IP/UDP address contained in the headers of the IP packets arriving from SIP devices with private IP/UDP addresses in the SIP messages contained in these packets. Therefore, the

-18-

embodiments of the invention described below will function whether or not any of the elements of the system are located behind NAT devices that obscure their real IP/UDP addresses.

5 Referring to Figure 1, in an attempt to make a regular call by the Vancouver telephone 12 to the London telephone 22, for example, the Vancouver telephone sends a SIP Invite message to the Vancouver supernode 11 and in response, the call controller 14 sends an RC Request message to the routing controller 16 which makes various enquiries of the database 18 to produce a
10 routing message which is sent to the call controller. The call controller 14 then causes a communications link, including audio paths, to be established through the media relay 17 which may include the same Vancouver supernode 11, a different supernode or a communications supplier gateway, for example, to carry voice traffic to and from the call recipient or callee.

15 In an attempt to make an emergency call, generally the call is made by dialling a short number such as 911 and the call is routed to an emergency response center (ERC) associated with the caller such as the emergency response center associated with the telephone 33. However, as will be
20 appreciated from the description below, this system will permit emergency calls originating from subscribers associated with one supernode to be received by emergency response centers associated with a different supernode, if necessary.

25 Subscriber Telephone

Referring to Figure 2, in this embodiment, the telephone 12 includes a processor circuit shown generally at 30 comprising a microprocessor 32, program memory 34, an input/output (I/O) interface 36, parameter memory 38 and temporary memory 40. The program memory 34, I/O interface 36,
30 parameter memory 38 and temporary memory 40 are all in communication with the microprocessor 32. The I/O interface 36 has a dial input 42 for receiving a dialed telephone number from a keypad, for example, or from a

-19-

voice recognition unit or from pre-stored telephone numbers stored in the parameter memory **38**, for example. For simplicity, a box labelled dialling functions **44** represents any device capable of informing the microprocessor **32** of a callee identifier, e.g., a callee telephone number.

5

The processor **32** stores the callee identifier in a dialed number buffer **41**. Where the callee is the London subscriber, the callee identifier may be **4401 1062 4444**, for example, identifying the London subscriber or the callee identifier may be a standard telephone number, or where the callee is the
10 Emergency Response Center, the callee identifier may be **911**, for example.

The I/O interface **36** also has a handset interface **46** for receiving and producing signals from and to a handset that receives user's speech to produce audio signals and produces sound in response to received audio
15 signals. The handset interface **46** may include a BLUETOOTH™ wireless interface, a wired interface or speakerphone, for example. The handset **45** acts as a termination point for an audio path (not shown) which will be appreciated later.

20

The I/O interface **36** also has a network interface **48** to an IP network, and is operable, for example, to connect the telephone to an ISP via a high speed Internet connection. The network interface **48** also acts as a part of the audio path, as will be appreciated later.

25

The parameter memory **38** has a username field **50**, a password field **52**, an IP address field **53** and a SIP proxy address field **54**. The username field **50** is operable to hold a username associated with the telephone **12**, which in this case is **2001 1050 8667**. The username is assigned upon subscription or registration into the system and, in this embodiment includes a twelve digit
30 number having a prefix **61**, a country code **63**, a dealer code **70** and a unique number code **74**. The prefix **61** is comprised of the first or left-most digit of the username in this embodiment. The prefix may act as a continent code in

-20-

some embodiments, for example. The country code **63** is comprised of the next three digits. The dealer code **70** is comprised of the next four digits and the unique number code **74** is comprised of the last four digits. The password field **52** holds a password of up to **512** characters, in this example. The IP address field **53** stores an IP address of the telephone **30**, which for this explanation is **192.168.0.20**. The SIP proxy address field **54** stores an IP address of a SIP proxy which may be provided to the telephone **12** through the network interface **48** as part of a registration procedure, for example.

The program memory **34** stores blocks of codes for directing the microprocessor **32** to carry out the functions of the telephone **12**, one of which includes a firewall block **56** which provides firewall functions to the telephone, to prevent unauthorized access through the network interface **48** to the microprocessor **32** and memories **34**, **38** and **40**. The program memory **34** also stores codes **57** for establishing a call ID. The call ID codes **57** direct the microprocessor **32** to produce call identifiers, that may, for example have the format of a hexadecimal string and an IP address of the telephone stored in IP address field **53**. Thus, an exemplary call identifier for a call might be **FF10 @ 192.168.0.20**.

Generally, in response to activating the handset **45** and using the dialling function **44**, the microprocessor **32** produces and sends a SIP Invite message **59** as shown in Figure 3, to the routing controller (RC) **14** shown in Figure 1.

Referring to Figure 3, the SIP Invite message includes a caller identifier field **60**, a callee identifier field **62**, a digest parameters field **64**, a call ID field **65**, a caller IP address field **67** and a caller UDP port field **69**. In this embodiment, the caller identifier field **60** includes the username **2001 1050 8667**, which is the username stored in the username field **50** of the parameter memory **38** in the Vancouver telephone **12** shown in Figure 2. In addition, as an example, referring back to Figure 3, where the call is a normal, non-emergency call to the London subscriber the callee identifier field **62** includes the username

-21-

5 **4401 1062 4444** which is the dialed number of the London subscriber stored in the dialed number buffer **41** shown in Figure 2. The digest parameters field **64** includes digest parameters and the call ID field **65** includes a code comprising a generated prefix code (FF**10**, for example) and a suffix which is the IP address of the telephone **12** stored in the IP address field **53**. The IP address field **67** and UDP port field **69** define a socket for audio communications. The IP address field **67** holds the IP address assigned to the telephone, in this embodiment **192.168.0.20**, and the caller UDP port field **69** includes a UDP port identifier identifying a UDP port at which the audio path will be terminated at the caller's telephone.

10

Call Controller

Referring to Figure 4, a call controller circuit of the call controller **14** (Figure 1) is shown in greater detail at **100**. The call controller circuit **100** includes a microprocessor **102**, program memory **104**, random access memory **105** and an I/O interface **106**. The call controller circuit **100** may include a plurality of microprocessors, a plurality of program memories and a plurality of I/O interfaces to be able to handle a large volume of calls. However, for simplicity, the call controller circuit **100** will be described as having only one microprocessor, program memory and I/O interface, it being understood that there may be more.

15

20

Generally, the I/O interface **106** includes an input **108** for receiving messages, such as the SIP Invite message shown in Figure 3, from the telephone **12** shown in Figure 2. The I/O interface **106** also has an RC Request message output **110** for transmitting an RC Request message to the routing controller **16** in Figure 1, an RC message input **112** for receiving routing messages from the RC **16**, a MR output **114** for transmitting messages to the media relay **17** (Figure 1) to advise the media relay to establish an audio path, and a MR input **116** for receiving messages from the media relay to which a message has been sent to attempt to establish the audio path. The I/O interface **106** further includes a SIP output **118** for transmitting SIP messages to the

25

30

-22-

telephone **12** (Figure **2**) to advise the telephone of the IP address of the media relay **17** (Figure **1**) which will establish the audio path.

5 While certain inputs and outputs have been shown as separate, it will be appreciated that some may be associated with a single IP address and TCP or UDP port. For example, the messages sent and received from the RC **16** may be transmitted and received at the same single IP address and TCP or UDP port.

10 The program memory **104** of the call controller circuit **100** includes blocks of code for directing the microprocessor **102** to carry out various functions of the call controller **14**. For example, these blocks of code include a first block **120** for causing the call controller circuit **100** to execute a SIP Invite to RC request process to produce a RC Request message in response to a received SIP
15 Invite message. In addition, there is a Routing Message to Media Relay message block **122** which causes the call controller circuit **100** to produce an MR Query message in response to a received routing message from the routing controller **16**.

20 Referring to Figure **5**, the SIP Invite-to-RC Request process is shown in more detail at **120**. On receipt of a SIP Invite message of the type shown in Figure **3**, block **132** of Figure **5** directs the call controller circuit **100** of Figure **4** to authenticate the user operating the telephone from which the SIP Invite message originated. This may be done, for example, by prompting the user
25 for a password by sending a message back to the caller telephone **12** in Figure **1**, which is interpreted at the telephone as a request for password entry or the password may automatically be sent to the call controller **14** from the telephone, in response to the message. The call controller **14** may then make enquiries of the database **18** to determine whether or not the user's password matches a password stored in the database. Various functions may be used
30 to pass encryption keys or hash codes back and forth to ensure the secure

-23-

transmission of passwords. Authentication may be bypassed when the call is to the ERC.

5 Should the authentication process fail, the call controller circuit **100** is directed to an error handling block **134** which causes messages to be displayed at the caller telephone **12** to indicate that there was an authentication error. If the authentication process is successful, block **131** directs the call controller circuit **100** of Figure **4** to determine whether or not the contents of the caller identifier field **60** of the SIP Invite message shown in Figure **3** is a validly formatted IP address. If it is a valid IP address, then block **133** of Figure **5** 10 directs the call controller circuit **100** of Figure **4** to associate a type code with the call to indicate that the call type is a third party invite.

15 If at block **131** the caller identifier field **60** contents do not identify an IP address (for example, they may identify a PSTN number or Emergency Calling short number such as **911**), then block **135** directs the call controller circuit **100** to associate a type code with the call to indicate the call type is a regular invite. Then, block **136** directs the call controller circuit **100** to establish a call ID by reading the call ID provided in the call ID field **65** of the SIP Invite message from the telephone **12**, and at block **138** the call controller circuit is directed to produce a routing request message of the type shown in 20 Figure **6** that includes that call ID. Block **139** of Figure **5** then directs the call controller circuit **100** of Figure **4** to send the RC Request message to the routing controller **16** of Figure **1**.

25 Referring to Figure **6**, a routing request message is shown generally at **150** and includes a caller identifier field **152**, a callee identifier field **154**, a digest field **156**, a call ID field **158** and a type field **160**. The caller, callee, digest, and call ID fields **152**, **154**, **156** and **158** contain copies of the caller, callee, digest parameters and call ID fields **60**, **62**, **64** and **65** of the SIP Invite message shown in Figure **3**. The type field **160** contains the type code established at 30 blocks **133** or **135** of Figure **5** to indicate whether the call is from a third party

-24-

or system subscriber, respectively. For a normal non-emergency call the callee identifier field **154** may include a PSTN number or a system subscriber username as shown, for example. For an emergency call, the callee identifier field **154** includes the Emergency short number **911**, in this embodiment.

5

Routing Controller

Referring to Figure 7, the routing controller **16** is shown in greater detail and includes an RC processor circuit shown generally at **200**. The RC processor circuit **200** includes a processor **202**, program memory **204**, a table memory **206**, a DID identifier buffer **203**, a caller ID buffer **205**, a callee ID buffer **209**, an emergency call flag **211**, a DID identifier buffer **203**, a and an I/O interface **208**, all in communication with the processor. (As earlier indicated, there may be a plurality of processors (**202**), memories (**204**), etc.) Separate caller ID buffers **205**, callee id buffers **209** and emergency call flags **211** are instantiated for each call and are associated with respective call IDs.

10

15

20

The I/O interface **208** includes a database output port **210** through which a request to the database **18** (Figure 1) can be made and includes a database response port **212** for receiving a reply from the database. The I/O interface **208** further includes an RC Request message input **214** for receiving the routing request message from the call controller **14**. Thus, the routing controller receives a routing request message including a caller identifier and a callee identifier. The I/O interface **208** further includes a routing message output **216** for sending a routing message back to the call controller **14**.

25

30

The program memory **204** includes blocks of codes for directing the RC processor circuit **200** to carry out various functions of the routing controller **16**. One of these blocks includes an RC Request message handler process **250** which directs the RC processor circuit to produce a routing message in response to a received routing request message of the type shown at **150** in Figure 6. The RC Request message handler process is shown in greater detail at **250** in Figures 8A through 8D.

-25-

RC Request Message Handler

Referring to Figure 8A, the routing request message handler **250** begins with a first block **252** that directs the RC processor circuit **200** (Figure 7) to store the contents of the RC Request message **150** (Figure 6) in the callee ID buffer **209** and the caller buffer **205** buffers for separately storing the contents of the callee field (**154** in Figure 6) and the caller field (**152** in Figure 6) respectively of the RC Request message. Block **254** then directs the RC processor circuit **200** to use the contents of the caller field (**152** in Figure 6) in the RC Request message **150**, to search the database **18** shown in Figure 1 and retrieve a dialling profile associated with the caller.

Referring to Figure 9, a dialling profile is shown generally at **256** and includes system fields including a username field **258**, a domain field **260**, a national dialling digits (NDD) field **262**, an International dialing digits (IDD) field **264**, a country code field **266**, a local area codes field **267**, a caller minimum local length field **268**, a caller maximum local length field **270**, a reseller field **273**, a user address field **275**, an emergency call identifier field **277** and an emergency response center (ERC) field **279**.

An exemplary dialling profile for the Vancouver subscriber is shown generally at **276** in Figure 10 and indicates that the username field **258** includes the username **2001 1050 8667** which is the same as the contents of the username field **50** in the Vancouver telephone **12** shown in Figure 2.

Referring back to Figure 10, the domain field **260** includes a domain name as shown at **282**, including a supernode type identifier **284**, a location code identifier **286**, a system provider identifier **288** and a top level domain identifier **290**, identifying a domain or supernode associated with the user identified by the contents of the username field **258**.

-26-

In this embodiment, the supernode type identifier **284** includes the code “sp” identifying a supernode and the location code identifier **286** identifies the supernode as being in Vancouver (yvr). The system provider identifier **288** identifies the company supplying the service and the top level domain identifier **290** identifies the “com” domain.

The NDD field **262** in this embodiment includes the digit “1” and in general includes a digit specified by the International Telecommunications Union – Telecommunications Standardization Sector (ITU-T) E.164 Recommendation which assigns national dialling digits to certain countries.

The IDD field **264** includes the code **011** and, in general, includes a code assigned by the ITU-T according to the country or geographical location of the subscriber.

The country code field **266** includes the digit “1” and, in general, includes a number assigned by the ITU-T to represent the country in which the subscriber is located.

The local area codes field **267** includes the numbers **604** and **778** and generally includes a list of area codes that have been assigned by the ITU-T to the geographical area in which the subscriber is located. The caller minimum and maximum local number length fields **268** and **270** each hold the number **10** representing minimum and maximum local number lengths permitted in the area code(s) specified by the contents of the local area codes field **267**. The reseller field **273** holds a code identifying a retailer of the telephone services, and in the embodiment shown, the retailer is “Klondike”.

The address field **275** holds an address at which the subscriber telephone is normally located. The emergency short number field **277** holds the short emergency number such as “911” that the user is expected to dial in the event of an emergency. The ERC number field **279** holds a full PSTN number

-27-

associated with an emergency response center that would desirably be geographically nearest to the address specified in the address field **275**.

5 A dialling profile of the type shown at **256** in Figure **9** is produced whenever a user registers with the system or agrees to become a subscriber to the system. An ERC may register as a user, but need not do so since, as will be appreciated below, provisions are made for making VoIP to PSTN calls which may include calls to an ERC only available via the PSTN. Of importance here is that the contents of the emergency short number field **277** and the contents
10 of the ERC number field **279** are assigned when the user registers with the system and thus it may be said that these numbers are "pre-assigned" to the user before the user makes any calls.

15 A user wishing to subscribe to the system may contact an office maintained by a system operator. Personnel in the office may ask the user certain questions about his location and service preferences, whereupon tables can be used to provide office personnel with appropriate information to be entered into the username, domain, NDD, IDD, country code, local area codes and caller minimum and maximum local length fields, emergency short number
20 field and ERC number field **258, 260, 262, 264, 266, 267, 268, 270, 277, 279** to establish a dialling profile for the user.

25 Referring to Figures **10A, 11, and 12**, dialling profiles for the ERC subscriber, Calgary subscriber, and the London subscriber, respectively for example, are shown.

30 In addition to creating dialling profiles when a user registers with the system, a direct-in-dial (DID) record of the type shown at **268** in Figure **13** may optionally be added to a direct-in-dial table in the database **18** to associate the username and a host name of the supernode, with which the user is associated, with an E.**164** number on the PSTN network. If the user does not

-28-

have such an E.164 number, no DID record need be created at this time for that user.

5 In this embodiment, the DID bank table records include a username field **291**, a user domain field **272** and DID identifier field **274**, for holding the username, hostname of the supernode and E.164 number respectively. Thus a DID bank table record pre-associates a DID identifier with a user (e.g. caller).

10 A DID bank table record may also include a creation time field and an expiration time field for use when the DID bank table record is a temporary record as will be explained below.

15 DID bank table records for the Vancouver, Calgary and London subscribers are shown in Figures **13A**, **13B**, and **14**, respectively

20 In addition to creating dialling profiles and DID records when a user registers with the system, call blocking records of the type shown in Figure **26**, call forwarding records of the type shown in Figure **28** and voicemail records of the type shown in Figure **30** may be added to the database **18** when a new subscriber is added to the system.

25 Referring back to Figure **8A**, after being directed at block **254** to retrieve a dialling profile associated with the caller, such as shown at **276** in Figure **10**, the RC processor circuit (**200**) is directed to block **255** which causes it to determine whether the contents of the callee ID buffer **209** shown in Figure **7** are equal to the contents of the emergency call identifier field **277** of the dialling profile **276** for the caller, shown in Figure **10**. If the contents of the callee ID buffer **209** are not equal to the contents of the emergency short number field **277**, the call is deemed not to be an emergency call and the RC processor circuit **200** is directed to location A in Figure **8B** to carry out further processing on the basis that the call is to be a normal, non-emergency call.

30

-29-

If the contents of the callee ID buffer **209** match the contents of the emergency call identifier field (**277** in Figure **10**), the call is deemed to be an emergency call and block **157** directs the RC processor circuit **200** to set a time to live (TTL) value to a high number such as **9999** to indicate that the call may have a long duration of **9999** seconds, for example. In addition block **157** directs the RC processor circuit **200** to set active the emergency call flag **211** in Figure **7**, to indicate that the call is an emergency call. Then, block **159** directs the RC processor circuit **200** to replace the contents of the callee ID buffer **209** with the contents of the ERC # field **279** of the caller dialling profile **276** (Figure **10**). Thus, the RC processor circuit produces an emergency response center identifier in response to the emergency call identifier by copying the emergency response center identifier from the ERC field **279** of the dialling profile **276** (Figure **10**) associated with the caller to the callee ID buffer **209** shown in Figure **7** so that effectively, the contents of the callee ID buffer are replaced with the Emergency Response Center number. The RC processor circuit **200** is then directed to location A in Figure **8B**.

In this embodiment, for regular and emergency call processing, beginning at location A in Figure **8B**, the RC processor circuit **200** is directed to perform certain checks on the callee identifier provided by the contents of the callee identifier buffer **209** shown in Figure **7**. Most of these checks are shown in greater detail in Figure **8B** and are used for regular non-emergency call handling. Emergency calls in which the ERC number has been substituted for the short emergency calling number (i.e., **911**) will pass all of the checks. Subjecting both emergency and non-emergency calls to these checks enables all calls, whether emergency or non-emergency, to be passed through the same process and, simplifies the introduction of emergency call handling processes into regular call processing routines depicted in Figures **8A** to **8D**. Alternatively, the RC processor circuit may be directed directly from block **159** to block **269** in Figure **8B** whenever the emergency call flag is set, as shown in broken outline in Figure **8B**.

-30-

Figure 8B

IDD Testing

Referring to Figure 8B, to start the first of the checks, the RC processor circuit **200** is directed to a first block **257** that causes it to determine whether a digit pattern of the callee identifier provided in the callee ID buffer **209** includes a pattern that matches the contents of the IDD field **264** in the caller dialling profile **276** shown in Figure 10. If so, then block **259** directs the RC processor circuit **200** to set a call type identifier code (not shown) to indicate that the call is a long distance call, e.g., from the Vancouver subscriber to the London subscriber, and block **261** directs the RC processor circuit **200** to produce a reformatted callee identifier by reformatting the current callee identifier into a predetermined target format. In this embodiment, this is done by removing the pattern of digits matching the IDD field contents **264** of the caller dialling profile **276** to effectively shorten the number. Then, block **263** directs the RC processor circuit **200** to determine whether or not the reformatted callee identifier meets criteria establishing it as an E.164 compliant number and if the length does not meet this criteria, block **265** directs the RC processor circuit **200** to send back to the call controller **14** a message indicating that the length of the call identifier is not correct. The process **250** is then ended. At the call controller **14**, routines may respond to the incorrect length message by transmitting a message back to the telephone **12** to indicate that an invalid number has been dialed, for example. Thus at the conclusion of block **263** a callee identifier having a pre-defined format should be available.

NDD Testing

Referring back to Figure 8B, if at block **257**, the callee identifier specified by the contents of the callee buffer **209** Figure 7 does not begin with an IDD, block **381** directs the RC processor circuit **200** to determine whether or not the callee identifier begins with the same NDD code as assigned to the caller. To do this, the RC processor circuit is directed to refer to the caller dialling profile **276** shown in Figure 10. In the embodiment shown, the NDD code stored in

-31-

an NDD field **262** is the digit **1**. Thus, if the callee identifier begins with the digit **1**, the RC processor circuit **200** is directed to block **382** in Figure **8B**.

Block **382** directs the RC processor circuit **200** to examine the callee identifier to determine whether or not digits following the NDD code identify an area code that is the same as any of the area codes identified in the local area codes field **267** of the caller dialling profile **276** shown in Figure **10**. If not, block **384** directs the RC processor circuit **200** to set a call type variable (not shown) to a code indicating the call is a national call. If the digits identify an area code that is the same as a local area code associated with the caller, block **386** directs the RC processor circuit **200** to set the call type variable to indicate that the call type is as a local call, national style. After executing blocks **384** or **386**, block **388** directs the RC processor circuit **200** to reformat the callee identifier by removing the national dial digit and prepending a caller country code identified by the country code field **266** of the caller dialling profile **276** shown in Figure **10**. The RC processor circuit **200** is then directed to block **263** to perform the processes described above beginning at block **263**. Again, at the conclusion of block **263** a callee identifier having a pre-defined format should be available.

Area Code Testing

If at block **381** the callee identifier does not begin with an NDD code, block **390** directs the RC processor circuit **200** to determine whether the callee identifier in the callee ID buffer **209** begins with digits that identify the same area code as the caller. Again, the reference for this is the caller profile **276** shown in Figure **10** and the RC processor circuit **200** determines whether or not the first few digits in the callee identifier identify an area code identified by the local area code field **267** of the caller profile **276**. If so, then block **392** directs the RC processor circuit **200** to set the call type to a code indicating the call is a local call and block **394** directs the RC processor circuit **200** to prepend the caller country code to the callee identifier, the caller country code being determined from the country code field **266** in the caller profile **276**. The

-32-

RC processor circuit **200** is then directed to block **263** for processing as described above beginning at block **263**. Emergency calls are likely to follow this path since the Emergency Response Center number that supplants the short emergency number (**911**) will normally be formatted to include an area code, but no IDD or NDD. Again at the conclusion of block **263** a callee identifier having a pre-defined length should be available.

Callee ID Length Testing

If at block **390**, the callee identifier does not have the same area code as the caller, as may be the case with non-emergency calls, block **396** directs the RC processor circuit **200** to determine whether the callee identifier in the callee ID buffer **209** has the same number of digits as the number of digits indicated in either the caller minimum local number length field **268** or the caller maximum local number length field **270** of the caller profile **276** shown in Figure **10**. If so, then block **398** directs the RC processor circuit **200** to set the call type to local and block **400** directs the processor to prepend to the callee identifier the caller country code as indicated by the country code field **266** of the caller profile **276** followed by the caller area code as indicated by the local area code field **267** of the caller profile shown in Figure **10**. The RC processor circuit **200** is then directed to block **263** for further processing as described above beginning at block **263**. Again at the conclusion of block **263** a callee identifier having a pre-defined length should be available.

Valid Subscriber Testing

If at block **396**, the callee identifier in the callee ID buffer **209** has a length that does not match the length specified by the contents of the caller minimum local number length field **268** or the caller maximum local number length field **270** of the caller profile **276**, block **402** directs the RC processor circuit **200** to determine whether or not the callee identifier identifies a valid username. To do this, the RC processor circuit **200** searches through the database **18** of dialling profiles to find a dialling profile having a username field **258** that matches the callee identifier. If no match is found, block **404** directs the RC

-33-

processor circuit **200** to send an error message back to the call controller (**14**). If at block **402**, a dialling profile having a username field **258** that matches the callee identifier is found, block **406** directs the RC processor circuit **200** to set the call type to a code indicating the call is a network call and the processor is directed to block **275** of Figure **8A**, to continue executing the RC message handler process **250**.

From Figure **8B**, it will be appreciated that there are certain groups of blocks of codes that direct the RC processor circuit **200** to determine whether the callee identifier in the callee ID buffer **209** has certain features such as an IDD code, a NDD code, an area code and a length that meet certain criteria and to reformat the callee identifier, as necessary, into a predetermined target format including only a country code, area code, and a normal telephone number, for example, to cause the callee identifier to be compatible with the E.164 standard, in this embodiment. This enables the RC processor circuit **200** to have a consistent format of callee identifiers for use at block **269** in searching through the DID bank table records of the type **268** shown in Figure **13** to determine how to route calls for subscriber to subscriber calls on the same system. Recall that the ERC may be a subscriber.

Still referring to Figure **8B**, if the length of the reformatted callee identifier meets the length criteria set forth at block **263**, block **269** directs the RC processor circuit **200** to determine whether or not the reformatted callee identifier is associated with a direct-in-dial bank (DID) record of the type shown at **268** in Figure **13**.

Exemplary DID records for the Vancouver, Calgary and London subscribers are shown in Figures **13A**, **13B** and **14**. The username field **291** and user domain field **272** are as specified in the username and user domain fields **258** and **260** of the corresponding dialling profiles shown in Figures **10**, **11** and **12** respectively. Referring to Figure **13A** the contents of the DID field **274** include an E.164 telephone number including a country code **293**, an area code **295**,

-34-

an exchange code **297** and a number **299**. If the user has multiple telephone numbers, then multiple records of the type shown at **276** would be included in the DID bank table in the database **18**, each having the same username and user domain, but different DID field **274** contents reflecting the different E. **164** telephone numbers associated with that user.

Referring back to Figure **8B**, at block **269**, if the RC processor circuit **200** determines that the current, (e.g. reformatted callee identifier produced at block **261**) can be found in a record in the DID bank table, then the callee is a subscriber to the system and block **279** directs the RC processor circuit **200** to copy the contents of the corresponding username field **291** from the DID bank table record into the callee ID buffer **209** shown in Figure **7**. Thus, the RC processor circuit **200** locates a subscriber username associated with the reformatted callee identifier. If the call is being made to the Emergency Response Center and the Emergency Response Center (ERC) is a subscriber to the system, a DID record would be found in the DID bank table, otherwise a DID record for the ERC would not be found. Assuming the Emergency Response Center is a subscriber to the system, the RC processor circuit **200** is directed to block **275** at point B in Figure **8A** for further processing now that it is known that the call is essentially a subscriber to subscriber call.

Subscriber to Subscriber Calls Between Different Nodes

Referring back to Figure **8A**, block **275** directs the RC processor circuit **200** to determine whether or not the username stored in the callee ID buffer **209** (in Figure **7**) is associated with the same supernode as the caller. To do this, the RC processor circuit **200** determines whether or not the prefix (i.e. the leftmost digit) of the username stored in the callee ID buffer **209** is the same as the prefix of the username of the caller specified by the caller identifier field **152** of the RC. Request message **150** shown in Figure **6**. If they are not the same, block **277** of Figure **8A** directs the RC processor circuit (**200**) to set a call type flag (not shown) to indicate that the call is a cross-domain call. Then, block **281** directs the RC processor circuit (**200**) to determine whether

-35-

the emergency call flag **211** shown in Figure **7** has been set and if so, block **283** of Figure **8A** directs the RC processor to determine whether the caller identifier is associated with a pre-associated direct inward dialing (DID) identifier. This is done by searching the DID bank table to attempt to locate a
5 DID record having DID field (**274**) contents matching the contents of the caller identifier stored in the caller ID buffer (**205**). If such a DID record is found, the processor circuit **200** has effectively determined that the caller has a pre-associated DID identifier.

10 If no such DID record is found, the RC processor circuit **200** has effectively determined that the caller has no pre-associated DID identifier. In this case, block **285** then directs the RC processor circuit **200** to produce a DID identifier for the caller by associating a temporary DID identifier with the caller identifier by associating with the caller identifier a DID identifier from a pool of pre-
15 determined DID identifiers. This is done by creating and associating with the caller a temporary DID record of the type shown in Figure **13**. The temporary DID record has a DID identifier field **274** populated with the DID identifier from the pool. The DID identifier from the pool may be **1 604 867 5309**, for example. The pool may be provided by causing the RC processor circuit **200**
20 to maintain a list of pre-defined DID identifiers and pointers identifying a current read point in the list and a current write point in the list. The current read pointer may be incremented each time the pool is addressed to obtain a temporary DID identifier.

25 A temporary DID record may be canceled after a pre-defined period of time. For example, the temporary DID identifier records are desirably as shown in Figure **13** and may further include a creation time field and an expiry time field for holding a creation time value and an expiry time value respectively. The expiry time may be **2** hours after the creation time, for example, such that
30 the temporary DID record is deleted two hours after it is created. A separate process, not shown, may continuously or periodically scan the DID records to determine whether any DID records have expiry times that have been

-36-

exceeded and if so, cause such temporary DID records to be cancelled or deleted. Thus, the RC processor produces a direct inward dialing identifier for the caller by associating a temporary DID identifier with the caller identifier when the emergency call flag is active and it is determined that the caller has
5 no pre-associated DID identifier, or by associating a DID identifier pre-assigned to the caller identifier.

After a temporary DID record has been created and stored in the DID bank table in the database **18** shown in Figure **1**, or if the caller already had a DID
10 record, block **287** of Figure **8A** directs the RC processor circuit to load the DID identifier buffer **203** with the contents of the field of DID temporary or pre-associated DID record. Then the RC processor circuit loads a routing message buffer with the contents of the DID identifier buffer **203** acting as the caller identifier and the contents of the callee ID buffer **209** as the callee
15 identifier. This will provide for a PSTN call back number to be provided to the emergency response center.

Thus, where the caller identifier has no pre-assigned DID identifier, the RC processor produces a routing message including the emergency response
20 center identifier and the temporary DID identifier for receipt by the routing controller to cause the routing controller to establish a route between the caller and the emergency response center.

Referring to Figure **15**, a routing message buffer is shown generally at **352**
25 and includes a supplier prefix field **354**, a delimiter field **356**, a callee field **358**, at least one route field **360**, a time-to-live (TTL) field **362** and a caller ID field **364**. The supplier prefix field **354** holds a code for identifying supplier traffic. The delimiter field **356** holds a symbol that delimits the supplier prefix code from the callee field **358** and in this embodiment, the symbol is a number sign
30 (#) as illustrated in Figure **25**. Referring back to Figure **15**, the callee field **358** holds a copy of the contents of the callee ID buffer **209** of Figure **7**. The route field **360** holds a domain name or an IP address of a gateway or supernode

-37-

that is to carry the call and the TTL field **362** holds a value representing the number of seconds the call is permitted to be active, based on subscriber available minutes and other billing parameters, for example.

5 Desirably, the time to live field holds a number indicating a maximum call time for the call and where the call is an emergency call, desirably the maximum call time exceeds a duration of an average non-emergency telephone call. The caller ID field **364** holds a caller identifier which in this case, is the temporary or pre-associated DID number from the DID record associated with
10 the caller.

Referring to Figure **8A** and Figure **16**, a routing message produced by the RC processor circuit **200** at block **287** is shown generally at **366** and includes only the callee field **358**, route field **360**, TTL field **362** and caller ID field **364**.

15 The callee field **358** holds the full username of the callee, and where the call is an emergency call as shown, the full username of the callee is the username of the emergency response center. The route field **360** contains the identification of the domain with which the emergency response center is associated, i.e., sp.yvr.digifonica.com. The TTL field holds the value **9999** set
20 at block **157** in Figure **8A** and the caller ID field **364** holds the DID identifier associated with the caller. Block **380** then directs the RC processor circuit to send the routing message shown in Figure **16** to the call controller **14** (Figure **1**).

25 Referring to Figure **8A**, if at block **281**, the emergency call flag is not set, the call is not an emergency call, and the RC processor is directed to block **350** which causes it to direct the RC processor circuit **200** to load the routing message buffer with information identifying the supernode in the system with
30 which the callee is associated and to set a time to live for the call to a high value such as **9999**. The supernode, with which the callee is associated, is determined by using the callee username stored in the callee ID buffer **209** to

-38-

address a supernode table having records of the type as shown at **370** in Figure **17**.

5 Referring to Figure **17**, each prefix to a supernode table record **370** has a prefix field **372** and a supernode address field **374**. The prefix field **372** includes the first n digits of the callee identifier. In this case n=1. The supernode address field **374** holds a code representing the IP address or a fully qualified domain name (FQDN) of the supernode associated with the code stored in the prefix field **372**. Referring to Figure **18**, for example, if the
10 prefix is **4**, the supernode address associated with that prefix is sp.lhr.digifonica.com, identifying the London supernode (**21** in Figure **1**), for example. After the routing message buffer has been loaded with identification of the supernode, block **380** of Figure **8A** directs the RC processor circuit to send the routing message shown in Figure **16A** to the call controller **14**
15 (Figure **1**).

Subscriber to Subscriber Calls Within the Same Node

Referring back to Figure **8A**, if at block **275**, the callee identifier stored in the callee ID buffer **209** (Figure **7**) has a prefix that identifies the same supernode as that associated with the caller, block **559** directs the RC processor circuit
20 **200** to determine whether or not the emergency call flag **211** of Figure **7** has been set. If at block **559**, the RC processor circuit **200** determines that the emergency call flag **211** is set, the RC processor circuit **200** is directed to resume processing at block **283** to scan the DID bank table to determine
25 whether the caller has a DID record and to assign a temporary DID number if necessary, as described above and then to send a routing message of the type shown in Figure **16** to the call controller.

If at block **559** the emergency call flag has not been set, regular non-emergency call processing ensues beginning with block **600** which directs the
30 RC processor circuit **200** to use the callee identifier to locate and retrieve a dialling profile for the callee identified by the callee identifier stored in the

-39-

5 callee ID buffer **209**. The dialling profile is of the type shown in Figure **9**, and may contain data as shown in Figure **11**, for example. In this case the same-node subscriber is the Calgary subscriber. Block **602** of Figure **8A** directs the RC processor circuit **200** to get call block, call forward and voicemail tables from the database **18** based on the username identified in the callee dialing profile retrieved by the RC processor circuit at block **600**. Call block, call forward and voicemail tables have records as shown in Figures **26**, **28** and **30** for example.

10 Referring to Figure **26**, the call block records include a username field **604** and a block pattern field **606**. The username field **604** holds a username matching the username in the username field **258** of the dialing profile (Figure **9**) associated with the callee, and the block pattern field **606** holds one or more E.**164**-compatible numbers or usernames identifying PSTN telephone numbers or system subscribers from whom the subscriber identified by the
15 contents of the username field **604** does not wish to receive calls.

Referring back to Figure **8A** and referring to Figure **27**, block **608** directs the RC processor circuit **200** to determine whether or not the caller identifier matches a block pattern stored in the block pattern field **606** of the call block record associated with the callee identified by the contents of the username field **604** in Figure **26**. If the caller identifier matches a block pattern stored in the field **606**, block **610** directs the RC processor circuit **200** to send a drop call or non-completion message to the call controller **14** and the process **250**
20 is ended. If the caller identifier does not match a block pattern associated with the callee, block **612** directs the RC processor circuit **200** to determine whether or not call forwarding is required.

Referring to Figure **28**, records in the call forwarding table include a username field **614**, a destination number field **616** and a sequence number field **618**. The username field **614** stores a code representing a username of a subscriber with whom the call forwarding record is associated. The destination
30

-40-

number field **616** holds a username or E.**164** number representing a number to which the current call should be forwarded, and the sequence number field **618** holds an integer number indicating the order in which the username associated with the corresponding destination number field should be attempted for call forwarding. The call forwarding table may have a plurality of records for a given subscriber. The RC processor circuit **200** uses the contents of the sequence number field **618** to place the records for a given subscriber in order. As will be appreciated below, this enables the call forwarding numbers to be tried in an ordered sequence.

Referring back to Figure **8A** and referring to Figure **28**, if at block **612**, the call forwarding record for the callee identified by the callee identifier contains no contents in the destination number field **616** and accordingly no contents in the sequence number field **618**, then there are no call forwarding entries and the RC processor circuit **200** is directed to load the routing message buffer shown in Figure **32** with the callee username, domain and time to live as shown at **650**. The RC processor circuit **200** is then directed to block **620** in Figure **8C**. However, if there are contents in the call forwarding record as shown in Figure **29**, block **622** shown in Figure **8A** directs the RC processor circuit **200** to search the dialling profile table in the database **18** to find a dialling profile record of the type shown in Figure **9**, for the callee identified in the destination number field **616** of the first call forwarding record and to store the contents in the routing message buffer. The RC processor circuit **200** is then directed to load the contents of the domain field **260** associated with the dialing profile specified by the contents of the destination number field **616** of the first call forwarding record into the routing message buffer as shown at **652** in Figure **32**. This process is repeated for each call forwarding record associated with the callee identified by the callee identifier to add to the routing message buffer all call forwarding usernames and domains associated with the callee.

-41-

Referring to Figure 8C, at block 620 the RC processor circuit 200 is directed to determine whether or not the user identified by the callee identifier has paid for voicemail service and this is done by checking to see whether or not a flag 630 is set in a voicemail record of the type shown in Figure 30 in a voicemail table stored in the database 18 in Figure 1.

Referring to Figure 30, voicemail table records include a username field 624, a voicemail server field 626, a seconds-to-voicemail field 628 and an enabled field 630. The username field 624 stores the username of the subscriber who purchased the service. The voicemail server field 626 holds a code identifying an IP address or a fully qualified domain name (FQDN) of a voicemail server associated with the subscriber identified by the username field 624. The seconds-to-voicemail field 628 holds a code identifying the time to wait before engaging voicemail and the enable field 630 holds a code representing whether or not voicemail is enabled for the user identified by the contents of the username field 624. Therefore, referring back to Figure 8C, at block 620 the RC processor circuit 200 finds a voicemail record as shown in Figure 31 having username field 624 contents matching the callee identifier and examines the contents of the enabled field 630 to determine whether or not voicemail is enabled. If voicemail is enabled, then block 640 in Figure 8C directs the RC processor circuit 200 to store the contents of the voicemail server field 626 of Figure 31, and the contents of the seconds to voicemail field 628 of Figure 31 in the routing message buffer as shown at 654 in Figure 32.

Referring back to Figure 8C, block 642 then directs the processor to get time to live (TTL) values for each route specified by the routing message according to any of a plurality of criteria such as, for example, the cost of routing and the user's account balance. These TTL values are then appended to corresponding routes already stored in the routing message buffer. Block 643 then directs the RC processor circuit 200 to store the TTL value determined at

-42-

block **642** in the routing message buffer. In the routing message shown in Figure **32**, the time to live value is set at **60** seconds, for example.

5 Block **644** of Figure **8C** then directs the RC processor circuit **200** to store the IP address or FQDM of the current supernode in the routing message buffer as shown at **656** in Figure **32**. An exemplary routing message for a subscriber to subscriber call on the same node is thus shown in the routing message buffer shown in Figure **32**.

10 Subscriber to Non-Subscriber Calls

Not all calls will be subscriber-to-subscriber calls and this will be detected by the RC processor circuit **200** when it executes block **269** of Figure **8B** and does not find a DID bank table record associated with the callee in the DID bank table. This may be the case, for example, where the Emergency Response Center (ERC) is not a subscriber to the system. When this occurs, 15 the RC processor circuit **200** is directed to block **408** in Figure **8B** which causes it to set the contents of the callee identifier buffer **209** equal to the reformatted callee identifier, i.e., the E.**164** compatible number produced prior to block **263** in Figure **8B**. Block **409** then directs the RC processor circuit **200** to determine whether the emergency call flag **211** in Figure **7** has been set. If 20 the emergency call flag is set, block **411** in Figure **8D** directs the RC processor to search the DID bank table to attempt to locate a DID record having DID field (**274**, Figure **13**) contents matching the contents of the caller identifier stored in the caller ID buffer (**205** in Figure **7**).

25 If no such DID record is found, the RC processor circuit **200** has effectively determined that the caller identifier is not associated with a pre-associated DID identifier. In this case, block **413** then directs the RC processor circuit **200** to associate a temporary DID identifier with the caller identifier by associating 30 with the caller identifier a DID identifier from the pool of pre-determined DID identifiers. Again, this is done by creating and associating with the caller a temporary DID record of the type shown in Figure **13**.

-43-

After a temporary DID record has been created or if the caller already has a DID record, block **415** directs the RC processor circuit to store the DID number (**274** in Figure **13**) in the caller ID buffer **209** in Figure **7**.

5

After having loaded the caller ID buffer **209** with the temporary or pre-associated DID number, or after having determined that the emergency call flag is not set, block **410** (Figure **8B**) directs the RC processor circuit **200** to initiate a process for identifying gateways to the PSTN through which the call will be established. This process begins with block **410** which directs the RC processor circuit **200** to address a master list having records of the type shown in Figure **19**.

10

Each master list record includes a master list ID field **500**, a dialling code field **502**, a country code field **504**, a national sign number field **506**, a minimum length field **508**, a maximum length field **510**, a NDD field **512**, an IDD field **514** and a buffer rate field **516**.

15

The master list ID field **500** holds a unique code such as **1019**, for example, identifying the record. The dialling code field **502** holds a predetermined number pattern that the RC processor circuit **200** uses at block **410** in Figure **8B** to find the master list record having a dialling code matching the first few digits of the reformatted callee identifier. The country code field **504** holds a number representing the country code associated with the record and the national sign number field **506** holds a number representing the area code associated with the record. (It will be observed that the dialling code **502** is a combination of the contents of the country code field **504** and the national sign number field **506**.) The minimum length field **508** holds a number representing the minimum number of digits that can be associated with the record and the maximum length field **510** holds a number representing the maximum number of digits in a number with which the record may be compared. The NDD field **512** holds a number representing an access code used to make a call within

25

30

-44-

the country specified by the country code **504** and IDD field **514** holds a number representing the international prefix needed to dial a call from the country indicated by the country code.

5 Thus, for example, a master list record may have a format as shown in Figure **20** with exemplary field contents as shown.

Referring back to Figure **8B**, using the country code and area code portions of the reformatted callee identifier that has been formatted for compatibility with
10 the E.**164** standard, block **410** directs the RC processor circuit **200** to find a master list record such as the one shown in Figure **20** having a dialling code that matches the country code and area code of the reformatted callee identifier held in the callee identifier buffer **209**. Thus, in this example, the RC processor circuit **200** might find a master list record having an ID field with the
15 number **1019**. This number may be also referred to as a route ID number. Thus, a route ID number is found in the master list record associated with a predetermined number pattern in the reformatted callee identifier.

After execution of block **410** in Figure **8B**, the process **250** continues as shown in Figure **8D**. Referring to Figure **8D**, block **412** directs the RC processor circuit **200** to use the route ID number determined at block **410** to locate at least one supplier record identifying a supplier operable to supply a communications link for this route. To do this, block **412** directs the RC processor circuit **200** to search a supplier ID table having records of the type
20 shown in Figure **21**.

Referring to Figure **21**, supplier list records include a supplier ID field **540**, a master list ID field **542**, an optional prefix field **544**, a route identifier field **546**, a NDD/IDD rewrite field **548** and a rate field **550**. The supplier ID field **540**
30 holds a code identifying the name of the supplier and the master list ID field **542** holds a code for associating the supplier record with the master list record. The prefix field **544** optionally holds a string used to identify the

-45-

supplier traffic and the route identifier field **546** holds an IP address of a gateway operated by the supplier indicated by the supplier ID field **540**. The NDD/IDD rewrite field **548** holds a code and the rate field **550** holds a code indicating the cost per second to the system operator to use the route through the gateway specified by the contents of the route identifier field **546**. Exemplary supplier records are shown in Figures **22**, **23** and **24** for Telus, Shaw and Sprint, respectively, for example.

Referring back to Figure **8D**, at block **412** the RC processor circuit **200** finds all supplier records that contain the master list ID found at block **410** of Figure **8B**.

Block **560** of Figure **8D** directs the RC processor circuit **200** to begin to produce routing messages. To do this, the RC processor circuit **200** loads a routing message buffer as shown in Figure **25** with a supplier prefix of the least costly supplier where the least costly supplier is determined from the rate fields **550** of the records associated with respective suppliers.

Referring to Figures **22-24**, in the embodiment shown, the supplier "Telus" has the lowest number in the rate field **550** and therefore the prefix **4973** associated with that supplier is loaded into the routing message buffer shown in Figure **25** first. At block **562**, the prefix **4973** is then delimited by the number sign (as defined by the contents of the delimiter field **356** in the routing message format **352** in Figure **15**) and the reformatted callee identifier is next loaded into the routing message buffer after the delimiter . Then, the contents of the route identifier field **546** of the record associated with the supplier Telus are added to the message after an @ sign delimiter and then block **564** in Figure **8D** directs the RC processor circuit **200** to get a TTL value (algorithm not shown), which in this embodiment may be **3600** seconds, for example. Block **566** of Figure **8D** then directs the RC processor circuit **200** to append this TTL value to the contents already in the routing message buffer shown in Figure **25**. Block **567** of Figure **8D** then directs the processor circuit to append

-46-

the contents of the caller ID buffer **205** of Figure **7** to the contents already in the routing message buffer shown in Figure **25**. Accordingly, the first part of the routing message is shown generally at **570** in Figure **25**.

5 Referring back to Figure **8D**, block **571** directs the RC processor circuit **200** back to block **560** and causes it to repeat blocks **560**, **562**, **564**, **566** and **567** for each successive supplier until the routing message buffer is loaded with information pertaining to each supplier. Thus, the second portion of the routing message is shown at **572** in Figure **25** and this second portion relates
10 to the second supplier identified by the record shown in Figure **23** and referring back to Figure **25**, the third portion of the routing message is shown at **574** which is associated with a third supplier as indicated by the supplier record shown in Figure **24**. Consequently, referring to Figure **25**, the routing message buffer holds a routing message identifying a plurality of different
15 suppliers able to provide gateways to establish a communication link to permit the caller to contact the callee. Each of the suppliers is identified, in succession, according to rate contained in the rate field **550** of the supplier list record shown in Figure **21**, in this embodiment. Other criteria for determining the order in which suppliers are listed in the routing message may include
20 preferred supplier priorities which may be established based on service agreements, for example.

Response to Routing Message

Referring back to Figure **1**, the routing message of the type shown in Figures
25 **16**, **16A**, **25** or **32**, is received at the call controller **14**. It will be recalled that the call controller **14** already has the original SIP invite message shown in Figure **3**. Referring to Figure **4**, the program memory **104** of the call controller **14** includes a routing-to-media relay routine depicted generally at **122**.

30 Referring to Figure **38**, the routing to media relay routine **122** directs the processor to participate in a process for establishing audio paths. Assume the call is directed to the ERC.

-47-

As a first step in the process for establishing audio paths, a message **1100** is sent from the call controller **14** to the media relay **17**, the message including the call ID, the caller telephone IP address and UDP port as determined from the caller IP address field **67** and caller UDP port field **69** in the SIP Invite message **59** shown in broken outline.

In response, the media relay (MR) **17** sends a confirmation message **1102** back to the call controller **14**, the message including a media relay IP address (**192.168.2.10**) and UDP port number (**22123**) defining a callee socket that the media relay will use to establish an audio path to the ERC telephone or a PSTN gateway to the ERC, where the Emergency Response Center is only available through the PSTN

The call controller **14** then sends a SIP Invite message **1104** of type shown in Figure **3** to the callee telephone **15** (or PSTN gateway), to advise the callee that telephone of the socket the media relay expects to use for audio communication with the caller telephone. The SIP invite message includes the caller and callee identifiers (**60** and **62**), the call ID (**65**) and the media relay **17** IP address (**192.168.2.10**) and the media relay UDP port number (**22123**) assigned to the callee socket as received from the confirmation message **1102**. The caller identifier may be that which was associated with the caller at blocks **413** in Figure **8D** or block **285** in Figure **8A**, for example, or may be the DID associated with the caller as determined from a DID record already associated with the caller. Such caller identifier, as obtained from the routing message, may be used as calling line identification (CLID) information and may be caused to appear on a display of the callee telephone, which is particularly advantageous where the callee telephone is one at an ERC. Such CLID information provides an ERC operator with callback information, enabling the operator to call back the caller who made the emergency call. Since the temporarily assigned DID records persist for some time after the emergency call has taken place, the ERC operator can call back the person

-48-

who made the emergency call during a period of time after the emergency call is terminated. In this embodiment, assume the callee telephone identifies its socket as IP address **192.168.3.10** and UDP port **33123**.

5 The callee (ERC) telephone **33** of Figure 1 (or PSTN gateway) stores the media relay **17** IP address (**192.168.2.10**) and assigned UDP port number (**22123**) and configures itself to create a socket for an audio path between the media relay. Referring to Figures 1 and **38** the callee telephone **15** (or PSTN gateway) then sends a SIP OK message **1106** back to the call controller **14**,
10 the message including the CALL ID, the callee IP address (**192.168.3.10**) and UDP port number (**33123**) to advise the call controller of the socket at which it expects to use for audio communications with the media relay **17**.

The call controller **14** then sends a message **1108** to the media relay **17**
15 including the IP address (**192.168.3.10**) and UDP port number (**33123**) identifying the socket at that the callee telephone **15** (or PSTN gateway) that is to be used for audio communications with the media relay. The media relay **17** then creates a caller socket identified by IP address **192.168.2.10** and UDP port number **22125** and creates an internal bridge for relaying audio
20 traffic between the caller socket (**192.168.2.10: 22125**) and the callee socket (**192.168.2.10: 22123**).

The media relay **17** then sends a message **1110** including the call ID and the IP address (**192.168.2.10**) and UDP port number (**22125**) identifying the caller
25 socket that the media relay assigned to the caller telephone **12**, back to the call controller **14** to indicate that the caller and callee sockets have been established and that the call can proceed.

The call controller **14** then sends a SIP OK message **1112** to the caller
30 telephone **12** to indicate that the call may now proceed. The SIP OK message includes the caller and callee usernames, the call ID and the IP address

-49-

(**192.168.2.10**) and UDP port number (**22125**) identifying the caller socket at the media relay **17**.

5 Alternatively, referring back to Figure **1**, if the routing message is of a type that identifies a domain associated with another supernode in the system, the call controller **14** may communicate with a different media relay (for example **27**) adapted to establish the above-mentioned links between separate media relays associated with respective supernodes, where the IP network links are provided by the communications medium **23**.

10 In the case of an emergency call, the routing message is unlikely to identify a domain other than that of the caller.

15 In the case of a regular, non-emergency call, if the routing message is of the type shown in Figure **25** where there are a plurality of suppliers available, the process proceeds as described above with the exception that instead of communicating with the callee telephone directly, the call controller **14** communicates with a gateway provided by a supplier. If a SIP OK message is not received back from the first gateway, the processor is directed to send the SIP Invite message **1104** to a gateway of the next indicated supplier. For
20 example, the call controller **14** sends the SIP Invite message **1104** to the first supplier, in this case Telus, to determine whether or not Telus is able to handle the call. If Telus does not send back an OK message **1106** or sends a message indicating that it is not able to handle the call, the call controller
25 proceeds to send a SIP Invite message **1104** to the next supplier, in this case Shaw. The process is repeated until one of the suppliers responds with a SIP OK message **1106** indicating that it is available to carry the call and the process proceeds as shown in connection with messages **1108**, **1110** and **1112**.

30 Referring to Figure **2**, in response to receiving the SIP OK message **1112** at the network interface **48**, the microprocessor **32** of the caller telephone **12**

-50-

stores the media relay IP address (**192.168.2.10**) and UDP port number (**22125**) identifying the caller socket at the media relay in an audio path IP address buffer **47** in the temporary memory **40**. The microprocessor **32** is now ready to transfer audio signals and from the handset and the media relay **17** using the sockets created above.

5

Referring back to Figure **1**, if the call is a regular, non-emergency call, and the call controller **14** receives a message of the type shown in Figure **32**, i.e., a type which has one call forwarding number and/or a voicemail number, the call controller attempts to establish a call (using message **1104** in Figure **38**) to the callee telephone **15** and if no call is established (i.e., message **1106** in Figure **38** is not received) within the associated TTL (**3600** seconds), the call controller **14** attempts to establish a call with the next user identified in the call routing message. This process is repeated until all call forwarding possibilities have been exhausted after respective times to live, in which case an audio path is established with the voicemail server **19** identified in the routing message. The voicemail server **19** sends message **1106** in response to receipt of message **1104** and functions as described above in connection with the callee telephone **15** to permit an outgoing audio message provided by the voicemail server to be heard by the caller and to permit the caller to record an audio message on the voicemail server.

10

15

20

When audio paths are established, a call timer (not shown) maintained by the call controller logs the start date and time of the call and logs the call ID and an identification of the route (i.e., audio path IP address) for later use in billing, for example.

25

Terminating the Call

In the event that either the caller or the callee (or callee via the PSTN) terminates a call, the telephone of the terminating party (or gateway associated with the terminating party) sends a SIP Bye message to the call controller **14**. An exemplary SIP Bye message is shown at **900** in Figure **33**

30

-51-

and includes a caller field **902**, a callee field **904** and a call ID field **906**. The caller field **902** holds the caller username, the callee field **904** holds a PSTN compatible number or username, and the call ID field **906** holds a unique call identifier field of the type shown in the caller ID field **65** of the SIP Invite message shown in Figure 3.

Thus, when terminating a regular non-emergency call, such as initiated by the Vancouver subscriber to the Calgary subscriber for example, referring to Figure 34, a SIP Bye message is produced as shown generally at **908** and the caller field **902** holds a username identifying the Vancouver caller, in this case **2001 1050 8667**, the callee field **904** holds a username identifying the Calgary callee, in this case **2001 1050 2222**, and the callee ID field **906** holds the code **FA10 @ 192.168.0.20**, which is the call ID for the call.

The SIP Bye message shown in Figure 34 is received at the call controller **14** and the call controller executes a process as shown generally at **910** in Figure 35. The process includes a first block **912** that directs the call controller circuit **100** to copy the caller, callee and call ID field contents from the SIP Bye message **900** shown in Figure 33 received from the terminating party to corresponding fields of an RC Call Stop message buffer (not shown). Block **914** then directs the call controller circuit **100** to copy the call start time from the call timer and to obtain a Call Stop time from the call timer. Block **916** then directs the call controller to calculate a communication session time by determining the difference in time between the call start time and the call stop time. This communication session time is then stored in a corresponding field of the RC Call Stop message buffer. Block **918** then directs the call controller circuit **100** to copy the route identifier from the call log. An RC Call Stop message produced as described above is shown generally at **1000** in Figure 36. An RC Call Stop message specifically associated with the call made to the Calgary callee is shown generally at **1020** in Figure 37.

-52-

Referring to Figure 36, the RC Call Stop message includes a caller field **1002**, callee field **1004**, a call ID field **1006**, an account start time field **1008**, an account stop time field **1010**, a communication session time **1012** and a route field **1014**. The caller field **1002** holds a username, the callee field **1004** holds a PSTN-compatible number or system number, the call ID field **1006** holds the unique call identifier received from the SIP Invite message shown in Figure 3, the account start time field **1008** holds the date and start time of the call, the account stop time field **1010** holds the date and time the call ended, the account session time field **1012** holds a value representing the difference between the start time and the stop time, in seconds, and the route field **1014** holds the IP address for the communications link that was established.

Referring to Figure 37, an exemplary RC stop call message for the Calgary callee is shown generally at **1020**. In this example the caller field **1002** holds the username **2001 1050 8667** identifying the Vancouver caller and the callee field **1004** holds the username **2001 1050 2222** identifying the Calgary callee. The contents of the call ID field **1006** are **FA10 @ 192.168.0.20**. The contents of the accounting start time field **1008** are **2006-12-30 12:12:12** and the contents of the accounting stop time field are **2006-12-30 12:12:14**. The contents of the communication session time field **1012** are **2** to indicate 2 seconds call duration and the contents of the route field are **72.64.39.58**.

Referring back to Figure 35, after having produced an RC Call Stop message, block **920** directs the call controller circuit **100** to send the RC stop message contained in the RC Call Stop message buffer to the routing controller **16**.

The routing controller **16** receives the Call Stop message and an RC Call Stop message process is invoked at the RC to deal with charges and billing for the call.

Block **922** directs the call controller circuit **100** to send a Bye message back to the party that did not terminate the call.

-53-

Block **924** then directs the call controller circuit **100** to send a "Bye" message of the type shown in Figure **33** to the media relay **17** to cause the media relay to delete the caller and callee sockets it established for the call and to delete the bridge between the sockets.

5

While specific embodiments of the invention have been described and illustrated, such embodiments should be considered illustrative of the invention only and not as limiting the invention as construed in accordance with the accompanying claims.

10

-54-

What is claimed is:

1. A process for handling emergency calls from a caller in a voice over IP system, the method comprising:

5 receiving a routing request message including a caller identifier and a callee identifier;

10 setting an emergency call flag active in response to said callee identifier matching an emergency call identifier pre-associated with the caller;

producing an emergency response center identifier in response to said emergency call identifier;

15 determining whether said caller identifier is associated with a pre-associated direct inward dialing (DID) identifier;

20 producing a direct inward dialing (DID) identifier for said caller by associating a temporary DID identifier with said caller identifier when said emergency call flag is active and it is determined that said caller has no pre-associated DID identifier;

25 producing a routing message including said emergency response center identifier and said temporary DID identifier for receipt by a routing controller operable to cause a route to be established between the caller and said emergency response center.

- 30 2. The process of claim 1 wherein setting said emergency call flag active comprises retrieving a dialing profile associated with the caller and setting said emergency call flag active when the contents of an

-55-

emergency call identifier field of said dialing profile match said callee identifier.

- 5
3. The process of claim 2 wherein determining whether said caller identifier is associated with a pre-associated DID identifier comprises searching a database for a DID record associating a DID identifier with said caller and determining that said caller identifier is associated with a pre-associated DID identifier when said record associating a DID identifier with said caller is found.
- 10
4. The process of claim 3 wherein associating a pre-assigned DID identifier with said caller identifier comprises copying said pre-associated DID identifier from said DID record to a DID identifier buffer.
- 15
5. The process of claim 4 wherein producing said routing message comprises causing the contents of said DID identifier buffer to define said DID identifier in said routing message.
- 20
6. The process of claim 2 wherein determining whether said caller identifier is associated with a pre-associated DID identifier comprises searching a database for a DID record associating a DID identifier with said caller and determining that said caller identifier is not associated with a pre-associated DID identifier when a record associating a DID identifier with said caller is not found.
- 25
7. The process of claim 6 wherein associating a temporary DID identifier with said caller identifier comprises associating with said caller identifier a DID identifier from a pool of pre-determined DID identifiers.
- 30
8. The process of claim 7 wherein associating said DID identifier from said pool comprises associating a temporary DID record with said

-56-

caller, said temporary DID record having a DID identifier field populated with said DID identifier from said pool.

- 5 **9.** The process of claim **8** wherein associating said DID identifier from said pool comprises copying said DID identifier from said temporary DID record to a DID identifier buffer.
- 10 **10.** The process of claim **9** wherein producing said routing message comprises causing the contents of said DID identifier buffer to define said DID identifier in said routing message.
- 11.** The process of claim **8** further comprising canceling said temporary DID record after a pre-defined period of time.
- 15 **12.** The process of claim **2** wherein producing said emergency response center identifier comprises obtaining an emergency response center identifier from an emergency response center field of said dialing profile associated with said caller.
- 20 **13.** The process of claim **12** wherein obtaining comprises copying an emergency response center identifier from said dialing profile associated with said caller to a routing message buffer such that the emergency response center identifier is included in the routing message.
- 25 **14.** The process of claim **1** wherein producing said routing message comprises causing said routing message to specify a maximum call time for said emergency call, said maximum call time exceeding a duration of an average non-emergency telephone call.
- 30 **15.** An apparatus for handling emergency calls from a caller in a voice over IP system, the apparatus comprising:

-57-

means for receiving a routing request message including a caller identifier and a callee identifier;

5 setting means for setting an emergency call flag active in response to said callee identifier matching an emergency call identifier pre-associated with the caller;

10 means for producing an emergency response center identifier in response to said emergency call identifier;

 means for determining whether said caller identifier is associated with a pre-associated direct inward dialing (DID) identifier; and

15 means for producing a direct inward dialing (DID) identifier for said caller including:

20 means for associating a temporary DID identifier with said caller identifier in response to said emergency call flag being active and said caller not being pre-associated with a direct inward dialing identifier; and

25 means for producing a routing message including said emergency response center identifier and said temporary DID identifier or said pre-assigned DID identifier for receipt by a routing controller operable to cause a route to be established between the caller and said emergency response center.

30

16. The apparatus of claim **15** further comprising means for accessing a database of dialing profiles associated with respective subscribers to

-58-

said system, each of said dialing profiles including an emergency call identifier field and an emergency call center field and wherein said setting means comprises means for retrieving a dialing profile associated with the caller and for setting said emergency call flag active when the contents of said emergency call identifier field of said dialing profile match said callee identifier.

5

17. The apparatus of claim **16** further comprising database accessing means for accessing a database including direct inward dialing (DID) records associated with at least some subscribers to said system, each of said direct inward dialing records comprising a system username and a direct inward dialing number, and wherein said determining means comprises searching means for a database for a DID record associating a DID identifier with said caller and wherein said determining means is operably configured to determine that said caller identifier is associated with a pre-associated DID identifier when said record associating a DID identifier with said caller is found.

10

15

18. The apparatus of claim **17** further comprising a DID identifier buffer and wherein said means for associating a pre-assigned DID identifier with said caller identifier comprises means for copying said pre-associated DID identifier from said DID record to said DID identifier buffer.

20

19. The apparatus of claim **18** wherein said means for producing said routing message comprises means for causing the contents of said DID identifier buffer to define said DID identifier in said routing message.

25

20. The apparatus of claim **16** further comprising database accessing means for accessing a database including direct inward dialing records associated with at least some subscribers to said system, each of said direct inward dialing records comprising a system username and a

30

-59-

5 direct inward dialing number and wherein said determining means comprises searching means for searching a database for a DID record associating a DID identifier with said caller and wherein said determining means is operably configured to determine that said caller identifier is not associated with a pre-associated DID identifier when a record associating a DID identifier with said caller is not found.

- 10 **21.** The apparatus of claim **18** further comprising means for accessing a pool of pre-determined DID identifiers and wherein said means for associating a temporary DID identifier with said caller identifier comprises means for associating a DID identifier from said pool of pre-determined DID identifiers with said caller identifier.
- 15 **22.** The apparatus of claim **20** wherein said means for associating said DID identifier from said pool comprises means for associating a temporary DID record with said caller, said temporary DID record having a DID identifier field populated with said DID identifier from said pool.
- 20 **23.** The apparatus of claim **22** wherein said means for associating comprises means for copying said DID identifier from said temporary DID record to a DID identifier buffer.
- 25 **24.** The apparatus of claim **22** wherein said means for producing said routing message comprises means for causing the contents of said DID identifier buffer to define said DID identifier in said routing message.
- 25.** The apparatus of claim **22** further comprising means for canceling said temporary DID record after a period of time.
- 30 **26.** The apparatus of claim **16** wherein said means for producing said emergency response center identifier comprises means for obtaining

-60-

an emergency response center identifier from an emergency response center field of said dialing profile associated with said caller.

5 **27.** The apparatus of claim **26** further comprising a routing message buffer and wherein said means for obtaining comprises means for copying the contents of said emergency response center field of said dialing profile associated with said caller to the routing message bufer such that said contents of said emergency response center field are included in said routing message.

10

28. The apparatus of claim **27** wherein said means for producing said routing message comprises means for causing said routing message to include a maximum call time for said emergency call, said maximum call time exceeding a duration of an average non-emergency telephone call.

15

29. An apparatus for handling emergency calls from a caller in a voice over IP system, the apparatus comprising a processor circuit operably configured to:

20

receive a routing request message including a caller identifier and a callee identifier;

25

set an emergency call flag active in response to said callee identifier matching an emergency call identifier pre-associated with the caller;

30

produce an emergency response center identifier in response to said emergency call identifier;

determine whether said caller identifier is associated with a pre-associated direct inward dialing (DID) identifier;

-61-

5 produce a direct inward dialing (DID) identifier for said caller by associating a temporary DID identifier with said caller identifier when said emergency call flag is active and it is determined that said caller has no pre-associated DID identifier; and

10 produce a routing message including said emergency response center identifier and said temporary DID identifier for receipt by a routing controller operable to cause a route to be established between the caller and said emergency response center.

15 **30.** The apparatus of claim **29** wherein said processor circuit is operably configured to retrieve a dialing profile associated with the caller and set said emergency call flag active when the contents of an emergency call identifier field of said dialing profile match said callee identifier.

20 **31.** The apparatus of claim **30** wherein said processor circuit is operably configured to search a database for a DID record associating a DID identifier with said caller and determine that said caller identifier is associated with a pre-associated DID identifier when said record associating a DID identifier with said caller is found.

25 **32.** The apparatus of claim **31** wherein said processor circuit is operably configured to copy said pre-associated DID identifier from said DID record to a DID identifier buffer.

30 **33.** The apparatus of claim **32** wherein said processor circuit is operably configured to cause the contents of said DID identifier buffer to define said DID identifier in said routing message.

34. The apparatus of claim **30** wherein said processor circuit is operably configured to search a database for a DID record associating a DID

-62-

identifier with said caller and determine that said caller identifier is not associated with a pre-associated DID identifier when a record associating a DID identifier with said caller is not found.

- 5 **35.** The apparatus of claim **32** wherein said processor circuit is operably configured to associate with said caller identifier a DID identifier from a pool of pre-determined DID identifiers.
- 10 **36.** The apparatus of claim **35** wherein said processor circuit is operably configured to associate a temporary DID record with the caller, said temporary DID record having a DID identifier field populated with said DID identifier from said pool.
- 15 **37.** The apparatus of claim **36** wherein said processor circuit is operably configured to copy said DID identifier from said temporary DID record to a DID buffer.
- 20 **38.** The apparatus of claim **35** wherein said processor circuit is operably configured to cause the contents of said DID identifier buffer to define said DID identifier in said routing message.
- 25 **39.** The apparatus of claim **36** wherein said processor circuit is operably configured to cancel said temporary DID record after a period of time.
- 30 **40.** The apparatus of claim **30** wherein said processor circuit is operably configured to obtain an emergency response center identifier from an emergency response center field of said dialing profile associated with said caller.
- 41.** The apparatus of claim **40** further comprising a routing message buffer and wherein said processor circuit is operably configured to copy an emergency response center identifier from said dialing profile

-63-

associated with said caller to said routing message buffer such that said emergency response center identifier is included in said routing message.

5 **42.** The apparatus of claim **29** wherein said processor circuit is operably configured to cause said routing message to include a maximum call time for said emergency call, said maximum call time exceeding a duration of an average non-emergency telephone call.

10 **43.** A computer readable medium encoded with codes for directing a processor circuit to handle emergency calls from callers in a voice over IP system, said codes directing said processor circuit to:

15 receive a routing request message including a caller identifier and a callee identifier;

 set an emergency call flag active in response to said callee identifier matching an emergency call identifier pre-associated with the caller;

20 produce an emergency response center identifier in response to said emergency call identifier;

25 determine whether said caller identifier is associated with a pre-associated direct inward dialing (DID) identifier;

30 produce a direct inward dialing (DID) identifier for said caller by associating a temporary DID identifier with said caller identifier when said emergency call flag is active and it is determined that said caller has no pre-associated DID identifier; and

-64-

produce a routing message including said emergency response center identifier and said temporary DID identifier for receipt by a routing controller operable to cause a route to be established between the caller and said emergency response center.

5

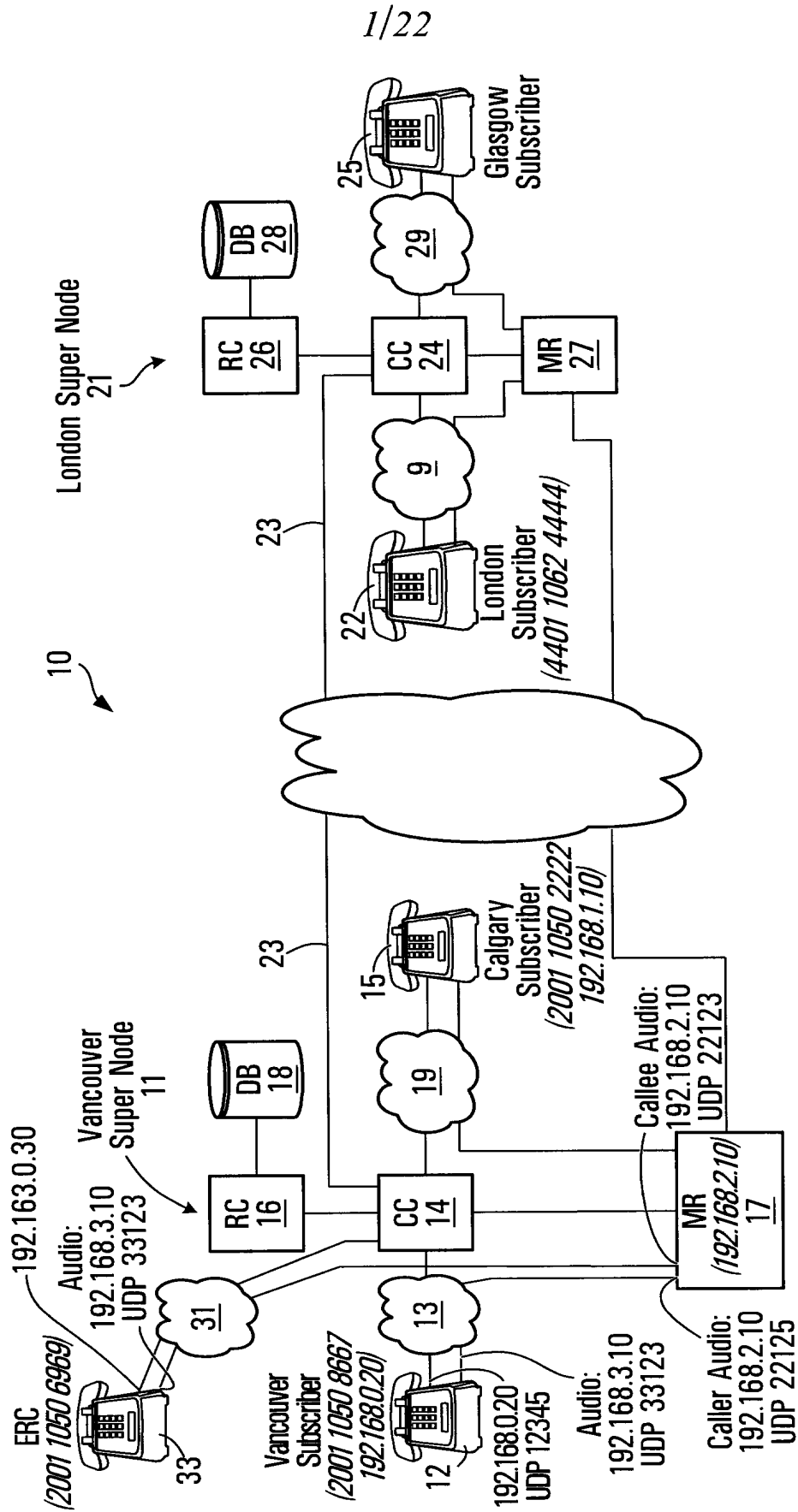

FIG. 1

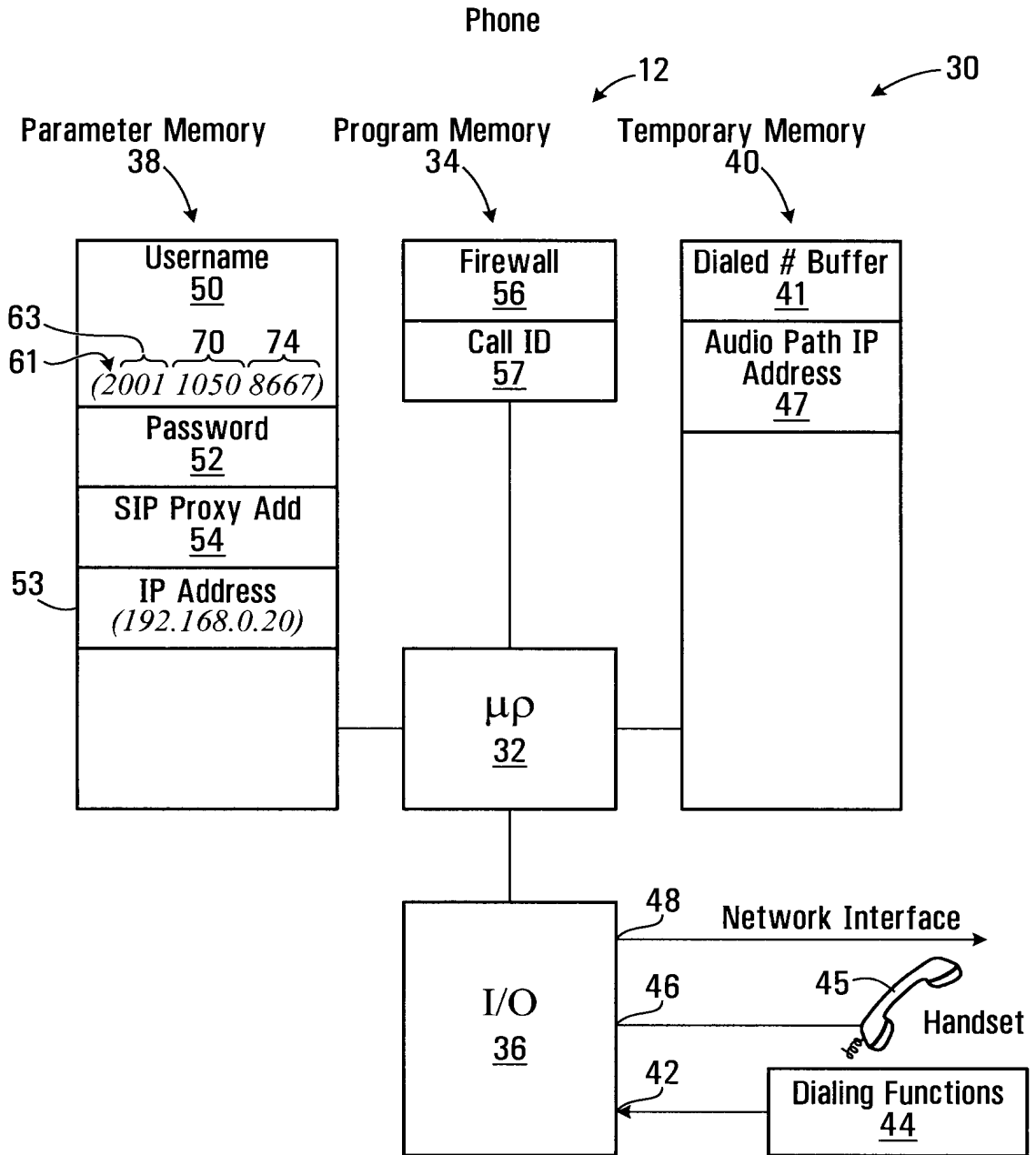

FIG. 2

3/22

SIP Invite Message ↖ 59

60 ~ Caller 2001 1050 8667

62 ~ Callee 4401 1062 4444

64 ~ Digest Parameters XXXXXX

65 ~ Call ID FF10@ 192.168.0.20

67 ~ Caller IP Address 192.168.0.20

69 ~ Caller UDP port 12345

FIG. 3

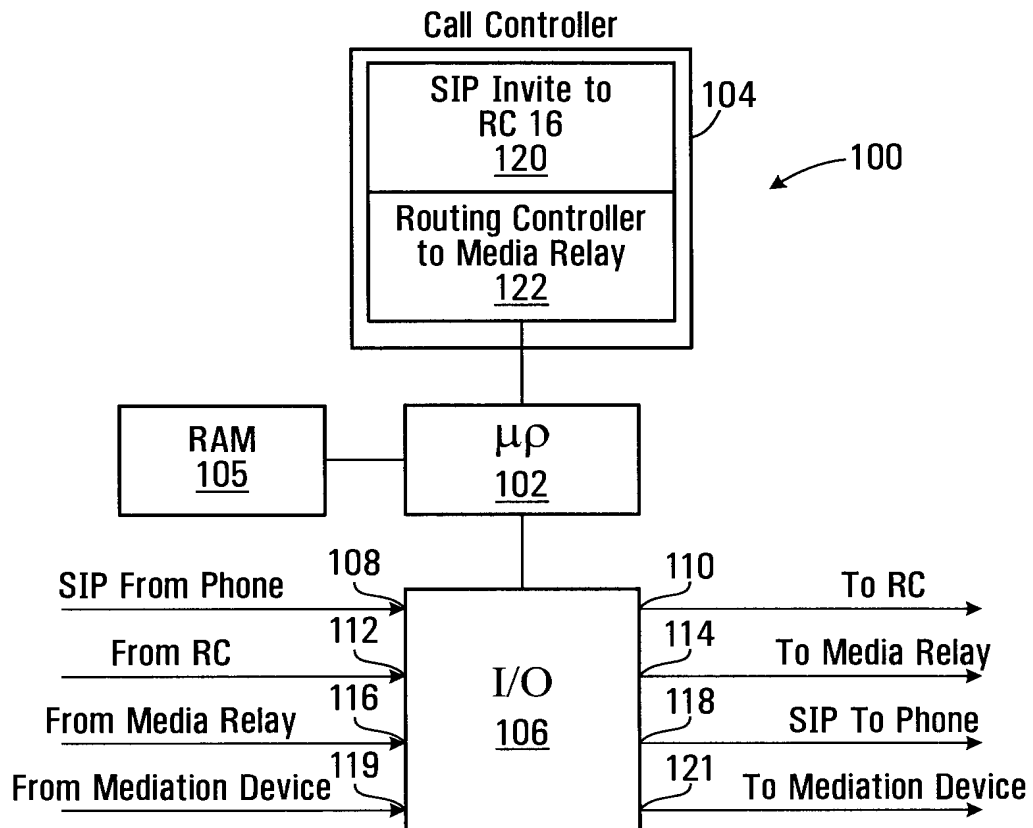

FIG. 4

4/22

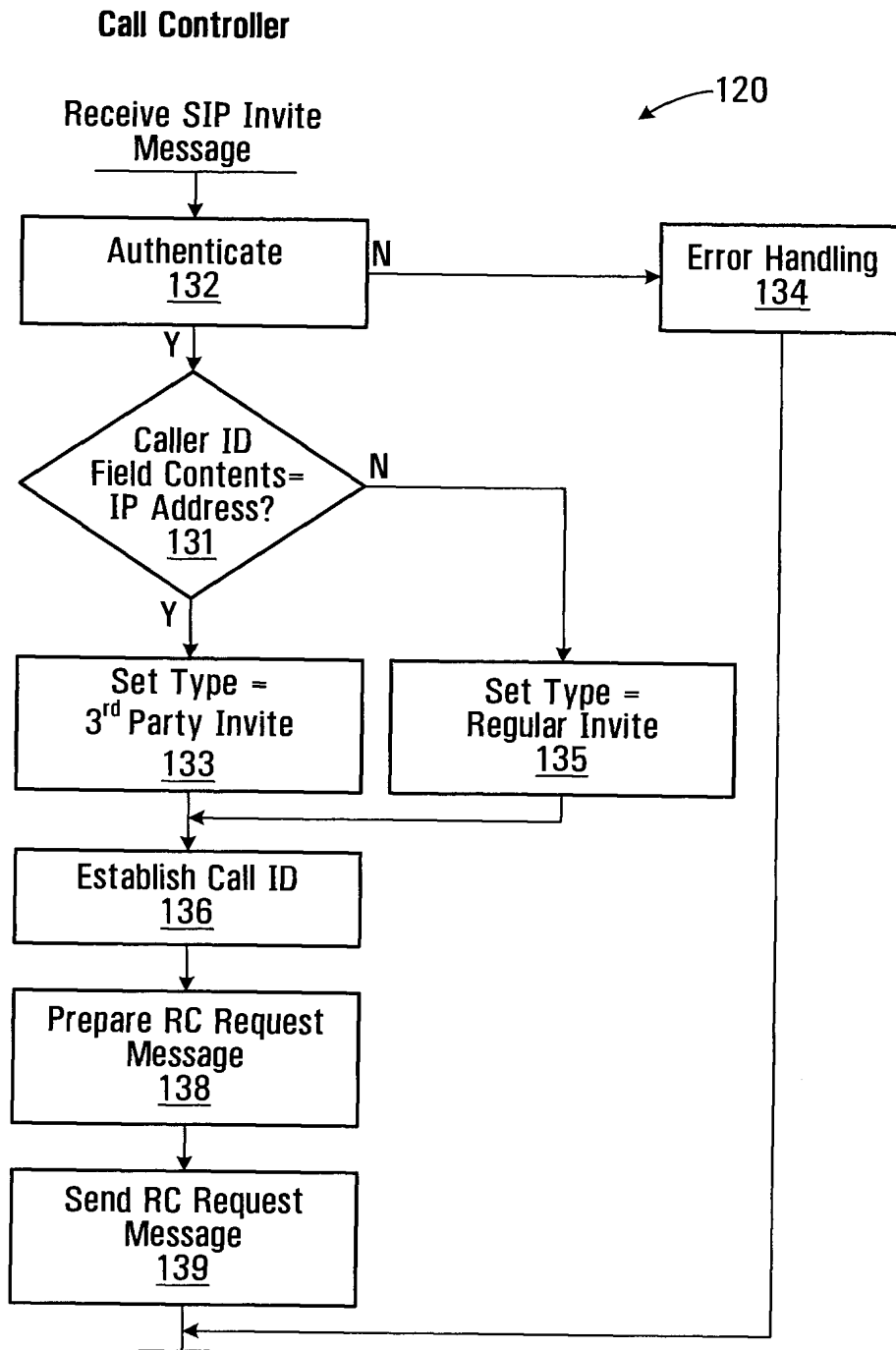

FIG. 5

5/22

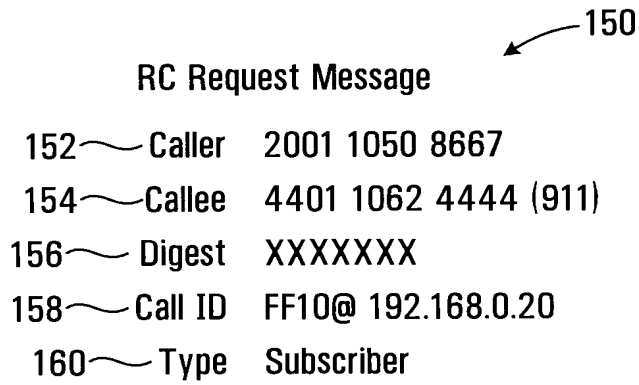

FIG. 6

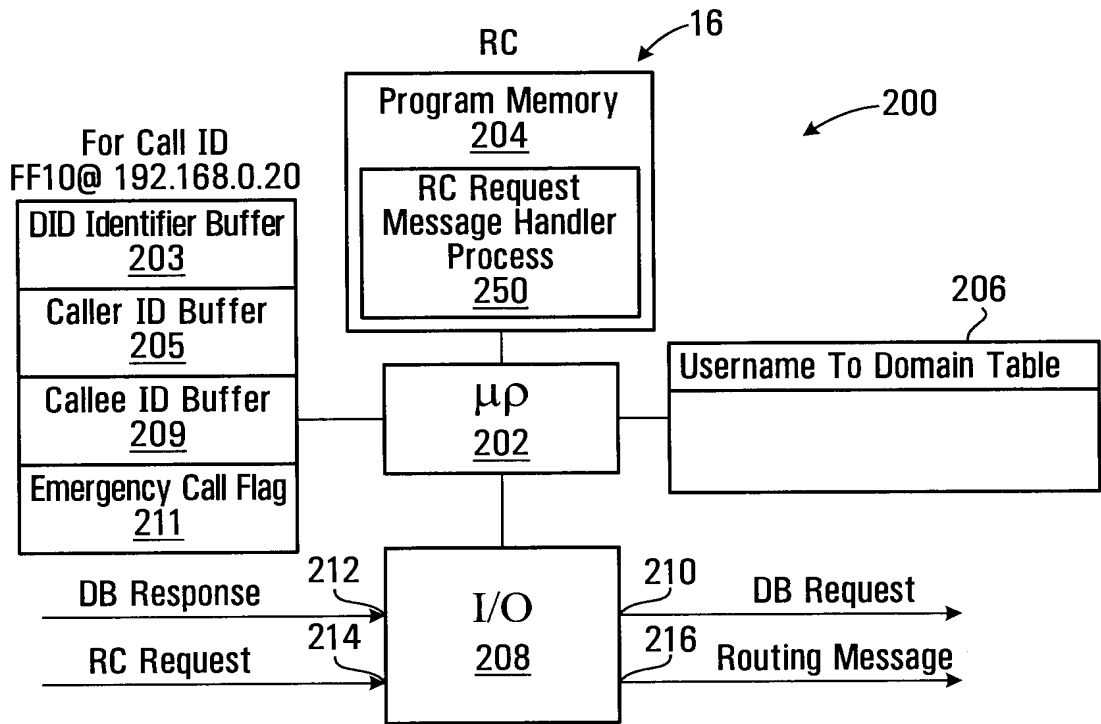

FIG. 7

6/22

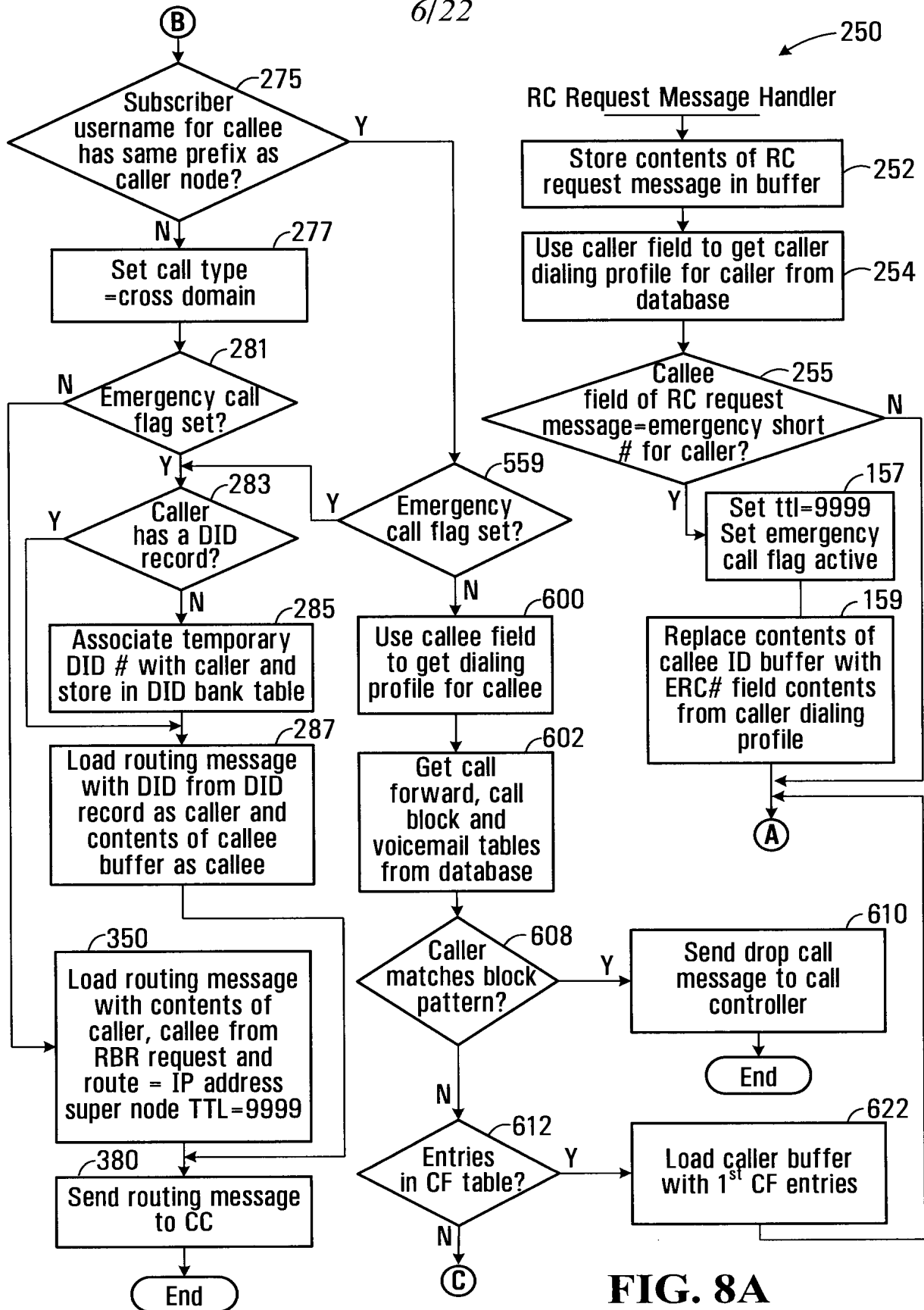

FIG. 8A

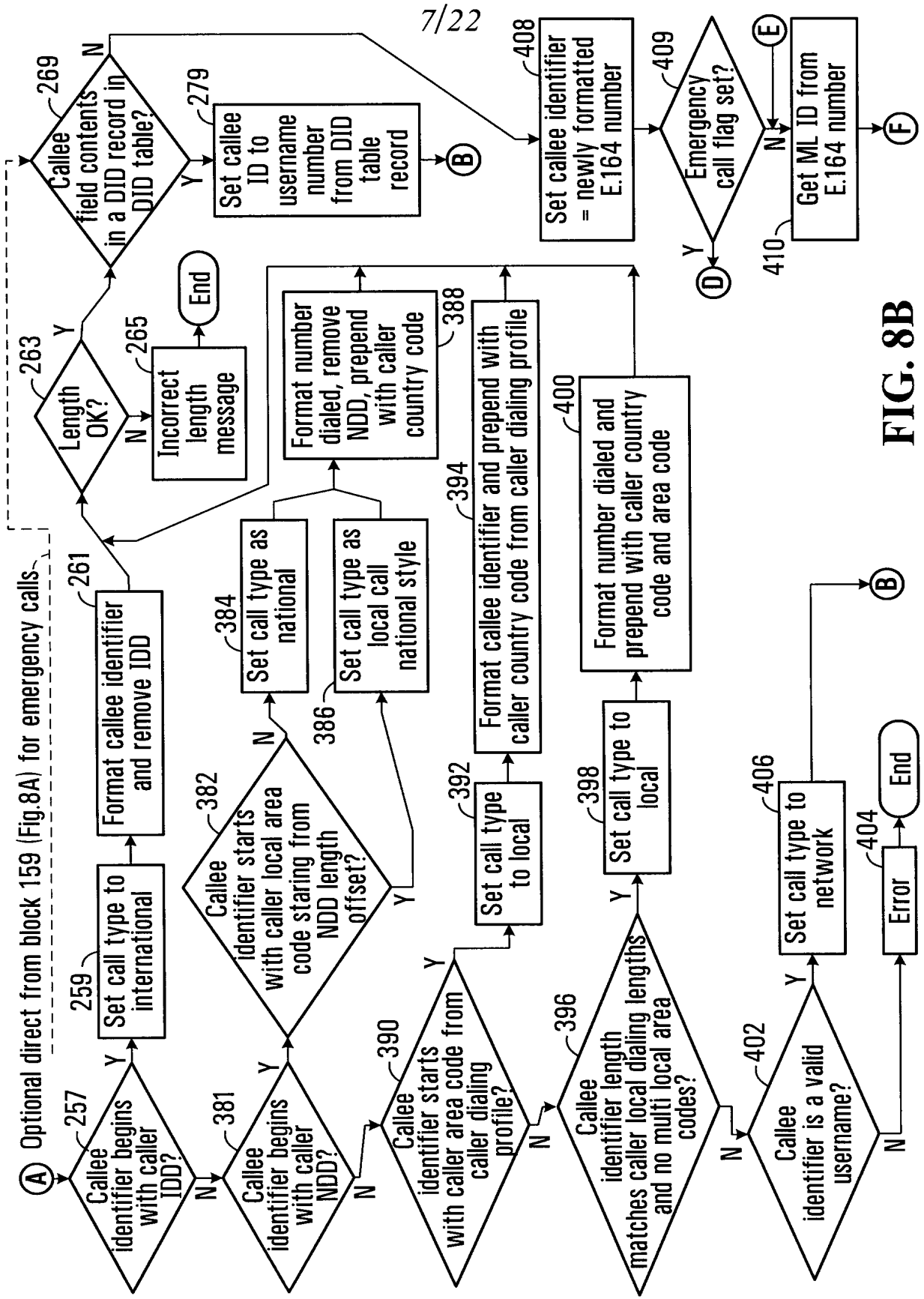

FIG. 8B

8/22

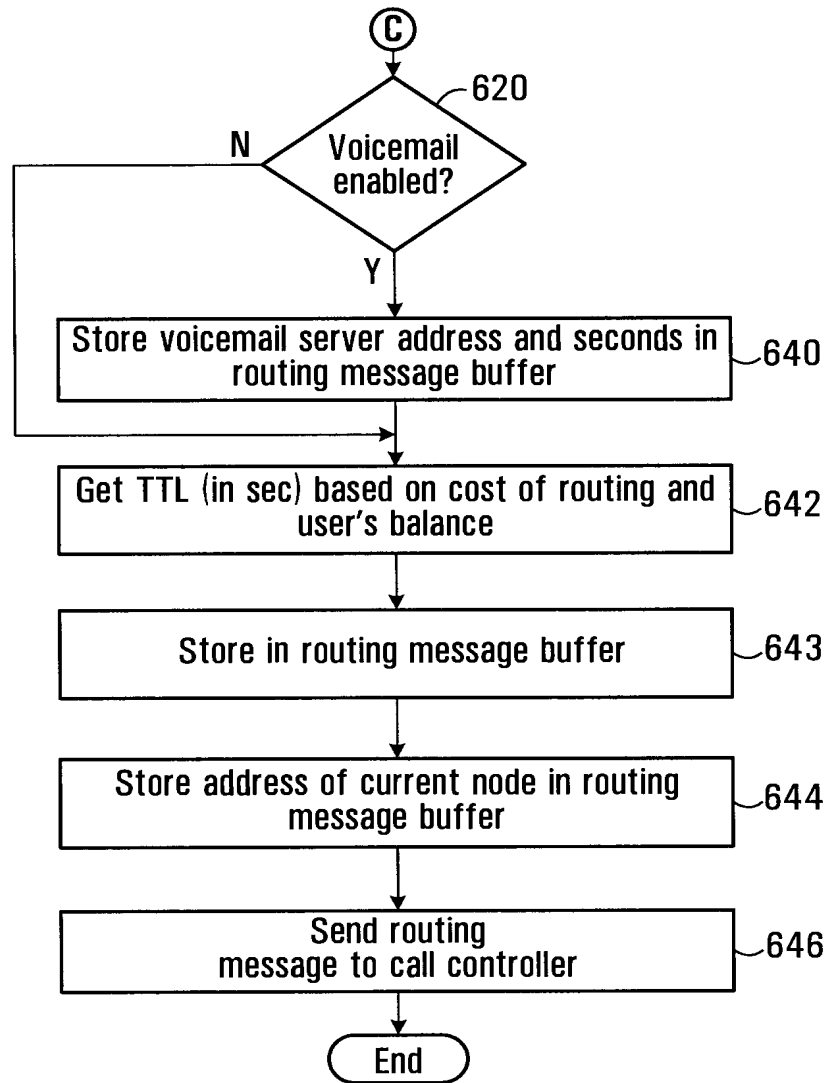

FIG. 8C

9/22

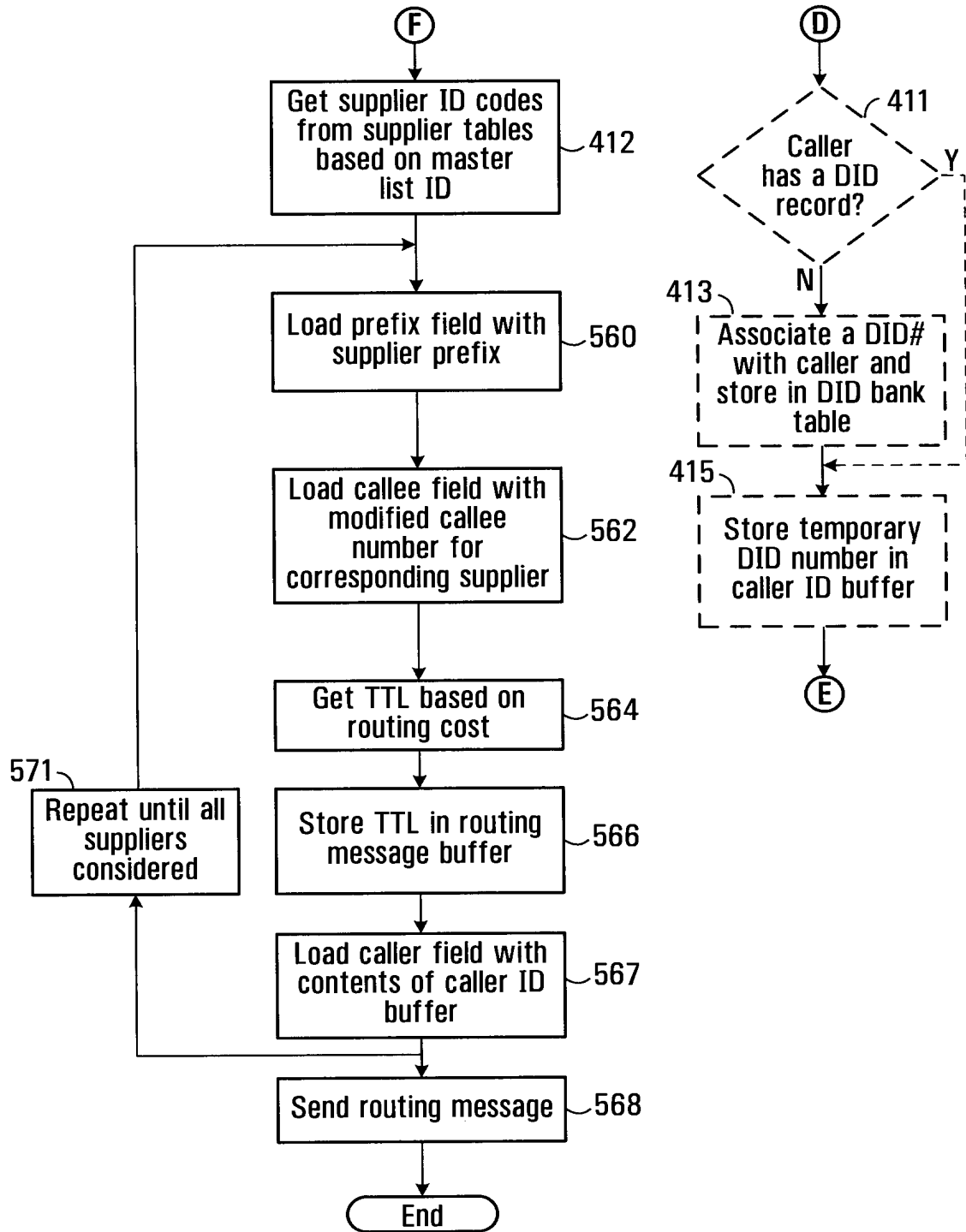

FIG. 8D

10/22

↖ 256

Dialing Profile for a User

258 ~ Username	Assigned on Subscription
260 ~ Domain	Domain Associated with User
262 ~ NDD	1
264 ~ IDD	011
266 ~ Country Code	1
267 ~ Local Area Codes	604;778
268 ~ Caller Minimum Local Length	10
270 ~ Caller Maximum Local Length	10
273 ~ Reseller	Retailer
275 ~ Subscriber Address	The Users Street Address
277 ~ Emergency Short#	Local Emergency No. (e.g. 911)
279 ~ ERC#	Emergency Response Center Number

FIG. 9

Dialing Profile for Vancouver Subscriber

258 ~ Username	2001 1050 8667	↖ 276
260 ~ Domain	sp.yvr.digifonica.com	← 282
262 ~ NDD	1	
264 ~ IDD	011	
266 ~ Country Code	1	
267 ~ Local Area Codes	604;778 (Vancouver)	
268 ~ Caller Minimum Local Length	10	
270 ~ Caller Maximum Local Length	10	
273 ~ Reseller	Klondike	
275 ~ User Address	2200 650 Georgia St. Van. B.C. Canada V4M 3G8	
277 ~ Emergency Call Identifier#	911	
279 ~ ERC#	604 666 3655	

Annotations: 284 points to Username; 61 points to 2001; 63 points to 1050; 70 points to 8667; 74 points to sp.yvr.digifonica.com; 286 points to 011; 288 points to 1; 290 points to 604;778 (Vancouver).

FIG. 10

*11/22***Dialing Profile for ERC Subscriber**

Username	2001 1050 6969
Domain	sp.yvr.digifonica.com
NDD	1
IDD	011
Country Code	1
Local Area Codes	604
Caller Minimum Local Length	7
Caller Maximum Local Length	10
Reseller	Klondike
User Address	#Epson downs, Tripson Falls B.C. Canada V0N 2N3
Emergency Call Identifier#	911
ERC#	604 666 3655

FIG. 10A

12/22

Dialing Profile for Calgary Subscriber

Username	2001 1050 2222
Domain	sp.yvr.digifonica.com
NDD	1
IDD	011
Country Code	1
Local Area Codes	403
Caller Minimum Local Length	7
Caller Maximum Local Length	10
User Address	1210 Deerfoot Trail SE, Calgary Alberta Canada HOH OH0
Emergency Short#	911
ERC#	403 123 4567

FIG. 11**Dialing Profile for London Subscriber**

Username	4401 1062 4444
Domain	sp.lhr.digifonica.com
NDD	0
IDD	00
Country Code	44
Local Area Codes	20 (London)
Caller Minimum Local Length	10
Caller Maximum Local Length	11
User Address	21 Basil Rd. Faulty Towers, London NW1 4NS
Emergency Short#	911
ERC#	7487-7973

FIG. 12

13/22

268

DID Bank Table Record Format

291	Username	System subscriber
272	User Domain	Host name of supernode
274	DID	E164#
For temporary DID records only {	Creation Time	Current time when record is created
	Expiration Time	Time at which record is to be deleted

FIG. 13

276

DID Bank Table Record for Vancouver Subscriber

291	Username	2001 1050 8667
272	User Domain	sp.yvr.digifonica.com
274	DID	1 604 321 3353
		293 295 297 299 1 604 321 3353

FIG. 13A

276

DID Bank Table Record for Calgary Subscriber

291	Username	2001 1050 2222
272	User Domain	sp.yvr.digifonica.com
274	DID	1 403 516 0744
		293 295 297 299 1 403 516 0744

FIG. 13B

276

DID Bank Table Record for London Subscriber

291	Username	4401 1062 4444
272	User Domain	sp.lhr.digifonica.com
274	DID	44 020 7487 7900
		293 295 297 299 44 020 7487 7900

FIG. 14

14/22

352

Routing Message Buffer

354	Supplier Prefix (optional)	Code identifying supplier traffic
356	Delimiter	Symbol separating fields
358	Callee	PSTN compatible number or Digifonica number
360	Route	Domain name and IP address
362	Time to Live(TTL)	In seconds
364	Caller ID	DID number or username (contents of callee ID buffer)

FIG. 15

Routing Message for Emergency Call

200110506969@sp.yvr.digifonica.com;tll=9999;CLI=16043213353

358 360 362 364

FIG. 16

Routing Message Different Node

44011062444@sph.lhr.digifonica.com;tll=9999;CLI=200110508667

358 360 362 364

FIG. 16A

Prefix to Supernode Table Record Format

372	Prefix	First n digits of callee identifier
374	Supernode Address	IP address or fully qualified domain name

FIG. 17

Prefix to Supernode Table Record for London Subscriber

Prefix 4
 Supernode Address sp.lhr.digifonica.com

FIG. 18

15/22

Master List Record Format

500 ~	ml_id	1019
502 ~	Dialing code	1604
504 ~	Country code	The country code is the national prefix to be used when dialing TO a particular country FROM another country.
506 ~	Nat Sign #(Area Code)	604
508 ~	Min Length	7
510 ~	Max Length	7
512 ~	NDD	The NDD prefix is the access code used to make a call WITHIN that country from on city to another (when calling another city in the same vicinity, this may not be necessary).
514 ~	IDD	The IDD prefix is the international prefix needed to dial a call FROM the country listed TO another country.
516 ~	Buffer rate	Safe charge rate above the highest rate charged by suppliers

FIG. 19

Example: Master List Record with Populated Fields

ml_id	1019
Dialing code	1604
Country code	1
Nat Sign #(Area Code)	604
Min Length	7
Max Length	7
NDD	1
IDD	011
Buffer rate	\$0.009/min

FIG. 20

16/22

Suppliers List Record Format

540	Sup_id	Name code
542	MI_id	Numeric code
544	Prefix (optional)	String identifying supplier's traffic #
546	Route	IP address
548	NDD/IDD rewrite	
550	Rate	Cost per second to Digifonica to use this route

FIG. 21

(Telus) Supplier Record

Sup_id	2010 (Telus)
MI_id	1019
Prefix (optional)	4973#
Route	72.64.39.58
NDD/IDD rewrite	011
Rate	\$0.02/min

FIG. 22

(Shaw) Supplier Record

Sup_id	2011 (Shaw)
MI_id	1019
Prefix (optional)	4974#
Route	73.65.40.59
NDD/IDD rewrite	011
Rate	\$0.025/min

FIG. 23

(Sprint) Supplier Record

Sup_id	2012 (Sprint)
MI_id	1019
Prefix (optional)	4975#
Route	74.66.41.60
NDD/IDD rewrite	011
Rate	\$0.03/min

FIG. 24

17/22

356

Routing Message Buffer for Gateway Call

570 ~ 4973#0116046663655@72.64.39.58;t1=3600;16046827780
 572 ~ 4974#0116046663655@73.65.40.59;t1=3600;16046827780
 574 ~ 4975#0116046663655@74.66.41.60;t1=3600;16046827780

FIG. 25

Call Block Table Record Format

604 ~ Username Digifonica #
 606 ~ Block Pattern PSTN compatible or Digifonica #

FIG. 26

Call Block Table Record for Calgary Subscriber

604 ~ Username of Callee 2001 1050 2222
 606 ~ Block Pattern 2001 1050 8664

FIG. 27

Call Forwarding Table Record Format for Callee

614 ~ Username of Callee Digifonica #
 616 ~ Destination Number Digifonica #
 618 ~ Sequence Number Integer indicating order to try this

FIG. 28

18/22

Call Forwarding Table Record for Calgary Subscriber

614 ~ Username of Callee 2001 1050 2222
 616 ~ Destination Number 2001 1055 2223
 618 ~ Sequence Number 1

FIG. 29

Voicemail Table Record Format

624 ~ Username of Callee Digifonica #
 626 ~ Vm Server domain name
 628 ~ Seconds to Voicemail time to wait before engaging voicemail
 630 ~ Enabled yes/no

FIG. 30

Voicemail Table Record for Calgary Subscriber

624 ~ Username of Callee 2001 1050 2222
 626 ~ Vm Server vm.yvr.digifonica.com
 628 ~ Seconds to Voicemail 20
 630 ~ Enabled 1

FIG. 31

Routing Message Buffer for CF/VM Routing Message

650 ~ 200110502222@sp.yvr.digifonica.com;ttl=3600
 652 ~ 200110552223@sp.yvr.digifonica.com;ttl=3600
 654 ~ vm.yvr.digifonica.com;20;ttl=60
 656 ~ sp.yvr.digifonica.com

FIG. 32

19/22

900
↙

Bye Message

902 ~	Caller	Username
904 ~	Callee	PSTN compatible # or Username
906 ~	Call ID	unique call identifier (hexadecimal string@IP)

FIG. 33

908
↙

Bye Message

902 ~	Caller	2001 1050 8667
904 ~	Callee	2001 1050 2222
906 ~	Call ID	<u>FA10@192.168.0.20</u>

FIG. 34

20/22

910 ↘

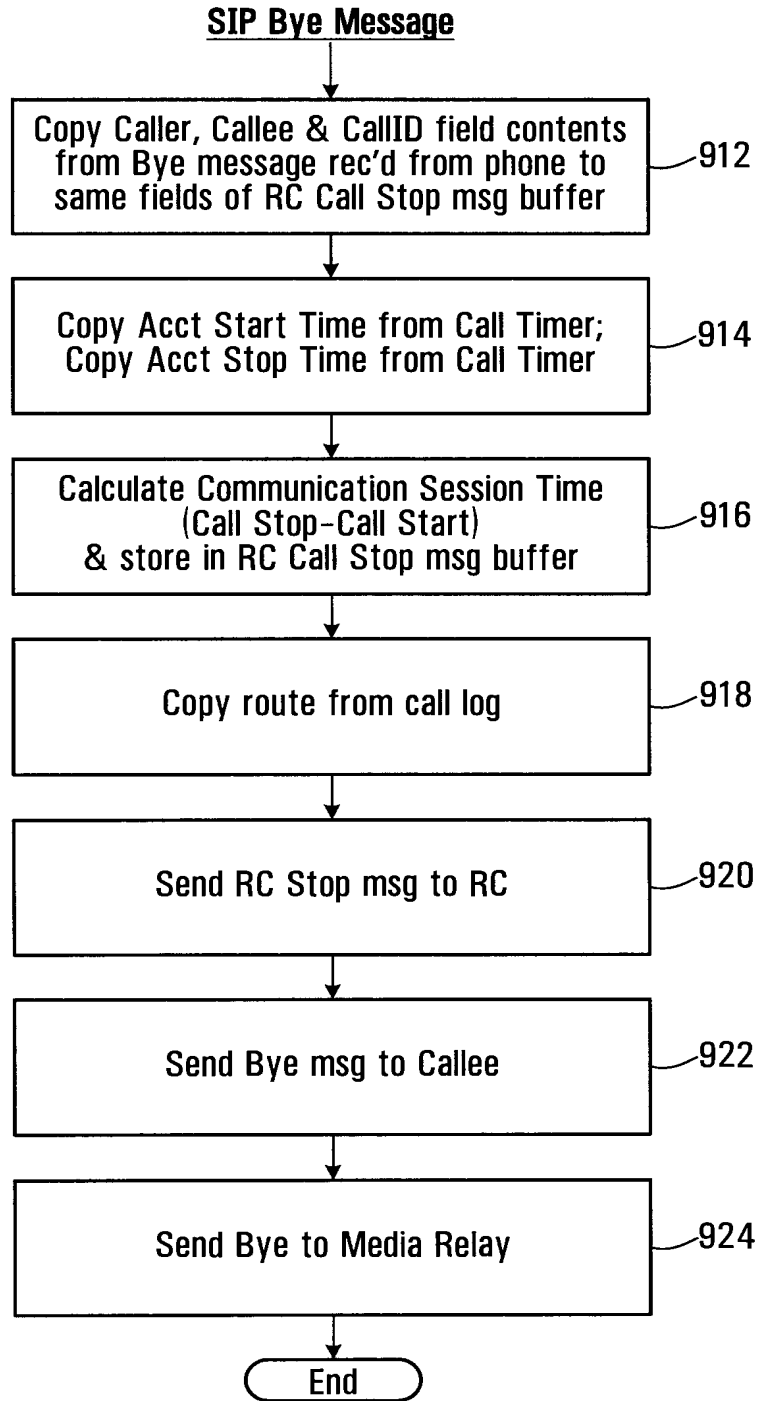

FIG. 35

1000 ↙

RC Call Stop Message

1002	~	Caller	Username
1004	~	Callee	PSTN compatible # or Username
1006	~	Call ID	unique call identifier (hexadecimal string@IP)
1008	~	Acct Start Time	start time of call
1010	~	Acct Stop Time	time the call ended
1012	~	Acct Session Time	start time-stop time (in seconds)
1014	~	Route	IP address for the communications link that was established

FIG. 36

1020 ↙

RC Call Stop Message for Calgary Subscriber

1002	~	Caller	2001 1050 8667
1004	~	Callee	2001 1050 2222
1006	~	Call ID	FA10@192.168.0.20
1008	~	Acct Start Time	2006-12-30 12:12:12
1010	~	Acct Stop Time	2006-12-30 12:12:14
1012	~	Acct Session Time	2
1014	~	Route	72.64.39.58

FIG. 37

22/22

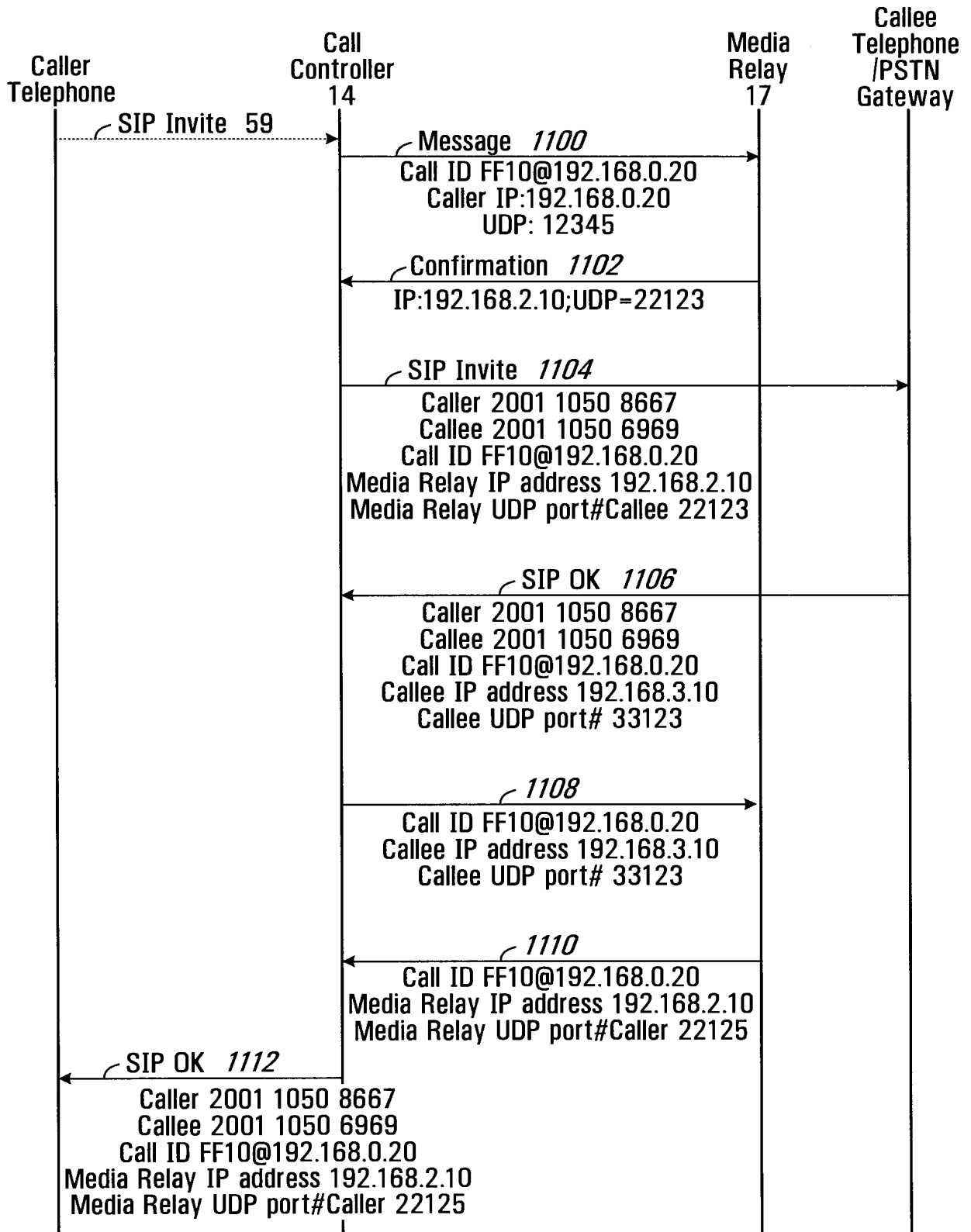

FIG. 38

INTERNATIONAL SEARCH REPORT

International application No.
PCT/CA2008/000545

<p>A. CLASSIFICATION OF SUBJECT MATTER IPC: H04L 12/66 (2006.01) , H04M 11/06 (2006.01) , H04M 3/42 (2006.01) , H04Q 3/00 (2006.01) , H04Q 3/64 (2006.01) According to International Patent Classification (IPC) or to both national classification and IPC</p>																				
<p>B. FIELDS SEARCHED</p> <p>Minimum documentation searched (classification system followed by classification symbols) IPC: H04L (2006.01), H04M (2006.01), H04Q (2006.01); US classes: 379/45, 370 in combination with keywords</p> <p>Documentation searched other than minimum documentation to the extent that such documents are included in the fields searched</p> <p>Electronic database(s) consulted during the international search (name of database(s) and, where practicable, search terms used) Canadian Patent Database, USPTO West, Delphion. Keywords: pbx, inward dialing, dial-in, voip, sip, psap, etc, ali, flag and variations thereof.</p>																				
<p>C. DOCUMENTS CONSIDERED TO BE RELEVANT</p> <table border="1"> <thead> <tr> <th>Category*</th> <th>Citation of document, with indication, where appropriate, of the relevant passages</th> <th>Relevant to claim No.</th> </tr> </thead> <tbody> <tr> <td>X, P A, P</td> <td>US 2008/0063153 A1 (Krivorot et al.) 13 March 2008 (13-03-2008) * Para. [0004] - [0024], [0042] - [0082]; Fig. 1 *</td> <td>1, 15, 29, 43 2-14, 16-28, 30-42</td> </tr> <tr> <td>A</td> <td>US 2005/0083911 A1 (Grabelsky et al.) 21 April 2005 (21-04-2005) * Para. [0041] - [0055], [0060] - [0138]; Fig. 1, 2 *</td> <td>1-43</td> </tr> <tr> <td>A</td> <td>US 2005/0169248 A1 (Truesdale et al.) 4 August 2005 (04-08-2005) * Para. [0013] - [0050] *</td> <td>1-43</td> </tr> <tr> <td>A, P</td> <td>US 2008/0037715 A1 (Prozeniuk et al.) 14 February 2008 (14-02-2008) * Entire document *</td> <td>1-43</td> </tr> <tr> <td>A, P</td> <td>WO 2007/044454 A2 (Croy et al.) 19 April 2007 (19-04-2007) * Entire document *</td> <td>1-43</td> </tr> </tbody> </table>			Category*	Citation of document, with indication, where appropriate, of the relevant passages	Relevant to claim No.	X, P A, P	US 2008/0063153 A1 (Krivorot et al.) 13 March 2008 (13-03-2008) * Para. [0004] - [0024], [0042] - [0082]; Fig. 1 *	1, 15, 29, 43 2-14, 16-28, 30-42	A	US 2005/0083911 A1 (Grabelsky et al.) 21 April 2005 (21-04-2005) * Para. [0041] - [0055], [0060] - [0138]; Fig. 1, 2 *	1-43	A	US 2005/0169248 A1 (Truesdale et al.) 4 August 2005 (04-08-2005) * Para. [0013] - [0050] *	1-43	A, P	US 2008/0037715 A1 (Prozeniuk et al.) 14 February 2008 (14-02-2008) * Entire document *	1-43	A, P	WO 2007/044454 A2 (Croy et al.) 19 April 2007 (19-04-2007) * Entire document *	1-43
Category*	Citation of document, with indication, where appropriate, of the relevant passages	Relevant to claim No.																		
X, P A, P	US 2008/0063153 A1 (Krivorot et al.) 13 March 2008 (13-03-2008) * Para. [0004] - [0024], [0042] - [0082]; Fig. 1 *	1, 15, 29, 43 2-14, 16-28, 30-42																		
A	US 2005/0083911 A1 (Grabelsky et al.) 21 April 2005 (21-04-2005) * Para. [0041] - [0055], [0060] - [0138]; Fig. 1, 2 *	1-43																		
A	US 2005/0169248 A1 (Truesdale et al.) 4 August 2005 (04-08-2005) * Para. [0013] - [0050] *	1-43																		
A, P	US 2008/0037715 A1 (Prozeniuk et al.) 14 February 2008 (14-02-2008) * Entire document *	1-43																		
A, P	WO 2007/044454 A2 (Croy et al.) 19 April 2007 (19-04-2007) * Entire document *	1-43																		
<p><input type="checkbox"/> Further documents are listed in the continuation of Box C. <input checked="" type="checkbox"/> See patent family annex.</p>																				
<table border="0"> <tr> <td>* Special categories of cited documents :</td> <td>"T"</td> <td>later document published after the international filing date or priority date and not in conflict with the application but cited to understand the principle or theory underlying the invention</td> </tr> <tr> <td>"A" document defining the general state of the art which is not considered to be of particular relevance</td> <td>"X"</td> <td>document of particular relevance; the claimed invention cannot be considered novel or cannot be considered to involve an inventive step when the document is taken alone</td> </tr> <tr> <td>"E" earlier application or patent but published on or after the international filing date</td> <td>"Y"</td> <td>document of particular relevance; the claimed invention cannot be considered to involve an inventive step when the document is combined with one or more other such documents, such combination being obvious to a person skilled in the art</td> </tr> <tr> <td>"L" document which may throw doubts on priority claim(s) or which is cited to establish the publication date of another citation or other special reason (as specified)</td> <td>"&"</td> <td>document member of the same patent family</td> </tr> <tr> <td>"O" document referring to an oral disclosure, use, exhibition or other means</td> <td></td> <td></td> </tr> <tr> <td>"P" document published prior to the international filing date but later than the priority date claimed</td> <td></td> <td></td> </tr> </table>			* Special categories of cited documents :	"T"	later document published after the international filing date or priority date and not in conflict with the application but cited to understand the principle or theory underlying the invention	"A" document defining the general state of the art which is not considered to be of particular relevance	"X"	document of particular relevance; the claimed invention cannot be considered novel or cannot be considered to involve an inventive step when the document is taken alone	"E" earlier application or patent but published on or after the international filing date	"Y"	document of particular relevance; the claimed invention cannot be considered to involve an inventive step when the document is combined with one or more other such documents, such combination being obvious to a person skilled in the art	"L" document which may throw doubts on priority claim(s) or which is cited to establish the publication date of another citation or other special reason (as specified)	"&"	document member of the same patent family	"O" document referring to an oral disclosure, use, exhibition or other means			"P" document published prior to the international filing date but later than the priority date claimed		
* Special categories of cited documents :	"T"	later document published after the international filing date or priority date and not in conflict with the application but cited to understand the principle or theory underlying the invention																		
"A" document defining the general state of the art which is not considered to be of particular relevance	"X"	document of particular relevance; the claimed invention cannot be considered novel or cannot be considered to involve an inventive step when the document is taken alone																		
"E" earlier application or patent but published on or after the international filing date	"Y"	document of particular relevance; the claimed invention cannot be considered to involve an inventive step when the document is combined with one or more other such documents, such combination being obvious to a person skilled in the art																		
"L" document which may throw doubts on priority claim(s) or which is cited to establish the publication date of another citation or other special reason (as specified)	"&"	document member of the same patent family																		
"O" document referring to an oral disclosure, use, exhibition or other means																				
"P" document published prior to the international filing date but later than the priority date claimed																				
Date of the actual completion of the international search 6 June 2008 (06-06-2008)		Date of mailing of the international search report 20 June 2008 (20-06-2008)																		
Name and mailing address of the ISA/CA Canadian Intellectual Property Office Place du Portage I, C114 - 1st Floor, Box PCT 50 Victoria Street Gatineau, Quebec K1A 0C9 Facsimile No.: 001-819-953-2476		Authorized officer Arthur Smith 819-953-1360																		

INTERNATIONAL SEARCH REPORT
 Information on patent family members

International application No.
 PCT/CA2008/000545

Patent Document Cited in Search Report	Publication Date	Patent Family Member(s)	Publication Date
US2008063153	13-03-2008	CA2598200 A1	21-02-2008
US2005083911	21-04-2005	EP1526697 A2	27-04-2005
US2005169248	04-08-2005	NONE	
US2008037715	14-02-2008	NONE	
WO2007044454	19-04-2007	US2007091831 A1 US2007091906 A1 US2007092070 A1 WO2007044455 A2 WO2007055971 A2	26-04-2007 26-04-2007 26-04-2007 19-04-2007 18-05-2007

INFORMATION DISCLOSURE STATEMENT

Applicant : Clay Perreault et al.
App. No : 12/513,147
Filed : March 1, 2010
For : PRODUCING ROUTING MESSAGES
FOR VOICE OVER IP
COMMUNICATIONS
Examiner : Unassigned
Art Unit : 2614
Conf No. : 9611

Mail Stop Amendment
Commissioner for Patents
P.O. Box 1450
Alexandria, VA 22313-1450

Dear Sir:

Enclosed for filing in the above-identified application is a PTO/SB/08 Equivalent listing 107 references, of which 16 are enclosed/submitted.

This Information Disclosure Statement is being filed before the receipt of a first Office Action on the merits, and presumably no fee is required. If a first Office Action on the merits was mailed before the mailing date of this Statement, the Commissioner is authorized to charge the fee set forth in 37 C.F.R. § 1.17(p) to Deposit Account No. 11-1410.

Respectfully submitted,
KNOBBE, MARTENS, OLSON & BEAR, LLP

Dated: 3/23/10

By: 
John M. Carson
Registration No. 34,303
Attorney of Record
Customer No. 20995
(619) 235-8550



UNITED STATES PATENT AND TRADEMARK OFFICE

UNITED STATES DEPARTMENT OF COMMERCE
United States Patent and Trademark Office
Address: COMMISSIONER FOR PATENTS
P.O. Box 1450
Alexandria, Virginia 22313-1450
www.uspto.gov

Table with 3 columns: U.S. APPLICATION NUMBER NO. (12/513,147), FIRST NAMED APPLICANT (Clay Perreault), ATTY. DOCKET NO. (SMARB19.001APC)

20995
KNOBBE MARTENS OLSON & BEAR LLP
2040 MAIN STREET
FOURTEENTH FLOOR
IRVINE, CA 92614

INTERNATIONAL APPLICATION NO.

PCT/CA07/01956

Table with 2 columns: I.A. FILING DATE (11/01/2007), PRIORITY DATE (11/02/2006)

CONFIRMATION NO. 9611
371 ACCEPTANCE LETTER



Date Mailed: 03/08/2010

NOTICE OF ACCEPTANCE OF APPLICATION UNDER 35 U.S.C 371 AND 37 CFR 1.495

The applicant is hereby advised that the United States Patent and Trademark Office in its capacity as a Designated / Elected Office (37 CFR 1.495), has determined that the above identified international application has met the requirements of 35 U.S.C. 371, and is ACCEPTED for national patentability examination in the United States Patent and Trademark Office.

The United States Application Number assigned to the application is shown above and the relevant dates are:

Table with 2 columns: DATE OF RECEIPT OF 35 U.S.C. 371(c)(1), (c)(2) and (c)(4) REQUIREMENTS (03/01/2010), DATE OF COMPLETION OF ALL 35 U.S.C. 371 REQUIREMENTS (03/01/2010)

A Filing Receipt (PTO-103X) will be issued for the present application in due course. THE DATE APPEARING ON THE FILING RECEIPT AS THE " FILING DATE" IS THE DATE ON WHICH THE LAST OF THE 35 U.S.C. 371 (c)(1), (c)(2) and (c)(4) REQUIREMENTS HAS BEEN RECEIVED IN THE OFFICE. THIS DATE IS SHOWN ABOVE. The filing date of the above identified application is the international filing date of the international application (Article 11(3) and 35 U.S.C. 363). Once the Filing Receipt has been received, send all correspondence to the Group Art Unit designated thereon.

The following items have been received:

- Indication of Small Entity Status
• Copy of the International Application filed on 04/30/2009
• Copy of the International Search Report filed on 04/30/2009
• Copy of Article 19 Amendments filed on 04/30/2009
• Preliminary Amendments filed on 04/30/2009
• Oath or Declaration filed on 03/01/2010
• U.S. Basic National Fees filed on 04/30/2009
• Priority Documents filed on 04/30/2009
• Power of Attorney filed on 03/01/2010
• Specification filed on 04/30/2009
• Claims filed on 04/30/2009
• Abstracts filed on 04/30/2009
• Drawings filed on 04/30/2009

The following defects have been observed:

- Article 19 amendments have not been entered because NOT A PAGE FOR PAGE SUBSTITUTION..

Applicant is reminded that any communications to the United States Patent and Trademark Office must be mailed to the address given in the heading and include the U.S. application no. shown above (37 CFR 1.5)

ANITA D JOHNSON

Telephone: (571) 272-0386



UNITED STATES PATENT AND TRADEMARK OFFICE

UNITED STATES DEPARTMENT OF COMMERCE
United States Patent and Trademark Office
Address: COMMISSIONER FOR PATENTS
P.O. Box 1450
Alexandria, Virginia 22313-1450
www.uspto.gov

Table with 6 columns: APPLICATION NUMBER, FILING or 371(c) DATE, GRP ART UNIT, FIL FEE REC'D, ATTY.DOCKET.NO, TOT CLAIMS, IND CLAIMS. Row 1: 12/513,147, 03/01/2010, 2614, 1704, SMARB19.001APC, 59, 3

CONFIRMATION NO. 9611

FILING RECEIPT

20995
KNOBBE MARTENS OLSON & BEAR LLP
2040 MAIN STREET
FOURTEENTH FLOOR
IRVINE, CA 92614



Date Mailed: 03/08/2010

Receipt is acknowledged of this non-provisional patent application. The application will be taken up for examination in due course. Applicant will be notified as to the results of the examination. Any correspondence concerning the application must include the following identification information: the U.S. APPLICATION NUMBER, FILING DATE, NAME OF APPLICANT, and TITLE OF INVENTION. Fees transmitted by check or draft are subject to collection. Please verify the accuracy of the data presented on this receipt. If an error is noted on this Filing Receipt, please submit a written request for a Filing Receipt Correction. Please provide a copy of this Filing Receipt with the changes noted thereon. If you received a "Notice to File Missing Parts" for this application, please submit any corrections to this Filing Receipt with your reply to the Notice. When the USPTO processes the reply to the Notice, the USPTO will generate another Filing Receipt incorporating the requested corrections

Applicant(s)

Clay Perreault, Panama City, PANAMA;
Steve Nicholson, Hamilton, NEW ZEALAND;
Rod Thomson, North Vancouver, BC, CANADA;
Johan Emil Victor Bjorsell, Vancouver, BC, CANADA;
Fuad Arafa, Vancouver, BC, CANADA;

Assignment For Published Patent Application

DIGIFONICA (INTERNATION) LIMITED, VANCOUVER, CANADA

Power of Attorney: The patent practitioners associated with Customer Number 20995

Domestic Priority data as claimed by applicant

This application is a 371 of PCT/CA07/01956 11/01/2007
which claims benefit of 60/856,212 11/02/2006

Foreign Applications

If Required, Foreign Filing License Granted: 03/03/2010

The country code and number of your priority application, to be used for filing abroad under the Paris Convention, is US 12/513,147

Projected Publication Date: 06/17/2010

Non-Publication Request: No

Early Publication Request: No

** SMALL ENTITY **

Title

PRODUCING ROUTING MESSAGES FOR VOICE OVER IP COMMUNICATIONS

Preliminary Class

379

PROTECTING YOUR INVENTION OUTSIDE THE UNITED STATES

Since the rights granted by a U.S. patent extend only throughout the territory of the United States and have no effect in a foreign country, an inventor who wishes patent protection in another country must apply for a patent in a specific country or in regional patent offices. Applicants may wish to consider the filing of an international application under the Patent Cooperation Treaty (PCT). An international (PCT) application generally has the same effect as a regular national patent application in each PCT-member country. The PCT process **simplifies** the filing of patent applications on the same invention in member countries, but **does not result** in a grant of "an international patent" and does not eliminate the need of applicants to file additional documents and fees in countries where patent protection is desired.

Almost every country has its own patent law, and a person desiring a patent in a particular country must make an application for patent in that country in accordance with its particular laws. Since the laws of many countries differ in various respects from the patent law of the United States, applicants are advised to seek guidance from specific foreign countries to ensure that patent rights are not lost prematurely.

Applicants also are advised that in the case of inventions made in the United States, the Director of the USPTO must issue a license before applicants can apply for a patent in a foreign country. The filing of a U.S. patent application serves as a request for a foreign filing license. The application's filing receipt contains further information and guidance as to the status of applicant's license for foreign filing.

Applicants may wish to consult the USPTO booklet, "General Information Concerning Patents" (specifically, the section entitled "Treaties and Foreign Patents") for more information on timeframes and deadlines for filing foreign patent applications. The guide is available either by contacting the USPTO Contact Center at 800-786-9199, or it can be viewed on the USPTO website at <http://www.uspto.gov/web/offices/pac/doc/general/index.html>.

For information on preventing theft of your intellectual property (patents, trademarks and copyrights), you may wish to consult the U.S. Government website, <http://www.stopfakes.gov>. Part of a Department of Commerce initiative, this website includes self-help "toolkits" giving innovators guidance on how to protect intellectual property in specific countries such as China, Korea and Mexico. For questions regarding patent enforcement issues, applicants may call the U.S. Government hotline at 1-866-999-HALT (1-866-999-4158).

LICENSE FOR FOREIGN FILING UNDER

Title 35, United States Code, Section 184

Title 37, Code of Federal Regulations, 5.11 & 5.15

GRANTED

The applicant has been granted a license under 35 U.S.C. 184, if the phrase "IF REQUIRED, FOREIGN FILING LICENSE GRANTED" followed by a date appears on this form. Such licenses are issued in all applications where the conditions for issuance of a license have been met, regardless of whether or not a license may be required as

set forth in 37 CFR 5.15. The scope and limitations of this license are set forth in 37 CFR 5.15(a) unless an earlier license has been issued under 37 CFR 5.15(b). The license is subject to revocation upon written notification. The date indicated is the effective date of the license, unless an earlier license of similar scope has been granted under 37 CFR 5.13 or 5.14.

This license is to be retained by the licensee and may be used at any time on or after the effective date thereof unless it is revoked. This license is automatically transferred to any related applications(s) filed under 37 CFR 1.53(d). This license is not retroactive.

The grant of a license does not in any way lessen the responsibility of a licensee for the security of the subject matter as imposed by any Government contract or the provisions of existing laws relating to espionage and the national security or the export of technical data. Licensees should apprise themselves of current regulations especially with respect to certain countries, of other agencies, particularly the Office of Defense Trade Controls, Department of State (with respect to Arms, Munitions and Implements of War (22 CFR 121-128)); the Bureau of Industry and Security, Department of Commerce (15 CFR parts 730-774); the Office of Foreign Assets Control, Department of Treasury (31 CFR Parts 500+) and the Department of Energy.

NOT GRANTED

No license under 35 U.S.C. 184 has been granted at this time, if the phrase "IF REQUIRED, FOREIGN FILING LICENSE GRANTED" DOES NOT appear on this form. Applicant may still petition for a license under 37 CFR 5.12, if a license is desired before the expiration of 6 months from the filing date of the application. If 6 months has lapsed from the filing date of this application and the licensee has not received any indication of a secrecy order under 35 U.S.C. 181, the licensee may foreign file the application pursuant to 37 CFR 5.15(b).

**Response to Missing
Requirements Under
35 USC § 371**

Attorney Docket No.: SMARB19.001APC
 First Named Inventor: Clay Perreault et al.
 Int'l Application No.: PCT/CA2007/001956
 US Application No.: 12/513,147
 Entered National Phase: April 30, 2009
 Title: PRODUCING ROUTING MESSAGES FOR VOICE OVER
 IP COMMUNICATIONS

Direct all correspondence to Customer # 20995

Date: March 1, 2010

Page 1 of 1

Mail Stop PCT

United States Patent and Trademark Office
 PO Box 1450
 Alexandria, VA 22313-1450

Applicant herewith submits to the US Designated/Elected Office (DO/EO/US) the following items and other information:

- (X) This is a **SECOND** or **SUBSEQUENT** submission of items concerning a filing under 35 USC 371.
- (X) An Oath or Declaration signed by the inventors (35 USC 371(c)(4)) in 6 pages.
- (X) Power of attorney, Statement under 37 CFR § 3.73(b), and copy of assignment in 6pages.

FILING FEES NOT YET PAID:

FEE CALCULATION				
FEE TYPE		LARGE FEE	CALCULATION	TOTAL
Late Oath/Decl.	37 CFR § 1.492(h)	1617 (\$130)		\$130
1 Month Extension	37 CFR § 1.17(a)(1)	1251 (\$130)		\$130
			SUB TOTAL	\$260
The present application qualifies for Small Entity status under 37 CFR § 1.27. Fee reduced by 1/2.				(\$130)
			TOTAL FEE DUE	\$130

- (X) Fees will be paid via EFS Web. Extension of time is requested by payment of any extension fee.

The Commissioner is hereby authorized to charge any additional fees which may be required, or credit any overpayment to Deposit Account No. 11-1410.

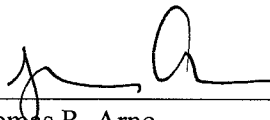

Thomas R. Arno
 Registration No. 40,490
 Attorney of Record
 Customer No. 20995
 (619) 235-8550

8635697\cey
 030110

**DECLARATION FOR UTILITY OR DESIGN APPLICATION
UNDER 37 CFR 1.63**

Docket No.: SMARB19.001APC

Page 1 of 2

Title: PRODUCING ROUTING MESSAGES FOR VOICE OVER IP COMMUNICATIONS

Inventors: Clay Perreault, Steve Nicholson, Rod Thomson, Johan Emil Viktor Bjorsell, and
Fuad Arafa

Please Direct All Correspondence to Customer Number 20995

This Declaration is directed to the invention that:

Was described and Claimed in PCT Application No. PCT/CA2007/001956 filed on
November 1, 2007.

▪ Amended under PCT Article 19 on April 17, 2008.

Was filed as Serial No. 12/513,147 filed on April 30, 2009.

As a below named inventor:

I believe the inventor(s) named below to be the original and first inventor(s) of the
subject matter which is described and claimed and for which a patent is sought;

I have reviewed and understand the contents of the above identified application,
including the claims, and any amendment filed herewith or identified above;

I acknowledge the duty to disclose information which is material to patentability as
defined in 37 CFR 1.56;

The application was originally filed with an Application Data Sheet (ADS). The ADS
sets forth any applicable Foreign Priority Claims under 35 USC § 119, and sets forth the full
mailing and residence address of each inventor whose signature appears below as allowed under
37 CFR 1.63(c). The ADS also sets forth any Domestic Priority Claims under 35 USC §§
119(e), 120, 121, and 365.

I hereby declare that all statements made herein of my own knowledge are true and that
all statements made on information and belief are believed to be true; and further that these
statements were made with the knowledge that willful false statements and the like so made are
punishable by fine or imprisonment, or both, under Section 1001 of Title 18 of the United States
Code and that such willful, false statements may jeopardize the validity of the application or any
patent issued thereon.

Full name of first inventor: Clay Perreault

Signature:

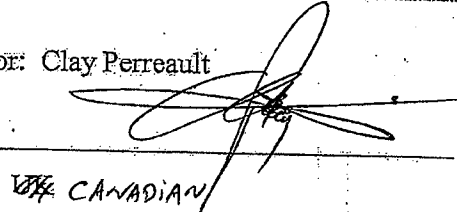

Date:

Feb 16, 2010

Citizenship:

~~USA~~ CANADIAN

**DECLARATION FOR UTILITY OR DESIGN APPLICATION
UNDER 37 CFR 1.63**

Docket No.: SMARB19.001APC

Page 2 of 2

Title: PRODUCING ROUTING MESSAGES FOR VOICE OVER IP COMMUNICATIONS

Inventors: Clay Perreault, Steve Nicholson, Rod Thomson, Johan Emil Viktor Bjorsell, and
Fuad Arafa

Please Direct All Correspondence to Customer Number 20995

Full name of second inventor: Steve Nicholson

Signature: _____

Date: _____

Citizenship: _____

NZ

Full name of third inventor: Rod Thomson

Signature: _____

Date: _____

Citizenship: _____

CA

Full name of fourth inventor: Johan Emil Viktor Bjorsell

Signature: _____

Date: _____

Citizenship: _____

CA

Full name of fifth inventor: Fuad Arafa

Signature: _____

Date: _____

Citizenship: _____

CA

Send Correspondence To:

KNOBBE, MARTENS, OLSON & BEAR, LLP

Customer No. 20995

81962631cxy
120209

**DECLARATION FOR UTILITY OR DESIGN APPLICATION
UNDER 37 CFR 1.63**

Docket No.: SMARB19.001APC

Page 1 of 2

Title: PRODUCING ROUTING MESSAGES FOR VOICE OVER IP COMMUNICATIONS

Inventors: Clay Perreault, Steve Nicholson, Rod Thomson, Johan Emil Viktor Bjorsell, and
Fuad Arafa

Please Direct All Correspondence to Customer Number 20995

This Declaration is directed to the invention that:

Was described and Claimed in PCT Application No. PCT/CA2007/001956 filed on
November 1, 2007.

Amended under PCT Article 19 on April 17, 2008.

Was filed as Serial No. 12/513,147 filed on April 30, 2009.

As a below named inventor:

I believe the inventor(s) named below to be the original and first inventor(s) of the
subject matter which is described and claimed and for which a patent is sought;

I have reviewed and understand the contents of the above identified application,
including the claims, and any amendment filed herewith or identified above;

I acknowledge the duty to disclose information which is material to patentability as
defined in 37 CFR 1.56;

The application was originally filed with an Application Data Sheet (ADS). The ADS
sets forth any applicable Foreign Priority Claims under 35 USC § 119, and sets forth the full
mailing and residence address of each inventor whose signature appears below as allowed under
37 CFR 1.63(c). The ADS also sets forth any Domestic Priority Claims under 35 USC §§
119(e), 120, 121, and 365.

I hereby declare that all statements made herein of my own knowledge are true and that
all statements made on information and belief are believed to be true; and further that these
statements were made with the knowledge that willful false statements and the like so made are
punishable by fine or imprisonment, or both, under Section 1001 of Title 18 of the United States
Code and that such willful, false statements may jeopardize the validity of the application or any
patent issued thereon.

Full name of first inventor: Clay Perreault

Signature: _____

Date: _____

Citizenship: _____

UK

CP 13 Feb 2010

**DECLARATION FOR UTILITY OR DESIGN APPLICATION
UNDER 37 CFR 1.63**

Docket No.: SMARB19.001APC

Page 2 of 2

Title: PRODUCING ROUTING MESSAGES FOR VOICE OVER IP COMMUNICATIONS

Inventors: Clay Perreault, Steve Nicholson, Rod Thomson, Johan Emil Viktor Bjorsell, and
Fuad Arafa

Please Direct All Correspondence to Customer Number 20995

Full name of second inventor: Steve Nicholson

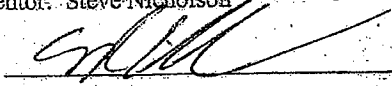
Signature: 

Date: 13 Feb 2010

Citizenship: NZ

Full name of third inventor: Rod Thomson

Signature: _____

Date: _____

Citizenship: CA

Full name of fourth inventor: Johan Emil Viktor Bjorsell

Signature: _____

Date: _____

Citizenship: CA

Full name of fifth inventor: Fuad Arafa

Signature: _____

Date: _____

Citizenship: CA

Send Correspondence To:
KNOBBE, MARTENS, OLSON & BEAR, LLP
Customer No. 20995

8196263\ccy
120209

**DECLARATION FOR UTILITY OR DESIGN APPLICATION
UNDER 37 CFR 1.63**

Docket No.: SMARB19.001APC

Page 1 of 2

Title: PRODUCING ROUTING MESSAGES FOR VOICE OVER IP COMMUNICATIONS

Inventors: Clay Perreault, Steve Nicholson, Rod Thomson, Johan Emil Viktor Bjorsell, and
Fuad Arafa

Please Direct All Correspondence to Customer Number 20995

This Declaration is directed to the invention that:

Was described and Claimed in PCT Application No. PCT/CA2007/001956 filed on
November 1, 2007.

- Amended under PCT Article 19 on April 17, 2008.

Was filed as Serial No. 12/513,147 filed on April 30, 2009.

As a below named inventor:

I believe the inventor(s) named below to be the original and first inventor(s) of the
subject matter which is described and claimed and for which a patent is sought;

I have reviewed and understand the contents of the above-identified application,
including the claims, and any amendment filed herewith or identified above;

I acknowledge the duty to disclose information which is material to patentability as
defined in 37 CFR 1.56;

The application was originally filed with an Application Data Sheet (ADS). The ADS
sets forth any applicable Foreign Priority Claims under 35 USC § 119, and sets forth the full
mailing and residence address of each inventor whose signature appears below as allowed under
37 CFR 1.63(c). The ADS also sets forth any Domestic Priority Claims under 35 USC §§
119(e), 120, 121, and 365.

I hereby declare that all statements made herein of my own knowledge are true and that
all statements made on information and belief are believed to be true; and further that these
statements were made with the knowledge that willful false statements and the like so made are
punishable by fine or imprisonment, or both, under Section 1001 of Title 18 of the United States
Code and that such willful, false statements may jeopardize the validity of the application or any
patent issued thereon.

Full name of first inventor: Clay Perreault

Signature: _____

Date: _____

Citizenship: _____

UK

**DECLARATION FOR UTILITY OR DESIGN APPLICATION
UNDER 37 CFR 1.63**

Docket No.: SMARB19.001APC

Page 2 of 2

Title: PRODUCING ROUTING MESSAGES FOR VOICE OVER IP COMMUNICATIONS

Inventors: Clay Perreault, Steve Nicholson, Rod Thomson, Johan Emil Viktor Bjorsell, and
Fuad Arafa

Please Direct All Correspondence to Customer Number 20995

Full name of second inventor: Steve Nicholson

Signature: _____ Date: _____

Citizenship: NZ

Full name of third inventor: Rod Thomson

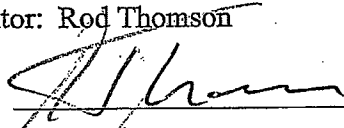
Signature:  _____ Date: Feb 12, 2010
RT

Citizenship: CA

Full name of fourth inventor: Johan Emil Viktor Bjorsell

Signature:  _____ Date: 12th Feb 2010

Citizenship: CA

Full name of fifth inventor: Fuad Arafa

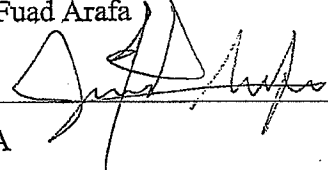
Signature:  _____ Date: Feb. 13th 2010

Citizenship: CA

Send Correspondence To:
KNOBBE, MARTENS, OLSON & BEAR, LLP
Customer No. 20995

8196263\occy
120209

**STATEMENT UNDER 37 CFR § 3.73(b)
ESTABLISHMENT OF ASSIGNEE**

Applicant	: Clay Perreault et al.
App. No.	: 12/513,147
Filed	: April 30, 2009
For	: PRODUCING ROUTING MESSAGES FOR VOICE OVER IP COMMUNICATIONS
Examiner	: Unassigned
Group Art Unit	: 2614

Commissioner for Patents
P.O. Box 1450
Alexandria, VA 22313-1450

Dear Sir:

This document is being filed with a copy of a Power of Attorney signed by the Assignee. This Statement sets forth the chain of title of the above-identified application.

DIGIFONICA (INTERNATIONAL) LIMITED is the Assignee of the entire right, title, and interest of the above-referenced application by virtue of:

The attached copy of the Assignment being forwarded to the Recordation Branch concurrently under separate cover.

The undersigned is an agent of Customer Number 20995 and is authorized to act on behalf of the Assignee. Please recognize or change the correspondence address for the above-identified application to **Customer No. 20995.**

Respectfully submitted,
KNOBBE, MARTENS, OLSON & BEAR, LLP

Dated: 3/1/10

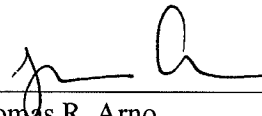
By: 
Thomas R. Arno
Registration No. 40,490
Attorney of Record
Customer No. 20995
(619) 235-8550

8635741\cey

030110

Docket No.: SMARB19.001APC

App. No.: 12/513,147

Page 1 of 1

Please Direct All Correspondence to Customer Number 20995

SPECIFIC POWER OF ATTORNEY WITH REVOCATION

Applicant : Perreault et al.
App. No. : 12/513,147
Filed : April 30, 2009
For : PRODUCING ROUTING MESSAGES FOR VOICE OVER IP
COMMUNICATIONS
Examiner : Unassigned
Art Unit : 2614

Commissioner for Patents
P.O. Box 1450
Alexandria, VA 22313-1450

Dear Sir:

The undersigned is an empowered representative of the Assignee. As of the execution date of the Assignment or the execution date set forth below, whichever is later, the undersigned hereby revokes any previous powers of attorney in the subject application, and hereby appoints the registrants of Knobbe, Martens, Olson & Bear, LLP, **Customer No. 20995**, as its attorneys with full power of substitution and revocation to prosecute this application and to transact all business in the U.S. Patent and Trademark Office connected herewith. This appointment is to be to the exclusion of the inventor(s) and his attorney(s) in accordance with the provisions of 37 CFR § 3.71.

Attached is a Statement under 37 CFR § 3.73(b), signed by a registrant of Knobbe, Martens, Olson & Bear, LLP, setting forth a full chain of title for the subject application owned by the Assignee named below.

Please recognize or change the correspondence address for the application identified in the attached Statement to **Customer No. 20995**.

By:

Name:

Assignee: DIGIFONICA (INTERNATIONAL) LIMITED
Suite 890, 990 West Hastings Street
Address: Vancouver, BC V6C 2W2 CANADA

Date:

Title:

8196406\cey
120209

-1-

ASSIGNMENT

WHEREAS **Clay Perreault**
of **Suite #5 Keats Avenue**
London
E161TW
United Kingdom
and **Steve Nicholson**
of **Suite #5 Keats Avenue**
London
E161TW
United Kingdom
and **Rod Thomson**
of **3320 Garibaldi Drive**
North Vancouver
British Columbia, Canada
V7H 2N9
and **Johan Emil Victor Björsell**
of **273 West 5th Street**
North Vancouver
British Columbia, Canada
V7M 1J9
and **Fuad Arafa**
of **305-3199 Willow Street**
Vancouver
British Columbia, Canada
V5Z 4L5

COPY
DO NOT RECORD

hereinafter referred to as the "Assignors", have invented certain new and useful improvements as described and set forth in United States provisional patent application number 60/856,212, filed the 2nd day of November 2006.

Title of Invention: **PRODUCING ROUTING MESSAGES FOR VOICEOVER IP COMMUNICATIONS**

SAL
P
EB
F.A.

WHEREAS DIGIFONICA (INTERNATIONAL) LIMITED

of Suite 1401, 4710 Kingsway
Burnaby, British Columbia
Canada
V5H 4M2

hereinafter referred to as "Assignee", is desirous of acquiring an interest in the said invention and application and in any Letters Patent which may be granted on the same;

NOW, THEREFORE, TO ALL WHOM IT MAY CONCERN: Be it known that, for good and valuable consideration, receipt and sufficiency of which are hereby acknowledged by Assignors, Assignors have sold, assigned and transferred, and hereby do sell, assign and transfer unto the said Assignee, and Assignee's successors and assigns, all right, title and interest in and to the said invention, the application aforesaid and all International Convention priority rights therewith, and in and to any Letters Patent which may hereafter be granted on the same in the United States of America and all countries throughout the world, the said interest to be held and enjoyed by said Assignee as fully and exclusively as it would have been held and enjoyed by said Assignors had this assignment and transfer not been made, to the full end and term of any Letters Patent which may be granted thereon, or of any division, renewal, continuation in whole or in part, substitution, conversion, reissue, prolongation or extension thereof. Assignors represent and warrant that they have not granted and will not grant to others any rights inconsistent with the rights granted herein.

Assignors further agree that they will, without charge to the said Assignee, but at Assignee's expense, cooperate with Assignee in the prosecution of said application and/or applications, execute, verify, acknowledge and deliver all such further papers, including applications for Letters Patent and for the reissue thereof, and instruments of assignment and transfer thereof, and will perform such other acts as Assignee lawfully may request, to obtain or maintain Letters Patent for said invention and improvements in any and all countries, and to vest title thereto in said Assignee, or Assignee's successors and assigns.

SIGNED AT LA JOLLA CALIFORNIA USA
(City or Town) (Country)

this 29 day of MAY, 07.

[Signature]
Witness's Signature

[Signature]
Clay Perreault

JOEL DONISAN
Witness's Name

7509 DRAPER

LA JOLLA CA.
Witness's Address

SAA
P
ES
F.A.
RT

**COPY
DO NOT RECORD**

SIGNED AT Kelburn Parade, Wellington, New Zealand
(City or Town) (Country)

this 1 day of June, 2007.

[Signature]
Witness's Signature

[Signature]
Steve Nicholson

Anna K. Greenhow
Witness's Name

8 Landcross street
Kelburn, Wellington
Witness's Address

SIGNED AT Vancouver Canada
(City or Town) (Country)

this 25th day of May, 2007.

[Signature]
Witness's Signature

[Signature]
Red Thomson

EMIL BJÖRSELL
Witness's Name

273 West 6th, North Vancouver,
BC, Canada
Witness's Address

SIGNED AT 1424 - 4710 Kingsway, Burnaby, BC, Canada
(City or Town) (Country)

this 24 day of May, 07.

[Signature]
Witness's Signature

[Signature]
Johan Emil Victor Björsell

Fuad Arafa
Witness's Name

305-3199 Willow St.
Vancouver, B.C. Canada V5Z-4L5
Witness's Address

[Handwritten initials]
EB
F.A.
RT

COPY
DO NOT RECORD

SIGNED AT 1424-4710- Kingsway, Burnaby, B.C. Canada
(City or Town) (Country)

this 24 day of May, 07.

[Signature]
Witness's Signature

[Signature]
Fuad Arafa

EMIL BJORSELL
Witness's Name

273 West 5th St, North Vancouver,
BC, Canada
Witness's Address

**COPY
DO NOT RECORD**

[Handwritten initials]
9
EB
F.A.
RT
Page 4 of 4

Electronic Patent Application Fee Transmittal

Application Number:	12513147
Filing Date:	
Title of Invention:	PRODUCING ROUTING MESSAGES FOR VOICE OVER IP COMMUNICATIONS
First Named Inventor/Applicant Name:	Clay Perreault
Filer:	Thomas Robert Arno/Caitlin Yaussi
Attorney Docket Number:	SMARB19.001 APC

Filed as Small Entity

U.S. National Stage under 35 USC 371 Filing Fees

Description	Fee Code	Quantity	Amount	Sub-Total in USD(\$)
Basic Filing:				
Pages:				
Claims:				
Miscellaneous-Filing:				
Oath/decl > 30 mo. from priority date	2617	1	65	65

Petition:

Patent-Appeals-and-Interference:

Post-Allowance-and-Post-Issuance:

Extension-of-Time:

PETITIONER APPLE INC. EX. 1002-863

Description	Fee Code	Quantity	Amount	Sub-Total in USD(\$)
Extension - 1 month with \$0 paid	2251	1	65	65
Miscellaneous:				
Total in USD (\$)				130

Electronic Acknowledgement Receipt

EFS ID:	7113809
Application Number:	12513147
International Application Number:	
Confirmation Number:	9611
Title of Invention:	PRODUCING ROUTING MESSAGES FOR VOICE OVER IP COMMUNICATIONS
First Named Inventor/Applicant Name:	Clay Perreault
Customer Number:	20995
Filer:	Thomas Robert Arno/Heide Young
Filer Authorized By:	Thomas Robert Arno
Attorney Docket Number:	SMARB19.001APC
Receipt Date:	01-MAR-2010
Filing Date:	
Time Stamp:	17:51:19
Application Type:	U.S. National Stage under 35 USC 371

Payment information:

Submitted with Payment	yes
Payment Type	Credit Card
Payment was successfully received in RAM	\$130
RAM confirmation Number	5689
Deposit Account	111410
Authorized User	KNOBBE MARTENS OLSON AND BEAR

The Director of the USPTO is hereby authorized to charge indicated fees and credit any overpayment as follows:

Charge any Additional Fees required under 37 C.F.R. 1.492 (National application filing, search, and examination fees)

Charge any Additional Fees required under 37 C.F.R. Section 1.17 (Patent application and examination processing fees)

PETITIONER APPLE INC. PEX: 1902865

File Listing:					
Document Number	Document Description	File Name	File Size(Bytes)/ Message Digest	Multi Part /.zip	Pages (if appl.)
1		Resp_and_dec.pdf	448413 78b7e98c4cbfb743df69c721984ea8e40331728c	yes	7
Multipart Description/PDF files in .zip description					
Document Description			Start	End	
Applicant Response to Pre-Exam Formalities Notice			1	1	
Oath or Declaration filed			2	7	
Warnings:					
Information:					
2	Power of Attorney	POA.pdf	269433 4247b6f2f81ac9cbcae755b25243518d74747d2f	no	6
Warnings:					
Information:					
3	Fee Worksheet (PTO-875)	fee-info.pdf	32130 f647237c2d489159abc9571e095de8f16a98693e	no	2
Warnings:					
Information:					
Total Files Size (in bytes):			749976		
<p>This Acknowledgement Receipt evidences receipt on the noted date by the USPTO of the indicated documents, characterized by the applicant, and including page counts, where applicable. It serves as evidence of receipt similar to a Post Card, as described in MPEP 503.</p> <p><u>New Applications Under 35 U.S.C. 111</u> If a new application is being filed and the application includes the necessary components for a filing date (see 37 CFR 1.53(b)-(d) and MPEP 506), a Filing Receipt (37 CFR 1.54) will be issued in due course and the date shown on this Acknowledgement Receipt will establish the filing date of the application.</p> <p><u>National Stage of an International Application under 35 U.S.C. 371</u> If a timely submission to enter the national stage of an international application is compliant with the conditions of 35 U.S.C. 371 and other applicable requirements a Form PCT/DO/EO/903 indicating acceptance of the application as a national stage submission under 35 U.S.C. 371 will be issued in addition to the Filing Receipt, in due course.</p> <p><u>New International Application Filed with the USPTO as a Receiving Office</u> If a new international application is being filed and the international application includes the necessary components for an international filing date (see PCT Article 11 and MPEP 1810), a Notification of the International Application Number and of the International Filing Date (Form PCT/RO/105) will be issued in due course, subject to prescriptions concerning national security, and the date shown on this Acknowledgement Receipt will establish the international filing date of the application.</p>					

MULTIPLE DEPENDENT CLAIM
 FEE CALCULATION SHEET
 (FOR USE WITH FORM PTO-875)

FIG. NO. 12-513, 141

FIG. NO. 141

APPLICANT(S)

CLAIMS

	AS FILED		AFTER 1. AMENDMENT		AFTER 2. AMENDMENT	
	IND.	DEP.	IND.	DEP.	IND.	DEP.
1	1		1			
2						
3						
4						
5						
6						
7						
8						
9						
10						
11						
12						
13						
14						
15						
16						
17						
18						
19						
20						
21						
22						
23						
24						
25						
26						
27						
28						
29						
30		29	1			
31	1		1			
32		1				
33		1				
34						
35						
36						
37						
38						
39						
40						
41						
42						
43						
44						
45						
46						
47						
48						
49						
50						
TOTAL IND.		↓	↓		↓	
TOTAL DEP.	←		←		←	
TOTAL CLAIMS						

	AS FILED		AFTER 1. AMENDMENT		AFTER 2. AMENDMENT	
	IND.	DEP.	IND.	DEP.	IND.	DEP.
51						
52						
53						
54						
55						
56						
57						
58						
59						
60	1					
61	1					
62	1					
63		1				
64						
65						
66						
67						
68						
69						
70						
71						
72						
73		10				
74	1					
75		1				
76						
77						
78						
79						
80						
81						
82						
83						
84						
85	1					
86						
87						
88						
89						
90						
91						
92						
93						
94						
95						
96		10				
97	1					
98		1				
99		1				
100		1				
TOTAL IND.	✓	↓	3	↓	↓	↓
TOTAL DEP.	✓	←	56	←	←	←
TOTAL CLAIMS			59			

**MULTIPLE DEPENDENT CLAIM
FEE CALCULATION SHEET
(FOR USE WITH FORM PTO-875)**

SERIAL NO.

12-513,147

FILING DATE

APPLICANT(S)

CLAIMS

	AS FILED		AFTER 1 st AMENDMENT		AFTER 2 nd AMENDMENT	
	IND.	DEP.	IND.	DEP.	IND.	DEP.
101						
102						
103						
104						
105						
106						
107						
108						
109						
110						
111						
112						
113						
114						
115						
116						
117						
118						
119						
120						
121						
122						
123						
124						
125						
126						
127						
128						
129						
130						
131						
132						
133						
134						
135						
136						
137						
138						
139						
140						
141						
142						
143						
144						
145						
146						
147						
148						
149						
150						
TOTAL IND.	8	↓		↓		↓
TOTAL DEP.	144	←		←		←
TOTAL CLAIMS	152					

	AS FILED		AFTER 1 st AMENDMENT		AFTER 2 nd AMENDMENT	
	IND.	DEP.	IND.	DEP.	IND.	DEP.
151						
152						
153						
154						
155						
156						
157						
158						
159						
160						
161						
162						
163						
164						
165						
166						
167						
168						
169						
170						
171						
172						
173						
174						
175						
176						
177						
178						
179						
180						
181						
182						
183						
184						
185						
186						
187						
188						
189						
190						
191						
192						
193						
194						
195						
196						
197						
198						
199						
200						
TOTAL IND.		↓		↓		↓
TOTAL DEP.		←		←		←
TOTAL CLAIMS						

PATENT APPLICATION FEE DETERMINATION RECORD

Effective October 2, 2008

Application or Docket Number

12-513,147

CLAIMS AS FILED - PART I

	(Column 1)	(Column 2)
U.S. NATIONAL STAGE FEES		
BASIC FEE		
EXAMINATION FEE		
SEARCH FEE		
FEE FOR EXTRA SPEC. PGS.	130 minus 100 =	30 / 50 = 1
TOTAL CHARGEABLE CLAIMS	59 minus 20 =	39
INDEPENDENT CLAIMS	3 minus 3 =	
MULTIPLE DEPENDENT CLAIM PRESENT <input type="checkbox"/>		

SMALL ENTITY		OR	LARGE ENTITY	
RATE	FEE		RATE	FEE
BASIC FEE	165	OR	BASIC FEE	
EXAM. FEE	110		EXAM. FEE	
SEARCH FEE	215		SEARCH FEE	
X \$ 135 =	135		X \$ 270 =	
X \$ 26 =	1014	OR	X \$ 52 =	
X \$ 110 =		OR	X \$ 220 =	
+ \$ 195 =		OR	+ \$ 390 =	
TOTAL	1639	OR	TOTAL	

* If the difference in column 1 is less than zero, enter "0" in column 2

CLAIMS AS AMENDED - PART II

	(Column 1)	(Column 2)	(Column 3)
AMENDMENT A	CLAIMS REMAINING AFTER AMENDMENT	HIGHEST NUMBER PREVIOUSLY PAID FOR	PRESENT EXTRA
	Total	Minus **	
	Independent	Minus ***	
FIRST PRESENTATION OF MULTIPLE DEPENDENT CLAIM <input type="checkbox"/>			

SMALL ENTITY		OR	OTHER THAN SMALL ENTITY	
RATE	ADDITIONAL FEE		RATE	ADDITIONAL FEE
X \$ 26 =		OR	X \$ 52 =	
X \$ 110 =		OR	X \$ 220 =	
+ \$ 195 =		OR	+ \$ 390 =	
TOTAL ADDIT. FEE		OR	TOTAL ADDIT. FEE	

	(Column 1)	(Column 2)	(Column 3)
AMENDMENT B	CLAIMS REMAINING AFTER AMENDMENT	HIGHEST NUMBER PREVIOUSLY PAID FOR	PRESENT EXTRA
	Total	Minus **	
	Independent	Minus ***	
FIRST PRESENTATION OF MULTIPLE DEPENDENT CLAIM <input type="checkbox"/>			

SMALL ENTITY		OR	OTHER THAN SMALL ENTITY	
RATE	ADDITIONAL FEE		RATE	ADDITIONAL FEE
X \$ 26 =		OR	X \$ 52 =	
X \$ 110 =		OR	X \$ 220 =	
+ \$ 195 =		OR	+ \$ 390 =	
TOTAL ADDIT. FEE		OR	TOTAL ADDIT. FEE	

* If the entry in column 1 is less than the entry in column 2, write "0" in column 3.
 ** If the "Highest Number Previously Paid For" IN THIS SPACE is less than '20', enter "20".
 *** If the "Highest Number Previously Paid For" IN THIS SPACE is less than '3', enter "3".
 The "Highest Number Previously Paid For" (Total or Independent) is the highest number found in the appropriate box in column 1.



UNITED STATES PATENT AND TRADEMARK OFFICE

UNITED STATES DEPARTMENT OF COMMERCE
United States Patent and Trademark Office
Address: COMMISSIONER FOR PATENTS
P.O. Box 1450
Alexandria, Virginia 22313-1450
www.uspto.gov

Table with 3 columns: U.S. APPLICATION NUMBER NO. (12/513,147), FIRST NAMED APPLICANT (Clay Perreault), ATTY. DOCKET NO. (SMARB19.001APC)

20995
KNOBBE MARTENS OLSON & BEAR LLP
2040 MAIN STREET
FOURTEENTH FLOOR
IRVINE, CA 92614

INTERNATIONAL APPLICATION NO.

PCT/CA07/01956

Table with 2 columns: I.A. FILING DATE (11/01/2007), PRIORITY DATE (11/02/2006)

CONFIRMATION NO. 9611
371 FORMALITIES LETTER



Date Mailed: 12/01/2009

NOTIFICATION OF MISSING REQUIREMENTS UNDER 35 U.S.C. 371
IN THE UNITED STATES DESIGNATED/ELECTED OFFICE (DO/EO/US)

The following items have been submitted by the applicant or the IB to the United States Patent and Trademark Office as a Designated Office (37 CFR 1.494):

- Indication of Small Entity Status
• Priority Document
• Copy of the International Application filed on 04/30/2009
• Copy of the International Search Report filed on 04/30/2009
• Copy of Article 19 Amendments filed on 04/30/2009
• Preliminary Amendments filed on 04/30/2009
• U.S. Basic National Fees filed on 04/30/2009
• Priority Documents filed on 04/30/2009
• Specification filed on 04/30/2009
• Claims filed on 04/30/2009
• Abstracts filed on 04/30/2009
• Drawings filed on 04/30/2009

The applicant needs to satisfy supplemental fees problems indicated below.

The following items MUST be furnished within the period set forth below in order to complete the requirements for acceptance under 35 U.S.C. 371:

- Oath or declaration of the inventors, in compliance with 37 CFR 1.497(a) and (b), identifying the application by the International application number and international filing date.
• To avoid abandonment, a surcharge (for late submission of filing fee, search fee, examination fee or oath or declaration) as set forth in 37 CFR 1.492(h) of \$65 for a small entity in compliance with 37 CFR 1.27, must be submitted with the missing items identified in this letter.

SUMMARY OF FEES DUE:

Total additional fees required for this application is \$65 for a Small Entity:

- \$65 Surcharge.

Additionally the following defects have been observed:

- Article 19 amendments have not been entered because NOT A PAGE FOR PAGE SUBSTITUTION..

ALL OF THE ITEMS SET FORTH ABOVE MUST BE SUBMITTED WITHIN TWO (2) MONTHS FROM THE DATE OF THIS NOTICE OR BY 32 MONTHS FROM THE PRIORITY DATE FOR THE APPLICATION, WHICHEVER IS LATER. FAILURE TO PROPERLY RESPOND WILL RESULT IN ABANDONMENT.

The time period set above may be extended by filing a petition and fee for extension of time under the provisions of 37 CFR 1.136(a).

Applicant is reminded that any communications to the United States Patent and Trademark Office must be mailed to the address given in the heading and include the U.S. application no. shown above (37 CFR 1.5)

Registered users of EFS-Web may alternatively submit their reply to this notice via EFS-Web.
<https://portal.uspto.gov/authenticate/AuthenticateUserLocalEPF.html>

For more information about EFS-Web please call the USPTO Electronic Business Center at **1-866-217-9197** or visit our website at <http://www.uspto.gov/ebc>.

If you are not using EFS-Web to submit your reply, you must include a copy of this notice.

ANITA D JOHNSON

Telephone: (571) 272-0386

Document code: WFEE

United States Patent and Trademark Office
Sales Receipt for Accounting Date: 11/30/2009

AJOHNSO2 RF #30077239 Mailroom Dt: 11/30/2009 12513147

Credit Card Refund Total: \$55.00

Master Card XXXXXXXXXXXXX5583

Please Direct All Correspondence to Customer Number **20995**

TRANSMITTAL FOR SUPPLEMENTAL APPLICATION DATA SHEET

Applicant	: Perreault et al.
App. No	: 12/513,147
Filed	: April 30, 2009
For	: PRODUCING ROUTING MESSAGES FOR VOICE OVER IP COMMUNICATIONS
Examiner	: Unassigned
Art Unit	: 2614

Mail Stop Amendment

Commissioner for Patents
P.O. Box 1450
Alexandria, VA 22313-1450

Dear Sir:

Enclosed for filing in the above-identified application is a Supplemental Application Data Sheet.

Please charge any additional fees, including any fees for additional extension of time, or credit overpayment to Deposit Account No. 11-1410.

Respectfully submitted,

KNOBBE, MARTENS, OLSON & BEAR, LLP

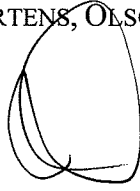

Dated: 7/6/09

By: _____

John M. Carson
Registration No. 34,303
Attorney of Record
Customer No. 20,995
(619) 235-8550

SUPPLEMENTAL APPLICATION DATA SHEET**Application Information**

Application Number: 12/513147
Filing Date: 04/30/2009
Application Type: Non-provisional
Subject Matter: Utility
Title: PRODUCING ROUTING MESSAGES FOR VOICE
OVER IP COMMUNICATIONS
Attorney Docket Number: SMARB19.001APC
Request for Early Publication?: NO
Request for Non-Publication?: NO
Total Drawing Sheets: 32
Small Entity?: YES

Inventor Information

Applicant Authority Type: Inventor
Primary Citizenship Country: UK
Given Name: Clay
Family Name: PERREAULT
City of Residence: Panama City
State or Prov. of Residence: Panama
Country of Residence: Panama
Street: ~~Suite #5 Keats Avenue~~ 340a Corozal West
City: ~~London~~ Panama City
State or Province: Panama
Country: ~~UK~~ Panama
Postal or Zip Code: E161TW

Applicant Authority Type: Inventor
Primary Citizenship Country: NZ
Given Name: Steve
Family Name: NICHOLSON
City of Residence: Hamilton
Country of Residence: New Zealand
Street: 423 Tauwhare Road, RD 3
City: Hamilton
Country: New Zealand
Postal or Zip Code: 3283

Applicant Authority Type: Inventor
Primary Citizenship Country: Canada
Given Name: Rod
Family Name: THOMSON
City of Residence: North Vancouver, British Columbia
Country of Residence: Canada
Street: 3320 Garabaldi Drive
City: North Vancouver, British Columbia
Country: Canada
Postal or Zip Code: V7H 2N9

Applicant Authority Type: Inventor
Primary Citizenship Country: Canada
Given Name: Johan
Middle Name: Emil Victor
Family Name: BJORSELL
City of Residence: Vancouver, British Columbia
Country of Residence: Canada
Street: P.O. Box 29164 RPO South Granville Post
City: Vancouver, British Columbia

Country: Canada
 Postal or Zip Code: V6J 0A6

Applicant Authority Type: Inventor
 Primary Citizenship Country: Canada
 Given Name: Fuad
 Family Name: ARAFA
 City of Residence: Vancouver, British Columbia
 Country of Residence: Canada
 Street: 782 West 22nd Street
 City: Vancouver, British Columbia
 Country: Canada
 Postal or Zip Code: V5Z 17Z

Correspondence Information

Correspondence Customer Number: 20,995
 E-Mail Address: efilings@kmb.com

Representative Information

Representative Customer Number: 20995

Domestic Priority Information

Application::	Continuity Type::	Parent Application::	Parent Filing Date::
This Application	A 371 of international	PCT/CA2007001956	2007-11-01
PCT/CA20070019[[6]]56	Non provisional of	60856212	2006-11-02

Foreign Priority Information

Country::	Application Number::	Filing Date::	Priority Claimed::

Assignment Information

Assignee Name: DIGIFONICA (INTERNATIONAL) LIMITED
Street: Suite 1401, 4710 Kingsway Suite 890, 990 West Hastings
Street
City: Burnaby Vancouver
State or Province: British Columbia
Country: CA
Postal or Zip Code: ~~VSH 4M2~~ V6C 2W2

7274845
061109

Electronic Acknowledgement Receipt

EFS ID:	5648904
Application Number:	12513147
International Application Number:	
Confirmation Number:	9611
Title of Invention:	PRODUCING ROUTING MESSAGES FOR VOICE OVER IP COMMUNICATIONS
First Named Inventor/Applicant Name:	Clay Perreault
Customer Number:	20995
Filer:	John M Carson/Valerie Jones
Filer Authorized By:	John M Carson
Attorney Docket Number:	SMARB19.001APC
Receipt Date:	06-JUL-2009
Filing Date:	
Time Stamp:	18:21:28
Application Type:	U.S. National Stage under 35 USC 371

Payment information:

Submitted with Payment	no
------------------------	----

File Listing:

Document Number	Document Description	File Name	File Size(Bytes)/ Message Digest	Multi Part /.zip	Pages (if appl.)
1		SMARB19_001APC.pdf	131829 5b2e91de472a1919a35273ee00b91a37df21266b	yes	5

Multipart Description/PDF files in .zip description			
Document Description		Start	End
Miscellaneous Incoming Letter		1	1
Application Data Sheet		2	5

Warnings:

Information:

Total Files Size (in bytes):	131829
-------------------------------------	--------

This Acknowledgement Receipt evidences receipt on the noted date by the USPTO of the indicated documents, characterized by the applicant, and including page counts, where applicable. It serves as evidence of receipt similar to a Post Card, as described in MPEP 503.

New Applications Under 35 U.S.C. 111

If a new application is being filed and the application includes the necessary components for a filing date (see 37 CFR 1.53(b)-(d) and MPEP 506), a Filing Receipt (37 CFR 1.54) will be issued in due course and the date shown on this Acknowledgement Receipt will establish the filing date of the application.

National Stage of an International Application under 35 U.S.C. 371

If a timely submission to enter the national stage of an international application is compliant with the conditions of 35 U.S.C. 371 and other applicable requirements a Form PCT/DO/EO/903 indicating acceptance of the application as a national stage submission under 35 U.S.C. 371 will be issued in addition to the Filing Receipt, in due course.

New International Application Filed with the USPTO as a Receiving Office

If a new international application is being filed and the international application includes the necessary components for an international filing date (see PCT Article 11 and MPEP 1810), a Notification of the International Application Number and of the International Filing Date (Form PCT/RO/105) will be issued in due course, subject to prescriptions concerning national security, and the date shown on this Acknowledgement Receipt will establish the international filing date of the application.

IN THE UNITED STATES PATENT AND TRADEMARK OFFICE

Applicant	: Perreault et al.
App. No	: Unknown
Filed	: April 30, 2009
For	: PRODUCING ROUTING MESSAGES FOR VOICE OVER IP COMMUNICATIONS
Examiner	: Unassigned
Art Unit	: Unassigned
Conf No.	: Unassigned

PRELIMINARY AMENDMENT**Mail Stop Amendment**

Commissioner for Patents
P.O. Box 1450
Alexandria, VA 22313-1450

Dear Sir:

Prior to examination of the above-identified application, Applicant respectfully submits the following amendment.

Amendments to the Specification begin on page 2 of this paper.

Amendments to the Claims are reflected in the listing of claims which begins on page 3 of this paper.

Remarks begin on page 12 of this paper.

Application No.: Unknown
Filing Date: April 30, 2009

AMENDMENTS TO THE SPECIFICATION

Please enter the following paragraph after the title:

This application is a national phase entry of PCT/CA2007/001956, filed November 1, 2007, which claims priority to U.S. Provisional Application No. 60/856,212, filed November 2, 2006, both of which are incorporated in their entirety.

Application No.: Unknown
Filing Date: April 30, 2009

AMENDMENTS TO THE CLAIMS

Please amend Claim 30. Please cancel Claims 60-107.

1. (Original) A process for operating a call routing controller to facilitate communication between callers and callees in a system comprising a plurality of nodes with which callers and callees are associated, the process comprising:

in response to initiation of a call by a calling subscriber, receiving a caller identifier and a callee identifier;

using call classification criteria associated with the caller identifier to classify the call as a public network call or a private network call;

producing a routing message identifying an address, on the private network, associated with the callee when the call is classified as a private network call; and

producing a routing message identifying a gateway to the public network when the call is classified as a public network call.

2. (Original) The process of claim 1 further comprising receiving a request to establish a call, from a call controller in communication with a caller identified by said callee identifier.

3. (Original) The process of claim 1 wherein using said call classification criteria comprises searching a database to locate a record identifying calling attributes associated with a caller identified by said caller identifier.

4. (Original) The process of claim 3 wherein locating a record comprises locating a caller dialing profile comprising a username associated with said caller, a domain associated with said caller, and at least one calling attribute.

5. (Original) The process of claim 4 wherein using said call classification criteria comprises comparing calling attributes associated with said caller dialing profile with aspects of said callee identifier.

6. (Original) The process of claim 4 wherein comparing comprises determining whether said callee identifier includes a portion that matches an IDD associated with said caller dialing profile.

Application No.: Unknown
Filing Date: April 30, 2009

7. (Original) The process of claim 4 wherein comparing comprises determining whether said callee identifier includes a portion that matches an NDD associated with said caller dialing profile.

8. (Original) The process of claim 4 wherein comparing comprises determining whether said callee identifier includes a portion that matches an area code associated with said caller dialing profile.

9. (Original) The process of claim 4 wherein comparing comprises determining whether said callee identifier has a length within a range specified in said caller dialing profile.

10. (Original) The process of claim 4 further comprising formatting said callee identifier into a pre-defined digit format to produce a re-formatted callee identifier.

11. (Original) The process of claim 10 wherein formatting comprises removing an international dialing digit from said callee identifier, when said callee identifier begins with a digit matching an international dialing digit specified by said caller dialing profile associated with said caller.

12. (Original) The process of claim 10 wherein formatting comprises removing a national dialing digit from said callee identifier and prepending a caller country code to said callee identifier when said callee identifier begins with a national dialing digit.

13. (Original) The process of claim 10 wherein formatting comprises prepending a caller country code to said callee identifier when said callee identifier begins with digits identifying an area code specified by said caller dialing profile.

14. (Original) The process of claim 10 wherein formatting comprises prepending a caller country code and area code to said callee identifier when said callee identifier has a length that matches a caller dialing number format specified by said caller dialing profile and only one area code is specified as being associated with said caller in said caller dialing profile.

15. (Original) The process of claim 10 further comprising classifying said call as a private network call when said re-formatted callee identifier identifies a subscriber to the private network.

16. (Original) The process of claim 10 further comprising determining whether said callee identifier complies with a pre-defined username format and if so classifying the call as a private network call.

Application No.: Unknown
Filing Date: April 30, 2009

17. (Original) The process of claim 10 further comprising causing a database of records to be searched to locate a direct in dial (DID) bank table record associating a public telephone number with said reformatted callee identifier and if said DID bank table record is found classifying the call as a private network call and if a DID bank table record is not found classifying the call as a public network call.

18. (Original) The process of claim 17 wherein producing said routing message identifying a node on the private network comprises setting a callee identifier in response to a username associated with said DID bank table record.

19. (Original) The process of claim 18 wherein producing said routing message comprises determining whether a node associated with the reformatted callee identifier is the same as a node associated the caller identifier.

20. (Original) The process of claim 19 wherein determining whether a node associated with the reformatted callee identifier is the same as a node associated the caller identifier comprises determining whether a prefix of said re-formatted callee identifier matches a corresponding prefix of a username associated with said caller dialing profile.

21. (Original) The process of claim 20 wherein when said node associated with said caller is not the same as the node associated with the callee, producing a routing message including said caller identifier, said reformatted callee identifier and an identification of a private network node associated with said callee and communicating said routing message to a call controller.

22. (Original) The process of claim 19 wherein when said node associated with said caller is the same as the node associated with said callee, determining whether to perform at least one of the following: forward said call to another party, block the call and direct the caller to a voicemail server associated with the callee.

23. (Original) The process of claim 22 wherein producing said routing message comprises producing a routing message having an identification of at least one of the callee identifier, an identification of a party to whom the call should be forwarded and an identification of a voicemail server associated with the callee.

24. (Original) The process of claim 23 further comprising communicating said routing message to a call controller.

Application No.: Unknown
Filing Date: April 30, 2009

25. (Original) The process of claim 10 wherein producing a routing message identifying a gateway to the public network comprises searching a database of route records associating route identifiers with dialing codes to find a route record having a dialing code having a number pattern matching at least a portion of said reformatted callee identifier.

26. (Original) The process of claim 25 further comprising searching a database of supplier records associating supplier identifiers with said route identifiers to locate at least one supplier record associated with said route identifier associated with said route record having a dialing code having a number pattern matching at least a portion of said reformatted callee identifier.

27. (Original) The process of claim 26 further comprising loading a routing message buffer with the reformatted callee identifier and an identification of specific routes associated respective ones of the supplier records associated with said route record and loading said routing message buffer with a time value and a timeout value.

28. (Original) The process of claim 27 further comprising communicating a routing message comprising the contents of said routing message buffer to a call controller.

29. (Original) The process of claim 4 further comprising causing said dialing profile to include a maximum concurrent call value and a concurrent call count value and causing said concurrent call count value to be incremented when the user associated with said dialing profile initiates a call and causing said concurrent call count value to be decremented when a call with said user associated with said dialing profile is ended.

30. **(Currently amended)** A computer readable medium encoded with codes for directing a processor to execute the a method of any one of claims 1-29 operating a call routing controller to facilitate communication between callers and callees in a system comprising a plurality of nodes with which callers and callees are associated, the method comprising:

in response to initiation of a call by a calling subscriber, receiving a caller identifier and a callee identifier;

using call classification criteria associated with the caller identifier to classify the call as a public network call or a private network call;

producing a routing message identifying an address, on the private network, associated with the callee when the call is classified as a private network call; and

Application No.: Unknown
Filing Date: April 30, 2009

producing a routing message identifying a gateway to the public network when the call is classified as a public network call.

31. (Original) A call routing apparatus for facilitating communications between callers and callees in a system comprising a plurality of nodes with which callers and callees are associated, the apparatus comprising:

receiving means for receiving a caller identifier and a callee identifier, in response to initiation of a call by a calling subscriber;

classifying means for classifying the call as a private network call or a public network call according to call classification criteria associated with the caller identifier;

means for producing a routing message identifying an address, on the private network, associated with the callee when the call is classified as a private network call; and

means for producing a routing message identifying a gateway to the public network if the call is classified as a public network call.

32. (Original) The apparatus of claim 31 wherein said receiving means is operably configured to receive a request to establish a call, from a call controller in communication with a caller identified by said callee identifier.

33. (Original) The apparatus of claim 31 further comprising searching means for searching a database comprising records associating calling attributes with subscribers to said private network to locate a record identifying calling attributes associated with a caller identified by said caller identifier.

34. (Original) The apparatus of claim 33 wherein said records include dialing profiles each comprising a username associated with said subscriber, an identification of a domain associated with said subscriber, and an identification of at least one calling attribute associated with said subscriber.

35. (Original) The apparatus of claim 34 wherein said call classification means is operably configured to compare calling attributes associated with said caller dialing profile with aspects of said callee identifier.

36. (Original) The apparatus of claim 35 wherein said calling attributes include an international dialing digit and wherein said call classification means is operably configured to

Application No.: Unknown
Filing Date: April 30, 2009

determine whether said callee identifier includes a portion that matches an IDD associated with said caller dialing profile.

37. (Original) The apparatus of claim 34 wherein said calling attributes include an national dialing digit and wherein said call classification means is operably configured to determine whether said callee identifier includes a portion that matches an NDD associated with said caller dialing profile.

38. (Original) The apparatus of claim 34 wherein said calling attributes include an area code and wherein said call classification means is operably configured to determine whether said callee identifier includes a portion that matches an area code associated with said caller dialing profile.

39. (Original) The apparatus of claim 34 wherein said calling attribute include a number length range and wherein said call classification means is operably configured to determine whether said callee identifier has a length within a range specified in said caller dialing profile.

40. (Original) The apparatus of claim 34 further comprising formatting means for formatting said callee identifier into a pre-defined digit format to produce a re-formatted callee identifier.

41. (Original) The apparatus of claim 40 wherein said formatting means is operably configured to remove an international dialing digit from said callee identifier, when said callee identifier begins with a digit matching an international dialing digit specified by said caller dialing profile associated with said caller.

42. (Original) The apparatus of claim 40 wherein said formatting means is operably configured to remove a national dialing digit from said callee identifier and prepend a caller country code to said callee identifier when said callee identifier begins with a national dialing digit.

43. (Original) The apparatus of claim 40 wherein said formatting means is operably configured to prepend a caller country code to said callee identifier when said callee identifier begins with digits identifying an area code specified by said caller dialing profile.

44. (Original) The apparatus of claim 40 wherein said formatting means is operably configured to prepend a caller country code and area code to said callee identifier when said

Application No.: Unknown
Filing Date: April 30, 2009

callee identifier has a length that matches a caller dialing number format specified by said caller dialing profile and only one area code is specified as being associated with said caller in said caller dialing profile.

45. (Original) The apparatus of claim 40 wherein said classifying means is operably configured to classifying said call as a private network call when said re-formatted callee identifier identifies a subscriber to the private network.

46. (Original) The apparatus of claim 40 wherein said classifying means is operably configured to classify the call as a private network call when said callee identifier complies with a pre-defined username format.

47. (Original) The apparatus of claim 40 further comprising searching means for searching a database of records to locate a direct in dial (DID) bank table record associating a public telephone number with said reformatted callee identifier and wherein said classifying means is operably configured to classify the call as a private network call when said DID bank table record is found and to classify the call as a public network call when a DID bank table record is not found

48. (Original) The apparatus of claim 47 wherein said private network routing message producing means is operably configured to produce a routing message having a callee identifier set according to a username associated with said DID bank table record.

49. (Original) The apparatus of claim 48 wherein said private network routing message producing means is operably configured to determine whether a node associated with the reformatted callee identifier is the same as a node associated the caller identifier.

50. (Original) The apparatus of claim 49 wherein said private network routing means includes means for determining whether a prefix of said re-formatted callee identifier matches a corresponding prefix of a username associated with said caller dialing profile.

51. (Original) The apparatus of claim 50 wherein said private network routing message producing means is operably configured to produce a routing message including said caller identifier, said reformatted callee identifier and an identification of a private network node associated with said callee and communicating said routing message to a call controller.

52. (Original) The apparatus of claim 49 wherein said private network routing message producing means is operably configured to perform at least one of the following:

Application No.: Unknown
Filing Date: April 30, 2009

forward said call to another party, block the call and direct the caller to a voicemail server associated with the callee, when said node associated with said caller is the same as the node associated with said callee.

53. (Original) The apparatus of claim 52 wherein said means for producing said private network routing message is operably configured to produce a routing message having an identification of at least one of the callee identifier, an identification of a party to whom the call should be forwarded and an identification of a voicemail server associated with the callee.

54. (Original) The apparatus of claim 53 further comprising means for communicating said routing message to a call controller.

55. (Original) The apparatus of claim 40 wherein said means for producing a public network routing message identifying a gateway to the public network comprises means for searching a database of route records associating route identifiers with dialing codes to find a route record having a dialing code having a number pattern matching at least a portion of said reformatted callee identifier.

56. (Original) The apparatus of claim 55 further comprising means for searching a database of supplier records associating supplier identifiers with said route identifiers to locate at least one supplier record associated with said route identifier associated with said route record having a dialing code having a number pattern matching at least a portion of said reformatted callee identifier.

57. (Original) The apparatus of claim 56 further comprising a routing message buffer and means for loading said routing message buffer with the reformatted callee identifier and an identification of specific routes associated respective ones of the supplier records associated with said route record and loading said routing message buffer with a time value and a timeout value.

58. (Original) The apparatus of claim 57 further comprising means for communicating a routing message comprising the contents of said routing message buffer to a call controller.

59. (Original) The apparatus of claim 34 further comprising means for causing said dialing profile to include a maximum concurrent call value and a concurrent call count value and for causing said concurrent call count value to be incremented when the user associated with said

Application No.: Unknown
Filing Date: April 30, 2009

dialing profile initiates a call and for causing said concurrent call count value to be decremented when a call with said user associated with said dialing profile is ended.

60. – 107. (Canceled)

Application No.: Unknown
Filing Date: April 30, 2009

REMARKS

Applicant has amended Claim 30 and canceled Claims 60-107. Applicant is not conceding in this application that the previously pending claims are not patentable over the cited references. Rather, any alterations or characterizations are being made to facilitate expeditious prosecution of this application. Applicant reserves the right to pursue at a later date the previously pending claims or other broader or narrower claims that capture any subject matter supported by the present disclosure. Accordingly, reviewers of this or any parent, child or related prosecution history shall not reasonably infer that Applicant has made any disclaimers or disavowals of any subject matter supported by the present application.

Please charge any additional fees, including any fees for additional extension of time, or credit overpayment to Deposit Account No. 11-1410.

Respectfully submitted,

KNOBBE, MARTENS, OLSON & BEAR, LLP



Dated: April 30, 2009

By: _____

John M. Carson
Registration No. 34,303
Attorney of Record
Customer No. 20995
(619) 235-8550

7058627
042809

IN THE PATENT COOPERATION TREATY

IN RE APPLICATION

Serial No.: PCT/CA2007/001956
Filing Date: 01 NOVEMBER 2007 (01-11-2007)
Applicant: DIGIFONICA (INTERNATIONAL) LIMITED
Title: PRODUCING ROUTING MESSAGES FOR VOICEOVER IP COMMUNICATIONS
Inventor: PERREAULT, Clay; NICHOLSON, Steve; THOMSON, Rod; BJORSELL, Johan Emil Victor; ARAFA, Fuad
Agent's Ref.: 83636-16

17 April 2008

VIA FACSIMILE ONLY

The International Bureau of WIPO
34, chemin des Colombettes
1211 Geneva 20
Switzerland

Dear Sirs:

AMENDMENT UNDER ARTICLE 19

Please cancel claim pages 82 – 84 and substitute the enclosed claim pages 82 – 84 therefor.

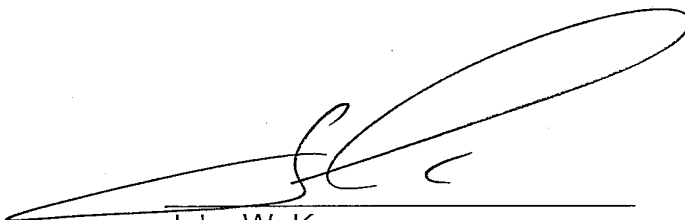

John W. Knox
SMART & BIGGAR
Box 11560 Vancouver Centre
Suite 2200, 650 West Georgia Street
Vancouver, British Columbia
Canada V6B 4N8

JWK:GHC:gsg:mlm
Encls.: Replacement Claim Pages 82 – 84

IN THE PATENT COOPERATION TREATY

IN RE APPLICATION

Serial No.: PCT/CA2007/001956
Filing Date: 01 NOVEMBER 2007 (01-11-2007)
Applicant: DIGIFONICA (INTERNATIONAL) LIMITED
Title: PRODUCING ROUTING MESSAGES FOR VOICEOVER IP
COMMUNICATIONS
Inventor: PERREAULT, Clay; NICHOLSON, Steve; THOMSON, Rod;
BJORSELL, Johan Emil Victor; ARAFA, Fuad
Agent's Ref.: 83636-16

14 April 2008

VIA FACSIMILE ONLY

The International Bureau of WIPO
34, chemin des Colombettes
1211 Geneva 20
Switzerland

Dear Sirs:

Letter Explaining the Differences Between the Claims as Filed and the Claims as
Amended

Claims 60 and 61 have been amended.

The remaining claims 1 – 59 and 62 – 107 are unchanged.

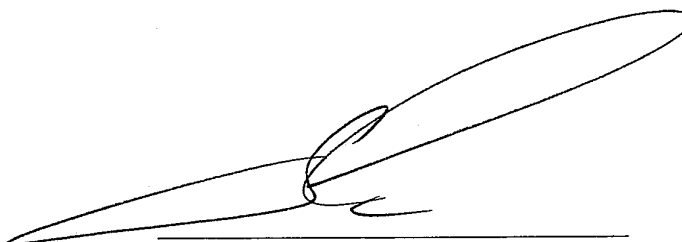

John W. Knox
SMART & BIGGAR
Box 11560 Vancouver Centre
Suite 2200, 650 West Georgia Street
Vancouver, British Columbia
Canada V6B 4N8

JWK:GHC:gsg:mlm

code having a number pattern matching at least a portion of said reformatted callee identifier.

5 57. The apparatus of claim 56 further comprising a routing message buffer and means for loading said routing message buffer with the reformatted callee identifier and an identification of specific routes associated respective ones of the supplier records associated with said route record and loading said routing message buffer with a time value and a timeout value.

10 58. The apparatus of claim 57 further comprising means for communicating a routing message comprising the contents of said routing message buffer to a call controller.

15 59. The apparatus of claim 34 further comprising means for causing said dialing profile to include a maximum concurrent call value and a concurrent call count value and for causing said concurrent call count value to be incremented when the user associated with said dialing profile initiates a call and for causing said concurrent call count value to be decremented when a call with said user associated with said dialing profile is ended.

Data Structure

25 60. A data structure for access by an apparatus for producing a routing message for use by a call routing controller in a communications system, the data structure comprising:

30 dialing profile records comprising fields for associating a subscriber username with respective subscribers to the system;

direct-in-dial records comprising fields for associating a user domain and a direct-in-dial number with respective subscriber usernames;

5 prefix to node records comprising fields for associating a node address of a node in said system with at least a portion of said respective subscriber usernames:

10 whereby said subscriber username can be used to find said user domain, at least a portion of said subscriber username can be used to find said node with which a subscriber identified by said subscriber user name is associated, and said user domain and said subscriber username can be located in response to said direct-in-dial number.

15

61. A data structure for access by an apparatus for producing a routing message for use by a call routing controller in a communications system, the data structure comprising:

20

master list records comprising fields for associating a dialing code with respective master list identifiers; and

25

supplier list records linked to said master list records by said master list identifiers, said supplier list records comprising fields for associating with a communications services supplier:

a supplier id;

a master list id;

30

a route identifier; and

a billing rate code,

5 whereby at least one communications service supplier is associated with said dialing code, such that said dialing code can be used to locate suppliers capable of providing a communications link associated with a given dialing code.

62. A method of determining a time to permit a communication session to be conducted, the method comprising:

10

calculating a cost per unit time;

15

calculating a first time value as a sum of a free time attributed to a participant in the communication session and the quotient of a funds balance held by said participant to said cost per unit time value; and

20

producing a second time value in response to said first time value and a billing pattern associated with said participant, said billing pattern including first and second billing intervals and said second time value being said time to permit a communication session to be conducted.

25

63. The method of claim 62 wherein calculating said first time value comprises retrieving a record associated with said participant and obtaining from said record at least one of said free time and said funds balance.

PATENT COOPERATION TREATY
PCT
INTERNATIONAL SEARCH REPORT
(PCT Article 18 and Rules 43 and 44)

RECEIVED

Applicant's or agent's file reference 83636-16	FOR FURTHER ACTION	7588 Form PCT/ISA/210: 26 as well as, where applicable, item 5 below 600 WEST GEORGIA ST. ATLANTA, GA 30308-3801 UNITED STATES PATENT & TRADEMARK OFFICE
International application No. PCT/CA2007/001956	International filing date (day/month/year) 01 November 2007 (01-11-2007)	(Earliest) Priority date (day/month/year) 02 November 2006 (02-11-2006)
Applicant DIGIFONICA (INTERNATIONAL) LIMITED ET AL		

This international search report has been prepared by this International Searching Authority and is transmitted to the applicant according to Article 18. A copy is being transmitted to the International Bureau.

This international search report consists of a total of 5 sheets.

It is also accompanied by a copy of each prior art document cited in this report.

1. Basis of the report

a. With regard to the **language**, the international search was carried out on the basis of:

the international application in the language in which it was filed

a translation of the international application into _____, which is the language of a translation furnished for the purposes of international search (Rules 12.3(a) and 23.1(b))

b. This international search report has been established taking into account the **rectification of an obvious mistake** authorized by or notified to this Authority under Rule 91 (Rule 43.6bis(a)).

c. With regard to any **nucleotide and/or amino acid sequence** disclosed in the international application, see Box No. I

2. **Certain claims were found unsearchable** (see Box No. II)

3. **Unity of invention is lacking** (see Box No. III)

4. With regard to the **title**,

the text is approved as submitted by the applicant

the text has been established by this Authority to read as follows :

5. With regard to the **abstract**,

the text is approved as submitted by the applicant

the text has been established, according to Rule 38.2, by this Authority as it appears in Box No. IV. The applicant may, within one month from the date of mailing of this international search report, submit comments to this Authority

6. With regard to the **drawings**,

a. the figure of the **drawings** to be published with the abstract is Figure No. 1

as suggested by the applicant

as selected by this Authority, because the applicant failed to suggest a figure

as selected by this Authority, because this figure better characterizes the invention

b. none of the figures is to be published with the abstract

DOC
JLE
JWK

Box No. II Observations where certain claims were found unsearchable (Continuation of item 2 of the first sheet)

This international search report has not been established in respect of certain claims under Article 17(2)(a) for the following reasons :

1. Claim Nos. :
because they relate to subject matter not required to be searched by this Authority, namely :

2. Claim Nos. :
because they relate to parts of the international application that do not comply with the prescribed requirements to such an extent that no meaningful international search can be carried out, specifically :

3. Claim Nos. :
because they are dependant claims and are not drafted in accordance with the second and third sentences of Rule 6.4(a).

Box No. III Observations where unity of invention is lacking (Continuation of item 3 of first sheet)

This International Searching Authority found multiple inventions in this international application, as follows :

Group I	Claims 1-59
Group II	Claims 60, 61
Group III	Claims 62-84
Group IV	Claims 85-107

1. As all required additional search fees were timely paid by the applicant, this international search report covers all searchable claims.
2. As all searchable claims could be searched without effort justifying additional fees, this Authority did not invite payment of additional fees.
3. As only some of the required additional search fees were timely paid by the applicant, this international search report covers only those claims for which fees were paid, specifically claim Nos. :
4. No required additional search fees were timely paid by the applicant. Consequently, this international search report is restricted to the invention first mentioned in the claims; it is covered by claim Nos. :

Remark on Protest The additional search fees were accompanied by the applicant's protest and, where applicable, the payment of a protest fee.

The additional search fees were accompanied by the applicant's protest but the applicable protest fee was not paid within the time limit specified in the invitation.

No protest accompanied the payment of additional search fees.

INTERNATIONAL SEARCH REPORT

International application No.
PCT/CA2007/001956

A. CLASSIFICATION OF SUBJECT MATTER
 IPC: *H04L 12/66* (2006.01), *H04L 12/14* (2006.01), *H04M 11/06* (2006.01), *H04M 15/00* (2006.01),
H04Q 3/64 (2006.01)
 According to International Patent Classification (IPC) or to both national classification and IPC

B. FIELDS SEARCHED

Minimum documentation searched (classification system followed by classification symbols)
 IPC: H04L (2006.01), H04M (2006.01), H04Q (2006.01); US classes: 370, 379 in combination with keywords

Documentation searched other than minimum documentation to the extent that such documents are included in the fields searched

Electronic database(s) consulted during the international search (name of database(s) and, where practicable, search terms used)
 Canadian Patent Database, USPTO West, Delphion. Keywords: public network, private network, routing message, instant messaging, ip phone, voip, routing controller, sip, gateway, tfl, metric, skype, data structure, routing message, billing, communication session, prepaid

C. DOCUMENTS CONSIDERED TO BE RELEVANT

Category*	Citation of document, with indication, where appropriate, of the relevant passages	Relevant to claim No.
A	CA2249668 C (Bruno et al.) 7 April 1999 (07-04-1999) * Page 9, line 4 to page 14, line 18; Figs 1, 2 *	1-59
A	US7120682 B1 (Salama) 10 October 2006 (10-10-2006) * Col. 1, line 47 to col. 4, line 67 *	1-59
A	US2006/0160565 A1 (Singh et al.) 20 July 2006 (20-07-2006) * Paragraphs 14, 15, 18; Figs 1, 2 *	1-59
A	US2006/0177035 A1 (Cope et al.) 10 August 2006 (10-08-2006) * Paragraphs 5, 6, 12 *	1-59
A, P	US7212522 B1 (Shankar et al.) 1 May 2007 (01-05-2007) * Col. 4, line 47 to col. 5, line 11; Fig. 1 *	1-59

Further documents are listed in the continuation of Box C.

See patent family annex.

* Special categories of cited documents :

"A" document defining the general state of the art which is not considered to be of particular relevance
 "E" earlier application or patent but published on or after the international filing date
 "L" document which may throw doubts on priority claim(s) or which is cited to establish the publication date of another citation or other special reason (as specified)
 "O" document referring to an oral disclosure, use, exhibition or other means
 "P" document published prior to the international filing date but later than the priority date claimed

"T" later document published after the international filing date or priority date and not in conflict with the application but cited to understand the principle or theory underlying the invention
 "X" document of particular relevance; the claimed invention cannot be considered novel or cannot be considered to involve an inventive step when the document is taken alone
 "Y" document of particular relevance; the claimed invention cannot be considered to involve an inventive step when the document is combined with one or more other such documents, such combination being obvious to a person skilled in the art
 "&" document member of the same patent family

Date of the actual completion of the international search

6 February 2008 (06-02-2008)

Date of mailing of the international search report

20 February 2008 (20-02-2008)

Name and mailing address of the ISA/CA
 Canadian Intellectual Property Office
 Place du Portage I, C114 - 1st Floor, Box PCT
 50 Victoria Street
 Gatineau, Quebec K1A 0C9
 Facsimile No.: 001-819-953-2476

Authorized officer

Arthur Smith 819-953-1360

INTERNATIONAL SEARCH REPORT

International application No.
PCT/CA2007/001956

C (Continuation). DOCUMENTS CONSIDERED TO BE RELEVANT

Category*	Citation of document, with indication, where appropriate, of the relevant passages	Relevant to claim No.
A	US7068772 (Widger et al.) 27 June 2006 (27-06-2006) * Col. 12, line 49 to col. 14, line 44; col. 15, line 26 to col. 16, line 30 Figs. 3, 5 *	60, 61
A	US2006/0209768 A1 (Yan et al.) 21 September 2006 (21-09-2006) * Paras. 71-99, 111-118, 128-141, 179-188; Figs. 3, 4, 7-9 *	60, 61
X	US6058300 (Hanson) 2 May 2000 (02-05-2000) * Col. 2, lines 9-13; col. 5, line 55 to col. 6, line 23; col. 6, line 55 to col. 7, line 18 *	62, 63, 73-75
A		64-72, 76-84
X	US2005/0177843 A1 (Williams) 11 August 2005 (11-08-2005) * Paragraphs 64 - 69 *	62, 63, 73-75
A		64-72, 76-84
A	US6188752 B1 (Lesley) 13 February 2001 (13-02-2001) * Col. 4, line 24 to col. 9, line 6; Figs 1, 3 *	85-107
A	US6507644 B1 (Henderson et al.) 14 January 2003 (14-01-2003) * Col. 1, line 51 to col. 6, line 28 *	85-107
A	US5359642 (Castro) 25 October 1994 (25-10-1994) * Abstract; Col. 5, lines 7-12, col. 6, line 5 to col. 8, line 38; col. 10, line 10 to col. 12, line 68 *	85-107

INTERNATIONAL SEARCH REPORT
Information on patent family members

International application No.
PCT/CA2007/001956

Patent Document Cited in Search Report	Publication Date	Patent Family Member(s)	Publication Date
CA2249668	07-04-1999	EP0915594 A2 US6614765 B1	12-05-1999 02-09-2003
US7120682	10-10-2006	NONE	
US2006160565	20-07-2006	NONE	
US2006177035	10-08-2006	CA2595429 A1 WO2006081115 A1	03-08-2006 03-08-2006
US7212522	01-05-2007	US6570869 B1 US6658022 B1 US6768733 B1	27-05-2003 02-12-2003 27-07-2004
US7068772	27-06-2006	NONE	
US2006209768	21-09-2006	CA2512959 A1 CN1762129 A EP1585270 A1 JP2004266310 A KR20050092405 A WO2004077754 A1	10-09-2004 19-04-2006 12-10-2005 24-09-2004 21-09-2005 10-09-2004
US6058300	02-05-2000	AU6142498 A CA2250845 A1 US6029062 A US6208851 B1 US6625438 B2 US7162220 B2 WO9834393 A2	25-08-1998 06-08-1998 22-02-2000 27-03-2001 23-09-2003 09-01-2007 06-08-1998
US2005177843	11-08-2005	AU2002351582 A1 CA2469959 A1 CA2471113 A1 US2003120553 A1 US2006190353 A1 WO03056803 A2	15-07-2003 10-07-2003 10-07-2003 26-06-2003 24-08-2006 10-07-2003
US6188752	13-02-2001	AU730021B B2 AU5073398 A BR9713025 A CA2271311 A1 CN1244987 A DE69732526D D1 DE69732526T T2 EP0944994 A1 ES2237791T T3 JP2001504299T T KR20000053241 A NO992280 A US6333976 B2 WO9821874 A1	22-02-2001 03-06-1998 25-01-2000 22-05-1998 16-02-2000 24-03-2005 28-07-2005 29-09-1999 01-08-2005 27-03-2001 25-08-2000 12-07-1999 25-12-2001 22-05-1998
US6507644	14-01-2003	NONE	
US5359642	25-10-1994	NONE	

PATENT COOPERATION TREATY

From the
INTERNATIONAL SEARCHING AUTHORITY

To:
SMART & BIGGAR
Box 11560 Vancouver Centre
2200 - 650 W. Georgia Street
VANCOUVER, British Columbia
Canada, V6B 4N8

RECEIVED **RPCTIVED**

2008 FEB 26 A 10:27 AM
INTERNATIONAL SEARCHING AUTHORITY
2200 - 650 WEST GEORGIA ST. VANCOUVER, B.C.
2200 - 650 WEST GEORGIA ST. VANCOUVER, B.C.
(PCT Rule 43bis) B.C.

Date of mailing (day/month/year) **20 February 2008 (20-02-2008)**

Applicant's or agent's file reference
83636-16

FOR FURTHER ACTION
See paragraph 2 below

International application No.
PCT/CA2007/001956

International filing date (day/month/year)
01 November 2007 (01-11-2007)

Priority date (day/month/year)
02 November 2006 (02-11-2006)

International Patent Classification (IPC) or both national classification and IPC
IPC: **H04L 12/66** (2006.01), **H04L 12/14** (2006.01), **H04M 11/06** (2006.01), **H04M 15/00** (2006.01),
H04Q 3/64 (2006.01)

Applicant
DIGIFONICA (INTERNATIONAL) LIMITED ET AL

NKS
Written Opinion
due Sep 2/08
DOCKET
doct: Sep 1/08

1. This opinion contains indications relating to the following items :

- Box No. I Basis of the opinion
- Box No. II Priority
- Box No. III Non-establishment of opinion with regard to novelty, inventive step and industrial applicability
- Box No. IV Lack of unity of invention
- Box No. V Reasoned statement under Rule 43bis.1(a)(i) with regard to novelty, inventive step or industrial applicability; citations and explanations supporting such statement
- Box No. VI Certain documents cited
- Box No. VII Certain defects in the international application
- Box No. VIII Certain observations on the international application

2. **FURTHER ACTION**

If a demand for international preliminary examination is made, this opinion will be considered to be a written opinion of the International Preliminary Examining Authority ("IPEA") except that this does not apply where the applicant chooses an Authority other than this one to be the IPEA and the chosen IPEA has notified the International Bureau under Rule 66.1bis(b) that written opinions of this International Searching Authority will not be so considered.

If this opinion is, as provided above, considered to be a written opinion of the IPEA, the applicant is invited to submit to the IPEA a written reply together, where appropriate, with amendments, before the expiration of 3 months from the date of mailing of Form PCT/ISA/220 or before the expiration of 22 months from the priority date, whichever expires later.

For further options, see Form PCT/ISA/220.

3. For further details, see notes to Form PCT/ISA/220.

Name and mailing address of the ISA/CA
Canadian Intellectual Property Office
Place du Portage I, C114 - 1st Floor, Box PCT
50 Victoria Street
Gatineau, Quebec K1A 0C9
Facsimile No.: 001-819-953-2476

Date of completion of this opinion
7 February 2008 (07-02-2008)

Authorized officer
Arthur Smith 819-953-1360

NKS

Form PCT/ISA/237 (cover sheet) (April 2007)

*Doc
JCC
JWW*

WRITTEN OPINION OF THE
INTERNATIONAL SEARCHING AUTHORITY

International application No.
PCT/CA2007/001956

Box No. I Basis of this opinion

1. With regard to the **language**, this opinion has been established on the basis of:
 - the international application in the language in which it was filed
 - a translation of the international application into _____, which is the language of a translation furnished for the purposes of international search (Rules 12.3(a) and 23.1(b)).
2. This opinion has been established taking into account the **rectification of an obvious mistake** authorized by or notified to this Authority under Rule 91 (Rule 43bis.1(a))
3. With regard to any **nucleotide and/or amino acid sequence** disclosed in the international application and necessary to the claimed invention, this opinion has been established on the basis of:
 - a. type of material
 - a sequence listing
 - table(s) related to the sequence listing
 - b. format of material
 - on paper
 - in electronic form
 - c. time of filing/furnishing
 - contained in the international application as filed.
 - filed together with the international application in electronic form
 - furnished subsequently to this Authority for the purposes of search.
4. In addition, in the case that more than one version or copy of a sequence listing and/or table(s) relating thereto has been filed or furnished, the required statements that the information in the subsequent or additional copies is identical to that in the application as filed or does not go beyond the application as filed, as appropriate, were furnished.
5. Additional comments :

WRITTEN OPINION OF THE
INTERNATIONAL SEARCHING AUTHORITY

International application No.
PCT/CA2007/001956

Box No. IV Lack of unity of invention

1. In response to the invitation (Form PCT/ISA/206) to pay additional fees the applicant has, within the applicable time limit :
- paid additional fees
 - paid additional fees under protest and, where applicable, the protest fee
 - paid additional fees under protest but the applicable protest fee was not paid
 - not paid additional fees

2. This Authority found that the requirement of unity of invention is not complied with and chose not to invite the applicant to pay additional fees.

3. This Authority considers that the requirement of unity of invention in accordance with Rules 13.1, 13.2 and 13.3 is

complied with

not complied with for the following reasons :

This International Searching Authority considers that there are four inventions claimed in the international application covered by the claims indicated below:

- I Claims 1-59
- II Claims 60, 61
- III Claims 62-84
- IV Claims 85-107

The claims of Group I have in common a call routing controller for facilitating communications between callers and callees in a communications system comprising a plurality of nodes in which, in response to initiation of a call, uses call classification criteria to classify the call as a public network call or a private network call, and produces accordingly a routing message.

The claims of Group II have in common a data structure for access by an apparatus for producing a routing message for use by a call routing controller in a communications system.

The claims of Group III have in common determining a time to permit a communication session to be conducted, the determination based on calculating a cost per unit time, a participant's billing pattern, and the quotient of a funds balance held by the participant.

The claims of Group IV have in common attributing charges for communications services by determining chargeable times and changing account balances of both user and communications services reseller.

Groups I and II have in common the call routing controller; however, call routing controllers are well known in the art so the claims of Groups I and II lack unity *a posteriori*.

Because the remainder of the claims of Groups I, II, III, and IV have no elements in common and would require separate searches by the examiner, these groups lack unity *a priori*.

4. Consequently, this opinion has been established in respect of the following parts of the international application :

all parts

the parts relating to claim Nos.

WRITTEN OPINION OF THE
INTERNATIONAL SEARCHING AUTHORITY

International application No.
PCT/CA2007/001956

Box No. V Reasoned statement under Rule 43bis.1(a)(i) with regard to novelty, inventive step or industrial applicability; citations and explanations supporting such statement

1. Statement

Novelty (N)	Claims <u>1-107</u>	YES
	Claims <u>None</u>	NO
Inventive step (IS)	Claims <u>1-61, 64-72, 76-107</u>	YES
	Claims <u>62, 63, 73-75</u>	NO
Industrial applicability (IA)	Claims <u>1-107</u>	YES
	Claims <u>None</u>	NO

2. Citations and explanations :

Group I (Claims 1-59)

The following document is referred to in this communication:

D1 CA 2249668

D1 is considered to form the closest prior art. D1 discloses routing information in an integrated global communications network in which a central routing processor collects routing capabilities of network nodes for which it has responsibility. The routing processor evaluates the routing requirements of a routing query signal transmitted by a source router, determines which routers and communication paths within the network are capable and available to route the information, evaluates the statistical availability of such routers, and selects an optimal routing path to a destination router.

Novelty

D1 fails to individually disclose all the elements of claims 1-59; therefore, claims 1-59 are considered to be novel in accordance with Article 33(2) PCT.

Inventive Step

Independent claims 1, 30, and 31 each claim operating a call routing controller to facilitate communication between callers and callees in a system or network comprising a plurality of nodes in which call classification criteria associated with a caller identifier is used to classify the call as a public network call or a private network call, and producing a routing message in accordance with the classification. D1 teaches facilitation of communication between callers and callees within a private network, including producing a routing message for a private network call. However, D1 fails to teach classification of a call as a public network call, and fails to teach producing an appropriate routing message for a public network call.

Claims 2-29 and 32-59 depend on independent claims 1 and 31, respectively.

Therefore, claims 1-59 are considered to have an inventive step in accordance with Article 33(3) PCT.

Industrial Applicability

Routing IP phone calls through a communication network including both private and public aspects finds use in telecommunications, and, thus, claims 1-59 are industrially applicable in accordance with Article 33(4) PCT.

Group II (Claims 60, 61)

The following documents are referred to in this communication:

D2 US7,068,772

D3 US2006/0209768

D2 and D3 are considered to form the closest prior art. D2 discloses a call processing system and method for providing one-number telecommunication services, wherein a data structure of a subscriber record for access by an apparatus for producing a routing message, the data structure comprising the subscriber's various profiles and the associated 1-800 number or address that the subscriber may be contacted.

(Continued in Supplemental Box)

Box No. VIII **Certain observations on the international application**

The following observations on the clarity of the claims, description, and drawings or on the question whether the claims are fully supported by the description, are made :

Claim-Related Objections

Claim 60 is unclear and does not comply with Article 6 of the PCT. The following terms lack a proper antecedent basis:

- “the subscriber” (claim 60, page 83, line 16)
- “subscriber name” (claim 60, page 83, line 17)

Claim 60 is unclear and does not comply with Article 6 of the PCT. The double inclusion of any element renders the claims indefinite. The following expressions have already been defined previously in the claims and should therefore be referred to using a definite article:

- “a user domain” (claim 60, page 83, lines 14, 17)
- “a direct-in-dial number” (claim 60, page 83, line 18)

Claim 60 is indefinite and does not comply with Article 6 of the PCT. The terms “a subscriber user name” (claim 60, page 82, line 32) and “subscriber name” (claim 60, page 83, lines 14, 15, 16-17, 17) cause ambiguity. It is not clear whether they are the same or different.

Claim 61 is indefinite and does not comply with Article 6 of the PCT. The term “master list records” (page 83, line 27) causes ambiguity. It should read “said master list records”.

Claim 61 is indefinite and does not comply with Article 6 of the PCT. The term “aid” (page 83, line 28) causes ambiguity. It should read “said aid”.

Claim 61 is indefinite and does not comply with Article 6 of the PCT. The term “dialing codes” (page 84, line 8) causes ambiguity. It should read “said dialing codes”.

Supplemental Box

In case the space in any of the preceding boxes is not sufficient.

Continuation of: Box V

D3 discloses a system for managing address allocation of a mobile terminal in wireless LAN (WLAN) to inter-work with another WLAN or a public cellular network, wherein a data structure comprises: Message_Type, Message_Length, Domain_Name, MT_ID, Service_Request, Session_ID, Address_Request, Tunnel_Request, WLAN_ID and Security_Field.

Novelty

The subject matter of claim 60 is considered to be novel and complies with the requirement of **Article 33(2) of the PCT**. The cited references, when taken alone, fail to disclose a data structure for access by an apparatus for producing a routing message for use by a call routing controller in a communications system, the data structure comprising: dialing profile records comprising fields for associating with respective subscribers to the system: a subscriber user name; direct-in-dial records comprising fields for associating with respective subscriber usernames: a user domain; and a direct-in-dial number; prefix to node records comprising fields for associating with at least a portion of said respective subscriber usernames: a node address of a node in said system, whereby a subscriber name can be used to find a user domain, at least a portion of said subscriber name can be used to find a node with which the subscriber identified by the subscriber name is associated, and a user domain and subscriber name can be located in response to a direct-in-dial number.

The subject matter of claim 61 is considered to be novel and complies with the requirement of **Article 33(2) of the PCT**. The cited references, when taken alone, fail to disclose a data structure for access by an apparatus for producing a routing message for use by a call routing controller in a communications system, the data structure comprising: master list records comprising fields for associating a dialing code with respective master list identifiers; and supplier list records linked to master list records by said master list identifiers, said supplier list records comprising fields for associating with a communications service supplier: a supplier id; a master list id; a route identifier; and a billing rate code, whereby communications services suppliers are associated with dialing codes, such that dialing codes can be used to locate suppliers capable of providing a communications link associated with a given dialing code.

Inventive Step

The subject matter of claim 60 is considered to involve an inventive step and does comply with **Article 33(3) of the PCT**. The prior art, D2 and D3, alone or in combination, does not fairly suggest a data structure comprising: dialing profile records; direct-in-dial records; prefix to node records, whereby a subscriber name can be used to find a user domain, at least a portion of said subscriber name can be used to find a node with which the subscriber identified by the subscriber name is associated, and a user domain and subscriber name can be located in response to a direct-in-dial number.

The subject matter of claim 61 is considered to involve an inventive step and does comply with **Article 33(3) of the PCT**. The prior art, D2 and D3, alone or in combination, does not fairly suggest a data structure comprising: master list records; and supplier list records linked to master list records, said supplier list records comprising fields for associating with a communications service supplier, whereby communications services suppliers are associated with dialing codes, such that dialing codes can be used to locate suppliers capable of providing a communications link associated with a given dialing code.

Industrial Applicability

Claims 60 and 61 are considered to be industrially applicable and do comply with **Article 33(4) of the PCT**.

Group III (Claims 62-84)

The following documents are referred to in this communication:

D4 US 6058300
D5 US 2005/0177843 A1

D4 discloses, in part, a calculation of a maximum call duration in response to a customer account balance for a prepaid telecommunications system.

D5 discloses, in part, calculation of a maximum call duration to a specific callee in response to a caller request to make a call in a prepaid telecommunications system. If the maximum call duration is sufficient, the system permits the call to take place.

Novelty

Each of D4 and D5 fail to individually disclose all the elements of claims 62-84; therefore, claims 62-84 are considered to be novel in accordance with Article 33(2) PCT.

(Continued in next Supplemental Box)

Supplemental Box

In case the space in any of the preceding boxes is not sufficient.

Continuation of: Previous Supplemental Box

Inventive Step

Claim 62 claims a method of determining a time to permit a communications session to be conducted (ie, a maximum call duration). Either of D4 or D5 disclose determination of a maximum call duration and cause claim 62 to lack an inventive step. Both of D4 and D5 teach determination of a cost per unit time (D4: "rate per minute" (col. 5, line 58); D5: "call credits" (para. 65)), calculating a first time value as a sum of a free time attributed to a participant in the communication session and the quotient of a funds balance held by the participant to the cost per unit time value (D4: col. 5, lines 61 - 65; D5: para. 67), and producing a second time value in response to the first time value and a billing pattern (D4: roaming or not roaming; D5: "call history"), the second time value being the time to permit a communications session to be conducted. Additional differences between claim 62 and either D4 or D5 such as "free time", "cost per unit time" and "billing pattern" also lack inventive step. Thus claim 62 is considered to **lack an inventive step** in accordance with Article 33(3) PCT.

As claims 73 and 74 are apparatus for carrying out methods steps similar or identical to those of claim 62, these claims **lack an inventive step** in accordance with Article 33(3) PCT for the same reasons as listed above.

Claim 63 and 75 lack an inventive step in view of either of D4 or D5 in that D4 and D5 disclose retrieving a record associated with said participant (D4: "customer's account" (col. 5, lines 63-64); D5: "certificate information" (para. 67)) and obtaining from said record said funds balance (D4: col. 5, line 63; D5: para. 67). To also obtain a participant's free time also lack an inventive step. Thus, claims 63 and 75 **lack an inventive step** in accordance with Article 33(3) PCT.

Claims 64-72 and 76-84 are found to be inventive since no combination of prior art documents were found which disclose the subject matter as set forth in claims 64-72 and 76-84 in accordance with Article 33(3) PCT.

Industrial Applicability

Determination of maximum time for a communication session finds application within Internet telephony; thus, claims 62-84 are considered to **have industrial applicability** in accordance with Article 33(4) PCT.

Group IV (Claims 85-107)

The following document is referred to in this communication:

D6 US 6188752

D6 is considered to form the closest prior art. D6 discloses provision of prepaid telecommunications services by a telecommunications network. A database record includes subscriber information fields such as account numbers, prepaid account information, and a current prepayment monetary amounts. Once a call or communication session has been established, the network monitors parameters related to any fee to be charged for the service such as start time, elapsed time, origination and destination locations, and rate information (ie, billing pattern) preferably in real time. D6 further discloses determining the cost of the call and debiting the account balance associated with the subscriber.

Novelty

D6 fails to individually disclose all the elements of claims 85-107; therefore, claims 85-107 **are considered to be novel** in accordance with Article 33(2) PCT.

Inventive Step

Independent claims 85, 96, and 97 each claim attributing charges for communications services including determining a chargeable time in response to a communication session time and a pre-defined billing pattern, determining a user cost value, and changing account balances associated with the user, reseller, and operator of the communications services. D6 teaches attributing charges for communications services, determining a chargeable time in response to a communication session time and a pre-defined billing pattern, determining a user cost value in response to said first chargeable time associated with a user of said communications services, and changing an account balance associated with said user in response to a user cost per unit time. However, D6 fails to suggest a free time value, nor does D6 teach changing the account balances of either a reseller or an operator of said communications services.

Claims 86-95 and 98-107 depend on independent claims 85 and 97, respectively.

Therefore, claims 85-107 **are considered to have an inventive step** in accordance with Article 33(3) PCT.

Industrial Applicability

Billing or attributing charges for communications services finds use in telecommunications, and, thus, claims 85-107 are considered to **have industrial applicability** in accordance with Article 33(4) PCT.

Under the Paperwork Reduction Act of 1995, no persons are required to respond to a collection of information unless it contains a valid OMB control number.

Application Data Sheet 37 CFR 1.76		Attorney Docket Number	SMARB19.001APC
		Application Number	
Title of Invention	PRODUCING ROUTING MESSAGES FOR VOICE OVER IP COMMUNICATIONS		
The application data sheet is part of the provisional or nonprovisional application for which it is being submitted. The following form contains the bibliographic data arranged in a format specified by the United States Patent and Trademark Office as outlined in 37 CFR 1.76. This document may be completed electronically and submitted to the Office in electronic format using the Electronic Filing System (EFS) or the document may be printed and included in a paper filed application.			

Secrecy Order 37 CFR 5.2

- Portions or all of the application associated with this Application Data Sheet may fall under a Secrecy Order pursuant to 37 CFR 5.2 (Paper filers only. Applications that fall under Secrecy Order may not be filed electronically.)

Applicant Information:

Applicant 1				
Applicant Authority		<input checked="" type="radio"/> Inventor		<input type="radio"/> Legal Representative under 35 U.S.C. 117
				<input type="radio"/> Party of Interest under 35 U.S.C. 118
Prefix	Given Name	Middle Name	Family Name	Suffix
	Clay		PERREAULT	
Residence Information (Select One) <input type="radio"/> US Residency <input checked="" type="radio"/> Non US Residency <input type="radio"/> Active US Military Service				
City	Country Of Residence			
	UK			
Citizenship under 37 CFR 1.41(b)				
UK				
Mailing Address of Applicant:				
Address 1	Suite #5 Keats Avenue			
Address 2				
City	London	State/Province		
Postal Code	E161TW	Country	UK	
Applicant 2				
Applicant Authority		<input checked="" type="radio"/> Inventor		<input type="radio"/> Legal Representative under 35 U.S.C. 117
				<input type="radio"/> Party of Interest under 35 U.S.C. 118
Prefix	Given Name	Middle Name	Family Name	Suffix
	Steve		NICHOLSON	
Residence Information (Select One) <input type="radio"/> US Residency <input checked="" type="radio"/> Non US Residency <input type="radio"/> Active US Military Service				
City	Hamilton	Country Of Residence	NZ	
Citizenship under 37 CFR 1.41(b)	NZ			
Mailing Address of Applicant:				
Address 1	423 Tauwhare Road, RD 3			
Address 2				
City	Hamilton	State/Province		
Postal Code	3283	Country	NZ	
Applicant 3				
Applicant Authority		<input checked="" type="radio"/> Inventor		<input type="radio"/> Legal Representative under 35 U.S.C. 117
				<input type="radio"/> Party of Interest under 35 U.S.C. 118
Prefix	Given Name	Middle Name	Family Name	Suffix
	Rod		THOMSON	
Residence Information (Select One) <input type="radio"/> US Residency <input checked="" type="radio"/> Non US Residency <input type="radio"/> Active US Military Service				
City	North Vancouver, British Columbia	Country Of Residence	CA	

Application Data Sheet 37 CFR 1.76		Attorney Docket Number	SMARB19.001APC
		Application Number	
Title of Invention	PRODUCING ROUTING MESSAGES FOR VOICE OVER IP COMMUNICATIONS		

Citizenship under 37 CFR 1.41(b)		CA	
Mailing Address of Applicant:			
Address 1	3320 Garabaldi Drive		
Address 2			
City	North Vancouver, British Columbia	State/Province	
Postal Code	V7H 2N9	Country	CA
Applicant 4			
Applicant Authority		<input checked="" type="radio"/> Inventor	
		<input type="radio"/> Legal Representative under 35 U.S.C. 117	
		<input type="radio"/> Party of Interest under 35 U.S.C. 118	
Prefix	Given Name	Middle Name	Family Name
	Johan	Emil Victor	BJORSELL
Residence Information (Select One)			
<input type="radio"/> US Residency			
<input checked="" type="radio"/> Non US Residency			
<input type="radio"/> Active US Military Service			
City	Vancouver, British Columbia	Country Of Residence	CA
Citizenship under 37 CFR 1.41(b)		CA	
Mailing Address of Applicant:			
Address 1	P.O. Box 29164 RPO South Granville Post		
Address 2			
City	Vancouver, British Columbia	State/Province	
Postal Code	V6J 0A6	Country	CA
Applicant 5			
Applicant Authority		<input checked="" type="radio"/> Inventor	
		<input type="radio"/> Legal Representative under 35 U.S.C. 117	
		<input type="radio"/> Party of Interest under 35 U.S.C. 118	
Prefix	Given Name	Middle Name	Family Name
	Fuad		ARAFA
Residence Information (Select One)			
<input type="radio"/> US Residency			
<input checked="" type="radio"/> Non US Residency			
<input type="radio"/> Active US Military Service			
City	Vancouver, British Columbia	Country Of Residence	CA
Citizenship under 37 CFR 1.41(b)		CA	
Mailing Address of Applicant:			
Address 1	782 West 22nd Street		
Address 2			
City	Vancouver, British Columbia	State/Province	
Postal Code	V5Z 17Z	Country	CA
All Inventors Must Be Listed - Additional Inventor Information blocks may be generated within this form by selecting the Add button. <input type="button" value="Add"/>			

Correspondence Information:

Enter either Customer Number or complete the Correspondence Information section below.
For further information see 37 CFR 1.33(a).

An Address is being provided for the correspondence information of this application.

Customer Number 20995

Application Data Sheet 37 CFR 1.76	Attorney Docket Number	SMARB19.001APC
	Application Number	
Title of Invention	PRODUCING ROUTING MESSAGES FOR VOICE OVER IP COMMUNICATIONS	

Email Address	efiling@kmob.com	<input type="button" value="Add Email"/>	<input type="button" value="Remove Email"/>
---------------	------------------	--	---

Application Information:

Title of the Invention	PRODUCING ROUTING MESSAGES FOR VOICE OVER IP COMMUNICATIONS		
Attorney Docket Number	SMARB19.001APC	Small Entity Status Claimed	<input checked="" type="checkbox"/>
Application Type	Nonprovisional		
Subject Matter	Utility		
Suggested Class (if any)		Sub Class (if any)	
Suggested Technology Center (if any)			
Total Number of Drawing Sheets (if any)	32	Suggested Figure for Publication (if any)	

Publication Information:

<input type="checkbox"/>	Request Early Publication (Fee required at time of Request 37 CFR 1.219)
<input type="checkbox"/>	Request Not to Publish. I hereby request that the attached application not be published under 35 U.S.C. 122(b) and certify that the invention disclosed in the attached application has not and will not be the subject of an application filed in another country, or under a multilateral international agreement, that requires publication at eighteen months after filing.

Representative Information:

Representative information should be provided for all practitioners having a power of attorney in the application. Providing this information in the Application Data Sheet does not constitute a power of attorney in the application (see 37 CFR 1.32). Enter either Customer Number or complete the Representative Name section below. If both sections are completed the Customer Number will be used for the Representative Information during processing.

Please Select One:	<input checked="" type="radio"/> Customer Number	<input type="radio"/> US Patent Practitioner	<input type="radio"/> Limited Recognition (37 CFR 11.9)
Customer Number	20995		

Domestic Benefit/National Stage Information:

This section allows for the applicant to either claim benefit under 35 U.S.C. 119(e), 120, 121, or 365(c) or indicate National Stage entry from a PCT application. Providing this information in the application data sheet constitutes the specific reference required by 35 U.S.C. 119(e) or 120, and 37 CFR 1.78(a)(2) or CFR 1.78(a)(4), and need not otherwise be made part of the specification.

Prior Application Status	Pending	<input type="button" value="Remove"/>	
Application Number	Continuity Type	Prior Application Number	Filing Date (YYYY-MM-DD)
	a 371 of international	PCT/CA2007001956	2007-11-01
Prior Application Status	Pending	<input type="button" value="Remove"/>	
Application Number	Continuity Type	Prior Application Number	Filing Date (YYYY-MM-DD)
PCT/CA20070019656	non provisional of	60856212	2006-11-02

Application Data Sheet 37 CFR 1.76	Attorney Docket Number	SMARB19.001APC
	Application Number	
Title of Invention	PRODUCING ROUTING MESSAGES FOR VOICE OVER IP COMMUNICATIONS	

Additional Domestic Benefit/National Stage Data may be generated within this form by selecting the **Add** button.

Foreign Priority Information:

This section allows for the applicant to claim benefit of foreign priority and to identify any prior foreign application for which priority is not claimed. Providing this information in the application data sheet constitutes the claim for priority as required by 35 U.S.C. 119(b) and 37 CFR 1.55(a).

<input type="button" value="Remove"/>			
Application Number	Country	Parent Filing Date (YYYY-MM-DD)	Priority Claimed
			<input type="radio"/> Yes <input checked="" type="radio"/> No

Additional Foreign Priority Data may be generated within this form by selecting the **Add** button.

Assignee Information:

Providing this information in the application data sheet does not substitute for compliance with any requirement of part 3 of Title 37 of the CFR to have an assignment recorded in the Office.

Assignee 1

If the Assignee is an Organization check here.

Organization Name DIGIFONICA (INTERNATIONAL) LIMITED

Mailing Address Information:

Address 1 Suite 1401, 4710 Kingsway

Address 2

City Burnaby, British Columbia

State/Province

Country CA

Postal Code

V5H 4M2

Phone Number

Fax Number

Email Address

Additional Assignee Data may be generated within this form by selecting the **Add** button.

Signature:

A signature of the applicant or representative is required in accordance with 37 CFR 1.33 and 10.18. Please see 37 CFR 1.4(d) for the form of the signature.

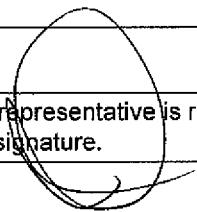
Signature				Date (YYYY-MM-DD)	2009-04-30
First Name	John	Last Name	Carson	Registration Number	34303

Under the Paperwork Reduction Act of 1995, no persons are required to respond to a collection of information unless it contains a valid OMB control number.

Application Data Sheet 37 CFR 1.76	Attorney Docket Number	SMARB19.001APC
	Application Number	
Title of Invention	PRODUCING ROUTING MESSAGES FOR VOICE OVER IP COMMUNICATIONS	

This collection of information is required by 37 CFR 1.76. The information is required to obtain or retain a benefit by the public which is to file (and by the USPTO to process) an application. Confidentiality is governed by 35 U.S.C. 122 and 37 CFR 1.14. This collection is estimated to take 23 minutes to complete, including gathering, preparing, and submitting the completed application data sheet form to the USPTO. Time will vary depending upon the individual case. Any comments on the amount of time you require to complete this form and/or suggestions for reducing this burden, should be sent to the Chief Information Officer, U.S. Patent and Trademark Office, U.S. Department of Commerce, P.O. Box 1450, Alexandria, VA 22313-1450. DO NOT SEND FEES OR COMPLETED FORMS TO THIS ADDRESS. **SEND TO: Commissioner for Patents, P.O. Box 1450, Alexandria, VA 22313-1450.**

Electronic Patent Application Fee Transmittal

Application Number:	
Filing Date:	
Title of Invention:	PRODUCING ROUTING MESSAGES FOR VOICE OVER IP COMMUNICATIONS
First Named Inventor/Applicant Name:	Clay Perreault
Filer:	John M Carson/Jadeanna Hill
Attorney Docket Number:	SMARB19.001APC

Filed as Small Entity

U.S. National Stage under 35 USC 371 Filing Fees

Description	Fee Code	Quantity	Amount	Sub-Total in USD(\$)
Basic Filing:				
Basic National Stage Fee	2631	1	165	165
Natl Stage Search Fee - all other cases	2632	1	270	270
Natl Stage Exam Fee - all other cases	2633	1	110	110

Pages:

Natl Stage Appl Sz fee per 50 pgs >100	2681	1	135	135
--	------	---	-----	-----

Claims:

Claims in excess of 20	2615	39	26	1014
------------------------	------	----	----	------

Miscellaneous-Filing:

Description	Fee Code	Quantity	Amount	Sub-Total in USD(\$)
Petition:				
Patent-Appeals-and-Interference:				
Post-Allowance-and-Post-Issuance:				
Extension-of-Time:				
Miscellaneous:				
			Total in USD (\$)	1694

Electronic Acknowledgement Receipt

EFS ID:	5255008
Application Number:	12513147
International Application Number:	PCT/CA07/01956
Confirmation Number:	9611
Title of Invention:	PRODUCING ROUTING MESSAGES FOR VOICE OVER IP COMMUNICATIONS
First Named Inventor/Applicant Name:	Clay Perreault
Customer Number:	20995
Filer:	John M Carson/angela chavez
Filer Authorized By:	John M Carson
Attorney Docket Number:	SMARB19.001APC
Receipt Date:	30-APR-2009
Filing Date:	
Time Stamp:	18:47:10
Application Type:	U.S. National Stage under 35 USC 371

Payment information:

Submitted with Payment	yes
Payment Type	Credit Card
Payment was successfully received in RAM	\$1694
RAM confirmation Number	4803
Deposit Account	111410
Authorized User	KNOBBE MARTENS OLSON AND BEAR

The Director of the USPTO is hereby authorized to charge indicated fees and credit any overpayment as follows:

Charge any Additional Fees required under 37 C.F.R. 1.492 (National application filing, search, and examination fees)

Charge any Additional Fees required under 37 C.F.R. Section 1.17 (Patent application and examination processing fees)

PETITIONER APPLE INC. FAX: 1902916

File Listing:					
Document Number	Document Description	File Name	File Size(Bytes)/ Message Digest	Multi Part /.zip	Pages (if appl.)
1		SMARB19-001APC- Preliminary_Amendment.pdf	582978 f5259e53b0c50fc2bf89db32837287935b6d88f8	yes	12
Multipart Description/PDF files in .zip description					
Document Description			Start	End	
Preliminary Amendment			1	1	
Specification			2	2	
Claims			3	11	
Applicant Arguments/Remarks Made in an Amendment			12	12	
Warnings:					
Information:					
2	Documents submitted with 371 Applications	SMARB19-001APC- PCTCA2007001956.pdf	4977460 ca3b0d5cc509a3a6f5d436cbfa9bf474b0a889b	no	138
Warnings:					
Information:					
3	Documents submitted with 371 Applications	SMARB19-001APC- Amendment_Under_Article_19 .pdf	149157 695c07806c89ceed3f7f7af3d0d9f9f72f116f005	no	5
Warnings:					
Information:					
4	Documents submitted with 371 Applications	SMARB19-001APC-ISR_WO.pdf	703721 f9277a31dd1e5e1f8593ab3faa963fa6e1f00cb5	no	12
Warnings:					
Information:					
5	Application Data Sheet	SMARB19-001APC-ADS.pdf	186377 d7d70f147eb846b0d3a6699f959ee88b23767ef4	no	5
Warnings:					
Information:					
This is not an USPTO supplied ADS fillable form					
6	Fee Worksheet (PTO-875)	fee-info.pdf	38466 7e32012046ff0ec1b57abd4e8531a559014b0e4d	no	2
Warnings:					

Information:	
Total Files Size (in bytes):	6638159
<p>This Acknowledgement Receipt evidences receipt on the noted date by the USPTO of the indicated documents, characterized by the applicant, and including page counts, where applicable. It serves as evidence of receipt similar to a Post Card, as described in MPEP 503.</p> <p><u>New Applications Under 35 U.S.C. 111</u> If a new application is being filed and the application includes the necessary components for a filing date (see 37 CFR 1.53(b)-(d) and MPEP 506), a Filing Receipt (37 CFR 1.54) will be issued in due course and the date shown on this Acknowledgement Receipt will establish the filing date of the application.</p> <p><u>National Stage of an International Application under 35 U.S.C. 371</u> If a timely submission to enter the national stage of an international application is compliant with the conditions of 35 U.S.C. 371 and other applicable requirements a Form PCT/DO/EO/903 indicating acceptance of the application as a national stage submission under 35 U.S.C. 371 will be issued in addition to the Filing Receipt, in due course.</p> <p><u>New International Application Filed with the USPTO as a Receiving Office</u> If a new international application is being filed and the international application includes the necessary components for an international filing date (see PCT Article 11 and MPEP 1810), a Notification of the International Application Number and of the International Filing Date (Form PCT/RO/105) will be issued in due course, subject to prescriptions concerning national security, and the date shown on this Acknowledgement Receipt will establish the international filing date of the application.</p>	

(19) World Intellectual Property Organization
International Bureau



(43) International Publication Date
8 May 2008 (08.05.2008)

(10) International Publication Number
WO 2008/052340 A1

(51) International Patent Classification:

H04L 12/66 (2006.01) H04M 15/00 (2006.01)
H04L 12/14 (2006.01) H04Q 3/64 (2006.01)
H04M 11/06 (2006.01)

(21) International Application Number:

PCT/CA2007/001956

(22) International Filing Date:

1 November 2007 (01.11.2007)

(25) Filing Language:

English

(26) Publication Language:

English

(30) Priority Data:

60/856,212 2 November 2006 (02.11.2006) US

(71) Applicant (for all designated States except US): **DIGIFONICA (INTERNATIONAL) LIMITED** [CA/CA]; Suite 1401, 4710 Kingsway Avenue, Burnaby, British Columbia V5H 4M2 (CA).

(72) Inventors; and

(75) Inventors/Applicants (for US only): **PERREAULT, Clay** [CA/GB]; Suite #5 Keats Avenue, London, E161TW (GB). **NICHOLSON, Steve** [CA/CA]; Suite #5 Keats Avenue, London, E161TW (CA). **THOMSON, Rod** [CA/CA]; 3320 Garabaldi Drive, North Vancouver, British Columbia V7H 2N9 (CA).

Columbia V7H 2N9 (CA). **BJORSELL, Johan Emil Victor** [SE/CA]; 273 West 5th Street, North Vancouver, British Columbia V7M 1J9 (CA). **ARAF, Fuad** [CA/CA]; 305 - 3199 Willow Street, Vancouver, British Columbia V5Z 4L5 (CA).

(74) Agents: **KNOX, John, W.** et al.; SMART & BIGGAR, Box 11560, Vancouver Centre, 650 West Georgia Street, Suite 2200, Vancouver, British Columbia V6B 4N8 (CA).

(81) Designated States (unless otherwise indicated, for every kind of national protection available): AE, AG, AL, AM, AT, AU, AZ, BA, BB, BG, BH, BR, BW, BY, BZ, CA, CH, CN, CO, CR, CU, CZ, DE, DK, DM, DO, DZ, EC, EE, EG, ES, FI, GB, GD, GE, GH, GM, GT, HN, HR, HU, ID, IL, IN, IS, JP, KE, KG, KM, KN, KP, KR, KZ, LA, LC, LK, LR, LS, LT, LU, LY, MA, MD, ME, MG, MK, MN, MW, MX, MY, MZ, NA, NG, NI, NO, NZ, OM, PG, PH, PL, PT, RO, RS, RU, SC, SD, SE, SG, SK, SL, SM, SV, SY, TJ, TM, TN, TR, TT, TZ, UA, UG, US, UZ, VC, VN, ZA, ZM, ZW.

(84) Designated States (unless otherwise indicated, for every kind of regional protection available): ARIPO (BW, GH, GM, KE, LS, MW, MZ, NA, SD, SL, SZ, TZ, UG, ZM, ZW), Eurasian (AM, AZ, BY, KG, KZ, MD, RU, TJ, TM), European (AT, BE, BG, CH, CY, CZ, DE, DK, EE, ES, FI, FR, GB, GR, HU, IE, IS, IT, LT, LU, LV, MC, MT, NL, PL,

[Continued on next page]

(54) Title: PRODUCING ROUTING MESSAGES FOR VOICE OVER IP COMMUNICATIONS

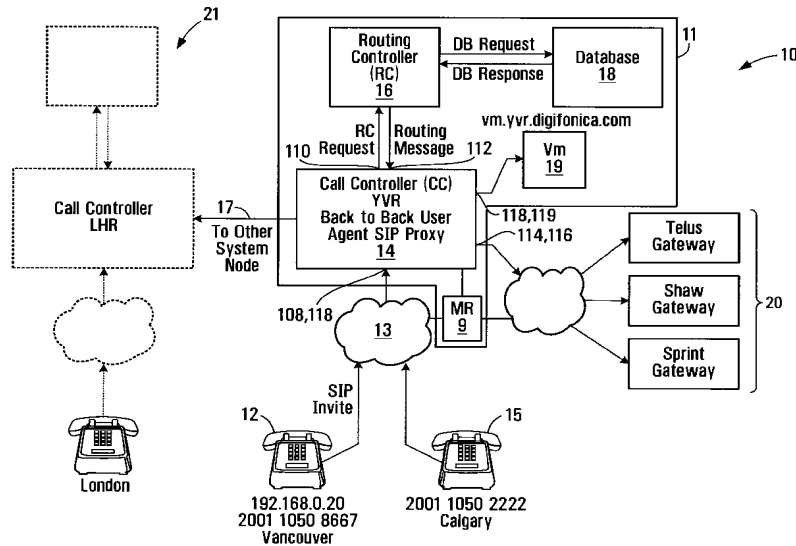

(57) Abstract: A process and apparatus to facilitate communication between callers and callees in a system comprising a plurality of nodes with which callers and callees are associated is disclosed. In response to initiation of a call by a calling subscriber, a caller identifier and a callee identifier are received. Call classification criteria associated with the caller identifier are used to classify the call as a public network call or a private network call. A routing message identifying an address, on the private network, associated with the callee is produced when the call is classified as a private network call and a routing message identifying a gateway to the public network is produced when the call is classified as a public network call.

WO 2008/052340 A1



PT, RO, SE, SI, SK, TR), OAPI (BF, BJ, CF, CG, CI, CM,
GA, GN, GQ, GW, ML, MR, NE, SN, TD, TG).

Published:

- *with international search report*
- *with amended claims*

-1-

PRODUCING ROUTING MESSAGES FOR VOICE OVER IP COMMUNICATIONS

BACKGROUND OF THE INVENTION

5 1. Field of Invention

This invention relates to voice over IP communications and methods and apparatus for routing and billing.

2. Description of Related Art

10 Internet protocol (IP) telephones are typically personal computer (PC) based telephones connected within an IP network, such as the public Internet or a private network of a large organization. These IP telephones have installed "voice-over-IP" (VoIP) software enabling them to make and receive voice calls and send and receive information in data and video formats.

15

IP telephony switches installed within the IP network enable voice calls to be made within or between IP networks, and between an IP network and a switched circuit network (SCN), such as the public switched telephone network (PSTN). If the IP switch supports the Signaling System 7 (SS7) protocol, the IP telephone can also access PSTN databases.

20

The PSTN network typically includes complex network nodes that contain all information about a local calling service area including user authentication and call routing. The PSTN network typically aggregates all information and traffic into a single location or node, processes it locally and then passes it on to other network nodes, as necessary, by maintaining route tables at the node. PSTN nodes are redundant by design and thus provide reliable service, but if a node should fail due to an earthquake or other natural disaster, significant, if not complete service outages can occur, with no other nodes being able to take up the load.

25
30

-2-

Existing VoIP systems do not allow for high availability and resiliency in delivering Voice Over IP based Session Initiation Protocol (SIP) Protocol service over a geographically dispersed area such as a city, region or continent. Most resiliency originates from the provision of IP based telephone services to one location or a small number of locations such as a single office or network of branch offices.

SUMMARY OF THE INVENTION

In accordance with one aspect of the invention, there is provided a process for operating a call routing controller to facilitate communication between callers and callees in a system comprising a plurality of nodes with which callers and callees are associated. The process involves, in response to initiation of a call by a calling subscriber, receiving a caller identifier and a callee identifier. The process also involves using call classification criteria associated with the caller identifier to classify the call as a public network call or a private network call. The process further involves producing a routing message identifying an address, on the private network, associated with the callee when the call is classified as a private network call. The process also involves producing a routing message identifying a gateway to the public network when the call is classified as a public network call.

The process may involve receiving a request to establish a call, from a call controller in communication with a caller identified by the callee identifier.

Using the call classification criteria may involve searching a database to locate a record identifying calling attributes associated with a caller identified by the caller identifier.

Locating a record may involve locating a caller dialing profile comprising a username associated with the caller, a domain associated with the caller, and at least one calling attribute.

-3-

Using the call classification criteria may involve comparing calling attributes associated with the caller dialing profile with aspects of the callee identifier.

5 Comparing may involve determining whether the callee identifier includes a portion that matches an IDD associated with the caller dialing profile.

Comparing may involve determining whether the callee identifier includes a portion that matches an NDD associated with the caller dialing profile.

10 Comparing may involve determining whether the callee identifier includes a portion that matches an area code associated with the caller dialing profile.

Comparing may involve determining whether the callee identifier has a length within a range specified in the caller dialing profile.

15

The process may involve formatting the callee identifier into a pre-defined digit format to produce a re-formatted callee identifier.

20

Formatting may involve removing an international dialing digit from the callee identifier, when the callee identifier begins with a digit matching an international dialing digit specified by the caller dialing profile associated with the caller.

25

Formatting may involve removing a national dialing digit from the callee identifier and prepending a caller country code to the callee identifier when the callee identifier begins with a national dialing digit.

30

Formatting may involve prepending a caller country code to the callee identifier when the callee identifier begins with digits identifying an area code specified by the caller dialing profile.

-4-

5 Formatting may involve prepending a caller country code and an area code to the callee identifier when the callee identifier has a length that matches a caller dialing number format specified by the caller dialing profile and only one area code is specified as being associated with the caller in the caller dialing profile.

The process may involve classifying the call as a private network call when the re-formatted callee identifier identifies a subscriber to the private network.

10 The process may involve determining whether the callee identifier complies with a pre-defined username format and if so, classifying the call as a private network call.

15 The process may involve causing a database of records to be searched to locate a direct in dial (DID) bank table record associating a public telephone number with the reformatted callee identifier and if the DID bank table record is found, classifying the call as a private network call and if a DID bank table record is not found, classifying the call as a public network call.

20 Producing the routing message identifying a node on the private network may involve setting a callee identifier in response to a username associated with the DID bank table record.

25 Producing the routing message may involve determining whether a node associated with the reformatted callee identifier is the same as a node associated the caller identifier.

30 Determining whether a node associated with the reformatted callee identifier is the same as a node associated the caller identifier may involve determining whether a prefix of the re-formatted callee identifier matches a corresponding prefix of a username associated with the caller dialing profile.

-5-

When the node associated with the caller is not the same as the node associated with the callee, the process involves producing a routing message including the caller identifier, the reformatted callee identifier and an identification of a private network node associated with the callee and communicating the routing message to a call controller.

5

When the node associated with the caller is the same as the node associated with the callee, the process involves determining whether to perform at least one of the following: forward the call to another party, block the call and direct the caller to a voicemail server associated with the callee.

10

Producing the routing message may involve producing a routing message having an identification of at least one of the callee identifier, an identification of a party to whom the call should be forwarded and an identification of a voicemail server associated with the callee.

15

The process may involve communicating the routing message to a call controller.

20

Producing a routing message identifying a gateway to the public network may involve searching a database of route records associating route identifiers with dialing codes to find a route record having a dialing code having a number pattern matching at least a portion of the reformatted callee identifier.

25

The process may involve searching a database of supplier records associating supplier identifiers with the route identifiers to locate at least one supplier record associated with the route identifier associated with the route record having a dialing code having a number pattern matching at least a portion of the reformatted callee identifier.

30

The process may involve loading a routing message buffer with the reformatted callee identifier and an identification of specific routes associated

-6-

respective ones of the supplier records associated with the route record and loading the routing message buffer with a time value and a timeout value.

5 The process may involve communicating a routing message involving the contents of the routing message buffer to a call controller.

10 The process may involve causing the dialing profile to include a maximum concurrent call value and a concurrent call count value and causing the concurrent call count value to be incremented when the user associated with the dialing profile initiates a call and causing the concurrent call count value to be decremented when a call with the user associated with the dialing profile is ended.

15 In accordance with another aspect of the invention, there is provided a call routing apparatus for facilitating communications between callers and callees in a system comprising a plurality of nodes with which callers and callees are associated. The apparatus includes receiving provisions for receiving a caller identifier and a callee identifier, in response to initiation of a call by a calling subscriber. The apparatus also includes classifying provisions for classifying
20 the call as a private network call or a public network call according to call classification criteria associated with the caller identifier. The apparatus further includes provisions for producing a routing message identifying an address, on the private network, associated with the callee when the call is classified as a private network call. The apparatus also includes provisions for
25 producing a routing message identifying a gateway to the public network when the call is classified as a public network call.

30 The receiving provisions may be operably configured to receive a request to establish a call, from a call controller in communication with a caller identified by the callee identifier.

-7-

The apparatus may further include searching provisions for searching a database including records associating calling attributes with subscribers to the private network to locate a record identifying calling attributes associated with a caller identified by the caller identifier.

5

The records may include dialing profiles each including a username associated with the subscriber, an identification of a domain associated with the subscriber, and an identification of at least one calling attribute associated with the subscriber.

10

The call classification provisions may be operably configured to compare calling attributes associated with the caller dialing profile with aspects of the callee identifier.

15

The calling attributes may include an international dialing digit and call classification provisions may be operably configured to determine whether the callee identifier includes a portion that matches an IDD associated with the caller dialing profile.

20

The calling attributes may include an national dialing digit and the call classification provisions may be operably configured to determine whether the callee identifier includes a portion that matches an NDD associated with the caller dialing profile.

25

The calling attributes may include an area code and the call classification provisions may be operably configured to determine whether the callee identifier includes a portion that matches an area code associated with the caller dialing profile.

30

The calling attribute may include a number length range and the call classification provisions may be operably configured to determine whether the

-8-

callee identifier has a length within a number length range specified in the caller dialing profile.

5 The apparatus may further include formatting provisions for formatting the callee identifier into a pre-defined digit format to produce a re-formatted callee identifier.

10 The formatting provisions may be operably configured to remove an international dialing digit from the callee identifier, when the callee identifier begins with a digit matching an international dialing digit specified by the caller dialing profile associated with the caller.

15 The formatting provisions may be operably configured to remove a national dialing digit from the callee identifier and prepend a caller country code to the callee identifier when the callee identifier begins with a national dialing digit.

20 The formatting provisions may be operably configured to prepend a caller country code to the callee identifier when the callee identifier begins with digits identifying an area code specified by the caller dialing profile.

25 The formatting provisions may be operably configured to prepend a caller country code and area code to the callee identifier when the callee identifier has a length that matches a caller dialing number format specified by the caller dialing profile and only one area code is specified as being associated with the caller in the caller dialing profile.

30 The classifying provisions may be operably configured to classify the call as a private network call when the re-formatted callee identifier identifies a subscriber to the private network.

-9-

The classifying provisions may be operably configured to classify the call as a private network call when the callee identifier complies with a pre-defined username format.

5 The apparatus may further include searching provisions for searching a database of records to locate a direct in dial (DID) bank table record associating a public telephone number with the reformatted callee identifier and the classifying provisions may be operably configured to classify the call as a private network call when the DID bank table record is found and to
10 classify the call as a public network call when a DID bank table record is not found

The private network routing message producing provisions may be operably configured to produce a routing message having a callee identifier set
15 according to a username associated with the DID bank table record.

The private network routing message producing provisions may be operably configured to determine whether a node associated with the reformatted callee identifier is the same as a node associated the caller identifier.
20

The private network routing provisions may include provisions for determining whether a prefix of the re-formatted callee identifier matches a corresponding prefix of a username associated with the caller dialing profile.

25 The private network routing message producing provisions may be operably configured to produce a routing message including the caller identifier, the reformatted callee identifier and an identification of a private network node associated with the callee and to communicate the routing message to a call controller.

30 The private network routing message producing provisions may be operably configured to perform at least one of the following forward the call to another

-10-

party, block the call and direct the caller to a voicemail server associated with the callee, when the node associated with the caller is the same as the node associated with the callee.

5 The provisions for producing the private network routing message may be operably configured to produce a routing message having an identification of at least one of the callee identifier, an identification of a party to whom the call should be forwarded and an identification of a voicemail server associated with the callee.

10

The apparatus further includes provisions for communicating the routing message to a call controller.

15 The provisions for producing a public network routing message identifying a gateway to the public network may include provisions for searching a database of route records associating route identifiers with dialing codes to find a route record having a dialing code having a number pattern matching at least a portion of the reformatted callee identifier.

20 The apparatus further includes provisions for searching a database of supplier records associating supplier identifiers with the route identifiers to locate at least one supplier record associated with the route identifier associated with the route record having a dialing code having a number pattern matching at least a portion of the reformatted callee identifier.

25

The apparatus further includes a routing message buffer and provisions for loading the routing message buffer with the reformatted callee identifier and an identification of specific routes associated respective ones of the supplier records associated with the route record and loading the routing message
30 buffer with a time value and a timeout value.

-11-

The apparatus further includes provisions for communicating a routing message including the contents of the routing message buffer to a call controller.

5 The apparatus further includes means for causing said dialing profile to include a maximum concurrent call value and a concurrent call count value and for causing said concurrent call count value to be incremented when the user associated with said dialing profile initiates a call and for causing said
10 concurrent call count value to be decremented when a call with said user associated with said dialing profile is ended.

In accordance with another aspect of the invention, there is provided a data structure for access by an apparatus for producing a routing message for use by a call routing controller in a communications system. The data structure
15 includes dialing profile records comprising fields for associating with respective subscribers to the system, a subscriber user name, direct-in-dial records comprising fields for associating with respective subscriber usernames, a user domain and a direct-in-dial number, prefix to node records comprising fields for associating with at least a portion of the respective
20 subscriber usernames, a node address of a node in the system, whereby a subscriber name can be used to find a user domain, at least a portion of the a subscriber name can be used to find a node with which the subscriber identified by the subscriber name is associated, and a user domain and subscriber name can be located in response to a direct-in-dial number.

25 In accordance with another aspect of the invention, there is provided a data structure for access by an apparatus for producing a routing message for use by a call routing controller in a communications system. The data structure includes master list records comprising fields for associating a dialing code
30 with respective master list identifiers and supplier list records linked to master list records by the master list identifiers, said supplier list records comprising fields for associating with a communications services supplier, a supplier id, a

-12-

master list id, a route identifier and a billing rate code, whereby communications services suppliers are associated with dialing codes, such that dialing codes can be used to locate suppliers capable of providing a communications link associated with a given dialing code.

5

In accordance with another aspect of the invention, there is provided a method for determining a time to permit a communication session to be conducted. The method involves calculating a cost per unit time, calculating a first time value as a sum of a free time attributed to a participant in the communication session and the quotient of a funds balance held by the participant to the cost per unit time value and producing a second time value in response to the first time value and a billing pattern associated with the participant, the billing pattern including first and second billing intervals and the second time value being the time to permit a communication session to be conducted.

10

15

Calculating the first time value may involve retrieving a record associated with the participant and obtaining from the record at least one of the free time and the funds balance.

20

Producing the second time value may involve producing a remainder value representing a portion of the second billing interval remaining after dividing the second billing interval into a difference between the first time value and the first billing interval.

25

Producing the second time value may involve setting a difference between the first time value and the remainder as the second time value.

30

The method may further involve setting the second time value to zero when the remainder is greater than zero and the first time value is less than the free time associated with the participant.

-13-

Calculating the cost per unit time may involve locating a record in a database, the record comprising a markup type indicator, a markup value and a billing pattern and setting a reseller rate equal to the sum of the markup value and the buffer rate.

5

Locating the record in a database may involve locating at least one of a record associated with a reseller and a route associated with the reseller, a record associated with the reseller and a default reseller markup record.

10

Calculating the cost per unit time value further may involve locating at least one of an override record specifying a route cost per unit time amount associated with a route associated with the communication session, a reseller record associated with a reseller of the communications session, the reseller record specifying a reseller cost per unit time associated with the reseller for the communication session, a default operator markup record specifying a default cost per unit time.

15

The method may further involve setting as the cost per unit time the sum of the reseller rate and at least one of the route cost per unit time, the reseller cost per unit time and the default cost per unit time.

20

The method may further involve receiving a communication session time representing a duration of the communication session and incrementing a reseller balance by the product of the reseller rate and the communication session time.

25

The method may further involve receiving a communication session time representing a duration of the communication session and incrementing a system operator balance by a product of the buffer rate and the communication session time.

30

-14-

In accordance with another aspect of the invention, there is provided an apparatus for determining a time to permit a communication session to be conducted. The apparatus includes a processor circuit, a computer readable medium coupled to the processor circuit and encoded with instructions for directing the processor circuit to calculate a cost per unit time for the communication session, calculate a first time value as a sum of a free time attributed to a participant in the communication session and the quotient of a funds balance held by the participant to the cost per unit time value and produce a second time value in response to the first time value and a billing pattern associated with the participant, the billing pattern including first and second billing intervals and the second time value being the time to permit a communication session to be conducted.

The instructions may include instructions for directing the processor circuit to retrieve a record associated with the participant and obtain from the record at least one of the free time and the funds balance.

The instructions may include instructions for directing the processor circuit to produce the second time value by producing a remainder value representing a portion of the second billing interval remaining after dividing the second billing interval into a difference between the first time value and the first billing interval.

The instructions may include instructions for directing the processor circuit to produce the second time value comprises setting a difference between the first time value and the remainder as the second time value.

The instructions may include instructions for directing the processor circuit to set the second time value to zero when the remainder is greater than zero and the first time value is less than the free time associated with the participant.

-15-

5 The instructions for directing the processor circuit to calculate the cost per unit time may include instructions for directing the processor circuit to locate a record in a database, the record comprising a markup type indicator, a markup value and a billing pattern and set a reseller rate equal to the sum of the markup value and the buffer rate.

10 The instructions for directing the processor circuit to locate the record in a database may include instructions for directing the processor circuit to locate at least one of a record associated with a reseller and a route associated with the reseller, a record associated with the reseller, and a default reseller markup record. The instructions for directing the processor circuit to calculate the cost per unit time value may further include instructions for directing the processor circuit to locate at least one of an override record specifying a route cost per unit time amount associated with a route associated with the communication session, a reseller record associated with a reseller of the communications session, the reseller record specifying a reseller cost per unit time associated with the reseller for the communication session, a default operator markup record specifying a default cost per unit time.

20 The instructions may include instructions for directing the processor circuit to set as the cost per unit time the sum of the reseller rate and at least one of the route cost per unit time, the reseller cost per unit time and the default cost per unit time.

25 The instructions may include instructions for directing the processor circuit to receive a communication session time representing a duration of the communication session and increment a reseller balance by the product of the reseller rate and the communication session time.

30 The instructions may include instructions for directing the processor circuit to receive a communication session time representing a duration of the

-16-

communication session and increment a system operator balance by a product of the buffer rate and the communication session time.

5 In accordance with another aspect of the invention, there is provided a process for attributing charges for communications services. The process involves determining a first chargeable time in response to a communication session time and a pre-defined billing pattern, determining a user cost value in response to the first chargeable time and a free time value associated with a user of the communications services, changing an account balance associated with the user in response to a user cost per unit time. The process may further involve changing an account balance associated with a reseller of the communications services in response to a reseller cost per unit time and the communication session time and changing an account balance associated with an operator of the communications services in response to an operator cost per unit time and the communication session time.

10

15

Determining the first chargeable time may involve locating at least one of an override record specifying a route cost per unit time and billing pattern associated with a route associated with the communication session, a reseller record associated with a reseller of the communications session, the reseller record specifying a reseller cost per unit time and billing pattern associated with the reseller for the communication session and a default record specifying a default cost per unit time and billing pattern and setting as the pre-defined billing pattern the billing pattern of the record located. The billing pattern of the record located may involve a first billing interval and a second billing interval.

20

25

Determining the first chargeable time may involve setting the first chargeable time equal to the first billing interval when the communication session time is less than or equal to the first billing interval.

30

-17-

5 Determining the first chargeable time may involve producing a remainder value representing a portion of the second billing interval remaining after dividing the second billing interval into a difference between communication session time and the first interval when the communication session time is greater than the communication session time and setting the first chargeable time to a difference between the communication session time and the remainder when the remainder is greater than zero and setting the first chargeable time to the communication session time when the remainder is not greater than zero.

10

The process may further involve determining a second chargeable time in response to the first chargeable time and the free time value associated with the user of the communications services when the first chargeable time is greater than or equal to the free time value associated with the user of the communications services.

15

Determining the second chargeable time may involve setting the second chargeable time to a difference between the first chargeable time.

20

The process may further involve resetting the free time value associated with the user to zero when the first chargeable time is greater than or equal to the free time value associated with the user of the communications services.

25

Changing an account balance associated with the user may involve calculating a user cost value in response to the second chargeable time and the user cost per unit time.

30

The process may further involve changing a user free cost balance in response to the user cost value.

The process may further involve setting the user cost to zero when the first chargeable time is less than the free time value associated with the user.

-18-

The process may further involve changing a user free time balance in response to the first chargeable time.

5 In accordance with another aspect of the invention, there is provided an apparatus for attributing charges for communications services. The apparatus includes a processor circuit, a computer readable medium in communication with the processor circuit and encoded with instructions for directing the processor circuit to determine a first chargeable time in response to a
10 communication session time and a pre-defined billing pattern, determine a user cost value in response to the first chargeable time and a free time value associated with a user of the communications services, change an account balance associated with the user in response to a user cost per unit time.

15 The instructions may further include instructions for changing an account balance associated with a reseller of the communications services in response to a reseller cost per unit time and the communication session time and changing an account balance associated with an operator of the communications services in response to an operator cost per unit time and
20 the communication session time.

The instructions for directing the processor circuit to determine the first chargeable time may further include instructions for causing the processor circuit to communicate with a database to locate at least one of an override
25 record specifying a route cost per unit time and billing pattern associated with a route associated with the communication session, a reseller record associated with a reseller of the communications session, the reseller record specifying a reseller cost per unit time and billing pattern associated with the reseller for the communication session and a default record specifying a
30 default cost per unit time and billing pattern and instructions for setting as the pre-defined billing pattern the billing pattern of the record located. The billing

-19-

pattern of the record located may include a first billing interval and a second billing interval.

5 The instructions for causing the processor circuit to determine the first chargeable time may include instructions for directing the processor circuit to set the first chargeable time equal to the first billing interval when the communication session time is less than or equal to the first billing interval.

10 The instructions for causing the processor circuit to determine the first chargeable time may include instructions for producing a remainder value representing a portion of the second billing interval remaining after dividing the second billing interval into a difference between communication session time and the first interval when the communication session time is greater than the communication session time and instructions for causing the
15 processor circuit to set the first chargeable time to a difference between the communication session time and the remainder when the remainder is greater than zero and instructions for causing the processor circuit to set the first chargeable time to the communication session time when the remainder is not greater than zero.

20 The instructions may further include instructions for causing the processor circuit to determine a second chargeable time in response to the first chargeable time and the free time value associated with the user of the communications services when the first chargeable time is greater than or
25 equal to the free time value associated with the user of the communications services.

The instructions for causing the processor circuit to determine the second chargeable time may include instructions for causing the processor circuit to
30 set the second chargeable time to a difference between the first chargeable time.

-20-

The instructions may further include instructions for causing the processor circuit to reset the free time value associated with the user to zero when the first chargeable time is greater than or equal to the free time value associated with the user of the communications services.

5

The instructions for causing the processor circuit to change an account balance associated with the user may include instructions for causing the processor circuit to calculate a user cost value in response to the second chargeable time and the user cost per unit time.

10

The instructions may further include instructions for causing the processor circuit to change a user free cost balance in response to the user cost value.

15

The instructions may further include instructions for causing the processor circuit to set the user cost to zero when the first chargeable time is less than the free time value associated with the user.

20

The instructions may further include instructions for causing the processor circuit to change a user free time balance in response to the first chargeable time.

25

In accordance with another aspect of the invention, there is provided a computer readable medium encoded with codes for directing a processor circuit to execute one or more of the methods described above and/or variants thereof.

30

Other aspects and features of the present invention will become apparent to those ordinarily skilled in the art upon review of the following description of specific embodiments of the invention in conjunction with the accompanying figures.

-21-

BRIEF DESCRIPTION OF THE DRAWINGS

In drawings which illustrate embodiments of the invention,

- 5 **Figure 1** is a block diagram of a system according to a first embodiment of the invention;
- Figure 2** is a block diagram of a caller telephone according to the first embodiment of the invention;
- 10 **Figure 3** is a schematic representation of a SIP invite message transmitted between the caller telephone and a controller shown in **Figure 1**;
- Figure 4** is a block diagram of a call controller shown in **Figure 1**;
- 15 **Figure 5** is a flowchart of a process executed by the call controller shown in **Figure 1**;
- Figure 6** is a schematic representation of a routing, billing and rating (RC) request message produced by the call controller shown in **Figure 1**;
- 20 **Figure 7** is a block diagram of a processor circuit of a routing, billing, rating element of the system shown in **Figure 1**;
- 25 **Figures 8A-8D** is a flowchart of a RC request message handler executed by the RC processor circuit shown in **Figure 7**;
- Figure 9** is a tabular representation of a dialing profile stored in a database accessible by the RC shown in **Figure 1**;
- 30 **Figure 10** is a tabular representation of a dialing profile for a caller using the caller telephone shown in **Figure 1**;

-22-

- Figure 11 is a tabular representation of a callee profile for a callee located in Calgary;
- 5 Figure 12 is a tabular representation of a callee profile for a callee located in London;
- Figure 13 is a tabular representation of a Direct-in-Dial (DID) bank table record stored in the database shown in Figure 1;
- 10 Figure 14 is a tabular representation of an exemplary DID bank table record for the Calgary callee referenced in Figure 11;
- Figure 15 is a tabular representation of a routing message transmitted from the RC to the call controller shown in Figure 1;
- 15 Figure 16 is a schematic representation of a routing message buffer holding a routing message for routing a call to the Calgary callee referenced in Figure 11;
- 20 Figure 17 is a tabular representation of a prefix to supernode table record stored in the database shown in Figure 1;
- Figure 18 is a tabular representation of a prefix to supernode table record that would be used for the Calgary callee referenced in Figure 11;
- 25 Figure 19 is a tabular representation of a master list record stored in a master list table in the database shown in Figure 1;
- 30 Figure 20 is a tabular representation of a populated master list record;

-23-

- Figure 21 is a tabular representation of a suppliers list record stored in the database shown in Figure 1;
- 5 Figure 22 is a tabular representation of a specific supplier list record for a first supplier;
- Figure 23 is a tabular representation of a specific supplier list record for a second supplier;
- 10 Figure 24 is a tabular representation of a specific supplier list record for a third supplier;
- Figure 25 is a schematic representation of a routing message, held in a routing message buffer, identifying to the controller a plurality of possible suppliers that may carry the call;
- 15 Figure 26 is a tabular representation of a call block table record;
- Figure 27 is a tabular representation of a call block table record for the Calgary callee;
- 20 Figure 28 is a tabular representation of a call forwarding table record;
- Figure 29 is a tabular representation of a call forwarding table record specific for the Calgary callee;
- 25 Figure 30 is a tabular representation of a voicemail table record specifying voicemail parameters to enable the caller to leave a voicemail message for the callee;
- 30 Figure 31 is a tabular representation of a voicemail table record specific to the Calgary callee;

Figure 32 is a schematic representation of an exemplary routing message, held in a routing message buffer, indicating call forwarding numbers and a voicemail server identifier;

5

Figures 33A and 33B are respective portions of a flowchart of a process executed by the RC processor for determining a time to live value;

Figure 34 is a tabular representation of a subscriber bundle table record;

10

Figure 35 is a tabular representation of a subscriber bundle record for the Vancouver caller;

Figure 36 is a tabular representation of a bundle override table record;

15

Figure 37 is a tabular representation of bundle override record for a located master list ID;

Figure 38 is a tabular representation of a subscriber account table record;

20

Figure 39 is a tabular representation of a subscriber account record for the Vancouver caller;

Figure 40 is a flowchart of a process for producing a second time value executed by the RC processor circuit shown in Figure 7;

25

Figure 41 is a flowchart for calculating a call cost per unit time;

Figure 42 is a tabular representation of a system operator special rates table record;

30

-25-

Figure 43 is a tabular representation of a system operator special rates table record for a reseller named Klondike;

5 Figure 44 is a tabular representation of a system operator mark-up table record;

Figure 45 is a tabular representation of a system operator mark-up table record for the reseller Klondike;

10 Figure 46 is a tabular representation of a default system operator mark-up table record;

Figure 47 is a tabular representation of a reseller special destinations table record;

15

Figure 48 is a tabular representation of a reseller special destinations table record for the reseller Klondike;

Figure 49 is a tabular representation of a reseller global mark-up table record;

20

Figure 50 is a tabular representation of a reseller global mark-up table record for the reseller Klondike;

25 Figure 51 is a tabular representation of a SIP bye message transmitted from either of the telephones shown in Figure 1 to the call controller;

Figure 52 is a tabular representation of a SIP bye message sent to the controller from the Calgary callee;

30

-26-

Figure 53 is a flowchart of a process executed by the call controller for producing a RC stop message in response to receipt of a SIP bye message;

5 Figure 54 is a tabular representation of an exemplary RC call stop message;

Figure 55 is a tabular representation of an RC call stop message for the Calgary callee;

10 Figures 56A and 56B are respective portions of a flowchart of a RC call stop message handling routine executed by the RC shown in Figure 1;

Figure 57 is a tabular representation of a reseller accounts table record;

15

Figure 58 is a tabular representation of a reseller accounts table record for the reseller Klondike;

Figure 59 is a tabular representation of a system operator accounts table record; and

20

Figure 60 is a tabular representation of a system operator accounts record for the system operator described herein.

25 **DETAILED DESCRIPTION**

Referring to Figure 1, a system for making voice over IP telephone/videophone calls is shown generally at 10. The system includes a first super node shown generally at 11 and a second super node shown generally at 21. The first super node 11 is located in geographical area, such as Vancouver, B.C., Canada for example and the second super node 21 is located in London, England, for example. Different super nodes may be located in different geographical regions throughout the world to provide

30

-27-

telephone/videophone service to subscribers in respective regions. These super nodes may be in communication with each other by high speed/ high data throughput links including optical fiber, satellite and/or cable links, forming a backbone to the system. These super nodes may alternatively or, in addition, be in communication with each other through conventional internet services.

In the embodiment shown, the Vancouver supernode **11** provides telephone/videophone service to western Canadian customers from Vancouver Island to Ontario. Another node (not shown) may be located in Eastern Canada to provide services to subscribers in that area.

Other nodes of the type shown may also be employed within the geographical area serviced by a supernode, to provide for call load sharing, for example within a region of the geographical area serviced by the supernode. However, in general, all nodes are similar and have the properties described below in connection with the Vancouver supernode **11**.

In this embodiment, the Vancouver supernode includes a call controller (C) **14**, a routing controller (RC) **16**, a database **18** and a voicemail server **19** and a media relay **9**. Each of these may be implemented as separate modules on a common computer system or by separate computers, for example. The voicemail server **19** need not be included in the node and can be provided by an outside service provider.

Subscribers such as a subscriber in Vancouver and a subscriber in Calgary communicate with the Vancouver supernode using their own internet service providers which route internet traffic from these subscribers over the internet shown generally at **13** in Figure 1. To these subscribers the Vancouver supernode is accessible at a pre-determined internet protocol (IP) address or a fully qualified domain name that can be accessed in the usual way through a subscriber's internet service provider. The subscriber in Vancouver uses a

-28-

telephone **12** that is capable of communicating with the Vancouver supernode **11** using Session Initiation Protocol (SIP) messages and the Calgary subscriber uses a similar telephone **15**, in Calgary AB.

5 It should be noted that throughout the description of the embodiments of this invention, the IP/UDP addresses of all elements such as the caller and callee telephones, call controller, media relay, and any others, will be assumed to be valid IP/UDP addresses directly accessible via the Internet or a private IP network, for example, depending on the specific implementation of the
10 system. As such, it will be assumed, for example, that the caller and callee telephones will have IP/UDP addresses directly accessible by the call controllers and the media relays on their respective supernodes, and those addresses will not be obscured by Network Address Translation (NAT) or similar mechanisms. In other words, the IP/UDP information contained in SIP
15 messages (for example the SIP Invite message or the RC Request message which will be described below) will match the IP/UDP addresses of the IP packets carrying these SIP messages.

20 It will be appreciated that in many situations, the IP addresses assigned to various elements of the system may be in a private IP address space, and thus not directly accessible from other elements. Furthermore, it will also be appreciated that NAT is commonly used to share a "public" IP address between multiple devices, for example between home PCs and IP telephones sharing a single Internet connection. For example, a home PC may be
25 assigned an IP address such as **192.168.0.101** and a Voice over IP telephone may be assigned an IP address of **192.168.0.103**. These addresses are located in so called "non-routable" (IP) address space and cannot be accessed directly from the Internet. In order for these devices to communicate with other computers located on the Internet, these IP addresses have to be
30 converted into a "public" IP address, for example **24.10.10.123** assigned by the Internet Service Provider to the subscriber, by a device performing NAT, typically a home router. In addition to translating the IP addresses, NAT

-29-

typically also translates UDP port numbers, for example an audio path originating at a VoIP telephone and using a UDP port **12378** at its private IP address, may have be translated to a UDP port **23465** associated with the public IP address of the NAT device. In other words, when a packet
5 originating from the above VoIP telephone arrives at an Internet-based supernode, the source IP/UDP address contained in the IP packet header will be **24.10.10.1:23465**, whereas the source IP/UDP address information contained in the SIP message inside this IP packet will be **192.168.0.103:12378**. The mismatch in the IP/UDP addresses may cause a
10 problem for SIP-based VoIP systems because, for example, a supernode will attempt to send messages to a private address of a telephone but the messages will never get there.

Referring to Figure 1, in an attempt to make a call by the Vancouver telephone/videophone **12** to the Calgary telephone/videophone **15**, the Vancouver telephone/videophone sends a SIP invite message to the Vancouver supernode **11** and in response, the call controller **14** sends an RC request message to the RC **16** which makes various enquiries of the database **18** to produce a routing message which is sent back to the call
15 controller **14**. The call controller **14** then communicates with the media relay **9** to cause a communications link including an audio path and a videophone (if a videopath call) to be established through the media relay to the same node, a different node or to a communications supplier gateway as shown generally
20 at **20** to carry audio, and where applicable, video traffic to the call recipient or callee.
25

Generally, the RC **16** executes a process to facilitate communication between callers and callees. The process involves, in response to initiation of a call by a calling subscriber, receiving a callee identifier from the calling subscriber,
30 using call classification criteria associated with the calling subscriber to classify the call as a public network call or a private network call and producing a routing message identifying an address on the private network,

-30-

associated with the callee when the call is classified as a private network call and producing a routing message identifying a gateway to the public network when the call is classified as a public network call.

5 Subscriber Telephone

In greater detail, referring to Figure 2, in this embodiment, the telephone/videophone 12 includes a processor circuit shown generally at 30 comprising a microprocessor 32, program memory 34, an input/output (I/O) port 36, parameter memory 38 and temporary memory 40. The program memory 34, I/O port 36, parameter memory 38 and temporary memory 40 are all in communication with the microprocessor 32. The I/O port 36 has a dial input 42 for receiving a dialled telephone/videophone number from a keypad, for example, or from a voice recognition unit or from pre-stored telephone/videophone numbers stored in the parameter memory 38, for example. For simplicity, in Figure 2 a box labelled dialing functions 44 represents any device capable of informing the microprocessor 32 of a callee identifier, e.g., a callee telephone/videophone number.

The processor 32 stores the callee identifier in a dialled number buffer 45. In this case, assume the dialled number is 2001 1050 2222 and that it is a number associated with the Calgary subscriber. The I/O port 36 also has a handset interface 46 for receiving and producing signals from and to a handset that the user may place to his ear. This interface 46 may include a BLUETOOTH™ wireless interface, a wired interface or speaker phone, for example. The handset acts as a termination point for an audio path (not shown) which will be appreciated later. The I/O port 36 also has an internet connection 48 which is preferably a high speed internet connection and is operable to connect the telephone/videophone to an internet service provider. The internet connection 48 also acts as a part of the voice path, as will be appreciated later. It will be appreciated that where the subscriber device is a videophone, a separate video path is established in the same way an audio path is established. For simplicity, the following description refers to a

-31-

telephone call, but it is to be understood that a videophone call is handled similarly, with the call controller causing the media relay to facilitate both an audio path and a video path instead of only an audio path.

5 The parameter memory **38** has a username field **50**, a password field **52** an IP address field **53** and a SIP proxy address field **54**, for example. The user name field **50** is operable to hold a user name, which in this case is **2001 1050 8667**. The user name is assigned upon subscription or registration into the system and, in this embodiment, includes a twelve digit number having a
10 continent code **61**, a country code **63**, a dealer code **70** and a unique number code **74**. The continent code **61** is comprised of the first or left-most digit of the user name in this embodiment. The country code **63** is comprised of the next three digits. The dealer code **70** is comprised of the next four digits and the unique number code **74** is comprised of the last four digits. The password
15 field **52** holds a password of up to **512** characters, in this example. The IP address field **53** stores an IP address of the telephone, which for this explanation is **192.168.0.20**. The SIP proxy address field **54** holds an IP protocol compatible proxy address which may be provided to the telephone through the internet connection **48** as part of a registration procedure.

20

The program memory **34** stores blocks of codes for directing the processor **32** to carry out the functions of the telephone, one of which includes a firewall block **56** which provides firewall functions to the telephone, to prevent access by unauthorized persons to the microprocessor **32** and memories **34**, **38** and
25 **40** through the internet connection **48**. The program memory **34** also stores codes **57** for establishing a call ID. The call ID codes **57** direct the processor **32** to produce a call identifier having a format comprising a hexadecimal string at an IP address, the IP address being the IP address of the telephone. Thus, an exemplary call identifier might be **FF10@192.168.0.20**.

30

Generally, in response to picking up the handset interface **46** and activating a dialing function **44**, the microprocessor **32** produces and sends a SIP invite

-32-

message as shown in Figure 3, to the routing controller 16 shown in Figure 1. This SIP invite message is essentially to initiate a call by a calling subscriber.

5 Referring to Figure 3, the SIP invite message includes a caller ID field 60, a
callee identifier field 62, a digest parameters field 64, a call ID field 65 an IP
address field 67 and a caller UDP port field 69. In this embodiment, the caller
ID field 60 includes the user name 2001 1050 8667 that is the Vancouver user
name stored in the user name field 50 of the parameter memory 38 in the
telephone 12 shown in Figure 2. In addition, referring back to Figure 3, the
10 callee identifier field 62 includes a callee identifier which in this embodiment is
the user name 2001 1050 2222 that is the dialled number of the Calgary
subscriber stored in the dialled number buffer 45 shown in Figure 2. The
digest parameters field 64 includes digest parameters and the call ID field 65
includes a code comprising a generated prefix code (FF10) and a suffix which
15 is the Internet Protocol (IP) address of the telephone 12 stored in the IP
address field 53 of the telephone. The IP address field 67 holds the IP
address assigned to the telephone, in this embodiment 192.168.0.20, and the
caller UDP port field 69 includes a UDP port identifier identifying a UDP port
at which the audio path will be terminated at the caller's telephone.

Call Controller

20 Referring to Figure 4, a call controller circuit of the call controller 14 (Figure 1)
is shown in greater detail at 100. The call controller circuit 100 includes a
microprocessor 102, program memory 104 and an I/O port 106. The circuit
25 100 may include a plurality of microprocessors, a plurality of program
memories and a plurality of I/O ports to be able to handle a large volume of
calls. However, for simplicity, the call controller circuit 100 will be described as
having only one microprocessor 102, program memory 104 and I/O port 106,
it being understood that there may be more.

30 Generally, the I/O port 106 includes an input 108 for receiving messages such
as the SIP invite message shown in Figure 3, from the telephone shown in

-33-

Figure 2. The I/O port **106** also has an RC request message output **110** for transmitting an RC request message to the RC **16** of Figure 1, an RC message input **112** for receiving routing messages from the RC **16**, a gateway output **114** for transmitting messages to one of the gateways **20** shown in Figure 1 to advise the gateway to establish an audio path, for example, and a gateway input **116** for receiving messages from the gateway. The I/O port **106** further includes a SIP output **118** for transmitting messages to the telephone **12** to advise the telephone of the IP addresses of the gateways which will establish the audio path. The I/O port **106** further includes a voicemail server input and output **117**, **119** respectively for communicating with the voicemail server **19** shown in Figure 1.

While certain inputs and outputs have been shown as separate, it will be appreciated that some may be a single IP address and IP port. For example, the messages sent to the RC **16** and received from the RC **16** may be transmitted and received on the same single IP port.

The program memory **104** includes blocks of code for directing the microprocessor **102** to carry out various functions of the call controller **14**. For example, these blocks of code include a first block **120** for causing the call controller circuit **100** to execute a SIP invite to RC request process to produce an RC request message in response to a received SIP invite message. In addition, there is a routing message to gateway message block **122** which causes the call controller circuit **100** to produce a gateway query message in response to a received routing message from the RC **16**.

Referring to Figure 5, the SIP invite to RC request process is shown in more detail at **120**. On receipt of a SIP invite message of the type shown in Figure 3, block **122** of Figure 5 directs the call controller circuit **100** of Figure 4 to authenticate the user. This may be done, for example, by prompting the user for a password, by sending a message back to the telephone **12** which is interpreted at the telephone as a request for a password entry or the

-34-

password may automatically be sent to the call controller **14** from the telephone, in response to the message. The call controller **14** may then make enquiries of databases to which it has access, to determine whether or not the user's password matches a password stored in the database. Various
5 functions may be used to pass encryption keys or hash codes back and forth to ensure that the transmittal of passwords is secure.

Should the authentication process fail, the call controller circuit **100** is directed to an error handling routine **124** which causes messages to be displayed at
10 the telephone **12** to indicate there was an authentication problem. If the authentication procedure is passed, block **121** directs the call controller circuit **100** to determine whether or not the contents of the caller ID field **60** of the SIP invite message received from the telephone is an IP address. If it is an IP address, then block **123** directs the call controller circuit **100** to set the
15 contents of a type field variable maintained by the microprocessor **102** to a code representing that the call type is a third party invite. If at block **121** the caller ID field contents do not identify an IP address, then block **125** directs the microprocessor to set the contents of the type field to a code indicating that the call is being made by a system subscriber. Then, block **126** directs
20 the call controller circuit to read the call identifier **65** provided in the SIP invite message from the telephone **12**, and at block **128** the processor is directed to produce an RC request message that includes that call ID. Block **129** then directs the call controller circuit **100** to send the RC request to the RC **16**.

Referring to Figure **6**, an RC request message is shown generally at **150** and includes a caller field **152**, a callee field **154**, a digest field **156**, a call ID field **158** and a type field **160**. The caller, callee, digest call ID fields **152**, **154**, **156** and **158** contain copies of the caller, callee, digest parameters and call ID
25 fields **60**, **62**, **64** and **65** of the SIP invite message shown in Figure **3**. The type field **160** contains the type code established at blocks **123** or **125** of
30 Figure **5** to indicate whether the call is from a third party or system subscriber,

-35-

respectively. The caller identifier field may include a PSTN number or a system subscriber username as shown, for example.

Routing Controller (RC)

5 Referring to Figure 7, the RC **16** is shown in greater detail and includes an RC processor circuit shown generally at **200**. The RC processor circuit **200** includes a processor **202**, program memory **204**, a table memory **206**, buffer memory **207**, and an I/O port **208**, all in communication with the processor **202**. (As earlier indicated, there may be a plurality of processor circuits (**202**),
10 memories (**204**), etc.)

The buffer memory **207** includes a caller id buffer **209** and a callee id buffer **211**.

15 The I/O port **208** includes a database request port **210** through which a request to the database (**18** shown in Figure 1) can be made and includes a database response port **212** for receiving a reply from the database **18**. The I/O port **208** further includes an RC request message input **214** for receiving the RC request message from the call controller (**14** shown in Figure 1) and
20 includes a routing message output **216** for sending a routing message back to the call controller **14**. The I/O port **208** thus acts to receive caller identifier and a callee identifier contained in the RC request message from the call controller, the RC request message being received in response to initiation of a call by a calling subscriber.

25 The program memory **204** includes blocks of codes for directing the processor **202** to carry out various functions of the RC (**16**). One of these blocks includes an RC request message handler **250** which directs the RC to produce a routing message in response to a received RC request message.
30 The RC request message handler process is shown in greater detail at **250** in Figures **8A** through **8D**.

-36-

RC Request Message Handler

Referring to Figure 8A, the RC request message handler begins with a first block 252 that directs the RC processor circuit (200) to store the contents of the RC request message (150) in buffers in the buffer memory 207 of Figure 7, one of which includes the caller ID buffer 209 of Figure 7 for separately storing the contents of the callee field 154 of the RC request message. Block 254 then directs the RC processor circuit to use the contents of the caller field 152 in the RC request message shown in Figure 6, to locate and retrieve from the database 18 a record associating calling attributes with the calling subscriber. The located record may be referred to as a dialing profile for the caller. The retrieved dialing profile may then be stored in the buffer memory 207, for example.

Referring to Figure 9, an exemplary data structure for a dialing profile is shown generally at 253 and includes a user name field 258, a domain field 260, and calling attributes comprising a national dialing digits (NDD) field 262, an international dialing digits (IDD) field 264, a country code field 266, a local area codes field 267, a caller minimum local length field 268, a caller maximum local length field 270, a reseller field 273, a maximum number of concurrent calls field 275 and a current number of concurrent calls field 277. Effectively the dialing profile is a record identifying calling attributes of the caller identified by the caller identifier. More generally, dialing profiles represent calling attributes of respective subscribers.

An exemplary caller profile for the Vancouver subscriber is shown generally at 276 in Figure 10 and indicates that the user name field 258 includes the user name (2001 1050 8667) that has been assigned to the subscriber and is stored in the user name field 50 in the telephone as shown in Figure 2.

Referring back to Figure 10, the domain field 260 includes a domain name as shown at 282, including a node type identifier 284, a location code identifier 286, a system provider identifier 288 and a domain portion 290. The domain

-37-

field **260** effectively identifies a domain or node associated with the user identified by the contents of the user name field **258**.

5 In this embodiment, the node type identifier **284** includes the code "sp" identifying a supernode and the location identifier **286** identifies the supernode as being in Vancouver (YVR). The system provider identifier **288** identifies the company supplying the service and the domain portion **290** identifies the "com" domain.

10 The national dialled digit field **262** in this embodiment includes the digit "1" and, in general, includes a number specified by the International Telecommunications Union (ITU) Telecommunications Standardization Sector (ITU-T) E. **164** Recommendation which assigns national dialing digits to countries.

15 The international dialing digit field **264** includes a code also assigned according to the ITU-T according to the country or location of the user.

20 The country code field **266** also includes the digit "1" and, in general, includes a number assigned according to the ITU-T to represent the country in which the user is located.

25 The local area codes field **267** includes a list of area codes that have been assigned by the ITU-T to the geographical area in which the subscriber is located. The caller minimum and maximum local number length fields **268** and **270** hold numbers representing minimum and maximum local number lengths permitted in the area code(s) specified by the contents of the local area codes field **267**. The reseller field **273** is optional and holds a code identifying a retailer of the services, in this embodiment "Klondike". The maximum number of concurrent calls field **275** holds a code identifying the maximum number of
30 concurrent calls that the user is entitled to cause to concurrently exist. This permits more than one call to occur concurrently while all calls for the user are

-38-

billed to the same account. The current number of concurrent calls field **277** is initially **0** and is incremented each time a concurrent call associated with the user is initiated and is decremented when a concurrent call is terminated.

5 The area codes associated with the user are the area codes associated with the location code identifier **286** of the contents of the domain field **260**.

A dialing profile of the type shown in Figure **9** is produced whenever a user registers with the system or agrees to become a subscriber to the system.
10 Thus, for example, a user wishing to subscribe to the system may contact an office maintained by a system operator and personnel in the office may ask the user certain questions about his location and service preferences, whereupon tables can be used to provide office personnel with appropriate information to be entered into the user name **258**, domain **260**, NDD **262**, IDD
15 **264**, country code **266**, local area codes **267**, caller minimum and maximum local length fields **268** and **270** reseller field **273** and concurrent call fields **275** and **277** to establish a dialing profile for the user.

Referring to Figures **11** and **12**, callee dialing profiles for users in Calgary and
20 London, respectively for example, are shown.

In addition to creating dialing profiles when a user registers with the system, a direct-in-dial (DID) record of the type shown at **278** in Figure **13** is added to a direct-in-dial bank table in the database (**18** in Figure **1**) to associate the
25 username and a host name of the supernode with which the user is associated, with an E.**164** number associated with the user on the PSTN network.

An exemplary DID table record entry for the Calgary callee is shown generally
30 at **300** in Figure **14**. The user name field **281** and user domain field **272** are analogous to the user name and user domain fields **258** and **260** of the caller dialing profile shown in Figure **10**. The contents of the DID field **274** include a

-39-

5 E.164 public telephone number including a country code **283**, an area code **285**, an exchange code **287** and a number **289**. If the user has multiple telephone numbers, then multiple records of the type shown at **300** would be included in the DID bank table, each having the same user name and user domain, but different DID field **274** contents reflecting the different telephone numbers associated with that user.

10 In addition to creating dialing profiles as shown in Figure **9** and DID records as shown in Figure **13** when a user registers with the system, call blocking records of the type shown in Figure **26**, call forwarding records of the type shown in Figure **28** and voicemail records of the type shown in Figure **30** may be added to the database **18** when a new subscriber is added to the system.

15 Referring back to Figure **8A**, after retrieving a dialing profile for the caller, such as shown at **276** in Figure **10**, the RC processor circuit **200** is directed to block **256** which directs the processor circuit (**200**) to determine whether the contents of the concurrent call field **277** are less than the contents of the maximum concurrent call field **275** of the dialing profile for the caller and, if so, block **271** directs the processor circuit to increment the contents of the concurrent call field **277**. If the contents of concurrent call field **277** are equal to or greater than the contents of the maximum concurrent call field **275**, block **259** directs the processor circuit **200** to send an error message back to the call controller (**14**) to cause the call controller to notify the caller that the maximum number of concurrent calls has been reached and no further calls can exist concurrently, including the presently requested call.

20 Assuming block **256** allows the call to proceed, the RC processor circuit **200** is directed to perform certain checks on the callee identifier provided by the contents of the callee field **154** in Figure **6**, of the RC request message **150**.
30 These checks are shown in greater detail in Figure **8B**.

-40-

Referring to Figure 8B, the processor (202 in Figure 7) is directed to a first block 257 that causes it to determine whether a digit pattern of the callee identifier (154) provided in the RC request message (150) includes a pattern that matches the contents of the international dialing digits (IDD) field 264 in the caller profile shown in Figure 10. If so, then block 259 directs the processor (202) to set a call type code identifier variable maintained by the processor to indicate that the call is an international call and block 261 directs the processor to produce a reformatted callee identifier by reformatting the callee identifier into a predefined digit format. In this embodiment, this is done by removing the pattern of digits matching the IDD field contents 264 of the caller dialing profile to effectively shorten the callee identifier. Then, block 263 directs the processor 202 to determine whether or not the callee identifier has a length which meets criteria establishing it as a number compliant with the E.164 Standard set by the ITU. If the length does not meet this criteria, block 265 directs the processor 202 to send back to the call controller (14) a message indicating the length is not correct. The process is then ended. At the call controller 14, routines (not shown) stored in the program memory 104 may direct the processor (102 of Figure 4) to respond to the incorrect length message by transmitting a message back to the telephone (12 shown in Figure 1) to indicate that an invalid number has been dialled.

Still referring to Figure 8B, if the length of the amended callee identifier meets the criteria set forth at block 263, block 269 directs the processor (202 of Figure 7) to make a database request to determine whether or not the amended callee identifier is found in a record in the direct-in-dial bank (DID) table. Referring back to Figure 8B, at block 269, if the processor 202 receives a response from the database indicating that the reformatted callee identifier produced at block 261 is found in a record in the DID bank table, then the callee is a subscriber to the system and the call is classified as a private network call by directing the processor to block 279 which directs the processor to copy the contents of the corresponding user name field (281 in Figure 14) from the callee DID bank table record (300 in Figure 14) into the

-41-

callee ID buffer (**211** in Figure 7). Thus, the processor **202** locates a subscriber user name associated with the reformatted callee identifier. The processor **202** is then directed to point B in Figure 8A.

5 Subscriber to Subscriber Calls Between Different Nodes

Referring to Figure 8A, block **280** directs the processor (**202** of Figure 7) to execute a process to determine whether or not the node associated with the reformatted callee identifier is the same node that is associated with the caller identifier. To do this, the processor **202** determines whether or not a prefix (e.g., continent code **61**) of the callee name held in the callee ID buffer (**211** in Figure 7), is the same as the corresponding prefix of the caller name held in the username field **258** of the caller dialing profile shown in Figure 10. If the corresponding prefixes are not the same, block **302** in Figure 8A directs the processor (**202** in Figure 7) to set a call type flag in the buffer memory (**207** in Figure 7) to indicate the call is a cross-domain call. Then, block **350** of Figure 8A directs the processor (**202** of Figure 7) to produce a routing message identifying an address on the private network with which the callee identified by the contents of the callee ID buffer is associated and to set a time to live for the call at a maximum value of **99999**, for example.

20

Thus the routing message includes a caller identifier, a call identifier set according to a username associated with the located DID bank table record and includes an identifier of a node on the private network with which the callee is associated.

25

The node in the system with which the callee is associated is determined by using the callee identifier to address a supernode table having records of the type as shown at **370** in Figure 17. Each record **370** has a prefix field **372** and a supernode address field **374**. The prefix field **372** includes the first n digits of the callee identifier. In this embodiment n=2. The supernode address field **374** holds a code representing the IP address or a fully qualified domain name of the node associated with the code stored in the callee identifier prefix field

30

-42-

372. Referring to Figure 18, for example, if the prefix is **20**, the supernode address associated with that prefix is sp.yvr.digifonica.com.

5 Referring to Figure 15, a generic routing message is shown generally at **352** and includes an optional supplier prefix field **354**, and optional delimiter field **356**, a callee user name field **358**, at least one route field **360**, a time to live field **362** and other fields **364**. The optional supplier prefix field **354** holds a code for identifying supplier traffic. The optional delimiter field **356** holds a symbol that delimits the supplier prefix code from the callee user name field
10 **358**. In this embodiment, the symbol is a number sign (#). The route field **360** holds a domain name or IP address of a gateway or node that is to carry the call, and the time to live field **362** holds a value representing the number of seconds the call is permitted to be active, based on subscriber available minutes and other billing parameters.

15 Referring to Figure 8A and Figure 16, an example of a routing message produced by the processor at block **350** for a caller associated with a different node than the caller is shown generally at **366** and includes only a callee field **359**, a route field **361** and a time to live field **362**.

20 Referring to Figure 8A, having produced a routing message as shown in Figure 16, block **381** directs the processor (**202** of Figure 7) to send the routing message shown in Figure 16 to the call controller **14** shown in Figure 1.

25 Referring back to Figure 8B, if at block **257**, the callee identifier stored in the callee id buffer (**211** in Figure 7) does not begin with an international dialing digit, block **380** directs the processor (**202**) to determine whether or not the callee identifier begins with the same national dial digit code as assigned to the caller. To do this, the processor (**202**) is directed to refer to the retrieved caller dialing profile as shown in Figure 10. In Figure 10, the national dialing
30

-43-

digit code **262** is the number **1**. Thus, if the callee identifier begins with the number **1**, then the processor (**202**) is directed to block **382** in Figure **8B**.

5 Block **382** directs the processor (**202** of Figure **7**) to examine the callee identifier to determine whether or not the digits following the NDD digit identify an area code that is the same as any of the area codes identified in the local area codes field **267** of the caller dialing profile **276** shown in Figure **10**. If not, block **384** of Figure **8B** directs the processor **202** to set the call type flag to indicate that the call is a national call. If the digits following the NDD digit
10 identify an area code that is the same as a local area code associated with the caller as indicated by the caller dialing profile, block **386** directs the processor **202** to set the call type flag to indicate a local call, national style. After executing blocks **384** or **386**, block **388** directs the processor **202** to format the callee identifier into a pre-defined digit format to produce a re-
15 formatted callee identifier by removing the national dialled digit and prepending a caller country code identified by the country code field **266** of the caller dialing profile shown in Figure **10**. The processor (**202**) is then directed to block **263** of Figure **8B** to perform other processing as already described above.

20 If at block **380**, the callee identifier does not begin with a national dialled digit, block **390** directs the processor (**202**) to determine whether the callee identifier begins with digits that identify the same area code as the caller. Again, the reference for this is the retrieved caller dialing profile shown in
25 Figure **10**. The processor (**202**) determines whether or not the first few digits of the callee identifier identify an area code corresponding to the local area code field **267** of the retrieved caller dialing profile. If so, then block **392** directs the processor **202** to set the call type flag to indicate that the call is a local call and block **394** directs the processor (**202**) to format the callee
30 identifier into a pre-defined digit format to produce a reformatted callee identifier by prepending the caller country code to the callee identifier, the caller country code being determined from the country code field **266** of the

-44-

retrieved caller dialing profile shown in Figure 10. The processor (202) is then directed to block 263 for further processing as described above.

5 Referring back to Figure 8B, at block 390, the callee identifier does not start with the same area code as the caller, block 396 directs the processor (202 of Figure 7) to determine whether the number of digits in the callee identifier, i.e. the length of the callee identifier, is within the range of digits indicated by the caller minimum local number length field 268 and the caller maximum local number length field 270 of the retrieved caller dialing profile shown in Figure 10. If so, then block 398 directs the processor (202) to set the call type flag to indicate a local call and block 400 directs the processor (202) to format the callee identifier into a pre-defined digit format to produce a reformatted callee identifier by prepending to the callee identifier the caller country code (as indicated by the country code field 266 of the retrieved caller dialing profile shown in Figure 10) followed by the caller area code (as indicated by the local area code field 267 of the caller profile shown in Figure 10). The processor (202) is then directed to block 263 of Figure 8B for further processing as described above.

20 Referring back to Figure 8B, if at block 396, the callee identifier has a length that does not fall within the range specified by the caller minimum local number length field (268 in Figure 10) and the caller maximum local number length field (270 in Figure 10), block 402 directs the processor 202 of Figure 7 to determine whether or not the callee identifier identifies a valid user name. To do this, the processor 202 searches through the database (18 of Figure 10) of dialing profiles to find a dialing profile having user name field contents (258 in Figure 10) that match the callee identifier. If no match is found, block 404 directs the processor (202) to send an error message back to the call controller (14). If at block 402, a dialing profile having a user name field 258 that matches the callee identifier is found, block 406 directs the processor 202 to set the call type flag to indicate that the call is a private network call and then the processor is directed to block 280 of Figure 8A. Thus, the call is

-45-

classified as a private network call when the callee identifier identifies a subscriber to the private network.

5 From Figure 8B, it will be appreciated that there are certain groups of blocks
of codes that direct the processor 202 in Figure 7 to determine whether the
callee identifier has certain features such as an international dialing digit, a
national dialing digit, an area code and a length that meet certain criteria, and
cause the processor 202 to reformat the callee identifier stored in the callee id
10 buffer 211, as necessary into a predetermined target format including only a
country code, area code, and a normal telephone number, for example, to
cause the callee identifier to be compatible with the E.164 number plan
standard in this embodiment. This enables block 269 in Figure 8B to have a
consistent format of callee identifiers for use in searching through the DID
15 bank table records of the type shown in Figure 13 to determine how to route
calls for subscriber to subscriber calls on the same system. Effectively,
therefore blocks 257, 380, 390, 396 and 402 establish call classification
criteria for classifying the call as a public network call or a private network call.
Block 269 classifies the call, depending on whether or not the formatted callee
20 identifier has a DID bank table record and this depends on how the call
classification criteria are met and block 402 directs the processor 202 of
Figure 7 to classify the call as a private network call when the callee identifier
complies with a pre-defined format, i.e. is a valid user name and identifies a
subscriber to the private network, after the callee identifier has been subjected
to the classification criteria of blocks 257, 380, 390 and 396.

25

Subscriber to Non-Subscriber Calls

30 Not all calls will be subscriber to subscriber calls and this will be detected by
the processor 202 of Figure 7 when it executes block 269 in Figure 8B, and
does not find a DID bank table record that is associated with the callee, in the
DID bank table. When this occurs, the call is classified as a public network

-46-

call by directing the processor **202** to block **408** of Figure **8B** which causes it to set the contents of the callee id buffer **211** of Figure **7** equal to the newly formatted callee identifier, i.e., a number compatible with the E.164 standard. Then, block **410** of Figure **8B** directs the processor (**202**) to search a database of route or master list records associating route identifiers with dialing codes shown in Figure **19** to locate a router having a dialing code having a number pattern matching at least a portion of the reformatted callee identifier.

Referring to Figure **19**, a data structure for a master list or route list record is shown. Each master list record includes a master list ID field **500**, a dialing code field **502**, a country code field **504**, a national sign number field **506**, a minimum length field **508**, a maximum length field **510**, a national dialled digit field **512**, an international dialled digit field **514** and a buffer rate field **516**.

The master list ID field **500** holds a unique code such as **1019**, for example, identifying the record. The dialing code field **502** holds a predetermined number pattern that the processor **202** of Figure **7** uses at block **410** in Figure **8B** to find the master list record having a dialing code matching the first few digits of the amended callee identifier stored in the callee id buffer **211**. The country code field **504** holds a number representing the country code associated with the record and the national sign number field **506** holds a number representing the area code associated with the record. (It will be observed that the dialing code is a combination of the contents of the country code field **504** and the national sign number field **506**.) The minimum length field **508** holds a number representing the minimum length of digits associated with the record and the maximum length field **51** holds a number representing the maximum number of digits in a number with which the record may be compared. The national dialled digit (NDD) field **512** holds a number representing an access code used to make a call within the country specified by the country code, and the international dialled digit (IDD) field **514** holds a

-47-

number representing the international prefix needed to dial a call from the country indicated by the country code.

Thus, for example, a master list record may have a format as shown in Figure 20 with exemplary field contents as shown.

Referring back to Figure 8B, using the country code and area code portions of the reformatted callee identifier stored in the callee id buffer 211, block 410 directs the processor 202 of Figure 7 to find a master list record such as the one shown in Figure 20 having a dialing code that matches the country code (1) and area code (604) of the callee identifier. Thus, in this example, the processor (202) would find a master list record having an ID field containing the number 1019. This number may be referred to as a route ID. Thus, a route ID number is found in the master list record associated with a predetermined number pattern in the reformatted callee identifier.

After executing block 410 in Figure 8B, the process continues as shown in Figure 8D. Referring to Figure 8D, block 412 directs the processor 202 of Figure 7 to use the route ID number to search a database of supplier records associating supplier identifiers with route identifiers to locate at least one supplier record associated with the route identifier to identify at least one supplier operable to supply a communications link for the route.

Referring to Figure 21, a data structure for a supplier list record is shown. Supplier list records include a supplier ID field 540, a master list ID field 542, an optional prefix field 544, a specific route identifier field 546, a NDD/IDD rewrite field 548, a rate field 550, and a timeout field 551. The supplier ID field 540 holds a code identifying the name of the supplier and the master list ID field 542 holds a code for associating the supplier record with a master list record. The prefix field 544 holds a string used to identify the supplier traffic and the specific route identifier field 546 holds an IP address of a gateway operated by the supplier indicated by the supplier ID field 540. The NDD/IDD

-48-

rewrite field **548** holds a code representing a rewritten value of the NDD/IDD associated with this route for this supplier, and the rate field **550** holds a code indicating the cost per second to the system operator to use the route provided by the gateway specified by the contents of the route identifier field **546**. The timeout field **551** holds a code indicating a time that the call controller should wait for a response from the associated gateway before giving up and trying the next gateway. This time value may be in seconds, for example. Exemplary supplier records are shown in Figures **22**, **23** and **24** for the exemplary suppliers shown at **20** in Figure **1**, namely Telus, Shaw and Sprint.

Referring back to Figure **8D**, at block **412** the processor **202** finds all supplier records that identify the master list ID found at block **410** of Figure **8B**.

Referring back to Figure **8D**, block **560** directs the processor **202** of Figure **7** to begin to produce a routing message of the type shown in Figure **15**. To do this, the processor **202** loads a routing message buffer as shown in Figure **25** with a supplier prefix of the least costly supplier where the least costly supplier is determined from the rate fields **550** of Figure **21** of the records associated with respective suppliers.

Referring to Figures **22-24**, in the embodiment shown, the supplier "Telus" has the lowest number in the rate field **550** and therefore the prefix **4973** associated with that supplier is loaded into the routing message buffer shown in Figure **25** first.

Block **562** in Figure **8D** directs the processor to delimit the prefix **4973** by the number sign (#) and to next load the reformatted callee identifier into the routing message buffer shown in Figure **25**. At block **563** of Figure **8D**, the contents of the route identifier field **546** of Figure **21** of the record associated with the supplier "Telus" are added by the processor **202** of Figure **7** to the routing message buffer shown in Figure **25** after an @ sign delimiter, and then

-49-

block **564** in Figure **8D** directs the processor to get a time to live value, which in one embodiment may be **3600** seconds, for example. Block **566** then directs the processor **202** to load this time to live value and the timeout value (**551**) in Figure **21** in the routing message buffer of Figure **25**. Accordingly, a first part of the routing message for the Telus gateway is shown generally at **570** in Figure **25**.

Referring back to Figure **8D**, block **571** directs the processor **202** back to block **560** and causes it to repeat blocks **560**, **562**, **563**, **564** and **566** for each successive supplier until the routing message buffer is loaded with information pertaining to each supplier identified by the processor at block **412**. Thus, a second portion of the routing message as shown at **572** in Figure **25** relates to the second supplier identified by the record shown in Figure **23**. Referring back to Figure **25**, a third portion of the routing message as shown at **574** and is associated with a third supplier as indicated by the supplier record shown in Figure **24**.

Consequently, referring to Figure **25**, the routing message buffer holds a routing message identifying a plurality of different suppliers able to provide gateways to the public telephone network (i.e. specific routes) to establish at least part of a communication link through which the caller may contact the callee. In this embodiment, each of the suppliers is identified, in succession, according to rate. Other criteria for determining the order in which suppliers are listed in the routing message may include preferred supplier priorities which may be established based on service agreements, for example.

Referring back to Figure **8D**, block **568** directs the processor **202** of Figure **7** to send the routing message shown in Figure **25** to the call controller **14** in Figure **1**.

Subscriber to Subscriber Calls Within the Same Node

-50-

5 Referring back to Figure 8A, if at block 280, the callee identifier received in the RC request message has a prefix that identifies the same node as that associated with the caller, block 600 directs the processor 202 to use the callee identifier in the callee id buffer 211 to locate and retrieve a dialing profile for the callee. The dialing profile may be of the type shown in Figure 11 or 12, for example. Block 602 of Figure 8A then directs the processor 202 of Figure 7 to get call block, call forward and voicemail records from the database 18 of Figure 1 based on the user name identified in the callee dialing profile retrieved by the processor at block 600. Call block, call forward and voicemail records may be as shown in Figures 26, 27, 28 and 30 for example.

15 Referring to Figure 26, the call block records include a user name field 604 and a block pattern field 606. The user name field holds a user name corresponding to the user name in the user name field (258 in Figure 10) of the callee profile and the block pattern field 606 holds one or more E.164-compatible numbers or user names identifying PSTN numbers or system subscribers from whom the subscriber identified in the user name field 604 does not wish to receive calls.

20 Referring to Figure 8A and Figure 27, block 608 directs the processor 202 of Figure 7 to determine whether or not the caller identifier received in the RC request message matches a block pattern stored in the block pattern field 606 of the call block record associated with the callee identified by the contents of the user name field 604 in Figure 26. If the caller identifier matches a block pattern, block 610 directs the processor to send a drop call or non-completion message to the call controller (14) and the process is ended. If the caller identifier does not match a block pattern associated with the callee, block 609 directs the processor to store the username and domain of the callee, as determined from the callee dialing profile, and a time to live value in the routing message buffer as shown at 650 in Figure 32. Referring back to

25

30

-51-

Figure 8A, block 612 then directs the processor 202 to determine whether or not call forwarding is required.

5 Referring to Figure 28, the call forwarding records include a user name field 614, a destination number field 616, and a sequence number field 618. The user name field 614 stores a code representing a user with which the record is associated. The destination number field 616 holds a user name representing a number to which the current call should be forwarded, and the sequence number field 618 holds an integer number indicating the order in
10 which the user name associated with the corresponding destination number field 616 should be attempted for call forwarding. The call forwarding table may have a plurality of records for a given user. The processor 202 of Figure 7 uses the contents of the sequence number field 618 to place the records for a given user in order. As will be appreciated below, this enables the call
15 forwarding numbers to be tried in an ordered sequence.

Referring to Figure 8A and Figure 29, if at block 612, the call forwarding record for the callee identified by the callee identifier contains no contents in the destination number field 616 and accordingly no contents in the sequence
20 number field 618, there are no call forwarding entries for this callee, and the processor 202 is directed to block 620 in Figure 8C. If there are entries in the call forwarding table 27, block 622 in Figure 8A directs the processor 202 to search the dialing profile table to find a dialing profile record as shown in Figure 9, for the user identified by the destination number field 616 of the call
25 forward record shown in Figure 28. The processor 202 of Figure 7 is further directed to store the username and domain for that user and a time to live value in the routing message buffer as shown at 652 in Figure 32, to produce a routing message as illustrated. This process is repeated for each call forwarding record associated with the callee identified by the callee id buffer
30 211 in Figure 7 to add to the routing message buffer all call forwarding usernames and domains associated with the callee.

-52-

Referring back to Figure 8A, if at block 612 there are no call forwarding records, then at block 620 in Figure 8C the processor 202 is directed to determine whether or not the user identified by the callee identifier has paid for voicemail service. This is done by checking to see whether or not a flag is set in a voicemail record of the type shown in Figure 30 in a voicemail table stored in the database 18 shown in Figure 1.

Referring to Figure 30, voicemail records in this embodiment may include a user name field 624, a voicemail server field 626, a seconds to voicemail field 628 and an enable field 630. The user name field 624 stores the user name of the callee. The voicemail server field 626 holds a code identifying a domain name of a voicemail server associated with the user identified by the user name field 624. The seconds to voicemail field 628 holds a code identifying the time to wait before engaging voicemail, and the enable field 630 holds a code representing whether or not voicemail is enabled for the user. Referring back to Figure 8C, at block 620 if the processor 202 of Figure 7 finds a voicemail record as shown in Figure 30 having user name field 624 contents matching the callee identifier, the processor is directed to examine the contents of the enable field 630 to determine whether or not voicemail is enabled. If voicemail is enabled, then block 640 in Figure 8C directs the processor 202 to Figure 7 to store the contents of the voicemail server field 626 and the contents of the seconds to voicemail field 628 in the routing message buffer, as shown at 654 in Figure 32. Block 642 then directs the processor 202 to get time to live values for each path specified by the routing message according to the cost of routing and the user's balance. These time to live values are then appended to corresponding paths already stored in the routing message buffer.

Referring back to Figure 8C, block 644 then directs the processor 202 of Figure 7 to store the IP address of the current node in the routing message buffer as shown at 656 in Figure 32. Block 646 then directs the processor 202 to send the routing message shown in Figure 32 to the call controller 14 in

-53-

Figure 1. Thus in the embodiment described the routing controller will produce a routing message that will cause at least one of the following: forward the call to another party, block the call and direct the caller to a voicemail server.

5 Referring back to Figure 1, the routing message whether of the type shown in Figures 16, 25 or 32, is received at the call controller 14 and the call controller interprets the receipt of the routing message as a request to establish a call.

10 Referring to Figure 4, the program memory 104 of the call controller 14 includes a routing to gateway routine depicted generally at 122.

15 Where a routing message of the type shown in Figure 32 is received by the call controller 14, the routing to gateway routine 122 shown in Figure 4 may direct the processor 102 cause a message to be sent back through the internet 13 shown in Figure 1 to the callee telephone 15, knowing the IP address of the callee telephone 15 from the user name.

20 Alternatively, if the routing message is of the type shown in Figure 16, which identifies a domain associated with another node in the system, the call controller may send a SIP invite message along the high speed backbone 17 connected to the other node. The other node functions as explained above, in response to receipt of a SIP invite message.

25 If the routing message is of the type shown in Figure 25 where there are a plurality of gateway suppliers available, the call controller sends a SIP invite message to the first supplier, in this case Telus, using a dedicated line or an internet connection to determine whether or not Telus is able to handle the call. If the Telus gateway returns a message indicating it is not able to handle the call, the call controller 14 then proceeds to send a SIP invite message to
30 the next supplier, in this case Shaw. The process is repeated until one of the suppliers responds indicating that it is available to carry the call. Once a supplier responds indicating that it is able to carry the call, the supplier sends

-54-

5 back to the call controller **14** an IP address for a gateway provided by the
supplier through which the call or audio path of the call will be carried. This IP
address is sent in a message from the call controller **14** to the media relay **9**
which responds with a message indicating an IP address to which the caller
10 telephone should send its audio/video, traffic and an IP address to which the
gateway should send its audio/video for the call. The call controller conveys
the IP address at which the media relay expects to receive audio/video from
the caller telephone, to the caller telephone **12** in a message. The caller
telephone replies to the call controller with an IP address at which it would like
15 to receive audio/video and the call controller conveys that IP address to the
media relay. The call may then be conducted between the caller and callee
through the media relay and gateway.

15 Referring back to Figure 1, if the call controller **14** receives a routing message
of the type shown in Figure **32**, and which has at least one call forwarding
number and/or a voicemail number, the call controller attempts to establish a
call to the callee telephone **15** by seeking from the callee telephone a
message indicating an IP address to which the media relay should send
audio/video. If no such message is received from the callee telephone, no call
20 is established. If no call is established within a pre-determined time, the call
controller **14** attempts to establish a call with the next user identified in the call
routing message in the same manner. This process is repeated until all call
forwarding possibilities have been exhausted, in which case the call controller
communicates with the voicemail server **19** identified in the routing message
25 to obtain an IP address to which the media relay should send audio/video and
the remainder of the process mentioned above for establishing IP addresses
at the media relay **9** and the caller telephone is carried out to establish
audio/video paths to allowing the caller to leave a voicemail message with the
voicemail server.

30 When an audio/video path through the media relay is established, a call timer
maintained by the call controller **14** logs the start date and time of the call and

-55-

logs the call ID and an identification of the route (i.e., audio/video path IP address) for later use in billing.

Time to Live

5 Referring to Figures **33A** and **33B**, a process for determining a time to live value for any of blocks **642** in Figure **8C**, **350** in Figure **8A** or **564** in Figure **8D** above is described. The process is executed by the processor **202** shown in Figure **7**. Generally, the process involves calculating a cost per unit time, calculating a first time value as a sum of a free time attributed to a participant
10 in the communication session and the quotient of a funds balance held by the participant to the cost per unit time value and producing a second time value in response to the first time value and a billing pattern associated with the participant, the billing pattern including first and second billing intervals and the second time value being the time to permit a communication session to be
15 conducted.

Referring to Figure **33A**, in this embodiment, the process begins with a first block **700** that directs the RC processor to determine whether or not the call type set at block **302** in Figure **8A** indicates the call is a network or cross-
20 domain call. If the call is a network or cross-domain call, block **702** of Figure **33A** directs the RC processor to set the time to live equal to **99999** and the process is ended. Thus, the network or cross-domain call type has a long time to live. If at block **700** the call type is determined not to be a network or cross-domain type, block **704** directs the RC processor to get a subscriber bundle table record from the database **18** in Figure **1** and store it locally in the
25 subscriber bundle record buffer at the RC **14**.

Referring to Figure **34**, a subscriber bundle table record is shown generally at **706**. The record includes a user name field **708** and a services field **710**. The
30 user name field **708** holds a code identifying the subscriber user name and the services field **710** holds codes identifying service features assigned to the subscriber, such as free local calling, call blocking and voicemail, for example.

-56-

Figure **35** shows an exemplary subscriber bundle record for the Vancouver caller. In this record the user name field **708** is loaded with the user name **2001 1050 8667** and the services field **710** is loaded with codes **10, 14** and **16** corresponding to free local calling, call blocking and voicemail, respectively. Thus, user **2001 1050 8667** has free local calling, call blocking and voicemail features.

Referring back to Figure **33A**, after having loaded a subscriber bundle record into the subscriber bundle record buffer, block **712** directs the RC processor to search the database (**18**) determine whether or not there is a bundle override table record for the master list ID value that was determined at block **410** in Figure **8B**. An exemplary bundle override table record is shown at **714** in Figure **36**. The bundle table record includes a master list ID field **716**, an override type field **718**, an override value field **720** a first interval field **722** and a second interval field **724**. The master list ID field **716** holds a master list ID code. The override type field **718** holds an override type code indicating a fixed, percent or cent amount to indicate the amount by which a fee will be increased. The override value field **720** holds a real number representing the value of the override type. The first interval field **722** holds a value indicating the minimum number of seconds for a first level of charging and the second interval field **724** holds a number representing a second level of charging.

Referring to Figure **37**, a bundle override record for the located master list ID code is shown generally at **726** and includes a master list ID field **716** holding the code **1019** which was the code located in block **410** of Figure **8B**. The override type field **718** includes a code indicating the override type is a percentage value and the override value field **720** holds the value **10.0** indicating that the override will be **10.0%** of the charged value. The first interval field **722** holds a value representing **30** seconds and the second interval field **724** holds a value representing **6** seconds. The **30** second value in the first interval field **722** indicates that charges for the route will be made at

-57-

a first rate for **30** seconds and thereafter the charges will be made at a different rate in increments of **6** seconds, as indicated by the contents of the second interval field **724**.

5 Referring back to Figure **33A**, if at block **712** the processor finds a bundle
override record of the type shown in Figure **37**, block **728** directs the
processor to store the bundle override record in local memory. In the
embodiment shown, the bundle override record shown in Figure **37** is stored
in the bundle override record buffer at the RC as shown in Figure **7**. Still
10 referring to Figure **33A**, block **730** then directs the RC processor to determine
whether or not the subscriber bundle table record **706** in Figure **35** has a
services field including a code identifying that the user is entitled to free local
calling and also directs the processor to determine whether or not the call type
is not a cross domain cell, i.e. it is a local or local/national style. If both of
15 these conditions are satisfied, block **732** directs the processor to set the time
to live equal to **99999**, giving the user a long period of time for the call. The
process is then ended. If the conditions associated with block **730** are not
satisfied, block **734** of Figure **33B** directs the RC processor to retrieve a
subscriber account record associated with a participant in the call. This is
20 done by copying and storing in the subscriber account record buffer a
subscriber account record for the caller.

Referring to Figure **38**, an exemplary subscriber account table record is
shown generally at **736**. The record includes a user name field **738**, a funds
25 balance field **740** and a free time field **742**. The user name field **738** holds a
subscriber user name, the funds balance field **740** holds a real number
representing the dollar value of credit available to the subscriber and the free
time field **742** holds an integer representing the number of free seconds that
the user is entitled to.

30

An exemplary subscriber account record for the Vancouver caller is shown
generally at **744** in Figure **39**, wherein the user name field **738** holds the user

-58-

name **2001 1050 8667**, the funds balance field **740** holds the value **\$10.00**, and the free time field **742** holds the value **100**. The funds balance field holding the value of **\$10.00** indicates the user has **\$10.00** worth of credit and the free time field having the value of **100** indicates that the user has a balance of **100** free seconds of call time.

5

Referring back to Figure **33B**, after copying and storing the subscriber account record shown in Figure **39** from the database to the subscriber account record buffer RC, block **746** directs the processor to determine whether or not the subscriber account record funds balance field **740** or free time field **742** are greater than zero. If they are not greater than zero, block **748** directs the processor to set the time to live equal to zero and the process is ended. The RC then sends a message back to the call controller to cause the call controller to deny the call to the caller. If the conditions associated with block **746** are satisfied, block **750** directs the processor to calculate the call cost per unit time. A procedure for calculating the call cost per unit time is described below in connection with Figure **41**.

10

15

Assuming the procedure for calculating the cost per second returns a number representing the call cost per second, block **752** directs the processor **202** in Figure **7** to determine whether or not the cost per second is equal to zero. If so, block **754** directs the processor to set the time to live to **99999** to give the caller a very long length of call and the process is ended.

20

If at block **752** the call cost per second is not equal to zero, block **756** directs the processor **202** in Figure **7** to calculate a first time to live value as a sum of a free time attributed to the participant in the communication session and the quotient of the funds balance held by the participant to the cost per unit time value. To do this, the processor **202** of Figure **7** is directed to set a first time value or temporary time to live value equal to the sum of the free time provided in the free time field **742** of the subscriber account record shown in Figure **39** and the quotient of the contents of the funds balance field **740** in the

25

30

-59-

subscriber account record for the call shown in Figure 39 and the cost per second determined at block 750 of Figure 33B. Thus, for example, if at block 750 the cost per second is determined to be three cents per second and the funds balance field holds the value \$10.00, the quotient of the funds balance and cost per second is 333 seconds and this is added to the contents of the free time field 742, which is 100, resulting in a time to live of 433 seconds.

Block 758 then directs the RC processor to produce a second time value in response to the first time value and the billing pattern associated with the participant as established by the bundle override record shown in Figure 37. This process is shown in greater detail at 760 in Figure 40 and generally involves producing a remainder value representing a portion of the second billing interval remaining after dividing the second billing interval into a difference between the first time value and the first billing interval.

Referring to Figure 40, the process for producing the second time value begins with a first block 762 that directs the processor 202 in Figure 7 to set a remainder value equal to the difference between the time to live value calculated at block 756 in Figure 33B and the contents of the first interval field 722 of the record shown in Figure 37, multiplied by the modulus of the contents of the second interval field 724 of Figure 37. Thus, in the example given, the difference between the time to live field and the first interval field is 433 minus 30, which is 403 and therefore the remainder produced by the mod of 403 divided by 6 is 0.17. Block 764 then directs the processor to determine whether or not this remainder value is greater than zero and, if so, block 766 directs the processor to subtract the remainder from the first time value and set the difference as the second time value. To do this the processor is directed to set the time to live value equal to the current time to live of 403 minus the remainder of 1, i.e., 402 seconds. The processor is then returned back to block 758 of Figure 33B.

-60-

Referring back to Figure 40, if at block 764 the remainder is not greater than zero, block 768 directs the processor 202 of Figure 7 to determine whether or not the time to live is less than the contents of the first interval field 722 in the record shown in Figure 37. If so, then block 770 of Figure 40 directs the processor to set the time to live equal to zero. Thus, the second time value is set to zero when the remainder is greater than zero and the first time value is less than the free time associated with the participant in the call. If at block 768 the conditions of that block are not satisfied, the processor returns the first time to live value as the second time to live value.

Thus, referring to Figure 33B, after having produced a second time to live value, block 772 directs the processor to set the time to live value for use in blocks 342, 350 or 564.

Cost per Second

Referring back to Figure 33B, at block 750 it was explained that a call cost per unit time is calculated. The following explains how that call cost per unit time value is calculated.

Referring to Figure 41, a process for calculating a cost per unit time is shown generally at 780. The process is executed by the processor 202 in Figure 7 and generally involves locating a record in a database, the record comprising a markup type indicator, a markup value and a billing pattern and setting a reseller rate equal to the sum of the markup value and the buffer rate, locating at least one of an override record specifying a route cost per unit time amount associated with a route associated with the communication session, a reseller record associated with a reseller of the communications session, the reseller record specifying a reseller cost per unit time associated with the reseller for the communication session and a default operator markup record specifying a default cost per unit time and setting as the cost per unit time the sum of the reseller rate and at least one of the route cost per unit time, the reseller cost per unit time and the default cost per unit time.

-61-

5 The process begins with a first set of blocks **782**, **802** and **820** which direct the processor **202** in Figure **7** to locate at least one of a record associated with a reseller and a route associated with the reseller, a record associated with the reseller, and a default reseller mark-up record. Block **782**, in particular, directs the processor to address the database **18** to look for a record associated with a reseller and a route with the reseller by looking for a special rate record based on the master list ID established at block **410** in Figure **8C**.

10 Referring to Figure **42**, a system operator special rate table record is shown generally at **784**. The record includes a reseller field **786**, a master list ID field **788**, a mark-up type field **790**, a mark-up value field **792**, a first interval field **794** and a second interval field **796**. The reseller field **786** holds a reseller ID code and the master list ID field **788** holds a master list ID code. The mark-up type field **790** holds a mark-up type such as fixed percent or cents and the mark-up value field **792** holds a real number representing the value corresponding to the mark-up type. The first interval field **794** holds a number representing a first level of charging and the second interval field **796** holds a number representing a second level of charging.

15 An exemplary system operator special rate table for a reseller known as "Klondike" is shown at **798** in Figure **43**. In this record, the reseller field **786** holds a code indicating the retailer ID is Klondike, the master list ID field **788** holds the code **1019** to associate the record with the master list ID code **1019**. The mark-up type field **790** holds a code indicating the mark-up type is cents and the mark-up value field **792** holds a mark-up value indicating **1/10** of one cent. The first interval field **794** holds the value **30** and the second interval field **796** holds the value **6**, these two fields indicating that the operator allows **30** seconds for free and then billing is done in increments of **6** seconds after that.

20

25

30

-62-

Referring back to Figure 41, if at block 782 a record such as the one shown in Figure 43 is located in the system operator special rates table, the processor is directed to block 800 in Figure 41. If such a record is not found in the system operator special rates table, block 802 directs the processor to address the database 18 to look in a system operator mark-up table for a mark-up record associated with the reseller.

Referring to Figure 44, an exemplary system operator mark-up table record is shown generally at 804. The record includes a reseller field 806, a mark-up type field 808, a mark-up value field 810, a first interval field 812 and a second interval field 814. The reseller mark-up type, mark-up value, first interval and second interval fields are as described in connection with the fields by the same names in the system operator special rates table shown in Figure 42.

Figure 45 provides an exemplary system operator mark-up table record for the reseller known as Klondike and therefore the reseller field 806 holds the value "Klondike", the mark-up type field 808 holds the value cents, the mark-up value field holds the value 0.01, the first interval field 812 holds the value 30 and the second interval field 814 holds the value 6. This indicates that the reseller "Klondike" charges by the cent at a rate of one cent per minute. The first 30 seconds of the call are free and billing is charged at the rate of one cent per minute in increments of 6 seconds.

Figure 46 provides an exemplary system operator mark-up table record for cases where no specific system operator mark-up table record exists for a particular reseller, i.e., a default reseller mark-up record. This record is similar to the record shown in Figure 45 and the reseller field 806 holds the value "all", the mark-up type field 808 is loaded with a code indicating mark-up is based on a percentage, the mark-up value field 810 holds the percentage by which the cost is marked up, and the first and second interval fields 812 and 814 identify first and second billing levels.

-63-

Referring back to Figure 41, if at block 802 a specific mark-up record for the reseller identified at block 782 is not located, block 820 directs the processor to get the mark-up record shown in Figure 46, having the "all" code in the reseller field 806. The processor is then directed to block 800.

5

Referring back to Figure 41, at block 800, the processor 202 of Figure 7 is directed to set a reseller rate equal to the sum of the mark-up value of the record located by blocks 782, 802 or 820 and the buffer rate specified by the contents of the buffer rate field 516 of the master list record shown in Figure 20. To do this, the RC processor sets a variable entitled "reseller cost per second" to a value equal to the sum of the contents of the mark-up value field (792, 810) of the associated record, plus the contents of the buffer rate field (516) from the master list record associated with the master list ID. Then, block 822 directs the processor to set a system operator cost per second variable equal to the contents of the buffer rate field (516) from the master list record. Block 824 then directs the processor to determine whether the call type flag indicates the call is local or national/local style and whether the caller has free local calling. If both these conditions are met, then block 826 sets the user cost per second variable equal to zero and sets two increment variables equal to one, for use in later processing. The cost per second has thus be calculated and the process shown in Figure 41 is ended.

10

15

20

If at block 824 the conditions of that block are not met, the processor 202 of Figure 7 is directed to locate at least one of a bundle override table record specifying a route cost per unit time associated with a route associated with the communication session, a reseller special destinations table record associated with a reseller of the communications session, the reseller record specifying a reseller cost per unit time associated with the reseller for the communication session and a default reseller global markup record specifying a default cost per unit time.

25

30

-64-

To do this block **828** directs the processor **202** of Figure **7** to determine whether or not the bundle override record **726** in Figure **37** located at block **712** in Figure **33A** has a master list ID equal to the stored master list ID that was determined at block **410** in Figure **8B**. If not, block **830** directs the processor to find a reseller special destinations table record in a reseller special destinations table in the database (**18**), having a master list ID code equal to the master list ID code of the master list ID that was determined at block **410** in Figure **8B**. An exemplary reseller special destinations table record is shown in Figure **47** at **832**. The reseller special destinations table record includes a reseller field **834**, a master list ID field **836**, a mark-up type field **838**, a mark-up value field **840**, a first interval field **842** and a second interval field **844**. This record has the same format as the system operator special rates table record shown in Figure **42**, but is stored in a different table to allow for different mark-up types and values and time intervals to be set according to resellers' preferences. Thus, for example, an exemplary reseller special destinations table record for the reseller "Klondike" is shown at **846** in Figure **48**. The reseller field **834** holds a value indicating the reseller as the reseller "Klondike" and the master list ID field holds the code **1019**. The mark-up type field **838** holds a code indicating the mark-up type is percent and the mark-up value field **840** holds a number representing the mark-up value as 5%. The first and second interval fields identify different billing levels used as described earlier.

Referring back to Figure **41**, the record shown in Figure **48** may be located at block **830**, for example. If at block **830** such a record is not found, then block **832** directs the processor to get a default operator global mark-up record based on the reseller ID.

Referring to Figure **49**, an exemplary default reseller global mark-up table record is shown generally at **848**. This record includes a reseller field **850**, a mark-up type field **852**, a mark-up value field **854**, a first interval field **856** and a second interval field **858**. The reseller field **850** holds a code identifying the

-65-

reseller. The mark-up type field **852**, the mark-up value field **854** and the first and second interval fields **856** and **858** are of the same type as described in connection with fields of the same name in Figure **47**, for example. The contents of the fields of this record **860** may be set according to system operator preferences, for example.

Referring to Figure **50**, an exemplary reseller global mark-up table record is shown generally at **860**. In this record, the reseller field **850** holds a code indicating the reseller is "Klondike", the mark-up type field **852** holds a code indicating the mark-up type is percent, the mark-up value field **854** holds a value representing **10%** as the mark-up value, the first interval field **856** holds the value **30** and the second interval field **858** holds the values **30** and **6** respectively to indicate the first **30** seconds are free and billing is to be done in **6** second increments after that.

Referring back to Figure **41**, should the processor get to block **832**, the reseller global mark-up table record as shown in Figure **50** is retrieved from the database and stored locally at the RC. As seen in Figure **41**, it will be appreciated that if the conditions are met in blocks **828** or **830**, or if the processor executes block **832**, the processor is then directed to block **862** which causes it to set an override value equal to the contents of the mark-up value field of the located record, to set the first increment variable equal to the contents of the first interval field of the located record and to set the second increment variable equal to the contents of the second interval field of the located record. (The increment variables were alternatively set to specific values at block **826** in Figure **41**.)

It will be appreciated that the located record could be a bundle override record of the type shown in Figure **37** or the located record could be a reseller special destination record of the type shown in Figure **48** or the record could be a reseller global mark-up table record of the type shown in Figure **50**. After the override and first and second increment variables have been set at block

-66-

5 **862**, the processor **202** if Figure **7** is directed to set as the cost per unit time the sum of the reseller rate and at least one of the route cost per unit time, the reseller cost per unit time and the default cost per unit time, depending on which record was located. To do this, block **864** directs the processor to set the cost per unit time equal to the sum of the reseller cost set at block **800** in Figure **41**, plus the contents of the override variable calculated in block **862** in Figure **41**. The cost per unit time has thus been calculated and it is this cost per unit time that is used in block **752** of Figure **33B**, for example.

10 Terminating the Call

15 In the event that either the caller or the callee terminates a call, the telephone of the terminating party sends a SIP bye message to the controller **14**. An exemplary SIP bye message is shown at **900** in Figure **51** and includes a caller field **902**, a callee field **904** and a call ID field **906**. The caller field **902** holds a twelve digit user name, the callee field **904** holds a PSTN compatible number or user name, and the call ID field **906** holds a unique call identifier field of the type shown in the call ID field **65** of the SIP invite message shown in Figure **3**.

20 Thus, for example, referring to Figure **52**, a SIP bye message for the Calgary callee is shown generally at **908** and the caller field **902** holds a user name identifying the caller, in this case **2001 1050 8667**, the callee field **904** holds a user name identifying the Calgary callee, in this case **2001 1050 2222**, and the call ID field **906** holds the code **FA10 @ 192.168.0.20**, which is the call ID
25 for the call.

30 The SIP bye message shown in Figure **52** is received at the call controller **14** and the call controller executes a process as shown generally at **910** in Figure **53**. The process includes a first block **912** that directs the call controller processor **202** of Figure **7** to copy the caller, callee and call ID field contents from the SIP bye message received from the terminating party to corresponding fields of an RC stop message buffer (not shown). Block **914**

-67-

then directs the processor to copy the call start time from the call timer and to obtain a call stop time from the call timer. Block **916** then directs the call controller to calculate a communication session time by determining the difference in time between the call start time and the call stop time. This session time is then stored in a corresponding field of the RC call stop message buffer. Block **917** then directs the processor to decrement the contents of the current concurrent call field **277** of the dialing profile for the caller as shown in Figure **10**, to indicate that there is one less concurrent call in progress. A copy of the amended dialing profile for the caller is then stored in the database **18** of Figure **1**. Block **918** then directs the processor to copy the route from the call log. An RC call stop message produced as described above is shown generally at **1000** in Figure **54**. An RC call stop message specifically associated with the call made to the Calgary callee is shown generally at **1020** in Figure **55**.

Referring to Figure **54**, the RC stop call message includes a caller field **1002**, callee field **1004**, a call ID field **1006**, an account start time field **1008**, an account stop time field **1010**, a communication session time **1012** and a route field **1014**. The caller field **1002** holds a username, the callee field **1004** holds a PSTN-compatible number or system number, the call ID field **1006** hold the unique call identifier received from the SIP invite message shown in Figure **3**, the account start time field **1008** holds the date and start time of the call, the account stop time field **1010** holds the date and time the call ended, the communication session time field **1012** holds a value representing the difference between the start time and the stop time, in seconds, and the route field **1014** holds the IP address for the communications link that was established.

Referring to Figure **55**, an exemplary RC stop call message for the Calgary callee is shown generally at **1020**. In this example the caller field **1002** holds the user name **2001 1050 8667** identifying the Vancouver-based caller and the callee field **1004** holds the user name **2001 1050 2222** identifying the

-68-

5 Calgary callee. The contents of the call ID field **1006** are **FA10 @ 192.168.0.20**. The contents of the account start time field **1008** are **2006-12-30 12:12:12** and the contents of the account stop time field are **2006-12-30 12:12:14**. The contents of the communication session time field **1012** are **2** to indicate **2** seconds call duration and the contents of the route field are **72.64.39.58**.

10 Referring back to Figure **53**, after having produced an RC call stop message, block **920** directs the processor **202** in Figure **7** to send the RC stop message compiled in the RC call stop message buffer to the RC **16** of Figure **1**. Block **922** directs the call controller **14** to send a “bye” message back to the party that did not terminate the call.

15 The RC **16** of Figure **1** receives the call stop message and an RC call stop message process is invoked at the RC, the process being shown at **950** in Figures **56A**, **56B** and **56C**. Referring to Figure **56A**, the RC stop message process **950** begins with a first block **952** that directs the processor **202** in Figure **7** to determine whether or not the communication session time is less than or equal to the first increment value set by the cost calculation routine shown in Figure **41**, specifically blocks **826** or **862** thereof. If this condition is met, then block **954** of Figure **56A** directs the RC processor to set a chargeable time variable equal to the first increment value set at block **826** or **862** of Figure **41**. If at block **952** of Figure **56A** the condition is not met, block **956** directs the RC processor to set a remainder variable equal to the difference between the communication session time and the first increment value mod the second increment value produced at block **826** or **862** of Figure **41**. Then, the processor is directed to block **958** of Figure **56A** which directs it to determine whether or not the remainder is greater than zero. If so, block **960** directs the RC processor to set the chargeable time variable equal to the difference between the communication session time and the remainder value. If at block **958** the remainder is not greater than zero, block **962** directs the RC processor to set the chargeable time variable equal to the contents of the

20

25

30

-69-

communication session time from the RC stop message. The processor is then directed to block **964**. In addition, after executing block **954** or block **960**, the processor is directed to block **964**.

5 Block **964** directs the processor **202** of Figure **7** to determine whether or not the chargeable time variable is greater than or equal to the free time balance as determined from the free time field **742** of the subscriber account record shown in Figure **39**. If this condition is satisfied, block **966** of Figure **56A**
10 directs the processor to set the free time field **742** in the record shown in Figure **39**, to zero. If the chargeable time variable is not greater than or equal to the free time balance, block **968** directs the RC processor to set a user cost variable to zero and Block **970** then decrements the free time field **742** of the subscriber account record for the caller by the chargeable time amount determined by block **954**, **960** or **962**.

15 If at Block **964** the processor **202** of Figure **7** was directed to Block **966** which causes the free time field (**742** of Figure **39**) to be set to zero, referring to Figure **56B**, Block **972** directs the processor to set a remaining chargeable time variable equal to the difference between the chargeable time and the
20 contents of the free time field (**742** of Figure **39**). Block **974** then directs the processor to set the user cost variable equal to the product of the remaining chargeable time and the cost per second calculated at Block **750** in Figure **33B**. Block **976** then directs the processor to decrement the funds balance field (**740**) of the subscriber account record shown in Figure **39** by the
25 contents of the user cost variable calculated at Block **974**.

30 After completing Block **976** or after completing Block **970** in Figure **56A**, block **978** of Figure **56B** directs the processor **202** of Figure **7** to calculate a reseller cost variable as the product of the reseller rate as indicated in the mark-up value field **810** of the system operator mark-up table record shown in Figure **45** and the communication session time determined at Block **916** in Figure **53**. Then, Block **980** of Figure **56B** directs the processor to add the

-70-

reseller cost to the reseller balance field **986** of a reseller account record of the type shown in Figure **57** at **982**.

5 The reseller account record includes a reseller ID field **984** and the aforementioned reseller balance field **986**. The reseller ID field **984** holds a reseller ID code, and the reseller balance field **986** holds an accumulated balance of charges.

10 Referring to Figure **58**, a specific reseller accounts record for the reseller "Klondike" is shown generally at **988**. In this record the reseller ID field **984** holds a code representing the reseller "Klondike" and the reseller balance field **986** holds a balance of **\$100.02**. Thus, the contents of the reseller balance field **986** in Figure **58** are incremented by the reseller cost calculated at block **978** of Figure **56B**.

15 Still referring to Figure **56B**, after adding the reseller cost to the reseller balance field as indicated by Block **980**, Block **990** directs the processor to **202** of Figure **7** calculate a system operator cost as the product of the system operator cost per second, as set at block **822** in Figure **41**, and the communication session time as determined at Block **916** in Figure **53**. Block **992** then directs the processor to add the system operator cost value calculated at Block **990** to a system operator accounts table record of the type shown at **994** in Figure **59**. This record includes a system operator balance field **996** holding an accumulated charges balance. Referring to Figure **60** in the embodiment described, the system operator balance field **996** may hold the value **\$1,000.02** for example, and to this value the system operator cost calculated at Block **990** is added when the processor executes Block **992** of Figure **56B**.

25
30 Ultimately, the final reseller balance **986** in Figure **58** holds a number representing an amount owed to the reseller by the system operator and the

-71-

system operator balance **996** of Figure **59** holds a number representing an amount of profit for the system operator.

5 While specific embodiments of the invention have been described and illustrated, such embodiments should be considered illustrative of the invention only and not as limiting the invention as construed in accordance with the accompanying claims.

-72-

What is claimed is:

- 5 **1.** A process for operating a call routing controller to facilitate communication between callers and callees in a system comprising a plurality of nodes with which callers and callees are associated, the process comprising:

10 in response to initiation of a call by a calling subscriber, receiving a caller identifier and a callee identifier;

15 using call classification criteria associated with the caller identifier to classify the call as a public network call or a private network call;

20 producing a routing message identifying an address, on the private network, associated with the callee when the call is classified as a private network call; and

25 producing a routing message identifying a gateway to the public network when the call is classified as a public network call.

- 30 **2.** The process of claim **1** further comprising receiving a request to establish a call, from a call controller in communication with a caller identified by said callee identifier.

- 35 **3.** The process of claim **1** wherein using said call classification criteria comprises searching a database to locate a record identifying calling attributes associated with a caller identified by said caller identifier.

- 40 **4.** The process of claim **3** wherein locating a record comprises locating a caller dialing profile comprising a username associated with said caller, a domain associated with said caller, and at least one calling attribute.

-73-

- 5
6. The process of claim 4 wherein comparing comprises determining whether said callee identifier includes a portion that matches an IDD associated with said caller dialing profile.
- 10
7. The process of claim 4 wherein comparing comprises determining whether said callee identifier includes a portion that matches an NDD associated with said caller dialing profile.
- 15
8. The process of claim 4 wherein comparing comprises determining whether said callee identifier includes a portion that matches an area code associated with said caller dialing profile.
- 20
9. The process of claim 4 wherein comparing comprises determining whether said callee identifier has a length within a range specified in said caller dialing profile.
- 25
10. The process of claim 4 further comprising formatting said callee identifier into a pre-defined digit format to produce a re-formatted callee identifier.
- 30
11. The process of claim 10 wherein formatting comprises removing an international dialing digit from said callee identifier, when said callee identifier begins with a digit matching an international dialing digit specified by said caller dialing profile associated with said caller.
12. The process of claim 10 wherein formatting comprises removing a national dialing digit from said callee identifier and prepending a caller

-74-

country code to said callee identifier when said callee identifier begins with a national dialing digit.

- 5 **13.** The process of claim **10** wherein formatting comprises prepending a caller country code to said callee identifier when said callee identifier begins with digits identifying an area code specified by said caller dialing profile.
- 10 **14.** The process of claim **10** wherein formatting comprises prepending a caller country code and area code to said callee identifier when said callee identifier has a length that matches a caller dialing number format specified by said caller dialing profile and only one area code is specified as being associated with said caller in said caller dialing profile.
- 15 **15.** The process of claim **10** further comprising classifying said call as a private network call when said re-formatted callee identifier identifies a subscriber to the private network.
- 20 **16.** The process of claim **10** further comprising determining whether said callee identifier complies with a pre-defined username format and if so classifying the call as a private network call.
- 25 **17.** The process of claim **10** further comprising causing a database of records to be searched to locate a direct in dial (DID) bank table record associating a public telephone number with said reformatted callee identifier and if said DID bank table record is found classifying the call as a private network call and if a DID bank table record is not found classifying the call as a public network call.
- 30 **18.** The process of claim **17** wherein producing said routing message identifying a node on the private network comprises setting a callee

-75-

identifier in response to a username associated with said DID bank table record.

- 5
- 19.** The process of claim **18** wherein producing said routing message comprises determining whether a node associated with the reformatted callee identifier is the same as a node associated the caller identifier.
- 10
- 20.** The process of claim **19** wherein determining whether a node associated with the reformatted callee identifier is the same as a node associated the caller identifier comprises determining whether a prefix of said re-formatted callee identifier matches a corresponding prefix of a username associated with said caller dialing profile.
- 15
- 21.** The process of claim **20** wherein when said node associated with said caller is not the same as the node associated with the callee, producing a routing message including said caller identifier, said reformatted callee identifier and an identification of a private network node associated with said callee and communicating said routing message to a call controller.
- 20
- 22.** The process of claim **19** wherein when said node associated with said caller is the same as the node associated with said callee, determining whether to perform at least one of the following: forward said call to another party, block the call and direct the caller to a voicemail server associated with the callee.
- 25
- 23.** The process of claim **22** wherein producing said routing message comprises producing a routing message having an identification of at least one of the callee identifier, an identification of a party to whom the call should be forwarded and an identification of a voicemail server associated with the callee.
- 30

-76-

24. The process of claim **23** further comprising communicating said routing message to a call controller.
- 5 25. The process of claim **10** wherein producing a routing message identifying a gateway to the public network comprises searching a database of route records associating route identifiers with dialing codes to find a route record having a dialing code having a number pattern matching at least a portion of said reformatted callee identifier.
- 10 26. The process of claim **25** further comprising searching a database of supplier records associating supplier identifiers with said route identifiers to locate at least one supplier record associated with said route identifier associated with said route record having a dialing code having a number pattern matching at least a portion of said reformatted
- 15 callee identifier.
27. The process of claim **26** further comprising loading a routing message buffer with the reformatted callee identifier and an identification of specific routes associated respective ones of the supplier records associated with said route record and loading said routing message
- 20 buffer with a time value and a timeout value.
28. The process of claim **27** further comprising communicating a routing message comprising the contents of said routing message buffer to a
- 25 call controller.
29. The process of claim **4** further comprising causing said dialing profile to include a maximum concurrent call value and a concurrent call count value and causing said concurrent call count value to be incremented
- 30 when the user associated with said dialing profile initiates a call and causing said concurrent call count value to be decremented when a call with said user associated with said dialing profile is ended.

-77-

30. A computer readable medium encoded with codes for directing a processor to execute the method of any one of claims **1-29**.

5 **31.** A call routing apparatus for facilitating communications between callers and callees in a system comprising a plurality of nodes with which callers and callees are associated, the apparatus comprising:

10 receiving means for receiving a caller identifier and a callee identifier, in response to initiation of a call by a calling subscriber;

15 classifying means for classifying the call as a private network call or a public network call according to call classification criteria associated with the caller identifier;

20 means for producing a routing message identifying an address, on the private network, associated with the callee when the call is classified as a private network call; and

means for producing a routing message identifying a gateway to the public network if the call is classified as a public network call.

25 **32.** The apparatus of claim **31** wherein said receiving means is operably configured to receive a request to establish a call, from a call controller in communication with a caller identified by said callee identifier.

30 **33.** The apparatus of claim **31** further comprising searching means for searching a database comprising records associating calling attributes with subscribers to said private network to locate a record identifying calling attributes associated with a caller identified by said caller identifier.

-78-

- 5 **34.** The apparatus of claim **33** wherein said records include dialing profiles each comprising a username associated with said subscriber, an identification of a domain associated with said subscriber, and an identification of at least one calling attribute associated with said subscriber.
- 10 **35.** The apparatus of claim **34** wherein said call classification means is operably configured to compare calling attributes associated with said caller dialing profile with aspects of said callee identifier.
- 15 **36.** The apparatus of claim **35** wherein said calling attributes include an international dialing digit and wherein said call classification means is operably configured to determine whether said callee identifier includes a portion that matches an IDD associated with said caller dialing profile.
- 20 **37.** The apparatus of claim **34** wherein said calling attributes include an national dialing digit and wherein said call classification means is operably configured to determine whether said callee identifier includes a portion that matches an NDD associated with said caller dialing profile.
- 25 **38.** The apparatus of claim **34** wherein said calling attributes include an area code and wherein said call classification means is operably configured to determine whether said callee identifier includes a portion that matches an area code associated with said caller dialing profile.
- 30 **39.** The apparatus of claim **34** wherein said calling attribute include a number length range and wherein said call classification means is operably configured to determine whether said callee identifier has a length within a range specified in said caller dialing profile.

-79-

5
40. The apparatus of claim 34 further comprising formatting means for formatting said callee identifier into a pre-defined digit format to produce a re-formatted callee identifier.

10
41. The apparatus of claim 40 wherein said formatting means is operably configured to remove an international dialing digit from said callee identifier, when said callee identifier begins with a digit matching an international dialing digit specified by said caller dialing profile associated with said caller.

15
42. The apparatus of claim 40 wherein said formatting means is operably configured to remove a national dialing digit from said callee identifier and prepend a caller country code to said callee identifier when said callee identifier begins with a national dialing digit.

20
43. The apparatus of claim 40 wherein said formatting means is operably configured to prepend a caller country code to said callee identifier when said callee identifier begins with digits identifying an area code specified by said caller dialing profile.

25
44. The apparatus of claim 40 wherein said formatting means is operably configured to prepend a caller country code and area code to said callee identifier when said callee identifier has a length that matches a caller dialing number format specified by said caller dialing profile and only one area code is specified as being associated with said caller in said caller dialing profile.

30
45. The apparatus of claim 40 wherein said classifying means is operably configured to classifying said call as a private network call when said re-formatted callee identifier identifies a subscriber to the private network.

-80-

- 5
46. The apparatus of claim **40** wherein said classifying means is operably configured to classify the call as a private network call when said callee identifier complies with a pre-defined username format.
- 10
47. The apparatus of claim **40** further comprising searching means for searching a database of records to locate a direct in dial (DID) bank table record associating a public telephone number with said reformatted callee identifier and wherein said classifying means is operably configured to classify the call as a private network call when said DID bank table record is found and to classify the call as a public network call when a DID bank table record is not found
- 15
48. The apparatus of claim **47** wherein said private network routing message producing means is operably configured to produce a routing message having a callee identifier set according to a username associated with said DID bank table record.
- 20
49. The apparatus of claim **48** wherein said private network routing message producing means is operably configured to determine whether a node associated with the reformatted callee identifier is the same as a node associated the caller identifier.
- 25
50. The apparatus of claim **49** wherein said private network routing means includes means for determining whether a prefix of said re-formatted callee identifier matches a corresponding prefix of a username associated with said caller dialing profile.
- 30
51. The apparatus of claim **50** wherein said private network routing message producing means is operably configured to produce a routing message including said caller identifier, said reformatted callee identifier and an identification of a private network node associated with

-81-

said callee and communicating said routing message to a call controller.

- 5
- 52.** The apparatus of claim **49** wherein said private network routing message producing means is operably configured to perform at least one of the following: forward said call to another party, block the call and direct the caller to a voicemail server associated with the callee, when said node associated with said caller is the same as the node associated with said callee.
- 10
- 53.** The apparatus of claim **52** wherein said means for producing said private network routing message is operably configured to produce a routing message having an identification of at least one of the callee identifier, an identification of a party to whom the call should be forwarded and an identification of a voicemail server associated with the callee.
- 15
- 54.** The apparatus of claim **53** further comprising means for communicating said routing message to a call controller.
- 20
- 55.** The apparatus of claim **40** wherein said means for producing a public network routing message identifying a gateway to the public network comprises means for searching a database of route records associating route identifiers with dialing codes to find a route record having a dialing code having a number pattern matching at least a portion of said reformatted callee identifier.
- 25
- 56.** The apparatus of claim **55** further comprising means for searching a database of supplier records associating supplier identifiers with said route identifiers to locate at least one supplier record associated with said route identifier associated with said route record having a dialing
- 30

-82-

code having a number pattern matching at least a portion of said reformatted callee identifier.

5 **57.** The apparatus of claim **56** further comprising a routing message buffer and means for loading said routing message buffer with the reformatted callee identifier and an identification of specific routes associated respective ones of the supplier records associated with said route record and loading said routing message buffer with a time value and a timeout value.

10 **58.** The apparatus of claim **57** further comprising means for communicating a routing message comprising the contents of said routing message buffer to a call controller.

15 **59.** The apparatus of claim **34** further comprising means for causing said dialing profile to include a maximum concurrent call value and a concurrent call count value and for causing said concurrent call count value to be incremented when the user associated with said dialing profile initiates a call and for causing said concurrent call count value to be decremented when a call with said user associated with said dialing profile is ended.

Data Structure

25 **60.** A data structure for access by an apparatus for producing a routing message for use by a call routing controller in a communications system, the data structure comprising:

30 dialing profile records comprising fields for associating with respective subscribers to the system:

 a subscriber user name

-83-

direct-in-dial records comprising fields for associating with respective subscriber usernames:

5 a user domain; and

a direct-in-dial number;

10 prefix to node records comprising fields for associating with at least a portion of said respective subscriber usernames:

a node address of a node in said system,

15 whereby a subscriber name can be used to find a user domain, at least a portion of said a subscriber name can be used to find a node with which the subscriber identified by the subscriber name is associated, and a user domain and subscriber name can be located in response to a direct-in-dial number.

20 **61.** A data structure for access by an apparatus for producing a routing message for use by a call routing controller in a communications system, the data structure comprising:

25 master list records comprising fields for associating a dialing code with respective master list identifiers; and

supplier list records linked to master list records by said master list identifiers, and supplier list records comprising fields for associating with a communications services supplier:

30 a supplier id;

a master list id;

a route identifier; and

5 a billing rate code,

whereby communications services suppliers are associated with dialing codes, such that dialing codes can be used to locate suppliers capable of providing a communications link associated with a given dialing code.

10

62. A method of determining a time to permit a communication session to be conducted, the method comprising:

15 calculating a cost per unit time;

calculating a first time value as a sum of a free time attributed to a participant in the communication session and the quotient of a funds balance held by said participant to said cost per unit time value; and

20

producing a second time value in response to said first time value and a billing pattern associated with said participant, said billing pattern including first and second billing intervals and said second time value being said time to permit a communication session to be conducted.

25

63. The method of claim **62** wherein calculating said first time value comprises retrieving a record associated with said participant and obtaining from said record at least one of said free time and said funds balance.

30

-85-

5 **64.** The method of claim **62** wherein producing said second time value comprises producing a remainder value representing a portion of said second billing interval remaining after dividing said second billing interval into a difference between said first time value and said first billing interval.

10 **65.** The method of claim **64** wherein producing said second time value comprises setting a difference between said first time value and said remainder as said second time value.

15 **66.** The method of claim **62** further comprising setting said second time value to zero when said remainder is greater than zero and said first time value is less than said free time associated with said participant.

20 **67.** The method of claim **62** wherein calculating said cost per unit time comprises:

 locating a record in a database, said record comprising a markup type indicator, a markup value and a billing pattern;

 and

 setting a reseller rate equal to the sum of said markup value and said buffer rate.

25 **68.** The method of claim **67** wherein locating said record in a database comprises locating at least one of:

30 a record associated with a reseller and a route associated with the reseller;

 a record associated with the reseller; and

a default reseller markup record.

5 **69.** The method of claim **67** wherein calculating said cost per unit time value further comprises locating at least one of:

10 an override record specifying a route cost per unit time amount associated with a route associated with the communication session;

15 a reseller record associated with a reseller of said communications session, said reseller record specifying a reseller cost per unit time associated with said reseller for the communication session;

 a default operator markup record specifying a default cost per unit time.

20 **70.** The method of claim **69** further comprising setting as said cost per unit time the sum of said reseller rate and at least one of said route cost per unit time, said reseller cost per unit time and said default cost per unit time.

25 **71.** The method of claim **69** further comprising receiving a communication session time representing a duration of said communication session and incrementing a reseller balance by the product of said reseller rate and said communication session time.

30 **72.** The method of claim **69** further comprising receiving a communication session time representing a duration of said communication session and incrementing a system operator balance by a product of said buffer rate and said communication session time.

-87-

73. A computer readable medium encoded with instructions for directing a processor circuit to execute the method of any one of claims **62-72**.

5 **74.** An apparatus for determining a time to permit a communication session to be conducted, the apparatus comprising:

a processor circuit;

10 a computer readable medium coupled to the processor circuit and encoded with instructions for directing the processor circuit to:

calculate a cost per unit time for the communication session;

15

calculate a first time value as a sum of a free time attributed to a participant in the communication session and the quotient of a funds balance held by said participant to said cost per unit time value; and

20

produce a second time value in response to said first time value and a billing pattern associated with said participant, said billing pattern including first and second billing intervals and said second time value being said time to permit a communication session to be conducted.

25

75. The apparatus of claim **74** wherein said instructions include instructions for directing the processor circuit to retrieve a record associated with said participant and obtain from said record at least one of said free time and said funds balance.

30

-89-

80. The apparatus of claim **79** wherein said instructions for directing the processor circuit to locate said record in a database comprises instruction for directing the processor circuit to locate at least one of:

5 a record associated with a reseller and a route associated with the reseller;

 a record associated with the reseller;

10 a default reseller markup record;

81. The apparatus of claim **79** wherein said instructions for directing the processor circuit to calculate said cost per unit time value further comprises instructions for directing the processor circuit to locate at least one of:

15

 an override record specifying a route cost per unit time amount associated with a route associated with the communication session;

20

 a reseller record associated with a reseller of said communications session, said reseller record specifying a reseller cost per unit time associated with said reseller for the communication session;

25

 a default operator markup record specifying a default cost per unit time.

82. The apparatus of claim **81** wherein said instructions include instructions for directing the processor circuit to set as said cost per unit time the sum of said reseller rate and at least one of said route

30

-90-

cost per unit time, said reseller cost per unit time and said default cost per unit time.

5 **83.** The apparatus of claim **81** wherein said instructions include instructions for directing the processor circuit to receive a communication session time representing a duration of said communication session and increment a reseller balance by the product of said reseller rate and said communication session time.

10 **84.** The apparatus of claim **81** wherein said instructions include instructions for directing the processor circuit to receive a communication session time representing a duration of said communication session and increment a system operator balance by a product of said buffer rate and said communication session time.

15 **Attributing Charges to a User**

20 **85.** A process for attributing charges for communications services, the process comprising:

determining a first chargeable time in response to a communication session time and a pre-defined billing pattern;

25 determining a user cost value in response to said first chargeable time and a free time value associated with a user of said communications services;

30 changing an account balance associated with said user in response to a user cost per unit time.

-91-

changing an account balance associated with a reseller of said communications services in response to a reseller cost per unit time and said communication session time; and

5 changing an account balance associated with an operator of said communications services in response to an operator cost per unit time and said communication session time.

10 **86.** The process of claim **85** wherein determining said first chargeable time comprises:

locating at least one of:

15 an override record specifying a route cost per unit time and billing pattern associated with a route associated with the communication session;

20 a reseller record associated with a reseller of said communications session, said reseller record specifying a reseller cost per unit time and billing pattern associated with said reseller for the communication session; and

25 a default record specifying a default cost per unit time and billing pattern; and

setting as said pre-defined billing pattern the billing pattern of the record located,

30 wherein the billing pattern of the record located comprises a first billing interval and a second billing interval.

-92-

5 **87.** The process of claim **85** wherein determining said first chargeable time comprises setting said first chargeable time equal to said first billing interval when said communication session time is less than or equal to said first billing interval.

10 **88.** The process of claim **86** wherein determining said first chargeable time comprises producing a remainder value representing a portion of said second billing interval remaining after dividing said second billing interval into a difference between communication session time and said first interval when said communication session time is greater than said communication session time; and

15 setting said first chargeable time to a difference between said communication session time and said remainder when said remainder is greater than zero; and

 setting said first chargeable time to said communication session time when said remainder is not greater than zero.

20 **89.** The process of claim **88** further comprising determining a second chargeable time in response to said first chargeable time and said free time value associated with said user of said communications services when said first chargeable time is greater than or equal to said free time value associated with said user of said communications services.

25 **90.** The process of claim **89** wherein determining said second chargeable time comprises setting said second chargeable time to a difference between said first chargeable time.

30 **91.** The process of claim **89** further comprising resetting said free time value associated with the user to zero when said first chargeable time

-93-

is greater than or equal to said free time value associated with said user of said communications services.

- 5 **92.** The process of claim **90** wherein changing an account balance associated with the user comprises calculating a user cost value in response to said second chargeable time and said user cost per unit time.
- 10 **93.** The process of claim **92** further comprising changing a user free cost balance in response to said user cost value.
- 15 **94.** The process of claim **85** further comprising setting said user cost to zero when said first chargeable time is less than said free time value associated with the user.
- 95.** The process of claim **85** further comprising changing a user free time balance in response to said first chargeable time.
- 20 **96.** A computer readable medium encoded with instructions for directing a processor circuit to execute the process of any one of claims **85-95**.
- 97.** An apparatus for attributing charges for communications services, the apparatus comprising:
- 25 a processor circuit;
- a computer readable medium in communication with the processor circuit and encoded with instructions for directing said processor circuit to;
- 30 determine a first chargeable time in response to a communication session time and a pre-defined billing pattern;

-94-

determine a user cost value in response to said first chargeable time and a free time value associated with a user of said communications services;

5

change an account balance associated with said user in response to a user cost per unit time.

change an account balance associated with a reseller of said communications services in response to a reseller cost per unit time and said communication session time; and

10

change an account balance associated with an operator of said communications services in response to an operator cost per unit time and said communication session time.

15

98. The apparatus of claim **97** wherein said instructions for directing the processor circuit to determine said first chargeable time comprises:

20

instructions for causing said processor circuit to communicate with a database to locate at least one of:

an override record specifying a route cost per unit time and billing pattern associated with a route associated with the communication session;

25

a reseller record associated with a reseller of said communications session, said reseller record specifying a reseller cost per unit time and billing pattern associated with said reseller for the communication session; and

30

-95-

a default record specifying a default cost per unit time and billing pattern; and

instructions for setting as said pre-defined billing pattern the billing pattern of the record located,

wherein the billing pattern of the record located comprises a first billing interval and a second billing interval.

10 **99.** The apparatus of claim **97** wherein said instructions causing the processor circuit to determine said first chargeable time comprises instructions for directing the processor circuit to set said first chargeable time equal to said first billing interval when said communication session time is less than or equal to said first billing interval.

15

100. The apparatus of claim **98** wherein said instructions for causing the processor circuit to determine said first chargeable time comprises instructions for producing a remainder value representing a portion of said second billing interval remaining after dividing said second billing interval into a difference between communication session time and said first interval when said communication session time is greater than said communication session time; and

25 instructions for causing the processor circuit to set said first chargeable time to a difference between said communication session time and said remainder when said remainder is greater than zero; and

30 instructions for causing the processor circuit to set said first chargeable time to said communication session time when said remainder is not greater than zero.

-96-

- 5 **101.** The apparatus of claim **100** wherein the computer readable medium is further encoded with instructions for causing the processor circuit to determine a second chargeable time in response to said first chargeable time and said free time value associated with said user of said communications services when said first chargeable time is greater than or equal to said free time value associated with said user of said communications services.
- 10 **102.** The apparatus of claim **101** wherein said instructions for causing the processor circuit to determine said second chargeable time comprises instructions for causing the processor circuit to set said second chargeable time to a difference between said first chargeable time.
- 15 **103.** The apparatus of claim **101** wherein the computer readable medium is further encoded with instructions for causing the processor circuit to reset said free time value associated with the user to zero when said first chargeable time is greater than or equal to said free time value associated with said user of said communications services.
- 20 **104.** The apparatus of claim **102** wherein said instructions for causing the processor circuit to change an account balance associated with the user comprises instructions for causing the processor circuit to calculate a user cost value in response to said second chargeable time and said user cost per unit time.
- 25 **105.** The apparatus of claim **104** wherein the computer readable medium is further encoded with instructions for causing the processor circuit to change a user free cost balance in response to said user cost value.
- 30 **106.** The apparatus of claim **97** wherein the computer readable medium is further encoded with instructions for causing the processor circuit to

-97-

set said user cost to zero when said first chargeable time is less than said free time value associated with the user.

- 5 **107.** The apparatus of claim **97** wherein the computer readable medium is further encoded with instructions for causing the processor circuit to change a user free time balance in response to said first chargeable time.

AMENDED CLAIMS**received by the International Bureau on 18 April 2008 (18.04.08)**

code having a number pattern matching at least a portion of said reformatted callee identifier.

5 **57.** The apparatus of claim **56** further comprising a routing message buffer and means for loading said routing message buffer with the reformatted callee identifier and an identification of specific routes associated respective ones of the supplier records associated with said route record and loading said routing message buffer with a time value and a timeout value.

10 **58.** The apparatus of claim **57** further comprising means for communicating a routing message comprising the contents of said routing message buffer to a call controller.

15 **59.** The apparatus of claim **34** further comprising means for causing said dialing profile to include a maximum concurrent call value and a concurrent call count value and for causing said concurrent call count value to be incremented when the user associated with said dialing profile initiates a call and for causing said concurrent call count value to be decremented when a call with said user associated with said dialing profile is ended.

Data Structure

25 **60.** A data structure for access by an apparatus for producing a routing message for use by a call routing controller in a communications system, the data structure comprising:

30 dialing profile records comprising fields for associating a subscriber username with respective subscribers to the system;

direct-in-dial records comprising fields for associating a user domain and a direct-in-dial number with respective subscriber usernames;

5 prefix to node records comprising fields for associating a node address of a node in said system with at least a portion of said respective subscriber usernames:

10 whereby said subscriber username can be used to find said user domain, at least a portion of said subscriber username can be used to find said node with which a subscriber identified by said subscriber user name is associated, and said user domain and said subscriber username can be located in response to said direct-in-dial number.

15

61. A data structure for access by an apparatus for producing a routing message for use by a call routing controller in a communications system, the data structure comprising:

20 master list records comprising fields for associating a dialing code with respective master list identifiers; and

25 supplier list records linked to said master list records by said master list identifiers, said supplier list records comprising fields for associating with a communications services supplier:

a supplier id;

30 a master list id;

a route identifier; and

a billing rate code,

whereby at least one communications service supplier is associated with said dialing code, such that said dialing code can be used to locate suppliers capable of providing a communications link associated with a given dialing code.

5
10
62. A method of determining a time to permit a communication session to be conducted, the method comprising:

calculating a cost per unit time;

calculating a first time value as a sum of a free time attributed to a participant in the communication session and the quotient of a funds balance held by said participant to said cost per unit time value; and

15
20
producing a second time value in response to said first time value and a billing pattern associated with said participant, said billing pattern including first and second billing intervals and said second time value being said time to permit a communication session to be conducted.

25
63. The method of claim **62** wherein calculating said first time value comprises retrieving a record associated with said participant and obtaining from said record at least one of said free time and said funds balance.

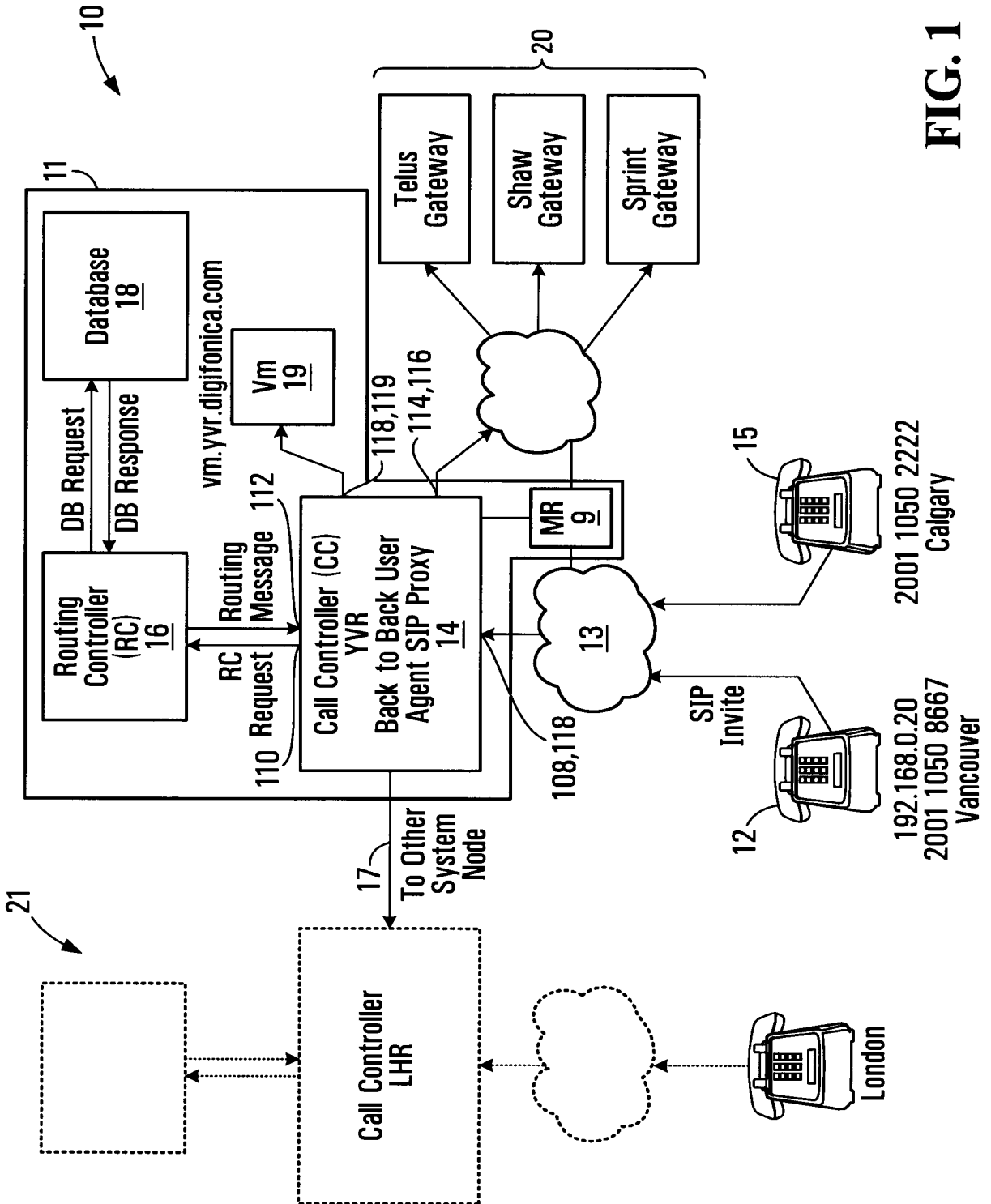

FIG. 1

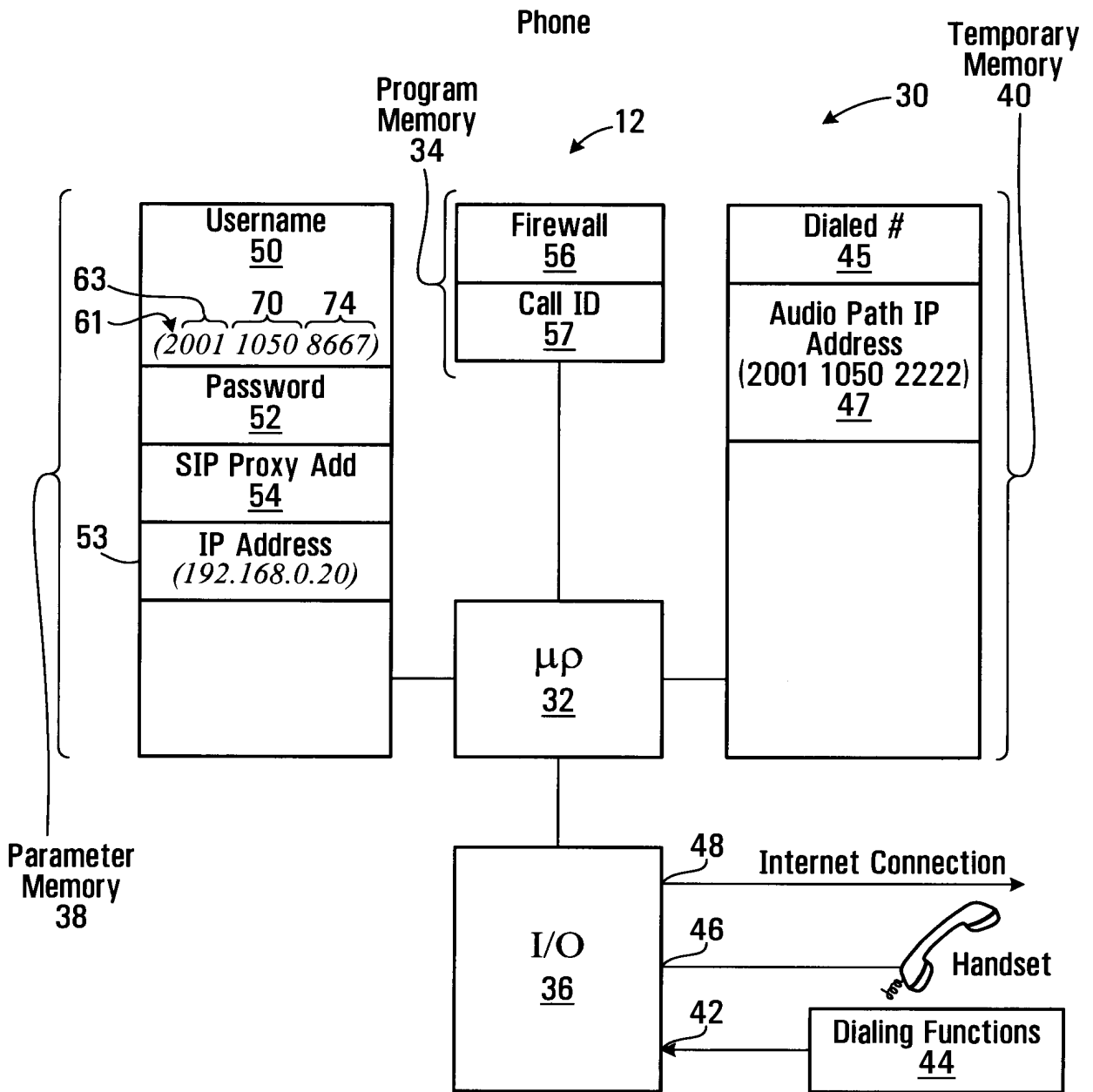

FIG. 2

3/32

SIP Invite Message

60 ~ Caller 2001 1050 8667
 62 ~ Callee 2001 1050 2222
 64 ~ Digest Parameters XXXXXXX
 65 ~ Call ID FF10@ 192.168.0.20
 67 ~ IP Address 192.168.0.20
 69 ~ Caller UDP Port 1

FIG. 3

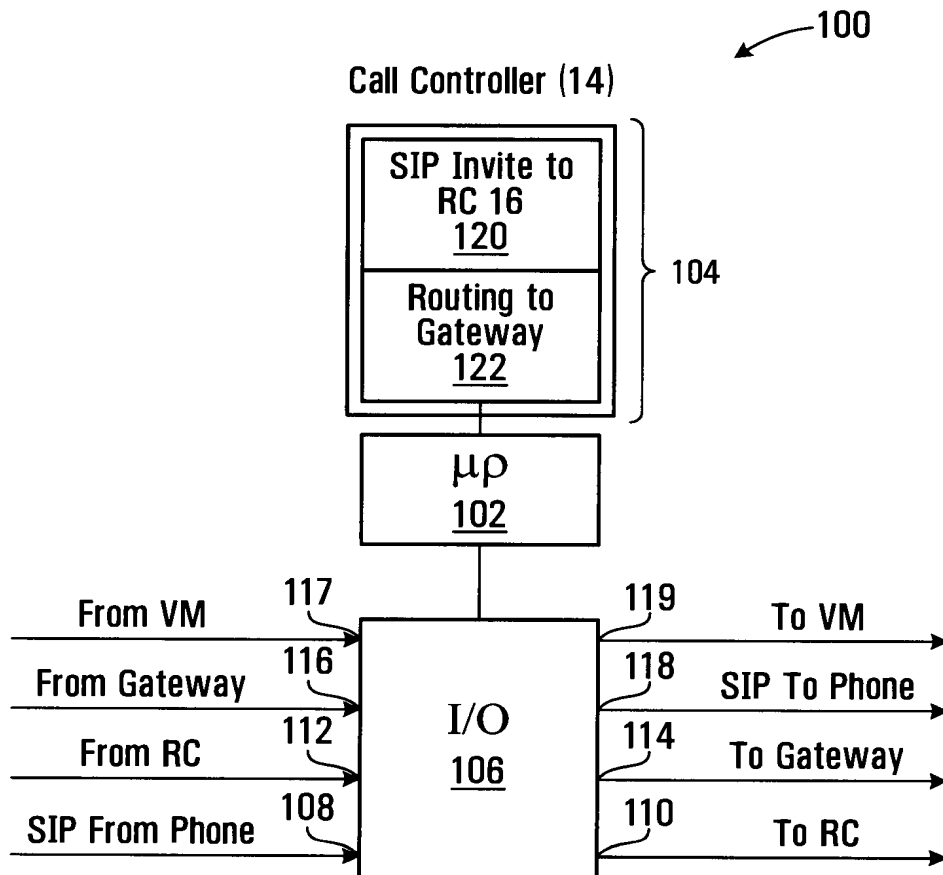

FIG. 4

4/32

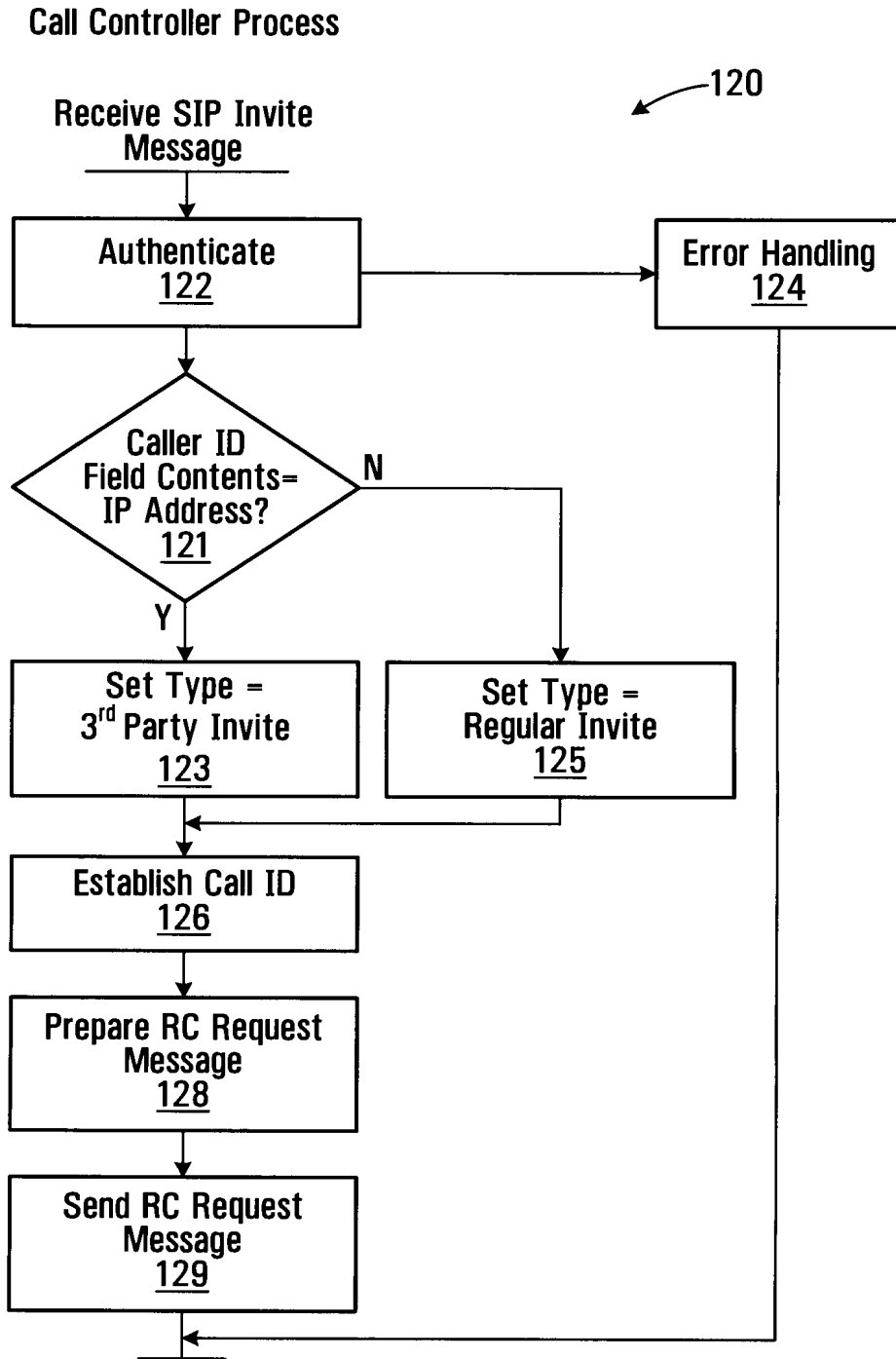

FIG. 5

5/32

150 ↙

RC Request Message

152 ~ Caller 2001 1050 8667
 154 ~ Callee 2001 1050 2222
 156 ~ Digest XXXXXXX
 158 ~ Call ID FF10@ 192.168.0.20
 160 ~ Type Subscriber

FIG. 6

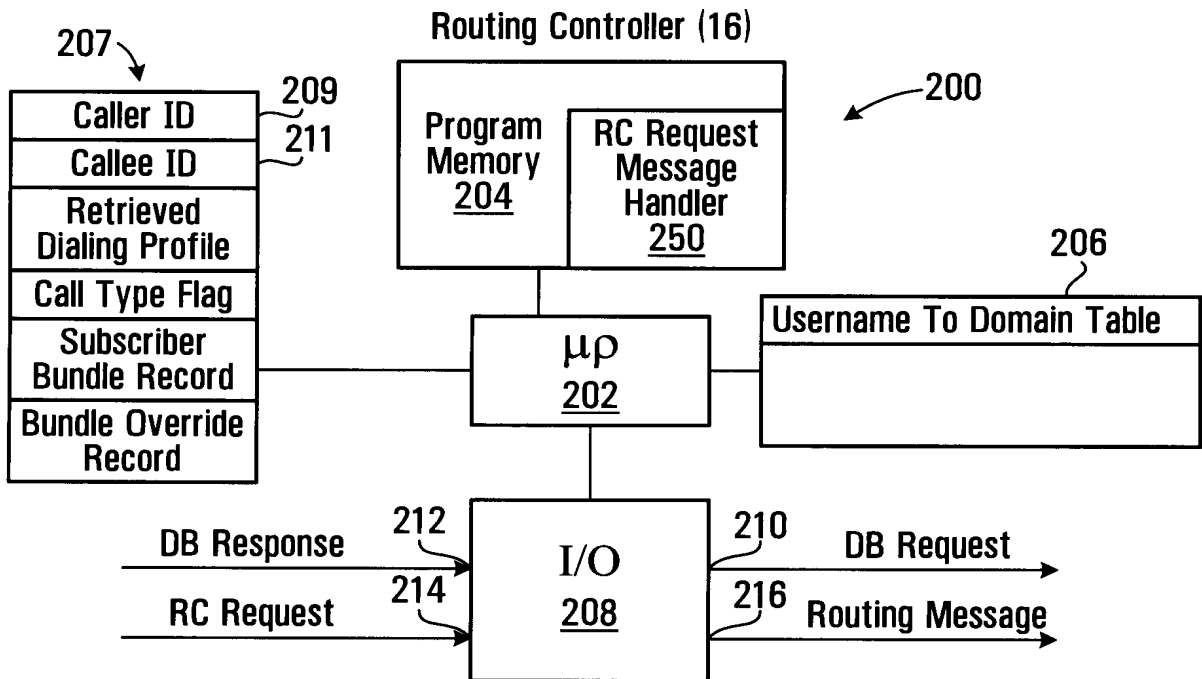

FIG. 7

6/32

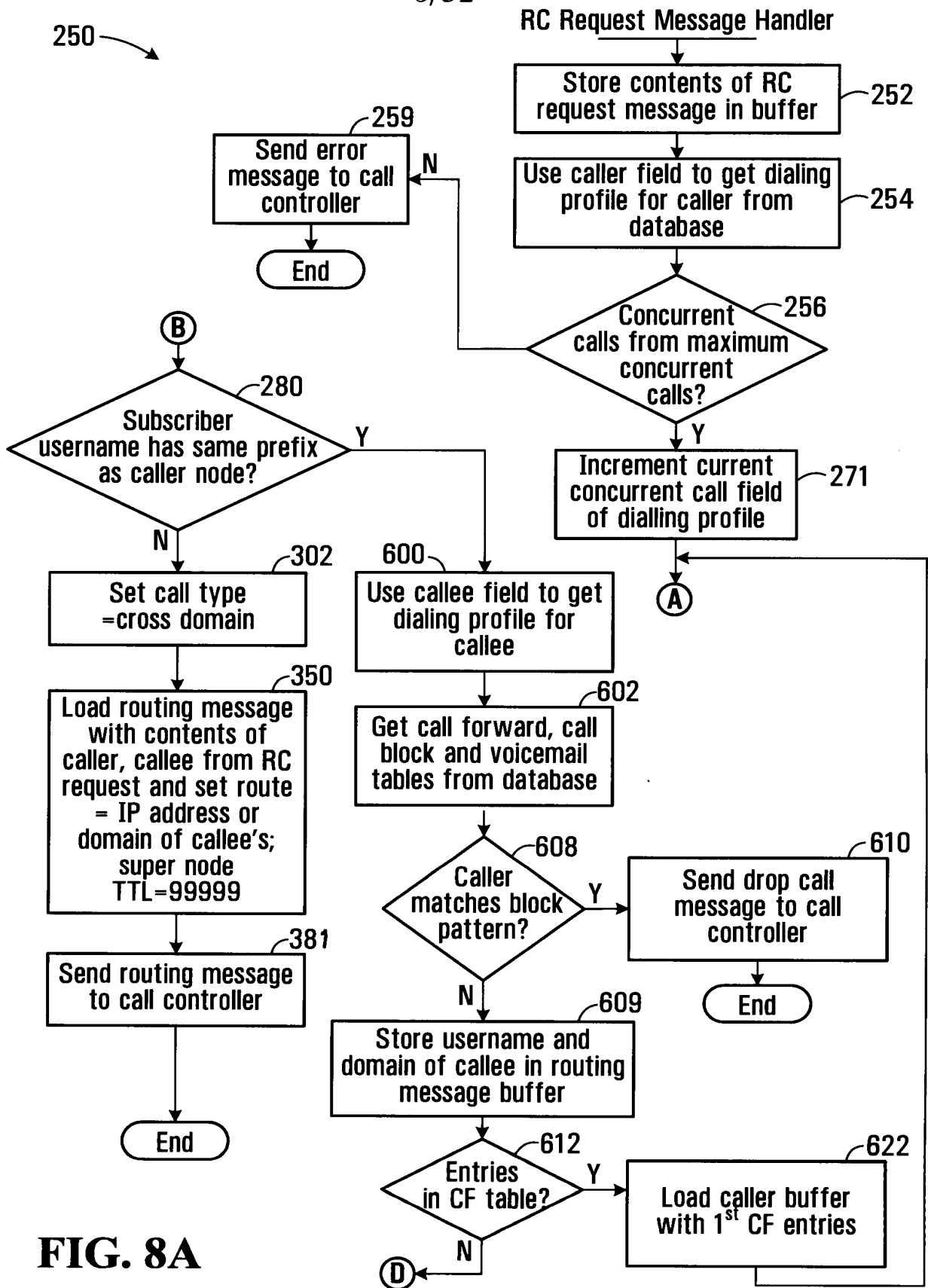

FIG. 8A

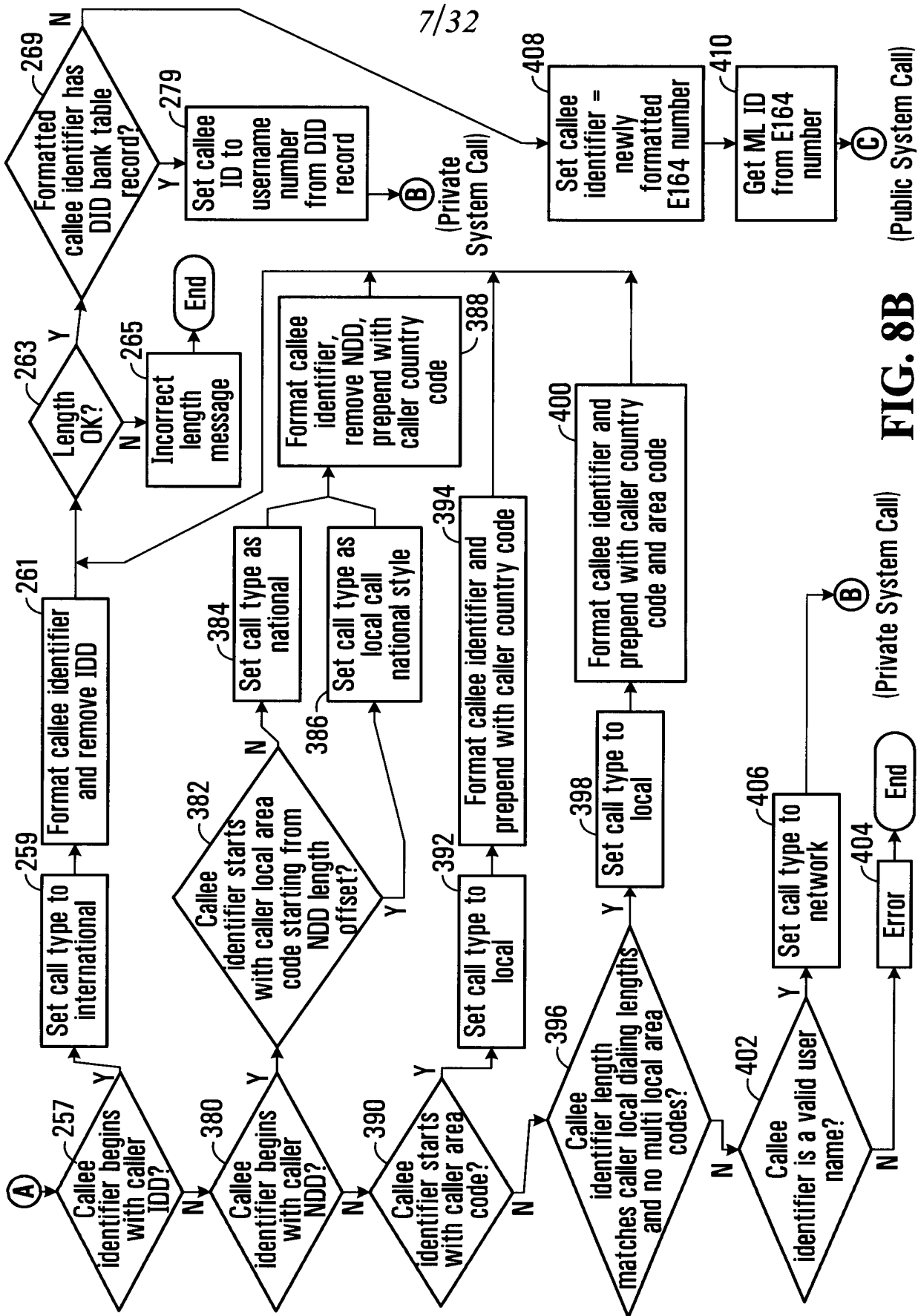

FIG. 8B (Public System Call)

(Private System Call)

8/32

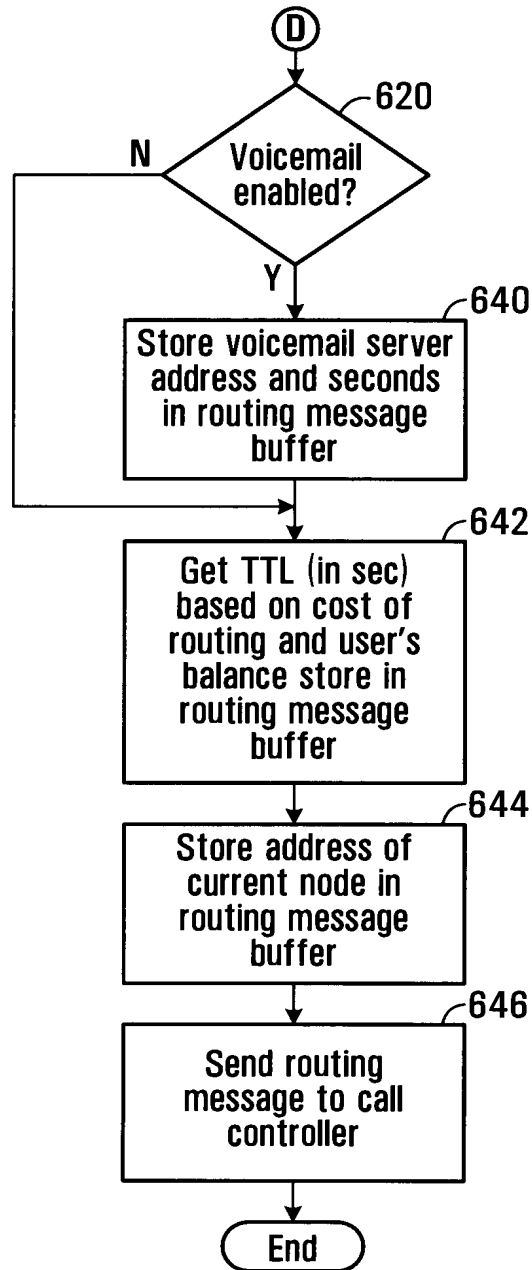

FIG. 8C

9/32

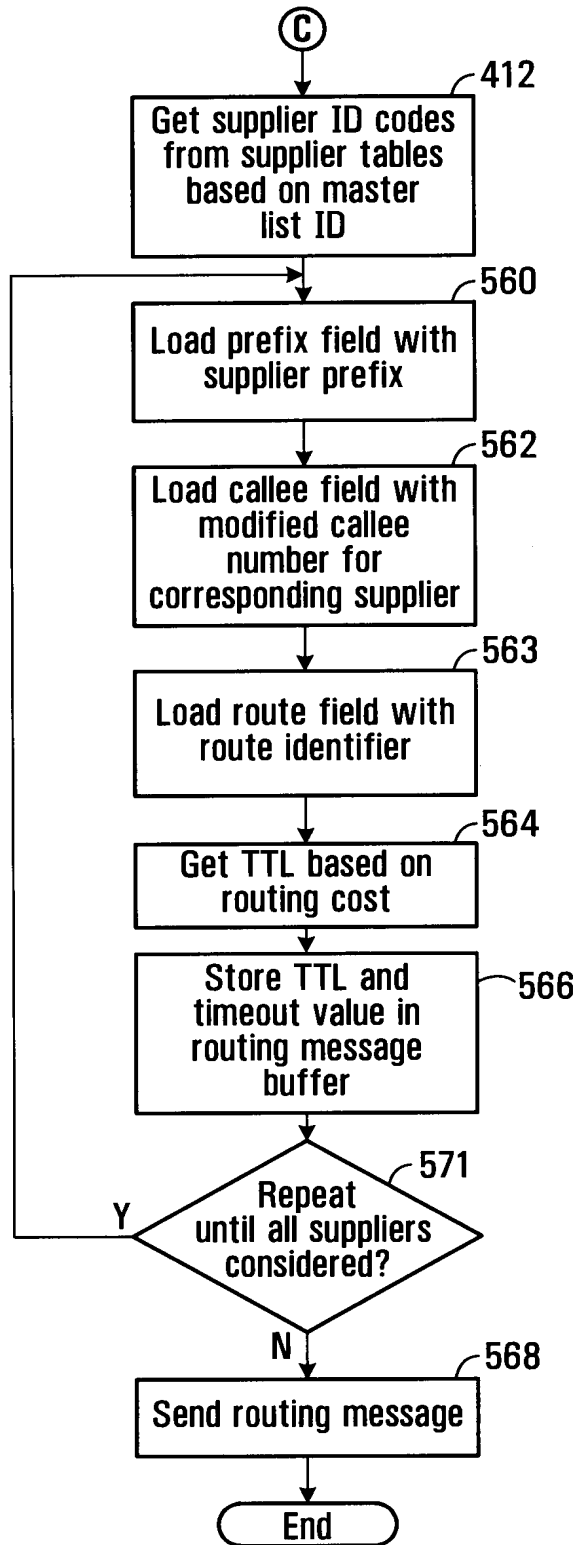

FIG. 8D

10/32

↖ 253

Dialing Profile for a User

258 ~ Username	Assigned on Subscription
260 ~ Domain	Domain Associated with User
262 ~ NDD	1
264 ~ IDD	011
266 ~ Country Code	1
267 ~ Local Area Codes	604;778
268 ~ Caller Minimum Local Length	10
270 ~ Caller Maximum Local Length	10
273 ~ Reseller	Retailer
275 ~ Maximum # of concurrent calls	Assigned on Subscription
277 ~ Current # of concurrent calls	Assigned on Subscription

FIG. 9

Dialing Profile for Caller (Vancouver Subscriber)

258 ~ Username	284	61	63	70	74	
260 ~ Domain	2001	1050	8667			↖ 276
262 ~ NDD	1	286	288	290		← 282
264 ~ IDD	011					
266 ~ Country Code	1					
267 ~ Local Area Codes	604;778 (Vancouver)					
268 ~ Caller Minimum Local Length	10					
270 ~ Caller Maximum Local Length	10					
273 ~ Reseller	Klondike					
275 ~ Maximum # of concurrent calls	5					
277 ~ Current # of concurrent calls	0					

FIG. 10

11/32

Callee Profile for Calgary Subscriber

Username	2001 1050 2222
Domain	sp.yvr.digifonica.com
NDD	1
IDD	011
Country Code	1
Local Area Codes	403 (Calgary)
Caller Minimum Local Length	7
Caller Maximum Local Length	10
Reseller	Deerfoot
Maximum # of concurrent calls	5
Current # of concurrent calls	0

FIG. 11**Callee Profile for London Subscriber**

Username	4401 1062 4444
Domain	sp.lhr.digifonica.com
NDD	0
IDD	00
Country Code	44
Local Area Codes	20 (London)
Caller Minimum Local Length	10
Caller Maximum Local Length	11
Reseller	Marble Arch
Maximum # of concurrent calls	5
Current # of concurrent calls	0

FIG. 12

12/32

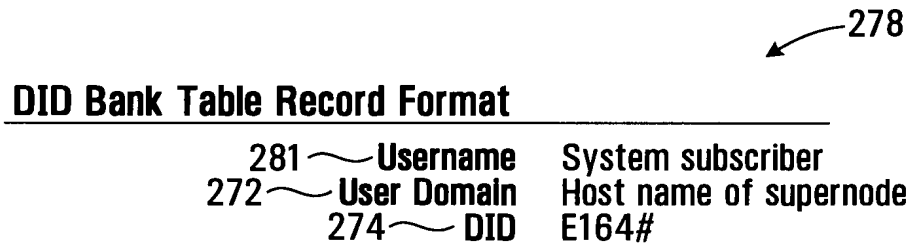

FIG. 13

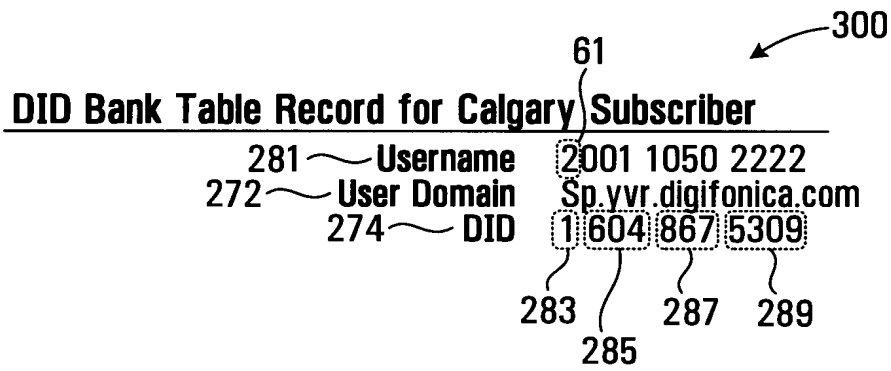

FIG. 14

13/32

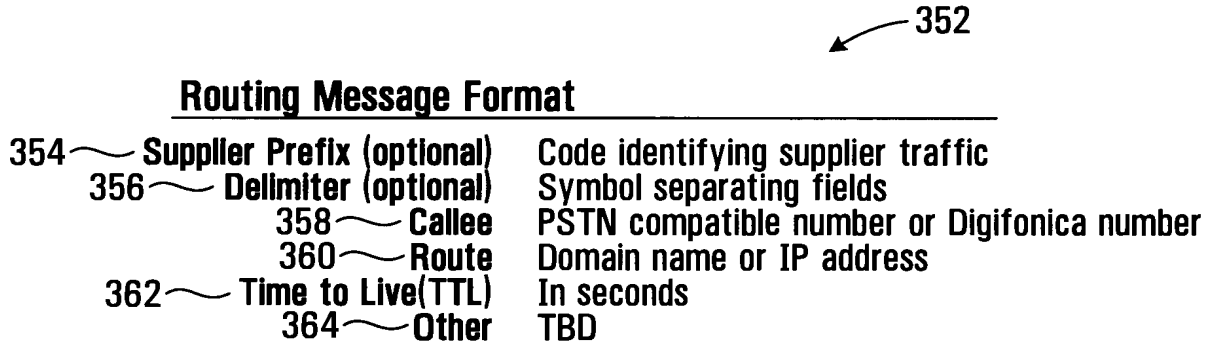

FIG. 15



FIG. 16



FIG. 17



FIG. 18

Master List Record Format

500 ~	ml_id	Alphanumeric
502 ~	Dialing code	Number Sequence
504 ~	Country code	The country code is the national prefix to be used when dialing TO a particular country FROM another country.
506 ~	Nat Sign #(Area Code)	Number Sequence
508 ~	Min Length	Numeric
510 ~	Max Length	Numeric
512 ~	NDD	The NDD prefix is the access code used to make a call WITHIN that country from one city to another (when calling another city in the same vicinity, this may not be necessary).
514 ~	IDD	The IDD prefix is the international prefix needed to dial a call FROM the country listed TO another country.
516 ~	Buffer rate	Safe change rate above the highest rate charged by suppliers

FIG. 19

Example: Master List Record with Populated Fields

ml_id	1019
Dialing code	1604
Country code	1
Nat Sign #(Area Code)	604
Min Length	7
Max Length	7
NDD	1
IDD	011
Buffer rate	\$0.009/min

FIG. 20

15/32

Suppliers List Record Format

540 ~	Sup_id	Name code
542 ~	MI_id	Numeric code
544 ~	Prefix (optional)	String identifying supplier's traffic #
546 ~	Specific Route	IP address
548 ~	NDD/IDD rewrite	
550 ~	Rate	Cost per second to Digifonica to use this route
551 ~	Timeout	Maximum time to wait for a response when requesting this gateway

FIG. 21**Telus Supplier Record**

Sup_id	2010 (Telus)
MI_id	1019
Prefix (optional)	4973#
Specific Route	72.64.39.58
NDD/IDD rewrite	011
Rate	\$0.02/min
Timeout	20

FIG. 22**Shaw Supplier Record**

Sup_id	2011 (Shaw)
MI_id	1019
Prefix (optional)	4974#
Specific Route	73.65.40.59
NDD/IDD rewrite	011
Rate	\$0.025/min
Timeout	30

FIG. 23**Sprint Supplier Record**

Sup_id	2012 (Sprint)
MI_id	1019
Prefix (optional)	4975#
Specific Route	74.66.41.60
NDD/IDD rewrite	011
Rate	\$0.03/min
Timeout	40

FIG. 24

16/32

Routing Message Buffer for Gateway Call

4973#0116048675309@72.64.39.58;tll=3600;to=20 ~ 570
 4974#0116048675309@73.65.40.59;tll=3600;to=30 ~ 572
 4975#0116048675309@74.66.41.60;tll=3600;to=40 ~ 574

FIG. 25

Call Block Table Record Format

604 ~ Username Digifonica #
 606 ~ Block Pattern PSTN compatible or Digifonica #

FIG. 26

Call Block Table Record for Calgary Callee

604 ~ Username of Callee 2001 1050 2222
 606 ~ Block Pattern 2001 1050 8664

FIG. 27

Call Forwarding Table Record Format for Callee

614 ~ Username of Callee Digifonica #
 616 ~ Destination Number Digifonica #
 618 ~ Sequence Number Integer indicating order to try this

FIG. 28

Call Forwarding Table Record for Calgary Callee

614 ~ Username of Callee 2001 1050 2222
 616 ~ Destination Number 2001 1055 2223
 618 ~ Sequence Number 1

FIG. 29

17/32

Voicemail Table Record Format

624	Username of Callee	Digifonica #
626	Vm Server	domain name
628	Seconds to Voicemail	time to wait before engaging voicemail
630	Enabled	yes/no

FIG. 30**Voicemail Table Record for Calgary Callee**

Username of Callee	2001 1050 2222
Vm Server	vm.yvr.digifonica.com
Seconds to Voicemail	20
Enabled	1

FIG. 31**Routing Message Buffer - Same Node**

650	200110502222@sp.yvr.digifonica.com;ttl=3600
652	200110552223@sp.yvr.digifonica.com;ttl=3600
654	vm.yvr.digifonica.com;20;ttl=60
656	sp.yvr.digifonica.com

FIG. 32

18/32

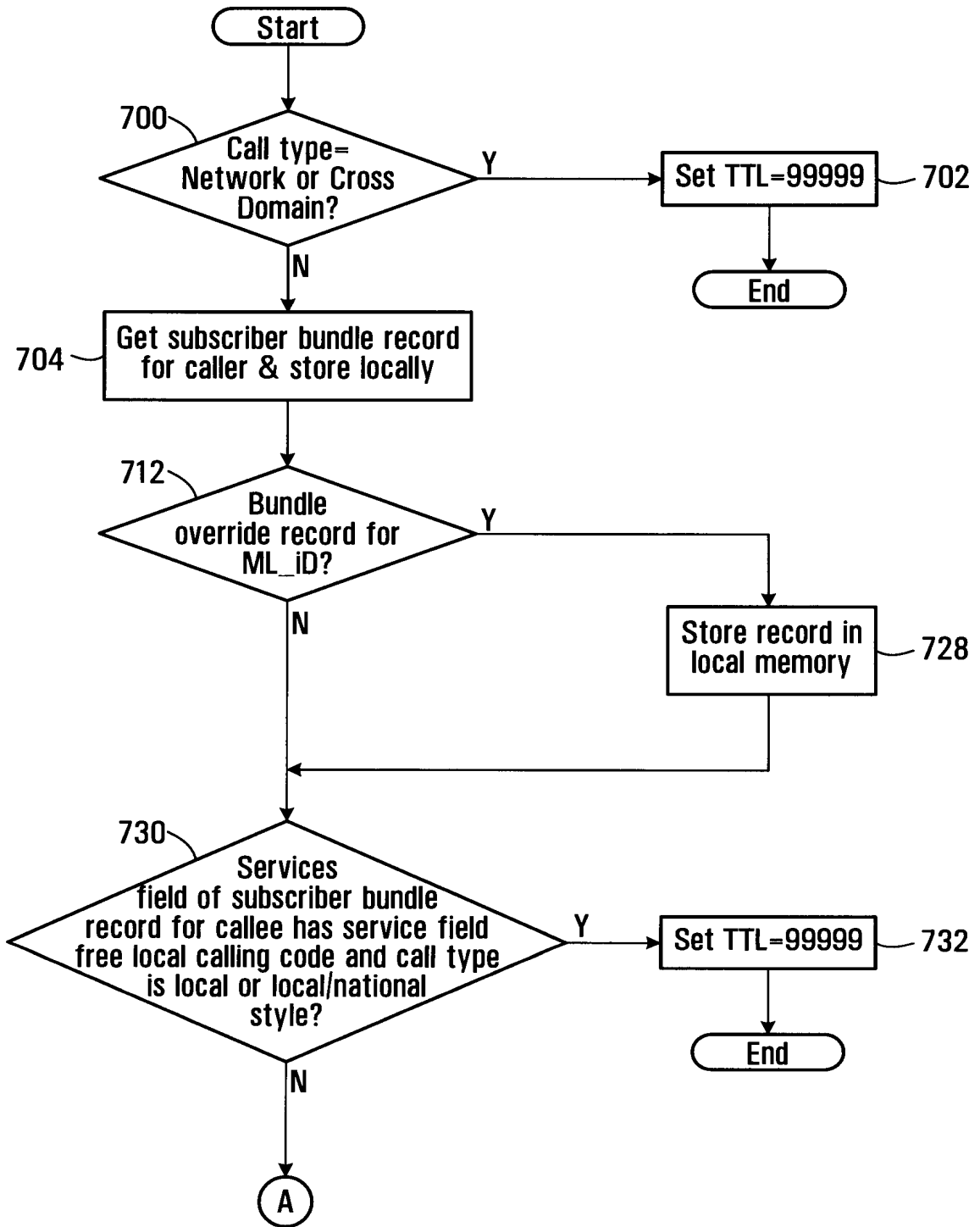

FIG. 33A

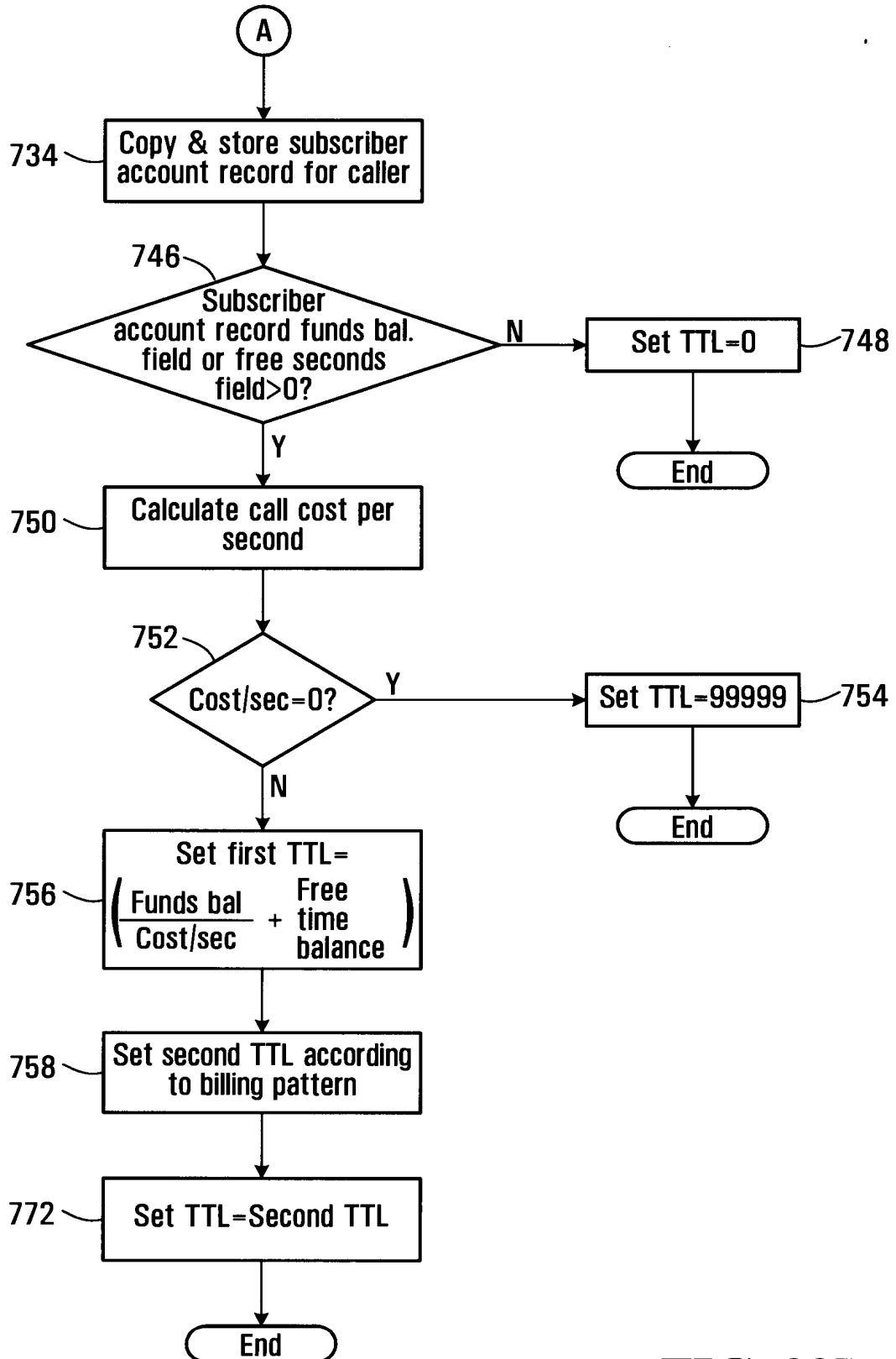



FIG. 33B

20/32

Subscriber Bundle Table Record

706



708 ~	Username	Subscriber username
710 ~	Services	Codes identifying service features (e.g. Free local calling; call blocking, voicemail)

FIG. 34

Subscriber Bundle Record for Vancouver Caller

708 ~	Username	2001 1050 8667
710 ~	Services	10; 14; 16

FIG. 35

Bundle Override Table Record

714



716 ~	ML_Id	Master list ID code
718 ~	Override type	Fixed; percent; cents
720 ~	Override value	real number representing value of override type
722 ~	Inc1	first level of charging (minimum # of seconds) charge
724 ~	Inc2	second level of charging

FIG. 36

Bundle Override Record for Located ML_id

726



716 ~	ML_Id	1019
718 ~	Override type	percent
720 ~	Override value	10.0
722 ~	Inc1	30 seconds
724 ~	Inc2	6 seconds

FIG. 37

21/32

736

Subscriber Account Table Record

738	Username	Subscriber username
740	Funds balance	real number representing \$ value of credit
742	Free time balance	integer representing # of free seconds

FIG. 38

744

Subscriber Account Record for Vancouver Caller

738	Username	2001 1050 8667
740	Funds balance	\$10.00
742	Free time balance	100

FIG. 39

22/32

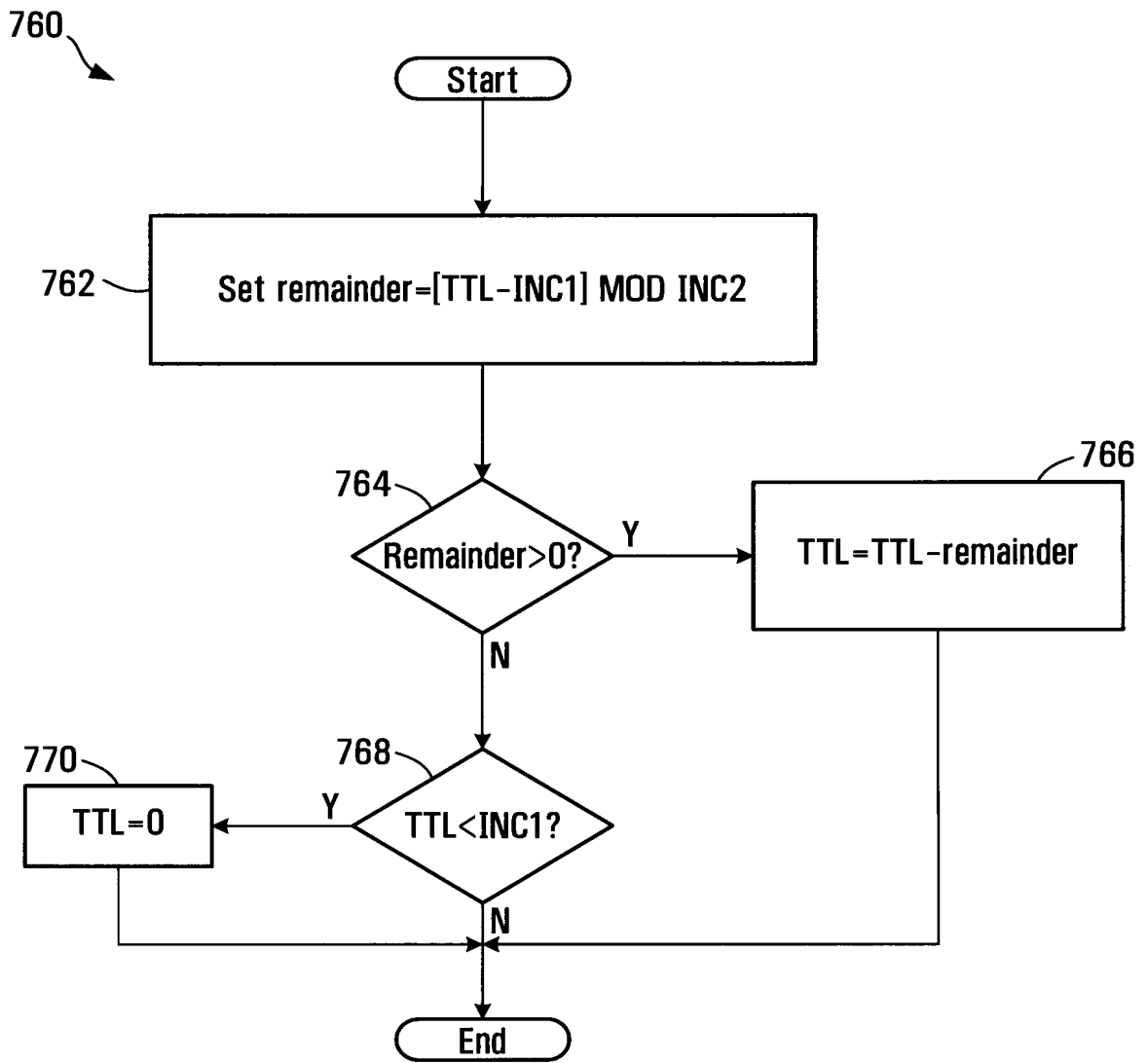

FIG. 40

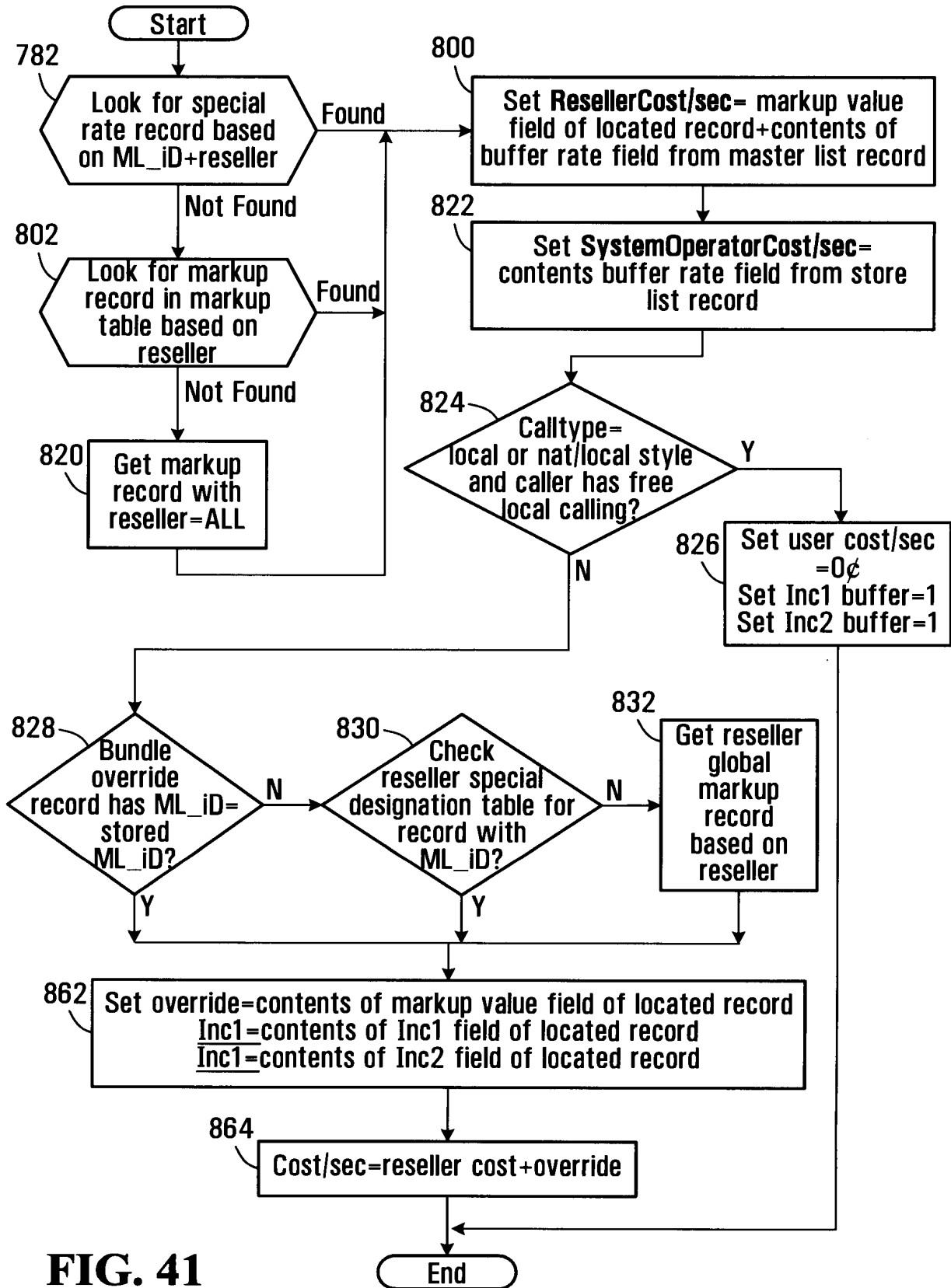

FIG. 41

784
↙

System Operator Special Rates Table Record

786	Reseller	retailer id
788	ML_Id	master list id
790	Markup Table	fixed; percent; cents
792	Markup Value	real number representing value of markup type
794	Inc1	first level of charging (minimum # of seconds) charge
796	Inc2	second level of charging

FIG. 42

798
↙

System Operator Special Rates Table Record for Klondike

786	Reseller	Klondike
788	ML_Id	1019
790	Markup Table	cents
792	Markup Value	\$0.001
794	Inc1	30
796	Inc2	6

FIG. 43

25/32

System Operator Markup Table Record

804 ↙

806	Reseller	reseller id code
808	Markup Table	fixed; percent; cents
810	Markup Value	real number representing value of markup type
812	Inc1	first level of charging (minimum # of seconds) charge
814	Inc2	second level of charging

FIG. 44

System Operator Markup Table Record for the Reseller Klondike

806	Reseller	Klondike
808	Markup Table	cents
810	Markup Value	\$0.01
812	Inc1	30
814	Inc2	6

FIG. 45

System Operator Markup Table Record

806	Reseller	all
808	Markup Table	percent
810	Markup Value	1.0
812	Inc1	30
814	Inc2	6

FIG. 46

26/32

Reseller Special Destinations Table Record

832

834	Reseller	reseller id code
836	ML_id	Master List ID code
838	Markup Table	fixed; percent; cents
840	Markup Value	real number representing value of markup type
842	Inc1	first level of charging (minimum # of seconds) charge
844	Inc2	second level of charging

FIG. 47

Reseller Special Destinations Table Record for the Reseller Klondike

846

834	Reseller	Klondike
836	ML_id	1019
838	Markup Table	percent
840	Markup Value	5%
842	Inc1	30
844	Inc2	6

FIG. 48

Reseller Global Markup Table Record

848

850	Reseller	reseller id code
852	Markup Table	fixed; percent; cents
854	Markup Value	real number representing value of markup type
856	Inc1	first level of charging (minimum # of seconds) charge
858	Inc2	second level of charging

FIG. 49

Reseller Global Markup Table Record for the Reseller Klondike

860

850	Reseller	Klondike
852	Markup Table	percent
854	Markup Value	10%
856	Inc1	30
858	Inc2	6

FIG. 50

27/32

900
↙

SIP Bye Message

902 ~	Caller	Username
904 ~	Callee	PSTN compatible # or Username
906 ~	Call ID	unique call identifier (hexadecimal string@IP)

FIG. 51

908
↙

SIP Bye Message

902 ~	Caller	2001 1050 8667
904 ~	Callee	2001 1050 2222
906 ~	Call ID	<u>FA10@192.168.0.20</u>

FIG. 52

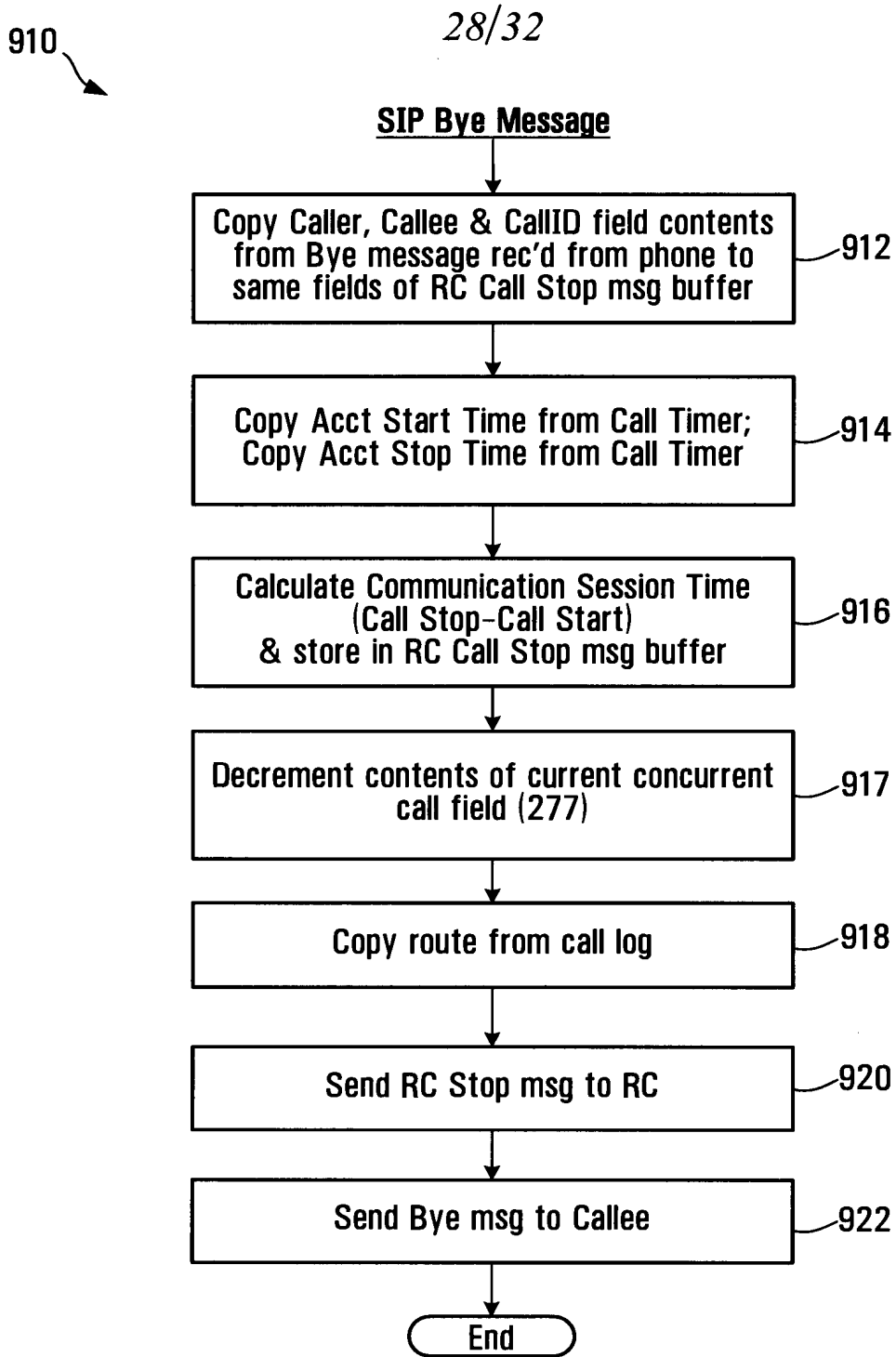

FIG. 53

1000
↙

RC Call Stop Message

1002	Caller	Username
1004	Callee	PSTN compatible # or Username
1006	Call ID	unique call identifier (hexadecimal string@IP)
1008	Acct Start Time	start time of call
1010	Acct Stop Time	time the call ended
1012	Acct Session Time	start time-stop time (in seconds)
1014	Route	IP address for the communications link that was established

FIG. 54

1020
↙

RC Call Stop Message for Calgary Callee

1002	Caller	2001 1050 8667
1004	Callee	2001 1050 2222
1006	Call ID	FA10@192.168.0.20
1008	Acct Start Time	2006-12-30 12:12:12
1010	Acct Stop Time	2006-12-30 12:12:14
1012	Acct Session Time	2
1014	Route	72.64.39.58

FIG. 55

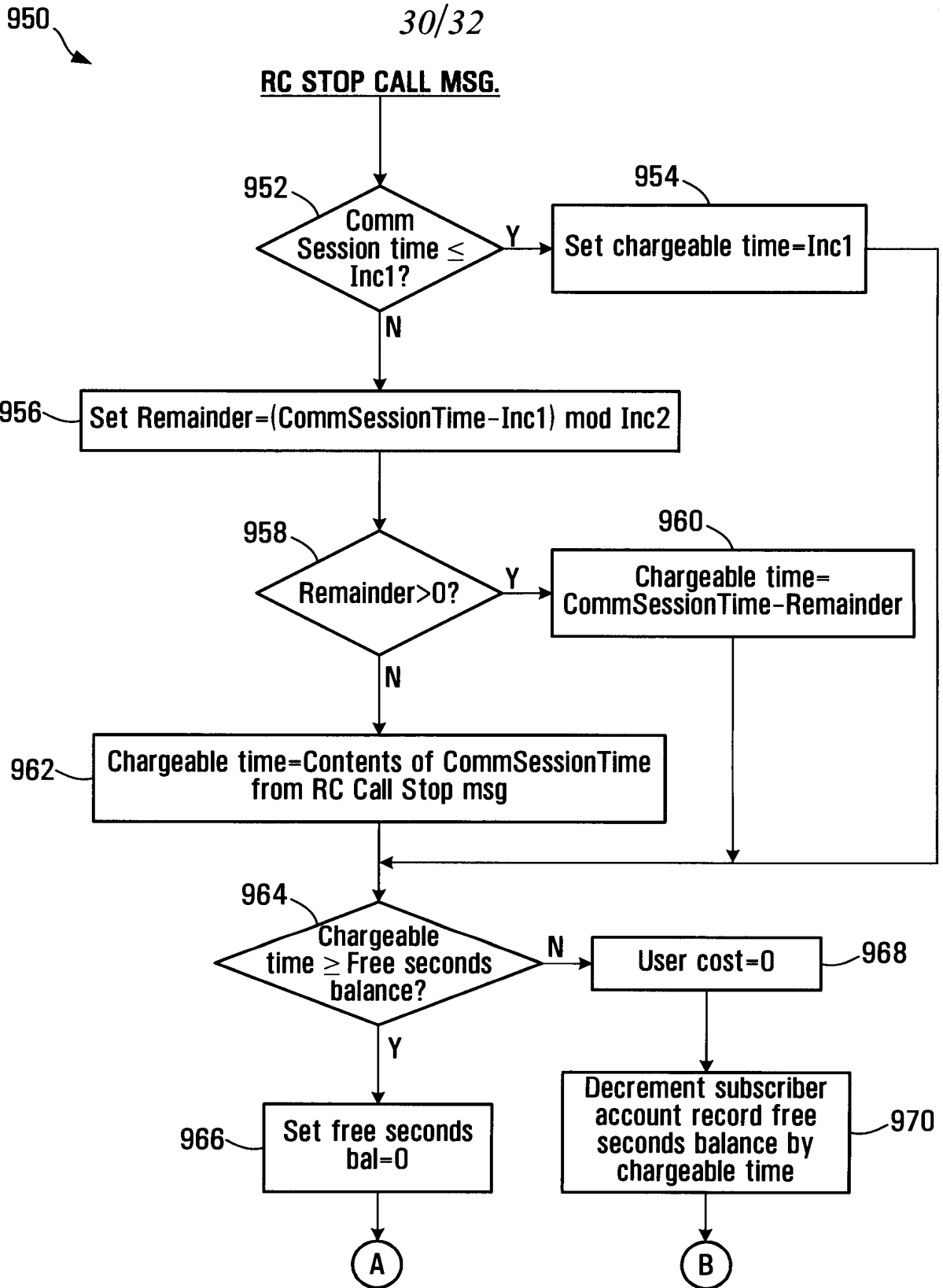

FIG. 56A

31/32

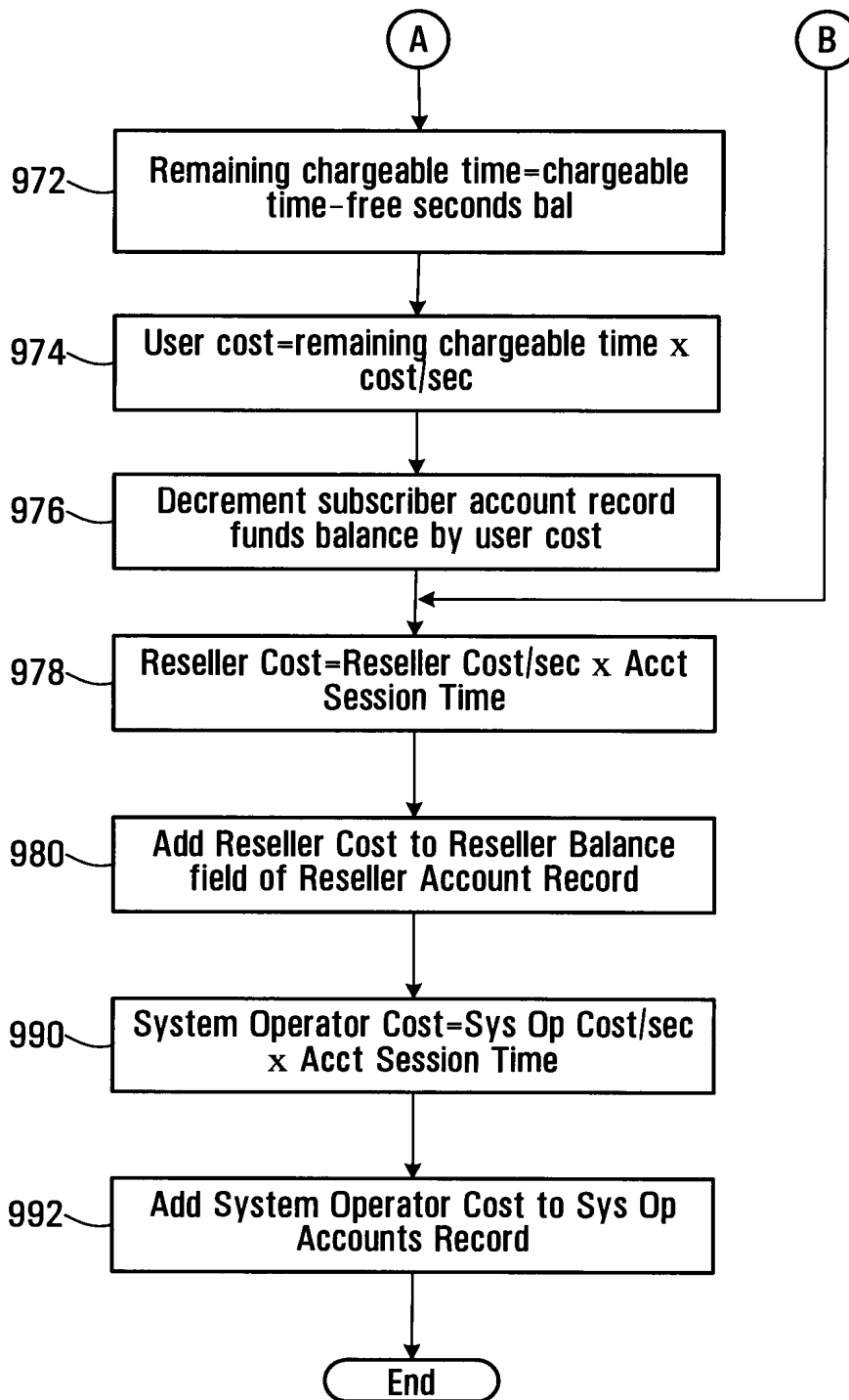

FIG. 56B

Reseller Accounts Table Record

982
↙

984 ~	Reseller ID	reseller id code
986 ~	Reseller balance	accumulated balance of charges

FIG. 57

Reseller Accounts Table Record for Klondike

988
↙

984 ~	Reseller ID	Klondike
986 ~	Reseller balance	\$100.02

FIG. 58

System Operator Accounts Table Record

994
↙

996 ~	System Operator balance	accumulated balance of charges
-------	-------------------------	--------------------------------

FIG. 59

System Operator Accounts Record for this System Operator

996 ~	System Operator balance	\$1000.02
-------	-------------------------	-----------

FIG. 60

Document made available under the Patent Cooperation Treaty (PCT)

International application number: PCT/CA2007/001956

International filing date: 01 November 2007 (01.11.2007)

Document type: Certified copy of priority document

Document details: Country/Office: US
Number: 60/856,212
Filing date: 02 November 2006 (02.11.2006)

Date of receipt at the International Bureau: 26 November 2007 (26.11.2007)

Remark: Priority document submitted or transmitted to the International Bureau in compliance with Rule 17.1(a) or (b)



World Intellectual Property Organization (WIPO) - Geneva, Switzerland
Organisation Mondiale de la Propriété Intellectuelle (OMPI) - Genève, Suisse

PETITIONER APPLE INC. EX. 1002-1053

PATENT COOPERATION TREATY

From the RECEIVING OFFICE

<p>To:</p> <p align="center">The International Bureau of WIPO 34, chemin des Colombettes 1211, Geneva 20 Switzerland</p>	<p align="center">PCT</p> <p align="center">NOTIFICATION OF DATE OF RECEIPT OF PRIORITY DOCUMENT OR OF PRIORITY APPLICATION NUMBER</p> <p align="center">(PCT Administrative Instructions, Section 323(a), (b) and (c))</p>							
<p>Applicant's or agent's file reference 83636-16</p>	<p>Date of mailing (day/month/year)</p>	<p>19 November 2007 (19-11-2007)</p>						
<p>International application No. PCT/CA2007/001956</p>	<p>International filing date (day/month/year)</p>	<p>01 November 2007 (01-11-2007)</p>						
<p>Applicant DIGIFONICA (INTERNATIONAL) LIMITED ET AL</p>								
<p>1. <input checked="" type="checkbox"/> This receiving Office hereby gives notice of the receipt of the priority document(s) identified below on:</p> <p align="center"><u>01 November 2007 (01-11-2007)</u> .</p> <p>2. <input type="checkbox"/> This receiving Office hereby gives notice of the receipt of a request (made under Rule 17.1(b)) to prepare and transmit to the International Bureau the priority document(s) identified below on:</p> <p>Identification of the priority document(s):</p> <table border="1"> <thead> <tr> <th data-bbox="82 1226 597 1276">Priority date</th> <th data-bbox="597 1226 1094 1276">Priority application No.</th> <th data-bbox="1094 1226 1479 1276">Country or regional Office or PCT receiving Office</th> </tr> </thead> <tbody> <tr> <td data-bbox="82 1325 597 1360">02 November 2006 (02-11-2006)</td> <td data-bbox="597 1325 1094 1360">60/856,212</td> <td data-bbox="1094 1325 1479 1360">US</td> </tr> </tbody> </table>			Priority date	Priority application No.	Country or regional Office or PCT receiving Office	02 November 2006 (02-11-2006)	60/856,212	US
Priority date	Priority application No.	Country or regional Office or PCT receiving Office						
02 November 2006 (02-11-2006)	60/856,212	US						
<p>Name and mailing address of the Receiving Office/CA Canadian Intellectual Property Office Place du Portage I, C114 - 1st Floor, Box PCT 50 Victoria Street Gatineau, Quebec K1A 0C9 Facsimile No.: 001-819-953-2476</p>	<p>Authorized Officer</p> <p align="center">Jean-Luc Robert 819- 953-0756</p>							

PA 7084606

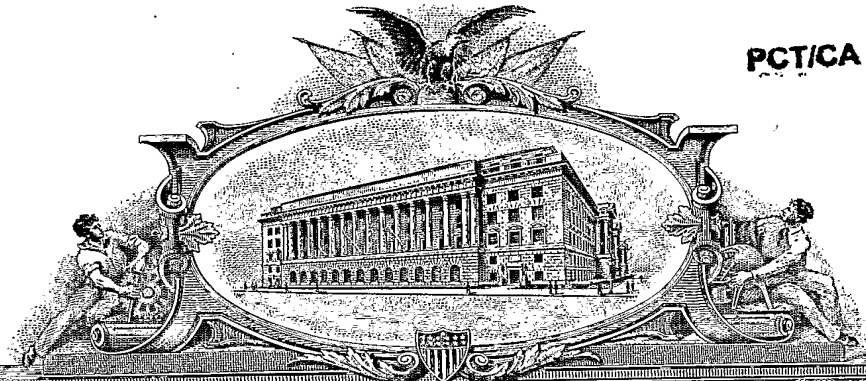

THE UNITED STATES OF AMERICA

TO ALL TO WHOM THESE PRESENTS SHALL COME:

UNITED STATES DEPARTMENT OF COMMERCE

United States Patent and Trademark Office

August 29, 2007

THIS IS TO CERTIFY THAT ANNEXED HERETO IS A TRUE COPY FROM THE RECORDS OF THE UNITED STATES PATENT AND TRADEMARK OFFICE OF THOSE PAPERS OF THE BELOW IDENTIFIED PATENT APPLICATION THAT MET THE REQUIREMENTS TO BE GRANTED A FILING DATE UNDER 35 USC 111.

APPLICATION NUMBER: 60/856,212

FILING DATE: November 02, 2006

THE COUNTRY CODE AND NUMBER OF YOUR PRIORITY APPLICATION, TO BE USED FOR FILING ABROAD UNDER THE PARIS CONVENTION, IS US60/856,212

**By Authority of the
Under Secretary of Commerce for Intellectual Property
and Director of the United States Patent and Trademark Office**

**T. LAWRENCE
Certifying Officer**

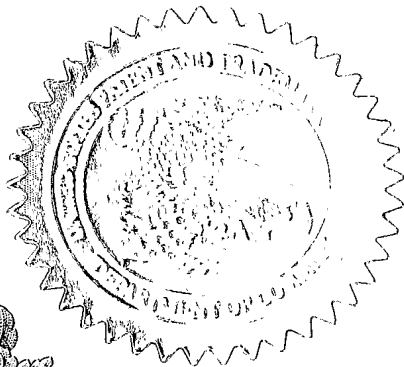

110206



16367 U.S. PTO

**Provisional Application
COVER SHEET**

Attorney Docket No.: SMARB19.001PRF
First Named Inventor: Clay Perreault
Title: PRODUCING ROUTING MESSAGES FOR VOICE OVER
IP COMMUNICATIONS
Express Mail Label No.: EV 898 101 135 US

13013 U.S. PTO
60/856212



110206

Date: November 2, 2006

Page 1 of 2

Direct all correspondence to Customer No.: 20995

Commissioner for Patents
P.O. Box 1450
Alexandria, VA 22313-1450

The following enclosures are transmitted herewith to be filed in the Provisional Patent Application of:

Inventors:

First Inventor : Clay Perreault
Residence Address : Suite #5 Keats Avenue London E161TW United Kingdom

Second Inventor : Steve Nicholson
Residence Address : Suite #5 Keats Avenue London E161TW United Kingdom

Third Inventor : Rod Thomson
Residence Address : 3320 Garabaldi Drive North Vancouver British Columbia, Canada V7H 2N9

Fourth Inventor : Johan Emil Victor Bjorsell
Residence Address : 273 West 5th Street North Vancouver British Columbia, Canada V7M 1J9

Fifth Inventor : Fuad Arafa
Residence Address : 305-3199 Willow Street Vancouver British Columbia, Canada V5Z 4L5

APPLICATION ELEMENTS:

- (X) Specification in 74 pages.
- (X) Drawings in 32 sheets.
- (X) Return prepaid postcard.

**Provisional Application
COVER SHEET**

Attorney Docket No.: SMARB19.001PRF
First Named Inventor: Clay Perreault
Title: PRODUCING ROUTING MESSAGES FOR VOICE OVER
IP COMMUNICATIONS
Express Mail Label No.: EV 898 101 135 US

Direct all correspondence to Customer No.: 20995

Date: November 2, 2006

Page 2 of 2

FILING FEES:

FEE CALCULATION				
FEE TYPE		LARGE FEE	CALCULATION	TOTAL
Basic Filing	37 CFR § 1.16(d)	1005 (\$200)		\$200
			SUB TOTAL	\$200
The present application qualifies for Small Entity status under 37 CFR § 1.27. Fee reduced by 1/2.				(\$100)
			TOTAL FEE DUE	\$100

(X) A check in the amount of \$100 is enclosed to cover the filing fee.

This invention WAS NOT made by an agency of the United States Government or under a contract with an agency of the United States Government.

Commissioner is hereby authorized to charge any additional fees which may be required, or credit any overpayment to Account No. 11-1410.

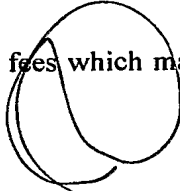

John M. Carson
Registration No. 34,303
Attorney of Record
Customer No. 20,995
(619) 235-8550

3080709
110206

Knobbe Martens Olson & Bear LLP

Intellectual Property Law

2040 Main Street
Fourteenth Floor
Irvine, CA 92614
Tel 949-760-0404
Fax 949-760-9502
www.kmob.com

John M. Carson
619-687-8632
jcarson@kmob.com

Commissioner for Patents
P.O. Box 1450
Alexandria, VA 22313-1450

SUBMISSION BY "EXPRESS MAIL"

Attorney Docket No. : SMARB19.001PRF
Applicant(s) : Clay Perreault et al.
For : PRODUCING ROUTING MESSAGES FOR
VOICE OVER IP COMMUNICATIONS
Attorney : John M. Carson
"Express Mail" Label No. : EV 898 101 135 US
Date of Deposit : November 2, 2006

The following documents are hereby placed into an Express Mail envelope bearing the number indicated above, which envelope is being deposited today with the U.S. Postal Service as Express Mail:

Transmittal letter; specification in 74 pages; 32 sheets of drawings; Check for Filing Fees; Return Prepaid Postcard.

The envelope, with the enclosures listed above, is addressed the Commissioner for Patents, P.O. Box 1450, Alexandria, VA 22313-1450.

This submission is being made in compliance with 37 CFR 1.10.

Name: Vanessa C. Dinger
Docketing Agent

3080658
110206

San Diego
619-235-8550

San Francisco
415-954-4114

Los Angeles
310-551-3450

Riverside
951-781-9231

San Luis Obispo
805-547-5580

PETITIONER APPLE INC. EX. 1002-1058

PRODUCING ROUTING MESSAGES FOR VOICE OVER IP COMMUNICATIONS

BACKGROUND OF THE INVENTION

5 **1. Field of Invention**

This invention relates to voice over IP communications and methods and apparatus for routing and billing.

10 **2. Description of Related Art**

Internet protocol (IP) telephones are typically personal computer (PC) based telephones connected within an IP network, such as the public Internet or a private network of a large organization. These IP telephones have installed "voice-over-IP" (VoIP) software enabling them to make and receive voice calls and send and receive information in data and video formats.

15

IP telephony switches installed within the IP network enable voice calls to be made within or between IP networks, and between an IP network and a switched circuit network (SCN), such as the public switched telephone network (PSTN). If the IP switch supports the Signaling System 7 (SS7) protocol, the IP telephone can also access PSTN databases.

20

The PSTN network typically includes complex network nodes that contain all information about a local calling service area including user authentication and call routing. The PSTN network typically aggregates all information and traffic into a single location or node, processes it locally and then passes it on to other network nodes, as necessary, by maintaining route tables at the node. PSTN nodes are redundant by design and thus provide reliable service, but if a node should fail due to an earthquake or other natural disaster, significant, if not complete service outages can occur, with no other nodes being able to take up the load.

25
30

Existing VoIP systems do not allow for high availability and resiliency in delivering Voice Over IP based Session Initiation Protocol (SIP) Protocol service over a geographically dispersed area such as a city, region or continent. Most resiliency originates from the provision of IP based telephone services to one location or a small number of locations such as a single office or network of branch offices.

SUMMARY OF CERTAIN INVENTIVE ASPECTS

In accordance with one aspect of the invention, there is provided a process for operating a call routing controller to facilitate communication between callers and callees in a system comprising a plurality of nodes with which callers and callees are associated. The process involves, in response to initiation of a call by a calling subscriber, receiving a caller identifier and a callee identifier. Call classification criteria associated with the caller identifier is used to classify the call as a public network call or a private network call. A routing message identifying a node, on the private network, associated with the callee is produced when the call is associated with a subscriber to the private network, and a routing message identifying a gateway to the public network is produced if the call is classified as a public network call.

The process may involve receiving a request to establish a call, from a call controller in communication with a caller identified by the callee identifier.

Using the call classification criteria may involve locating a record identifying calling attributes associated with a caller identified by the caller identifier.

Locating a record may involve locating a caller dialling profile comprising a username associated with the caller, a domain associated with the caller, and at least one calling attribute defined by an international standard.

The process may involve formatting the callee identifier into a pre-defined digit format to produce a re-formatted callee identifier.

5 Formatting may involve removing an international dialing digit from the callee identifier, when the callee identifier begins with a digit matching an international dialling digit specified by the caller dialling profile associated with the caller.

10 Formatting may involve removing a national dialing digit from the callee identifier and prepending a caller country code to the callee identifier when the callee identifier begins with a national dialling digit.

15 Formatting may involve prepending a caller country code to the callee identifier when the callee identifier begins with digits identifying an area code specified by the caller dialling profile.

20 Formatting may involve prepending a caller country code and area code to the callee identifier when the callee identifier has a length that matches a caller dialing number format specified by the caller dialling profile and only one area code is specified as being associated with the caller in the caller dialling profile.

25 Using the call classification criteria may involve classifying the call as a private network call when the re-formatted callee identifier has an associated private network username.

30 Classifying may involve executing a process to determine a node on the private network associated with the re-formatted callee identifier.

Executing the process to determine a node may involve determining whether a prefix of the re-formatted callee identifier matches a corresponding prefix of a username associated with the caller, as identified by the caller dialling profile.

Producing a routing message identifying a node on the private network may involve loading into a routing message buffer an identification of a callee node on the private network, the callee node being identified by a user domain associated with the re-formatted callee identifier.

5

The process may involve communicating a routing message including the identification of the callee node, to a call controller.

10

Producing a routing message identifying a gateway to the public network may involve loading a routing message buffer with an identification of a callee node on the private network, the callee node being the same as a caller node associated with the caller.

15

Producing the routing message may involve loading the routing message buffer with a route indicator to effect call forwarding or loading the routing message buffer with a route indicator to effect a voicemail function.

20

Producing the routing message may involve locating a dialling profile for the callee identified by the re-formatted callee identifier.

25

The process may involve using information in the dialling profile to determine at least one of call forwarding information, call blocking information and voicemail server information.

30

Using the call classification criteria may involve classifying the call as a public network call when the re-formatted callee identifier has no associated private network username.

Classifying may involve executing a process to identify at least one gateway to the public network.

Producing a routing message may involve producing a routing message including an identification of at least one of a plurality of gateways for routing the call using the public network.

5 Producing a routing message may involve locating a master list record associating at least a portion of the re-formatted callee identifier with a master list identifier.

10 Producing a routing message may involve locating at least one supplier identifier record associated with the master list identifier, the at least one supplier identifier record identifying at least one supplier and an IP address of a gateway associated with the at least one supplier.

15 Producing the routing message may involve loading a routing buffer with at least one IP address of a gateway to the public network.

Producing the routing message may involve loading a routing buffer with a plurality of IP addresses identifying respective gateways to the public network.

20 The process may involve communicating the routing message to a call controller to cause the call controller to route a call between a caller associated with the caller identifier and a callee associated with the callee identifier.

25 In accordance with another aspect of the invention, there is provided a computer readable medium encoded with codes for directing a processor to carry out the process above and its variations.

30 In accordance with another aspect of the invention, there is provided an apparatus for operating a call routing controller to facilitate communication between callers and callees in a system comprising a plurality of nodes with which callers and callees are associated. The apparatus includes receiving

provisions for receiving a caller identifier and a callee identifier in response to initiation of a call by a calling subscriber. The apparatus includes classifying provisions for classifying the call as a public network call or a private network call using call classification criteria associated with the caller identifier. The
5 apparatus also includes first routing message producing provisions for producing a routing message identifying a node, on the private network, associated with the callee when the call is associated with a subscriber to the private network. The apparatus includes second routing message producing provisions for producing a routing message identifying a gateway to the public
10 network if the call is classified as a public network call.

The apparatus may further include provisions for receiving a request to establish a call, from a call controller in communication with a caller identified by the callee identifier.

15 The apparatus may further include storage accessing provisions for accessing a storage device storing records associating calling attributes with caller identifiers to locate a record identifying calling attributes associated with a caller identified by the caller identifier.

20 The storage accessing provisions may be operably configured to locate a caller dialling profile that may include a username associated with the caller, a domain associated with the caller, and at least one calling attribute defined by an international standard.

25 The apparatus may further include formatting provisions for formatting the callee identifier into a pre-defined digit format to produce a re-formatted callee identifier.

30 The formatting provisions may be operably configured to remove an international dialing digit from the callee identifier, when the callee identifier

begins with a digit matching an international dialling digit specified by the caller dialling profile associated with the caller.

5 The formatting provisions may be operably configured to remove a national dialling digit from the callee identifier and prepend a caller country code to the callee identifier when the callee identifier begins with a national dialling digit.

10 The formatting provisions may be operably configured to prepend a caller country code to the callee identifier when the callee identifier begins with digits identifying an area code specified by the caller dialling profile.

15 The formatting provisions may be operably configured to prepend a caller country code and area code to the callee identifier when the callee identifier has a length that matches a caller dialling number format specified by the caller dialling profile and only one area code is specified as being associated with the caller in the caller dialling profile.

20 The classifying provisions may be operably configured to classify the call as a private network call when the re-formatted callee identifier has an associated private network username.

The classifying provisions may be operably configured to determine a node on the private network associated with the re-formatted callee identifier.

25 The classifying provisions may be operably configured to determine whether a prefix of the re-formatted callee identifier matches a corresponding prefix of a username associated with the caller, as identified by the caller dialling profile.

30 The apparatus may further include a routing message buffer and the first routing message producing means may be operably configured to load into the routing message buffer an identification of a callee node on the private

network, the callee node being identified by a user domain associated with the re-formatted callee identifier.

5 The apparatus may further include provisions for communicating to a call controller a routing message including at least some of the contents of the routing message buffer, at least some of the contents of the routing message buffer including the identification of the callee node.

10 The apparatus may further include a routing message buffer and the second routing message producing provisions may include provisions for loading the routing message buffer with an identification of a callee node on the private network, the callee node being the same as a caller node associated with the caller.

15 The provisions for loading the routing message buffer may include provisions for loading the routing message buffer with a route indicator to effect call forwarding or with a route indicator to effect a voicemail function.

20 The first routing message producing provisions may include provisions for locating a dialling profile for the callee identified by the re-formatted callee identifier.

25 The apparatus may further include provisions for using information in the dialling profile to determine at least one of call forwarding information, call blocking information and voicemail server information.

30 The classifying provisions may be operably configured to classify the call as a public network call when the reformatted callee identifier has no associated private network username.

The classifying provisions may be operably configured to identify at least one gateway to the public network.

The second routing message producing provisions may be operably configured to produce a routing message including an identification of at least one of a plurality of gateways for routing the call using the public network.

5

The second routing message producing provisions may include provisions for locating a master list record associating at least a portion of a reformatted callee identifier, with a master list identifier.

10

The second routing message producing provisions may include provisions for accessing a storage device to locate at least one supplier identifier record associated with the master list identifier, the at least one supplier identifier record identifying at least one supplier and an IP address of a gateway associated with the at least one supplier.

15

The apparatus may further include a routing buffer and the second routing message producing provisions may include provisions for loading the routing buffer with at least one IP address of a gateway to the public network.

20

The provisions for loading a routing buffer may be operably configured to load the routing buffer with a plurality of IP addresses identifying respective gateways to the public network.

25

The apparatus may further include provisions for communicating the routing message to a call controller to cause the call controller to route a call between a caller associated with the caller identifier and a callee associated with the callee identifier.

30

In accordance with another aspect of the invention, there is provided an apparatus for operating a call routing controller to facilitate communication between callers and callees in a system comprising a plurality of nodes with which callers and callees are associated. The apparatus includes a receiver

operably configured to receive a caller identifier and a callee identifier in response to a call request by a subscriber to the private system. The apparatus also includes a processor circuit operably configured to access a storage device storing records associating call classification criteria with caller identifiers and to classify the call as a public network call or a private network call using the call classification criteria associated with the caller identifier received at the receiver. The processor circuit is also operably configured to produce a first routing message identifying a node, on the private network, associated with the callee when the call is associated with a subscriber to the private network, and produce a second routing message identifying a gateway to the public network when the call is classified as a public network call.

The receiver may be operably configured to receive the request from a call controller in communication with a caller identified by the callee identifier.

The processor circuit may be operably configured to access a storage device storing records associating calling attributes with caller identifiers to locate a record identifying calling attributes associated with a caller identified by the caller identifier.

The processor circuit may be operably configured to access a storage device storing dialling profiles each associating a username, user domain and at least one calling attribute, defined by an international standard with a subscriber to the private network.

The processor circuit may be operably configured to format the callee identifier into a pre-defined digit format to produce a re-formatted callee identifier.

The processor circuit may be operably configured to remove an international dialing digit from the callee identifier, when the callee identifier begins with a

digit matching an international dialling digit specified by the at least one attribute in a dialling profile associated with the caller.

5 The processor circuit may be operably configured to remove a national dialling digit from the callee identifier and prepend a caller country code to the callee identifier when the callee identifier begins with a national dialling digit specified by the at least one attribute specified by a dialling profile associated with the caller.

10 The processor circuit may be operably configured to prepend a caller country code to the callee identifier when the callee identifier begins with digits identifying an area code specified by the at least one attribute in the dialling profile associated with the caller.

15 The processor circuit may be operably configured to prepend a caller country code and area code to the callee identifier when the callee identifier has a length that matches a caller dialing number format specified by the at least one attribute in a dialling profile associated with the caller and only one area code is specified by the at least one attribute as being associated with the caller in the dialling profile associated with the caller.

25 The processor circuit may be operably configured to classify the call as a private network call when the re-formatted callee identifier has an associated private network username.

The processor circuit may be operably configured to determine a node on the private network associated with the re-formatted callee identifier.

30 The processor circuit may be operably configured to determine whether a prefix of the re-formatted callee identifier matches a corresponding prefix of a username associated with the caller, as identified by a caller dialling profile.

The apparatus may further include a routing message buffer and the processor may be operably configured to load into the routing message buffer an identification of a callee node on the private network, the callee node being identified by a user domain associated with the re-formatted callee identifier.

5

The apparatus may further include a transmitter operably configured to transmit to a call controller a routing message involving at least some of the contents of the routing message buffer, the at least some of the contents of the routing message buffer involving the identification of the callee node.

10

The apparatus may further include a routing message buffer and the processor may be operably configured to produce a routing message by loading the routing message buffer with an identification of a callee node on the private network, the callee node being the same as a caller node associated with the caller.

15

The processor circuit may be operably configured to load the routing message buffer with a route indicator to effect call forwarding or with a route indicator to effect a voicemail function.

20

The processor circuit may be operably configured to access the storage device to locate a dialling profile for the callee identified by the re-formatted callee identifier.

25

The processor circuit may be operably configured to use information in the dialling profile to determine at least one of call forwarding information, call blocking information and voicemail server information.

30

The processor circuit may be operably configured to classify the call as a public network call when the re-formatted callee identifier has no associated private network username.

The processor circuit may be operably configured to identify at least one gateway to the public network.

5 The processor circuit may be operably configured to produce a routing message including an identification of at least one of a plurality of gateways for routing the call using the public network.

10 The processor circuit may be operably configured to access a storage device storing master list records associating different calling attributes with a route identifier, to locate a master list record associating at least a portion of the re-formatted callee identifier, with the route identifier.

15 The processor circuit may be operably configured to access a storage device storing records associating route identifiers with communications services suppliers to locate at least one supplier identifier record associated with the route identifier, the at least one supplier identifier record identifying at least one supplier and an IP address of a gateway associated with the at least one communications services supplier.

20 The apparatus may further include a routing buffer and the processor circuit may be operably configured to load the routing buffer with at least one IP address of a gateway to the public network.

25 The processor circuit may be operably configured to load the routing buffer with a plurality of IP addresses identifying respective gateways to the public network.

30 The apparatus may further include a transmitter in communication with the processor circuit for transmitting the routing message to a call controller to cause the call controller to route a call between a caller associated with the caller identifier and a callee associated with the callee identifier.

In accordance with another aspect of the invention, there is provided a data structure for access by an apparatus for producing a routing message for use by a call routing controller in a communications system. The data structure includes dialing profile records comprising fields for associating with
5 respective subscribers to the system, a subscriber user name, direct-in-dial records comprising fields for associating with respective subscriber usernames, a user domain and a direct-in-dial number, prefix to node records comprising fields for associating with at least a portion of the respective
10 subscriber usernames, a node address of a node in the system, whereby a subscriber name can be used to find a user domain, at least a portion of the a subscriber name can be used to find a node with which the subscriber identified by the subscriber name is associated, and a user domain and subscriber name can be located in response to a direct-in-dial number.

15 In accordance with another aspect of the invention, there is provided a data structure for access by an apparatus for producing a routing message for use by a call routing controller in a communications system. The data structure includes master list records comprising fields for associating a dialing code with respective master list identifiers and supplier list records linked to master
20 list records by the master list identifiers, said supplier list records comprising fields for associating with a communications services supplier, a supplier id, a master list id, a route identifier and a billing rate code, whereby communications services suppliers are associated with dialing codes, such that dialing codes can be used to locate suppliers capable of providing a
25 communications link associated with a given dialing code.

30 In accordance with another aspect of the invention, there is provided a method for determining a time to permit a communication session to be conducted. The method involves calculating a cost per unit time, calculating a first time value as a sum of a free time attributed to a participant in the communication session and the quotient of a funds balance held by the participant to the cost per unit time value and producing a second time value

in response to the first time value and a billing pattern associated with the participant, the billing pattern including first and second billing intervals and the second time value being the time to permit a communication session to be conducted.

5

Calculating the first time value may involve retrieving a record associated with the participant and obtaining from the record at least one of the free time and the funds balance.

10

Producing the second time value may involve producing a remainder value representing a portion of the second billing interval remaining after dividing the second billing interval into a difference between the first time value and the first billing interval.

15

Producing the second time value may involve setting a difference between the first time value and the remainder as the second time value.

20

The method may further involve setting the second time value to zero when the remainder is greater than zero and the first time value is less than the free time associated with the participant.

25

Calculating the cost per unit time may involve locating a record in a database, the record comprising a markup type indicator, a markup value and a billing pattern and setting a reseller rate equal to the sum of the markup value and the buffer rate.

30

Locating the record in a database may involve locating at least one of a record associated with a reseller and a route associated with the reseller, a record associated with the reseller and a default reseller markup record.

Calculating the cost per unit time value further may involve locating at least one of an override record specifying a route cost per unit time amount

associated with a route associated with the communication session, a reseller record associated with a reseller of the communications session, the reseller record specifying a reseller cost per unit time associated with the reseller for the communication session, a default operator markup record specifying a default cost per unit time.

5

The method may further involve setting as the cost per unit time the sum of the reseller rate and at least one of the route cost per unit time, the reseller cost per unit time and the default cost per unit time.

10

The method may further involve receiving a communication session time representing a duration of the communication session and incrementing a reseller balance by the product of the reseller rate and the communication session time.

15

The method may further involve receiving a communication session time representing a duration of the communication session and incrementing a system operator balance by a product of the buffer rate and the communication session time.

20

In accordance with another aspect of the invention, there is provided a computer readable medium encoded with instructions for directing a processor circuit to determine a time to permit a communication session to be conducted, the instructions comprising instructions for directing the processor circuit to calculate a cost per unit time, calculate a first time value as a sum of a free time attributed to a participant in the communication session and the quotient of a funds balance held by the participant to the cost per unit time value and produce a second time value in response to the first time value and a billing pattern associated with the participant, the billing pattern including first and second billing intervals and the second time value being the time to permit a communication session to be conducted.

25

30

In accordance with another aspect of the invention, there is provided an apparatus for determining a time to permit a communication session to be conducted. The apparatus includes a processor circuit, a computer readable medium coupled to the processor circuit and encoded with instructions for directing the processor circuit to calculate a cost per unit time for the communication session, calculate a first time value as a sum of a free time attributed to a participant in the communication session and the quotient of a funds balance held by the participant to the cost per unit time value and produce a second time value in response to the first time value and a billing pattern associated with the participant, the billing pattern including first and second billing intervals and the second time value being the time to permit a communication session to be conducted.

The instructions may include instructions for directing the processor circuit to retrieve a record associated with the participant and obtain from the record at least one of the free time and the funds balance.

The instructions may include instructions for directing the processor circuit to produce the second time value by producing a remainder value representing a portion of the second billing interval remaining after dividing the second billing interval into a difference between the first time value and the first billing interval.

The instructions may include instructions for directing the processor circuit to produce the second time value comprises setting a difference between the first time value and the remainder as the second time value.

The instructions may include instructions for directing the processor circuit to set the second time value to zero when the remainder is greater than zero and the first time value is less than the free time associated with the participant.

5 The instructions for directing the processor circuit to calculate the cost per unit time may include instructions for directing the processor circuit to locate a record in a database, the record comprising a markup type indicator, a markup value and a billing pattern and set a reseller rate equal to the sum of the markup value and the buffer rate.

10 The instructions for directing the processor circuit to locate the record in a database may include instruction for directing the processor circuit to locate at least one of a record associated with a reseller and a route associated with the reseller, a record associated with the reseller, a default reseller markup record. The instructions for directing the processor circuit to calculate the cost per unit time value may further include instructions for directing the processor circuit to locate at least one of an override record specifying a route cost per unit time amount associated with a route associated with the communication session, a reseller record associated with a reseller of the communications session, the reseller record specifying a reseller cost per unit time associated with the reseller for the communication session, a default operator markup record specifying a default cost per unit time.

20 The instructions may include instructions for directing the processor circuit to set as the cost per unit time the sum of the reseller rate and at least one of the route cost per unit time, the reseller cost per unit time and the default cost per unit time.

25 The instructions may include instructions for directing the processor circuit to receive a communication session time representing a duration of the communication session and increment a reseller balance by the product of the reseller rate and the communication session time.

30 The instructions may include instructions for directing the processor circuit to receive a communication session time representing a duration of the

communication session and increment a system operator balance by a product of the buffer rate and the communication session time.

5 In accordance with another aspect of the invention, there is provided an apparatus for determining a time to permit a communication session to be conducted. The apparatus includes provisions for calculating a cost per unit time for the communication session, provisions for calculating a first time value as a sum of a free time attributed to a participant in the communication session and the quotient of a funds balance held by the participant to the cost
10 per unit time value and provisions for producing a second time value in response to the first time value and a billing pattern associated with the participant, the billing pattern including first and second billing intervals and the second time value being the time to permit a communication session to be conducted.

15 The provisions for calculating the first time value may include provisions for retrieving a record associated with the participant and provisions for obtaining from the record at least one of the free time and the funds balance.

20 The provisions for producing the second time value may include provisions for producing a remainder value representing a portion of the second billing interval remaining after dividing the second billing interval into a difference between the first time value and the first billing interval.

25 The provisions for producing the second time value may include means for setting a difference between the first time value and the remainder as the second time value.

30 The apparatus may further include provisions for setting the second time value to zero when the remainder is greater than zero and the first time value is less than the free time associated with the participant.

The provisions for calculating the cost per unit time may include provisions for locating a record in a database, the record comprising a markup type indicator, a markup value and a billing pattern and provisions for setting a reseller rate equal to the sum of the markup value and the buffer rate.

5

The provisions for locating the record in a database may include provisions for locating at least one of a record associated with a reseller and a route associated with the reseller, a record associated with the reseller, a default reseller markup record.

10

The provisions for calculating the cost per unit time value may further include provisions for locating at least one of an override record specifying a route cost per unit time amount associated with a route associated with the communication session, a reseller record associated with a reseller of the communications session, the reseller record specifying a reseller cost per unit time associated with the reseller for the communication session, a default operator markup record specifying a default cost per unit time.

15

The apparatus may further include provisions for setting as the cost per unit time the sum of the reseller rate and at least one of the route cost per unit time, the reseller cost per unit time and the default cost per unit time.

20

The apparatus may further include provisions for receiving a communication session time representing a duration of the communication session and incrementing a reseller balance by the product of the reseller rate and the communication session time.

25

The apparatus may further include provisions for receiving a communication session time representing a duration of the communication session and incrementing a system operator balance by a product of the buffer rate and the communication session time.

30

In accordance with another aspect of the invention, there is provided a process for attributing charges for communications services. The process involves determining a first chargeable time in response to a communication session time and a pre-defined billing pattern, determining a user cost value in response to the first chargeable time and a free time value associated with a user of the communications services, changing an account balance associated with the user in response to a user cost per unit time. The process may further involve changing an account balance associated with a reseller of the communications services in response to a reseller cost per unit time and the communication session time and changing an account balance associated with an operator of the communications services in response to an operator cost per unit time and the communication session time.

Determining the first chargeable time may involve locating at least one of an override record specifying a route cost per unit time and billing pattern associated with a route associated with the communication session, a reseller record associated with a reseller of the communications session, the reseller record specifying a reseller cost per unit time and billing pattern associated with the reseller for the communication session and a default record specifying a default cost per unit time and billing pattern and setting as the pre-defined billing pattern the billing pattern of the record located. The billing pattern of the record located may involve a first billing interval and a second billing interval.

Determining the first chargeable time may involve setting the first chargeable time equal to the first billing interval when the communication session time is less than or equal to the first billing interval.

Determining the first chargeable time may involve producing a remainder value representing a portion of the second billing interval remaining after dividing the second billing interval into a difference between communication session time and the first interval when the communication session time is

greater than the communication session time and setting the first chargeable time to a difference between the communication session time and the remainder when the remainder is greater than zero and setting the first chargeable time to the communication session time when the remainder is not greater than zero.

5

The process may further involve determining a second chargeable time in response to the first chargeable time and the free time value associated with the user of the communications services when the first chargeable time is greater than or equal to the free time value associated with the user of the communications services.

10

Determining the second chargeable time may involve setting the second chargeable time to a difference between the first chargeable time.

15

The process may further involve resetting the free time value associated with the user to zero when the first chargeable time is greater than or equal to the free time value associated with the user of the communications services.

20

Changing an account balance associated with the user may involve calculating a user cost value in response to the second chargeable time and the user cost per unit time.

25

The process may further involve changing a user free cost balance in response to the user cost value.

The process may further involve setting the user cost to zero when the first chargeable time is less than the free time value associated with the user.

30

The process may further involve changing a user free time balance in response to the first chargeable time.

In accordance with another aspect of the invention, there is provided an apparatus for attributing charges for communications services. The apparatus includes a processor circuit, a computer readable medium in communication with the processor circuit and encoded with instructions for directing the processor circuit to determine a first chargeable time in response to a communication session time and a pre-defined billing pattern, determine a user cost value in response to the first chargeable time and a free time value associated with a user of the communications services, change an account balance associated with the user in response to a user cost per unit time.

The apparatus may further include changing an account balance associated with a reseller of the communications services in response to a reseller cost per unit time and the communication session time and changing an account balance associated with an operator of the communications services in response to an operator cost per unit time and the communication session time.

The instructions for directing the processor circuit to determine the first chargeable time may further include instructions for causing the processor circuit to communicate with a database to locate at least one of an override record specifying a route cost per unit time and billing pattern associated with a route associated with the communication session, a reseller record associated with a reseller of the communications session, the reseller record specifying a reseller cost per unit time and billing pattern associated with the reseller for the communication session and a default record specifying a default cost per unit time and billing pattern and instructions for setting as the pre-defined billing pattern the billing pattern of the record located. The billing pattern of the record located may include a first billing interval and a second billing interval.

The instructions causing the processor circuit to determine the first chargeable time may include instructions for directing the processor circuit to

set the first chargeable time equal to the first billing interval when the communication session time is less than or equal to the first billing interval.

5 The instructions for causing the processor circuit to determine the first chargeable time may include instructions for producing a remainder value representing a portion of the second billing interval remaining after dividing the second billing interval into a difference between communication session time and the first interval when the communication session time is greater than the communication session time and instructions for causing the
10 processor circuit to set the first chargeable time to a difference between the communication session time and the remainder when the remainder is greater than zero and instructions for causing the processor circuit to set the first chargeable time to the communication session time when the remainder is not greater than zero.

15 The computer readable medium may be further encoded with instructions for causing the processor circuit to determine a second chargeable time in response to the first chargeable time and the free time value associated with the user of the communications services when the first chargeable time is
20 greater than or equal to the free time value associated with the user of the communications services.

25 The instructions for causing the processor circuit to determine the second chargeable time may include instructions for causing the processor circuit to set the second chargeable time to a difference between the first chargeable time.

30 The computer readable medium may be further encoded with instructions for causing the processor circuit to reset the free time value associated with the user to zero when the first chargeable time is greater than or equal to the free time value associated with the user of the communications services.

The instructions for causing the processor circuit to change an account balance associated with the user may include instructions for causing the processor circuit to calculate a user cost value in response to the second chargeable time and the user cost per unit time.

5

The computer readable medium may be further encoded with instructions for causing the processor circuit to change a user free cost balance in response to the user cost value.

10

The computer readable medium may be further encoded with instructions for causing the processor circuit to set the user cost to zero when the first chargeable time is less than the free time value associated with the user.

15

The computer readable medium may be further encoded with instructions for causing the processor circuit to change a user free time balance in response to the first chargeable time.

20

In accordance with another aspect of the invention, there is provided an apparatus for attributing charges for communications services. The apparatus includes provisions for determining a first chargeable time in response to a communication session time and a pre-defined billing pattern, provisions for determining a user cost value in response to the first chargeable time and a free time value associated with a user of the communications services, and provisions for changing an account balance associated with the user in response to a user cost per unit time.

25

30

The apparatus may further include provisions for changing an account balance associated with a reseller of the communications services in response to a reseller cost per unit time and the communication session time and provisions for changing an account balance associated with an operator of the communications services in response to an operator cost per unit time and the communication session time.

5 The provisions for determining the first chargeable time may include provisions for locating at least one of an override record specifying a route cost per unit time and billing pattern associated with a route associated with the communication session, a reseller record associated with a reseller of the communications session, the reseller record specifying a reseller cost per unit time and billing pattern associated with the reseller for the communication session and a default record specifying a default cost per unit time and billing pattern and provisions for setting as the pre-defined billing pattern the billing pattern of the record located. The billing pattern of the record located may include a first billing interval and a second billing interval.

15 The provisions for determining the first chargeable time may include provisions for setting the first chargeable time equal to the first billing interval when the communication session time is less than or equal to the first billing interval.

20 The provisions for determining the first chargeable time may include provisions for producing a remainder value representing a portion of the second billing interval remaining after dividing the second billing interval into a difference between communication session time and the first interval when the communication session time is greater than the communication session time and provisions for setting the first chargeable time to a difference between the communication session time and the remainder when the remainder is greater than zero and provisions for setting the first chargeable time to the communication session time when the remainder is not greater than zero.

30 The apparatus may further include provisions for determining a second chargeable time in response to the first chargeable time and the free time value associated with the user of the communications services when the first

chargeable time is greater than or equal to the free time value associated with the user of the communications services.

5 The provisions for determining the second chargeable time may include provisions for setting the second chargeable time to a difference between the first chargeable time.

10 The apparatus may further include provisions for resetting the free time value associated with the user to zero when the first chargeable time is greater than or equal to the free time value associated with the user of the communications services.

15 The provisions for changing an account balance associated with the user may include provisions for calculating a user cost value in response to the second chargeable time and the user cost per unit time.

The apparatus may further include provisions for changing a user free cost balance in response to the user cost value.

20 The apparatus may further include provisions for setting the user cost to zero when the first chargeable time is less than the free time value associated with the user.

25 The apparatus may further include provisions for changing a user free time balance in response to the first chargeable time.

30 In accordance with another aspect of the invention, there is provided a computer readable medium encoded with codes for directing a processor circuit to execute one or more of the methods described above and/or variants thereof.

In accordance with another aspect of the invention, there is provided a computer readable signal encoded with codes for directing a processor circuit to execute one or more of the methods described above and/or variants thereof.

5

Other aspects and features of the present invention will become apparent to those ordinarily skilled in the art upon review of the following description of specific embodiments of the invention in conjunction with the accompanying figures.

10

BRIEF DESCRIPTION OF THE DRAWINGS

In drawings which illustrate embodiments of the invention,

15

Figure 1 is a block diagram of a system according to a first embodiment of the invention;

Figure 2 is a block diagram of a caller telephone according to the first embodiment of the invention;

20

Figure 3 is a schematic representation of a SIP invite message transmitted between the caller telephone and a controller shown in Figure 1;

Figure 4 is a block diagram of a call controller shown in Figure 1;

25

Figure 5 is a flowchart of a process executed by the call controller shown in Figure 1;

30

Figure 6 is a schematic representation of a routing, billing and rating (RC) request message produced by the call controller shown in Figure 1;

Figure 7 is a block diagram of a processor circuit of a routing, billing, rating element of the system shown in Figure 1;

5 Figures 8A-8D is a flowchart of a RC request message handler executed by the RC processor circuit shown in Figure 7;

Figure 9 is a tabular representation of a dialling profile stored in a database accessible by the RC shown in Figure 1;

10 Figure 10 is a tabular representation of a dialling profile for a caller using the caller telephone shown in Figure 1;

Figure 11 is a tabular representation of a callee profile for a callee located in Calgary;

15 Figure 12 is a tabular representation of a callee profile for a callee located in London;

20 Figure 13 is a tabular representation of a Direct-in-Dial (DID) bank table record stored in the database shown in Figure 1;

Figure 14 is a tabular representation of an exemplary DID bank table record for the Calgary callee referenced in Figure 11;

25 Figure 15 is a tabular representation of a routing message transmitted from the RC to the call controller shown in Figure 1;

30 Figure 16 is a schematic representation of a routing message buffer holding a routing message for routing a call to the Calgary callee referenced in Figure 11;

- Figure 17 is a tabular representation of a prefix to supernode table record stored in the database shown in Figure 1;
- 5 Figure 18 is a tabular representation of a prefix to supernode table record that would be used for the Calgary callee referenced in Figure 11;
- Figure 19 is a tabular representation of a master list record stored in a master list table in the database shown in Figure 1;
- 10 Figure 20 is a tabular representation of a populated master list record;
- Figure 21 is a tabular representation of a suppliers list record stored in the database shown in Figure 1;
- 15 Figure 22 is a tabular representation of a specific supplier list record for a first supplier;
- Figure 23 is a tabular representation of a specific supplier list record for a second supplier;
- 20 Figure 24 is a tabular representation of a specific supplier list record for a third supplier;
- Figure 25 is a schematic representation of a routing message, held in a routing message buffer, identifying to the controller a plurality of possible suppliers that may carry the call;
- 25 Figure 26 is a tabular representation of a call block table record;
- 30 Figure 27 is a tabular representation of a call block table record for the Calgary callee;

Figure 28 is a tabular representation of a call forwarding table record;

Figure 29 is a tabular representation of a call forwarding table record specific for the Calgary callee;

5

Figure 30 is a tabular representation of a voicemail table record specifying voicemail parameters to enable the caller to leave a voicemail message for the callee;

10

Figure 31 is a tabular representation of a voicemail table record specific to the Calgary callee;

Figure 32 is a schematic representation of an exemplary routing message, held in a routing message buffer, indicating call forwarding numbers and a voicemail server identifier;

15

Figures 33A and 33B are respective portions of a flowchart of a process executed by the RC processor for determining a time to live value;

20

Figure 34 is a tabular representation of a subscriber bundle table record;

Figure 35 is a tabular representation of a subscriber bundle record for the Vancouver caller;

25

Figure 36 is a tabular representation of a bundle override table record;

Figure 37 is a tabular representation of bundle override record for a located master list ID;

30

Figure 38 is a tabular representation of a subscriber account table record;

- Figure 39 is a tabular representation of a subscriber account record for the Vancouver caller;
- 5 Figure 40 is a flowchart of a process for producing a second time value executed by the RC processor circuit shown in Figure 7;
- Figure 41 is a flowchart for calculating a call cost per unit time;
- 10 Figure 42 is a tabular representation of a system operator special rates table record;
- Figure 43 is a tabular representation of a system operator special rates table record for a reseller named Klondike;
- 15 Figure 44 is a tabular representation of a system operator mark-up table record;
- Figure 45 is a tabular representation of a system operator mark-up table record for the reseller Klondike;
- 20 Figure 46 is a tabular representation of a default system operator mark-up table record;
- Figure 47 is a tabular representation of a reseller special destinations table record;
- 25 Figure 48 is a tabular representation of a reseller special destinations table record for the reseller Klondike;
- 30 Figure 49 is a tabular representation of a reseller global mark-up table record;

- Figure 50 is a tabular representation of a reseller global mark-up table record for the reseller Klondike;
- 5 Figure 51 is a tabular representation of a SIP bye message transmitted from either of the telephones shown in Figure 1 to the call controller;
- Figure 52 is a tabular representation of a SIP bye message sent to the controller from the Calgary callee;
- 10 Figure 53 is a flowchart of a process executed by the call controller for producing a RC stop message in response to receipt of a SIP bye message;
- Figure 54 is a tabular representation of an exemplary RC call stop message;
- 15 Figure 55 is a tabular representation of an RC call stop message for the Calgary callee;
- 20 Figures 56A and 56B are respective portions of a flowchart of a RC call stop message handling routine executed by the RC shown in Figure 1;
- Figure 57 is a tabular representation of a reseller accounts table record;
- 25 Figure 58 is a tabular representation of a reseller accounts table record for the reseller Klondike;
- Figure 59 is a tabular representation of a system operator accounts table record; and
- 30 Figure 60 is a tabular representation of a system operator accounts record for the system operator described herein.

DETAILED DESCRIPTION OF CERTAIN INVENTIVE EMBODIMENTS

Referring to Figure 1, a system for making voice over IP telephone calls is shown generally at **10**. The system includes a first super node shown generally at **11** and a second super node shown generally at **21**. The first super node **11** is located in geographical area, such as Vancouver, B.C., Canada for example and the second super node **21** is located in London, England, for example. Different super nodes may be located in different geographical regions throughout the world to provide telephone service to subscribers in respective regions. These super nodes may be in communication with each other by high speed/ high data throughput links including optical fiber, satellite and/or cable links, forming a backbone to the system. These super nodes may alternatively or, in addition, be in communication with each other through conventional internet services.

In the embodiment shown, the Vancouver supernode **11** provides telephone service to western Canadian customers from Vancouver Island to Ontario. Another node (not shown) may be located in Eastern Canada to provide services to subscribers in that area.

Other nodes of the type shown may also employed within the geographical area serviced by a supernode, to provide for call load sharing, for example within a region of the geographical area serviced by the supernode. However, in general, all nodes are similar and have the properties described below in connection with the Vancouver supernode **11**.

In this embodiment, the Vancouver supernode includes a call controller (CC) **14**, a routing RCcontroller (RC) **16**, a database **18** and a voicemail server **19**. Each of these may be implemented as separate modules on a common computer system or by separate computers, for example. The voicemail server **19** need not be included in the node and can be provided by an outside service provider. Subscribers such as a subscriber in the City of Vancouver

and a subscriber in the city of Calgary communicate with the Vancouver supernode using their own internet service providers which route internet traffic from these subscribers over the internet shown generally at 13 in Figure 1. To these subscribers the Vancouver supernode is accessible at a pre-determined internet protocol (IP) address or a fully qualified domain name that can be accessed in the usual way through a subscriber's internet service provider. The subscriber in the city of Vancouver uses a telephone 12 that is capable of communicating with the Vancouver supernode 11 using Session Initiation Protocol (SIP) messages and the Calgary subscriber uses a similar telephone 15, in Calgary AB.

It should be noted that throughout the description of the embodiments of this invention, the IP/UDP addresses of all elements such as the caller and callee telephones, call controller, media relay, and any others, will be assumed to be valid IP/UDP addresses directly accessible via the Internet or a private IP network, for example, depending on the specific implementation of the system. As such, it will be assumed, for example, that the caller and callee telephones will have IP/UDP addresses directly accessible by the call controllers and the media relays on their respective supernodes, and those addresses will not be obscured by Network Address Translation (NAT) or similar mechanisms. In other words, the IP/UDP information contained in SIP messages (for example the SIP Invite message or the RC Request message which will be described below) will match the IP/UDP addresses of the IP packets carrying these SIP messages.

It will be appreciated that in many situations, the IP addresses assigned to various elements of the system may be in a private IP address space, and thus not directly accessible from other elements. Furthermore, it will also be appreciated that NAT is commonly used to share a "public" IP address between multiple devices, for example between home PCs and IP telephones sharing a single Internet connection. For example, a home PC may be assigned an IP address such as 192.168.0.101 and a Voice over IP telephone

may be assigned an IP address of 192.168.0.103. These addresses are located in so called "non-routable" (IP) address space and cannot be accessed directly from the Internet. In order for these devices to communicate with other computers located on the Internet, these IP addresses have to be converted into a "public" IP address, for example 24.10.10.123 assigned by the Internet Service Provider to the subscriber, by a device performing NAT, typically a home router. In addition to translating the IP addresses, NAT typically also translates UDP port numbers, for example an audio path originating at a VoIP telephone and using a UDP port 12378 at its private IP address, may have be translated to a UDP port 23465 associated with the public IP address of the NAT device. In other words, when a packet originating from the above VoIP telephone arrives at an Internet-based supernode, the source IP/UDP address contained in the IP packet header will be 24.10.10.1:23465, whereas the source IP/UDP address information contained in the SIP message inside this IP packet will be 192.168.0.103:12378. The mismatch in the IP/UDP addresses may cause a problem for SIP-based VoIP systems because, for example, a supernode will attempt to send messages to a private address of a telephone – the messages will never get there.

Referring to Figure 1, in an attempt to make a call by the Vancouver telephone 12 to the Calgary telephone 15, the Vancouver telephone sends a SIP invite message to the Vancouver supernode 11 and in response, the call routing controller 14 sends a RC request message to the RC 16 which makes various enquiries of the database 18 to produce a routing message which is sent back to the call controller 14. The call routing controller 14 then causes a communications link including an audio path to be established either through the same node, a different node or using a communications supplier gateway as shown generally at 20 to carry voice traffic to the call recipient or callee.

Generally, the RCRouting Controller16 executes a process for operating a call routing controller to facilitate communication between callers and callees. The

process involves, in response to initiation of a call by a calling subscriber, receiving a callee identifier from the calling subscriber, using call classification criteria associated with the calling subscriber to classify the call as a PSTN call or a system call and producing a routing message identifying a node associated with the called subscriber if the call is classified as a system call or if the call is classified as a PSTN call and the callee identifier is associated with a subscriber to the system.

Subscriber Telephone

In greater detail, referring to Figure 2, in this embodiment, the telephone 12 includes a processor circuit shown generally at 30 comprising a microprocessor 32, program memory 34, an input/output (I/O) port 36, parameter memory 38 and temporary memory 40. The program memory 34, I/O port 36, parameter memory 38 and temporary memory 40 are all in communication with the microprocessor 32. The I/O port 36 has a dial input 42 for receiving a dialled telephone number from a keypad, for example, or from a voice recognition unit or from pre-stored telephone numbers stored in the parameter memory 38, for example. For simplicity, a box labelled dialling functions 44 represents any device capable of informing the microprocessor 32 of a callee identifier, e.g., a callee telephone number.

The processor 32 stores the callee identifier in a dialled number buffer 45. In this case, assume the dialled number is 2001 1050 2222 and that it is a number associated with the Calgary subscriber. The I/O port 36 also has a handset interface 46 for receiving and producing signals from and to a handset (not shown) that the user may place to his ear. This interface 46 may include a BLUETOOTH™ wireless interface, a wired interface or speaker phone, for example. The handset acts as a termination point for an audio path (not shown) which will be appreciated later. The I/O port 36 also has an internet connection 48 which is preferably a high speed internet connection and is operable to connect the telephone to an internet service provider. The

internet connection **48** also acts as a part of the voice path, as will be appreciated later.

5 The parameter memory **38** has a username field **50**, a password field **52** an IP address field **53** and a SIP proxy address field **54**, for example. The user name field **50** is operable to hold a user name, which in this case is **2001 1050 8667**. The user name is assigned upon subscription or registration into the system and, in this embodiment, includes a twelve digit number having a continent code **61**, a country code **63**, a dealer code **70** and a unique number code **74**. The continent code **61** is comprised of the first or left-most digit of the user name in this embodiment. The country code **63** is comprised of the next three digits. The dealer code **70** is comprised of the next four digits and the unique number code **74** is comprised of the last four digits. The password field **52** holds a password of up to **512** characters, in this example. The IP address field **53** stores an IP address of the telephone, which for this explanation is **192.168.0.20**. The SIP proxy address field **54** holds a IP protocol compatible proxy address which may be provided to the telephone through the internet connection **48** as part of a registration procedure.

20 The program memory **34** stores blocks of codes for directing the processor **32** to carry out the functions of the telephone, one of which includes a firewall block **56** which provides firewall functions to the telephone, to prevent access by unauthorized persons to the microprocessor **32** and memories **34**, **38** and **40** through the internet connection **48**. The program memory **34** also stores codes **57** for establishing a call ID. The call ID codes **57** direct the processor **32** to produce a call identifier having a format comprising a hexadecimal string at an IP address, the IP address being the IP address of the telephone. Thus, an exemplary call identifier might be **FF10@192.168.0.20**.

30 Generally, in response to picking up the handset **46** and activating a dialling function **44**, the microprocessor **32** produces and sends a SIP invite message as shown in Figure 3, to the routing controller **14** shown in Figure 1.

Referring to Figure 3, the SIP invite message includes a caller ID field **60**, a callee identifier field **62**, a digest parameters field **64** and a call ID field **65**. In this embodiment, the caller ID field **60** includes the user name **2001 1050 8667**, which is the user name stored in the user name field **50** of the parameter memory **38** in the telephone **12** shown in Figure 2. In addition, referring back to Figure 3, the callee identifier field **62** includes the user name **2001 1050 2222** which is the dialed number of the Calgary subscriber stored in the dial number buffer **45** shown in Figure 2. The digest parameters field **64** includes digest parameters and the call ID field **65** includes a code comprising a generated prefix code (**FF10**) and a suffix which is the Internet Protocol (IP) address of the telephone **12** stored in the IP address field **53**. The IP address field **67** holds the IP address assigned to the telephone, in this embodiment **192.168.0.20**, and the caller UDP port field **69** includes a UDP port identifier identifying a UDP port at which the audio path will be terminated at the caller's telephone.

Call Routing Controller

Referring to Figure 4, a call controller circuit of the call controller **14** (Figure 1) is shown in greater detail at **100**. The call controller circuit **100** includes a microprocessor **102**, program memory **104** and an I/O port **106**. The circuit **100** may include a plurality of microprocessors, a plurality of program memories and a plurality of I/O ports to be able to handle a large volume of calls. However, for simplicity, the call controller circuit **100** will be described as having only one microprocessor **102**, program memory **104** and I/O port **106**, it being understood that there may be more.

Generally, the I/O port **106** includes an input **108** for receiving messages such as the SIP invite message shown in Figure 3, from the telephone shown in Figure 2. The I/O port **106** also has an RC request message output **110** for transmitting an RC request message to the RC **16** of Figure 1, an RC message input **112** for receiving routing messages from the RC **16**, a gateway

output 114 for transmitting messages to one of the gateways 20 shown in Figure 1 to advise the gateway to establish an audio path, for example, and a gateway input 116 for receiving messages from the gateway. The I/O port 106 further includes a SIP output 118 for transmitting messages to the telephone 12 to advise the telephone of the IP addresses of the gateways which will establish the audio path. The I/O port 106 further includes a voicemail server input and output 117, 119 respectively for communicating with the voicemail server 19 shown in Figure 1.

While certain inputs and outputs have been shown as separate, it will be appreciated that some may be a single IP address and IP port. For example, the messages sent to the RC 16 and received from the RC 16 may be transmitted and received on the same single IP port.

The program memory 104 includes blocks of code for directing the microprocessor 102 to carry out various functions of the call routing controller 14. For example, these blocks of code include a first block 120 for causing the call controller circuit 100 to execute a SIP invite to RC request process to produce an RC request message in response to a received SIP invite message. In addition, there is a routing message to gateway message block 122 which causes the call controller circuit 100 to produce a gateway query message in response to a received routing message from the RC 16.

Referring to Figure 5, the SIP invite to RC request process is shown in more detail at 120. On receipt of a SIP invite message of the type shown in Figure 3, block 122 of Figure 5 directs the call controller circuit 100 of Figure 4 to authenticate the user. This may be done, for example, by prompting the user for a password, by sending a message back to the telephone 12 which is interpreted at the telephone as a request for a password entry or the password may automatically be sent to the call controller 14 from the telephone, in response to the message. The call controller 14 may then make enquiries of databases to which it has access, to determine whether or not the

user's password matches a password stored in the database. Various functions may be used to pass encryption keys or hash codes back and forth to ensure that the transmittal of passwords is secure.

5 Should the authentication process fail, the call controller circuit **100** is directed to an error handling routine **124** which causes messages to be displayed at the telephone **12** to indicate there was an authentication problem. If the authentication procedure is passed, block **121** directs the call controller circuit to determine whether or not the contents of the caller ID field **60** of the SIP
10 invite message received from the telephone is an IP address. If it is an IP address, then block **123** directs the call controller circuit **100** to set the contents of a type field variable maintained by the call controller to a code representing that the call type is a third party invite. If at block **121** the caller ID field contents do not identify an IP address, then block **125** directs the call
15 controller circuit to set the contents of the type field to a code indicating that the call is being made by a system subscriber. Then, block **126** directs the call controller circuit to establish a call identification by assigning the call ID **65** provided in the SIP invite message from the telephone **12**, and at block **128** the processor is directed to produce an RC request message that includes that call ID. Block **129** then directs the call controller circuit **100** to send the
20 RC request to the RC **16**.

Referring to Figure **6**, an RC request message is shown generally at **150** and includes a caller field **152**, a callee field **154**, a digest field **156**, a call ID field
25 **158** and a type field **160**. The caller, callee, digest call ID fields **152**, **154**, **156** and **158** contain copies of the caller, callee, digest parameters and call ID fields **60**, **62**, **64** and **65** of the SIP invite message shown in Figure **3**. The type field **160** contains the type code established at blocks **123** or **125** of Figure **5** to indicate whether the call is from a third party or system subscriber, respectively. The caller identifier field may include a PSTN number or a
30 system subscriber username as shown, for example.

RCRouting Controller

Referring to Figure 7, the RCRC 16 is shown in greater detail and includes a processor circuit shown generally at 200. The processor circuit 200 includes a processor 202, program memory 204, a table memory 206 and an I/O port 208, all in communication with the processor 202. (As earlier indicated, there may be a plurality of processor circuits (202), memories (204), etc.)

The I/O port 208 includes a database port 210 through which a request to the database 18 can be made and includes a database response port 212 for receiving a reply from the database 18. The I/O port 208 further includes an RC request message input 214 for receiving the RC request message from the call controller 14 and includes a routing message output 216 for sending a routing message back to the call controller 14.

The program memory 204 includes blocks of codes for directing the processor 202 to carry out various functions of the RC 16. One of these blocks includes an RC request message handler 250 which directs the RC to produce a routing message in response to a received RC request message. The RC request message handler process is shown in greater detail at 250 in Figures 8A through 8D.

RCRC Request Message Handler

Referring to Figure 8A, the RCRC request message handler begins with a first block 252 that directs the RCRC circuit to store the contents of the RCRC request message in buffers in the buffer memory 207, one of which includes the caller ID buffer 209 for separately storing the contents of the called field 154 of the RC request message. Block 254 then directs the RCRC processor circuit to use the contents of the caller field 152 in the RCRC request message shown in Figure 6, to locate and retrieve from the database 18 a dialling profile for the caller.

Referring to Figure 9, an exemplary dialling profile is shown generally at 256 and includes a user name field 258, a domain field 260, a national dialling digits (NDD) field 262, an international dialling digits (IDD) field 264, a country code field 266, a local area codes field 267, a caller minimum local length field 268, a caller maximum local length field 270 and a reseller field 273.

An exemplary caller profile for the present embodiment is shown generally at 276 in Figure 10 and indicates that the user name field 258 includes the user name (2001 1050 8667) that has been assigned to the subscriber and is stored in the user name field 50 in the telephone as shown in Figure 2.

The domain field 260 includes a domain name as shown at 282, including a node type identifier 284, a location code identifier 286, a system provider identifier 288 and a domain portion 290, the domain field 260 effectively identifying a domain or node associated with the user identified by the contents of the user name field 258.

In this embodiment, the node type identifier 284 includes the code "sp" identifying a supernode and the location identifier 286 identifies the supernode as being in Vancouver (YVR). The system provider identifier 288 identifies the company supplying the service and the domain portion 290 identifies the "com" domain.

The national dialled digit field 262 in this embodiment includes the digit "1" and in general includes a number specified by the International Telecommunications Union (ITU) Telecommunications Standardization Sector (ITU-T) E. 164 Recommendation which assigns national dialling digits to certain countries.

The international dialling digit field 264 includes a code also assigned according to the ITU-T according to the country or location of the user.

The country code field **266** also includes the digit "1" and in general includes a number assigned according to the ITU-T to represent the country in which the user is located.

5 The local area codes field **267** includes a list of area codes that have been assigned by the ITU-T to the geographical area in which the subscriber is located. The caller minimum and maximum local number length fields **268** and **270** hold numbers representing minimum and maximum local number lengths permitted in the area code(s) specified by the contents of the local area codes
10 field **267**. The reseller field **273** is optional and holds a code identifying a retailer of the services, in this embodiment "Klondike".

The area codes associated with the user are the area codes associated with the location code portion **286** of the contents of the domain field **260**.

15 A dialling profile of the type shown at **256** in Figure **9** is produced whenever a user registers with the system or agrees to become a subscriber to the system. Thus, for example, a user wishing to subscribe to the system may contact an office maintained by a system operator and personnel in the office
20 may ask the user certain questions about his location and service preferences, whereupon tables can be used to provide office personnel with appropriate information to be entered into the user name **258**, domain **260**, NDD **262**, IDD **264**, country code **266**, local area codes **267**, and caller minimum and maximum local length fields **268** and **270** to establish a dialling
25 profile for the user.

Referring to Figures **11** and **12**, callee dialling profiles for users in Calgary and London, respectively for example, are shown.

30 In addition to creating dialling profiles when a user registers with the system, a direct-in-dial (DID) record of the type shown at **268** in Figure **13** is added to a direct-in-dial table in the database **18** to associate the username and a host

name of the supernode with which the user is associated, with an E.164 number associated with the user on the PSTN network.

5 An exemplary DID table record entry for the current callee is shown generally at 276 in Figure 14. The user name field 281 and user domain field 272 are analogous to the user name and user domain fields 258 and 260 of the caller dialling profile shown in Figure 10. The contents of the DID field 274 include a E.164 telephone number including a country code 283, an area code 285, an exchange code 287 and a number 289. If the
10 user has multiple telephone numbers, then multiple records of the type shown at 276 would be included in the DID bank table, each having the same user name and user domain, but different DID field 274 contents reflecting the different telephone numbers associated with that user.

[Note to JWK: integrate into DID description]

15 A DID bank table record for the London subscriber is shown generally at 276 in Figure 14.

20 In addition to creating dialling profiles and DID records when a user registers with the system, call blocking records of the type shown in Figure 26, call forwarding records of the type shown in Figure 28 and voicemail records of the type shown in Figure 30 may be added to the database 18 when a new subscriber is added to the system.

25 Referring back to Figure 8A, after retrieving a dialling profile for the caller, such as shown at 276 in Figure 10, the RC processor circuit 200 is directed to perform certain checks on the callee identifier as provided by the contents of the callee field 154 in Figure 6, of the RC request message. These checks are
30 shown in greater detail in Figure 8B.

Referring to Figure 8B, the processor 202 is directed to a first block 257 that causes it to determine whether a digit pattern of the callee identifier (154) provided in the RC request message (150) includes a pattern that matches the contents of the international dialling digits (IDD) field 264 in the caller profile shown in Figure 10. If so, then block 259 directs the processor to set a call type code identifier variable maintained by the RC element to indicate that the call is an international call and block 261 directs the processor to produce a reformatted callee identifier by reformatting the callee identifier into a predetermined target format. In this embodiment, this is done by removing the pattern of digits matching the IDD field contents 264 of the caller profile to effectively shorten the number. Then, block 263 directs the processor 202 to determine whether or not the callee identifier has a length which meets criteria establishing it as a number compliant with the E.164 Standard set by the ITU. If the length does not meet this criteria, block 265 directs the processor 202 to send back to the call controller a message indicating the length is not correct. The process is then ended. At the call controller 14, routines may direct the processor 32 to respond to the incorrect length message by transmitting a message back to the telephone 12 to indicate that an invalid number has been dialled.

Still referring to Figure 8B, if the length of the amended callee identifier meets the criteria set forth at block 263, block 269 directs the processor 202 to determine whether or not the amended callee identifier is found in a record in the direct-in-dial bank (DID) table. Referring back to Figure 8B, at block 269, if the processor 202 finds that the reformatted callee identifier produced at block 261 is found in a record in the DID bank table, then the callee is a subscriber to the system and block 279 directs the processor to copy the contents of the corresponding user name field 281 from the callee DID bank table read into a callee ID buffer (not shown). Thus, the processor 202 locates a subscriber user name associated with the reformatted callee identifier. The processor 202 is then directed to point B in Figure 8A.

Subscriber to Subscriber Calls Between Different Nodes

Referring back to Figure 8A, block 275 then directs the processor 202 to determine whether or not the subscriber (callee) user name is associated with the same node as the caller. To do this, the processor 202 determines whether or not a prefix of the user name 281 (e.g., the continent code 61 of the user name 281), as determined from the contents of the callee ID buffer, is the same as the prefix (e.g., continent code 61) of the user name 258 of the caller specified by the caller field 152 of the RC request message shown in Figure 6. If it is not the same, block 277 directs the RC processor to set a call type flag maintained by the RC processor to indicate the call is a cross-domain call. Then, block 350 directs the processor 202 to produce a routing message identifying the node in the system with which the callee is associated and to set a time to live for the call at the maximum value of 99999. The node in the system with which the callee is associated is determined by using the callee identifier to address a supernode table having records of the type as shown at 370 in Figure 17. Each record 370 has a prefix field 372 and a supernode address field 374. The prefix field 372 includes the first n digits of the callee identifier. In this embodiment n=2. The supernode address field 374 holds a code representing the IP address or a fully qualified domain name of the node associated with the code stored in the callee identifier prefix field 372. Referring to Figure 18, for example, if the prefix is 20, the supernode address associated with that prefix is sp.yvr.digifonica.com. In the example provided, the callee is in Calgary and serviced by the same node as the caller and therefore with this callee and caller, the processor would not be directed to block 277 or 350.

Referring to Figure 15, a generic routing message is shown generally at 352 and includes an optional supplier prefix field 354, and optional delimiter field 356, a callee user name field 358, at least one route field 360, a time to live field 362 and other fields 364. The optional supplier prefix field 354 holds a code for identifying supplier traffic. The optional delimiter field 356 holds a symbol that delimits the supplier prefix code from the callee field 358. In this

embodiment, the symbol is a number sign (#). The route field **360** holds a domain name or IP address of a gateway or node that is to carry the call, and the time to live field **362** holds a value representing the number of seconds the call is permitted to be active, based on subscriber available minutes and other billing parameters.

5

Referring to Figure **8A** and Figure **16**, an example of a routing message produced by the processor at block **350** for a caller associated with the same node as the caller is shown generally at **366** and includes only a callee field **359**, a route field **361** and a time to live field **363**.

10

Referring to Figure **8A**, having produced a routing message as shown in Figure **16**, block **380** directs the processor **202** to send the routing message shown in Figure **16** to the call controller **14** shown in Figure **1**.

15

Referring back to Figure **8B**, if at block **257**, the callee identifier does not begin with an international dialling digit, block **380** directs the processor **202** to determine whether or not the callee identifier begins with the same national dial digit code as assigned to the caller. To do this, the processor **202** is directed to refer to the caller dialling profile as shown in Figure **10**. In the embodiment shown, the national dialling digit code **262** is the number **1**. Thus, if the callee identifier begins with the number **1**, then the processor **202** is directed to block **382** in Figure **8B**.

20

25

Block **382** directs the processor **202** to examine the callee identifier to determine whether or not the digits following the NDD digit identify an area code that is the same as any of the area codes identified in the local area codes field **267** of the caller dialling profile **276** shown in Figure **10**. If not, block **384** directs the processor **202** to set the call type to a code indicating that the call is a national call. If the digits identify an area code that is the same as a local area code associated with the caller as indicated by the caller profile, block **386** directs the processor **202** to set the call type as a local call,

30

national style. After executing blocks **384** or **386**, block **388** directs the processor **202** to format the callee identifier by removing the national dial digit and prepending a caller country code identified by the country code field **266** of the caller dialling profile shown in Figure **10**. The processor **202** is then directed to block **263** to perform other processing as already described above.

If at block **380**, the callee identifier does not begin with a national dialled digit, block **390** directs the processor **202** to determine whether the callee identifier begins with digits that identify the same area code as the caller. Again, the reference for this is the caller profile shown in Figure **10**. The processor **202** determines whether or not the first few digits in the callee identifier identify an area code corresponding to the local area code field **267** of the caller profile. If so, then block **392** directs the processor **202** to set the call type to a code indicating that the call is a local call and block **394** directs the processor to prepend the caller country code to the callee identifier, the caller country code being determined from the country code field **266** from the caller profile shown in Figure **10**. The processor **202** is then directed to block **263** for further processing as described above.

If at block **390**, the callee identifier does not start with the same area code as the caller, block **396** directs the processor **202** to determine whether the number of digits in the callee identifier is within the range of digits indicated by the caller minimum local number length field **268** and the caller maximum local number length field **270** of the caller profile shown in Figure **10**. If so, then block **398** directs the processor **202** to set the call type to local and block **400** directs the processor to prepend to the callee identifier the caller country code (as indicated by the country code field **266** of the caller profile shown in Figure **10**) followed by the caller area code (as indicated by the local area code field **267** of the caller profile shown in Figure **10**). The processor **202** is then directed to block **263** for further processing as described above.

If at block 396, the callee identifier has a length that does not fall within the range specified by the caller minimum local number length field 268 and the caller maximum local number length field 270, block 402 directs the processor 202 to determine whether or not the callee identifier identifies a valid user name. To do this, the processor 202 searches through the database of dialling profiles to find a dialling profile having user name field contents 258 that match the callee identifier. If no match is found, block 404 directs the processor 202 to send an error message back to the call controller (14). If at block 402, a dialling profile having a user name field 258 that matches the callee identifier is found, block 406 directs the processor 202 to set the call type to a code indicating that the call is a network call and then the processor is directed to block 275 of Figure 8A.

From Figure 8B, it will be appreciated that there are certain groups of blocks of codes that direct the processor 202 to determine whether the callee identifier has certain features such as an international dialling digit, a national dialling digit, an area code and a length that meet certain criteria, and cause the processor to reformat the callee identifier as necessary into a predetermined target format including only a country code, area code, a normal telephone number, for example, to cause the callee identifier to be compatible with the E.164 number plan standard in this embodiment. This enables block 269 in Figure 8 to have a consistent format of callee identifiers for use in searching through the DID bank table records of the type shown in Figure 13 to determine how to route calls for subscriber to subscriber calls on the same system.

Subscriber to Non-Subscriber Calls

Not all calls will be subscriber to subscriber calls and this will be detected by the processor 202 when it executes block 269 in Figure 8B, and does not find a record that is associated with the callee in the DID bank table. When this occurs, the processor 202 is directed to block 408 which causes it to set the callee identifier equal to the newly formatted callee identifier, i.e., a number

compatible with the E.164 standard. Then, block 410 directs the processor 202 to address a master list having records of the type shown in Figure 19. Exemplary values for several fields are shown in Figure 19 for illustrative purposes.

5

Each master list record includes a master list ID field 500, a dialling code field 502, a country code field 504, a national sign number field 506, a minimum length field 508, a maximum length field 510, a national dialled digit field 512, an international dialled digit field 514 and a buffer rate field 516.

10

The master list ID field 500 holds a unique code such as 1019, for example, identifying the record. The dialling code field 502 holds a predetermined number pattern which the processor 202 uses at block 410 in Figure 8B to find the master list record having a dialling code matching the first few digits of the amended callee identifier. The country code field 504 holds a number representing the country code associated with the record and the national sign number field 506 holds a number representing the area code associated with the record. (It will be observed that the dialling code is a combination of the contents of the country code field 504 and the national sign number field 506.) The minimum length field 508 holds a number representing the minimum length of digits associated with the record and the maximum length field 51 holds a number representing the maximum number of digits in a number with which the record may be compared. The national dialled digit (NDD) field 512 holds a number representing an access code used to make a call within the country specified by the country code, and the international dialled digit (IDD) field 514 holds a number representing the international prefix needed to dial a call from the country indicated by the country code.

15

20

25

30

Thus, for example, a master list record may have a format as shown in Figure 20 with exemplary field contents as shown.

Referring back to Figure 8B, using the country code and area code portions of the reformatted callee identifier that has been formatted for compatibility with the E.164 standard, block 410 directs the processor 202 to find a master list record such as the one shown in Figure 20 having a dialling code that matches the country code and area code of the callee identifier. Thus, in this example, the processor would find a master list record having an ID field with the number 1019. This number may be referred to as a route ID. Thus, a route ID number is found in the master list record associated with a predetermined number pattern in the reformatted callee identifier.

After executing block 410 in Figure 8B, the process continues as shown in Figure 8D. Referring to Figure 8D, block 412 directs the processor 202 to use the route ID number to locate at least one supplier record identifying a supplier operable to supply a communications link for the route. To do this, block 412 directs the processor 202 to search a supplier ID table having records of the type shown in Figure 21.

Referring to Figure 21, the supplier list records include a supplier ID field 540, a master list ID field 542, an optional prefix field 544, a route identifier field 546, a NDD/IDD rewrite field 548, and a rate field 550. The supplier ID field 540 holds a code identifying the name of the supplier and the master list ID field 542 holds a code for associating the supplier record with the master list record. The prefix field 544 holds a string used to identify the supplier traffic and the route identifier field 546 holds an IP address of a gateway operated by the supplier indicated by the supplier ID field 540. The NDD/IDD rewrite field 548 holds a code representing a rewritten value of the NDD/IDD associated with this route for this supplier, and the rate field 550 holds a code indicating the cost per second to the system operator to use the route provided by the gateway specified by the contents of the route identifier field 546. Exemplary supplier records are shown in Figures 22, 23 and 24 for the exemplary suppliers shown at 20 in Figure 1, namely Telus, Shaw and Sprint.

Referring back to Figure 8D, at block 412 the processor 202 finds all supplier records that identify the master list ID found at block 410 of Figure 8B.

5 Referring back to Figure 8D, block 560 directs the processor 202 to begin to produce routing messages of the type shown in Figure 15. To do this, the processor 202 loads a routing message buffer as shown in Figure 25 with a supplier prefix of the least costly supplier where the least costly supplier is determined from the rate fields 550 of the records associated with respective suppliers.

10 Referring to Figures 22-24, in the embodiment shown, the supplier "Telus" has the lowest number in the rate field 550 and therefore the prefix 4973 associated with that supplier is loaded into the routing message buffer shown in Figure 25 first.

15 Block 562 in Figure 8D directs the processor to delimit the prefix 4973 by the number sign (#) and to next load the reformatted callee identifier into the routing message buffer. At block 563, the contents of the route identifier field 546 of the record associated with the supplier Telus are added by the processor 202 to the routing message buffer after an @ sign delimiter, and then block 564 in Figure 8D directs the processor to get a time to live value, which in one embodiment may be 3600 seconds, for example. Block 566 then directs the processor 202 to load this time to live value in the routing message buffer as shown in Figure 25. Accordingly, a first part of the routing message is shown generally at 570 in Figure 25.

20
25
30 Referring back to Figure 8D, block 571 directs the processor 202 back to block 560 and causes it to repeat blocks 560, 562, 563, 564 and 566 for each successive supplier until the routing message buffer is loaded with information pertaining to each supplier. Thus, a second portion of the routing message is shown at 572 in Figure 25 relates to the second supplier identified by the record shown in Figure 23. Referring back to Figure 25, a third portion of the

routing message is shown at **574** and is associated with a third supplier as indicated by the supplier record shown in Figure **24**.

5
Consequently, referring to Figure **25**, the routing message buffer holds a routing message identifying a plurality of different suppliers able to provide gateways to establish at least part of a communication link through which the caller may contact the callee. In this embodiment, each of the suppliers is identified, in succession, according to rate. Other criteria for determining the order in which suppliers are listed in the routing message may include
10 preferred supplier priorities which may be established based on service agreements, for example.

Referring back to Figure **8D**, block **568** directs the processor **202** to send the routing message shown in Figure **25** to the call controller **14** in Figure **1**.

15

Subscriber to Subscriber Calls Within the Same Node

Referring back to Figure **8A**, if at block **275**, the callee identifier received in the RC request message has a prefix that identifies the same node as that associated with the caller, block **600** directs the processor **202** to use the
20 callee identifier to locate and retrieve a dialling profile for the callee identified by the callee identifier. The dialling profile may be of the type shown in Figure **10**, for example. Block **602** then directs the processor **202** to get call block, call forward and voicemail tables from the database based on the user name identified in the callee profile retrieved by the processor at block **600**. Call
25 block, call forward and voicemail tables in this embodiment have records as shown in Figures **26**, **27**, **28** and **30** for example.

Referring to Figure **26**, the call block records include a user name field **604** and a block pattern field **606**. The user name field holds a user name
30 corresponding to the user name in the user name field of the callee profile and the block pattern field **606** holds one or more E.164-compatible numbers or

user names identifying PSTN numbers or system subscribers from whom the subscriber identified in the user name field **604** does not wish to receive calls.

5 Referring to Figure **8A** and Figure **27**, block **608** directs the processor **202** to determine whether or not the caller identifier received in the RC request message matches a block pattern stored in the block pattern field **606** of the call block record associated with the callee identified by the contents of the user name field **604** in Figure **26**. If the caller identifier matches a block pattern, block **610** directs the processor to send a drop call or non-completion
10 message to the call controller (**14**) and the process is ended. If the caller identifier does not match a block pattern associated with the callee, block **612** directs the processor **202** to determine whether or not call forwarding is required.

15 Referring to Figure **28**, records in the call forwarding table include a user name field **614**, a destination number field **616**, and a sequence number field **618**. The user name field **614** stores a code representing a user with which the record is associated. The destination number field **616** holds a user name representing a number to which the current call should be forwarded, and the
20 sequence number field **618** holds an integer number indicating the order in which the user name associated with the corresponding destination number field **616** should be attempted for call forwarding. The call forwarding table may have a plurality of records for a given user. The processor uses the contents of the sequence number field **618** to place the records for a given
25 user in order. As will be appreciated below, this enables the call forwarding numbers to be tried in an ordered sequence.

30 Referring to Figure **8A** and Figure **29**, if at block **612**, the call forwarding record for the callee identified by the callee identifier contains no contents in the destination number field **616** and accordingly no contents in the sequence number field **618**, there are no call forwarding entries for this callee, and the processor **202** is directed to block **620** in Figure **8C**. If there are entries in the

5 call forwarding table 27, block 622 in Figure 8A directs the processor 202 to search the dialling profile table to find a dialling profile record as shown in Figure 10, for the user identified by the destination number field 616. The processor 202 is further directed to store the contents of the destination number field in the routing message buffer, and also to load into the routing message buffer, the contents of the domain field 260 associated with the user name specified by the contents of the destination number field 616 into the routing message so as to produce a routing message of the type illustrated in Figure 32, for example. This process is repeated for each call forwarding record associated with the callee identified by the callee identifier to add to the routing message buffer all call forwarding usernames and domains associated with the callee.

10 Referring to Figure 8C, if at block 612 (in Figure 8A) there are no call forwarding entries, then at block 620 the processor 202 is directed to determine whether or not the user identified by the callee identifier has paid for voicemail service. This is done by checking to see whether or not a flag is set in a voicemail record of the type shown in Figure 30 in a voicemail table stored in the database 18 shown in Figure 1.

15 Referring to Figure 30, voicemail table records in this embodiment may include a user name field 624, a voicemail server field 626, a seconds to voicemail field 628 and an enable field 630. The user name field 624 stores the user name of the callee. The voicemail server field 626 holds a code identifying a domain name of a voicemail server associated with the user identified by the user name field 624. The seconds to voicemail field 628 holds a code identifying the time to wait before engaging voicemail, and the enable field 630 holds a code representing whether or not voicemail is enabled for the user. Referring back to Figure 8C, at block 620 the processor 202 may find a voicemail record as shown in Figure 30 having user name field 624 contents matching the callee identifier, whereupon the processor is directed to examine the contents of the enabled field 630 to determine

whether or not voicemail is enabled. If voicemail is enabled, then block **640** in Figure **8C** directs the processor **202** to store the contents of the voicemail server field **626** and the contents of the seconds to voicemail field **628** in the routing message buffer, as shown at **654** in Figure **32**. Block **642** then directs the processor **202** to get time to live values for each path specified by the routing message according to the cost of routing and the user's balance. These time to live values are then appended to corresponding paths already stored in the routing message buffer.

Block **644** then directs the processor **202** to store the IP address of the current node in the routing message buffer as shown at **656** in Figure **32**. Block **646** then directs the processor **202** to send the routing message to the call controller. An exemplary routing message is shown in the routing message buffer in Figure **32**.

Referring back to Figure **1**, the routing message whether of the type shown in Figures **16**, **25** or **32**, is received at the call controller **14**. Referring to Figure **4**, the program memory **104** of the call controller **14** includes a routing to gateway routine depicted generally at **122**.

Where a routing message of the type shown in Figure **32** is received by the call controller **14**, the routing to gateway routine **122** shown in Figure **4** may direct the processor **102** cause a message to be sent back through the internet **13** shown in Figure **1** to the callee telephone **15**, knowing the IP address of the callee telephone **15** from the user name.

Alternatively, if the routing message is of the type shown in Figure **16**, which identifies a domain associated with another node in the system, the call controller may send a SIP invite message along the high speed backbone **17** connected to the other node. The other node functions as explained above, in response to receipt of a SIP invite message.

If the routing message is of the type shown in Figure 25 where there are a plurality of suppliers available, the call controller sends a SIP invite message to the first supplier, in this case Telus, using a dedicated line or an internet connection to determine whether or not Telus is able to handle the call. If the
5 Telus gateway sends a message that it is not able to handle the call, the call controller 14 then proceeds to send a SIP invite message to the next supplier, in this case Shaw. The process is repeated until one of the suppliers responds indicating that it is available to carry the call. Once a supplier responds indicating that it is able to carry the call, the supplier sends back to the call
10 controller 14 an IP address for a gateway provided by the supplier through which the call or audio path of the call will be carried. This IP address is sent in a message from the call controller 14 to the caller telephone 12.

Referring to Figure 2, the microprocessor 32 of the caller telephone stores this
15 audio path IP address in an audio path IP address buffer 47 in the temporary memory 40. Then, the microprocessor 32 causes audio to be transferred to and from the handset and the internet connection 48 using the audio path IP address stored in the audio path IP address buffer 47.

Referring back to Figure 1, if the call controller 14 receives a routing message
20 of the type shown in Figure 32, and which has at least one call forwarding number and/or a voicemail number, the call controller attempts to establish a call to the callee telephone 15 and if no call is established within a pre-determined time, the call controller 14 attempts to establish a call with the
25 next user identified in the call routing message. This process is repeated until all call forwarding possibilities have been exhausted, in which case an audio path is established with the voicemail server 19 identified in the routing message, allowing the caller to leave a voicemail message.

When an audio path is established a call timer maintained by the call
30 controller logs the start date and time of the call and logs the call ID and an identification of the route (i.e., audio path IP address) for later use in billing.

Time to Live

5 Referring to Figures 33A and 33B, a process for determining a time to live
value for any of blocks 342 in Figure 8C, 350 in Figure 8A or 564 in Figure 8D
above is described. The process is executed by the RC processor 200 shown
in Figure 7. Generally, the process involves calculating a cost per unit time,
calculating a first time value as a sum of a free time attributed to a participant
10 in the communication session and the quotient of a funds balance held by the
participant to the cost per unit time value and producing a second time value
in response to the first time value and a billing pattern associated with the
participant, the billing pattern including first and second billing intervals and
the second time value being the time to permit a communication session to be
conducted.

15 In this embodiment, the process and begins with a first block 700 that directs
the RC processor to determine whether or not the call type set at block 271 in
Figure 8A indicates the call is a network or cross-domain call. If the call is a
network or cross-domain call, block 702 directs the RC processor to set the
20 time to live equal to 99999 and the process is ended. Thus, the network or
cross-domain call type has a long time to live. If at block 700 the call type is
determined not to be a network or cross-domain type, block 704 directs the
RC processor to get a subscriber bundle table record from the database 18 in
Figure 1 and store it locally at the RC 11.

25 Referring to Figure 34, a subscriber bundle table record is shown generally at
706. The record includes a user name field 708 and a services field 710. The
user name field holds a code identifying the subscriber user name and the
services field 710 holds codes identifying service features assigned to the
30 subscriber, such as free local calling, call blocking and voicemail, for example.

Figure 35 shows an exemplary subscriber bundle record for the Vancouver caller. In this record the user name field 708 is loaded with the user name 2001 1050 8667 and the services field 710 is loaded with codes 10, 14 and 16 corresponding to free local calling, call blocking and voicemail, respectively. Thus, user 2001 1050 8667 has free local calling, call blocking and voicemail features.

Referring back to Figure 33A, after having loaded a subscriber bundle record into the RC from the database, block 712 directs the RC processor to determine whether or not there is a bundle override table record for the master list ID value that was determined at block 410 in Figure 8B. An exemplary bundle override table record is shown at 714 in Figure 36. The bundle table record includes a master list ID field 716, an override type field 718, an override value field 720 a first interval field 722 and a second interval field 724. The master list ID field 716 holds a master list ID code. The override type field 718 holds an override type code indicating a fixed, percent or cent amount to indicate the amount by which a fee will be increased. The override value field 720 holds a real number representing the value of the override type. The first interval field 722 holds a value indicating the minimum number of seconds for a first level of charging and the second interval field 724 holds a number representing a second level of charging.

Referring to Figure 37, a bundle override record for the located master list ID code is shown generally at 726 and includes a master list ID field 716 holding the code 1019 which was the code located in block 410 of Figure 8B. The override type field 718 includes a code indicating the override type is a percentage value and the override value field 720 holds the value 10.0 indicating that the override will be 10.0% of the charged value. The first interval field 722 holds a value representing 30 seconds and the second interval field 724 holds a value representing 6 seconds. The 30 second value in the first interval field 722 indicates that charges for the route will be made at a first rate for 30 seconds and thereafter the charges will be made at a

different rate in increments of 6 seconds, as indicated by the contents of the second interval field **724**.

5 Referring back to Figure **33A**, if at block **712** the processor finds a bundle
override record of the type shown in Figure **37**, block **728** directs the
processor to store the bundle override record in local memory. In the
embodiment shown, the bundle override record shown in Figure **37** is stored
in local memory at the RC. Still referring to Figure **33A**, block **730** then directs
10 the RC processor to determine whether or not the subscriber bundle table
record **706** in Figure **35** has a services field including a code identifying that
the user is entitled to free local calling and also directs the processor to
determine whether or not the call type set at block **277** in Figure **8A** is local or
local/national style. If both of these conditions are satisfied, block **732** directs
15 the processor to set the time to live equal to **99999**, giving the user a long
period of time for the call. The process is then ended. If the conditions
associated with block **730** are not satisfied, block **734** of Figure **33B** directs
the RC processor to retrieve a record associated with a participant in the call.
This is done by copying and storing a subscriber account record for the caller.

20 Referring to Figure **38**, an exemplary subscriber account table record is
shown generally at **736**. The record includes a user name field **738**, a funds
balance field **740** and a free time field **742**. The user name field **738** holds a
subscriber user name, the funds balance field **740** holds a real number
representing the dollar value of credit available to the subscriber and the free
25 time field **742** holds an integer representing the number of free seconds that
the user is entitled to.

30 An exemplary subscriber account record for the Vancouver caller is shown
generally at **744** in Figure **39**, wherein the user name field **738** holds the user
name **2001 1050 8667**, the funds balance field **740** holds the value **\$10.00**,
and the free time field **742** holds the value **100**. The funds balance field
holding the value of **\$10.00** indicates the user has **\$10.00** worth of credit and

the free time field having the value of **100** indicates that the user has a balance of **100** free seconds of call time.

5 Referring back to Figure **33B**, after copying and storing the subscriber account record shown in Figure **39** from the database to the RC, block **746** directs the RC processor to determine whether or not the subscriber account record funds balance field **740** or free time balance field **742** are greater than zero. If they are not greater than zero, block **748** directs the processor to set the time to live equal to zero and the process is ended. The RC then sends a
10 message back to the call controller to cause the call controller to deny the call to the caller. If the conditions associated with block **746** are satisfied, block **750** directs the RC processor to calculate the call cost per unit time. A procedure for calculating the call cost per unit time is described below in connection with Figure **41**.

15 Assuming the procedure for calculating the cost per second returns a number representing the call cost per second, block **752** directs the processor to determine whether or not the cost per second is equal to zero. If so, block **754** directs the processor to set the time to live to **99999** to give the caller a very
20 long length of call and the process is ended.

If at block **752** the call cost per second is not equal to zero, block **756** directs the RC processor to calculate a first time value as a sum of a free time attributed to the participant in the communication session and the quotient of
25 the funds balance held by the participant to the cost per unit time value. To do this, the RC processor is directed to set a first time value or temporary time to live value equal to the sum of the free time provided in the free time field **742** of the subscriber account record shown in Figure **39** and the quotient of the contents of the funds balance field **740** in the subscriber account record
30 for the call shown in Figure **39** and the cost per second determined at block **750** of Figure **33B**. Thus, for example, if at block **750** the cost per second is determined to be three cents per second and the funds balance field holds the

value \$10.00, the quotient of the funds balance and cost per second is 333 seconds and this is added to the contents of the free time field 742, which is 100, resulting in a time to live of 433 seconds.

5 Block 758 then directs the RC processor to produce a second time value in response to the first time value and the billing pattern associated with the participant as established by the bundle override record shown in Figure 37. This process is shown in greater detail at 760 in Figure 40 and generally involves producing a remainder value representing a portion of the second
10 billing interval remaining after dividing the second billing interval into a difference between the first time value and the first billing interval.

Referring to Figure 40, the process for producing the second time value begins with a first block 762 that directs the RC processor to set a remainder
15 value equal to the difference between the time to live value calculated at block 756 in Figure 33B and the contents of the first interval field 722 of the record shown in Figure 37, multiplied by the modulus of the contents of the second interval field 724 of Figure 37. Thus, in the example given, the difference between the time to live field and the first interval field is 433 minus 30, which
20 is 403 and therefore the remainder produced by the mod of 403 divided by 6 is 0.17. Block 764 then directs the processor to determine whether or not this remainder value is greater than zero and, if so, block 766 directs the processor to subtract the remainder from the first time value and set the difference as the second time value. To do this the processor is directed to
25 set the time to live value equal to the current time to live of 403 minus the remainder of 1, i.e., 402 seconds. The processor is then returned back to block 758 of Figure 33B.

Referring back to Figure 40, if at block 764 the remainder is not greater than
30 zero, block 768 directs the processor to determine whether or not the time to live is less than the contents of the first interval field 722 in the record shown in Figure 37. If so, then block 770 of Figure 40 directs the processor to set the

time to live equal to zero. Thus, the second time value is set to zero when the remainder is greater than zero and the first time value is less than the free time associated with the participant in the call. If at block **768** the conditions of that block are not satisfied, the processor returns the first time to live value as the second time to live value.

Thus, referring to Figure **33B**, after having produced a second time to live value, block **772** directs the processor to set the time to live value for use in blocks **342**, **350** or **564**.

Cost per Second

Referring back to Figure **33B**, at block **750** it was explained that a call cost per unit time is calculated. The following explains how that call cost per unit time value is calculated.

Referring to Figure **41**, a process for calculating a cost per unit time is shown generally at **780**. The process is executed by the RC processor and generally involves locating a record in a database, the record comprising a markup type indicator, a markup value and a billing pattern and setting a reseller rate equal to the sum of the markup value and the buffer rate, locating at least one of an override record specifying a route cost per unit time amount associated with a route associated with the communication session, a reseller record associated with a reseller of the communications session, the reseller record specifying a reseller cost per unit time associated with the reseller for the communication session and a default operator markup record specifying a default cost per unit time and setting as the cost per unit time the sum of the reseller rate and at least one of the route cost per unit time, the reseller cost per unit time and the default cost per unit time.

The process begins with a first set of blocks **782**, **802** and **820** which direct the processor to locate at least one of a record associated with a reseller and a route associated with the reseller, a record associated with the reseller, and

a default reseller mark-up record. Block **782**, in particular, directs the processor to address the database **18** to look for a record associated with a reseller and a route with the reseller by looking for a special rate record based on the master list ID established at block **410** in Figure **8C**.

5

Referring to Figure **42**, a system operator special rate table record is shown generally at **784**. The record includes a reseller field **786**, a master list ID field **788**, a mark-up type field **790**, a mark-up value field **792**, a first interval field **794** and a second interval field **796**. The reseller field **786** holds a reseller ID code and the master list ID field **788** holds a master list ID code. The mark-up type field **790** holds a mark-up type such as fixed percent or cents and the mark-up value field **792** holds a real number representing the value corresponding to the mark-up type. The first interval field **794** holds a number representing a first level of charging and the second interval field **796** holds a number representing a second level of charging.

10

15

An exemplary system operator special rate table for a reseller known as "Klondike" is shown at **798** in Figure **43**. In this record, the reseller field **786** holds a code indicating the retailer ID is Klondike, the master list ID field **788** holds the code **1019** to associate the record with the master list ID code **1019**. The mark-up type field **790** holds a code indicating the mark-up type is cents and the mark-up value field **792** holds a mark-up value indicating **1/10** of one cent. The first interval field **794** holds the value **30** and the second interval field **796** holds the value, these two fields indicating that the operator allows **30** seconds for free and then billing is done in increments of **6** seconds after that.

20

25

Referring back to Figure **41**, if at block **782** a record such as the one shown in Figure **43** is located in the system operator special rates table, the processor is directed to block **800** in Figure **41**. If such a record is not found in the system operator special rates table, block **802** directs the processor to

30

address the database **18** to look in a system operator mark-up table for a mark-up record associated with the reseller.

5 Referring to Figure **44**, an exemplary system operator mark-up table record is shown generally at **804**. The record includes a reseller field **806**, a mark-up type field **808**, a mark-up value field **810**, a first interval field **812** and a second interval field **814**. The reseller mark-up type, mark-up value, first interval and second interval fields are as described in connection with the fields by the same names in the system operator special rates table shown in Figure **42**.

10 Figure **45** provides an exemplary system operator mark-up table record for the reseller known as Klondike and therefore the reseller field **806** holds the value "Klondike", the mark-up type field **808** holds the value cents, the mark-up value field holds the value **0.01**, the first interval field **812** holds the value
15 **30** and the second interval field **814** holds the value **6**. This indicates that the reseller "Klondike" charges by the cent at a rate of one cent per minute. The first **30** seconds of the call are free and billing is charged at the rate of one cent per minute in increments of **6** seconds.

20 Figure **46** provides an exemplary system operator mark-up table record for cases where no specific system operator mark-up table record exists for a particular reseller, i.e., a default reseller mark-up record. This record is similar to the record shown in Figure **45** and the reseller field **806** holds the value "all", the mark-up type field **808** is loaded with a code indicating mark-up is
25 based on a percentage, the mark-up value field **810** holds the percentage by which the cost is marked up, and the first and second interval fields **812** and **814** identify first and second billing levels.

30 Referring back to Figure **41**, if at block **802** a specific mark-up record for the reseller identified at block **782** is not located, block **820** directs the processor to get the mark-up record shown in Figure **46**, having the "all" code in the reseller field **806**. The processor is then directed to block **800**.

Referring back to Figure 41, at block 800, the processor is directed to set a reseller rate equal to the sum of the mark-up value of the record located by blocks 782, 802 or 820 and the buffer rate specified by the contents of the
5 buffer rate field 516 of the master list record shown in Figure 20. To do this, the RC processor sets a variable entitled "reseller cost per second" to a value equal to the sum of the contents of the mark-up value field (792, 812) of the associated record, plus the contents of the buffer rate field (516) from the master list record associated with the master list ID. Then, block 822 directs
10 the processor to set a system operator cost per second variable equal to the contents of the buffer rate field (516) from the master list record. Block 824 then directs the processor to determine whether the call type is local or national/local style and whether the caller has free local calling. If both these conditions are met, then block 826 sets the user cost per second variable
15 equal to zero and sets two increment variables equal to one, for use in later processing. The cost per second has thus be calculated and the process shown in Figure 41 is ended.

If at block 824 the conditions of that block are not met, the processor is
20 directed to locate at least one of an override table record specifying a route cost per unit time associated with a route associated with the communication session, a reseller special destinations table record associated with a reseller of the communications session, the reseller record specifying a reseller cost per unit time associated with the reseller for the communication session and a
25 default reseller global markup record specifying a default cost per unit time.

To do this block 828 directs the processor to determine whether or not the bundle override record 726 in Figure 37 located at block 304 in Figure 33A has a master list ID equal to the stored master list ID that was determined at
30 block 410 in Figure 8B. If not, block 830 directs the processor to find a reseller special destinations table record in a reseller special destinations table in the database, having a master list ID code equal to the master list ID code of the

5 master list ID that was determined at block **410** in Figure **8B**. An exemplary reseller special destinations table record is shown in Figure **47** at **832**. The reseller special destinations table record includes a reseller field **834**, a master list ID field **836**, a mark-up type field **838**, a mark-up value field **840**, a first interval field **842** and a second interval field **844**. This record has the same format as the system operator special rates table record shown in Figure **42**, but is stored in a different table to allow for different mark-up types and values and time intervals to be set according to resellers' preferences. Thus, for example, an exemplary reseller special destinations table record for the reseller "Klondike" is shown at **846** in Figure **48**. The reseller field **834** holds a value indicating the reseller as the reseller "Klondike" and the master list ID field holds the code **1019**. The mark-up type field **838** holds a code indicating the mark-up type is percent and the mark-up value field **840** holds a number representing the mark-up value as **5%**. The first and second interval fields identify different billing levels used as described earlier.

10 Referring back to Figure **41**, the record shown in Figure **48** may be located at block **830**, for example. If at block **830** such a record is not found, then block **832** directs the processor to get a default operator global mark-up record based on the reseller ID.

20 Referring to Figure **49**, an exemplary default reseller global mark-up table record is shown generally at **848**. This record includes a reseller field **850**, a mark-up type field **852**, a mark-up value field **854**, a first interval field **856** and a second interval field **858**. The reseller field **850** holds a code identifying the reseller. The mark-up type field **852**, the mark-up value field **854** and the first and second interval fields **856** and **858** are of the same type as described in connection with fields of the same name in Figure **47**, for example. The contents of the fields of this record **860** may be set according to system operator preferences, for example.

Referring to Figure 50, an exemplary reseller global mark-up table record is shown generally at 860. In this record, the reseller field 850 holds a code indicating the reseller is "Klondike", the mark-up type field 852 holds a code indicating the mark-up type is percent, the mark-up value field 854 holds a value representing 10% as the mark-up value, the first interval field 856 holds the value 30 and the second interval field 858 holds the values 30 and 6 respectively to indicate the first 30 seconds are free and billing is to be done in 6 second increments after that.

Referring back to Figure 41, should the processor get to block 832, the reseller global mark-up table record as shown in Figure 50 is retrieved from the database and stored locally at the RC. As seen in Figure 41, it will be appreciated that if the conditions are met in blocks 828 or 830, or if the processor executes block 832, the processor is then directed to block 862 which causes it to set an override value equal to the contents of the mark-up value field of the located record, to set the first increment variable equal to the contents of the first interval field of the located record and to set the second increment variable equal to the contents of the second interval field of the located record. (The increment variables were alternatively set to specific values at block 826 in Figure 41.)

It will be appreciated that the located record could be a bundle override record of the type shown in Figure 37 or the located record could be a reseller special destination record of the type shown in Figure 48 or the record could be a reseller global mark-up table record of the type shown in Figure 50. After the override and first and second increment variables have been set at block 862, the processor is directed to set as the cost per unit time the sum of the reseller rate and at least one of the route cost per unit time, the reseller cost per unit time and the default cost per unit time, depending on which record was located. To do this, block 864 directs the processor to set the cost per unit time equal to the sum of the reseller cost set at block 800 in Figure 41, plus the contents of the override variable calculated in block 862 in Figure 41.

The cost per unit time has thus been calculated and it is this cost per unit time that is used in block 752 of Figure 33B, for example.

Terminating the Call

5 In the event that either the caller or the callee terminates a call, the telephone of the terminating party sends a SIP bye message to the controller 14. An exemplary SIP bye message is shown at 900 in Figure 51 and includes a caller field 902, a callee field 904 and a call ID field 906. The caller field 902 holds a twelve digit user name, the callee field 904 holds a PSTN compatible
10 number or user name, and the call ID field 906 holds a unique call identifier field of the type shown in the caller ID field 65 of the SIP invite message shown in Figure 3.

15 Thus, for example, referring to Figure 52, a SIP bye message for the Calgary callee is shown generally at 908 and the caller field 902 holds a user name identifying the caller, in this case 2001 1050 8667, the callee field 904 holds a user name identifying the Calgary callee, in this case 2001 1050 2222, and the callee ID field 906 holds the code FA10 @ 192.168.0.20, which is the call ID for the call.

20 The SIP bye message shown in Figure 52 is received at the call controller 14 and the call controller executes a process as shown generally at 910 in Figure 53. The process includes a first block 912 that directs the call controller processor to copy the caller, callee and call ID field contents from the SIP bye message received from the terminating party to corresponding fields of an RC stop message buffer (not shown). Block 914 then directs the processor to
25 copy the call start time from the call timer and to obtain a call stop time from the call timer. Block 916 then directs the call controller to calculate a communication session time by determining the difference in time between the call start time and the call stop time. This session time is then stored in a
30 corresponding field of the RC call stop message buffer. Block 918 then directs the processor to copy the route from the call log. An RC call stop message

produced as described above is shown generally at **1000** in Figure **54**. An RC call stop message specifically associated with the call made to the Calgary callee is shown generally at **1020** in Figure **55**.

5 Referring to Figure **54**, the RC stop call message includes a caller field **1002**,
callee field **1004**, a call ID field **1006**, an account start time field **1008**, an
account stop time field **1010**, a communication session time **1012** and a route
10 field **1014**. The caller field **1002** holds a username, the callee field **1004** holds
a PSTN-compatible number or system number, the call ID field **1006** hold the
unique call identifier received from the SIP invite message shown in Figure **3**,
the account start time field **1008** holds the date and start time of the call, the
account stop time field **1010** holds the date and time the call ended, the
account session time field **1012** holds a value representing the difference
15 holds the IP address for the communications link that was established.

Referring to Figure **55**, an exemplary RC stop call message for the Calgary
callee is shown generally at **1020**. In this example the caller field **1002** holds
the user name **2001 1050 8667** identifying the Vancouver-based caller and
20 the callee field **1004** holds the user name **2001 1050 2222** identifying the
Calgary callee. The contents of the call ID field **1006** are **FA10 @**
192.168.0.20. The contents of the accounting start time field **1008** are **2006-**
12-30 12:12:12 and the contents of the accounting stop time field are **2006-**
12-30 12:12:14. The contents of the communication session time field **1012**
25 are **2** to indicate **2** seconds call duration and the contents of the route field are
72.64.39.58.

Referring back to Figure **53**, after having produced an RC call stop message,
block **920** directs the call controller processor to send the RC stop message
30 compiled in the RC call stop message buffer to the RC **16**. Block **922** directs
the call controller to send a bye message back to the party that did not
terminate the call.

The RC receives the call stop message and an RC call stop message process is invoked at the RC, the process being shown at 950 in Figures 56A, 56B and 56C. Referring to Figure 56A, the RC stop message process 950 begins with a first block 952 that directs the RC processor to determine whether or not the communication session time is less than or equal to the first increment value set by the cost calculation routine shown in Figure 41, specifically blocks 826 or 862 thereof. If this condition is met, then block 954 directs the RC processor to set a chargeable time variable equal to the first increment value set at block 826 or 862 of Figure 41. If at block 952 the condition is not met, block 956 directs the RC processor to set a remainder variable equal to the difference between the communication session time and the first increment value mod the second increment value produced at block 826 or 862 of Figure 41. Then, the processor is directed to block 958 which directs it to determine whether or not the remainder is greater than zero. If so, block 960 directs the RC processor to set the chargeable time variable equal to the difference between the communication session time and the remainder value. If at block 958 the remainder is not greater than zero, block 962 directs the RC processor to set the chargeable time variable equal to the contents of the communication session time from the RC stop message. The processor is then directed to block 964. In addition, after executing block 954 or block 960, the processor is directed to block 964.

Block 964 directs the RC processor to determine whether or not the chargeable time variable is greater than or equal to the free time balance as determined from the free time field 742 of the subscriber account table record shown in Figure 39. If this condition is satisfied, Block 966 directs the processor to set the free time field 742 in the record shown in Figure 39, to zero. If the chargeable time variable is not greater than or equal to the free time balance, Block 968 directs the RC processor to set a user cost variable to zero and Block 970 then decrements the free time field 742 of the

subscriber account record for the caller by the chargeable time amount determined by block 954, 960 or 962.

5 If at Block 964 the RC processor was directed to Block 966 which causes the free time field (742) to be set to zero, referring to Figure 56B, Block 972 directs the processor to set a remaining chargeable time variable equal to the difference between the chargeable time and the contents of the free time field (742). Block 974 then directs the processor to set the user cost variable equal to the product of the remaining chargeable time and the cost per second
10 calculated at Block 750 in Figure 33B. Block 976 then directs the processor to decrement the funds balance field (740) of the subscriber account record shown in Figure 39 by the contents of the user cost variable calculated at Block 974. After completing Block 976 or after completing Block 970 in Figure 56A. Block 978 directs the processor to calculate a reseller cost variable as
15 the product of the reseller rate as indicated in the mark-up value field 810 of the system operator mark-up table record shown in Figure 45 and the communication session time determined at Block 916 in Figure 53. Then, Block 980 directs the processor to add the reseller cost to the reseller balance field of a reseller account record of the type shown in Figure 57 at 982.

20 The reseller account record includes a reseller ID field 984 and the aforementioned reseller balance field 986. The reseller ID field 984 holds a reseller ID code, and the reseller balance field 986 holds an accumulated balance of charges.

25 Referring to Figure 58, a specific reseller accounts record for the reseller "Klondike" is shown generally at 988. In this record the reseller ID field 984 holds a code representing the reseller "Klondike" and the reseller balance field 986 holds a balance of \$100.02. Thus, referring back to Figure 56B, the
30 contents of the reseller balance field 986 in Figure 58 are incremented by the reseller cost calculated at Block 978.

5 Still referring to Figure 56B, after adding the reseller cost to the reseller
balance field as indicated by Block 980, Block 990 directs the processor to
calculate a system operator cost as the product of the system operator cost
per second, as set at block 822 in Figure 41, and the communication session
10 time as determined at Block 916 in Figure 53. Block 992 then directs the
processor to add the system operator cost value calculated at Block 990 to a
system operator accounts table record of the type shown at 994 in Figure 59.
This record includes a system operator balance field 996 holding an
accumulated charges balance. Referring to Figure 60 in the embodiment
15 described, the system operator balance field 996 may hold the value
\$1,000.02 for example, and to this value the system operator cost calculated
at Block 990 is added when the processor executes Block 992 at Figure 56C.

20 Ultimately, the final reseller balance in Figure 58 holds a number representing
an amount owed to the reseller by the system operator and the system
operator balance holds a number representing an amount of profit for the
system operator.

25 While specific embodiments of the invention have been described and
illustrated, such embodiments should be considered illustrative of the
invention only and not as limiting the invention as construed in accordance
with the accompanying claims.

PRODUCING ROUTING MESSAGES FOR VOICE OVER
IP COMMUNICATIONS
Clay Perreault et al.

Appl. No.: Unassigned

Atty. Docket: SMARB19.001PRF

1/32

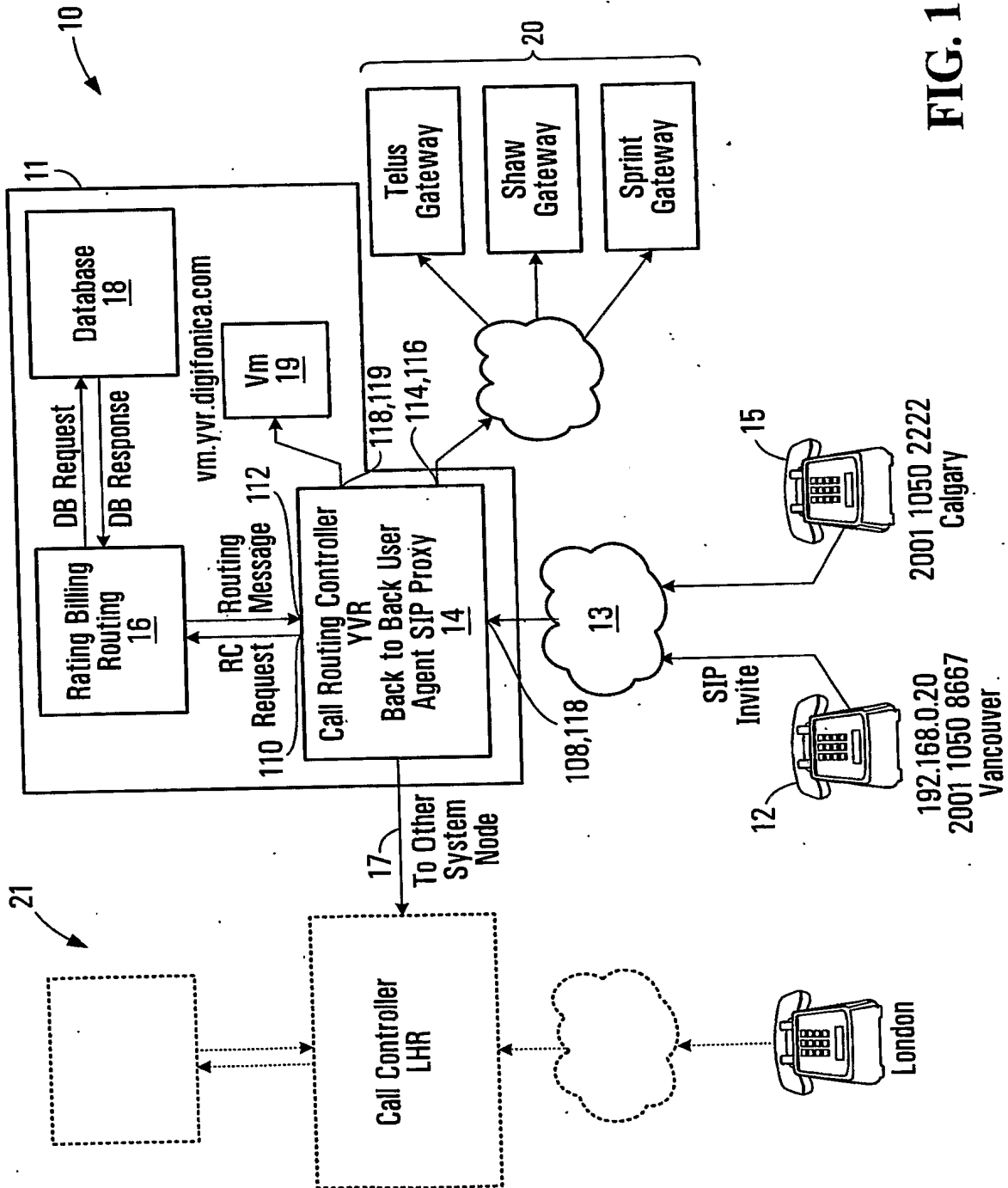

FIG. 1

PRODUCING ROUTING MESSAGES FOR VOICE OVER
 IP COMMUNICATIONS
 Clay Perreault et al.

Appl. No.: Unassigned Atty. Docket: SMARB19.001PRE
 2/32

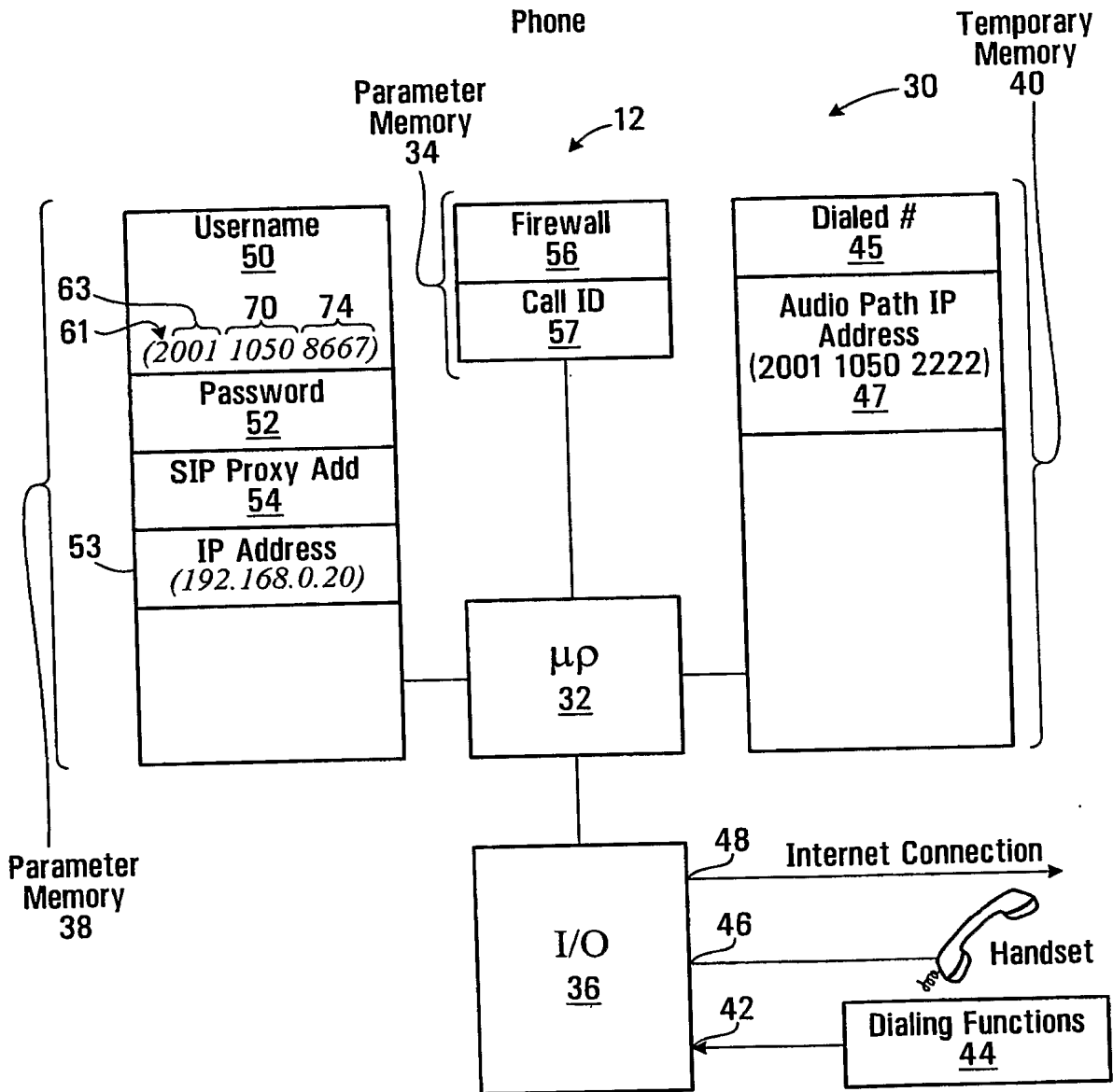

FIG. 2

PRODUCING ROUTING MESSAGES FOR VOICE OVER
IP COMMUNICATIONS
Clay Perreault et al.

Appl. No.: Unassigned Atty. Docket: SMARB19.001PRF

3/32

SIP Invite Message

60 ~ Caller 2001 1050 8667
62 ~ Callee 2001 1050 2222
64 ~ Digest Parameters XXXXXXX
65 ~ Caller ID FF10@ 192.168.0.20

FIG. 3

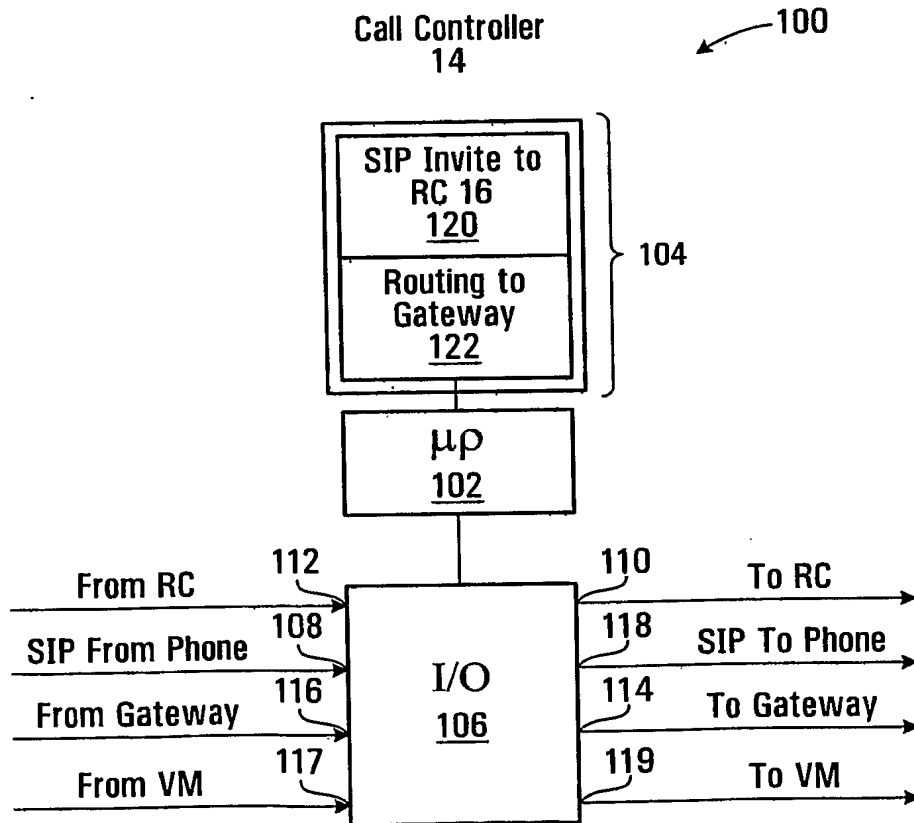

FIG. 4

PRODUCING ROUTING MESSAGES FOR VOICE OVER
IP COMMUNICATIONS
Clay Perreault et al.

Appl. No.: Unassigned

Atty. Docket: SMARB19.001PRF

4/32

Call Controller Process

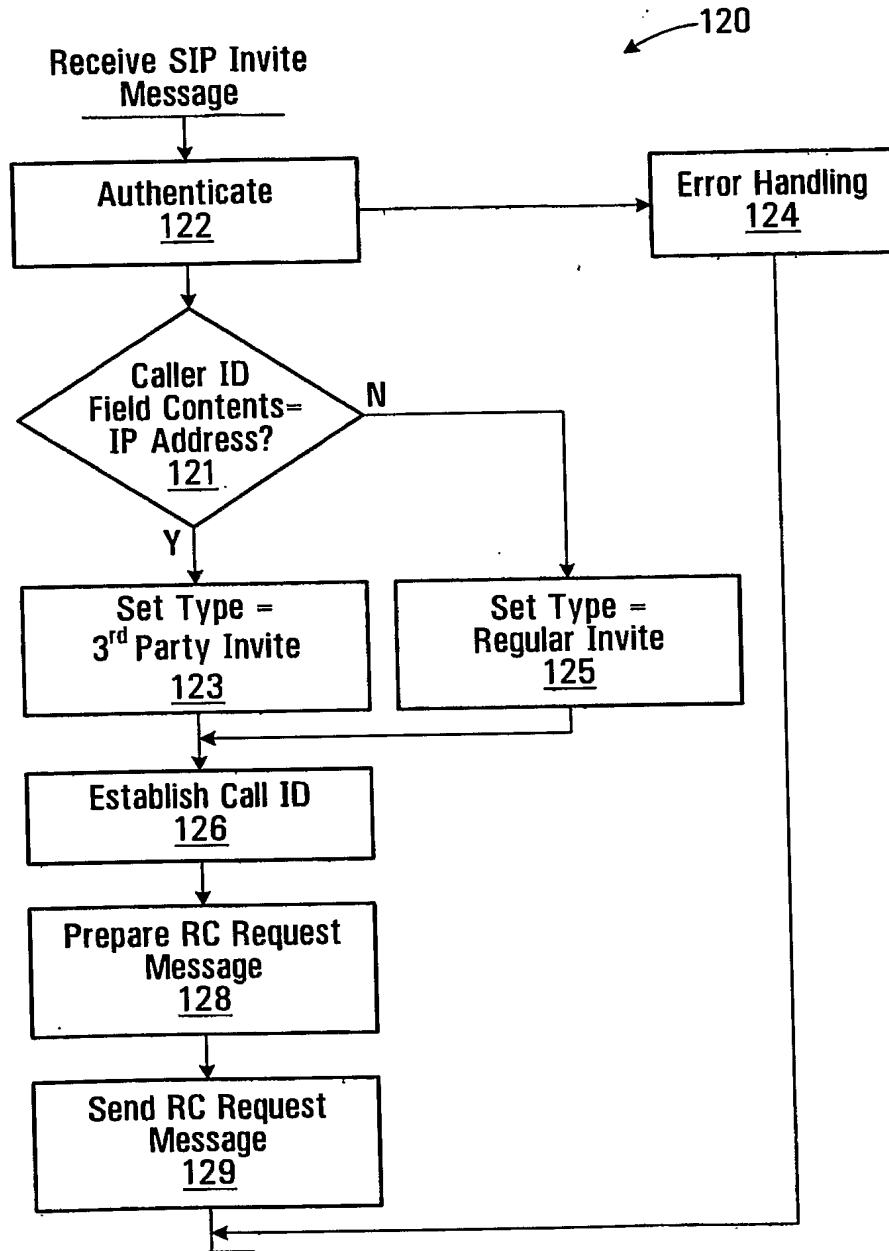

FIG. 5

PRODUCING ROUTING MESSAGES FOR VOICE OVER
IP COMMUNICATIONS

Clay Perreault et al.

Appl. No.: Unassigned

Atty. Docket: SMARB19.001PRF

5/32

150

RC Request Message

152 ~ Caller 2001 1050 8667
 154 ~ Callee 2001 1050 2222
 156 ~ Digest XXXXXXX
 158 ~ Call ID FF10@ 192.168.0.20
 160 ~ Type Subscriber

FIG. 6

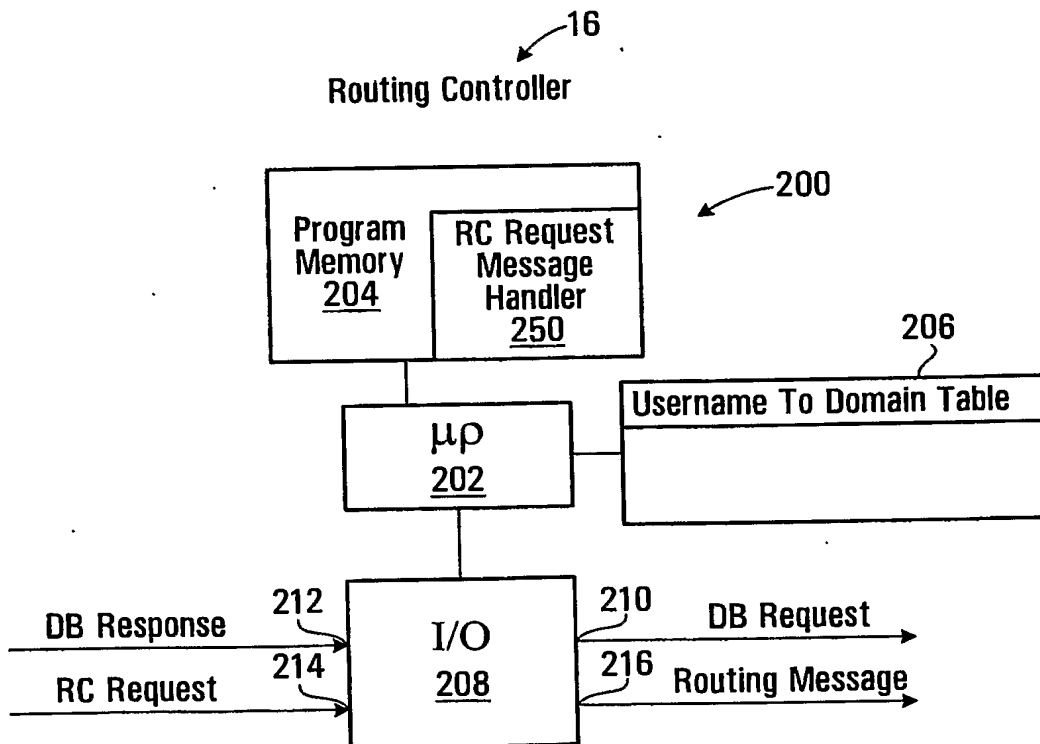

FIG. 7

PRODUCING ROUTING MESSAGES FOR VOICE OVER
IP COMMUNICATIONS
Clay Perreault et al.

Appl. No.: Unassigned

Atty. Docket: SMARB19.001PRF

6/32

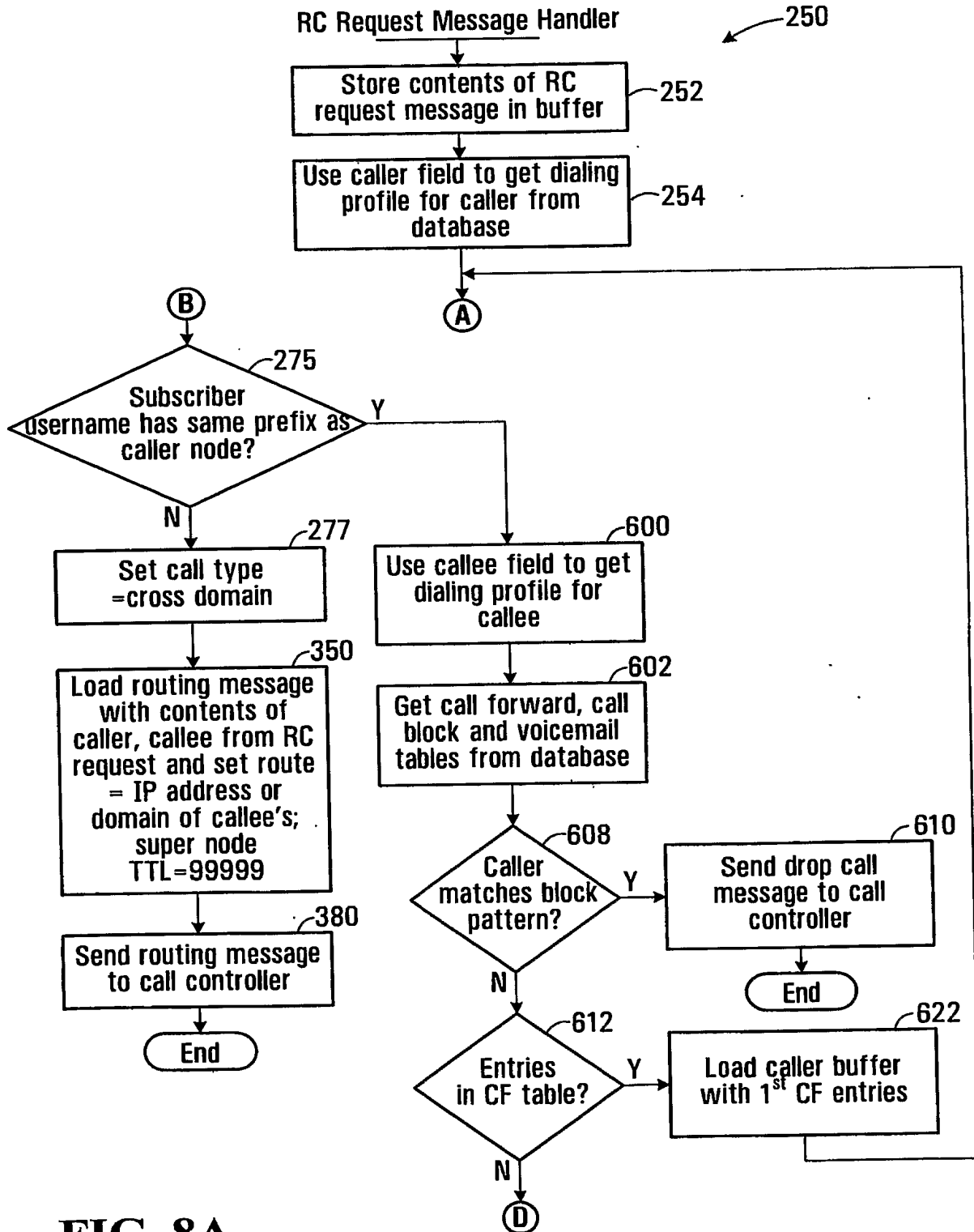

FIG. 8A

PRODUCING ROUTING MESSAGES FOR VOICE OVER
IP COMMUNICATIONS
Clay Perreault et al.

Appl. No.: Unassigned

Atty. Docket: SMARB19.001PRF

7/32

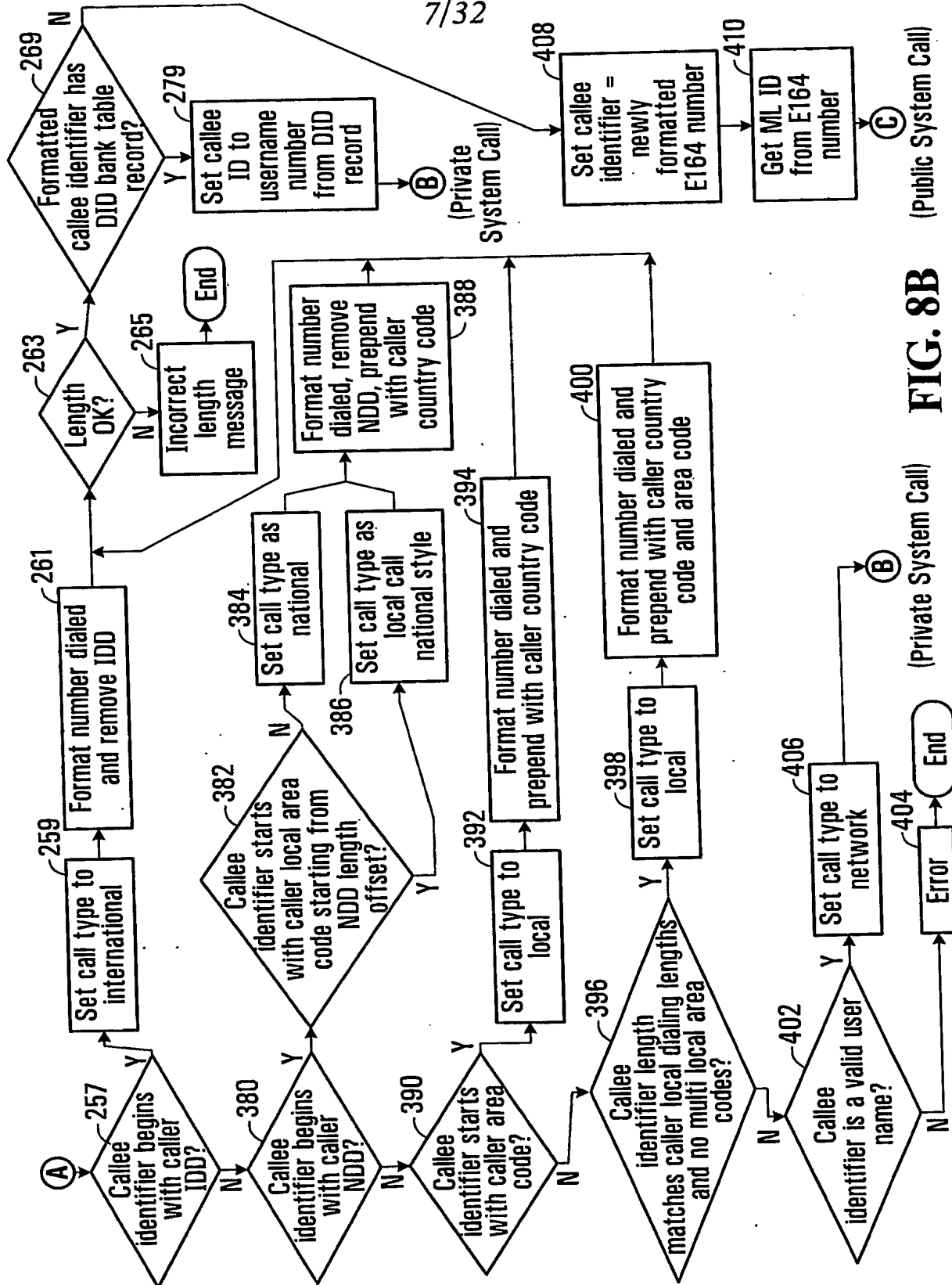

(Public System Call)

(Private System Call)

FIG. 8B

PRODUCING ROUTING MESSAGES FOR VOICE OVER
IP COMMUNICATIONS
Clay Perreault et al.

Appl. No.: Unassigned

Atty. Docket: SMARB19.001PRF

8/32

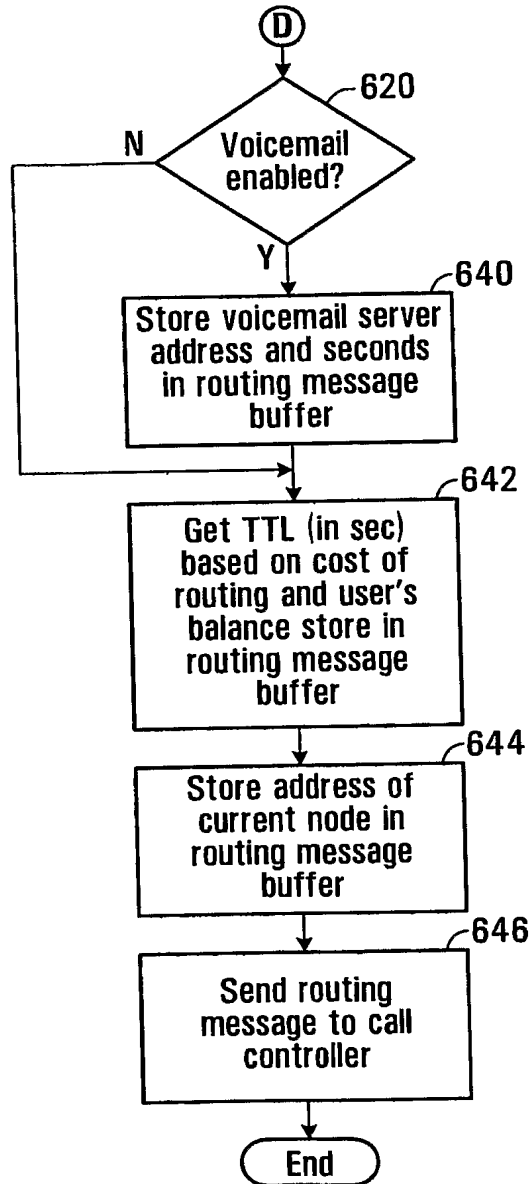

FIG. 8C

PRODUCING ROUTING MESSAGES FOR VOICE OVER
IP COMMUNICATIONS
Clay Perreault et al.

Appl. No.: Unassigned

Atty. Docket: SMARB19.001PRF

9/32

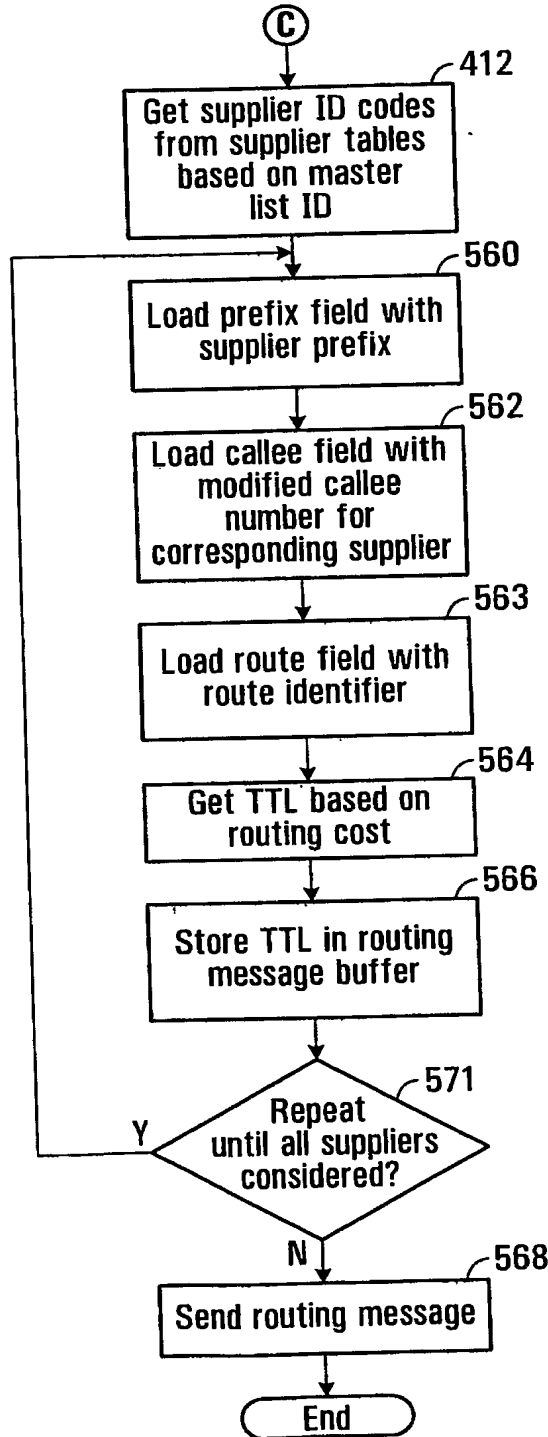

FIG. 8D

PRODUCING ROUTING MESSAGES FOR VOICE OVER
IP COMMUNICATIONS
Clay Perreault et al.

Appl. No.: Unassigned Atty. Docket: SMARB19.001PRF

10/32

Dialing Profile for a User

258 ~ Username	Assigned on Subscription
260 ~ Domain	Domain Associated with User
262 ~ NDD	1
264 ~ IDD	011
266 ~ Country Code	1
267 ~ Local Area Codes	604;778
268 ~ Caller Minimum Local Length	10
270 ~ Caller Maximum Local Length	10
273 ~ Reseller	Retailer

256

FIG. 9

Dialing Profile for Caller (Vancouver Subscriber)

258 ~ Username	284	61	63	70	74	2001 1050 8667
260 ~ Domain						sp.yvr.digifonica.com ← 282
262 ~ NDD						1
264 ~ IDD						011 286 288 290
266 ~ Country Code						1
267 ~ Local Area Codes						604;778 (Vancouver)
268 ~ Caller Minimum Local Length						10
270 ~ Caller Maximum Local Length						10
273 ~ Reseller						Klondike

276

FIG. 10

PRODUCING ROUTING MESSAGES FOR VOICE OVER
IP COMMUNICATIONS
Clay Perreault et al.

Appl. No.: Unassigned

Atty. Docket: SMARB19.001PRF

11/32

Callee Profile for Calgary Subscriber

Username	2001 1050 8667
Domain	sp.yvr.digifonica.com
NDD	1
IDD	011
Country Code	1
Local Area Codes	403 (Calgary)
Caller Minimum Local Length	7
Caller Maximum Local Length	10

FIG. 11

Callee Profile for London Subscriber

Username	4401 1062 4444
Domain	sp.lhr.digifonica.com
NDD	0
IDD	00
Country Code	44
Local Area Codes	20 (London)
Caller Minimum Local Length	10
Caller Maximum Local Length	11

FIG. 12

PRODUCING ROUTING MESSAGES FOR VOICE OVER
IP COMMUNICATIONS
Clay Perreault et al.

Appl. No.: Unassigned Atty. Docket: SMARB19.001PRF

12/32

DID Bank Table Record Format

281 ~ Username System subscriber
272 ~ User Domain Host name of supernode
274 ~ DID E164#

268

FIG. 13

DID Bank Table Record for Calgary Subscriber

281 ~ Username 2001 1050 2222
272 ~ User Domain Sp.yvr.digifonica.com
274 ~ DID 1 604 867 5309
 283 287 289
 285

276

FIG. 14

PRODUCING ROUTING MESSAGES FOR VOICE OVER
IP COMMUNICATIONS
Clay Perreault et al.

Appl. No.: Unassigned

Atty. Docket: SMARB19.001PRF)

13/32

352

Routing Message Format

354	Supplier Prefix (optional)	Code identifying supplier traffic
356	Delimiter (optional)	Symbol separating fields
	358 Callee	PSTN compatible number or Digifonica number
	360 Route	Domain name or IP address
362	Time to Live(TTL)	In seconds
	364 Other	TBD

FIG. 15

Example of Routing Message - Different Node

44011062444@sp.lhr.digifonica.com;tll=9999

359 361 363

366

FIG. 16

Prefix to Supernode Table Record Format

374	372 Prefix	First n digits of callee identifier
	Supernode Address	IP address or fully qualified domain name

370

FIG. 17

Prefix to Supernode Table Record for Calgary Subscriber

Prefix 20
Supernode Address sp.yvr.digifonica.com

FIG. 18

PRODUCING ROUTING MESSAGES FOR VOICE OVER
IP COMMUNICATIONS
Clay Perreault et al.

Appl. No.: Unassigned

Atty. Docket: SMARB19.001PRF

14/32

Master List Record Format

500 ~	ml_id	1019
502 ~	Dialing code	1604
504 ~	Country code	The country code is the national prefix to be used when dialing TO a particular country FROM another country.
506 ~	Nat Sign #(Area Code)	604
508 ~	Min Length	7
510 ~	Max Length	7
512 ~	NDD	The NDD prefix is the access code used to make a call WITHIN that country from one city to another (when calling another city in the same vicinity, this may not be necessary).
514 ~	IDD	The IDD prefix is the international prefix needed to dial a call FROM the country listed TO another country.
516 ~	Buffer rate	Safe change rate above the highest rate charged by suppliers

FIG. 19

Example: Master List Record with Populated Fields

ml_id	1019
Dialing code	1604
Country code	1
Nat Sign #(Area Code)	604
Min Length	7
Max Length	7
NDD	1
IDD	011
Buffer rate	\$0.009/min

FIG. 20

PRODUCING ROUTING MESSAGES FOR VOICE OVER
IP COMMUNICATIONS
Clay Perreault et al.

Appl. No.: Unassigned Atty. Docket: SMARB19.001PRF

15/32

Suppliers List Record Format

540 ~	Sup_id	Name code
542 ~	MI_id	Numeric code
544 ~	Prefix (optional)	String identifying supplier's traffic #
546 ~	Route	IP address
548 ~	NDD/IDD rewrite	
550 ~	Rate	Cost per second to Digifonica to use this route

FIG. 21

Telus Supplier Record

Sup_id	2010 (Telus)
MI_id	1019
Prefix (optional)	4973#
Route	72.64.39.58
NDD/IDD rewrite	011
Rate	\$0.02/min

FIG. 22

Shaw Supplier Record

Sup_id	2011 (Shaw)
MI_id	1019
Prefix (optional)	4974#
Route	73.65.40.59
NDD/IDD rewrite	011
Rate	\$0.025/min

FIG. 23

Sprint Supplier Record

Sup_id	2012 (Sprint)
MI_id	1019
Prefix (optional)	4975#
Route	74.66.41.60
NDD/IDD rewrite	011
Rate	\$0.03/min

FIG. 24

PRODUCING ROUTING MESSAGES FOR VOICE OVER
IP COMMUNICATIONS
Clay Perreault et al.

Appl. No.: Unassigned

Atty. Docket: SMARB19.001PRF

16/32

Routing Message Buffer for Gateway Call

4973#0116048675309@72.64.39.58;ttl=3600 ~ 570
4974#0116048675309@73.65.40.59;ttl=3600 ~ 572
4975#0116048675309@74.66.41.60;ttl=3600 ~ 574

FIG. 25

Call Block Table Record Format

604 ~ Username Digifonica #
606 ~ Block Pattern PSTN compatible or Digifonica #

FIG. 26

Call Block Table Record for Calgary Callee

604 ~ Username of Callee 2001 1050 2222
606 ~ Block Pattern 2001 1050 8664

FIG. 27

Call Forwarding Table Record Format for Callee

614 ~ Username of Callee Digifonica #
616 ~ Destination Number Digifonica #
618 ~ Sequence Number Integer indicating order to try this

FIG. 28

Call Forwarding Table Record for Calgary Callee

614 ~ Username of Callee 2001 1050 2222
616 ~ Destination Number 2001 1055 2223
618 ~ Sequence Number 1

FIG. 29

PRODUCING ROUTING MESSAGES FOR VOICE OVER
IP COMMUNICATIONS
Clay Perreault et al.

Appl. No.: Unassigned

Atty. Docket: SMARB19.001PRF

17/32

Voicemail Table Record Format

624	Username of Callee	Digifonica #
626	Vm Server	domain name
628	Seconds to Voicemail	time to wait before engaging voicemail
630	Enabled	yes/no

FIG. 30

Voicemail Table Record for Calgary Callee

Username of Callee	2001 1050 2222
Vm Server	vm.yvr.digifonica.com
Seconds to Voicemail	20
Enabled	1

FIG. 31

Routing Message Buffer - Same Node

650	200110502222@sp.yvr.digifonica.com;tll=3600
652	200110552223@sp.yvr.digifonica.com;tll=3600
654	vm.yvr.digifonica.com;20;tll=60
656	sp.yvr.digifonica.com

FIG. 32

PRODUCING ROUTING MESSAGES FOR VOICE OVER
IP COMMUNICATIONS
Clay Perreault et al.

Appl. No.: Unassigned Atty. Docket: SMARB19.001PRF

18/32

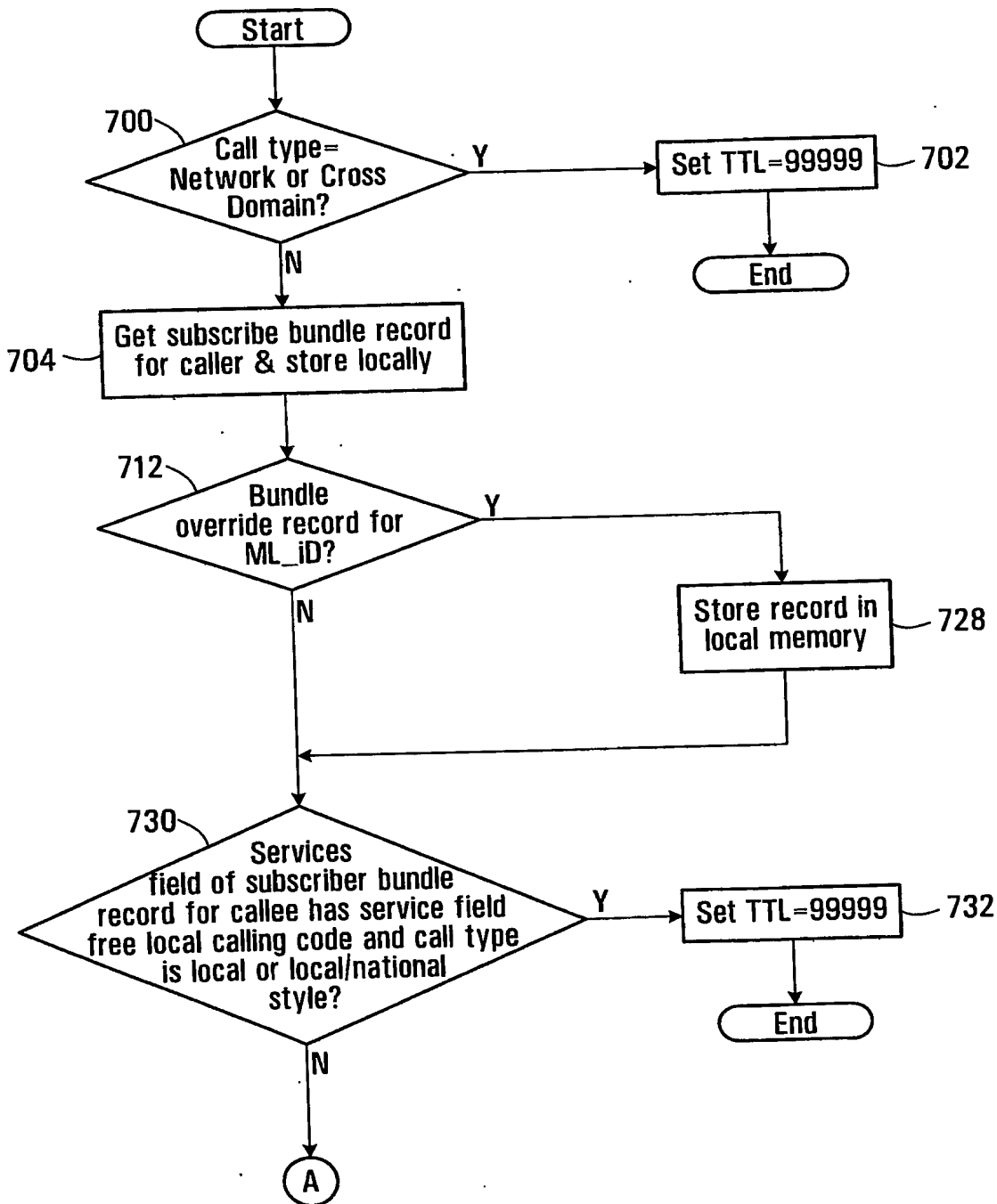

FIG. 33A

PRODUCING ROUTING MESSAGES FOR VOICE OVER
IP COMMUNICATIONS
Clay Perreault et al.

Appl. No.: Unassigned Atty. Docket: SMARB19.001PRF

19/32

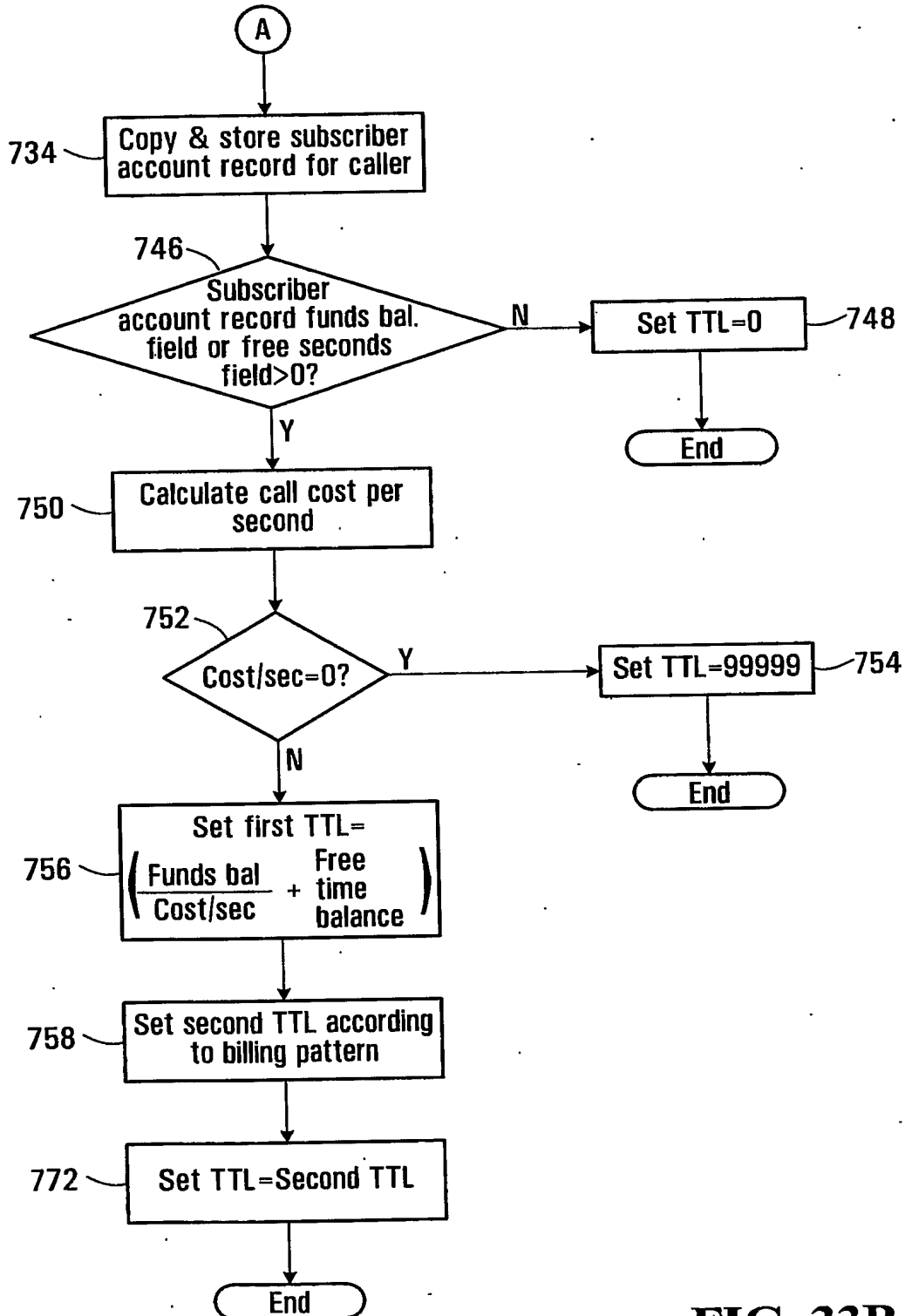

FIG. 33B

PRODUCING ROUTING MESSAGES FOR VOICE OVER
IP COMMUNICATIONS
Clay Perreault et al.

Appl. No.: Unassigned Atty. Docket: SMARB19.001PRF

20/32

Subscriber Bundle Table Record

708 ~ Username Subscriber username
710 ~ Services Codes identifying service features
(e.g. Free local calling; call blocking, voicemail)

706

FIG. 34

Subscriber Bundle Record for Vancouver Caller

708 ~ Username 2001 1050 8667
710 ~ Services 10; 14; 16

FIG. 35

Bundle Override Table Record

716 ~ ML_Id Master list ID code
718 ~ Override type Fixed; percent; cents
720 ~ Override value real number representing value of override type
722 ~ Inc1 first level of charging (minimum # of seconds) charge
724 ~ Inc2 second level of charging

714

FIG. 36

Bundle Override Record for Located ML_id

716 ~ ML_Id 1019
718 ~ Override type percent
720 ~ Override value 10.0
722 ~ Inc1 30 seconds
724 ~ Inc2 6 seconds

726

FIG. 37

PRODUCING ROUTING MESSAGES FOR VOICE OVER
IP COMMUNICATIONS
Clay Perreault et al.

Appl. No.: Unassigned Atty. Docket: SMARB19.001PRF,

21/32

Subscriber Account Table Record

736 ↙

738 ~	Username	Subscriber username
740 ~	Funds balance	real number representing \$ value of credit
742 ~	Free time balance	integer representing # of free seconds

FIG. 38

Subscriber Account Record for Vancouver Caller

744 ↙

738 ~	Username	2001 1050 8667
740 ~	Funds balance	\$10.00
742 ~	Free time balance	100

FIG. 39

PRODUCING ROUTING MESSAGES FOR VOICE OVER
IP COMMUNICATIONS
Clay Perreault et al.

Appl. No.: Unassigned

Atty. Docket: SMARB19.001PRF

22/32

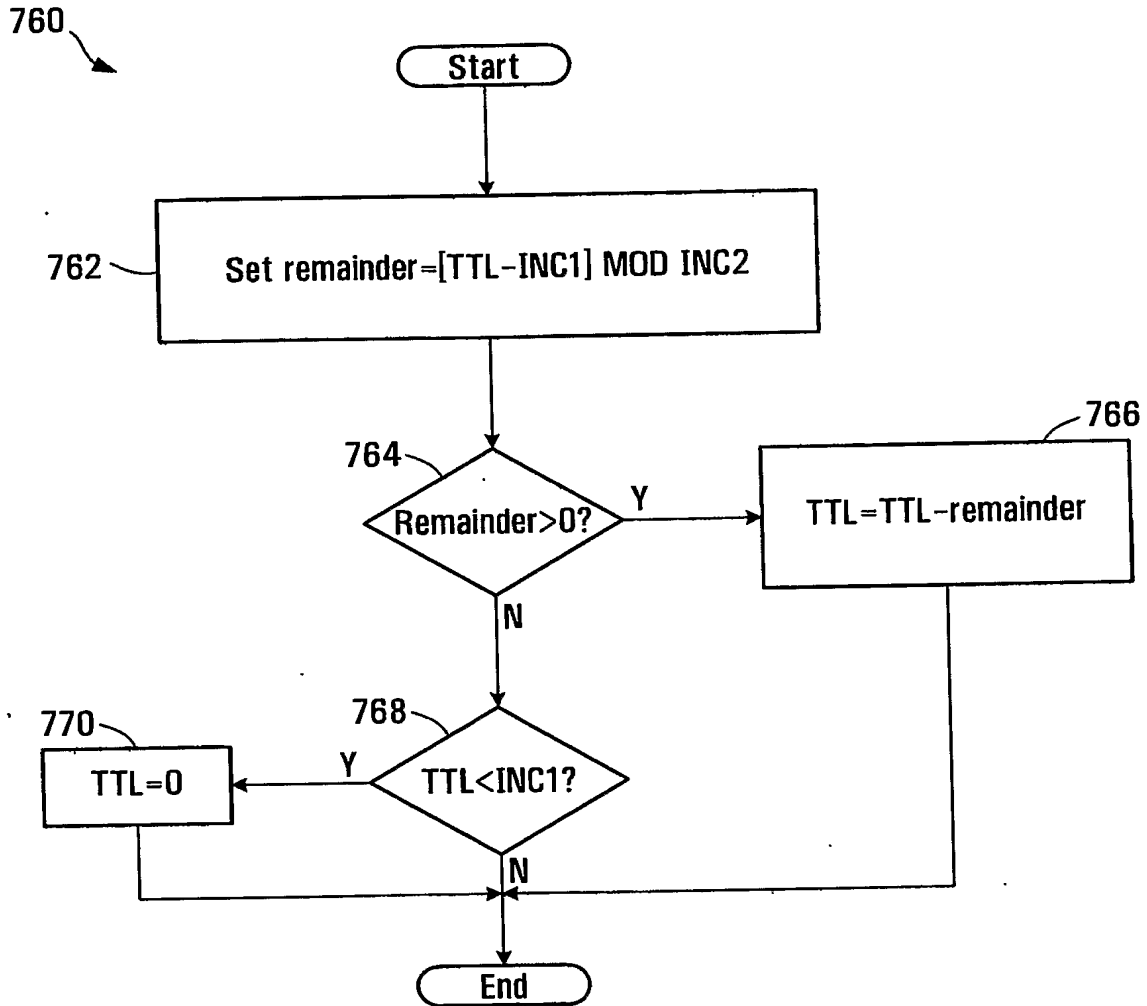

FIG. 40

PRODUCING ROUTING MESSAGES FOR VOICE OVER
IP COMMUNICATIONS
Clay Perreault et al.

Appl. No.: Unassigned

Atty. Docket: SMARB19.001PRF

23/32

780

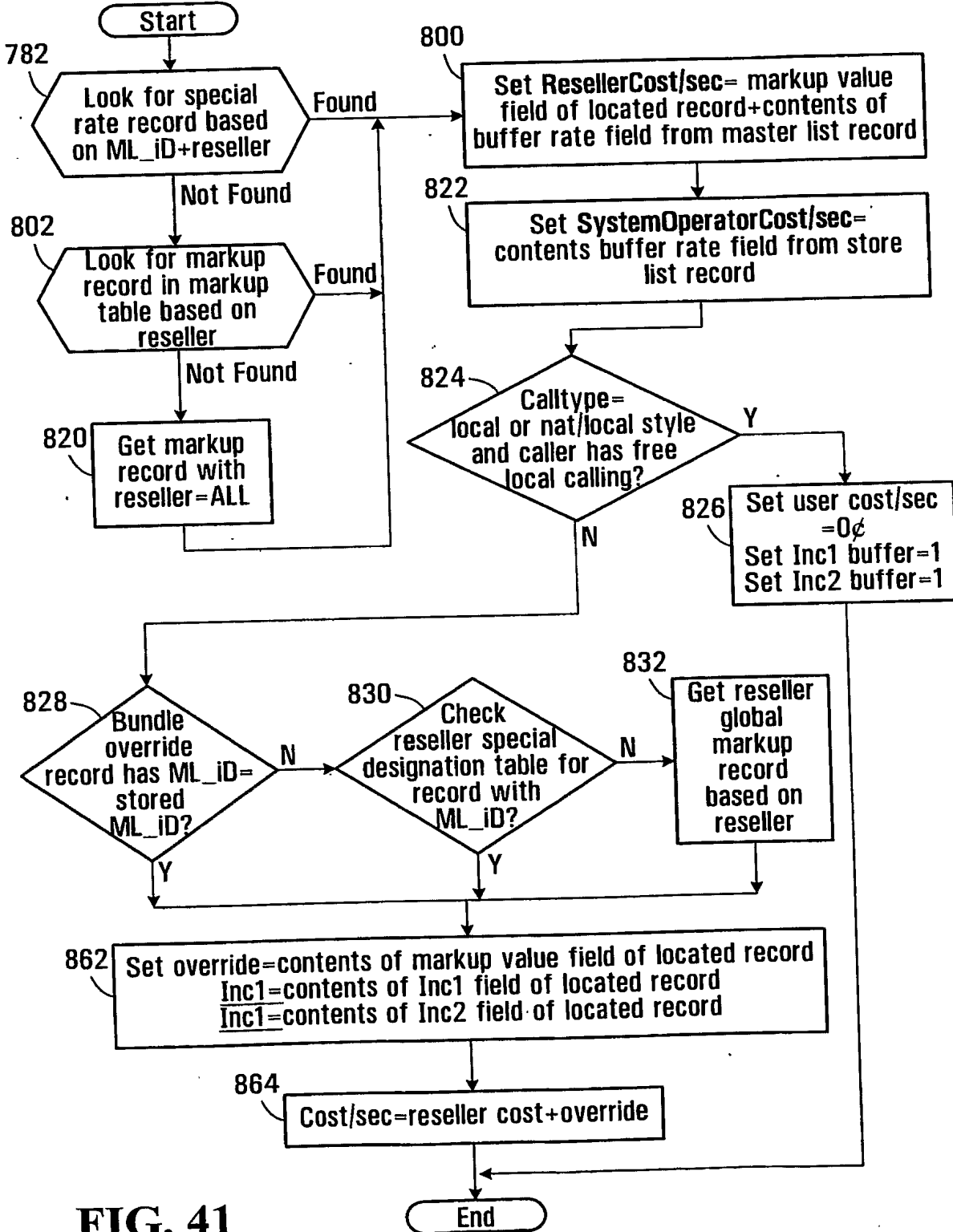

FIG. 41

PRODUCING ROUTING MESSAGES FOR VOICE OVER
IP COMMUNICATIONS
Clay Perreault et al.

Appl. No.: Unassigned Atty. Docket: SMARB19.001PRF

24/32

784

System Operator Special Rates Table Record

786	Reseller	retailer id
788	ML_Id	master list id
790	Markup Table	fixed; percent; cents
792	Markup Value	real number representing value of markup type
794	Inc1	first level of charging (minimum # of seconds) charge
796	Inc2	second level of charging

FIG. 42

798

System Operator Special Rates Table Record for Klondike

786	Reseller	Klondike
788	ML_Id	1019
790	Markup Table	cents
792	Markup Value	\$0.001
794	Inc1	30
796	Inc2	6

FIG. 43

PRODUCING ROUTING MESSAGES FOR VOICE OVER
IP COMMUNICATIONS
Clay Perreault et al.

Appl. No.: Unassigned Atty. Docket: SMARB19.001PRF)

25/32

804

System Operator Markup Table Record

806	Reseller	reseller id code
808	Markup Table	fixed; percent; cents
810	Markup Value	real number representing value of markup type
812	Inc1	first level of charging (minimum # of seconds) charge
814	Inc2	second level of charging

FIG. 44

System Operator Markup Table Record for the Reseller Klondike

806	Reseller	Klondike
808	Markup Table	cents
810	Markup Value	\$0.01
812	Inc1	30
814	Inc2	6

FIG. 45

System Operator Markup Table Record

806	Reseller	all
808	Markup Table	percent
810	Markup Value	1.0
812	Inc1	30
814	Inc2	6

FIG. 46

PRODUCING ROUTING MESSAGES FOR VOICE OVER
IP COMMUNICATIONS
Clay Perreault et al.

Appl. No.: Unassigned Atty. Docket: SMARB19.001PRF

26/32

Reseller Special Destinations Table Record

834 ~ Reseller reseller id code
836 ~ ML_id Master List ID code
838 ~ Markup Table fixed; percent; cents
840 ~ Markup Value real number representing value of markup type
842 ~ Inc1 first level of charging (minimum # of seconds) charge
844 ~ Inc2 second level of charging

832

FIG. 47

Reseller Special Destinations Table Record for the Reseller Klondike

834 ~ Reseller Klondike
836 ~ ML_id 1019
838 ~ Markup Table percent
840 ~ Markup Value 5%
842 ~ Inc1 30
844 ~ Inc2 6

846

FIG. 48

Reseller Global Markup Table Record

850 ~ Reseller reseller id code
852 ~ Markup Table fixed; percent; cents
854 ~ Markup Value real number representing value of markup type
856 ~ Inc1 first level of charging (minimum # of seconds) charge
858 ~ Inc2 second level of charging

848

FIG. 49

Reseller Global Markup Table Record for the Reseller Klondike

850 ~ Reseller Klondike
852 ~ Markup Table percent
854 ~ Markup Value 10%
856 ~ Inc1 30
858 ~ Inc2 6

860

FIG. 50

PRODUCING ROUTING MESSAGES FOR VOICE OVER
IP COMMUNICATIONS
Clay Perreault et al.

Appl. No.: Unassigned Atty. Docket: SMARB19.001PRF

27/32

900

SIP Bye Message

902 ~	Caller	Username
904 ~	Callee	PSTN compatible # or Username
906 ~	Call ID	unique call identifier (hexadecimal string@IP)

FIG. 51

908

SIP Bye Message

902 ~	Caller	2001 1050 8667
904 ~	Callee	2001 1050 2222
906 ~	Call ID	<u>FA10@192.168.0.20</u>

FIG. 52

PRODUCING ROUTING MESSAGES FOR VOICE OVER
IP COMMUNICATIONS
Clay Perreault et al.

Appl. No.: Unassigned Atty. Docket: SMARB19.001PRE

28/32

910

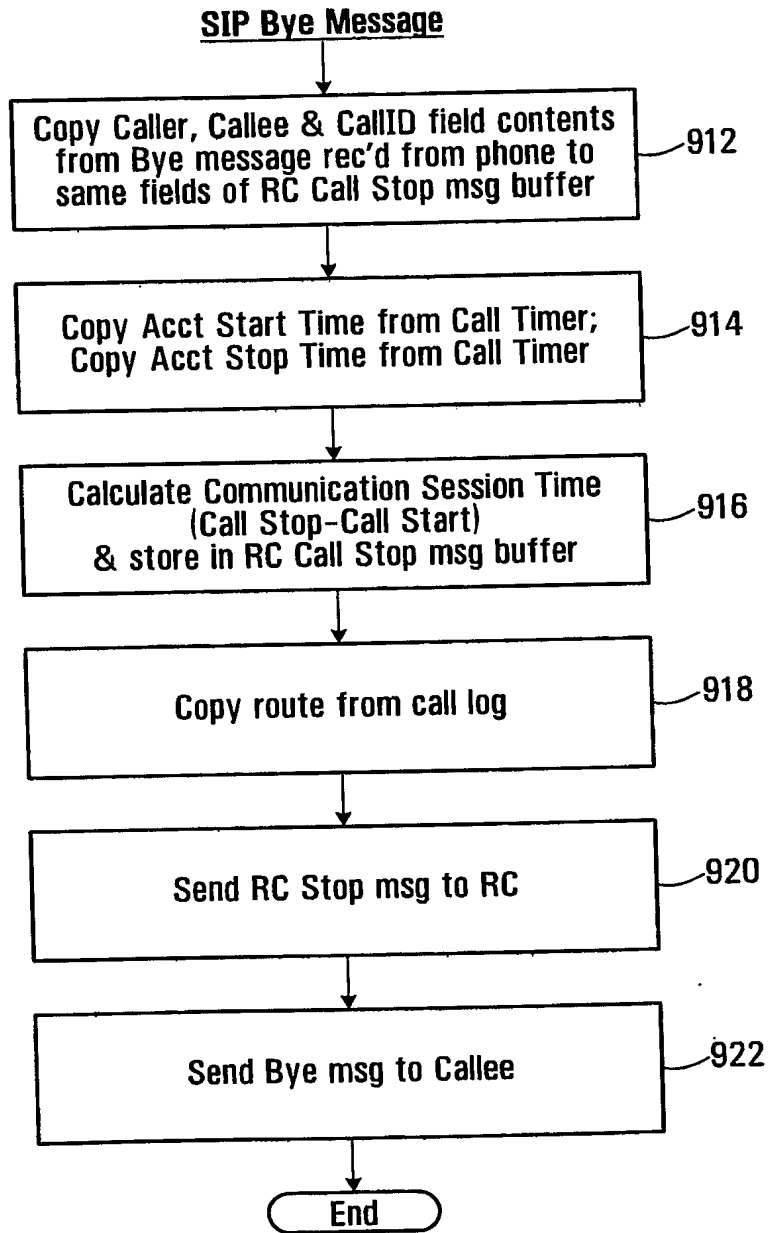

FIG. 53

PRODUCING ROUTING MESSAGES FOR VOICE OVER
IP COMMUNICATIONS
Clay Perreault et al.

Appl. No.: Unassigned Atty. Docket: SMARB19.001PRF

29/32

1000

RC Call Stop Message

1002	Caller	Username
1004	Callee	PSTN compatible # or Username
1006	Call ID	unique call identifier (hexadecimal string@IP)
1008	Acct Start Time	start time of call
1010	Acct Stop Time	time the call ended
1012	Acct Session Time	start time-stop time (in seconds)
1014	Route	IP address for the communications link that was established

FIG. 54

1020

RC Call Stop Message for Calgary Callee

1002	Caller	2001 1050 8667
1004	Callee	2001 1050 2222
1006	Call ID	FA10@192.168.0.20
1008	Acct Start Time	2006-12-30 12:12:12
1010	Acct Stop Time	2006-12-30 12:12:14
1012	Acct Session Time	2
1014	Route	72.64.39.58

FIG. 55

PRODUCING ROUTING MESSAGES FOR VOICE OVER
 IP COMMUNICATIONS
 Clay Perreault et al.

Appl. No.: Unassigned Atty. Docket: SMARB19.001PRF

30/32

950

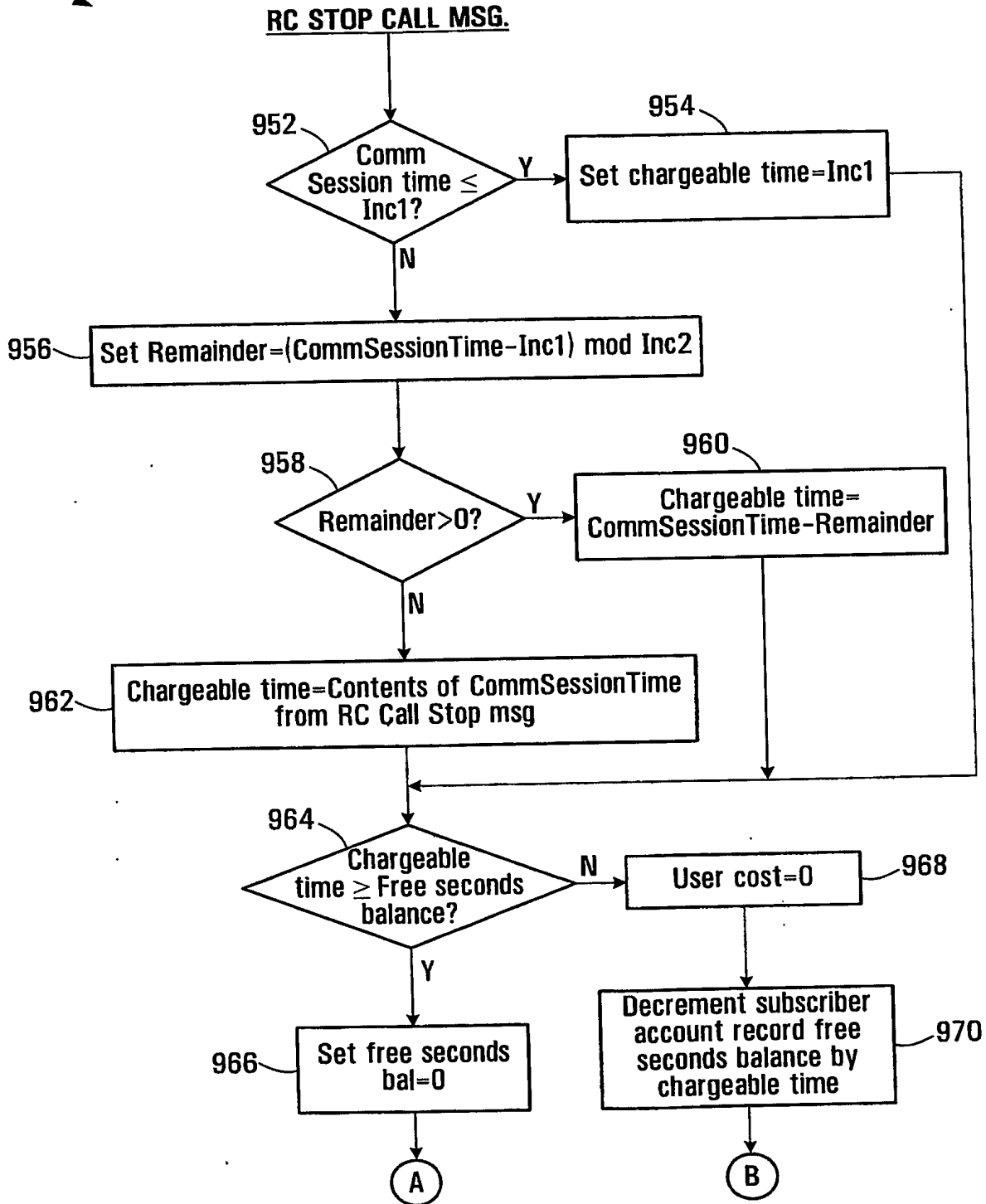

FIG. 56A

PRODUCING ROUTING MESSAGES FOR VOICE OVER
IP COMMUNICATIONS
Clay Perreault et al.

Appl. No.: Unassigned

Atty. Docket: SMARB19.001PRF)

31/32

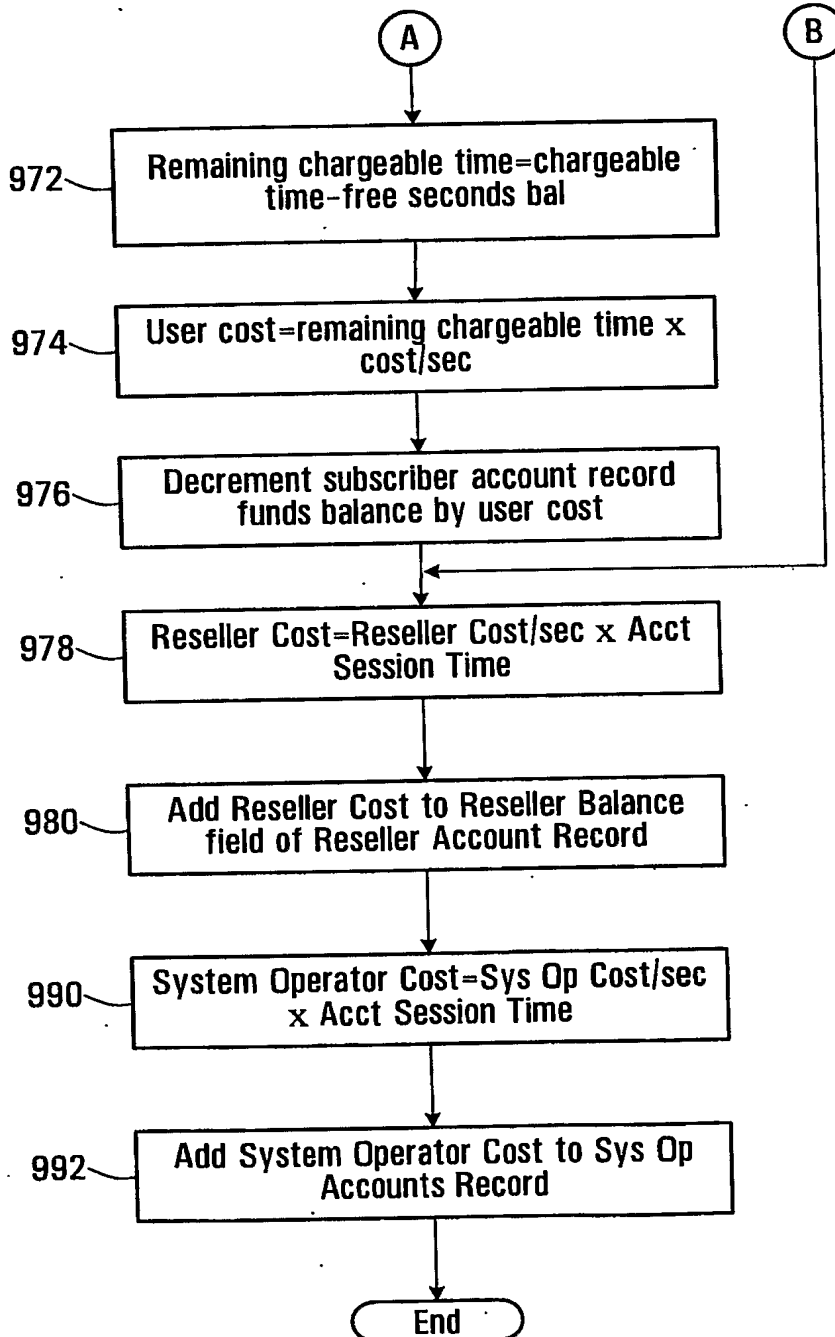

FIG. 56B

PRODUCING ROUTING MESSAGES FOR VOICE OVER
IP COMMUNICATIONS
Clay Perreault et al.

Appl. No.: Unassigned Atty. Docket: SMARB19.001PRF)

32/32

982

Reseller Accounts Table Record

984 ~ Reseller ID reseller id code
986 ~ Reseller balance accumulated balance of charges

FIG. 57

Reseller Accounts Table Record for Klondike

984 ~ Reseller ID Klondike
986 ~ Reseller balance \$100.02

988

FIG. 58

System Operator Accounts Table Record

996 ~ System Operator balance accumulated balance of charges

994

FIG. 59

System Operator Accounts Record for this System Operator

996 ~ System Operator balance \$1000.02

FIG. 60

Document code: WFEE

United States Patent and Trademark Office
Sales Receipt for Accounting Date: 11/30/2009

AJOHNSO2	SALE	#00000004	Mailroom Dt:	04/30/2009	12513147
		01	FC : 2642	215.00	OP

Document code: WFEE

United States Patent and Trademark Office
Sales Receipt for Accounting Date: 11/30/2009

AJOHNSO2	ADJ #00000002	Mailroom Dt: 04/30/2009	
	Seq No: 4803	Sales Acctg Dt: 05/01/2009	12513147
	02 FC : 2632	-270.00 OP	