

FIG. 2

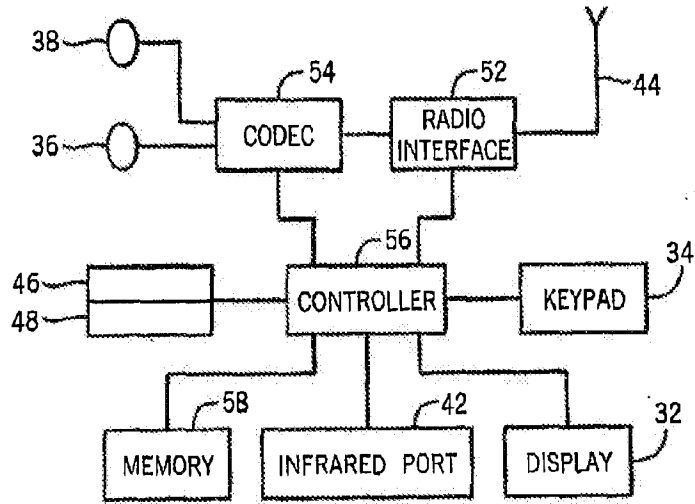


FIG. 3

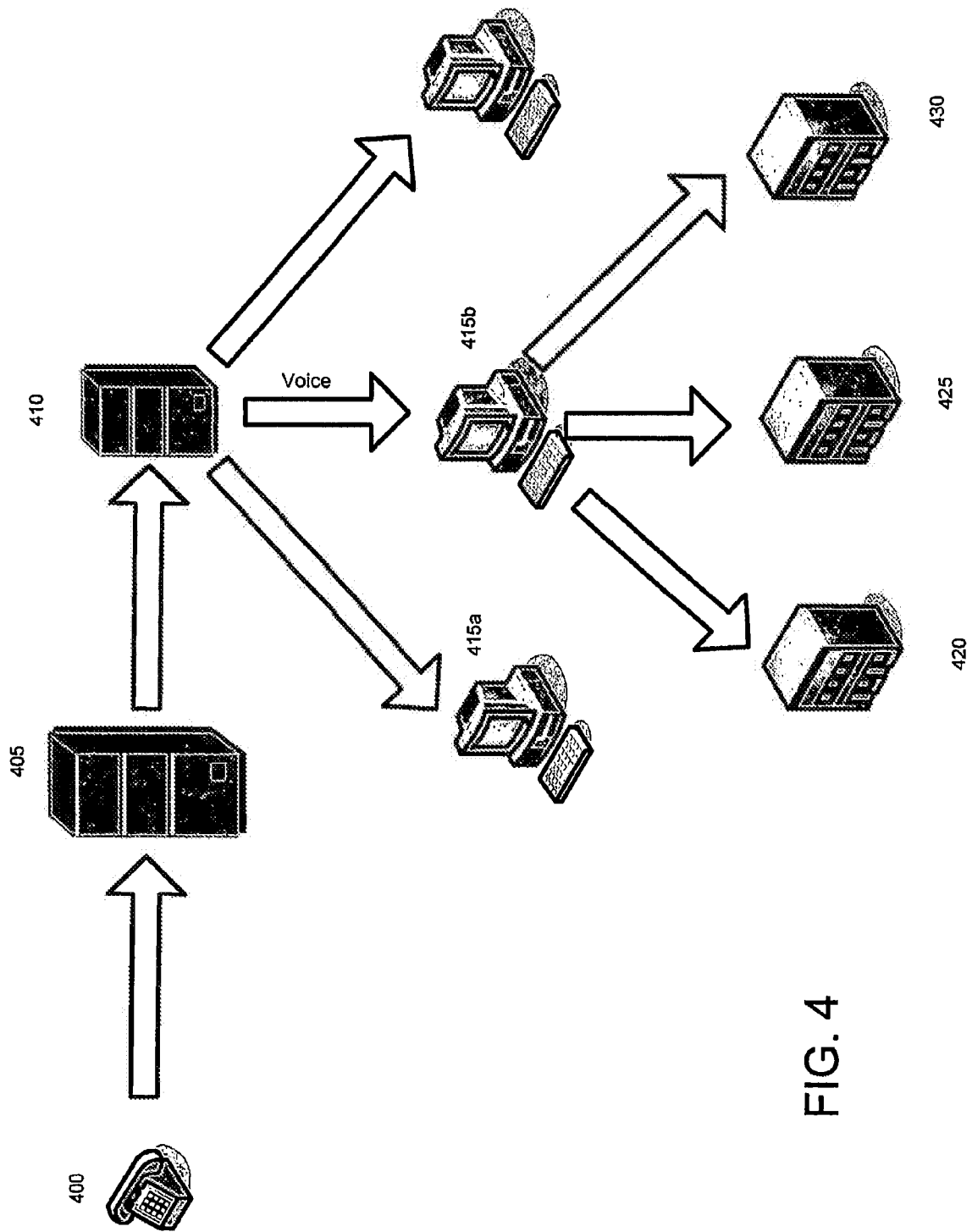


FIG. 4

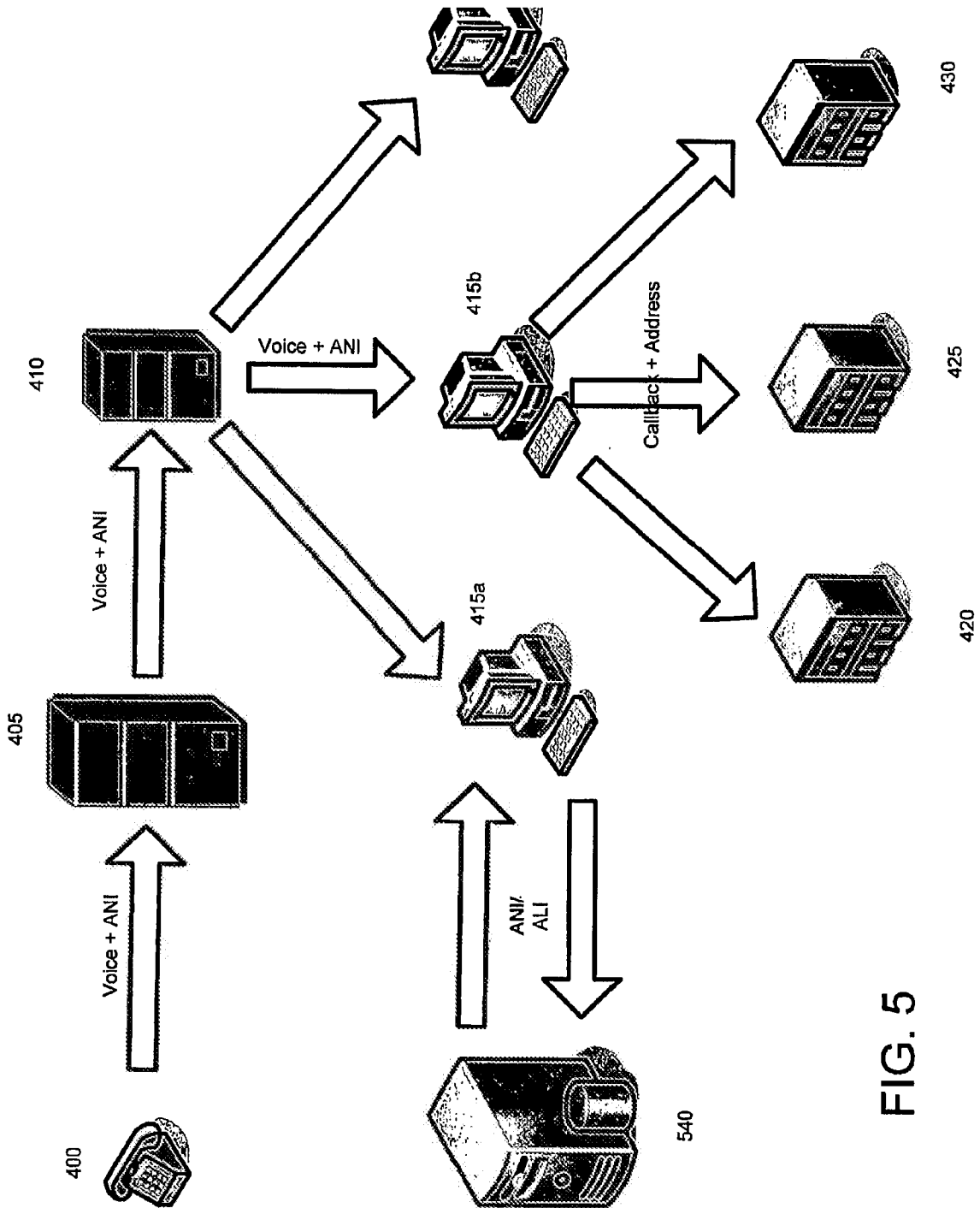


FIG. 5

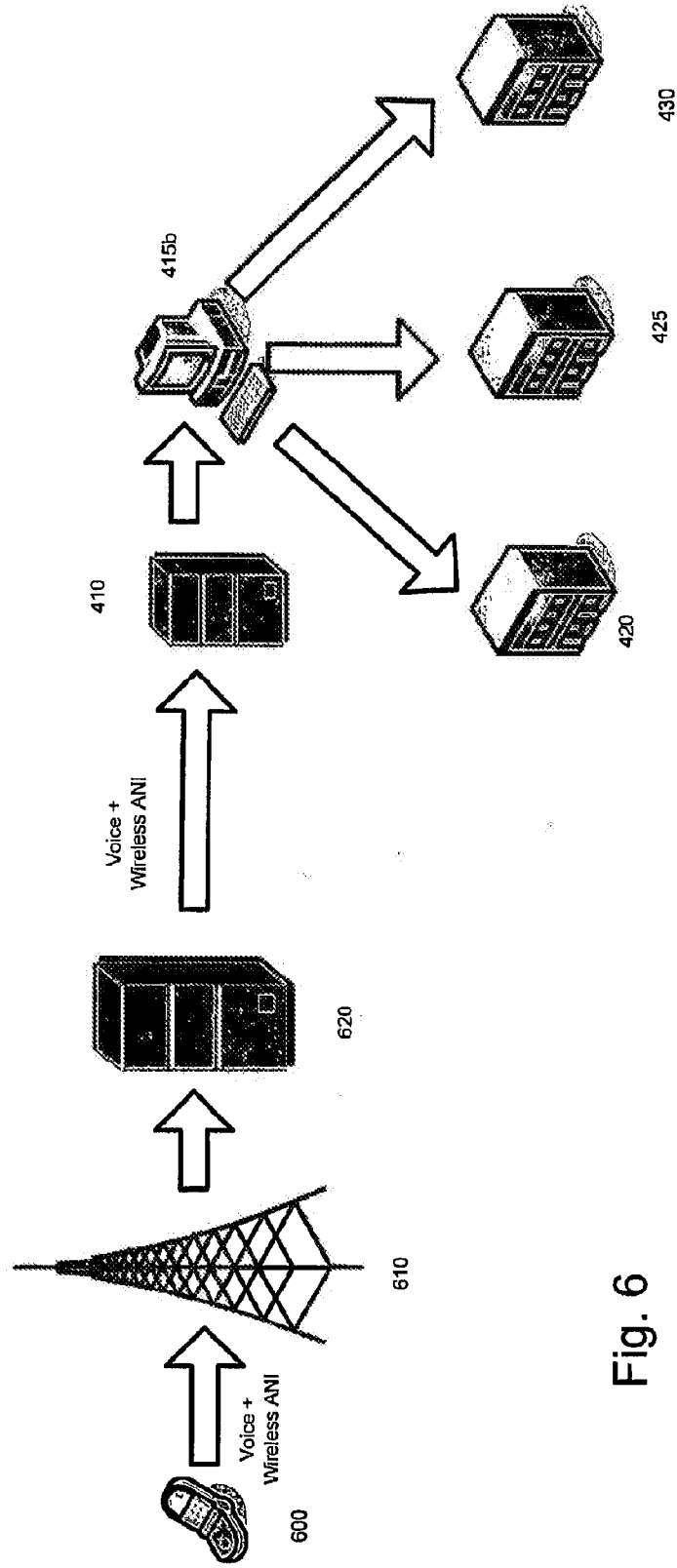


Fig. 6

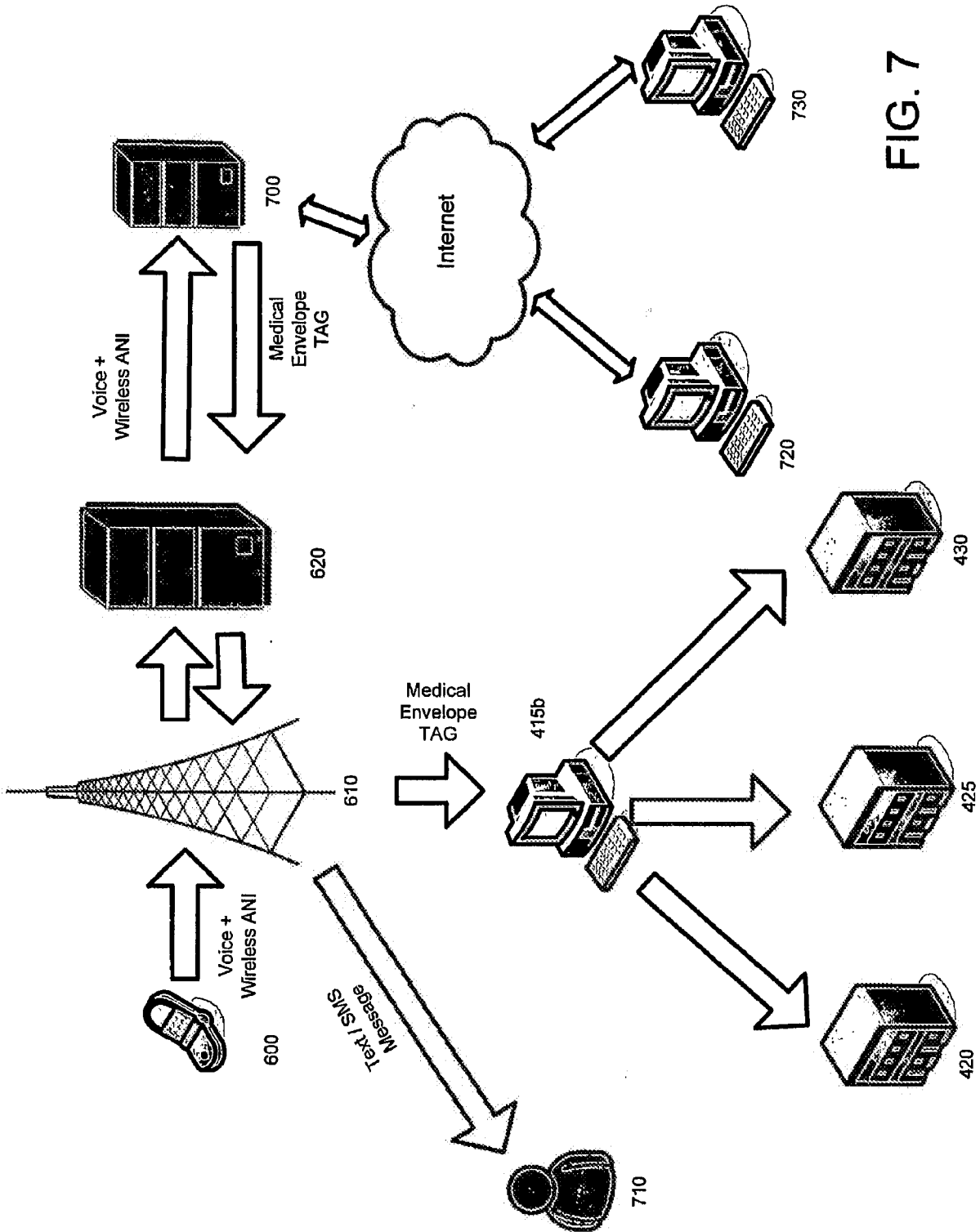


FIG. 7

(19) World Intellectual Property Organization
International Bureau



(43) International Publication Date
2 August 2007 (02.08.2007)

PCT

(10) International Publication Number
WO 2007/087077 A3

- (51) International Patent Classification:
G06F 19/00 (2006.01) H04M 11/00 (2006.01)
A61B 5/00 (2006.01)
- (21) International Application Number:
PCT/US2006/049603
- (22) International Filing Date:
28 December 2006 (28.12.2006)
- (25) Filing Language: English
- (26) Publication Language: English
- (30) Priority Data:
60/759,524 17 January 2006 (17.01.2006) US
- (71) Applicant (for all designated States except US): MEDICAL ENVELOPE L.L.C. [US/US]; 1555 Riviera Avenue, Apt. 306, Walnut Creek, CA 94596 (US).
- (72) Inventors; and
- (75) Inventors/Applicants (for US only): PATEL, Subodh, M. [US/US]; 1555 Riviera Avenue, Apt. 306, Walnut Creek, CA 94596 (US). BROOKS, Antoine, P. [US/US]; 1240 Saratoga Avenue, Palo Alto, CA 94303 (US).
- (74) Agents: ALBERT, Peter, G., Jr. et al.; Foley & Lardner LLP, 11250 El Camino Real, Suite 200, San Diego, CA 92130 (US).

- (81) Designated States (unless otherwise indicated, for every kind of national protection available): AE, AG, AL, AM, AT, AU, AZ, BA, BB, BG, BR, BW, BY, BZ, CA, CH, CN, CO, CR, CU, CZ, DE, DK, DM, DZ, EC, EE, EG, ES, FI, GB, GD, GE, GH, GM, GT, HN, HR, HU, ID, IL, IN, IS, JP, KE, KG, KM, KN, KP, KR, KZ, LA, LC, LK, LR, LS, LT, LU, LV, LY, MA, MD, MG, MK, MN, MW, MX, MY, MZ, NA, NG, NI, NO, NZ, OM, PG, PH, PL, PT, RO, RS, RU, SC, SD, SE, SG, SK, SL, SM, SV, SY, TJ, TM, TN, TR, TT, TZ, UA, UG, US, UZ, VC, VN, ZA, ZM, ZW.
- (84) Designated States (unless otherwise indicated, for every kind of regional protection available): ARIPO (BW, GH, GM, KE, LS, MW, MZ, NA, SD, SL, SZ, TZ, UG, ZM, ZW), Eurasian (AM, AZ, BY, KG, KZ, MD, RU, TJ, TM), European (AT, BE, BG, CH, CY, CZ, DE, DK, EE, ES, FI, FR, GB, GR, HU, IE, IS, IT, LT, LU, LV, MC, NL, PL, PT, RO, SE, SI, SK, TR), OAPI (BF, BJ, CF, CG, CI, CM, GA, GN, GQ, GW, ML, MR, NE, SN, TD, TG).

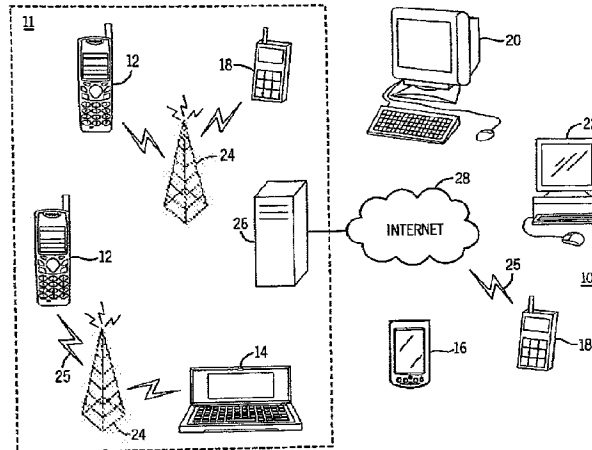
Published:

- with international search report
- before the expiration of the time limit for amending the claims and to be republished in the event of receipt of amendments

(88) Date of publication of the international search report:
13 December 2007

[Continued on next page]

(54) Title: SYSTEM AND METHOD FOR PROVIDING MEDICAL AND CONTACT INFORMATION DURING AN EMERGENCY CALL



(57) Abstract: A system and method for providing medical and contact information of a subscriber initiating an emergency 911 call, directly to a response center at the time of the receipt of the emergency 911 call. Upon the initiation of an emergency 911 call, the existing infrastructure equipment of a communication service provider are able to access a central server containing the medical and contact information of a subscriber, and relay that information directly to a response center to speed response time and response effectiveness. Alternatively, an agent resident on a communications device used by a subscriber can store and maintain medical and contact information of the subscriber, as well directly transmit the medical and contact information to the response center. In addition, a subscriber has the ability to access, view, and modify his or her medical and contact information through an appropriate interface allowing interaction with either the central server or the agent.

WO 2007/087077 A3



For two-letter codes and other abbreviations, refer to the "Guidance Notes on Codes and Abbreviations" appearing at the beginning of each regular issue of the PCT Gazette.

INTERNATIONAL SEARCH REPORT

International application No.
PCT/US 06/49603

A. CLASSIFICATION OF SUBJECT MATTER IPC(8) - G06F 19/00; A61B 5/00; H04M 11/00 (2007.01) USPC - 379/45 According to International Patent Classification (IPC) or to both national classification and IPC		
B. FIELDS SEARCHED Minimum documentation searched (classification system followed by classification symbols) USPC: 379/45 Documentation searched other than minimum documentation to the extent that such documents are included in the fields searched USPC: 379/45,37,38,39,40,265.09 370/352 Electronic data base consulted during the international search (name of data base and, where practicable, search terms used) USPTO WEST (PGPB, USPT, EPAB, JPAB); Google Scholar Search terms: sending or forwarding or retrieving or receiving medical or subscriber or contact or location information or data, PSAP or public safety answering position, enhanced emergency, 911, wireless or cell or mobile, SMS, accessing or modifying or changing		
C. DOCUMENTS CONSIDERED TO BE RELEVANT		
Category*	Citation of document, with indication, where appropriate, of the relevant passages	Relevant to claim No.
Y	US 6,721,396 B2 (CHIN et al.) 13 April 2004 (13.04.2004) abstract, col 2, ln 10-65, col 3, ln 4-35, col 4, ln 11-18	1-22
Y	US 5,805,670 A (PONS et al.) 08 September 1998 (08.09.1998), abstract, col 8, ln 27-36	1-22
<input type="checkbox"/> Further documents are listed in the continuation of Box C. <input type="checkbox"/>		
* Special categories of cited documents: "A" document defining the general state of the art which is not considered to be of particular relevance "E" earlier application or patent but published on or after the international filing date "L" document which may throw doubts on priority claim(s) or which is cited to establish the publication date of another citation or other special reason (as specified) "O" document referring to an oral disclosure, use, exhibition or other means "P" document published prior to the international filing date but later than the priority date claimed "T" later document published after the international filing date or priority date and not in conflict with the application but cited to understand the principle or theory underlying the invention "X" document of particular relevance; the claimed invention cannot be considered novel or cannot be considered to involve an inventive step when the document is taken alone "Y" document of particular relevance; the claimed invention cannot be considered to involve an inventive step when the document is combined with one or more other such documents, such combination being obvious to a person skilled in the art "&" document member of the same patent family		
Date of the actual completion of the international search 22 September 2007 (22.09.2007)		Date of mailing of the international search report <div style="text-align: center; font-size: 1.2em; font-weight: bold;">18 OCT 2007</div>
Name and mailing address of the ISA/US Mail Stop PCT, Attn: ISA/US, Commissioner for Patents P.O. Box 1450, Alexandria, Virginia 22313-1450 Facsimile No. 571-273-3201		Authorized officer: Lee W. Young PCT Helpdesk: 571-272-4300 PCT OSP: 571-272-7774

Form PCT/ISA/210 (second sheet) (April 2007)

(19) World Intellectual Property Organization
International Bureau



(43) International Publication Date
17 July 2008 (17.07.2008)

PCT

(10) International Publication Number
WO 2008/085614 A2

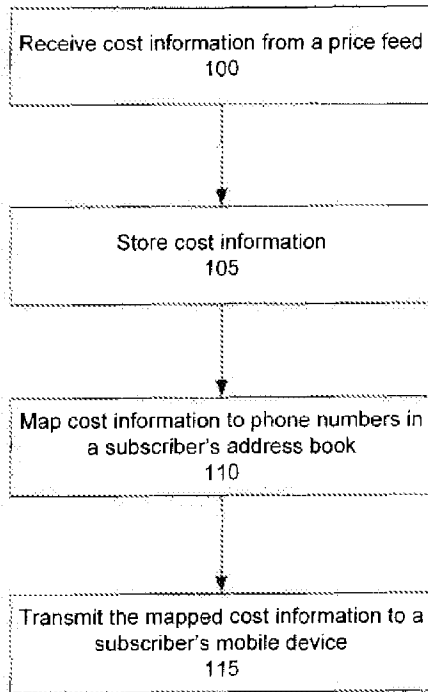
- (51) International Patent Classification:
H04M 15/00 (2006.01)
- (21) International Application Number:
PCT/US2007/086063
- (22) International Filing Date:
30 November 2007 (30.11.2007)
- (25) Filing Language: English
- (26) Publication Language: English
- (30) Priority Data:

60/883,841	8 January 2007 (08.01.2007)	US
60/884,045	9 January 2007 (09.01.2007)	US
60/889,305	12 February 2007 (12.02.2007)	US
60/889,959	15 February 2007 (15.02.2007)	US
60/896,003	21 March 2007 (21.03.2007)	US
60/908,726	29 March 2007 (29.03.2007)	US
60/940,758	30 May 2007 (30.05.2007)	US
60/942,557	7 June 2007 (07.06.2007)	US
60/945,931	24 June 2007 (24.06.2007)	US
60/947,963	4 July 2007 (04.07.2007)	US

- (71) Applicant (for all designated States except US): iSKOOT, INC. [US/US]; One Broadway, Cambridge, Massachusetts 02142 (US).
- (72) Inventors; and
- (75) Inventors/Applicants (for US only): GUEDALIA, Jacob [US/US]; 119 Langdon Street, Newton, Massachusetts 02458 (US). GUEDALIA, Issac [IL/IL]; Shimon 80, 99000 Bet Shemesh (IL).
- (74) Agent: HALLAJ, Ibrahim; Pepper Hamilton LLP, 500 Grant Street, 50th Floor, Pittsburgh, Pennsylvania 15219 (US).
- (81) Designated States (unless otherwise indicated, for every kind of national protection available): AE, AG, AL, AM, AT, AU, AZ, BA, BB, BG, BH, BR, BW, BY, BZ, CA, CH, CN, CO, CR, CU, CZ, DE, DK, DM, DO, DZ, EC, EE, EG, ES, FI, GB, GD, GE, GH, GM, GT, HN, HR, HU, ID, IL, IN, IS, JP, KE, KG, KM, KN, KP, KR, KZ, LA, LC, LK, LR, LS, LT, LU, LY, MA, MD, ME, MG, MK, MN, MW, MX, MY, MZ, NA, NG, NI, NO, NZ, OM, PG, PH, PL, PT, RO, RS, RU, SC, SD, SE, SG, SK, SL, SM, SV, SY,

[Continued on next page]

(54) Title: METHODS AND SYSTEMS OF PROVIDING MOBILE DEVICE CALLING FEATURES



(57) Abstract: A method of providing cost information associated with one or more contact numbers in an address book may include receiving cost information, storing the cost information, mapping at least a portion of the cost information to one or more contact numbers using one or more pre-defined rules and transmitting the mapped cost information to a mobile device.

WO 2008/085614 A2



TJ, TM, TN, TR, TT, TZ, UA, UG, US, UZ, VC, VN, ZA, ZM, ZW.

FR, GB, GR, HU, IE, IS, IT, LT, LU, LV, MC, MT, NL, PL, PT, RO, SE, SI, SK, TR), OAPI (BF, BJ, CF, CG, CI, CM, GA, GN, GQ, GW, ML, MR, NE, SN, TD, TG).

(84) Designated States (*unless otherwise indicated, for every kind of regional protection available*): ARIPO (BW, GH, GM, KE, LS, MW, MZ, NA, SD, SL, SZ, TZ, UG, ZM, ZW), Eurasian (AM, AZ, BY, KG, KZ, MD, RU, TJ, TM), European (AT, BE, BG, CH, CY, CZ, DE, DK, EE, ES, FI,

Published:

— *without international search report and to be republished upon receipt of that report*

METHODS AND SYSTEMS OF PROVIDING MOBILE DEVICE CALLING FEATURES

CLAIM OF PRIORITY

[0001] This application claims priority under 35 U.S.C. § 119(e) to U.S. Provisional Application No. 60/883,841, filed January 8, 2007, U.S. Provisional Application No. 60/884,045 filed January 9, 2007, U.S. Provisional Application No. 60/889,305, filed February 12, 2007, U.S. Provisional Application No. 60/889,959, filed February 15, 2007, U.S. Provisional Application No. 60/896,003, filed March 21, 2007, U.S. Provisional Application No. 60/908,726, filed March 29, 2007, U.S. Provisional Application No. 60/940,758, filed May 30, 2007, U.S. Provisional Application No. 60/942,557, filed June 7, 2007, U.S. Provisional Application No. 60/945,931, filed June 24, 2007, and U.S. Provisional Application No. 60/947,963, filed July 4, 2007, the entireties of which are incorporated by reference herein.

BACKGROUND

[0002] As the mobile telecommunication industry grows, mobile subscribers are becoming increasingly more aware of their leverage in the market. They carefully compare service providers and call plans, and make educated choices before subscribing to a carrier and a service. Subscribers also continuously seek new and improved features to integrate into their mobile service such as enhanced chat, long distance service options, customized graphical user interfaces and the like.

[0003] Despite being informed consumers, mobile subscribers are often disadvantaged in the mobile market. For example, although a subscriber may be knowledgeable about their own calling plan subscription, subscribers are usually unaware of the cost per minute of a call to the

calling destination. This puts a mobile subscriber at a disadvantage in making educated and economical calling choices.

[0004] Mobile subscribers would also welcome more long distance service options. A subscriber to a telecommunication carrier service typically needs a local access number to utilize the service. This usually involves selecting a number from a list of regional or area numbers, such as a preprinted list on a calling card, to find the access number closest to the subscriber's current location. The subscriber dials the local access number and is usually connected to a long distance service provider via a telephony network. Typically, the subscriber can then enter a target long distance telephone number, and the long distance service provider will route the call to a subscriber-specified number. The current approach has many disadvantages, however, such as having to purchase a phone card and locating a local access number. In addition, a subscriber who accidentally places a call using a non-local access number may incur long distance charges.

[0005] It is common for a subscriber to experience a significant delay after powering on his mobile device before he is able to access updated contact information in his address book. This is because the mobile device must contact and retrieve an updated contact list from a server. As such, subscribers may desire to access his address book while the contact information is being updated.

[0006] To keep pace with the constant evolution of mobile telephony, mobile subscribers are treated to a variety of applications designed to optimize their mobile communication experience. For example, subscribers can access the Internet with the mobile device, send chat messages to their contacts and the like. Subscribers can glean relevant and up-to-date information about their contacts in their address books by viewing presence-statuses, away messages, sometimes referred to as status messages, mood messages or the like. However,

it is common for a subscriber's status message to read the same regardless of which contact views it. As such, a subscriber cannot customize his status message based on the contact who is viewing it.

SUMMARY

[0007] Before the present methods are described, it is to be understood that this invention is not limited to the particular systems, methodologies or protocols described, as these may vary. It is also to be understood that the terminology used herein is for the purpose of describing particular embodiments only, and is not intended to limit the scope of the present disclosure which will be limited only by the appended claims.

[0008] In an embodiment, a method of providing cost information associated with one or more contact numbers in an address book may include receiving cost information, storing the cost information, mapping at least a portion of the cost information to one or more contact numbers using one or more pre-defined rules and transmitting the mapped cost information to a mobile device.

[0009] In an embodiment, a system of providing cost information associated with one or more contact numbers may include one or more mobile devices and a processor for processing cost information, wherein the processor is in communication with the one or more mobile devices.

[0010] In an embodiment, a method of providing a local access number to a subscriber may include receiving subscriber locale information indicating a location of a subscriber, mapping the subscriber locale information to one or more local access numbers, identifying, from the one or more local access numbers, a local access number corresponding to the

subscriber locale information and transmitting the identified local access number to the subscriber's mobile device.

[0011] In an embodiment, a method of placing a call using a local access number may include transmitting subscriber locale information to a processor, receiving, from the processor, one or more long distance service providers, selecting a long distance service provider from the plurality of long distance service providers and receiving a local access number based on the selected long distance service provider.

[0012] In an embodiment, a system for providing a local access number to a subscriber may include one or more mobile devices, a processor in communication with the one or more mobile devices and a processor-readable storage medium comprising locale information and one or more local access numbers, wherein the processor-readable storage medium is in communication with the processor.

[0013] In an embodiment, a method of providing a status message may include receiving, from a mobile device, one or more status messages, wherein each status message corresponds to one or more contacts in an address book, storing the status messages and corresponding one or more contacts, transmitting one of the status messages to a mobile device associated with one of the one or more contacts, wherein the status message is displayed on the associated mobile device and integrating the status message into an address book associated with the contact.

[0014] In an embodiment, a method of providing contact information on a mobile device may include generating a list of a predefined number of most-recently called contacts from an address book on a subscriber's mobile device and for each most-recently called contact, receiving contact information, comprising one or more of a contact name, a telephone number, a

mood message, a holographic message, and a status message. The method may also include transmitting the list, associated contact information and one or more instructions to the subscriber's mobile device, wherein the one or more instructions instruct the mobile device to display the list and associated contact information.

[0015] In an embodiment, a system of providing a status message may include a subscriber mobile device comprising an address book having one or more contacts, a processor for processing data relating to one or more status messages, wherein the processor is in communication with the subscriber mobile device and one or more contact mobile devices associated with one or more contacts in the address book, wherein each contact mobile device is in communication with the processor.

[0016] In an embodiment, a method of accessing contact information on a mobile device may include caching contact information prior to powering off a mobile device, storing the cached contact information on the mobile device and displaying the cached contact information on a display screen of the mobile device when a subscriber accesses the address book after the mobile device is powered on.

[0017] In an embodiment, a method of accessing contact information may include receiving, from a subscriber, an instruction to dial a telephone number, wherein the telephone number is associated with one or more of a session identification number, a contact identification number and a contact name. If one or more of the session identification number and the contact identification number is expired, one or more of the session identification number, the contact identification number and the contact name may be transmitted to a server. The method may also include receiving from the server one or more of an updated session identification number and an

updated contact identification number and dialing the telephone number using one or more of the updated session identification number and the updated contact identification number.

[0018] In an embodiment, a method of accessing contact information may include receiving, from a subscriber, an instruction to dial a telephone number, wherein the telephone number is associated with one or more of a session identification number, a contact identification number and a contact name. If one or more of the session identification number and the contact identification number is expired, a call may be placed by dialing a direct inward dialing number associated with the contact name, wherein a dial-string associated with the call comprises one or more first dual-tone multi-frequency tones.

[0019] In an embodiment, a system for accessing contact information on a mobile device may include a mobile device comprising a processor and a processor-readable storage medium for storing cached contact information and a server in communication with the mobile device, wherein the server provides updated contact information to the mobile device.

BRIEF DESCRIPTION OF THE DRAWINGS

[0020] FIG. 1 depicts a flow chart for implementing an exemplary call-cost feature on a mobile device.

[0021] FIG. 2 depicts a mobile device display of exemplary cost information according to an embodiment.

[0022] FIG. 3 depicts an exemplary system of providing cost information according to an embodiment.

[0023] FIG. 4 depicts an exemplary system of providing cost information according to an embodiment.

[0024] FIG. 5 illustrates flow chart for assigning an exemplary local access number according to an embodiment.

[0025] FIG. 6 illustrates a method of placing an exemplary long distance call using a local access number according to an embodiment.

[0026] FIG. 7 illustrates a flow chart for an exemplary method of accessing contact information on a subscriber's mobile device according to an embodiment.

[0027] FIG. 8 illustrates an exemplary system for implementing mobile address book interaction according to an embodiment.

[0028] FIG. 9 illustrates an exemplary method of providing contact information according to an embodiment.

DETAILED DESCRIPTION

[0029] FIG. 1 illustrates a flow chart for implementing an exemplary call-cost feature on a mobile device. A mobile device may include mobile or portable devices such as cellular phones, PDAs, media players or the like. A mobile device may have a processor and a processor-readable storage medium in communication with the processor.

[0030] As illustrated by FIG. 1, a price table database may receive **100** cost information from a price feed. A price feed provides real time pricing information for a product or service. For example, stock prices may be available to an online trader via a price feed.

[0031] In an embodiment, the price table database may be housed on a computing device, such as a server, and the cost information may include the cost per minute for a plurality of calling destinations or the like. Table 1 illustrates an exemplary price table database according to an embodiment.

Calling Destination	Cost per minute
Canada	\$0.33/minute
France	\$0.56/minute
Israel	\$0.35/minute
United States	\$0.15/minute

Table 1

[0032] The price table database may receive **100** cost information from the price feed on a regular basis. In an embodiment, the price feed may include a rate sheet provided by a telephone service provider.

[0033] In an embodiment, at least a portion of the received cost information may be stored **105** in the price table database. For example, the price table database may receive a cost-per-minute for calling Canada. If the price table database does not currently include a cost-per-minute for Canada, the cost information may be added to the price table database. If the price table database includes a different cost-per-minute for Canada, the stored cost information may be replaced with the cost information from the price feed. In an embodiment, if the received cost information associated with a calling destination is less than the stored cost information associated with the calling destination, an alert may be generated. The alert may be used to notify a subscriber of the price discount associated with the particular calling destination. In an embodiment, the server may transmit the alert to a subscriber's mobile device to notify the subscriber of the price discount.

[0034] A mapper may use the cost information contained in the price table database to map **110** cost information to one or more phone numbers in a subscriber's address book. In an embodiment, the mapper may utilize pre-defined rules to map **110** cost information to a contact

number. A contact is an entry in an address book that is accessible by a mobile device. A contact number is a mobile device number associated with a contact. In an embodiment, the mapper may map **110** cost information to one or more contact numbers using pre-defined rules. The pre-defined rules may be used to determine, for example, a calling destination, whether the phone number belongs to a landline or a mobile device, or the like. For example, in Israel, landlines are provisioned with the country code +972 followed by an area code ranging from '1' to '9', with the exception of '5.' Mobile phone numbers typically begin with '5.' If a subscriber has the phone number "972-2-5388-0234" in his address book, the mapper may use one or more pre-defined rules to determine the contact number is a landline number is Israel. The mapper may use this information to map the corresponding cost per minute to one or more contact numbers in a subscriber's address book.

[0035] In an embodiment, the mapped cost information may be transmitted to the subscriber's mobile device for display to the subscriber. FIG. 2 depicts a mobile phone display of exemplary cost information according to an embodiment. As illustrated, the cost to call one or more contacts in a subscriber's address book may be displayed. For example, calling Jim on his mobile phone costs \$0.0136/minute **200**, whereas calling Jim on his landline phone costs \$0.017/minute **205**. The subscriber may use this information to make an informed calling decision regarding which number to call.

[0036] In an embodiment, cost information may be provided based on associated calling plans. As illustrated by FIG. 3, the price table database may include cost information such as mobile providers' calling plans **300**, a cost-per-minute value **305** associated with the calling plans, a dialing prefix **310** provisioned for each calling plan and/or the like. In an embodiment,

the price table database may receive this cost information from the price feed on a regularly updated basis.

[0037] In an embodiment, the mapper may map a contact's number with the subscriber's calling plan and the corresponding cost information may be displayed to a subscriber. One or more contacts in a subscriber's address book may be displayed with cost information based on the subscriber's and/or the contact's calling plan. For example, FIG. 3 illustrates exemplary information that may be displayed on a mobile device. A contact's number 315 may be listed with a cost-per-minute value 320 and a calling plan 325 associated with the number 315.

[0038] In an embodiment, the mapper may use a contact's phone number to determine calling destination information such as a contact's locale, whether the contact's number corresponds to a landline or a mobile phone or the like. After calling destination information is determined, the mapper may map at least a portion of the calling destination information to the subscriber's calling plan. For example, a subscriber may want to call a contact who has two numbers. The first number may be a landline in Israel while the second number may be a mobile phone in Israel. The mapper may match the subscriber's calling plan with the destination information to determine that cost information associated with calling the two numbers.

[0039] In an embodiment, multiple service providers may be used to place a call. In such an embodiment, the mapper may map cost information associated with all necessary providers so that a combined price may be displayed to a subscriber. For example, if a subscriber calls an overseas contact using a long-distance service provider, the cost-per-minute may reflect both the long distance provider's charges as well as the local mobile carrier's airtime charges.

[0040] FIG. 4 depicts an environment suitable for practicing the illustrative embodiments. A processor, such as a server 400 may include a mapper 405 and/or a price table database 410. The server 400 may be in communication with a price feed 415 and one or more mobile devices 420 via a network 425. The server 400 may be implemented on a stand-alone computer system or may be implemented by distributed components such as separate electronic devices.

[0041] In an embodiment, a subscriber may use a local access number to place a long distance call. A local access number is a local telephone number a subscriber may employ to connect to a certain long distance service provider. FIG. 5 illustrates an exemplary flow chart of a method for assigning a local access number according to an embodiment. A subscriber's locale information may be received 500 by a server. In an embodiment, a subscriber may use a mobile device to subscribe to a telecommunication service via a data line. For example, a subscriber may access a browser to transmit an HTTP request. Upon registration, a subscriber may provide locale information such as an area code and a telephone number, a zip code or the like corresponding to the subscriber's current location. The locale information may be communicated to a server.

[0042] In another embodiment, locale information may be automatically received 500 by a server. For example, the locale information may be transmitted via an HTTP browser to a server where it may be processed by a service delivery framework (SDF). The SDF may be aware of the subscriber locale information, such as a Mobile Systems International Subscriber Identity Number (MSISDN), and may insert such information into an HTTP header. The header may be transmitted to the server where the mapper may extract the locale information.

[0043] In an embodiment, the mapper may map 510 the locale information to a database of available access numbers. A local access number may be identified 520 based on the subscriber's current location and the identified local access number may be transmitted 530 to the subscriber's mobile device.

[0044] In an embodiment, the mapper may generate a list of long distance service providers having local access numbers corresponding to the subscriber's locale. The server may transmit the list via a data line to the subscriber's mobile device. The subscriber may select a long distance service provider, and may receive the corresponding local access number on his mobile device.

[0045] In an embodiment, the subscriber may use the local access number to connect to a chosen long distance service provider. The subscriber may manually input the local access number, followed by the desired long-distance phone number. Alternatively, the subscriber may employ an application, such as an address book, to automate this process. For example, a mobile device's address book may include a long-distance automatic dialing feature that allows for quick-dialing of a previously entered local access code.

[0046] In an embodiment, an existing address book may be populated with the local access number for future retrieval. In an embodiment, as a subscriber travels, his mobile device may receive and store new local access numbers based on his current location.

[0047] FIG. 6 illustrates a method of placing a long distance call using a local access number according to an embodiment. For example, subscriber who wants to make a third-party long distance call may register 600 for a long distance service using a browser on his mobile device. Upon registration, the subscriber may be asked to provide 605 locale information, such as a local telephone number with an area code. The locale information may be processed 610 by

the server, and the subscriber may receive 615 a list of one or more long distance service providers. The subscriber may select 620 a long distance service provider and may receive 625 a local access number based on the selected long distance provider on his mobile device. The subscriber may employ the local access number for as long as he remains in his current location. If the subscriber's address book is equipped with a long distance auto-dial feature, it may be automatically populated with the local access number when the server transmits it to the mobile device. If the subscriber changes locations, he may access his account on the subscription site, enter a new telephone number and area code, and receive a new local access number. The subscriber's old access number may be stored for later use.

[0048] In an embodiment, a local access number may be automatically dialed for the subscriber, and may or may not require subscriber confirmation. As such, the subscriber may only need to specify the preferred long distance number to call. For example, a subscriber may select or input the preferred long distance number to call, and an application on the mobile device may place the call by automatically dialing the access code local to the subscriber's local information. As described above, the locale information may be ascertained based on the telephone number provided by the subscriber at sign-up or by extracting the subscriber locale information from an HTTP header.

[0049] For example, a mobile user who wants to place a long distance call may select a contact from his address book to call. The subscriber's long distance subscription service may ascertain the subscriber's location by extracting locale information from an HTTP header transmitted by the subscriber's phone or by the locale information the subscriber provided at sign-up. The server may map the subscriber's location to an appropriate local access number which may be sent to the subscriber's mobile device. The subscriber may make one or more

selections to dial the received local access number. Alternatively, the service may auto-dial the local access number and connect the call without the subscriber being aware that a local access number has been dialed.

[0050] FIG. 7 illustrates a flow chart for an exemplary method of accessing contact information on a subscriber's mobile device according to an embodiment. When a subscriber first accesses a server-based mobile address book application, the subscriber may experience a significant delay while the address book attempts to retrieve the subscriber's address book from the server. In an embodiment, a cache of the address book may be created 700 before the subscriber's mobile device is powered off. The cache may include contact information stored in the subscriber's address book during the last application session. For example, the cache may include a contact's name, one or more telephone numbers associated with the contact, a status message associated with the contact and/or the like.

[0051] In an embodiment, a status message indicates whether the contact is online, offline or the like. A status message includes information relating to a status or state of a subscriber, and can be presented automatically to anyone who attempts to contact the subscriber. The status message may provide further information regarding the subscriber. In an embodiment, exemplary status messages may include "Having a bad day," "In a meeting," "At the gym," or the like.

[0052] In an embodiment, the cache may be stored 710 on the subscriber's mobile device. When a subscriber powers on his mobile device, at least a portion of the cache may be displayed 720 to a subscriber until a fresh upload of contact information can be obtained from the server. For example, when a subscriber accesses an address book application after powering on his mobile device, the subscriber may be presented with a cached version of his address book

that may include contacts' names, telephone numbers, status message and/or the like which were stored in the cache prior to the mobile device being powered off.

[0053] In an embodiment, because the server may take a significant amount of time to upload a complete fresh address book, contacts may be updated in a particular order according to an embodiment. For example, the first several contacts that appear in a subscriber's mobile device display may have their information updated first. Alternatively, priority may be given to one or more pre-determined contacts.

[0054] A problem may arise when a subscriber attempts to call a contact's telephone number using a cached address book. In an embodiment, the cached information may include a contact identification number associated with a contact and/or a unique session identification number. A contact identification number is a unique identifier associated with a certain contact in an address book. A session identification number is a unique identifier associated with a calling period. The unique session identification number may remain valid for the length of an entire calling period, which, in an embodiment, may be the period of time from when the application is powered up and connected until the time that the application is powered down. A contact identification number may be assigned to each contact, and may remain valid for the duration of a calling period. In an embodiment, the unique session identification number and the contact identification numbers may expire after the calling period has closed, thus rendering them invalid for subsequent calling sessions. As such, when a subscriber attempts to call a contact with stale status information, the application may attempt to dial in with an expired session identification number and/or reference an expired contact identification number, which may result in call failure. While a delay may exist while the server refreshes and updates a

subscriber's contact information, a service provider may want to give a subscriber a feeling of being logged onto the network as soon as the subscriber's mobile device is powered on.

[0055] For example, in an embodiment, if a subscriber selects a contact from the cached address book having expired status information, the contact's phone number may not be immediately dialed. Instead, the subscriber's mobile device may dial a server and may dispatch the name of the desired callee across a network. The server may send back a session identification number to be utilized during the calling period and/or a contact information number that references the callee. In an embodiment, the server may also send a local access number to be used to contact the callee. Alternatively, the call may be completed without the use of a local access number.

[0056] In an embodiment, if a subscriber selects a contact from the cached contact list having stale status information, a prepare call may be sent to the server. The prepare call may include a session identification number, a callee's contact identification number, a callee's contact name and the like. The server may send back a new session identification number for the subscriber, a contact information number that references the callee, a local access number to be used to contact the callee and/or the like.

[0057] In an embodiment, if a subscriber selects a contact from the cached contact list having stale status information, a direct inward dialing (DID) number of the callee may be directly dialed, and the dual-tone multi-frequency (DTMF) tones of the caller may be appended to a dial-string associated with the call. A DID number is a feature offered by telephone companies for use with customer's private branch exchange. A telephone company may allocate a range of numbers all connected to the customers' PBX. As the PBX receives calls, the number that the caller dialed may also be presented so the PBX can route the call to the target callee. For

example, DID numbers may be obtained by administrators of a VoIP network and assigned to a gateway in the network. The gateway may route incoming calls from the network to appropriate VoIP subscribers.

[0058] In an embodiment, a set of DIDs may be assigned to a gateway. The gateway may then reassign the DIDs to a particular mapping of caller-callee. For example, Caller A may have ten contacts, A-K. Each contact may be assigned a unique DID number. When Caller A selects a contact from his cached contact list, Caller A is, in effect, selecting the DID number associated with the contact.

[0059] In an embodiment, if a subscriber selects a contact from the cached contact list having expired status information, a callee's DID number may be directly dialed, and the DID number and the identification number of the caller may appear within the dial-string.

[0060] In an embodiment, a subscriber may use an address book on the subscriber's mobile device to call one or more contacts stored in the address book. The subscriber may communicate with these contacts by dialing the contact directly, by sending chat messages or the like. FIG. 8 illustrates an exemplary system for implementing mobile address book interaction according to an embodiment. In addition to being stored locally on a mobile device **800**, the contact information in a subscriber's address book **805** may also be cached on a server **810** which may regularly update the address book information. The server may send information about the subscriber's contacts to the subscriber's mobile device **800** as it become available. In an embodiment, the subscriber's mobile device **800** may poll the server at specified intervals to receive updates about the subscriber's contacts. Updated information may be integrated into the subscriber's mobile address book **805** for the subscriber to access. In an embodiment, contact information may include a status message or the like.

[0061] As FIG. 8 illustrates, bi-directional communication 815 may exist between the server, the subscriber's mobile device and the contacts 820 who appear in the subscriber's address book. In an embodiment, the server may push information, such as a status message associated with the subscriber, to the contacts 820. The server may also pull information from the contacts 820 for transmission to the subscriber's mobile device.

[0062] For example, if the subscriber wishes to change his status message, the subscriber may set a new status message using his mobile device. The new status message may then be sent to the server to be propagated to the subscriber's contacts. When the server receives and processes the new status message, the server may send the new status message to all of the subscriber's contacts.

[0063] FIG. 9 illustrates a method of providing contact information according to an embodiment. A server may receive 900 one or more status messages, such as a holographic message, from a subscriber's mobile device. A holographic message relates to customized messages that differ based on which contact inquires about the subscriber's status. That is, different contacts may be presented with different messages depending on the identity of the contact. The present discussion is intended to comprehend a one-to-one correspondence between messages and contacts, but is not so limited, and also includes messages directed to subsets of more than one contact. For example, a subscriber's holographic message may read "I'm in a meeting" to work colleagues, but may read "I'm unavailable" to all other contacts.

[0064] In an embodiment, a subscriber may set a holographic message using the subscriber's mobile phone. The subscriber may identify a message for a specific contact. For example, a subscriber may set a holographic message that reads "I'll be home at 6:30pm" to his

wife. The subscriber may also set a holographic message for a specific contact group. For example, a subscriber may set a holographic message that reads "At the beach" to his friends.

[0065] In an embodiment, the holographic messages set by a subscriber may be sent to the server to be transmitted to the contacts in the subscriber's contact book. The server may store 910 a holographic message and corresponding contact or contact group. The server may transmit 920 the holographic message to the mobile phones of the appropriate contacts based on the contact's name, the contact's group or the like. In an embodiment, the server may integrate 930 the holographic message into an address book associated with a contact. The server may transmit one or more instructions to a contact's mobile device instructing the mobile device to display the holographic message.

[0066] In an embodiment, a list of most-recently called contacts may be kept. For example, the list may reflect the last ten contacts a subscriber called, chatted with, changed a status message for, or the like. Typically, a subscriber's address book is stored on a server, and a push presence technique is utilized to access contact information, such as a status message or the like. In an embodiment, the push presence technique requires a subscriber to retrieve the latest contact information from the server. However, a subscriber who has many contacts must access the server numerous times in order to view contact information, which may drain the battery of the subscriber's mobile device. As such, a list of most-recently called contacts may be kept. This list may be stored on a subscriber's mobile device or on the server. If the list is stored on the server, the server must only push the contact information associated with the contacts in the most-recently called list instead of the contact information for every contact in the subscriber's address book.

[0067] It will be appreciated that various of the above-disclosed and other features and functions, or alternatives thereof, may be desirably combined into many other different systems or applications. Also that various presently unforeseen or unanticipated alternatives, modifications, variations or improvements therein may be subsequently made by those skilled in the art which are also intended to be encompassed by the following claims.

CLAIMS

What Is Claimed Is:

1. A method of providing cost information associated with one or more contact numbers in an address book, the method comprising:
 - receiving cost information;
 - storing the cost information;
 - mapping at least a portion of the cost information to one or more contact numbers using one or more pre-defined rules; and
 - transmitting the mapped cost information to a mobile device.
2. The method of claim 1, wherein receiving cost information comprises receiving cost information from a rate sheet provided by a service provider.
3. The method of claim 1, wherein receiving cost information comprises receiving cost information from a price feed.
4. The method of claim 1, wherein mapping comprises using the pre-defined rules to determine one or more of a calling location, a phone type and a calling plan.
5. The method of claim 1, wherein mapping comprises mapping at least a portion of the cost information to one or more contact numbers in an address book, wherein the address book is stored on the mobile device.

6. The method of claim 1, wherein transmitting the mapped cost information comprises integrating the cost information into one or more address books associated with one or more subscribers, wherein at least a portion of the cost information is displayed to the one or more subscribers.
7. The method of claim 1, further comprising:
determining whether there is a discount associated with the mapped cost information; and
if a discount is determined to exist, transmitting an alert to the mobile device.
8. The method of claim 7, wherein determining whether there is a discount comprises:
comparing the received cost information with the stored cost information; and
if the received cost information associated with one or more telephone numbers is less than the stored cost information associated with the contact numbers, generating an alert.
9. A system of providing cost information associated with one or more contact numbers, the system comprising:
one or more mobile devices; and
a processor for processing cost information, wherein the processor is in communication with the one or more mobile devices.
10. The system of claim 9, further comprising:
a price table database in communication with a price feed, wherein the price table database comprises cost information.

11. The system of claim 9, further comprising:
a mapper for mapping cost information, wherein the mapper is in communication with the one or more mobile devices.

12. A method of providing a local access number to a subscriber, the method comprising:
receiving subscriber locale information indicating a location of a subscriber;
mapping the subscriber locale information to one or more local access numbers;
identifying, from the one or more local access numbers, a local access number corresponding to the subscriber locale information; and
transmitting the identified local access number to the subscriber's mobile device.

13. The method of claim 12, wherein receiving subscriber locale information comprises receiving, from the subscriber's mobile device, locale information provided by the subscriber, wherein the locale information comprises a telephone number and an area code.

14. The method of claim 12, wherein receiving subscriber locale information comprises automatically receiving the subscriber locale information from a browser on the subscriber's mobile device.

15. The method of claim 12, wherein mapping the subscriber locale information comprises automatically determining, by a mapper, one or more local access numbers based on the received subscriber locale information.

16. A method of placing a call using a local access number, the method comprising:
transmitting subscriber locale information to a processor;
receiving, from the processor, one or more long distance service providers;
selecting a long distance service provider from the plurality of long distance service providers; and
receiving a local access number based on the selected long distance service provider.
17. The method of claim 16, wherein transmitting subscriber locale information comprises transmitting subscriber locale information provided by a subscriber, wherein the subscriber locale information comprises a telephone number and an area code.
18. The method of claim 16, wherein transmitting subscriber locale information comprises automatically transmitting subscriber locale information from a browser on a mobile device.
19. The method of claim 16, wherein receiving a local access number comprises automatically populating an address book on a mobile device with the local access number.
20. A system for providing a local access number to a subscriber comprising:
one or more mobile devices;
a processor in communication with the one or more mobile devices; and
a processor-readable storage medium comprising locale information and one or more local access numbers, wherein the processor-readable storage medium is in communication with the processor.

21. A method of providing a status message, the method comprising:
receiving, from a mobile device, one or more status messages, wherein each status message corresponds to one or more contacts in an address book;
storing the status messages and corresponding one or more contacts;
transmitting one of the status messages to a mobile device associated with one of the one or more contacts, wherein the status message is displayed on the associated mobile device; and
integrating the status message into an address book associated with the contact.
22. The method of claim 21, wherein receiving one or more status messages comprises receiving a status message associated with a contact group.
23. The method of claim 21, wherein transmitting one of the status messages comprises:
determining the contacts corresponding to the status message;
identifying one or more mobile devices associated with the corresponding contacts; and
transmitting the status message to the mobile devices associated with the corresponding contacts.
24. The method of claim 21, wherein integrating the status message comprises instructing a mobile device of the contact to display the status message.
25. A method of providing contact information on a mobile device, the method comprising:
generating a list of a predefined number of most-recently called contacts from an address book on a subscriber's mobile device;

for each most-recently called contact, receiving contact information, comprising one or more of a contact name, a telephone number, a mood message, a holographic message, and a status message; and

transmitting the list, associated contact information and one or more instructions to the subscriber's mobile device, wherein the one or more instructions instruct the mobile device to display the list and associated contact information.

26. A system of providing a status message, the system comprising:

a subscriber mobile device comprising an address book having one or more contacts;

a processor for processing data relating to one or more status messages, wherein the processor is in communication with the subscriber mobile device; and

one or more contact mobile devices associated with one or more contacts in the address book, wherein each contact mobile device is in communication with the processor.

27. A method of accessing contact information on a mobile device, the method comprising:

caching contact information prior to powering off a mobile device;

storing the cached contact information on the mobile device; and

displaying the cached contact information on a display screen of the mobile device when a subscriber accesses the address book after the mobile device is powered on.

28. The method of claim 27, wherein caching contact information comprises caching

information from an address book associated with the mobile device.

29. The method of claim 27, wherein caching contact information comprises caching one or more of the following:

a name of a contact; and

a contact number associated with the contact.

30. The method of claim 27, further comprising:

receiving updated contact information;

replacing at least a portion of the cached contact information with the updated contact information; and

displaying the updated contact information on the display screen.

31. The method of claim 30, wherein replacing at least a portion of the contact information comprises:

replacing the cached contact information in a specified order, wherein the order is based on the position of the contact information in the address book.

32. The method of claim 30, wherein replacing at least a portion of the contact information comprises:

replacing the contact information in a specified order, wherein the order is based on a predefined priority associated with the contact information.

33. A method of accessing contact information, the method comprising:

receiving, from a subscriber, an instruction to dial a telephone number, wherein the telephone number is associated with one or more of a session identification number, a contact identification number and a contact name;

if one or more of the session identification number and the contact identification number is expired, transmitting one or more of the session identification number, the contact identification number and the contact name to a server;

receiving from the server one or more of an updated session identification number and an updated contact identification number; and

dialing the telephone number using one or more of the updated session identification number and the updated contact identification number.

34. A method of accessing contact information, the method comprising:

receiving, from a subscriber, an instruction to dial a telephone number, wherein the telephone number is associated with one or more of a session identification number, a contact identification number and a contact name; and

if one or more of the session identification number and the contact identification number is expired:

placing a call by dialing a direct inward dialing number associated with the contact name, wherein a dial-string associated with the call comprises one or more first dual-tone multi-frequency tones.

35. The method of claim 34, wherein dialing a direct inward dialing number comprises:
appending one or more second dual-tone multi-frequency tones associated with the subscriber to the dial-string.
36. A method of claim 34, wherein placing a call comprises:
dialing a direct inward dialing number associated with the contact name, wherein the dial-string associated with the call comprises the session identification number and the direct inward dialing number.
37. A system for accessing contact information on a mobile device comprising:
a mobile device comprising a processor and a processor-readable storage medium for storing cached contact information; and
a server in communication with the mobile device, wherein the server provides updated contact information to the mobile device.

1/9

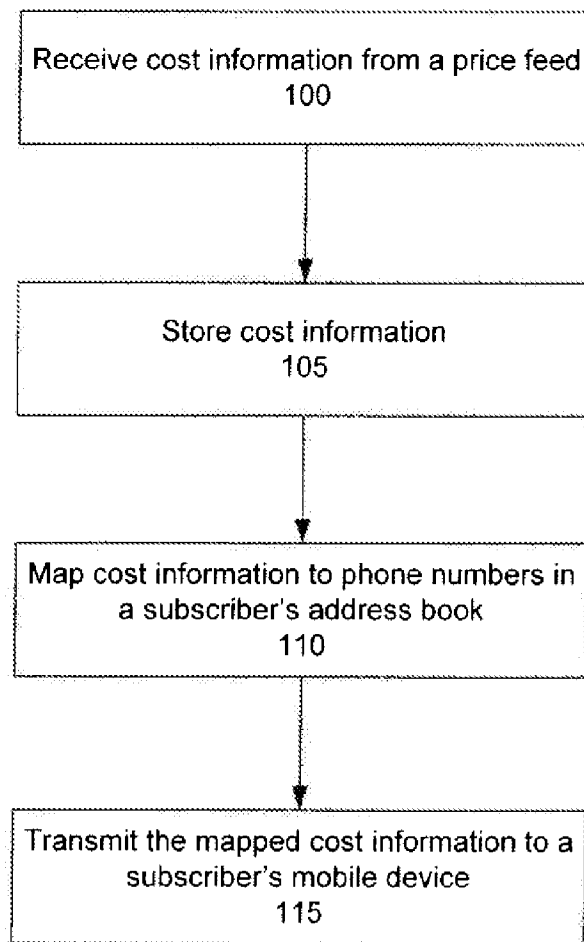


FIGURE 1

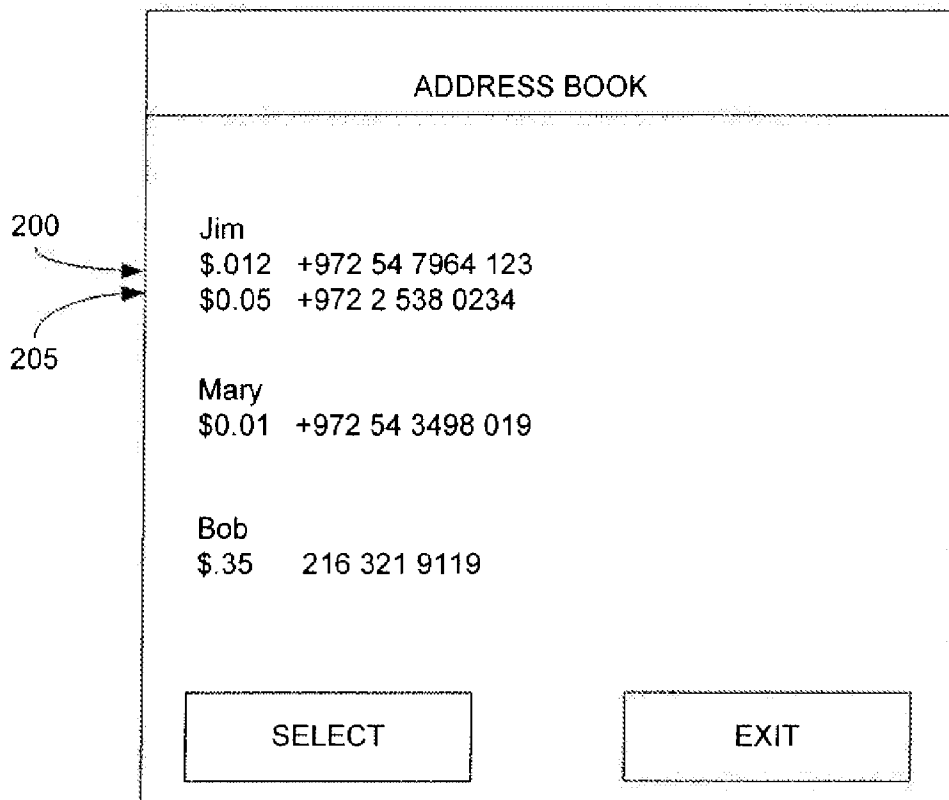


FIGURE 2

3/9

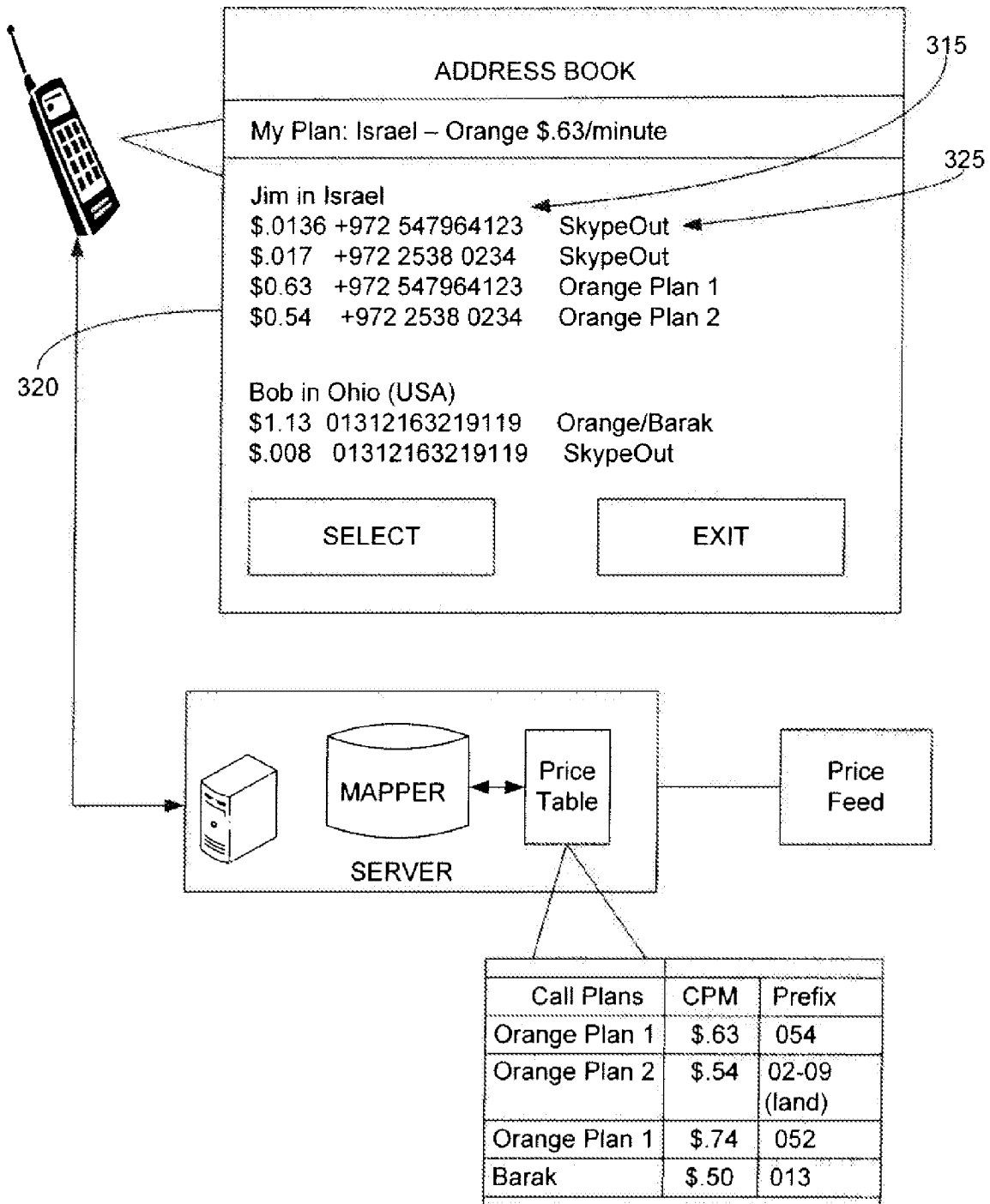


FIGURE 3

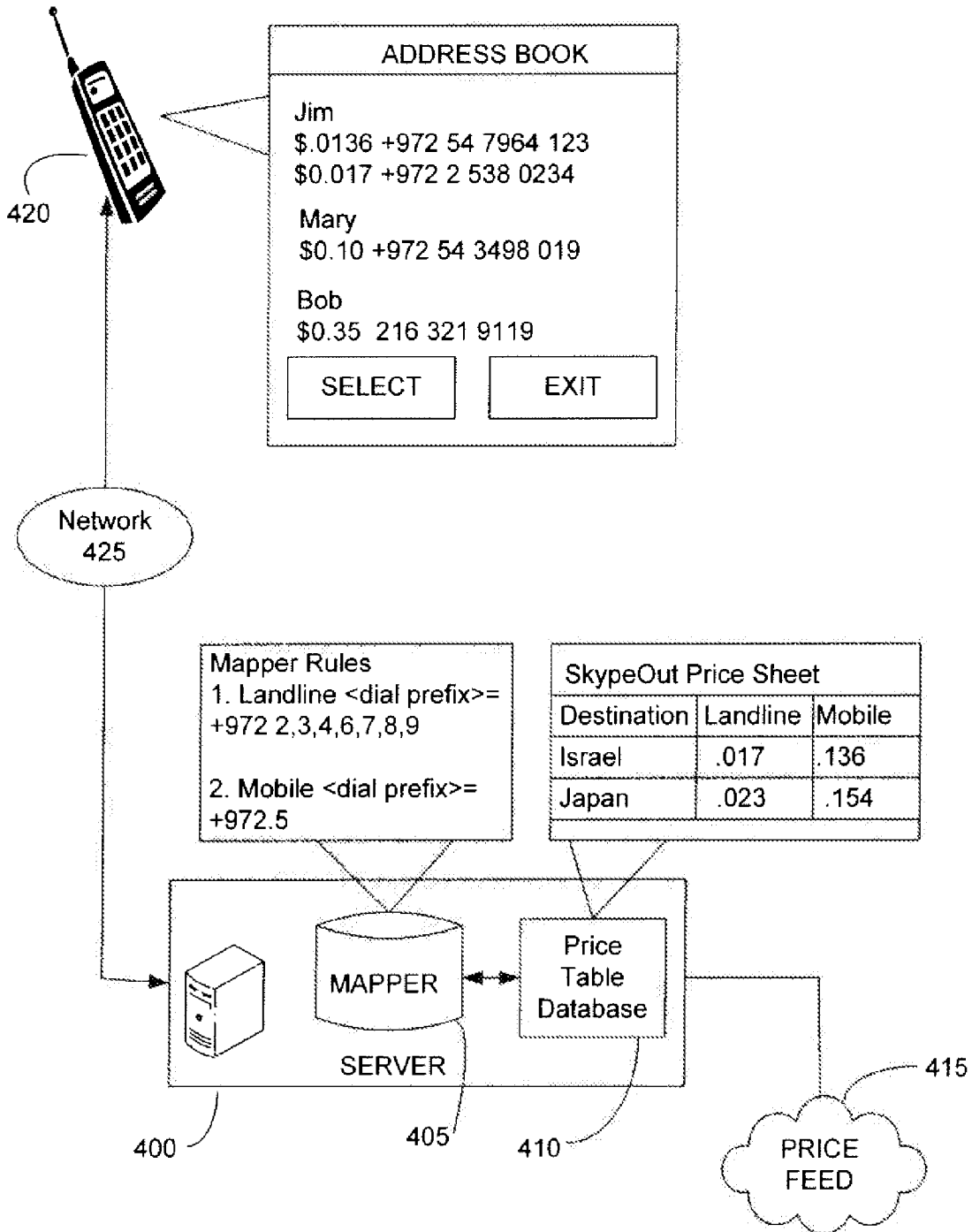


FIGURE 4

5/9

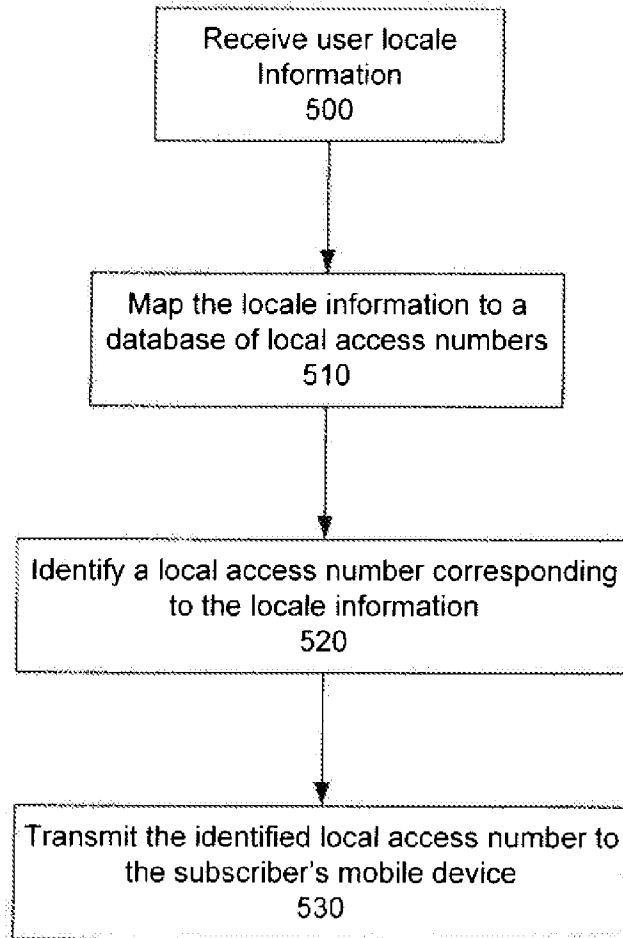


FIGURE 5

6/9

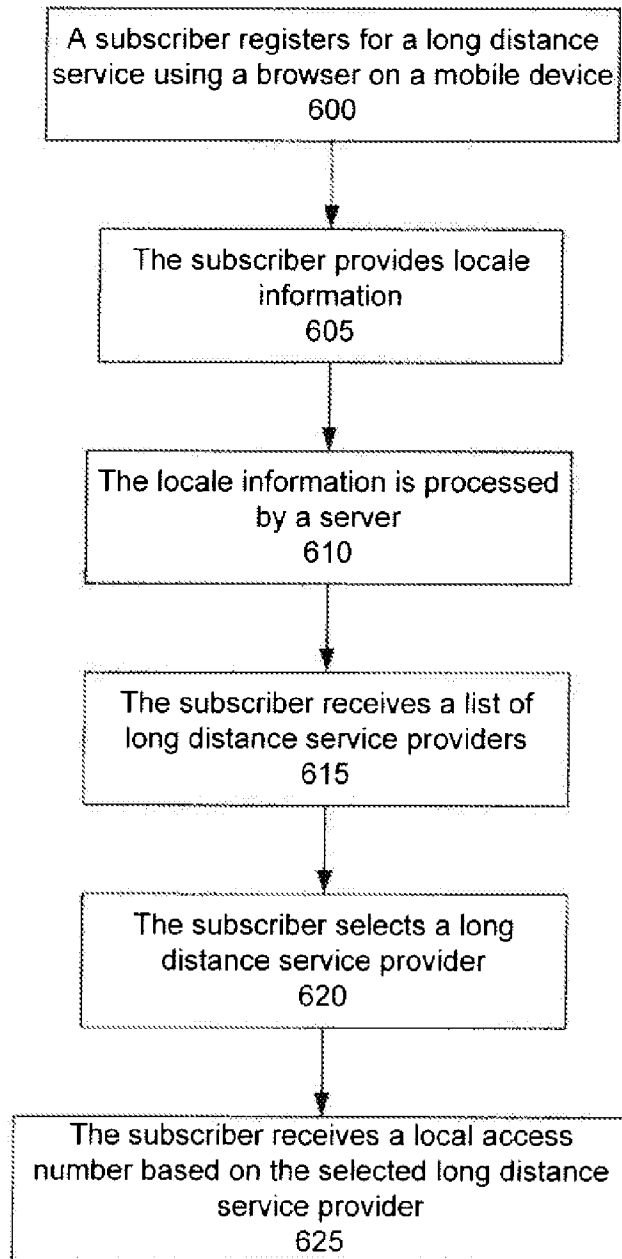


FIGURE 6

7/9

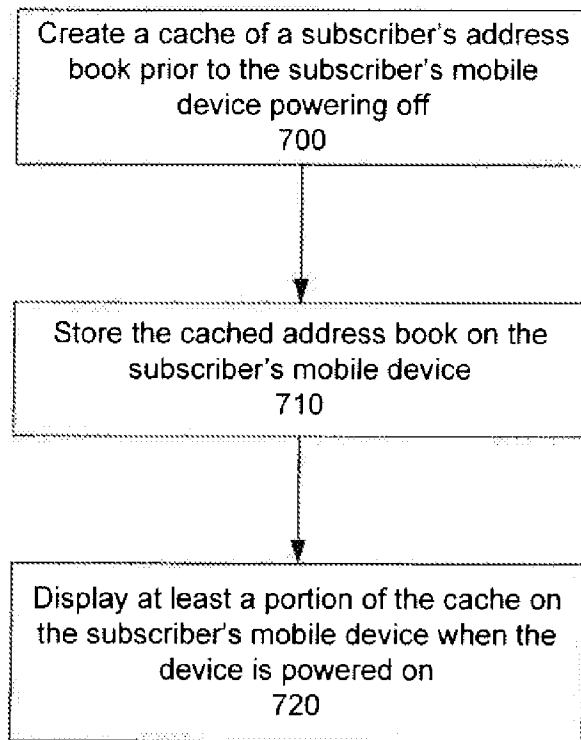


FIGURE 7

8/9

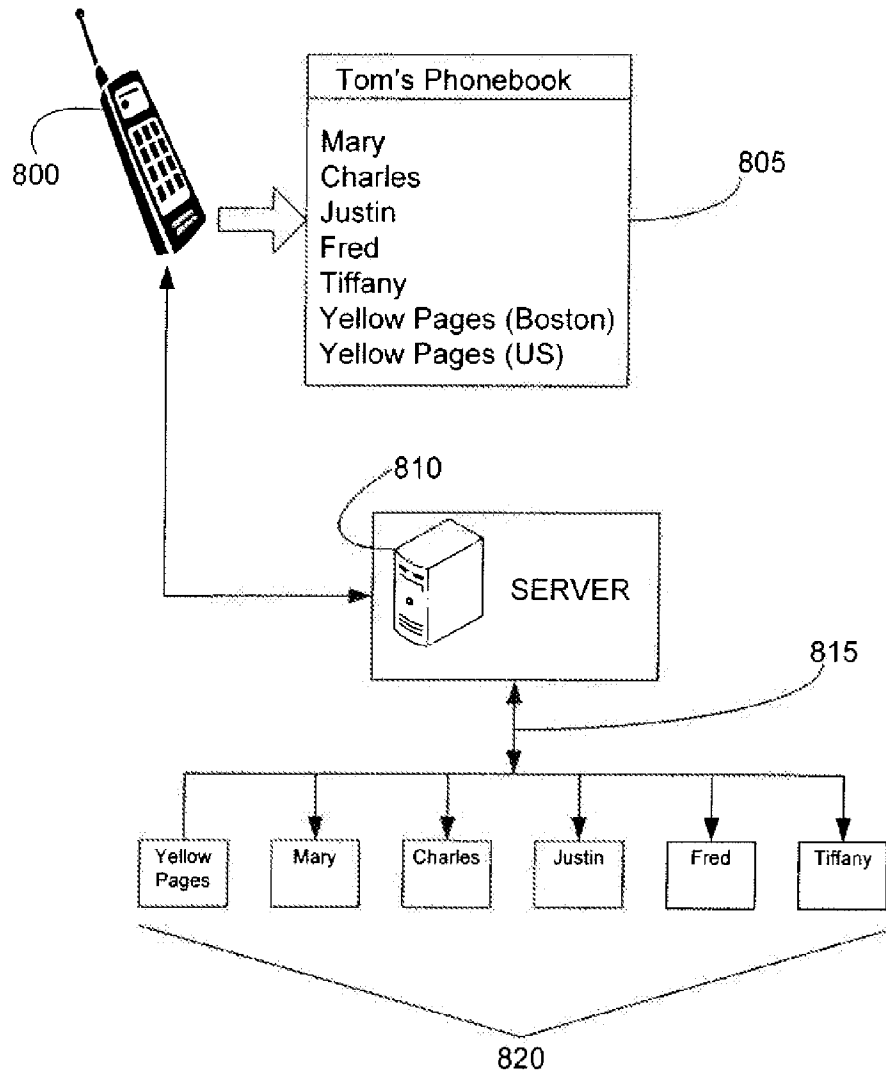


FIGURE 8

9/9

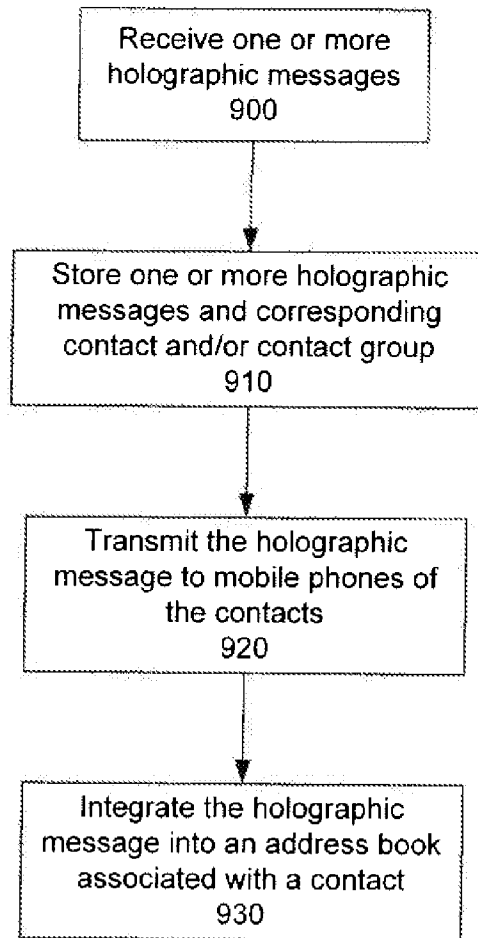


FIGURE 9

REVISED VERSION

(19) World Intellectual Property Organization
International Bureau



(43) International Publication Date
17 July 2008 (17.07.2008)

PCT

(10) International Publication Number
WO 2008/085614 A3

- (51) International Patent Classification: 60/945,931 24 June 2007 (24.06.2007) US
H04M 15/00 (2006.01) 60/947,963 4 July 2007 (04.07.2007) US
- (21) International Application Number: PCT/US2007/086063
- (22) International Filing Date: 30 November 2007 (30.11.2007)
- (25) Filing Language: English
- (26) Publication Language: English
- (30) Priority Data:
 - 60/883,841 8 January 2007 (08.01.2007) US
 - 60/884,045 9 January 2007 (09.01.2007) US
 - 60/889,305 12 February 2007 (12.02.2007) US
 - 60/889,959 15 February 2007 (15.02.2007) US
 - 60/896,003 21 March 2007 (21.03.2007) US
 - 60/908,726 29 March 2007 (29.03.2007) US
 - 60/940,758 30 May 2007 (30.05.2007) US
 - 60/942,557 7 June 2007 (07.06.2007) US
- (71) Applicant (for all designated States except US): iSKOOT, INC. [US/US]; One Broadway, Cambridge, Massachusetts 02142 (US).
- (72) Inventors; and
- (75) Inventors/Applicants (for US only): GUEDALIA, Jacob [US/US]; 119 Langdon Street, Newton, Massachusetts 02458 (US). GUEDALIA, Isaac [IL/IL]; Shimon 80, 99000 Bet Shemesh (IL).
- (74) Agent: HALLAJ, Ibrahim; Pepper Hamilton LLP, 500 Grant Street, 50th Floor, Pittsburgh, Pennsylvania 15219 (US).
- (81) Designated States (unless otherwise indicated, for every kind of national protection available): AE, AG, AL, AM, AT, AU, AZ, BA, BB, BG, BH, BR, BW, BY, BZ, CA, CH, CN, CO, CR, CU, CZ, DE, DK, DM, DO, DZ, EC, EE, EG, ES, FI, GB, GD, GE, GI, GM, GT, HN, IIR, IU, ID, IL,

[Continued on next page]

(54) Title: METHODS AND SYSTEMS OF PROVIDING MOBILE DEVICE CALLING FEATURES

WO 2008/085614 A3

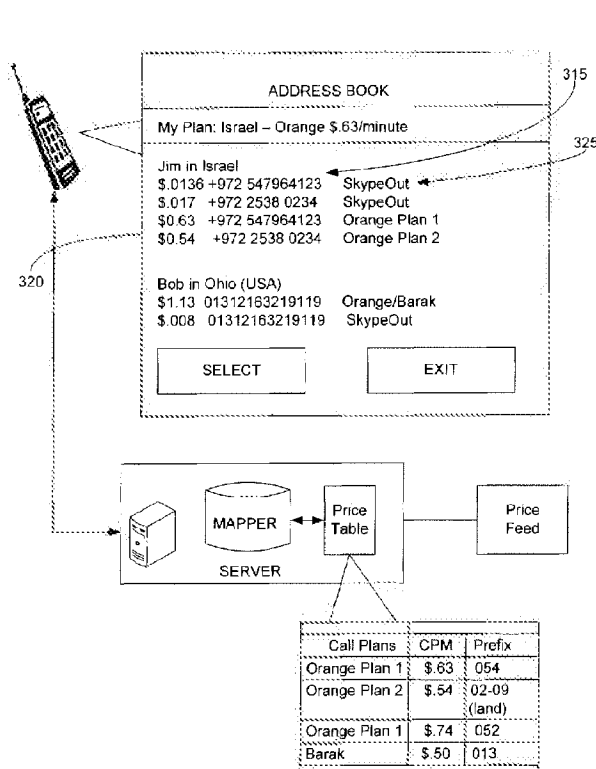


FIGURE 3

(57) Abstract: A method of providing cost information associated with one or more contact numbers in an address book may include receiving cost information, storing the cost information, mapping at least a portion of the cost information to one or more contact numbers using one or more pre-defined rules and transmitting the mapped cost information to a mobile device.



IN, IS, JP, KE, KG, KM, KN, KP, KR, KZ, LA, LC, LK, LR, LS, LT, LU, LY, MA, MD, ME, MG, MK, MN, MW, MX, MY, MZ, NA, NG, NI, NO, NZ, OM, PG, PH, PL, PT, RO, RS, RU, SC, SD, SE, SG, SK, SL, SM, SV, SY, TJ, TM, TN, TR, TT, TZ, UA, UG, US, UZ, VC, VN, ZA, ZM, ZW.

(84) Designated States (*unless otherwise indicated, for every kind of regional protection available*): ARIPO (BW, GI, GM, KE, LS, MW, MZ, NA, SD, SL, SZ, TZ, UG, ZM, ZW), Eurasian (AM, AZ, BY, KG, KZ, MD, RU, TJ, TM), European (AT, BE, BG, CH, CY, CZ, DE, DK, EE, ES, FI, FR, GB, GR, HU, IE, IS, IT, LT, LU, LV, MC, MT, NL, PL, PT, RO, SE, SI, SK, TR), OAPI (BF, BJ, CF, CG, CI, CM, GA, GN, GQ, GW, ML, MR, NE, SN, TD, TG).

Published:

- *with international search report*
- *before the expiration of the time limit for amending the claims and to be republished in the event of receipt of amendments*

(88) Date of publication of the international search report:
28 August 2008
Date of publication of the revised international search report:
11 December 2008

(15) Information about Correction:
see Notice of 11 December 2008

INTERNATIONAL SEARCH REPORT

International application No.

PCT/US 07/66063

<p>A. CLASSIFICATION OF SUBJECT MATTER IPC(8) - H04M 15/00 (2008.01) USPC - 379/114.28 According to International Patent Classification (IPC) or to both national classification and IPC</p>		
<p>B. FIELDS SEARCHED Minimum documentation searched (classification system followed by classification symbols) IPC(8): H04M 15/00 (2008.01) USPC: 379/114.28</p>		
<p>Documentation searched other than minimum documentation to the extent that such documents are included in the fields searched 379/114.02; 379/114.03; 379/201.01</p>		
<p>Electronic data base consulted during the international search (name of data base and, where practicable, search terms used) USPTO WEST (PGPB, USPT, EPAB, JPAB); GOOGLE Search Terms Used: phone, call, plan\$, pricing, discount, bonus, alert, contact, address, book, database, rules, wireless, cellular, mobile, device, telephone, cost\$, info\$, provider\$</p>		
<p>C. DOCUMENTS CONSIDERED TO BE RELEVANT</p>		
Category*	Citation of document, with indication, where appropriate, of the relevant passages	Relevant to claim No.
X	US 2002/0099670 A1 (JAKOBSSON) 25 July 2002 (25.07.2002), entire document, especially para [0009], [0020], [0031]-[0045]	1-11
A	US 2005/0036597 A1 (KOBROSLY et al.) 17 February 2005 (17.02.2005)	1-11
A	US 2003/0115138 A1 (BROWN et al.) 19 June 2003 (19.06.2003)	1-11
A	US 2005/0163065 A1 (YULE) 28 July 2005 (28.07.2005)	1-11
<p><input type="checkbox"/> Further documents are listed in the continuation of Box C. <input type="checkbox"/></p>		
<p>* Special categories of cited documents:</p>		
"A"	document defining the general state of the art which is not considered to be of particular relevance	"T" later document published after the international filing date or priority date and not in conflict with the application but cited to understand the principle or theory underlying the invention
"E"	earlier application or patent but published on or after the international filing date	"X" document of particular relevance; the claimed invention cannot be considered novel or cannot be considered to involve an inventive step when the document is taken alone
"L"	document which may throw doubts on priority claim(s) or which is cited to establish the publication date of another citation or other special reason (as specified)	"Y" document of particular relevance; the claimed invention cannot be considered to involve an inventive step when the document is combined with one or more other such documents, such combination being obvious to a person skilled in the art
"O"	document referring to an oral disclosure, use, exhibition or other means	"&" document member of the same patent family
"P"	document published prior to the international filing date but later than the priority date claimed	
<p>Date of the actual completion of the international search 12 June 2008 (12.06.2008)</p>		<p>Date of mailing of the international search report 14 OCT 2008</p>
<p>Name and mailing address of the ISA/US Mail Stop PCT, Attn: ISA/US, Commissioner for Patents P.O. Box 1450, Alexandria, Virginia 22313-1450 Facsimile No. 571-273-3201</p>		<p>Authorized officer: Lee W. Young PCT Helpdesk: 571-272-4300 PCT OSP: 571-272-7774</p>

INTERNATIONAL SEARCH REPORT

International application No.

PCT/US 07/86063

Box No. II Observations where certain claims were found unsearchable (Continuation of item 2 of first sheet)

This international search report has not been established in respect of certain claims under Article 17(2)(a) for the following reasons:

- 1. Claims Nos.:
because they relate to subject matter not required to be searched by this Authority, namely:

- 2. Claims Nos.:
because they relate to parts of the international application that do not comply with the prescribed requirements to such an extent that no meaningful international search can be carried out, specifically:

- 3. Claims Nos.:
because they are dependent claims and are not drafted in accordance with the second and third sentences of Rule 6.4(a).

Box No. III Observations where unity of invention is lacking (Continuation of item 3 of first sheet)

This International Searching Authority found multiple inventions in this international application, as follows:

-- see extra sheet --

- 1. As all required additional search fees were timely paid by the applicant, this international search report covers all searchable claims.
- 2. As all searchable claims could be searched without effort justifying additional fees, this Authority did not invite payment of additional fees.
- 3. As only some of the required additional search fees were timely paid by the applicant, this international search report covers only those claims for which fees were paid, specifically claims Nos.:
- 4. No required additional search fees were timely paid by the applicant. Consequently, this international search report is restricted to the invention first mentioned in the claims; it is covered by claims Nos.:
1-11

Remark on Protest

- The additional search fees were accompanied by the applicant's protest and, where applicable, the payment of a protest fee.
- The additional search fees were accompanied by the applicant's protest but the applicable protest fee was not paid within the time limit specified in the invitation.
- No protest accompanied the payment of additional search fees.

INTERNATIONAL SEARCH REPORT
Information on patent family members

International application No.

PCT/US 07/86063

This application contains the following inventions or groups of inventions which are not so linked as to form a single general inventive concept under PCT Rule 13.1. In order for all inventions to be examined, the appropriate additional examination fees must be paid.

Group I: claims 1-11 directed to a method of providing cost information associated with one or more contact numbers in an address book.

Group II: claims 12-15 and 20 directed to a method and system of providing a local access number to a subscriber

Group III: claims 16-19 directed to a method of placing a call using a local access number.

Group IV: claims 21-32 and 37 directed to a method and system for providing and accessing a status message and contact information.

Group V: claims 33-36 directed to a method for receiving an instruction from a subscriber to dial a telephone number.

The inventions listed as Groups I-V do not relate to a single general inventive concept under PCT Rule 13.1 because under PCT Rule 13.2 they lack the same or corresponding technical features for the following reasons:

Groups II-V do not include the inventive concept of mapping at least a portion of the cost information to one or more contact numbers using one or more pre-defined rules of Group I.

Groups I and III-V do not include the inventive concept of subscriber locale information and one or more local access numbers of Group II.

Groups I-II and IV-V do not include the inventive concept of selecting a long distance service provider from the plurality of long distance service providers of Group III.

Groups I-III and V-V do not include the inventive concept of a mobile device including one or more contacts and contact information in an address book of Group IV.

Groups I-IV and VI-V do not include the inventive concept of receiving, from a subscriber, an instruction to dial a telephone number of Group V.

None of these technical features are common to the other groups, nor do they correspond to a special technical feature in the other groups. Therefore, unity of invention is lacking.

Patent Record Full View Tuesday, November 25 2014

THOMSON INNOVATION

Patent/Publication: WO2008085614A8

Bibliography

DWPI Title

Cost information providing method for use in e.g. cellular phone, involves mapping portion of cost information to set of contact numbers using number of pre-defined rules, and transmitting mapped cost information to mobile device

Original Title

METHODS AND SYSTEMS OF PROVIDING MOBILE DEVICE CALLING FEATURES

Assignee/Applicant

Standardized: **ISKOOT INC** **GUEDALIA JACOB** **GUEDALIA ISAAC**

Original: iSKOOT INC., US GUEDALIA Jacob, US GUEDALIA Isaac, IL

DWPI Assignee/Applicant

GUEDALIA I D (GUED-I); GUEDALIA J (GUED-I); ISKOOT INC (ISKO-N); QUALCOMM CONNECTED EXPERIENCES INC (QUAL-N)

Inventor

GUEDALIA Jacob, US GUEDALIA Isaac, IL

Publication Date (Kind Code)

2008-12-11 (A3)

Application Number / Date

WO2007US86063A / 2007-11-30

Priority Number / Date / Country

US2007883841P / 2007-01-08 / US

US2007884045P / 2007-01-09 / US

US2007889305P / 2007-02-12 / US

US2007889959P / 2007-02-15 / US

US2007896003P / 2007-03-21 / US

US2007908726P / 2007-03-29 / US

US2007940758P / 2007-05-30 / US

US2007942557P / 2007-06-07 / US

US2007945931P / 2007-06-24 / US

US2007947963P / 2007-07-04 / US

Translation of / Language

- /English

Abstract

DWPI Abstract

(US20080166999A1)

Novelty

The method involves receiving cost information by receiving cost information from a rate sheet provided by a service provider or from a price feed. The cost information is stored. A portion of the cost information is mapped to a set of contact numbers (315) in an address book using a number of pre-defined rules, where the address book is stored on the mobile device such as cellular phone. The mapped cost information is transmitted to the mobile device. A discount associated with the mapped cost information is determined.

Detailed Description

An INDEPENDENT CLAIM is also included for a system of providing cost information associated with contact numbers.

Use

Method for providing cost information associated with a set of contact numbers in an address book, in a mobile device. Uses include but are not limited to a cellular phone, personal digital assistant (PDA) and media player.

Advantage

The portion of the cost information is mapped to the contact numbers using the number of pre-defined rules, and the mapped cost information is transmitted to the mobile device, thus effectively providing the cost information.

Drawing Description

The drawing shows a schematic representation of a system for providing cost information.

315 - Contact number.

320 - Cost-per-minute value.

325 - Calling plan.

Abstract

A method of providing cost information associated with one or more contact numbers in an address book may include receiving cost information, storing the cost information, mapping at least a portion of the cost information to one or more contact numbers using one or more pre-defined rules and transmitting the mapped cost information to a mobile device.

Classes/Indexing

CPC

Current CPC

Invention	Additional	Version	Office
H04M 15/00	H04W 8/26 H04W 48/08	20130101	EP

Current Combination Codes CPC

Legal Status

INPADOC Legal Status

Gazette Date	Code	Description
2010-12-29	122	EP: PCT APP. NOT ENT. EUROP. PHASE EP 07864975 A2
2009-07-09	NENP	NON-ENTRY INTO THE NATIONAL PHASE IN: DE
2008-09-03	121	EP: THE EPO HAS BEEN INFORMED BY WIPO THAT EP WAS DESIGNATED IN THIS APPLICATION EP 07864975 A2

Get Family Legal Status

Family

Family

Expand INPADOC Family (28)

Expand DWPI Family (15); Countries (121)

Claims

No Claims exist for this Record

Description

Description

Expand Description

Citations

Citation *Record level*

Citing Patents (0)

Expand Cited Patents (4)

Cited Non-patents (0)

DPCI Citation *Patent family level*

Expand DPCI Citing Patents (15)

Expand DPCI Cited Patents (168)

Expand DPCI Cited Non-patents (20)

Expand DPCI Citation Counts

DPCI Field of Search

-

DPCI Citing Patents Country

WO; US

DPCI Cited Patents Country

WO; EP; US; GB; DE

Other

Attorney / Agent

HALLAJ Ibrahim, Pepper Hamilton LLP, 500 Grant Street, 50th Floor, Pittsburgh, Pennsylvania 15219, US

Copyright 2007-2014 THOMSON REUTERS

(19) World Intellectual Property Organization
International Bureau



(43) International Publication Date
17 July 2008 (17.07.2008)

PCT

(10) International Publication Number
WO 2008/086350 A2

(51) International Patent Classification: **Not classified**

(71) Applicant (for all designated States except US): **ISKOOT, INC.** [US/US]; One Broadway, 16th Floor, Cambridge, Massachusetts 02142 (US).

(21) International Application Number:
PCT/US2008/050508

(72) Inventors; and

(22) International Filing Date: 8 January 2008 (08.01.2008)

(75) Inventors/Applicants (for US only): **GUEDALIA, Isaac David** [US/IL]; Shimon 80, Bet Shemesh, 99000 Israel (IL). **GUEDALIA, Jacob** [US/US]; 119 Langdon Street, Newton, Massachusetts 02458 (US).

(25) Filing Language: English

(26) Publication Language: English

(30) Priority Data:

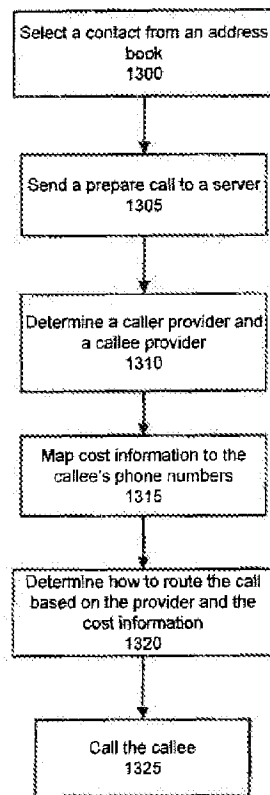
60/883,841	8 January 2007 (08.01.2007)	US
60/884,045	9 January 2007 (09.01.2007)	US
60/889,305	12 February 2007 (12.02.2007)	US
60/889,959	15 February 2007 (15.02.2007)	US
60/896,003	21 March 2007 (21.03.2007)	US
60/908,726	29 March 2007 (29.03.2007)	US
60/940,758	30 May 2007 (30.05.2007)	US
60/942,557	7 June 2007 (07.06.2007)	US
60/945,931	24 June 2007 (24.06.2007)	US
60/947,963	4 July 2007 (04.07.2007)	US

(74) Agent: **HALLAJ, Ibrahim**; Pepper Hamilton, LLP, One Mellon Center, 500 Grant Street, Pittsburgh, Pennsylvania 15219 (US).

(81) Designated States (unless otherwise indicated, for every kind of national protection available): AE, AG, AL, AM, AO, AT, AU, AZ, BA, BB, BG, BH, BR, BW, BY, BZ, CA, CH, CN, CO, CR, CU, CZ, DE, DK, DM, DO, DZ, EC, EE, EG, ES, FI, GB, GD, GE, GH, GM, GT, HN, HR, HU, ID, IL, IN, IS, JP, KE, KG, KM, KN, KP, KR, KZ, LA, LC, LK, LR, LS, LT, LU, LY, MA, MD, ME, MG, MK, MN, MW, MX, MY, MZ, NA, NG, NI, NO, NZ, OM, PG, PH,

[Continued on next page]

(54) Title: METHODS AND SYSTEMS OF PROCESSING MOBILE CALLS



(57) Abstract: A method of optimizing call dialing may include receiving a first call including one or more of a session identification number, a contact identification number, a contact name and a direct inward dialing number, determining a caller provider and a callee provider based on the first call, determining cost information associated with one or more numbers corresponding to a callee and routing a second call between the caller and the callee based on one or more of the caller provider, the callee provider and the cost information.

WO 2008/086350 A2



PL, PT, RO, RS, RU, SC, SD, SE, SG, SK, SL, SM, SV,
SY, TJ, TM, TN, TR, TT, TZ, UA, UG, US, UZ, VC, VN,
ZA, ZM, ZW.

European (AT, BE, BG, CH, CY, CZ, DE, DK, EE, ES, FI,
FR, GB, GR, HR, HU, IE, IS, IT, LT, LU, LV, MC, MT, NL,
NO, PL, PT, RO, SE, SI, SK, TR), OAPI (BF, BJ, CF, CG,
CI, CM, GA, GN, GQ, GW, ML, MR, NE, SN, TD, TG).

(84) Designated States (*unless otherwise indicated, for every
kind of regional protection available*): ARIPO (BW, GH,
GM, KE, LS, MW, MZ, NA, SD, SL, SZ, TZ, UG, ZM,
ZW), Eurasian (AM, AZ, BY, KG, KZ, MD, RU, TJ, TM),

Published:

— *without international search report and to be republished
upon receipt of that report*

METHODS AND SYSTEMS OF PROCESSING MOBILE CALLS

CLAIM OF PRIORITY AND RELATED APPLICATIONS

[0001] This application claims priority under 35 U.S.C. § 119(e) to U.S. Provisional Application No. 60/883,841, filed January 8, 2007, U.S. Provisional Application No. 60/884,045 filed January 9, 2007, U.S. Provisional Application No. 60/889,305, filed February 12, 2007, U.S. Provisional Application No. 60/889,959, filed February 15, 2007, U.S. Provisional Application No. 60/896,003, filed March 21, 2007, U.S. Provisional Application No. 60/908,726, filed March 29, 2007, U.S. Provisional Application No. 60/940,758, filed May 30, 2007, U.S. Provisional Application No. 60/942,557, filed June 7, 2007, U.S. Provisional Application No. 60/945,931, filed June 24, 2007, and U.S. Provisional Application No. 60/947,963, filed July 4, 2007, the entireties of which are incorporated by reference herein.

BACKGROUND

[0002] As the mobile telecommunication industry grows, mobile subscribers are becoming increasingly more aware of their leverage in the market. They carefully compare service providers and call plans, and make educated choices before subscribing to a carrier and a service. Subscribers also continuously seek new and improved features to integrate into their mobile service such as enhanced chat, long distance service options, customized graphical user interfaces and the like.

[0003] Despite being informed consumers, mobile subscribers are often disadvantaged in the mobile market. For example, although a subscriber may be knowledgeable about their own calling plan subscription, subscribers are usually unaware of the cost per minute of a call to the calling destination. This puts a mobile subscriber at a disadvantage in making educated and economical calling choices.

[0004] Mobile subscribers would also welcome more long distance service options. A subscriber to a telecommunication carrier service typically needs a local access number to utilize

the service. This usually involves selecting a number from a list of regional or area numbers, such as a preprinted list on a calling card, to find the access number closest to the subscriber's current location. The subscriber dials the local access number and is usually connected to a long distance service provider via a telephony network. Typically, the subscriber can then enter a target long distance telephone number, and the long distance service provider will route the call to a subscriber-specified number. The current approach has many disadvantages, however, such as having to purchase a phone card and locating a local access number. In addition, a subscriber who accidentally places a call using a non-local access number may incur long distance charges.

[0005] It is common for a subscriber to experience a significant delay after powering on his mobile device before he is able to access updated contact information in his address book. This is because the mobile device must contact and retrieve an updated contact list from a server. As such, subscribers may desire to access his address book while the contact information is being updated.

[0006] To keep pace with the constant evolution of mobile telephony, mobile subscribers are treated to a variety of applications designed to optimize their mobile communication experience. For example, subscribers can access the Internet with the mobile device, send chat messages to their contacts and the like. Subscribers can glean relevant and up-to-date information about their contacts in their address books by viewing presence-statuses, away messages, sometimes referred to as status messages, mood messages or the like. However, it is common for a subscriber's status message to read the same regardless of which contact views it. As such, a subscriber cannot customize his status message based on the contact who is viewing it.

[0007] A mobile subscriber may have one or more contacts in an address book that belong to different networks than the subscriber. It is often difficult for a subscriber to determine which network a contact is subscribed to, which precludes the subscriber from making informed decisions about how to optimally call the contact. As such, a subscriber would

like to ascertain to which network a contact belongs so that the subscriber can optimize call-dialing to this contact.

[0008] It is often difficult to determine the origin of a Voice over IP call because the call usually does not contain typical country code identifiers. As such, service providers would like to determine the origin of incoming calls to determine whether to accept or reject the call.

[0009] A mobile subscriber may only have limited contact information for a callee. A subscriber may want to obtain further information associated with the callee in order to decide how best to contact the callee.

SUMMARY

[0010] Before the present methods are described, it is to be understood that this invention is not limited to the particular systems, methodologies or protocols described, as these may vary. It is also to be understood that the terminology used herein is for the purpose of describing particular embodiments only, and is not intended to limit the scope of the present disclosure which will be limited only by the appended claims.

[0011] In an embodiment, a method of optimizing call dialing may include receiving a first call including one or more of a session identification number, a contact identification number, a contact name and a direct inward dialing number, determining a caller provider and a callee provider based on the first call, determining cost information associated with one or more numbers corresponding to a callee and routing a second call between the caller and the callee based on one or more of the caller provider, the callee provider and the cost information.

[0012] In an embodiment, a system for optimizing call dialing may include a processor for optimizing call dialing by processing one or more of a session identification number, a contact identification number, a contact name and a direct inward dialing number to determine provider information associated with one or more of a caller and a callee.

[0013] In an embodiment, a method of determining an origin of an incoming call may include receiving, by a callee gateway, a call from a mobile device associated with a caller, where the call is transmitted over a network via a caller gateway, identifying an origin of the call and determining whether to accept or reject the call based on the origin. If the call is accepted, the call may be processed. If the call is rejected, the caller may be alerted that the call cannot be completed.

[0014] In an embodiment, a system for determining an origin of an incoming call may include a caller gateway in communication with at least one mobile device and a callee gateway in communication with at least one mobile device and the caller gateway. The callee gateway may receive information pertaining to a call, and may determine an origin of the call based on at least a portion of the received information.

[0015] In an embodiment, a method of ascertaining information associated with a callee may include receiving a direct inward dialing number associated with a callee, comparing the direct inward dialing number to one or more entries in a consolidated general registry, where each entry comprises contact information and if an entry having the direct dialing number is found, transmitting at least a portion of the contact information to the caller.

[0016] In an embodiment, a system of ascertaining information associated with a callee may include one or more mobile devices, a processor in communication with the one or more mobile devices and a central general registry in communication with at least one of the one or more mobile devices.

[0017] In an embodiment, a method of filtering one or more contacts in an address book on a mobile device may include identifying one or more contacts in an address book associated with a mobile device, automatically filtering the one or more contacts in real time based on one or more predetermined criteria, where each predetermined criterion corresponds to a tab and displaying the filtered contacts to the user on a mobile device, where the tab

corresponding to each predetermined criterion includes the contacts associated with the predetermined criterion.

BRIEF DESCRIPTION OF THE DRAWINGS

[0018] FIG. 1 depicts a flow chart for implementing an exemplary call-cost feature on a mobile device.

[0019] FIG. 2 depicts a mobile device display of exemplary cost information according to an embodiment.

[0020] FIG. 3 depicts an exemplary system of providing cost information according to an embodiment.

[0021] FIG. 4 depicts an exemplary system of providing cost information according to an embodiment.

[0022] FIG. 5 illustrates flow chart for assigning an exemplary local access number according to an embodiment.

[0023] FIG. 6 illustrates a method of placing an exemplary long distance call using a local access number according to an embodiment.

[0024] FIG. 7 illustrates a flow chart for an exemplary method of accessing contact information on a subscriber's mobile device according to an embodiment.

[0025] FIG. 8 illustrates an exemplary system for implementing mobile address book interaction according to an embodiment.

[0026] FIG. 9 illustrates an exemplary method of providing contact information according to an embodiment.

[0027] FIG. 10 illustrates a diagram depicting a call originating in one country and terminating in a different country according to an embodiment.

[0028] FIG. 11 depicts a flow chart of an exemplary method of determining a call's point of origin according to an embodiment.

[0029] FIG. 12 illustrates a flow chart of an exemplary method of determining information associated with a callee according to an embodiment.

[0030] FIG. 13 illustrates an exemplary diagram of determining information associated with a callee according to an embodiment.

[0031] FIG. 14 illustrates a flow chart for an exemplary method of optimizing call dialing according to an embodiment.

[0032] FIG. 15 illustrates an exemplary graphical user interface illustrating a filter according to an embodiment.

DETAILED DESCRIPTION

[0033] FIG. 1 illustrates a flow chart for implementing an exemplary call-cost feature on a mobile device. A mobile device may include mobile or portable devices such as cellular phones, PDAs, media players or the like. A mobile device may have a processor and a processor-readable storage medium in communication with the processor.

[0034] As illustrated by FIG. 1, a price table database may receive **100** cost information from a price feed. A price feed provides real time pricing information for a product or service. For example, stock prices may be available to an online trader via a price feed.

[0035] In an embodiment, the price table database may be housed on a computing device, such as a server, and the cost information may include the cost per minute for a plurality of calling destinations or the like. Table 1 illustrates an exemplary price table database according to an embodiment.

Calling Destination	Cost per minute
Canada	\$0.33/minute

France	\$0.56/minute
Israel	\$0.35/minute
United States	\$0.15/minute

Table 1

[0036] The price table database may receive **100** cost information from the price feed on a regular basis. In an embodiment, the price feed may include a rate sheet provided by a telephone service provider.

[0037] In an embodiment, at least a portion of the received cost information may be stored **105** in the price table database. For example, the price table database may receive a cost-per-minute for calling Canada. If the price table database does not currently include a cost-per-minute for Canada, the cost information may be added to the price table database. If the price table database includes a different cost-per-minute for Canada, the stored cost information may be replaced with the cost information from the price feed. In an embodiment, if the received cost information associated with a calling destination is less than the stored cost information associated with the calling destination, an alert may be generated. The alert may be used to notify a subscriber of the price discount associated with the particular calling destination. In an embodiment, the server may transmit the alert to a subscriber's mobile device to notify the subscriber of the price discount.

[0038] A mapper may use the cost information contained in the price table database to map **110** cost information to one or more phone numbers in a subscriber's address book. In an embodiment, the mapper may utilize pre-defined rules to map **110** cost information to a contact number. A contact is an entry in an address book that is accessible by a mobile device. A contact number is a mobile device number associated with a contact. In an embodiment, the mapper may map **110** cost information to one or more contact numbers using pre-defined rules. The pre-defined rules may be used to determine, for example, a calling destination, whether the phone number belongs to a landline or a mobile device, or the like. For example, in Israel, landlines are

provisioned with the country code +972 followed by an area code ranging from '1' to '9', with the exception of '5.' Mobile phone numbers typically begin with '5.' If a subscriber has the phone number "972-2-5388-0234" in his address book, the mapper may use one or more pre-defined rules to determine the contact number is a landline number is Israel. The mapper may use this information to map the corresponding cost per minute to one or more contact numbers in a subscriber's address book.

[0039] In an embodiment, the mapped cost information may be transmitted to the subscriber's mobile device for display to the subscriber. FIG. 2 depicts a mobile phone display of exemplary cost information according to an embodiment. As illustrated, the cost to call one or more contacts in a subscriber's address book may be displayed. For example, calling Jim on his mobile phone costs \$0.0136/minute **200**, whereas calling Jim on his landline phone costs \$0.017/minute **205**. The subscriber may use this information to make an informed calling decision regarding which number to call.

[0040] In an embodiment, cost information may be provided based on associated calling plans. As illustrated by FIG. 3, the price table database may include cost information such as mobile providers' calling plans **300**, a cost-per-minute value **305** associated with the calling plans, a dialing prefix **310** provisioned for each calling plan and/or the like. In an embodiment, the price table database may receive this cost information from the price feed on a regularly updated basis.

[0041] In an embodiment, the mapper may map a contact's number with the subscriber's calling plan and the corresponding cost information may be displayed to a subscriber. One or more contacts in a subscriber's address book may be displayed with cost information based on the subscriber's and/or the contact's calling plan. For example, FIG. 3 illustrates exemplary information that may be displayed on a mobile device. A contact's number **315** may be listed with a cost-per-minute value **320** and a calling plan **325** associated with the number **315**.

[0042] In an embodiment, the mapper may use a contact's phone number to determine calling destination information such as a contact's locale, whether the contact's number corresponds to a landline or a mobile phone or the like. After calling destination information is determined, the mapper may map at least a portion of the calling destination information to the subscriber's calling plan. For example, a subscriber may want to call a contact who has two numbers. The first number may be a landline in Israel while the second number may be a mobile phone in Israel. The mapper may match the subscriber's calling plan with the destination information to determine that cost information associated with calling the two numbers.

[0043] In an embodiment, multiple service providers may be used to place a call. In such an embodiment, the mapper may map cost information associated with all necessary providers so that a combined price may be displayed to a subscriber. For example, if a subscriber calls an overseas contact using a long-distance service provider, the cost-per-minute may reflect both the long distance provider's charges as well as the local mobile carrier's airtime charges.

[0044] FIG. 4 depicts an environment suitable for practicing the illustrative embodiments. A processor, such as a server **400** may include a mapper **405** and/or a price table database **410**. The server **400** may be in communication with a price feed **415** and one or more mobile devices **420** via a network **425**. The server **400** may be implemented on a stand-alone computer system or may be implemented by distributed components such as separate electronic devices.

[0045] In an embodiment, a subscriber may use a local access number to place a long distance call. A local access number is a local telephone number a subscriber may employ to connect to a certain long distance service provider. FIG. 5 illustrates an exemplary flow chart of a method for assigning a local access number according to an embodiment. A subscriber's locale information may be received **500** by a server. In an embodiment, a subscriber may use a mobile device to subscribe to a telecommunication service via a data line. For example, a subscriber may access a browser to transmit an HTTP request. Upon registration, a subscriber may provide

locale information such as an area code and a telephone number, a zip code or the like corresponding to the subscriber's current location. The locale information may be communicated to a server.

[0046] In another embodiment, locale information may be automatically received **500** by a server. For example, the locale information may be transmitted via an HTTP browser to a server where it may be processed by a service delivery framework (SDF). The SDF may be aware of the subscriber locale information, such as a Mobile Systems International Subscriber Identity Number (MSISDN), and may insert such information into an HTTP header. The header may be transmitted to the server where the mapper may extract the locale information.

[0047] In an embodiment, the mapper may map **510** the locale information to a database of available access numbers. A local access number may be identified **520** based on the subscriber's current location and the identified local access number may be transmitted **530** to the subscriber's mobile device.

[0048] In an embodiment, the mapper may generate a list of long distance service providers having local access numbers corresponding to the subscriber's locale. The server may transmit the list via a data line to the subscriber's mobile device. The subscriber may select a long distance service provider, and may receive the corresponding local access number on his mobile device.

[0049] In an embodiment, the subscriber may use the local access number to connect to a chosen long distance service provider. The subscriber may manually input the local access number, followed by the desired long-distance phone number. Alternatively, the subscriber may employ an application, such as an address book, to automate this process. For example, a mobile device's address book may include a long-distance automatic dialing feature that allows for quick-dialing of a previously entered local access code.

[0050] In an embodiment, an existing address book may be populated with the local access number for future retrieval. In an embodiment, as a subscriber travels, his mobile device may receive and store new local access numbers based on his current location.

[0051] FIG. 6 illustrates a method of placing a long distance call using a local access number according to an embodiment. For example, subscriber who wants to make a third-party long distance call may register **600** for a long distance service using a browser on his mobile device. Upon registration, the subscriber may be asked to provide **605** locale information, such as a local telephone number with an area code. The locale information may be processed **610** by the server, and the subscriber may receive **615** a list of one or more long distance service providers. The subscriber may select **620** a long distance service provider and may receive **625** a local access number based on the selected long distance provider on his mobile device. The subscriber may employ the local access number for as long as he remains in his current location. If the subscriber's address book is equipped with a long distance auto-dial feature, it may be automatically populated with the local access number when the server transmits it to the mobile device. If the subscriber changes locations, he may access his account on the subscription site, enter a new telephone number and area code, and receive a new local access number. The subscriber's old access number may be stored for later use.

[0052] In an embodiment, a local access number may be automatically dialed for the subscriber, and may or may not require subscriber confirmation. As such, the subscriber may only need to specify the preferred long distance number to call. For example, a subscriber may select or input the preferred long distance number to call, and an application on the mobile device may place the call by automatically dialing the access code local to the subscriber's local information. As described above, the locale information may be ascertained based on the telephone number provided by the subscriber at sign-up or by extracting the subscriber locale information from an HTTP header.

[0053] For example, a mobile user who wants to place a long distance call may select a contact from his address book to call. The subscriber's long distance subscription service may ascertain the subscriber's location by extracting locale information from an HTTP header transmitted by the subscriber's phone or by the locale information the subscriber provided at sign-up. The server may map the subscriber's location to an appropriate local access number which may be sent to the subscriber's mobile device. The subscriber may make one or more selections to dial the received local access number. Alternatively, the service may auto-dial the local access number and connect the call without the subscriber being aware that a local access number has been dialed.

[0054] FIG. 7 illustrates a flow chart for an exemplary method of accessing contact information on a subscriber's mobile device according to an embodiment. When a subscriber first accesses a server-based mobile address book application, the subscriber may experience a significant delay while the address book attempts to retrieve the subscriber's address book from the server. In an embodiment, a cache of the address book may be created 700 before the subscriber's mobile device is powered off. The cache may include contact information stored in the subscriber's address book during the last application session. For example, the cache may include a contact's name, one or more telephone numbers associated with the contact, a status message associated with the contact and/or the like.

[0055] In an embodiment, a status message indicates whether the contact is online, offline or the like. A status message includes information relating to a status or state of a subscriber, and can be presented automatically to anyone who attempts to contact the subscriber. The status message may provide further information regarding the subscriber. In an embodiment, exemplary status messages may include "Having a bad day," "In a meeting," "At the gym," or the like.

[0056] In an embodiment, the cache may be stored 710 on the subscriber's mobile device. When a subscriber powers on his mobile device, at least a portion of the cache may be

displayed 720 to a subscriber until a fresh upload of contact information can be obtained from the server. For example, when a subscriber accesses an address book application after powering on his mobile device, the subscriber may be presented with a cached version of his address book that may include contacts' names, telephone numbers, status message and/or the like which were stored in the cache prior to the mobile device being powered off.

[0057] In an embodiment, because the server may take a significant amount of time to upload a complete fresh address book, contacts may be updated in a particular order according to an embodiment. For example, the first several contacts that appear in a subscriber's mobile device display may have their information updated first. Alternatively, priority may be given to one or more pre-determined contacts.

[0058] A problem may arise when a subscriber attempts to call a contact's telephone number using a cached address book. In an embodiment, the cached information may include a contact identification number associated with a contact and/or a unique session identification number. A contact identification number is a unique identifier associated with a certain contact in an address book. A session identification number is a unique identifier associated with a calling period. The unique session identification number may remain valid for the length of an entire calling period, which, in an embodiment, may be the period of time from when the application is powered up and connected until the time that the application is powered down. A contact identification number may be assigned to each contact, and may remain valid for the duration of a calling period. In an embodiment, the unique session identification number and the contact identification numbers may expire after the calling period has closed, thus rendering them invalid for subsequent calling sessions. As such, when a subscriber attempts to call a contact with stale status information, the application may attempt to dial in with an expired session identification number and/or reference an expired contact identification number, which may result in call failure. While a delay may exist while the server refreshes and updates a

subscriber's contact information, a service provider may want to give a subscriber a feeling of being logged onto the network as soon as the subscriber's mobile device is powered on.

[0059] For example, in an embodiment, if a subscriber selects a contact from the cached address book having expired status information, the contact's phone number may not be immediately dialed. Instead, the subscriber's mobile device may dial a server and may dispatch the name of the desired callee across a network. The server may send back a session identification number to be utilized during the calling period and/or a contact information number that references the callee. In an embodiment, the server may also send a local access number to be used to contact the callee. Alternatively, the call may be completed without the use of a local access number.

[0060] In an embodiment, if a subscriber selects a contact from the cached contact list having stale status information, a prepare call may be sent to the server. The prepare call may include a session identification number, a callee's contact identification number, a callee's contact name and the like. The server may send back a new session identification number for the subscriber, a contact information number that references the callee, a local access number to be used to contact the callee and/or the like.

[0061] In an embodiment, if a subscriber selects a contact from the cached contact list having stale status information, a direct inward dialing (DID) number of the callee may be directly dialed, and the dual-tone multi-frequency (DTMF) tones of the caller may be appended to a dial-string associated with the call. A DID number is a feature offered by telephone companies for use with customer's private branch exchange. A telephone company may allocate a range of numbers all connected to the customers' PBX. As the PBX receives calls, the number that the caller dialed may also be presented so the PBX can route the call to the target callee. For example, DID numbers may be obtained by administrators of a VoIP network and assigned to a gateway in the network. The gateway may route incoming calls from the network to appropriate VoIP subscribers.

[0062] In an embodiment, a set of DIDs may be assigned to a gateway. The gateway may then reassign the DIDs to a particular mapping of caller-callee. For example, Caller A may have ten contacts, A-K. Each contact may be assigned a unique DID number. When Caller A selects a contact from his cached contact list, Caller A is, in effect, selecting the DID number associated with the contact.

[0063] In an embodiment, if a subscriber selects a contact from the cached contact list having expired status information, a callee's DID number may be directly dialed, and the DID number and the identification number of the caller may appear within the dial-string.

[0064] In an embodiment, a subscriber may use an address book on the subscriber's mobile device to call one or more contacts stored in the address book. The subscriber may communicate with these contacts by dialing the contact directly, by sending chat messages or the like. FIG. 8 illustrates an exemplary system for implementing mobile address book interaction according to an embodiment. In addition to being stored locally on a mobile device 800, the contact information in a subscriber's address book 805 may also be cached on a server 810 which may regularly update the address book information. The server may send information about the subscriber's contacts to the subscriber's mobile device 800 as it become available. In an embodiment, the subscriber's mobile device 800 may poll the server at specified intervals to receive updates about the subscriber's contacts. Updated information may be integrated into the subscriber's mobile address book 805 for the subscriber to access. In an embodiment, contact information may include a status message or the like.

[0065] As FIG. 8 illustrates, bi-directional communication 815 may exist between the server, the subscriber's mobile device and the contacts 820 who appear in the subscriber's address book. In an embodiment, the server may push information, such as a status message associated with the subscriber, to the contacts 820. The server may also pull information from the contacts 820 for transmission to the subscriber's mobile device.

[0066] For example, if the subscriber wishes to change his status message, the subscriber may set a new status message using his mobile device. The new status message may then be sent to the server to be propagated to the subscriber's contacts. When the server receives and processes the new status message, the server may send the new status message to all of the subscriber's contacts.

[0067] FIG. 9 illustrates a method of providing contact information according to an embodiment. A server may receive 900 one or more status messages, such as a holographic message, from a subscriber's mobile device. A holographic message relates to customized messages that differ based on which contact inquires about the subscriber's status. That is, different contacts may be presented with different messages depending on the identity of the contact. The present discussion is intended to comprehend a one-to-one correspondence between messages and contacts, but is not so limited, and also includes messages directed to subsets of more than one contact. For example, a subscriber's holographic message may read "I'm in a meeting" to work colleagues, but may read "I'm unavailable" to all other contacts.

[0068] In an embodiment, a subscriber may set a holographic message using the subscriber's mobile phone. The subscriber may identify a message for a specific contact. For example, a subscriber may set a holographic message that reads "I'll be home at 6:30pm" to his wife. The subscriber may also set a holographic message for a specific contact group. For example, a subscriber may set a holographic message that reads "At the beach" to his friends.

[0069] In an embodiment, the holographic messages set by a subscriber may be sent to the server to be transmitted to the contacts in the subscriber's contact book. The server may store 910 a holographic message and corresponding contact or contact group. The server may transmit 920 the holographic message to the mobile phones of the appropriate contacts based on the contact's name, the contact's group or the like. In an embodiment, the server may integrate 930 the holographic message into an address book associated with a contact. The server may

transmit one or more instructions to a contact's mobile device instructing the mobile device to display the holographic message.

[0070] In an embodiment, a list of most-recently called contacts may be kept. For example, the list may reflect the last ten contacts a subscriber called, chatted with, changed a status message for, or the like. Typically, a subscriber's address book is stored on a server, and a push presence technique is utilized to access contact information, such as a status message or the like. In an embodiment, the push presence technique requires a subscriber to retrieve the latest contact information from the server. However, a subscriber who has many contacts must access the server numerous times in order to view contact information, which may drain the battery of the subscriber's mobile device. As such, a list of most-recently called contacts may be kept. This list may be stored on a subscriber's mobile device or on the server. If the list is stored on the server, the server must only push the contact information associated with the contacts in the most-recently called list instead of the contact information for every contact in the subscriber's address book.

[0071] In an embodiment, a gateway may decide to accept or reject a call based on the call's point of origin. For example, a call may originate in one country and terminate in a different country. FIG. 10 illustrates a diagram depicting a call originating in one country and terminating in a different country according to an embodiment. FIG. 11 depicts a flow chart of an exemplary method of determining a call's point of origin according to an embodiment.

[0072] In an embodiment, a caller may select **1100** a contact to call via the caller's mobile device. As illustrated by FIG. 10, the caller **1000** may be located in the United Kingdom, while the callee **1005** may be located in Germany. The call may be sent from the caller's mobile device **1010** and received **1105** by a caller gateway **1015**, or a gateway associated with the caller's location. In an embodiment, the caller gateway may reside on a server. In the example illustrated by FIG. 10, the callee gateway **1015** is a UK Gateway **1015**. The call may be transmitted **1110** over a network **1020**, and may be received **1115** by a callee gateway **1025**, or a gateway associated with

the callee's location. In an embodiment, the callee gateway may reside on a server. In the example illustrated by FIG. 10, the callee gateway is a Germany Gateway **1025**. In an embodiment, the callee gateway **1025** may process the call as a mobile-terminated call to the callee's mobile device **1030**.

[0073] In an embodiment, a callee gateway may determine **1120** whether to accept or reject a call based on the origin of the call. In an embodiment, out of band signaling may be employed **1125** to make this determination. In an embodiment, a first communication channel may be created to bridge the call. The first communication channel may be a standard communication channel. In an embodiment, the first communication channel may be HTTP. In an embodiment a second communication may be created. The second communication channel may serve as a communication channel between a plurality of servers. In an embodiment, before a call is transmitted, an HTTP request may be transmitted to one or more servers on the second communication channel alerting the servers of the origin of the call. For example, in the example illustrated by FIG. 10, a caller may select a contact from an address book. Before the call is transmitted, an HTTP request may be transmitted to one or more servers on the communication channel alerting the servers that the call about to be processed is originating from the United Kingdom. As such, the alerted servers will be notified as to the call's country of origin before the call reaches its final destination.

[0074] In an embodiment, in-band signaling audio may be employed **1130** to identify the origin of a call. In an embodiment, one or more DTMF tones may be used to identify the origin of the call. Before a call is connected to a callee, one or more DTMF tones may be inserted into the call. These tones may be heard by the callee as a series of pings. In an embodiment, the DTMF tones may be encoded to represent the country of origin. The server that receives the call may interpret the DTMF tones to ascertain the country of origin. An indication of the country of origin may be transmitted to the callee gateway, which may determine whether to accept or reject the call.

[0075] In an embodiment, in-band signaling non-audio may be employed 1135 to determine the origin of a call. In an embodiment, the network may employ an audio channel and a data channel. The data channel may be used for sending data as well as a protocol for allowing the caller gateway and callee gateway to communicate with each other. In an embodiment, information associated with the call origin may be sent to the callee gateway via the data channel. In an embodiment, the origin information may be sent in a text message, in a data message or the like. In an embodiment, a data message may include a data protocol or the like.

[0076] In an embodiment, after the country of origin is ascertained from an incoming call, the callee gateway may use this information to decide 1120 whether to accept or refuse a call. If the call is accepted, the call may be routed 1140 through the callee gateway to the callee's mobile device. If the call is refused, the callee may be alerted 1145 that the call could not be completed.

[0077] In an embodiment, a caller may use a portion of information regarding a callee to ascertain other information pertaining to the callee. For example, a caller may know a DID number corresponding a contact, however, the caller may be unaware of the contact's screen name, account name, email address or the like. If the caller directly dials the contact's DID number, he may incur long distance charges that he may not incur if he contacts the callee via the callee's screen name.

[0078] FIG. 12 illustrates a flow chart of an exemplary method of determining information associated with a callee according to an embodiment. FIG. 13 illustrates an exemplary diagram of determining information associated with a callee according to an embodiment.

[0079] In an embodiment, a caller 1230 may dial 1200 a DID number associated with a callee 1235. The DID number may be received 1205 by a server which may compare 1210 the DID number to one or more entries in a consolidated general registry 1240. In an embodiment, a consolidated general registry 1240 may include contact information associated with a subscriber,

such as the subscriber's telephone number, screen name, email address and/or the like and may reside on a server. The server may use a portion of information transmitted from a caller to identify **1215** other information corresponding to the callee **1235**. For example, if a caller **1230** dials a callee's DID number, the consolidated general registry **1240** may use the DID number to determine that the callee **1235** also has a screen name. In an embodiment, at least a portion of the contact information may be transmitted to the caller. In an embodiment, one or more images, such as the transmitted contact information, may be downloaded to a mobile device in one or more stages. In an embodiment, an images may be downloaded progressively in one or more stages as the user continues to use the mobile device. In an embodiment, an image may be displayed in low resolution in a first stage, but with each subsequent stage, the image quality associated with the image may progressively improve. For example, when a user first powers on his mobile device, the user's address book may appear in low resolution. After a certain period of time, the resolution and image quality may improve. After a certain period of time, the image quality and resolution may further improve.

[0080] Table 2 illustrates an exemplary entry in the consolidated general registry according to an embodiment.

DID Number	Screen Name	Email Address 1	Email Address 2
3024562786	isapr25	isapr25@aol.com	isapr25@gmail.com

Table 2

[0081] For example, if a caller **1230** wants to contact the callee **1235** identified by Table 2, he may dial the callee's DID number because this is the only contact information he has regarding the callee **1235**. The server may match the received DID number to the screen name isapr25 as illustrated by Table 2. The callee's screen name may be transmitted **1220** back to the caller **1230** and the caller **1230** may be provided the option of contacting the callee **1235** using her screen name. In an embodiment, the call may automatically be completed **1225** using a predetermined method. For example, the call may be completed using the least expensive

method. In an embodiment, the call may be transmitted through a gateway 1245 which may connect the call to the callee 1235.

[0082] In an embodiment, call dialing may be optimized so that a call is processed more efficiently. Optimization may involve identifying to which provider a caller and a callee belong, and deciding how to route a call between the two based on at least the provider information and cost information.

[0083] FIG. 11 illustrates a flow chart for an exemplary method of optimizing call dialing according to an embodiment. In an embodiment, a caller may select 1300 a contact from an address book. A first call, such as a prepare call, may be sent 1305 to a server. In an embodiment, the first call may include one or more of a session identification number, a callee's contact identification number, a callee's contact name, a DID number and the like. In an embodiment, a DID number may include one or more of a country code and a unique identifier associated with the mobile provider.

[0084] In an embodiment, the server may use the information contained in the first call to determine how to best optimize call dialing. For example, the server may determine 1310 a provider associated with the caller and a provider associated with the callee. In an embodiment, if a caller and a callee are subscribers to the same provider, the server may connect a second call using direct dial. In an embodiment, the second call may be a voice call. For example, if the caller is a subscriber to Provider A, and the callee also belongs to Provider A's network, the server may automatically connect the caller to the callee's number.

[0085] In an embodiment, if a caller belongs to a different network than the callee, the server may provide an access number that may serve as a gateway through which to connect to a third party provider network, such as a third party VoIP provider network. In an embodiment, an access number may be returned to the caller. The caller may dial the access number to reach the callee. Routing the second call through a third party network may reduce the charges incurred and the call may be processed more quickly and efficiently.

[0086] In an embodiment, a mapper, such as that illustrated by FIG. 1, may use the cost information contained in the price table database to map **1315** cost information to the callee's phone number. For example, if a caller dials a callee that has two possible phone numbers, the server may determine **1320** how to optimize call dialing by determining whether the callee is a subscriber of the callee's network for either phone number and the cost information associated with the callee's phone numbers. The server may use this information to call **1325** the callee.

[0087] In an embodiment, a mobile device may include a filter that sorts one or more contacts in an address book based on certain criteria. FIG. 15 illustrates an exemplary graphical user interface illustrating a filter according to an embodiment.

[0088] In an embodiment, one or more contacts from an address book **1430** on a mobile device **1435** may be automatically filtered in real-time. In an embodiment, filtered contacts may be displayed under one or more tabs for increased accessibility. FIG. 15 illustrates exemplary tabs **1400** such as "Landline," **1405** "Wireless," **1410** "My Carrier," **1415** "Recent Received" **1420** and "Recent Called" **1425**.

[0089] In an embodiment, the "Landline" tab **1405** may include one or more contacts having landline telephone numbers and/or their landline telephone numbers. The "Wireless" tab **1410** may include one or more contacts having wireless telephone numbers, and their corresponding wireless telephone numbers. The "My Carrier" tab **1415** may include one or more contacts that belong to the same carrier or provider as the user. In an embodiment, one or more contacts may be filtered through auto-detection of a user's network based on the user's phone number. In an embodiment, the user's phone number may include an identifier string that is unique to the cellular provider.

[0090] In an embodiment, the "Recent Received" tab **1420** may include one or more contacts that have recently called the user. In an embodiment, this tab **1420** may include one or more contacts that have called the user within a predefined period of time. For example, only the contacts that have called the user within the past twenty-four hours may be displayed.

Alternatively, this tab **1420** may include one or more predefined number of contacts. For example, only the last ten contacts that have called the user may be displayed.

[0091] In an embodiment, the “Recent Called” **1425** tab may include one or more contacts that the user has recently called. In an embodiment, this tab **1425** may include one or more contacts that the user has called within a predefined period of time. For example, only the contacts that the user has called within the past twenty-four hours may be displayed. Alternatively, this tab **1425** may include one or more predefined number of contacts. For example, only the last ten contacts that the user has called may be displayed. Additional and/or alternate tabs may be used within the scope of this disclosure.

[0092] It will be appreciated that various of the above-disclosed and other features and functions, or alternatives thereof, may be desirably combined into many other different systems or applications. Also that various presently unforeseen or unanticipated alternatives, modifications, variations or improvements therein may be subsequently made by those skilled in the art which are also intended to be encompassed by the following claims.

[0093] What is claimed is:

CLAIMS

1. A method of optimizing call dialing, the method comprising:
 - receiving a first call comprising one or more of a session identification number, a contact identification number, a contact name and a direct inward dialing number;
 - determining a caller provider and a callee provider based on the first call;
 - determining cost information associated with one or more numbers corresponding to a callee; and
 - routing a second call between the caller and the callee based on one or more of the caller provider, the callee provider and the cost information.

2. The method of claim 1, wherein receiving a first call comprises receiving a first call from a mobile device.

3. The method of claim 1, wherein routing a second call comprises:
 - determining whether the caller provider is the same as the callee provider;
 - if so, automatically dialing the direct inward dialing number; and
 - if not, transmitting an access number to the caller.

4. The method of claim 1, wherein determining cost information comprises mapping at least a portion of the cost information to one or more numbers associated with the callee using one or more pre-defined rules.

5. A system for optimizing call dialing comprising:

a processor for optimizing call dialing by processing one or more of a session identification number, a contact identification number, a contact name and a direct inward dialing number to determine provider information associated with one or more of a caller and a callee.

6. The system of claim 5, further comprising:

a mapper for mapping cost information associated with calling the callee based on the determined provider information.

7. A method of determining an origin of an incoming call, the method comprising:

receiving, by a callee gateway, a call from a mobile device associated with a caller, wherein the call is transmitted over a network via a caller gateway;

identifying an origin of the call;

determining whether to accept or reject the call based on the origin;

if the call is accepted, processing the call; and

if the call is rejected, alerting the caller that the call cannot be completed.

8. The method of claim 7, wherein identifying an origin of the call comprises:

creating a first communication channel to bridge the call;

creating a second communications channel that communicates with a plurality of servers;

and

transmitting an HTTP request to one or more of the plurality of servers, wherein the HTTP request comprises an indication of the origin of the call.

9. The method of claim 7, wherein identifying an origin of the call comprises:

decoding one or more DTMF tones that have been encoded to represent the origin of the call.

10. The method of claim 7, wherein identifying an origin of the call comprises:
receiving information associated with the origin via a data channel.
11. The method of claim 7, wherein the caller gateway and the callee gateway are located in different countries.
12. A system for determining an origin of an incoming call comprising:
a caller gateway in communication with at least one mobile device; and
a callee gateway in communication with at least one mobile device and the caller gateway,
wherein the callee gateway receives information pertaining to a call, wherein the callee gateway determines an origin of the call based on at least a portion of the received information.
13. A method of ascertaining information associated with a callee, the method comprising:
receiving a direct inward dialing number associated with a callee;
comparing the direct inward dialing number to one or more entries in a consolidated general registry, wherein each entry comprises contact information; and
if an entry having the direct dialing number is found, transmitting at least a portion of the contact information to the caller.
14. The method of claim 13, wherein the contact information comprises one or more of a telephone number, a screen name and an email address.
15. The method of claim 13, further comprising:

automatically connecting the call using one or more predetermined rules.

16. The method of claim 13, wherein transmitting at least a portion of the contact information to the caller comprises:

downloading a portion of the contact information in one or more stages such that image quality associated with the downloaded portion in each stages progressively improves.

17. A system for ascertaining information associated with a callee comprising:

one or more mobile devices;

a processor in communication with the one or more mobile devices; and

a central general registry in communication with at least one of the one or more mobile devices.

18. A method of filtering one or more contacts in an address book on a mobile device, the method comprising:

identifying one or more contacts in an address book associated with a mobile device;

automatically filtering the one or more contacts in real time based on one or more predetermined criteria, wherein each predetermined criterion corresponds to a tab; and

displaying the filtered contacts to the user on a mobile device, wherein the tab corresponding to each predetermined criterion includes the contacts associated with the predetermined criterion.

19. The method of claim 18, wherein automatically filtering the one or more contacts comprises filtering the one or more contacts based on one or more of the following:

whether a contact has a landline telephone number;

whether a contact has a wireless telephone number;

whether a contact belongs to the same carrier as the mobile device user;
whether a contact has recently called the mobile device user; and
whether the mobile device user has recently called a contact.

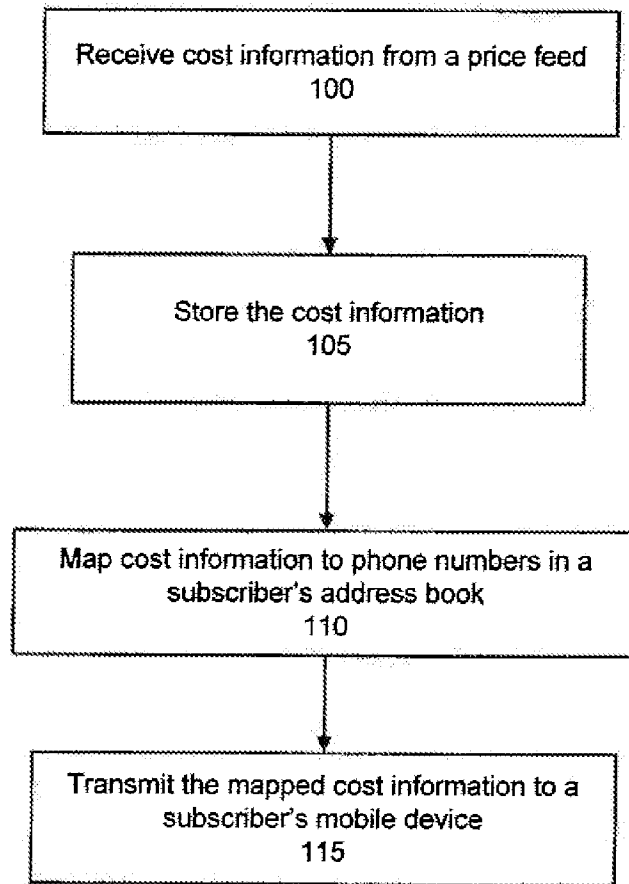


FIG. 1

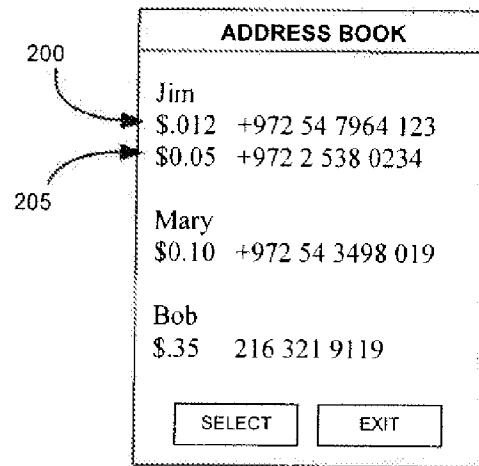


FIG. 2

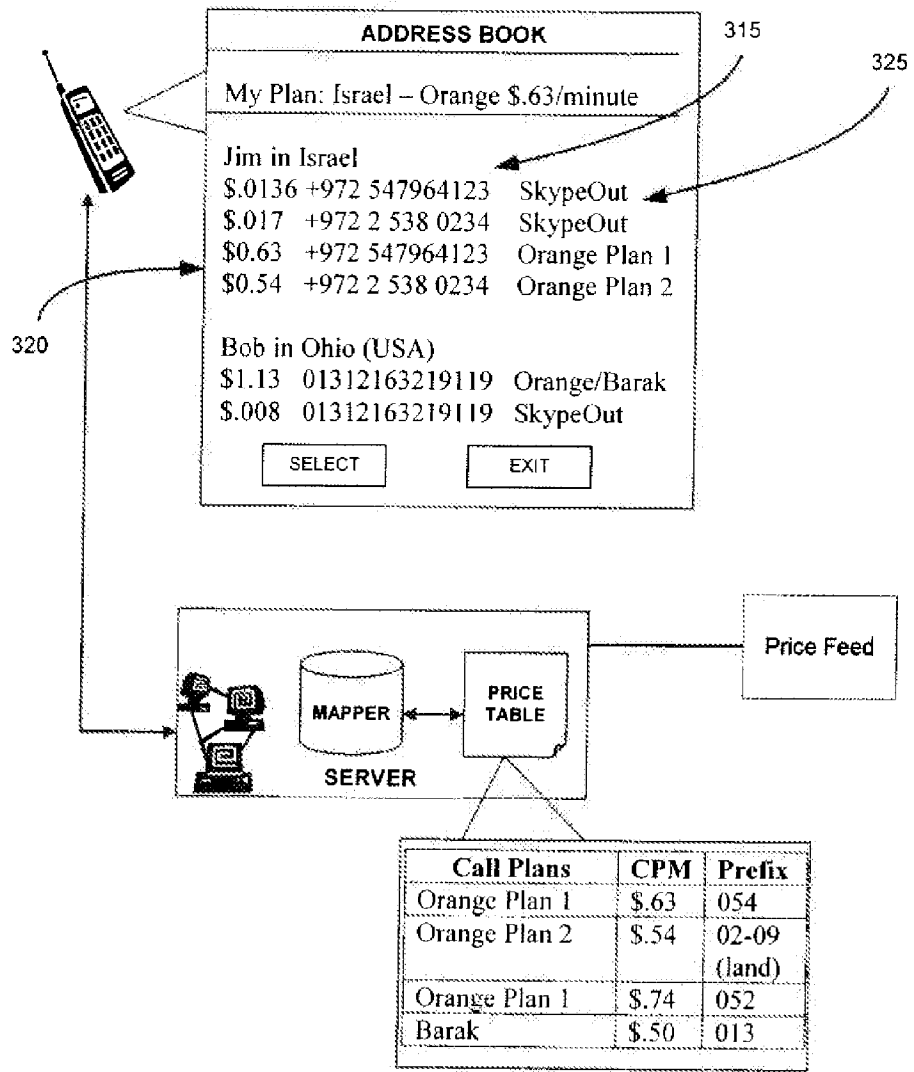


FIG. 3

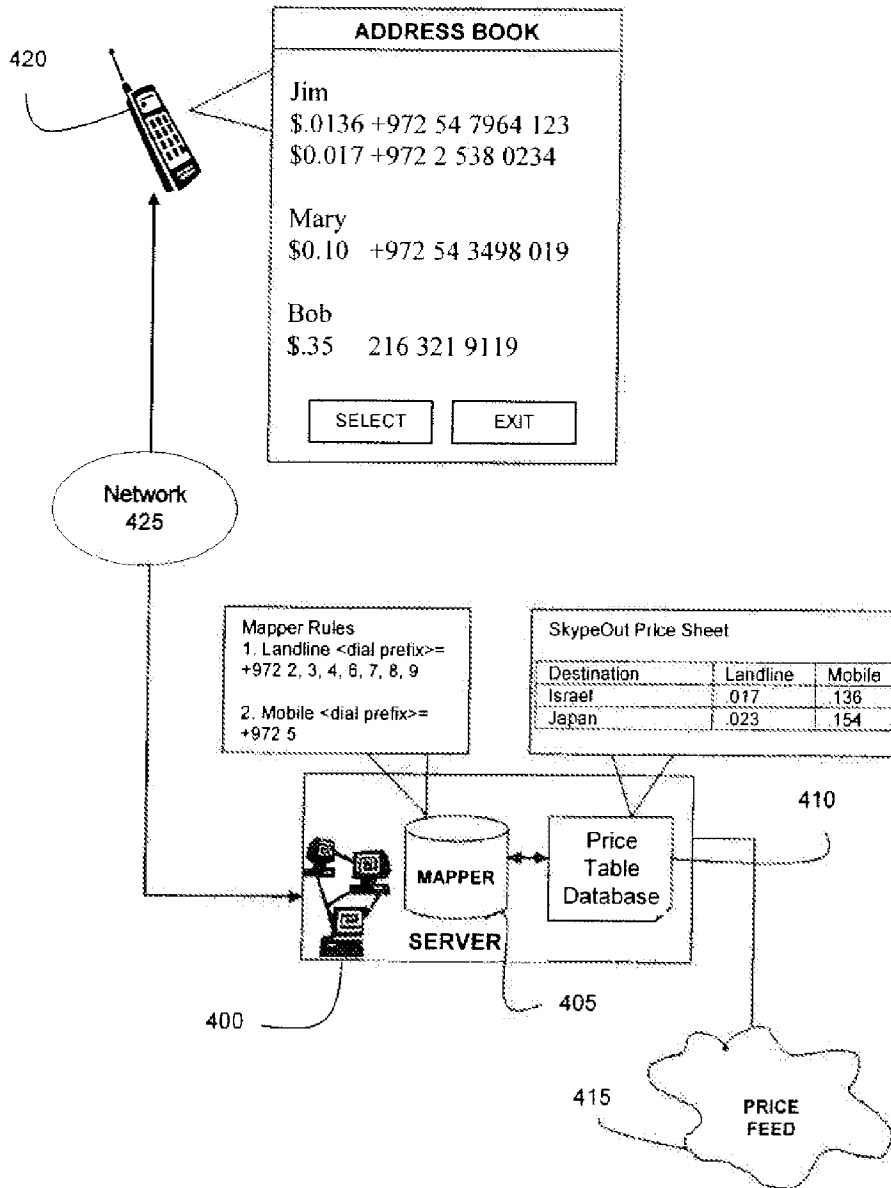


Fig. 4

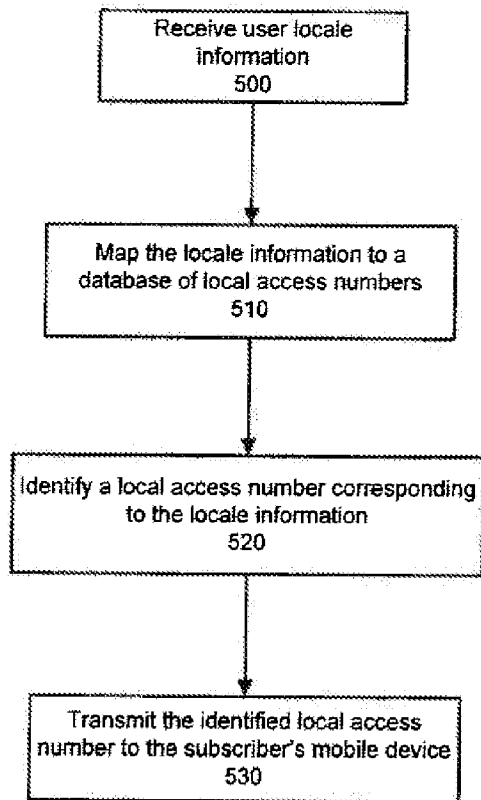


FIG. 5

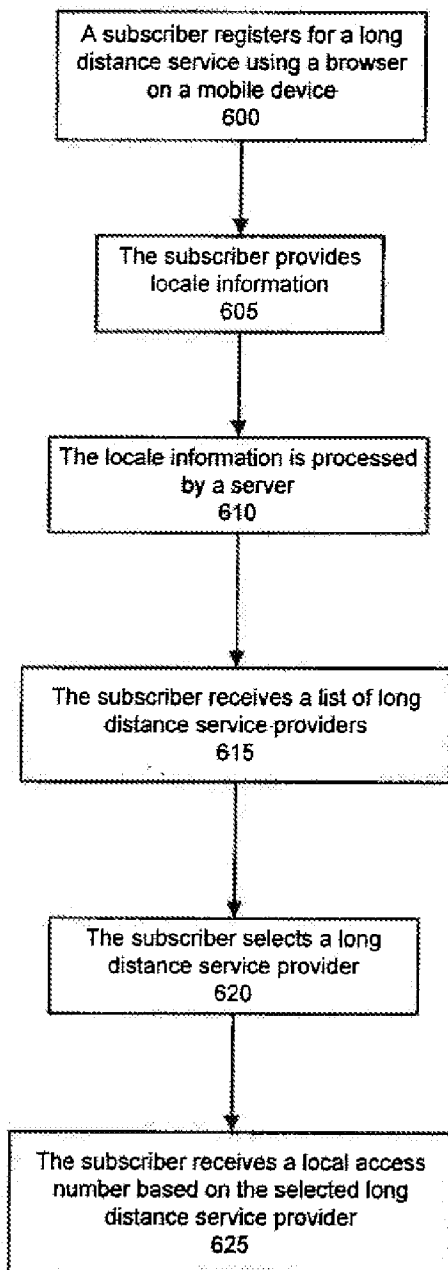


FIG. 6

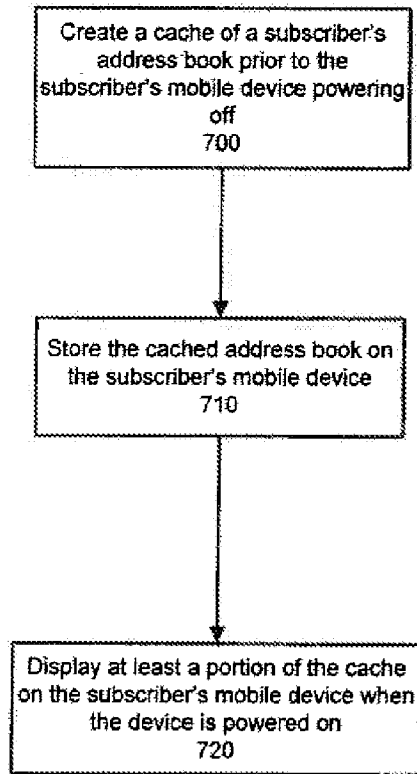


FIG. 7

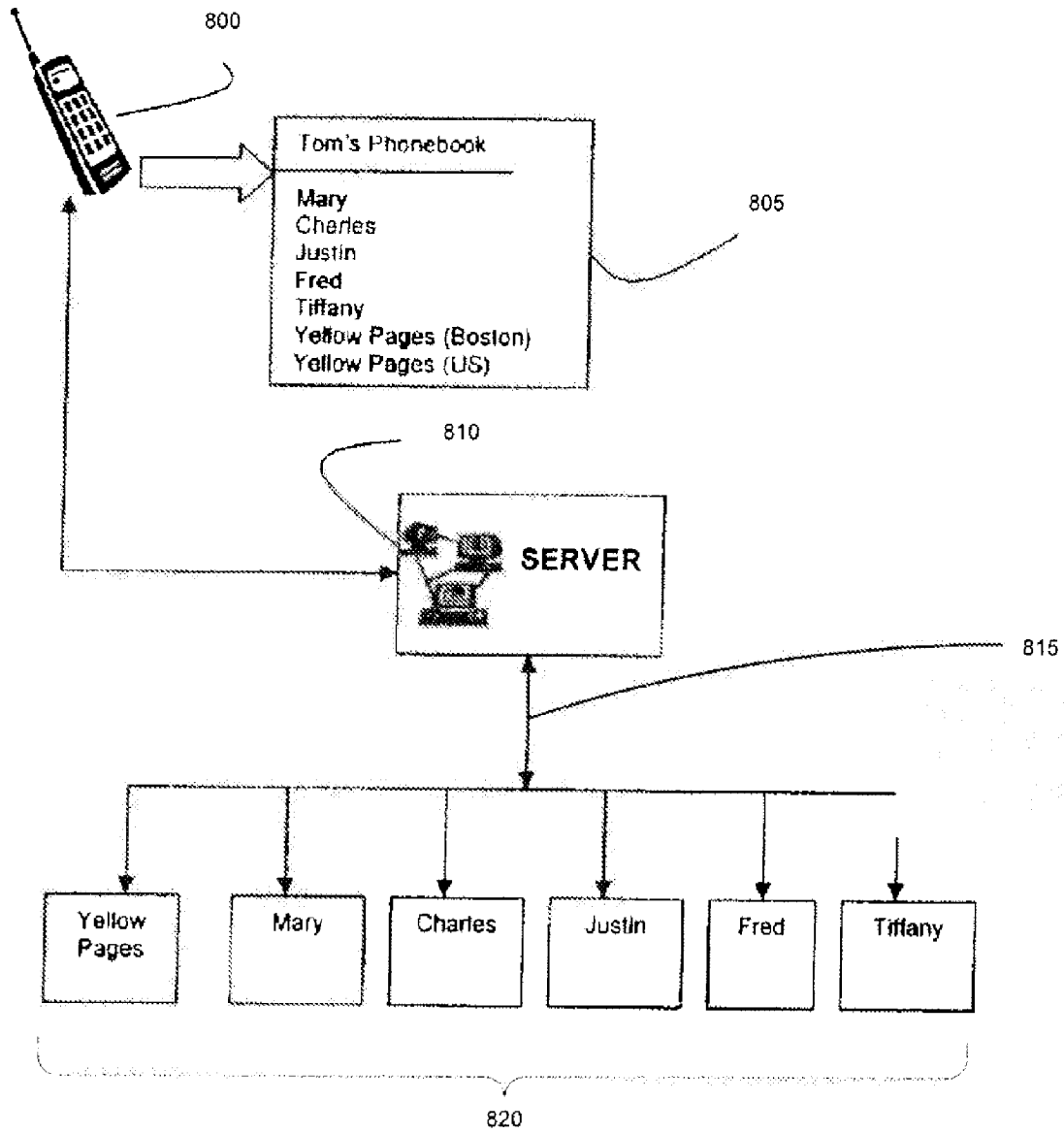


FIG. 8

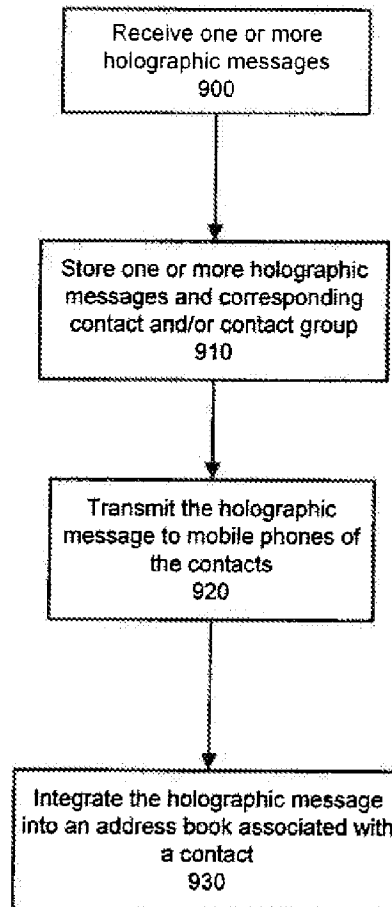


FIG. 9

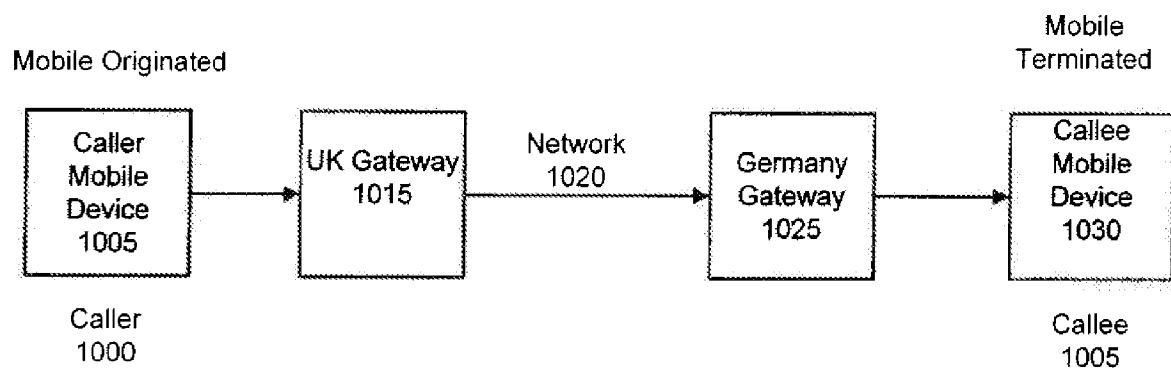


FIG. 10

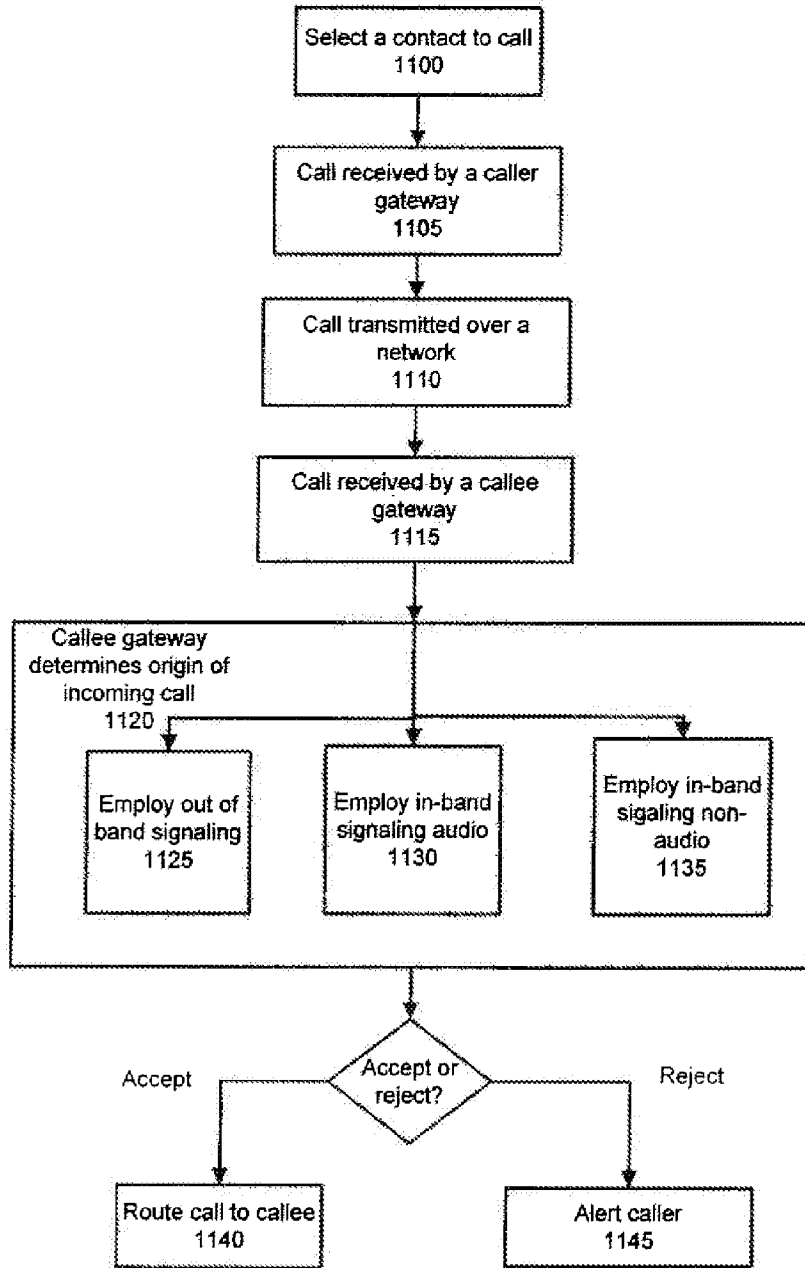


FIG. 11

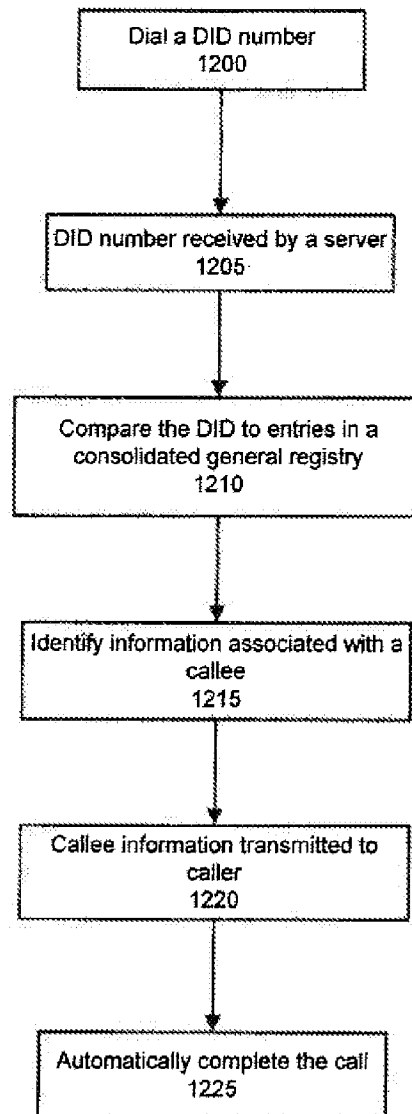


FIG. 12

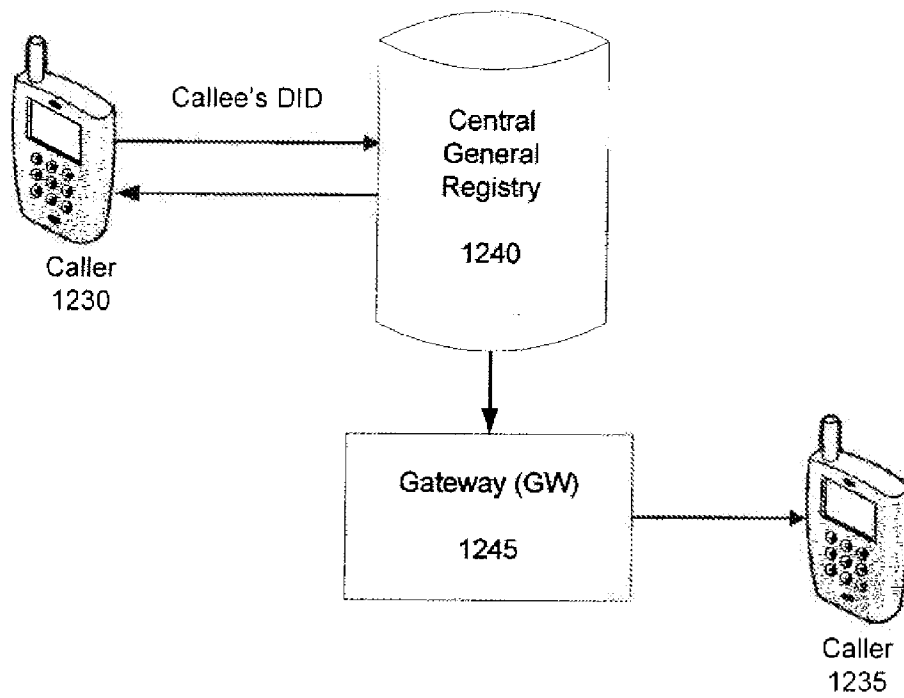


FIG. 13

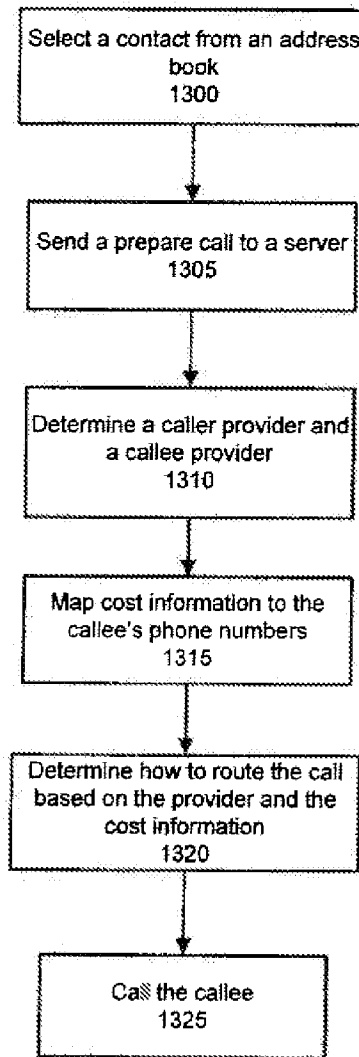


FIG. 14

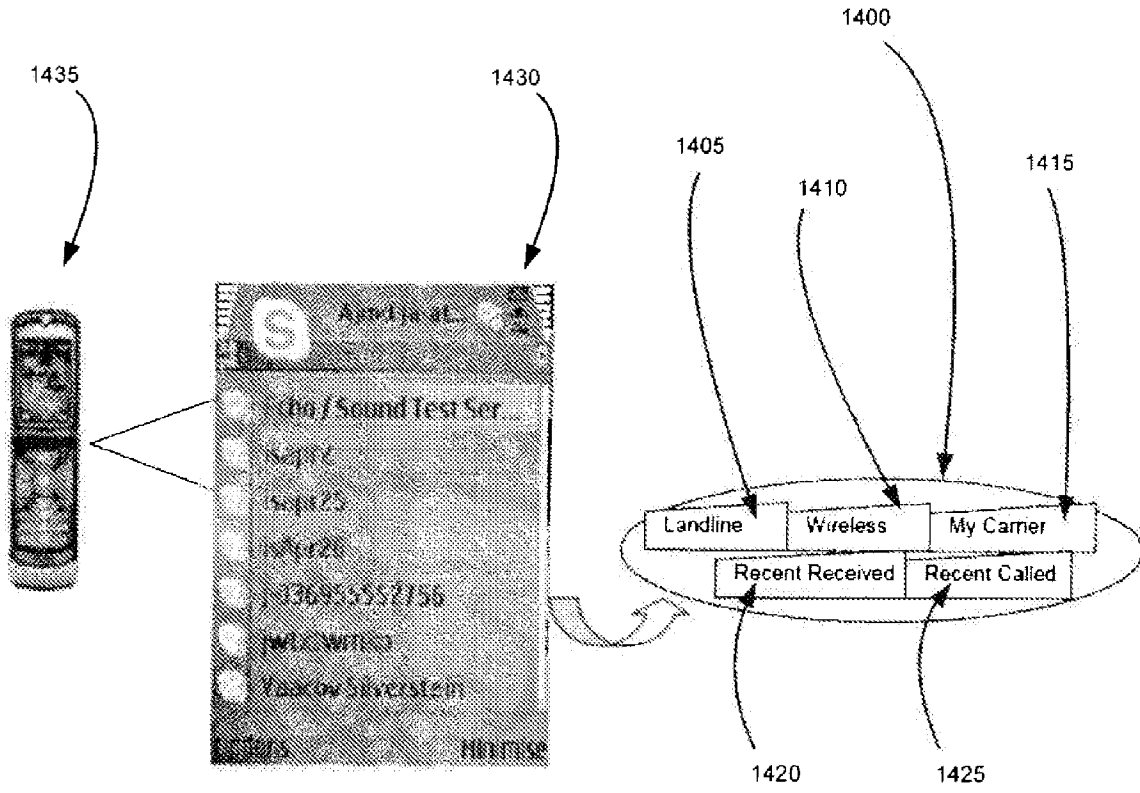


FIG. 15

(19) World Intellectual Property Organization
International Bureau



(43) International Publication Date
17 July 2008 (17.07.2008)

PCT

(10) International Publication Number
WO 2008/086350 A3

- (51) International Patent Classification:
H04M 15/00 (2006.01)
- (21) International Application Number:
PCT/US2008/050508
- (22) International Filing Date: 8 January 2008 (08.01.2008)
- (25) Filing Language: English
- (26) Publication Language: English
- (30) Priority Data:

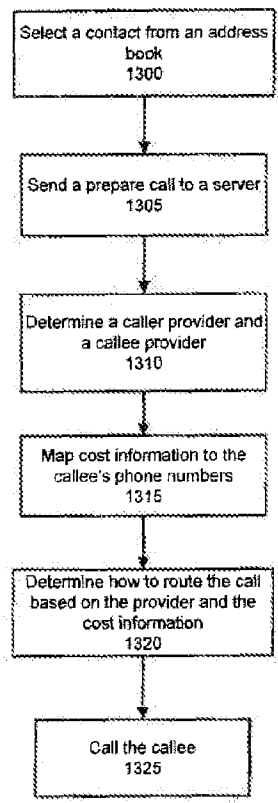
60/883,841	8 January 2007 (08.01.2007)	US
60/884,045	9 January 2007 (09.01.2007)	US
60/889,305	12 February 2007 (12.02.2007)	US
60/889,959	15 February 2007 (15.02.2007)	US
60/896,003	21 March 2007 (21.03.2007)	US
60/908,726	29 March 2007 (29.03.2007)	US
60/940,758	30 May 2007 (30.05.2007)	US
60/942,557	7 June 2007 (07.06.2007)	US
60/945,931	24 June 2007 (24.06.2007)	US
60/947,963	4 July 2007 (04.07.2007)	US

- (71) Applicant (for all designated States except US): ISKOOT, INC. [US/US]; One Broadway, 16th Floor, Cambridge, Massachusetts 02142 (US).
- (72) Inventors; and
- (73) Inventors/Applicants (for US only): GUEDALIA, Isaac David [US/IL]; Shimon 80, Bet Shemesh, 99000 Israel (IL). GUEDALIA, Jacob [US/US]; 119 Langdon Street, Newton, Massachusetts 02458 (US).
- (74) Agent: HALLAJ, Ibrahim; Pepper Hamilton, LLP, One Mellon Center, 500 Grant Street, Pittsburgh, Pennsylvania 15219 (US).
- (81) Designated States (unless otherwise indicated, for every kind of national protection available): AE, AG, AL, AM, AO, AT, AU, AZ, BA, BB, BG, BH, BR, BW, BY, BZ, CA, CH, CN, CO, CR, CU, CZ, DE, DK, DM, DO, DZ, EC, EE, EG, ES, FI, GB, GD, GE, GH, GM, GT, HN, HR, HU, ID, IL, IN, IS, JP, KE, KG, KM, KN, KP, KR, KZ, LA, LC, LK, LR, LS, LT, LU, LY, MA, MD, ME, MG, MK, MN, MW, MX, MY, MZ, NA, NG, NI, NO, NZ, OM, PG, PH, PL, PT, RO, RS, RU, SC, SD, SE, SG, SK, SL, SM, SV,

[Continued on next page]

WO 2008/086350 A3

(54) Title: METHODS AND SYSTEMS OF PROCESSING MOBILE CALLS



(57) Abstract: A method of optimizing call dialing may include receiving a first call including one or more of a session identification number, a contact identification number, a contact name and a direct inward dialing number, determining a caller provider and a callee provider based on the first call, determining cost information associated with one or more numbers corresponding to a callee and routing a second call between the caller and the callee based on one or more of the caller provider, the callee provider and the cost information.



SY, TJ, TM, TN, TR, TT, TZ, UA, UG, US, UZ, VC, VN,
ZA, ZM, ZW.

NO, PL, PT, RO, SE, SI, SK, TR), OAPI (BF, BJ, CF, CG,
CI, CM, GA, GN, GQ, GW, ML, MR, NE, SN, TD, TG).

(84) Designated States (*unless otherwise indicated, for every kind of regional protection available*): ARIPO (BW, GH, GM, KE, LS, MW, MZ, NA, SD, SI, SZ, TZ, UG, ZM, ZW), Eurasian (AM, AZ, BY, KG, KZ, MD, RU, TJ, TM), European (AT, BE, BG, CH, CY, CZ, DE, DK, EE, ES, FI, FR, GB, GR, HR, HU, IE, IS, IT, LT, LU, LV, MC, MT, NL,

Published:

- *with international search report*
- *before the expiration of the time limit for amending the claims and to be republished in the event of receipt of amendments*

(88) Date of publication of the international search report:
19 February 2009

INTERNATIONAL SEARCH REPORT

International application No
PCT/US2008/050508

A. CLASSIFICATION OF SUBJECT MATTER INV. H04M15/00		
According to International Patent Classification (IPC) or to both national classification and IPC		
B. FIELDS SEARCHED Minimum documentation searched (classification system followed by classification symbols) H04M		
Documentation searched other than minimum documentation to the extent that such documents are included in the fields searched		
Electronic data base consulted during the international search (name of data base and, where practical, search terms used) EPO-Internal, WPI Data, COMPENDEX, INSPEC		
C. DOCUMENTS CONSIDERED TO BE RELEVANT		
Category*	Citation of document, with indication, where appropriate, of the relevant passages	Relevant to claim No.
X	EP 1 701 569 A (TOKYO SHIBAURA ELECTRIC CO [JP]) 13 September 2006 (2006-09-13) abstract paragraph [0041] - paragraph [0046]	1-6
A	WO 2006/044654 A (NOVATEL WIRELESS INC [US]; SOUISSI SLIM S [US]) 27 April 2006 (2006-04-27) paragraph [0020] - paragraph [0023]	1-6
A	DE 103 41 737 A1 (VIERLING COMM GMBH [DE]) 7 April 2005 (2005-04-07) paragraph [0006] - paragraph [0017] paragraph [0035] - paragraph [0037]	1-6
<input type="checkbox"/> Further documents are listed in the continuation of Box C. <input checked="" type="checkbox"/> See patent family annex.		
* Special categories of cited documents :		
A document defining the general state of the art which is not considered to be of particular relevance *E* earlier document but published on or after the international filing date *L* document which may throw doubts on priority claim(s) or which is cited to establish the publication date of another citation or other special reason (as specified) *O* document referring to an oral disclosure, use, exhibition or other means *P* document published prior to the international filing date but later than the priority date claimed		**T* later document published after the international filing date or priority date and not in conflict with the application but cited to understand the principle or theory underlying the invention *X* document of particular relevance; the claimed invention cannot be considered novel or cannot be considered to involve an inventive step when the document is taken alone **Y* document of particular relevance; the claimed invention cannot be considered to involve an inventive step when the document is combined with one or more other such documents, such combination being obvious to a person skilled in the art. *&* document member of the same patent family
Date of the actual completion of the international search <p align="center">22 October 2008</p>		Date of mailing of the international search report <p align="center">05/01/2009</p>
Name and mailing address of the ISA/ European Patent Office, P.B. 5818 Patentlaan 2 NL - 2260 HV Rijswijk Tel. (+31-70) 340-2040, Fax: (+31-70) 340-3016		Authorized officer <p align="center">Lebas, Yves</p>

INTERNATIONAL SEARCH REPORT

International application No.
PCT/US2008/050508

Box No. II Observations where certain claims were found unsearchable (Continuation of item 2 of first sheet)

This international search report has not been established in respect of certain claims under Article 17(2)(a) for the following reasons:

1. Claims Nos.:
because they relate to subject matter not required to be searched by this Authority, namely:

2. Claims Nos.:
because they relate to parts of the international application that do not comply with the prescribed requirements to such an extent that no meaningful international search can be carried out, specifically:

3. Claims Nos.:
because they are dependent claims and are not drafted in accordance with the second and third sentences of Rule 6.4(a).

Box No. III Observations where unity of invention is lacking (Continuation of item 3 of first sheet)

This International Searching Authority found multiple inventions in this international application, as follows:

see additional sheet

1. As all required additional search fees were timely paid by the applicant, this international search report covers allsearchable claims.

2. As all searchable claims could be searched without effort justifying an additional fees, this Authority did not invite payment of additional fees.

3. As only some of the required additional search fees were timely paid by the applicant, this international search report covers only those claims for which fees were paid, specifically claims Nos.:

4. No required additional search fees were timely paid by the applicant. Consequently, this international search report is restricted to the invention first mentioned in the claims; it is covered by claims Nos.:

1-6

Remark on Protest

- The additional search fees were accompanied by the applicant's protest and, where applicable, the payment of a protest fee.
- The additional search fees were accompanied by the applicant's protest but the applicable protest fee was not paid within the time limit specified in the invitation.
- No protest accompanied the payment of additional search fees.

FURTHER INFORMATION CONTINUED FROM PCT/ISA/ 210

This International Searching Authority found multiple (groups of) inventions in this international application, as follows:

1. claims: 1-6

method and system for optimizing the costs of a call for a caller.

2. claims: 7-12

method and system for filtering an incoming call based on its origin.

3. claims: 13-17

method and system for retrieving callee contact information for a caller.

4. claims: 18-19

method for filtering one or more contacts in an address book on a mobile device.

INTERNATIONAL SEARCH REPORT

Information on patent family members

International application No

PCT/US2008/050508

Patent document cited in search report		Publication date		Patent family member(s)	Publication date
EP 1701569	A	13-09-2006	JP	2006254208 A	21-09-2006
			US	2006205400 A1	14-09-2006
WO 2006044654	A	27-04-2006	EP	1808033 A2	18-07-2007
DE 10341737	A1	07-04-2005	NONE		

(19) World Intellectual Property Organization
International Bureau



(43) International Publication Date
28 August 2008 (28.08.2008)

PCT

(10) International Publication Number
WO 2008/103652 A1

- (51) International Patent Classification:
H04L 12/28 (2006.01)
- (21) International Application Number:
PCT/US2008/054271
- (22) International Filing Date:
19 February 2008 (19.02.2008)
- (25) Filing Language: English
- (26) Publication Language: English
- (30) Priority Data:
11/678,315 23 February 2007 (23.02.2007) US
- (71) Applicant (for all designated States except US): INTER-
ACTIVE INTELLIGENCE, INC. [US/US]; 7601 Inter-
active Way, Indianapolis, IN 46278 (US).
- (72) Inventors; and
- (75) Inventors/Applicants (for US only): WYSS, Felix,
Immanuel [CH/US]; 8275 North Fox Hollow Road,
Bloomington, IN 47408 (US). SNYDER, Michael, D.
[US/US]; 2117 Dakota Drive, Noblesville, IN 46062
(US). O'CONNOR, Kevin [US/US]; 120 Bow Lane,
Indianapolis, IN 46220 (US).
- (74) Agents: HENRY, Thomas, Q. et al.; Woodard, Emhardt,
Moriarty, Mcnett & Henry Llp, 111 Monument Circle,
Suite 3700, Indianapolis, IN 46204 (US).

(81) Designated States (unless otherwise indicated, for every kind of national protection available): AE, AG, AL, AM, AO, AT, AU, AZ, BA, BB, BG, BH, BR, BW, BY, BZ, CA, CH, CN, CO, CR, CU, CZ, DE, DK, DM, DO, DZ, EC, EE, EG, ES, FI, GB, GD, GE, GH, GM, GT, HN, HR, HU, ID, IL, IN, IS, JP, KE, KG, KM, KN, KP, KR, KZ, LA, LC, LK, LR, LS, LT, LU, LY, MA, MD, ME, MG, MK, MN, MW, MX, MY, MZ, NA, NG, NI, NO, NZ, OM, PG, PH, PL, PT, RO, RS, RU, SC, SD, SE, SG, SK, SL, SM, SV, SY, TJ, TM, TN, TR, TT, TZ, UA, UG, US, UZ, VC, VN, ZA, ZM, ZW.

(84) Designated States (unless otherwise indicated, for every kind of regional protection available): ARIPO (BW, GH, GM, KE, LS, MW, MZ, NA, SD, SL, SZ, TZ, UG, ZM, ZW), Eurasian (AM, AZ, BY, KG, KZ, MD, RU, TJ, TM), European (AT, BE, BG, CH, CY, CZ, DE, DK, EE, ES, FI, FR, GB, GR, HR, HU, IE, IS, IT, LI, LU, LV, MC, MT, NL, NO, PL, PT, RO, SE, SI, SK, TR), OAPI (BF, BJ, CF, CG, CI, CM, GA, GN, GQ, GW, ML, MR, NE, SN, TD, TG).

Declarations under Rule 4.17:

- as to applicant's entitlement to apply for and be granted a patent (Rule 4.17(ii))
- as to the applicant's entitlement to claim the priority of the earlier application (Rule 4.17(iii))

[Continued on next page]

(54) Title: SYSTEM AND METHOD FOR RECORDING AND MONITORING COMMUNICATIONS USING A MEDIA SERVER

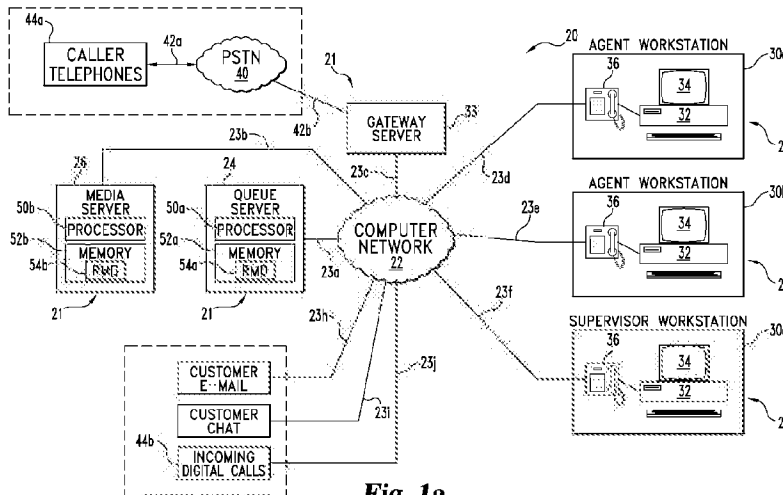


Fig. 1a

(57) Abstract: A communication system including a media server through which communication packets are exchanged for recording and monitoring purposes is disclosed. A tap is associated with each communication endpoint allowing for cradle to grave recording of communications despite their subsequent routing or branching. An incoming communication is routed to a first tap and upon selection of a receiving party; the first tap is routed to a second tap which forwards communication packets on to the receiving party. The taps may be used to forward communication packets to any number of other taps or destinations, such as a recording device, monitoring user, or other user in the form of a conference.

WO 2008/103652 A1



Published:

- *with international search report*
- *before the expiration of the time limit for amending the claims and to be republished in the event of receipt of amendments*

SYSTEM AND METHOD FOR RECORDING AND MONITORING
COMMUNICATIONS USING A MEDIA SERVER

FIELD OF INVENTION

5 The present invention generally relates to telecommunication systems and methods, as well as systems for monitoring and recording communications. More particularly, the present invention pertains to a system and method for flexibly monitoring and/or creating trusted and secure recordings of communications over a digital transmission line.

10

BACKGROUND

 Current telecommunication technology allows for monitoring and recording of communications. Contact centers have traditionally used standard analog transmission methods for connecting agents to incoming callers. However, monitoring and recording of communications in such an environment is resource intensive and can require multiple breaks in the recording as parties are transferred or otherwise enter and leave a communication session. This presents a problem for users that wish to generate uninterrupted “cradle to grave” recordings for quality control, verification, and other purposes. Users may also wish to make separate recordings of each party to a communication in order to provide a further level of authentication.

20

 Many contact centers have begun installing systems capable of routing voice communications over a digital network. In order to facilitate recording, however, a communication still has to be rerouted through the main server. This increases the resource load on the server, reduces overall scalability, and creates constraints which make it more difficult to flexibly create uninterrupted recordings of individual parties.

25

SUMMARY

Various technologies and techniques are disclosed for recording and monitoring communications over a digital transmission line. In one form, a main contact center server receives a notification of an incoming communication from an outside party. The server then instructs a separate media server to create a tap for monitoring the digital communication packets received from and transmitted to the outside caller. The packets arriving at the tap are simply passed through with no order or timing adjustment. As a result, the tap incurs only a small amount of latency in the communication path. Single party recording is easily achieved since the tap will continue to be associated with a party even when the party is transferred to another agent or put in a hold queue.

In another embodiment, the tap is used by the media server to record all communications sent and received by an outside party. If the party is placed in a hold queue, the recording pauses until the party is connected to an agent. A beep or other identifier can be inserted in the recording to signal that an interruption had occurred.

In yet another embodiment, a tap is used to monitor all communications sent to and received by an agent. The data captured by the tap is then sent to a third party, such as a supervisor, for observation or training purposes.

This summary is provided to introduce a selection of concepts in a simplified form that are described in further detail in the detailed description and drawings contained herein. This summary is not intended to identify key features or essential features of the claimed subject matter, nor is it intended to be used as an aid in determining the scope of the claimed subject matter. Yet other forms, embodiments, objects, advantages, benefits, features, and aspects of the present invention will become apparent from the detailed description and drawings contained herein.

BRIEF DESCRIPTION OF THE DRAWINGS

FIG. 1a is a diagrammatic view of a computer system of one implementation.

5 FIG. 1b is a logical view of one possible configuration for the computer system of FIG. 1a.

FIG. 2 is a process flow diagram demonstrating one example of the stages involved in creating a recording of an incoming communication in one embodiment of the present system and method.

10 FIG. 3 is a process flow diagram demonstrating one example of the stages involved in creating a recording of an outgoing communication in another embodiment of the present system and method.

FIG. 4 is a process flow diagram demonstrating one example of the stages involved in supervisory monitoring of a communication session.

DETAILED DESCRIPTION

For the purposes of promoting and understanding of the principles of the invention, reference will now be made to the embodiment illustrated in the drawings and specific language will be used to describe the same. It will
5 nevertheless be understood that no limitation of the scope of the invention is thereby intended. Any alterations and further modifications in the described embodiments, and any further applications of the principles of the invention as described herein are contemplated as would normally occur to one skilled in the art to which the invention relates.

10 One implementation includes a unique system and methods for monitoring communications over a digital transmission line using a media server which functions to receive and route packets to selected network communication endpoints, such as in a contact center. It shall be understood that the principles of the present invention may also be applied to similar systems, such as by way of
15 non-limiting example, a corporate telecommunication system.

FIG. 1a is a diagrammatic view of computer system 20 of one embodiment of the present invention. Computer system 20 includes computer network 22. Computer network 22 couples together a number of computers 21 over network pathways 23. More specifically, system 20 includes several servers, namely Queue
20 Server 24, Gateway Server 33, and Media Server 26. System 20 also includes a plurality of client workstations 30. While computers 21 are each illustrated as being a server or client, it should be understood that any of computers 21 may be arranged to include both a client and server. Furthermore, it should be understood that while six computers 21 are illustrated, more or fewer may be utilized in
25 alternative embodiments.

Queue Server 24 and Media Server 26 include one or more processors or CPUs (50a and 50b, respectively) and one or more types of memory (52a and 52b, respectively). Each memory 52a and 52b, includes a removable memory device (54a and 54b, respectively). Although not shown to preserve clarity, each
30 computer 21 of system 20 includes one or more processors or CPUs and one or more types of memory. Each processor may be comprised of one or more

components configured as a single unit. Alternatively, when of a multi-component form, a processor may have one or more components located remotely relative to the others. One or more components of each processor may be of the electronic variety defining digital circuitry, analog circuitry, or both. In one embodiment, 5 each processor is of a conventional, integrated circuit microprocessor arrangement, such as one or more PENTIUM III or PENTIUM 4 processors supplied by INTEL Corporation of 2200 Mission College Boulevard, Santa Clara, Calif. 95052, USA.

Each memory (removable or generic) is one form of computer-readable device. Each memory may include one or more types of solid-state electronic 10 memory, magnetic memory, or optical memory, just to name a few. By way of non-limiting example, each memory may include solid-state electronic Random Access Memory (RAM), Sequentially Accessible Memory (SAM) (such as the First-In, First-Out (FIFO) variety or the Last-In-First-Out (LIFO) variety), Programmable Read Only Memory (PROM), Electronically Programmable Read 15 Only Memory (EPROM), or Electrically Erasable Programmable Read Only Memory (EEPROM); an optical disc memory (such as a DVD or CD ROM); a magnetically encoded hard disc, floppy disc, tape, or cartridge media; or a combination of any of these memory types. Also, each memory may be volatile, nonvolatile, or a hybrid combination of volatile and nonvolatile varieties.

20 System 20 further illustrates Public Switched Telephone Network (PSTN) 40 coupled to Gateway Server 33, by pathway 42b. Caller telephones 44 may be coupled to PSTN 40 by pathway 42a. It should be understood that callers using analog telephones 44a will normally connect to the PSTN 40 by dialing a standard directory phone number, such as an "800" number. The PSTN then sends a 25 connection request to the Gateway Server 33, which translates the request to a digital format for retransmission to Queue Server 24 via network 22. The Queue Server 24 then establishes an audio connection with the PSTN, using Gateway Server 33 as the digital/analog conversion point.

30 However, callers using digital telephones 44b have the additional option of bypassing both the PSTN 40 and the Gateway Server 33 and directly dialing the digital address of the network 22 or the Queue Server 24. In this scenario, the

digital telephone sends a connection request, such as a SIP invitation, to the Queue Server 24 via network 22. The Queue Server 24 then establishes a digital audio connection with the digital telephone 44b via network 22.

Workstations 30 each include a workstation computer 32 coupled to a
5 display 34. Workstation computers 32 may be of the same type, or a heterogeneous combination of different computing devices. Likewise, displays 34 may be of the same type, or a heterogeneous combination of different visual devices. It should be understood that while three workstations 30 are described in the illustrative embodiment, more or fewer may be utilized in alternative
10 embodiments. Contact center applications of system 20 typically include many more workstations of this type at one or more physical locations, but only a few are illustrated in FIG. 1a to preserve clarity. In addition, each workstation 30 can be configured as an agent workstation, a supervisor workstation, or as both an agent and a supervisor workstation. In the illustrative embodiment, workstations 30a and
15 30b are configured as agent workstations and workstation 30c is configured as a supervisor workstation.

Digital telephones 36a, 36b, and 36c are each associated with a different one of workstations 30a, 30b, and 30c, respectively. Additionally, digital telephones 36 may be integrated into the agent computer 32 and/or implemented in
20 software. It should be understood that digital telephones 36, which are capable of being directly connected to network 22, may be in the form of a handset, headset, or other arrangement as would occur to those skilled in the art. It shall be further understood that the connection from computer network 22 to a workstation 30 can be made first to the associated workstation phone, then from the workstation phone
25 to the workstation computer by way of a pass-through connection on the workstation phone. Alternatively, two connections from the network can be made, one to the workstation phone and one to the workstation computer. Although not shown to preserve clarity, each agent workstation 30 may also include one or more operator input devices such as a keyboard, mouse, track ball, light pen, and/or
30 microtelecommunicator, to name just a few representative examples. Also, besides

display 34, one or more other output devices may be included such as loudspeaker(s) and/or a printer.

Computer network 22 can be in the form of a Local Area Network (LAN), Municipal Area Network (MAN), Wide Area Network (WAN), such as the
5 Internet, a combination of these, or such other network arrangement as would occur to those skilled in the art. The operating logic of system 20 can be embodied in signals transmitted over network 22, in programming instructions, dedicated hardware, or a combination of these. It should be understood that more or fewer computers 21 can be coupled together by computer network 22. It should
10 also be recognized that computer network 22 may include one or more elements of PSTN 40.

In one embodiment, system 20 operates as a contact center at one or more physical locations that are remote from one another with Queue Server 24 being configured as a contact center server host, Media Server 26 being configured as a
15 server for monitoring agent communications, and workstations 30 each arranged as a contact center client host. It shall be understood that one or more Media Servers 26 may be included to handle the recording and monitoring load in a contact center, but only one has been shown in FIG. 1a to preserve clarity. Also, one or more Queue Servers 24 may be configured as a contact center server host at one or
20 more physical locations and may also be configured to provide, collectively or individually, the features of Media Server 26 described herein. Furthermore, any of the computers 21 may be incorporated into other devices or located in geographically different locations from one another.

Alternatively or additionally, system 20 may be arranged to provide for
25 distribution and routing of a number of different forms of communication, such as telephone calls, voice mails, faxes, e-mail, web chats, instant messages, web call backs, and the like. In addition, business/customer data associated with various communications may be selectively accessed by system 20. This data may be presented to an agent at each agent workstation 30 by way of monitor 34
30 operatively coupled to the corresponding agent computer 32.

Incoming communication signaling and audio stream data may arrive in either an analog or digital format. In the case of analog communications arriving from the PSTN 40, both the signaling and audio stream data must be translated to a digital format by a conversion device, such as Gateway Server 33, before being
5 propagated over network 22 to a server or workstation. Likewise, outgoing communication data will exist in a digital format while propagating over network 22 but will need to be converted to an analog PSTN format before being passed to PSTN 40.

If communication data is being sent to a digital device that is connected
10 directly to network 22, no digital/analog conversion is required. As a non-limiting example, an outside caller using a digital phone may establish a direct digital communication stream with an agent workstation after being assigned to that agent by Queue Server 24. In fact, all signaling and audio stream data between endpoints on network 22 will remain in a digital format. References to digital
15 audio communications in the illustrative embodiment shall be understood to include all forms of digital telephony such as VOIP, SIP, and SRTP to name just a few representative examples. The present system and method may be applied to many other types of communications and their use within the current system and method is desired to be protected.

Turning now to FIG. 2, with continued reference to FIG. 1a, the stages for
20 recording a communication using a media server in one embodiment of the present system and method is shown. In one form, the process of FIG. 2 is at least partially implemented in the operating logic of system 20. The process begins at start point 200 with the Queue Server 24 receiving a request, such as a SIP
25 invitation, to establish a communication session with an outside party (stage 202). If the outside party is using an analog phone, the Gateway Server 33 acts as the digital/analog conversion point between the parties. The Gateway Server 33 receives the communication initiation request from the PSTN, performs an analog to digital conversion, and sends a SIP invitation to the Queue Server 24. If,
30 however, the outside party is using a digital device, such as a SIP enabled phone,

the outside party device can route the request directly to the Queue Server 24, bypassing the Gateway Server 33.

In the illustrative embodiment, the Queue Server 24 instructs the Media Server 26 to establish individual monitoring taps for each known party prior to creating the communication session (stage 204). For example, if the outside party is initially routed to an IVR, individual taps would be associated with the outside party and the IVR device.

In the illustrative embodiment, a tap is a logical component residing on the Media Server 26 to duplicate or record packets from a network stream, perform some processing upon them, and subsequently forward them along to their intended destination. A simple tap association for a communication arrangement between two parties having monitoring and recording functionality is shown in FIG. 1b. The illustrative communication involves two parties, Party A and Party B using digital communication devices 80 and 82 respectively. Party A's device 80 is connected with tap 90 while Party B's device 82 is similarly connected to tap 92. It shall be appreciated that taps 90 and 92 are within Media Server 26. Communication packets sent from Party A are received by tap 90, forwarded to tap 92, and subsequently forwarded to Party B. Going the other way, communication packets sent from Party B are received by tap 92, forwarded to tap 90, and subsequently forwarded to Party A.

In order to provide additional functionality, Media Server 26 may be configured to forward communication packets from a tap, such as tap 90 as shown, to a recording device 94. In a further form, the recording device 94 may be combined with tap 90. Additionally, Media Server 26 may forward communication packets from a tap, such as tap 92 as shown, to another device, such as digital communication device 84 associated with a Monitoring Party.

Returning to FIG. 2, as new parties are added to the session, the Media Server 26 creates additional taps for those parties, such as those illustrated in FIG. 1B. In other embodiments, taps may only be created for designated parties, depending on the configuration of the Media Server 26. It should be understood

that the Media Server 26 can create taps at any time prior to or during a communication session.

After the taps are created, the Queue Server 24 establishes a digital communication stream between the parties (stage 206). The taps may be specified
5 as destinations, allowing the Media Server 26 to receive and route the communication data packets. In one form, the individual taps simply pass the data (digital audio in this embodiment) through with no processing or time correction, thereby incurring virtually no latency on the communication path. In another form, the data passed through the tap may be processed if, for example, the transmitting
10 and receiving devices use different digital audio protocols. The taps may also replicate the incoming data packets, process them, such as mixing the streams from both parties or encode/decode them, and forward them to a selected device for recording and/or monitoring purposes.

At any point during the communication session, the Queue Server 24 may
15 send a request to the Media Server 26 to record the communication session. In the illustrative embodiment, the request includes information identifying the communication to be recorded as well as a set of configuration options. This identifying information may include a specification of which individual parties are to be recorded, a unique communication identifier, or any other identifier known to
20 one of skill in the art. Additionally, the configuration options may include, but are in no way limited to, the amount of each communication to record, the method of storage for the communication, an optional recording format, encryption parameters, encryption and authentication keys, and/or a storage location.

After receiving the request, the Media Server 26 begins recording the
25 communication data passing through the tap associated with the outside party by writing the data packets to a file on the Media Server 26 (stage 208). This is the normal scenario when a recording of the communication sent to and received from the outside party is needed for later verification, such as with financial transactions. In further embodiments, the Media Server 26 monitors multiple taps
30 and records them as individual files or collective files combining the communications of two or more parties, as specified by the configuration options.

It shall be appreciated that the communication data may be received by the Media Server 26 in one format and saved to file in another more favorable format. Additionally, system 20 may notify the parties that the call may be recorded to comply with legal requirements.

5 In a further form, to ensure call privacy, the audio data packets may be encrypted. The tap may thus have to decrypt the duplicated packets before processing them for recording and/or monitoring. In an alternate embodiment, the audio packets are recorded in encrypted form to avoid Queue Server 24 having to disclose the encryption keys to the Media Server 26. In yet another embodiment,
10 the tap decrypts the packets before forwarding them to the agent phones 36 and encrypts the packets from the agent phones. This arrangement is useful if the local network is trusted and the agent phones do not support encryption. In a still further form, the Queue Server 24 discloses the keys to the Media Server 26 which
15 decrypts the packets for recording and encrypts the recorded packets using a new key. The packets may then be forwarded to their destinations having their original encoding using the keys disclosed by the Queue Server 24 while the player eventually used to playback the recording may operate using a distinct key system.

 In response to a request by the agent to consult privately with a supervisor during the communication, the Queue Server 24 transfers the outside party to a
20 hold queue (stage 210). In the illustrative embodiment, the Media Server 26 pauses the recording through the outside party tap and inserts a beep or other audio marker for later verification that the outside party was placed on hold. In another embodiment, additional meta-data, such as timestamps are added to the recording to indicate the duration of a hold operation. However, this does not close the
25 recording file associated with the outside party on the Media Server 26. In a further embodiment, the Media Server 26 continues to record the data flowing through the outside party tap, including any on-hold music, IVR responses, or messages broadcast by the Queue Server 24. In yet another embodiment, only the audio from the external caller is recorded during hold operations and the hold-
30 music or messages played to the caller are excluded from the recording.

Once the outside party has been transferred to a hold queue, the Queue Server 24 connects the agent to a supervisor for consultation as requested, with no interruption in the recording of the outside party tap (stage 212). Upon completion of the consultation or by request of the agent, the Queue Server 24 removes the
5 outside caller from the hold queue, reconnects the agent, and resumes the recording if it had been paused (stage 214). At some later point in the communication session (normally when the outside party disconnects), the Queue Server 24 instructs the Media Server 26 to end the recording (stage 216). In one form, the recording may be stored on Media Server 26 and subsequently transferred to a
10 central server for archival. In another form, the recording may be encrypted and/or hashed as it is archived or stored to preserve confidentiality and/or prevent/detect tampering. In yet another form, in the event of a spoken communication, language processing techniques may be utilized to create and store a transcript of the recorded communication. Once the recording has been stored, the process ends at
15 point 218.

FIG. 3 illustrates an example of the stages involved in recording an outgoing communication from the contact center using the Media Server 26. The process begins at start point 300 with the Queue Server 24 sending a request, such as a SIP invitation, to an outside party device to establish a communication session
20 (stage 302). As discussed above, the Gateway Server 33 is utilized as a conversion point if the receiving outside party is using an analog phone or a digital phone based on a different digital protocol. Once the outside party device replies with an acceptance, the Queue Server 24 assigns an agent to the session and instructs the Media Server 26 to establish monitoring taps with each of the parties (stage 304).
25 The Queue Server 24 then establishes a digital communication stream between the parties (stage 306) and instructs the Media Server 26 to begin recording the communication using the outside party tap (stage 308). It shall be understood that the instruction to begin recording may be included in the same request as the instruction to create the monitoring taps.

30 After communicating with the outside party, the agent may decide to transfer the outside party to a different agent or supervisor (stage 310). The Queue

Server 24 disconnects the first agent from the session and connects a second agent or supervisor to the outside party. Since the recording is being made through the outside party tap, there is no interruption in the recording during the transfer. Once the communication session is completed, the Media Server 26 stores the recording
5 for later retrieval (stage 312). The process then ends at point 314.

FIG. 4 illustrates the stages involved in monitoring an agent communication in real time, such as when a supervisor wishes to listen in on a communication between an agent and an outside party for training or quality assurance purposes. The process begins at start point 400 with the Queue Server
10 24 receiving a request from an outside party to establish a communication session (stage 402). The Queue Server 24 then instructs the Media Server 26 to associate monitoring taps with the outside party and an available agent (stage 404) and establishes a digital communication stream between the parties (stage 406). In a further form, the system may be configured to associated taps with all
15 communications, even if they are not recorded and/or monitored initially to avoid interruption in the event recording and/or monitoring is later required.

After receiving a request from a supervisor to monitor the communication (stage 408), the Media Server 26 sends a parallel feed of the digital audio received by the outside party tap to the supervisor workstation, allowing the supervisor to
20 listen to the communication with no discernable interruption in the conversation between the agent and the outside party (stage 410). It shall be appreciated that there may be multiple concurrent supervisors receiving streams from the same tap, as stage 410 may be performed multiple times at any point during an active communication. Upon receiving a request from the supervisor workstation to stop
25 monitoring the conversation (stage 412), the Media Server 26 disconnects the parallel feed to the supervisor tap, again with no discernable interruption in the communication between the outside party and the agent (stage 414). The process ends when the outside party disconnects at point 416.

While the invention has been illustrated and described in detail in the
30 drawings and foregoing description, the same is to be considered as illustrative and not restrictive in character, it being understood that only the preferred embodiment

has been shown and described and that all equivalents, changes, and modifications that come within the spirit of the inventions as described herein and/or by the following claims are desired to be protected.

Hence, the proper scope of the present invention should be determined only
5 by the broadest interpretation of the appended claims so as to encompass all such modifications as well as all relationships equivalent to those illustrated in the drawings and described in the specification.

What is claimed is:

1. A method comprising the steps of:
 - receiving a notification at a first server from a first digital endpoint
 - corresponding to a first party of a digital communication over a network;
 - 5 connecting said first digital endpoint to a second server on said network using said first server;
 - connecting said second server to a second digital endpoint corresponding to a second party;
 - establishing a first communication session over said network between said
 - 10 first party and said second party by routing communication packets received by said second server from said first digital endpoint to said second digital endpoint and from said second digital endpoint to said first digital endpoint; and
 - initiating a recording or monitoring operation of at least a portion of said first communication session using said second server.
 - 15
2. The method of claim 1, wherein said second server applies a transformation to at least a portion of said communication packets.
3. The method of claim 2, wherein said transformation is selected from the
- 20 group consisting of decoding, encoding, error correction, loss concealment, decrypting, encrypting, delaying, re-ordering, re-packaging, compression, and decompression and gain control.
4. The method of claim 2, wherein said transformation is different for said
- 25 communication packets received from said first digital endpoint than said communication packets received from said second digital endpoint.
5. The method of claim 1, wherein said second server applies a transformation to all of said communication packets.
- 30

6. The method of claim 2, wherein said recording includes said portion of said communication packets.
7. The method of claim 1, wherein said recording includes only communication packets from either said first digital endpoint or said second digital endpoint.
8. The method of claim 1, wherein said recording includes communication packets from both said first digital endpoint and said second digital endpoint.
9. The method of claim 1, wherein said second server records from said notification to disconnection of said first digital endpoint.
10. The method of claim 1, wherein said first server is an automatic call distribution system.
11. The method of claim 1, wherein said first server is an interactive voice response system.
12. The method of claim 1, wherein said digital communication is a SIP session.
13. The method of claim 1, wherein said first server is a SIP gateway.
14. The method of claim 13, wherein said first digital endpoint is a SIP enabled telephone.
15. The method of claim 14, wherein said notification is a SIP invite message.
16. The method of claim 13, wherein said second digital endpoint is a SIP enabled telephone.

17. The method of claim 13, wherein at least one of said first and second digital endpoints is associated with a contact center agent.

18. The method of claim 1, further comprising the steps of:

5 connecting said second server to a third digital endpoint corresponding to a third party;

establishing a second communication session over said network between said first party and said third party by routing communication packets received by said second server from said first digital endpoint to said third digital endpoint and
10 from said third digital endpoint to said first digital endpoint; and

continuing said recording or monitoring operation on said second communication session using said second server.

19. The method of claim 18, further comprising the step of:

15 disconnecting said second digital endpoint from said first communication session.

20. The method of claim 1, further comprising the steps of:

forwarding said communication packets received by said second server
20 from said first and said second digital endpoint to at least a third digital endpoint.

21. The method of claim 20, wherein said third digital endpoint is associated with a contact center supervisor.

25 22. The method of claim 18, wherein said third digital endpoint is a hold server providing hold audio.

23. A method comprising the steps of:
connecting a first digital endpoint corresponding to a first party to a first tap
on a media server over a digital network;
replicating the communication packets received by said first tap and
5 forwarding said communication packets to at least a first recording or monitoring
device;
establishing a first communication session over said network between said
first party and said second party by routing communication packets from said first
digital endpoint received by said first tap to said second digital endpoint and from
10 said second digital endpoint through said first tap to said first digital endpoint
without interrupting said forwarding.
24. The method of claim 23, further comprising the step of:
connecting a second digital endpoint corresponding to a second party to a
15 second tap on said media server over said digital network.
25. The method of claim 24, wherein said communication packets are routed
from said first digital endpoint through said first tap and said second tap to said
second digital endpoint and by said second tap through said second tap and said
20 first tap to said first digital endpoint.
26. The method of claim 25, further comprising the step of:
removing said second party from said communication session by ceasing
said routing;
25 connecting a third digital endpoint corresponding to a third party to a third
tap on a media server over a digital network;
establishing a second communication session over said network between
said first party and said third party by routing communication packets received by
said first tap to through said third tap to said third digital endpoint and by said third
30 tap through said first tap to said first digital endpoint without interrupting said
forwarding.

27. The method of claim 26, wherein said third digital endpoint is a hold server.
- 5 28. The method of claim 27, wherein said hold server provides hold audio.
29. The method of claim 23, further comprising the step of:
terminating said first communication session without interrupting said forwarding.
- 10 30. The method of claim 25, further comprising the step of:
connecting a third digital endpoint corresponding to a third party to a third tap on a media server over a digital network;
adding said third party to said first communication session by routing
15 communication packets received by said first tap and said second tap through said third tap to said third digital endpoint and by said third tap through said first and said second taps to said first and said second digital endpoints respectively without interrupting said forwarding.
- 20 31. The method of claim 23, wherein said monitoring device is a digital endpoint associated with a contact center supervisor.
32. The method of claim 23, wherein said recording device is a storage device.
- 25 33. The method of claim 23, wherein said file server stores said communication packets to a file.
34. The method of claim 33, wherein said file is encrypted.
- 30 35. The method of claim 33, wherein said file is compressed.

36. The method of claim 33, wherein said file includes meta-data associated with said communication packets.

37. The method of claim 23, wherein each of said digital endpoints is a SIP
5 endpoint.

38. A system comprising:
a digital communication network;
a first digital endpoint connected to said network;
10 a second digital endpoint connected to said network;
a media server connected to said network, said media server operable to
associate a first tap with said first digital endpoint, receive communication packets
from said first digital endpoint, replicate said communication packets, and route
said communication packets to said second digital endpoint; and
15 a file server suitable for receiving and storing said replicated packets from
said media server or a third digital endpoint suitable for receiving and
playing said replicated packets from said media server.

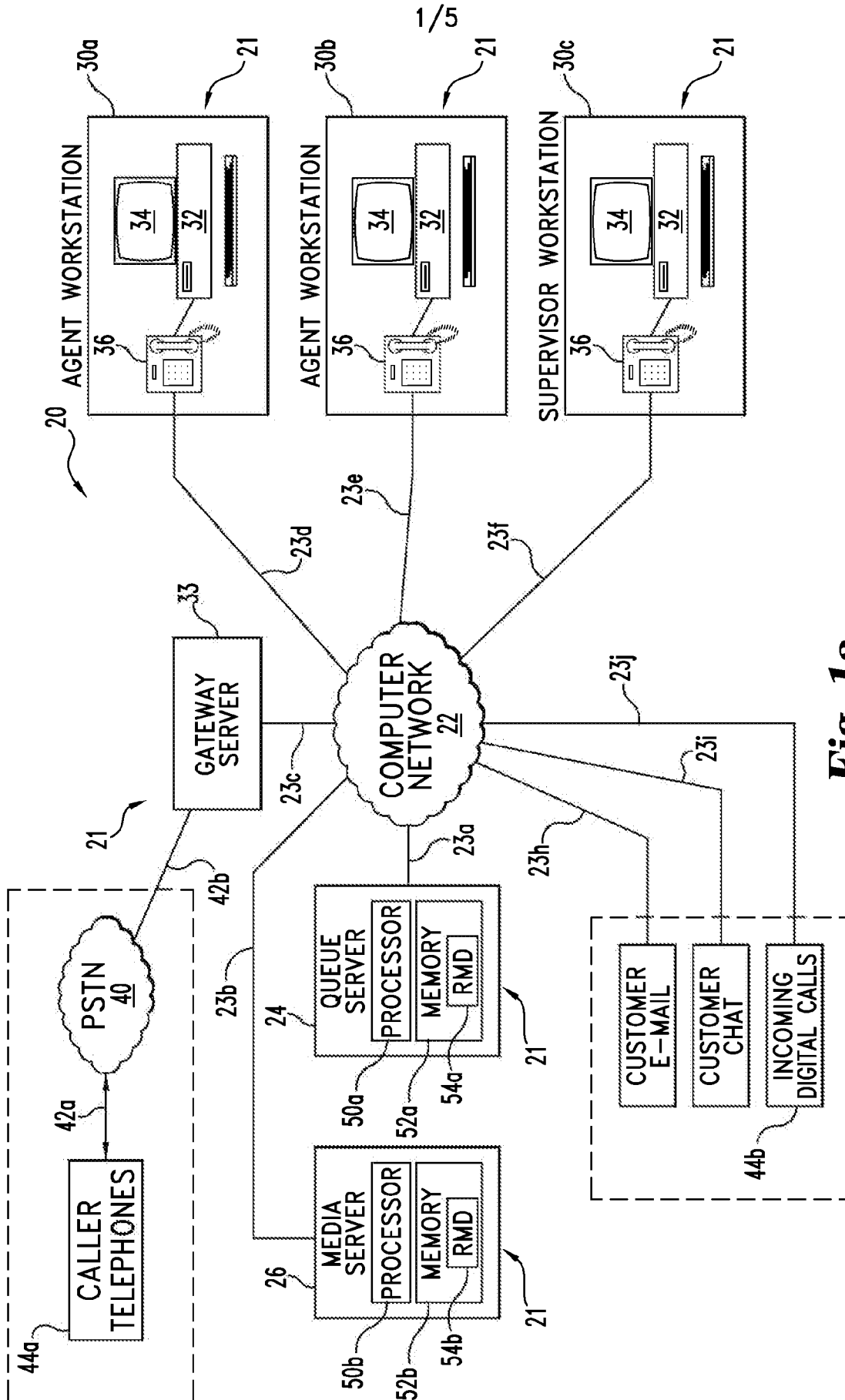


Fig. 1a

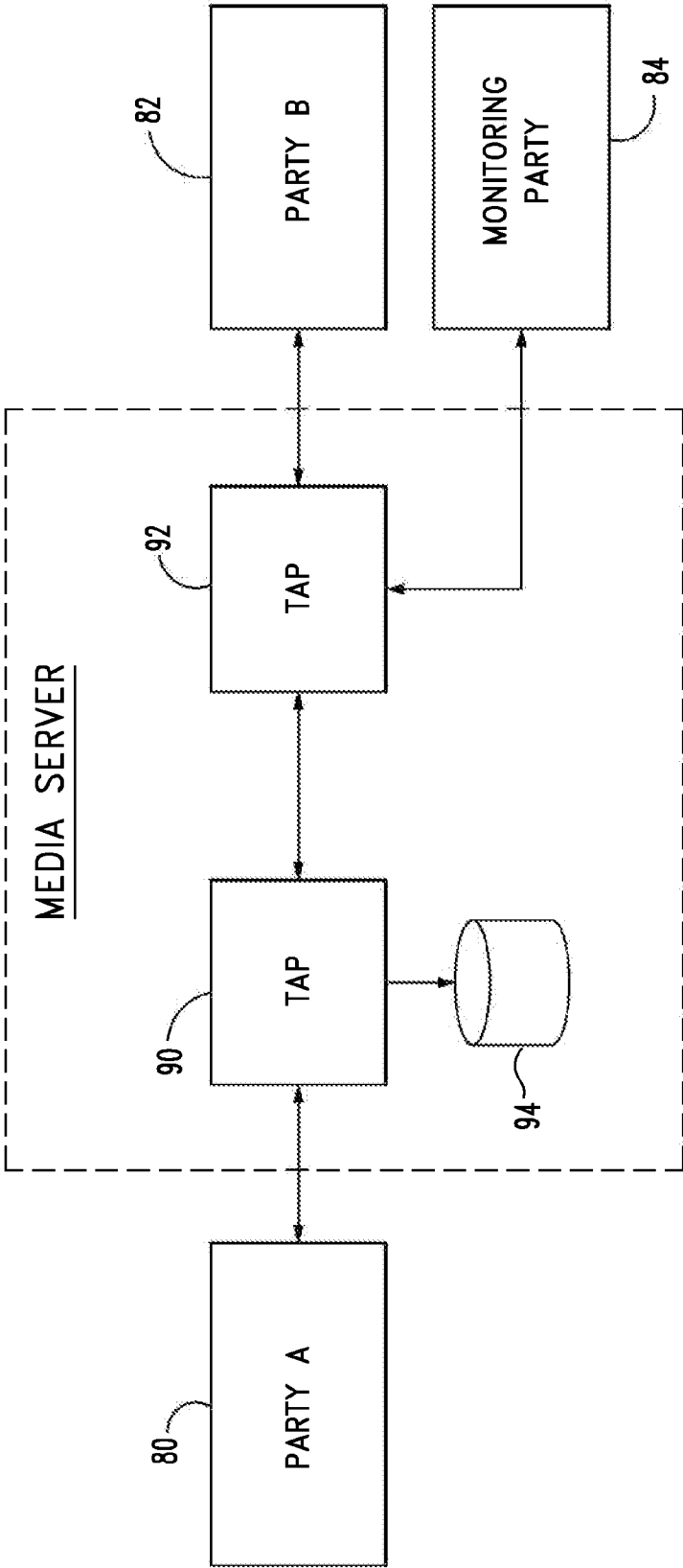


Fig. 1b

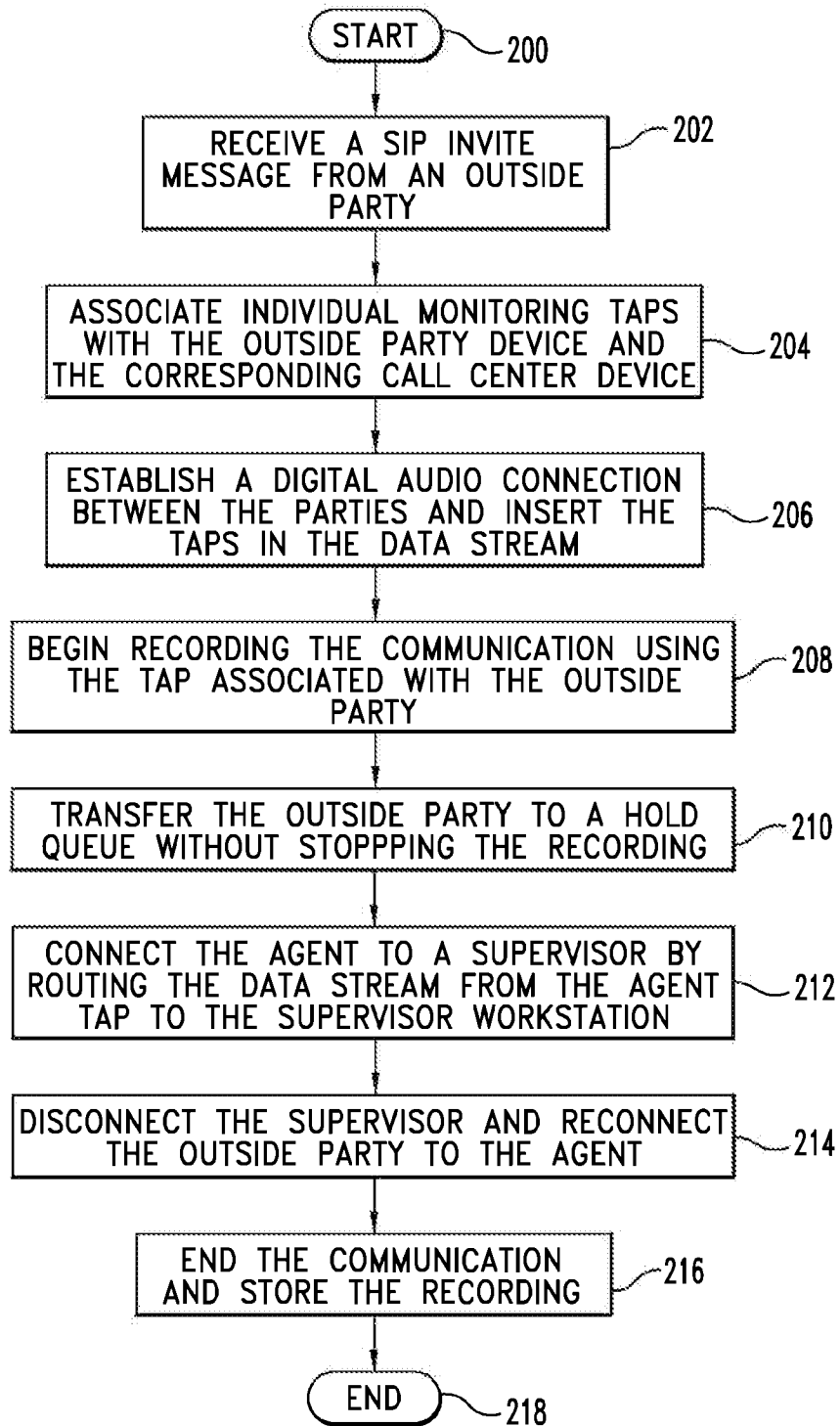
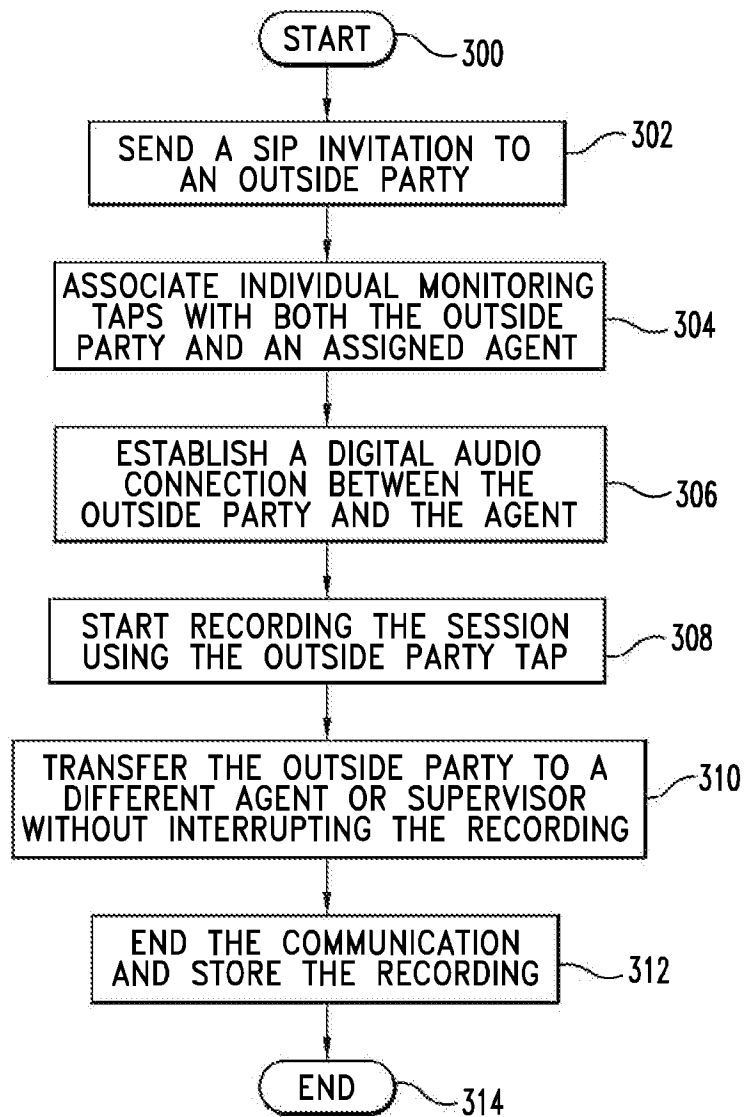
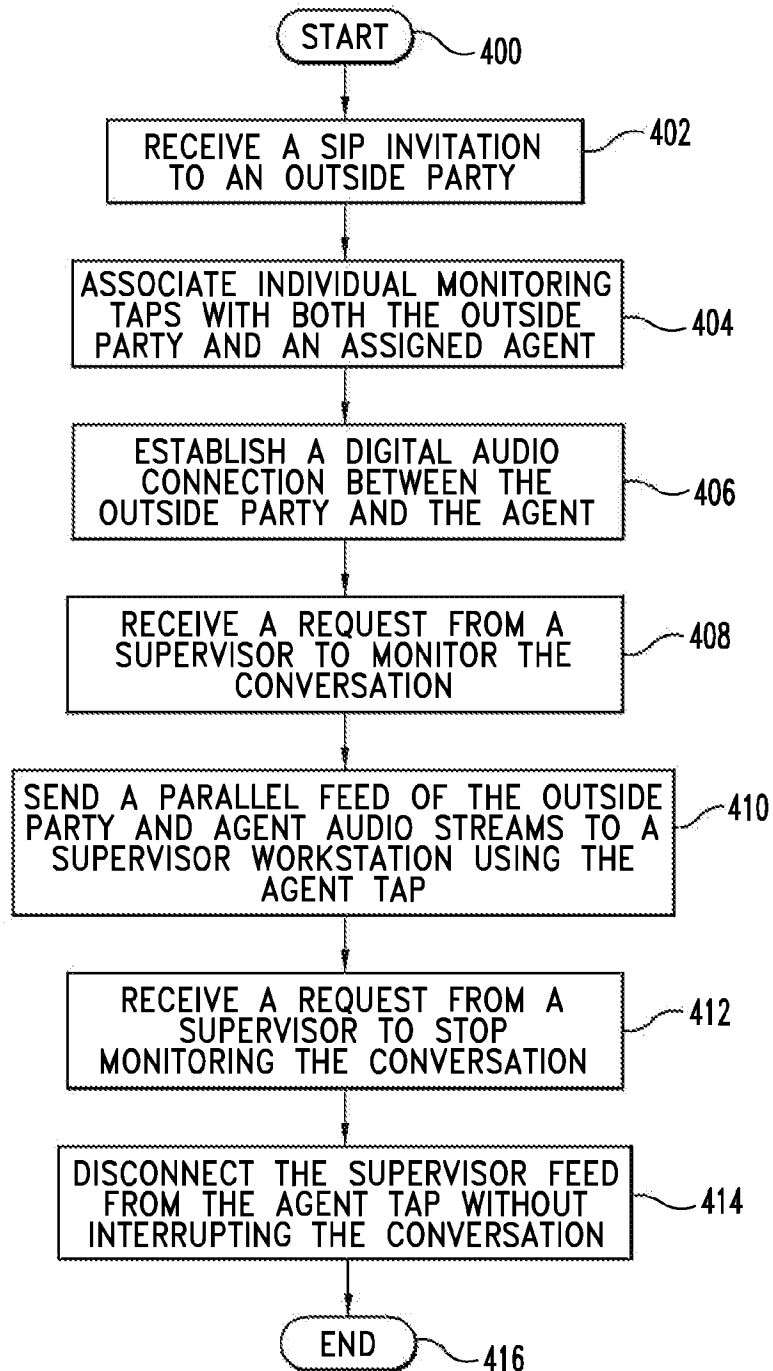


Fig. 2

4/5

**Fig. 3**

5/5

**Fig. 4**

INTERNATIONAL SEARCH REPORT

International application No.
PCT/US2008/054271

<p>A. CLASSIFICATION OF SUBJECT MATTER IPC(8) - H04L 12/28 (2008.04) USPC - 370/352 According to International Patent Classification (IPC) or to both national classification and IPC</p>														
<p>B. FIELDS SEARCHED Minimum documentation searched (classification system followed by classification symbols) IPC(8) - H04L 12/28 (2008.04) USPC - 370/352 Documentation searched other than minimum documentation to the extent that such documents are included in the fields searched</p>														
<p>Electronic data base consulted during the international search (name of data base and, where practicable, search terms used) MicroPatent</p>														
<p>C. DOCUMENTS CONSIDERED TO BE RELEVANT</p> <table border="1"> <thead> <tr> <th>Category*</th> <th>Citation of document, with indication, where appropriate, of the relevant passages</th> <th>Relevant to claim No.</th> </tr> </thead> <tbody> <tr> <td>X</td> <td>US 2006/0221941 A1 (KISHINSKY et al) 05 October 2006 (05.10.2006) see whole document</td> <td>1-35, 37-38</td> </tr> <tr> <td>Y</td> <td></td> <td>36</td> </tr> <tr> <td>Y</td> <td>GB 2 389 736 A (HALBRALCH) 17 December 2003 (17.12.2003) see whole document</td> <td>36</td> </tr> </tbody> </table>			Category*	Citation of document, with indication, where appropriate, of the relevant passages	Relevant to claim No.	X	US 2006/0221941 A1 (KISHINSKY et al) 05 October 2006 (05.10.2006) see whole document	1-35, 37-38	Y		36	Y	GB 2 389 736 A (HALBRALCH) 17 December 2003 (17.12.2003) see whole document	36
Category*	Citation of document, with indication, where appropriate, of the relevant passages	Relevant to claim No.												
X	US 2006/0221941 A1 (KISHINSKY et al) 05 October 2006 (05.10.2006) see whole document	1-35, 37-38												
Y		36												
Y	GB 2 389 736 A (HALBRALCH) 17 December 2003 (17.12.2003) see whole document	36												
<p><input type="checkbox"/> Further documents are listed in the continuation of Box C. <input type="checkbox"/></p>														
<p>* Special categories of cited documents:</p> <table border="0"> <tr> <td style="vertical-align: top;"> <p>"A" document defining the general state of the art which is not considered to be of particular relevance</p> <p>"E" earlier application or patent but published on or after the international filing date</p> <p>"L" document which may throw doubts on priority claim(s) or which is cited to establish the publication date of another citation or other special reason (as specified)</p> <p>"O" document referring to an oral disclosure, use, exhibition or other means</p> <p>"P" document published prior to the international filing date but later than the priority date claimed</p> </td> <td style="vertical-align: top;"> <p>"T" later document published after the international filing date or priority date and not in conflict with the application but cited to understand the principle or theory underlying the invention</p> <p>"X" document of particular relevance; the claimed invention cannot be considered novel or cannot be considered to involve an inventive step when the document is taken alone</p> <p>"Y" document of particular relevance; the claimed invention cannot be considered to involve an inventive step when the document is combined with one or more other such documents, such combination being obvious to a person skilled in the art</p> <p>"&" document member of the same patent family</p> </td> </tr> </table>			<p>"A" document defining the general state of the art which is not considered to be of particular relevance</p> <p>"E" earlier application or patent but published on or after the international filing date</p> <p>"L" document which may throw doubts on priority claim(s) or which is cited to establish the publication date of another citation or other special reason (as specified)</p> <p>"O" document referring to an oral disclosure, use, exhibition or other means</p> <p>"P" document published prior to the international filing date but later than the priority date claimed</p>	<p>"T" later document published after the international filing date or priority date and not in conflict with the application but cited to understand the principle or theory underlying the invention</p> <p>"X" document of particular relevance; the claimed invention cannot be considered novel or cannot be considered to involve an inventive step when the document is taken alone</p> <p>"Y" document of particular relevance; the claimed invention cannot be considered to involve an inventive step when the document is combined with one or more other such documents, such combination being obvious to a person skilled in the art</p> <p>"&" document member of the same patent family</p>										
<p>"A" document defining the general state of the art which is not considered to be of particular relevance</p> <p>"E" earlier application or patent but published on or after the international filing date</p> <p>"L" document which may throw doubts on priority claim(s) or which is cited to establish the publication date of another citation or other special reason (as specified)</p> <p>"O" document referring to an oral disclosure, use, exhibition or other means</p> <p>"P" document published prior to the international filing date but later than the priority date claimed</p>	<p>"T" later document published after the international filing date or priority date and not in conflict with the application but cited to understand the principle or theory underlying the invention</p> <p>"X" document of particular relevance; the claimed invention cannot be considered novel or cannot be considered to involve an inventive step when the document is taken alone</p> <p>"Y" document of particular relevance; the claimed invention cannot be considered to involve an inventive step when the document is combined with one or more other such documents, such combination being obvious to a person skilled in the art</p> <p>"&" document member of the same patent family</p>													
<p>Date of the actual completion of the international search 14 June 2008</p>		<p>Date of mailing of the international search report 07 JUL 2008</p>												
<p>Name and mailing address of the ISA/US Mail Stop PCT, Attn: ISA/US, Commissioner for Patents P.O. Box 1450, Alexandria, Virginia 22313-1450 Facsimile No. 571-273-3201</p>		<p>Authorized officer: Blaine R. Copenheaver PCT Helpdesk: 571-272-4300 PCT OSP: 571-272-7774</p>												

Form PCT/ISA/210 (second sheet) (April 2005)

(19) World Intellectual Property Organization
International Bureau



(43) International Publication Date
18 December 2008 (18.12.2008)

PCT

(10) International Publication Number
WO 2008/151406 A1

(51) International Patent Classification:
H04L 12/66 (2006.01) *H04Q 3/64* (2006.01)
H04M 11/06 (2006.01)

(74) Agents: **WONG, Jeffrey W.** et al.; Borden Ladner Gervais LLP, World Exchange Plaza, 100 Queen Street, Suite 1100, Ottawa, Ontario K1P 1J9 (CA).

(21) International Application Number:
PCT/CA2007/002176

(81) Designated States (unless otherwise indicated, for every kind of national protection available): AE, AG, AL, AM, AO, AT, AU, AZ, BA, BB, BG, BH, BR, BW, BY, BZ, CA, CH, CN, CO, CR, CU, CZ, DE, DK, DM, DO, DZ, EC, EE, EG, ES, FI, GB, GD, GE, GH, GM, GT, HN, HR, HU, ID, IL, IN, IS, JP, KE, KG, KM, KN, KP, KR, KZ, LA, LC, LK, LR, LS, LT, LU, LY, MA, MD, ME, MG, MK, MN, MW, MX, MY, MZ, NA, NG, NI, NO, NZ, OM, PG, PH, PL, PT, RO, RS, RU, SC, SD, SE, SG, SK, SL, SM, SV, SY, TJ, TM, TN, TR, TT, TZ, UA, UG, US, UZ, VC, VN, ZA, ZM, ZW.

(22) International Filing Date:
27 December 2007 (27.12.2007)

(25) Filing Language: English

(26) Publication Language: English

(30) Priority Data:
60/944,258 15 June 2007 (15.06.2007) US

(84) Designated States (unless otherwise indicated, for every kind of regional protection available): ARIPO (BW, GH, GM, KE, LS, MW, MZ, NA, SD, SL, SZ, TZ, UG, ZM, ZW), Eurasian (AM, AZ, BY, KG, KZ, MD, RU, TJ, TM), European (AT, BE, BG, CH, CY, CZ, DE, DK, EE, ES, FI, FR, GB, GR, HU, IE, IS, IT, LT, LU, LV, MC, MT, NL, PL, PT, RO, SE, SI, SK, TR), OAPI (BF, BJ, CF, CG, CI, CM, GA, GN, GQ, GW, ML, MR, NE, SN, TD, TG).

(71) Applicant (for all designated States except US): **RESEARCH IN MOTION LIMITED** [CA/CA]; 295 Phillip Street, Waterloo, Ontario N2L 3W8 (CA).

(72) Inventors; and

(75) Inventors/Applicants (for US only): **PURNADI, Rene W.** [US/US]; 118 Elm Fork Drive, Coppell, Texas 75019 (US). **ISLAM, M. Khaledul** [CA/CA]; 88 Broughton Street, Ottawa, Ontario K2K 3N4 (CA).

Published:
— with international search report

(54) Title: SYSTEM AND METHOD FOR INDICATING EMERGENCY CALL BACK TO USER EQUIPMENT

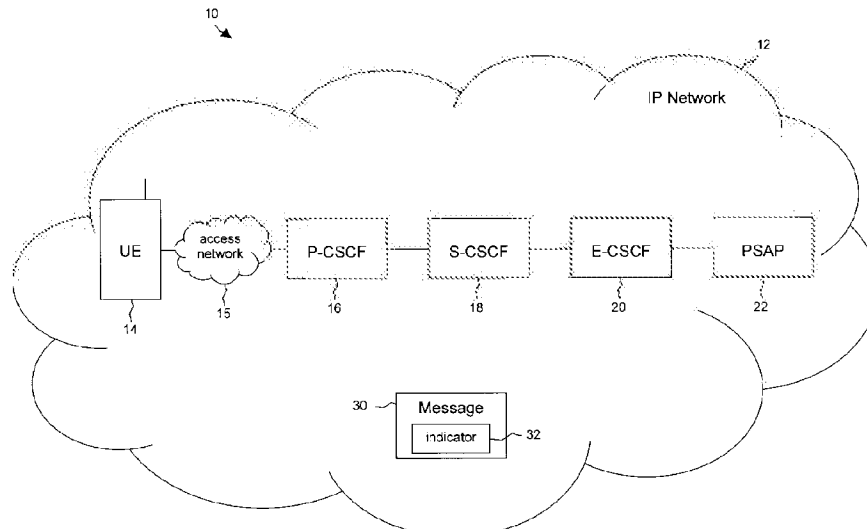


Figure 1

(57) Abstract: A method is provided for indicating an IMS (Internet Protocol Multimedia Subsystem) emergency call back to a user equipment 14 and an access network 15. The method comprises including in a message 30 from a PSAP (Public Safety Answering Point) 22 to the user equipment 14 and the access network 15 an indication 32 that the emergency call back is from the PSAP 22.

WO 2008/151406 A1

Figure 2 is a sequence diagram illustrating a call flow according to an embodiment of the disclosure.

Figure 3 is a diagram of a wireless communications system including user equipment operable for some of the various embodiments of the disclosure.

5 Figure 4 is a block diagram of user equipment operable for some of the various embodiments of the disclosure.

Figure 5 is a diagram of a software environment that may be implemented on user equipment operable for some of the various embodiments of the disclosure.

10 Figure 6 is an illustrative general purpose computer system suitable for some of the various embodiments of the disclosure.

DETAILED DESCRIPTION

It should be understood at the outset that although illustrative implementations of one or more embodiments of the present disclosure are provided below, the disclosed systems and/or methods may be implemented using any number of techniques, whether currently known or in
15 existence. The disclosure should in no way be limited to the illustrative implementations, drawings, and techniques illustrated below, including the exemplary designs and implementations illustrated and described herein, but may be modified within the scope of the appended claims along with their full scope of equivalents.

20 In an embodiment, a method is provided for indicating an IMS (Internet Protocol Multimedia Subsystem) emergency call back to a user equipment and an access network. The method comprises including in a message from a PSAP (Public Safety Answering Point) to the user equipment and the access network an indication that the emergency call back is from the PSAP.

25 In another embodiment, a user equipment is provided that includes a processor configured to recognize an IMS (Internet Protocol Multimedia Subsystem) call as an emergency call back from a PSAP.

In another embodiment, a system is provided that includes one or more processors and instructions. The instructions when executed by the one or more processors promote providing
30 an emergency call back indicator in a message from a PSAP to user equipment (UE).

When a PSAP attempts an IMS call back to a UE after an IMS emergency call from the UE to the PSAP is terminated, undesirable results may occur if the UE does not recognize that the call back is from the PSAP. For example, the UE may treat the call back as a regular call and place it on hold or call waiting, the call back could be blocked, or the UE might otherwise fail to respond appropriately to the call back. The present disclosure provides for indicating an IMS emergency call back from a PSAP to a UE by including in the call back an indication to the UE that the call back is from the PSAP. This allows the UE to distinguish between emergency call backs and regular calls. The indication or indicator that identifies the call to the UE as a call back from a PSAP may be associated with the call in various manners, some of which will be discussed in greater detail below. Others will readily suggest themselves to one skilled in the art in light of the present disclosure. Other techniques are provided in U.S. Patent Nos. 7,050,785 and 7,139,549, both by Islam et al, which are incorporated herein by reference for all purposes.

Figure 1 illustrates a system 10 including an IP (Internet Protocol) network 12, which may also include one or more components of an IMS network. A UE 14 is shown and may include any end user device or system (e.g., mobile phone, mobile wireless device (including digital, cellular, or dual mode devices) personal digital assistant, laptop/tablet/notebook computer, desktop computer, etc.) that connects to an IMS network. A CSCF (Call Session Control Function) (not explicitly shown) is a well known element in an IMS network responsible, for example, for maintaining a SIP (Session Initiation Protocol) call and providing session control for subscribers accessing services within an IMS network.

The UE 14 communicates via an access network 15 with a P-CSCF (Proxy CSCF) 16. The access network 15 might be any well known set of components, such as base stations and other radio transmission and reception equipment, that can promote wireless connections to subsequent network components. The P-CSCF 16 is a SIP proxy that may be the first point of contact for the IMS terminal and may be located in the visited network in full IMS networks or in the home network if the visited network is not yet IMS-compliant. The P-CSCF 16 communicates with an S-CSCF (Serving CSCF) 18. The S-CSCF 18 is a SIP server that may be located in the home network and that may perform session control, downloading and uploading of user profiles, and other functions. The S-CSCF 18 communicates with an E-

CSCF (Emergency CSCF) 20. The E-CSCF 20 provides session control functions for a PSAP (Public Safety Answering Point) 22, which may be a 911 system or another emergency call center or system.

To make an emergency or 911 call, the UE 14 might communicate with the PSAP 22 via the P-CSCF 16, S-CSCF 18, and E-CSCF 20. However, communication via the P-CSCF 16 might occur only when the UE 14 is roaming. When the UE 14 is in its home network, there may be no need for the P-CSCF 16, and the UE 14 might communicate directly with the S-CSCF 18. Hereinafter, any communication that is described as occurring via the P-CSCF 16 should be understood as possibly occurring without the presence of the P-CSCF 16.

Current 3GPP (3rd Generation Partnership Project) and 3GPP2 (3rd Generation Partnership Project 2) specifications (TS 23.167 in 3GPP and X.P0049 in 3GPP2) do not specify a method for the UE 14 to determine whether an incoming call is in fact a call back from an emergency system, such as the PSAP 22. According to one embodiment, the PSAP 22 provides an IMS emergency call back message 30, such as a SIP Invite, that includes an emergency call back indication or indicator 32. The UE 14 can use the indicator 32 to identify a call as an IMS emergency call back from the PSAP 22 and can then respond appropriately to the call back. For example, the UE 14 might use the indicator 32 to set a proper priority during bearer setup with the access network 15, might drop and block other calls if necessary, or might take other actions to promote or increase the likelihood of successfully completing the emergency call back. The indicator 32 may also allow the UE 14 to provide events, such as audible or video displayed alerts, that notify the UE user about the incoming emergency call back.

The UE 14 may also use the indicator 32 to trigger an action if the UE user has not responded to the call back after a certain time has elapsed. A failure to answer an emergency call back in a timely manner might be an indication that the user is incapacitated or is otherwise in need of emergency services. When no response to an emergency call back occurs within a predefined length of time after the indicator 32 is received, the UE 14 might initiate an automatic reply to the PSAP 22 that indicates that the user is unable to respond, might send the location coordinates of the UE 14, might send an automated message to another emergency system, or might trigger other actions. For example, the UE 14 might complete the call without

physical input from the user, which might be useful when the user is unable to physically activate the UE 14 to receive the call. The P-CSCF 16 can provide the emergency call back indicator 32 to the access network 15 and the access network 15 can use the emergency call back indicator 32 to prepare and prioritize the appropriate resources for the emergency call
5 back.

The emergency call back indicator 32 may be conveyed based on the current specifications in a variety of manners. However, the present disclosure is not so limited and is applicable in a variety of different systems and environments. In one embodiment, the indicator 32 may be provided by including the PSAP public identifier (PSAP PUID) in a SIP message
10 sent from the PSAP 22 to the UE 14 after termination of an emergency call from the UE 14. More specifically, the PSAP PUID could be included in a SIP Invite message as the indicator 32. In this case, it may be useful for the PSAP PUID to have a standard naming convention or format, such as name@sos.domain, psap@domain, and so on, that identifies the PSAP 22 as an emergency-related entity. That is, words or arrangements of letters, numbers, or other
15 characters, such as 'psap', 'sos', or 'emergency', might be used in the SIP Invite to indicate that the message 30 is from an emergency system, such as the PSAP 22.

The PSAP PUID may be provided in various locations in the SIP Invite message sent from the PSAP 22 to the UE 14. For example, the PSAP PUID could be placed in the 'From Header' that typically provides information on the identify of the sender of a SIP message. The
20 standardized PSAP PUID format in the SIP Invite 'From Header' may make the SIP Invite readily recognizable by the UE 14 as a message associated with an emergency call back from PSAP 22. That is, the UE 14 might check the 'From Header' for a name or string, such as 'psap', 'sos', or 'emergency', that indicates that the SIP Invite is from the PSAP 22. If such a string is found, the UE 14 knows that the message is from the PSAP 22 and responds
25 accordingly. The UE 14 might check every SIP Invite message for the name or string or might check only for some period of time after the UE 14 places a 911 or other emergency call.

In another embodiment, the UE emergency public identifier (ePUID) may be used as the indicator 32. As background, the UE 14 currently obtains an ePUID, which is different from the standard PUID, only when it performs an IMS emergency registration. However, under the
30 current guidelines, the UE 14 performs an IMS emergency registration only when the UE 14

places an emergency call while outside its home network or only when the UE 14 does not have enough credentials to perform IMS regular registration. Therefore, the ePUID might not always be available for use as the indicator 32.

The present embodiment provides that the UE 14 performs an emergency IMS registration whenever the UE 14 places an emergency call, regardless of whether it is in its home network or roaming and regardless of whether it has enough credentials for regular registration. The UE 14 would then have an ePUID even when it makes an emergency call from within its home network and could provide the ePUID to the PSAP 22 whenever it makes an emergency call. When the PSAP 22 makes an emergency call back to the UE 14, the PSAP 22 could then use the ePUID as the indicator 32 in the message 30. More specifically, the ePUID could be placed in the SIP Invite 'To Header', which identifies the recipient of a SIP message. When the UE 14 receives a message that includes its own ePUID, such as a SIP Invite that has the UE ePUID in the 'To Header', the UE 14 could recognize the message as being associated with an emergency call back from the PSAP 22 and could respond appropriately.

In other embodiments, the emergency call back indicator 32 may be included in a SIP Invite from the PSAP 22 to the UE 14 in numerous other ways. For example, an explicit new emergency call back header might be added, or an implicit emergency call back indicator 32 might be placed inside an existing header, such as the P-Asserted-Identity header. Alternatively, other messages 30 may include or may be used as the indicator 32, or a myriad of other ways or techniques could be employed which will readily suggest themselves to one skilled in the art in view of the present disclosure.

Figure 2 illustrates an exemplary call flow diagram for a UE 14 that has previously initiated an IMS emergency call session using its standard PUID. In this embodiment, when the emergency call is terminated, the PSAP 22 attempts an emergency call back to the UE 14 using a SIP Invite message. The SIP Invite includes the UE PUID in the 'To Header' and includes a standardized or recognized PSAP PUID, such as name@sos.domain, in the 'From Header'. The standardized PSAP PUID format used in the 'From Header' is recognized by the P-CSCF 16 (or the S-CSCF 18 when the P-CSCF 16 is not present) and by the UE 14 as an indication of an emergency call back from the PSAP 22. The P-CSCF 16 or S-CSCF 20 triggers the access

network 15 so UE 14 and the access network 15 may then set the highest priority for the call to ensure a successful emergency call back and/or may perform other actions, as discussed above.

At event 202, responsive to abnormal emergency call termination, or for some other reason, the PSAP 22 initiates a call back to the UE 14. The PSAP 22 forms a SIP Invite message that includes the UE PUID in the 'To Header' and uses the standardized or recognized PSAP PUID format as the indicator in the 'From Header'. In this example, the PSAP PUID uses name@sos.domain as the standard format. The 'sos' in the SIP Invite originating from the PSAP 22 indicates to the UE 14 that this is an emergency call back. However, other parameters placed in other locations in the SIP Invite message or in other messages may also be used as the indicator. The SIP Invite formed in this manner is then sent to the E-CSCF 20.

At event 204, the E-CSCF 20 forwards the SIP Invite to the S-CSCF 18. At event 206, the S-CSCF 18 forwards the SIP Invite to the P-CSCF 16. At event 208, the P-CSCF 16 forwards the SIP Invite to the UE 14. The P-CSCF 16 may use the emergency call back indicator as a trigger to inform an access network to prepare and prioritize resources for the emergency call back. At event 210, the UE 14 examines the 'From Header' in the incoming SIP Invite and recognizes 'sos' as the standardized format indicating that the SIP Invite is from the PSAP 22 and is associated with an emergency call back. The UE 14 may then use this indication to put the call in the highest priority to assure a successful emergency call back. The UE 14 may take other actions as well, including dropping other ongoing calls, setting proper priority during the radio bearer setup procedure, and so on.

At event 212, the UE 14 forms a SIP 200OK message to respond to the SIP Invite. The UE 14 places the PSAP PUID in the 'To Header' and its own UE PUID in the 'From Header'. The SIP 200OK is then sent to the P-CSCF 16. As a note, according to the 3GPP2 specification, the P-CSCF 16 may not allow an emergency call initialization by means of a SIP Invite that has a PSAP PUID in the 'To Header'. However, the message sent at event 212 is not a SIP Invite initialization message, but instead may be a SIP 200OK. Therefore, as indicated at event 214, the P-CSCF 16 does allow the message that has the PSAP PUID in the 'To Header'. It should be noted that the P-CSCF 16 typically needs to be aware of and ready to receive the SIP 200OK or else it might reject the SIP 200OK. After the P-CSCF 16 has received the SIP

Invite from the PSAP 22, the P-CSCF 16 can be made aware that the UE 14 might send the 200OK.

At events 216, 218, and 220, the P-CSCF 16 routes the SIP 200OK, via the S-CSCF 18 and the E-CSCF 20, to the PSAP 22. At event 222, the PSAP 22 forms a SIP ACK message to respond to the SIP 200OK. The PSAP 22 puts the UE PUID in the 'To Header' and its own PSAP PUID in the 'From Header' and sends the SIP ACK to the E-CSCF 20. At events 224, 226, and 228, the SIP ACK is then routed via the S-CSCF 18 and the P-CSCF 16 to the UE 14. At this point, the setup of the emergency call back is complete, as indicated at event 230. It should be appreciated that Figure 2 is merely illustrative of one call flow for one embodiment of the present disclosure and that the present disclosure is not limited to only the illustrated call flow. Other call flows would occur for the numerous other embodiments disclosed herein.

Figure 3 illustrates a wireless communications system including an embodiment of the UE 14. The UE 14 is operable for implementing aspects of the disclosure, but the disclosure should not be limited to these implementations. Though illustrated as a mobile phone, the UE 14 may take various forms including a wireless handset, a pager, a personal digital assistant (PDA), a portable computer, a tablet computer, or a laptop computer. Many suitable devices combine some or all of these functions. In some embodiments of the disclosure, the UE 14 is not a general purpose computing device like a portable, laptop or tablet computer, but rather is a special-purpose communications device such as a mobile phone, a wireless handset, a pager, a PDA, or a telecommunications device installed in a vehicle. In another embodiment, the UE 14 may be a portable, laptop or other computing device. The UE 14 may support specialized activities such as gaming, inventory control, job control, and/or task management functions, and so on.

The UE 14 includes a display 402. The UE 14 also includes a touch-sensitive surface, a keyboard or other input keys generally referred as 404 for input by a user. The keyboard may be a full or reduced alphanumeric keyboard such as QWERTY, Dvorak, AZERTY, and sequential types, or a traditional numeric keypad with alphabet letters associated with a telephone keypad. The input keys may include a trackwheel, an exit or escape key, a trackball, and other navigational or functional keys, which may be inwardly depressed to provide further

input function. The UE 14 may present options for the user to select, controls for the user to actuate, and/or cursors or other indicators for the user to direct.

The UE 14 may further accept data entry from the user, including numbers to dial or various parameter values for configuring the operation of the UE 14. The UE 14 may further execute one or more software or firmwarc applications in response to user commands. These applications may configure the UE 14 to perform various customized functions in response to user interaction. Additionally, the UE 14 may be programmed and/or configured over-the-air, for example from a wireless base station, a wireless access point, or a peer UE 14.

Among the various applications executable by the UE 14 are a web browser, which enables the display 402 to show a web page. The web page may be obtained via wireless communications with a wireless network access node, a cell tower, a peer UE 14, or any other wireless communication network or system 400. The network 400 is coupled to a wired network 408, such as the Internet. Via the wireless link and the wired network, the UE 14 has access to information on various servers, such as a server 410. The server 410 may provide content that may be shown on the display 402. Alternately, the UE 14 may access the network 400 through a peer UE 14 acting as an intermediary, in a relay type or hop type of connection.

Figure 4 shows a block diagram of the UE 14. While a variety of known components of UEs 14 are depicted, in an embodiment a subset of the listed components and/or additional components not listed may be included in the UE 14. The UE 14 includes a digital signal processor (DSP) 502 and a memory 504. As shown, the UE 14 may further include an antenna and front end unit 506, a radio frequency (RF) transceiver 508, an analog baseband processing unit 510, a microphone 512, an earpiece speaker 514, a headset port 516, an input/output interface 518, a removable memory card 520, a universal serial bus (USB) port 522, a short range wireless communication sub-system 524, an alert 526, a keypad 528, a liquid crystal display (LCD), which may include a touch sensitive surface 530, an LCD controller 532, a charge-coupled device (CCD) camera 534, a camera controller 536, and a global positioning system (GPS) sensor 538. In an embodiment, the UE 14 may include another kind of display that does not provide a touch sensitive screen. In an embodiment, the DSP 502 may communicate directly with the memory 504 without passing through the input/output interface 518.

The DSP 502 or some other form of controller or central processing unit operates to control the various components of the UE 14 in accordance with embedded software or firmware stored in memory 504 or stored in memory contained within the DSP 502 itself. In addition to the embedded software or firmware, the DSP 502 may execute other applications
5 stored in the memory 504 or made available via information carrier media such as portable data storage media like the removable memory card 520 or via wired or wireless network communications. The application software may comprise a compiled set of machine-readable instructions that configure the DSP 502 to provide the desired functionality, or the application software may be high-level software instructions to be processed by an interpreter or compiler
10 to indirectly configure the DSP 502.

The antenna and front end unit 506 may be provided to convert between wireless signals and electrical signals, enabling the UE 14 to send and receive information from a cellular network or some other available wireless communications network or from a peer UE 14. In an embodiment, the antenna and front end unit 506 may include multiple antennas to support beam
15 forming and/or multiple input multiple output (MIMO) operations. As is known to those skilled in the art, MIMO operations may provide spatial diversity which can be used to overcome difficult channel conditions and/or increase channel throughput. The antenna and front end unit 506 may include antenna tuning and/or impedance matching components, RF power amplifiers, and/or low noise amplifiers.

The RF transceiver 508 provides frequency shifting, converting received RF signals to baseband and converting baseband transmit signals to RF. In some descriptions a radio transceiver or RF transceiver may be understood to include other signal processing functionality such as modulation/demodulation, coding/decoding, interleaving/deinterleaving, spreading/despreading, inverse fast Fourier transforming (IFFT)/fast Fourier transforming
25 (FFT), cyclic prefix appending/removal, and other signal processing functions. For the purposes of clarity, the description here separates the description of this signal processing from the RF and/or radio stage and conceptually allocates that signal processing to the analog baseband processing unit 510 and/or the DSP 502 or other central processing unit. In some embodiments, the RF Transceiver 508, portions of the Antenna and Front End 506, and the

analog baseband processing unit 510 may be combined in one or more processing units and/or application specific integrated circuits (ASICs).

The analog baseband processing unit 510 may provide various analog processing of inputs and outputs, for example analog processing of inputs from the microphone 512 and the headset 516 and outputs to the earpiece 514 and the headset 516. To that end, the analog baseband processing unit 510 may have ports for connecting to the built-in microphone 512 and the earpiece speaker 514 that enable the UE 14 to be used as a cell phone. The analog baseband processing unit 510 may further include a port for connecting to a headset or other hands-free microphone and speaker configuration. The analog baseband processing unit 510 may provide digital-to-analog conversion in one signal direction and analog-to-digital conversion in the opposing signal direction. In some embodiments, at least some of the functionality of the analog baseband processing unit 510 may be provided by digital processing components, for example by the DSP 502 or by other central processing units.

The DSP 502 may perform modulation/demodulation, coding/decoding, interleaving/deinterleaving, spreading/despreading, inverse fast Fourier transforming (IFFT)/fast Fourier transforming (FFT), cyclic prefix appending/removal, and other signal processing functions associated with wireless communications. In an embodiment, for example in a code division multiple access (CDMA) technology application, for a transmitter function the DSP 502 may perform modulation, coding, interleaving, and spreading, and for a receiver function the DSP 502 may perform despreading, deinterleaving, decoding, and demodulation. In another embodiment, for example in an orthogonal frequency division multiplex access (OFDMA) technology application, for the transmitter function the DSP 502 may perform modulation, coding, interleaving, inverse fast Fourier transforming, and cyclic prefix appending, and for a receiver function the DSP 502 may perform cyclic prefix removal, fast Fourier transforming, deinterleaving, decoding, and demodulation. In other wireless technology applications, yet other signal processing functions and combinations of signal processing functions may be performed by the DSP 502.

The DSP 502 may communicate with a wireless network via the analog baseband processing unit 510. In some embodiments, the communication may provide Internet connectivity, enabling a user to gain access to content on the Internet and to send and receive e-

mail or text messages. The input/output interface 518 interconnects the DSP 502 and various memories and interfaces. The memory 504 and the removable memory card 520 may provide software and data to configure the operation of the DSP 502. Among the interfaces may be the USB interface 522 and the short range wireless communication sub-system 524. The USB
5 interface 522 may be used to charge the UE 14 and may also enable the UE 14 to function as a peripheral device to exchange information with a personal computer or other computer system. The short range wireless communication sub-system 524 may include an infrared port, a Bluetooth interface, an IEEE 802.11 compliant wireless interface, or any other short range wireless communication sub-system, which may enable the UE 14 to communicate wirelessly
10 with other nearby mobile devices and/or wireless base stations.

The input/output interface 518 may further connect the DSP 502 to the alert 526 that, when triggered, causes the UE 14 to provide a notice to the user, for example, by ringing, playing a melody, or vibrating. The alert 526 may serve as a mechanism for alerting the user to any of various events such as an incoming call, a new text message, and an appointment
15 reminder by silently vibrating, or by playing a specific pre-assigned melody for a particular caller.

The keypad 528 couples to the DSP 502 via the interface 518 to provide one mechanism for the user to make selections, enter information, and otherwise provide input to the UE 14. The keyboard 528 may be a full or reduced alphanumeric keyboard such as QWERTY, Dvorak,
20 AZERTY and sequential types, or a traditional numeric keypad with alphabet letters associated with a telephone keypad. The input keys may include a trackwheel, an exit or escape key, a trackball, and other navigational or functional keys, which may be inwardly depressed to provide further input function. Another input mechanism may be the LCD 530, which may include touch screen capability and also display text and/or graphics to the user. The LCD
25 controller 532 couples the DSP 502 to the LCD 530.

The CCD camera 534, if equipped, enables the UE 14 to take digital pictures. The DSP 502 communicates with the CCD camera 534 via the camera controller 536. In another embodiment, a camera operating according to a technology other than Charge Coupled Device cameras may be employed. The GPS sensor 538 is coupled to the DSP 502 to decode global
30 positioning system signals, thereby enabling the UE 14 to determine its position. Various other

peripherals may also be included to provide additional functions, e.g., radio and television reception.

Figure 5 illustrates a software environment 602 that may be implemented by the DSP 502. The DSP 502 executes operating system drivers 604 that provide a platform from which the rest of the software operates. The operating system drivers 604 provide drivers for the wireless device hardware with standardized interfaces that are accessible to application software. The operating system drivers 604 include application management services (“AMS”) 606 that transfer control between applications running on the UE 14. Also shown in Figure 5 are a web browser application 608, a media player application 610, and Java applets 612. The web browser application 608 configures the UE 14 to operate as a web browser, allowing a user to enter information into forms and select links to retrieve and view web pages. The media player application 610 configures the UE 14 to retrieve and play audio or audiovisual media. The Java applets 612 configure the UE 14 to provide games, utilities, and other functionality. A component 614 might provide functionality related to emergency calls.

The UE 14, P-CSCF 16, S-CSCF 18, E-CSCF 20, and PSAP 22, as well as other components described herein, may be implemented in whole or part on, or may include, a general-purpose computer with sufficient processing power, memory resources, and network throughput capability to handle the necessary workload placed upon it. Figure 6 illustrates a typical, general-purpose computer system 700 that may be suitable for implementing one or more embodiments disclosed herein. The computer system 700 includes a processor 720 (which may be referred to as a central processor unit or CPU) that is in communication with memory devices including secondary storage 750, read only memory (ROM) 740, random access memory (RAM) 730, input/output (I/O) devices 710, and network connectivity devices 760. The processor may be implemented as one or more CPU chips.

The secondary storage 750 is typically comprised of one or more disk drives or tape drives and is used for non-volatile storage of data and as an over-flow data storage device if RAM 730 is not large enough to hold all working data. Secondary storage 750 may be used to store programs which are loaded into RAM 730 when such programs are selected for execution. The ROM 740 is used to store instructions and perhaps data which are read during program execution. ROM 740 is a non-volatile memory device which typically has a small memory

capacity relative to the larger memory capacity of secondary storage. The RAM 730 is used to store volatile data and perhaps to store instructions. Access to both ROM 740 and RAM 730 is typically faster than to secondary storage 750.

I/O devices 710 may include printers, video monitors, liquid crystal displays (LCDs), touch screen displays, keyboards, keypads, switches, dials, mice, track balls, voice
5 recognizers, card readers, paper tape readers, or other well-known input devices.

The network connectivity devices 760 may take the form of modems, modem banks, ethernet cards, universal serial bus (USB) interface cards, serial interfaces, token ring cards, fiber distributed data interface (FDDI) cards, wireless local area network (WLAN) cards, radio
10 transceiver cards such as code division multiple access (CDMA) and/or global system for mobile communications (GSM) radio transceiver cards, and other well-known network devices. These network connectivity 760 devices may enable the processor 720 to communicate with an Internet or one or more intranets. With such a network connection, it is contemplated that the processor 720 might receive information from the network, or might output information to the
15 network in the course of performing the above-described method steps. Such information, which is often represented as a sequence of instructions to be executed using processor 720, may be received from and outputted to the network, for example, in the form of a computer data signal embodied in a carrier wave.

Such information, which may include data or instructions to be executed using
20 processor 720 for example, may be received from and outputted to the network, for example, in the form of a computer data baseband signal or signal embodied in a carrier wave. The baseband signal or signal embodied in the carrier wave generated by the network connectivity 760 devices may propagate in or on the surface of electrical conductors, in coaxial cables, in waveguides, in optical media, for example optical fiber, or in the air or free space. The
25 information contained in the baseband signal or signal embedded in the carrier wave may be ordered according to different events, as may be desirable for either processing or generating the information or transmitting or receiving the information. The baseband signal or signal embedded in the carrier wave, or other types of signals currently used or hereafter developed, referred to herein as the transmission medium, may be generated according to several methods
30 well known to one skilled in the art.

The processor 720 executes instructions, codes, computer programs, scripts which it accesses from hard disk, floppy disk, optical disk (these various disk based systems may all be considered secondary storage 750), ROM 740, RAM 730, or the network connectivity devices 760. Although only one processor 720 is shown, multiple processors may be present. 5 Instructions or processing discussed as accomplished by the processor may be simultaneously, serially, or otherwise a processed by one or more processors.

While several embodiments have been provided in the present disclosure, it should be understood that the disclosed systems and methods may be embodied in many other specific forms without departing from the spirit or scope of the present disclosure. The present 10 examples are to be considered as illustrative and not restrictive, and the intention is not to be limited to the details given herein. For example, the various elements or components may be combined or integrated in another system or certain features may be omitted, or not implemented.

Also, techniques, systems, subsystems and methods described and illustrated in the 15 various embodiments as discrete or separate may be combined or integrated with other systems, modules, techniques, or methods without departing from the scope of the present disclosure. Other items shown or discussed as coupled or directly coupled or communicating with each other may be indirectly coupled or communicating through some interface, device, or intermediate component, whether electrically, mechanically, or otherwise. Other examples of 20 changes, substitutions, and alterations are ascertainable by one skilled in the art and could be made without departing from the spirit and scope disclosed herein.

CLAIMS

What is claimed is:

1. A method for indicating an IMS (Internet Protocol Multimedia Subsystem) emergency call back to a user equipment and an access network, comprising:
5 including in a message from a PSAP (Public Safety Answering Point) to the user equipment and the access network an indication that the emergency call back is from the PSAP.
2. The method of claim 1, wherein the message is a SIP (Session Initiation Protocol) Invite
10 message.
3. The method of claim 1, wherein the indication is included in a From Header.
4. The method of claim 1, wherein the indication is a string of characters that identifies the
15 PSAP as an emergency-related entity.
5. The method of claim 1, wherein the indication is included in a To Header.
6. The method of claim 1, wherein the indication is an emergency public identifier of the user
20 equipment.
7. The method of claim 6, wherein the emergency public identifier is created whenever the user equipment initiates an IMS emergency call.
- 25 8. The method of claim 1, further comprising the user equipment and the access network responding to the indication in a manner that promotes a successful completion of the emergency call back.
9. The method of claim 1, further comprising the user equipment triggering an autonomous
30 action when the user equipment does not receive an input in response to the emergency call back within a predefined length of time after the user equipment receives the indication.

10. The method of claim 9, wherein the autonomous action is at least one of:
sending an automated message to the PSAP;
sending a location of the user equipment to the PSAP; and
sending an automated message to an emergency-related entity other than the PSAP.
- 5
11. The method of claim 2, wherein the user equipment inspects all incoming SIP Invite messages for the indication, and wherein a Proxy Call Session Control Function inspects all incoming SIP Invite messages for the indication to inform the access network to prepare and prioritize resources for the emergency call back.
- 10
12. The method of claim 2, wherein the user equipment inspects incoming SIP Invite messages for the indication only for a predefined length of time after the user equipment initiates an IMS emergency call to the PSAP.
- 15
13. A user equipment, comprising:
a processor configured to recognize an IMS (Internet Protocol Multimedia Subsystem) call as an emergency call back from a PSAP (Public Safety Answering Point).
14. The user equipment of claim 13, wherein the processor recognizes the IMS call as the
20 emergency call back from the PSAP by the IMS call including an emergency call back indicator.
15. The user equipment of claim 14, wherein the emergency call back indicator is a string of characters that identifies the PSAP as an emergency-related entity and that is included in a SIP (Session Initiation Protocol) Invite message from the PSAP to the user equipment.
- 25
16. The user equipment of claim 14, wherein the emergency call back indicator is included in a From Header.
17. The user equipment of claim 14, wherein the emergency call back indicator is an
30 emergency public identifier of the user equipment that is included in a To Header.

18. The user equipment of claim 17, wherein the emergency public identifier is created whenever the user equipment initiates an IMS emergency call.
19. The user equipment of claim 14, wherein the user equipment triggers an autonomous
5 action when the user equipment does not receive an input in response to the emergency call back within a predefined length of time after the user equipment receives the emergency call back indicator.
20. The user equipment of claim 19, wherein the autonomous action is at least one of:
10 sending an automated message to the PSAP;
sending a location of the user equipment to the PSAP; and
sending an automated message to an emergency-related entity other than the PSAP.
21. The user equipment of claim 14, wherein a Proxy Call Session Control Function inspects
15 all incoming SIP Invite messages for the emergency call back indicator to inform the access network to prepare and prioritize resources for the emergency call back.
22. A system, comprising:
one or more processors; and
20 instructions that when executed by the one or more processors promote providing an emergency call back indicator in a message from a PSAP (Public Safety Answering Point) to user equipment.
23. The system of claim 22, wherein the emergency call back indicator is one of:
25 a string of characters that identifies the PSAP as an emergency-related entity and that is included in a From Header of a SIP (Session Initiation Protocol) Invite message from the PSAP to the user equipment; and
an emergency public identifier of the user equipment that is included in a To Header of the
SIP Invite message and that is created whenever the user equipment initiates an
30 IMS emergency call.

24. The system of claim 22, wherein the user equipment triggers an autonomous action when the user equipment does not receive an input in response to the emergency call back within a predefined length of time after the user equipment receives the emergency call back indicator.
- 5 25. The system of claim 24, wherein the autonomous action is at least one of:
sending an automated message to the PSAP;
sending a location of the user equipment to the PSAP; and
sending an automated message to an emergency-related entity other than the PSAP.

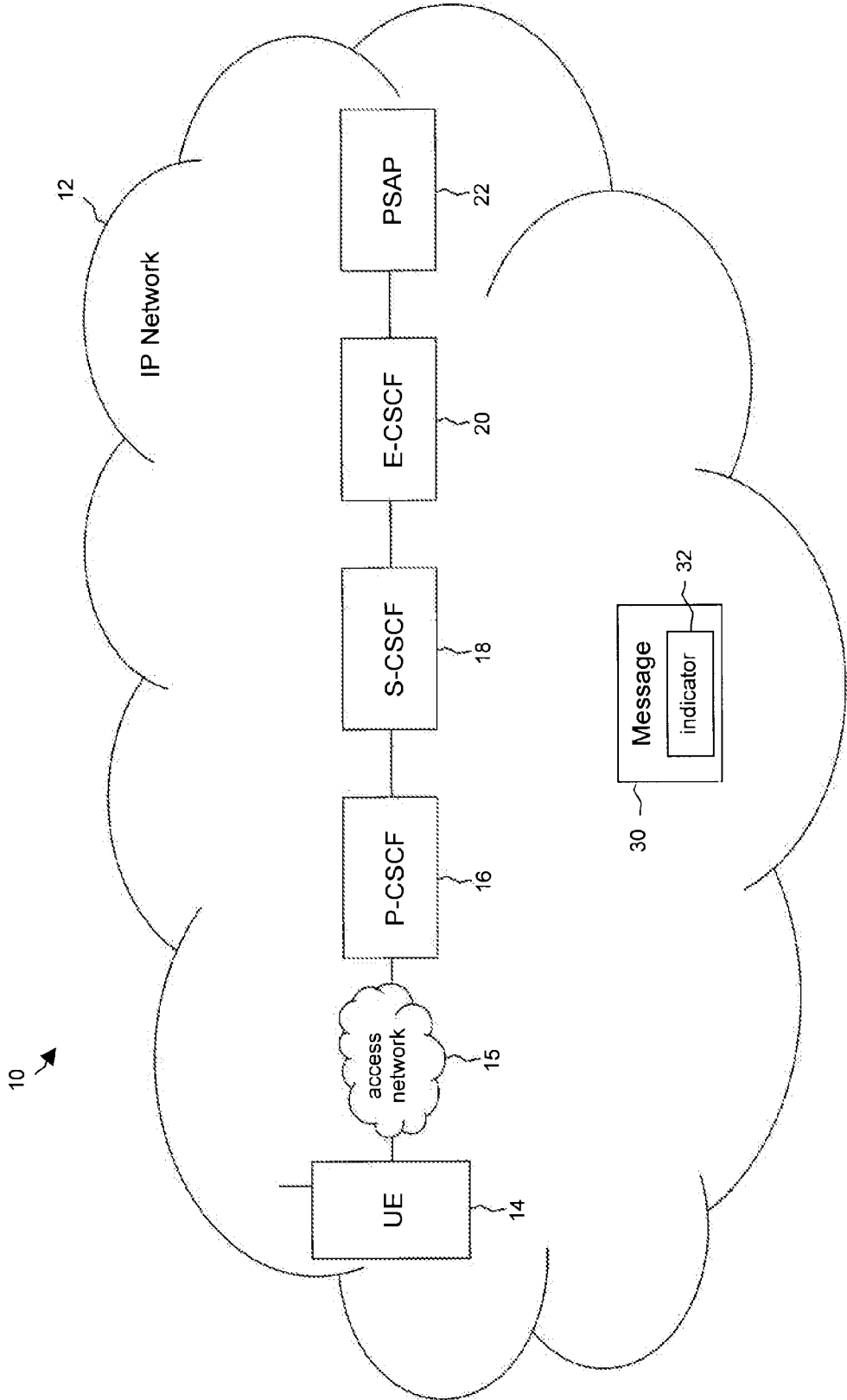


Figure 1

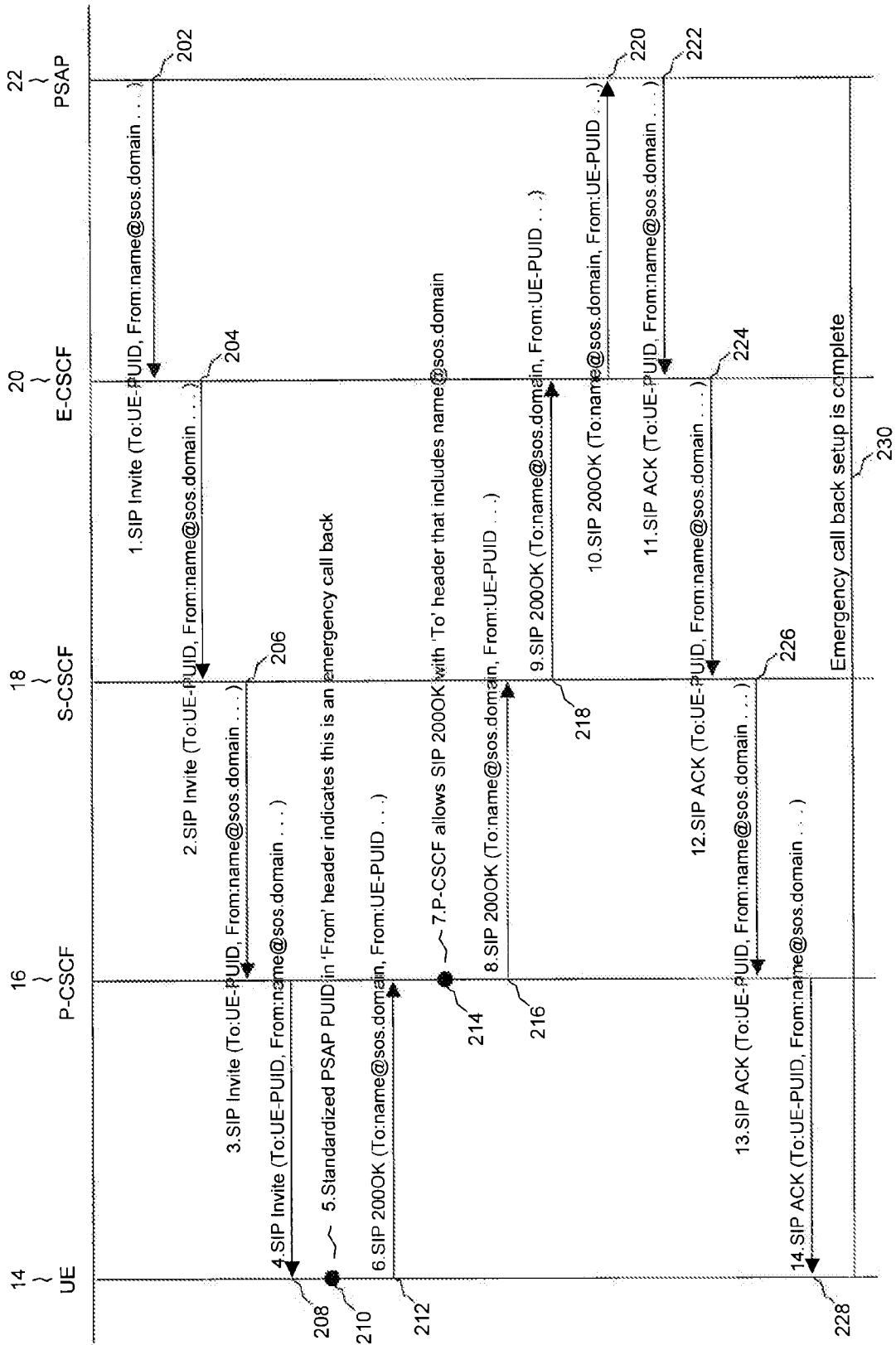


Figure 2

Fig. 3

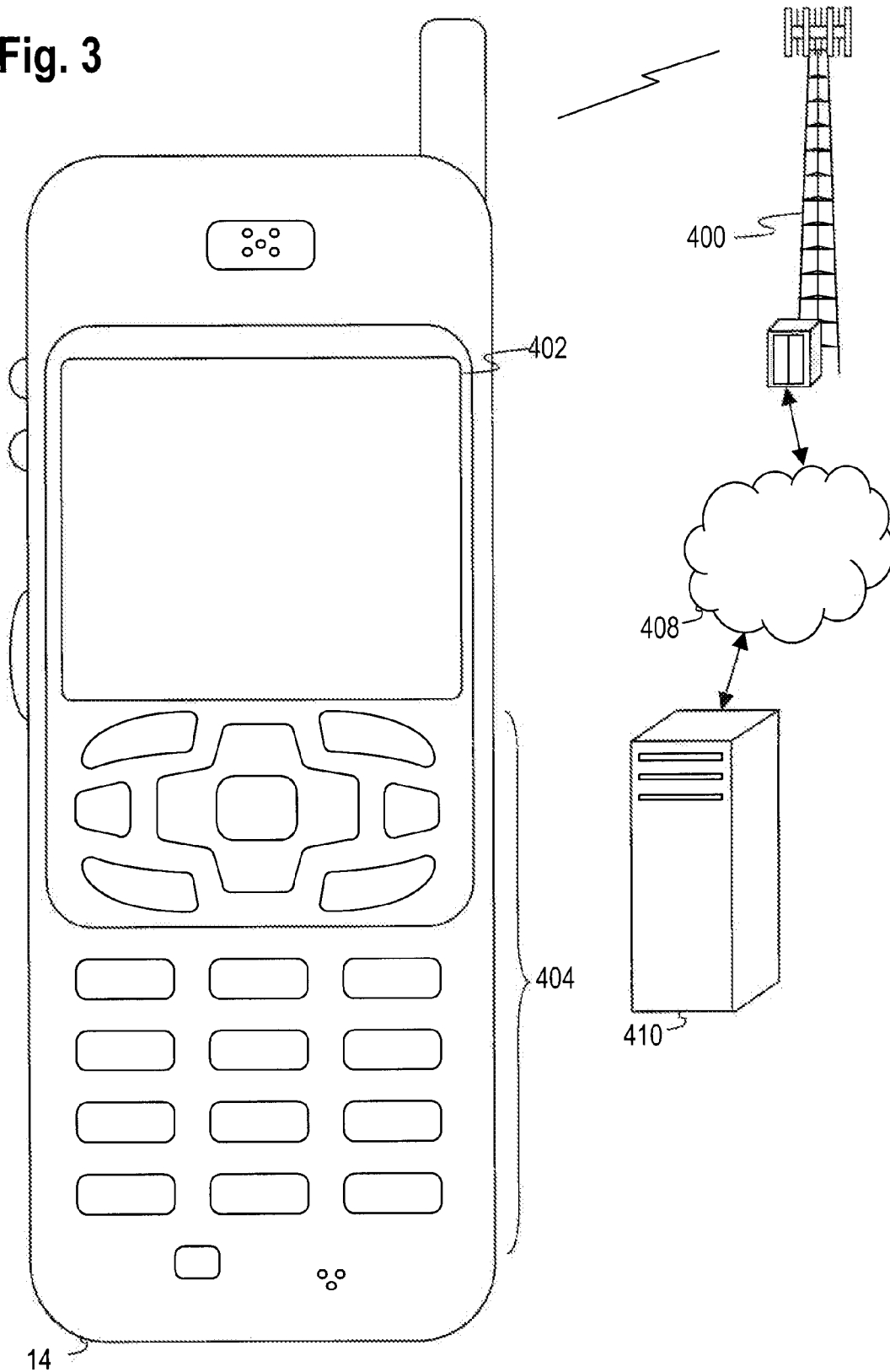


Fig. 4

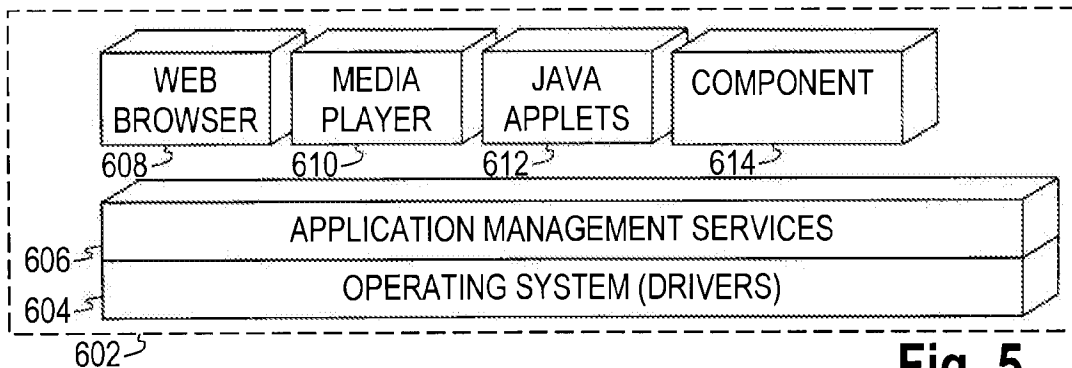
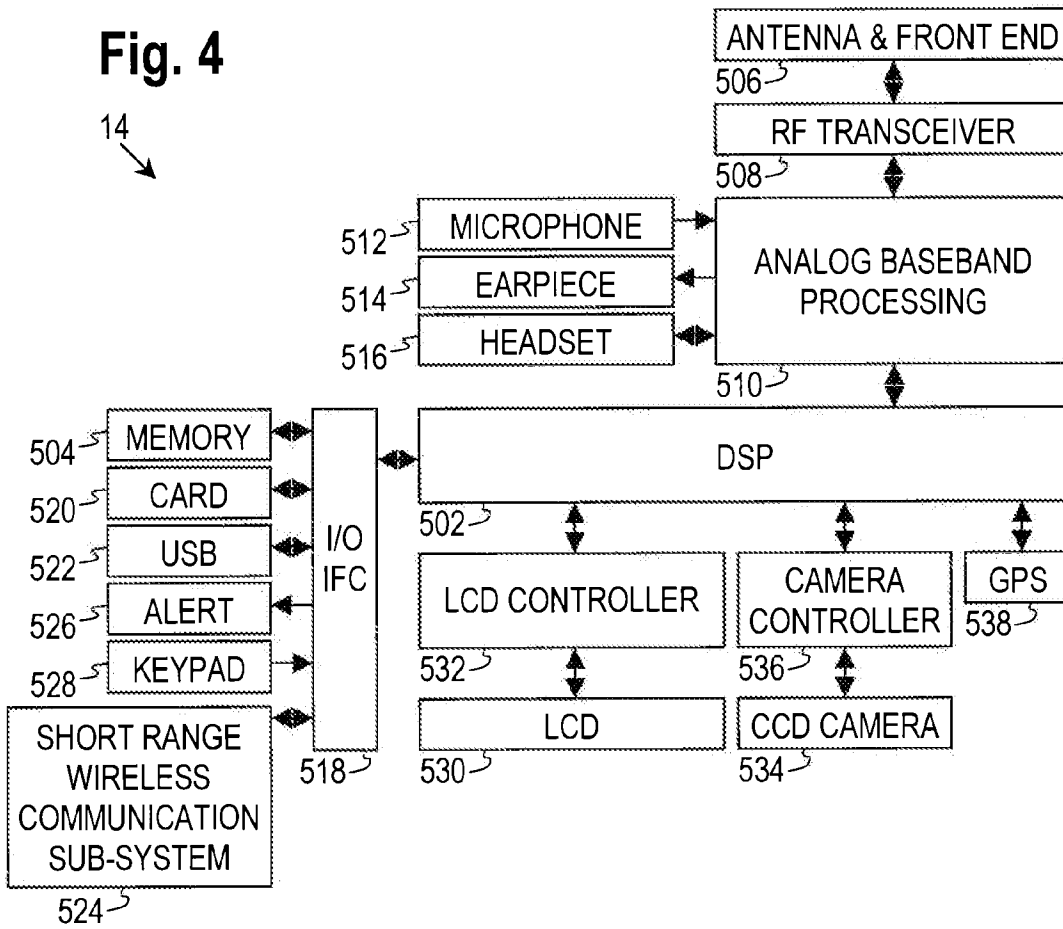


Fig. 5

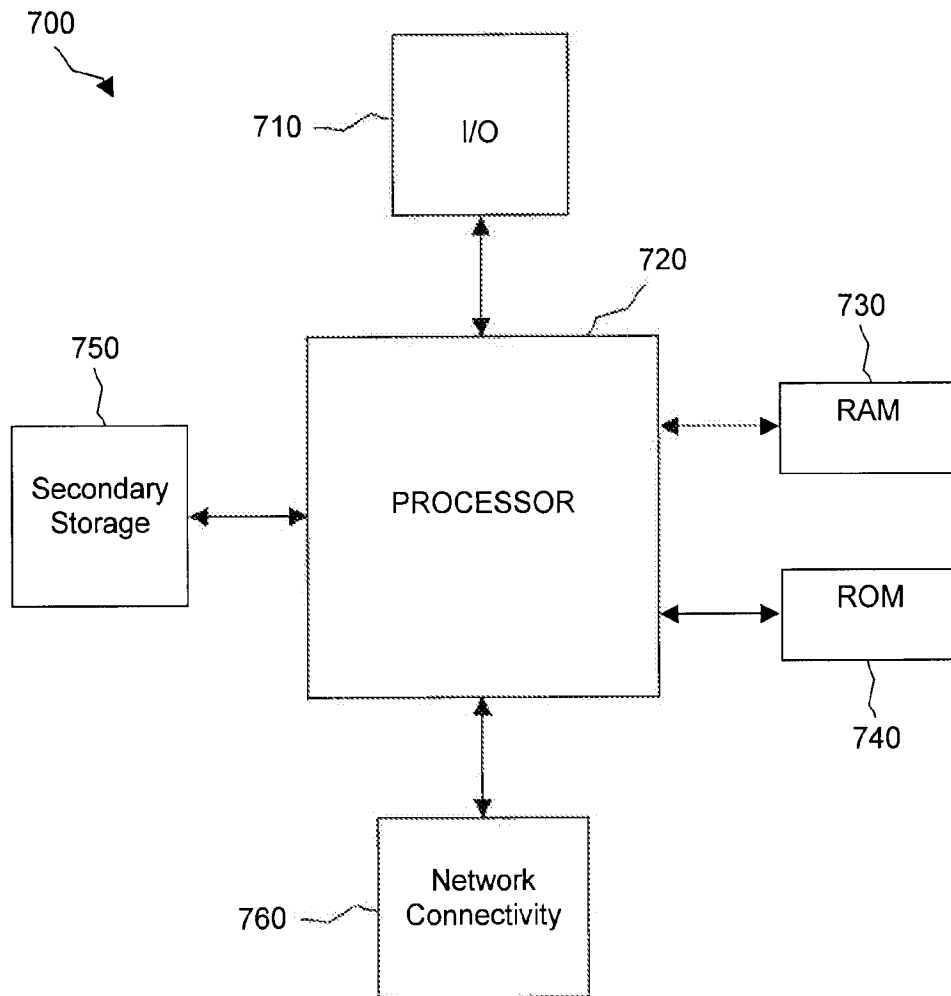


Figure 6

INTERNATIONAL SEARCH REPORT

International application No.
PCT/CA2007/002176

<p>A. CLASSIFICATION OF SUBJECT MATTER IPC: H04L 12/66 (2006.01) , H04M 11/06 (2006.01) , H04Q 3/64 (2006.01) According to International Patent Classification (IPC) or to both national classification and IPC</p>		
<p>B. FIELDS SEARCHED</p>		
<p>Minimum documentation searched (classification system followed by classification symbols) IPC: H04L (2006.01), H04M (2006.01), H04Q (2006.01); US classes: 455, 370 in combination with keywords</p>		
<p>Documentation searched other than minimum documentation to the extent that such documents are included in the fields searched</p>		
<p>Electronic database(s) consulted during the international search (name of database(s) and, where practicable, search terms used) Canadian Patent Database, USPTO West, Google Scholar, Delphion. Keywords: ims, psap, call back, callback, caller-id, ani, dnis, call centre, call center, emergency, 911</p>		
<p>C. DOCUMENTS CONSIDERED TO BE RELEVANT</p>		
Category	Citation of document, with indication, where appropriate, of the relevant passages	Relevant to claim No.
X A	US 7139549 B2 (Islam et al.) 21 November 2006 (21-11-2006) * Entire document *	22 1-21, 23-25
X A	EP 1124394 A1 (Gafrić et al.) 16 August 2001 (16-08-2001) * Entire document *	22 1-21, 23-25
A	US 2004/0176066 A1 (Binzel et al.) 9 September 2004 (09-09-2004) * Entire document *	1-25
A, P	US 2007/0268992 A1 (Goldman et al.) 22 November 2007 (22-11-2007) * Para. 25 - 31, para. 40-44 *	1-25
<p><input type="checkbox"/> Further documents are listed in the continuation of Box C. <input checked="" type="checkbox"/> See patent family annex.</p>		
* Special categories of cited documents	"T" later document published after the international filing date or priority date and not in conflict with the application but cited to understand the principle or theory underlying the invention	
"A" document defining the general state of the art which is not considered to be of particular relevance	"X" document of particular relevance; the claimed invention cannot be considered novel or cannot be considered to involve an inventive step when the document is taken alone	
"E" earlier application or patent but published on or after the international filing date	"Y" document of particular relevance; the claimed invention cannot be considered to involve an inventive step when the document is combined with one or more other such documents, such combination being obvious to a person skilled in the art	
"L" document which may throw doubts on priority claim(s) or which is cited to establish the publication date of another citation or other special reason (as specified)	"&" document member of the same patent family	
"O" document referring to an oral disclosure, use, exhibition or other means		
"P" document published prior to the international filing date but later than the priority date claimed		
Date of the actual completion of the international search	Date of mailing of the international search report	
26 February 2008 (26-02-2008)	2 April 2008 (02-04-2008)	
Name and mailing address of the ISA/CA Canadian Intellectual Property Office Place du Portage I, C114 - 1st Floor, Box PCT 50 Victoria Street Gatineau, Quebec K1A 0C9 Facsimile No.: 001-819-953-2476	Authorized officer Arthur Smith 819-953-1360	

INTERNATIONAL SEARCH REPORT
Information on patent family members

International application No.
PCT/CA2007/002176

Patent Document Cited in Search Report	Publication Date	Patent Family	Publication Member(s) Date
US7139549	21-11-2006	AU2003294532 A1	24-06-2005
		CA2549277 A1	16-06-2005
		US7050785 B2	23-05-2006
		US2007054653 A1	08-03-2007
		WO2005055629 A1	16-06-2005
EP1124394	16-08-2001	CA2328257 A1	31-07-2001
		JP2001245360 A	07-09-2001
		KR20010078156 A	20-08-2001
		US6556816 B1	29-04-2003
US2004176066	09-09-2004	CN1748439 A	15-03-2006
		EP1590987 A2	02-11-2005
		KR20050099992 A	17-10-2005
		RU2005127859 A	27-01-2006
		US7190947 B2	13-03-2007
		WO2004072784 A2	26-08-2004
US2007268992	22-11-2007	NONE	

CORRECTED VERSION

(19) World Intellectual Property Organization
International Bureau



(43) International Publication Date
18 December 2008 (18.12.2008)

(10) International Publication Number
WO 2008/151406 A8

- (51) International Patent Classification:
H04L 12/66 (2006.01) H04Q 3/64 (2006.01)
H04M 11/06 (2006.01)
- (21) International Application Number:
PCT/CA2007/002176
- (22) International Filing Date:
4 December 2007 (04.12.2007)
- (25) Filing Language: English
- (26) Publication Language: English
- (30) Priority Data:
60/944,258 15 June 2007 (15.06.2007) US
- (71) Applicant (for all designated States except US): **RESEARCH IN MOTION LIMITED** [CA/CA]; 295 Phillip Street, Waterloo, Ontario N2L 3W8 (CA).
- (72) Inventors; and
- (75) Inventors/Applicants (for US only): **PURNADI, Rene W.** [US/US]; 118 Elm Fork Drive, Coppell, Texas 75019 (US). **ISLAM, M. Khaledul** [CA/CA]; 88 Broughton Street, Ottawa, Ontario K2K 3N4 (CA).
- (74) Agents: **WONG, Jeffrey W.** et al.; Borden Ladner Gervais LLP, World Exchange Plaza, 100 Queen Street, Suite 1100, Ottawa, Ontario K1P 1J9 (CA).
- (81) Designated States (unless otherwise indicated, for every kind of national protection available): AE, AG, AL, AM,

AT, AU, AZ, BA, BB, BG, BH, BR, BW, BY, BZ, CA, CH, CN, CO, CR, CU, CZ, DE, DK, DM, DO, DZ, EC, EE, EG, ES, FI, GB, GD, GE, GH, GM, GT, HN, HR, IU, ID, IL, IN, IS, JP, KE, KG, KM, KN, KP, KR, KZ, LA, LC, LK, LR, LS, LT, LU, LY, MA, MD, ME, MG, MK, MN, MW, MX, MY, MZ, NA, NG, NI, NO, NZ, OM, PG, PH, PL, PT, RO, RS, RU, SC, SD, SE, SG, SK, SL, SM, SV, SY, TJ, TM, TN, TR, TT, TZ, UA, UG, US, UZ, VC, VN, ZA, ZM, ZW.

(84) Designated States (unless otherwise indicated, for every kind of regional protection available): ARIPO (BW, GH, GM, KE, LS, MW, MZ, NA, SD, SL, SZ, TZ, UG, ZM, ZW), Eurasian (AM, AZ, BY, KG, KZ, MD, RU, TJ, TM), European (AT, BE, BG, CH, CY, CZ, DE, DK, EE, ES, FI, FR, GB, GR, HU, IE, IS, IT, LT, LU, LV, MC, MT, NL, PL, PT, RO, SE, SI, SK, TR), OAPI (BF, BJ, CF, CG, CI, CM, GA, GN, GQ, GW, ML, MR, NE, SN, TD, TG).

- Published:
with international search report (Art. 21(3))
- (48) Date of publication of this corrected version:
28 January 2010
- (15) Information about Correction:
see Notice of 28 January 2010

(54) Title: SYSTEM AND METHOD FOR INDICATING EMERGENCY CALL BACK TO USER EQUIPMENT

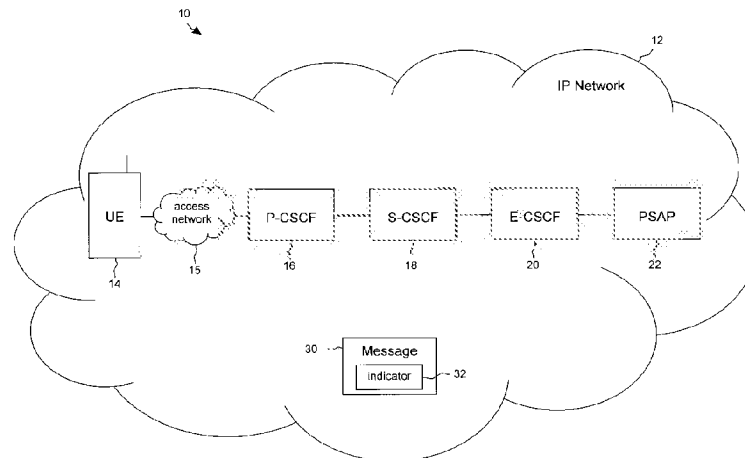


Figure 1

(57) Abstract: A method is provided for indicating an IMS (Internet Protocol Multimedia Subsystem) emergency call back to a user equipment 14 and an access network 15. The method comprises including in a message 30 from a PSAP (Public Safety Answering Point) 22 to the user equipment 14 and the access network 15 an indication 32 that the emergency call back is from the PSAP 22.

WO 2008/151406 A8

(19) World Intellectual Property Organization
International Bureau



(43) International Publication Date
4 June 2009 (04.06.2009)

PCT

(10) International Publication Number
WO 2009/070202 A1

- (51) International Patent Classification:
H04L 29/06 (2006.01)
- (21) International Application Number:
PCT/US2008/012588
- (22) International Filing Date:
7 November 2008 (07.11.2008)
- (25) Filing Language: English
- (26) Publication Language: English
- (30) Priority Data:
11/986,983 27 November 2007 (27.11.2007) US
12/082,021 8 April 2008 (08.04.2008) US
- (63) Related by continuation (CON) or continuation-in-part (CIP) to earlier applications:
US 12/082,021 (CON)
Filed on 8 April 2008 (08.04.2008)
US 11/986,983 (CIP)
Filed on 27 November 2007 (27.11.2007)
- (71) Applicant (for all designated States except US):
TELLABS OPERATIONS, INC. [US/US]; 1415 West Dichl Road, MS 16, Naperville, IL 60563 (US).
- (72) Inventors; and
- (75) Inventors/Applicants (for US only): **ZHANG, Peng**

[CN/US]; 909 Bedford Court, Buffalo Grove, IL 60089 (US). **SUKKAR, Rafid, A.** [US/US]; 68 Forestview Lane, Aurora, IL 60502 (US). **HAWBAKER, Jeffrey, A.** [US/US]; 10 S. 057 Alago Road, Naperville, IL 60564 (US).

(74) Agents: **SOLOMON, Mark, B.** et al.; Hamilton, Brook, Smith & Reynolds, P.C., 530 Virginia Road, P.O. Box 9133, Concord, MA 01742-9133 (US).

(81) Designated States (unless otherwise indicated, for every kind of national protection available): AE, AG, AL, AM, AO, AT, AU, AZ, BA, BB, BG, BH, BR, BW, BY, BZ, CA, CH, CN, CO, CR, CU, CZ, DE, DK, DM, DO, DZ, EC, EE, EG, ES, FI, GB, GD, GE, GH, GM, GT, HN, HR, HU, ID, IL, IN, IS, JP, KE, KG, KM, KN, KP, KR, KZ, LA, LC, LK, LR, LS, LT, LU, LY, MA, MD, ME, MG, MK, MN, MW, MX, MY, MZ, NA, NG, NI, NO, NZ, OM, PG, PH, PL, PT, RO, RS, RU, SC, SD, SE, SG, SK, SL, SM, ST, SV, SY, TJ, TM, TN, TR, TT, TZ, UA, UG, US (patent), UZ, VC, VN, ZA, ZM, ZW.

(84) Designated States (unless otherwise indicated, for every kind of regional protection available): ARIPO (BW, GH, GM, KE, LS, MW, MZ, NA, SD, SL, SZ, TZ, UG, ZM, ZW), Eurasian (AM, AZ, BY, KG, KZ, MD, RU, TJ, TM), European (AT, BE, BG, CH, CY, CZ, DE, DK, EE, ES, FI, FR, GB, GR, HR, HU, IE, IS, IT, LT, LU, LV, MC, MT, NL,

[Continued on next page]

(54) Title: METHOD AND APPARATUS OF RTP CONTROL PROTOCOL (RTCP) PROCESSING IN REAL-TIME TRANSPORT PROTOCOL (RTP) INTERMEDIATE SYSTEMS

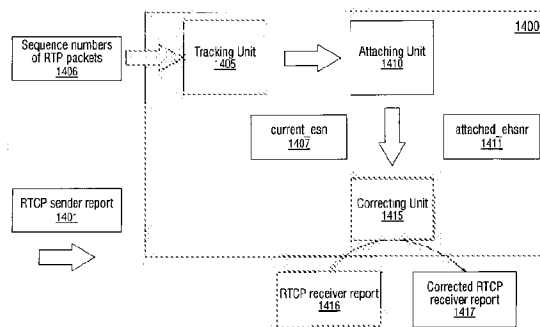


FIG. 13

(57) Abstract: Media processing of real-time protocol (RTP) packets used in time sensitive applications makes efficient use of network resources, e.g., by dropping or resizing the packets, but hinders measuring and reporting end-to-end reception quality. Because media processing causes a difference between what is sent and received, end-to-end reception quality cannot be measured validly without accounting for this difference. Accordingly, a method and corresponding apparatus are provided to track changes to RTP packets of an RTP session caused by media processing, modify RTP packet information of the RTP packets based on the tracked changes, correct RTP control protocol (RTCP) packets corresponding to the RTP session based on the tracked changes, the corrected RTCP packets being a measure of the end-to-end reception quality of the RTP session, and report the end-to-end reception quality of the RTP session by forwarding the corrected RTCP packets. Thus, end-to-end reception quality can be validly measured and reported.

WO 2009/070202 A1



NO, PL, PT, RO, SE, SI, SK, TR), OAPI (BF, BJ, CF, CG, CI, CM, GA, GN, GQ, GW, ML, MR, NE, SN, TD, TG). **Published:** — *with international search report*

METHOD AND APPARATUS OF RTP CONTROL PROTOCOL (RTCP)
PROCESSING IN REAL-TIME TRANSPORT PROTOCOL (RTP)
INTERMEDIATE SYSTEMS

RELATED APPLICATIONS

5 This application is a continuation of U.S. Application No. 12/082,021, filed April 8, 2008, which is a continuation-in-part of U.S. Application No. 11/986,983, filed November 27, 2007. The entire teachings of the above application are incorporated herein by reference.

BACKGROUND OF THE INVENTION

10 The real-time transport protocol (RTP) provides end-to-end network transport functions suitable for applications transmitting real-time data, such as audio, video or simulation data, over multicast or unicast network services. The data transport is augmented by a real-time control protocol (RTCP) to allow monitoring of the data delivery in a manner scalable to large multicast networks and to provide
15 minimal control and identification functionality. RTP and RTCP are designed to be independent of the underlying transport and network layers.

SUMMARY OF THE INVENTION

 An example embodiment of the present invention may be implemented in the form of a method or corresponding apparatus which provides end-to-end reception
20 quality feedback between a sending end system and a receiving end system. The method and corresponding apparatus according to one embodiment of the present invention includes: (i) tracking changes to real time transport protocol (RTP) packets of the RTP session caused by media processing of the RTP packets to produce tracked changes; (ii) modifying RTP packet information of the RTP packets
25 based on the tracked changes; (iii) correcting RTP control protocol (RTCP) packets corresponding to the RTP session based on the tracked changes to produce corrected RTCP packets, the corrected RTCP packets being a measure of the end-to-end reception quality of the RTP session; and (iv) reporting the end-to-end reception quality of the RTP session by forwarding the corrected RTCP packets.

BRIEF DESCRIPTION OF THE DRAWINGS

The foregoing will be apparent from the following more particular description of example embodiments of the invention, as illustrated in the accompanying drawings in which like reference characters refer to the same parts throughout the different views. The drawings are not necessarily to scale, emphasis
5 instead being placed upon illustrating embodiments of the present invention.

FIG. 1 is a network diagram of an example network in which example embodiments of the present invention may be employed;

FIG. 2A is a network diagram of an example network in which packet
10 information is modified in accordance with an example embodiment of the present invention;

FIG. 2B is a packet diagram that illustrates a typical real-time transport protocol (RTP) header and an example modified RTP header modified in accordance with an example embodiment of the present invention;

FIG. 3A is a network diagram of an example network in which report
15 packets are corrected in accordance with example embodiments of the present invention;

FIGS. 3B-1, 3B-2, 3C-1, and 3C-2 are packet diagrams that illustrate typical
20 RTP control protocol (RTCP) packets and example corrected RTCP packets corrected in accordance with example embodiments of the present invention;

FIG. 4 is a flow chart of an example process used to estimate an extended highest sequence number received in accordance with an example embodiment of the present invention;

FIG. 5 is a flow chart of an example process for measuring end-to-end
25 reception quality of an RTP session in accordance with an example embodiment of the present invention;

FIG. 6 is a block diagram of an example apparatus to measure end-to-end reception quality of an RTP session, in accordance with an example embodiment of the present invention;

FIG. 7 is a block diagram of an example correcting unit to correct packets
30 used to measure end-to-end reception quality of an RTP session, in accordance with an example embodiment of the present invention;

FIGS. 8-1 and 8-2 are flow charts providing an overview of an example process for measuring end-to-end reception quality of an RTP session, in accordance with example embodiments of the present invention;

5 FIG. 9 is a flow chart of an example process for providing a meaning of a sequence number reported in an RTCP receiver report from a receiver, in accordance with an example embodiment of the present invention;

FIG. 10-1 and 10-2 are packet diagrams that illustrate a typical RTP control protocol (RTCP) receiver report and example corrected RTCP receiver report corrected in accordance with example embodiments of the present invention;

10 FIG. 11 is a flow chart of an example process for measuring a reception quality of RTP packets sent from a sender, in accordance with an example embodiment of the present invention;

FIG. 12 is a flow chart of an example process for extracting a reception quality of RTP packets sent to a receiver, in accordance with an example
15 embodiment of the present invention; and

FIG. 13 is a block diagram of an example apparatus to measure end-to-end reception quality of an RTP session, in accordance with an example embodiment of the present invention.

DETAILED DESCRIPTION OF THE INVENTION

20 A description of example embodiments of the invention follows.

FIG. 1 is an example network 105 that includes a media processor 110 that performs media processing on packets 115 from a sender 120. Resulting media processed packets 125 are received by a receiver 130. Media processing causes changes in packets such that the packets 115 sent by the sender 120 are not the same
25 as the media processed packets 125 received by the receiver 130. These changes include, for example, a change in the number of the packets 115 sent by the sender 120 and the number of the media processed packets 125 received by the receiver 130, and a change in the size of the packets 115 sent by the sender 120 and the size of the media processed packets 125 received by the receiver 130. As an example,
30 media processing of real-time protocol (RTP) packets used in Voice over Internet Protocol (VoIP) and other time sensitive applications makes for efficient use of

network resources, e.g., by dropping or changing the size of RTP packets carrying echo as contrasted with voice.

One measure of quality of a network is reception quality. Intuitively, if what was received by a receiver matches what was sent by a sender, then the reception
5 quality of a network is “good.” Conversely, if what was received by a receiver differs from what was sent by a sender, for example, the receiver received fewer packets than were sent by the sender, the reception quality of a network is “poor.” However, in a network, such as the network 105 of FIG. 1, in which packets are media processed such that packets sent by a sender and packets received by a
10 receiver are not the same, simply comparing what was received with what was sent, and no more, produces an invalid measure of reception quality. Differences between what was received and what was sent are not necessarily due to poor reception quality of a network, but rather may be caused at least in part by media processing of packets in the network.

15 As an example, when a media processor or other RTP intermediate systems changes the RTP packet size of an RTP packet, such as to change an RTP packet carrying an echo into an RTP packet carrying comfort noise, a sender’s byte count field in an RTCP sender report does not reflect the changes in packet size. In another example, when an RTP intermediate system changes the number of RTP
20 packets transported, such as to remove an RTP packet carrying an echo as contrasted with carrying a voice, sequence numbers in RTP headers and a sender’s packet count field in an RTCP sender report do not reflect changes in packets transported. If reception reports from a receiving end system are forwarded to a sending end system by the RTP intermediate system with the reception report’s contents intact,
25 that is unchanged, an inconsistency between the two end systems may cause the reception quality feedback in the reception report to be invalid.

One way to avoid the foregoing problem of reception quality feedback is for an RTP intermediate system to discard all reception reports from a receiving end system. This approach, however, makes no reception quality feedback available.

30 Another way is for an RTP intermediate system to generate reception reports based on reception by the RTP intermediate system itself. However, this approach is inadequate because the reception quality feedback is only available for either a link

between a sending end system and the RTP intermediate system or a link between the RTP intermediate system and a receiving end system, but not between the sending end system and the receiving end system.

In yet another way, one that addresses the aforementioned inadequacies and reflects changes caused by media processing, a reception quality feedback technique may: (1) track changes to packets caused by media processing of the packets; (2) modify packet information of the packets based on the tracked changes; (3) corrects report packets based on the tracked changes; and (4) report the end-to-end reception quality by forwarding the corrected report packets. The corrected packets of this reception quality feedback technique may be considered a valid a measure of end-to-end reception quality.

One of ordinary skill in the art will readily recognize that the foregoing reception quality feedback technique and example embodiments thereof may be employed by an intermediate system, such as the media processor 110. Alternatively, the technique and example embodiments thereof may be employed by another intermediate system separate and distinct from the media processor 110. The particulars of the last technique and example embodiments thereof will now be described.

In TABLE 1, an embodiment tracks changes caused by media processing by updating both a send sequence number (sn_send) 230 and a total packet count of packets sent (tpcps) 235 by a number of packets sent to a receiver after media processing by a media processor.

In a convenient embodiment illustrated by TABLE 1, for a first packet 225a sent after media processing, the embodiment sets the send sequence number 230 to a sequence number of the first packet 225a, i.e., $sn_send = sn_first$. In some embodiments, it may be advantageous to store the sequence number of the first packet 225a. For each packet sent thereafter, after media processing, the embodiment increments the send sequence number 230 by one, i.e., $sn_send = sn_send + 1$.

For example, for a second packet 225b, the send sequence number 230 is the next sequence number after the send sequence number 230. A third packet 225c,

however, is not sent after media processing, but rather is dropped. The embodiment does not increment the send sequence number 230, i.e., $sn_send = sn_send$.

The above example illustrated in TABLE 1 highlights an important effect or result of media processing. A sequence number for a packet, as is known to the media processor 110 and the sender 120, differs from a sequence number for the packet after media processing, as is known to the media processor 110 and the receiver 130. As such, it may be said that there are two “streams” of sequence numbers: one stream for packets between the processor 110 and the sender 120 and another stream for packets between the media processor 110 and the receiver 130. There being two streams of sequence numbers has significant implications when measuring and reporting reception quality, as will be described later. In the interim, because media processing results in there being two streams of sequence numbers, sequence numbers for packets before media processing and sequence numbers for packets after media processing are not the same, but are rather corresponding.

In another convenient embodiment also illustrated by TABLE 1, for the first packet 225a, the embodiment sets a total packet count of packets (tpcps) 235 to one. For each packet sent thereafter, after media processing, the embodiment increments the total packet count of packets sent 235 by one, i.e., $tpcps = tpcps + 1$.

For example, after sending the first packet 225a, sending the second packet 225b increases the total packet count of packets sent 235 by one. The third packet 225c, however, is not sent after media processing, but rather is dropped. The embodiment does not increment the total packet count of packets sent 235, i.e., $tpcps = tpcps$.

Additionally, the embodiment tracks changes caused by media processing by updating a total octet count of packets sent (tocps) 240 by a number of octets sent to a receiver after media processing by a media processor. For the first packet 225a, the embodiment sets the total octet count of packets sent 240 to the octet count of the first packet 225a. For each packet sent thereafter, after media processing, the embodiment increments the total octet count of packets sent 240 by the octet count of the respective sent packet, i.e., $tocps = tocps + \text{octet count of packet sent}$.

For example, after sending the first packet 225a, sending the second packet 225b increases the total octet count of packets sent 240 by the octet count of the

second packet 225b. The third packet 225c, however, is not sent after media processing, but rather is dropped. The embodiment does not increment the total octet count of packets sent 240, i.e., $to cps = to cps$.

As described above, the embodiment reflects changes to packets caused by
5 media processing, such as changes in a number and a size of packets sent to a receiver, by updating a send sequence number (sn_send), a total packet count of packets sent ($tpcps$), and a total octet count of packets sent ($tocps$). Subsequently, these updated values may be further used by the embodiment to modify packet
10 information and to correct packets that are a measure of reception quality. In this way, the embodiment modifies packet information and corrects packets based on the changes caused by media processing.

FIG. 2A, is an example network 305 in which a media processor 310 media processes packets 315 from a sender 320. Resulting media processed packets 325
15 are received by a receiver 330. Each of the packets 315 sent from the sender 320 has a packet information portion (i.e. overhead) 335 and a payload portion 340. An embodiment modifies the packet information portion 335 based on changes caused by media processing. In each of the resulting media processed packets 325 sent to the receiver 330, a modified packet information portion 345 reflects the changes caused by media processing.

20 Depending on the changes caused by media processing, the payload portion 340 of the packet 315 sent from the sender 320 and a payload portion 350 of the media processed packet 325 sent to the receiver 330 after media processing may be different. For example, media processing causes the size of a packet to change. In such an example, a payload portion of a packet sent from a sender differs from the
25 payload portion after media processing.

FIG. 2B is a packet diagram that illustrates packet information, which may be a real-time transport protocol (RTP) header 355. The embodiment modifies the RTP header 355 by replacing a sequence number 360. In a modified RTP header 365, a sequence number of a packet sent after media processing (sn_send) 370
30 replaces the sequence number 360. As described above in reference to TABLE 1, the sequence number of the packet sent after media processing 370 reflects changes caused by media processing, namely, a change in the number of packets sent to a

receiver after media processing. Consequently, an RTP packet sent to a receiver after media processing has the modified RTP header 365 and not the RTP header 355.

5 While a receiver's understanding of what was received reflects changes caused by media processing, this understanding differs or is otherwise inconsistent with a sender's understanding of what was sent. Without correcting this inconsistency in understanding, a measure of end-to-end reception quality of a network in which packets are media processed and changed cannot be valid.

10 FIG. 3A is a data flow diagram that illustrates a sender's 420 understanding that what was sent is embodied or otherwise described in a sender report 425. Similarly, a receiver's 430 understanding of what was received is described in a receiver report 435. The sender 420 and the receiver 430 exchange the sender report 425 and the receiver report 435, respectively, to measure reception quality of the network. If the sender report 425 and the receiver report 435 "match," that is, the
15 sender's 420 understanding of what was sent agrees with the receiver's 430 understanding of what was received (and vice versa), then the measure of reception quality may be deemed "good." Conversely, if the sender report 425 and the receiver report 435 do not match, or rather the sender 420 disagrees with the receiver 430 regarding what was sent (and vice versa), then the measure of reception quality
20 may be deemed "bad."

In a network in which packets are media processed and thus changed, a sender's understanding of what was sent and a receiver's understanding of what was received are different. Because this difference is not due to reception quality, or lack of, necessarily, a measure reception quality based on a sender report, such as
25 the sender report 425, and a receiver report, such as the received report 435, is not entirely valid.

The embodiment corrects the sender's 420 understanding of what was sent by correcting the sender report 425. A resulting corrected sender report 440 reflects changes caused by media processing. As such, a measure of reception quality based
30 on the corrected sender report 440 is valid. A difference between the corrected sender report 440 and the receiver's 430 understanding of what was received stems from reception quality and not from changes caused by media processing.

In a similar manner, the embodiment corrects the receiver's 430 understanding of what was received by correcting the receiver report 435. A resulting corrected receiver report 445 reflects changes caused by media processing. As such, a measure of reception quality based on the corrected receiver report 445 is
5 valid. A difference between the corrected receiver report 445 and the sender's 420 understanding of what was sent is due to reception quality and not changes caused by media processing.

FIGS. 3B-1 and 3B-2 are packet diagrams that illustrate a sender report, which may be an RTP control protocol (RTCP) sender report 450. The embodiment
10 corrects the RTCP sender report 450 by replacing a sender's packet count 455 and a sender's octet count 460. The sender's packet count 455 is a total number of packets sent by a sender since starting transmission up until the RTCP sender report 450 is generated. The sender's octet count 460 is a total number of payload octets (i.e., not including header or padding) sent by the sender since starting transmission up until
15 the RTCP sender report 450 is generated.

In a corrected RTCP sender report 465, a total packet count of packets sent to a receiver (tpcps) 470 and a total octet count of packets sent to a receiver (tocps) 475 replaces the sender's packet count 455 and the sender's octet count 460, respectively. It should be appreciated that the total number of packets sent by a sender (sender's
20 packet count 455) and a total number of packets sent to a receiver (tpcps 470) are not necessarily the same because of media processing of packets. For the same reason, it should also be appreciated that the total number of octets sent by a sender (sender's octet count 460) and a total octet count of packets sent to a receiver (tocps) 475 are also not necessarily the same.

As described in reference to TABLE 1, the total packet count of packets sent
25 470 reflect changes caused by media processing, namely, a change in a number of packets sent to a receiver after media processing. The total octet count of packets sent 475 reflects a change in the size of packets sent to a receiver after media processing. As such, the corrected RTCP sender report 465 corrects an
30 inconsistency caused by media processing between a sender's understanding of what was sent from the sender and what was sent to a receiver. Having considered or otherwise accounted for changes caused by media processing with the corrected

RTCP sender report 465, a difference between a sender's understanding and what was sent to a receiver is not the result of media processing, but is rather a valid measure of reception quality.

FIGS. 3C-1 and 3C-2 are packet diagrams that illustrate a receiver report, which may be an RTP control protocol (RTCP) receiver report 480. The embodiment corrects the RTCP receiver report 480 by replacing an extended highest sequence number received (ehsnr) 485. The extended highest sequence number received 485 contains the highest sequence number received in an RTP data packet from a sender.

In a corrected RTCP receiver report 490, an estimated extended highest sequence number received (est_ehsnr) 495 replaces the extended highest sequence number received 485. Because RTP packets may be discarded as a result of media processing, resulting in packet information of packets sent to a receiver being modified with updated sequence numbers, as described in reference to TABLE 1 and FIG. 2, a sequence number carried in the extended highest sequence number received 485 in the RTCP receiver report 480 loses its meaning to a sender. To provide meaning, the embodiment estimates the extended highest sequence number received in a process, as described below.

It should be appreciated that the highest sequence number of a packet sent to a receiver and thus received by the receiver (ehsnr 485) and the highest sequence number of a packet sent from a sender are not the same necessarily because of media processing.

As such, the corrected RTCP receiver report 490 corrects an inconsistency caused by media processing between what was sent from a sender and a receiver's understanding of what was sent to the receiver. Having considered or otherwise accounted for changes caused by media processing with the corrected RTCP receiver report 490, a difference between what was sent from a sender and a receiver's understanding is not the result of media processing, but is rather a valid measure of reception quality.

While described within the context of the RTCP receiver report 480, one of ordinary skill in the art will recognize that the foregoing embodiment also applies to the RTCP sender report illustrated in FIGS. 3B-1 and 3B-2. Because an RTP

session is typically duplex, i.e., a sender is also a receiver, and vice versa, the embodiment may also correct the RTCP sender report 450 by replacing an extended highest sequence number received reported in a report block (e.g., a report block 451 of FIG. 3B-1). In this case, the extended highest sequence number received contains
5 the highest sequence number received in an RTP data packet from a receiver in a duplex RTP session.

As alluded to in the above description, estimating an extended highest sequence number received provides meaning to a case in which RTP packets are discarded as a result of media processing resulting in packet information of packets
10 sent to a receiver being modified with updated sequence numbers. However, because of media processing, an extended highest sequence number received cannot be estimated from a sequence number. Instead, the extended highest sequence number received is estimated by calculating a time when a last RTP packet sent from a sender was received (ts_lntp) according to the following:

- 15 (1) $delay_rt = ts_rr - ts_sr - DLSR$; and
(2) $ts_lntp = ts_rr - delay_rt - delay_mp$

where,

ts_rr denotes a timestamp from an RTCP receiver report record representing when the RTCP receiver report was received;

20 ts_sr denotes a timestamp from an RTCP sender report record representing when the RTCP sender report having the same synchronization source as the RTCP receiver report was received;

$delay_mp$ denotes a mean delay caused by media processing; and

25 $DLSR$ denotes a delay between receiving the last RTCP sender report and the sending an RTCP packet, e.g., a delay between a time a receiver receiving an RTCP sender report and the receiver sending an RTCP receiver report.

It is useful to note that the ts_rr and ts_sr denoting when the RTCP receiver report and the RTCP sender report were received, respectively, are not the same as a network time protocol (NTP) timestamp of an RTCP packet. The network time
30 protocol (NTP) timestamp represents when the RTCP packet was sent, e.g., from a sender (i.e., an RTCP sender report) or from a receiver (i.e., an RTCP receiver report).

The estimated extended highest sequence number received is a sequence number of an RTP record received at the calculated time ts_lrtp . In this way, it may be said that the extended highest sequence number received is estimated from time measurements, namely, (i) a time when the RTCP receiver report was received
5 (ts_rr), (ii) a time when the RTCP sender report was received (ts_sr), (iii) the mean delay caused by media processing; and (iv) the delay between receiving the last RTCP sender report and the sending an RTCP packet (e.g., the RTCP receiver report or the RTCP sender report).

FIG. 4 is a flow diagram that illustrates an example process 500 to estimate
10 an extended highest sequence number received for correcting an RTCP packet. For purposes of illustration, the RTCP packet being corrected is an RTCP receiver report sent from a receiver and received by an RTP intermediate system. It should be readily apparent that the process 500 also applies to estimating an extended highest sequence number received for correcting an RTCP sender report sent from a sender
15 and received by the RTP intermediate system.

The process 500 starts (501). The process 500 searches (505) RTCP sender report records to find those RTCP sender report records with the same synchronization source (SSRC) as a subject RTCP receiver report record which is to be corrected, i.e., $ssrc_sr = ssrc_rr$. In this way, RTCP packets of interest are limited
20 to those packets belonging to the same RTP session or call.

The process 500 searches (510) the SSRC matching RTCP sender report records to find a subject RTCP sender report record with the same network time protocol (NTP) timestamp (ntp_sr) as the subject RTCP receiver report record (ntp_rr), i.e., $ntp_sr = ntp_rr$. This further limits the RTCP packets of interest found
25 by the process 500 at (505) to just the subject RTCP packet sender report. As such, the NTP timestamp serves as a unique identifier identifying the subject RTCP packet receiver report and sender report.

The process 500 estimates (515) a round-trip transmission delay to and from a receiver ($delay_rt$) and the RTP intermediate system from the following time
30 measurements: (i) a time when the RTP intermediate system received the subject RTCP receiver report (ts_rr), (ii) a time when the RTP intermediate system received the RTCP sender report record (ts_sr) (as found by the process 500 at (505)), and

(iii) a delay between the receiver receiving the last RTCP sender report and the receiver sending the subject RTCP receiver report (DSL_R), i.e., $\text{delay_rt} = \text{ts_rr} - \text{ts_sr} - \text{DSL}_R$.

Because of media processing, the highest sequence number of RTP packets received by a receiving end-system (e.g., the receiver) up to a time when an RTCP packet (e.g., the RTCP receiver report) is generated, as reported in the RTCP packet as an extended highest sequence number received, has no significance or meaning to a transmitting end-system (e.g., the sender). Recall, however, RTP packets after media processing correspond to RTP packets before media processing.

10 Accordingly, there may be an RTP packet corresponding (i.e., a corresponding RTP packet) to the RTP packet whose sequence number is reported as the extended highest sequence number in the RTCP packet. The sequence number of the corresponding RTP packet, unlike the highest sequence number reported in the RTCP packet, does have meaning to the transmitting end-system. Accordingly, the

15 RTCP packet may be corrected (to account for media processing) by finding the sequence number of the corresponding RTP packet.

Continuing to refer to FIG. 4, to find a corresponding RTP packet and thus the sequence number of the corresponding RTP packet, the process 500 estimates (520) an approximate time (ts_lrtp) when the corresponding RTP packet was received by the RTP intermediate system from the following time measurements: (i) the time when the RTP intermediate system received the RTCP receiver report (ts_rr); (ii) the round-trip transmission delay to and from a receiver (delay_rt) and the RTP intermediate system as estimated (515) above; and (iii) an estimate of mean delay for media processing (delay_mp), i.e., $\text{ts_lrtp} = \text{ts_rr} - \text{delay_rt} - \text{delay_mp}$.

25 The process 500 continues and searches (525) RTP records to find those RTP records (ssrc_rtp) with the same SSRC as the subject RTCP receiver report (ssrc_rr), i.e., $\text{ssrc_rtp} = \text{ssrc_rr}$.

The process 500 searches (530) the SSRC matching RTP records to find the last RTP record received at the time ts_lrtp . The process 500 sets an extended

30 highest sequence number received (ehsnr) to the sequence number of the found RTP record (sn_rtp), i.e., $\text{ehsnr} = \text{sn_rtp}$.

The process 500 ends (536) with the extended highest sequence number estimated.

In a convenient embodiment, in an event an RTP packet is received by an RTP intermediate system, the process 500 stores (not shown) the following
5 information: a synchronization source identifier identifying a source of the RTP packet (ssrc_rtp), a sequence number of the RTP packet (sn_rtp), and a timestamp representing when the RTP packet was received (ts_rtp). In an event an RTCP sender report is received, the process 500 stores (not shown) the following
10 information: a synchronization source identifier identifying a source of the RTCP sender report (ssrc_sr), an NTP timestamp of the RTCP sender report (ntp_sr) representing when the RTCP sender report was sent, and a timestamp from the RTCP sender report record (ts_sr) representing when the RTCP sender report was received. In an event an RTCP receiver report is received, the process 500 stores (not shown) the following information: a synchronization source identifier
15 identifying a source of the RTCP receiver report (ssrc_rr), a last sender report timestamp (LSR) representing when the last RTCP sender report was received, and a timestamp (ts_rr) representing when the RTCP receiver report was received.

FIG. 5 is a flow diagram of a process 600 that starts (601) measuring end-to-end reception quality of an RTP session. The process 600 tracks (605) changes to
20 RTP packets of the RTP session to produce tracked changes. The tracked changes are caused by media processing of the RTP packets. The process 600 modifies (610) RTP packet information of the RTP packets based on the tracked changes. The process 600 corrects (615) RTCP packets corresponding to the RTP session based on the tracked changes to produce corrected RTCP packets reports. The corrected
25 RTCP packets are a measure of the end-to-end reception quality of the RTP session. The process 600 reports (620) the end-to-end reception quality of the RTP session by forwarding the corrected RTCP packets. The process 600 ends (621) with end-to-end reception quality of the RTP session measured.

FIG. 6 is a block diagram of an example apparatus 700 to measure end-to-end reception quality of an RTP session that has a tracking unit 705, a correcting
30 unit 710 in communication with the tracking unit 705, a modifying unit 715 also in communication with the tracking unit 705, and a reporting unit 720 in

communication with the correcting unit 710. The tracking unit 705 tracks changes 706 caused by media processing (in accordance with example embodiments described above) to produce tracked changes 707. One of ordinary skill in the art will readily recognize that the apparatus 700 may be supplied with the changes 706, 5 for example, from a media processor (not shown). Alternatively, the apparatus 700 may itself determine the change 706 caused by media processing. As such, the apparatus 700 may or may not perform media processing itself.

Based on the tracked changes 707, the correcting unit 710 corrects (denoted by an arc with an arrowhead) an RTCP packet 711 resulting in a corrected RTCP 10 packet 712, in accordance with example embodiments described. Also based on the tracked changes 707, the modifying unit 715 modifies (denoted by an arc with an arrowhead) an RTP packet 716, resulting in a modified RTP packet 717, in accordance with example embodiments described above. The reporting unit reports the end-to-end reception quality of the RTP session by forwarding the corrected 15 RTCP packet 712.

In a convenient embodiment, the example apparatus 700 has an interface (not shown) to interface the apparatus 700 to an RTP network (not shown). The interface is in communication with the correcting unit 710 to receive the RTCP packet 711 from the RTP network and is in communication with the reporting unit 720 to 20 forward the corrected RTCP packet 712 to the RTP network and thus report end-to-end reception quality. The interface is also in communication with the modifying unit 715 to receive the RTP packet 716 from the RTP network and to transmit the modified RTP packet 717 to the RTP network.

FIG. 7 is a block diagram of an example correcting unit 810 to correct an 25 RTCP packet 811 (e.g., an RTCP sender report and RTCP receiver report) and to produce a corrected RTCP packet 812. The correcting unit 810 includes a replacing unit 825 and an estimating unit 830. The replacing unit 825 replaces, in an RTCP sender report (viz., the RTCP packet 811), a first total packet count and octet count of packets sent from a sender with a second total packet count and octet count of 30 packets sent to a receiver, which is based on the tracked changes to produce a corrected RTCP sender report (viz., the corrected RTCP packet 812). The corrected RTCP sender report is a measure of the end-to-end reception quality of the RTP

session. Additionally, the replacing unit 825 replaces, in an RTCP receiver report (viz., the RTCP packet 811), an extended highest sequence number received with an estimated extended highest sequence number received (estimated by the estimating unit 830 described below), the corrected RTCP receiver report being a measure of
5 the end-to-end reception quality of the RTP session.

The estimating unit 830 estimates an extended highest sequence number 835, in accordance with example embodiments described above. The estimating unit 830 estimates the extended highest sequence number 835 from input 840. The input 840 includes: a time when an RTP intermediate system received the RTCP receiver
10 report (ts_rr); (ii) a time when the RTP intermediate system received the RTCP sender report (ts_sr); (iii) an estimate of mean delay for media processing (delay_mp); and (iv) a delay between a receiver receiving the last RTCP sender report and the receiver sending the RTCP receiver report (DSLRL).

In a convenient embodiment, the correcting unit 810 also includes a storing
15 unit (not shown) to store: (i) in an RTP record, in an event an RTP packet is received, a synchronization identifier source identifying a source of the RTP packet (ssrc_rtp), a sequence number of the RTP packet (sn_rtp), and a timestamp representing when the RTP packet was received (ts_rtp); (ii) in an RTCP sender report record, in an event an RTCP sender report is received, a synchronization
20 source identifying a source of the RTCP sender report (ssrc_sr), an NTP timestamp of the RTCP sender report (ntp_sr) representing when the RTCP sender report was sent, and a timestamp (ts_sr) representing when the RTCP sender report was received; and (iii) in an RTCP receiver report record, in an event an RTCP receiver report is received, a synchronization source identifying a source of the RTCP
25 receiver report (ssrc_rr), a last sender report timestamp (LSR) representing when the last RTCP sender report was received, and a timestamp (ts_rr) representing when the RTCP receiver report was received.

The foregoing embodiments describe correcting an RTCP receiver report by replacing an extended highest sequence number received with an estimated extended
30 highest sequence number received. The estimated extended highest sequence number received is estimated based on a time a last RTP packet sent from a sender

as received. As such, it may be said that an RTP packet is the basis for correcting an RTCP receiver report.

In another correcting technique, the basis for correcting an RTCP receiver report is an RTCP sender report. An RTCP sender report from a sender, reporting
5 what was sent (e.g., the sender's packet count 455 and the sender's octet count 460 of FIG. 3B-1), causes a receiver to respond and report in an RTCP receiver report what was received. As such, it may be said that the RTCP sender report corresponds to the RTCP receiver report (hereinafter, referred to as a corresponding sender report).

10 FIGS. 8-1 and 8-2 are flowcharts which together provide an illustrated overview of an example process 900 for measuring end-to-end reception quality of a real-time transport protocol (RTP) session. As an overview the process 900 begins (901) and waits (905) for a packet. The process 900 determines (910) whether the packet received is an RTP packet. If the process 900 determines (910) the packet
15 received is an RTP packet, the process 900 updates (915) an extended highest sequence number received from a sender to produce a current extended sequence number (current_esn).

However, if the process 900 determines (910) the packet received is not an RTP packet, the process 900 then determines (920) whether the packet received is an
20 RTCP sender report (SR).

If the process 900 determines (920) the received packet is an RTCP sender report, referred to as a corresponding sender report, the process 900 attaches (925) the current_esn to the corresponding sender report to produce an attached extended highest sequence number received (attached_ehsnr).

25 However, if the process 900 determines (920) the packet received is not an RTCP sender report, the process 900 then determines (930) whether the packet received is an RTCP receiver report (RR).

If the process 900 determines (930) the packet received is not an RTCP receiver report, the process 900 returns and waits (905) for another packet.

30 However, if the process 900 determines (930) the packet received is an RTCP receiver report, the process 900 then replaces (935) an extended highest sequence number received reported in the RTCP receiver report with the

attached_ehsnr from the corresponding sender report (as attached above at 925) to produce a corrected RTCP receiver report. The corrected RTCP receiver report is a measure of the end-to-end reception quality of the RTP session.

5 Additionally, if the process 900 determines (930) the packet received is an RTCP receiver report, the process 900 calculates (945) a packet loss from the sender for a current sender report period or duration. The process 900 further calculates (950) a packet loss to the receiver for the current sender report period or duration. The process 900 then calculates (955) an end-to-end packet loss for the current sender report period or duration from the packet loss to the sender and the packet
10 loss to the receiver (as calculated above at 945 and 950, respectively).

The process 900 also calculates (960) an end-to-end fraction lost for the current sender report period or duration. The process 900 further calculates (965) an end-to-end cumulative number of packets lost.

The process 900 replaces (970) a fraction lost and a cumulative number of
15 packets lost reported in the RTCP receiver report with the end-to-end fraction lost and the end-to-end cumulative number of packets lost (as calculated above at 960 and 965, respectively) to produce a corrected RTCP receiver report. The corrected RTCP receiver report is a measure of the end-to-end reception quality of the RTP session.

20 The process 900 then returns (971) and waits (905) for another packet.

Typically, an extended highest sequence number received reported in an RTCP receiver report (e.g., the extended highest sequence number received 485 of FIG. 3C-1) is a time reference point providing a context in which to measure reception quality of RTP packets sent from the sender to the receiver. As such, it
25 may be said that the extended highest sequence number received reported in the RTCP receiver report is a component making up a measure reception quality of RTP packets sent from the sender to the receiver.

However, because of media processing or other such processes resulting in two streams of sequence numbers (one stream of sequence numbers for RTP
30 packets sent from the sender prior to processing and another stream of sequence numbers for RTP packets sent to the receiver after processing), the highest sequence number of an RTP packet sent to a receiver (and thus received by the receiver) and

the highest sequence number of an RTP packet sent from the sender are not necessarily the same. As such, it may be said that a sequence number reported in an RTCP receiver report from a receiver as the extended highest sequence number received loses its meaning to a sender.

5 FIG. 9 is a flow chart that illustrates an example process 1000 to provide a meaning of a sequence number reported in an RTCP receiver report from a receiver. The process 1000 starts (1001). The process 1000 tracks (1005) sequence numbers of RTP packets sent from a sender to produce a current extended sequence number. It should be appreciated that the sequence numbers may be extended or otherwise
10 calculated with a corresponding count of sequence number cycles to account for recycling of the sequence numbers. The process 1000, in an event an RTCP sender report is received (1010), attaches (1015) the current extended sequence number to the RTCP sender report received to produce an attached extended highest sequence number received. In this way, the attached extended highest sequence number
15 received represents an RTP packet sent from the sender prior to the sender sending the RTCP sender report. The process 1000 ends (1016) with the meaning of the sequence number reported in the RTCP receiver report from the receiver provided.

 Having provided a meaning, an attached extended highest sequence number received attached to an RTCP sender report which corresponds to an RTCP receiver
20 report, corrects the RTCP receiver report and produces a corrected RTCP receiver report. The corrected RTCP receiver report corrects an inconsistency caused by media processing between what was sent from a sender and a receiver's understanding of what was sent to the receiver. By considering or otherwise accounting for changes caused by media processing with the corrected RTCP
25 receiver report, a difference between what was sent from a sender and a receiver's understanding is not the result of media processing, but is rather a valid measure of end-to-end reception quality of an RTP session.

 FIGS. 10-1 and 10-2 are packet diagrams that illustrate a receiver report, which may be an RTP control protocol (RTCP) receiver report 1105. In an
30 illustrated example, an embodiment corrects the RTCP receiver report 1105 by replacing an extended highest sequence number received 1110. In a corrected RTCP receiver report 1125, an attached extended highest sequence number received 1130

replaces the extended highest sequence number received 1110. As such, in this embodiment, it may be said that an attached extended highest sequence number received corrects an RTCP receiver report directly.

5 Other embodiments, on the other hand, correct an RTCP receiver report by replacing a measure of reception quality reported with a measure of reception quality calculated or otherwise determined from an extended highest sequence number received. As such, in these embodiments, it may be said that an attached extended highest sequence number received corrects an RTCP receiver report indirectly.

10 Continuing with FIGS. 10-1 and 10-2, in the illustrated example, another embodiment replaces a fraction lost 1115 and a cumulative number of packets lost 1120. The fraction lost 1115 is the fraction of RTP data packets from a sender lost since a previous receiver report packet. The cumulative number of packets lost 1120 is the total number of RTP data packets from a sender lost since the beginning of an RTP session.

15 In the corrected RTCP receiver report 1125, a combined measure of reception quality of RTP packets sent from the sender to the receiver replaces the measure of reception quality of RTP packets sent from the sender. In the illustrated example, a combined fraction lost 1135 (labeled in FIG. 10-2 as c_ fraction lost) and a combined cumulative number of packets lost 1140 (labeled in FIG. 10-2 as c_ cumulative number of packets lost) replace the fraction lost 1115 and the cumulative number of packets lost 1120, respectively.

20 The embodiment combines a first measure of reception quality of packets sent from a sender with a second measure of reception quality of packets sent to a receiver to produce a combined third measure of reception quality of packets sent from the sender to the receiver.

The combined third measure of reception quality, such as the combined fraction lost 1135 (combined_fraction_lost), may be produced by combining as follows:

30 (3) combined_fraction_lost = (packet_lost_sender + packet_lost_receiver) / packet_expected

where,

packet_lost_sender is a number of RTP packets sent from the sender lost during a duration defined by a first time and a second time;

packet_lost_receiver is a number of RTP packets sent to the receiver lost during the duration; and

5 packet_expected is a number of RTP packets expected from the sender during the duration.

In another example, the combined third measure of reception quality, such as the combined cumulative number of packets lost 1140 (combined_cnpl), may be produced by combining as follows:

10
$$(4) \text{ combined_cnpl} = \text{count_cnpl} + \text{cnpl_current}$$

where,

count_cnpl is a total number of RTP packets sent from the sender lost during an RTP session (i.e., packet_lost_sender for a duration defined by the RTP session); and

15 cnpl_current is the total number of RTP packets sent to the receiver lost since the beginning of the RTP session.

FIG. 11 is a flow chart that illustrates an example process 1200 to measure a reception quality of RTP packets sent from a sender. The process 1200 starts (1201). The process 1200 determines (1205) a number of RTP packets expected from a sender during a duration defined by a first time and a second time (packets_expected). The duration may be a sender report interval which begins with receiving a first sender report and ends with receiving a second sender report. Continuing with FIG. 11, the process 1200 determines (1205) the packets_expected from a first extended highest sequence number received attached to a first RTCP sender report received at the first time (attached_ehsnr_{at time 1}), and (ii) a second extended highest sequence number received attached to a second RTCP sender report received at the second time (attached_ehsnr_{at time 2}), i.e., packets_expected = attached_ehsnr_{at time 2} - attached_ehsnr_{at time 1}.

25 It is important to note that an RTCP sender report from a sender lacks an appropriate field to report an attached extended highest sequence number received (attached_ehsnr). As noted earlier, an RTP session is typically duplex in which a sender is also a receiver, and vice versa. As such, the RTCP sender report may

include one or more report blocks (e.g., the report block 451 of FIG. 3B-1) reporting what was received by the sender. The extended highest sequence number received (ehsnr) reported in the report block in the RTCP sender report, however, is the extended highest sequence number of a packet received by the sender and not the
5 extended highest sequence number of a packet sent by the sender (i.e., the attached_ehsnr). Accordingly, an attached_ehsnr is not reported in an RTCP sender report from a sender, but is rather attached to the RTCP sender report in the process described above.

The process 1200 determines (1210) a number of RTP packets sent from the
10 sender lost during the duration (packet_lost_sender) from the packets_expected, as determined (1205) above, and a number of RTP packets sent from the sender received prior to media processing during the duration (packets_received), i.e.,
$$\text{packet_lost_sender} = \text{packet_expected} - \text{packet_received}.$$

The process 1200 ends (1211) with the reception quality of the RTP packets
15 sent from the sender measured.

In a convenient embodiment (not shown), in an event an RTCP sender report is received by an RTP immediate system, the embodiment stores (not shown) in an RTCP sender report record the following information: synchronization source (SSRC) of a sender sending the sender report (SSRC_sr), Network Time Protocol
20 (NTP) timestamp of the sender report (NTP_sr), timestamp representing the time when the sender report was received by the RTP immediate system (TS_sr), number of packets expected from the sender during a duration or sender report interval (e.g., the packet_expected determined (1205) above), number of RTP packets sent from the sender lost during the duration (e.g., the packet_lost_sender determined (1210)
25 above).

In another convenient embodiment (not shown), in an event a subject RTCP receiver report is received by an RTP intermediate system to be corrected, the embodiment retrieves a stored number of packets expected from the sender during a duration or sender report interval (e.g., the packet_expected determined (1205)
30 above) and stored number of RTP packets sent from the sender lost during the duration (e.g., the packet_lost_sender determined (1210) above).

To retrieve the foregoing, the embodiment searches RTCP sender report records to find those RTCP sender report records with the same synchronization source (SSRC) as the subject RTCP receiver report, i.e., $ssrc_sr = ssrc_rr$. In this way, RTCP packets of interest are limited to those packets belonging to the same
5 RTP session or call.

Using the last sender report timestamp in the subject RTCP receiver report (LSR_rr) the embodiment searches the SSRC matching RTCP sender report records to find a subject RTCP sender report record with the same network time protocol (NTP) timestamp (ntp_sr), i.e., $ntp_sr = LSR_rr$. In this way, the RTCP packets of
10 interest found by the embodiment are further limited to just the subject RTCP packet sender report.

FIG. 12 is a flow chart that illustrates an example process 1300 to extract a reception quality of RTP packets sent to a receiver. The process 1300 starts (1301). The process 1300 determines (1305) a number of RTP packets sent to the receiver
15 lost during a duration defined by a first time and a second time ($packets_lost_receiver$) from a first cumulative number of packets lost reported in a first RTCP receiver report (such as the RTCP receiver report 1105 of FIG. 10-1) at the first time ($cnpl_{at\ time\ 1}$), and a second cumulative number of packets lost reported in a second RTCP receiver report at the second time $cnpl_{at\ time\ 2}$, i.e., $packet_lost_$
20 $receiver = cnpl_{at\ time\ 2} - cnpl_{at\ time\ 1}$.

The process 1300 ends (1306) with the reception quality of the RTP packets sent to the receiver extracted.

FIG. 13 is a block diagram of an example apparatus 1400 to measure end-to-end reception quality of an RTP session that has a tracking unit 1405, an attaching
25 unit 1410 in communication with the tracking unit 1405, and a correcting unit 1415 in communication with the attaching unit 1410. The tracking unit 1405 tracks sequence numbers of RTP packets sent from a sender 1406 to produce a current extended sequence number 1407. In an event the apparatus 1400 receives an RTCP sender report 1401 (or an indication thereof), the attaching unit 1410 attaches the
30 current extended sequence number 1407 to the received RTCP sender report 1401 to produce an attached extended highest sequence number received 1411. With the attached extended highest sequence number received 1411, the correcting unit 1415

corrects (denoted by an arc with an arrowhead) an RTCP receiver report 1416 resulting in a corrected RTCP receiver report 1417, in accordance with example embodiments described.

5 While this invention has been particularly shown and described with references to example embodiments thereof, it will be understood by those skilled in the art that various changes in form and details may be made therein without departing from the scope of the invention encompassed by the appended claims.

10 It should be understood that the network, flow, and block diagrams may include more or fewer elements, be arranged differently, or be represented differently. It should be understood that implementation may dictate the network, flow, and block diagrams and the number of network, flow, and block diagrams illustrating the execution of embodiments of the invention.

15 It should be understood that elements of the network, flow, and block diagrams described above may be implemented in software, hardware, or firmware. In addition, the elements of the network, flow, and block diagrams described above may be combined or divided in any manner in software, hardware, or firmware. If implemented in software, the software may be written in any language that can support the embodiments disclosed herein. The software may be stored on any form of computer readable medium, such as random access memory (RAM), read only
20 memory (ROM), compact disk read only memory (CD-ROM), and so forth. In operation, a general purpose or application specific processor loads and executes the software in a manner well understood in the art.

CLAIMS

What is claimed is:

1. A method for measuring end-to-end reception quality of a real-time transport protocol (RTP) session, the method comprising:
 - 5 tracking changes to RTP packets of the RTP session caused by media processing of the RTP packets to produce tracked changes;
 - modifying RTP packet information of the RTP packets based on the tracked changes;
 - correcting RTP control protocol (RTCP) packets corresponding to the
10 RTP session based on the tracked changes to produce corrected RTCP packets, the corrected RTCP packets being a measure of the end-to-end reception quality of the RTP session; and
 - reporting the end-to-end reception quality of the RTP session by forwarding the corrected RTCP packets.
- 15 2. The method of claim 1 wherein tracking changes includes:
 - updating a send sequence number by a number of RTP packets sent to the receiver after media processing;
 - updating a total packet count of packets sent to the receiver after
20 media processing; and
 - updating a total octet count of packets sent to the receiver after media processing.
- 25 3. The method of claim 2 wherein updating the send sequence number includes:
 - storing a sequence number of a first RTP packet in the RTP session to be sent after media processing;
 - setting the send sequence number to the stored sequence number; and
 - incrementing the send sequence number by one for each RTP packet sent thereafter after media processing.

30

4. The method of claim 2 wherein updating the total packet count of packets sent includes:
- resetting the total packet count of packets sent to one in an event the RTP session is a new RTP session;
 - 5 incrementing the total packet count of packets by one for each RTP packet sent thereafter after media processing; and
 - incrementing the total octet count of packets by the octet count of each RTP packet sent thereafter after media processing.
- 10 5. The method of claim 1 wherein modifying includes replacing a first sequence number in the RTP packet information of an RTP packet sent from a sender with a second sequence number which is based on the tracked changes.
6. The method of claim 1 wherein correcting includes in an RTCP sender report
15 replacing a first total packet count and octet count of packets sent from a sender with a second total packet count and octet count of packets sent to a receiver which is based on the tracked changes to produce a corrected RTCP sender report, the corrected RTCP sender report being a measure of the end-to-end reception quality of the RTP session.
- 20 7. The method of claim 1 wherein correcting includes in an RTCP receiver report, replacing an extended highest sequence number received with an estimated extended highest sequence number received to produce a corrected RTCP receiver report, the corrected RTCP receiver report being a measure of
25 the end-to-end reception quality of the RTP session.
8. The method of claim 7 further comprising estimating an extended highest sequence number received from: (i) a timestamp from an RTCP receiver report record (ts_rr) representing when the RTCP receiver report was
30 received; (ii) a timestamp from a subject RTCP sender report record (ts_sr) with a same synchronization source as the RTCP receiver report representing when the RTCP sender report was received; (iii) a mean delay caused by

media processing; and (iv) a delay since last sender report (DLSR) from the subject RTCP sender report representing a delay between receiving a last RTCP sender report and the subject RTCP sender report.

5 9. The method of claim 8 wherein estimating includes:

in an event an RTP packet is received, storing in an RTP record a synchronization source identifying a source of the RTP packet (ssrc_rtp), a sequence number of the RTP packet (sn_rtp), and a timestamp representing when the RTP packet was received (ts_rtp);

10 in an event an RTCP sender report is received, storing in an RTCP sender report record a synchronization source identifying a source of the RTCP sender report (ssrc_sr), an NTP timestamp of the RTCP sender report (ntp_sr) representing when the RTCP sender report was sent, and a timestamp (ts_sr) representing when the RTCP sender report was received;
15 and

in an event an RTCP receiver report is received, storing in an RTCP receiver report record a synchronization source identifying a source of the RTCP receiver report (ssrc_rr), a last sender report timestamp (LSR) representing when the last RTCP sender report was received, and a
20 timestamp (ts_rr) representing when the RTCP receiver report was received.

10. The method of claim 1 further comprising:

tracking sequence numbers of RTP packets sent from a sender to produce a current extended sequence number; and

25 in an event an RTCP sender report is received, attaching the current extended sequence number to the RTCP sender report to produce an attached extended highest sequence number received at a time of the RTCP sender report received.

30 11. The method of claim 10 wherein correcting includes in an RTCP receiver report, replacing an extended highest sequence number received with an attached extended highest sequence number received attached to an RTCP

sender report which corresponds to the RTCP receiver report to produce a corrected RTCP receiver report, the corrected RTCP receiver report being a measure of the end-to-end reception quality of the RTP session.

- 5 12. The method of claim 11 further comprising:
- in an event an RTCP sender report is received, storing in an RTCP sender report record: (i) a synchronization source identifying a source of the RTCP sender report (ssrc_sr), (ii) an NTP timestamp of the RTCP sender report (ntp_sr) representing when the RTCP sender report was sent, and (iii)
- 10 the attached extended highest sequence number received attached to the RTCP sender report received; and
- in an event an RTCP receiver report is received, retrieving from a corresponding RTCP sender report record, a stored attached extended highest sequence number received attached to a corresponding RTCP sender report
- 15 which corresponds to the RTCP receiver report received, the corresponding RTCP sender report record having: (i) a stored synchronization source the same as a reported synchronization source reported in the RTCP receiver report received (ssrc_rr); and (ii) a stored NTP timestamp the same as a reported last SR timestamp reported in the RTCP receiver report received
- 20 (lsr_rr) representing when the last RTCP sender report was received.
13. The method of claim 10 wherein correcting includes:
- measuring a reception quality of RTP packets sent from the sender to produce a measured first measure of reception quality of RTP packets sent
- 25 from the sender;
- extracting from an RTCP receiver report a reception quality of RTP packets sent to a receiver to produce an extracted second measure of reception quality of RTP packets sent to the receiver;
- combining the measured first measure of reception quality with the
- 30 extracted second measure of reception quality to produce a combined third measure of reception quality of RTP packets sent from the sender to the receiver;

replacing in the RTCP receiver report, a measure of reception quality of RTP packets sent to the receiver with the combined third measure of reception quality of RTP packets sent from the sender to the receiver to produce a corrected RTCP receiver report, the corrected RTCP receiver report being a measure of the end-to-end reception quality of the RTP session.

14. The method of claim 13 wherein measuring includes determining: (a) a number of RTP packets expected from the sender during a duration defined by a first time and a second time and (b) a number of RTP packets sent from the sender lost during the duration from: (i) a first attached extended highest sequence number attached to a first RTCP sender report received at the first time, (ii) a second attached extended highest sequence number attached to a second RTCP sender report received at the second time, and (iii) a number of RTP packets sent from the sender received prior to media processing during the duration, to produce the measured first measure of reception quality.

15. The method of claim 14 further comprising:
in an event an RTCP sender report is received, storing in an RTCP sender report record: (i) a synchronization source identifying a source of the RTCP sender report (ssrc_sr), (ii) an NTP timestamp of the RTCP sender report (ntp_sr) representing when the RTCP sender report was sent, (iii) the number of RTP packets expected during the duration, and (iv) a number of RTP packets sent from the sender lost during the duration; and

in an event an RTCP receiver report is received, retrieving from a corresponding RTCP sender report record: (a) a stored number of RTP packets expected during a duration, and (b) a stored number of RTP packets sent from the sender lost during the duration, the corresponding RTCP sender report record having: (i) a stored synchronization source the same as a reported synchronization source reported in the RTCP receiver report received (ssrc_rr); and (ii) a stored NTP timestamp the same as a reported

last SR timestamp reported in the RTCP receiver report received (lsr_rr) representing when the last RTCP sender report was received.

16. The method of claim 13 wherein extracting includes determining a number
5 of RTP packets sent to the receiver lost during a duration defined by a first time and a second time from: (i) a first cumulative number of packets lost reported in a first RTCP receiver report at the first time and (ii) a second cumulative number of packets lost reported in a second RTCP receiver report at the second time, to produce the extracted second measure of reception
10 quality.
17. An apparatus to measure end-to-end reception quality of a real-time transport protocol (RTP) session, comprising:
a tracking unit to track changes to RTP packets of the RTP session
15 caused by media processing of the RTP packets to produce tracked changes;
a modifying unit in communication with the tracking unit to modify RTP packet information of the RTP packets based on the tracked changes;
a correcting unit in communication with the tracking unit to correct
RTP control protocol (RTCP) packets corresponding to the RTP session
20 based on the tracked changes to produce corrected RTCP packets, the corrected RTCP packets being a measure of the end-to-end reception quality of the RTP session; and
a reporting unit to report the end-to-end reception quality of the RTP session by forwarding the corrected RTCP packets.
25
18. The apparatus of claim 17 wherein the tracking unit includes:
a first updating unit to update a send sequence number by a number
of RTP packets sent to the receiver after media processing;
a second updating unit to update a total packet count of packets sent
30 to the receiver after media processing; and
a third updating unit to update a total octet count of packets sent to the receiver after media processing.

19. The apparatus of claim 18 wherein the first updating unit includes:
- a storing unit to store a sequence number of a first RTP packet in the RTP session to be sent after media processing;
 - 5 a setting unit to set the send sequence number to the stored sequence number; and
 - a incrementing unit to increment the send sequence number by one for each RTP packet sent thereafter after media processing.
- 10 20. The apparatus of claim 18 wherein the second updating unit includes:
- a resetting unit to reset the total packet count of packets sent to one in an event the RTP session is a new RTP session;
 - a first incrementing unit to increment the total packet count of packets by one for each RTP packet sent thereafter after media processing;
 - 15 and
 - a second incrementing unit to increment the total octet count of packets by the octet count of each RTP packet sent thereafter after media processing.
- 20 21. The apparatus of claim 17 wherein modifying unit includes a replacing unit to replace a first sequence number in the RTP packet information of an RTP packet sent from a sender with a second sequence number which is based on the tracked changes.
- 25 22. The apparatus of claim 17 wherein the correcting unit includes a replacing unit to replace, in an RTCP sender report, a first total packet count and octet count of packets sent from a sender with a second total packet count and octet count of packets sent to a receiver which is based on the tracked changes to produce a corrected RTCP sender report, the corrected RTCP sender report being a measure of the end-to-end reception quality of the RTP session.
- 30

23. The apparatus of claim 17 wherein correcting unit includes a replacing unit to replace, in an RTCP receiver report, an extended highest sequence number received with an estimated extended highest sequence number received to produce a corrected RTCP receiver report, the corrected RTCP receiver report being a measure of the end-to-end reception quality of the RTP session.
24. The apparatus of claim 23 wherein the correcting unit further includes an estimating unit to estimate an extended highest sequence number received from: (i) a timestamp from the RTCP receiver report record (ts_rr) representing when the RTCP receiver report was received; (ii) a timestamp from a subject RTCP sender report (ts_sr) with a same synchronization source as the RTCP receiver report representing when the RTCP sender report was received; (iii) a mean delay caused by media processing; and (iv) a delay since last sender report (DLSR) from the subject RTCP sender report representing a delay between receiving a last RTCP sender report and the subject RTCP sender report.
25. The apparatus of claim 18 wherein the correcting unit further includes an storing unit to: (i) in an event an RTP packet is received, store a synchronization source identifying a source of the RTP packet (ssrc_rtp), a sequence number of the RTP packet (sn_rtp), and a timestamp representing when the RTP packet was received (ts_rtp); (ii) in an event an RTCP sender report is received, store a synchronization source identifying a source of the RTCP sender report (ssrc_sr), an NTP timestamp of the RTCP sender report (ntp_sr) representing when the RTCP sender report was sent, and a timestamp (ts_sr) representing when the RTCP sender report was received; and (iii) in an event an RTCP receiver report is received, store a synchronization source identifying a source of the RTCP receiver report (ssrc_rr), a last sender report timestamp (LSR) representing when the last RTCP sender report was received, and a timestamp (ts_rr) representing when the RTCP receiver report was received.

26. The apparatus of claim 17 further comprising:
- a tracking unit to track sequence numbers of RTP packets sent from a sender to produce a current extended sequence number; and
 - an attaching unit in communication with the tracking unit and the correcting unit to attach, in an event an RTCP sender report is received, the current extended sequence number to the RTCP sender report to produce an attached extended highest sequence number received at a time of the RTCP sender report received.
27. The apparatus of claim 26 wherein the correcting unit includes a replacing unit to replace, in an RTCP receiver report, an extended highest sequence number received with an attached extended highest sequence number received attached to an RTCP sender report which corresponds to an RTCP receiver report to produce a corrected RTCP receiver report, the corrected RTCP receiver report being a measure of the end-to-end reception quality of the RTP session.
28. The apparatus of claim 27 further comprising:
- a storing unit to store, in an event an RTCP sender report is received, in an RTCP sender report record: (i) a synchronization source identifying a source of the RTCP sender report (ssrc_sr), (ii) an NTP timestamp of the RTCP sender report (ntp_sr) representing when the RTCP sender report was sent, and (iii) the attached extended highest sequence number received attached to the RTCP sender report received; and
 - a retrieving unit to retrieve, in an event an RTCP receiver report is received, from a corresponding RTCP sender report record a stored attached extended highest sequence number received attached to a corresponding RTCP sender report which corresponds to the RTCP receiver report received, the corresponding RTCP sender report record having: (i) a stored synchronization source the same as a reported synchronization source reported in the RTCP receiver report received (ssrc_rr); and (ii) a stored NTP timestamp the same as a reported last SR timestamp reported in the RTCP

receiver report received (lsr_rr) representing when the last RTCP sender report was received.

29. The apparatus of claim 26 wherein the correcting unit includes:

5 a measuring unit to measure a reception quality of RTP packets sent from the sender to produce a measured first measure of reception quality of RTP packets sent from the sender;

an extracting unit to extract from an RTCP receiver report a reception quality of RTP packets sent to a receiver to produce an extracted second
10 measure of reception quality of RTP packets sent to the receiver;

a combining unit to combine the measured first measure of reception quality with the extracted second measure of reception quality to produce a combined third measure of reception quality of RTP packets sent from the sender to the receiver;

15 a replacing unit to replace, in the RTCP receiver report, a measure of reception quality of RTP packets sent to the receiver with the combined third measure of reception quality of RTP packets sent from the sender to the receiver to produce a corrected RTCP receiver report, the corrected RTCP receiver report being a measure of the end-to-end reception quality of the
20 RTP session.

30. The apparatus of claim 29 wherein the measuring unit includes a determining unit to determine: (a) a number of RTP packets expected from the sender during a duration defined by a first time and a second time and (b) a number
25 of RTP packets sent from the sender lost during the duration from: (i) a first attached extended highest sequence number attached to a first RTCP sender report received at the first time, (ii) a second attached extended highest sequence number attached to a second RTCP sender report received at the second time, and (iii) a number of RTP packets sent from the sender received
30 prior to media processing during the duration, to produce the measured first measure of reception quality.

31. The apparatus of claim 30 further comprising:
a storing unit to store, in an event an RTCP sender report is received, in an RTCP sender report record: (i) a synchronization source identifying a source of the RTCP sender report (ssrc_sr), (ii) an NTP timestamp of the RTCP sender report (ntp_sr) representing when the RTCP sender report was sent, (iii) the number of RTP packets expected during the duration, and (iv) a number of RTP packets sent from the sender lost during the duration; and
a retrieving unit to retrieve, in an event an RTCP receiver report is received, from a corresponding RTCP sender report record: (a) a stored number of RTP packets expected during a duration, and (b) a stored number of RTP packets sent from the sender lost during the duration, the corresponding RTCP sender report record having: (i) a stored synchronization source the same as a reported synchronization source reported in the RTCP receiver report received (ssrc_rr); and (ii) a stored NTP timestamp the same as a reported last SR timestamp reported in the RTCP receiver report received (lsr_rr) representing when the last RTCP sender report was received.
32. The apparatus of claim 29 wherein the extracting unit includes a determining unit to determine a number of RTP packets sent to the receiver lost during a duration defined by a first time and a second time from: (i) a first cumulative number of packets lost reported in a first RTCP receiver report at the first time and (ii) a second cumulative number of packets lost reported in a second RTCP receiver report at the second time, to produce the extracted second measure of reception quality.
33. A computer program product including a computer readable medium having a computer readable program, the computer readable program, when executed by a computer causes the computer to:
track changes to real-time transport protocol (RTP) packets of an RTP session caused by media processing of the RTP packets to produce tracked changes;

modify RTP packet information of the RTP packets based on the tracked changes;

5 correct RTP control protocol (RTCP) packets corresponding to the RTP session based on the tracked changes to produce corrected RTCP packets, the corrected RTCP packets being a measure of the end-to-end reception quality of the RTP session; and

report the end-to-end reception quality of the RTP session by forwarding the corrected RTCP packets.

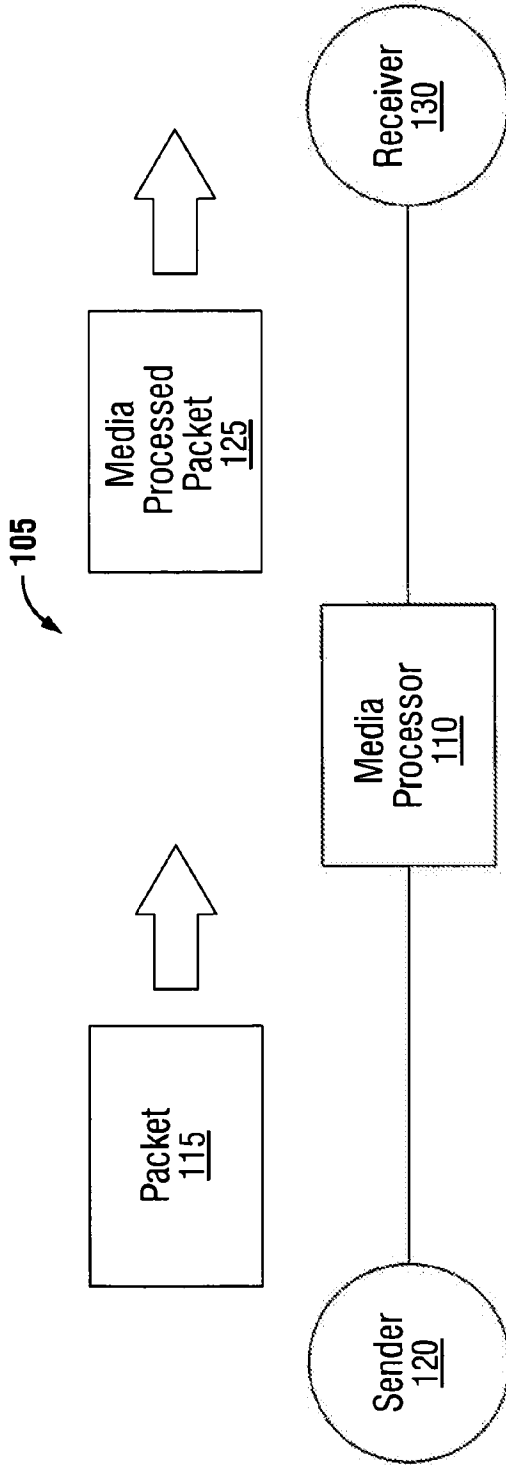


FIG. 1

packet	sn_send	tpcps	240
1st_packet	sn_first	1	octet count of packet sent
2nd_packet	sn_send + 1	tpcps + 1	tpcps + octet count of packet sent
3rd_packet*	sn_send	tpcps	tpcps

*Packet dropped as a result of media processing.

TABLE 1

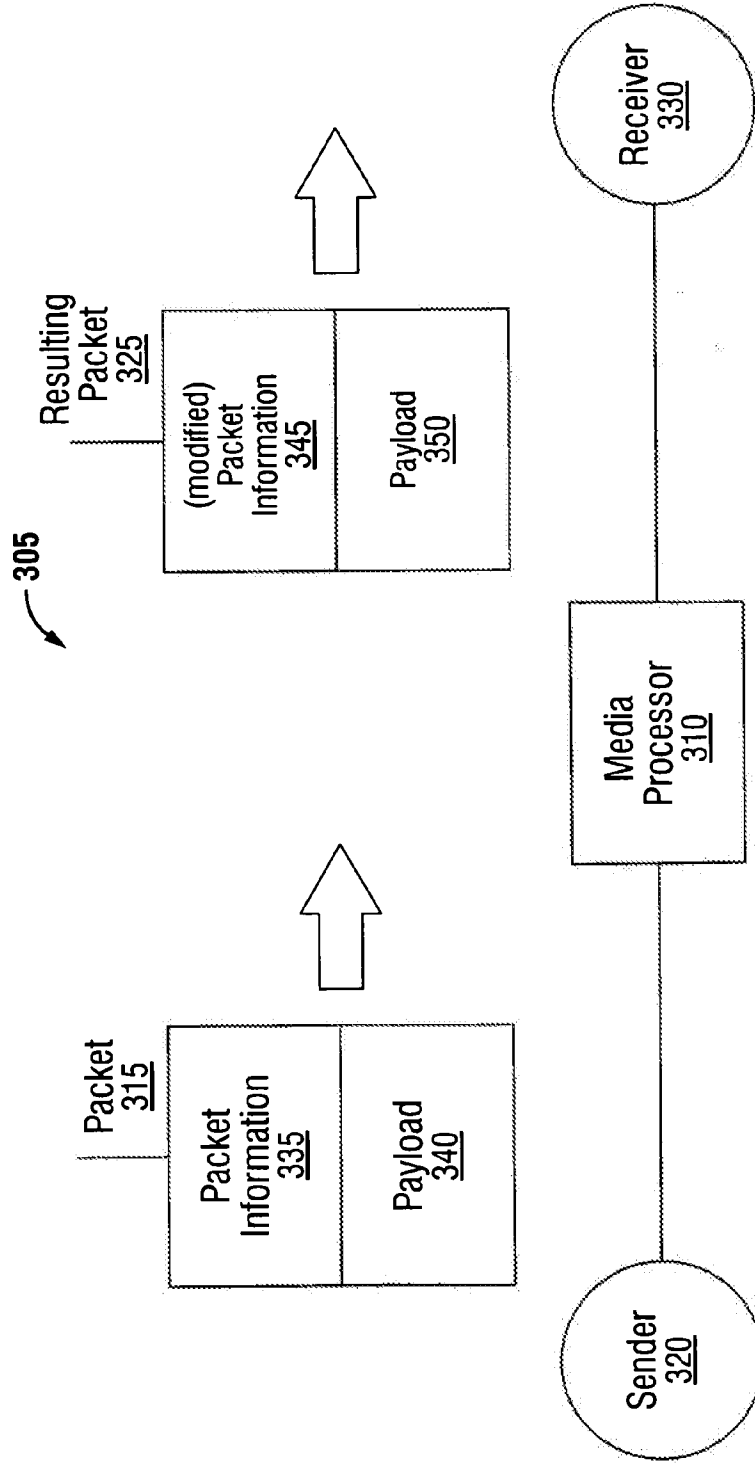
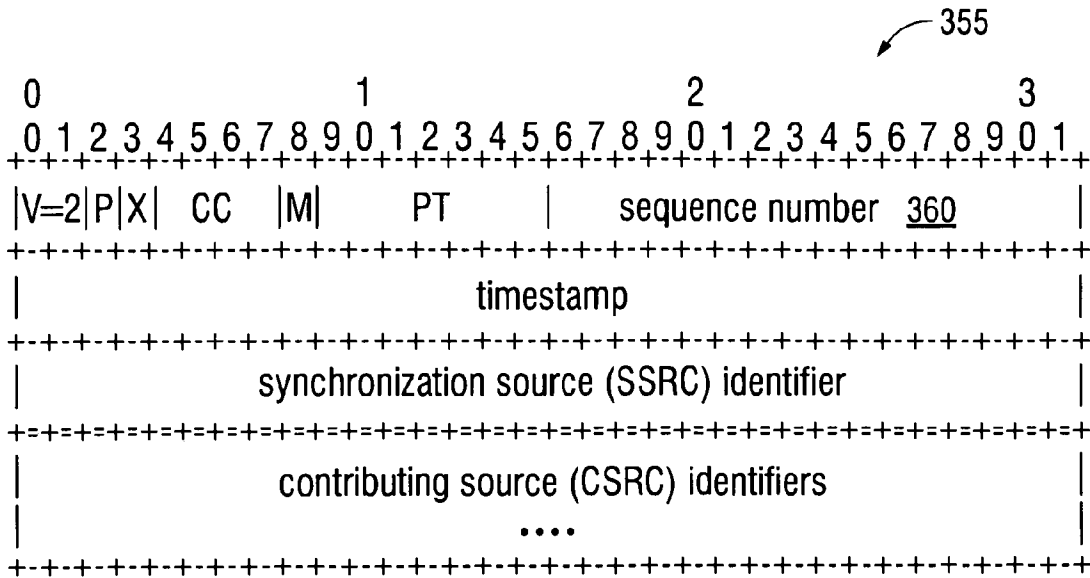


FIG. 2A

3/20



Modify packet information based on changes caused by media processing

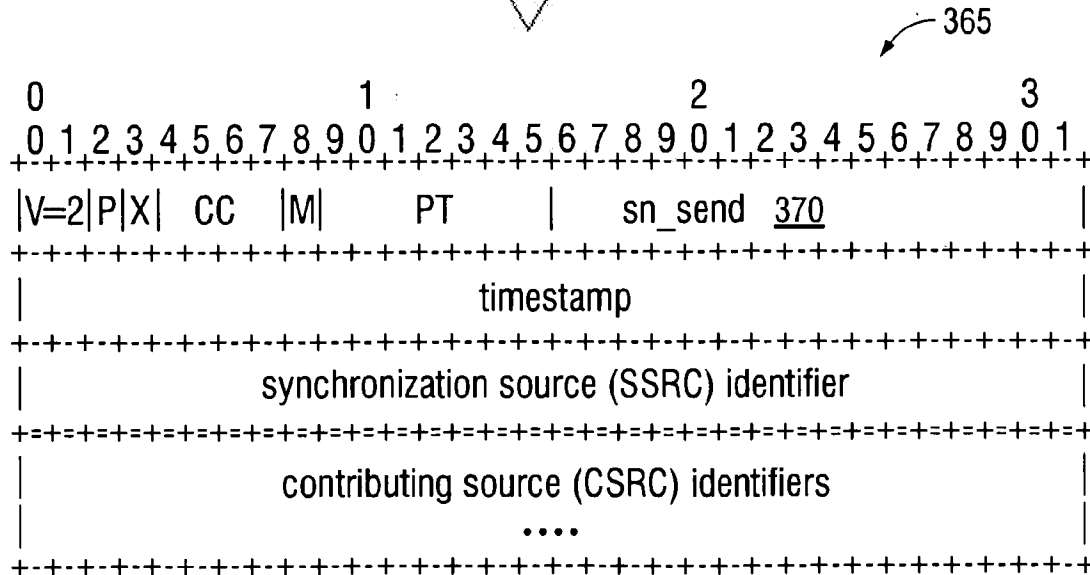


FIG. 2B

4/20

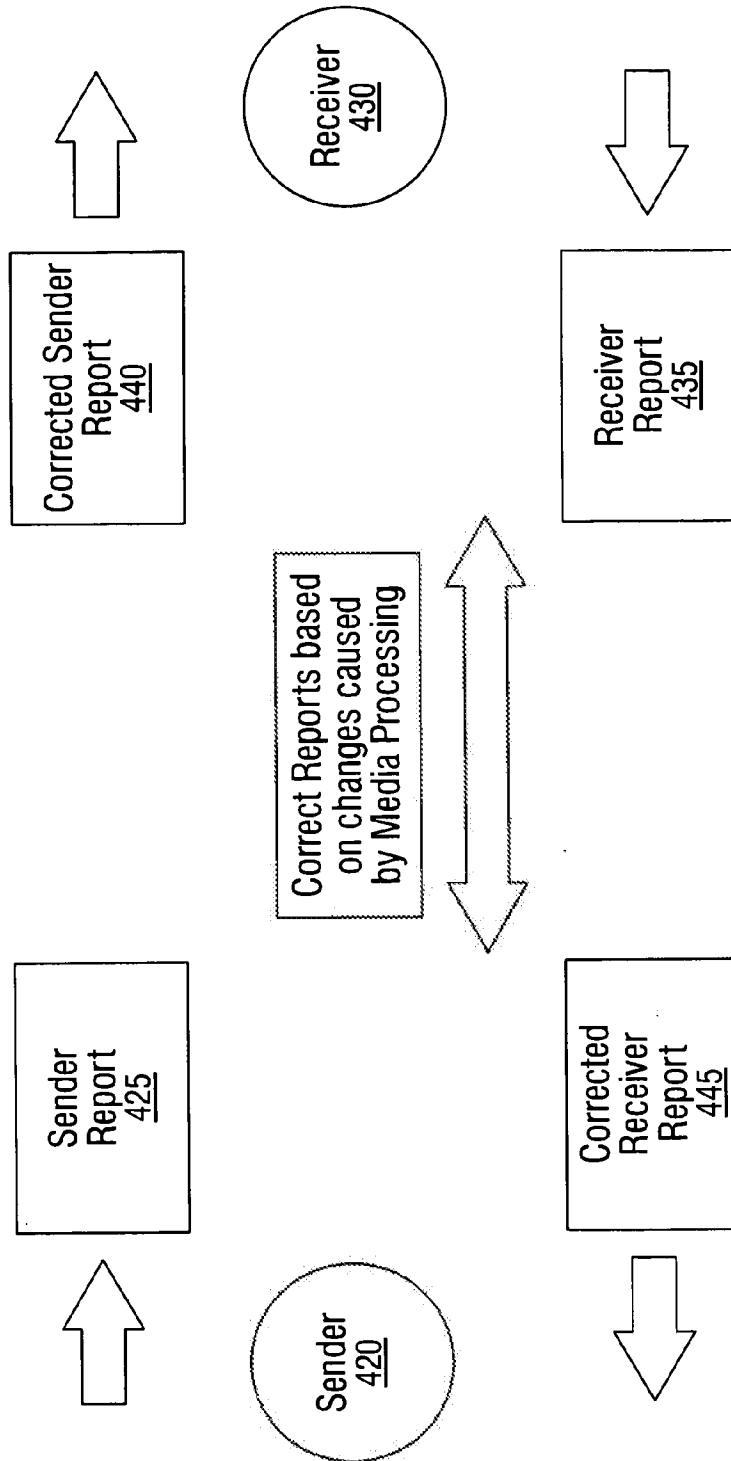


FIG. 3A

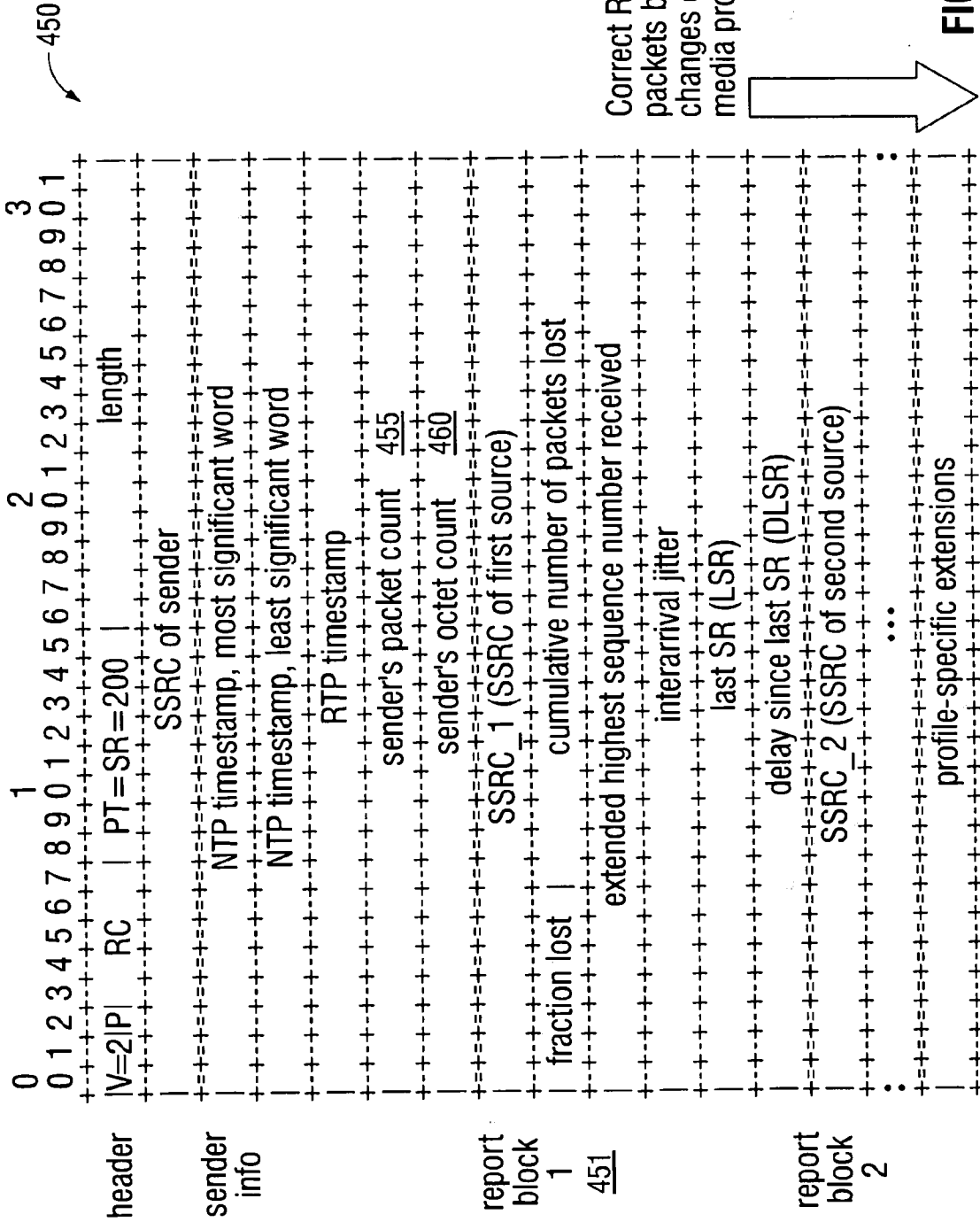


FIG. 3B-1

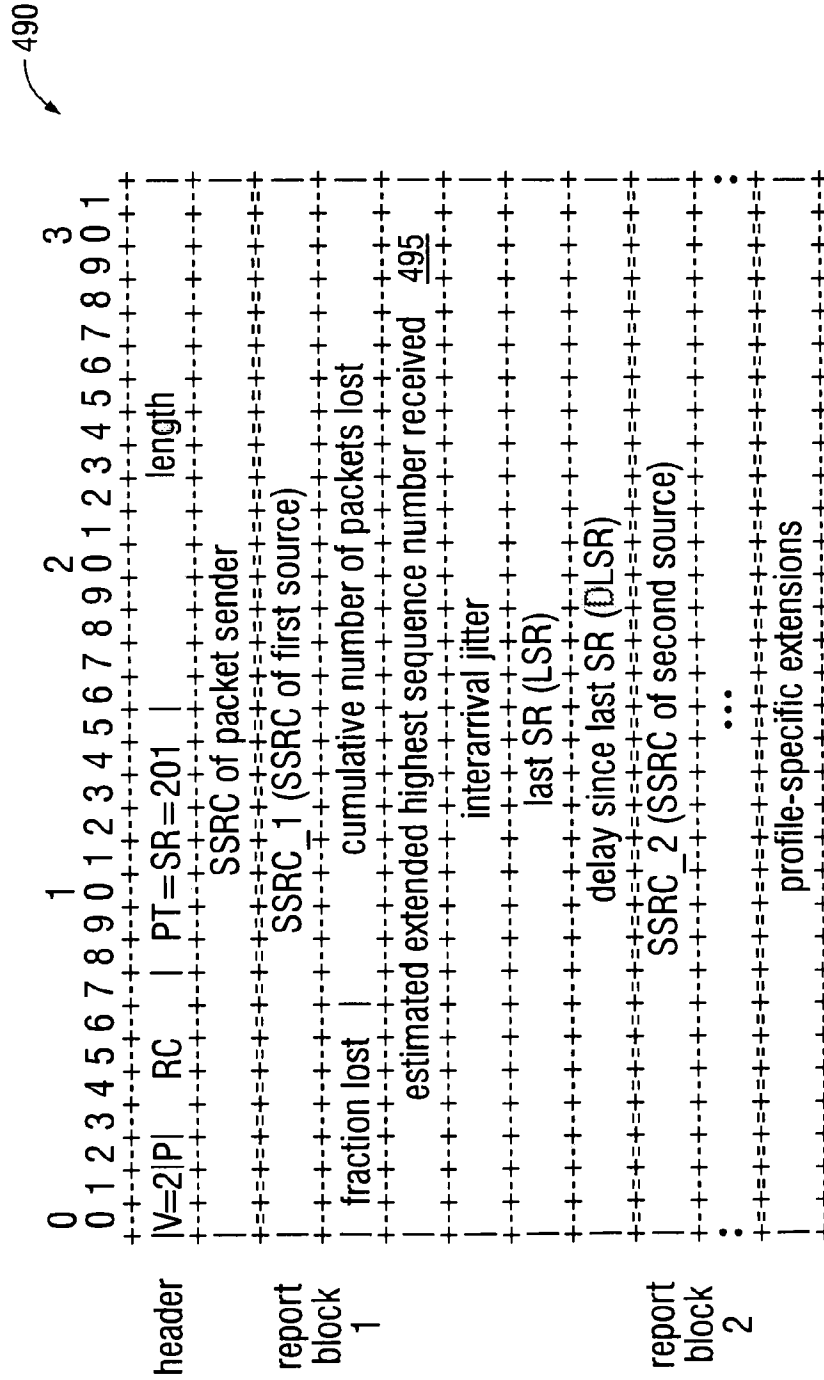


FIG. 3C-2

9/20

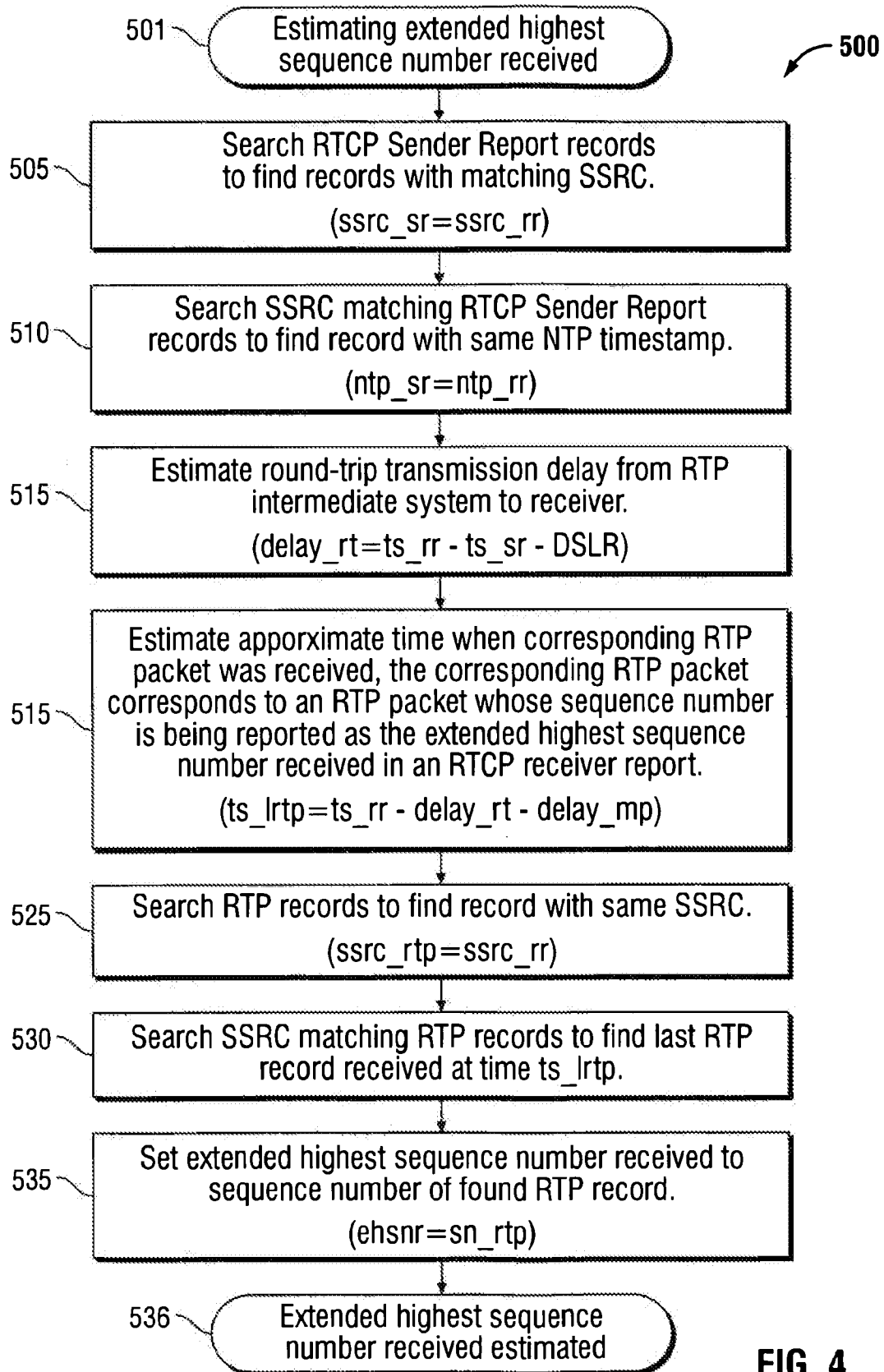


FIG. 4

10/20

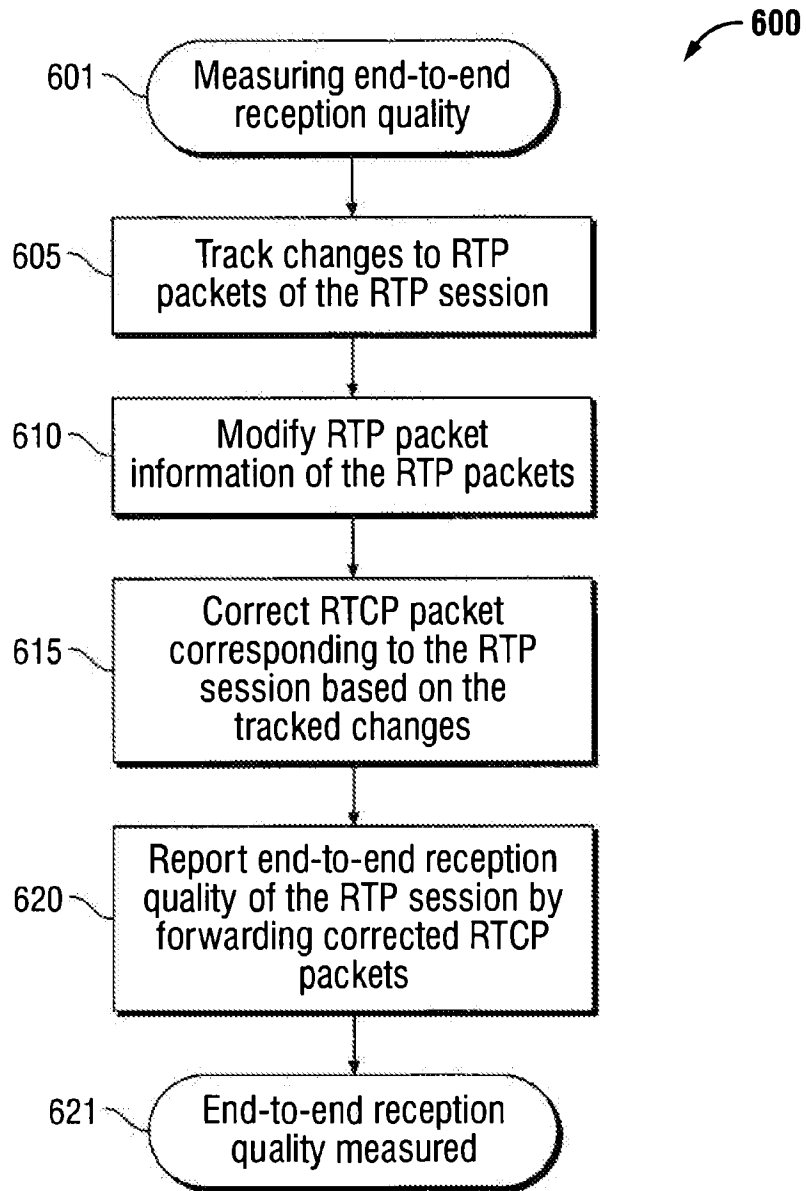


FIG. 5

11/20

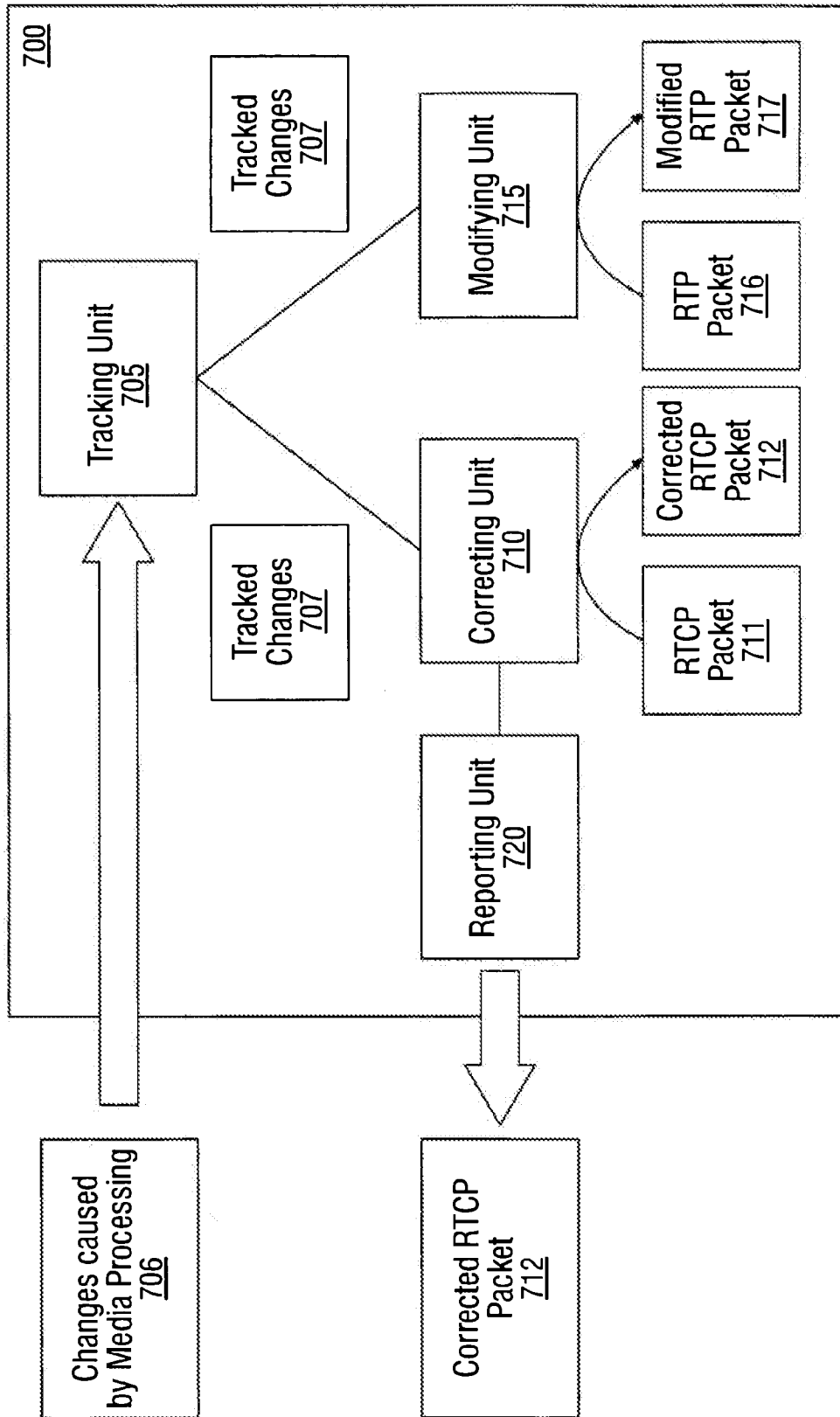


FIG. 6

12/20

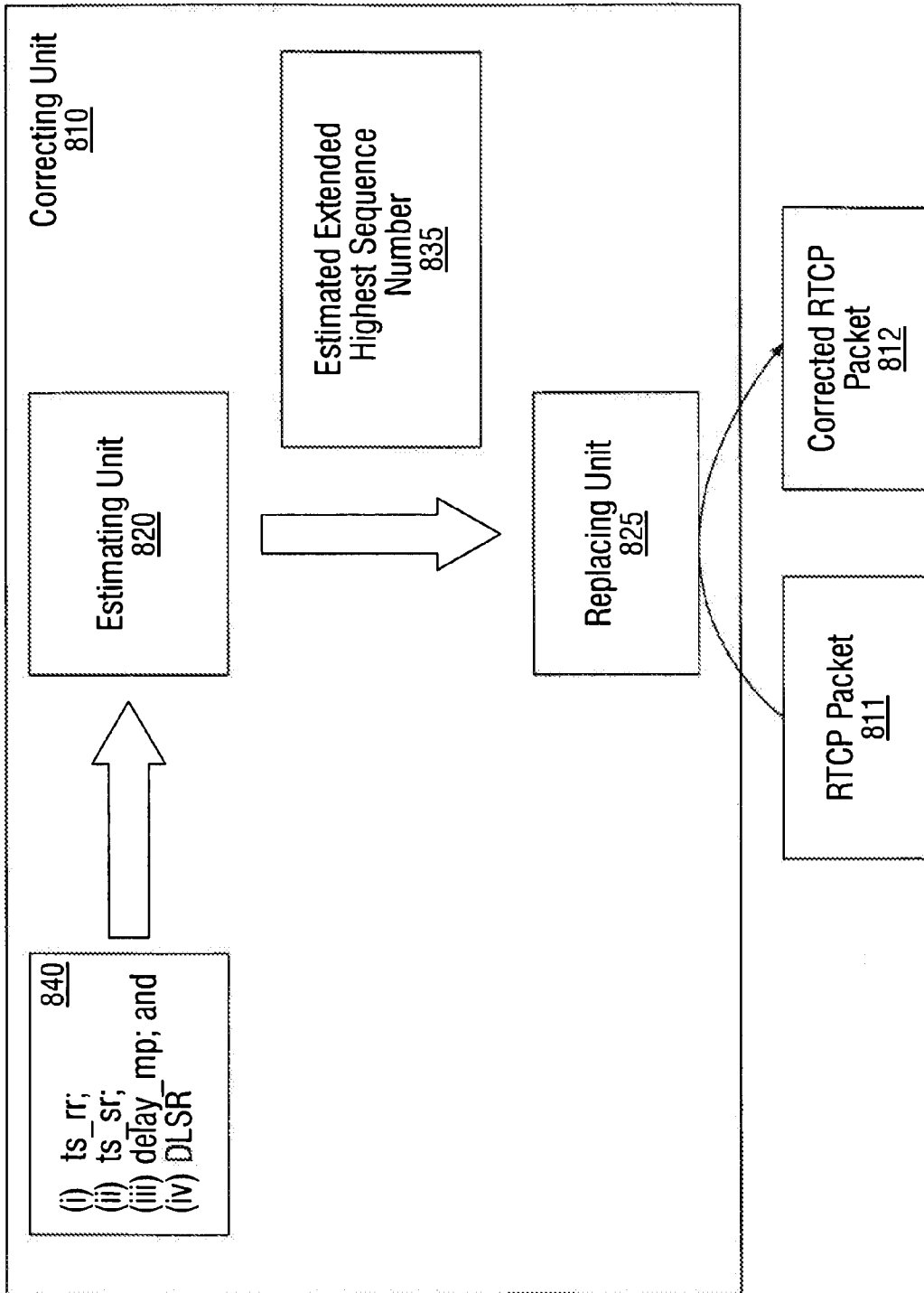


FIG. 7

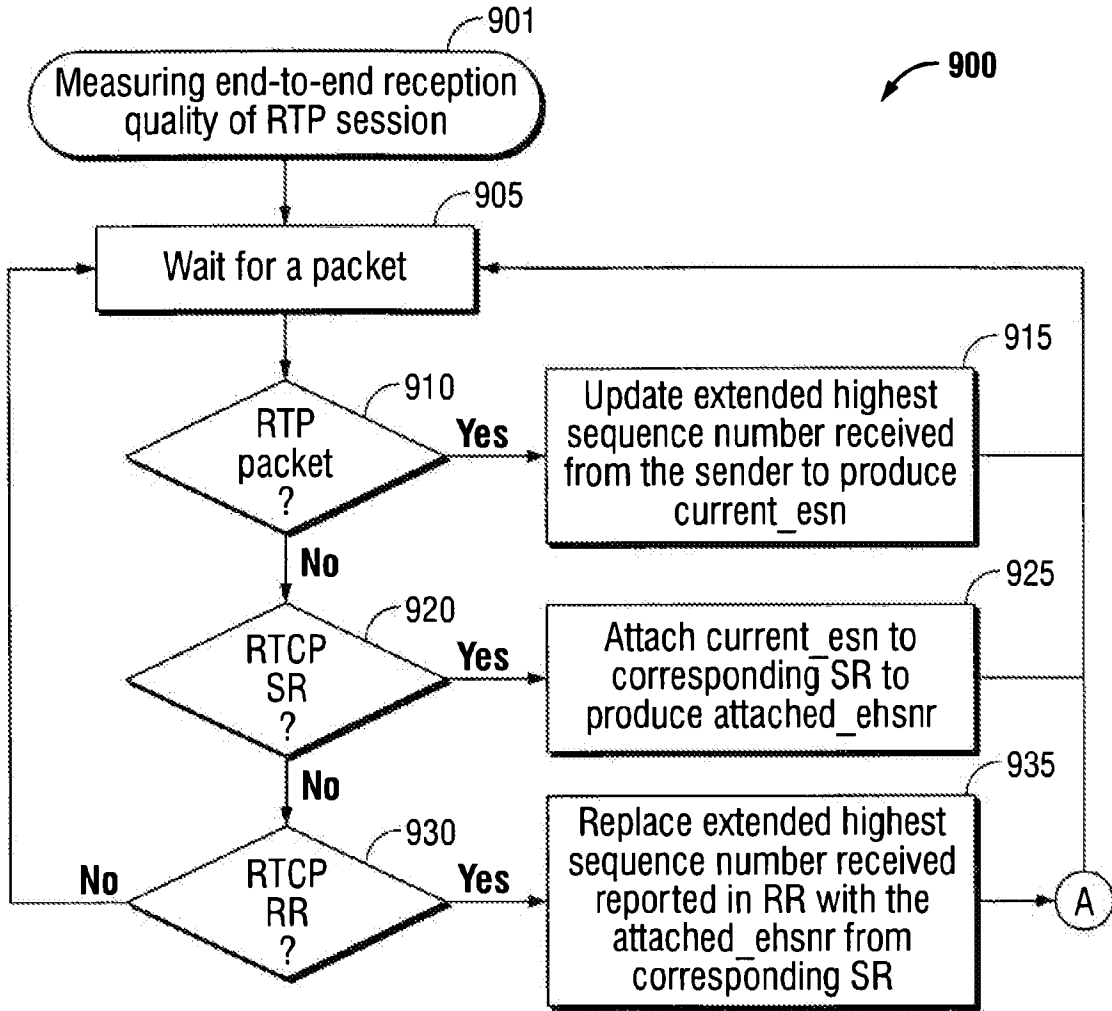


FIG. 8-1

14/20

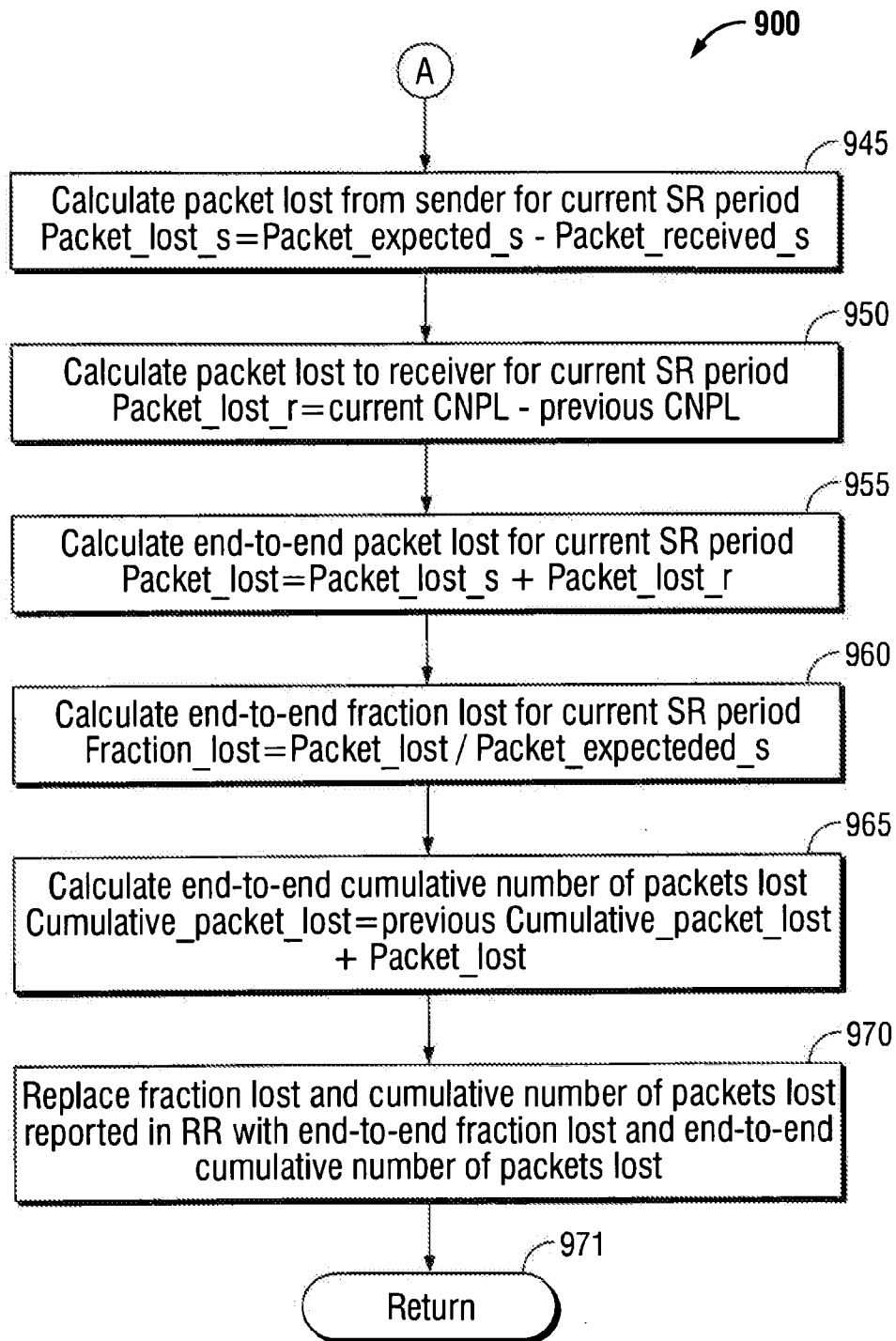


FIG. 8-2

15/20

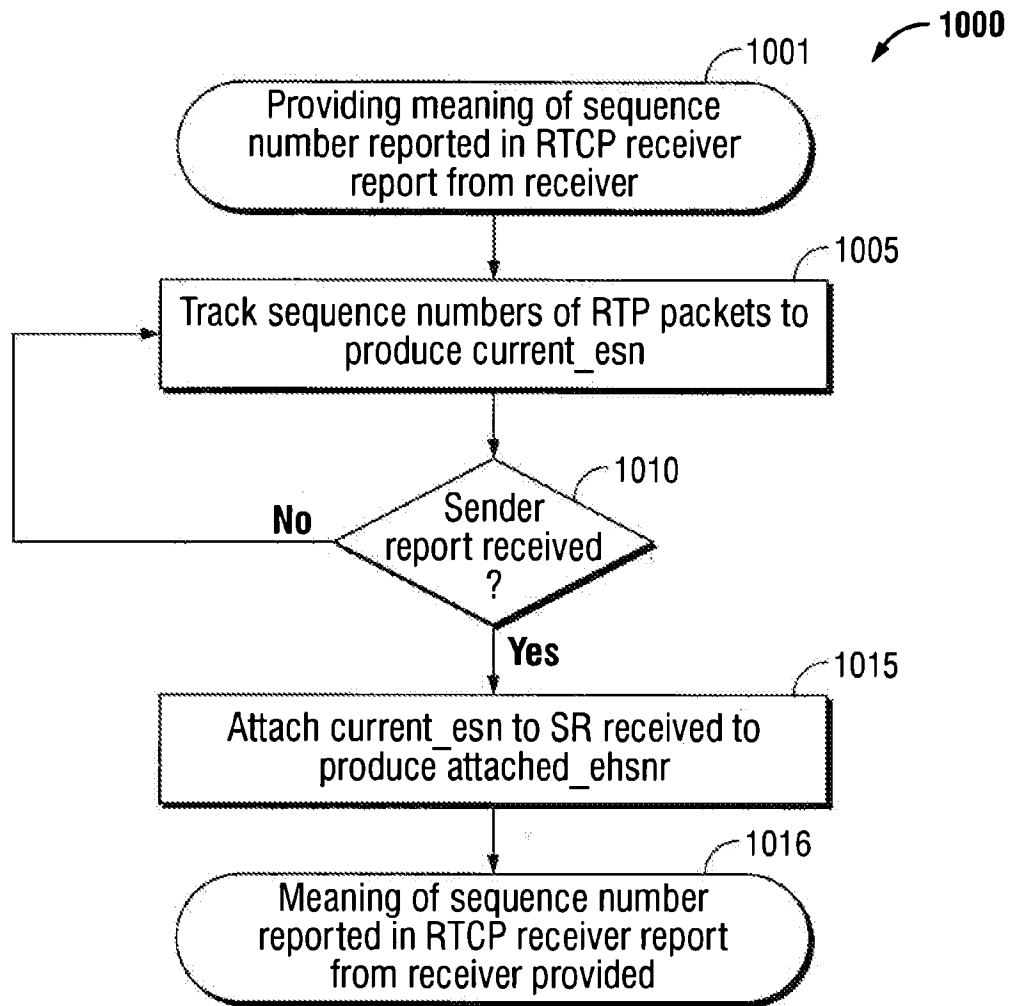
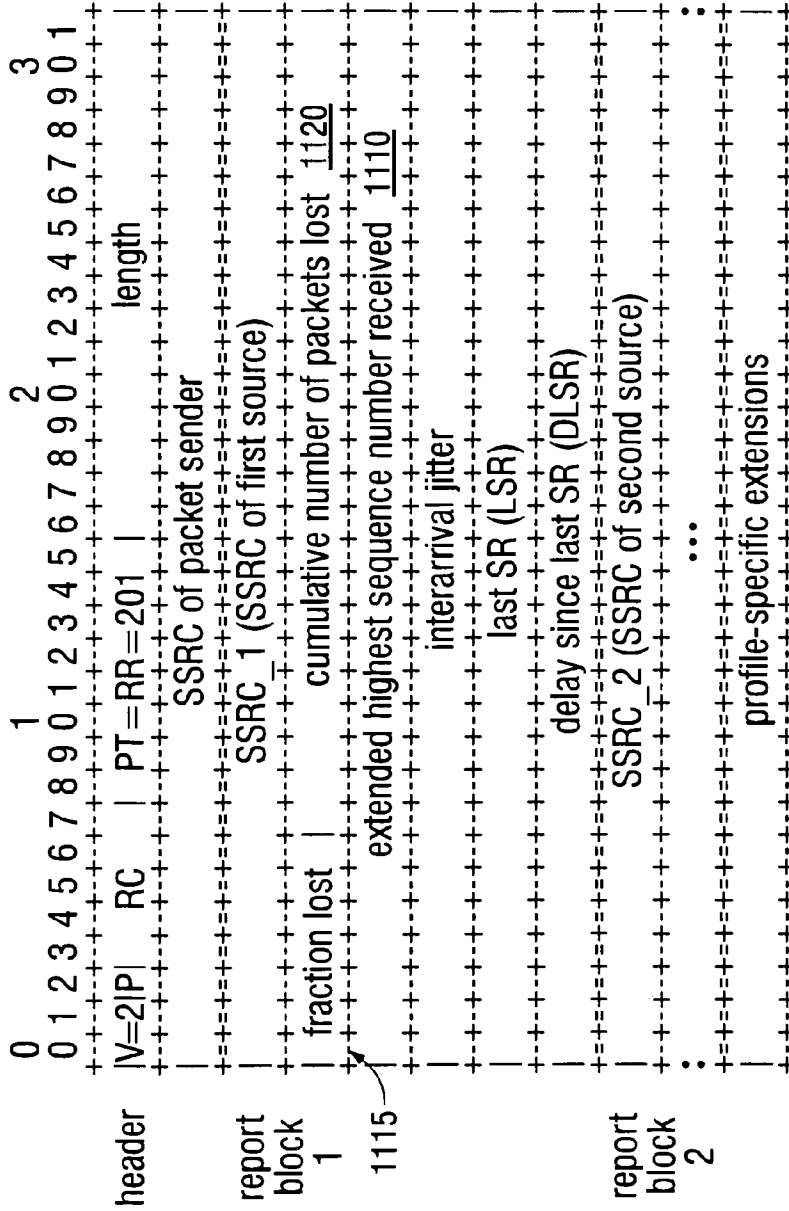


FIG. 9

16/20

1105



Correct RTCP packets based on changes caused by media processing

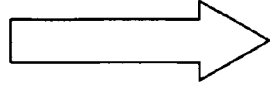


FIG. 10-1

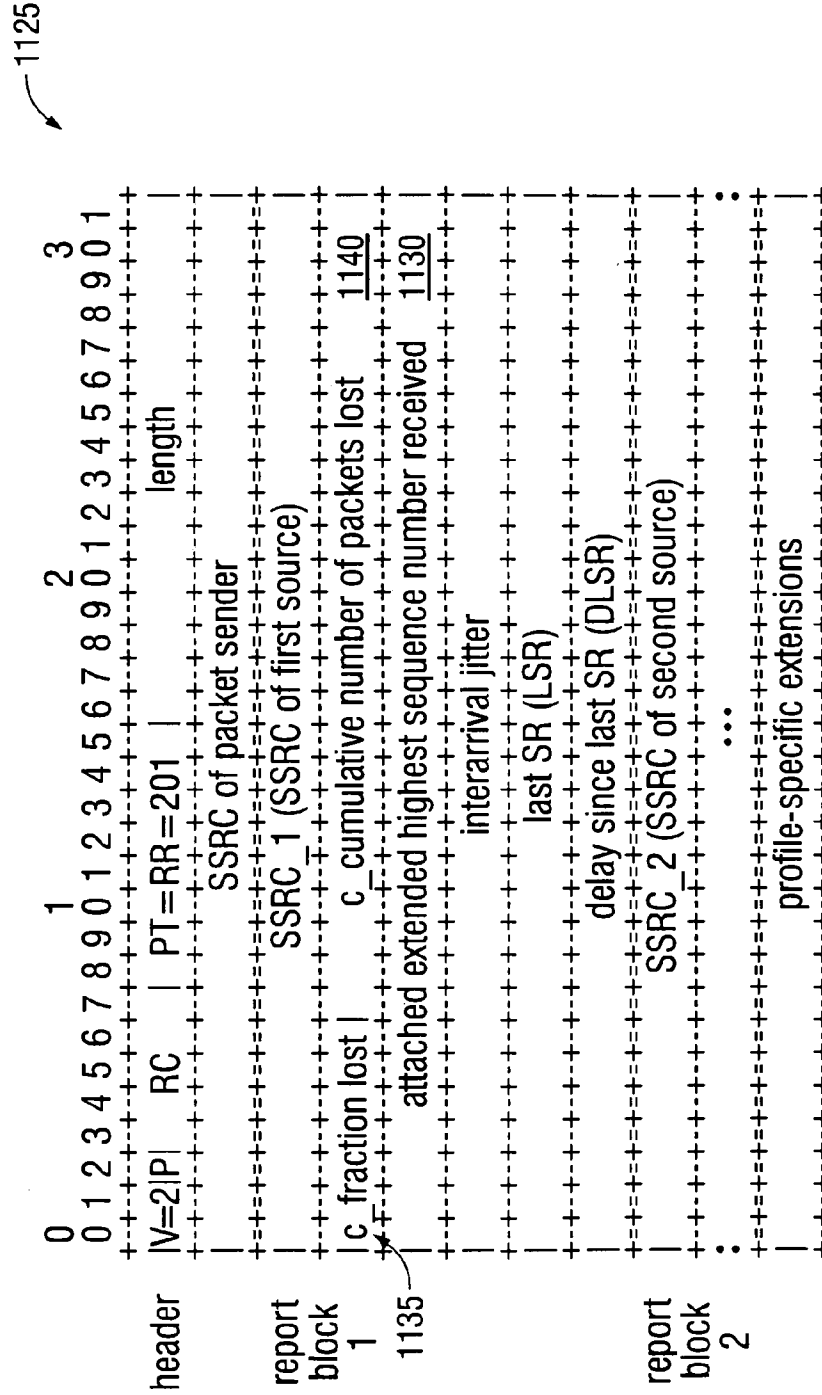


FIG. 10-2

18/20

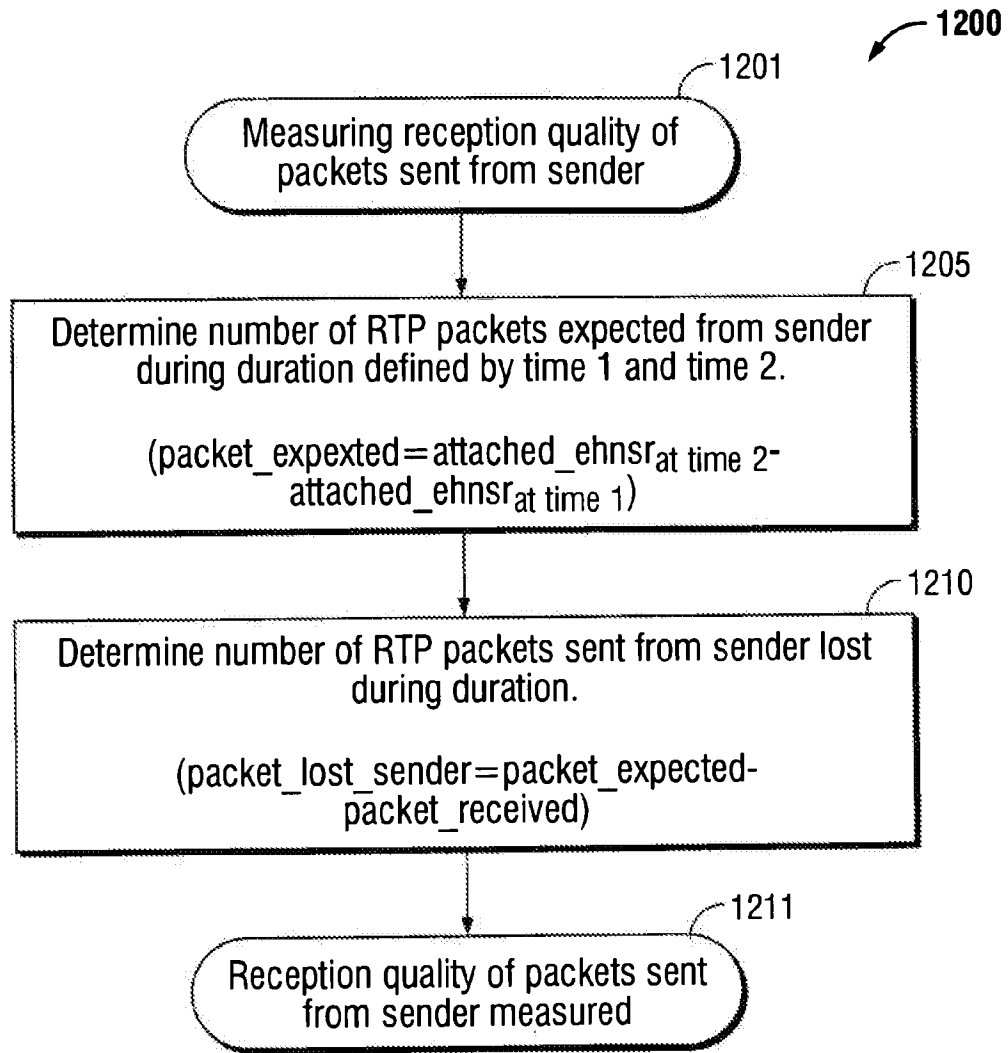


FIG. 11

19/20

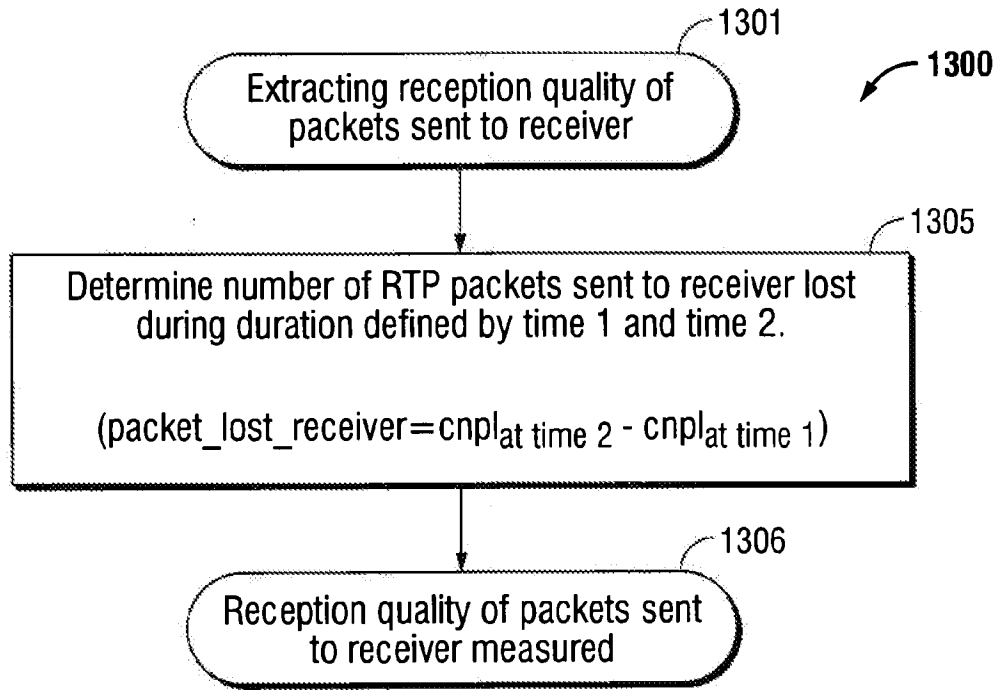


FIG. 12

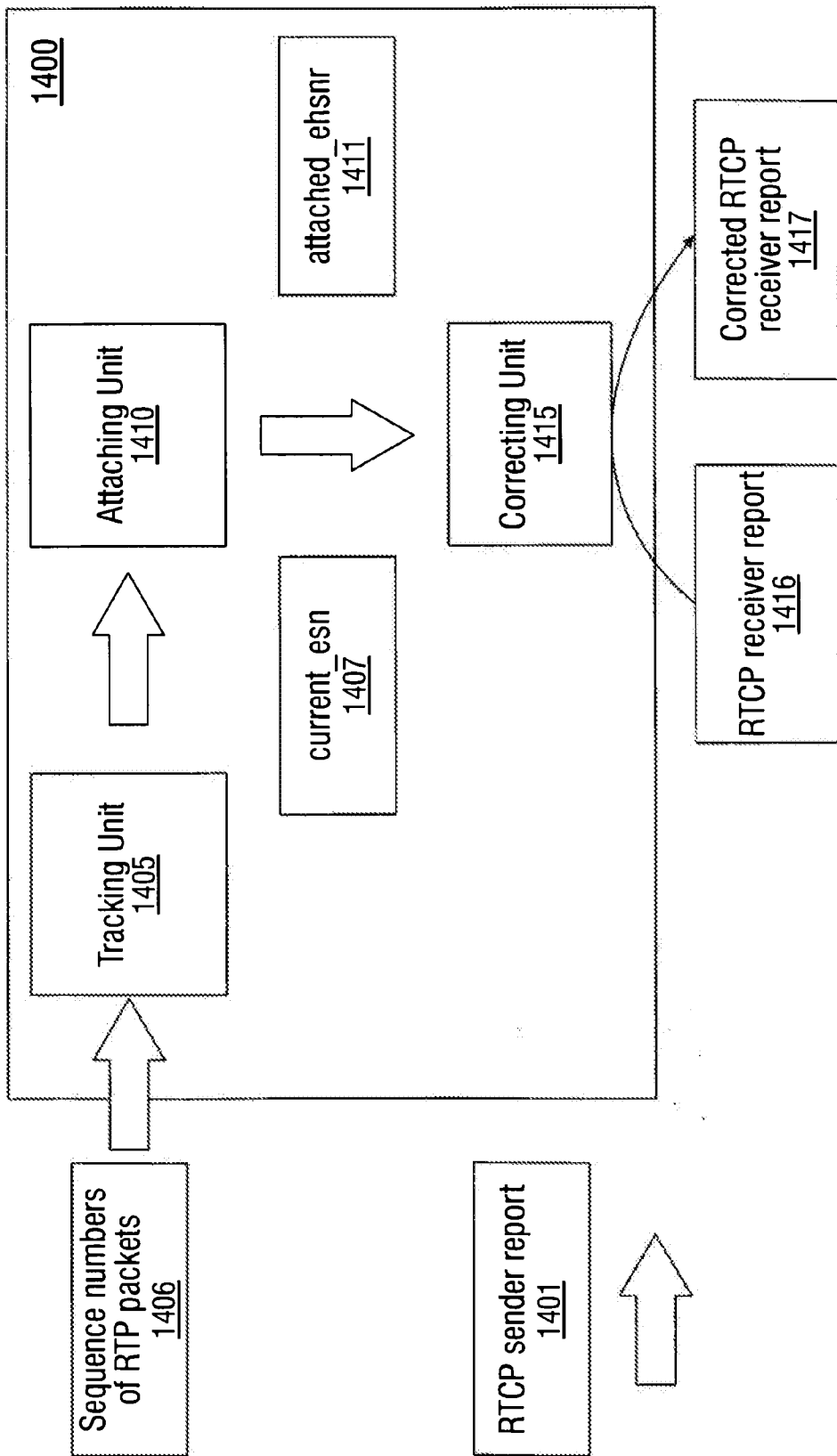


FIG. 13

INTERNATIONAL SEARCH REPORT

International application No
PCT/US2008/012588

A. CLASSIFICATION OF SUBJECT MATTER
INV. H04L29/06

According to International Patent Classification (IPC) or to both national classification and IPC

B. FIELDS SEARCHED

Minimum documentation searched (classification system followed by classification symbols)
H04L

Documentation searched other than minimum documentation to the extent that such documents are included in the fields searched

Electronic data base consulted during the international search (name of data base and, where practical, search terms used)

EPO-Internal, WPI Data

C. DOCUMENTS CONSIDERED TO BE RELEVANT

Category*	Citation of document, with indication, where appropriate, of the relevant passages	Relevant to claim No.
A	US 6 724 736 B1 (AZRIEL GAD [IL]) 20 April 2004 (2004-04-20) abstract column 4, line 34 - line 49 column 6, line 50 - column 8, line 45 column 12, line 58 - column 14, line 15	1-33
A	OTT J ET AL: "Extended RTP Profile for RTCP-based Feedback (RTP/AVPF)" INTERNET CITATION, [Online] XP002206349 Retrieved from the Internet: URL: http://www.ietf.org/internet-drafts/draft-ietf-avt-rtcp-bw-05.txt [retrieved on 2002-07-12] abstract page 1, line 1 - page 6, line 9	1-33

Further documents are listed in the continuation of Box C.

See patent family annex.

* Special categories of cited documents:

- *A* document defining the general state of the art which is not considered to be of particular relevance
- *E* earlier document but published on or after the international filing date
- *L* document which may throw doubts on priority claim(s) or which is cited to establish the publication date of another citation or other special reason (as specified)
- *O* document referring to an oral disclosure, use, exhibition or other means
- *P* document published prior to the international filing date but later than the priority date claimed

- *T* later document published after the international filing date or priority date and not in conflict with the application but cited to understand the principle or theory underlying the invention
- *X* document of particular relevance; the claimed invention cannot be considered novel or cannot be considered to involve an inventive step when the document is taken alone
- *Y* document of particular relevance; the claimed invention cannot be considered to involve an inventive step when the document is combined with one or more other such documents, such combination being obvious to a person skilled in the art.
- *8* document member of the same patent family

Date of the actual completion of the international search

17 February 2009

Date of mailing of the international search report

26/02/2009

Name and mailing address of the ISA/

European Patent Office, P.B. 5818 Patentlaan 2
NL - 2280 HV Rijswijk
Tel. (+31-70) 340-2040,
Fax: (+31-70) 340-3016

Authorized officer

Stergiou, Christos

INTERNATIONAL SEARCH REPORT

Information on patent family members

International application No

PCT/US2008/012588

Patent document cited in search report	Publication date	Patent family member(s)	Publication date
US 6724736	B1	20-04-2004	NONE

(19) World Intellectual Property Organization
International Bureau



(43) International Publication Date
4 June 2009 (04.06.2009)

PCT

(10) International Publication Number
WO 2009/070278 A1

- (51) International Patent Classification:
H04J 3/26 (2006.01)
- (21) International Application Number:
PCT/US2008/013100
- (22) International Filing Date:
25 November 2008 (25.11.2008)
- (25) Filing Language: English
- (26) Publication Language: English
- (30) Priority Data:
11/987,486 30 November 2007 (30.11.2007) US
- (71) Applicant (for all designated States except US): BROAD-SOFT, INC. [US/US]; 220 Perry Parkway, Gaithersburg, MD 20877 (US).
- (72) Inventor; and
- (75) Inventor/Applicant (for US only): BASTIEN, Stephane [CA/CA]; 270 rue de la Paline, Pincourt, Québec J7V 0B3 (CA).
- (74) Agent: SARTORI, Michael, A.; Venable LLP, P.O. Box 34385, Washington, DC 20043-9998 (US).

- (81) Designated States (unless otherwise indicated, for every kind of national protection available): AE, AG, AL, AM, AO, AT, AU, AZ, BA, BB, BG, BH, BR, BW, BY, BZ, CA, CH, CN, CO, CR, CU, CZ, DE, DK, DM, DO, DZ, EC, EE, EG, ES, FI, GB, GD, GE, GH, GM, GT, HN, HR, HU, ID, IL, IN, IS, JP, KE, KG, KM, KN, KP, KR, KZ, LA, LC, LK, LR, LS, LT, LU, LY, MA, MD, ME, MG, MK, MN, MW, MX, MY, MZ, NA, NG, NI, NO, NZ, OM, PG, PH, PL, PT, RO, RS, RU, SC, SD, SE, SG, SK, SL, SM, ST, SV, SY, TJ, TM, TN, TR, TT, TZ, UA, UG, US, UZ, VC, VN, ZA, ZM, ZW.
- (84) Designated States (unless otherwise indicated, for every kind of regional protection available): ARIPO (BW, GH, GM, KE, LS, MW, MZ, NA, SD, SL, SZ, TZ, UG, ZM, ZW), Eurasian (AM, AZ, BY, KG, KZ, MD, RU, TJ, TM), European (AT, BE, BG, CH, CY, CZ, DE, DK, EE, ES, FI, FR, GB, GR, HR, HU, IE, IS, IT, LT, LU, LV, MC, MT, NL, NO, PL, PT, RO, SE, SI, SK, TR), OAPI (BF, BJ, CF, CG, CI, CM, GA, GN, GQ, GW, ML, MR, NE, SN, TD, TG).

Published:
— with international search report

(54) Title: IP-BASED CALL CONTENT INTERCEPT USING REPEATERS

WO 2009/070278 A1

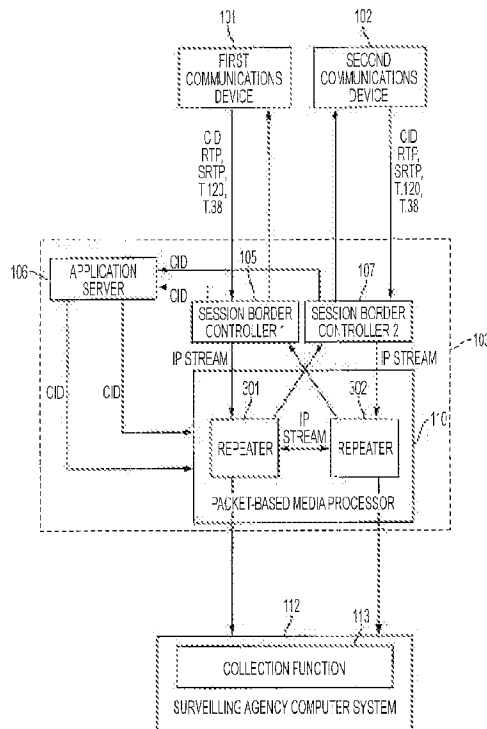


FIG. 3A

(57) Abstract: A computer-readable medium for performing IP-based call intercept includes instructions for receiving call initiation data, a first IP packet from the first communications device, and a second IP packet from a second communications device, generating copies of the first IP packet and the second IP packet, and transmitting one of the first IP packets to the second communications device according to the call initiation data, another of the first IP packets to a surveilling agency computer system without encoding or decoding the IP packet, one of the second IP packets to the first communications device according to the call initiation data, and another of the second IP packets to the surveilling agency computer system without encoding or decoding the IP packet.

IP-Based Call Content Intercept Using Repeaters

Background

[0001] Lawful intercept of call content on the public switched telephone network (PSTN) is mandated functionality by the Communications Assistance for Law Enforcement Act (CALEA) in the United States and by similar legislation in many other countries. Phone calls carried over Internet protocol (IP) networks must comply with the same lawful intercept rules as calls carried over the traditional PSTN. Lawful intercept of call content over IP networks is difficult due to the wide range of protocols and codecs that are deployed. While the PSTN network typically carries audio data using G.711 over a dedicated time-division multiplexing (TDM) channel, voice over IP (VoIP) networks can be encoded using many codecs (e.g., G.711, G.729, iLBC) and transmitted using different protocols (e.g., real-time transport protocol (RTP), secure real-time transport protocol (SRTP)).

[0002] There are four known methods for intercepting IP-based call content. IP-based call content may be intercepted at a network gateway when the call content is between a communications device on a VoIP network and a communications device on a traditional wired or wireless telephone network. This method allow for the interception of audio, but not video, data, or encrypted content. IP-based call content may also be intercepted at the session border controllers of the VoIP network. The session border controller may only be able to see the signaling from one party to a call. If lawful intercept applies to the second party to a call, the session border controllers may not know this and may not intercept the call. A third method allows for the interception of IP-based call content at routers and switches on an IP-network. This method requires that every packet of data passing through a router or switch be scanned to determine whether or not the packet needs to be intercepted. The VoIP provider generally has no control over this method of interception, as the routers and switches on the an IP-network outside of the VoIP provider's network belong to parties other than the VoIP provider. A fourth method allows for the interception of IP-based call content at the packet-based media processor through use of conferencing bridge. This method is limited to audio call content only, as video, data, and encrypted content may not be intercepted. Further, the conferencing bridge

must understand the audio codec being used by the communications devices on the call. This may require the conferencing bridge to force the communications devices on the call to change the codec they use, which may allow the parties using the communications devices to discover that the call is being intercepted.

[0003] As a first way, a PSTN gateway may be used to redirect a copy of call content to a surveilling agency. PSTN gateways may only accept a standard RTP stream containing audio, making it impossible for the gateways to provide the original user datagram protocol (UDP)/IP/RTP packet header, an abstract syntax notation number one (ASN.1) envelope as defined in T1.678, or other packet or envelope types required by country-specific rules and regulations. Further, the PSTN gateway may not accept video, T.38 signaling, or any other IP-based media protocols.

[0004] As a second way, IP-based call content may also be intercepted by session border controllers (SBCs). A session border control may redirect a copy of call content to a surveilling agency in the same manner as a PSTN gateway. surveilling agencyThe SBC may only see signaling for one of the two parties to a call, because the other party is hidden by an application server. If lawful intercept applies to the second party, the SBC may not know this because it can only see the signaling from the first party. The SBC may therefore not initiate the intercept of a call when the presence of the second party would make interception appropriate.

[0005] As a third way, IP-based call content may also be intercepted at an Ethernet switch or router on an IP-network in the path of the call content. As the IP packets, such as, for example, RTP, UDP, TCP/IP, and T.38 packets, containing the call content pass through a switch or router that is part of the network over which the call is routed, the switch or router may send copies of the IP packets to a surveilling agency. However, this may be processor intensive, since the switch or router must examine every single IP packet passing through to determine if the packet contains call content that is to be intercepted.

[0006] As a fourth way, IP-based call content may be intercepted at a packet-based media processor using a conferencing bridge. A call between two communications devices may be connected through a packet-based media processor on the VoIP provider's network. The packet-based media processor may setup a conferencing bridge. Each of the parties

to the call may be connected to the conferencing bridge via a two way connection, so that each party can both talk and listen to the other parties on the call. A surveilling agency may be connected to the conferencing bridge via a one way connection, so that surveilling agency may listen to the other parties on the call, but may not talk, concealing the presence of the surveilling agency from the other parties. However, this may only work for audio content, the surveilling agency will receive only one audio stream containing audio from all parties to the call, and the conferencing bridge may be required to change the audio codec used by the communications device on the call, which may increase the risk of the call interception being detected.

[0007] FIGs. 1A, 1B, 1C, and 1D depict four prior art systems for intercepting call content.

[0008] First communications device 101 may be any device suitable for communication, including making and/or receiving calls, over a VoIP network. For example, first communications device 101 may be a computer, set-top console, fax machine, VoIP handset, cellular handsets with VoIP capability, or any other handheld or stationary device with VoIP capability.

[0009] Second communications device 102 may be any device suitable for telecommunications over any communications network. For example, second communications device 102 may be any computer, phone, fax machine, set-top console, or handheld device connected to any communications network capable of receiving calls from a communications device connected to a VoIP network.

[0010] Communication between the first communications device 101 and the second communications device 102 may always travel over a VoIP network for at least a portion of the trip between the first communications device 101 and the second communications device 102. The first communications device 101 may be connected directly to a VoIP network, for example, through a VoIP service provider, or may be connected to another communications network which routes communications traffic over a VoIP network. The second communications device 102 may also be connected directly to a VoIP network, or may be connected to any other communications network which may receive communications traffic from a VoIP network. For example, the first communications device 101 may be a VoIP handset, and the second communications device 102 may be a

landline connected to a traditional phone service. The communications from the first communications device 101 may travel over the VoIP network to which the first communications device 101 is connected, and then over the non-VoIP network to which the second communications device 102 is connected.

- [0011] VoIP provider's network 103 may be an IP-network, or portion thereof, controlled by provider of VoIP services. The VoIP provider's network 103 may contain hardware used for the creation of IP-networks, such as, for example, routers, switches, hubs, servers, firewalls, and may have incoming and outgoing connections to other IP-networks. For example, the VoIP provider's network 103 may be the Internet, a section of the Internet controlled by the VoIP provider, or may be a proprietary IP networks, managed IP networks, or service provider's IP networks.
- [0012] Router/switch 104 may be any router or switch used for handling routing and/or switching of traffic on an IP network, such as, for example, the Internet. For example, the router/switch 104 may be a router belonging to an internet service provider (ISP), handling the routing of traffic originating from the ISP's customers, and from other users of an IP network when the traffic passes through the network belonging to the ISP.
- [0013] Session Border Controller (SBC) 105 and SBC 107 may be any computer, computing device, or the like on the border of the VoIP provider's network 103. For example, the SBC 105 and the SBC 107 may be hardware firewalls on the border of the VoIP provider's network 103 and may be responsible for monitoring all traffic entering and leaving the VoIP provider's network 103.
- [0014] Application server 106 may be any computer, computing device, or the like suitable to function as a server on the VoIP provider's network 103. For example, the application server 106 may be a dedicated server. The application server 106 may control the routing of call content traveling over the VoIP network and the allocation of packet-based media processor resources for various calling features. For example, application server 106 may allocate proper packet-based media processor resources for videoconferencing and teleconferencing.
- [0015] Packet-based media processor 110 may be any computer, computing device, or the like suitable to function as a server on the VoIP provider's network. For example, the packet-based media processor 110 may be a dedicated server. The packet-based media

processor 110 may provide resources, such as, for example, processing cycles, required for various calling features, including, for example, videoconferencing, teleconferencing, speech recognition, and any other calling features provided by the VoIP network provider.

[0016] Network Gateway 111 may be any computer, computing device, or the like that may function as a gateway on a PSTN network. For example, the network gateway 111 may be a PSTN gateway. The network gateway 111 may function as a gateway between an IP-network, and VoIP networks on the IP-network, and wired and wireless telephone networks, allowing communication to take place between a communications device on a VoIP network and a communications devices on the wired and wireless networks.

[0017] Surveilling agency computer system 112 may be any computer, computing device, or the like, belonging to a surveilling agency or any other entity, such as, for example, a contractor or subcontractor, acting on behalf of a surveilling agency. Surveilling agencies may include, for example, the Federal Bureau of Investigation, the Central Intelligence Agency, the National Security Agency, the Department of Homeland Security, other federal and state law enforcement agencies and agencies supporting law enforcement in both the United States and foreign nations, and international organization such as, for example, Interpol. For example, surveilling agency computer system 112 may be a server located in the surveilling agency headquarters, a laptop or handheld computing device belonging to a field agent of the surveilling agency, a personal computer commandeered by the surveilling agency, etc. The surveilling agency computer system 112 may be controlled by the surveilling agency that has placed one or both of the first communications device 101 and the second communications device 102 under surveillance, as determined by the application server 106.

[0018] Collection function 113 may be any combination of software or hardware on the surveilling agency computer system 112 suitable for handling incoming call content. For example, collection function 113 may be a software program that records incoming call content to a computer readable medium accessible to the surveilling agency computer system 112. The recorded call content may be accessed on the surveilling agency computer system 112 after recording. As another example, collection function 113 may play back the incoming call content in real time.

[0019] Conferencing bridge 114 may be any combination of software and hardware on the packet-based media processor 110 suitable for handling a conference call. For example, conferencing bridge 114 may be software on the packet-based media processor 110 activated by the packet-based media processor 110 to set up a conference call between the first communications device 101 and the second communications device 102. A conference call may be similar to a normal call, except that more than two parties are allowed to be connected to the call at the same time.

[0020] FIG. 1A depicts the first previously used method for intercepting IP-based call content. As illustrated in FIG. 1A, the first previously used method for intercepting call content is described in, for example, U.S. Patent No. 7,006,508 "Communication network with a collection gateway and method for providing surveillance services" to Bondy et. al. (Bondy), U.S. Patent No. 6,870,905 "Wiretap implemented by media gateway multicasting" to Pelaez et. al. (Pelaez), and U.S. Patent No. 7,092,493 "Methods and systems for providing lawful intercept of a media stream in a media gateway" to Hou et. al. (Hou). In this previous method, call content is intercepted at the network gateway 111. The first communications device 101 on the VoIP network may be used to initiate a call to the second communications device 102 on a telecommunications network which may be wired, wireless, or a combination of wired and wireless.

[0021] The first communications device 101 may initiate the call by sending call initiation data to the application server 106. Call initiation data may be Session Initiation Protocol (SIP) packets, Media Gateway Control Protocol (MGCP) packets, H.323 packets, or any other suitable data or packet type, and may contain data conforming to Session Description Protocol (SDP). The application server 106 may determine from the call initiation data that the call content needs to be routed through the network gateway 111, in order for the call content to reach the second communications device 102 on the traditional telephone networks. Call initiation data may be sent to the network gateway 111, and call content in the form of RTP packets may be sent from the first communications device 101 to the network gateway 111.

[0022] At the network gateway 111, the RTP packets may be converted into, for example, a TDM signal and transmitted over the telecommunications network to the second communications device 102. Call content from the second communications

device 102, in the form of a TDM signal, may be transmitted over the telecommunications network to the network gateway 111, where the call content may be packetized into RTP packets. These RTP packets may be transmitted over the IP-network to the first communications device 101.

[0023] Call content may be intercepted at the network gateway 111. If either the first communications device 101 or the second communications device 102 is under surveillance, the network gateway may be instructed to copy the RTP packets incoming from the first communications device 101 and created from the call content incoming from the second communications device 102 and to transmit the copies to the surveilling agency computer system 112. The collection function 113 may handle the incoming call content according to the setup of the collection function 113. Because the network gateway 111 only understands RTP packets, only RTP packets containing an audio stream may be sent to the surveilling agency computer system 112. This may prevent the interception of any non-audio call data, such as, for example, video data or desktop collaboration data. Additionally, the network gateway 111 cannot copy and transmit Secure RTP (SRTP) packets, which may use 128-bit encryption, to the surveilling agency computer system 112. This may prevent the interception of any call data, audio or otherwise, that is encrypted.

[0024] FIG. 1B depicts the second previously used method for intercepting IP-based call content. As illustrated in FIG. 1B, the second previously used method for intercepting IP-based call content is described, for example, in Bondy. Call content is intercepted at the session border controllers 105 and/or 107. The first communications device 101 on the VoIP network may be used to initiate a call to the second communications device 102 on any VoIP or traditional wired or wireless telephone network.

[0025] The first communications device 101 may initiate a call to the second communications device 102, as described above. Call content in the form of RTP packets from the first communications device 101 may be transmitted over IP-networks, such as, for example, the Internet, to the VoIP provider's network 103. The RTP packets may reach the session border controller 105 on the edge of the VoIP provider's network 103. The session border controller 105 may help route the RTP packets through the VoIP provider's network 103, where the RTP packets will be directed to their destination. The

RTP packets may pass through session border controller 107 upon leaving the VoIP provider's network 103. The RTP packets may then traverse other IP-networks, such as, for example, the Internet or managed IP networks, or service provider's IP networks, to reach the second communications device 102. Call content may be transmitted from the second communications device 102 to the first communications device 101 in the same manner, reaching session border controller 107 at the edge of the VoIP provider's network 103, and then session border controller 105 upon leaving the VoIP provider's network 103.

[0026] If either of the first communications device 101 or the second communications device 102 is under surveillance, the session border controllers 105 and 107 may be instructed to copy the incoming RTP packets from the first communications device 101 and the second communications device 102 and transmit the copies to surveilling agency computer system 112. The collection function 113 may handle the incoming call content according to the setup of the collection function 113. Each of the session border controllers 105 and 107 surveilling agency may only see signaling for one of the two parties to a call, because the other party is hidden by an AS. If lawful intercept applies to the second communications device 102, the session border controllers 105 may not know this because it can only see the signaling from the first communications device 101. The session border controller 105 may therefore not initiate the intercept of a call when the presence of the second communications device 102 would make interception appropriate. The session border controller 107 may face the same limitations with respect to the first communications device 101.

[0027] FIG. 1C depicts the third previously used method for intercepting IP-based call content. As illustrated in FIG. 1C, the third previously used method for intercepting call content is described in, for example, Bondy. Call content is intercepted at the router/switch 104. The first communications device 101 on the VoIP network may be used to initiate a call to the second communications device 102 on any VoIP or traditional wired or wireless telephone network.

[0028] When the first communications device 101 transmits call content to the second communications device 102, and vice versa, the call content, in the form of IP packets, such as, for example, RTP, UDP, TCP/IP and T.38 packets, must traverse an IP-network.

In traversing the IP-network, the IP packets may be routed and switched through the router/switch 104, which may be one of the routers and switches responsible for routing IP packets on the IP-network. If either the first communications device 101 or the second communications device 102 is under surveillance, call content may be intercepted as it passes through the router/switch 104 on its way to or from the VoIP provider's network 103.

[0029] In order for call content to be intercepted by the router/switch 104, the router/switch 104 may be instructed to check every incoming IP packet to determine whether the incoming IP packet is part of the call content between the first communications device 101 and the second communications device 102. When an IP packet that is part of the call content between the first communications device 101 and the second communications device 102 is detected by the router/switch 104, the router/switch 104 may copy the IP packet and transmit the copy to the surveilling agency computer system 112. The collection function 113 may handle the incoming call content according to the setup of the collection function 113. The computational resources required to check every incoming IP packet passing through the router/switch 104 are immense. The result of attempting to check every incoming IP packet using currently available routing and switching hardware would be a slowdown in traffic passing through the router/switch 104, as each packet was checked to determine if the packet belonged to an intercepted call.

[0030] FIG. 1D depicts the fourth previously used method for intercepting IP-based call content. Call content is intercepted at the packet-based media processor 110 through the use of the conferencing bridge 114. The first communications device 101 on the VoIP network may be used to initiate a call to the second communications device 102 on any VoIP or traditional wired or wireless telephone network. This may require the first communications device 101 to transmit call initiation data to the application server 106. The application server 106 may examine the call initiation data to determine if either the first communications device 101 or the second communications device 102 is under surveillance.

[0031] If either the first communications device 101 or the second communications device 102 is under surveillance, the application server 106 may instruct the packet-based

media processor 110 to setup conferencing bridge 114. The application server 106 may then modify the call initiation data so that the first communications device 101 and the second communications device 102 send call content to the conferencing bridge 114 on the packet-based media processor 110, setting up a conference call. The conferencing bridge 114 may then connect the surveilling agency computer system 112 to the conference call between the first communications device 101 and the second communications device 102 via a one way, listening only, connection. As part of the conference call, the surveilling agency 112 may listen to the audio content transmitted between the first communications device 101 and the second communications device 102, intercepting the call content.

[0032] The conferencing bridge 114 may only be able to handle unencrypted audio content, and may not be able to set up a conference call with video, data, or encrypted content. The conferencing bridge 114 may also be required to force the first communications device 101 and the second communications device 102 to use an audio codec with which the conferencing bridge 114 is compatible. The forced change of audio codec may be detected by the users of the first communications device 101 and the second communications device 102, allowing the user to discover that the call is being intercepted.

[0033] Each of the four prior art methods of intercepting IP based call content may be used when more than two communications devices participate in the call, such as, for example, during a conference call.

[0034] Also in the prior art, VoIP providers currently use packet-based media processors to provide additional calling features on their networks. These calling features may include, for example, voice mail, speech recognition, teleconferencing, video conferencing, and desktop collaboration. Calls requiring the use of these features are routed through the VoIP provider's network 103 to the VoIP provider's packet-based media processor, where the computing resources in the form of software and/or hardware needed to implement the features may be provided.

[0035] FIG. 2 depicts an exemplary embodiment of the use of a packet-based media processor in a VoIP network according to the prior art. The first communications device 101 may initiate, for example, a video conference with the second communications

device 102. The call initiation data transmitted from the first communications device 101 to the application server 106 may indicate that the call is to be a video conference. The application server 106 may then transmit information to the packet-based media processor 110, instructing the packet-based media processor 110 to set up a video conferencing module 201, to be used by the first communications device 101 and the second communications device 102. Video conferencing module 201 may be any combination of hardware and software on the packet-based media processor 110 suitable for providing the necessary resources for the routing of video and audio data between the participants in a video conference call.

[0036] Call content transmitted from the first communications device 101, in the form of a stream of RTP packets containing audio and a stream of RTP packets containing video, is then routed to the packet-based media processor 110 upon reaching the VoIP provider's network 103, for example, at session border controller 105. The video conferencing module 201 may handle any necessary processing of the call content, including the audio and video, to ensure the video conference functions properly. The call content is transmitted from the packet-based media processor 110 to the second communication device 102. Call content transmitted by the second communications device 102 is handled in a likewise manner, being routed to the packet-based media processor 110 upon reaching the VoIP provider's network 103, for example, at session border controller 107. If the video conference call has more than two participants, the video conferencing module 201 may handle any necessary copying of the audio and video and manage the transmission of the copied audio and video to all other communication devices participating in the video conference call.

Summary

One embodiment includes a computer-readable medium comprising instructions, which when executed by a computer system causes the computer system to perform operations for IP-based call content intercept, the computer-readable medium including: instructions for receiving at least one call initiation data, instructions for receiving a first IP packet from a first communications device, instructions for receiving a second IP packet from a second communications device, instructions for generating a plurality of

first IP packets comprising either the first IP packet and at least one copy of the first IP packet, or at least two copies of the first IP packet, instructions for generating a plurality of second IP packets comprising either the second IP packet and at least one copy of the second IP packet, or at least two copies of the second IP packet, instructions for transmitting one of the plurality of first IP packets to the second communications device according to one or more of the call initiation data, instructions for transmitting another of the plurality of first IP packets to a surveilling agency computer system without encoding or decoding the another of the plurality of first IP packets, instructions for transmitting one of the plurality of second IP packets to the first communications device according to one or more of the call initiation data, and instructions for transmitting another of the plurality of second IP packets to the surveilling agency computer system without encoding or decoding the another of the plurality of second IP packets.

[0037] One embodiment includes a computer-implemented method for IP-based call content intercept, comprising: receiving at least one call initiation data, receiving a first IP packet from the first communications device, receiving a second IP packet from a second communications device, generating a plurality of first IP packets comprising either the first IP packet and at least one copy of the first IP packet, or at least two copies of the first IP packet, generating a plurality of second IP packets comprising either the second IP packet and at least one copy of the second IP packet, or at least two copies of the second IP packet, transmitting one of the plurality of first IP packets to the second communications device according to one or more of the call initiation data, transmitting another of the plurality of first IP packets to a surveilling agency computer system without encoding or decoding the another of the plurality of first IP packets, transmitting one of the plurality of second IP packets to the first communications device according to one or more of the call initiation data, and transmitting another of the plurality of second IP packets to the surveilling agency computer system without encoding or decoding the another of the plurality of second IP packets.

[0038] One embodiment includes an apparatus for IP-based call content intercept, including means for receiving at least one call initiation data, means for receiving a first IP packet from the first communications device, means for receiving a second IP packet from a second communications device, means for generating a plurality of first IP packets

comprising either the first IP packet and at least one copy of the first IP packet, or at least two copies of the first IP packet, means for generating a plurality of second IP packets comprising either the second IP packet and at least one copy of the second IP packet, or at least two copies of the second IP packet, means for transmitting one of the plurality of first IP packets to the second communications device according to one or more of the call initiation data, means for transmitting another of the plurality of first IP packets to a surveilling agency computer system without encoding or decoding the another of the plurality of first IP packets, means for transmitting one of the plurality of second IP packets to the first communications device according to one or more of the call initiation data, and means for transmitting another of the plurality of second IP packets to the surveilling agency computer system without encoding or decoding the another of the plurality of second IP packets.

One embodiment includes a system for IP-based call content intercept, including a packet-based media processor adapted to receive a first IP packet from a first communications device and a second IP packet from a second communications device, generate with at least one repeater a plurality of first IP packets comprising either the first IP packet and at least one copy of the first IP packet, or at least two copies of the first IP packet, generate with at least one repeater a plurality of second IP packets comprising either the second IP packet and at least one copy of the second IP packet, or at least two copies of the second IP packet, transmit one of the plurality of first IP packets to the second communications device, transmit another of the plurality of first IP packets to a surveilling agency computer system, transmit one of the plurality of second IP packets to the first communications device, and transmit another of the plurality of second IP packets to the surveilling agency computer system.

[0039] Further features of the invention, as well as the structure and operation of various embodiments of the invention, are described in detail below with reference to the accompanying drawings.

Brief Description of the Drawings

- [0040] Embodiments will now be described in connection with the associated drawings, in which:
- [0041] FIG. 1A, 1B, and 1C, and 1D depict four prior art systems for intercepting call content.
- [0042] FIG. 2 depicts an exemplary embodiment of the use of a packet-based media processor in a VoIP network according to the prior art.
- [0043] FIG. 3A depicts an exemplary system for IP-based call content intercept using repeaters.
- [0044] FIG. 3B depicts an alternative exemplary system for IP-based call content intercept using repeaters without session border controllers.
- [0045] FIG. 3C depicts another alternative exemplary system for IP-based call content intercept using repeaters and a network gateway.
- [0046] FIG. 4 depicts an exemplary time-flow chart for IP-based call content intercept using repeaters and a network gateway.
- [0047] FIG. 5 depicts an exemplary flowchart for IP-based call content intercept using repeaters,
- [0048] FIG. 6 depicts an exemplary embodiment of the repeaters 301 and 302.
- [0049] FIG. 7 depicts an exemplary architecture for implementing a computer.

Definitions

- [0050] In describing the invention, the following definitions are applicable throughout (including above).
- [0051] A “computer” may refer to one or more apparatus and/or one or more systems that are capable of accepting a structured input, processing the structured input according to prescribed rules, and producing results of the processing as output. Examples of a computer may include: a computer; a stationary and/or portable computer; a computer having a single processor, multiple processors, or multi-core processors, which may operate in parallel and/or not in parallel; a general purpose computer; a supercomputer; a mainframe; a super mini-computer; a mini-computer; a workstation; a micro-computer; a server; a client; an interactive television; a web appliance; a telecommunications device

with internet access; a hybrid combination of a computer and an interactive television; a portable computer; a tablet personal computer (PC); a personal digital assistant (PDA); a portable telephone; application-specific hardware to emulate a computer and/or software, such as, for example, a digital signal processor (DSP), a field-programmable gate array (FPGA), an application specific integrated circuit (ASIC), an application specific instruction-set processor (ASIP), a chip, chips, or a chip set; a system-on-chip (SoC) or a multiprocessor system-on-chip (MPSoC); and an apparatus that may accept data, may process data in accordance with one or more stored software programs, may generate results, and typically may include input, output, storage, arithmetic, logic, and control units.

[0052] “Software” may refer to prescribed rules to operate a computer or a portion of a computer. Examples of software may include: code segments; instructions; applets; pre-compiled code; compiled code; interpreted code; computer programs; and programmed logic.

[0053] A “computer-readable medium” may refer to any storage device used for storing data accessible by a computer. Examples of a computer-readable medium may include: a magnetic hard disk; a floppy disk; an optical disk, such as a CD-ROM and a DVD; a magnetic tape; a memory chip; and/or other types of media that can store data, software, and other machine-readable instructions thereon.

[0054] A “computer system” may refer to a system having one or more computers, where each computer may include a computer-readable medium embodying software to operate the computer. Examples of a computer system may include: a distributed computer system for processing information via computer systems linked by a network; two or more computer systems connected together via a network for transmitting and/or receiving information between the computer systems; and one or more apparatuses and/or one or more systems that may accept data, may process data in accordance with one or more stored software programs, may generate results, and typically may include input, output, storage, arithmetic, logic, and control units.

[0055] A “network” may refer to a number of computers and associated devices that may be connected by communication facilities. A network may involve permanent connections such as cables or temporary connections such as those that may be made

through telephone or other communication links. A network may further include hard-wired connections (e.g., coaxial cable, twisted pair, optical fiber, waveguides, etc.) and/or wireless connections (e.g., radio frequency waveforms, free-space optical waveforms, acoustic waveforms, etc.). Examples of a network may include: an internet, such as the Internet; an intranet; a local area network (LAN); a wide area network (WAN); and a combination of networks, such as an internet and an intranet. Exemplary networks may operate with any of a number of protocols, such as Internet protocol (IP), asynchronous transfer mode (ATM), and/or synchronous optical network (SONET), user datagram protocol (UDP), IEEE 802.x, etc.

Detailed Description of the Embodiments

[0056] Exemplary embodiments are discussed in detail below. While specific exemplary embodiments are discussed, it should be understood that this is done for illustration purposes only. In describing and illustrating the exemplary embodiments, specific terminology is employed for the sake of clarity. However, the embodiments are not intended to be limited to the specific terminology so selected. A person skilled in the relevant art will recognize that other components and configurations may be used without parting from the spirit and scope of the embodiments. It is to be understood that each specific element includes all technical equivalents that operate in a similar manner to accomplish a similar purpose. The examples and embodiments described herein are non-limiting examples.

[0057] In contrast to the prior art, the present embodiments uses repeaters in the packet-based media processor 110 to intercept call content and forward copies of the intercepted call content to the surveilling agency computer system 112.

[0058] FIG. 3A depicts an exemplary system IP-based call content intercept using repeaters. The first communications device 101 may initiate a call to the second communications device 102 over a VoIP network. An application server 106 may receive call initiation data from the first communications device 101, and determine whether either of the first or second communications devices 101 and 102 is under surveillance. If at least one of the first or second communications devices 101 and 102 is under surveillance, the application server 106 may make changes to the call initiation

data sent from the first communications device 101 to the second communications device 102 and from the second communications device 102 to the first communications device 101. The changes to the call initiation data may result in the call content between the first and second communications devices 101 and 102 being routed through the packet-based media processor 110 on the VoIP providers network. The routing may be accomplished by, for example, the session border controllers 105 and 107.

[0059] The call content may be transmitted to the session border controllers 105 and 107 from the first and second communication devices 101 and 102 in the form of RTP packets. The session border controllers 105 and 107 may transmit the call content to the packet-based media processor 110 in the form of IP packets, such as, for example, RTP packets, UDP packets, TCP/IP packets, and T.38 packets. The packet-based media processor 110 may make copies of the IP packets incoming from the session border controllers 105 and 107. IP packet copies may be made by repeaters 301 and 302 on the packet-based media processor 110. The repeaters 301 and 302 may be any combination of hardware and software on packet-based media processor 110 suitable for receiving, copying, and transmitting IP packets. For example, the repeaters 301 and 302 may be software constructs using the hardware of packet-based media processor 110, or the repeaters 301 and 302 may be hardware devices, such as, for example, specialized processors, integrated into, or otherwise accessible to, the packet-based media processor 110. The repeaters 301 and 302 may receive incoming IP packets, and make one or more copies of the packets. The repeaters 301 and 302 may apply profiles to when copying incoming IP packets. A profile applied to a packet being copied may result in a copied packet that is packaged differently from the incoming packet, although the packet will still contain the same data, i.e., the same call content. The repeaters 301 and 302 are discussed further below with reference to FIGs. 4-6. The packet-based media processor 110 may transmit copies of the IP packets made by the repeaters 301 and 302 to a surveilling agency computer system 112, and send the original, or copies, of the IP packets to the session border controllers 105 and 107 to be sent to the first and second communications devices 101 and 102.

[0060] FIG. 3B depicts an alternative exemplary system for IP-based call content intercept using repeaters without session border controllers. The exemplary system

depicted in FIG. 3B is functionally the same as the exemplary system of FIG. 3A, except for the absence of the session border controllers 105 and 107. The session border controllers 105 and 107 are not a mandatory part of a VoIP provider's network 103, and call content may be routed to and from the VoIP's provider's network 103 without them. The session border controllers 105 and 107 may be used to control the flow of IP packets on the border of the VoIP provider's network. However, the embodiments do not require this functionality.

[0061] FIG. 3C depicts another alternative exemplary system for IP-based call content intercept using repeaters and a network gateway. The exemplary system depicted in FIG. 3C is functionally the same as the exemplary system of FIG. 3B, except for the presence of the network gateway 111. In some cases, the surveilling agency computer system 112 may not be capable of accepting an incoming IP-based connection, and may be limited to receiving phone calls as incoming communication. In these cases, to intercept a call using the repeaters 301 and 302, the packet-based media processor 110 may need to establish a telephony connection with the surveilling agency computer system 112, through the network gateway 111. The packet-based media processor 110 may place a call to the surveilling agency computer system 112, and the surveilling agency computer system 112 may pick up the call, establishing the connection. Copied call content may then be transmitted to the surveilling agency computer system 112 through the network gateway 111. The surveilling agency computer system 112 may be limited to receiving only audio content through the network gateway, for example, in the form of TDM signals.

[0062] FIG. 4 depicts an exemplary time-flow chart for IP-based call content intercept using repeaters and a network gateway, and FIG. 5 depicts an exemplary flowchart for IP-based call content intercept using repeaters. FIGs. 4 and 5 will be discussed with reference to FIG. 3C. The exemplary time-flow depicted in FIG. 4 differs from exemplary time-flows for FIGs. 3A and 3B due to the presence of the network gateway 110. The exemplary time-flows for FIGs. 3A and 3B would contain IP network connections to the surveilling agency computer system 112 instead of a calls placed to the surveilling agency computer system 112 in time-slices 403 and 404. The operations of the blocks of the exemplary flowchart depicted in FIG. 5 may be performed by any

suitable combination of hardware and software. For example, the operations of the blocks may be performed in whole or in part by one or more stand-alone software package installed on one or more computers.

[0063] In block 501, the first communications device 101, on a VoIP network, may initiate a call to the second communications device 102. To initiate the call, the first communications device 101 may transmit call initiation data to the application server 106 on the VoIP provider's network 103.

[0064] In block 502, the application server 106 may receive the call initiation data from the first communications device 101. The Application server 106 may use the call initiation data to set up the call between the first communications device 101 and the second communications device 102. Time-slice 401 may be an exemplary time-flow representation of messages exchanged between the first communications device 101 and the application server 106 during blocks 501 and 502. As indicated by the solid line, the first communications device 101 may send an Invite message, conforming to session initiation protocol (SIP), to the application server 106, indicating the intended recipient of the call. Upon receiving the Invite message, the application server 106 may return the SIP message Trying (status code 100), indicating that the application server 106 is attempting to complete the call as requested.

[0065] In block 503 the application server 106 may determine whether either of the first communications device 101 or the second communications device 102 are under surveillance, based on the call initiation data. Information the application server 106 may use from the call initiation data may include, for example, data identifying the first communications device 101 and second communications device 102, such as, for example, an IP address, Media Access Control (MAC) Address, assigned phone number, userid, etc. Information from the call initiation data may be, for example, compared to lists which may be stored on, or otherwise accessible to, the application server 106. The lists may contain information that may be used to identify communication devices under surveillance based on call initiation data. Individual surveilling agencies may maintain their own lists including data on communications device placed under surveillance by the individual surveilling agencies. Any other suitable method for identifying whether or not

a given communications device is under surveillance by a surveilling agency may also be used by the application server 106.

[0066] In block 504, if neither the first communications device 101 nor the second communications device 102 has been placed under surveillance, flow proceeds to block 505. If at least one of the first communications device 101 and second communications device 102 is under surveillance, flow proceeds to block 506.

[0067] In block 505, the call initiated by the first communications device 101 may be completed normally. For example, if the call is a voice-only call, the first communications device 101 and second communications device 102 may be connected over the IP-network without passing data through the VoIP provider's network 103. If the call is, for example, a video-conference call, the call may be routed through the packet-based media processor 110 on the VoIP provider's network 103.

[0068] In block 506, at least one of the first communications device 101 and the second communications device 102 is under surveillance by at least one surveilling agency. The application server 106 may transmit instructions to the packet-based media processor 110 to set up the repeaters 301 and 302. One repeater may be set up on packet-based media processor 110 for each data stream originating from each party to a call. For example, if the call content is a video conference, each party to the call may generate an audio stream and a video stream. With two parties to the call, four repeaters may be set up on packet-based media processor 110. If three or more communications devices participate in the video conference, two repeaters will be set up on packet-based media processor 110 for each communications device participating in the video conference. If more than one surveilling agency has requested surveillance of the call, each surveilling agency may be added as a listener to the repeaters set up on packet-based media processor 110, or, alternatively, additional repeaters may be set up to support the additional surveilling agencies. Each surveilling agency may have its own surveilling agency computer system similar to surveilling agency computer system 112, and the packet-based media processor 110 may establish a connection with each of the surveilling agency computer systems. Alternatively, an individual repeater may be set up to support connections with multiple surveilling agency computer systems. When more than one surveilling agency computer system is connected to the packet-based media processor 110 to receive copied packets,

the presence of each surveilling agency computer system connected may be hidden from all other connected surveilling agency computer systems. The application server 106 may transmit information to the packet-based media processor 110 indicating which surveilling agencies have placed one or both of the first communications device 101 and the second communications device 102 under surveillance. This information may include, or may be used by the packet-based media processor 110 to determine, the surveilling agency computer system 112 to which the repeaters 301 and 302 should transmit the copied call content. The packet-based media processor 110 may establish a connection between the repeaters 301 and 302 and the surveilling agency computer system 112.

[0069] The time-slice 402 may be an exemplary time-flow representation of messages exchanged between the application server 106 and the packet-based media processor 110 in setting up the repeaters 301 and 302 in block 506. As indicated by the dashed box, during this time slice the application server 106 may attempt to terminate, i.e., connect, the call between the first communications device 101 and the second communications device 102. The application server 106 may also communicate with the packet-based media processor 110, as indicated by the dashed lines. The application server 106 may instruct the packet-based media processor 110 to allocate the repeaters 301 and 302 for the call. The packet-based media processor 110 may set up the repeaters 301 and 302 and signal this to the application server 106, which may then send an AddListener request to the packet-based media processor 110, instructing the packet-based media processor 110 to add the first communications device 101 to the call. The time-slice 403 may be an exemplary time-flow representation of messages exchanged between the application server 106 and the surveilling agency computer system 112 in establishing a connection to the surveilling agency computer system 112. The application server 106 may first send the Invite from the first communications device 101 to the second communications device 102 in a termination attempt. The application server 106 may then generate its own Invite messages, one for each of the repeaters 301 and 302, to be sent to the surveilling agency computer system 112. In this exemplary time-flow, the surveilling agency computer system 112 may only accept connections through the network gateway

111, thus the application server 106 may call the surveilling agency computer system 112.

[0070] In block 507, the application server 106 may modify the call initiation data to cause the call content from the first communications device 101 and the second communications device 102 to be routed through the repeaters 301 and 302. The application server 106 may modify the SDP carried in the SIP INVITE, transmitted in time-slice 403, and SIP 200 OK transmitted in time-slice 405, to the IP address and port of the packet-based media processor 110. The routing of call content through the repeaters 301 and 302 may be invisible to the first communication device 101 and second communication device 102, because of, for example, the presence of session border controllers 105 and 107 between the first and second communication devices 101 and 102 and the internal structure of the VoIP provider's network 103, including the packet-based media processor 110. Other network devices in-between the VoIP provider's network and the first and second and second communications devices 101 and 102 may also result in the routing of the call content being invisible to the first and second communication devices 101 and 102.

[0071] The time-slices 404 and 405 may be exemplary time-flow representations of messages exchanged between the first communications device 101, the application server 106, the packet-based media processor 110, the second communications device 102 and the surveilling agency 112 during block 507. In time-slice 404, the surveilling agency 112 is added to the call. First, the second communications device 102, upon receiving the Invite sent in time-slice 403, may respond with the SIP message Ringing. The Ringing message may be transmitted from the application server 106 back to the first communications device 101, indicating to the first communications device 101 that the second communications device 102 has been contacted. The surveilling agency computer system 112 may also respond with Ringing messages to each of the Invites from the applications server 106, and then with OK messages once the surveilling agency computer system 112 answers the incoming calls from the application server 106. The application server 106 may then instruct the packet-based media processor 110 to add the surveilling agency computer system 112 as a listener to both ends of the call, i.e., as a recipient of copied call content from both of the repeaters 301 and 302. In time-slice 405,

the second communications device 102 has a connection established with first communications device 101. The second communications device 102 may transmit an OK message back to the application server 106 upon picking up the call. The application server 106 may relay the OK message back to the first communications device 101, indicating to the first communications device 101 that the call has been connected.

[0072] In block 508, call content from the first communications device 101 and the second communications device 102 may be copied by the repeaters 301 and 302. Call content, in the form of RTP packets, may be transmitted from the first communications device 101. The RTP packets may enter the VoIP provider's network 103 at, for example, the session border controller 105, where they may be routed to the packet-based media processor 110, and the repeaters 301 and 302 on the packet-based media processor, as IP packets. The IP packets may not need to be filtered by the packet-based media processor 110, as the modifications to the call initiation data may ensure that the IP packets routed to the packet-based media processor and the repeaters 301 and 302 are part of the call under surveillance. The packet-based media processor 110 may route the IP packets to the repeater 301 on the packet-based media processor 110. The repeater 301 may copy the IP packets. Before the copied IP packets are transmitted to the surveilling agency computer system 112, they may be packaged according to a profile provided to repeater 301. For example, the IP packets may be packaged in an ASN.1 envelope. If more than one surveilling agency has placed one or both of first communications device 101 and second communications device 102 under surveillance, the repeater 301 may make additional copies of the IP packet as necessary. Each surveilling agency computer system may have a separate connection to the repeaters 301 and 302.

[0073] Call content in the form of RTP packets transmitted from the second communications device 102 may be treated in the same manner as the RTP packets transmitted from the first communications device 101, except the RTP packets may enter the VoIP provider's network 103 at session border controller 107, and may be routed to the repeater 302. The repeater 302 performs the same functions as the repeater 301, only with the IP packets containing call content originating from the second communications device 102.

- [0074]** In block 509, the copied call content may be transmitted to the surveilling agency computer system 112. The repeaters 301 and 302 may transmit the copied IP packets to the surveilling agency computer system 112. The collection function 113 on the surveilling agency computer system 112 may handle the incoming call content according to the setup of the collection function 113.
- [0075]** The repeaters 301 and 302 may transfer any type of IP-based call content to the surveilling agency computer system 112, if no network gateway 111 is present between the packet-based media processor 110 and the surveilling agency computer system 112. This may include, for example, call content that is audio, video, fax, desktop collaboration, or encrypted data. The transfer of the call content may also be codec independent. Audio or video encoded with any codec may be transferred to the surveilling agency computer system 112, even if the codec used to encode the audio or video is unknown to the VoIP provider and/or the surveilling agency computer system 112. Encrypted call content for which the key is not known may also be transferred. In these cases, the collection function 113 may record the call content with the unknown encoding or encryption on a computer readable medium accessible to surveilling agency computer system 112, from which the call content may be retrieved at a later time for decoding or decryption. If a network gateway 111 is present in between the packet-based media processor 110 and the surveilling agency computer system 112, as in FIG. 4, then only audio content may be transferred by the repeaters 301 and 302.
- [0076]** In block 510, the original IP packets may be packaged as the IP packets would have been on a normal call, and routed by the repeaters 301 and 302 back to the packet-based media processor 110. The packet-based media processor 110 may proceed with delivering the packets to the first communications device 101 and the second communications device 102, as would happen in a normal call routed through the packet-based media processor 110.
- [0077]** For the purposes of this exemplary embodiment, the IP packet transmitted to the second communications device 102 from media sever 110 has been referred to as the original IP packet, and the IP packet transmitted to the surveilling agency computer system 112 has been referred to as a copy of the IP packet. One of ordinary skill in the art would understand that the original IP packet and all copies of the original IP packet

are interchangeable. For example, the copy of the original IP packet may be transmitted to the surveilling agency computer system 112 and the original IP packet may be transmitted to the second communications device 102. Further, in some circumstances the original IP packet will be destroyed, and only copies of the original IP packet will be transmitted. For example, the original IP packet may be copied twice, into a first copy of the IP packet and a second copy of the IP packet. The first and second copy of the IP packet may be transmitted in the same manner as the original IP packet and the first copy of the IP packet described above.

[0078] Blocks 508 through 510 operate continuously until the call is ended by the first communications device 101 or the second communications device 102. The call may end during the operation any of blocks 508 through 510.

[0079] In block 511, the call may be ended. Either of the first communications device 101 or second communications device 102 may end the call. The call may be ended by, for example, hanging up the first communications device 101. When the call is ended, the repeaters 301 and 302 on the packet-based media processor 110 may be released or terminated, depending on what combination of hardware and software has been used to implement the repeaters 301 and 302. For example, if the repeaters 301 and 302 are software based processes running on the packet-based media processor 110, the processes may be terminated.

[0080] The time slice 406 may be an exemplary time-flow representation of messages exchanged between the first communications device 101, the application server 106, the packet-based media processor 110, the second communications device 102 and the surveilling agency 112 during block 511. The second communications device 102 may end the call by transmitting the SIP message Bye to the application server 106. The application server 106 may then instruct the packet-based media processor 110 to release the repeaters 301 and 302, close the connection between the packet-based media processor 110 and the surveilling agency computer system 112 by transmitting the Bye message to the surveilling agency computer system 112, and then close the connection between the first communications device 101 and the second communications device 102 by transmitting the Bye message to the first communications device 101.

[0081] FIG. 6 depicts an exemplary embodiment of the repeater 301. The repeater 302 may have a similar configuration. The repeater 301 may receive incoming IP packet 601 from the IP stream, which may be part of a call. IP packet 601 may be copied a number of times by the repeater 301. The number of copies made of IP packet 601 may be dependent on, for example, the number of recipients the IP packet was originally intended for, for example, the receiver of the call or participants in a conference call, and the number of surveilling agencies that have requested surveillance of at least one of the communications devices involved in the call.

[0082] Each copy of the IP packet 601 may be created according to a profile. Profiles 602, 603, and 604 may be used by the repeater 301 to make copies of IP packet 601 that are packaged in accordance with the standards required by the various recipients of the copied IP packets. The profile 602 may be used to create IP packet copy 605, intended to be received by communications device 608, which may be the recipient of the call, for example, second communications device 102. The profile 602 may package the IP packet as it would be packaged in a normal VoIP call, equivalent to what would have happened to the IP packet 601 if the IP packet 601 had not been routed to the repeater 301. The profile 603 may be used to create IP packet copy 606, intended to be received by surveilling agency 1 computer system 609. The profile 603 may package the IP packet as a standard UDP packet without an envelope, so that surveilling agency 1 computer system 609 may receive the raw data of the call content. The profile 604 may be used to create IP packet copy 607, intended to be received by surveilling agency 2 computer system 610. The profile 603 may package the IP packet in an ASN.1 envelope, which may be required for compatibility with surveilling agency 2 computer system 610. Other profiles may be used to package IP packets according to any suitable packaging format.

[0083] FIG. 7 illustrates an exemplary architecture for implementing a computing device 701, which may be used to implement any of the first communications device 101, the second communications device 102, the router/switch 104, the session border controllers 105 and 107, the applications server 106, the packet-based media processor 110, the network gateway 111, and the surveilling agency computer system 112. It will be appreciated that other devices that can be used with the computing device 701, such as a

client or a server, may be similarly configured. As illustrated in FIG. 7, computing device 701 may include a bus 710, a processor 720, a memory 730, a read only memory (ROM) 740, a storage device 750, an input device 760, an output device 770, and a communication interface 780.

- [0084] Bus 710 may include one or more interconnects that permit communication among the components of computing device 701. Processor 720 may include any type of processor, microprocessor, or processing logic that may interpret and execute instructions (e.g., a field programmable gate array (FPGA)). Processor 720 may include a single device (e.g., a single core) and/or a group of devices (e.g., multi-core). Memory 730 may include a random access memory (RAM) or another type of dynamic storage device that may store information and instructions for execution by processor 720. Memory 730 may also be used to store temporary variables or other intermediate information during execution of instructions by processor 720.
- [0085] ROM 740 may include a ROM device and/or another type of static storage device that may store static information and instructions for processor 720. Storage device 750 may include a magnetic disk and/or optical disk and its corresponding drive for storing information and/or instructions. Storage device 750 may include a single storage device or multiple storage devices, such as multiple storage devices operating in parallel. Moreover, storage device 750 may reside locally on the computing device 701 and/or may be remote with respect to a server and connected thereto via network and/or another type of connection, such as a dedicated link or channel.
- [0086] Input device 760 may include any mechanism or combination of mechanisms that permit an operator to input information to computing device 701, such as a keyboard, a mouse, a touch sensitive display device, a microphone, a pen-based pointing device, and/or a biometric input device, such as a voice recognition device and/or a finger print scanning device. Output device 770 may include any mechanism or combination of mechanisms that outputs information to the operator, including a display, a printer, a speaker, etc.
- [0087] Communication interface 780 may include any transceiver-like mechanism that enables computing device 701 to communicate with other devices and/or systems, such as a client, a server, a license manager, a vendor, etc. For example, communication

interface 780 may include one or more interfaces, such as a first interface coupled to a network and/or a second interface coupled to a license manager. Alternatively, communication interface 780 may include other mechanisms (e.g., a wireless interface) for communicating via a network, such as a wireless network. In one implementation, communication interface 780 may include logic to send code to a destination device, such as a target device that can include general purpose hardware (e.g., a personal computer form factor), dedicated hardware (e.g., a digital signal processing (DSP) device adapted to execute a compiled version of a model or a part of a model), etc.

[0088] Computing device 701 may perform certain functions in response to processor 720 executing software instructions contained in a computer-readable medium, such as memory 730. In alternative embodiments, hardwired circuitry may be used in place of or in combination with software instructions to implement features consistent with principles of the invention. Thus, implementations consistent with principles of the invention are not limited to any specific combination of hardware circuitry and software.

[0089] Exemplary embodiments may be embodied in many different ways as a software component. For example, it may be a stand-alone software package, a combination of software packages, or it may be a software package incorporated as a "tool" in a larger software product. It may be downloadable from a network, for example, a website, as a stand-alone product or as an add-in package for installation in an existing software application. It may also be available as a client-server software application, or as a web-enabled software application. It may also be embodied as a software package installed on a hardware device.

[0090] Exemplary embodiments may be used to intercept IP based call content when more than two communications devices participate in the call, such as, for example, during a conference call.

[0091] While various exemplary embodiments have been described above, it should be understood that they have been presented by way of example only, and not limitation. Thus, the breadth and scope of the present invention should not be limited by any of the above-described exemplary embodiments, but should instead be defined only in accordance with the following claims and their equivalents.

Claims

What is claimed is:

1. A computer-readable medium comprising instructions, which when executed by a computer system causes the computer system to perform operations for IP-based call content intercept, the computer-readable medium comprising:
 - instructions for receiving at least one call initiation data;
 - instructions for receiving a first IP packet from a first communications device;
 - instructions for receiving a second IP packet from a second communications device;
 - instructions for generating a plurality of first IP packets comprising either the first IP packet and at least one copy of the first IP packet, or at least two copies of the first IP packet;
 - instructions for generating a plurality of second IP packets comprising either the second IP packet and at least one copy of the second IP packet, or at least two copies of the second IP packet;
 - instructions for transmitting one of the plurality of first IP packets to the second communications device according to one or more of the call initiation data;
 - instructions for transmitting another of the plurality of first IP packets to a surveilling agency computer system without encoding or decoding the another of the plurality of first IP packets;
 - instructions for transmitting one of the plurality of second IP packets to the first communications device according one or more of the call initiation data; and
 - instructions for transmitting another of the plurality of second IP packets to the surveilling agency computer system without encoding or decoding the another of the plurality of second IP packets.

2. The computer-readable medium of claim 1, further comprising:

instructions for determining if the first communications device or the second communications device is under surveillance based on the at least one call initiation data before generating the plurality of first IP packets; and

instructions for not generating the plurality of first IP packets and not generating the plurality of second IP packets if neither the first communications device nor the second communications device is under surveillance.

3. The computer-implemented method of claim 1, further comprising:

instructions for transmitting another one of the plurality of first IP packets to a second surveilling agency computer system without encoding or decoding the another one of the plurality of first IP packets; and

instructions for transmitting another one of the plurality of second IP packets to a second surveilling agency computer system without encoding or decoding the another one of the plurality of second IP packets.

4. The computer-readable medium method of claim 3, wherein the surveilling agency computer system does not detect the second surveilling agency computer system and the second surveilling agency computer system does not detect the surveilling agency computer system.

5. The computer-readable medium of claim 3:

wherein the surveilling agency computer system receives the another of the plurality of first IP packets and the another of the plurality of second IP packets over a first connection;

wherein the second surveilling agency computer system receives the another one of the plurality of first IP packets and the another one of the plurality of second IP packets over a second connection; and

wherein the first connection and the second connection are separate.

6. The computer-readable medium of claim 1, wherein the first IP packet is selected from a group consisting of an RTP packet, a UDP packet, a SRTP packet, a TCP/IP packet, and a T.38 packet; and

the second IP packet is selected from a group consisting of one of RTP packet, a UDP packet, a SRTP packet, a TCP/IP packet, and a T.38 packet.

7. The computer-readable medium of claim 1, wherein the first IP packet is the IP packet of a stream selected from a group consisting of an audio packet stream comprising at least one of audio, modem, and fax signals, a video packet stream, a text messaging packet stream, and desktop collaboration data packet stream; and

the second IP packet is the IP packet of a stream selected from a group consisting of an audio packet stream comprising at least one of audio, modem, and fax signals, a video packet stream, a text messaging packet stream, and desktop collaboration data packet stream.

8. The computer-readable medium of claim 1, wherein generating the plurality of first IP packets or second IP packets comprises applying a repeater profile to the first IP packet or the second IP packet.

9. The computer-readable medium of claim 1, wherein the first IP packet and the second IP packet are not checked for originating IP address and destination IP address before being copied.

10. The computer-readable medium of claim 1, wherein generating the plurality of first IP packets and generating the plurality of second IP packets are performed by at least one repeater.

11. The computer-readable medium of claim 1, wherein the first IP packet and the second IP packet are received and routed by a plurality of session border controllers

12. The computer-readable medium of claim 1, wherein transmitting the another of the plurality of first IP packets and the another of the plurality of second IP packets to the surveilling agency computer system further comprises forwarding the another of the plurality of first IP packets and the another of the plurality of second IP packets to a network gateway.

13. The computer-readable medium of claim 1, further comprising:
instructions for receiving a third IP packet from a third communications device;
instructions for generating a plurality of third IP packets comprising either the third IP packet and at least one copy of the third IP packet, or at least two copies of the third IP packet;
instructions for transmitting one of the plurality of third IP packets to the surveilling agency computer system without encoding or decoding the one of the plurality of third IP packets;
instructions for transmitting another of the plurality of third IP packets to the first communications device according to one or more of the call initiation data; and
instructions for transmitting another one of the plurality of third IP packets to the second communications device according to one of the one or more call initiation data.

14. A computer-implemented method for Internet Protocol (IP)-based call content intercept, comprising:
receiving at least one call initiation data;
receiving a first IP packet from a first communications device;
receiving a second IP packet from a second communications device;
generating a plurality of first IP packets comprising either the first IP packet and at least one copy of the first IP packet, or at least two copies of the first IP packet;
generating a plurality of second IP packets comprising either the second IP packet and at least one copy of the second IP packet, or at least two copies of the second IP packet;
transmitting one of the plurality of first IP packets to the second communications device according to one or more of the call initiation data;

transmitting another of the plurality of first IP packets to a surveilling agency computer system without encoding or decoding the another of the plurality of first IP packets;

transmitting one of the plurality of second IP packets to the first communications device according to one or more of the call initiation data; and

transmitting another of the plurality of second IP packets to the surveilling agency computer system without encoding or decoding the another of the plurality of second IP packets.

15. The computer-implemented method of claim 14, further comprising, after receiving the at least one call initiation data:

determining if the first communications device or the second communications device is under surveillance based on the one or more of the call initiation data before generating the plurality of the first IP packets; and

if neither the first communications device nor the second communications device is under surveillance, not generating the plurality of first IP packets and not generating the plurality of second IP packets.

16. The computer-implemented method of claim 14, wherein generating the plurality of first IP packets and generating the plurality of second IP packets are performed by at least one repeater.

17. The computer-implemented method of claim 14, wherein the first IP packet and the second IP packet are received and routed by a plurality of session border controllers

18. The computer-implemented method of claim 14, wherein transmitting the another of the plurality of first IP packets and the another of the plurality of second IP packets to the surveilling agency computer system further comprises forwarding the another of the plurality of first IP packets and the another of the plurality of second IP packets to a network gateway.

19. An apparatus for IP-based call content intercept, comprising:
- means for receiving at least one call initiation data;
 - means for receiving a first IP packet from a first communications device;
 - means for receiving a second IP packet from a second communications device;
 - means for generating a plurality of first IP packets comprising either the first IP packet and at least one copy of the first IP packet, or at least two copies of the first IP packet;
 - means for generating a plurality of second IP packets comprising either the second IP packet and at least one copy of the second IP packet, or at least two copies of the second IP packet;
 - means for transmitting one of the plurality of first IP packets to the second communications device according to one or more of the call initiation data;
 - means for transmitting another of the plurality of first IP packets to a surveilling agency computer system without encoding or decoding the another of the plurality of first IP packets;
 - means for transmitting one of the plurality of second IP packets to the first communications device according to one or more of the call initiation data; and
 - means for transmitting another of the plurality of second IP packets to the surveilling agency computer system without encoding or decoding the another of the plurality of second IP packets.
20. The apparatus of claim 19, further comprising:
- means for determining if the first communications device or the second communications device is under surveillance based on the at least one call initiation data before generating the plurality of first IP packets; and
 - means for not generating the plurality of first IP packets and not generating the plurality of second IP packets if neither the first communications device nor the second communications device is under surveillance.
21. The apparatus of claim 19, wherein generating the plurality of first IP packets and generating the plurality of second IP packets are performed by at least one repeater.

22. The apparatus of claim 19, wherein the first IP packet and the second IP packet are received and routed by a plurality of session border controllers
23. The apparatus of claim 19, wherein transmitting the another of the plurality of first IP packets and the another of the plurality of second IP packets to the surveilling agency computer system further comprises forwarding the another of the plurality of first IP packets and the another of the plurality of second IP packets to a network gateway.
24. A system for IP-based call content intercept comprising:
a packet-based media processor adapted to receive a first IP packet from a first communications device and a second IP packet from a second communications device, generate with at least one repeater a plurality of first IP packets comprising either the first IP packet and at least one copy of the first IP packet, or at least two copies of the first IP packet, generate with at least one repeater a plurality of second IP packets comprising either the second IP packet and at least one copy of the second IP packet, or at least two copies of the second IP packet, transmit one of the plurality of first IP packets to the second communications device, transmit another of the plurality of first IP packets to a surveilling agency computer system, transmit one of the plurality of second IP packets to the first communications device, and transmit another of the plurality of second IP packets to the surveilling agency computer system.
25. The system of claim 24, further comprising:
an application server adapted to receive call initiation data, transmit a message to the packet-based media processor instructing the packet-based media processor to setup at least one repeater, and modify the call initiation data to cause the first IP packet from the first communications device and the second IP packet from the second communications device to be transmitted to the packet-based media processor.

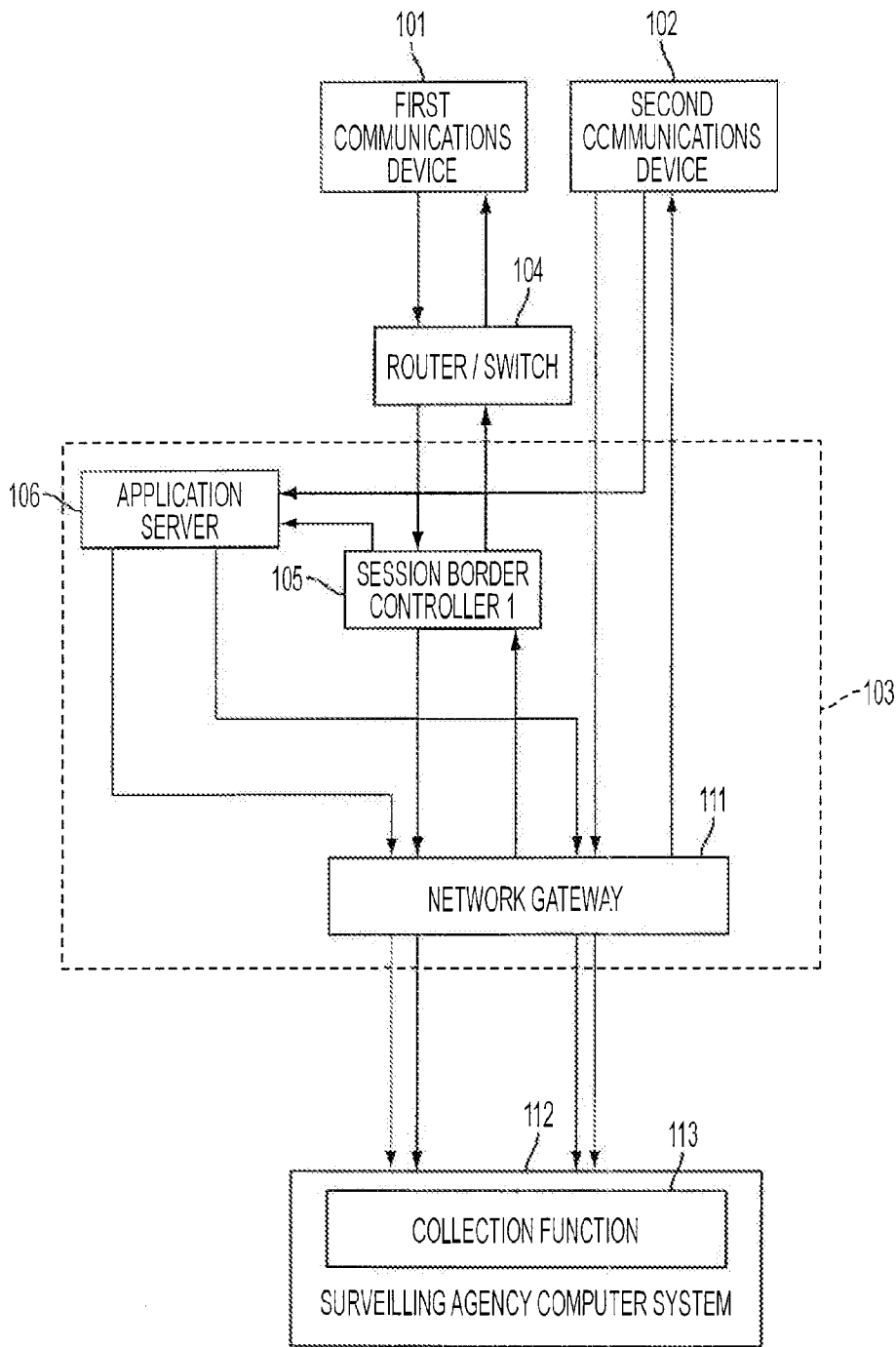


FIG. 1A
PRIOR ART

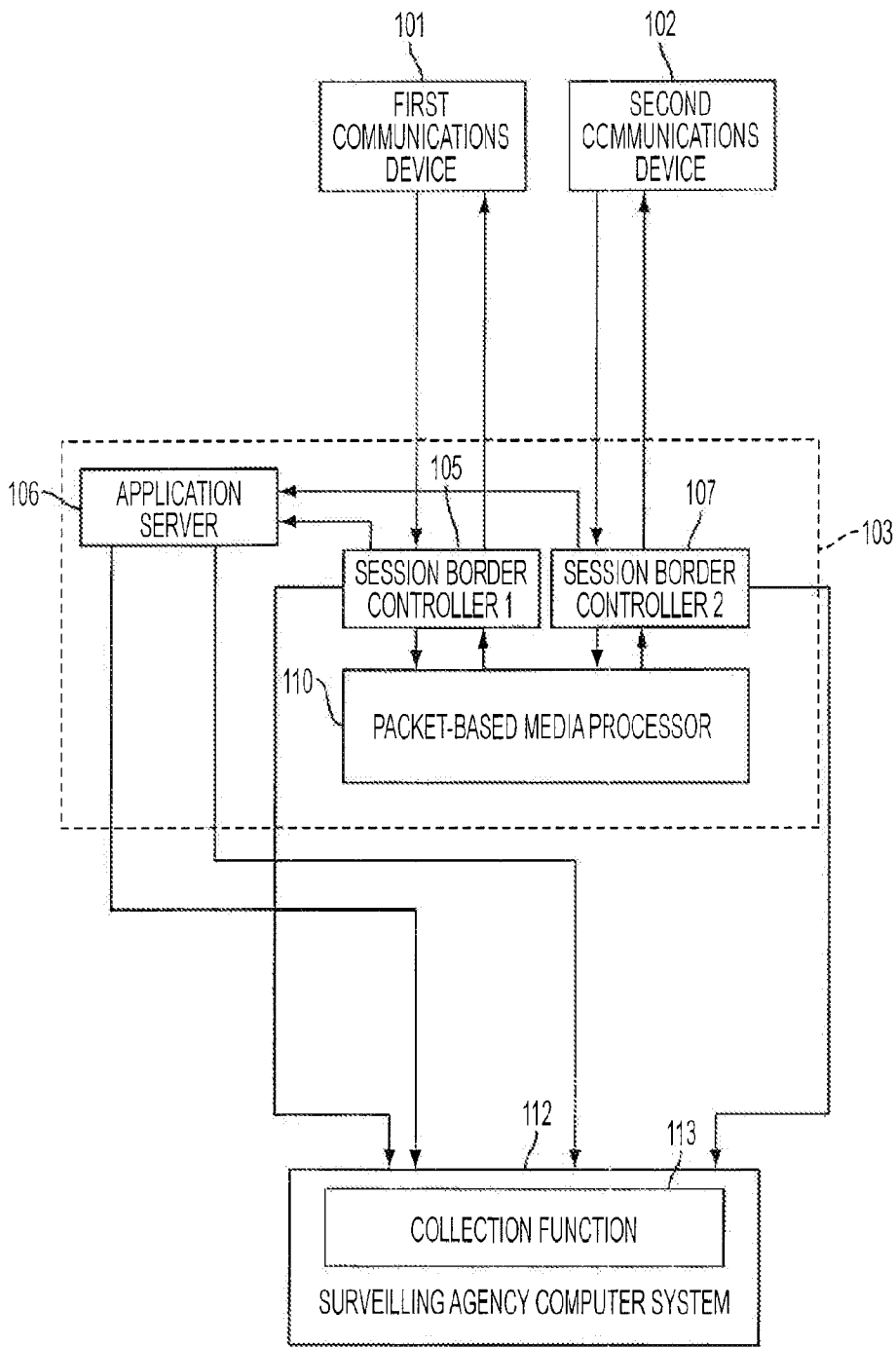


FIG. 1B
PRIOR ART

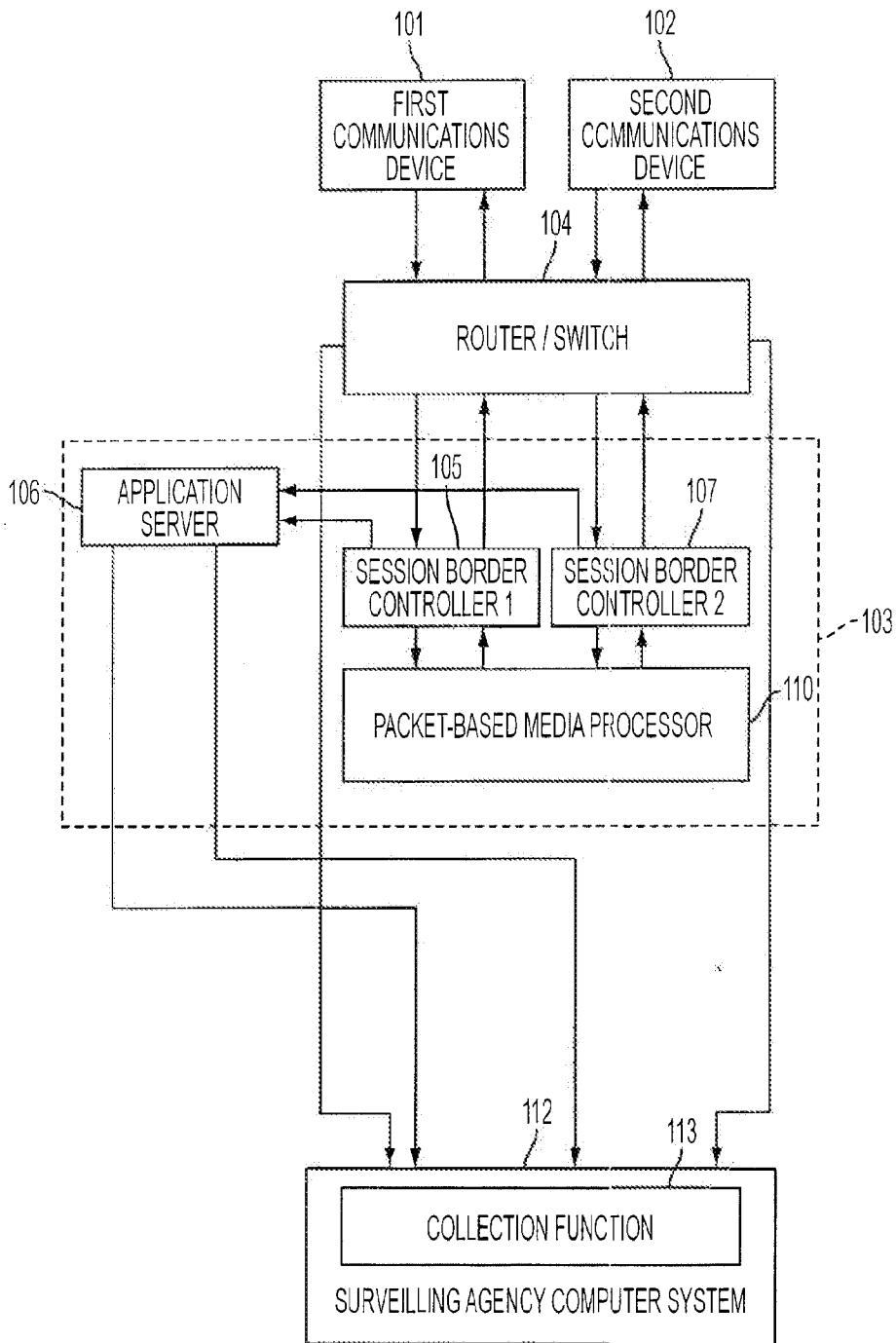


FIG. 1C
PRIOR ART

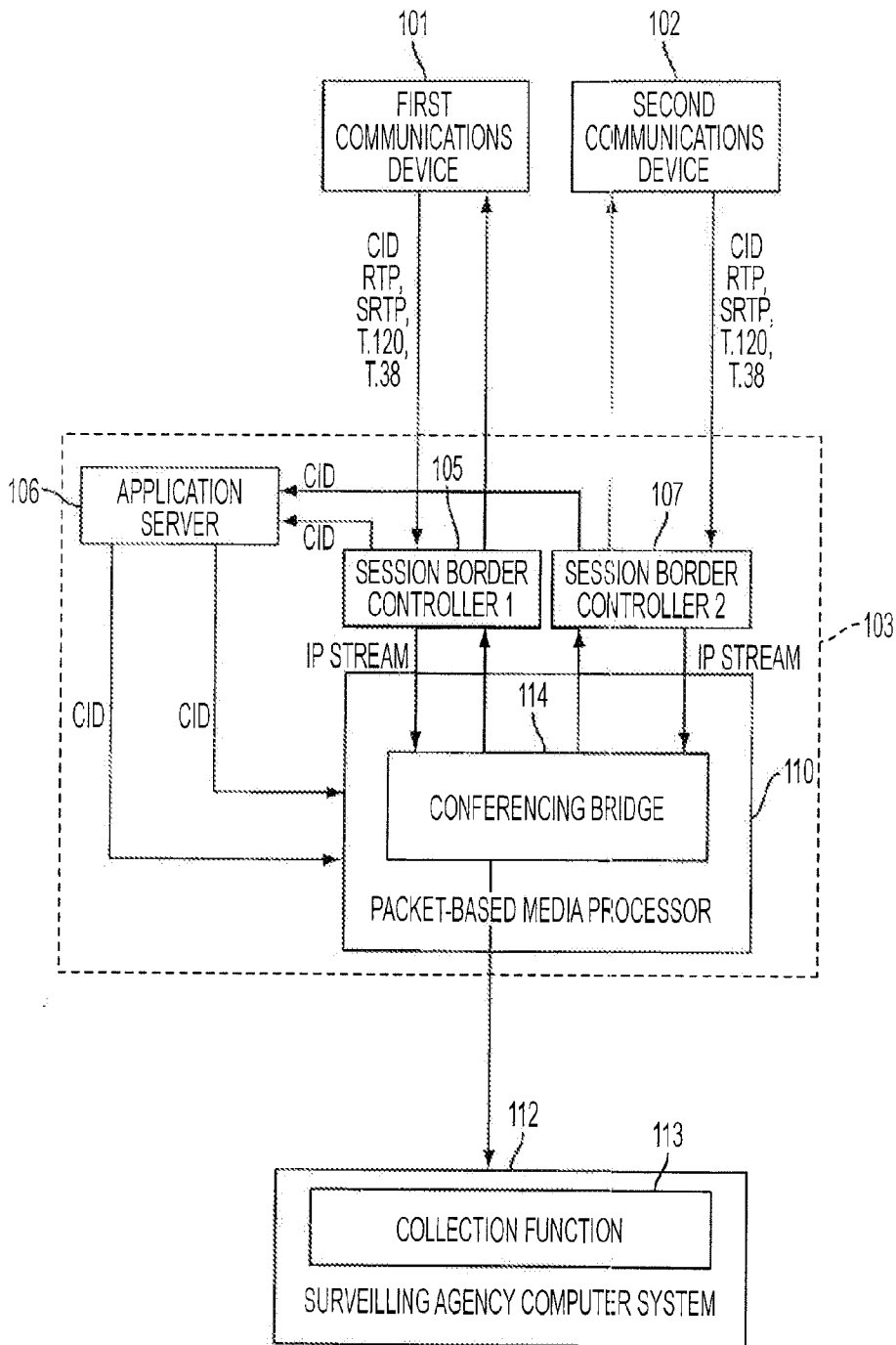


FIG. 1D
PRIOR ART

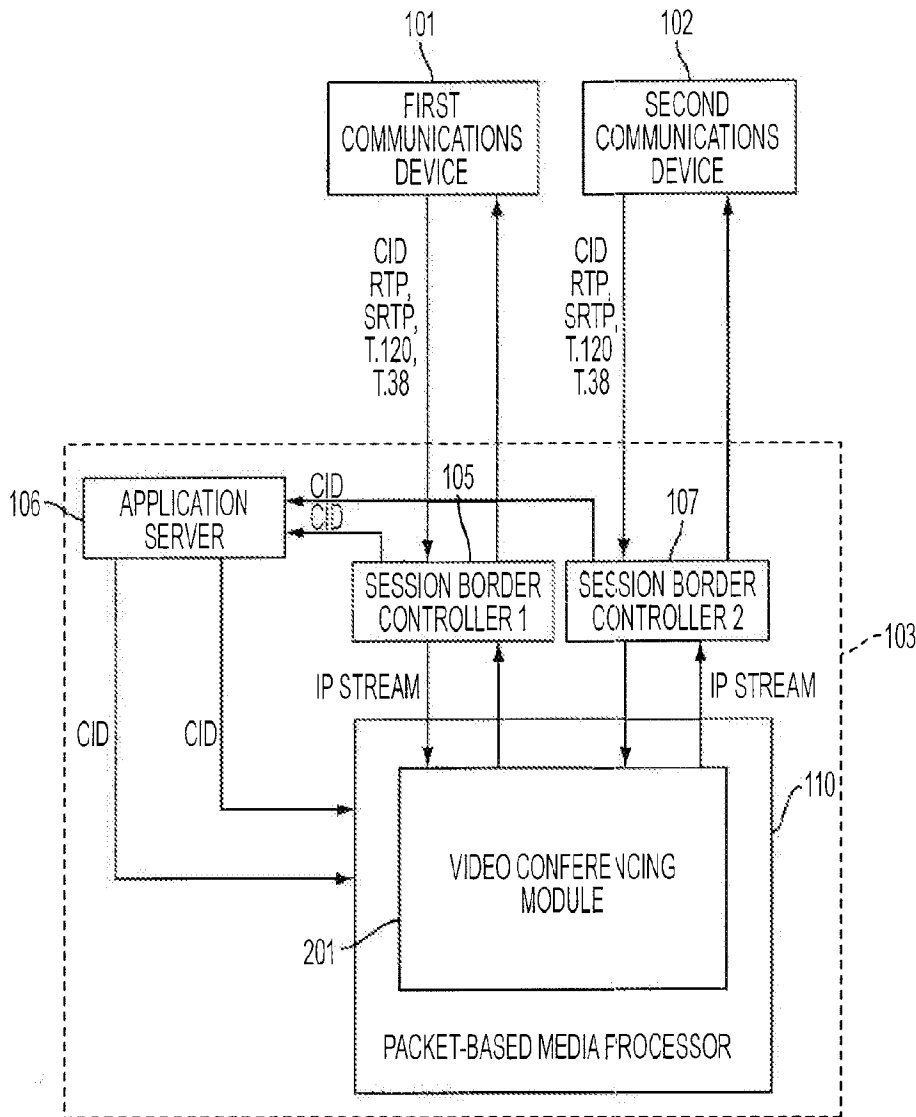


FIG. 2
PRIOR ART

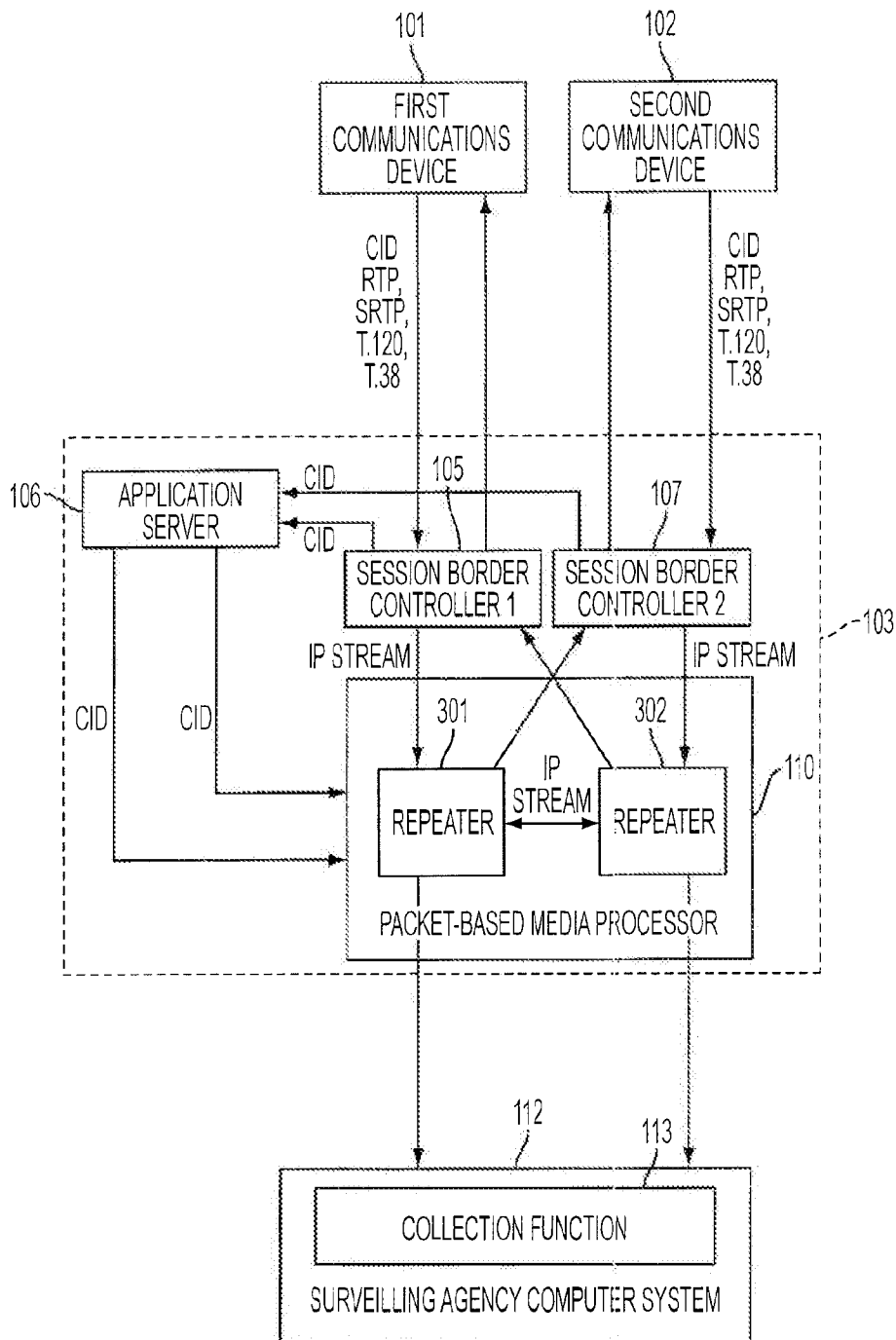


FIG. 3A

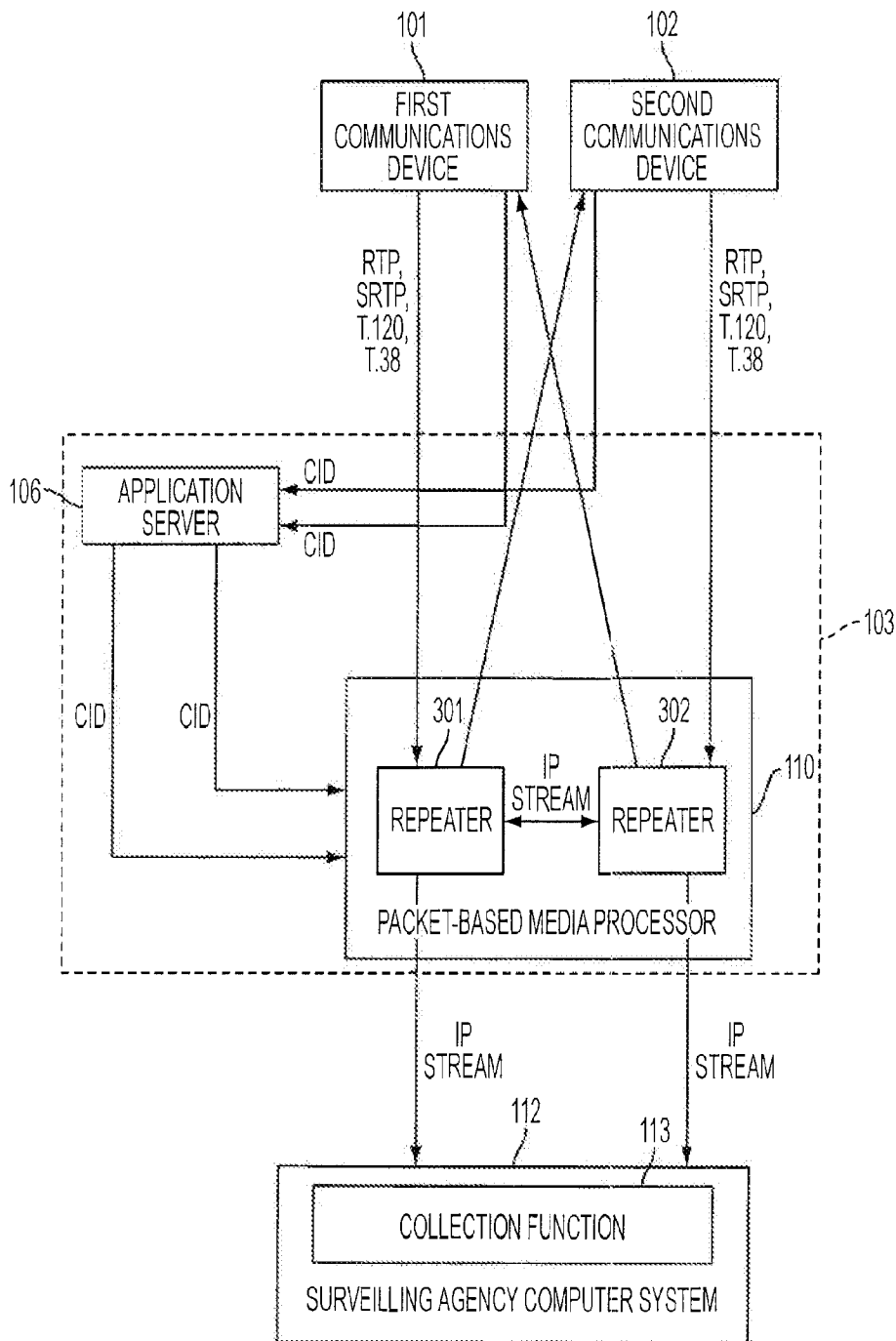


FIG. 3B

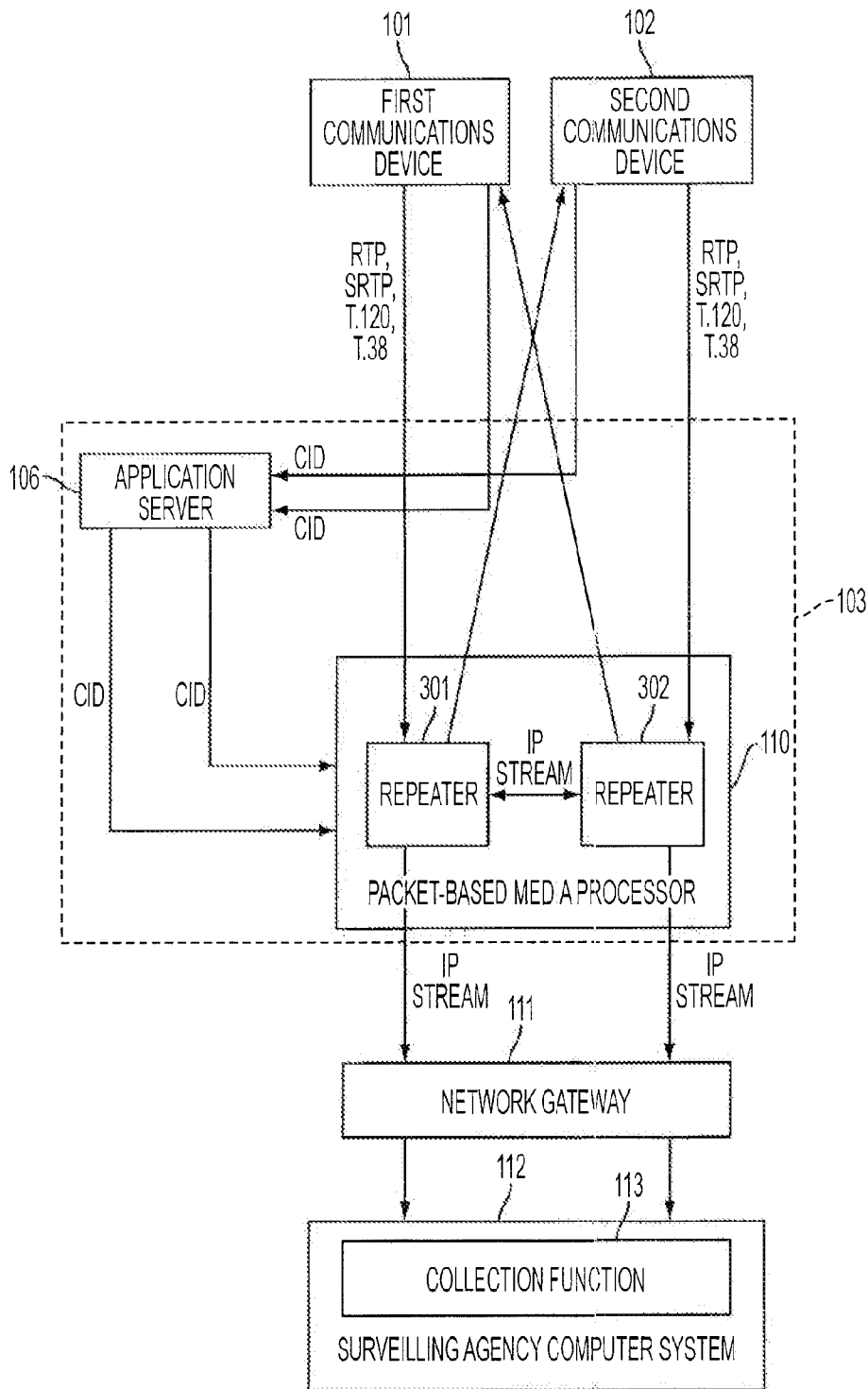


FIG. 3C

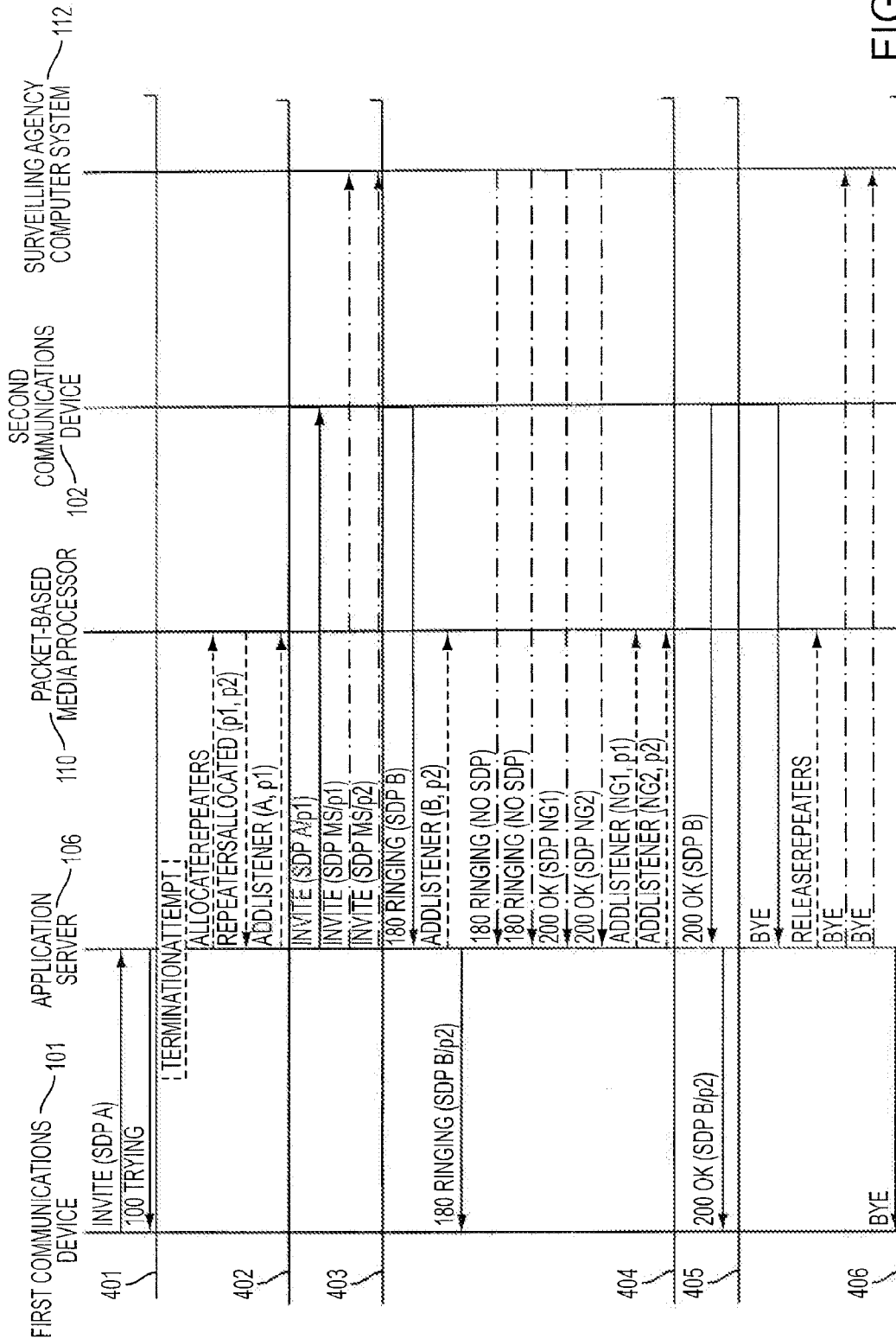


FIG. 4

10/12

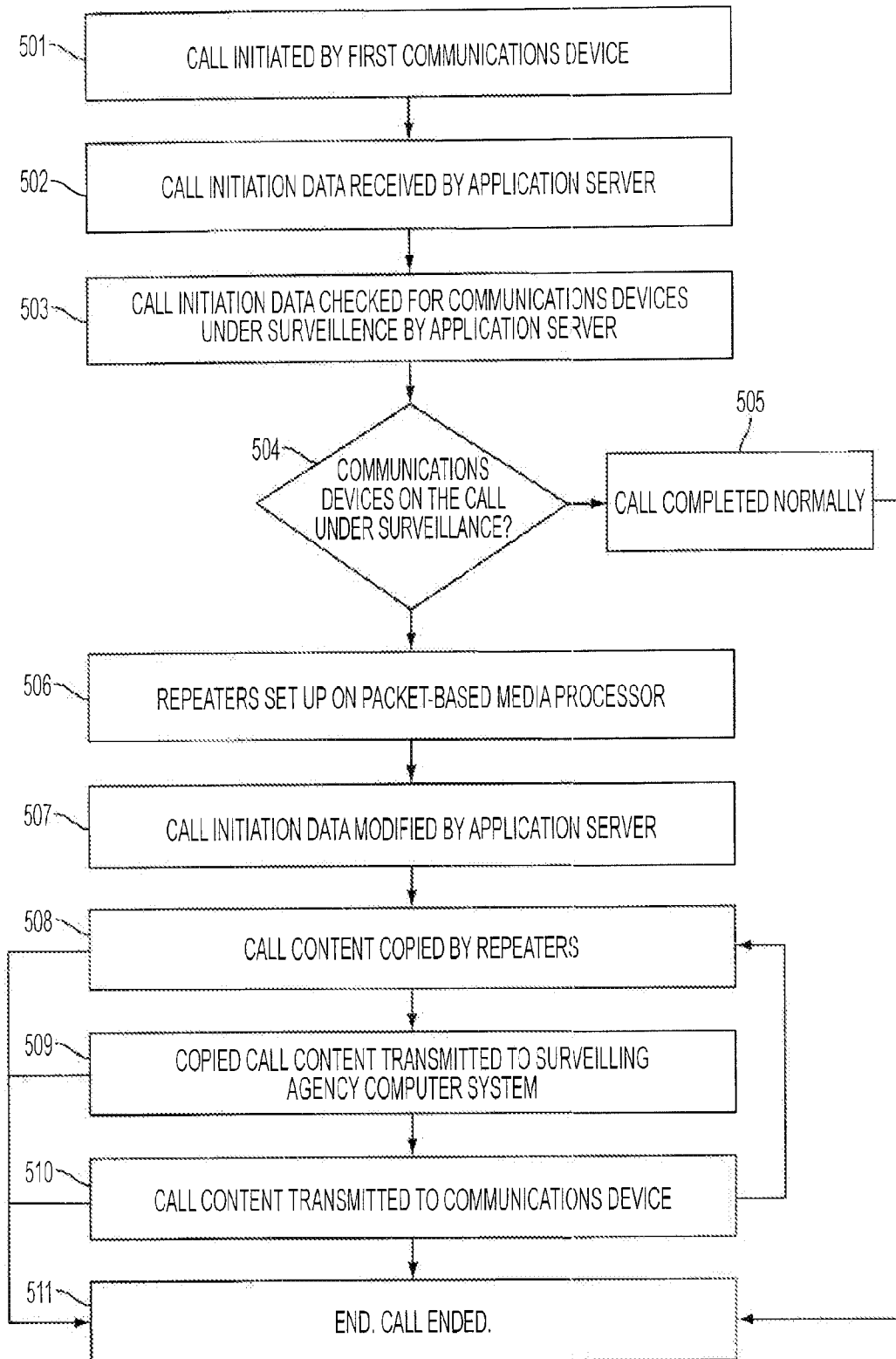


FIG. 5

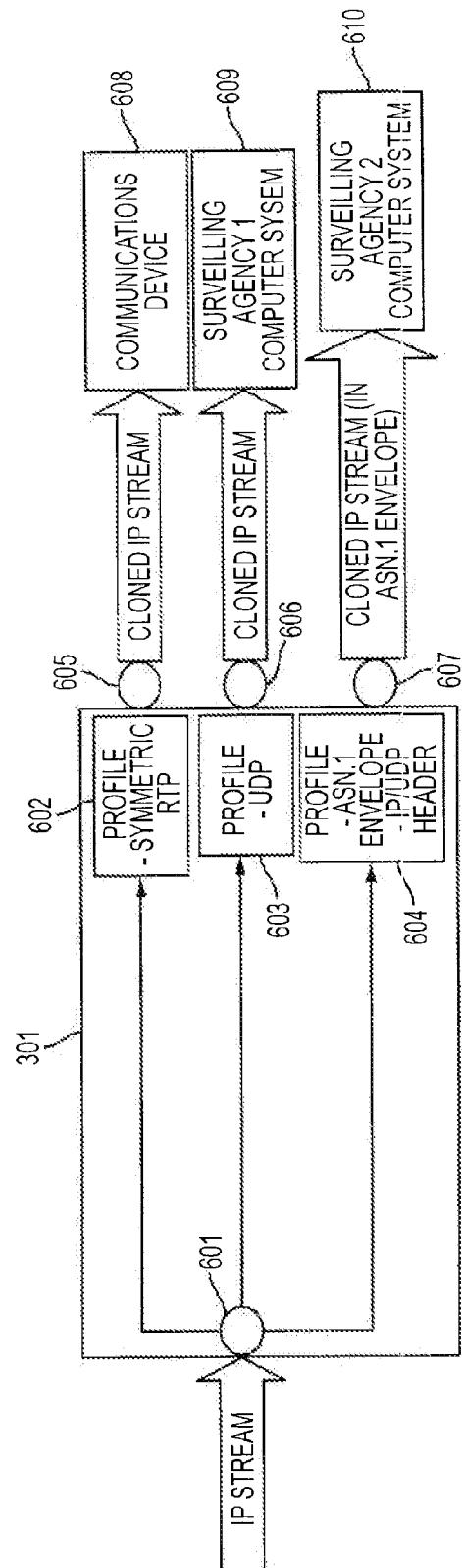


FIG. 6

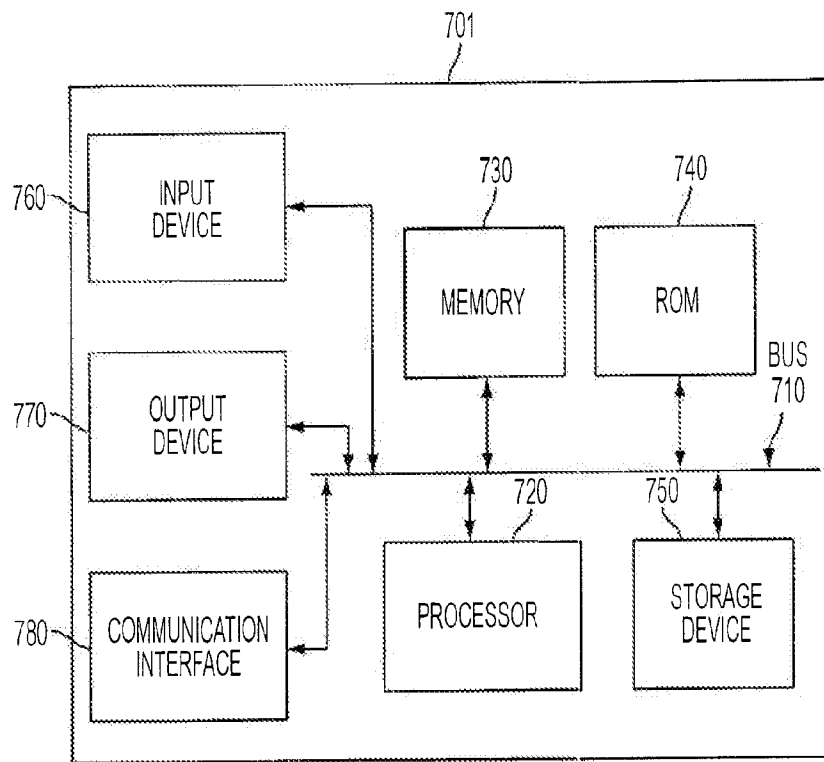



FIG. 7

INTERNATIONAL SEARCH REPORT

International application No.
PCT/US 08/13100

A. CLASSIFICATION OF SUBJECT MATTER IPC(8) - H04J 3/26 (2008.04) USPC - 370/432 According to International Patent Classification (IPC) or to both national classification and IPC		
B. FIELDS SEARCHED Minimum documentation searched (classification system followed by classification symbols) USPC: 370/432 Documentation searched other than minimum documentation to the extent that such documents are included in the fields searched USPC: 370/432, 226 (keyword limited - see search terms below) Electronic data base consulted during the international search (name of data base and, where practicable, search terms used) PubWest (PGPB,USPT,USOC,EPAB,JPAB), Google Scholar, Google Patent Search terms: IP, IP-based, Internet, call, surveillance, under, VoIP, intercept, wire tapping, repeater, law enforcement, forward, copy, encode, decode, session border, network gateway, packet, initiate, CID, agency, multiple, plurality, more, additional, se		
C. DOCUMENTS CONSIDERED TO BE RELEVANT		
Category*	Citation of document, with indication, where appropriate, of the relevant passages	Relevant to claim No.
X	US 2006/0133595 A1 (RAVISHANKAR) 22 June 2006 (22.06.2006), para [0010], [0022]-[0025], [0027]-[0028], [0030]-[0032], [0036]-[0039], [0044]-[0045]	1 - 25
A	US 2004/0165709 A1 (PENCE et al.) 26 August 2004 (26.08.2004), entire document	1 - 25
A	US 2006/0222158 A1 (NAGARAJA) 05 October 2006 (05.10.2006), entire document	1 - 25
<input type="checkbox"/> Further documents are listed in the continuation of Box C. <input type="checkbox"/>		
* Special categories of cited documents: "A" document defining the general state of the art which is not considered to be of particular relevance "E" earlier application or patent but published on or after the international filing date "L" document which may throw doubts on priority claim(s) or which is cited to establish the publication date of another citation or other special reason (as specified) "O" document referring to an oral disclosure, use, exhibition or other means "P" document published prior to the international filing date but later than the priority date claimed "T" later document published after the international filing date or priority date and not in conflict with the application but cited to understand the principle or theory underlying the invention "X" document of particular relevance; the claimed invention cannot be considered novel or cannot be considered to involve an inventive step when the document is taken alone "Y" document of particular relevance; the claimed invention cannot be considered to involve an inventive step when the document is combined with one or more other such documents, such combination being obvious to a person skilled in the art "&" document member of the same patent family		
Date of the actual completion of the international search 26 December 2008 (26.12.2008)	Date of mailing of the international search report 05 JAN 2009	
Name and mailing address of the ISA/US Mail Stop PCT, Attn: ISA/US, Commissioner for Patents P.O. Box 1450, Alexandria, Virginia 22313-1450 Facsimile No. 571-273-3201	Authorized officer: Lee W. Young  PCT Helpdesk: 571-272-4300 PCT OSP: 571-272-7774	

(19) World Intellectual Property Organization
International Bureau



(43) International Publication Date
6 January 2011 (06.01.2011)

(10) International Publication Number
WO 2011/000405 A1

- (51) International Patent Classification:
H04L 29/12 (2006.01)
- (21) International Application Number:
PCT/EP2009/058129
- (22) International Filing Date:
29 June 2009 (29.06.2009)
- (25) Filing Language: English
- (26) Publication Language: English
- (71) Applicant (for all designated States except US): TELEFONAKTIEBOLAGET LM ERICSSON (publ) [SE/SE]; S-164 83 Stockholm (SE).
- (72) Inventors; and
- (75) Inventors/Applicants (for US only): KERÄNEN, Ari [FI/FI]; Tuijatie 2 F 30, FIN-02880 Veikkola (FI). HAU-TAKORPI, Jani [FI/FI]; Sepänkyläntie 10 C 10, FIN-02430 Masala (FI). MÄENPÄÄ, Jouni [FI/FI]; Naaranpajuntie 32 A 5, FIN-03100 Nummela (FI).
- (74) Agent: LIND, Robert; Marks & Clerk LLP, 4220 Nash Court, Oxford Business Park South, Oxford Oxfordshire OX4 2RU (GB).

- (81) Designated States (unless otherwise indicated, for every kind of national protection available): AE, AG, AL, AM, AO, AT, AU, AZ, BA, BB, BG, BH, BR, BW, BY, BZ, CA, CH, CL, CN, CO, CR, CU, CZ, DE, DK, DM, DO, DZ, EC, EE, EG, ES, FI, GB, GD, GE, GH, GM, GT, HN, HR, HU, ID, IL, IN, IS, JP, KE, KG, KM, KN, KP, KR, KZ, LA, LC, LK, LR, LS, LT, LU, LY, MA, MD, ME, MG, MK, MN, MW, MX, MY, MZ, NA, NG, NI, NO, NZ, OM, PE, PG, PH, PL, PT, RO, RS, RU, SC, SD, SE, SG, SK, SL, SM, ST, SV, SY, TJ, TM, TN, TR, TT, TZ, UA, UG, US, UZ, VC, VN, ZA, ZM, ZW.
- (84) Designated States (unless otherwise indicated, for every kind of regional protection available): ARIPO (BW, GH, GM, KE, LS, MW, MZ, NA, SD, SL, SZ, TZ, UG, ZM, ZW), Eurasian (AM, AZ, BY, KG, KZ, MD, RU, TJ, TM), European (AT, BE, BG, CH, CY, CZ, DE, DK, EE, ES, FI, FR, GB, GR, HR, HU, IE, IS, IT, LT, LU, LV, MC, MK, MT, NL, NO, PL, PT, RO, SE, SI, SK, TR), OAPI (BF, BJ, CF, CG, CI, CM, GA, GN, GQ, GW, ML, MR, NE, SN, TD, TG).

Published:
— with international search report (Art. 21(3))

(54) Title: METHOD AND APPARATUS FOR RELAYING PACKETS

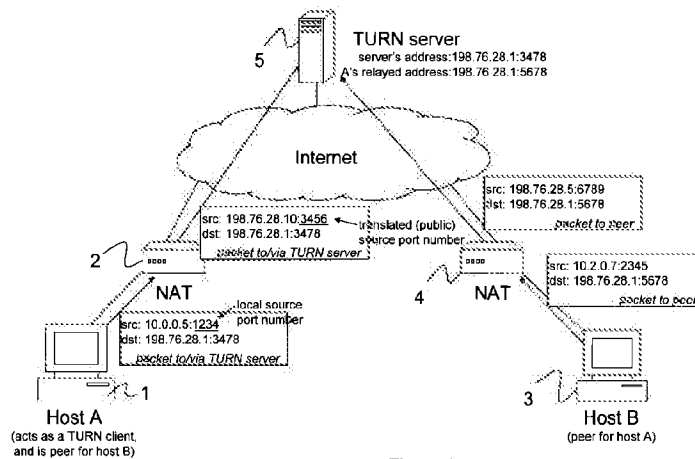


Figure 1

(57) Abstract: Apparatus for relaying packets between a first host and a second host. The apparatus comprises a memory for registering for said first host; an address of the first host, a relayed address of the first host, an address of the second host, and an out-bound Higher Layer Identifier and/or an inbound Higher Layer Identifier. The apparatus further comprises and one or both of : an out-bound packet inspector for inspecting packets received from said first host and addressed to an address of the apparatus to determine whether or not they contain a registered outbound Higher Layer Identifier and, if so, for forwarding the packets to said address of the second host; and an inbound packet inspector for inspecting packets received from said second host and addressed to said relayed address to determine whether or not they contain a registered inbound Higher Layer Identifier and, if so, for forwarding the packets to said address of the first host.

WO 2011/000405 A1

METHOD AND APPARATUS FOR RELAYING PACKETS

Technical Field

5 The present invention relates to a method and apparatus for relaying packets. It is applicable to achieving traversal of a Network Address Translation (NAT) server and in particular to such a method and apparatus that makes use of the Traversal Using Relays around NAT (TURN) protocol.

10 Background

Network Address Translation (NAT) is the process of modifying network address information in datagram packet headers while in transit across a traffic routing device for the purpose of remapping a given address space into another. NAT is used in conjunction with network masquerading (or IP masquerading) which is a technique that 15 hides an entire address space, usually consisting of private network addresses, behind a single IP address in another, often public address space. This mechanism is implemented in a routing device that uses stateful translation tables to map the "hidden" addresses into a single address and then rewrites the outgoing Internet Protocol (IP) packets on exit so that they appear to originate from the router. In the reverse communications path, responses are mapped back to the originating IP address using the rules ("state") stored in the translation tables. The translation table rules established in this fashion are flushed after a short period without new traffic refreshing their state. 20

25 Of course, the use of Network Address Translation means that many hosts in the Internet cannot be contacted directly by other hosts because they are behind a Network Address Translator (NAT) that prevents inbound connections. Different NAT traversal techniques, e.g., Interactive Connectivity Establishment (ICE) [see J. Rosenberg. Interactive Connectivity Establishment (ICE): A Protocol for Network Address Translator (NAT) Traversal for Offer/Answer Protocols. draft-ietf-mmusicice-19 (work in progress). October 2007] have been developed to overcome this problem, but with certain kinds of NATs the only way to create a peer-to-peer connection between two hosts is to relay all the traffic through a node that both of the peers can contact 35 (including the peer or peers behind a NAT).

Traversal Using Relays around NAT (TURN) [see Traversal Using Relays around NAT (TURN): Relay Extensions to Session Traversal Utilities for NAT (STUN). draft-ietf-behave-turn-15 (work in progress). February, 2009] allows a host (that is a TURN client) to register a “relayed address” (a combination of IP address and port number) at the TURN server such that a session is established “through” the NAT between the TURN server and the TURN client (nb. a connection initiated by the host behind the NAT will generally result in a session being established through the NAT and via which the node to which the connection is initiated can send packets to the host). A connection initiated by a remote peer to the relayed address is relayed by the TURN server to the TURN client, such that it passes through the punched hole in the NAT. The TURN client can send data to the peer via the TURN server such that, from the point of view of the peer, the data appears to originate from the relayed address. Using a TURN server, even with the most restrictive type of NATs, a communication path can be established between two peers.

After obtaining a relayed address from the TURN server, a TURN client needs to maintain its state in the NAT by sending periodic keep-alive messages to the TURN server via the NAT. To minimize the volume of keep-alive messages, TURN allows multiple connections with different peers to re-use the same relayed address. Thus, regardless of the number of peers, only one set of keep-alive messages is required. In addition to reducing the volume of keep-alive traffic, this method also conserves public ports at the TURN server and at the NAT allowing them to serve a larger number of simultaneous users.

In the case where multiple peer connections are multiplexed onto one connection between the TURN client and the TURN server, it is necessary to provide a mechanism which allows the TURN server and the TURN client to identify peers within the data packets that they exchange. For this purpose, data sent between the server and client is encapsulated within TURN messages.

TURN encapsulation increases the per-packet overhead and decreases the Maximum Transmission Unit (MTU) on the link between the TURN server and client. The overhead problem is especially severe in restricted bandwidth environments (e.g., when using a cellular data connection), and for data that is sent in multiple small

packets (e.g., real time audio). More significantly perhaps, encapsulation prevents the use of unmodified operating system kernel protocol stacks for receiving and sending the data. This gives rise at least to performance problems, as data needs to be sent back and forth between the kernel and user space process. In the case of restricted
5 operating systems (such as those commonly used in mobile devices) it may of course be impossible to feed the packets back to the kernel protocol stack or capture the packets after the stack processing. TURN encapsulation is not a viable option in such cases.

10 The Internet (IETF) draft – “Traversal Using Relays around NAT: Relay Extensions to Session Traversal Utilities for NAT (July 8, 2007)” provides a mechanism for avoiding encapsulation. This mechanism makes use of the “Set Active Destination” request. However, the mechanism does not allow multiple sessions to be multiplexed onto the TURN server to client link.

15

Summary

It is an object of the present invention to allow packets to be sent between a client and a relay server without using encapsulation, and which mitigates the problems of known
20 solutions.

According to a first aspect of the present invention there is provided apparatus for relaying packets between a first host and a second host. The apparatus comprises a memory for registering for said first host; an address of the first host, a relayed address
25 of the first host, an address of the second host, and an outbound Higher Layer Identifier and/or an inbound Higher Layer Identifier. The apparatus further comprises and one or both of:

an outbound packet inspector for inspecting packets received from said first host and addressed to an address of the apparatus to determine whether or not
30 they contain a registered outbound Higher Layer Identifier and, if so, for forwarding the packets to said address of the second host; and
an inbound packet inspector for inspecting packets received from said second host and addressed to said relayed address to determine whether or not they contain a registered inbound Higher Layer Identifier and, if so, for forwarding the
35 packets to said address of the first host.

Embodiments of the invention allow packets to be sent between the first host and the apparatus, acting as relay server, without encapsulation in one or both of the inbound and outbound directions. The bandwidth occupied on the link between the first host and the apparatus can be reduced, whilst at the same time allowing multiple sessions to be multiplexed onto that link.

The outbound packet inspector, if present, may be configured to replace the address of the first host in a source address field of packets to be forwarded to said second host, with said relayed address.

The inbound packet inspector, if present, may be configured to replace said relayed address in a destination address field of packets to be forwarded to said first host, with said address of the first host, and to replace said address of the second host in a source address field of those packets with an address of the apparatus. The inbound packet inspector may be configured to deliver packets which contain said inbound Higher Layer Identifier, to said first host, without additional relay encapsulation.

The memory may be configured to additionally register for said first host an offset position for the or each of said inbound and outbound Higher Layer Identifiers, the offset position identifying a position of the associated Higher Layer Identifier within a packet, and the outbound and inbound packet inspectors being configured to use the respective offset position to determine the presence of a Higher Layer Identifier.

The memory and the or each of said inbound packet inspector and said outbound packet inspector may be configured to additionally handle the relaying of packets between said first host and one or more further hosts using one or both of the inbound and outbound Higher Layer Identifiers.

The invention is applicable to the case where said first host is located behind a Network Address Translator, and said address of the first host is a NATed address of the first host. In this case, any additional relay encapsulation is encapsulation according to the Traversal Using Relays around NAT protocol. The apparatus acting as relay server may comprise a client terminal registration unit for registering said first host and any further hosts, the registration unit being configured to use the Traversal

Using Relays around NAT, TURN, protocol.

5 According to a second aspect of the present invention there is provided a client terminal configured to exchange packets with a peer terminal via a relay server. The client terminal comprises a relay unit for registering with the relay server so as to be allocated a relayed address by the relay server, and an identification determining unit for determining an inbound Higher Layer Identifier to be used in packets exchanged with said peer terminal. The terminal further comprises an identifier registration unit for registering the inbound Higher Layer Identifier with said relay server, together with said
10 relayed address, an address of the client terminal, and an address of the peer terminal, and a packet handler for associating packets received from said relay server with said peer terminal using said inbound Higher Layer Identifier.

15 The identification determining unit of the terminal may be configured to determine an outbound Higher Layer Identifier to be used in packets exchanged with said peer terminal, with said identifier registration unit being configured to register the outbound Higher Layer Identifier with said relay server together with the inbound Higher Layer Identifier.

20 The identification determining unit may be configured to determine inbound and/or outbound Higher Layer Identifiers by identifying and using one of the following protocol parameters: a Host Identity Tag, HIT; a synchronisation source (SSRC) identifier; a Security Parameter Index (SPI); TCP port numbers.

25 The relay unit may be configured to implement NAT traversal and said address of the client terminal being a NATed address. In this case, the relay unit and said identifier registration unit may be configured to use the Traversal Using Relays around NAT, TURN, protocol. A further packet handler may be provided for using Traversal Using Relays around NAT, TURN, encapsulation to send and/or receive packets to a peer
30 terminal in the event that said identification determining unit is unable to determine an inbound and, optionally, an outbound Higher Layer Identifier, or a TURN encapsulated packet is received from said relay server.

35 The relay unit may be configured to determine whether or not a relay server supports a Higher Layer Identifier based relaying method and, if not, to initiate packet routing with

said peer terminal using relaying encapsulation.

According to a third aspect of the present invention there is provided a method of sending packets between a first host and a second host. The method comprises registering at a relay server, on behalf of the first host an address of the first host, a
5 relayed address of the first host, an address of the second host, and an outbound Higher Layer Identifier and/or an inbound Higher Layer Identifier. The method further comprises one or both of the steps of:

10 at the relay server, inspecting packets received from said first host and addressed to an address of the relay server to determine whether or not they contain said outbound Higher Layer Identifier and, if so, forwarding the packets to said address of the second host; and
inspecting packets received from said second host and addressed to said relayed address to determine whether or not they contain said inbound Higher
15 Layer Identifier and, if so, forwarding the packets to said address of the first host.

The first host may be located behind a Network Address Translator., in which case said step of registering may be carried out using the Traversal Using Relays around NAT, TURN, protocol. Packets sent from the relay server to the first host may be forwarded
20 using TURN encapsulation if packets received from the second host do not contain said inbound Higher Layer Identifier.

Brief Description of the Drawings

25

Figure 1 illustrates schematically a network communication scenario involving NAT traversal using TURN;

Figure 2 illustrates registration signalling in the network scenario of Figure 1 and associated with the modified TURN protocol;

30 Figure 3 illustrates schematically an ESP packet format;

Figure 4 illustrates packet relaying in the network scenario of Figure 1;

Figure 5 illustrates schematically a TURN client and TURN server of the network scenario of Figure 1;

35 Figure 6 is a flow diagram illustrating TURN server registration and packet relay processes;

Figure 7 illustrates schematically an RTP packet format; and
Figure 8 illustrates schematically a HIP packet format.

Detailed Description

5

The problem of NAT traversal has been considered above in the context of TURN encapsulation. An enhancement to TURN and other NAT traversal solutions using data relaying will now be described.

10

Data that may otherwise be the subject of TURN encapsulation between the TURN client and the TURN server will often include a persistent Higher Layer Identifier (HLI) at a consistent location within packets. It is proposed here to make use of such a HLI on top of the transport layer protocol, to multiplex/demultiplex packets in place of TURN encapsulation. When a TURN client wants to communicate with a peer without using

15 TURN encapsulation, it first checks with the TURN server to determine whether or not the TURN server supports the HLI mechanism described here. If so, then the TURN client registers a pair of HLIs (one inbound and one outbound) at the TURN server. A TURN server HLI registration contains two byte arrays (one for each HLI), as well as an array length, offset and peer address. For inbound traffic, when the TURN server

20 receives a packet directed to the relayed address, it checks to see if the packet data matches a registered inbound HLI and, if it does, it sends the packet without any encapsulation to the TURN client as the inbound HLI will uniquely identify the peer address to the TURN client. When the TURN server receives a packet from the TURN client, it checks to see if the packet data matches a registered outbound HLI and, if it

25 does, the packet is sent to the peer address that was registered for that outbound HLI (the public address allocated to the TURN client by the NAT, i.e. the "NATed" address of the client, which is included as the source address of the packet received at the TURN server, is switched for the relayed address according to normal TURN behaviour).

30

The HLI can be any byte array whose value and location is known before data is sent or received. The length of the arrays and their offsets (i.e. how many bytes after the transport layer header the HLI starts) can be defined at registration of the HLIs (by TURN client) with the TURN server. For example, in the case of UDP encapsulated

35 ESP [RFC3948], the SPI value could be used as the HLI. Another example of a

potential HLI would be a TCP port number if TCP is tunneled over UDP and relayed through a TURN server. A Real-time Transport Protocol's (RTP) synchronization source identifier is another example of an HLI.

5 Packets sent to the relayed address (from a peer) that do not match to a registered HLI are forwarded by the TURN server to the TURN client with TURN encapsulation. Any packets arriving at the TURN server from the TURN client that do not contain a match to any registered HLI are assumed to be TURN encapsulated. This behaviour allows a
10 TURN server including the new functionality to be compatible with legacy TURN clients, and to be useable with traffic which does not include useable HLIs.

If data associated with a certain protocol needs to be exchanged between the TURN client and a single peer only, any constant field in the protocol header that is different from other concurrently relayed protocols is sufficient. For example, a protocol version
15 number or a magic cookie value could be sufficient for this purpose. A "magic cookie" value (in this context) is a constant value in a protocol header that is used for differentiating certain protocol messages from messages associated with other protocols in the same stream. For example, STUN [RFC5389], the protocol used by
20 TURN and ICE, carries this kind of identifier in all messages.

If, on the other hand, messages using the same protocol are exchanged by the TURN client with multiple peers, an identifier that is different for each peer is needed. Many protocols have some identifier in each packet for the source and/or destination of the data (e.g., HIP sender and receiver HITs or RTP synchronization source). For other
25 protocols, it may be necessary to generate a HLI by combining information in multiple protocol fields.

Usually the TURN client knows implicitly the value for the outbound HLI since it is the entity originating the packets and generating the higher layer messages. If an external
30 protocol stack (such as IPsec provided by the operating system) is used and the stack generates the value used as the HLI, the client may need to query the value from the stack or look it up from sent packets.

If the TURN client knows *a priori* the HLI value for the peer (e.g., it is a constant protocol field or certain peers always use the same value), no additional signaling is
35

needed before registering HLIs at the TURN server. For example, in the case of HIP signaling traffic, hosts know the Host Identity Tags (HITs) that will be used in the HIP header even prior to contacting each other since a HIT is calculated from a host identity. Hence, HITs can be used as HLIs without any extra signaling. If however the HLI is not known *a priori* by the TURN client, the TURN client needs to learn the HLI value either from protocol signaling or automatically from the first received packet. Of course, that signalling (assuming that it goes through the TURN server and not via some other relay, e.g. a SIP server or HIP relay server) or first data packet must be TURN encapsulated. By way of example, consider an IPsec security association set up using IKE [RFC4306] or HIP. The hosts negotiate the SPI value that will be inserted into the beginning of every encrypted ESP packet. Thus, before any data is sent, the TURN client learns the peer's SPI value that it can utilize as HLI. The methods described do not require any support for HLI, or even for regular TURN, in the peer. An alternative approach that does require HLI support in the peer involves the TURN client explicitly asking the peer (using e.g., new STUN/TURN messages) for an HLI value.

To illustrate the proposed approach to implementing TURN without necessarily requiring TURN encapsulation, consider the case of UDP encapsulated ESP. Figure 1 illustrates schematically a TURN client (Host A) 1 that is behind a NAT 2. A peer, Host B, 3 is also behind a NAT 4, and wishes to communicate with Host A using UDP encapsulated ESP. This is achieved using a TURN server (or relay) 5. Figure 1 shows exemplary source (src) and destination (dst) IP addresses and port numbers included in packets at various points in the network. Figure 2 illustrates signalling associated with this scenario. A TURN client that supports the HLI extension first registers at the TURN server using a standard TURN allocation request (step 1). The client includes HLI-SUPPORTED parameter in the request to test whether the TURN server supports this extension. If the server supports HLI relaying, it responds with an Allocation OK message (step 2). If however the TURN server does not support HLI relaying, it rejects the request and the client can either register to the server without the extension or try some other TURN server. The HLI-SUPPORTED parameter has "comprehension-required" [RFC5389] type so that if a (legacy) TURN server does not recognize it, it rejects the request. One or both of the hosts in Figure 1 may be located behind multiple NATs. This does not change the principle of the relaying process.

35

Next, the hosts negotiate IPsec Security Associations. They can use for example HIP or IKE for this purpose. The negotiation can be done either through the TURN server or using some other relaying service such as HIP relay server [id-hip-nat-traversal: see Basic HIP Extensions for Traversal of Network Address Translators. draft-ietf-hip-nat-traversal-06 (work in progress). March 2009] or a peer-to-peer overlay network. If a
5 TURN server is involved in the IPsec signalling, the signaling messages are TURN encapsulated between the TURN server and client unless HLIs have been set for the signaling protocol.

10 The TURN client then requests "permissions" for the peer and includes the inbound and outbound HLIs that should be checked against all relayed data (step 3). The TURN server responds with a Permission OK (step 4). Permissions are part of the normal TURN behavior and increase security by allowing only peers with registered permission to use the relayed address. The HLI registration is piggybacked on the
15 standard permission registration procedure. As the client will use UDP encapsulated ESP, it registers the SPI values for the peer (at address 198.76.28.5:6789) as the HLIs. In the example of Figure 1, the inbound SPI is "0xA1B2C3D4" and the outbound SPI is "0xB2C3D4E5". Both parameters are four bytes long and start immediately after the UDP header (HLI offset is zero) since the SPI is always in the first four bytes of the
20 ESP packet. At the TURN client, the peer's address in the IPsec SAs is set to the TURN server's address so that the IPsec stack sends ESP packets, destined for the peer, to the TURN server. Figure 3 illustrates the packet format of ESP.

Figure 4 illustrates an exchange of ESP packets between the TURN client and the peer
25 (the lower message sequence in the Figure) and which does not require TURN encapsulation. When the peer sends a packet that does not match to the registered HLI (in this example, something other than ESP, e.g., a NAT traversal connectivity check message or a signaling protocol message), the data is forwarded to the client with TURN encapsulation (the upper sequence in Figure 4). The client can reply to the
30 message by encapsulating the response and signaling the peer's address in the encapsulation meta data. When the TURN server relays the response, it removes the TURN encapsulation. After receiving the response, the peer sends UDP encapsulated ESP packets with an SPI that matches the registered HLI. The TURN server detects the match and forwards the packets without any encapsulation. The TURN client's
35 IPsec stack receives the data and processes it accordingly. When the program using

IPsec sends data back to the peer, the IPsec stack automatically sends the data (with only UDP encapsulation) to the TURN server. The TURN server detects that the data matches to a registered HLI and forwards the data to the peer whose address was registered for the HLI. It will be readily apparent that the great majority of the packets exchanged do not require TURN encapsulation when utilising the approach described here.

While the method above uses simple byte arrays for matching data to permissions, more complicated forwarding rules could be implemented. For example, one could augment the byte arrays with bit-masks and allow bit-level checks for multiplexing the connections. Also, instead of just a single forwarding rule, a TURN client could add multiple rules that all match to a certain peer address. Even logical operations taking into account multiple byte/bit positions in the data could be used for selecting a rule. This would make it possible, for example, to forward all packets to the TURN client without encapsulation, except for packets relating to NAT traversal connectivity checks (and for which the real sender address information is necessary).

Figure 5 illustrates schematically a client terminal 1 (or UE) and a TURN server 5 configured to implement the approach described above (with a NAT interposed between these two entities). Within the UE 1, a NAT traversal unit 6 is provided, the role of which is to register the UE with TURN server in order to allocate to the UE a relayed address. An HLI determining unit 7 is provided to determine appropriate HLIs for both inbound and outbound flows towards a given peer. Once determined, these HLIs are passed to an HLI registration unit 8 which registers the HLIs with the TURN server, in association with the address of the peer. The registration details are also passed to a packet handler 9 which uses the HLIs and the peer's address to determine whether or not TURN encapsulation is required for outgoing packets, and to correctly route incoming packets to higher layers.

Figure 5 further illustrates the TURN server 5. This comprises a client terminal registration unit 10 and associated memory 11 for registering HLI associations for the UE 1. An inbound packet inspector 12 is configured to examine packets addressed to the relayed address to identify the registered inbound HLI, and to forward such packets to the UE without TURN encapsulation. An outbound packet inspector 13 is configured to identify the registered outbound HLI in packets received from the UE, and to route

packets to the destination address of the peer accordingly. It will be appreciated of course that the TURN server will handle multiple HLI registrations in parallel for different UEs (and also, potentially, for the same UE).

5 Figure 6 is a flow diagram illustrating the main steps in the HLI based packet handling process. The process begins at step 100, and at step 200 the UE registers itself with the TURN server to obtain a relayed address. This registration may occur before the user decides to initiate a session. Assuming that this is the case, at step 300 the user initiates a session with a peer, via the UE. This step may be in response to receipt of a
10 session initiation message from the peer (e.g. received via the TURN server using TURN encapsulation or via some other relay server). At step 400 the UE then determines inbound and outbound HLIs for the session, and registers these with the TURN server, in association with an address of the peer, at step 500. Following completion of this registration step, at steps 600 and 700, the UE and TURN server
15 handle packets as described, to avoid TURN encapsulation between the UE and the TURN server. Steps 600 and 700 are performed in parallel.

The following subsections illustrate how HLI relaying can be used with some example protocols, other than ESP. The list is not exhaustive however, and the skilled person
20 will appreciate that the approach described is applicable to a large number of different protocols.

Real-time Transport Protocol (RTP)

RTP [RFC3550: RTP: A Transport Protocol for Real-Time Applications. RFC 3550. July 2003] packets start with a fixed header, as illustrated in Figure 7. The
25 SSRC field, used to label streams from different sources, contains a random number that is required to be globally unique within an RTP session. When using RTP with HLI relaying, the TURN client sets its outbound HLI to match to its own SSRC used with a certain peer, and its inbound HLI to match the SSRC of the peer.

30

Host Identity Protocol (HIP)

A HIP [RFC5201: Host Identity Protocol. RFC 5201. April 2008] packet header is logically an IPv6 extension header and its format is shown in Figure 8. The sender and receiver Host Identity Tags (HITs) identify the communicating endpoints and are
35 therefore suitable for HLIs. The TURN client using HLI relaying sets the outbound HLI

to match the "receiver's HIT" with the peer's HIT and the inbound HLI to match the "sender's HIT" with the peer's HIT.

5 TCP port numbers may also be used as HLIs in the case where TCP packets are encapsulated in UDP.

10 It will be apparent from the above discussion that HLI-based relaying removes or reduces the bandwidth overhead created by TURN encapsulation between the TURN client and server. Also, the processing overhead is reduced since there is no need to add and remove the encapsulation headers at TURN client and server. Furthermore, native operating system stacks can be used for handling the relayed data due to the absence of a requirement for encapsulation. The solution is backward compatible with existing TURN clients and does not require HLI support from peers.

15 The extended TURN server described here is not protocol dependent and the HLI-based relaying can be achieved for any protocol that is carried over UDP and contains sufficient markers that can be used for multiplexing connections. Even where a protocol does not provide for such markers, if there is no requirement for multiplexing multiple connections (e.g., only a single connection through the TURN server is used),
20 HLIs with zero length can be used to make TURN encapsulation unnecessary.

HLIs registered with the TURN server may be considered more generally as a rule set. For example, where no single, unique, identifier is present in packets a rule set such as, "If HLI_1 is at position 1 and HLI_2 in position 2 but there is no HLI_3 in position 3,
25 a packet matches to a relaying rule/permission" may be specified and registered with the TURN server.

30 It will be appreciated by the person of skill in the art that various modifications may be made to the above described embodiments without departing from the scope of the present invention. For example, the approach may be applied to relaying protocols other than TURN (and which use encapsulation of the relayed packets), e.g. SOCKS 5 (IETF RFC 1928), and indeed to further enhancements of the currently specified TURN protocol, for example. Certain embodiments may allow the TURN server, or some other network based node, to determine the HLIs to be used for a session. In this
35 case, that determining node may signal the HLI(s) to the TURN client, and also to the

TURN server if the node is not itself the TURN server. The skilled person will also appreciate that the relaying mechanism described here is not only applicable to NAT traversal. It could for example be applied to a scenario where a client makes use of a relay server in order to maintain anonymity. The skilled person will also appreciate that

5 a benefit may be achieved by applying this HLI-based approach in only one of the inbound and outbound directions, and not both.

CLAIMS:

1. Apparatus for relaying packets between a first host and a second host, the apparatus comprising:
- 5 a memory for registering for said first host
an address of the first host,
a relayed address of the first host,
an address of the second host, and
an outbound Higher Layer Identifier and/or an inbound Higher Layer
10 Identifier;
and one or both of
an outbound packet inspector for inspecting packets received from said
first host and addressed to an address of the apparatus to determine
whether or not they contain a registered outbound Higher Layer
15 Identifier and, if so, for forwarding the packets to said address of the
second host;
an inbound packet inspector for inspecting packets received from said
second host and addressed to said relayed address to determine
whether or not they contain a registered inbound Higher Layer Identifier
20 and, if so, for forwarding the packets to said address of the first host.
2. Apparatus according to claim 1, said outbound packet inspector being
configured to replace the address of the first host in a source address field of packets
to be forwarded to said second host, with said relayed address.
- 25
3. Apparatus according to claim 1 or 2, said inbound packet inspector being
configured to replace said relayed address in a destination address field of packets to
be forwarded to said first host, with said address of the first host, and to replace said
address of the second host in a source address field of those packets with an address
30 of the apparatus.
4. Apparatus according to any one of the preceding claims, said inbound packet
inspector being configured to deliver packets which contain said inbound Higher Layer
Identifier, to said first host, without additional relay encapsulation.
- 35

5. Apparatus according to any one of the preceding claims, wherein said memory is configured to additionally register for said first host an offset position for the or each of said inbound and outbound Higher Layer Identifiers, the offset position identifying a position of the associated Higher Layer Identifier within a packet, and the outbound and inbound packet inspectors being configured to use the respective offset position to determine the presence of a Higher Layer Identifier.

6. Apparatus according to any one of the preceding claims, wherein said memory and the or each of said inbound packet inspector and said outbound packet inspector being configured to additionally handle the relaying of packets between said first host and one or more further hosts using one or both of the inbound and outbound Higher Layer Identifiers.

7. Apparatus according to any one of the preceding claims, wherein said first host is located behind a Network Address Translator, and said address of the first host is a NATed address of the first host.

8. Apparatus according to claim 7 when appended to claim 4, wherein said additional relay encapsulation is encapsulation according to the Traversal Using Relays around NAT protocol.

9. Apparatus according to claim 7 or 8 and comprising a client terminal registration unit for registering said first host and any further hosts, the registration unit being configured to use the Traversal Using Relays around NAT, TURN, protocol.

10. A client terminal configured to exchange packets with a peer terminal via a relay server, the client terminal comprising:

a relay unit for registering with the relay server so as to be allocated a relayed address by the relay server;

an identification determining unit for determining an inbound Higher Layer Identifier to be used in packets exchanged with said peer terminal;

an identifier registration unit for registering the inbound Higher Layer Identifier with said relay server, together with said relayed address, an address of the client terminal, and an address of the peer terminal;

a packet handler for associating packets received from said relay server with

said peer terminal using said inbound Higher Layer Identifier.

5 11. A client terminal according to claim 10, said identification determining unit being configured to determine an outbound Higher Layer Identifier to be used in packets exchanged with said peer terminal, and said identifier registration unit being configured to register the outbound Higher Layer Identifier with said relay server together with the inbound Higher Layer Identifier.

10 12. A client terminal according to claim 9 or 10, said identification determining unit being configured to determine inbound and/or outbound Higher Layer Identifiers by identifying and using one of the following protocol parameters:

- 15 a Host Identity Tag, HIT;
- a synchronisation source (SSRC) identifier;
- a Security Parameter Index (SPI);
- 15 TCP port numbers.

20 13. A client terminal according to any one of claims 10 to 12, said relay unit being configured to implement NAT traversal and said address of the client terminal being a NATed address.

14. A client terminal according to claim 13, said relay unit and said identifier registration unit being configured to use the Traversal Using Relays around NAT, TURN, protocol.

25 15. A client terminal according to claim 13 or 14 and comprising a further packet handler for using Traversal Using Relays around NAT, TURN, encapsulation to send and/or receive packets to a peer terminal in the event that said identification determining unit is unable to determine an inbound and, optionally, an outbound Higher Layer Identifier, or a TURN encapsulated packet is received from said relay server.

30 16. A client terminal according to any one of claims 13 to 15, said relay unit being configured to determine whether or not a relay server supports a Higher Layer Identifier based relaying method and, if not, to initiate packet routing with said peer terminal using relaying encapsulation.

35

17. A method of sending packets between a first host and a second host, the method comprising:
- registering at a relay server, on behalf of the first host
 - an address of the first host,
 - 5 a relayed address of the first host,
 - an address of the second host, and
 - an outbound Higher Layer Identifier and/or an inbound Higher Layer Identifier;
 - and one or both of the steps of
 - 10 at the relay server, inspecting packets received from said first host and addressed to an address of the relay server to determine whether or not they contain said outbound Higher Layer Identifier and, if so, forwarding the packets to said address of the second host;
 - 15 inspecting packets received from said second host and addressed to said relayed address to determine whether or not they contain said inbound Higher Layer Identifier and, if so, forwarding the packets to said address of the first host.
18. A method according to claim 17, wherein said first host is located behind a
20 Network Address Translator.
19. A method according to claim 18, said step of registering being carried out using the Traversal Using Relays around NAT, TURN, protocol.
20. A method according to claim 19 and comprising forwarding the packets from the
25 relay server to the first host using TURN encapsulation if packets received from the second host do not contain said inbound Higher Layer Identifier.

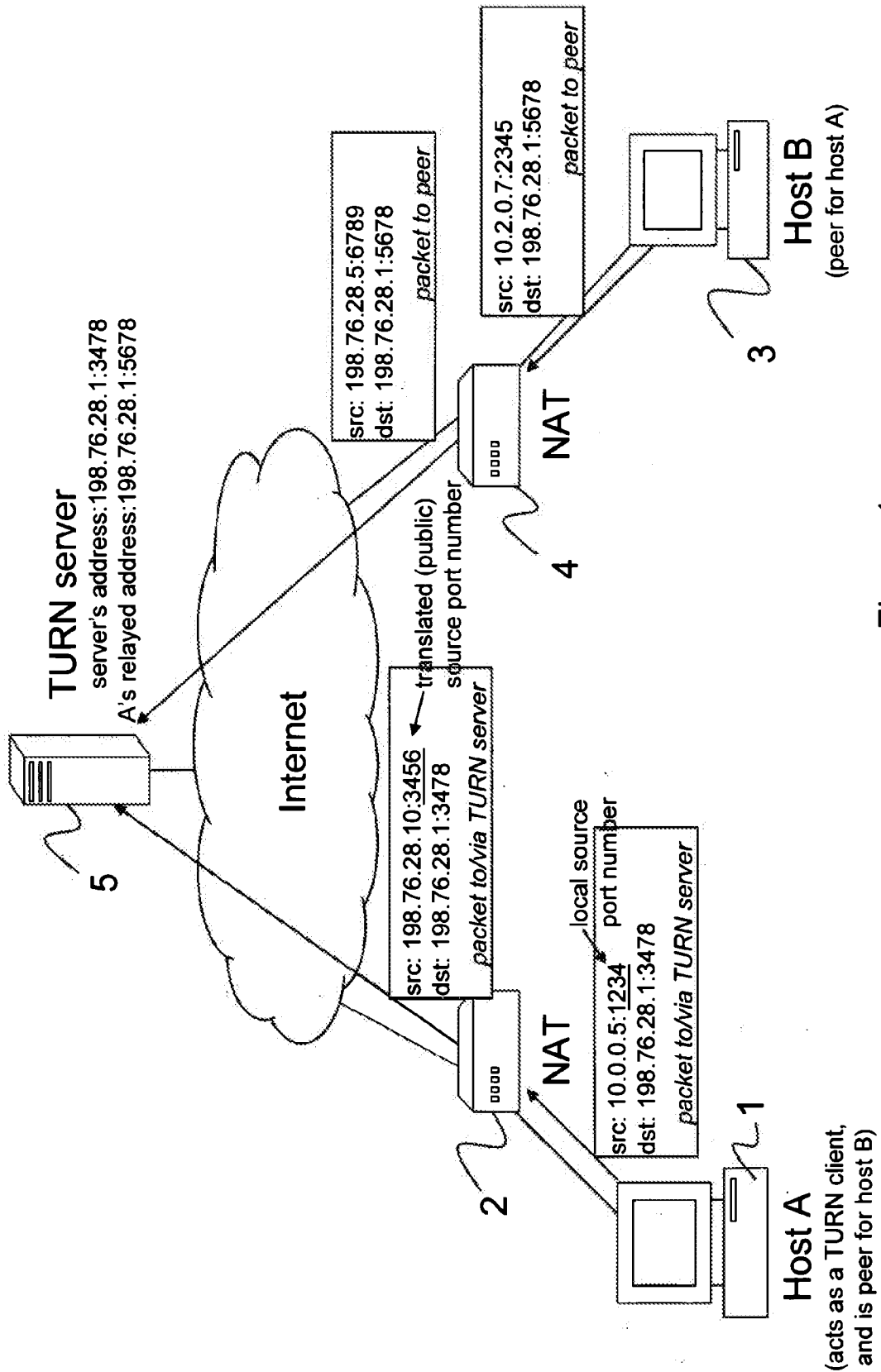


Figure 1

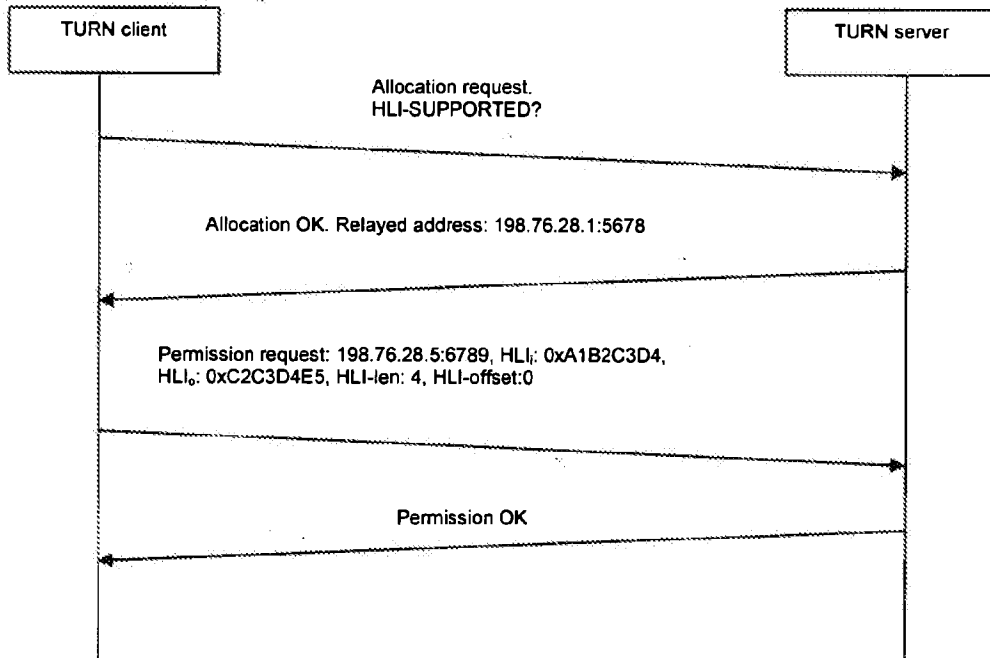


Figure 2

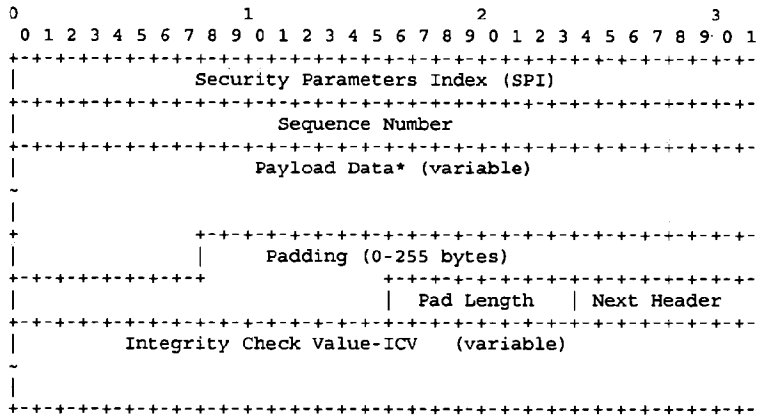


Figure 3

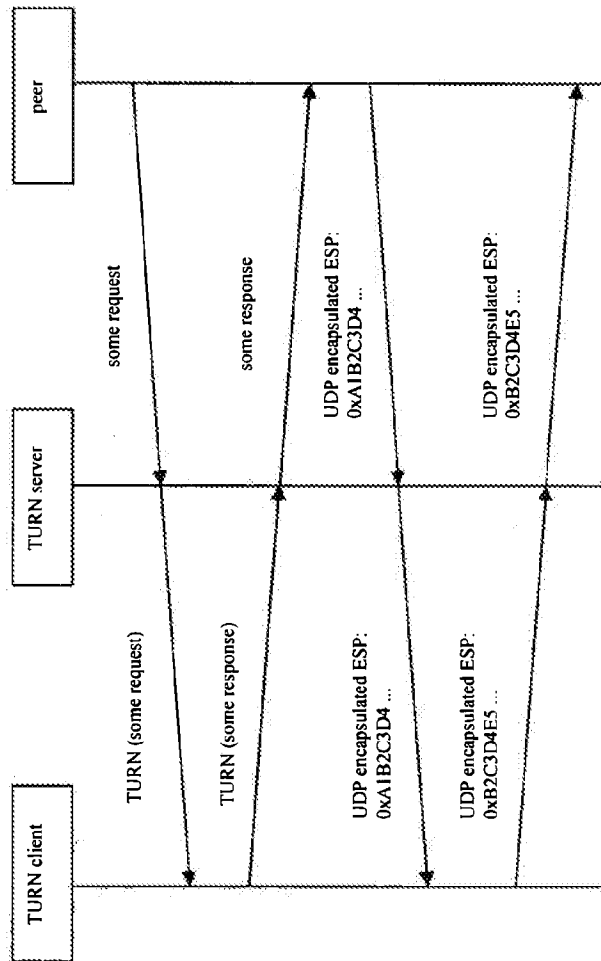


Figure 4

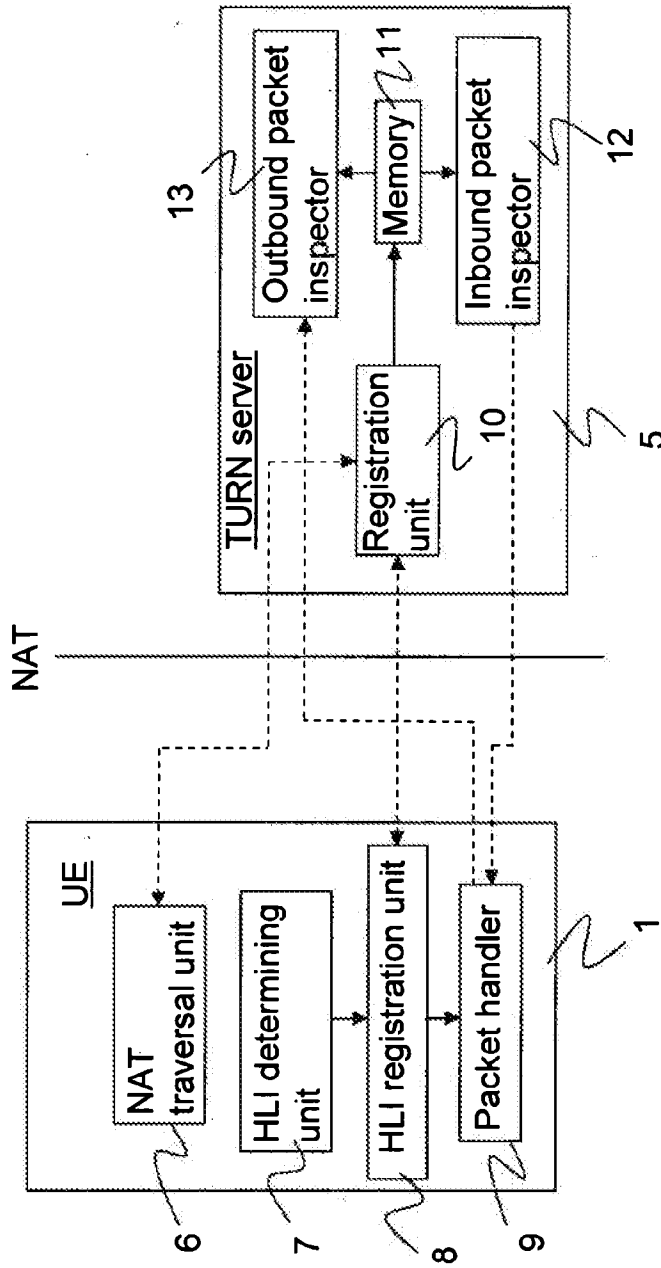


Figure 5

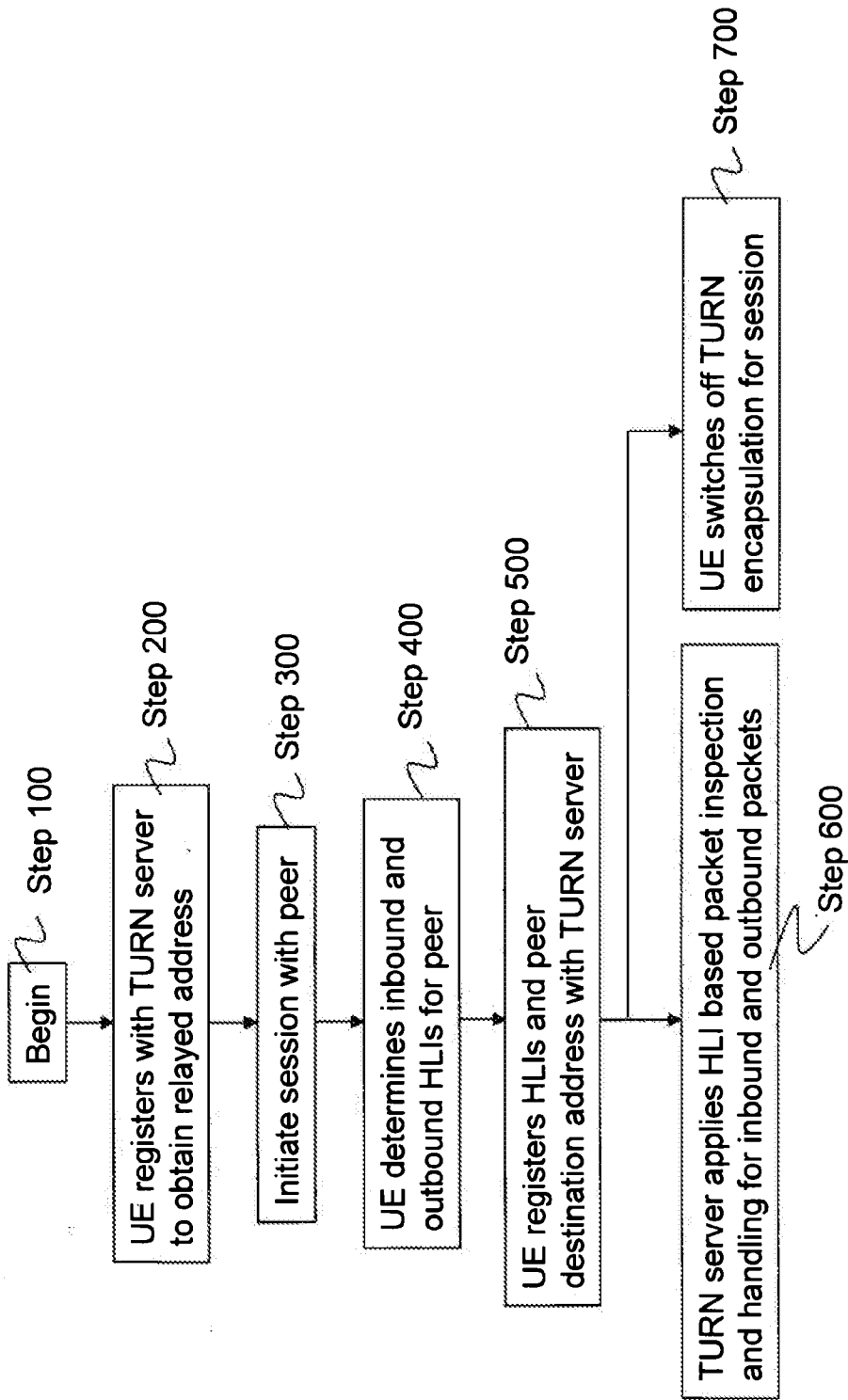


Figure 6

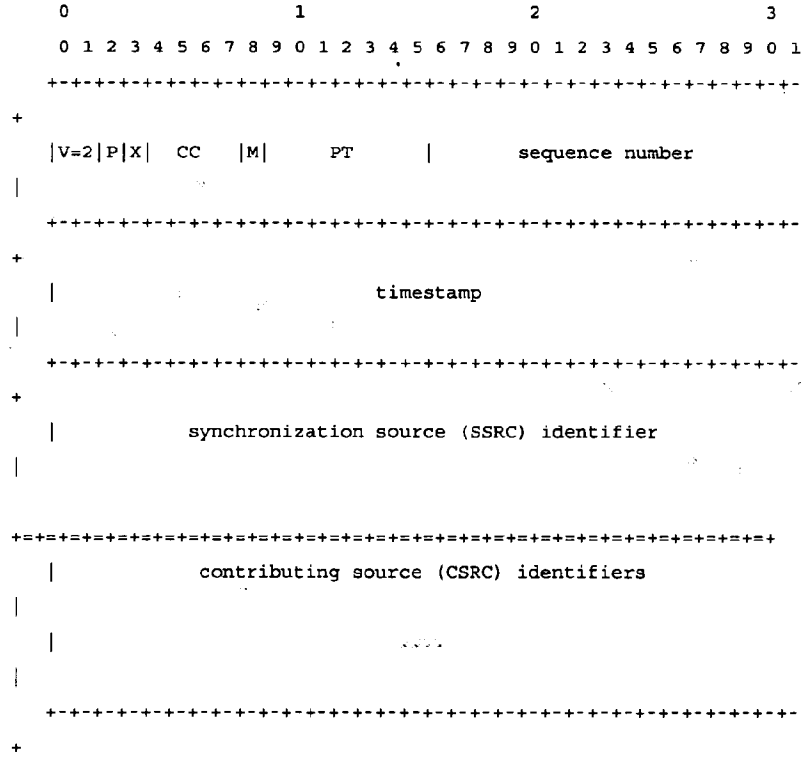


Figure 7

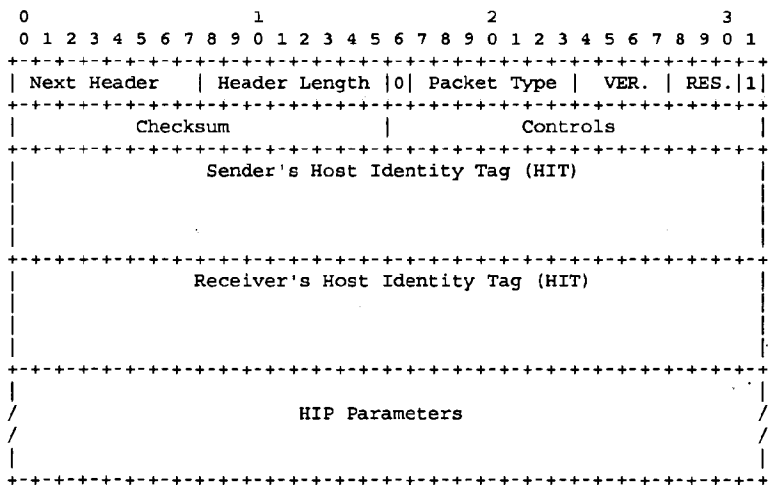


Figure 8

INTERNATIONAL SEARCH REPORT

International application No
PCT/EP2009/058129

A. CLASSIFICATION OF SUBJECT MATTER
INV. H04L29/12

According to International Patent Classification (IPC) or to both national classification and IPC

B. FIELDS SEARCHED

Minimum documentation searched (classification system followed by classification symbols)
H04L

Documentation searched other than minimum documentation to the extent that such documents are included in the fields searched

Electronic data base consulted during the international search (name of data base and, where practical, search terms used)

EPO-Internal, INSPEC

C. DOCUMENTS CONSIDERED TO BE RELEVANT

Category*	Citation of document, with indication, where appropriate, of the relevant passages	Relevant to claim No.
X	<p>PERREULT S ET AL: "Traversal Using Relays around NAT (TURN) Extensions for TCP Allocations; draft-ietf-behave-turn-tcp-03.txt" TRaversal USING RELAYS AROUND NAT (TURN) EXTENSIONS FOR TCP ALLOCATIONS; DRAFT-IETF-BEHAVE-TURN-TCP-03.TXT, INTERNET ENGINEERING TASK FORCE, IETF; STANDARDWORKINGDRAFT, INTERNET SOCIETY (ISOC) 4, RUE DES FALAISES CH- 1205 GENEVA, SWITZERLAND, vol. behave, no. 3, 4 May 2009 (2009-05-04), XP015062268 [retrieved on 2009-05-04] pages 3-5; figure 1</p> <p align="center">----- -/--</p>	1-20

Further documents are listed in the continuation of Box C.

See patent family annex.

* Special categories of cited documents :

"A" document defining the general state of the art which is not considered to be of particular relevance

"E" earlier document but published on or after the international filing date

"L" document which may throw doubts on priority claim(s) or which is cited to establish the publication date of another citation or other special reason (as specified)

"O" document referring to an oral disclosure, use, exhibition or other means

"P" document published prior to the international filing date but later than the priority date claimed

"T" later document published after the international filing date or priority date and not in conflict with the application but cited to understand the principle or theory underlying the invention

"X" document of particular relevance; the claimed invention cannot be considered novel or cannot be considered to involve an inventive step when the document is taken alone

"Y" document of particular relevance; the claimed invention cannot be considered to involve an inventive step when the document is combined with one or more other such documents, such combination being obvious to a person skilled in the art.

"&" document member of the same patent family

Date of the actual completion of the international search

17 March 2010

Date of mailing of the international search report

25/03/2010

Name and mailing address of the ISA/

European Patent Office, P.B. 5818 Patentlaan 2
NL - 2280 HV Rijswijk
Tel. (+31-70) 340-2040,
Fax: (+31-70) 340-3016

Authorized officer

Milano, Massimo

INTERNATIONAL SEARCH REPORT

International application No
PCT/EP2009/058129

C(Continuation). DOCUMENTS CONSIDERED TO BE RELEVANT		
Category*	Citation of document, with indication, where appropriate, of the relevant passages	Relevant to claim No.
X	<p>ROSENBERG CISCO R MAHY PLANTRONICS P MATTHEWS AVAYA J: "Traversal Using Relays around NAT (TURN): Relay Extensions to Session Traversal Utilities for NAT (STUN); draft-ietf-behave-turn-07.txt" IETF STANDARD-WORKING-DRAFT, INTERNET ENGINEERING TASK FORCE, IETF, CH, vol. behave, no. 7, 25 February 2008 (2008-02-25), XP015053106 ISSN: 0000-0004 pages 7-9 pages 15,16</p> <p style="text-align: center;">-----</p>	1-20
A	<p>SCHULZRINNE COLUMBIA U R HANCOCK SIEMENS/RMR H: "GIST: General Internet Signaling Transport; draft-ietf-nsis-ntlp-08.txt" IETF STANDARD-WORKING-DRAFT, INTERNET ENGINEERING TASK FORCE, IETF, CH, vol. nsis, no. 8, 27 September 2005 (2005-09-27), XP015040926 ISSN: 0000-0004 the whole document</p> <p style="text-align: center;">-----</p>	1-20



UNITED STATES PATENT AND TRADEMARK OFFICE

UNITED STATES DEPARTMENT OF COMMERCE
United States Patent and Trademark Office
Address: COMMISSIONER FOR PATENTS
P.O. Box 1450
Alexandria, Virginia 22313-1450
www.uspto.gov

Table with 7 columns: APPLICATION NUMBER, FILING or 371(c) DATE, GRP ART UNIT, FIL FEE REC'D, ATTY.DOCKET.NO, TOT CLAIMS, IND CLAIMS. Row 1: 13/966,096, 08/13/2013, 2653, 3750, SMARB19.001C1, 78, 6

CONFIRMATION NO. 8712

CORRECTED FILING RECEIPT



20995
KNOBBE MARTENS OLSON & BEAR LLP
2040 MAIN STREET
FOURTEENTH FLOOR
IRVINE, CA 92614

Date Mailed: 11/20/2014

Receipt is acknowledged of this non-provisional patent application. The application will be taken up for examination in due course. Applicant will be notified as to the results of the examination. Any correspondence concerning the application must include the following identification information: the U.S. APPLICATION NUMBER, FILING DATE, NAME OF APPLICANT, and TITLE OF INVENTION. Fees transmitted by check or draft are subject to collection. Please verify the accuracy of the data presented on this receipt. If an error is noted on this Filing Receipt, please submit a written request for a Filing Receipt Correction. Please provide a copy of this Filing Receipt with the changes noted thereon. If you received a "Notice to File Missing Parts" for this application, please submit any corrections to this Filing Receipt with your reply to the Notice. When the USPTO processes the reply to the Notice, the USPTO will generate another Filing Receipt incorporating the requested corrections

Inventor(s)

CLAY PERREAULT, Panama City, PANAMA;
STEVE NICHOLSON, Hamilton, NEW ZEALAND;
ROD THOMSON, North Vancouver, CANADA;
JOHAN EMIL VIKTOR BJÖRSELL, Vancouver, CANADA;
FUAD ARAFA, Vancouver, CANADA;

Applicant(s)

Digifonica (INTERNATIONAL) Limited, Vancouver, CANADA

Assignment For Published Patent Application

Digifonica (INTERNATIONAL) Limited, Vancouver, CANADA

Power of Attorney: The patent practitioners associated with Customer Number 20995

Domestic Priority data as claimed by applicant

This application is a CON of 12/513,147 03/01/2010 PAT 8542815
which is a 371 of PCT/CA07/01956 11/01/2007
which claims benefit of 60/856,212 11/02/2006

Foreign Applications for which priority is claimed (You may be eligible to benefit from the Patent Prosecution Highway program at the USPTO. Please see http://www.uspto.gov for more information.) - None.

Foreign application information must be provided in an Application Data Sheet in order to constitute a claim to foreign priority. See 37 CFR 1.55 and 1.76.

Permission to Access - A proper Authorization to Permit Access to Application by Participating Offices (PTO/SB/39 or its equivalent) has been received by the USPTO.

If Required, Foreign Filing License Granted: 08/28/2013

The country code and number of your priority application, to be used for filing abroad under the Paris Convention, is **US 13/966,096**

Projected Publication Date: Not Applicable

Non-Publication Request: No

Early Publication Request: No

**** SMALL ENTITY ****

Title

PRODUCING ROUTING MESSAGES FOR VOICE OVER IP COMMUNICATIONS

Preliminary Class

379

Statement under 37 CFR 1.55 or 1.78 for AIA (First Inventor to File) Transition Applications: No

PROTECTING YOUR INVENTION OUTSIDE THE UNITED STATES

Since the rights granted by a U.S. patent extend only throughout the territory of the United States and have no effect in a foreign country, an inventor who wishes patent protection in another country must apply for a patent in a specific country or in regional patent offices. Applicants may wish to consider the filing of an international application under the Patent Cooperation Treaty (PCT). An international (PCT) application generally has the same effect as a regular national patent application in each PCT-member country. The PCT process **simplifies** the filing of patent applications on the same invention in member countries, but **does not result** in a grant of "an international patent" and does not eliminate the need of applicants to file additional documents and fees in countries where patent protection is desired.

Almost every country has its own patent law, and a person desiring a patent in a particular country must make an application for patent in that country in accordance with its particular laws. Since the laws of many countries differ in various respects from the patent law of the United States, applicants are advised to seek guidance from specific foreign countries to ensure that patent rights are not lost prematurely.

Applicants also are advised that in the case of inventions made in the United States, the Director of the USPTO must issue a license before applicants can apply for a patent in a foreign country. The filing of a U.S. patent application serves as a request for a foreign filing license. The application's filing receipt contains further information and guidance as to the status of applicant's license for foreign filing.

Applicants may wish to consult the USPTO booklet, "General Information Concerning Patents" (specifically, the section entitled "Treaties and Foreign Patents") for more information on timeframes and deadlines for filing foreign patent applications. The guide is available either by contacting the USPTO Contact Center at 800-786-9199, or it can be viewed on the USPTO website at <http://www.uspto.gov/web/offices/pac/doc/general/index.html>.

For information on preventing theft of your intellectual property (patents, trademarks and copyrights), you may wish to consult the U.S. Government website, <http://www.stopfakes.gov>. Part of a Department of Commerce initiative, this website includes self-help "toolkits" giving innovators guidance on how to protect intellectual property in specific countries such as China, Korea and Mexico. For questions regarding patent enforcement issues, applicants may call the U.S. Government hotline at 1-866-999-HALT (1-866-999-4258).

LICENSE FOR FOREIGN FILING UNDER
Title 35, United States Code, Section 184
Title 37, Code of Federal Regulations, 5.11 & 5.15

GRANTED

The applicant has been granted a license under 35 U.S.C. 184, if the phrase "IF REQUIRED, FOREIGN FILING LICENSE GRANTED" followed by a date appears on this form. Such licenses are issued in all applications where the conditions for issuance of a license have been met, regardless of whether or not a license may be required as set forth in 37 CFR 5.15. The scope and limitations of this license are set forth in 37 CFR 5.15(a) unless an earlier license has been issued under 37 CFR 5.15(b). The license is subject to revocation upon written notification. The date indicated is the effective date of the license, unless an earlier license of similar scope has been granted under 37 CFR 5.13 or 5.14.

This license is to be retained by the licensee and may be used at any time on or after the effective date thereof unless it is revoked. This license is automatically transferred to any related applications(s) filed under 37 CFR 1.53(d). This license is not retroactive.

The grant of a license does not in any way lessen the responsibility of a licensee for the security of the subject matter as imposed by any Government contract or the provisions of existing laws relating to espionage and the national security or the export of technical data. Licensees should apprise themselves of current regulations especially with respect to certain countries, of other agencies, particularly the Office of Defense Trade Controls, Department of State (with respect to Arms, Munitions and Implements of War (22 CFR 121-128)); the Bureau of Industry and Security, Department of Commerce (15 CFR parts 730-774); the Office of Foreign Assets Control, Department of Treasury (31 CFR Parts 500+) and the Department of Energy.

NOT GRANTED

No license under 35 U.S.C. 184 has been granted at this time, if the phrase "IF REQUIRED, FOREIGN FILING LICENSE GRANTED" DOES NOT appear on this form. Applicant may still petition for a license under 37 CFR 5.12, if a license is desired before the expiration of 6 months from the filing date of the application. If 6 months has lapsed from the filing date of this application and the licensee has not received any indication of a secrecy order under 35 U.S.C. 181, the licensee may foreign file the application pursuant to 37 CFR 5.15(b).

SelectUSA

The United States represents the largest, most dynamic marketplace in the world and is an unparalleled location for business investment, innovation, and commercialization of new technologies. The U.S. offers tremendous resources and advantages for those who invest and manufacture goods here. Through SelectUSA, our nation works to promote and facilitate business investment. SelectUSA provides information assistance to the international investor community; serves as an ombudsman for existing and potential investors; advocates on behalf of U.S. cities, states, and regions competing for global investment; and counsels U.S. economic development organizations on investment attraction best practices. To learn more about why the United States is the best country in the world to develop technology, manufacture products, deliver services, and grow your business, visit <http://www.SelectUSA.gov> or call +1-202-482-6800.

Please Direct All Correspondence to Customer Number 20995

REQUEST TO CORRECT INVENTORSHIP

Inventor	:	Clay Perrault
App. No	:	13/966,096
Filed	:	August 13, 2013
For	:	PRODUCING ROUTING MESSAGES FOR VOICE OVER IP COMMUNICATIONS
Examiner	:	Kizou, Hassan
Art Unit	:	2653

Commissioner for Patents
P.O. Box 1450
Alexandria, VA 22313-1450

Dear Sir:

Pursuant to 37 CFR 1.48, this Request is being made to correct or change inventorship which may include; the addition or deletion of inventors, or correction to an inventor's name.

This Request is being made after examination and is accompanied by:

1. An Application Data Sheet including markings under 1.76(c) identifying changes being made to inventorship; and
2. \$70 as directed under 37 CFR 1.17(i)(1) for small entity.

Please charge any additional fees, including any fees for additional extension of time, or credit overpayment to Deposit Account No. 11-1410.

Respectfully submitted,

KNOBBE MARTENS OLSON & BEAR LLP



Dated: November 14, 2014

By: _____

John M. Carson
Registration No. 34,303
Attorney of Record
Customer No. 20995
(858) 707-4000

19340047
111414

Electronic Patent Application Fee Transmittal

Application Number:	13966096
Filing Date:	13-Aug-2013
Title of Invention:	PRODUCING ROUTING MESSAGES FOR VOICE OVER IP COMMUNICATIONS
First Named Inventor/Applicant Name:	CLAY PERRAULT
Filer:	John M Carson/Noriko Cook
Attorney Docket Number:	SMARB19.001C1

Filed as Small Entity

Utility under 35 USC 111(a) Filing Fees

Description	Fee Code	Quantity	Amount	Sub-Total in USD(\$)
Basic Filing:				
Pages:				
Claims:				
Miscellaneous-Filing:				
PROCESSING FEE, EXCEPT PROV. APPLS.	2830	1	70	70

Petition:

Patent-Appeals-and-Interference:

Post-Allowance-and-Post-Issuance:

Extension-of-Time:

PETITIONER APPLE INC. EX. 1005-306

Description	Fee Code	Quantity	Amount	Sub-Total in USD(\$)
Miscellaneous:				
Total in USD (\$)				70

Electronic Acknowledgement Receipt

EFS ID:	20706593
Application Number:	13966096
International Application Number:	
Confirmation Number:	8712
Title of Invention:	PRODUCING ROUTING MESSAGES FOR VOICE OVER IP COMMUNICATIONS
First Named Inventor/Applicant Name:	CLAY PERRAULT
Customer Number:	20995
Filer:	John M Carson/Mason Leu
Filer Authorized By:	John M Carson
Attorney Docket Number:	SMARB19.001C1
Receipt Date:	14-NOV-2014
Filing Date:	13-AUG-2013
Time Stamp:	19:14:20
Application Type:	Utility under 35 USC 111(a)

Payment information:

Submitted with Payment	yes
Payment Type	Credit Card
Payment was successfully received in RAM	\$70
RAM confirmation Number	5573
Deposit Account	111410
Authorized User	KNOBBE MARTENS OLSON AND BEAR

The Director of the USPTO is hereby authorized to charge indicated fees and credit any overpayment as follows:

Charge any Additional Fees required under 37 C.F.R. Section 1.16 (National application filing, search, and examination fees)

Charge any Additional Fees required under 37 C.F.R. Section 1.17 (Patent application and examination processing fees)

PETITIONER APPLE INC. PEX: 1905308

File Listing:					
Document Number	Document Description	File Name	File Size(Bytes)/ Message Digest	Multi Part /.zip	Pages (if appl.)
1		SMARB19_001C1_CorrectedADS.pdf	74928 2c2596b6ba104d333ca12a8e0aadb80ceb7ed57	yes	3
Multipart Description/PDF files in .zip description					
Document Description			Start	End	
Application Data Sheet			1	2	
Request under Rule 48 correcting inventorship			3	3	
Warnings:					
Information:					
2	Fee Worksheet (SB06)	fee-info.pdf	30201 eb458e415ae74a5a47db9375508faab35d7dba15	no	2
Warnings:					
Information:					
Total Files Size (in bytes):			105129		
<p>This Acknowledgement Receipt evidences receipt on the noted date by the USPTO of the indicated documents, characterized by the applicant, and including page counts, where applicable. It serves as evidence of receipt similar to a Post Card, as described in MPEP 503.</p> <p><u>New Applications Under 35 U.S.C. 111</u> If a new application is being filed and the application includes the necessary components for a filing date (see 37 CFR 1.53(b)-(d) and MPEP 506), a Filing Receipt (37 CFR 1.54) will be issued in due course and the date shown on this Acknowledgement Receipt will establish the filing date of the application.</p> <p><u>National Stage of an International Application under 35 U.S.C. 371</u> If a timely submission to enter the national stage of an international application is compliant with the conditions of 35 U.S.C. 371 and other applicable requirements a Form PCT/DO/EO/903 indicating acceptance of the application as a national stage submission under 35 U.S.C. 371 will be issued in addition to the Filing Receipt, in due course.</p> <p><u>New International Application Filed with the USPTO as a Receiving Office</u> If a new international application is being filed and the international application includes the necessary components for an international filing date (see PCT Article 11 and MPEP 1810), a Notification of the International Application Number and of the International Filing Date (Form PCT/RO/105) will be issued in due course, subject to prescriptions concerning national security, and the date shown on this Acknowledgement Receipt will establish the international filing date of the application.</p>					

CORRECTED APPLICATION DATA SHEET

Application Information

Application Number: 13/966,096
Filing Date: August 13, 2013
Title: PRODUCING ROUTING MESSAGES FOR VOICE
OVER IP COMMUNICATIONS
Attorney Docket Number: SMARB19.001C1

1st Inventor Information

Given Name: * CLAY
Middle Name: *
Family Name: * PERRAULT PERREAULT

2nd Inventor Information

Given Name: * STEVE
Middle Name: *
Family Name: * NICHOLSON

3rd Inventor Information

Given Name: * ROD
Middle Name: *
Family Name: * THOMSON

4th Inventor Information

Given Name: * JOHAN
Middle Name: * EMIL VIKTOR
Family Name: * BJÖRSELL

5th Inventor Information

Given Name: * FUAD
Middle Name: *
Family Name: * ARAFA

Correspondence Information

Correspondence Customer Number: 20995
Phone Number: (949) 760-0404
Fax Number: (949) 760-9502
E-Mail Address: efilings@knobbe.com

Representative Information

Representative Customer Number: 20995



Dated: November 14, 2014

By: _____
John M. Carson
Registration No. 34,303
Attorney of Record
Customer No. 20995
(858) 707-4000

19338747
111414

INFORMATION DISCLOSURE STATEMENT BY APPLICANT	Application No.	13/966,096
	Filing Date	August 13, 2013
	First Named Inventor	Clay Perrault
	Art Unit	2472
<i>(Multiple sheets used when necessary)</i>	Examiner	Kizou, Hassan
SHEET 1 OF 1	Attorney Docket No.	SMARB19.001C1

U.S. PATENT DOCUMENTS					
Examiner Initials	Cite No.	Document Number <i>Number - Kind Code (if known)</i> Example: 1,234,567 B1	Publication Date MM-DD-YYYY	Name of Patentee or Applicant	Pages, Columns, Lines Where Relevant Passages or Relevant Figures Appear

FOREIGN PATENT DOCUMENTS						
Examiner Initials	Cite No.	Foreign Patent Document <i>Country Code-Number-Kind Code</i> Example: JP 1234567 A1	Publication Date MM-DD-YYYY	Name of Patentee or Applicant	Pages, Columns, Lines Where Relevant Passages or Relevant Figures Appear	T ¹
	1	WO 2007/056158 A2	05-18-2007	Roamware, Inc.		
	2	WO 2008/027065 A1	03-06-2008	Syniverse Technologies, Inc.		

NON PATENT LITERATURE DOCUMENTS			
Examiner Initials	Cite No.	Include name of the author (in CAPITAL LETTERS), title of the article (when appropriate), title of the item (book, magazine, journal, serial, symposium, catalog, etc.), date, page(s), volume-issue number(s), publisher, city and/or country where published.	T ¹
	3	Extended European Search Report dated April 16, 2014 for European Patent Application No. EP 09 802 316.1 which shares priority of U.S. Provisional Application No. 61/129,898, filed July 28, 2008 with U.S. Application No. 13/056,277, filed January 27, 2011, which is related to captioned U.S. Application No. 13/966,096, and cites above-identified reference numbers 1 and 2.	

17875349
042814

Examiner Signature	Date Considered
<p>*Examiner: Initial if reference considered, whether or not citation is in conformance with MPEP 609. Draw line through citation if not in conformance and not considered. Include copy of this form with next communication to applicant.</p>	

T¹ - Place a check mark in this area when an English language translation is attached. PETITIONER APPLE INC. EX. 1005-312

(19) World Intellectual Property Organization
International Bureau



(43) International Publication Date
18 May 2007 (18.05.2007)

PCT

(10) International Publication Number
WO 2007/056158 A2

- (51) International Patent Classification:
H04Q 7/20 (2006.01)
- (21) International Application Number:
PCT/US2006/042987
- (22) International Filing Date:
3 November 2006 (03.11.2006)
- (25) Filing Language: English
- (26) Publication Language: English
- (30) Priority Data:
60/733,439 3 November 2005 (03.11.2005) US
- (71) Applicant (for all designated States except US):
ROAMWARE, INC. [US/US]; 3031 TISCH WAY,
SUITE 1000, San Jose, CA 95128 (US).
- (72) Inventor; and
- (75) Inventor/Applicant (for US only): JIANG, John Yue,
Jun [GB/US]; 4114 SUGAR MAPLE DRIVE, Danville,
CA 94506 (US).
- (74) Agents: CHESSER, Wilburn, L. et al.; ARENT FOX,
P.L.L.C., 1050 CONNECTICUT AVENUE, N.W. #400,
Washington, DC 20036-5339 (US).

- (81) Designated States (unless otherwise indicated, for every kind of national protection available): AE, AG, AL, AM, AT, AU, AZ, BA, BB, BG, BR, BW, BY, BZ, CA, CH, CN, CO, CR, CU, CZ, DE, DK, DM, DZ, EC, EE, EG, ES, FI, GB, GD, GE, GH, GM, GT, HN, HR, HU, ID, IL, IN, IS, JP, KE, KG, KM, KN, KP, KR, KZ, LA, LC, LK, LR, LS, LT, LU, LV, LY, MA, MD, MG, MK, MN, MW, MX, MY, MZ, NA, NG, NI, NO, NZ, OM, PG, PH, PL, PT, RO, RS, RU, SC, SD, SE, SG, SK, SL, SM, SV, SY, TJ, TM, TN, TR, TT, TZ, UA, UG, US, UZ, VC, VN, ZA, ZM, ZW.
- (84) Designated States (unless otherwise indicated, for every kind of regional protection available): ARIPO (BW, GH, GM, KE, LS, MW, MZ, NA, SD, SL, SZ, TZ, UG, ZM, ZW), Eurasian (AM, AZ, BY, KG, KZ, MD, RU, TJ, TM), European (AT, BE, BG, CH, CY, CZ, DE, DK, EE, ES, FI, FR, GB, GR, HU, IE, IS, IT, LT, LU, LV, MC, NL, PL, PT, RO, SE, SI, SK, TR), OAPI (BF, BJ, CF, CG, CI, CM, GA, GN, GQ, GW, ML, MR, NE, SN, TD, TG).

Published:
— without international search report and to be republished upon receipt of that report

For two-letter codes and other abbreviations, refer to the "Guidance Notes on Codes and Abbreviations" appearing at the beginning of each regular issue of the PCT Gazette.



WO 2007/056158 A2

(54) Title: NETWORK-BASED SYSTEM FOR REROUTING PHONE CALLS FROM PHONE NETWORKS TO VOIP CLIENTS FOR ROAMERS AND SUBSCRIBERS WHO DO NOT ANSWER

(57) Abstract: A system, method, computer product and service are provided which, when a subscriber's VoIP client is online and the subscriber's non-VoIP wireless or fixed line number is called, will automatically route the call over IP to the subscriber's VoIP client. This routing may be performed by the subscriber's wireless or fixed line home operator and can be conditioned to depend on whether the non-VoIP number is roaming or not answering.

**NETWORK-BASED SYSTEM FOR REROUTING PHONE CALLS FROM
PHONE NETWORKS TO VOIP CLIENTS FOR ROAMERS AND
SUBSCRIBERS WHO DO NOT ANSWER**

Related Applications

[0001] This application claims the benefit of U.S. Provisional Patent Application No. 60/733,439, filed Nov 3, 2005, entitled "Integrating Cellular VoIP Client with Cellular or Fixed Line Phone Services for Automatic Call Rerouting to Roamers or Subscribers Away From Phones." This application is also related to United States Patent Application No. 11/064,200, filed on February 23, 2005 entitled, "Integrated Cellular VOIP for Call Rerouting" (hereinafter "VoIP Call Rerouting Patent Application"), which claims priority from U.S. Provisional Patent Application No. 60/547,389 filed February 23, 2004; and is related to United States Patent Application No. 10/778,970 filed February 13, 2004 entitled, "Integrating GSM and WiFi Services in Mobile Communications Devices," which claims priority from U.S. Provisional Patent Application No. 60/448,000 filed February 18, 2003; and is related to United States Patent Application No. 11/503,301, filed August 14, 2006, entitled, "Method and System for Wireless Voice Channel/Data Channel Integration," which claims priority from United States Patent Application No. 09/932,439 filed August 15, 2001, now U.S. Patent No. 7,092,370 ("the '370 Patent"), bearing the same title, issued August 15, 2006, the '370 Patent also claiming priority to U.S. Provisional Patent Application No. 60/226,255 filed August 17, 2000. The entirety of each of the foregoing is incorporated by reference herein.

BACKGROUND OF THE INVENTION

Field of the Invention

[0002] The present invention generally relates to roaming users in mobile networks. More specifically, the invention relates to steering the traffic of the roaming users in VoIP clients.

[0003] VoIP (Voice Over Internet Protocol) services use Internet Protocol to carry voice and related content, and, beside other advantages, offer better rates than traditional switched-circuit voice services (so-called "Plain Old Telephone Service" or POTS), and can also provide better and more efficient

integration of other data services as well, such as multimedia, context and video.

[0004]The advent and widespread use of the VoIP client Skype on personal computers has increased the popularity of VoIP services. In addition to built-in presence management and instant messaging, Skype also provides "Skype-out" for calling out to, and "Skype-in" for receiving calls from, fixed or mobile phone lines. Other providers, such as MSN®, Yahoo®, and Google®, have also added VoIP service to their instant messaging clients.

[0005]Cellular IP phones, such as a window-enabled mobile GSM WiFi phone, configured with a Skype client, allow the IP phone user to enjoy the same free VoIP service as a personal computer Skype user. This, however, requires a special WiFi phone, or a dual-system phone with a Skype client installed.

[0006]Skype has also enhanced its VoIP client and service, to enable a user to receive calls to his Skype ID or Skype-IN number on an ordinary mobile, or on a fixed line phone via call forwarding. Additionally, ISkoot™ – a Skype add-on service, allows a user to make outbound Skype calls to either a phone number or another Skype ID with ordinary mobile phones, by using SMS to send call out information to the ISkoot™ service. Thus, a two-way call out bridge, connecting the caller's mobile phone and his called party, is established. The bridge may use Skype Out to call both the called party and the caller's mobile number. Skype also provides a plug-in API, (Applications Programming Interface), used to develop presence information applications at network servers in a scalable manner, as well as server side APIs to support simultaneous VoIP calls.

[0007]However, whether a GSM/WiFi (or WiMax or VoIP) mobile phone is used or an ordinary phone is used, these services fail to address the case in which a mobile user is roaming when called on his ordinary mobile phone number. For example, in the case of GSM WiFi phone, even though the phone can make an inexpensive outbound Skype call when it is on a WiFi connection, it cannot seamlessly receive a call over VoIP when called on the WiFi phone's mobile number. Another unaddressed case is when an ordinary cell phone is called on its mobile number while roaming – the call cannot be received via Skype on the user's laptop, even if the user is connected online to an IP connection and the mobile is out of its coverage area. Normally, a

mobile subscriber roaming internationally might prefer to receive calls over Skype or his VoIP account either to save money on roaming charges, for improved quality, or in order to benefit from the additional presence or other services associated with their chosen VoIP method.

[0008] Yet another missing case is an enhanced Skype call-in service to forward a call to an SMS alert, or for a mobile phone to use SMS to set up a bridged VoIP call via a VoIP-to-POTS service such as Skype Out. That type of call setup would assist an international roamer to carry on the desired phone call without needing to pay his home mobile carrier lofty international roaming charges.

[0009] The co-pending VoIP Call Rerouting Patent Application describes a service that allows automatic rerouting of a call to a mobile or fixed line subscriber over an IP network to the subscriber's phone. That VoIP Call Rerouting Patent Application teaches a way for a special cellular VoIP integrated handset to detect a broadband IP connection, enabling the client to automatically set call forwarding to the VoIP number that corresponds to the current IP address. A similar concept also applies to any ordinary mobile phone, so that as soon as a mobile goes on roaming, a user may receive calls on a VoIP phone number corresponding to the user's location via IP.

[0010] That co-pending VoIP Call Rerouting Patent Application also describes a service that allows a mobile or fixed line subscriber to receive a call automatically rerouted over an IP network at the subscriber's mobile. This application also teaches how an ordinary phone can accomplish this rerouting to a VoIP mobile phone, and how VPMN, HPMN or IP service providers can enable this service based on various business models.

[0011] In accordance with the foregoing, there is a need in the art for a system, method, computer product and service which, will automatically route a call to the subscriber's non-VoIP wireless or fixed line number over IP to the subscriber's VoIP client when a subscriber's VoIP client is online. The subscriber's wireless or fixed line carrier or home wireless network operator may perform the routing operation, and can condition the routing to depend on whether the non-VoIP number is roaming or not answering.

BRIEF DESCRIPTION OF DRAWINGS

[0012] In the drawings, the same or similar reference numbers identify similar elements or acts.

[0013] FIG. 1 represents an Integrated Cellular VoIP (ICV) System, in accordance with an embodiment of the invention;

[0014] FIG. 2 represents the ICV system implemented using a Skype service, in accordance with an embodiment of the invention;

[0015] FIG. 3 represents a flow diagram of unconditional call forwarding implementation of the ICV system using the Skype service, in accordance with an embodiment of the invention;

[0016] FIGS. 4A and 4B represent a flow diagram of conditional late call forwarding implementation of the ICV system using the Skype service, in accordance with a first embodiment of the invention;

[0017] FIGS. 5A and 5B represent a flow diagram of conditional late call forwarding implementation of the ICV system using the Skype service, in accordance with a second embodiment of the invention;

[0018] FIG. 6 represents a flow diagram for switching of traffic from a second communication network to a first communication network, in accordance with one embodiment of the invention;

[0019] FIG. 7 represents a flow diagram for switching of traffic from the first communication network to the second communication network, in accordance with another embodiment of the invention;

[0020] FIG. 8 represents a system for implementing the ICV system using an IM-VoIP like service, in accordance with an embodiment of the invention;

[0021] FIG. 9 represents a flow diagram of unconditional call forwarding implementation of the ICV system using the IM-VoIP like service, in accordance with an embodiment of the invention;

[0022] FIGS. 10A and 10B represent a flow diagram of conditional late call forwarding implementation of the ICV system using the IM-VoIP like service, in accordance with a first embodiment of the invention;

[0023] FIGS. 11A and 11B represent a flow diagram of conditional late call forwarding implementation of the ICV system using the IM-VoIP like service, in accordance with a second embodiment of the invention;

[0024] FIG. 12 represents a system for implementing the ICV system using a Vonage like service, in accordance with an embodiment of the invention;

[0025] FIG. 13 represents a flow diagram of unconditional call forwarding implementation of the ICV system using the Vonage like service, in accordance with an embodiment of the invention;

[0026] FIGS. 14A and 14B represent a flow diagram of conditional late call forwarding implementation of the ICV system using the Vonage like service, in accordance with a first embodiment of the invention;

[0027] FIGS. 15A and 15B represent a flow diagram of conditional late call forwarding implementation of the ICV system using the Vonage like service, in accordance with a second embodiment of the invention;

[0028] FIG. 16 represents a system for implementing the ICV system using a Skype-IN like service for a fixed line subscriber, in accordance with an embodiment of the invention;

[0029] FIG. 17 represents a flow diagram representing unconditional call forwarding implementation of the ICV system using the Skype-IN like service for the fixed line subscriber, in accordance with an embodiment of the invention;

[0030] FIG. 18 represents a flow diagram of conditional call forwarding implementation of the ICV system using the Skype-IN like service for the fixed line subscriber, in accordance with an embodiment of the invention;

[0031] FIG. 19 represents a system for implementing the ICV system using the IM-VoIP like service for a fixed line subscriber, in accordance with an embodiment of the invention;

[0032] FIG. 20 represents a flow diagram of unconditional call forwarding implementation of the ICV system using the IM-VoIP like service for the fixed line subscriber, in accordance with an embodiment of the invention;

[0033] FIG. 21 represents a flow diagram of conditional call forwarding implementation of the ICV system using the IM-VoIP like service for the fixed line subscriber, in accordance with an embodiment of the invention;

[0034] FIG. 22 represents a system for implementing the ICV system using the Vonage like service for a fixed line subscriber, in accordance with an embodiment of the invention;

[0035] FIG. 23 represents a flow diagram of unconditional call forwarding implementation of the ICV system using the Vonage like service for the fixed line subscriber, in accordance with an embodiment of the invention;

[0036] FIG. 24 represents a flow diagram of conditional late call forwarding implementation of the ICV system using the Vonage like service for the fixed line subscriber, in accordance with a first embodiment of the invention;

[0037] FIG. 25 represents a generic SIP based system diagram for implementing the ICV system for both wireless and fixed line subscribers, in accordance with an embodiment of the invention;

[0038] FIG. 26 represents a flow chart for SMS forwarding via a second communication network, in accordance with an embodiment of the invention;

[0039] FIG. 27 represents a flow chart for SMS forwarding via a second communication network, in accordance with another embodiment of the invention; and

[0040] FIG. 28 represents a flow chart for implementing the ICV system, in accordance with an embodiment of the invention.

SUMMARY

[0041] The present invention is directed to a service that will automatically route a call to the subscriber's non-VoIP wireless or fixed line number over IP to the subscriber's VoIP client, when a subscriber's VoIP client is online. The subscriber's wireless or fixed line home operator may perform the routing, and system can route to different destinations based on conditions such as whether the the non-VoIP number is roaming or whether it is not answering.

[0042] An aspect of the present invention comprises a system for routing a subscriber's calls associated with a first communication network including a home network or a visited network, by means of a gateway coupled to that first communications network. That gateway monitors roaming links of the first communication network and detects the subscriber registering with the visited network, and which receives location information corresponding to the location of the subscriber and selects a routing identifier, associated with at least one client coupled to the gateway via a second communication network.

The routing identifier is associated with the client, and the gateway transfers the traffic of the subscriber to the client at the associated routing identifier, using the first or second communication network. The gateway further includes a mechanism to determine status of the client or the subscriber.

[0043] Another aspect of the present invention provides a system including a gateway coupled to a first communication system and a client application coupled to a client, which detects a coupling with a second communication system and transfers at least one message to the gateway via the coupling. The message may include identification information of the client or instructions and status information. The gateway establishes an association between a subscriber and a routing identifier associated with the client on the second communication system, and determines routing to the client via the second communication system that corresponds to the routing identifier of the client. The gateway transfers the traffic, received at the first communication system to the client as a VoIP call via the second communication system, using the routing and the status information.

[0044] Yet another aspect of the present invention presents a method for routing subscriber traffic that includes detecting the status or presence of the subscriber in a visited network. The method includes detecting a subscriber registration to a visited network, the subscriber being initially registered to a home network, the home network and the visited network being a part of a first communication network, receiving location information corresponding to a location of the subscriber, detecting at a gateway, status of at least one client associated with the subscriber, the client being coupled to the gateway via a second communication network, the gateway coupled to the first communication network, selecting a routing identifier associated with the client, the routing identifier corresponding to the location of the subscriber, and transferring traffic of the subscriber to the client at the associated routing identifier using at least one of the first communication network and the second communication network, wherein the transfer of traffic is performed based on the detected status of the client.

[0045] Another aspect of the present invention provides a computer program product including computer usable program code for routing subscriber traffic, detecting a subscriber registration to a visited network, in which the subscriber

is initially registered to a home network and the home and visited networks being a part of a first communication network, receiving subscriber location information, detecting client status at a gateway, the client being coupled to the gateway via a second communication network, and the gateway being coupled to the first communication network, selecting a routing identifier corresponding to the location of the subscriber associated with the client, and transferring traffic of the subscriber to the client at the associated routing identifier using at least one of the first communication network and the second communication network, in which the transfer of traffic is performed based on the detected status of the client.

DETAILED DESCRIPTION

[0046] In the following description, for purposes of explanation, specific numbers, materials and configurations are set forth in order to provide a thorough understanding of the invention. It will be apparent, however, to one having ordinary skill in the art, that the invention may be practised without these specific details. In some instances, well-known features may be omitted or simplified, so as not to obscure the present invention. Furthermore, reference in the specification to "one embodiment" or "an embodiment" means that a particular feature, structure or characteristic, described in connection with the embodiment, is included in at least one embodiment of the invention. The appearance of the phrase "in an embodiment," in various places in the specification, does not necessarily refer to the same embodiment.

[0047] *The first communications network or second communications network under the present invention can be WiMax.* Many embodiments of the present invention are illustrated in this patent application using examples of subscribers using the present invention to integrate phone calls with VoIP and the Internet. In the current state of the art, phone calls are often made using POTS or GSM or CDMA cellular networks. VoIP calls are often received over the Internet, connected via Ethernet, WiFi, DSL, cable modem connected by DOCSYS or other physical layers or even by dialup connections. Integrating presence and routing phone calls from one such network to any other such network are possible under the present invention. In addition, in the state of the art, so-called WiMax networks are being established worldwide, using

public free spectrum, or spectrum specially allocated and licensed by governments. WiMax is a very high bandwidth protocol for transmitting data by radio frequency carrier wave. It is ammenable to use for phone calls and video calls such as those known in todays POTS, cellular and so-called "3G" networks. WiMax is also ammenable to use by personal computers, laptops or smart devices for data or Internet connectivity in the same manner as WiFi connections are commonly used today. In the present invention, phone calls to be rerouted may be placed in WiMax networks using WiMax enabled phone devices, or alternatively phone calls from any source can be rerouted to VoIP clients or other second communications networks to which a subscriber connects by means of a WiMax transciever.

ICV System

[0048]FIG. 1 represents an Integrated Cellular VoIP (ICV) System 100 for routing traffic of a subscriber 102 associated with a first communication network 104 via a second communication network 106. First communication network 104 includes an HPMN (Home Public Mobile Network) 108, and a VPMN (Visited Public Mobile Network) 110, which are cellular networks. In another embodiment of the invention, the first communication network 104 is POTS, and the subscriber is a fixed line subscriber. Second communication network 106 is an IP based network, such as, but not limited to, a VoIP network, the Internet, a WiFi network, or a WiMax network. Subscriber 102 is a home subscriber of the HPMN 108, and may be roaming in VPMN 110, thus making it an outbound roamer from the perspective of HPMN 108.

[0049]In accordance with an embodiment of the invention, subscriber 102 uses a communication device, such as, but not limited to, a mobile station, a fixed line phone, a Wi-Fi enabled mobile phone, a WiMax enabled mobile phone, a personal computer connected to a widely accessible network such as the Internet, a portable computing device connected to a widely accessible network such as the Internet, a portable telephone, a portable communication device, a phone adaptor, or a personal digital assistant connected to a communications network.

[0050]HPMN 108 includes a GMSC (Gateway Mobile Switching Center) 112 and an HLR (Home Location Register) 114, which receives subscriber 102's

location information when it is roaming in VPMN 110 from a VLR/VMSC (Visited Location Register/Visited Mobile Switching Center) 116 connected to the HLR 114, such as by a SS7 link 118. There may be a case when subscriber 102 is not in the coverage of either HPMN 108 or VPMN 110. For example, the subscriber may have his mobile phone switched off or may not be picking up the calls. In such cases, a gateway 120 is able to route any calls intended to subscriber 102 originally intended for mobile termination, instead to a client 122 associated with subscriber 102 via second communication network 106. Client 122 preferably couples to gateway 120 via second communication network 106. In accordance with an embodiment of the invention, the gateway can be any sort of gateway for person to person communications, including but not limited to, a VoIP gateway, a Skype gateway, a Vonage like gateway, a SIP/IMS gateway, or an IM-VoIP gateway or any other type of VoIP, SIP or instant-messaging type type gateway. Client 122 is a VoIP client such as, but not limited to, Skype™, Yahoo®, Google®, GizmoProject, MSN®, Vonage or any SIP, VoIP or messaging client. Client 122 may be a VoIP based application installed on a PC, a laptop or a smart device associated with subscriber 102. The client installed on any one of the devices listed above hereinafter interchangeably refers to as client 122.

[0051] In one embodiment of the invention, gateway 120 couples to both, HPMN 108 and VPMN 110. Alternatively, HPMN 108 may deploy gateway 120 or a third network that has access to HPMN 108 may host gateway 120. If the third network hosts the gateway, the gateway can support multiple home operators, thereby making the implementation scalable. In another embodiment of the invention, the visited network operator 106 deploys ICV system 100 and gateway 120 couples to VPMN 110. Usually, gateway 120 has an SS7 interface to HLR 114 of HPMN 108 and hence is always online from HLR's perspective. When subscriber 102 subscribes to the services provided by ICV system 100, the client 122, installed at subscriber's device, is able mutually to accept VoIP client interface of gateway 120 at HPMN 108, as buddies. In other words, this embodiment enables each client to indicate the presence of other VoIP clients as being available for communications, to the extent that each VoIP client has designated the other as a "buddy" or as being permitted to indicate presence. Subscriber 102 can turn on or turn off

"Incoming calls on his mobile" number via IP when connected by configuring client's 122 presence indication to the home operator's VoIP client (at gateway 120). (for example "visible/invisible (or block/unblock)", or "visible but not available" or "visible but do not disturb" or "invisible but available" – a designation meaning the client will be able to see which buddies are present, but will not display its own presence to them_) This client control of visibility to gateway 120 is referred to herein as presence management of the client. The presence management of a VoIP client can be controlled via an API (a client application built on the application programming interface of the VoIP client), which may also provide a user interface to the VoIP client. For example, the API of the VoIP client can switch the visibility status of its client towards the VoIP gateway.

[0052]In accordance with an embodiment of the invention, the client application (i.e. the API) coupled to client 122 detects a coupling of client 122 with the second communication system, and transfers one or more messages to the gateway via the coupling. The messages may include identification information of client 122 and one or more instructions and status information pertaining to client 122. The message may contain in its header, routing information from client 122 to gateway 120. The status information is either blocking or unblocking information of client 122. The status information may also define the call forwarding status of client 122 with the required call forwarding number. Gateway 120 may receive these instructions including control instructions such as, an Instant Message (IM) or an SMS.

[0053]In one embodiment of the invention, gateway 120 can support any number of types of VoIP clients 122 to support different subscribers. Often, ordinary users will subscribe to a number of different VoIP or messaging services. For example, a person might generally use Skype to communicate with all other Skype subscribers, but might also operate a SIP client for Vonage Softphone, in order to make calls from his laptop using his home Vonage account. Or a person might both subscribe to AOL Instant Messenger for buddies in the U.S., but also Neophone to make calls in Europe. Or a person may have one set of friends that are "buddies" on MSN Messenger, but another set of friends that use Google Talk. A gateway 120 that supports multiple types of VoIP or messaging clients could enable a

single subscriber to have phone calls forwarded to various VoIP clients based on configurable conditions.

[0054] In particular, gateway 120 supports different subscribers or phone numbers (fixed or mobile) with a single VoIP client or multiple VoIP clients. There could also be one physical gateway 120 supporting multiple types of VoIP clients, or one gateway for each type of VoIP client. For example, there may be a Skype™ VoIP gateway for a Skype type client and a Yahoo® VoIP gateway for a Yahoo® type client. In another embodiment of the invention, a subscriber may have multiple associated VoIP clients of different types. In such cases, the subscriber may choose to have a client preferential order such that only the most preferred client available online (with the VoIP gateway client), is called. The preference can also be sequential whereby a caller may call the next preferred client only when the most preferred client is unavailable. In yet another embodiment of the invention, the gateway couples to the HPMN to cater to multiple subscribers present in the home network.

[0055] Gateway 120 monitors the SS7 link 118 (i.e. the roaming SCCP link) exchanged between HPMN 108 and VPMN 110, thereby detecting registration of subscriber 102 with VPMN 110. In one embodiment of the invention, gateway 112 uses a roamer probe database (RPD) 124 to intercept the SS7 link 118. Gateway 120 connects to the RPD 124 using an IP protocol. RPD 124 monitors messages, including but not limited to, MAP location update, InsertSubscriberData (ISD), Cancel Location, and PurgeMS messages at the roaming links of the operator (i.e. HPMN 108). RPD 124 stores the subscriber's current VLR/VMSC/SGSN locations, IMSI/MSISDN, conditional forwarding information and other subscriber profile data. Further, when HPMN 108 receives a PurgeMS or a CancelLocation without a new location update, the current roamer's RPD deletes the subscriber record. Gateway 120 may access RPD 122 to check if subscriber 102 is roaming with VPMN 110. Thus, gateway 120 receives the location information corresponding to the location of subscriber 102 from RPD 124. Hence, gateway 120 embodies a mechanism to determine the status of both subscriber 102 and client 122. Gateway 120 uses RPD 124 to detect whether subscriber 102 is in any operator's coverage in first communication network

104. Also, the VoIP client of gateway 120 at HPMN 108 receives the client's status information via the second communication network 106.

[0056] Also, gateway 120 selects a routing identifier associated with client 122. The routing identifier is typically a number associated with the client. Examples of routing identifiers may include, but are not limited to, a Skype-IN number, a mobile number of the subscriber, a fixed landline number associated with the subscriber, a temporary assigned routing number corresponding to the location of the subscriber and a temporarily assigned late call forwarding number for the subscriber. Gateway 120 selects the routing identifier based on the type of VoIP client is used. In addition, the selection also depends on whether the subscriber is a wireless or a wireline subscriber. The VoIP client may or may not have a call-in number associated with it. For example, a VoIP client such as Skype has a Skype-IN number associated with it. However, a VoIP client like MSN® does not have any associated call-in number. Even in such a case, it is possible to route the traffic (call traffic etc.) for the subscriber at a routing identifier associated with such client. The routing identifier in this case may be a temporary assigned routing number. In one embodiment of the invention, the routing identifier may be corresponding to the location of the subscriber. In the case of a temporarily assigned number, the HPMN operator may configure / program the VoIP Gateway to support independent VoIP calls between the HPMN's VoIP Client and each subscriber's VoIP Client. Thereafter, gateway 120 transfers the traffic associated with the subscriber to client 122 at the associated routing identifier using second communication network 106. The traffic associated with the subscriber may be call traffic or value added services traffic such as an SMS. In other words, gateway 120 may forward a subscriber's call, text message, or a text message indicating the call, to the client. Gateway 120 typically would transfer the traffic to the routing identifier using second communication network 106, i.e., the IP based network. The case, in which the IP network is down, gateway 120 routes the traffic using first communication network 104, i.e., the cellular network. However, in such cases, gateway 120 routes the call to the mobile number of the subscriber and not to the VoIP client of the subscriber.

[0057] The ICV system described herein integrates VoIP with SS7 signaling and, in contrast to typical integrated communication systems, allows roaming subscribers to receive telephone calls as VoIP calls at the routing numbers of the client associated with the subscriber. The ICV system also supports integrated cellular Wi-Fi services for cellular telephones. The ICS system also supports multiple cellular technologies including GSM, CDMA, and TDMA, to name a few.

[0058] SS7 signaling is a Common Channel Signaling ("CCS") system defined by the International Telecommunications Union-Telecommunication Standardization Sector ("ITU-T"). SS7 signaling is common in telecommunication networks and provides a suite of protocols, which enables routing of circuit and non-circuit related information within and between networks. The protocols of SS7 signaling include but are not limited to Message Transfer Part ("MTP"), Signaling Connection Control Part ("SCCP"), and Integrated Service Digital Network ("ISDN") User Part ("ISUP").

[0059] FIG. 2 represents an ICV system 200 implemented using the Skype™ service, in accordance with an embodiment of the invention. This embodiment applies to wireless subscribers present in first communication network 104. ICV system 200 is a modified version of ICV system 100. ICV system 200 includes a Skype gateway 202 as the VoIP gateway, so as to cater to Skype users. Further, HPMN 108 deploys Skype gateway 202, with RPD 124 monitoring the roaming SCCP links between HPMN 108 and VPMN 110. RPD 124 provides the roaming information to Skype gateway 202. The subscriber may use a laptop, a PC or a smart device with a Skype client 204 connected to the Skype gateway 202 using IP protocol. ICV system 200 advantageously utilizes the fact that Skype provides a call-in number (Skype-IN) facility and assumes that subscriber 102 has subscribed to the call-in service of Skype™.

[0060] FIG. 3 represents a flow diagram of unconditional call forwarding implementation in ICV system 200 using the Skype service, in accordance with an embodiment of the invention. The unconditional call forwarding implies that routing of any mobile terminated (MT) call to an outbound roamer at his mobile number to its associated client over the IP network. In accordance with various embodiments of the invention, subscriber 102 is interchangeably referred to herein as subscriber B. At step 302, subscriber B connects to the

"Internet (or any other IP based network) using the Skype client 204. At step 304, Skype client 204 informs his 'online' status to the Skype gateway 202 present in HPMN 108 of subscriber B. Thereafter, in accordance with an embodiment of the invention, at step 306, Skype gateway 204 checks subscriber B's roaming status and other subscriber information with HLR 114. Skype gateway 204 checks whether unconditional call forwarding is set against RPD 124. If not, at step 308, Skype gateway 202 sets unconditional call forwarding for subscriber B to the Skype-IN number. To do so, Skype gateway 202 issues messages, for example, MAP RegisterSS in GSM network, to the HLR 114. Next, at step 310, another subscriber A calls subscriber B at his mobile number and the call reaches at GMSC 112 of subscriber B's network. Thereafter, at step 312, GMSC 112 requests subscriber B's routing information from the HLR 114 by sending a MAP SRI message (in a GSM implementation) to the HLR. In case of a CDMA network implementation, an IS 41 MAP Location Request message is used. Thereafter, at step 314, HLR 114 returns subscriber B's Skype-IN number to GMSC 112. Finally, at step 316, GMSC 112 initiates a call set up using subscriber A's number, subscriber B's called number (as the originally called number) and the Skype-IN number of subscriber B. Hence, the Skype gateway 202 re-directs the call initially destined to mobile number of subscriber B, to the Skype-IN number associated with the Skype client 204.

[0061]FIGS. 4A and 4B represent a flow diagram of conditional late call forwarding implementation of the ICV system 200 using Skype a VoIP or messaging client or method such as Skype, in accordance with a first embodiment of the invention. In the case of Skype, and other peer-to-peer or client-based VoIP networks, often a variation of the ordinary client is available that permits commercial operation of Skype, permits publishing presence to other applications, and is configured as a "supernode," that is as a client that is capable of processing a great deal more peer traffic than the ordinary free-of-charge client that ordinary users download and operate on their computers. Optionally, ICV System 200, or gateway 202 would operate in conjunction with such a "supernode" or commercial-grade version of a VoIP client. More information about state-of-the art commercial extensions on free peer-to-peer

1. messaging systems is available in the September 15, 2004 article by Salman A. Basset which is incorporated herein by this reference.

[0062] This embodiment uses DP 12 terminating trigger to implement the conditional late call forwarding. At step 402, subscriber B connects to the Internet (or any other IP based network) using Skype client 204. At step 404, Skype client 204 informs his 'online' status to Skype gateway 202 present in HPMN 108 of subscriber B. Thereafter, at step 406, subscriber A calls subscriber B at his mobile number and the call reaches GMSC 112 of B's network. At step 408, GMSC 112 requests B's routing information from HLR 114, by sending a MAP SRI message (in a GSM implementation) to HLR 114. In case of a CDMA network implementation, an IS 41 MAP Location Request message is used. Thereafter, at step 410, HLR 114 returns the terminating trigger to GMSC 112. The terminating trigger may be a Camel T-CSI in GSM implantation or a WIN in CDMA implementation. The terminating trigger used may also depend on specific switch vendors such as Siemens, Nokia etc. GMSC 112 downloads the terminating trigger only when the subscriber is roaming. At step 412, GMSC 112 issues a trigger request, such as Initial DP in IN protocol, to the Skype gateway 202, which is equipped with support of IN protocols.

[0063] Thereafter, at step 414, Skype gateway 202 issues a MAP ISD (IMSI-B) message to VLR/VMSC 116 of subscriber B. The Skype gateway 202 receives VLR/ VMSC 116 information either from Initial DP or from RPD 124. The Skype gateway 202 sends the MAP ISD message to remove (set to empty) the conditional forwarding information from the VLR/VMSC. Next, at step 416, Skype gateway 202 requests the monitoring of call events, such as NO-ANSWER and BUSY, from GMSC 112, and issues a CONTINUE message to GMSC 112. At step 418, GMSC 112 again requests HLR 114 for the routing information of subscriber B. At step 420, HLR 114 returns the routing number (i.e. the routing identifier), such as MSRN in GSM implementation and TLDN in CDMA implementation. GMSC 112 then continues the call setup using the routing number, at step 422. If subscriber B does not respond to the call at the MSRN, then, at step 424, GMSC 112 sends an event report to Skype gateway 202. At step 426, Skype gateway

202 again requests for monitoring of call events such as NO-ANSWER and BUSY from GMSC 112. Thereafter, at step 428, Skype gateway 202 requests GMSC 112 to connect subscriber B's Skype-IN number. Hence, at step 430, GMSC 112 initiates a call set up using subscriber A's number, subscriber B's called number (as the originally called number) and the Skype-IN number of subscriber B.

[0064]In case Skype client 204 did not respond to the call at the Skype-IN number, at step 432, GMSC 112 is able to send an event report to Skype gateway 202. If subscriber B sets the Skype client 204 with call forwarding, such as to a Skype voicemail, the call goes to the forwarded number. Thereafter, at step 434, Skype gateway 202 gets the conditional forwarding number of subscriber B, either from RPD 124 or by issuing MAP Interrogate SS (or messages like AnyTimeSubscriberProfile, restoreData or SendParameters), to HLR 114 on the late call forwarding number corresponding to the late forwarding condition received. The late call forwarding number maybe a temporarily allocated number. At step 436, Skype gateway 202, requests GMSC 112 to connect to the late call forwarding number of subscriber B. Hence, at step 438, Skype gateway 202 re-directs the call initially destined to mobile number of subscriber B, to the late call forwarding number of subscriber B.

[0065]FIGS. 5A and 5B represent a flow diagram of conditional late call forwarding implementation of ICV system 200 using the Skype service, in accordance with a second embodiment of the invention. This embodiment uses DP 2 or DP 3 trigger to implement the conditional late call forwarding. Contrary to the previously described embodiment for the DP 12 trigger implementation, this implementation does not require a HLR trigger profile, which is an expensive resource in terms of HLR storage when there are many subscribers, and in terms of the number of different T-CSI profiles a subscriber can have. Also, the call flow is no different from ordinary call flow when subscriber B is not roaming or not online. At step 502, subscriber B connects to the Internet (or any other IP based network) using Skype client 204. At step 504, Skype client 204 informs his 'online' status to the Skype gateway 202 present in HPMN 108 of subscriber B. Skype gateway 202 may

check that the roaming status and unconditional call forwarding (CFU) status is unset. Thereafter, at step 506, Skype gateway 202 sets the CFU to a Dummy Number (DN) via MAP RegisterSS at subscriber B's HLR entry. Since GMSC 112 uses the DP 2 or DP 3 trigger, it is able to perform event supervision on the DN. At step 508, subscriber A calls subscriber B at his mobile number and the call reaches GMSC 112 of subscriber B's network. At step 510, GMSC 112 requests subscriber B's routing information from HLR 114 by sending a MAP SRI message (in a GSM implementation) to HLR 114. In case of a CDMA network implementation, an IS 41 MAP Location Request message is used. Thereafter, at step 512, HLR 114 returns the DN to GMSC 112.

[0066]Next, at step 514, GMSC 112 issues the DP2 or DP3 network trigger request on the DN (e.g. InitialDP in IN protocol) to Skype Gateway 202, which is equipped with support for IN protocols. In this case, the IDP parameters should contain the original called number of subscriber B. At step 516, Skype gateway 202 issues a MAP ISD (IMSI-B) message to VLR/VMSC 116 of subscriber B. Skype gateway 202 receives the information of VLR/ VMSC 116 either from Initial DP or from RPD 124. Skype gateway 202 sends the MAP ISD message to remove (set to empty) the conditional forwarding information from VLR/VMSC 116. Then, at step 518, Skype gateway 202 requests the monitoring of call events such as NO-ANSWER, and BUSY from GMSC 112. Thereafter, at step 520, Skype gateway 202 issues a MAP PRN (IMSI-B) message to VLR/VMSC 116 with the information received from RPD 124. At step 522, VLR/VMSC 116 returns the routing number to Skype gateway 202. The routing number is the MSRN in GSM implementation, while it is the TLDN in CDMA implementation. Upon receiving the routing number, Skype gateway 202, at step 524, issues an IN protocol message CONNECT (A, MSRN) to GMSC 112. At step 526, GMSC 112 continues the call setup towards the routing number. In case, subscriber B did not respond to the call at the mobile number, at step 528, GMSC 112 sends the event report to Skype gateway 202.

[0067]Thereafter, at step 530, Skype gateway 202 again requests for monitoring of call events such as NO-ANSWER and BUSY from GMSC 112. Thereafter, at step 532, Skype gateway 202 requests GMSC 112 to connect

subscriber B's Skype-IN number. Hence, at step 534, GMSC 112 initiates a call set up using subscriber A's number, subscriber B's called number (as originally called number) and the Skype-IN number of subscriber B. The Skype client can answer the call, when ringing.

[0068] In case, Skype client 204 did not respond to the call at the Skype-IN number either, at step 536, GMSC 112 sends the event report to Skype gateway 202. In case the subscriber B sets Skype client 204 with call forwarding such as a Skype voicemail, the call goes to the forwarded number. At step 538, Skype gateway 202 gets the conditional forwarding number of B, either from RPD 124 or by issuing MAP Interrogate SS (or messages like AnyTimeSubscriberProfile, restoreData or SendParameters), to HLR 114 on the late call forwarding number corresponding to the late forwarding condition received. At step 540, Skype gateway 202 requests GMSC 112 to connect to the late call forwarding number of subscriber B. Hence at step 542, the Skype gateway 202 re-directs the call initially destined to mobile number of subscriber B, to the late call forwarding number of subscriber B.

[0069] In some of the above explanations accompanying the figures, the VoIP clients may be busy, not answering, or not reachable. Hence, it is desirable for the ICV system to have the ability to switch the calls from VoIP clients to mobile station and vice versa. The reason for switching from VoIP client to mobile may be due to improvement in the voice quality during the middle of VoIP client call, by switching the call to the mobile.

[0070] FIG. 6 represents a flow diagram for switching of traffic from a second communication network to a first communication network, in accordance with one embodiment of the invention. This embodiment uses DP 12 terminating trigger to implement the switching of traffic. At step 602, subscriber B connects to the Internet (or any other IP based network) using the Skype client 204. At step 604, Skype client 204 informs his 'online' status to Skype gateway 202, present in HPMN 108 of subscriber B. Thereafter, at step 606, subscriber A calls subscriber B at his mobile number and the call reaches GMSC 112 of subscriber B's network. At step 608, GMSC 112 requests subscriber B's routing information from HLR 114 by sending a MAP SRI message (in a GSM implementation) to HLR 114. In case of a CDMA network implementation, an IS 41 MAP Location Request message is used.

Thereafter, at step 610, HLR 114 returns the terminating trigger to GMSC 112. The terminating trigger may be a Camel T-CSI in GSM implantation or a WIN in CDMA implementation. The terminating trigger is also dependent on specific switch vendors such as Siemens, Nokia etc. GMSC 112 downloads the terminating trigger only when a subscriber is roaming. At step 612, GMSC 112 issues a trigger request such as, Initial DP in IN protocol, to Skype gateway 202, which is equipped with support of IN protocols.

[0071] Thereafter, at step 614, Skype gateway 202 requests monitoring of call events such as DISCONNECT, Busy or No Answer from GMSC and issues a CONNECT (Skype-IN number). At step 616, GMSC 112 sets up the call from subscriber A to Skype-IN number of subscriber B. At step 618, Skype client 204 answers the call at Skype-IN number. Thereafter, at step 620, Skype client 204 sends an Instant Message (IM) to Skype gateway 202 requesting to switch the ongoing call to subscriber B's mobile number. At step 622, Skype gateway 202 grants switching and asks Skype client 204 to disconnect the call. Hence, at step 624, Skype client 204 disconnects the call. GMSC 112, at step 626, issues the event report of DISCONNECT to Skype gateway 204. Further, at step 628, Skype gateway 204 issues the PRN (IMSI-B) to VLR/VMSC 116. Skype gateway 202 receives the information of VLR/VMSC 116 either from Initial DP or from RPD 124. At step 630, VLR 116 returns the routing number (i.e. the routing identifier) such as, MSRN in GSM implementation and TLDN in CDMA implementation. Skype gateway 202 issues a Connect to routing number to GMSC 112, step 632. Finally, at step 634, subscriber B answers the voice call from A at his mobile number.

[0072] There may also be a requirement of switching an ongoing call and not just a no responding call from a mobile number to the VoIP client. The reason for this would be the higher cost of a call to the mobile in comparison to the call at the VoIP client when it is online. FIG. 7 represents a flow diagram for switching of traffic from first communication network 104 to second communication network 106, in accordance with another embodiment of the invention. This embodiment uses DP 2 or DP 3 trigger to implement the switching of traffic. At step 702, subscriber B connects to the Internet (or any other IP based network) using Skype client 204. At step 704, Skype client 204

informs his online status to Skype gateway 202 present in HPMN 108 of subscriber B. At step 706, Skype gateway 202 checks the roaming status and unconditional call forwarding (CFU) status against RPD 124. Thereafter, Skype gateway 202 sets the CFU to a Dummy Number (DN) via MAP RegisterSS at subscriber B's HLR entry. Since GMSC 112 uses DP 2 or DP 3 trigger, it is able to perform event supervision on the DN. At step 708, subscriber A calls subscriber B at his mobile number and the call reaches GMSC 112 of subscriber B's network. At step 710, GMSC 112 requests subscriber B's routing information from HLR 114 by sending a MAP SRI message (in a GSM implementation) to the HLR. In case of a CDMA network implementation, an IS 41 MAP Location Request message is used. Further, at step 712, HLR 114 returns the DN to GMSC 112.

[0073] Thereafter, at step 714, GMSC 112 issues the DP2 or DP3 network trigger request on the DN (e.g. InitialDP in IN protocol) to Skype Gateway 202, which is equipped with support for IN protocols. In this case, the IDP parameters should contain the original called number of B. At step 716, Skype gateway 202 requests monitoring of events such as DISCONNECT from GMSC 112. Thereafter, at step 718, Skype gateway 202 issues PRN (IMSI-B) message to VLR/VMSC 116 of subscriber B. VLR/VMSC 116 returns the routing number (MSRN) at step 720. GMSC 112, at step 722, routes the call to the mobile. Subscriber B answers the call at step 724. At step 726, Skype client 204 sends an IM to the Skype gateway requesting to switch the call to Skype client 204. Thereafter, at step 728, Skype gateway 202 grants the switching and requests the subscriber to disconnect the call to the mobile. The subscriber disconnects the call at his mobile number at step 730. At step 732, GMSC 112 issues the DISCONNECT event report to Skype gateway 202. Thereafter, at step 734, Skype gateway 202 issues a CONNECT (Skype-IN) to GMSC 112. GMSC 112 routes the call to the Skype-IN number at step 736. Hence, the voice call gets through the IP network when the Skype client answers the call.

[0074] In both the above embodiments, Skype is an explanatory VoIP client for switching call flow. However, it would be apparent to a person skilled in the art that similar call flows would be applicable to other VOIP clients like Yahoo®,

Google, Gizmon, MSN etc. It would also be apparent to a person skilled in the art that the implementation, as explained above, also allows the subscriber to alternate between one device and another several times using the instructions communicated to the VoIP/Skype™-Gateway from the IM/Skype client.

[0075] FIG. 8 represents a system for implementing an ICV system 800 using an IM-VoIP service, in accordance with an embodiment of the invention. This embodiment caters to wireless subscribers in first communication network 104. ICV system 800 is modified version of ICV system 200 to include an IM-VoIP gateway 802 instead of the Skype gateway to cater to any IM based VoIP service. Further, ICV system 800 includes a voice gateway 804 connected to GMSC 112 via a Voice trunk using ISUP protocol. The voice gateway 804 connects to IM-VoIP gateway 802 via an IP link. Moreover, HPMN 108 deploys IM-VoIP gateway 802, with RPD 124 monitoring the roaming SCCP links between HPMN 108 and VPMN 110. The RPD provides the roaming information to IM-VoIP gateway 802 by monitoring roaming messages at the roaming links of HPMN 108 to build up roaming profile of the roamers in the database. The subscriber may use a laptop, a PC or a smart device with an IM-VoIP client 806 connected to the IM-VoIP gateway 802 using IP protocol. The ICV system 800 is applicable for IM-VoIP clients, such as, but not limited to, MSN, Yahoo®, Google and the like, wherein, there is no call-in number facility. It's even useful for a subscriber of IM-VoIP clients such as Skype and Gizmon where there is a call-in number service but the subscriber has not signed up for it. In such a case, a temporary assigned number, preferably a local number depending on the local area where the subscriber is present, is used to route the call.

[0076] FIG. 9 represents a flow diagram of unconditional call forwarding implementation of ICV system 800 using the IM-VoIP service, in accordance with an embodiment of the invention. The unconditional call forwarding implies the routing of any mobile terminated (MT) call to an outbound roamer to its associated client over the IP network. At step 902, subscriber B connects to the Internet (or any other IP based network) using IM-VoIP client 806. At step 904, IM-VoIP client 806 informs his 'online' status to IM-VoIP gateway 802 present in HPMN 108 of subscriber B. At step 906, IM-VoIP gateway 802

requests a free local (temporary assigned) F for B from voice gateway 804, which maintains a pool of available local numbers. Thereafter, at step 908, voice gateway 804 assigns the free number F to B and records the assignment. At step 910, IM-VoIP Gateway 802 sets the unconditional call forwarding of subscriber B to the assigned number F by issuing messages such as MAP RegisterSS in GSM network to HLR 114. Further, at step 912, subscriber A calls subscriber B at his mobile number and the call reaches GMSC 112 of subscriber B's network. Thereafter, at step 914, GMSC 112 requests subscriber B's routing information from HLR 114 by sending a MAP SRI message (in a GSM implementation) to the HLR. In case of a CDMA network implementation, an IS 41 MAP Location Request message is used. Thereafter, at step 916, HLR 114 returns the assigned number F to GMSC 112. Further, at step 918, GMSC 112 initiates a call set up using subscriber A's number, subscriber B's called number and the assigned number F. Finally, at step 920, voice gateway 804 uses the recorded number assignment on subscriber B to route the call over IP to IM-VoIP client 806 of subscriber B. Hence, the IM-VoIP gateway 802 re-directs the call initially destined to mobile number of subscriber B, to the temporary assigned number F associated with IM-VoIP client 806.

[0077]FIGS. 10A and 10B represent a flow diagram of conditional late call forwarding implementation of the ICV system 800 using the IM-VoIP service, in accordance with a first embodiment of the invention. This embodiment uses DP 12 terminating trigger to implement the conditional late call forwarding in ICV system 800. At step 1002, subscriber B connects to the Internet (or any other IP based network) using the IM-VoIP client 806. At step 1004, IM-VoIP client 806 informs its 'online' status to IM-VoIP gateway 802 present in HPMN 108 of subscriber B. At step 1006, IM-VoIP gateway 802 requests a free local (temporary assigned) F for B from voice gateway 804, which maintains a pool of available local numbers. Thereafter, at step 1008, voice gateway 804 assigns the free number F to B and records the assignment. In one embodiment of the invention, ICV system performs step 1006 and 1008 later in the call flow when conditional call forwarding takes place. Thereafter, at step 1010, subscriber A calls subscriber B at his mobile number and the call reaches GMSC 112 of subscriber B's network. At step 1012, GMSC 112

requests subscriber B's routing information from HLR 114 by sending a MAP SRI message (in a GSM implementation) to the HLR. In case of a CDMA network implementation, an IS 41 MAP Location Request message is used. Thereafter, at step 1014, HLR 114 returns the terminating trigger to GMSC 112. The terminating trigger may be a Camel T-CSI in GSM implantation or a WIN in CDMA implementation. The terminating trigger is also dependent on specific switch vendors such as Siemens, Nokia etc. GMSC 112 downloads the terminating trigger only when the subscriber B is roaming. At step 1016, GMSC 112 issues a trigger request such as, Initial DP in IN protocol, to the IM-VoIP gateway 802, which is equipped with support for IN protocols.

[0078] Thereafter, at step 1018, IM-VoIP gateway 802 issues a MAP ISD (IMSI-B) message to VLR/VMSC 116 of subscriber B. IM-VoIP gateway 802 receives the information of VLR/VMSC 116 either from Initial DP or from RPD 124. Skype gateway 202 sends the MAP ISD message to remove (set to empty) the conditional forwarding information from VLR/VMSC 116. Further, at step 1020, IM-VoIP gateway 802 requests the monitoring of call events such as NO-ANSWER, and BUSY from GMSC 112 and issues a CONTINUE message to GMSC 112. At step 1022, GMSC 112 again requests to HLR 114 for the routing information of subscriber B. At step 1024, HLR 114 returns the routing number (i.e. the routing identifier) such as, MSRN in GSM implementation and TLDN in CDMA implementation. GMSC 112 continues the call setup towards the routing number, at step 1026. In case, subscriber B does not respond to the call setup at his routing number, which is the mobile number in this case. Thereafter, at step 1028, GMSC 112 sends event report to IM-VoIP gateway 802. ICV system 800 may perform the steps 1006 and 1008 after step 1028 to avoid assign pre-assigning a temporary number until a conditional forwarding call on subscriber B's mobile number takes place. At step 1030, IM-VoIP gateway 802 again requests for monitoring of call events such as NO-ANSWER and BUSY from GMSC 112. Thereafter, at step 1032, IM-VoIP gateway 802 requests GMSC 112 to connect subscriber B's assigned number F by voice gateway 804. Hence, at step 1034, GMSC 112 initiates a call set up using subscriber A's number, subscriber B's called number and the assigned number F for B, towards the voice gateway 804. Thereafter, at step 1036, voice gateway 804 uses the stored record for

subscriber B to route the call over IP to subscriber B's IM VoIP client 806. IM-VoIP client 806 can answer the call when ringing.

[0079] In case, IM VoIP client 806 did not respond to the call at the number F, at step 1038, GMSC 112 sends the event report to IM-VoIP gateway 802. In case, subscriber B sets IM VoIP client 806 with call forwarding such as a voicemail, the call goes to the forwarded number. At step 1040, IM-VoIP gateway 802 gets the conditional forwarding number of B from either RPD 124 or by issuing MAP Interrogate SS (or AnyTimeSubscriberProfile, restoreData or SendParameters) to HLR 114 on the late call forwarding number corresponding to the late forwarding condition received. At step 1042, IM-VoIP gateway 802 requests GMSC 112 to connect to the late call forwarding number of B. Thereafter, voice gateway 804 releases the temporary assigned F back to the free number pool. Hence, at step 1044, IM-VoIP gateway 802 re-directs the call initially destined to mobile number of subscriber B, to the late call forwarding number of subscriber B.

[0080] FIGS. 11A and 11B represent a flow diagram of conditional late call forwarding implementation of the ICV system 800 using the IM-VoIP service, in accordance with a second embodiment of the invention. This embodiment uses DP 2 or DP 3 trigger to implement the conditional late call forwarding. At step 1102, subscriber B connects to the Internet (or any other IP based network) using IM-VoIP client 806. At step 1104, IM-VoIP client 806 informs his 'online' status to IM-VoIP gateway 802 present in HPMN 108 of subscriber B. At step 1106, IM-VoIP gateway 802 sets the CFU to a Dummy Number (DN) via MAP RegisterSS at subscriber B's HLR entry. IM-VoIP gateway 802 may request for temporary assigned free number F from voice gateway 804, at step 1108. At step 1110, IM-VoIP gateway 802 assigns the number F from a pool of free numbers and records the assignment. At step 1112, subscriber A calls subscriber B at his mobile number and the call reaches GMSC 112 of subscriber B's network. At step 1114, GMSC 112 requests subscriber B's routing information from HLR 114 by sending a MAP SRI message (in a GSM implementation) to the HLR. Thereafter, at step 1116, HLR 114 returns the DN to GMSC 112. Further, at step 1118, GMSC 112 issues the DP2 or DP3 network trigger request on the DN (e.g. InitialDP in IN protocol) to IM-VoIP Gateway 802, which is equipped with support for IN protocols. In this case,

the IDP parameters should contain the original called number of B. At step 1120, IM-VoIP gateway 802 issues a MAP ISD (IMSI-B) to VLR/VMSC 116 of subscriber B to remove the conditional call forwarding. Further, at step 1122, IM-VoIP gateway 802 requests the monitoring of call events such as NO-ANSWER, and BUSY from GMSC 112. Thereafter, at step 1124, IM-VoIP gateway 802 issues a MAP PRN (IMSI-B) message to VLR/VMSC 116 with the information received from RPD 124. At step 1126, VLR/VMSC 116 returns the routing number (MSRN) to IM-VoIP gateway 802. Upon receiving the routing number, IM-VoIP gateway 802, at step 1128, issues an IN protocol message CONNECT (A, MSRN) to GMSC 112. At step 1130, GMSC 112 continues the call setup towards the routing number. In case, the subscriber B (i.e. the mobile) did not respond to the call at the routing number, at step 1132, GMSC 112 sends the event report to IM-VoIP gateway 802. In one embodiment of the invention, ICV system 800 performs the steps 1108 and 1110 here to avoid pre-assigning of the number F until a conditional call forward on mobile number of subscriber B takes place.

[0081] Thereafter, at step 1134, IM-VoIP gateway 802 again requests for monitoring of call events such as NO-ANSWER and BUSY from GMSC 112. Thereafter, at step 1136, IM-VoIP gateway 802 requests GMSC 112 to connect subscriber B's temporary number F to IM-VoIP gateway 802. Hence, at step 1138, GMSC 112 initiates a call set up using subscriber A's number, subscriber B's called number (as the originally called number) and number F for subscriber B. At step 1140, voice gateway 804 uses the stored record (number F) on B to route the call over IP to subscriber B's IM VoIP client 806. The IM-VoIP client can answer the call when ringing.

[0082] In case, IM-VoIP client 806 does not respond to the call at the number F, at step 1142, GMSC 112 sends the event report to IM-VoIP gateway 802. In case, the subscriber B sets the IM-VoIP client 806 with call forwarding such as a voicemail, the call goes to the forwarded number. At step 1144, IM-VoIP gateway 802 gets the conditional forwarding number of subscriber B from either RPD 124 or by issuing MAP Interrogate SS (or AnyTimeSubscriberProfile, restoreData or SendParameters) to HLR 114 on the late call forwarding number corresponding to the late forwarding condition received. At step 1146, IM-VoIP gateway 802 requests GMSC 112 to connect

to the late call forwarding number of subscriber B. Finally, voice gateway 804 releases the assigned number F back to free pool of number. Hence, at step 1148, IM-VoIP gateway 802 re-directs the call initially destined to mobile number of subscriber B, to the late call forwarding number of subscriber B.

[0083] Another embodiment of the invention provides the re-routing service to subscribers using Vonage like service. FIG. 12 represents a system for implementing an ICV system 1200 using the Vonage like service. This embodiment caters to wireless subscribers in first communication network 104. ICV system 1200 is a modified version of ICV system 800 to include a Vonage like gateway 1202 instead of IM-VoIP gateway 802 to cater to any Vonage based VoIP service. Further, ICV system 1200 includes subscriber's Vonage-like Client device 1204 (phone adaptor) that has an IP interface and a phone interface to a phone 1206. Each time the phone adaptor connects to an IP network, it reports the IP address and phone number to a Vonage-like Directory Service 1208. Vonage-like Gateway 1202 subscribes to Directory Service 1208 for any information pertaining to subscriber of the network deploying ICV system 1200. Whenever such a subscriber's Vonage-like Client device 1204 registers with Directory Service 1208, Directory Service 1208 notifies Vonage-like Gateway 1202. Further, there is RPD 124 for monitoring the roaming links to capture information about roamers (subscribers) in a database. The architecture caters to VoIP clients like Vonage, SunRocket where there is a call-in number service and an IP phone adaptor. There is no IM or presence component. However, there is still a registration of IP address with the phone number on a directory service.

[0084] FIG. 13 represents a flow diagram of unconditional call forwarding implementation of the ICV system 1200 using the Vonage like service, in accordance with an embodiment of the invention. The unconditional call forwarding implies the routing of any mobile terminated (MT) call to an outbound roamer to its associated Vonage like client over the IP network. At step 1302, subscriber B connects to the Internet (or any other IP based network) using Vonage-like client 1204. At step 1304, Vonage-like VoIP client 1204 registers with Vonage-like Directory Service 1208. Thereafter, at step 1306, Directory Service 1208 notifies Vonage-like Gateway 1202 at HPMN 108. Further, at step 1308, Vonage-like Gateway 1202 may optionally check if

subscriber B is roaming or not by issuing messages such as, but not limited to, MAP SRI-SM in GSM network or IS-41 MAP SMS-REQUEST in CDMA network to get the VLR/VMSC 116 address. If subscriber B is roaming, then, at step 1310, Vonage-like Gateway 1202 sets the unconditional call forwarding of subscriber B to the Vonage number by issuing, messages such as, but not limited to, MAP RegisterSS in GSM network in HLR 114. Further, at step 1312, subscriber A calls subscriber B at his mobile number and call reaches GMSC 112 of subscriber B's network. At step 1314, GMSC 112 requests routing information by issuing, messages such as, but not limited to, MAP SRI in GSM network or IS 41 MAP LocationRequest in CDMA from HLR 114. Then at step 1316, HLR 114 returns Vonage-like number of subscriber B. Further at step 1318, GMSC 112 continues the call set up using subscriber A's number, subscriber B's called number (as originally called number) and the Vonage-like number of subscriber B.

[0085]FIGS. 14A and 14B represent a flow diagram of conditional late call forwarding implementation of the ICV system 1200 using the Vonage like service, in accordance with a first embodiment of the invention. This embodiment uses DP 12 terminating trigger to implement the conditional late call forwarding in ICV system 1200. At step 1402, subscriber B's Vonage-like client device is connected to the IP network. Further, at step 1404, Vonage-like client 1204 registers his presence with Vonage-like Directory Service 1208. Directory service 1208 notifies subscriber B's presence information to Vonage-like Gateway 1202, at step 1406. Thereafter, at step 1408, subscriber A calls subscriber B's mobile number and the call reaches GMSC 112. GMSC 112 requests routing information by issuing a MAP SRI message to HLR 114, at step 1410. Thereafter, at step 1412, HLR 114 returns terminating trigger such as a Camel T-CSI message in GSM or WIN in CDMA to GMSC 112. GMSC 112 downloads the terminating trigger only when subscriber B is roaming. Henceforth, at step 1414, GMSC 112 issues trigger request to Vonage-like Gateway 1202, which is equipped with support for IN protocols. Then at step 1416, Vonage-like Gateway 1202 issues MAP ISD to VLR/VMSC 116 obtained from the InitialDP or RPD 124 to remove the conditional forwarding information from VLR/VMSC 116.

[0086] Thereafter at step 1418, Vonage-like Gateway 1202 requests the monitoring of call events such as NO-ANSWER, and BUSY from GMSC and issues CONTINUE message. The GMSC 112 requests routing information from HLR 114 again on subscriber B, at step 1420. At step 1422, HLR 114 returns the routing number (MSRN) to GMSC 112. GMSC 112 continues the call set up towards the routing number, at step 1424. There may be a case, when subscriber B (i.e. the mobile) does not answer the call on its MSRN. Hence, at step 1426, GMSC 112 sends event report to Vonage-like Gateway 1202. Vonage-like Gateway 1202 again requests the monitoring of call events such as NO-ANSWER, and BUSY from GMSC 112. Vonage-like Gateway 112, at step 1428, requests via IN-CONNECT GMSC 112 to connect to the subscriber B's Vonage number. At step 1430, GMSC 112 continues the call set up using subscriber A's number, subscriber B's called number (as originally called number) and the Vonage-like number of subscriber B. Again, in case, subscriber B's Vonage-like client 1204 did not answer the call, at step 1432, GMSC 112 sends event report to Vonage-like Gateway 1202. In cases when Vonage-like Client 1204 itself is set with call forwarding on a voicemail, the call goes to the forwarding number. Thereafter, at step 1434, Vonage-like Gateway 1202 gets conditional call forwarding number from RPD 124 or by issues a MAP Interrogate SS (or AnyTimeSubscriberProfile, restoreData or SendParameters etc) to HLR 114 of subscriber B on the late call forwarding number corresponding to the late forwarding condition received. Further, at step 1436, Vonage-like Gateway 1202 then requests GMSC 112 via IN-CONNECT message to connect to the subscriber B's late call forwarding number. Finally at step 1438, the GMSC initiates the call setup to the subscriber B's late call forwarding number.

[0087] FIGS. 15A and 15B represent a flow diagram of conditional late call forwarding implementation of ICV system 1200 using the Vonage like service, in accordance with a second embodiment of the invention. This embodiment uses DP 2 or DP 3 trigger to implement the conditional late call forwarding. At step 1502, subscriber B connects to the Internet (or any other IP based network) using Vonage-like client 1204. At step 1504, Vonage-like client 1204 registers his presence with Vonage-like Directory Service 1208. The subscriber registers its presence using the Vonage number and current

IP address associated with the Vonage number. Further, Directory Service 1208 notifies subscriber B's presence information to Vonage-like Gateway 1202 at step 1506. Again, the check for roaming status and unconditional call forwarding status maybe omitted at this point of call flow. Further, at step 1507, Vonage-like Gateway uses MAP RegisterSS to set the unconditional call forwarding to the DN. Thereafter, at step 1508, subscriber A calls subscriber B's mobile number and the call reaches GMSC 112 of subscriber B's network. At step 1510, GMSC 112 requests routing information by issuing MAP SRI to HLR 114. HLR 114 returns the DN at step 1512. Thereafter at step 1514, GMSC 112 issues trigger request on the DN to the Vonage-like Gateway 1202, which is equipped with support of IN protocols. At step 1516, Vonage-like Gateway 1202 issues MAP ISD (IMSI-B) message to VLR/VMSC 116 to remove the conditional forwarding information from VLR/VMSC 116. Vonage-like Gateway 1202 at step 1518, requests the monitoring of call events such as NO-ANSWER, and BUSY from GMSC 112. At step 1520, Vonage-like Gateway 1202 issues MAP PRN(IMSI-B) message to VLR 116. VLR 116 returns the routing number (MSRN) at step 1522. Vonage-like Gateway 1202 issues a CONNECT (routing-number) to GMSC 112 at step 1524. Thereafter, at step 1526, GMSC 112 continues the call set up towards the routing number. In case subscriber B does not answer the call on his routing number, then at step 1528, GMSC 112 sends event report to Vonage-like Gateway 1202. At step 1530, Vonage-like Gateway 1202 again requests the monitoring of call events such as NO-ANSWER, and BUSY from GMSC 112. At step 1532, Vonage-like Gateway 1202 then requests GMSC 112 via an IN-CONNECT message to connect to subscriber B's Vonage number. Thereafter, at step 1534, GMSC 112 continues the call set up using subscriber A's number, subscriber B's called number (as originally called number) the Vonage-like number of subscriber B. Further, when subscriber B's Vonage-like client 1204 does not answer the call, then at step 1536, GMSC 112 sends event report to Vonage-like Gateway 1202. In case, call forwarding at voicemail is present in the Vonage-like Client 1204, the forwarding number receives the call. At step 1538, Vonage-like Gateway 1202 gets conditional call forwarding number from RPD 124 or by issues MAP Interrogate SS (or AnyTimeSubscriberProfile, restoreData or SendParameters

etc) to HLR 114 of subscriber B on the late call forwarding number corresponding to the late forwarding condition received. Henceforth, at step 1540, Vonage-like Gateway 1202 then request GMSC 112 via IN-CONNECT message to connect to the subscriber B's late call forwarding number. Finally, at step 1542, GMSC 112 initiates a call setup to subscriber B's late call forwarding number.

[0088] In each of the above embodiments, subscriber B (i.e. subscriber 102) is associated with a wireless operator. It is also desirable to have an ICV system for providing services to subscriber B when he is associated with the wireline (fixed line) operators. Further, it is also desirable to provide ICV systems that cater to various types of VoIP clients such as Skype™, IM-VoIP like, and Vonage. FIG. 16 represents an ICV system 1600 using the Skype-IN like service for a fixed line subscriber B, in accordance with an embodiment of the invention. The ICV system 1600 includes a Skype gateway 1602, a fixed line switch 1604 and a switch directory 1606 in HPMN 108 of the fixed line subscriber B. The subscriber's Skype client 1608 may be associated with a device such as, but not limited to, a laptop, a PC or a smart device that has an IP interface. Skype client 1608 of the subscriber connects to Skype gateway 1602 via an IP network. ICV system 1600 does not require a Roamer Probe Database (RPD) because the objective for this system is to connect to the subscriber when he is online on his VoIP client and unavailable at the fixed line. Further, in this embodiment, subscriber B registers for the call-in number service for its VoIP client.

[0100] FIG. 17 represents a flow diagram of unconditional call forwarding implementation of ICV system 1600 using the Skype-IN service for the fixed line subscriber, in accordance with an embodiment of the invention. The unconditional call forwarding implies that any call that terminates at the fixed line number of subscriber B, is routed to its associated client over the IP network. At step 1702, subscriber B's Skype client 1608 connects to the IP network (i.e. the second communication network). At step 1704, Skype client 1608 informs his 'online' status to Skype Gateway 1602 in HPMN 108 of the fixed line subscriber B. Thereafter, at step 1706, Skype Gateway 1602 requests Switch Directory 1606 for an address of fixed line switch 1604 corresponding to subscriber B. At step 1708, Switch Directory 1606 returns

the address of fixed line switch 1604 of subscriber B. Henceforth, at step 1710, Skype Gateway 1602 sets the unconditional call forwarding of subscriber B at fixed line switch 1604 to the Skype-IN number at fixed line switch 1604 of B. In such a case, ICV system 1600 may use a possibly proprietary fixed line switch interface. Further, at step 1712, subscriber A calls subscriber B and the call reaches fixed line switch 1604. Fixed line switch 1604, at step 1714, continues the call set up using subscriber A's number, subscriber B's called number (as originally called number) and the Skype-IN number of subscriber B.

[0101]FIG. 18 represents a flow diagram for conditional call forwarding implementation of the ICV system 1600 using the Skype-IN service for fixed line subscriber, in accordance with an embodiment of the invention. At step 1802, subscriber B's Skype client 1608 connects to the IP network (i.e. the second communication network). Skype client 1608 informs his 'online' status to Skype Gateway 1602 in HPMN 108 of subscriber B, at step 1804. Further, at step 1806, Skype Gateway 1602 requests from Switch Directory 1606, information about fixed line switch 1604 of subscriber B. At step 1808, Switch Directory 1606 returns the address of fixed line switch 1604 of subscriber B. Thereafter, at step 1810, Skype Gateway 1602 sets conditional call forwarding of subscriber B at fixed line switch 1604 to the Skype-IN number at fixed line switch 1604. In case, fixed line switch 1604 originally already has a late call forwarding number such as a voicemail, fixed line switch 1604 saves it. Further, at step 1812, subscriber A calls subscriber B and the call reaches fixed line switch 1604 of subscriber B. Fixed line switch 1604, at step 1814, facilitates a ring at the fixed line phone of subscriber B. If there is a NO-ANSWER response from the fixed line phone, fixed line switch 1604, at step 1816, continues the call set up using A's number, subscriber B's called number (as originally called number) and the Skype-IN number of B. However, in case Skype client 1608 is set with a call forwarding facility, the call is forwarded to the number based on condition such as, but not limited to, no answer or busy or always. Furthermore, in case there is a NO-ANSWER or busy from Skype-IN number, then fixed line switch 1604, at step 1818, routes the call to the saved original call forwarding number (if any).

[0102] FIG. 19 represents an ICV system 1900 implemented using the IM-VoIP service for a fixed line subscriber B, in accordance with an embodiment of the invention. ICV system 1900 includes an IM-VoIP gateway 1902, a voice gateway 1904, a switch directory 1906, and a fixed line switch 1908 in HPMN 204 of fixed line subscriber B. Subscriber B has an IM-VoIP client 1910 associated with devices such as, a laptop, a PC, and a smart device. IM-VoIP client 1910 has an IP interface using which it connects to IM-VoIP gateway 1902 (via the IP network) and add each other as 'buddies'. ICV system 1900 is applicable for IM-VoIP clients such as, Yahoo®, MSN®, Google® etc. where there is no call-in number facility. Alternatively, VoIP clients like Skype or Gizmon may also use ICV system 1900, when the subscriber has not registered with their call-in number facility. In such cases, ICV system 1900 selects a local temporary number depending upon the location of the subscriber to route the call to that temporary number.

[0103] FIG. 20 represents a flow diagram of unconditional call forwarding implementation of ICV system 1900 using the IM-VoIP service for the fixed line subscriber, in accordance with an embodiment of the invention. The unconditional call forwarding implies routing any call that terminates at the fixed line number of the subscriber B to its associated IM-VoIP client over the IP network. At step 2002, IM-VoIP client 1910 of subscriber B connects to the IP network (i.e. second communication network). At step 2004, IM-VoIP client 1910 informs his 'online' status to IM-VoIP Gateway 1902 in HPMN 204 of fixed line subscriber B. Thereafter, at step 2006, IM-VoIP Gateway 1902 requests a free (local) temporary number for B from Voice Gateway 1904, which maintains a pool of available local numbers. At step 2008, Voice Gateway 1904 assigns a free local number F to subscriber B and records the assignment. Further, at step 2010, IM-VoIP Gateway 1902 requests Switch Directory 1906 for address of fixed line switch 1908. At step 2012, Switch Directory 1906 returns the address of fixed line switch 1908 of subscriber B. Thereafter, at step 2014, IM-VoIP Gateway 1902 sets unconditional call forwarding of subscriber B to the temporary assigned number F at fixed line switch 1908 of subscriber B. In such a case, ICV system 1900 may use a proprietary fixed line switch interface. Furthermore, at step 2016, subscriber A calls subscriber B and the call reaches fixed line switch 1908. At step 2018,

Fixed line switch 1908 continues call set up using subscriber A's number, subscriber B's called number (as originally called number) and the temporary assigned number F of subscriber B towards voice gateway 1904. Finally, at step 2020, voice gateway 1904 uses the recorded assignment on subscriber B to route the call over IP network to the subscriber B's IM VoIP client 1910.

[0104]FIG. 21 represents a flow diagram of conditional call forwarding implementation of ICV system 1900 using the IM-VoIP service for the fixed line subscriber B, in accordance with an embodiment of the invention. At step 2102, subscriber B's IM-VoIP client connects to the IP network (i.e. the second communication network). At step 2104, IM-VoIP client 1910 informs his 'online' status to IM-VoIP Gateway 1902 in HPMN of fixed line subscriber B. At step 2106, IM-VoIP Gateway 1902 requests a free (local) temporary assigned number for subscriber B from Voice Gateway 1904, which maintains a pool of available local numbers. At step 2108, Voice Gateway 1904 assigns a free local number F to B and records the assignment. Thereafter, at step 2110, IM-VoIP Gateway 1902 requests for address of fixed line switch of subscriber B from Switch Directory 1906. At step 2112, Switch Directory 1906 returns the address of fixed line switch 1908 of subscriber B. Further, at step 2114, IM-VoIP Gateway 1902 sets the conditional call forwarding of subscriber B to the assigned number F at fixed line switch 1908 of subscriber B. The conditional call forwarding may be applied on one or more criteria such as, but not limited to, no-answer, busy etc. The ICV system 1900 using call forwarding may use a proprietary fixed line switch interface. In case fixed line switch 1908 already has a late call forwarding number, such as voicemail, fixed line switch 1908 saves it. Furthermore, at step 2116, subscriber A calls subscriber B and the call reaches fixed line switch 1908. At step 2118, fixed line switch 1908 facilitates a ring at subscriber B's fixed line phone. In case there is a NO-ANSWER message response, fixed line switch 1908, at step 2120, sets the call at voice gateway 1904 using subscriber A's number, subscriber B's called number (as originally called number) and the assigned number F of subscriber B. Finally, at step 2122, voice gateway 1904 uses the recorded assignment on subscriber B to route the call over IP to subscriber B's IM VoIP client 1910. Also, in case of a NO-ANSWER or busy or non-

availability of a late call forwarding number, fixed line switch 1908 routes the call to the original saved call forwarding number.

[0105]FIG. 22 represents an ICV system 2200 implemented using the Vonage like service for a fixed line subscriber, in accordance with an embodiment of the invention. ICV system 2200 includes a Vonage like gateway 2202, a switch directory 2204, and a fixed line switch 2206 in the HPMN of subscriber B. Further, ICV system 2200 includes subscriber's Vonage like client device 2208 (phone adaptor) that has an IP interface and phone interface connected to a fixed line phone 2210. Each time the phone adaptor connects to an IP network, it reports the IP address and phone number to a Vonage-like Directory Service 2212. Vonage-like Gateway 2202 subscribes to Directory Service 2212 for any information pertaining to subscriber of the network deploying ICV system 2200. Whenever such a subscriber's Vonage-like client device 2208 registers with Directory Service 2212, Directory Service 2212 notifies Vonage-like Gateway 2202. Clients such as, but not limited to, Vonage and SunRocket, may use ICV 2200, where there is a call-in number facility and an IP phone adaptor. However, since there is no IM or presence component, the IP address of the phone number registers with the directory service.

[0106]FIG. 23 represents a flow diagram for unconditional call forwarding implementation of ICV system 2200 using the Vonage like service for the fixed line subscriber, in accordance with an embodiment of the invention. At step 2302, subscriber B's Vonage-like client device 2208 connects to the IP network. At step 2304, Vonage-like VoIP client 2208 registers with Vonage-like Directory 2212. Directory Service 2212, at step 2306, notifies Vonage-like Gateway 2202 at the fixed line home network of subscriber B. At step 2308, Vonage-like Gateway 2202 requests for address of the local fixed line switch from switch directory 2204. Switch Directory 2204 returns the address of fixed line switch 2206 of subscriber B, at step 2310. Thereafter, at step 2312, Vonage-like Gateway 2202 sets unconditional call forwarding to subscriber B's Vonage-like number at fixed line switch 2206. ICV system 2200 using this call forwarding may use a proprietary fixed line switch interface. Further, at step 2314, subscriber A calls subscriber B and the call reaches at fixed line switch 2206. At step 2316, fixed line switch 2206 continues the call set up

using subscriber A's number, subscriber B's called number (as originally called number) and subscriber B's Vonage-like number towards the subscriber B's Vonage client device 2208.

[0107]FIG. 24 represents a flow diagram for conditional late call forwarding implementation of ICV system 2200 using the Vonage-like service for the fixed line subscriber, in accordance with an embodiment of the invention. At step 2402, subscriber B's Vonage-like client device 2208 connects to the IP network. At step 2404, Vonage-like client 2208 registers with Vonage-like Directory 2212. Directory Service 2212, at step 2406, notifies Vonage-like Gateway 2202 at the home network of subscriber B. At step 2408, Vonage-like Gateway 2202 requests for information about the local fixed line switch of B from Switch Directory 2204. At step 2410, Switch Directory 2204 returns the address of fixed line switch 2206 of subscriber B. Thereafter, at step 2412, Vonage-like Gateway 2202 sets conditional call forwarding to subscriber B's Vonage-like number (by using a possibly proprietary fixed line switch interface) at fixed line switch 2206. The conditional forwarding may be set based on criteria such as, but not limited to, NO ANSWER, and busy response. In case fixed line switch 2206 already has late call forwarding number such as voicemail, fixed line switch 2206 saves it. Thereafter, at step 2414, subscriber A calls subscriber B and the call reaches fixed line switch 2206. At step 2416, fixed line switch 2206 facilitates a call at the fixed line phone of B. In case there is a NO ANSWER response from the fixed line phone, fixed line switch 2206, at step 2418, continues the call set up using A's number, subscriber B's called number (as originally called number) and B's Vonage-like number towards Vonage client device 2208. However, in case of still a NO-ANSWER or busy message response, fixed line switch 2206 routes the call to the original saved call forwarding number.

[0108]FIG 25 represents a generic SIP based system diagram 2500 for implementing ICV system for both wireless and fixed line subscribers, in accordance with an embodiment of the invention. System 2500 includes a Voice Gateway 2502, a SIP/IMS Gateway 2504 in a home network 2505 of the fixed or wireless subscriber. SIP/IMS Gateway 2504 subscribes to a SIP IM-VoIP Directory Service 2506 to check for the status of the subscriber. Further, SIP/IMS gateway 2504 uses a roamer probe database (RPD) 2507 to

monitor SS7 roaming links between home operator 2505 and the visited network. A SIP IM-VoIP client device 2508 registers with Directory Service 2506 when it connects to an IP network. In the case of a wireless subscriber (mobile user), the mobile device can optionally register with a VLR/VMSC 2510 in the visited network (VPMN).

[0109]In accordance with an embodiment of the invention, when a SIP IM-VoIP client device 2508 registers with Directory Service 2506, Directory Service 2506 notifies subscriber B's status information (i.e. presence information) to SIP/IMS Gateway 2504. Thereafter, SIP/IMS Gateway 2504 sets the unconditional or conditional call forwarding of subscriber B either at the HLR of subscriber B or at the fixed line switch of subscriber B. Now, when subscriber A calls subscriber B, the call gets rerouted over an IP network to SIP IM-VoIP client 2508 via Voice Gateway 2502. Voice Gateway 2502 is responsible to assign a temporary local number in the current area of subscriber B so to reduce the forwarding call cost. Voice Gateway 2502 also routes the final call to SIP IM-VoIP client device 2508.

[0110]It would be apparent to a person skilled in the art that signal flow for non-call related traffic is similar to the one as explained in one or more of the above embodiments of routing call related traffic. A mobile terminated SMS (MT SMS) is usually free even when the subscriber is roaming. The forwarding of a MT-SMS is preferred when subscriber's mobile is not in coverage area, yet connects to IP network. It may not be necessary that the subscriber is out of coverage only when he's roaming, it may also be possible that mobile subscriber is at the home network and yet may be unreachable because subscriber may have switched off his mobile or may not answer the call. In such cases, the gateway delivers any mobile terminated SMS to the subscriber via the IP network.

[0089]FIG. 26 represents a flow chart for SMS forwarding via the second communication network (IP network), in accordance with an embodiment of the invention. In this embodiment of the invention, the HLR in consideration does not have mobility notification capability. In other words, whenever the subscriber changes his VMSC, the HLR does not notify the VoIP gateway of the same. Hence, whenever an IP connection is available, the VoIP gateway modifies the only VMSC address to be that of the VoIP gateway. Further, the

VoIP Gateway periodically modifies (e.g. every minute) the VMSC address of the subscriber at the HLR without changing the subscriber's VLR location. At step 2602, one of the following occurs: the device associated with the subscriber notifies the VoIP Gateway of IP connection with the VoIP client; or the HLR sends a MAP Cancel Location message to the VoIP Gateway while the VoIP client is online; or a periodical timer of the VoIP Gateway's expires for the subscriber. Thereafter, at step 2604, the VoIP gateway sends a MAP SRI-SM query message to get the current VLR/VMSC address for the subscriber's location. The VoIP gateway also records the received address information. At step 2606, the VoIP gateway checks if the VLR/VMSC address is empty. In case, the VLR/VMSC location is empty, then at step 2608, the VoIP gateway issues a MAP Update Location message to the HLR to set both the VLR and VMSC address as that of the VoIP gateway. And if, the VLR/VMSC address is not empty, then at step 2610, the VoIP gateway records the address and issues a MAP Update Location message with VLR address to be the VMSC address returned from the MAP SRI-SM query (in step 2604) and the VMSC address to be same as that of the VoIP gateway. These process steps repeat to check for validity of the conditions in step 2602.

[0100] FIG. 27 represents a flow chart for SMS forwarding via the second communication network (IP network), in accordance with another embodiment of the invention. Unlike the previous embodiment, this embodiment considers the mobility notification capability with the HLR or the Roaming Probe Device (RPD). Whenever an IP connection is available, the VoIP gateway modifies the VMSC address to be that of the VoIP gateway. Further, the subscriber notifies the VoIP Gateway when he changes his VMSC location. At step 2702, one of the following occurs: the device associated with the subscriber notifies the VoIP Gateway of IP connection with the VoIP client; or the HLR or RPD sends a mobility notification to the VoIP Gateway when the VoIP client is online. Thereafter, at step 2704, the VoIP gateway sends a MAP SRI-SM query message to get the current VLR/VMSC address for the subscriber's location. The VoIP gateway also records the received address information. At step 2706, the VoIP gateway checks if the VLR/VMSC address is empty. In case the VLR/VMSC location is empty, then at step 2708, the VoIP gateway

issues a MAP Update Location message to the HLR to set both the VLR and VMSC address as that of the VoIP gateway. And if VLR/VMSC address is not empty, then at step 2710, the VoIP gateway records the address and issues a MAP Update Location message with VLR address to be the VMSC address returned from the MAP SRI-SM query (in step 2704) and the VMSC address to be same as that of the VoIP gateway. These process steps repeat to check for validity of conditions in step 2702.

[0101] In both cases, the VoIP client responds to the received SMS from the sending party. The response will reach the VoIP gateway at the HPMN. The VoIP Gateway will put the responding party's mobile number as the sending number and the original sending party as the destination number. In some cases, the original sending party may be a VoIP client or a mobile.

[0102] The generic method explained in one or more of the above embodiments is represented in FIG. 28 as a flow chart for implementing an ICV system, in accordance with an embodiment of the invention. At step 2802, the gateway detects a subscriber registration to the visited network when the subscriber initially registers with the home network. At step 2804, the gateway receives location information corresponding to the subscriber's current location of the subscriber by using the RPD to probe the roaming SS7 links between the home network and the visited network. At step 2806, the gateway detects the status of the client (VoIP client) associated with the subscriber. Further, at step 2808, the gateway selects a routing identifier associated with the client. The routing identifier corresponds to the subscriber's current location. Thereafter, at step 2810, the gateway transfers the subscriber's traffic to the client at the associated routing identifier, using the second communication network based upon the status of the client. In accordance with another embodiment of the invention, the VoIP gateway transfers the subscriber's traffic using the first communication network when the status of the client is seen either as offline or unreachable.

[0103] The present invention can take the form of an entirely hardware embodiment, an entirely software embodiment or an embodiment containing both hardware and software elements. In accordance with an embodiment of

the present invention, software including but is not limited to firmware, resident software, and microcode, implements the invention.

[0104] Furthermore, the invention can take the form of a computer program product accessible from a computer-usable or computer-readable medium providing program code for use by or in connection with a computer or any instruction execution system. For the purposes of this description, a computer-usable or computer readable medium can be any apparatus that can contain, store, communicate, propagate, or transport the program for use by or in connection with the instruction execution system, apparatus, or device.

[0105] The medium can be an electronic, magnetic, optical, electromagnetic, infrared, or semiconductor system (or apparatus or device) or a propagation medium. Examples of a computer-readable medium include a semiconductor or solid-state memory, magnetic tape, a removable computer diskette, a random access memory (RAM), a read-only memory (ROM), a rigid magnetic disk and an optical disk. Current examples of optical disks include compact disk – read only memory (CDROM), compact disk – read/write (CD-RW) and Digital Versatile Disk (DVD).

[0106] An HPMN operator uses the Integrated Cellular VoIP (ICV) system to serve subscribers associated with its network even when they are not the coverage of home network. The ICV system connects with its subscribers via an IP network to provide call related and value added service. The subscriber may be using various VoIP clients, which may connect to the home operator via a VoIP gateway deployed at the HPMN. The ICV system may forward a call, destined to the subscriber at his mobile number, as a VoIP call to a client associated with the subscriber. The ICV system is capable of switching an ongoing call on mobile to a call on a VoIP client and vice-versa. In case of multiple VoIP clients with a subscriber, the subscriber may specify preferential order amongst multiple clients.

[0107] The components of ICV system described above include any combination of computing components and devices operating together. The components of the ICV system can also be components or subsystems within a larger computer system or network. The ICV system components can also be coupled with any number of other components (not shown), for example

other buses, controllers, memory devices, and data input/output devices, in any number of combinations. In addition any number or combination of other processor-based components may be carrying out the functions of the ICV system.

[0108] It should be noted that the various components disclosed herein may be described using computer aided design tools and/or expressed (or represented), as data and/or instructions embodied in various computer-readable media, in terms of their behavioral, register transfer, logic component, transistor, layout geometries, and/or other characteristics. Computer-readable media in which such formatted data and/or instructions may be embodied include, but are not limited to, non-volatile storage media in various forms (e.g., optical, magnetic or semiconductor storage media) and carrier waves that may be used to transfer such formatted data and/or instructions through wireless, optical, or wired signaling media or any combination thereof.

[0109] Unless the context clearly requires otherwise, throughout the description and the claims, the words "comprise," "comprising," and the like are to be construed in an inclusive sense as opposed to an exclusive or exhaustive sense; that is to say, in a sense of "including, but not limited to." Words using the singular or plural number also include the plural or singular number respectively. Additionally, the words "herein," "hereunder," "above," "below," and words of similar import refer to this application as a whole and not to any particular portions of this application. When the word "or" is used in reference to a list of two or more items, it covers all of the following interpretations: any of the items in the list, all of the items in the list and any combination of the items in the list.

[0110] The above description of illustrated embodiments of the ICV system is not intended to be exhaustive or to limit the ICV system to the precise form disclosed. While specific embodiments of, and examples for, the ICV system are described herein for illustrative purposes, various equivalent modifications are possible within the scope of the ICV system, as those skilled in the art will recognize. The teachings of the ICV system provided herein can be applied to other processing systems and methods. They may not be limited to the systems and methods described above.

[0111] The elements and acts of the various embodiments described above can be combined to provide further embodiments. These and other changes can be made to the AITRS in light of the above detailed description.

Other Variations

[0112] In describing certain embodiments of the ICV system under the present invention, this specification follows the path of a telecommunications call from a calling party to a called party. For the avoidance of doubt, that call can be for a normal voice call, in which the subscriber telecommunications equipment is also capable of visual, audiovisual or motion picture display. Alternatively, those devices or calls can be for text, video, pictures or other communicated data.

[0113] In the foregoing specification, specific embodiments of the present invention have been described. However, one of ordinary skill in the art will appreciate that various modifications and changes can be made without departing from the scope of the present invention as set forth in the claims below. Accordingly, the specification and figures are to be regarded in an illustrative rather than a restrictive sense, and all such modifications are intended to be included within the scope of present invention. The benefits, advantages, solutions to problems, and any element(s) that may cause any benefit, advantage, or solution to occur or become more pronounced are not to be construed as a critical, required, or essential features or elements of any or all the claims.

Technical references

Each of the following is incorporated herein by reference in its entirety.

GSM 902 on MAP specification

Digital cellular telecommunications system (Phase 2+)

Mobile Application Part (MAP) Specification

(3GPP TS 09.02 version 7.9.0 Release 1998)

Digital cellular telecommunications system (Phase 2+); Security Mechanisms for the SIM application toolkit; Stage 2 (GSM 03.48 version 8.3.0 Release 1999)

Basset, Salman A. and Schulzrinne, Henning; **"An Analysis of Peer-to-Peer Internet Telephony Protocol"**; Department of Computer Science, Columbia University; published September 15, 2004. (see: <http://www1.cs.columbia.edu/~library/TR-repository/reports/reports-2004/cucs-039-04.pdf>) as viewed November 3, 2006.

GSM 348

International Patent Application number WO 2006/027772, entitled "Roaming Presence and Context Management," published March 16, 2006

APPENDIX

Acronym	Description
3G	Third generation of mobile
BSC	Base Station Controller
BCSM	Basic Call State Model
CAMEL	Customized Application for Mobile Enhanced Logic
CDMA	Code Division Multiplexed Access
CLI	Calling Line Identification
CgPA	Calling Party Address
CdPA	Called Party Address
CAP	Camel Application Part
CC	Country Code
CB	Call Barring
CSI	Camel Subscription Information
DPC	Destination Point Code
GMSC	Gateway MSC
GPRS	General Packet Radio System
GLR	Gateway Location Register
GSM	Global System for Mobile
GSM SSF	GSM Service Switching Function
GT	Global Title
HLR -H	HLR from HPMN
HLR	Home Location Register
HPMN	Home Public Mobile Network
IMSI	International Mobile Subscriber Identity
ICV	Integrated Cellular VoIP
IN	Intelligent Network
ISG	International Signal Gateway
INAP	Intelligent Network Application Part
ISD	MAP Insert Subscriber Data
IAM	Initial Address Message
IDP	Initial DP IN/CAP message
ITR	Inbound Traffic Redirection
ISUP	ISDN User Part
LU	Location Update
LUP	MAP Location Update
MAP	Mobile Application Part
MCC	Mobile Country Code
MCC	Mobile Country Code
ME	Mobile Equipment
MNC	Mobile Network Code
MO	Mobile Originated
MSC	Mobile Switching Center
MSISDN	Mobile Subscriber ISDN Number
MSRN	Mobile Subscriber Roaming Number
MT	Mobile Terminated
MTP	Message Transfer Part
NP	Numbering Plan

NPI	Numbering Plan Indicator
NDC	National Dialing Code
ODB	Operator Determined Barring
OTA	Over The Air
O-CSI	Originating CAMEL Subscription Information
PRN	Provide Roaming Number
RNA	Roaming Not Allowed
RPD	Roamer Probe Database
RR	Roaming Restricted due to unsupported feature
RI	Routing Indicator
SPC	Signal Point Code
SRI	Send Routing Information
SCCP	Signal Connection Control part
STP	Signal Transfer Point
STP-H	HPMN STP
SRI-SM	Send Routing Information For Short Message
SSP	Service Switch Point
SSN	Sub System Number
SIM	Subscriber Identify Module
STK	SIM Tool Kit Application
SM-RP-UI	Short Message Relay Protocol User Information
STP	Signal Transfer Point
SS	Supplementary Services
TR	Traffic Redirection
T-CSI	Terminating CAMEL Service Information
TCAP	Transaction Capabilities Application Part
TP	SMS Transport Protocol
UDHI	User Data Header Indicator
UDH	User Data Header
UD	User Data
VAS	Value Added Service
VLR - V	VLR from VPMN
VoIP	Voice over Internet Protocol
VLR	Visited Location Register
VMSC	Visited Mobile Switching Center
VPMN	Visited Public Mobile Network

CLAIMS

1. A system for routing traffic of a subscriber associated with a first communication network comprising a visited network, the system comprising:
a gateway coupled to the first communication network and a second communication network, wherein the gateway monitors roaming links of the first communication network and detects the subscriber registering with the visited network, wherein the gateway receives location information corresponding to a location of the subscriber, a client being coupled to the gateway via the second communication network, wherein the gateway transfers the traffic of the subscriber to the client using at least one of the first communication network and the second communication network, and the gateway further comprising a mechanism to determine status of at least one of the client and the subscriber.
2. The system of claim 1, wherein that first communication network comprises a visited network and a home network.
3. The system of claim 1, wherein the gateway selects a routing identifier associated with at least one client and transfers the traffic of the subscriber to the client at the associated routing identifier.
4. The system of claim 1, wherein the first communication network is at least one of a Plain Old Telephone System (POTS) and a cellular network.
5. The system of claim 1, wherein the second communication network is at least one of a VoIP network, a SIP/IMS network, a Wi-Fi network, an IP based network and a Wi-Max network.
6. The system of claim 1, wherein the subscriber is one selected from a group, consisting of a mobile station, a fixed line telephone, a Wi-Fi

enabled mobile telephone, a personal computer, a portable computing device, a portable telephone, a portable communication device, a telephone adaptor, and a personal digital assistant.

7. The system of claim 1, wherein the client is a VoIP client of a service provider including at least one selected from a group consisting of Skype, Vonage, Gizmon, Google, Yahoo®, and MSN.
8. The system of claim 3, wherein the routing identifier is at least one selected from a group consisting of a Skype-IN, a mobile number of the subscriber, a fixed landline number, a temporary assigned routing number corresponding to the location of the subscriber, and a temporary late call forwarding number assigned to the subscriber.
9. The system of claim 1, wherein the gateway includes at least one selected from a group consisting of a VoIP gateway, a Skype gateway, an MSN gateway, a Google Talk Gateway, a Yahoo® Talk Gateway, a Gizmon Gateway for Instant Messaging, and a VoIP Gateway for an instant message and VoIP client.
10. The system of claim 1, wherein the gateway includes a SIP/IMS gateway with a directory service.
11. The system of claim 1, wherein the gateway includes a Vonage gateway with a directory service.
12. The system of claim 1 further comprising a switch when the gateway is an IM-VoIP gateway.
13. The system of claim 3, wherein the subscriber registers one or more clients with the gateway using one or more routing identifiers.
14. The system of claim 3, wherein the subscriber registers each of the one or more clients with the gateway using one routing identifier.

15. The system of claim 1, wherein the gateway determines if unconditional call forwarding is enabled by the subscriber at an HLR via the first communication network.
16. The system of claim 1, wherein the gateway enables switching of traffic between the first communication network and the second communication network during an ongoing call.
17. The system of claim 1, wherein the gateway performs redirection of the traffic to one or more clients based on one or more application logics.
18. The system of claim 1, wherein determining the status of the client includes identifying the client as one of being active and in-active with the gateway.
19. The system of claim 1, wherein determining the status of the subscriber includes identifying the subscriber as one of being active and in-active with the first communication network.
20. The system of claim 1, wherein the gateway transfers the traffic of the subscriber to the routing identifier of the client via the second communication network when the status of the subscriber is identified as in-active and the status of the client is identified as active.
21. The system of claim 1, wherein the gateway transfers the traffic of the subscriber to the routing identifier of the client via the second communication network based on pre-defined criteria.
22. The system of claim 3, wherein the gateway transfers the traffic of the subscriber to the routing identifier of the client via the first communication network when the status of the client is identified as in-active.

23. The system of claim 3, wherein the gateway routes the traffic of an incoming call to the subscriber at the routing identifier of the client associated with the subscriber as a VoIP call.
24. The system of claim 1, wherein the gateway routes the traffic of an MT SMS to the subscriber as an IM to the client associated with the subscriber.
25. The system of claim 1, wherein receiving location information further comprises acquiring at least one selected from a group consisting of an International Mobile Subscriber Identity (IMSI), a Visited Location Register (VLR), a Visited Mobile Switching Center (VMSC), and subscription information of the subscriber from a roamer probe database (RPD).
26. The system of claim 1, wherein receiving location information further comprises acquiring location information from Mobile Application Part (MAP) transaction messages between the home network and the visited network.
27. The system of claim 1, wherein selecting a routing identifier further comprises selecting a telephone number at the home network from a set of numbers.
28. The system of claim 1, wherein the gateway is coupled to one or more home networks in the first communication network.
29. The system of claim 1, wherein the gateway transfers the traffic of one or more subscribers associated with the home network in the first communication network.
30. A system comprising:
 - a gateway coupled to a first communication system and a second communication system; and

a client application coupled to a client, the client application detecting a coupling with the second communication system and transferring at least one message to the gateway via the coupling, the message comprising one of identification information of the client, one or more instructions and status information, wherein the gateway establishes an association between a subscriber and a routing identifier associated with the client on the second communication system, wherein the gateway determines routing to the client via the second communication system that corresponds to the routing identifier of the client, wherein the gateway transfers the traffic received at the first communication system to the client as a VoIP call via the second communication system using the routing and the status information.

31. The system of claim 28, wherein header of the message contains IP routing information from the client to the gateway.
32. The system of claim 28, wherein the status information includes at least one of call blocking and unblocking information by the client.
33. The system of claim 28, wherein the status information defines unconditional call forwarding status of the subscriber and if so the forwarding address.
34. The system of claim 28, wherein the instructions include control instructions to the gateway using Instant Messaging.
35. The system of claim 28, wherein the instructions include control instructions to the gateway using SMS.
36. A method for routing traffic of a subscriber, the method comprising:
 - detecting a registration of the subscriber to a visited network, the subscriber being initially registered to a home network, the home network and the visited network being a part of a first communication network;

receiving location information corresponding to a location of the subscriber;

detecting at a gateway, status of at least one client associated with the subscriber, the client being coupled to the gateway via a second communication network, wherein the gateway is coupled to the first communication network;

selecting a routing identifier associated with the client, the routing identifier corresponding to the location of the subscriber; and

transferring traffic of the subscriber to the client at the associated routing identifier using at least one of the first communication network and the second communication network, wherein the transfer of traffic is performed based on the detected status of the client.

37. The method of claim 34, further comprising:

determining at the gateway whether unconditional call forwarding is enabled by the subscriber at an HLR via the first communication network.

38. The method of claim 34, wherein the gateway enables switching of traffic between the first communication network and the second communication network during an ongoing call.

39. The method of claim 34, wherein the gateway performs redirection of the traffic to one or more clients based on one or more application logics.

40. The method of claim 34, wherein detecting the status of the client includes:

identifying the client as one of being active and in-active with the gateway.

41. The method of claim 34, wherein detecting the status of the subscriber includes:
identifying the subscriber as one of being active and in-active with the first communication network.
42. The method of claim 34, wherein the gateway transfers the traffic of the subscriber to the routing identifier of the client via the second communication network when the status of the subscriber is identified as in-active and the status of the client is identified as active.
43. The method of claim 34, wherein the gateway transfers the traffic of the subscriber to the routing identifier of the client via the second communication network based on pre-defined criteria.
44. The method of claim 34, wherein the gateway transfers the traffic of the subscriber to the routing identifier of the client via the first communication network when the status of the client is identified as in-active.
45. The method of claim 34, wherein receiving location information further comprises acquiring at least one selected from a group consisting of an International Mobile Subscriber Identity (IMSI), a Visited Location Register (VLR), a Visited Mobile Switching Center (VMSC), and subscription information of the subscriber from a roamer probe database (RPD).
46. The method of claim 34, wherein receiving location information further comprises:
acquiring location information from Mobile Application Part (MAP) transaction messages between the home network and the visited network.

47. The method of claim 34, wherein selecting the routing identifier further comprises:

selecting a telephone number at the home network from a set of numbers.

48. The method of claim 34, wherein the gateway routes the traffic of an incoming call to the subscriber at the routing identifier of the client associated with the subscriber as a VoIP call.

49. The method of claim 34, wherein the gateway routes the traffic of an MT SMS to the subscriber as an IM to the client associated with the subscriber.

50. The method of claim 34, wherein the gateway transfers the traffic of one or more subscribers associated with the home network in the first communication network.

51. A computer program product comprising a computer useable medium including a computer usable program code for routing traffic of a subscriber, the computer program product comprising:

computer usable program code for detecting a registration of the subscriber to a visited network, the subscriber being initially registered to a home network, the home network and the visited network being a part of a first communication network;

computer usable program code for receiving location information corresponding to a location of the subscriber;

computer usable program code for detecting at a gateway, status of at least one client associated with the subscriber, the client being coupled to the gateway via a second communication network, wherein the gateway is coupled to the first communication network;

computer usable program code for selecting a routing identifier associated with the client, the routing identifier corresponding to the location of the subscriber; and

computer usable program code for transferring traffic of the subscriber to the client at the associated routing identifier using at least one of the first communication network and the second communication network, wherein the transfer of traffic is performed based on the detected status of the client.

52. The computer program product of claim 49, further comprising a computer usable program code for determining at the gateway whether unconditional call forwarding is enabled by the subscriber at an HLR via the first communication network.
53. The computer program product of claim 49, further comprising a computer usable program code for enabling the gateway to switch of traffic between the first communication network and the second communication network during an ongoing call.
54. The computer program product of claim 49, further comprising a computer usable program code for enabling the gateway to perform redirection of the traffic to one or more clients based on one or more application logics.
55. The computer program product of claim 49, further comprising a computer usable program code for enabling the gateway to transfer the traffic of the subscriber to the routing identifier of the client via the second communication network when the status of the subscriber is identified as in-active and the status of the client is identified as active.
56. The computer program product of claim 49, further comprising a computer usable program code for enabling the gateway to transfer the traffic of the subscriber to the routing identifier of the client via the second communication network based on pre-defined criteria.

57. The computer program product of claim 49, further comprising a computer usable program code for enabling the gateway to transfer the traffic of the subscriber to the routing identifier of the client via the first communication network when the status of the client is identified as inactive.
58. The computer program product of claim 49, further comprising a computer usable program code for enabling the gateway to route the traffic of an incoming call to the subscriber at the routing identifier of the client associated with the subscriber as a VoIP call.
59. The computer program product of claim 49, further comprising a computer usable program code for enabling the gateway to route the traffic of an MT SMS to the subscriber as an IM to the client associated with the subscriber.
60. The computer program product of claim 49, wherein receiving location information further comprises acquiring at least one selected from a group consisting of an International Mobile Subscriber Identity (IMSI), a Visited Location Register (VLR), a Visited Mobile Switching Center (VMSC), and subscription information of the subscriber from a roamer probe database (RPD).
61. The computer program product of claim 49, wherein receiving location information further comprises acquiring location information from Mobile Application Part (MAP) transaction messages between the home network and the visited network.
62. The computer program product of claim 49, wherein selecting the routing identifier further comprises selecting a telephone number at the home network from a set of numbers.

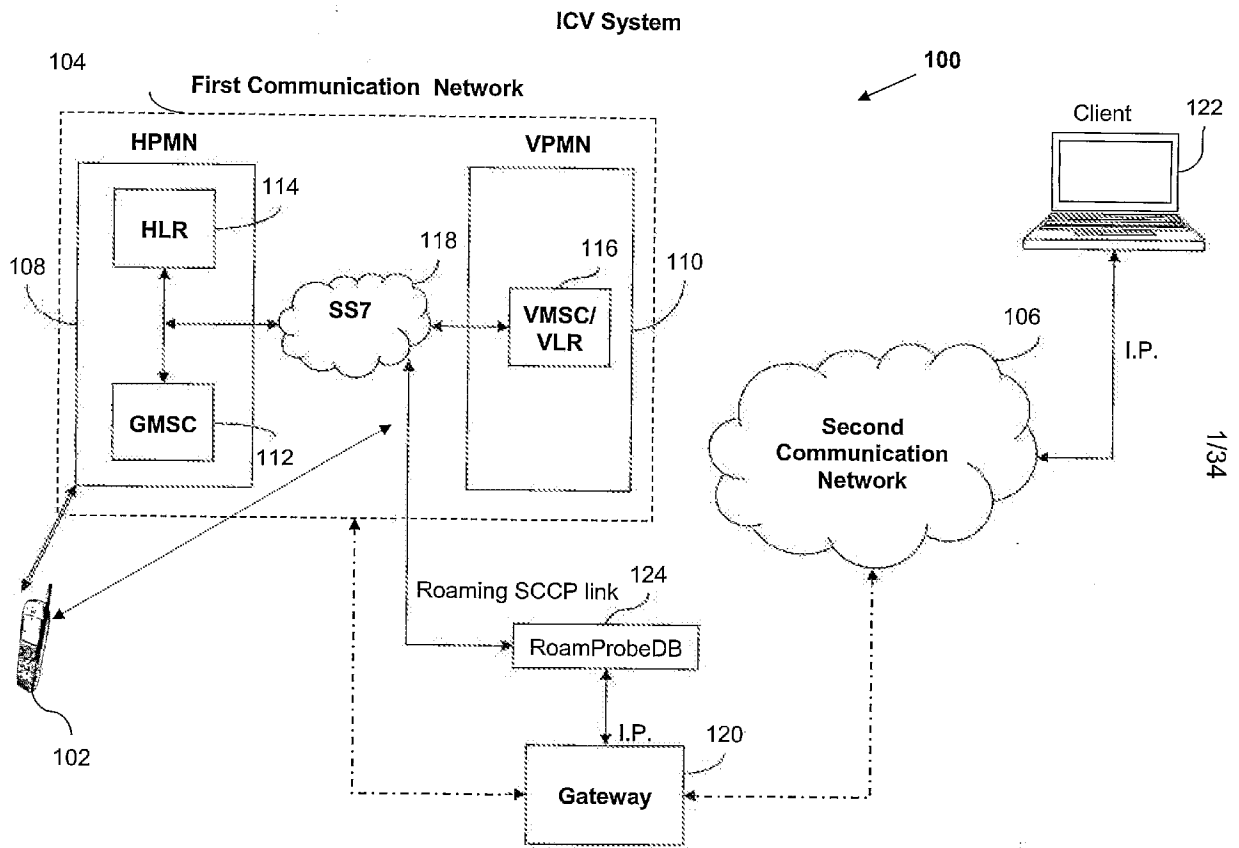


FIG. 1

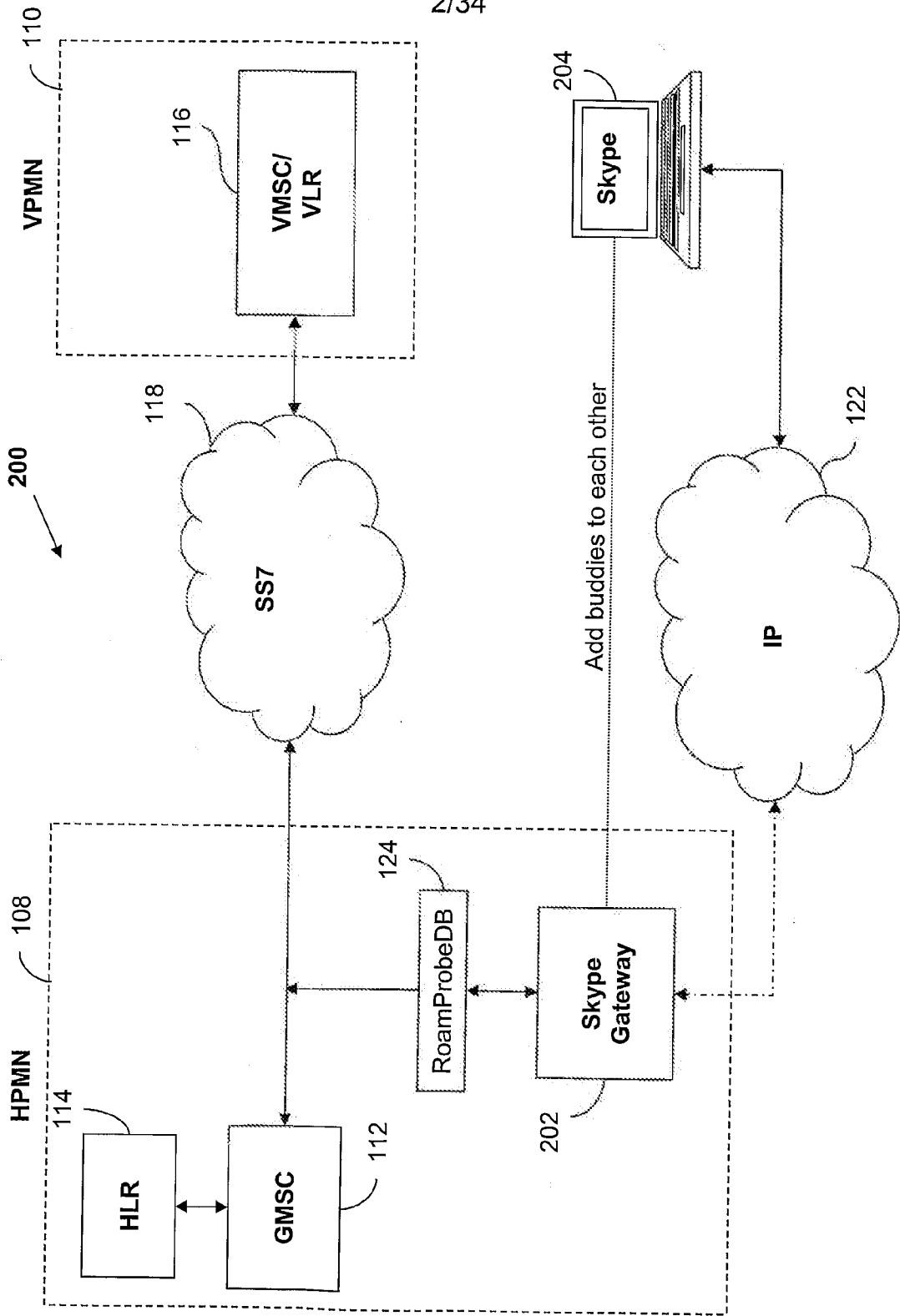


FIG. 2

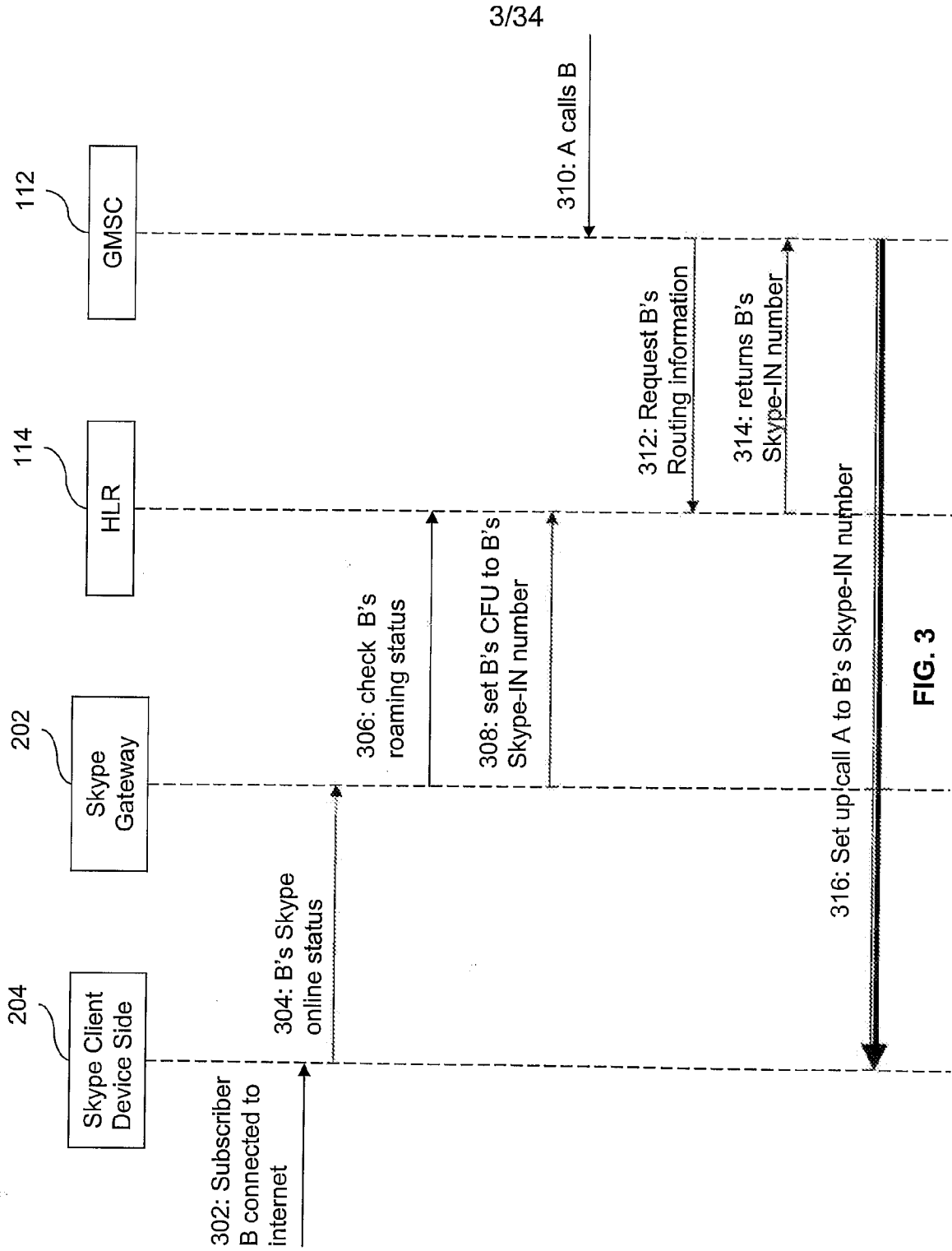


FIG. 3

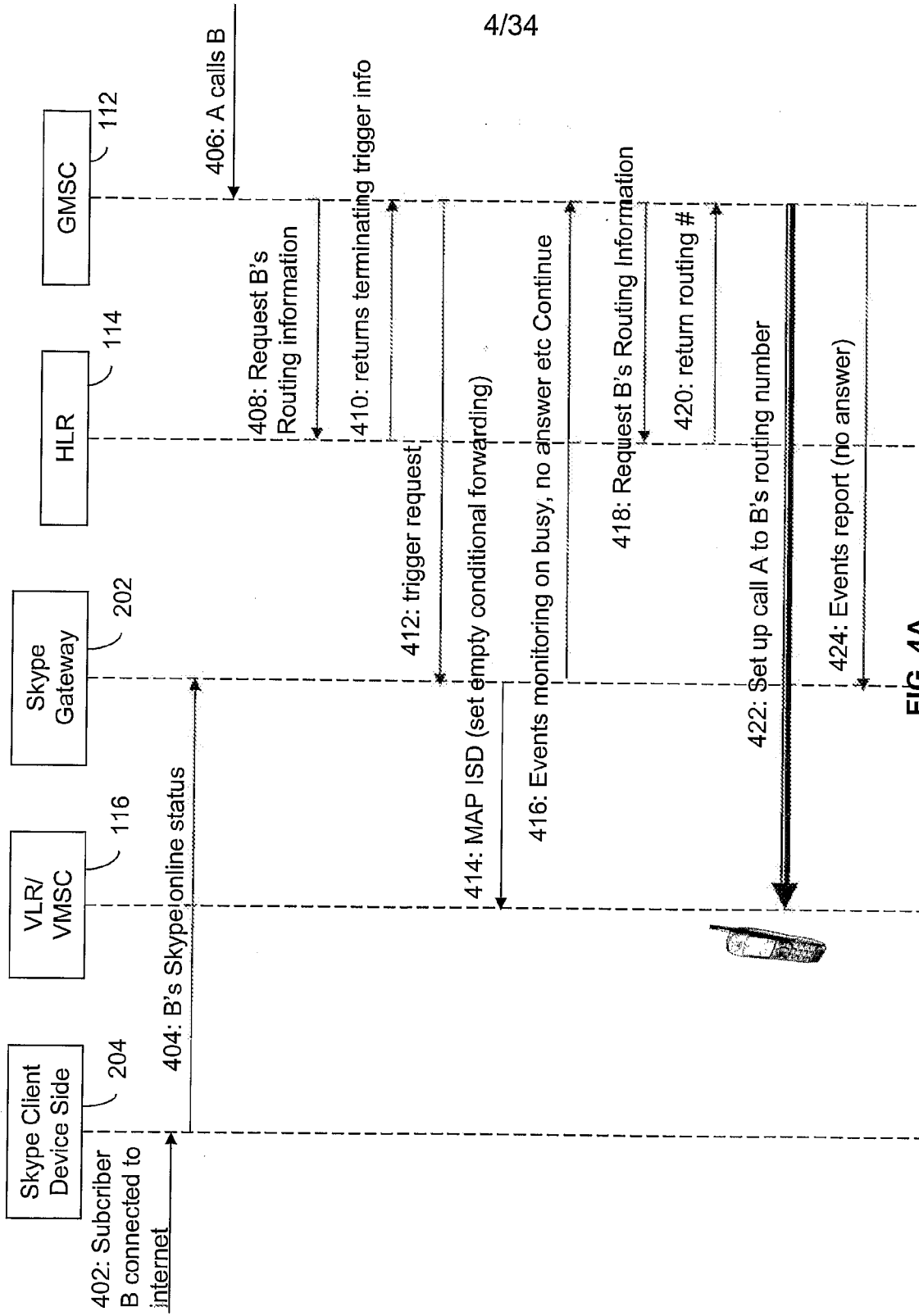


FIG. 4A

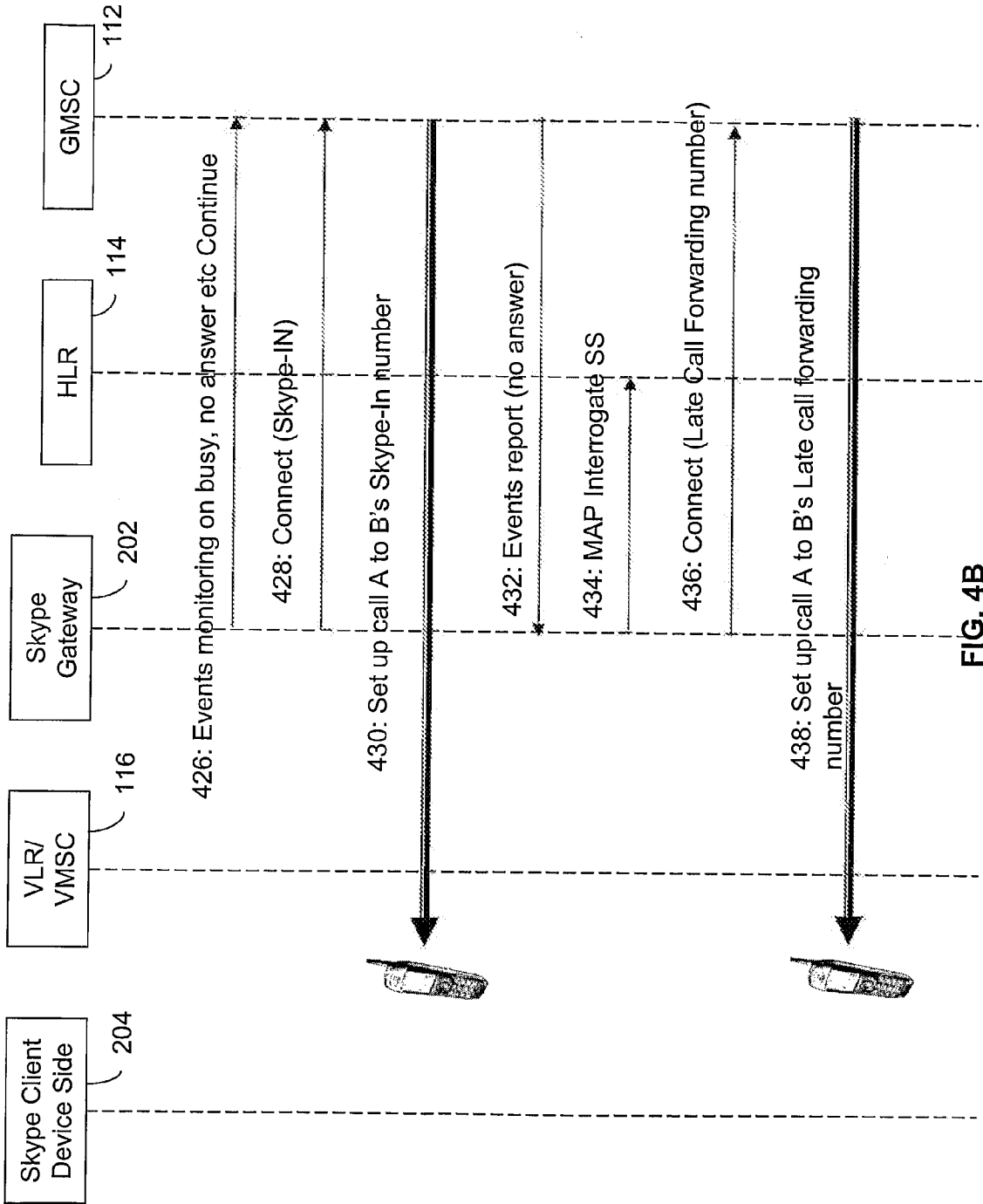


FIG. 4B

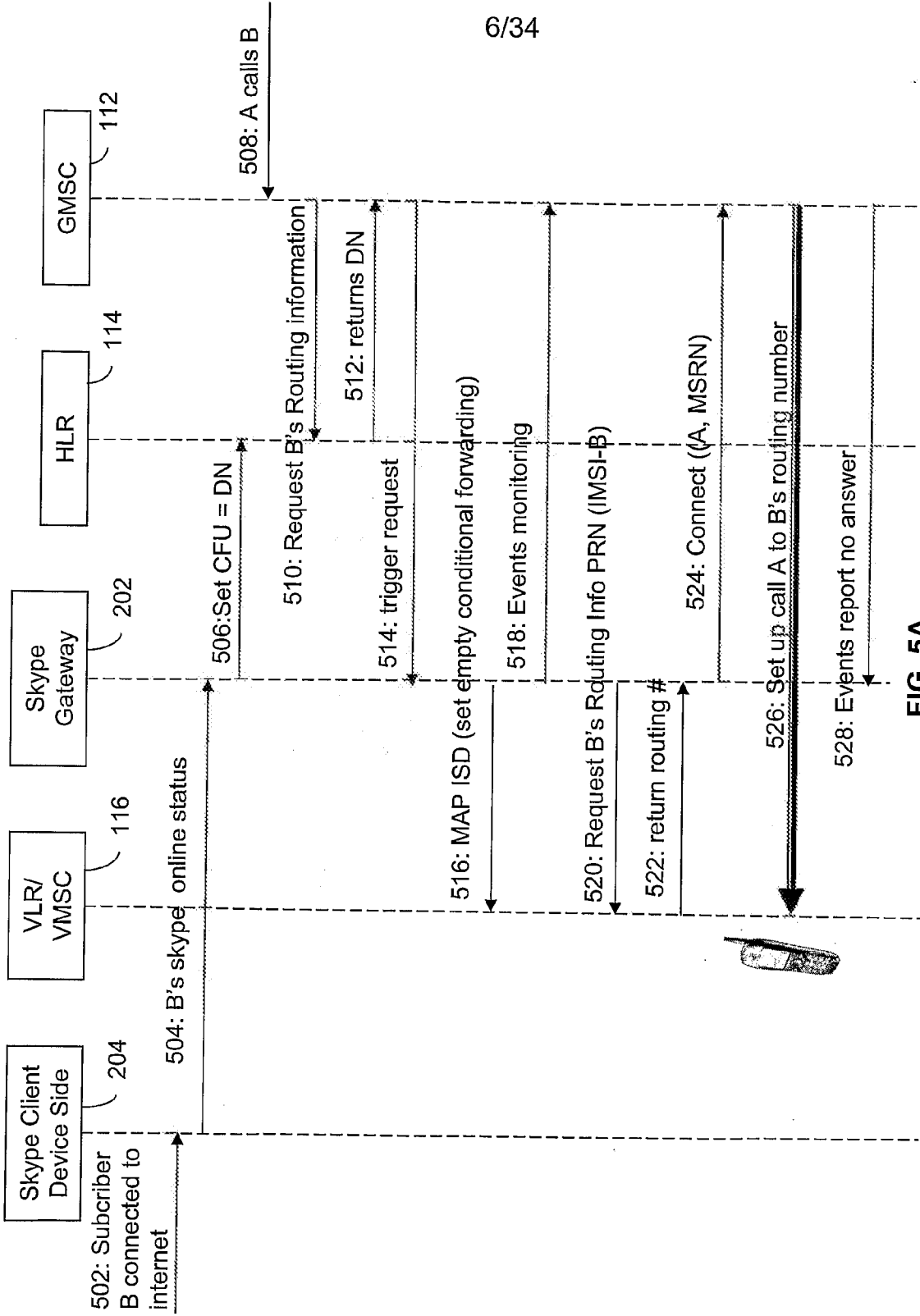


FIG. 5A

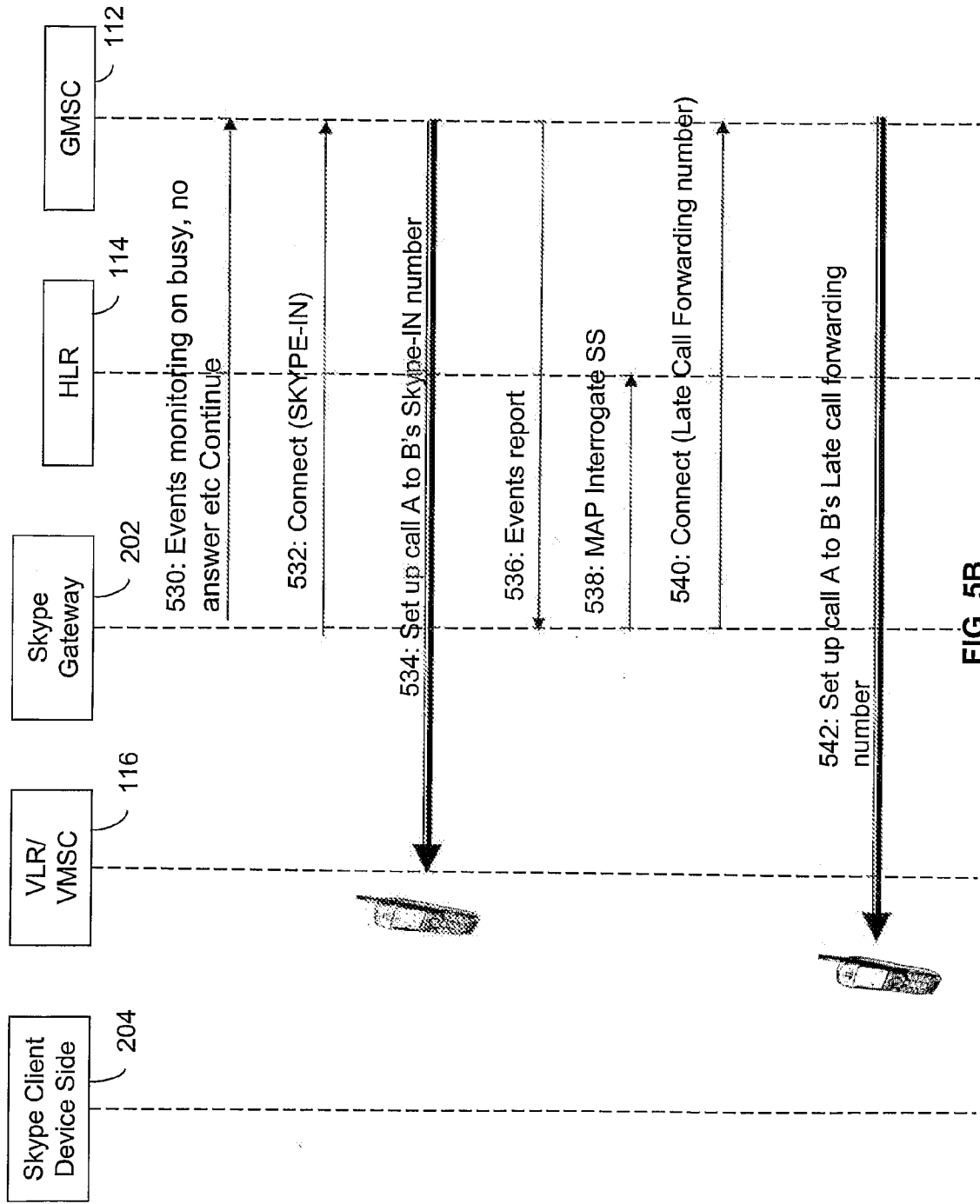


FIG. 5B

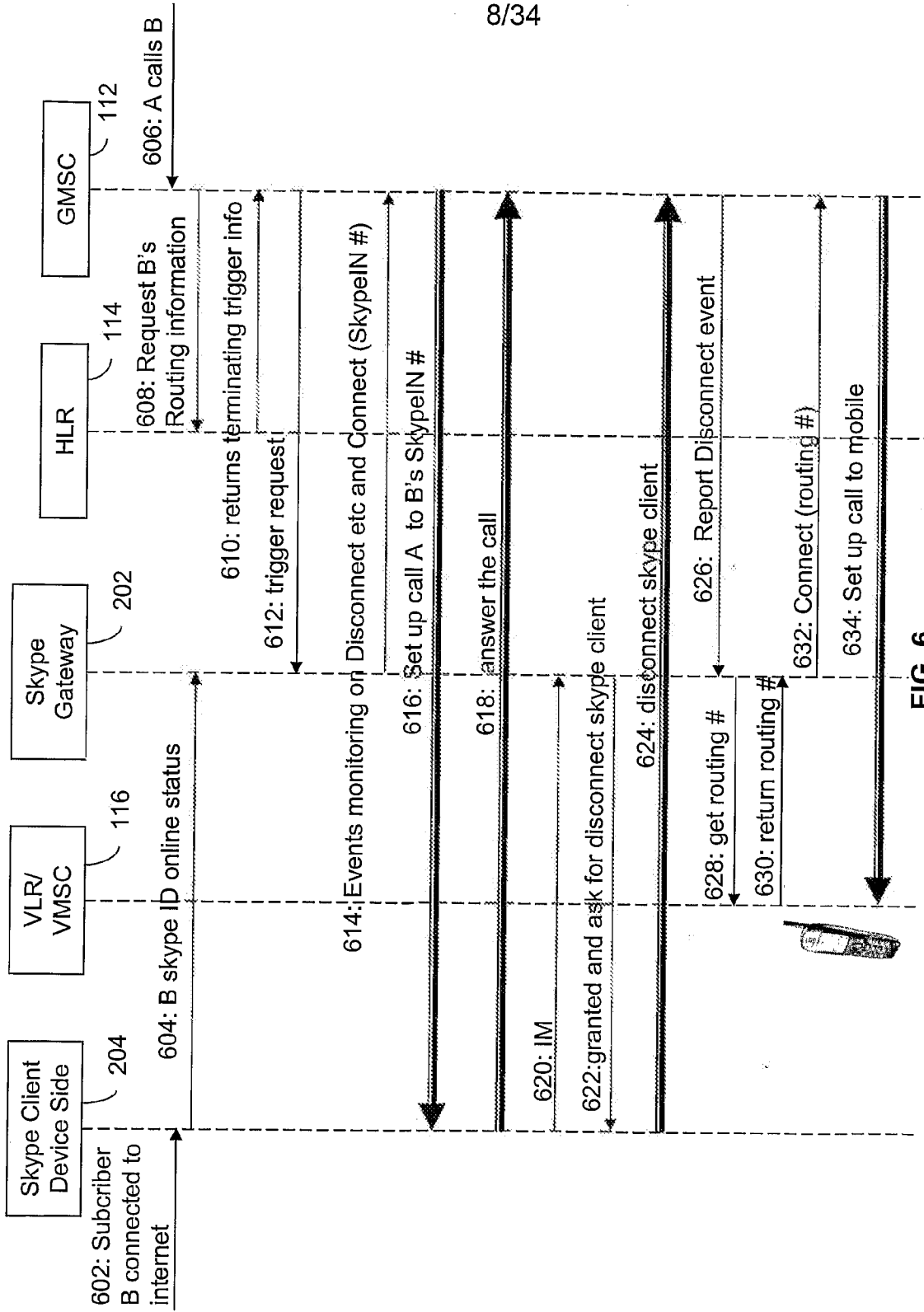


FIG. 6

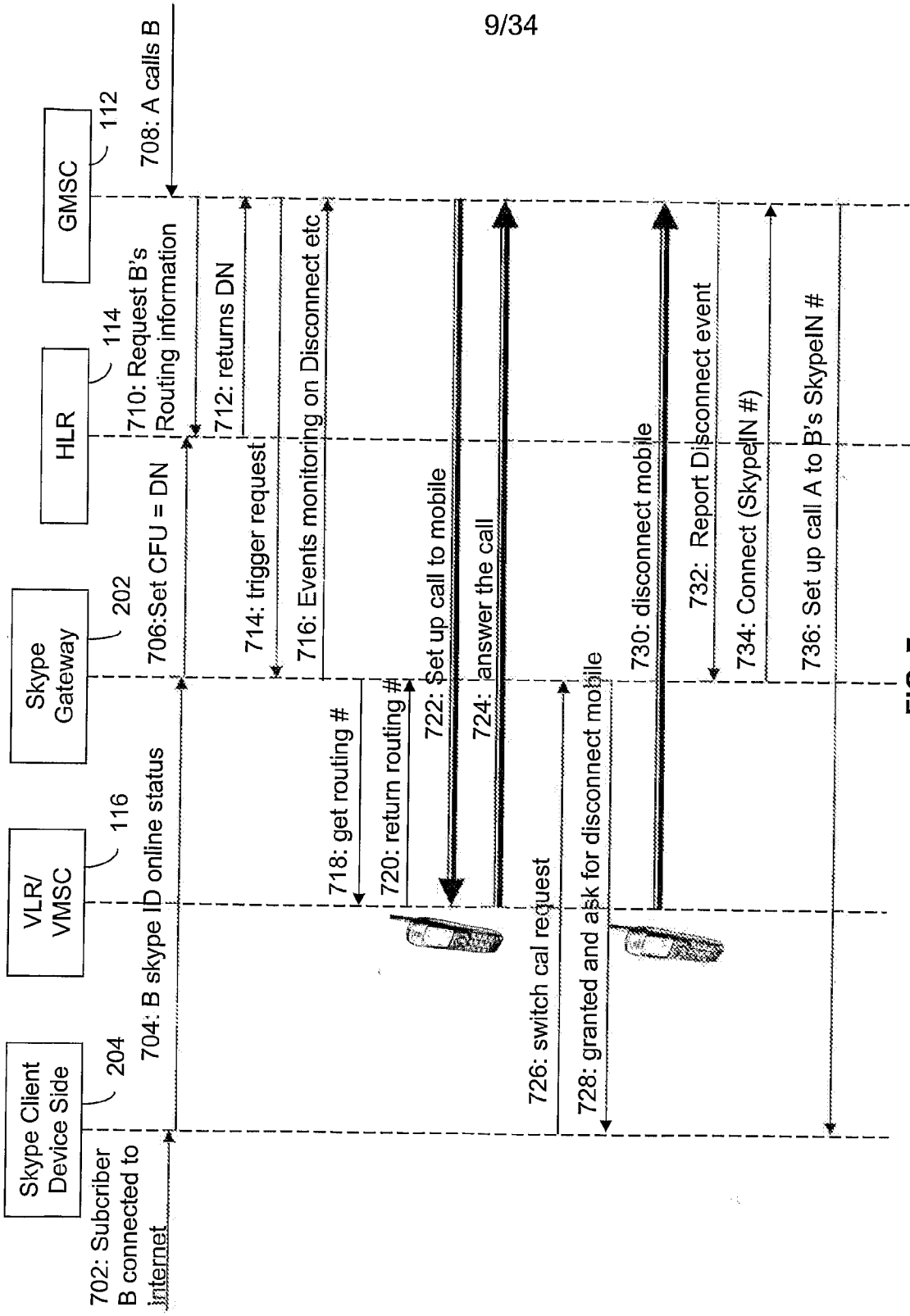


FIG. 7

10/34

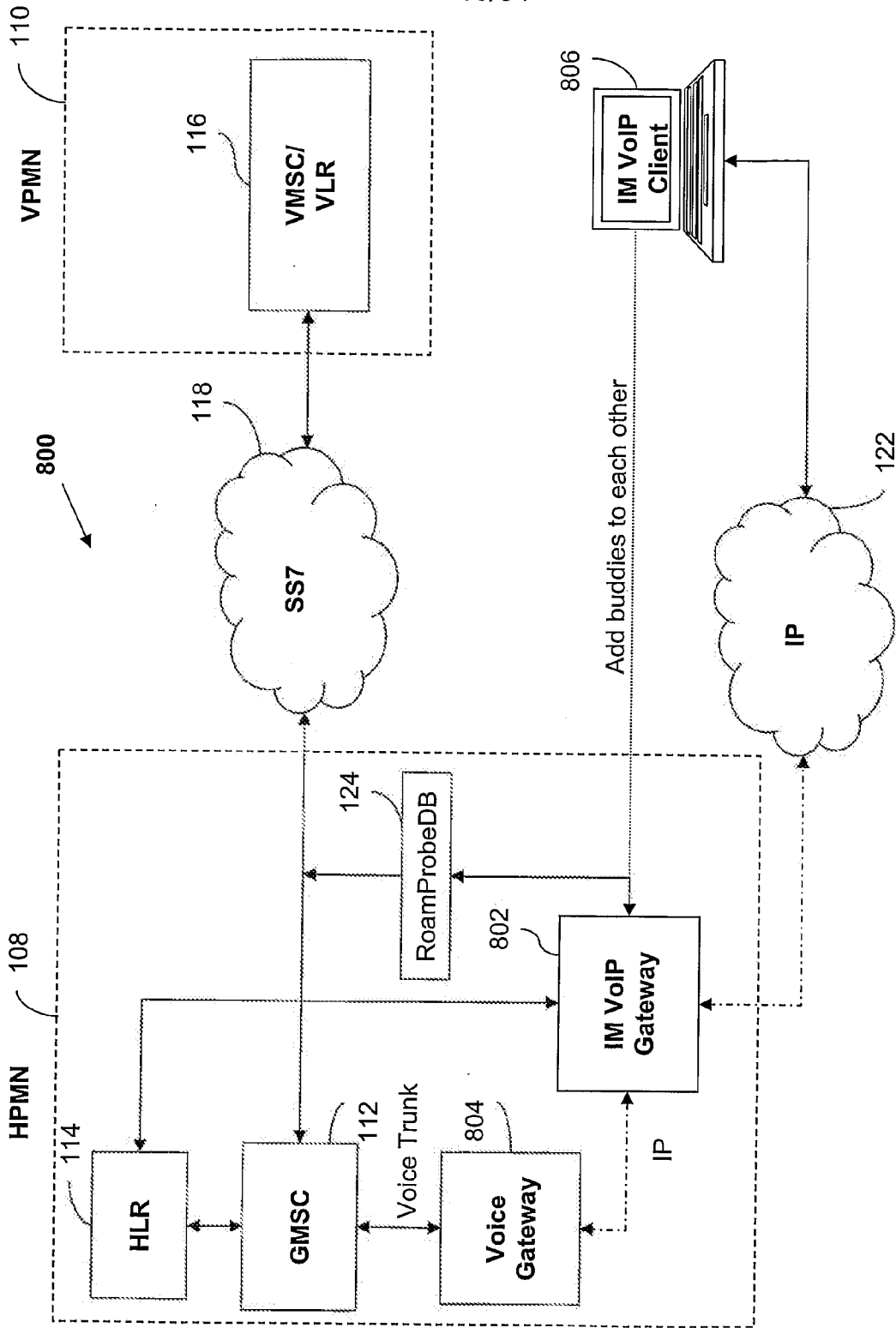


FIG. 8

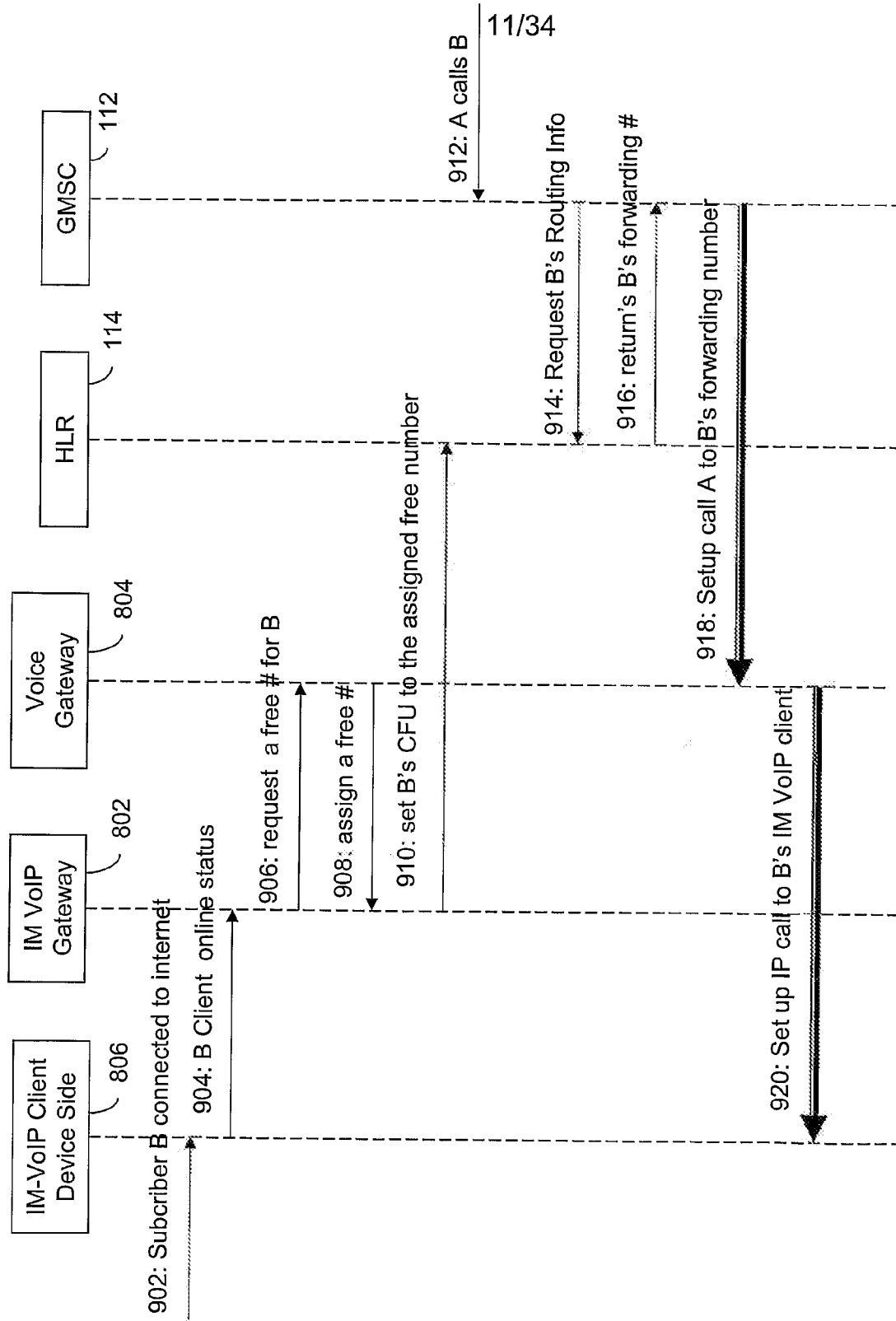


FIG. 9

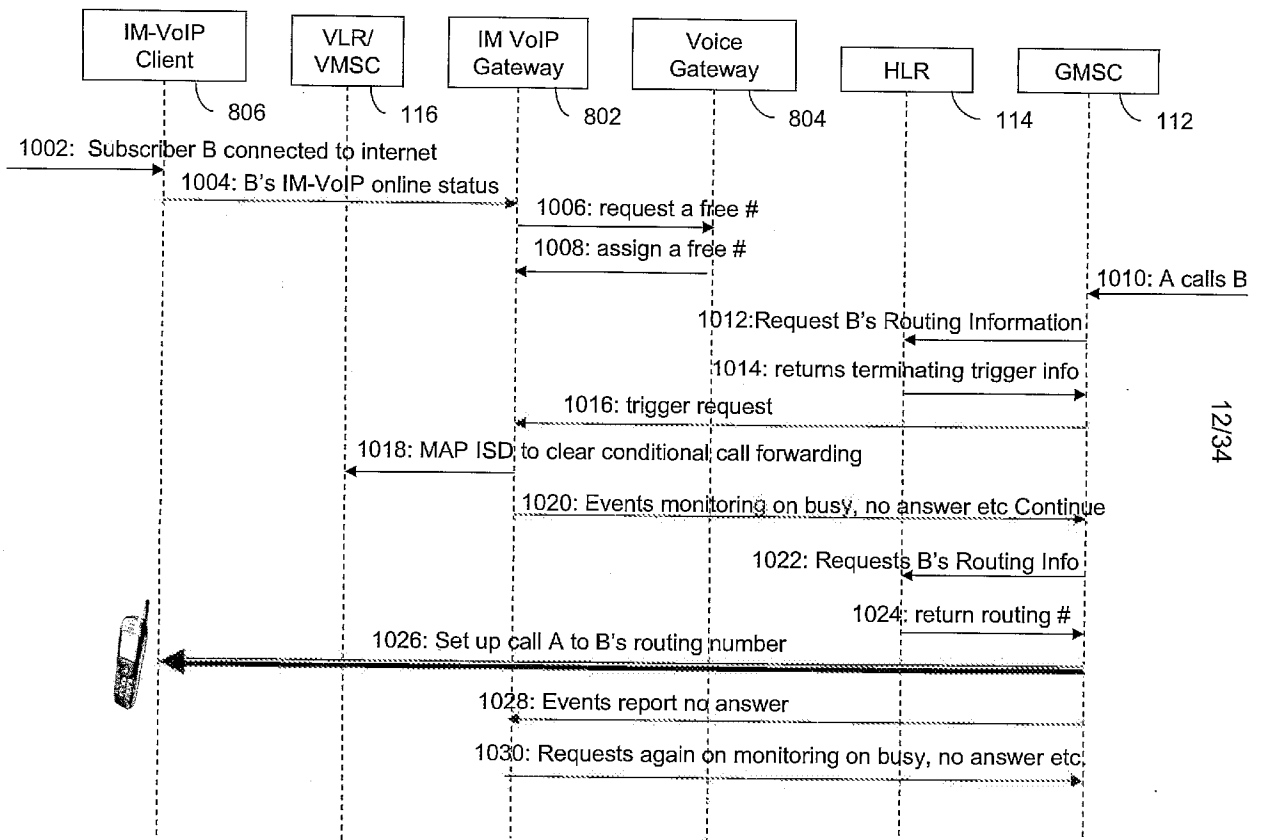


FIG. 10A

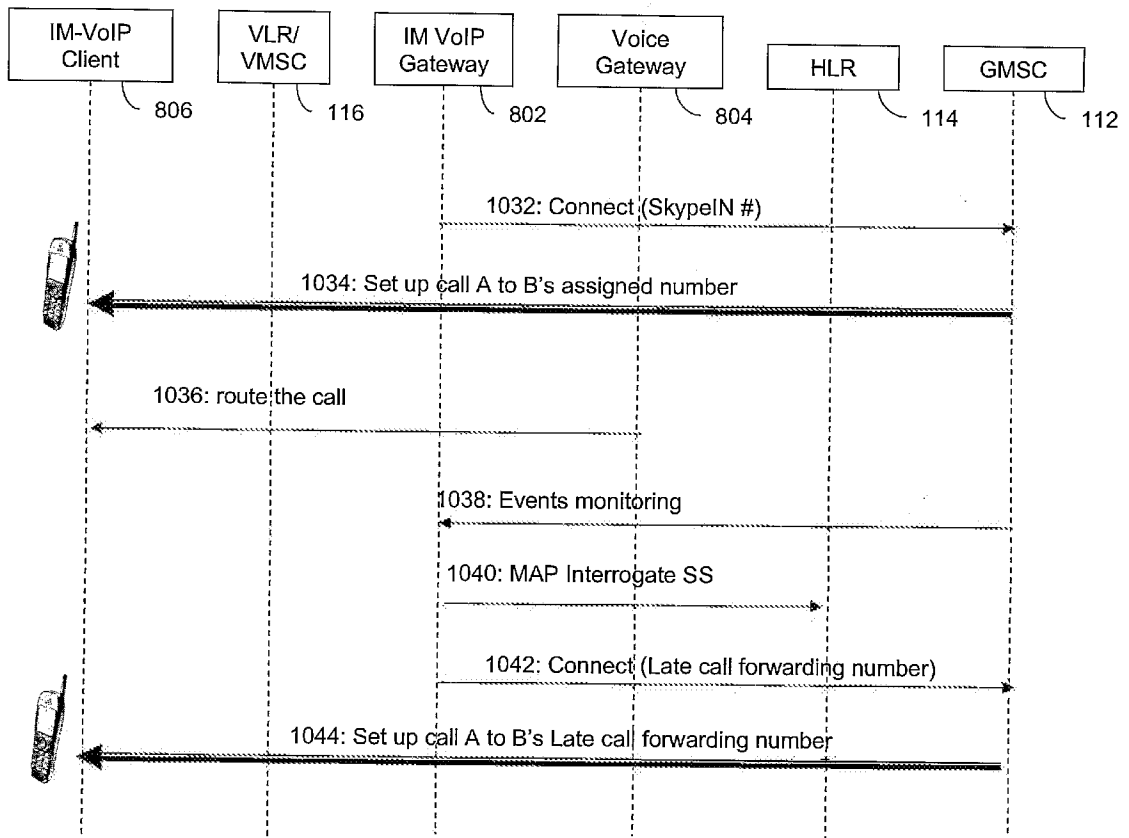


FIG. 10B

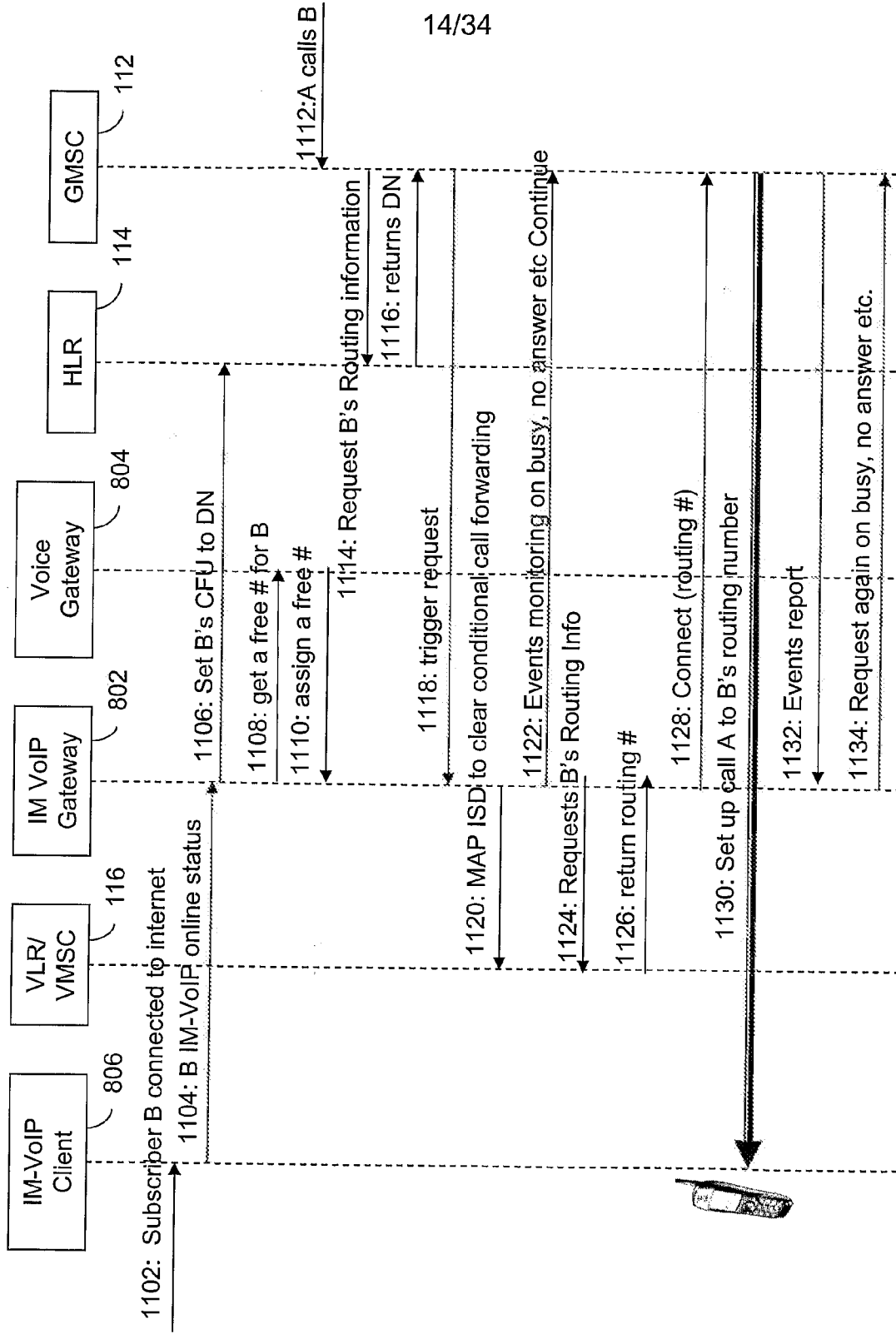


FIG. 11A

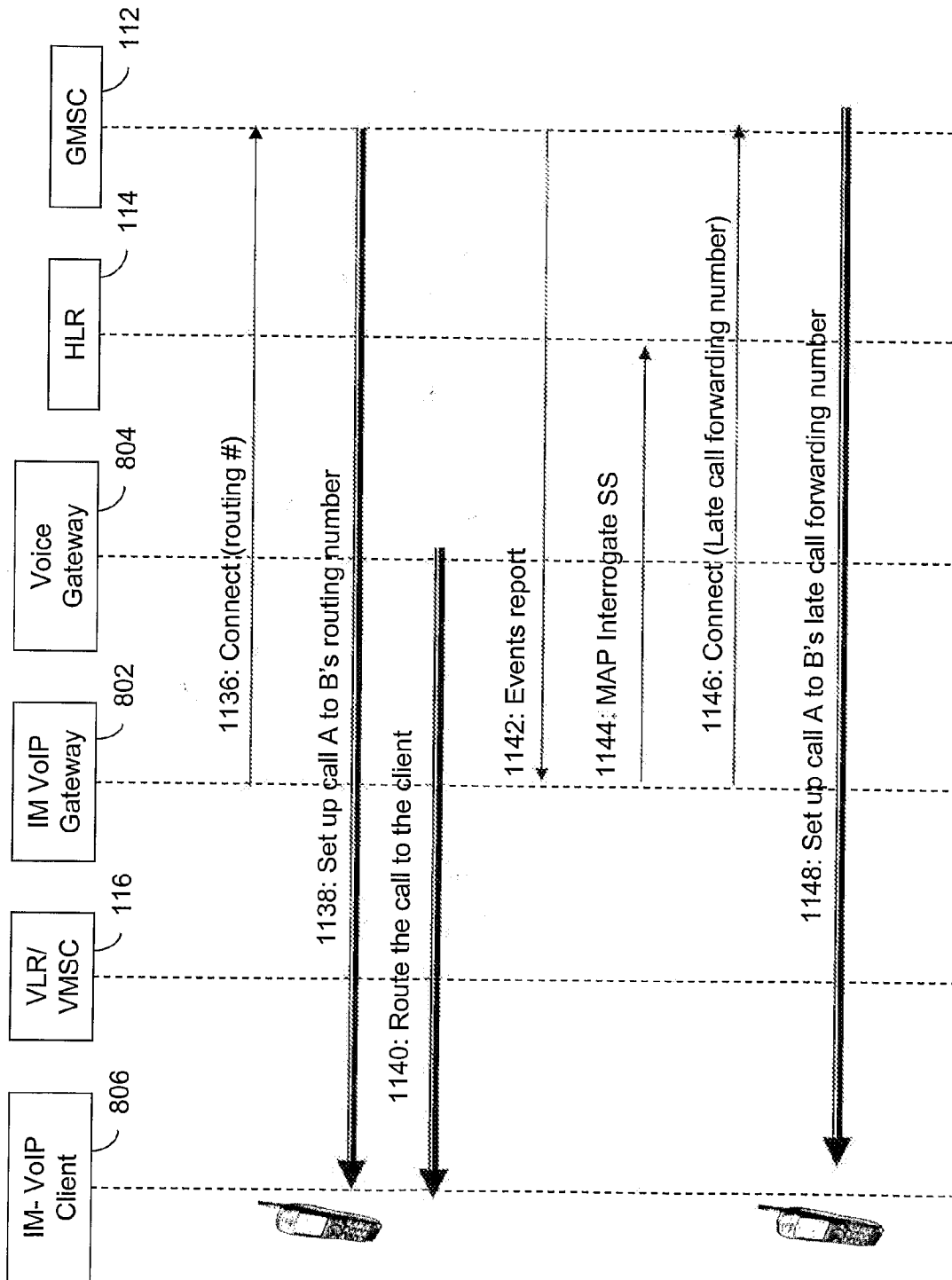


FIG. 11B

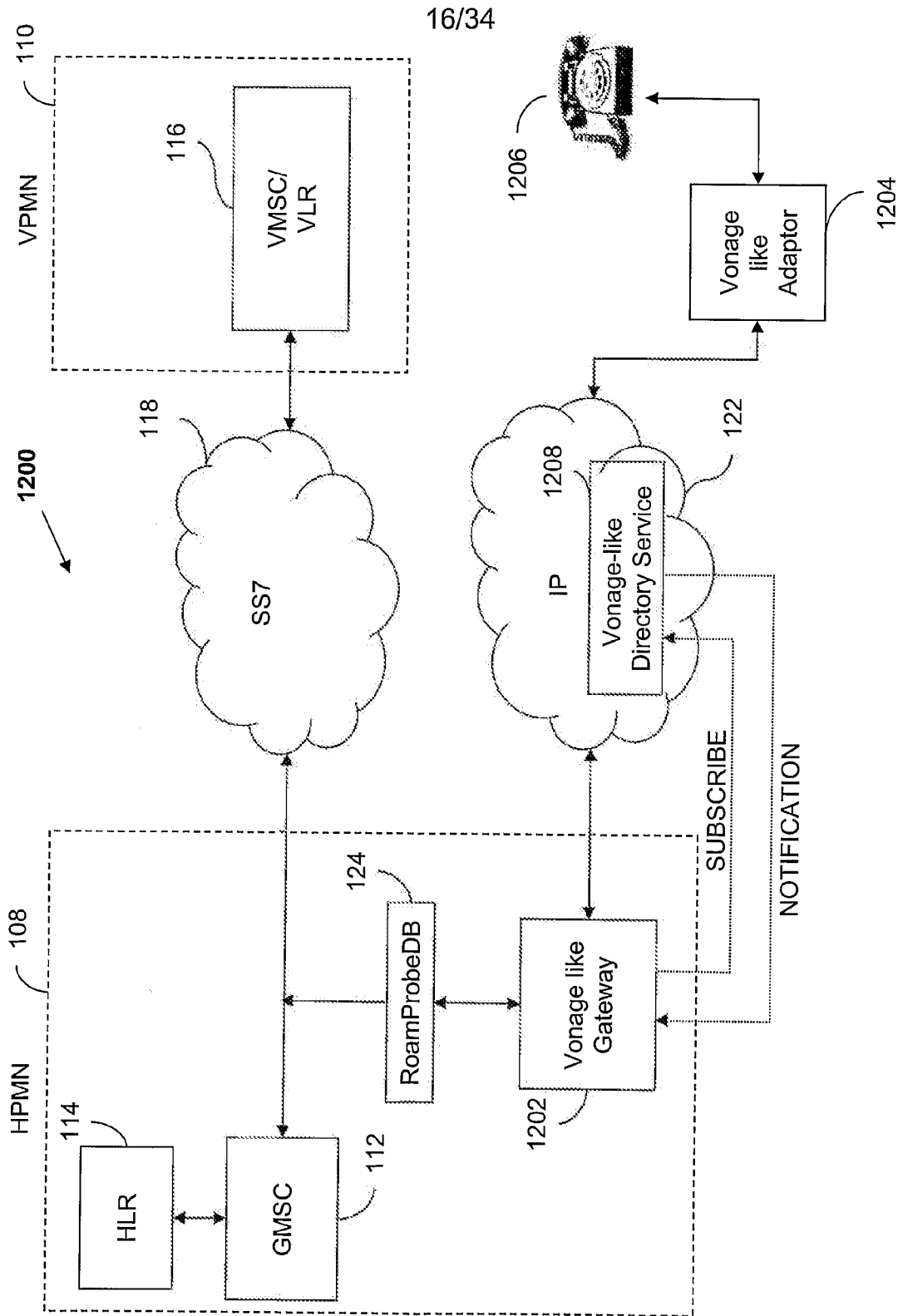


FIG. 12

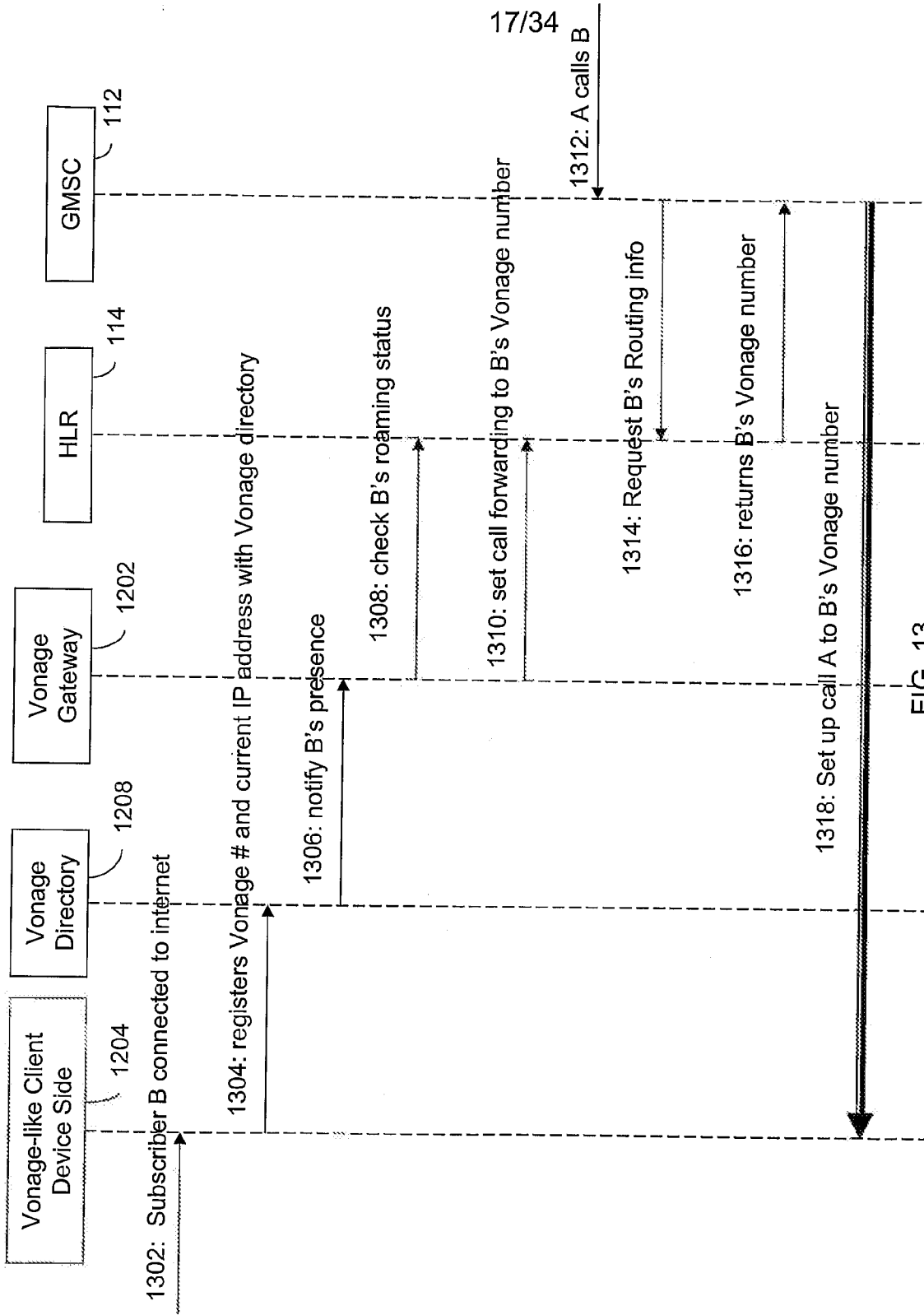


FIG. 13

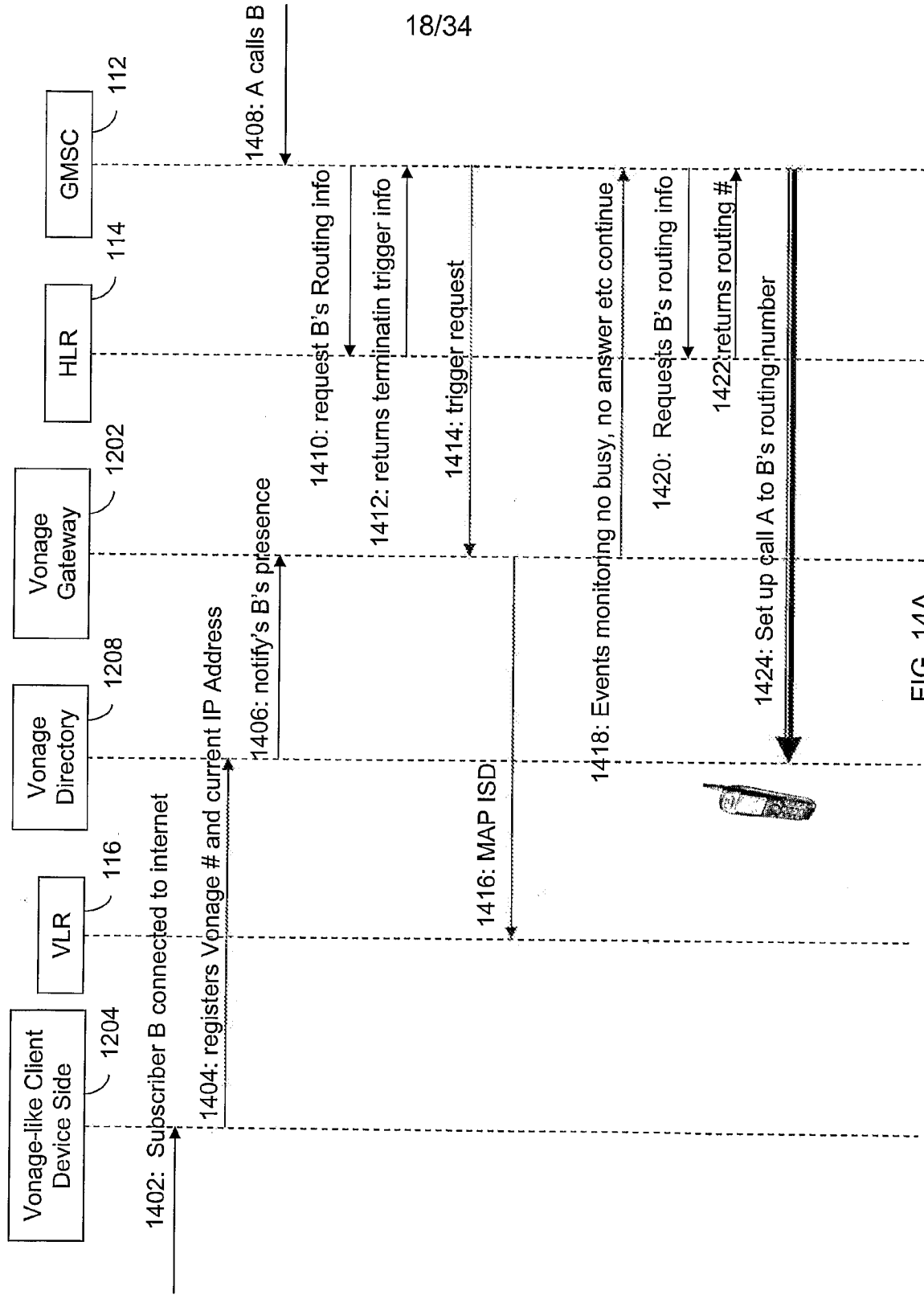


FIG. 14A

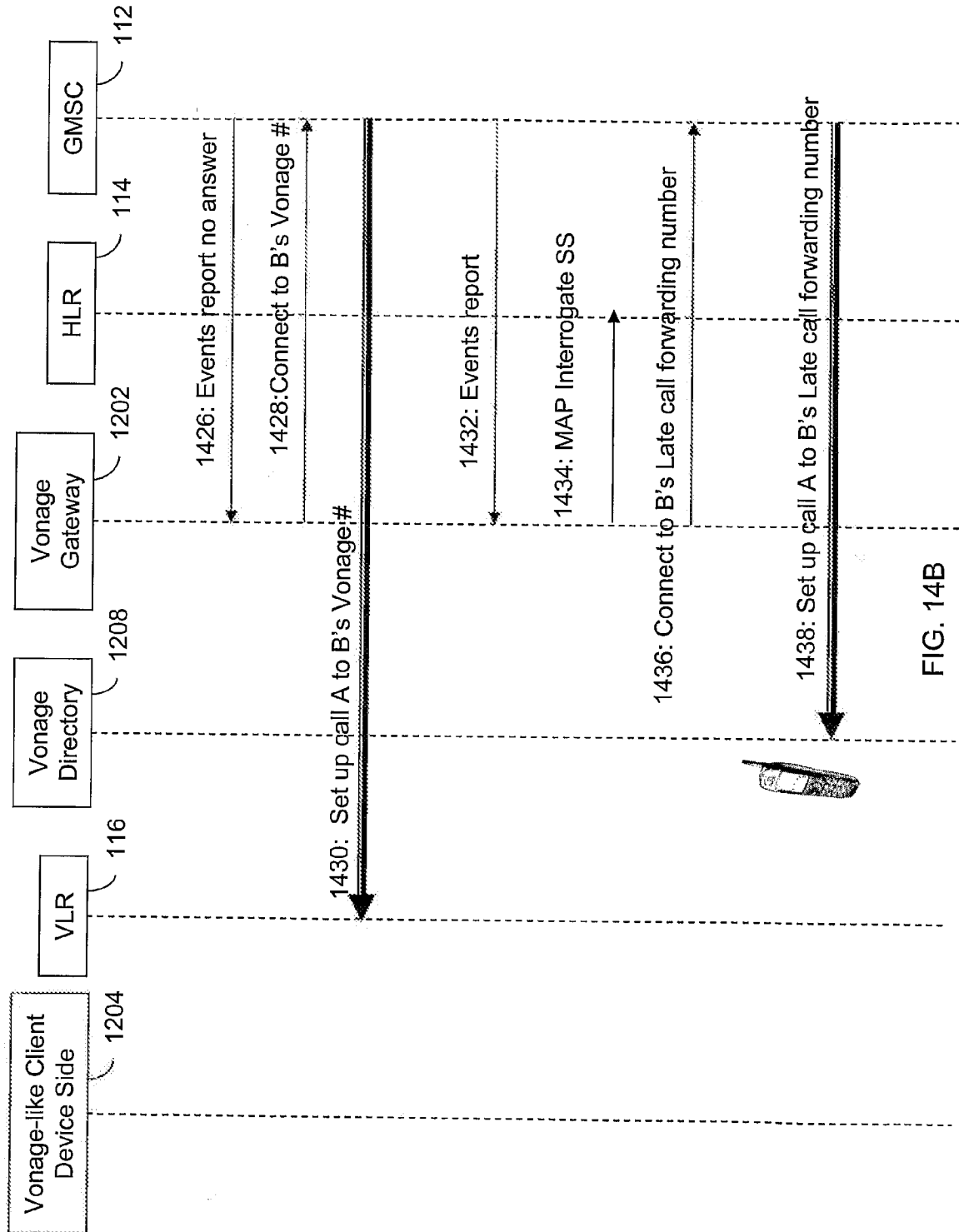
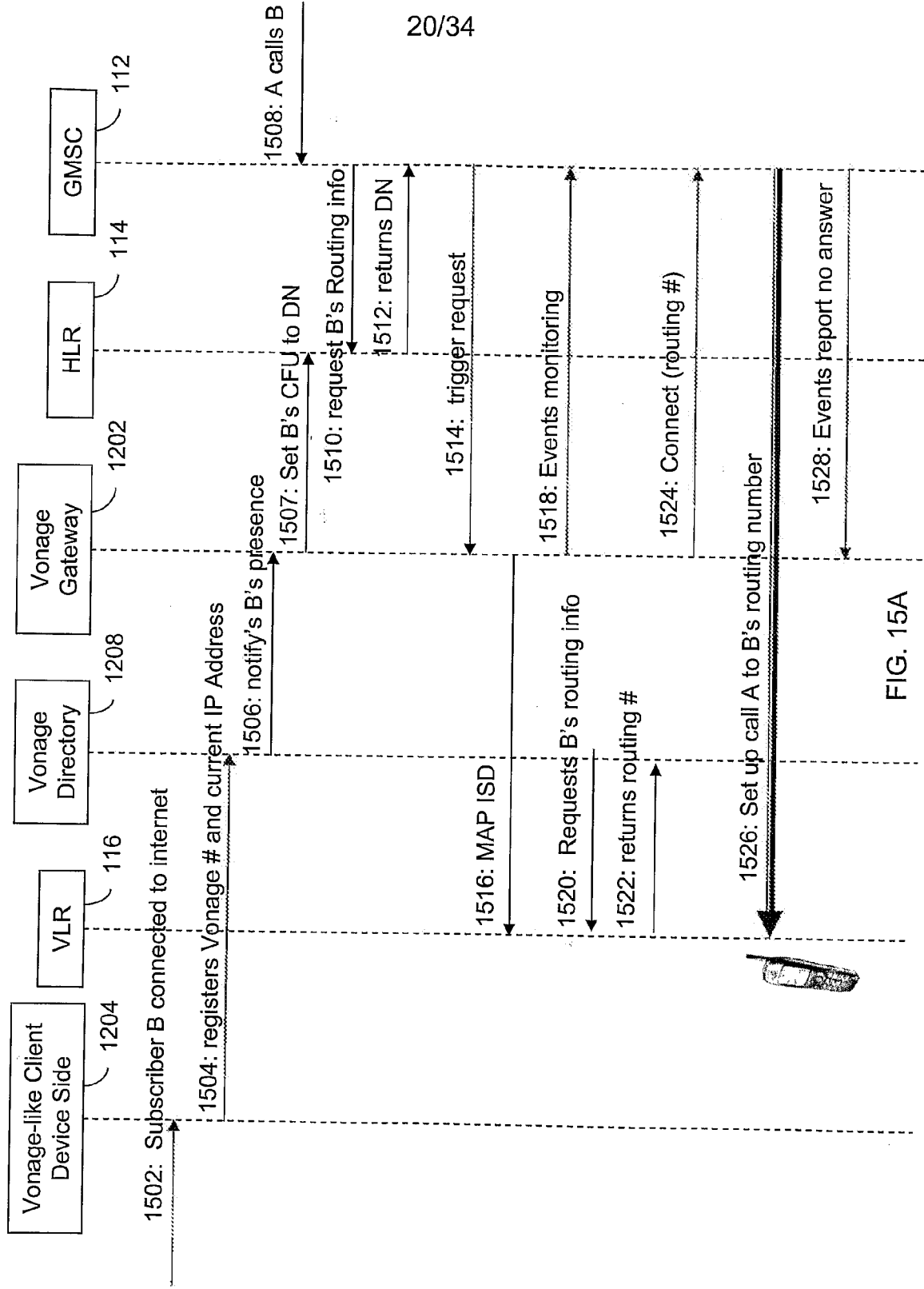


FIG. 14B



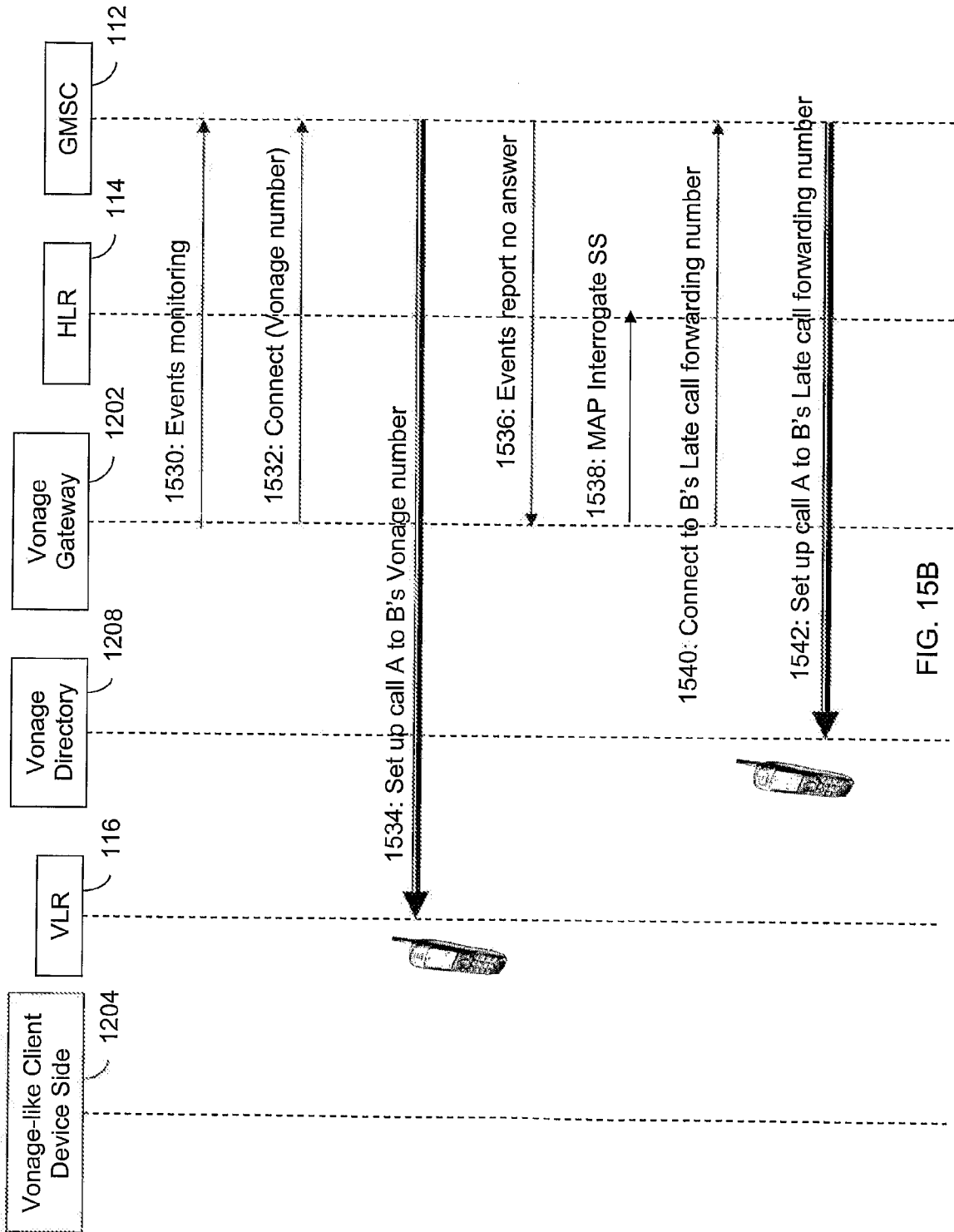


FIG. 15B

Skype-IN based ICVS for fixed line subscriber

1600

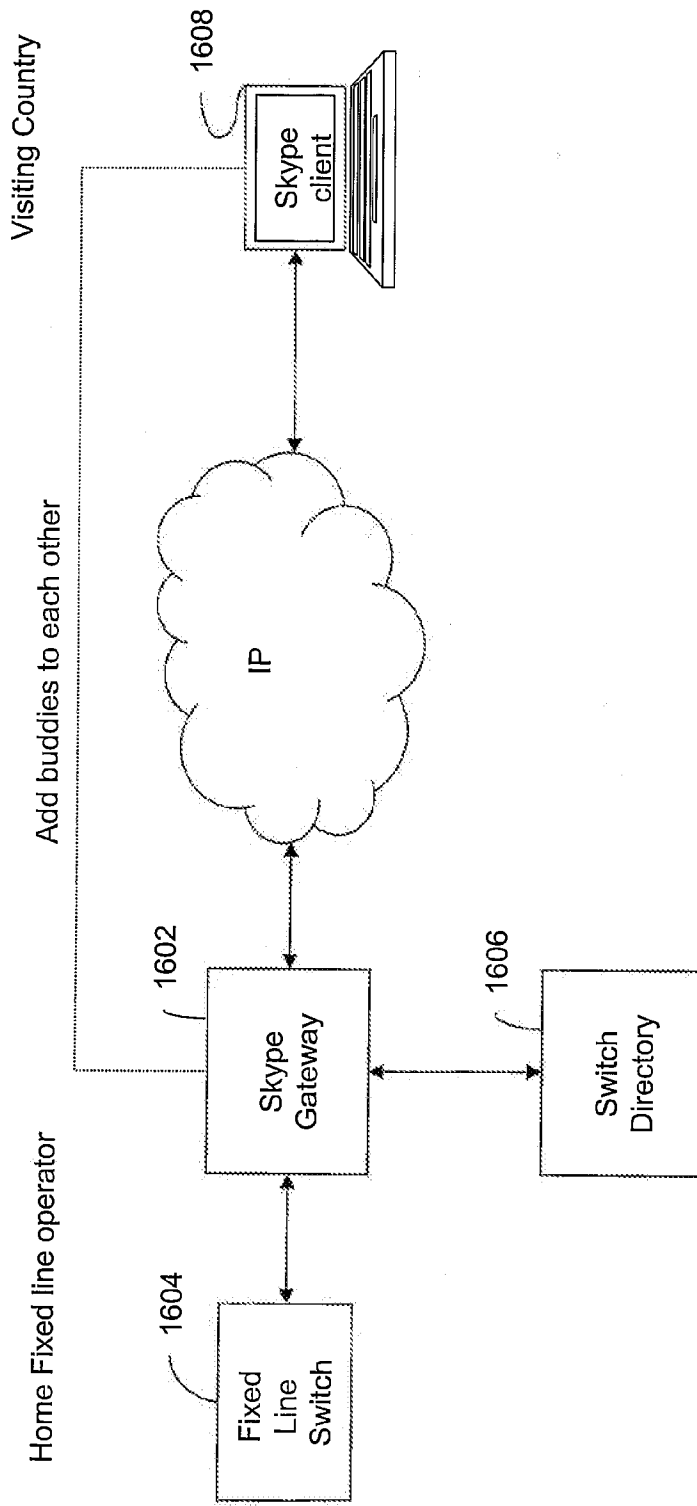


FIG. 16

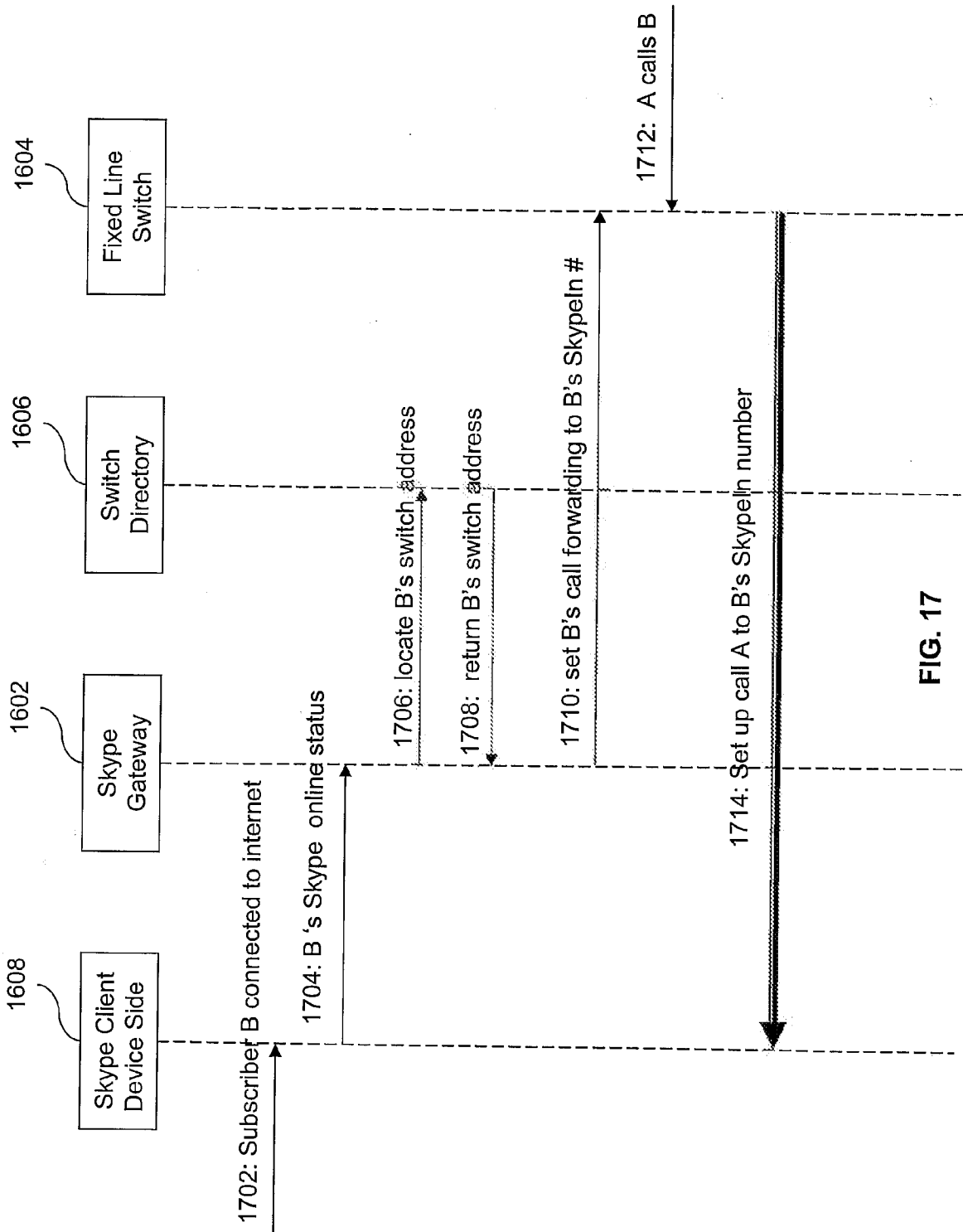


FIG. 17

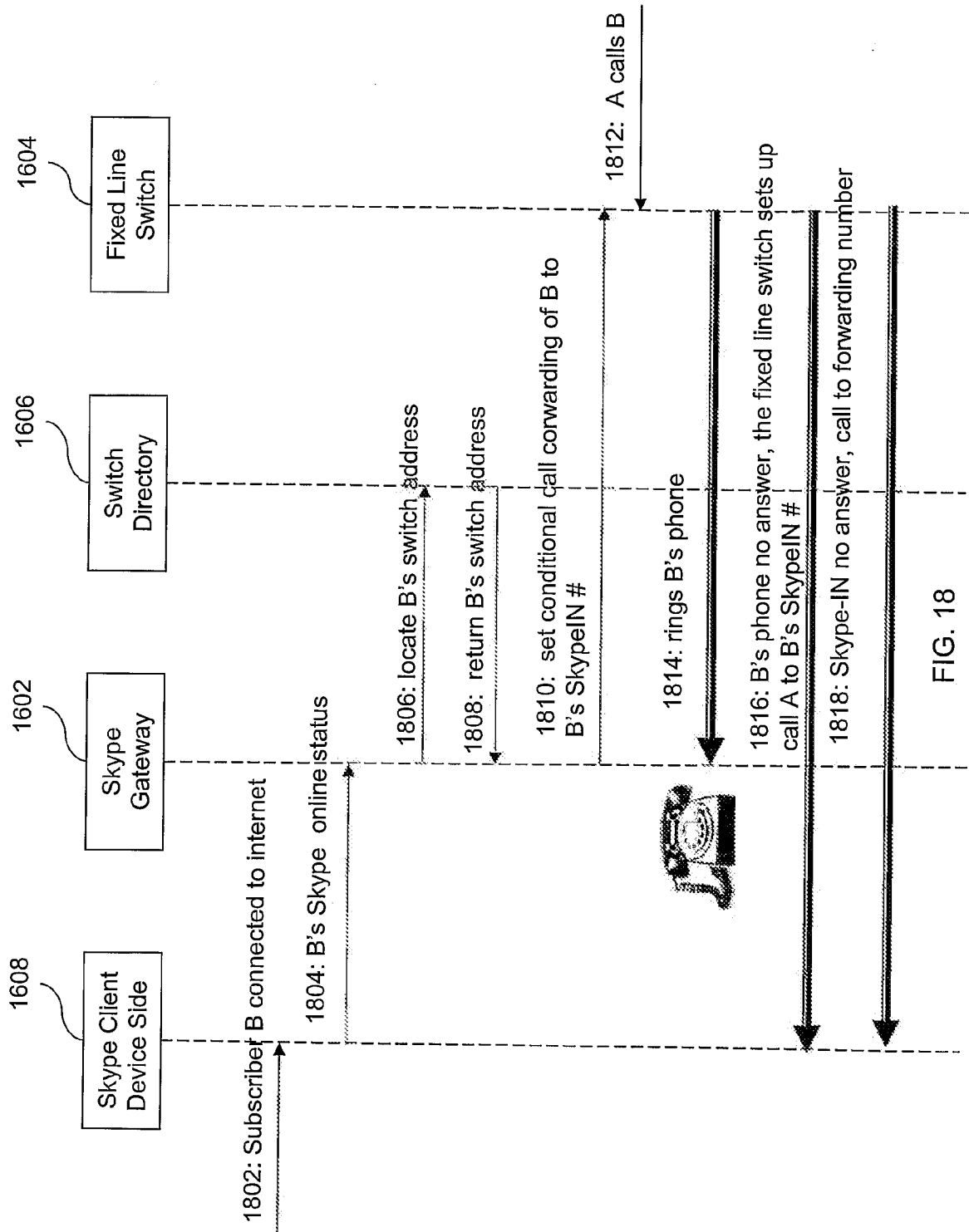


FIG. 18

IM-VoIP based ICVS for fixed line subscriber

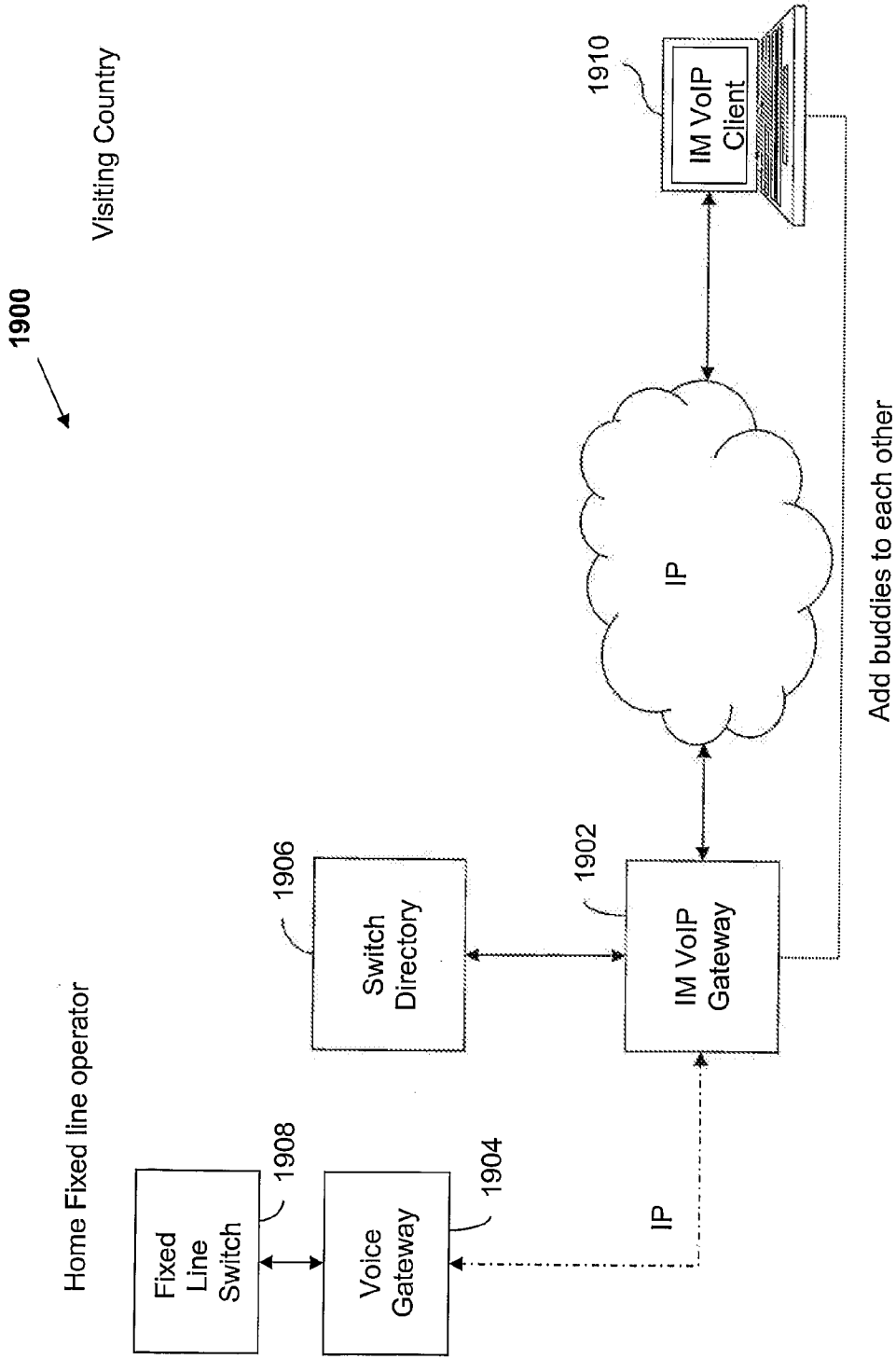


FIG. 19

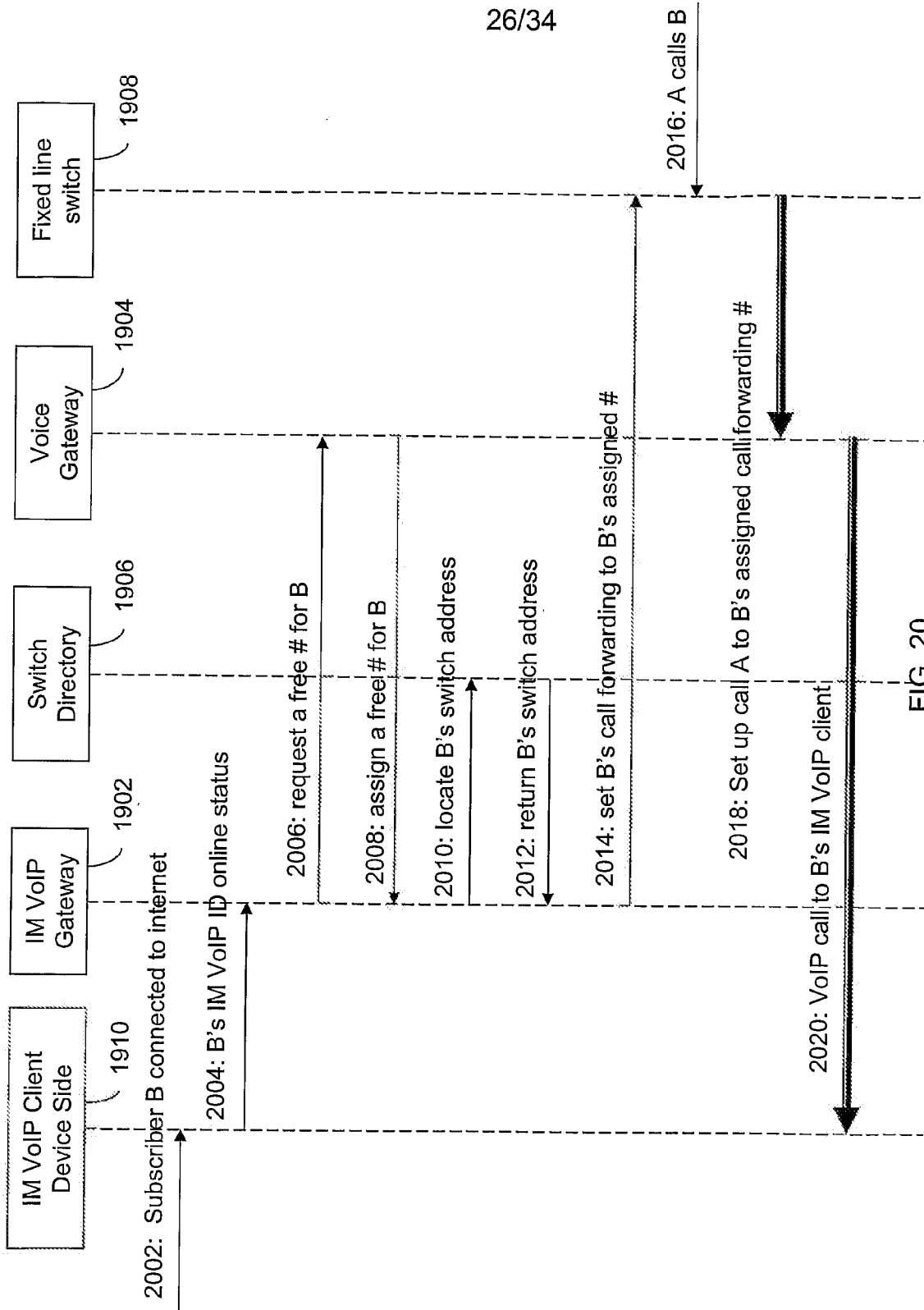


FIG. 20

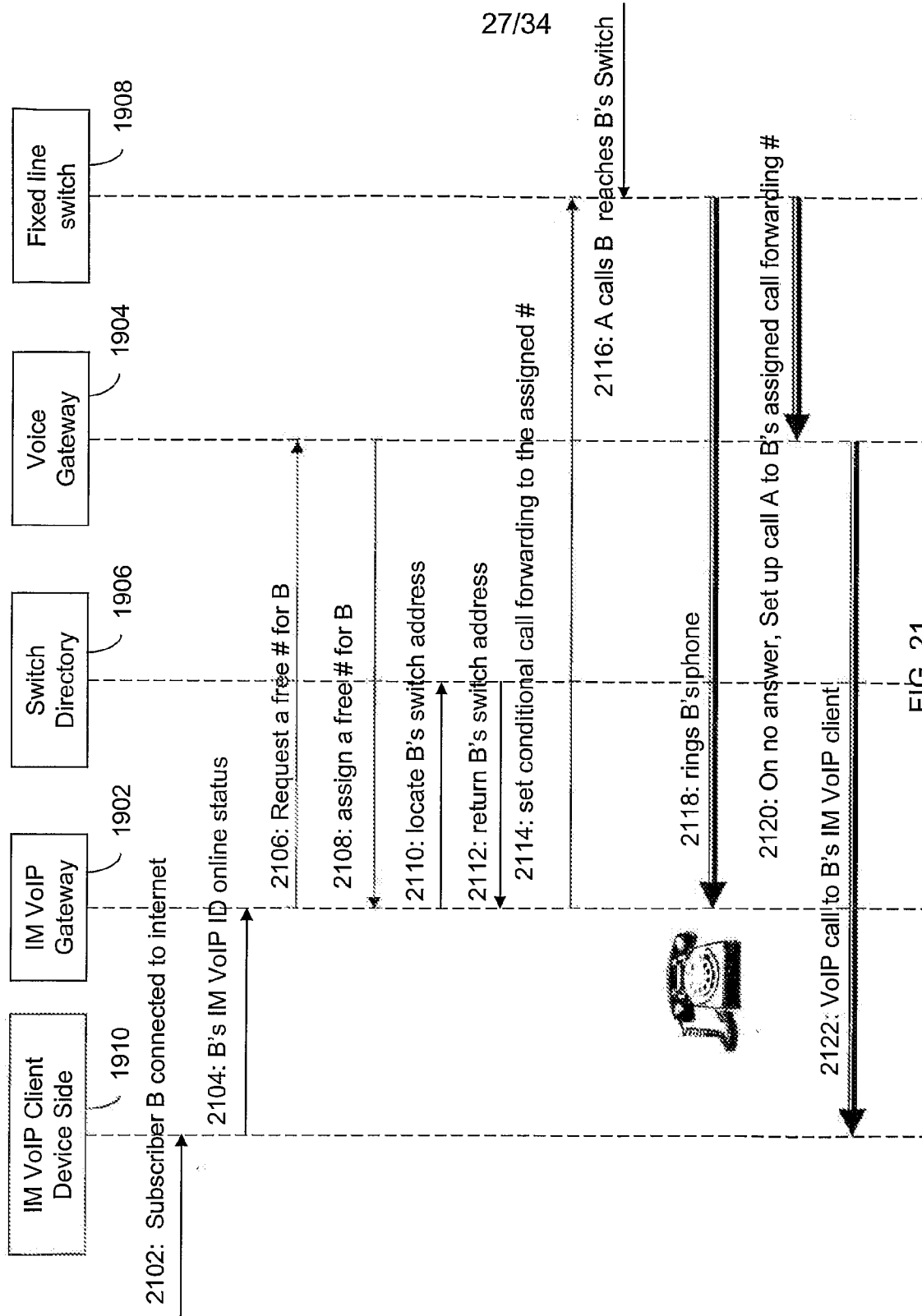


FIG. 21

Vonage based ICVS for fixed line subscriber

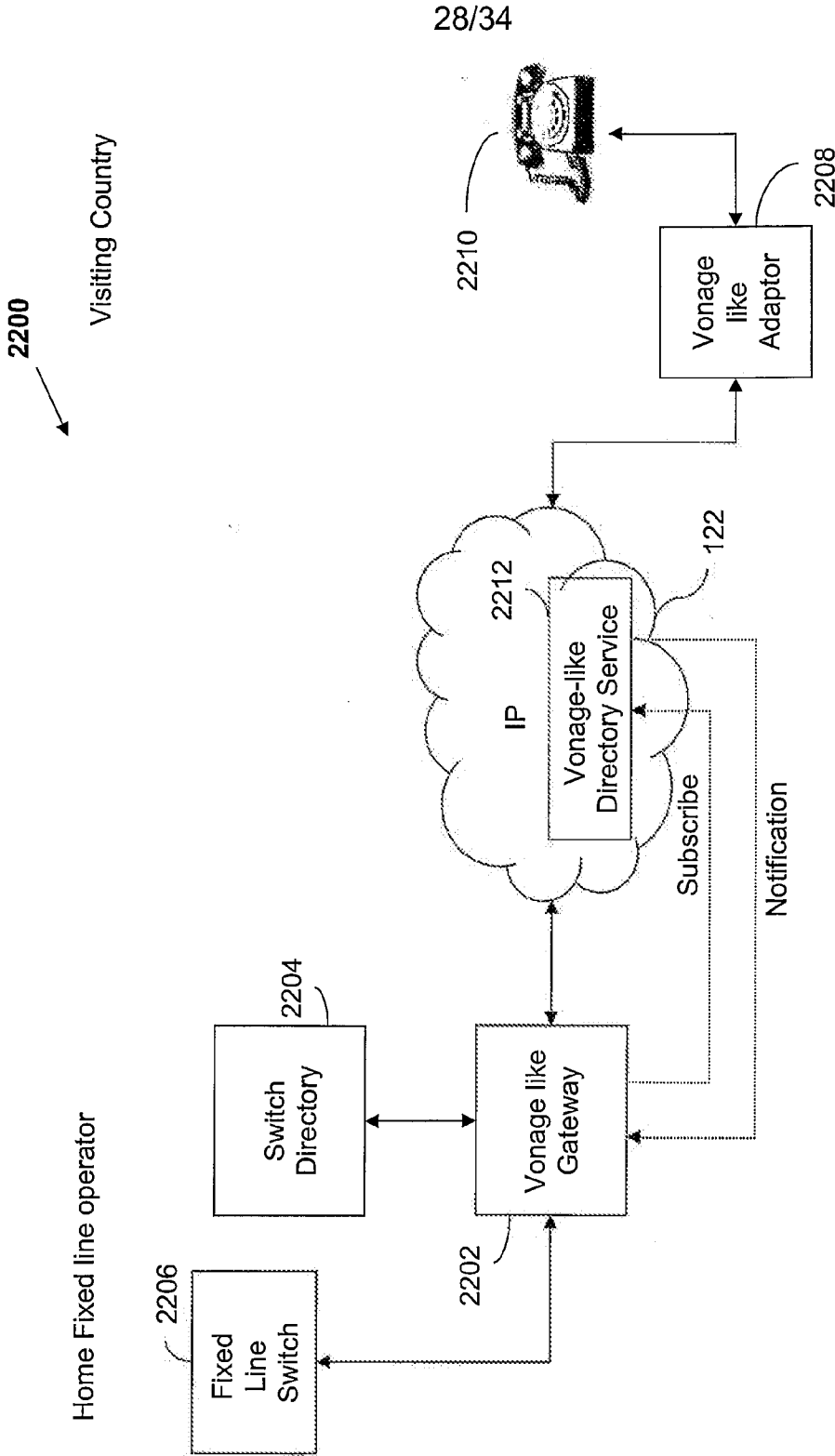
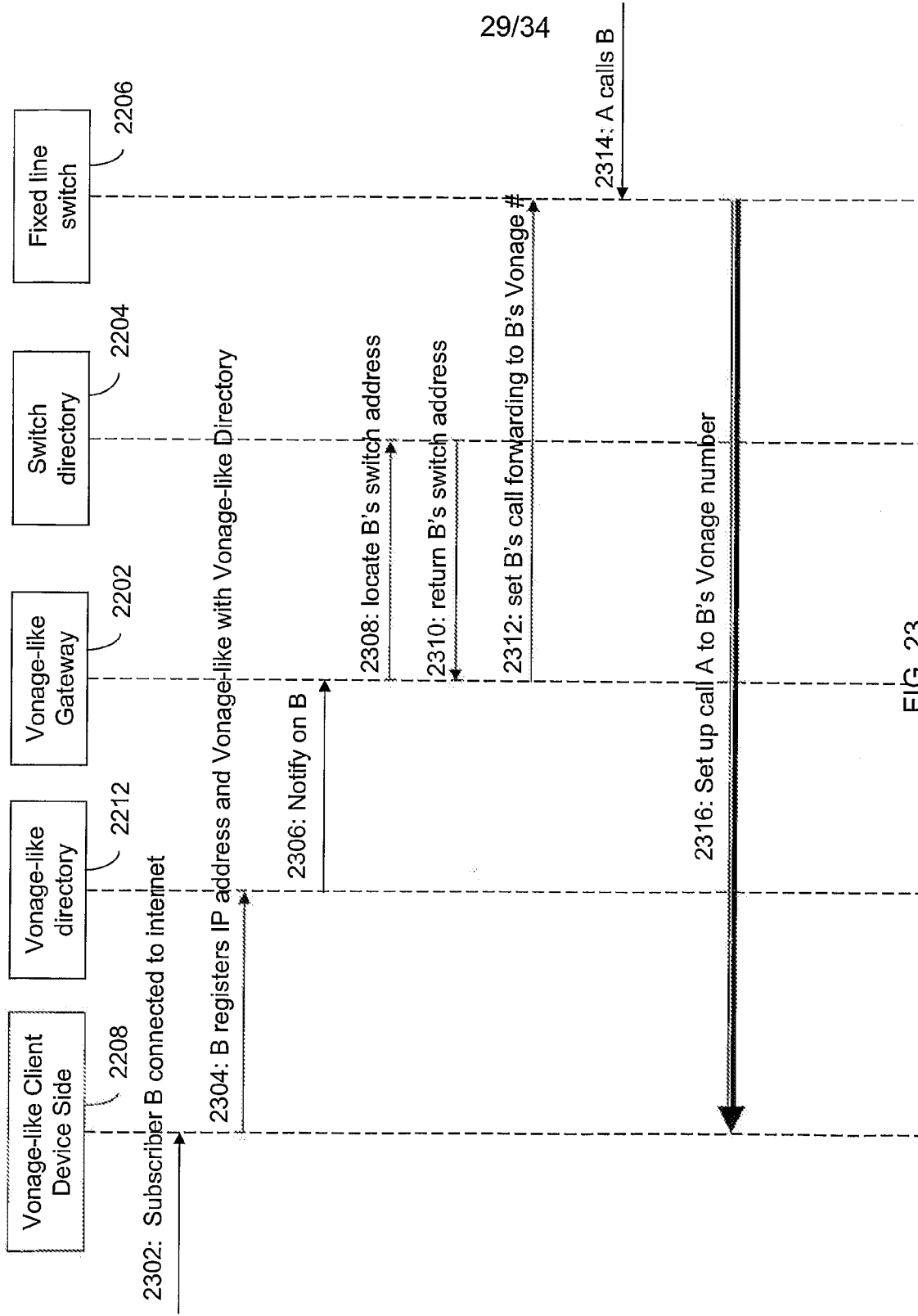


FIG. 22



29/34

FIG. 23

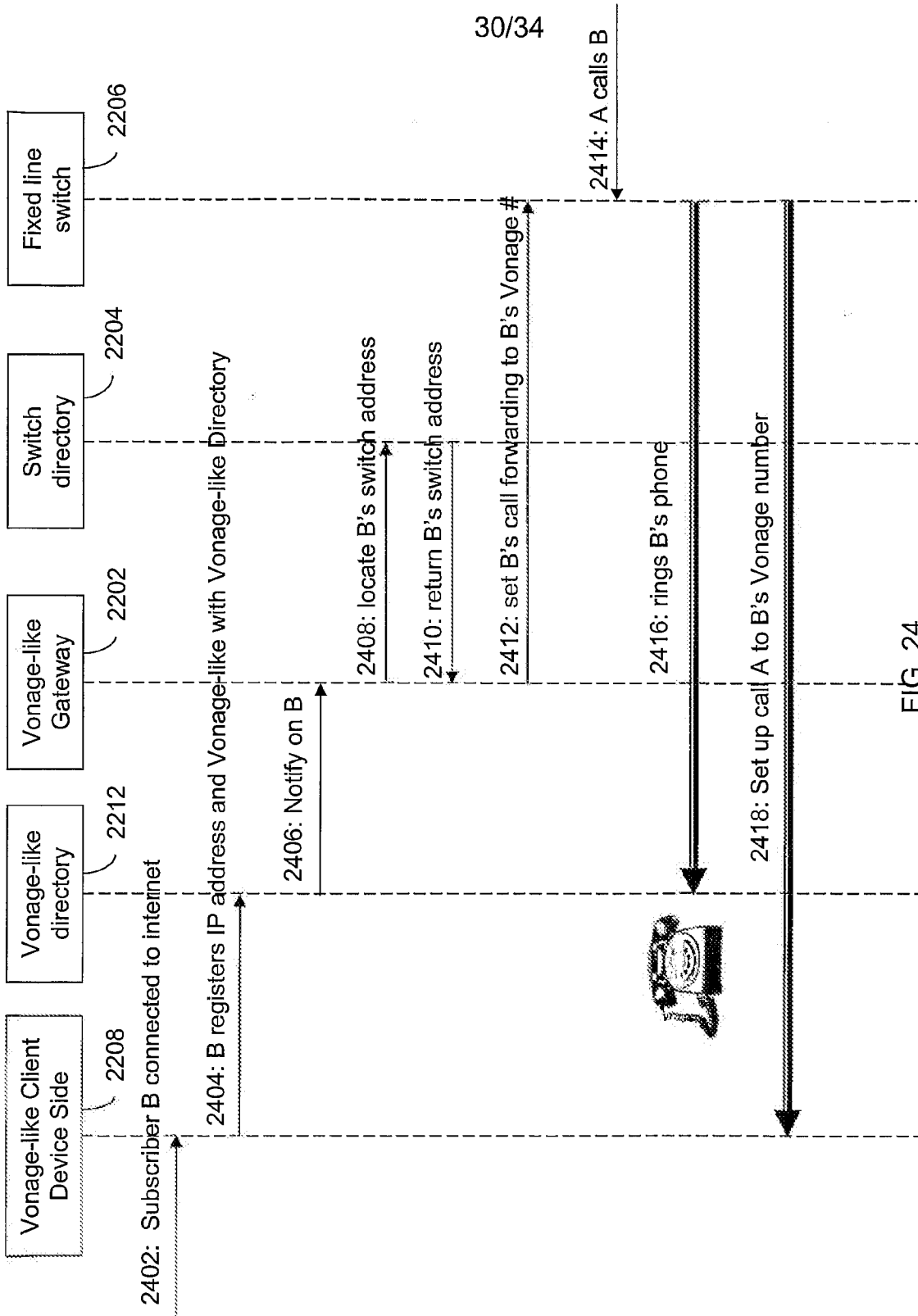


FIG. 24

Generic SIP/IMS based ICVS for both wireless and fixed line subscriber over an IP network for wireless and fixed line operators

2500

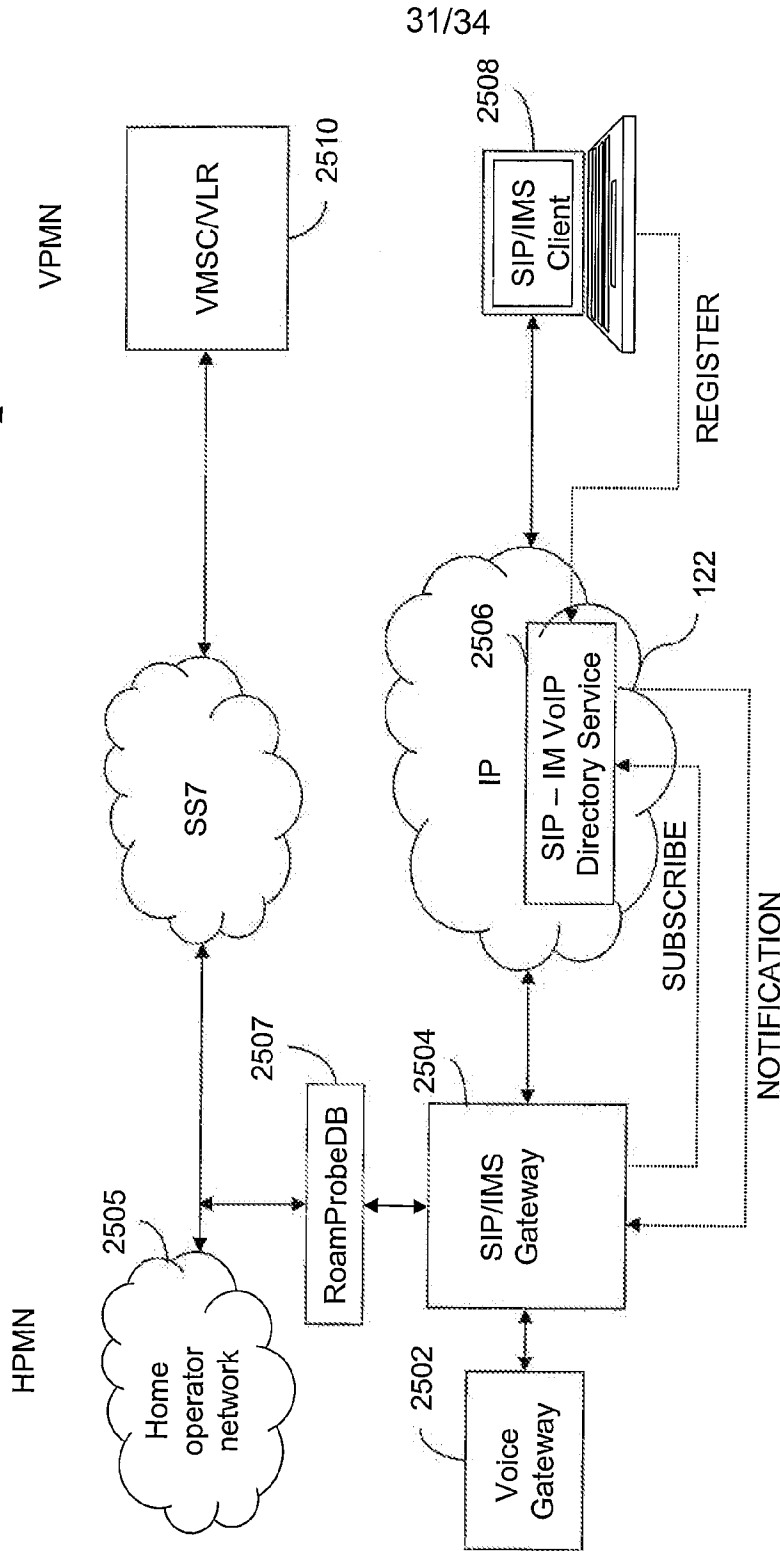


FIG. 25

31/34

HLR mobility notification

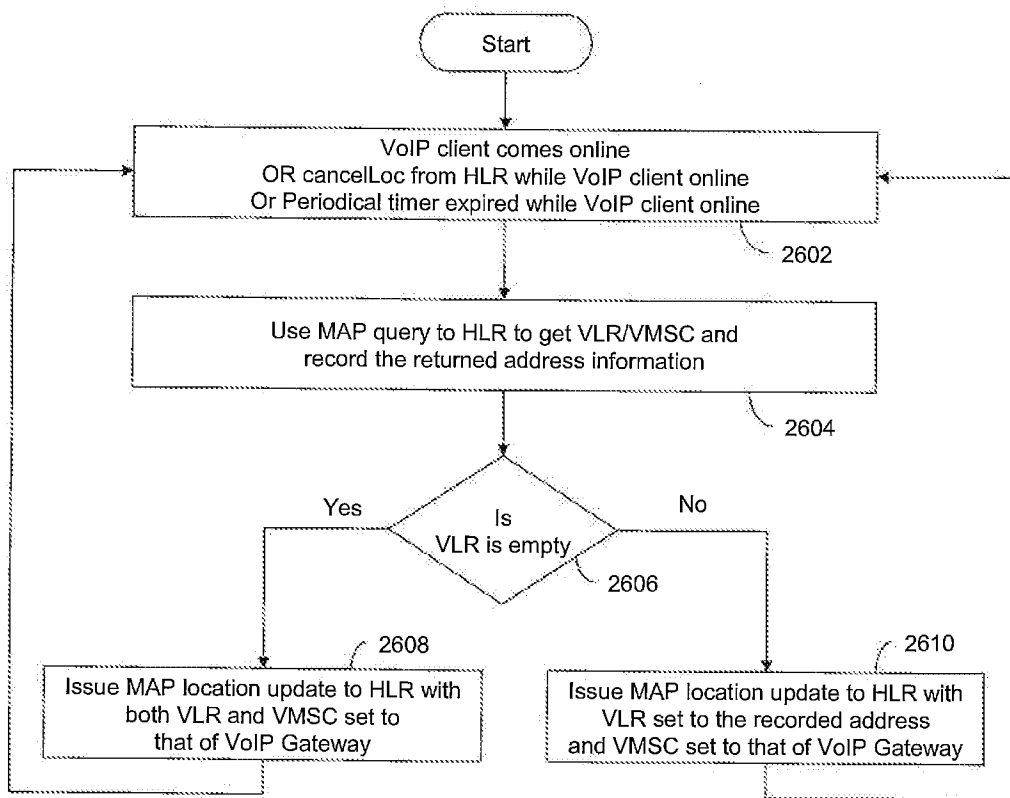


FIG. 26

Without HLR mobility notification

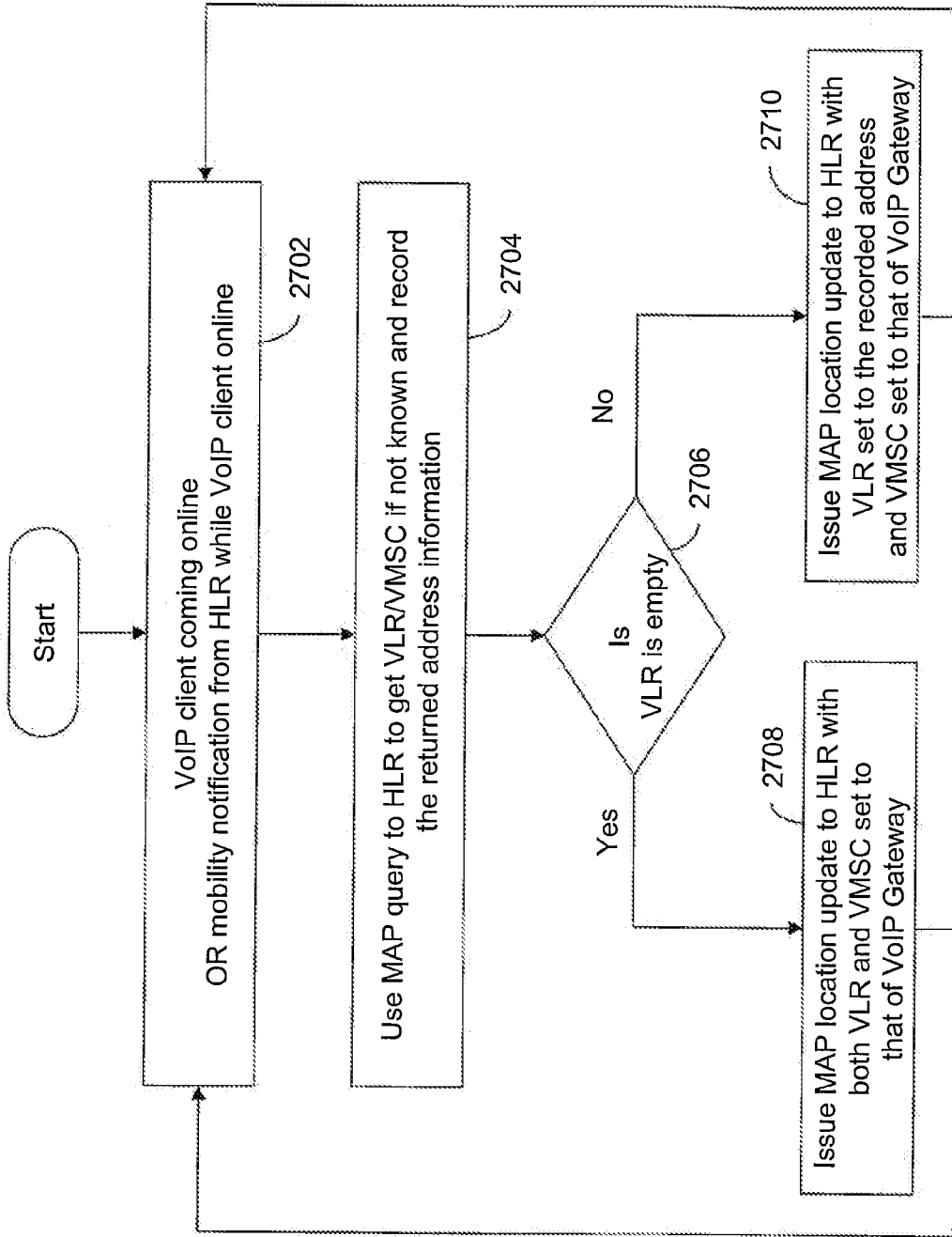


FIG. 27

ICV method

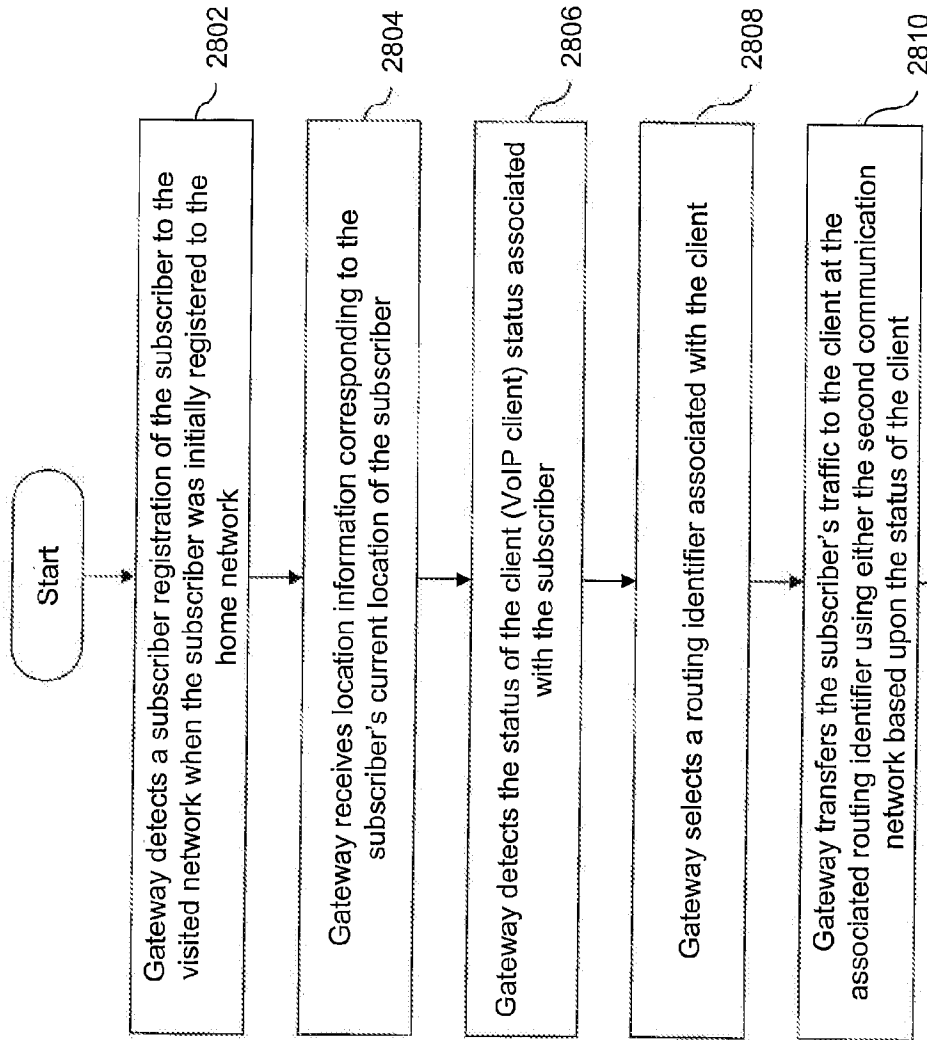


FIG. 28

(19) World Intellectual Property Organization
International Bureau



(43) International Publication Date
6 March 2008 (06.03.2008)

PCT

(10) International Publication Number
WO 2008/027065 A1

(51) International Patent Classification:
H04Q 7/20 (2006.01)

(74) Agent: CRALL, Adam, E.; SHUTTS & BOWEN LLP,
100 S. Ashley Drive, Suite 1500, Tampa, FL 33602 (US).

(21) International Application Number:
PCT/US2006/039482

(81) Designated States (unless otherwise indicated, for every kind of national protection available): AE, AG, AL, AM, AT, AU, AZ, BA, BB, BG, BR, BW, BY, BZ, CA, CH, CN, CO, CR, CU, CZ, DE, DK, DM, DZ, EC, EE, EG, ES, FI, GB, GD, GE, GH, GM, HN, HR, HU, ID, IL, IN, IS, JP, KE, KG, KM, KN, KP, KR, KZ, LA, LC, LK, LR, LS, LT, LU, LV, LY, MA, MD, MG, MK, MN, MW, MX, MY, MZ, NA, NG, NI, NO, NZ, OM, PG, PH, PL, PT, RO, RS, RU, SC, SD, SE, SG, SK, SI, SM, SV, SY, TJ, TM, TN, TR, TT, TZ, UA, UG, US, UZ, VC, VN, ZA, ZM, ZW.

(22) International Filing Date: 10 October 2006 (10.10.2006)

(25) Filing Language: English

(26) Publication Language: English

(30) Priority Data:
11/513,529 31 August 2006 (31.08.2006) US

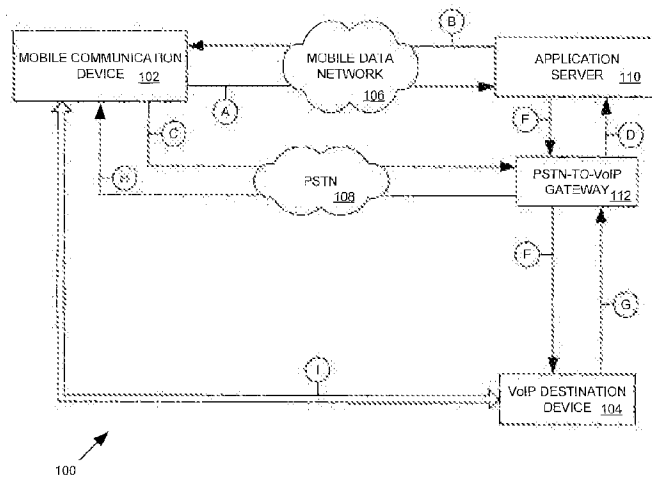
(84) Designated States (unless otherwise indicated, for every kind of regional protection available): ARIPO (BW, GII, GM, KE, LS, MW, MZ, NA, SD, SL, SZ, TZ, UG, ZM, ZW), Eurasian (AM, AZ, BY, KG, KZ, MD, RU, TJ, TM), European (AT, BE, BG, CH, CY, CZ, DE, DK, EE, ES, FI, FR, GB, GR, HU, IE, IS, IT, LT, LU, LV, MC, NL, PL, PT, RO, SE, SI, SK, TR), OAPI (BF, BJ, CF, CG, CI, CM, GA, GN, GQ, GW, ML, MR, NE, SN, TD, TG).

(71) Applicant (for all designated States except US): SYNERGISE TECHNOLOGIES, INC. [US/US]; 8125 Ihighwoods Palm Way, Tampa, FL 33647-1765 (US).

Published:
— with international search report

(72) Inventors: ALBINA, Troy, J.; 15909 Price William Place, Odessa, FL 33556 (US). DRUECKHAMMER, Carl; 2315 Marseille Court, Valrico, FL 33594 (US). HAMMER, Kenneth, W.; 617 Chancellor Drive, Lutz, FL 33548 (US).

(54) Title: CELLULAR-TO-VOIP CALL ESTABLISHMENT SYSTEMS, METHODS, DEVICES, AND COMPUTER SOFTWARE



(57) Abstract: A method for establishing a VoIP media session between an originating cellular telephone and a VoIP destination device. One such method comprises receiving a first data message from an originating cellular telephone, the first data message comprising an identifier associated with a VoIP destination device, sending a second data message to the originating cellular telephone, the second data message comprising information identifying a temporary directory number (TDN) associated with the VoIP destination device, detecting an incoming voice call to the TDN from the originating cellular telephone, sending an invite message to the identifier associated with the VoIP destination device, sending a ringing indication to the originating cellular telephone, receiving an accept reply from the VoIP destination device, and answering the incoming voice call from the cellular telephone and establishing a VoIP media session between the originating cellular telephone and the VoIP destination device.

WO 2008/027065 A1

**CELLULAR-TO-VOIP CALL ESTABLISHMENT SYSTEMS,
METHODS, DEVICES, AND COMPUTER SOFTWARE**

BACKGROUND

[0001] The telecommunication industry is replacing old business models dictated by the public switched telephone network (PSTN) with Internet technologies, next generation networks, and new interconnect business models. Examples of this shift include the rapid deployment of voice over Internet protocol (VoIP) services, and the migration toward Internet protocol multimedia subsystems (IMS). In general, IMS services are implemented using a blended architecture of Internet technologies and wireless network capabilities to enable creation of new services within and across different wireless and wireline networks.

[0002] Currently, there are a number of telecommunication systems, methods, and services which integrate cellular and VoIP services. For example, U.S. Patent Application Nos. 2004/0240430, 2005/0096024, 2005/0129069, 2005/0117566, 2005/0186960, 2005/0147049, 2005/0152343, 2001/0015968 and U.S. Patent Nos. 6,385,195 and 6,611,516 (each of which are hereby incorporated by reference in their entirety) disclose systems for switching between a cellular service and a VoIP service. Other known cellular-to-VoIP systems (e.g., U.S. Patent Application No. 2004/0240430, which is hereby incorporated by reference in its entirety) employ a PSTN-to-VoIP gateway which interfaces with the cellular telephone via a cellular wireless network and interfaces with the VoIP destination device via a VoIP network. The PSTN-to-VoIP gateway exchanges messages, call signaling, and audio media with the cellular telephone and the VoIP destination device to enable the cellular telephone to roam from the cellular wireless network to the VoIP network. U.S. Patent Application Nos. 2005/0096024, 2005/0129069, 2005/0117566, 2005/0186960, 2005/0147049, 2005/0152343, 2001/0015968 and U.S. Patent Nos. 6,385,195 and 6,611,516 (each of which are hereby incorporated by

reference in their entirety) disclose additional telecommunication systems and methods which employ a PSTN-to-VoIP gateway for transitioning between a cellular service and VoIP service.

[0003] There are various existing commercial solutions for establishing a voice session from a cellular telephone to a VoIP destination device over the PSTN. One such solution uses a telephone number which is permanently assigned to a VoIP destination device. A cellular service subscriber enters the telephone number assigned to the VoIP destination device into their cellular telephone. The cellular telephone originates a voice call to the entered telephone number, which terminates at a PSTN-to-VoIP gateway. The gateway detects the called telephone number for the incoming call and sends an SIP INVITE message to the SIP URI permanently assigned to that telephone number. The VoIP destination device sends a SIP "ringing" reply to the gateway. The gateway sends a "ringing" indication to the cellular telephone. The VoIP destination device sends a SIP "success" reply to the gateway, if the session invitation is accepted (i.e., the "call" is answered). The gateway "answers" the incoming call from the cellular telephone and bridges the PSTN circuit to a VoIP media session with the VoIP destination device.

[0004] Another existing commercial solution, referred to as the iSkoot™ service, establishes a voice session between a cellular telephone and a VoIP destination device using the following process. The cellular telephone sends a text message or an e-mail (containing the cellular telephone number and the VoIP destination) to a PSTN-to-VoIP gateway. The PSTN-to-VoIP gateway originates a PSTN call to the cellular telephone number. The cellular telephone answers the incoming call from the PSTN-to-VoIP gateway. The PSTN-to-VoIP gateway sends a SIP INVITE message to VoIP destination. If the VoIP destination device is available and session invitation is accepted (i.e., the call is answered), a SIP "success" reply is

sent to the PSTN-to-VoIP gateway. Then the PSTN-to-VoIP gateway bridges the PSTN call to the cellular telephone with the VoIP media session to the VoIP destination device.

[0005] Another commercial solution offered by Skype implements a peer-to-peer internet telephony software application. The software application enables peer-to-peer or computer-to-computer VoIP calls. The Skype™ service also offers a hosted, fee-based service, referred to as SkypeOut™, which allows computer users to initiate calls to non-computer-based landline or cellular telephones from a desktop application. Another hosted, fee-based service, SkypeIn™, allows computer users to receive incoming calls from non-computer-based landline or cellular telephones on their computer.

[0006] Another solution currently provided by EQO Communications (referred to as EQO Mobile Internet Phone Service for Skype™) enables mobile phone users to initiate VoIP calls from their mobile phone. The EQO software application on the mobile phone enables users to select Skype™ users from a buddy list. After the user selects the Skype destination, the software application sends an SMS to a personal computer configured with the Skype software. The PC initiates a Skype session to the VoIP destination. The PC calls the originating mobile phone number, and then the PC bridges the call to the VoIP destination.

SUMMARY

[0007] Various embodiments of systems, methods, devices, and computer software for establishing a cellular-to-VoIP call are provided. One embodiment comprises a communication system for establishing a VoIP media session between an originating cellular telephone and a VoIP destination device, the communication system comprising: an application server configured to receive a first data message from an originating cellular telephone via the mobile data network, the

first data message comprising information associated with a VoIP destination device, and further configured to send a second data message to the originating cellular telephone, the second data message comprising a temporary directory number (TDN) associated with the VoIP destination device; and a media gateway which interfaces with a circuit switched network and an IP network, the media gateway configured to receive an incoming voice call to the TDN from the originating cellular telephone, and further configured to establish a VoIP media session between the originating cellular telephone and the VoIP destination device.

[0008] Another embodiment comprises a method for establishing a session between an originating mobile communication device and a VoIP destination device. One such method comprises: receiving a first data message from an originating mobile communication device, the first data message comprising information identifying a VoIP destination device; sending a second data message to the originating mobile communication device, the second data message comprising information identifying a temporary directory number (TDN) associated with the VoIP destination device; receiving a voice call to the TDN from the originating mobile communication device; and establishing a session between the originating mobile communication device and the VoIP destination device.

[0009] Yet another embodiment comprises an application server associated with a PSTN-to-VoIP gateway for facilitating a VoIP media session between an originating cellular telephone and a VoIP destination device. One such application server comprises: logic configured to receive a first data message sent by an originating cellular telephone, the first data message comprising an identifier associated with a VoIP destination device; logic configured to send a second data message to the originating cellular telephone, the second data message comprising a temporary directory number (TDN) associated with the

VoIP destination device which terminates at a media gateway; logic configured to receive a first session invite from the media gateway, in response to the media gateway detecting an incoming voice call to the TDN from the originating cellular telephone; logic configured to retrieve the identifier associated with the VoIP destination device; and logic configured to send a second session invite containing the identifier to the media gateway.

[0010] A further embodiment comprises a media gateway for establishing a VoIP media session between an originating cellular telephone and a VoIP destination device. One such media gateway comprises: a first interface device configured to communicate with a public switched telephone network (PSTN); a second interface device configured to communicate with an IP network; logic configured to detect an incoming voice call to a temporary directory number (TDN), via the first interface device, from an originating cellular telephone; logic configured to send, via the second interface device, a first invite message containing the TDN to an application server; logic configured to receive, via the second interface device, a second invite message from the application server which contains an identifier for a VoIP destination device associated with the TDN; logic configured to send, via the second interface device, a third invite message to the VoIP destination device; logic configured to send, via the first interface device, a ringing indication to the originating cellular telephone; logic configured to receive, via the second interface device, an accept reply from the VoIP destination device; logic configured to answer the incoming voice call from the cellular telephone; and logic configured to establish a VoIP media session between the originating cellular telephone and the VoIP destination device.

[0011] Another embodiment is a mobile communication device comprising: a user interface for enabling a user to select a VoIP destination device with which a VoIP media session is to be established; a wireless transceiver for communicating

with a cellular network; and a cellular-to-VoIP call establishment module for facilitating the establishment of the VoIP media session between the mobile communication device and the VoIP destination device, the cellular-to-VoIP call establishment module comprising: logic configured to send a first data message via the cellular network, the first data message comprising an identifier associated with the VoIP destination device; logic configured to receive a second data message via the cellular network, the second data message comprising a temporary directory number (TDN) associated with the VoIP destination device; logic configured to initiate a voice call via the cellular network to the TDN; and logic configured to terminate the voice call and join the VoIP media session with the VoIP destination device.

BRIEF DESCRIPTION OF THE DRAWINGS

[0012] Other aspects, advantages and novel features of the invention will become more apparent from the following detailed description of exemplary embodiments of the invention when considered in conjunction with the following drawings.

[0013] FIG. 1 is a block diagram of an embodiment of a communication system for establishing a session between an originating mobile communication device and a VoIP destination device.

[0014] FIG. 2 is a flow diagram illustrating an embodiment of method for establishing a session between the originating mobile device and VoIP destination device of FIG. 1.

[0015] FIG. 3 is an operational flow chart illustrating another embodiment for establishing a session between the originating mobile device and the VoIP destination device of FIG. 1.

[0016] FIG. 4 is a flow chart illustrating the architecture, operation, and/or functionality of an embodiment of the application server of FIG. 1 for facilitating the establishment of the session between the originating mobile communication device and the VoIP destination device.

[0017] FIG. 5 is a flow chart illustrating the architecture, operation, and/or functionality of an embodiment of the PSTN-to-VoIP gateway of FIG. 1 for facilitating the establishment of the session between the originating mobile communication device and the VoIP destination device.

[0018] FIG. 6 is a block diagram of an embodiment of the originating mobile communication device of FIG. 1.

[0019] FIG. 7 is a flow chart illustrating the architecture, operation, and/or functionality of an embodiment of the cellular-to-VoIP call establishment module of FIG. 6.

[0020] FIG. 8 is a screen shot of an embodiment of a presence-enabled user interface for enabling a user to initiate a cellular-to-VoIP call.

[0021] FIG. 9 illustrates the user interface of FIG. 8 with a particular VoIP destination selected by the user.

[0022] FIG. 10 is a call flow diagram illustrating an embodiment of a method for establishing a session between an originating cellular telephone and a VoIP destination client.

[0023] FIG. 11 is a call flow diagram illustrating another embodiment of a method for establishing a session between an origination mobile station and a VoIP subscriber.

[0024] FIG. 12 is a call flow diagram illustrating another embodiment of a method for establishing a session between an originating mobile communication device and a peer-to-peer VoIP user.

[0025] FIG. 13 is a call flow diagram illustrating an embodiment of a method for establishing a session between an originating mobile communication device and a destination mobile communication device.

DETAILED DESCRIPTION

[0026] This disclosure relates to various embodiments of systems, methods, devices, and computer software for establishing a session between an originating mobile communication device and a VoIP destination device are provided.

[0027] FIG. 1 illustrates an embodiment of a communication system 100 for enabling a mobile communication device 102 (e.g., a cellular telephone or other wireless device) to initiate and establish communication with a VoIP destination device 104. Communication system 100 provides the communication infrastructure for implementing unique cellular-to-VoIP call establishment processes. As the name suggests, the call establishment process is from the cellular or wireless end (mobile communication device 102) to the VoIP end (VoIP destination device 104). In other words, the cellular-to-VoIP call establishment processes enable the user of a cellular or wireless telephone (or other mobile communication device) to place a call to a VoIP destination device.

[0028] As illustrated in the embodiment of FIG. 1, the cellular-to-VoIP call establishment process occurs across various types of networks and/or service providers. In this embodiment of FIG. 1, communication system 100 employs a mobile data network 106, a public switched telephone network (PSTN) 108, an application server 110, a gateway (e.g., PSTN-to-VoIP gateway 112), and a VoIP network 114.

[0029] Mobile data network 102 may comprise, for example, the mobile device accessible IP networks associated with the air interface type. In one embodiment, mobile data network 102 may comprise a GSM network and may

support, for example, GPRS (General Packet Radio Service). In other embodiments, mobile data network 102 may comprise a CDMA network which supports the 1xRTT (single carrier (1x) radio transmission technology), a 3G wireless technology based on the CDMA platform. In further embodiments, mobile data network 102 may support 1xEVDO (single carrier (1x) Evolution Data Optimized). One of ordinary skill in the art will appreciate that any and all future evolutions of these networks (e.g., IMS (IP Multimedia System) and MMD (MultiMedia Domain)), as well as other suitable networks may be implemented, by which the mobile device accesses via mobile data network 102 using, for example, Internet Protocol (IP). It should be further appreciated that mobile data network 102 and/or PSTN 108 may be provided by one or more wireless service providers 116 (and/or other carriers).

[0030] VoIP network 114 may comprise any network that transports VoIP traffic, including but not limited to, SIP and RTP protocols. These networks typically have subscribers associated with them or may be transport networks only. The subscribers associated with them are typically the destination or origination of voice calls associated with this service.

[0031] Application server 110 and PSTN-to-VoIP gateway 112 may comprise VoIP and other protocol based services to those subscribers transiting the Gateway Service Provider network. Translation, transform, number management, routing and proxy functions are a few examples of services that may be provided. PSTN-to-VoIP gateway 112 may comprise the function of transform between traditional telephony protocols (e.g., ISDN User Part (ISUP), Telephone User Part (TUP), etc.) to VoIP protocols (e.g., SIP, RTP, etc.).

[0032] Application server 110 and PSTN-to-VoIP gateway 112 may be provided by one or more so-called gateway service providers 118 (e.g., an IP network provider, an IP exchange service provider). In alternative embodiments,

application server 110 and/or PSTN-to-VoIP gateway 112 may be provided in conjunction with a wireless service provider 116 or a VoIP service provider 120.

[0033] Having generally described the supporting infrastructure of communication system 100, the operation of various embodiments of the cellular-to-VoIP call establishment process will be described. In the embodiment illustrated in FIG. 2, the cellular-to-VoIP call establishment process begins, at reference A, with mobile communication device 102 providing a data message to mobile data network 106, which is delivered to application server 110. While the data message is initially carried via mobile data network 106, it should be appreciated that the data message may be routed to other communication networks (wireless or wired) before arriving at application server 110. The data message from mobile communication device 102 comprises information associated with VoIP destination device 104. The data message may include a unique identifier or other information sufficient to identify VoIP destination device 104. At reference B, application server 110 provides a reply data message to mobile data network 106, which is delivered back to mobile communication device 102. The reply data message comprises a temporary directory number (TDN) which application server 110 associates with VoIP destination device 104. In this regard, application server 110 maintains a logical association between the TDN and the unique identifier for VoIP destination device 104. At reference C, mobile communication device 102 initiates a voice call (via PSTN 108) to the TDN which terminates at PSTN-to-VoIP gateway 112. At reference D, PSTN-to-VoIP gateway 112 detects the incoming call to the TDN and, in response, sends a query to application server 110 requesting the unique identifier associated with the TDN. At reference E, application server 110 sends an invite message to VoIP destination device 104. At reference F, VoIP destination device 104 sends an accept reply message to PSTN-to-VoIP gateway 112. With knowledge that VoIP destination device 104 is

available, at reference H, PSTN-to-VoIP gateway 112 answers the incoming call from mobile communication device 102. Now, with open connections with both mobile communication device 102 and VoIP destination device 104, at reference I, PSTN-to-VoIP gateway 102 establishes a VoIP media session. As described below in more detail, the PSTN-to-VoIP gateway 112 may establish the VoIP media session (or other type of call or session) by bridging the voice call with mobile communication device 102 to the session with VoIP destination device 104.

[0034] The cellular-to-VoIP call establishment process is implemented via logic (e.g., hardware, processor-implemented software, firmware, or any combination thereof) distributed across the various devices in communication system 100. In the embodiment of FIG. 2, the logic embodying the cellular-to-VoIP call establishment process is distributed across, for example, mobile communication device 102, application server 110, PSTN-to-VoIP gateway 112, VoIP destination device 104. It should be appreciated, however, that certain aspects of the logic may be implemented by other suitable devices in mobile data network 106, PSTN 108, VoIP network 114, or other associated networks. Furthermore, one ordinary skill in the art will appreciate that communication system 100 may employ other technologies, devices, software, processes, protocols, etc., which are known in the art (or developed in the future).

[0035] It should be appreciated that any process or logical descriptions of the cellular-to-VoIP call establishment process may represent modules, segments, or portions of code which include one or more executable instructions for implementing specific logical functions, steps, or acts in a process. It should be further appreciated that any logical functions may be executed out of order from that shown or discussed, including substantially concurrently or in reverse order,

depending on the functionality involved, as would be understood by those reasonably skilled in the art.

[0036] One of ordinary skill in the art will further appreciate that the cellular-to-VoIP call establishment process may be implemented using any communication protocol, computer language, etc. and may embodied in any computer-readable medium for use by or in connection with an instruction execution system, apparatus, or device, such as a computer-based system, processor-containing system, or other system that can fetch the instructions from the instruction execution system, apparatus, or device and execute the instructions. In the context of this document, a "computer-readable medium" can be any means that can contain, store, communicate, propagate, or transport the logic embodying the cellular-to-VoIP call establishment process for use by or in connection with the instruction execution system, apparatus, or device. The computer-readable medium may be, for example, an electronic, magnetic, optical, electromagnetic, infrared, or semiconductor system, apparatus, device, or propagation medium. More specific examples (a nonexhaustive list) of the computer-readable medium would include the following: an electrical connection (electronic) having one or more wires, a portable computer diskette (magnetic), a random access memory (RAM) (electronic), a read-only memory (ROM) (electronic), an erasable programmable read-only memory (EPROM or Flash memory) (electronic), an optical fiber (optical), a portable compact disc read-only memory (CDROM) (optical), and a communication signal containing the logic. Note that the computer-readable medium could even be paper or another suitable medium upon which the program is printed, as the program can be electronically captured, via for instance optical scanning of the paper or other medium, then compiled, interpreted or otherwise processed in a suitable manner if necessary, and then stored in a computer memory.

[0037] As mentioned above, the logic or functionality of the cellular-to-VoIP call establishment process is distributed across components of communication system 100. FIG. 3 illustrates, from the perspective of communication system 100, an embodiment of a cellular-to-VoIP call establishment process. At block 302, a user of mobile communication device 102 (e.g., a cellphone user or subscriber) selects a name from a stored contact list, with whom a communication session is to be established. From the user's perspective, the name need not represent a VoIP destination. Preferably, the user merely specifies a name from the contact list, and a client application on mobile communication device 102 recognizes the name as a VoIP destination. In this regard, the user need not be concerned with whether the "name" represents a VoIP subscriber, a wireless number, or a landline number. At block 304, the client application determines that the "name" represents a VoIP subscriber, and then sends a data message to application server 110. The data message identifies the VoIP destination with whom the user wants to establish a session.

[0038] At block 306, application server 110 receives the data message from the client application and associates the identifier with a temporary directory number (TDN). The TDN may be predefined to terminate at a media gateway affiliated with application server 110 (e.g., PSTN-to-VoIP gateway 112 – FIGS. 1 & 2). Application server 110 sends the TDN to mobile communication device 102. At block 308, the client application receives the TDN and initiates a PSTN call to the TDN. At block 310, the media gateway receives or detects the incoming call from mobile communication device 102. At block 312, the media gateway sends a request to application server 110. The media gateway may provide information associated with the TDN to application server 110. Application server 110 receives the TDN, matches it to the corresponding identifier associated with the VoIP destination, and returns the identifier to the media gateway (block 314). At block

316, the media gateway establishes a session between mobile communication device 102 and VoIP destination device 104.

[0039] Having described several embodiments of the cellular-to-VoIP call establishment process from the perspective of communication system 100, various aspects of the cellular-to-VoIP call establishment process will be described from the perspective of certain system components. FIG. 4 illustrates aspects of the cellular-to-VoIP call establishment process from the perspective of application server 110. In this regard, FIG. 4 illustrates the architecture, operation, and/or functionality of an embodiment of application server 110, as well as a particular method for facilitating the cellular-to-VoIP call establishment process. At block 402, application server 110 receives the data message initiated by mobile communication device 102, which may include a unique identifier associated with VoIP destination device 104. At block 404, application server 110 associates the unique identifier with a TDN that terminates at a signaling gateway or a media gateway. Application server may bind the TDN, the unique identifier, and/or information related to mobile communication device 102. At block 406, application server 110 sends the TDN to mobile communication device 102. At block 408, application server 110 receives a session request (e.g., from an affiliated media gateway). The session request includes information identifying the TDN. At block 410, application server 110 determines the unique identifier which corresponds to the TDN. At block 412, application server 110 sends a session request to the media gateway which includes the unique identifier associated with VoIP destination device 104.

[0040] FIG. 5 illustrates various aspects of the cellular-to-VoIP call establishment process from the perspective of the media gateway (e.g., PSTN-to-VoIP gateway 112) associated with application server 110. It should be appreciated that the process illustrated in FIG. 5 may represent the architecture, operation, and/or

functionality of an embodiment of the media gateway, as well as the general operation of an accompanying method for facilitating the cellular-to-VoIP call establishment process. At block 502, the media gateway receives an incoming call from mobile communication device 102. The incoming call is to a temporary directory number (TDN) assigned by application server 110. As mentioned above, application server 110 maintains a binding between the TDN and the associated VoIP destination selected by mobile communication device 102. The media gateway determines the TDN and, at block 504, sends a request to application server 110. The request comprises information sufficient for application server 110 to identify the TDN and determine the associated VoIP destination. At block 506, the media gateway receives a reply from application server 110 which identifies the VoIP destination device. At block 508, the media gateway sends a session request to the VoIP destination identified by application server 110. At block 510, the media gateway establishes the session between the originating mobile communication device 102 and the terminating VoIP destination device 104.

[0041] The aspects of the cellular-to-VoIP call establishment process that occur at mobile communication device 102 will be described with respect to FIGS. 6 – 9. In general, mobile communication device 102 is configured to provide 2-way communications using any of a variety of cellular standards (e.g., GSM, CDMA, TDMA, AMPS, etc.) Mobile communication station 102 is further configured with appropriate hardware and/or software subsystems to convert voice signals into IP packets and to implement appropriate standards and protocols for VoIP (and other desirable communication protocols to implement the cellular-to-VoIP call establishment process). As illustrated in FIG. 6, mobile communication device 102 generally comprises a display 602, I/O devices 604, a user interface 606, a microphone 608, a speaker 610, a voice CODEC 612, processor(s) 614 (e.g., digital baseband, analog baseband, etc.), wireless transceiver 616, and memory 618.

The operation of these components is not discussed in detail, as they are generally known in the art.

[0042] Regarding the unique cellular-to-VoIP call establishment processes, however, it is noted that memory 618 comprises specially-configured logic (i.e., cellular-to-VoIP call establishment module 600) and a list 620 of contacts. Module 600 comprises the logic for implementing the cellular-to-VoIP call establishment process on mobile communication device 102. Although FIG. 6 illustrates a software embodiment, it should be appreciated that, in other embodiments, module 600 may be embodied in hardware, software, firmware, or any combination thereof. FIG. 7 illustrates the architecture, operation, and/or functionality of an embodiment of cellular-to-VoIP call establishment module 600. At block 702, module 600 receives a user selection of a name from list 620. In one embodiment, user interface 606 provides appropriate functionality, via display 602 and I/O devices 604, for enabling a user to select contacts from list 620. The name may be selected via any appropriate I/O device 604 (e.g., via touch screen, keypad, navigation wheel, function keys, buttons, audio commands, etc.).

[0043] Referring to the example of FIGS. 8 and 9, user interface 606 may provide a list 620 as a series of names 902. User interface 606 may be presence-enabled, in which case presence information 904 is displayed for names 904, indicating the availability of the particular name. Presence management functions may be implemented using, for example, an extension of session initiation protocol (SIP) called SIP for Instant Messaging and Presence Leveraging (SIMPLE). SIMPLE provides subscriber presence management and instant messaging functions similar to instant messaging services. The presence management functionality may range from simple on/off or available/unavailable status information, or much more elaborate types of information. For example, a subscriber might be

available for certain types of sessions – text only if they are in a meeting. The subscriber may only want to accept calls from certain categories of users – friends, family, business, etc. Presence may also indicate geographic location or type of location – at work, at home, in transit, etc.

[0044] Names 902 may be defined by the user of mobile communication device 102, by communication system 100, or by the individual identified by the name. Presence information 904 is managed by appropriate software residing on mobile communication device 102 and associated services provided via communication system 100. In the example illustrated in FIG. 9, the user scrolls down list 620 and selects an entry (in this case, Evan, who is identified based on system presence information as being "available"). The user does not need to know that Evan is a VoIP destination. From the user's perspective, "Evan" could be a mobile number, a landline, or a VoIP identity. In certain embodiments, this information may be left intentionally transparent to the user. In this manner, a wireless service provider (or other provider) may provide the cellular-to-VoIP call establishment process as a seamless service which, from the user perspective, functions like an enhanced IP service (e.g., an IMS or converged service).

[0045] Referring again to FIG. 7, module 600 may be configured to receive the user selection of the VoIP destination in any suitable manner. At block 704, module 600 generates a data message for delivery to application server 110. It should be appreciated that the data message may be configured to support any suitable protocols. In one embodiment, the protocol between mobile communication device 102 and application server 110 is SIP (session initiation protocol). SIP is a standard of the Internet Engineering Task Force (IETF) for multimedia conferencing over Internet protocol (IP). SIP is an ASCII-based, application-layer control protocol defined in RFC 2543, which is hereby incorporated by reference in its entirety. SIP may be used to establish, maintain, and terminate calls between two

more end points. The connection between mobile communication device 102 and application server 110 may support, for example, 1X, GPRS, or other wireless data connections.

[0046] Regardless the protocol, message structure or type of data connection, the data message contains information sufficient to identify the VoIP destination. At block 706, module 600 receives a reply message from application server 110, which contains a TDN, as described above. At block 708, module 600 triggers a PSTN call to the TDN. If the VoIP destination is available, at block 710, the PSTN call may be answered and bridged to a connection with VoIP destination device 104.

[0047] As mentioned above, the cellular-to-VoIP call establishment process may be implemented using various communication protocols and standards and may be adapted to support various service providers and networks. Various examples are provided below. One exemplary embodiment operates as follows:

- A wireless subscriber initiates the process of establishing a call to a VoIP "buddy" by selecting a name from their contact list (name@skype.net) using a client application running on their wireless device.
- The client application requests routing instructions from an application server. The protocol used for the request could be an SIP invite method.
- The SIP application server validates the VoIP destination and allocates a temporary number based on the location of the originating switch.
- The application server returns the assigned temporary number to the client application running on the wireless device. The protocol used for the response could be an SIP redirection response.

- The client application causes the wireless device to place a standard TDM call to the returned telephone number.
- A media gateway receives the call and routes the SIP signaling associated with the destination phone number (the assigned local temporary number) to the SIP application server.
- The original SIP URI destination for the received calling party address is retrieved from application context.
- An SIP invite message is sent back to the media gateway with the temporary number replaced with the original destination (name@skype.net).
- The media gateway extends the call to the VoIP subscriber via VoIP.

In this embodiment, the usage information may be maintained by the SIP application server and used to create wholesale settlement reports for *termination access fees between the participating wireless operators and VoIP service providers.*

[0048] Another exemplary embodiment is illustrated in FIG. 10. In the embodiment of FIG. 10, the cellular-to-VoIP call establishment process occurs across the following system components: an originating cellular phone 1002, an authentication/authorization/accounting (AAA) server 1004, an application server 1006, an originating softswitch 1008, a terminating softswitch 1010, a VoIP provider 1012, and a destination client 1014. The cellular-to-VoIP call establishment process establishes a voice session from originating cellular telephone 1002 to a SIP-based VoIP destination client 1014 using a temporary directory number (TDN). The TDN is assigned to the VoIP destination device for a single call. The reference letters to the right of the call flow diagram of FIG. 10 correspond to the following description.

- [0049] A. Originating cellular phone 1002 sends a data message using, for example, 1XRTT, WAP, SMS, etc. to an SIP application service (application server 1006). The message contains at least one SIP URI for a VoIP destination (e.g., name@siptalk.com) as well as the MSISDN/MDN of originating cellular phone 1002 (e.g., CgP Number).
- [0050] B. Accounting for a session invitation for originating cellular telephone 1002 is started.
- [0051] C. The SIP application service assigns a TDN to this call and returns a data message to originating cellular phone 1002 containing the TDN. SIP application server 1006 marries and stores the TDN, the SIP URI, and the CgP number in context (CTX). A business-rule-defined timer may be set and the client application (on originating cellular phone 1002) configured to await a call to the TDN.
- [0052] D. Accounting for the session invite for originating cellular phone 1002 is stopped.
- [0053] E. The subscriber for originating cellular phone 1002 or a handset-resident application reads a data reply from application server 1006 and calls the TDN returned.
- [0054] F. Because the TDN is associated in the PSTN with the originating soft switch, the call is terminated at originating soft switch 1008. This number may be associated with SIP application server 1006, so a SIP INVITE is sent to the application server:

```
INVITE sip: +1-813-xxx-  
xxxx@syniverse.com;npdi=yes@syniverse.com:5060 SIP/2.0  
To: sip:name@siptalk.com; tag=fdfabb  
From: tel:+1-303-123-xxxx; tag=kdreffa  
Call-ID: 12345600  
CSeq: 1 INVITE
```

Content-Type: application/sdp

- [0055] G. SIP application server 1006 checks the target URI and compares the number there with the list of numbers in CTX. When it finds a match, it functions as a back-to-back user agent (B2BUA) and creates an INVITE sent to terminating soft switch 1010 with the SIP URI and the From header of the CgP number (or an alias URI):

```
INVITE sip:name@siptalk.com; SIP/2.0
To: sip:name@siptalk.com; tag=fdfabb
From: tel:+1-3-3-123-xxxx; tag=kdreffa
Call-ID: 12345600
CSeq: 1 INVITE
Record-Route: <sip:s1.syniverse.com;lr>
Content-Type: application/sdp
```

- [0056] H. The SIP INVITE is routed to the appropriate destination (e.g., via DNS look-up, etc.)
- [0057] I. The SIP INVITE is routed to the appropriate destination (e.g., via DNS look-up, etc.)
- [0058] J. The SIP INVITE is acknowledged via 200 OK method.
- [0059] K. The SIP INVITE is acknowledged via 200 OK method.
- [0060] L. The SIP INVITE is acknowledged via 200 OK method.
- [0061] M. The SIP INVITE is acknowledged via 200 OK method.
- [0062] N. Account for the VoIP media session is started.
- [0063] O. Originating soft switch 1008 bridges the inbound PSTN call leg with the RTP stream defined by the SIP messaging.
- [0064] P. The originating mobile phone subscriber or the application ends the PSTN call.
- [0065] Q. The SIP BYE is routed to the appropriate destination.
- [0066] R. Accounting for the VoIP media session is stopped.
- [0067] S. The SIP BYE is routed to the appropriate destination.

- [0068] T. The SIP BYE is routed to the appropriate destination.
- [0069] U. The SIP BYE is routed to the appropriate destination.
- [0070] V. The SIP BYE is acknowledged via 200 OK method.
- [0071] W. The SIP BYE is acknowledged via 200 OK method.
- [0072] X. The SIP BYE is acknowledged via 200 OK method.
- [0073] Y. The SIP BYE is acknowledged via 200 OK method.

[0074] FIG. 11 illustrates another embodiment of a cellular-to-VoIP call establishment process, which occurs across the following system components: a mobile station 1102, a mobile switching center 1104, a wireless data network 1106, an application server 1108, an IP service provider softswitch 1110, an SIP gateway 1112, a VoIP service provider 1114, and a VoIP subscriber 1116. The reference letters to the right of the call flow diagram of FIG. 11 correspond to the following description.

- [0075] A. A user or subscriber selects a name from an address book or contacts list presented by the client application on mobile station 1102 (e.g., a BREW/Java application) and presses SEND. The MS application connects to the operator's wireless IP network (e.g., wireless data network 1106) and sends appropriate information to SIP Application server 1108).
- [0076] B. The wireless operator's IP network element forwards the IP packets to SIP application server 1108.
- [0077] C. SIP application server 1108 responds to the IP query with, for example, a VoIP network provider E.164 number based on the information received in the query, and returns the information. SIP application server 1108 stores all relevant information regarding the query/response data in context (memory).

- [0078] D. The wireless operator's IP network element routes the response to mobile station 1102.
- [0079] E. The client application retrieves the VoIP network provider E.164 number and places a traditional wireless telephony call to the E.164 number.
- [0080] F. The voice channel is assigned to mobile station 1102.
- [0081] G. MSC 1104 launches an IAM based on its routing tables to the VoIP network provider softswitch (e.g., IP service provider softswitch 1110).
- [0082] H. the VoIP network provider softswitch has the E.164 number associated with SIP application server 1108 and routes the signaling to the EPS for SIP INVITE delivery.
- [0083] I. SIP application server 1108 receives the INVITE and retrieves the context information based on the E.164 number. It extracts the address that mobile station 1102 sent, as well as the mobile station calling number, adds a Record-Route header and formulates an INVITE; TO: the named address and FROM: the MS E.164.
- [0084] J. the VoIP network provider EPS receives and processes the INVITE. Application server 1108 or the IP service provider infrastructure may perform DNS name resolution and send an IP address. The VoIP network provider EPS routes the signaling to SIP Gateway 1112 (e.g., a gateway associated with a VoIP provider, such as Skype, etc.).
- [0085] K. SIP gateway 1112 delivers signaling to VoIP provider server 1114 associated with the VoIP subscriber.
- [0086] L. VoIP provider server 1114 delivers signaling to their VoIP subscriber.

- [0087] M. VoIP subscriber client acknowledges the invoke and returns information regarding the method of connection.
- [0088] N. VoIP provider server 1114 acknowledges the invoke and forwards information regarding the method of connection.
- [0089] O. SIP gateway 1112 responds with a 200 OK message with the SDP connection information.
- [0090] P. The VoIP network provider EPS responds with a 200 OK message with the SDP connection information.
- [0091] Q. SIP application server 1108 responds with a 200 OK message with the SDP connection information.
- [0092] R. The VoIP network provider softswitch responds to the IAM with an ANM message.
- [0093] S. End-to-end MS voice channel, TDM circuit voice channel, RTP voice session and VoIP proprietary voice session connected and stable.

[0094] It should be appreciated that SIP routing towards the VoIP provider through the IP service provider may be configured to support the particular addressing scheme employed by the VoIP provider. In this example, SIP gateway 1112 performs appropriate mapping of the E.164 telephone number to the VoIP-specific addressing scheme. Furthermore, SIP application server 1108 may be configured to add a record-Route header to the outbound INVITE. This may facilitate CDR-type logging output and enable clearing and settlement between the providers.

[0095] FIG. 12 illustrates yet another embodiment of a cellular-to-VoIP call establishment process, which occurs across the following system components: a mobile station 1202, PDSN 1204, a mobile switching center 1206, an

internetworking function 1208, a registrar/location server 1210, an SIP proxy 1212, an IP service provider proxy server 1214, a PSTN gateway 1216, and a VoIP SIP proxy. In this example, it assumed that a client application resides on mobile station 1202 for enabling the user to select a party to call by name (e.g., voip@prov.com). The application is configured such that requests arrive at the IP address of internetworking function (IWF) 1208. The user@domain (or realm) passed by mobile station 1202 to identify itself as registered is a domain that the Registrar is authoritative for or which it can proxy. The reference letters to the right of the call flow diagram of FIG. 12 correspond to the following description. It call flow assumes a CDMA handset. If the handset was GSM, the MDN=MSISDN, the MIN=IMSI, and the SID and ESN would be null. All TDNs are routed to a partner network in the PSTN. Provisional SIP responses (numbered 1xx) have been omitted for brevity. Authentication of the user is not shown, although there are various ways to accomplish this.

[0096] A. Mobile station 1202 registers with registrar/location server 1210 through PDSN/SGSN (e.g., PDSN 1204). This occurs on application start and reoccurs every "Expires" (see c. below) seconds. Data sent in registrations includes:

```
TransactionType: REG
Registration Domain: =syniverse.com
SIP uri: name@syniverse.com
MDN
MIN
ESN
SID
```

[0097] B. IP Packet is transported to IWF 1208.

[0098] C. IWF 1208 translates the packet into the SIP (RFC3261) protocol as a SIP REGISTER method and sends it to registrar/location server 1210:

```
REGISTER sip:syniverse.com SIP/2.0
From: <IWF@syniverse.com>;tag=2696193006
To: <name@syniverse.com>
```


Contact: "MDN.MIN.ESN.SID" <tel:MDN@Syniverse.com:5060>
 Call-ID: E141452EB7CC4164A30703E5BBE9EA52@syniverse.com
 CSeq: 62650 REGISTER
 Expires: 3600
 Max-Forwards: 70
 User-Agent: IWF-Syn
 Content-Length: 0

- [0099] D. SIP registrar/location server 1210 receives the REGISTER and parses the information appropriately. It stores the MDN, MIN, ESN, SID and address of record from the To: header into the Location data store. Server 1210 responds to IWF 1208 with a 200 OK SIP response method.
- [00100] E. IWF 1208 forwards an empty response signifying an ACK to mobile station 1202.
- [00101] F. PDSN 1204 forwards ACK to mobile station 1202.
- [00102] G. The user of mobile station 1202 selects, via a calling application, an address to call, in this example, voip@prov.com and presses Enter, or Select, etc. within the application. The application builds an ORIG transaction type with the following information and sends it to SIP Proxy 1212 via the PDSN/SGSN:
- TransactionType: ORIG
 CdP uri: voip@prov.com
 SIP uri: name@syniverse.com
 MDN
 MIN
 ESN
 SID
- [00103] H. IP Packet is transported to IWF 1208.
- [00104] I. IWF 1208 recognizes by transaction type=ORIG that the data needs to be translated to a SIP INVITE method and forwarded on SIP Proxy 1212:
- INVITE sip: voip@prov.com SIP/2.0
 From: <name@syniverse.com>;tag=4112001205
 To: <sip: voip@prov.com>

Contact: <sip:MDN@Syniverse.com:5060>
Call-ID: COB5EAC5-46C7-49A5-A3D3-A02309385A71@syniverse.com
CSeq: 4458 INVITE
Max-Forwards: 70
User-Agent: IWF-Syn
Content-Length: 0

- [00105] J. SIP proxy 1212 queries registrar/location server 1210 for the called party name using a SIP REGISTER method with no contact header. This is done to ensure that the called party is not registered with this service already (if it were, the MDN would be returned and be done with the call).
- [00106] K. In this example the called party is not registered with this service therefore, a 404 Not Found response is returned.
- [00107] L. SIP proxy 1212 then queries the registrar/location server 1210 for the calling party name using a SIP REGISTER method with no contact header. This is done to retrieve the TDN associated with this user.
- [00108] M. Because this user is registered with this service, registrar/location server 1210 takes the previously stored SID portion of the "name" field and queries an internal SID to TDN table to retrieve the appropriate local TDN. Registrar/location server 1210 will create a Contact header on the fly and return all contacts associated with the user to SIP proxy 1212.
- [00109] N. SIP Proxy 1212 selects the Contact Header that has "tdn" in the domain and formulates a 302-redirect response using the TDN and sends it to IWF 1208. SIP proxy 1212 stores context related to this call by MDN
- [00110] O. IP packet is transported to mobile station 1202 with TDN in it.
- [00111] P. PDSN 1204 forwards packet to mobile station 1202.

- [00112] Q. Application resident on mobile station 1202 receives the response with TDN and by controlling the phone originates a call to the TDN using traditional telephony.
- [00113] R. MSC 1206 sends ISUP IAM to destination switch in partner network.
- [00114] S. A partner network media gateway (e.g., PSTN gateway 1216) has an a priori arrangement to route calls destined to TDN to SIP proxy server 1212 through a partner network Edge Proxy Server (e.g., proxy server 1214).
- [00115] T. EPS routes INVITE to SIP proxy 1212.
- [00116] U. SIP proxy 1212 receives INVITE to TDN, restores context and retrieves the Request URI from the stored data. SIP proxy 1212 performs a DNS name resolution query, creates an INVITE with the same Call-ID as retrieved call and sends it to destination address via IP to the appropriate domain, in this example, prov.com.
- [00117] V. 200 OK response(s) are transmitted through network signifying call setup can proceed.
- [00118] W. 200 OK response(s) are transmitted through network signifying call setup can proceed.
- [00119] X. The partner network media gateway returns the ISUP Answer message (ANM) to the originating MSC.
- [00120] Y. MSC 1206 brings mobile station 1202 up on voice channel.
- [00121] Z. Call is connected end-to-end.

[00122] FIG. 13 illustrates a further embodiment of a cellular-to-VoIP call establishment process between two mobile stations. In this embodiment the cellular-to-VoIP call establishment process occurs across the following system components: a mobile station A 1302 (originating device), a PDSN 1304, an MSC

1306, an IWF 1308, a registrar/location server 1310, an SIP proxy 1312, PSTN 1312, MSC 1316, PDSN 1318, and a mobile station B 1320 (terminating device). The reference letters to the right of the call flow diagram of FIG. 13 correspond to the following description.

[00123] A. Mobile station A 1302 registers with registrar/location server 1310 through PDSN/SGSN (e.g., PDSN 1304). This occurs on application start and reoccurs every "Expires" (see c. below) seconds. Data sent in registrations includes:

TransactionType: REG
 Registration Domain: = syniverse.com
 SIP uri: name@syniverse.com
 MDN
 MIN
 ESN
 SID

[00124] B. IP Packet is transported to IWF 1308

[00125] C. IWF 1308 translates the packet into the SIP (RFC3261) protocol as a SIP REGISTER method and sends it to the Registrar/Location Server1310:

REGISTER sip:syniverse.com SIP/2.0
 From: <IWF@syniverse.com>;tag=2696193006
 To: <name@syniverse.com>
 Contact: "MDN.MIN.ESN.SID" <tel:MDN@Syniverse.com:5060>
 Call-ID: E141452EB7CC4164A30703E5BBE9EA52@syniverse.com
 CSeq: 62650 REGISTER
 Expires: 3600
 Max-Forwards: 70
 User-Agent: IWF-Syn
 Content-Length: 0

[00126] D. SIP registrar/location server 1310 receives the REGISTER and parses the information appropriately. It stores the MDN, MIN, ESN, SID and address of record from the To: header into the Location data store. Registrar/location server 1310 responds to IWF 1308 with a 200 OK SIP response method.

- [00127] E. IWF 1308 forwards an empty response signifying an ACK to mobile station A 1302.
- [00128] F. PDSN 1304 forwards ACK to mobile station A 1302
- [00129] G. Mobile station B 1320 registers with registrar/location server 1320 through PDSN/SGSN (e.g., PDSN 1318).
- [00130] H. IP packet is transported to IWF 1308.
- [00131] I. IWF 1308 translates the packet into the SIP (RFC3261) protocol as a SIP REGISTER method and sends it to registrar/location server 1310:
- ```
REGISTER sip:syniverse.com SIP/2.0
From: <IWF@syniverse.com>;tag=2696193006
To: <MSb@syniverse.com>
Contact: "MDN.MIN.ESN.SID" <tel:MDN@Syniverse.com:5060>
Call-ID: E141452EB7CC4164A30703E5BBE9EA54@syniverse.com
CSeq: 62660 REGISTER
Expires: 3600
Max-Forwards: 70
User-Agent: IWF-Syn
Content-Length: 0
```
- [00132] J. Registrar/location server 1310 receives the REGISTER and parses the information appropriately. It stores the MDN, MIN, ESN, SID and address of record from the To: header into the Location data store. The Registrar responds to IWF 1308 with a 200 OK SIP response method.
- [00133] K. IWF 1308 forwards an empty response signifying an ACK to mobile station B 1320.
- [00134] L. PDSN 1318 forwards ACK to mobile station B 1320.
- [00135] M. The user of mobile station A 1302 selects (with the calling application) an address to call, in this example, MSb@prov.com and presses Enter, or Select, etc. within the application. The application builds an ORIG transaction type with the following information and sends it to SIP proxy 1312 via the PDSN/SGSN:

TransactionType: ORIG  
 CdP uri: MSb@prov.com  
 SIP uri: name@syniverse.com  
 MDN  
 MIN  
 ESN  
 SID

- [00136] N. IP Packet is transported to IWF 1308
- [00137] O. IWF 1308 recognizes by transaction type=ORIG that the data needs to be translated to a SIP INVITE method and forwarded on SIP proxy 1312:

INVITE sip: MSb@prov.com SIP/2.0  
 From: <name@syniverse.com>;tag=4112001215  
 To: <sip: MSb@prov.com>  
 Contact: <sip:MDN@Syniverse.com:5060>  
 Call-ID: C0B5EAC5-46C7-49A5-A3D3-A02309385B56@syniverse.com  
 CSeq: 4488 INVITE  
 Max-Forwards: 70  
 User-Agent: IWF-Syn  
 Content-Length: 0

- [00138] P. SIP proxy 1312 queries registrar/location server 1310 for the called party name using a SIP REGISTER method with no contact header. This is done to determine if the called party is registered with this service already.
- [00139] Q. In this example the called party is registered with this service and, therefore, the MDN of the Called Party (mobile station B 1320) is returned as a Contact header in the response.
- [00140] R. SIP proxy 1312 selects the Contact Header that has "mdn" in the domain and formulates a 302-redirect response using the MDN and sends it to the IWF. SIP proxy 1312 stores context related to this call by MDN.
- [00141] S. IP packet is transported to mobile station A 1302 with MDN in it.
- [00142] T. PDSN 1304 forwards packet to mobile station A 1302.

- [00143] U. Application resident on mobile station A 1302 receives the response with MDN and by controlling the phone originates a call to the MDN using traditional telephony.
- [00144] V. MSC 1306 sends ISUP IAM to destination switch in PSTN 1314.
- [00145] W. MSC 1316 serving mobile station B 1320 pages the mobile.
- [00146] X. Mobile station B 1320 answers the page.
- [00147] Y. ISUP ANM is passed through PSTN 1314 to originating MSC 1306
- [00148] Z. MSC 1306 brings mobile station A 1302 up on voice channel.
- [00149] aa. Call is connected end-to-end through PSTN 1314.

[00150] It should be appreciated that the cellular-to-VoIP call establishment processes described above may be leveraged using various novel business models. In most existing cellular-to-VoIP solutions, the VoIP providers use a bill-and-keep business model for peering between providers, while most wireless operators pay transit and termination access fees to the LEC. In certain aspects, the cellular-to-VoIP call establishment process may be implemented to leverage an IP network service (e.g., a VoIP network provider's Transit service) as a cost-effective solution for LEC-bypass and introduce a termination fee payable by the wireless operator to the VoIP provider for allowing access to their subscribers and for sharing presence information. This model may introduce a new revenue stream for the VoIP providers and may be closer to what wireless operators are going to expect when the VoIP provider wants to terminate traffic on their network.

[00151] The wireless operators may be willing to pay the VoIP termination fee because it will be far less than the alternative, which is to pay LEC transit fees to terminate calls to a normal PSTN number for those VoIP subscribers that opt for in-bound calling services. To call a VoIP subscriber today from a standard cell

phone requires the VoIP subscriber to purchase additional services from their VoIP service provider that include one or more standard telephone numbers and the ability to receive in-coming calls from the PSTN. When a wireless subscriber calls one of these numbers, the wireless operator normally pays a transit fee to the LEC or the IXC to carry the voice traffic to another network.

[00152] Wireless operators and VoIP service providers may perceive significant business value from the cellular-to-VoIP call establishment processes described above. For example, cellular-to-VoIP call establishment processes may offer the following value propositions to wireless operators:

- Enable cellular subscribers to send and receive calls to worldwide VoIP subscribers using their subscriber name (URI) and without the VoIP subscriber requiring a dedicated phone number
- Provide a presence-enabled, "next generation" user interface prior to true end-to-end VoIP availability in the wireless network
- Enable bundling of a branded VoIP soft-client with their in-network calling programs to drive additional value and reduce network radio resources associated with unlimited in-network rate plans
- The presence-enabled user interface can also be used for mobile-to-mobile presence information if both subscribers are running the VoIP calling user interface application.
- By bundling VoIP calling with in-network rate plans, the wireless operator can increase the take-rate for in-network subscriptions, which will increase their revenue.
- While today's phone numbers are portable, leading to possible increased churn, SIP URIs are tied to a particular domain (sip:name@VzW.net). If the wireless operator were to bundle their own



softphone and "branded" user id, this could provide increased stickiness similar to how e-mail addresses tie subscribers to particular ISPs.

[00153] The cellular-to-VoIP call establishment processes may offer the following value propositions to VoIP service providers:

- Introduce a new revenue stream through termination access fees charged to transit providers for call terminations to their subscribers that use "free" PC-to-PC calling agents
- Increase reach and usage of VoIP service and drive additional demand for other chargeable services such as PSTN voice terminations
- Possibility to offer a special kind of voice termination service to terminate to participating wireless operators for substantially less than traditional PSTN voice termination charges
- Possibility to build partnerships with wireless operators or MVNOs for branded user agents running on wireless devices.

[00154] The cellular-to-VoIP call establishment processes offer the following additional opportunities to other services providers, such as IP exchange service providers:

- Leverage VoIP calling as a foundation for other VoIP services such as PSTN by-pass, VoIP peering, and IP access to SS7 databases, etc.
- Leverage VoIP calling to establish business relationships with VoIP service providers and identify other business opportunities within their market segment
- Opportunity for shorter-term TDM-based wireless-to-VoIP peering and longer-term VoIP peering marketplace

[00155] Although this disclosure describes the invention in terms of exemplary embodiments, the invention is not limited to those embodiments. Rather, a person skilled in the art will construe the appended claims broadly, to include other variants and embodiments of the invention, which those skilled in the art may make or use without departing from the scope and range of equivalents of the invention.

## CLAIMS

What is claimed is:

- 1 1. A communication system for establishing a VoIP media session between  
2 an originating cellular telephone and a VoIP destination device, the  
3 communication system comprising:  
4 an application server configured to receive a first data message from an  
5 originating cellular telephone via the mobile data network, the first data  
6 message comprising information associated with a VoIP destination device, and  
7 further configured to send a second data message to the originating cellular  
8 telephone, the second data message comprising a temporary directory number  
9 (TDN) associated with the VoIP destination device; and  
10 a media gateway which interfaces with a circuit switched network and  
11 an IP network, the media gateway configured to receive an incoming voice call  
12 to the TDN from the originating cellular telephone, and further configured to  
13 establish a VoIP media session between the originating cellular telephone and  
14 the VoIP destination device.
- 1 2. The communication system of claim 1, wherein the media gateway is  
2 further configured to:  
3 detect the incoming voice call to the TDN;  
4 send an invite message to the VoIP destination device;  
5 send a ringing indication to the originating cellular telephone;  
6 receive an accept reply from the VoIP destination device;  
7 answer the incoming voice call from the cellular telephone; and  
8 establish a VoIP media session between the originating cellular telephone  
9 and the VoIP destination device.

1 3. The communications system of claim 1, wherein the incoming voice call is  
2 answered if the VoIP destination device accepts a session invitation from the  
3 media gateway.

1 4. The communication system of claim 1, wherein the media gateway and  
2 the application server are associated with different service providers.

1 5. A method for establishing a session between an originating mobile  
2 communication device and a VoIP destination device, the method comprising:  
3 receiving a first data message from an originating mobile communication  
4 device, the first data message comprising information identifying a VoIP  
5 destination device;  
6 sending a second data message to the originating mobile  
7 communication device, the second data message comprising information  
8 identifying a temporary directory number (TDN) associated with the VoIP  
9 destination device;  
10 receiving a voice call to the TDN from the originating mobile  
11 communication device; and  
12 establishing a session between the originating mobile communication  
13 device and the VoIP destination device.

1 6. The method of claim 5, wherein the receiving the first data message  
2 comprises receiving a session initiation protocol (SIP) uniform resource indicator  
3 (URI) associated with the VoIP destination device.

1 7. The method of claim 5, further comprising validating the VoIP destination  
2 device, in response to receiving the first data message.

1 8. The method of claim 7, further comprising allocating the TDN based on a  
2 location of an originating switch.

1 9. The method of claim 5, wherein the establishing a session between the  
2 originating mobile communication device and the VoIP destination device  
3 involves a session initiation protocol (SIP).

1 10. The method of claim 5, wherein the establishing the session between the  
2 originating mobile communication device and the VoIP destination device  
3 comprises bridging the voice call with the originating mobile communication  
4 device to a VoIP media session with the VoIP destination device.

1 11. The method of claim 5, wherein the establishing a session between the  
2 originating mobile communication device and the VoIP destination device  
3 comprises:

4 sending an invite message to the VoIP destination device;  
5 answering the incoming voice call;  
6 receiving an accept reply from the VoIP destination device; and  
7 sending a ringing indication to the originating mobile communication  
8 device.

1 12. A method for establishing a VoIP media session between an originating  
2 cellular telephone and a VoIP destination device, the method comprising:

3 receiving a first data message from an originating cellular telephone, the  
4 first data message comprising an identifier associated with a VoIP destination  
5 device;

6            sending a second data message to the originating cellular telephone, the  
7 second data message comprising information identifying a temporary directory  
8 number (TDN) associated with the VoIP destination device;  
9            detecting an incoming voice call to the TDN from the originating cellular  
10 telephone;  
11           sending an invite message to the identifier associated with the VoIP  
12 destination device;  
13           sending a ringing indication to the originating cellular telephone;  
14           receiving an accept reply from the VoIP destination device; and  
15           answering the incoming voice call from the cellular telephone and  
16 establishing a VoIP media session between the originating cellular telephone  
17 and the VoIP destination device.

1    13.    The method of claim 12, wherein the receiving the first data message  
2 comprises receiving a SIP URI associated with the VoIP destination device.

1    14.    The method of claim 12, wherein the first data message comprises one of  
2 a 1XRTT message, a WAP message, and an SMS message.

1    15.    The method of claim 12, wherein the detecting the incoming voice call  
2 comprises:  
3           routing the signaling associated with the TDN to an application server;  
4           and  
5           retrieving the identifier associated with the VoIP destination.

1 16. An application server associated with a PSTN-to-VoIP gateway for  
2 facilitating a VoIP media session between an originating cellular telephone and  
3 a VoIP destination device, the application server comprising:  
4 logic configured to receive a first data message sent by an originating  
5 cellular telephone, the first data message comprising an identifier associated  
6 with a VoIP destination device;  
7 logic configured to send a second data message to the originating  
8 cellular telephone, the second data message comprising a temporary directory  
9 number (TDN) associated with the VoIP destination device which terminates at a  
10 media gateway;  
11 logic configured to receive a first session invite from the media gateway,  
12 in response to the media gateway detecting an incoming voice call to the TDN  
13 from the originating cellular telephone;  
14 logic configured to retrieve the identifier associated with the VoIP  
15 destination device; and  
16 logic configured to send a second session invite containing the identifier  
17 to the media gateway.

1 17. A media gateway for establishing a VoIP media session between an  
2 originating cellular telephone and a VoIP destination device, the media  
3 gateway comprising:  
4 a first interface device configured to communicate with a public  
5 switched telephone network (PSTN);  
6 a second interface device configured to communicate with an IP  
7 network;

8 logic configured to detect an incoming voice call to a temporary directory  
9 number (TDN), via the first interface device, from an originating cellular  
10 telephone;

11 logic configured to send, via the second interface device, a first invite  
12 message containing the TDN to an application server;

13 logic configured to receive, via the second interface device, a second  
14 invite message from the application server which contains an identifier for a VoIP  
15 destination device associated with the TDN;

16 logic configured to send, via the second interface device, a third invite  
17 message to the VoIP destination device;

18 logic configured to send, via the first interface device, a ringing indication  
19 to the originating cellular telephone;

20 logic configured to receive, via the second interface device, an accept  
21 reply from the VoIP destination device;

22 logic configured to answer the incoming voice call from the cellular  
23 telephone; and

24 logic configured to establish a VoIP media session between the  
25 originating cellular telephone and the VoIP destination device.

1 18. The media gateway of claim 17, wherein the VoIP media session  
2 comprises an RTP stream.

1 19. A mobile communication device comprising:

2 a user interface for enabling a user to select a VoIP destination device  
3 with which a VoIP media session is to be established;

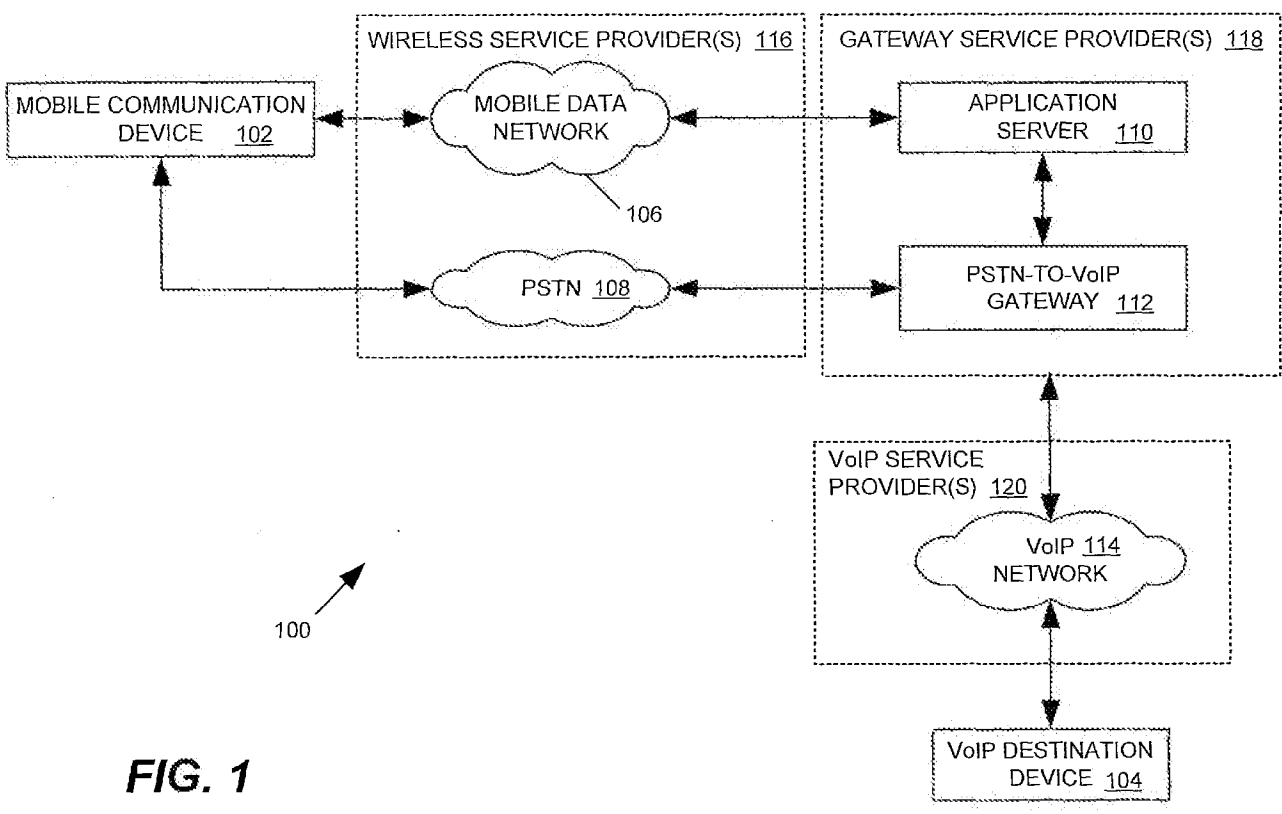
4 a wireless transceiver for communicating with a cellular network; and



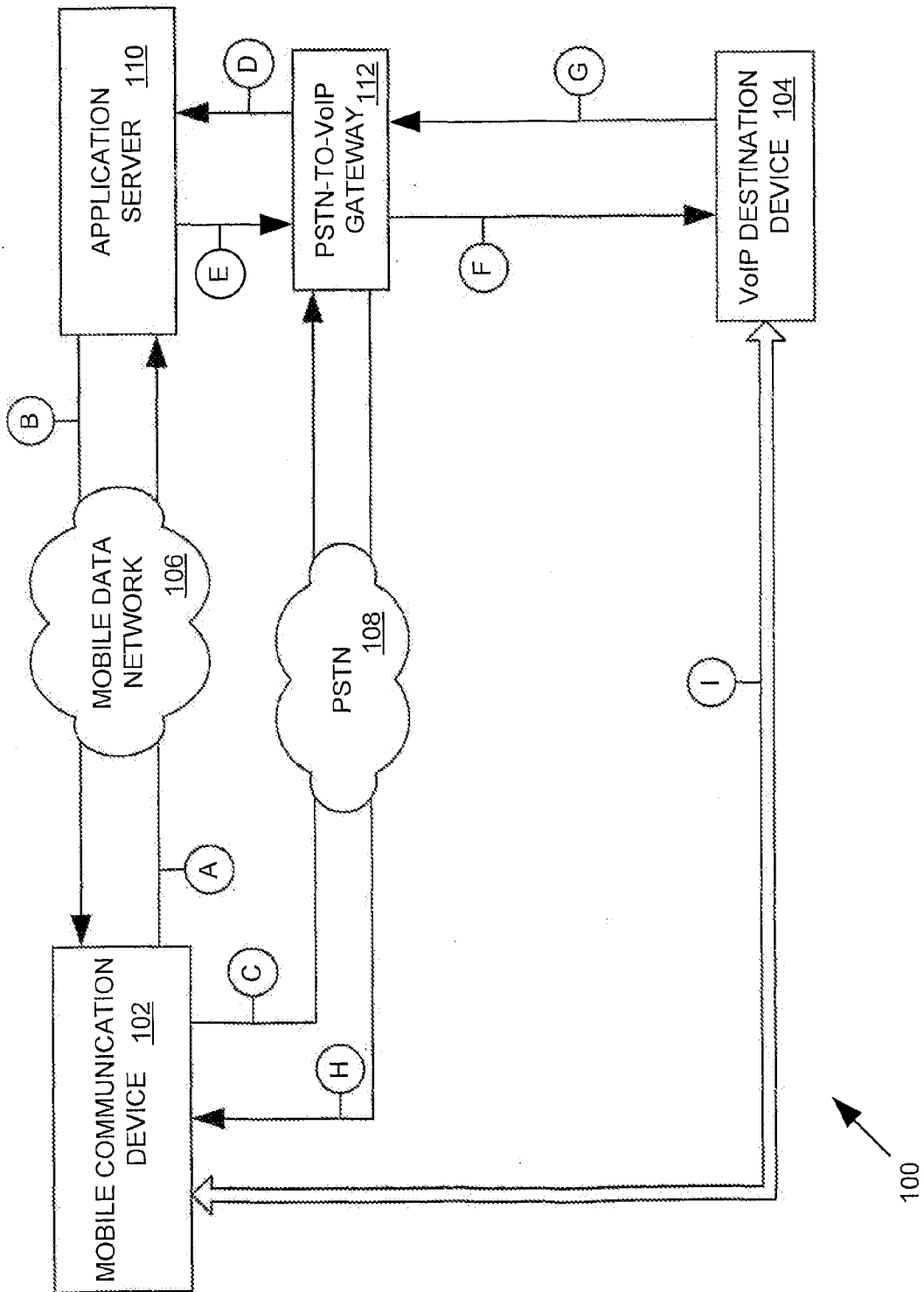
5 a cellular-to-VoIP call establishment module for facilitating the  
6 establishment of the VoIP media session between the mobile communication  
7 device and the VoIP destination device, the cellular-to-VoIP call establishment  
8 module comprising:  
9 logic configured to send a first data message via the cellular  
10 network, the first data message comprising an identifier associated with  
11 the VoIP destination device;  
12 logic configured to receive a second data message via the  
13 cellular network, the second data message comprising a temporary  
14 directory number (TDN) associated with the VoIP destination device;  
15 logic configured to initiate a voice call via the cellular network to  
16 the TDN; and  
17 logic configured to terminate the voice call and join the VoIP  
18 media session with the VoIP destination device.

1 20. A cellular telephone comprising:  
2 a user interface device for enabling a user to select a VoIP destination  
3 device with which a VoIP media session is to be established;  
4 a wireless transceiver for communicating with a cellular network; and  
5 a client application for facilitating the establishment of the VoIP media  
6 session between the cellular telephone and the VoIP destination device, the  
7 client application comprising:  
8 logic configured to send a first data message via the cellular  
9 network to an application server, the first data message comprising an  
10 identifier associated with the VoIP destination device;  
11 logic configured to receive a second data message via the  
12 cellular network from the application server, the second data message

13 comprising a temporary directory number (TDN) which the application  
14 server associates with the VoIP destination device;  
15 logic configured to initiate a voice call via the cellular network to  
16 the TDN; and  
17 logic configured to bridge the voice call with a VoIP media session  
18 between a media gateway and the VoIP destination device.



**FIG. 1**



**FIG. 2**

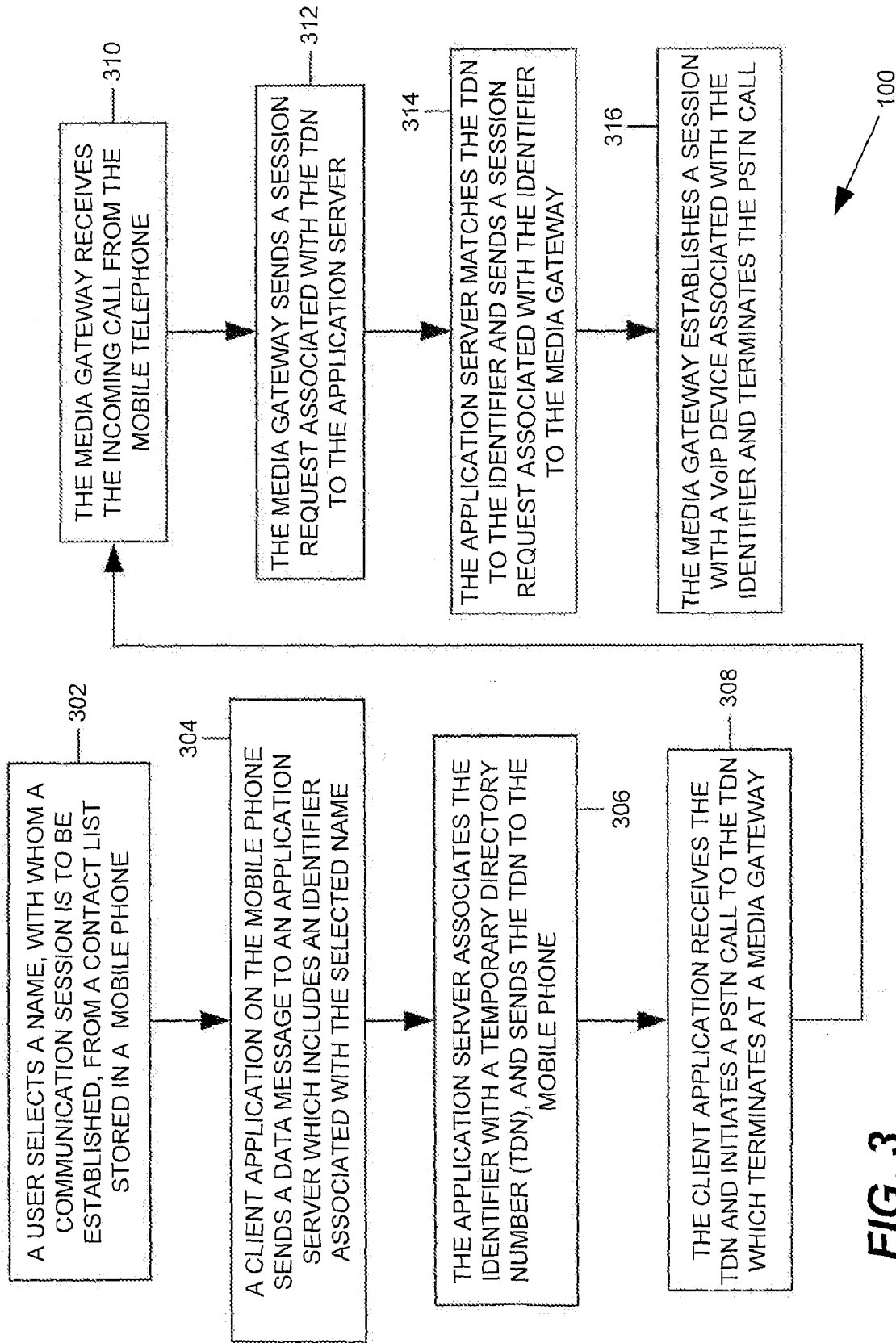
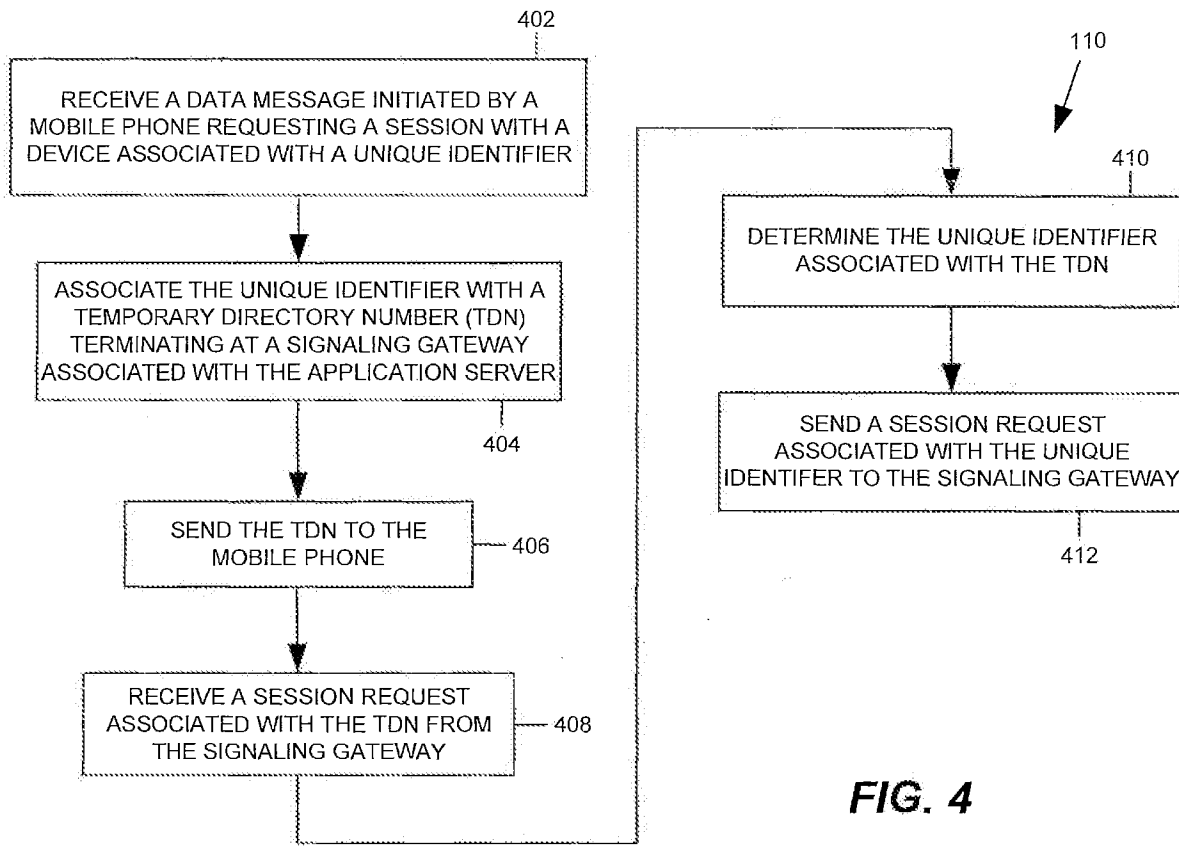


FIG. 3



**FIG. 4**

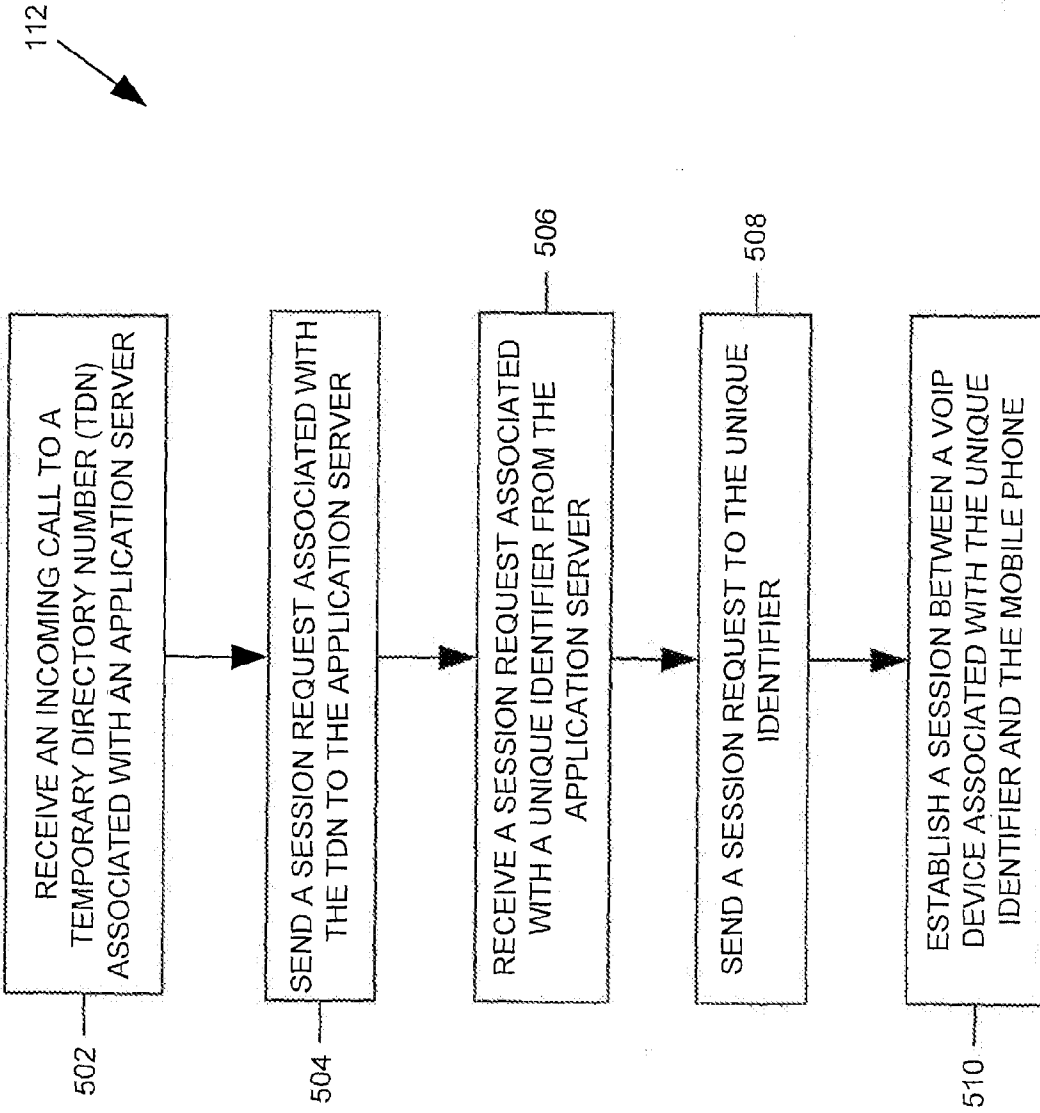


FIG. 5

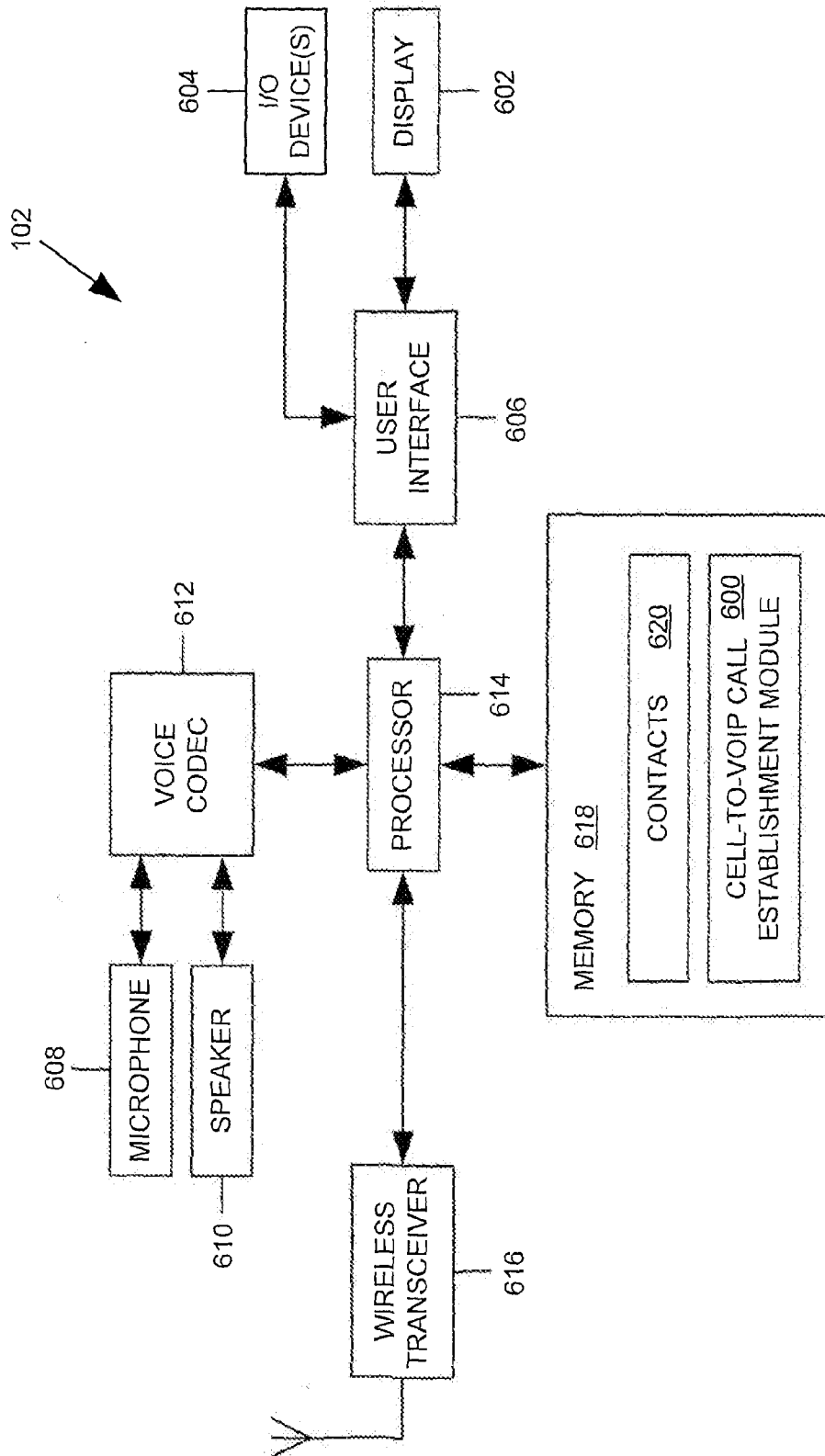
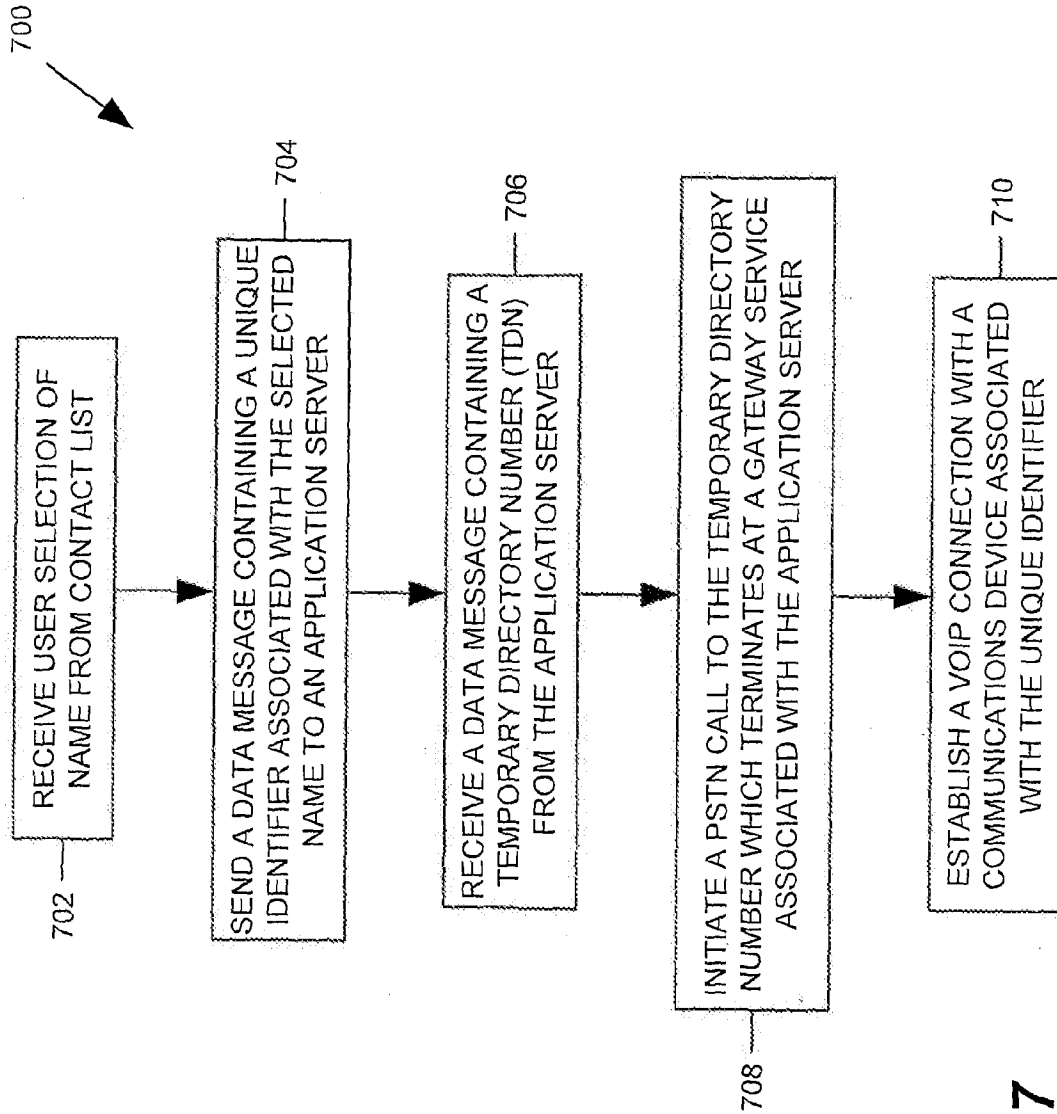
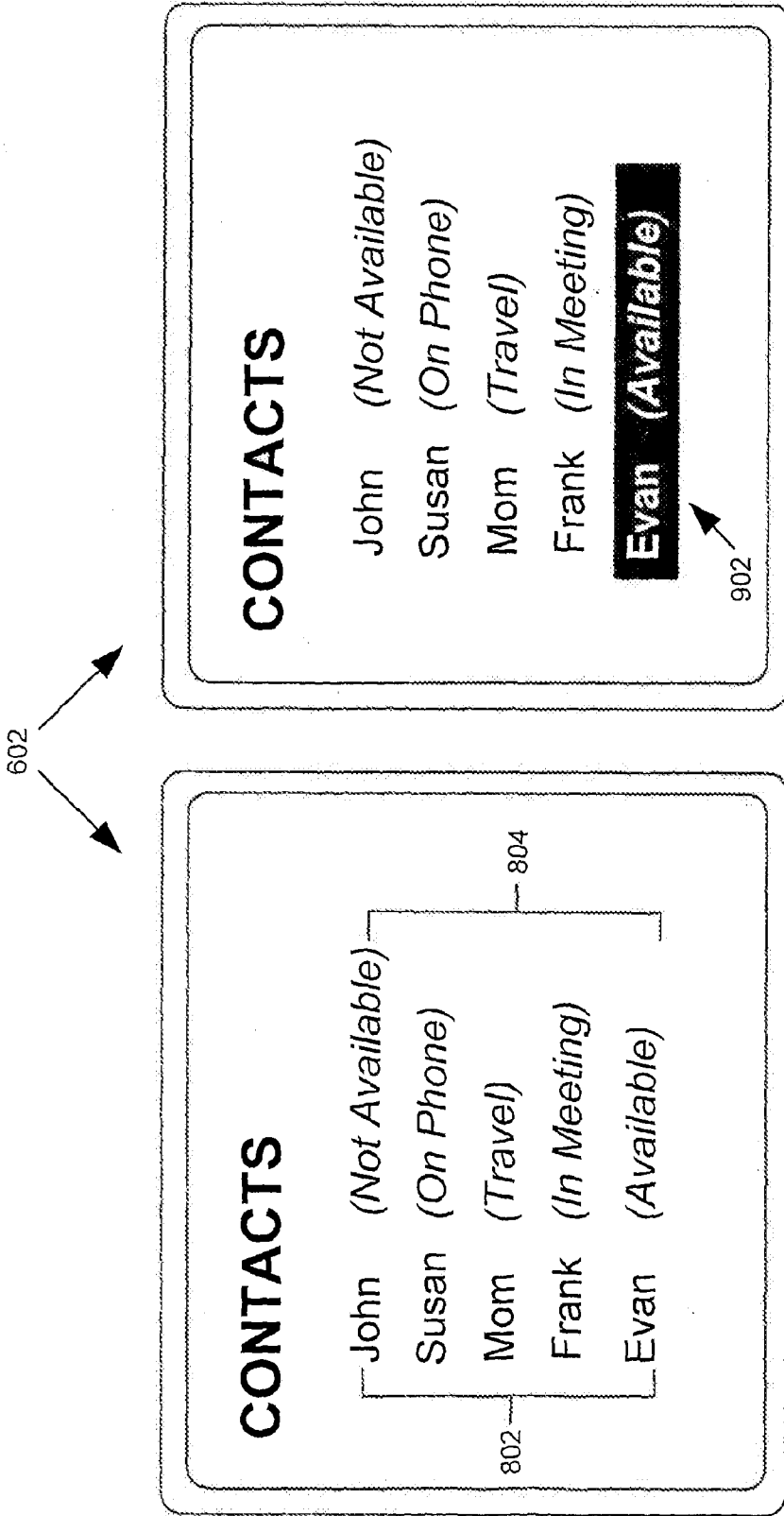


FIG. 6





**FIG. 7**



**FIG. 8**

**FIG. 9**

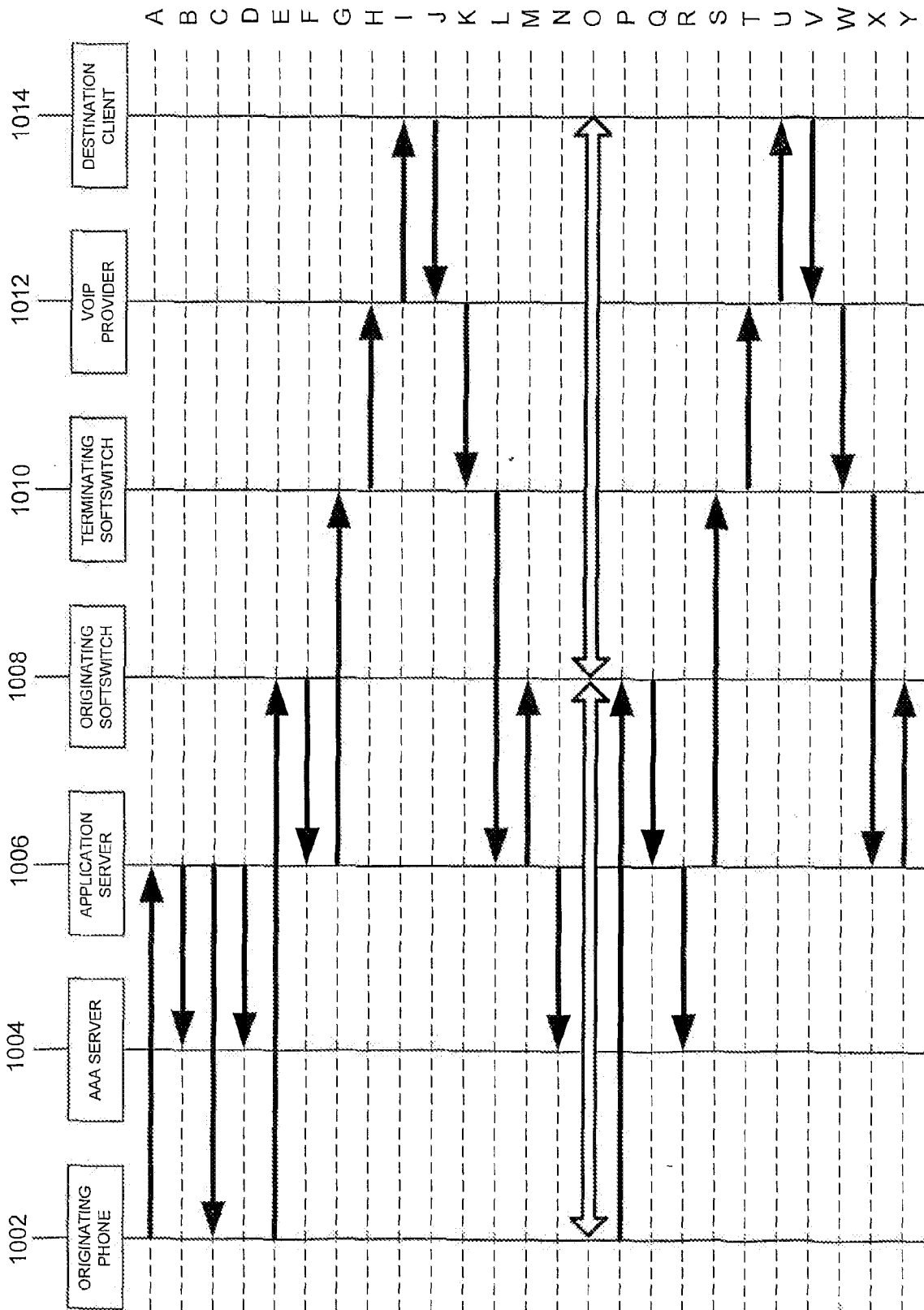


FIG. 10

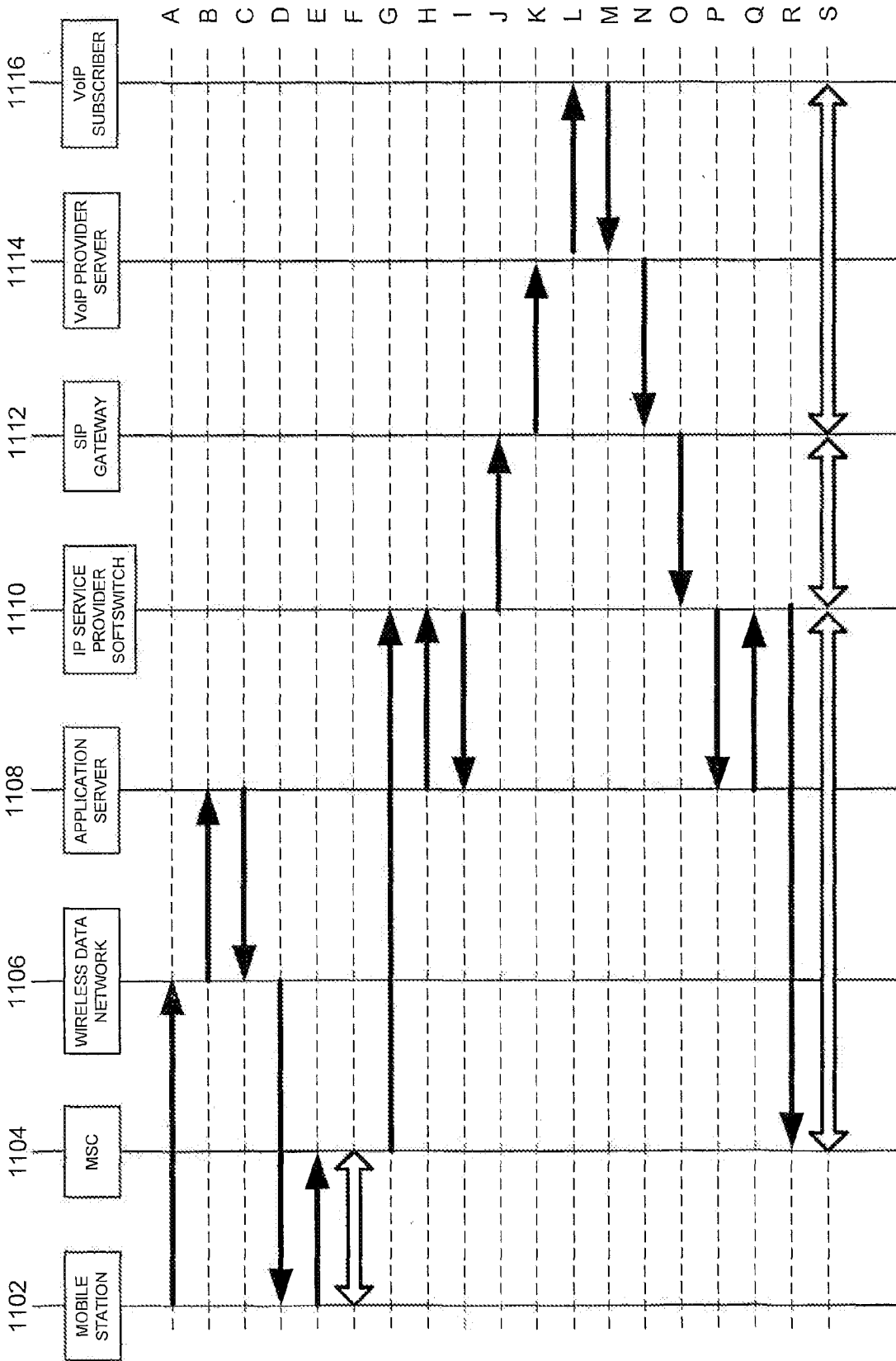


FIG. 11



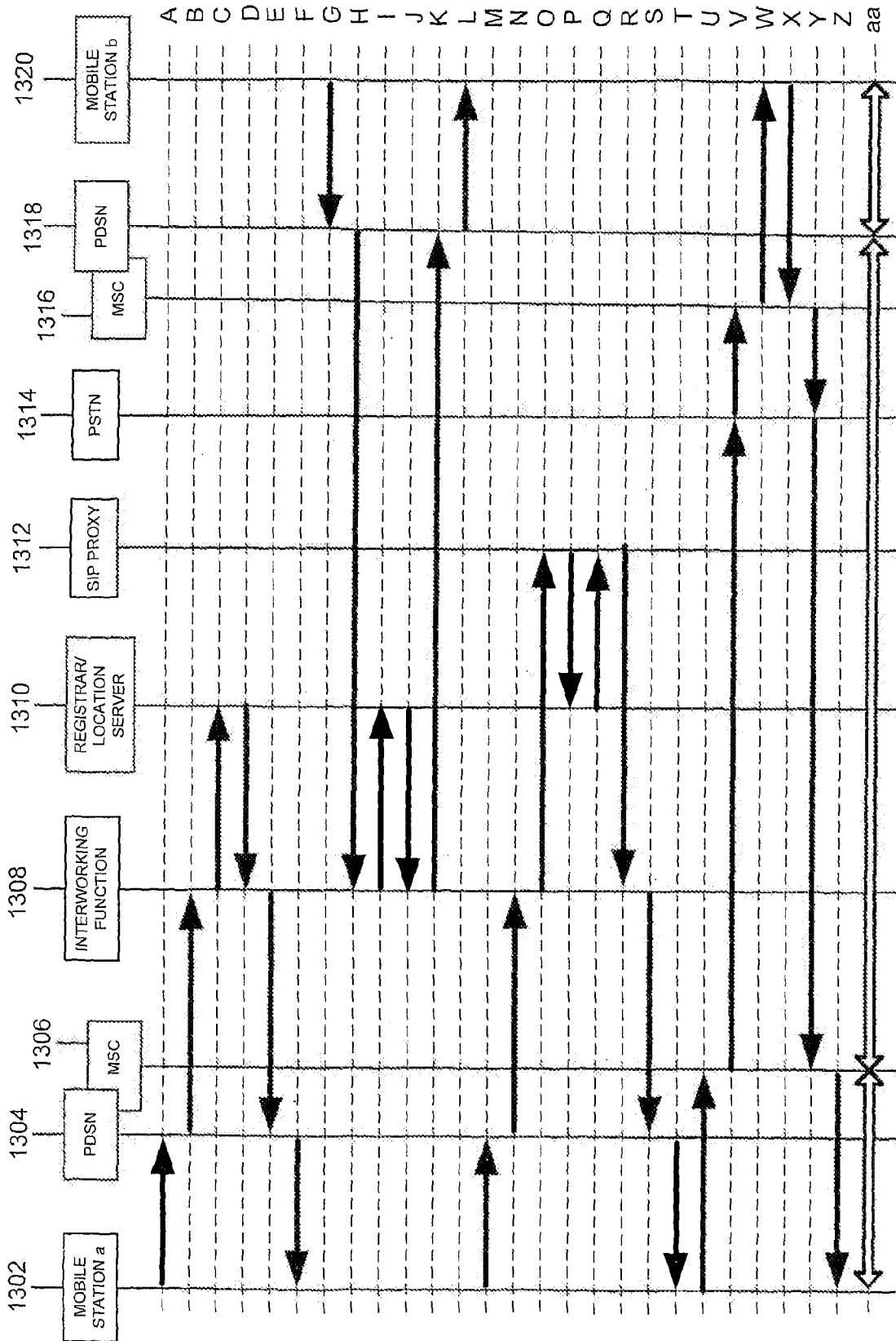


FIG. 13

INTERNATIONAL SEARCH REPORT

International application No.

PCT/US06/39482

A. CLASSIFICATION OF SUBJECT MATTER

IPC(8) - H04Q 7/20 (2007.01)

USPC - 455/445

According to International Patent Classification (IPC) or to both national classification and IPC

B. FIELDS SEARCHED

Minimum documentation searched (classification system followed by classification symbols)

IPC(8) - H04Q 7/20; H05B 1/00; H04L 12/66 (2007.01)

USPC - 455/445, 428, 518, 517; 370/352, 401, 466, 340 349

Documentation searched other than minimum documentation to the extent that such documents are included in the fields searched

Electronic data base consulted during the international search (name of data base and, where practicable, search terms used)

MicroPatent

C. DOCUMENTS CONSIDERED TO BE RELEVANT

| Category* | Citation of document, with indication, where appropriate, of the relevant passages  | Relevant to claim No. |
|-----------|-------------------------------------------------------------------------------------|-----------------------|
| X         | US 2006/0025140 A1 (BALES et al) 02 February 2006 (02.02.2006), entire document     | 1-13, 15-20           |
| Y         |                                                                                     | 14                    |
| Y         | WO 2006/077587 A2 (ITZKOVITZ et al) 27 July 2006 (27.07.2006), entire document      | 14                    |
| A         | US 6,996,414 B2 (VISHWANATHAN et al) 07 February 2006 (07.02.2006), entire document | 1-20                  |
| A         | US 4,723,238 A1 (ISREAL et al) 02 February 1998 (02.02.1998), entire document       | 1-20                  |
| A         | US 6,747,970 B1 (LAMB et al) 08 June 2004 (08.06.2004), entire document             | 1-20                  |

Further documents are listed in the continuation of Box C.

\* Special categories of cited documents:

"A" document defining the general state of the art which is not considered to be of particular relevance

"E" earlier application or patent but published on or after the international filing date

"L" document which may throw doubts on priority claim(s) or which is cited to establish the publication date of another citation or other special reason (as specified)

"O" document referring to an oral disclosure, use, exhibition or other means

"P" document published prior to the international filing date but later than the priority date claimed

"T" later document published after the international filing date or priority date and not in conflict with the application but cited to understand the principle or theory underlying the invention

"X" document of particular relevance: the claimed invention cannot be considered novel or cannot be considered to involve an inventive step when the document is taken alone

"Y" document of particular relevance: the claimed invention cannot be considered to involve an inventive step when the document is combined with one or more other such documents, such combination being obvious to a person skilled in the art

"&" document member of the same patent family

Date of the actual completion of the international search

12 March 2007

Date of mailing of the international search report

17 AUG 2007

Name and mailing address of the ISA/US

Mail Stop PCT, Attn: ISA/US, Commissioner for Patents

P. O. Box 1450, Alexandria, Virginia 22313-1450

Facsimile No. 571-273-3201

Authorized officer:

Blaine R. Copenheaver

PCT Helpdesk: 571-272-4300

PCT OSP: 571-272-7774

## Electronic Acknowledgement Receipt

|                                             |                                                             |
|---------------------------------------------|-------------------------------------------------------------|
| <b>EFS ID:</b>                              | 18910180                                                    |
| <b>Application Number:</b>                  | 13966096                                                    |
| <b>International Application Number:</b>    |                                                             |
| <b>Confirmation Number:</b>                 | 8712                                                        |
| <b>Title of Invention:</b>                  | PRODUCING ROUTING MESSAGES FOR VOICE OVER IP COMMUNICATIONS |
| <b>First Named Inventor/Applicant Name:</b> | CLAY PERRAULT                                               |
| <b>Customer Number:</b>                     | 20995                                                       |
| <b>Filer:</b>                               | John M Carson/Norman Green                                  |
| <b>Filer Authorized By:</b>                 | John M Carson                                               |
| <b>Attorney Docket Number:</b>              | SMARB19.001C1                                               |
| <b>Receipt Date:</b>                        | 30-APR-2014                                                 |
| <b>Filing Date:</b>                         | 13-AUG-2013                                                 |
| <b>Time Stamp:</b>                          | 18:02:24                                                    |
| <b>Application Type:</b>                    | Utility under 35 USC 111(a)                                 |

### Payment information:

|                        |    |
|------------------------|----|
| Submitted with Payment | no |
|------------------------|----|

### File Listing:

| Document Number | Document Description | File Name                        | File Size(Bytes)/<br>Message Digest               | Multi Part /.zip | Pages (if appl.) |
|-----------------|----------------------|----------------------------------|---------------------------------------------------|------------------|------------------|
| 1               |                      | IDS_SMARB19_001C1_04_30_2014.pdf | 85368<br>b6d6f32707ed7af98a0bb231ba66b0a2285d05eb | yes              | 2                |



| Multipart Description/PDF files in .zip description |                                                    |       |     |
|-----------------------------------------------------|----------------------------------------------------|-------|-----|
|                                                     | Document Description                               | Start | End |
|                                                     | Transmittal Letter                                 | 1     | 1   |
|                                                     | Information Disclosure Statement (IDS) Form (SB08) | 2     | 2   |

**Warnings:**

**Information:**

|   |                   |                          |                                                     |    |    |
|---|-------------------|--------------------------|-----------------------------------------------------|----|----|
| 2 | Foreign Reference | REF1__WO2007056158A2.pdf | 6843532<br>8950d1de610127108591cf89be266fa3413e824b | no | 90 |
|---|-------------------|--------------------------|-----------------------------------------------------|----|----|

**Warnings:**

**Information:**

|   |                   |                          |                                                      |    |    |
|---|-------------------|--------------------------|------------------------------------------------------|----|----|
| 3 | Foreign Reference | REF2__WO2008027065A1.pdf | 4387615<br>70db7096ceec475d9bfa1e11c34142e8153f28778 | no | 57 |
|---|-------------------|--------------------------|------------------------------------------------------|----|----|

**Warnings:**

**Information:**

|   |                       |                                |                                                    |    |   |
|---|-----------------------|--------------------------------|----------------------------------------------------|----|---|
| 4 | Non Patent Literature | REF3__EP_EESR_EP09802316_1.pdf | 500450<br>c10eecf83d282b4c70eb4a7303a4c34dcaf5ccd1 | no | 6 |
|---|-----------------------|--------------------------------|----------------------------------------------------|----|---|

**Warnings:**

**Information:**

|                                     |  |  |          |  |  |
|-------------------------------------|--|--|----------|--|--|
| <b>Total Files Size (in bytes):</b> |  |  | 11816965 |  |  |
|-------------------------------------|--|--|----------|--|--|

**This Acknowledgement Receipt evidences receipt on the noted date by the USPTO of the indicated documents, characterized by the applicant, and including page counts, where applicable. It serves as evidence of receipt similar to a Post Card, as described in MPEP 503.**

**New Applications Under 35 U.S.C. 111**

**If a new application is being filed and the application includes the necessary components for a filing date (see 37 CFR 1.53(b)-(d) and MPEP 506), a Filing Receipt (37 CFR 1.54) will be issued in due course and the date shown on this Acknowledgement Receipt will establish the filing date of the application.**

**National Stage of an International Application under 35 U.S.C. 371**

**If a timely submission to enter the national stage of an international application is compliant with the conditions of 35 U.S.C. 371 and other applicable requirements a Form PCT/DO/EO/903 indicating acceptance of the application as a national stage submission under 35 U.S.C. 371 will be issued in addition to the Filing Receipt, in due course.**

**New International Application Filed with the USPTO as a Receiving Office**

**If a new international application is being filed and the international application includes the necessary components for an international filing date (see PCT Article 11 and MPEP 1810), a Notification of the International Application Number and of the International Filing Date (Form PCT/RO/105) will be issued in due course, subject to prescriptions concerning national security, and the date shown on this Acknowledgement Receipt will establish the international filing date of the application.**

**INFORMATION DISCLOSURE STATEMENT**

Inventor : Clay Perrault, et al.  
App. No. : 13/966,096  
Filed : August 13, 2013  
For : PRODUCING ROUTING MESSAGES FOR  
VOICE OVER IP COMMUNICATIONS  
Examiner : Kizou, Hassan  
Art Unit : 2472  
Conf. No. : 8712

Commissioner for Patents  
P.O. Box 1450  
Alexandria, VA 22313-1450

**References and Listing**

Submitted herewith in the above-identified application is an Information Disclosure Statement listing references for consideration. Copies of any listed foreign and non-patent literature references are being submitted.

**Timing of Disclosure**

This Information Disclosure Statement is being filed before the receipt of a First Office Action on the merits, and presumably no fee is required. If a First Office Action on the merits was mailed before the mailing date of this Statement, the Commissioner is authorized to charge the fee set forth in 37 CFR 1.17(p) to Deposit Account No. 11-1410.

Respectfully submitted,

KNOBBE, MARTENS, OLSON & BEAR, LLP

Dated: \_\_\_\_\_

4/30/14

By: \_\_\_\_\_



John M. Carson  
Registration No. 34,303  
Attorney of Record  
Customer No. 20995  
(858) 707-4000

IDS  
17875834  
042814

|                                                          |                      |                 |
|----------------------------------------------------------|----------------------|-----------------|
| <b>INFORMATION DISCLOSURE<br/>STATEMENT BY APPLICANT</b> | Application No.      | 13/966,096      |
|                                                          | Filing Date          | August 13, 2013 |
|                                                          | First Named Inventor | Perrault, Clay  |
|                                                          | Art Unit             | 2472            |
| <i>(Multiple sheets used when necessary)</i>             | Examiner             | Kizou, Hassan   |
| SHEET 1 OF 1                                             | Attorney Docket No.  | SMARB19.001C1   |

| U.S. PATENT DOCUMENTS |          |                                                                                  |                                |                               |                                                                          |
|-----------------------|----------|----------------------------------------------------------------------------------|--------------------------------|-------------------------------|--------------------------------------------------------------------------|
| Examiner Initials     | Cite No. | Document Number<br><i>Number - Kind Code (if known)</i><br>Example: 1,234,567 B1 | Publication Date<br>MM-DD-YYYY | Name of Patentee or Applicant | Pages, Columns, Lines Where Relevant Passages or Relevant Figures Appear |

| FOREIGN PATENT DOCUMENTS |          |                                                                                           |                                |                               |                                                                          |                |
|--------------------------|----------|-------------------------------------------------------------------------------------------|--------------------------------|-------------------------------|--------------------------------------------------------------------------|----------------|
| Examiner Initials        | Cite No. | Foreign Patent Document<br><i>Country Code-Number-Kind Code</i><br>Example: JP 1234567 A1 | Publication Date<br>MM-DD-YYYY | Name of Patentee or Applicant | Pages, Columns, Lines Where Relevant Passages or Relevant Figures Appear | T <sup>1</sup> |
|                          | 1        | EP 2 090 024 A0                                                                           | 8/19/2009                      | Björzell et al.               |                                                                          |                |

| NON PATENT LITERATURE DOCUMENTS |          |                                                                                                                                                                                                                                                                 |                |
|---------------------------------|----------|-----------------------------------------------------------------------------------------------------------------------------------------------------------------------------------------------------------------------------------------------------------------|----------------|
| Examiner Initials               | Cite No. | Include name of the author (in CAPITAL LETTERS), title of the article (when appropriate), title of the item (book, magazine, journal, serial, symposium, catalog, etc.), date, page(s), volume-issue number(s), publisher, city and/or country where published. | T <sup>1</sup> |
|                                 | 2        | Extended European Search Report dated November 2, 2012 for European Application No. EP 07 855 436.7                                                                                                                                                             |                |

17537789  
032014

|                                                                                                                                                                                                                                                         |                 |
|---------------------------------------------------------------------------------------------------------------------------------------------------------------------------------------------------------------------------------------------------------|-----------------|
| Examiner Signature                                                                                                                                                                                                                                      | Date Considered |
| <p><b>*Examiner:</b> Initial if reference considered, whether or not citation is in conformance with MPEP 609. Draw line through citation if not in conformance and not considered. Include copy of this form with next communication to applicant.</p> |                 |

T<sup>1</sup> - Place a check mark in this area when an English language PENSIONER APPROPRIATE INC. EX. 1005-463

(19)



(11) Veröffentlichungsnummer:

(11) Publication number: **EP 2 090 024 A0**

(11) Numéro de publication:

Internationale Anmeldung veröffentlicht durch die  
Weltorganisation für geistiges Eigentum unter der Nummer:

**WO 2008/064481** (Art. 153(3) EPÜ).

International application published by the World  
Intellectual Property Organization under number:

**WO 2008/064481** (Art. 153(3) EPC).

Demande internationale publiée par l'Organisation  
Mondiale de la Propriété Intellectuelle sous le numéro:

**WO 2008/064481** (art. 153(3) CBE).

(19) World Intellectual Property Organization  
International Bureau



(43) International Publication Date  
5 June 2008 (05.06.2008)

PCT

(10) International Publication Number  
WO 2008/064481 A1

(51) International Patent Classification:  
H04L 12/26 (2006.01) H04M 11/06 (2006.01)  
H04L 12/66 (2006.01) H04M 3/22 (2006.01)

(74) Agent: SMART & BIGGAR; Box 11560 Vanconver Center, 2200 - 650 West Georgia Street, Vancouver, British Columbia V6B 4N8 (CA).

(21) International Application Number:  
PCT/CA2007/002150

(81) Designated States (unless otherwise indicated, for every kind of national protection available): AE, AG, AL, AM, AT, AU, AZ, BA, BB, BG, BH, BR, BW, BY, BZ, CA, CH, CN, CO, CR, CU, CZ, DE, DK, DM, DO, DZ, EC, EE, EG, ES, FI, GB, GD, GE, GH, GM, GT, HN, HR, HU, ID, IL, IN, IS, JP, KE, KG, KM, KN, KP, KR, KZ, LA, LC, LK, LR, LS, LT, LU, LY, MA, MD, ME, MG, MK, MN, MW, MX, MY, MZ, NA, NG, NI, NO, NZ, OM, PG, PH, PL, PT, RO, RS, RU, SC, SD, SE, SG, SK, SL, SM, SV, SY, TJ, TM, TN, TR, TT, TZ, UA, UG, US, UZ, VC, VN, ZA, ZM, ZW.

(22) International Filing Date:  
29 November 2007 (29.11.2007)

(25) Filing Language: English

(26) Publication Language: English

(30) Priority Data:  
60/861,431 29 November 2006 (29.11.2006) US

(84) Designated States (unless otherwise indicated, for every kind of regional protection available): ARIPO (BW, GH, GM, KE, LS, MW, MZ, NA, SD, SL, SZ, TZ, UG, ZM, ZW), Eurasian (AM, AZ, BY, KG, KZ, MD, RU, TJ, TM), European (AT, BE, BG, CH, CY, CZ, DE, DK, EE, ES, FI, FR, GB, GR, HU, IE, IS, IT, LT, LU, LV, MC, MT, NL, PL, PT, RO, SE, SI, SK, TR), OAPI (BF, BJ, CF, CG, CI, CM, GA, GN, GQ, GW, ML, MR, NE, SN, TD, TG).

(71) Applicant (for all designated States except US): DIGIFONICA (INTERNATIONAL) LIMITED [CA/CA]; Suite 1401, 4710 Kingsway Avenue, Burnaby, British Columbia V5H 4M2 (CA).

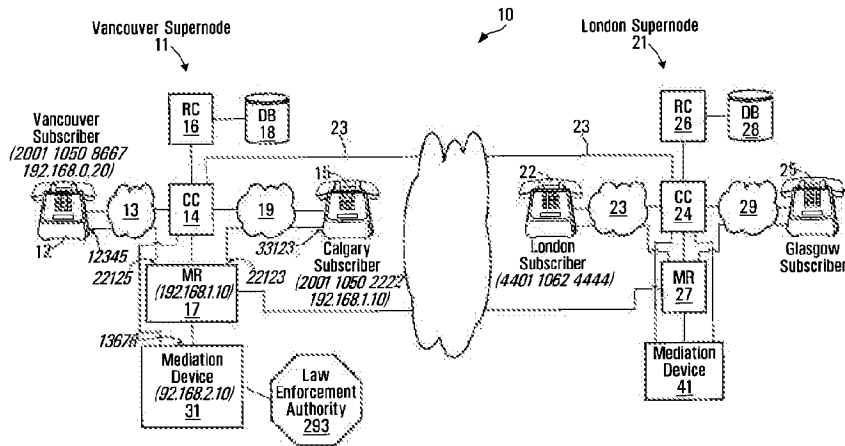
(72) Inventors; and

(75) Inventors/Applicants (for US only): BJORSELL, Johan Emil Victor [SE/CA]; 273 West 5th Street, North Vancouver, British Columbia V7M 1J9 (CA). SOBOLYEV, maksym [UA/CA]; 307-265 Tenth Street, New Westminster, BC, V3M 3Y1 (CA).

Published:

- with international search report
- with amended claims

(54) Title: INTERCEPTING VOICE OVER IP COMMUNICATIONS AND OTHER DATA COMMUNICATIONS



(57) Abstract: Methods and apparatus for intercepting communications in an Internet Protocol (IP) network involve maintaining dialing profiles for respective subscribers to the IP network, each dialing profile including a username associated with the corresponding subscriber, and associating intercept information with the dialing profile of a subscriber whose communications are to be monitored. Intercept information will include determination information for determining whether to intercept a communication involving the subscriber, and destination information identifying a device to which intercepted communications involving the subscriber are to be sent. When the determination information meets intercept criteria communications are established with a media relay through which communications involving the subscriber will be conducted or are being conducted to cause the media relay to send a copy of the communications involving the subscriber to a mediation device specified by the destination information.

WO 2008/064481 A1

## INTERCEPTING VOICE OVER IP COMMUNICATIONS AND OTHER DATA COMMUNICATIONS

### CROSS REFERENCE TO RELATED APPLICATIONS

5 This application claims the benefit of U.S. Provisional Application No. 60/861,431 filed November 29, 2006.

### BACKGROUND OF THE INVENTION

#### 1. Field of Invention

10 This invention relates to data communications and methods and apparatus for intercepting data communications, particularly voice over IP data communications, in an IP network.

#### 2. Description of Related Art

15 The term "lawful intercept" is used to describe a procedure which allows law enforcement agencies to perform electronic surveillance of telecommunications. Lawful intercept of telecommunications, particularly phone calls, is premised on a notion that a law enforcement agency has identified a person of interest, obtained a legal authorization for the surveillance (for example, a judicial or administrative warrant), and then  
20 contacted the person's telecommunications service provider that will be required to provide the law enforcement agency with a real-time copy of the person's communications. This real-time copy can then be used by the law enforcement agency to monitor or record the person's communications.

25 Within the framework of traditional telecommunications networks, such as, for example, the Public Switched Telephone Network (PSTN) or cellular networks, lawful intercept generally presents a purely economic problem for the service providers that have to ensure that sufficient interception equipment and dedicated links to the law enforcement agencies have been  
30 deployed to satisfy lawful intercept requirements mandated by law. However, in the context of Voice over Internet Protocol (VoIP) communications, in addition to the economic problems mentioned above, lawful intercept presents

-2-

significant technological challenges which often makes compliance with legally mandated lawful intercept requirements exceedingly difficult.

5 The problem lies in the very nature of the VoIP technology and the Internet Protocol (IP) networks (for example, the Internet) that underlie it.

10 Traditional telecommunications networks are "connection-oriented" or "circuit-switched". Communications over such networks occur via dedicated "circuits". Although the networks typically comprise a plurality of available parallel paths, when a circuit is established, only a single one of the available paths is picked. In situations where a circuit has failure protection, a redundant path, also determined at the time of the circuit establishment, can also be reserved. Once the circuit is established, all communications traverse from end to end. Interception of such communications is easy as the service provider can "tap" the circuit at any point in the network that is under its lawful control.

20 In contrast to circuit-switched networks, IP-based networks are "connectionless" by design. A connectionless IP network essentially comprises a plurality of interconnected network devices (routers) which establish a plurality of paths from any point on the network to any other point. Information that needs to traverse an IP network is divided into small "packets", each one comprising an IP header containing source and destination addressing information, and service flags; and user payload. The specific path that each packet in a communication between parties takes across an IP network is not determined in advance such as in a circuit-switched network. The path is defined on a hop-by-hop basis (router-by-router), each router at which the packet arrives examines the source and destination addresses contained in the IP header and applies a number of service variables such as hop-count (number of routers between the current router and the destination), latency and bandwidth of available links, and administrative considerations such as inter-provider agreements, to determine

25

30

-3-

the next hop to which the packet will be forwarded. Because the service variables change dynamically, for example in response to a failure of a link in the network, the available paths may change significantly and it is impossible to reliably predict the path or paths that the packets that comprise a specific communication will traverse. Furthermore, it is not even possible to predict the order in which the packets will arrive at their destination as the different paths taken may have different latency. While the plurality of available paths and out-of-order arrivals present no problems to IP-based applications that usually keep track of the packet sequence to reassemble the communication, the same factors present formidable problems for the lawful intercept of communication over IP networks, particularly lawful intercept of VoIP calls.

The problem of lawful intercept in VoIP systems is further exacerbated by the distributed technologies often utilized in such systems. While a VoIP caller typically communicates with a VoIP call controller to facilitate the connection to the VoIP callee, the actual communication between the parties typically occurs by establishing a direct IP connection between them using the User Datagram Protocol (UDP) to encapsulate audio information into IP packets. These packets may take any available path across the IP network as described above. Even if a service provider could place an interception device at every point in the network through which a subscriber's packet could traverse, in order to provide a useful copy of the communication to a law enforcement agency, the service provider would have to reassemble all of the intercepted packets at a single device and only then pass the result to the law enforcement agency. In essence, the service provider would have to mirror the functions of the callee VoIP telephone, except the packets that comprise the communication would have to be collected from multiple points in the network. The technological challenges and economic costs associated with this proposition have thus far resulted in lack of meaningful lawful intercept capabilities in VoIP systems.



-4-

**SUMMARY OF THE INVENTION**

In accordance with one aspect of the invention, there is provided a method for intercepting communications in an Internet Protocol (IP) network. The method involves maintaining dialing profiles for respective subscribers to the IP network, each dialing profile including a username associated with the corresponding subscriber. The method also involves associating intercept information with the dialing profile of a subscriber whose communications are to be monitored, the intercept information including determination information for determining whether to intercept a communication involving the subscriber, and destination information identifying a device to which intercepted communications involving the subscriber are to be sent. The method further involves, when the determination information meets intercept criteria, communicating with a media relay through which the communications involving the subscriber will be conducted or are being conducted to cause the media relay to send a copy of the communications to a mediation device specified by the destination information.

Associating intercept information may involve associating the intercept information with the dialing profile when communications involving the subscriber are not in progress.

Associating intercept information may involve associating the intercept information when communications involving the subscriber are in progress.

Associating the intercept information may involve populating intercept information fields in the dialing profile of the subscriber whose communications are to be monitored.

The method may involve producing a routing message for routing communications involving the subscriber through components of the IP network and determining whether the determination information meets the

-5-

intercept criteria prior to producing the routing message and including at least some of the intercept information in the routing message when the determination information meets the intercept criteria.

- 5 Determining whether the determination information meets the intercept criteria may involve determining whether a current date and time is within a range specified by the determination information.

10 The method may involve identifying a media relay through which communications involving the subscriber will be conducted in response to the routing message.

15 The method may involve pre-associating at least one media relay with the dialing profile of the subscriber whose communications are to be monitored and identifying the media relay may involve identifying the media relay pre-associated with the subscriber whose communications are to be monitored.

20 Pre-associating may involve populating media relay fields in the dialing profile with an identification of at least one media relay.

The intercept information may be associated with the dialing profile of the subscriber whose communications are to be monitored, in response to receipt of an intercept request message, and the intercept request message may include the intercept information.

25 The method may involve invoking an intercept request message handler to find a dialing profile associated with the subscriber whose communications are to be monitored, and to perform the step of associating the intercept information with the dialing profile, and to determine whether the intercept  
30 criteria are met, and identify a media relay through which the communications are being conducted.

-6-

5 The method may involve maintaining active call records for communications in progress, and the active call records may include a username identifier and a media relay identifier identifying the media relay through which the communications are being conducted and identifying a media relay through which the communications are being conducted may involve locating an active call record associated with communications of the subscriber whose communication are to be monitored to find the media relay associated with the communications.

10 The method may involve maintaining direct-inward-dialing (DID) records associating PST telephone numbers with usernames of users subscribing to the IP network, and finding a dialing profile associated with the subscriber whose communications are to be monitored may involve finding a username in a DID record bearing a PSTN number associated with the subscriber  
15 whose communications are to be monitored. The username may be used to locate a dialing profile associated with the username.

In accordance with another aspect of the invention, there is provided an apparatus for intercepting communications in an Internet Protocol (IP)  
20 network. The apparatus includes provisions for maintaining dialing profiles for respective subscribers to the IP network, each dialing profile including a username associated with the corresponding subscriber. The apparatus also includes provisions for associating intercept information with the dialing profile of a subscriber whose communications are to be monitored, the intercept  
25 information including determination information for determining whether to intercept a communication involving the subscriber, and destination information identifying a device to which intercepted communications involving the subscriber are to be sent. The apparatus further includes provisions for communicating with a media relay through which the communications  
30 involving the subscriber will be conducted or are being conducted to cause the media relay to send a copy of the communications to a mediation device

-7-

specified by the destination information, when the determination information meets intercept criteria.

5 The provisions for associating intercept information may be operably configured to associate the intercept information with the dialing profile when communications involving the subscriber are not in progress.

10 The provisions for associating intercept information may be operably configured to associate the intercept information when communications involving the subscriber are in progress.

15 The provisions for associating the intercept information may be operably configured to populate intercept information fields in the dialing profile of the subscriber whose communications are to be monitored.

20 The apparatus may further include provisions for producing a routing message for routing communications involving the subscriber through components of the IP network and provisions for determining whether the determination information meets the intercept criteria prior to producing the routing message and the provisions for producing the routing message may be operably configured to include at least some of the intercept information in the routing message when the determination information meets the intercept criteria.

25 The provisions for determining whether the determination information meets the intercept criteria may be operably configured to determine whether a current date and time is within a range specified by the determination information.

30 The apparatus may further include provisions for identifying a media relay through which communications involving the subscriber will be conducted in response to the routing message.

-8-

5 The apparatus may further include provisions for pre-associating at least one media relay with the dialing profile of the subscriber whose communications are to be monitored and the routing provisions may be operably configured to identify from the dialing profile the media relay pre-associated with the subscriber whose communications are to be monitored.

10 The provisions for pre-associating may be operably configured to populate media relay fields in the dialing profile with an identification of at least one media relay.

15 Provisions for associating the intercept information may be operably configured to associate the intercept information associated with the dialing profile of the subscriber whose communications are to be monitored, in response to receipt of an intercept request message, wherein the intercept request message comprises the intercept information.

20 The apparatus may further include provisions for handling an intercept request message. The provisions for handling an intercept request message may include provisions for finding a dialing profile associated with the subscriber whose communications are to be monitored. The provisions for finding a dialing profile may cooperate with the provisions for associating the intercept information with the dialing profile to cause the intercept information to be associated with the dialing profile. The provisions for handling an intercept request message may include provisions for determining whether the intercept criteria are met and provisions for identifying a media relay through which the communications are being conducted.

30 The apparatus may further include provisions for maintaining active call records for communications in progress, the active call records including a username identifier and a media relay identifier identifying the media relay through which the communications are being conducted and the provisions for

-9-

identifying a media relay through which the communications are being conducted may be operably configured to locate an active call record associated with communications of the subscriber whose communication are to be monitored to find the media relay associated with the communications.

5

The apparatus may further include provisions for maintaining direct-inward-dialing (DID) records associating PST telephone numbers with usernames of users subscribing to the IP network, and the provisions for finding a dialing profile associated with the subscriber whose communications are to be monitored may be operably configured to find a username in a DID record bearing a PSTN number associated with the subscriber whose communications are to be monitored and use the username to locate a dialing profile associated with the username.

10

15

By employing a media replay, all VoIP communications traverse a point in the VoIP system that is under a provider's control and at which the communications can be copied in real-time to a mediation device that passes the intercepted communication to a law enforcement agency.

20

By maintaining dialing profiles for respective subscribers and associating intercept information of the type described, with the dialing profiles of subscribers whose communications are to be monitored, the dialing profile can serve as the source of determination information for determining whether or not communications involving the subscriber will be monitored and for providing destination information for specifying where the copy of the communications is to be sent. Use of the dialing profile in this manner easily facilitates the dialing profile to be considered a repository for intercept information for a given subscriber and this repository can be addressed whether a call is being initiated or in progress, thereby simplifying control algorithms because they can cooperate with a common source and format of data in the dialing profile.

25

30

-10-

Other aspects and features of the present invention will become apparent to those ordinarily skilled in the art upon review of the following description of specific embodiments of the invention in conjunction with the accompanying figures.

5

**BRIEF DESCRIPTION OF THE DRAWINGS**

In drawings which illustrate embodiments of the invention,

10      **Figure 1**      is a block diagram of a system according to a first embodiment of the invention;

**Figure 2**      is a block diagram of a caller VoIP telephone according to the first embodiment of the invention;

15      **Figure 3**      is a schematic representation of a SIP Invite message transmitted between the caller telephone and a call controller (CC) shown in Figure 1;

**Figure 4**      is a block diagram of the call controller shown in Figure 1;

20

**Figure 5**      is a flowchart of a process executed by the call controller shown in Figure 1;

**Figure 6**      is a schematic representation of a routing controller (RC) request message produced by the call controller shown in Figure 1;

25

**Figure 7**      is a block diagram of a routing controller (RC) processor circuit of the system shown in Figure 1;

30      **Figures 8A-8D**      are flowcharts of a RC Request message handler executed by the RC processor circuit shown in Figure 7;

-11-

- Figure 9 is a tabular representation of a dialing profile stored in a database accessible by the RC shown in Figure 1;
- 5 Figure 10 is a tabular representation of a dialing profile for a Vancouver subscriber ;
- Figure 11 is a tabular representation of a dialing profile for a Calgary subscriber;
- 10 Figure 12 is a tabular representation of a dialing profile for a London subscriber;
- Figure 13 is a tabular representation of a direct-inward-dialing (DID) bank table record stored in the database shown in Figure 1;
- 15 Figure 14 is a tabular representation of an exemplary DID bank table record for the London subscriber referenced in Figure 12;
- Figure 15 is a tabular representation of a routing message transmitted from the routing controller to the call controller shown in Figure 1;
- 20 Figure 16 is a tabular representation of a routing message buffer holding a routing message for routing a call to the London callee referenced in Figure 12;
- 25 Figure 16A is a tabular representation of a routing message buffer holding a message for routing a call to the London callee and to a law enforcement agency for the purpose of lawful intercept;
- 30 Figure 17 is a tabular representation of a prefix to supernode table record stored in the database shown in Figure 1;



-12-

- Figure 18 is a tabular representation of a prefix to supernode table record that would be used for the Calgary callee referenced in Figure 11;
- 5 Figure 19 is a tabular representation of a master list record stored in a master list table in the database shown in Figure 1;
- Figure 20 is a tabular representation of an exemplary populated master list record;
- 10 Figure 21 is a tabular representation of a suppliers list record stored in the database shown in Figure 1;
- Figure 22 is a tabular representation of a specific supplier list record for a first supplier;
- 15 Figure 23 is a tabular representation of a specific supplier list record for a second supplier;
- Figure 24 is a tabular representation of a specific supplier list record for a third supplier;
- 20 Figure 25 is a tabular representation of a routing message, held in a routing message buffer, identifying to the routing controller a plurality of possible suppliers that may carry the call;
- 25 Figure 25A is a tabular representation of a routing message held in a routing message buffer, with lawful intercept fields appended;
- Figure 26 is a tabular representation of a call block table record;
- 30 Figure 27 is a tabular representation of a call block table record for the Calgary callee;

-13-

- Figure 28 is a tabular representation of a call forwarding table record;
- 5 Figure 29 is a tabular representation of an exemplary call forwarding table record specific for the Calgary callee;
- Figure 30 is a tabular representation of a voicemail table record specifying voicemail parameters to enable the caller to leave a voicemail message for the callee;
- 10 Figure 31 is a tabular representation of an exemplary voicemail table record for the Calgary callee;
- Figure 32 is a tabular representation of an exemplary routing message, held in a routing message buffer, indicating call forwarding numbers and a voicemail server identifier;
- 15 Figure 32A is a tabular representation of an exemplary routing message, held in a routing message buffer, indicating call forwarding numbers and a voicemail server identifier with caller lawful intercept fields appended;
- 20 Figure 32B is a tabular representation of an exemplary routing message, held in a routing message buffer, indicating call forwarding numbers and a voicemail server identifier with caller and callee lawful intercept fields appended;
- 25 Figure 33 is a flowchart of a routing message handler process executed by the call controller.
- 30

-14-

- Figure 34 is a schematic representation of messages exchanged during execution of process for establishing audio paths between telephones and a media relay;
- 5 Figure 35 is a tabular representation of an active call record maintained by the call controller of Figure 1;
- Figure 36 is a tabular representation of an active call record maintained by the routing controller of Figure 1;
- 10 Figure 37 is a tabular representation of a SIP Invite message transmitted from the call controller to the mediation device;
- Figure 38 is a tabular representation of a SIP OK message transmitted from the mediation device to the call controller.
- 15 Figure 39 is a tabular representation of a SIP Bye message transmitted from either of the telephones shown in Figure 1 to the call controller;
- 20 Figure 40 is a tabular representation of a SIP Bye message sent to the call controller from the Calgary callee;
- Figure 41 is a flowchart of a process executed by the call controller for producing a RC stop message in response to receipt of a SIP Bye message;
- 25 Figure 42 is a tabular representation of an exemplary RC Call Stop message;
- 30 Figure 43 is a tabular representation of an exemplary RC Call Stop message for the Calgary callee;

-15-

Figure 44 is a flowchart of a routing controller Law Enforcement Authority request message handler executed by the routing controller shown in Figure 1;

5 Figure 45 is a flowchart of a call controller in-call intercept message handler executed by the call controller shown in Figure 1;

Figure 46 is a flowchart of a routing controller in-call intercept shut down routine executed by the routing controller shown in Figure 1;

10

Figure 47 is a flowchart of a call controller cease intercept message handler routing executed by the call controller shown in Figure 1.

#### DETAILED DESCRIPTION

15 Referring to Figure 1, a system for making voice over IP telephone calls is shown generally at 10. The system includes a first supernode shown generally at 11 and a second supernode shown generally at 21. The first supernode 11 is located in a geographical area, such as Vancouver B.C., for example and the second supernode 21 is located in London England, for example. Different supernodes may be located in different geographical regions throughout the world to provide telephone service to subscribers in respective regions. These supernodes may be in communication with each other through high speed / high data throughput links including optical fiber, satellite and/or cable links, for example, forming a system backbone. These  
20 supernodes may alternatively or in addition be in communication with each other through conventional Internet services. In the embodiment shown, data communication media for providing for data communications between the first and second supernodes 11 and 21 are shown generally at 23 and may include very high speed data links, for example.

30

In the embodiment shown, the Vancouver supernode 11 provides telephone service to a geographical region comprising Western Canadian customers

-16-

from Vancouver Island to Ontario and includes a Vancouver subscriber and a Calgary subscriber. Another supernode (not shown) may be located in Eastern Canada to provide services to subscribers in that area.

5 Other, smaller supernodes similar to the type shown may also be employed within the geographical area serviced by a supernode, to provide for call load sharing, for example within a region of the geographical area serviced by the supernode. However, in general, all supernodes are similar and have the properties described below in connection with the Vancouver supernode 11.

10

In this embodiment, the Vancouver supernode includes a call controller (CC) 14, a routing controller (RC) 16, a database 18, a media relay 17 and one or more mediation devices (MD), only one of which is shown at 31. Subscribers such as the Vancouver subscriber and the Calgary subscriber communicate with the Vancouver supernode 11 using their own Internet Service Providers (ISPs) 13 and 19 which route Internet traffic from these subscribers over the Internet. To these subscribers the Vancouver supernode 11 is accessible at a pre-determined IP address or a fully qualified domain name (FQDN) so that it can be accessed in the usual way through a subscriber's ISP. The subscriber in the city of Vancouver uses a telephone 12 that is capable of communicating with the Vancouver supernode 11 using Session Initiation Protocol (SIP) messages and the Calgary subscriber uses a similar telephone 15, to communicate with the Vancouver supernode from Calgary, AB.

15

20

25

30

It should be noted that throughout the description of the embodiments of this invention, the IP/UDP addresses of all elements such as the caller and callee telephones, call controller, media relay, and any others, will be assumed to be valid IP/UDP addresses directly accessible via the Internet or a private IP network, for example, depending on the specific implementation of the system. As such, it will be assumed, for example, that the caller and callee telephones will have IP/UDP addresses directly accessible by the call controllers and the media relays on their respective supernodes, and that will

-17-

not be obscured by Network Address Translation (NAT) or similar mechanisms. In other words, the IP/UDP information contained in SIP messages (for example the SIP Invite message or the RC Request message which will be described below) will match the IP/UDP addresses of the IP packets carrying these SIP messages.

It will be appreciated that in many situations, the IP addresses assigned to various elements of the system may be in a private IP address space, and thus not directly accessible from other elements. Furthermore, it will also be appreciated that NAT is commonly used to share a “public” IP address between multiple devices, for example between home PCs and IP telephones sharing a single Internet connection. For example, a home PC may be assigned an IP address such as **192.168.0.101** and a Voice over IP telephone may be assigned an IP address of **192.168.0.103**. These addresses are located in so called “non-routable” address space and cannot be accessed directly from the Internet. In order for these devices to communicate with other computers located on the Internet, these IP addresses have to be converted into a “public” IP address, for example **24.10.10.123** assigned to the subscriber by the Internet Service Provider, by a device performing NAT, typically a home router. In addition to translating the IP addresses, the NAT typically also translates UDP port numbers, for example an audio path originating at an IP telephone and using a UDP port **12378** at its private IP address may have been translated to a UDP port **23465** associated with the public IP address of the NAT device. In other words, when a packet originating from the above IP telephone arrives at an Internet-based supernode, the source IP/UDP address contained in the IP packet header will be **24.10.10.1:23465**, whereas the source IP/UDP address information contained in the SIP message inside this IP packet will be **192.168.0.103:12378**. The mismatch in the IP/UDP addresses may cause a problem for SIP-based systems because, for example, a supernode will attempt to send messages to a private address of a telephone – the messages will never get there.

-18-

It will be appreciated that a number of methods are available to overcome this problem. For example, the SIP NATHelper open source software module may run on the supernode to correlate public IP/UDP address contained in the headers of the IP packets arriving from SIP devices with private IP/UDP addresses in the SIP messages contained in these packets. Therefore, the embodiments of the invention described below will function whether or not any of the elements of the system are located behind NAT devices that obscure their real IP/UDP addresses.

Referring to Figure 1, in an attempt to make a call by the Vancouver telephone 12 to the Calgary telephone 15, for example, the Vancouver telephone sends a SIP Invite message to the Vancouver supernode 11 and in response, the call controller 14 sends an RC Request message to the routing controller 16 which makes various enquiries of the database 18 to produce a routing message which is sent to the call controller 14. The call controller 14 then causes a communications link including audio paths to be established through the media relay 17 which may include the same Vancouver supernode 11, a different supernode or a communications supplier gateway, for example, to carry voice traffic to and from the call recipient or callee. Subject to certain conditions being satisfied, as will be described below, when lawful intercept of data is to occur, data on the audio paths is copied to the mediation device 31 which may provide for real time listening of the audio data or recording of same.

#### Subscriber Telephone

Referring to Figure 2, in this embodiment, the telephones 12, 15, 22 and 25 each includes a processor circuit shown generally at 30 comprising a microprocessor 32, program memory 34, an input/output (I/O) interface 36, parameter memory 38 and temporary memory 40. The program memory 34, I/O interface 36, parameter memory 38 and temporary memory 40 are all in communication with the microprocessor 32. The I/O interface 36 has a dial

-19-

input **42** for receiving a dialed telephone number from a keypad, for example, or from a voice recognition unit or from pre-stored telephone numbers stored in the parameter memory **38**, for example. For simplicity, a box labelled dialing functions **44** represents any device capable of informing the  
5 microprocessor **32** of a callee identifier, e.g., a callee telephone number.

The microprocessor **32** stores the callee identifier in a dialed number buffer **41**. In the case of the Vancouver subscriber for example, the dialed number may be **2001 1050 2222**, identifying the Calgary subscriber or the dialed  
10 number may be a PSTN number, for example. The I/O interface **36** also has a handset interface **46** for receiving and producing signals from and to a handset **45** that the user may place to his ear. The handset interface **46** may include a BLUETOOTH™ wireless interface, a wired interface or speakerphone, for example. The handset **45** acts as a termination point for an  
15 audio path (not shown) which will be appreciated later.

The I/O interface **36** also has a network interface **48** to an IP network which may provide a high speed Internet connection, for example, and is operable to connect the telephone to an ISP. The network interface **48** also acts as a part  
20 of the audio path, as will be appreciated later.

The parameter memory **38** has a username field **50**, a password field **52** an IP address field **53** and a SIP proxy address field **54**. The username field **50** is operable to hold a username, which, for the Vancouver subscriber, is **2001**  
25 **1050 8667**. The username is assigned upon subscription or registration into the system and, in this embodiment includes a twelve digit number having a continent code **61**, a country code **63**, a dealer code **70** and a unique number code **74**. The continent code **61** is comprised of the first or left-most digit of the username in this embodiment. The country code **63** is comprised of the  
30 next three digits. The dealer code **70** is comprised of the next four digits and the unique number code **74** is comprised of the last four digits. The password field **52** holds a password of up to **512** characters, in this example. The IP



-20-

address field **53** stores an IP address and UDP port number of the telephone **12**, which, for this explanation, is **192.168.0.20:12345**. The SIP proxy address field **54** stores an IP address of a SIP proxy which may be provided to the telephone **12** through the network interface **48** as part of a registration procedure.

The program memory **34** stores blocks of codes for directing the microprocessor **32** to carry out the functions of the telephone, one of which includes a firewall block **56** which provides firewall functions to the telephone, to prevent unauthorized access through the network connection to the microprocessor **32** and memories **34**, **38** and **40**. The program memory **34** also stores call ID codes **57** for establishing a call ID. The call ID codes **57** direct the microprocessor **32** to produce call identifiers having the format of a hexadecimal string and an IP address of the telephone stored in the IP address field **53**. Thus, an exemplary call identifier for a call might be **FF10@192.168.0.20**.

Generally, in response to activating the handset **45** and using the dialing function **44**, the microprocessor **32** produces and sends a SIP Invite message as shown in Figure **3**, to the call controller **14** shown in Figure **1**.

Referring to Figure **3**, the SIP Invite message includes a caller identifier field **60**, a callee identifier field **62**, a digest parameters field **64**, a call identifier field **65**, a caller IP address field **67** and a caller UDP port field **69**. In this embodiment, the caller identifier field **60** includes the username **2001 1050 8667**, which is the username stored in the username field **50** of the parameter memory **38** in the Vancouver telephone **12** shown in Figure **2**. In addition, as an example, referring back to Figure **3**, the callee identifier field **62** includes the username **2001 1050 2222** which is the dialed number of the Calgary subscriber stored in the dialed number buffer **41** shown in Figure **2**. The digest parameters field **64** includes digest parameters and the call identifier field **65** includes a code comprising a generated prefix code (**FF10**) and a

-21-

suffix which is the IP address of the telephone **12** stored in the IP address field **53**. The caller IP address field **67** holds the IP address assigned to the telephone, in this embodiment **192.168.0.20**, and the caller UDP port field **69** includes a UDP port identifier identifying a UDP port to which audio data is to be sent for reception by the caller's telephone.

#### Call Controller

Referring to Figure 4, a call controller circuit of the call controller **14** (Figure 1) is shown in greater detail at **100**. The call controller circuit **100** includes a microprocessor **102**, program memory **104** and an I/O interface **106**. The call controller circuit **100** may include a plurality of microprocessors, a plurality of program memories and a plurality of I/O interfaces to be able to handle a large volume of calls. However, for simplicity, the call controller circuit **100** will be described as having only one microprocessor, program memory and I/O interface, it being understood that there may be more.

Generally, the I/O interface **106** includes an input **108** for receiving messages, such as the SIP Invite message shown in Figure 3, from the telephone shown in Figure 2. The I/O interface **106** also has an RC Request message output **110** for transmitting an RC Request message to the routing controller **16** of Figure 1, an RC message input **112** for receiving routing messages from the routing controller **16** (Figure 1), a media relay (MR) output **114** for transmitting messages to the media relay (Figure 1) to advise the media relay to establish an audio path, and a MR input **116** for receiving messages from the media relay to which a message has been sent to attempt to establish the audio path. The I/O interface **106** further includes a SIP output **118** for transmitting SIP messages to the telephone **12** (Figure 1) to advise the telephone of the IP address of the media relay **17** (Figure 1) which will establish the audio path. The I/O interface **106** further includes mediation device input **119** and output **121** for communicating with the mediation device **31** (Figure 1).

While certain inputs and outputs have been shown as separate, it will be appreciated that some may be associated with a single IP address and TCP or UDP port. For example, the messages sent and received from the routing controller **16** may be transmitted and received at the same single IP address and TCP or UDP port.

The program memory **104** of the call controller circuit **100** includes blocks of code for directing the microprocessor **102** to carry out various functions of the call controller **14**. For example, these blocks of code include a first block **120** for causing the call controller circuit **100** to execute a SIP Invite-to-RC request process to produce an RC Request message in response to a received SIP Invite message. In addition, there is a Routing Message Handler block **122** which causes the call controller circuit **100** to engage the mediation device and/or execute a call handling routine to establish audio paths through a media relay to establish the call. The program memory **104** further includes an in-call intercept message handler **1450** for intercepting a call in progress and a cease intercept message handler **1520** for ceasing the interception of a call in progress.

Referring to Figure **5**, the SIP Invite-to-RC Request process is shown in more detail at **120**. On receipt of a SIP Invite message of the type shown in Figure **3**, block **132** of Figure **5** directs the call controller circuit **100** of Figure **4** to authenticate the user operating the telephone from which the SIP Invite message originated. This may be done, for example, by prompting the user for a password, by sending a message back to the telephone **12** which is interpreted at the telephone as a request for password entry or the password may automatically be sent to the call controller **14** from the telephone, in response to the message. The call controller **14** may then make enquiries of databases to which it has access, to determine whether or not the user's password matches a password stored in the database. Various functions may be used to pass encryption keys or hash codes back and forth to ensure the secure transmission of passwords.

-23-

Should the authentication process fail, the call controller circuit **100** is directed to an error handling block **134** which causes messages to be displayed at the telephone **12** to indicate that there was an authentication error. If the authentication process is successful, block **131** directs the call controller circuit **100** to determine whether or not the contents of the caller identifier field **60** of the SIP Invite message is a validly formatted IP address. If it is a valid IP address, then block **133** directs the call controller circuit **100** to associate a type code with the call to indicate that the call type is a third party invite.

If at block **131** the caller identifier field **60** contents do not identify an IP address, then block **135** directs the call controller circuit **100** to associate a type code with the call to indicate the call type is a regular SIP Invite message. Then, block **136** directs the call controller circuit **100** to establish a call ID by assigning the call ID provided in the call identifier field **65** of the SIP Invite message from the telephone **12**, and at block **138** the call controller circuit is directed to produce an RC Request message of the type shown in Figure **6** that includes that call ID. Referring back to Figure **5**, block **139** then directs the call controller circuit **100** to send the RC Request message to the routing controller **16**.

Referring to Figure **6**, an RC Request message is shown generally at **150** and includes a caller identifier field **152**, a callee identifier field **154**, a digest field **156**, a call ID field **158** and a type field **160**. The caller, callee, digest, and call identifier fields **152**, **154**, **156** and **158** contain copies of the caller, callee, digest parameters and call ID fields **60**, **62**, **64** and **65** of the SIP Invite message **59** shown in Figure **3**. The type field **160** contains the type code established at block **133** or **135** of Figure **5** to indicate whether the call is from a third party or system subscriber, respectively. The callee identifier field **154** may include a PSTN number or a system subscriber username as shown, for example.

-24-

### Routing Controller

Referring to Figure 7, the routing controller **16** is shown in greater detail and includes a routing controller processor circuit shown generally at **200**. The RC processor circuit **200** includes a microprocessor **202**, program memory **204**, a  
5 table memory **206** and an I/O interface **208**, all in communication with the processor. There may be a plurality of processor circuits (**202**), memories (**204**), etc.

The I/O interface **208** includes a database output port **210** through which a  
10 request to the database **18** (Figure 1) can be made and includes a database response port **212** for receiving a reply from the database. The I/O interface **208** further includes an RC Request message input **214** for receiving the RC Request message from the call controller **14** and includes a routing message output **216** for sending a routing message back to the call controller **14**.

15 The program memory **204** includes blocks of codes for directing the RC processor circuit **200** to carry out various functions of the routing controller **16**. One of these blocks implements an RC Request message handler process **250** which directs the RC to produce a routing message in response to a  
20 received RC Request message of the type shown at **150** in Figure 6. Referring back to Figure 7, the program memory **204** further includes a Law Enforcement Authority (LEA) request message handler **1400** and an in-call intercept shut down route **1500**.

25 The RC Request message handler process **250** is shown in greater detail in Figures **8A** through **8D**.

### RC Request Message Handler

Referring to Figure **8A**, the RC Request message handler process **250** begins  
30 with a first block **252** that directs the RC processor circuit **200** (Figure 7) to store the contents of the RC Request message **150** (Figure 6) in buffers. Block **254** then directs the RC processor circuit **200** to use the contents of the

-25-

caller identifier field **152** in the RC Request message shown in Figure **6**, to locate and retrieve a dialing profile for the caller from the database **18**.

5 The routing controller maintains, in the database, a dialing profile for each subscriber to the system. Referring to Figure **9**, an exemplary dialing profile is shown generally at **256** and includes system fields including a username field **258**, a domain field **260**, a national dialing digits (NDD) field **262**, an IDD (IDD) field **264**, a country code field **266**, a local area codes field **267**, a caller minimum local length field **268**, a caller maximum local length field **270** and a reseller field **273**.

10 The exemplary dialing profile further includes lawful intercept related fields including a lawful intercept (LI) flag field **702**, at least one mediation device field **704**, at least one warrant ID field **706**, and intercept period start and stop date/time fields **708** and **710**. The LI flag field **702**, the warrant ID field **706** and the LI start/stop fields **708** and **710** may be regarded as determination information fields for determining whether to intercept a communication involving the subscriber and the MD1 address field **704** may be regarded as a destination information field for identifying a device to which intercepted communications involving the subscriber are to be sent.

20 The system fields (**258, 260, 262, 264, 266, 267, 268, 270, 273**) are assigned values by a system operator or are assigned automatically according to pre-defined algorithms (not shown) when a user registers with the system to become a subscriber. The lawful intercept fields (**702, 704, 706, 708, 710**) are assigned values in response to communications with one or more authorized devices and may be populated at any time regardless of whether or not communications involving the subscriber are in progress.

30 For example, referring back to Figure **1** the mediation device **31** may be regarded as an authorized device operated by a law enforcement authority **293**. A communications channel between the call controller **14** and the

-26-

mediation device **31** may be established to permit the mediation device to communicate with the call controller to cause the call controller to communicate with the routing controller **16** to find a subscriber record in the database **18** which is associated with a subscriber for which a warrant for lawful intercept has been obtained. For example, once a warrant identifying a user and permitting lawful intercept of that user's communications has been received by the law enforcement authority **293**, that authority can use its own computers to communicate with the mediation device **31** to cause the mediation device to communicate with the call controller **14** to cause the call controller to interact with the routing controller **16** to access a dialing profile (Figure **9**) for the user specified in the warrant and load the lawful intercept fields (**702, 704, 706, 708, 710**) with data that sets the lawful intercept flag field **702** to "on", stores an IP address of the mediation device **31** in the MD1 address field **704**, loads the warrant ID field **706** with an identifier of the warrant and loads the start and stop fields **708** and **710** with start and stop dates and times to specify a period during which lawful intercept of communications of the identified user may occur according to the warrant. Thus, intercept information is associated with the dialing profile by the routing controller, in response to information it receives from the call controller.

A plurality of groups of lawful intercept fields of the type shown may be added, each group being added by a different authorized device, for example, if several different law enforcement agencies operating the same or different mediation devices have warrants to monitor communications of a user. Alternatively the authorized device may include a handover interface operable to communicate with the call controller or routing controller to access the database to load the lawful intercept fields associated with a subscriber of interest.

An exemplary dialing profile for the Vancouver subscriber is shown generally at **276** in Figure **10** and indicates that the username field includes the

-27-

username **2001 1050 8667** which is the same as the contents of the username field **50** in the Vancouver telephone **12** shown in Figure 2.

5 Referring back to Figure **10**, the domain field **260** includes a domain name as shown at **282**, including a supernode type identifier **284**, a location code identifier **286**, a system provider identifier **288** and a top level domain identifier **290**, identifying a domain or supernode associated with the user identified by the contents of the username field **258**.

10 In this embodiment, the supernode type identifier **284** includes the code "sp" identifying a supernode and the location code identifier **286** identifies the supernode as being in Vancouver (YVR). The system provider identifier **288** identifies the company supplying the service and the top level domain identifier **290** identifies the "com" domain.

15 The national dialing digit (NDD) field **262** in this embodiment includes the digit "1" and, in general, includes a digit specified by the International Telecommunications Union – Telecommunications Standardization Sector (ITU-T) E.164 Recommendation which assigns national dialing digits to  
20 certain countries. Herein numbering sequences compliant with this standard will be regarded as "E.164" numbers.

The International Dialing Digit (IDD) field **264** includes the code **011** and in general includes a code assigned by the ITU-T according to the country or  
25 geographical location of the user.

The country code field **266** includes the digit "1" and in general includes a number assigned by the ITU-T to represent the country in which the user is  
30 located.

The local area codes field **267** includes the numbers **604** and **778** and generally includes a list of area codes that have been assigned by the ITU-T



-28-

to the geographical area in which the subscriber is located. The caller minimum and maximum local number length fields **268** and **270** hold the number **10** representing minimum and maximum local number lengths permitted in the area code(s) specified by the contents of the local area codes field **267**. The reseller field **273** holds a code identifying a retailer of the telephone services, and in the embodiment shown, the retailer is "Klondike".

Initially, the lawful intercept fields shown in Figure **9** might not be included in the dialing profile and may be added as described above, by the mediation device **31**, in the event a warrant is obtained to intercept the user's calls. Alternatively, the lawful intercept fields may be included, but populated with null values until modified by a mediation device **31**.

A dialing profile of the type shown at **256** in Figure **9** is produced whenever a user registers with the system or agrees to become a subscriber to the system. Thus, for example, a user wishing to subscribe to the system may contact an office maintained by a system operator and personnel in the office may ask the user certain questions about his location and service preferences, whereupon tables can be used to provide office personnel with appropriate information to be entered into the username, domain, NDD, IDD, country code, local area codes and caller minimum and maximum local length fields **258**, **260**, **262**, **264**, **266**, **267**, **268**, **270** to establish a dialing profile for the user.

Referring to Figures **11** and **12**, dialing profiles for subscribers in Calgary and London, respectively for example, are shown.

In addition to creating dialing profiles, optionally when a user registers with the system, a direct inward dialing (DID) record of the type shown at **268** in Figure **13** is added to a direct inward dialing table in the database **18** to associate the username with a host name of the supernode with which the user is associated and with an E.**164** number on the PSTN network.

-29-

In this embodiment, the DID bank table records include a username field **281**, a user domain field **272** and a DID field **274**, for holding the username, hostname of the supernode, and an E.**164** number respectively.

5

A DID bank table record for the London subscriber is shown generally at **291** in Figure 14.

10 In addition to creating dialing profiles and DID records when a user registers with the system, call blocking records of the type shown in Figure **26**, call forwarding records of the type shown in Figure **28** and voicemail records of the type shown in Figure **30** may be stored in the database **18** when a new subscriber is added to the system.

15 Referring back to Figure **8A**, after being directed at block **254** to retrieve a dialing profile for the caller, a dialing profile such as shown at **276** in Figure **10** is retrieved and the RC processor circuit **200** is directed to perform certain checks on the callee identifier provided by the contents of the callee identifier field **154** of the RC Request message shown in Figure **6**. These checks are  
20 shown in greater detail in Figure **8B**.

Referring to Figure **8B**, the RC processor circuit **200** is directed to a first block **257** that causes it to determine whether a digit pattern of the callee identifier **154** provided in the RC Request message includes a pattern that matches the  
25 contents of the IDD field **264** in the caller dialing profile **276** shown in Figure **10**. If so, then block **259** directs the RC processor circuit **200** to set a call type code identifier (not shown) to indicate that the call is a long distance call, e.g., from the Vancouver subscriber to the London subscriber, and block **261** directs the RC processor circuit **200** to produce a reformatted callee identifier  
30 by reformatting the callee identifier into a predetermined target format. In this embodiment, this is done by removing the pattern of digits matching the IDD field contents **264** of the caller dialing profile **276** to effectively shorten the

-30-

number. Then, block **263** directs the RC processor circuit **200** to determine whether or not the reformatted callee identifier meets criteria establishing it as a number compliant with the E.164 Recommendation set by the ITU-T and if the length does not meet this criteria, block **265** directs the RC processor circuit **200** to send back to the call controller **14** a message indicating that the length of the call identifier is not correct. The process **250** is then ended. At the call controller **14**, routines may respond to the incorrect length message by transmitting a message back to the telephone **12** to indicate that an invalid number has been dialed.

Still referring to Figure **8B**, if the length of the reformatted callee identifier meets the criteria set forth at block **263**, block **269** directs the RC processor circuit **200** to determine whether or not the reformatted callee identifier is associated with a direct inward dialing (DID) bank table record such as shown at **268** in Figure **13**.

An exemplary DID bank table record entry for the London callee is shown generally at **291** in Figure **14**. The username field **281** and user domain field **272** are as specified in the username and user domain fields **258** and **260** of the dialing profile **276** shown in Figure **12**. The contents of the DID field **274** include an E.164 telephone number including a country code **283**, an area code **285**, an exchange code **287** and a number **289**. If the user has multiple telephone numbers, then multiple records of the type shown at **291** would be included in the DID bank table in the database **18**, each having the same username and user domain, but different DID field **274** contents reflecting the different telephone numbers associated with that user.

Referring back to Figure **8B**, at block **269**, if the RC processor circuit **200** finds that the reformatted callee identifier produced at block **261** is found in a record in the DID bank table, then the callee is a subscriber to the system and block **279** directs the RC processor circuit **200** to copy the contents of the corresponding username field **270** into a callee ID buffer (not shown). Thus,

-31-

the RC processor circuit **200** locates a subscriber username associated with the reformatted callee identifier. The processor is then directed to block **275** at point B in Figure **8A**.

5     Subscriber to Subscriber Calls Between Different Nodes

Referring back to Figure **8A**, block **275** then directs the RC processor circuit **200** to determine whether or not the subscriber username is associated with the same supernode as the caller. To do this, the RC processor circuit **200** determines whether or not the continent code (**61**) of the username stored in  
10     the callee ID buffer is the same as the continent code (**61**) of the username of the caller specified by the caller identifier field **152** of the RC Request message shown in Figure **6**. If they are not the same, block **277** directs the RC processor circuit **200** to set a call type flag (not shown) to indicate that the call is a cross-domain call. Then, block **350** directs the RC processor circuit  
15     **200** to produce a routing message identifying the supernode in the system with which the callee is associated and to set a TTL for the call to the maximum value of **99999**. The supernode in the system, with which the callee is associated, is determined by using the callee username stored in the callee ID buffer to address a supernode table having records of the type as shown at  
20     **370** in Figure **17**.

Referring to Figure **17**, each prefix to supernode table record **370** has a prefix field **372** and a supernode address field **374**. The prefix field **372** includes the first n digits of the callee identifier. In this case n=1. The supernode address  
25     field **374** holds a code representing the IP address or a fully qualified domain name of the supernode associated with the code stored in the prefix field **372**. Referring to Figure **18**, for example, if the prefix is **4**, the supernode address associated with that prefix is sp.lhr.digifonica.com, identifying the London supernode **21**, for example.

30

Referring to Figure **15**, a generic routing message is shown generally at **352** and includes a supplier prefix field **354**, a delimiter field **356**, a callee field **358**,

-32-

at least one route field **360**, a time-to-live (TTL) field **362** and other fields **364**. The supplier prefix field **354** holds a code for identifying supplier traffic. The delimiter field holds a symbol that delimits the supplier prefix code from the callee field **358** and in this embodiment, the symbol is a number sign (#). The route field **360** holds a domain name or an IP address of a gateway or supernode that is to carry the call and the TTL field **362** holds a value representing the number of seconds the call is permitted to be active, based on subscriber available minutes and other billing parameters, for example.

Referring to Figure **8A** and Figure **16**, in this example the routing message produced by the RC processor circuit **200** at block **350** is shown generally at **366** and includes only a callee field **358**, a route field **360** and a TTL field **362**.

The callee field **358** holds the full username of the callee and the route field **360**, shown in Figure **15**, contains the identification of the domain with which the callee is associated, i.e., sp.lhr.digifonica.com.

Having produced the routing message **366** as shown in Figure **16A**, referring back to Figure **8A**, block **351** then directs the RC processor circuit **200** to check the caller dialing profile (see Figure **9**) to determine whether or not it contains lawful intercept fields (**702**, **704**, **706**, **708**, **710**) and if so, to determine whether or not the determination information contained therein meets intercept criteria. The intercept criteria may be that the lawful intercept flag field **702** (Figure **9**) contains a flag indicating lawful intercept is enabled and whether the current date and time is within the period specified by the LI start date/time field contents **708** and the LI stop date/time field contents **710**, for example. If the intercept criteria are met, block **353** directs the RC processor circuit **200** to append the contents of the lawful intercept fields **702**, **704**, **706**, **708**, **710** to the routing message produced at block **350** to produce a routing message as shown in Figure **16A**. Generally, the determination of whether or not the destination information meets intercept criteria is done prior to producing the routing message so that when the intercept criteria are met,

-33-

at least some of the intercept information, in this embodiment all of it, can be included in the routing message.

5 If at block **351** in Figure **8A**, it is determined there are no lawful intercept fields associated with the caller dialing profile or that the intercept criteria are not met, the processor does not append any lawful intercept fields to the routing message produced at block **350** in Figure **8A** and the routing message shown in Figure **16** is sent to the call controller **14** as shown at block **380**. If the lawful intercept fields have been appended, block **380** directs the RC processor circuit **200** to send the routing message shown in Figure **16A** to the call controller **14** (Figure **1**).

15 Referring back to Figure **8B**, if at block **257**, the callee identifier specified by the contents of the callee field **154** of the RC Request message shown in Figure **6** does not begin with an IDD, block **381** directs the RC processor circuit **200** to determine whether or not the callee identifier begins with the same national dial digit code as assigned to the caller. To do this, the processor is directed to refer to the caller dialing profile shown in Figure **10**. In the embodiment shown, the NDD code **262** is the digit **1**. Thus, if the callee identifier begins with the digit **1**, the RC processor circuit **200** is directed to block **382** in Figure **8B**.

25 Block **382** directs the RC processor circuit **200** to examine the callee identifier to determine whether or not digits following the NDD code identify an area code that is the same as any of the area codes identified in the local area codes field **267** of the caller dialing profile **276** shown in Figure **10**. If not, block **384** directs the RC processor circuit **200** to set a call type variable (not shown) to a code indicating the call is a national code. If the digits identify an area code that is the same as a local area code associated with the caller, block **386** directs the RC processor circuit **200** to set the call type variable to indicate that the call type is a local call, national style. After executing blocks **384** or **386**, block **388** directs the RC processor circuit **200** to format the

-34-

number dialed by removing the national dial digit (NDD) and prepending a caller country code identified by the country code field **266** of the caller dialing profile shown in Figure **10**. The RC processor circuit **200** is then directed to block **263** to perform the processes described above beginning at block **263**.

5

If at block **381**, the callee identifier does not begin with an NDD code, block **390** directs the RC processor circuit **200** to determine whether the callee identifier begins with digits that identify the same area code as the caller. Again, the reference for this is the caller profile shown in Figure **10** and the RC processor circuit **200** determines whether or not the first few digits in the callee identifier identify an area code identified by the local area code field **267** of the caller profile. If so, then block **392** directs the RC processor circuit **200** to set the call type to a code indicating the call is a local call and block **394** directs the RC processor circuit **200** to prepend the caller country code to the callee identifier, the caller country code being determined from the country code field **266** in the caller profile shown in Figure **10**. The RC processor circuit **200** is then directed to block **263** for processing as described above beginning at block **263**.

15

If at block **390**, the callee identifier does not have the same area code as the caller, block **396** directs the RC processor circuit **200** to determine whether the callee identifier has the same number of digits as the number of digits indicated in either the caller minimum local number length field **268** or the caller maximum local number length field **270** of the caller profile shown in Figure **10**. If so, then block **398** directs the RC processor circuit **200** to set the call type to local and block **400** directs the processor to prepend to the callee identifier the caller country code as indicated by the country code field **266** of the caller profile shown in Figure **10** followed by the caller area code as indicated by the local area code field **267** of the caller profile shown in Figure **10**. The RC processor circuit **200** is then directed to block **263** for further processing as described above beginning at block **263**.

20

25

30

-35-

If at block **396**, the callee identifier has a length that does not match the length specified by the contents of the caller minimum local number length field **268** or the caller maximum local number length field **270**, block **402** directs the RC processor circuit **200** to determine whether or not the callee identifier identifies a valid username. To do this, the RC processor circuit **200** searches through the database of dialing profiles to find a dialing profile having username field contents **258** that match the callee identifier. If no match is found, block **404** directs the RC processor circuit **200** to send an error message back to the call controller (**14**). If at block **402**, a dialing profile having a username field **258** that matches the callee identifier is found, block **406** directs the RC processor circuit **200** to set the call type to a code indicating the call is a network call and the processor is directed to block **275** of Figure **8A**, to continue processing the RC message handler process **250**.

From Figure **8B**, it will be appreciated that there are certain groups of blocks of codes that direct the RC processor circuit **200** to determine whether the callee identifier has certain features such as an IDD code, a NDD code, an area code and a length that meet certain criteria and to reformat the callee identifier as necessary into a predetermined target format including only a country code, area code, and a normal telephone number, for example, to cause the callee identifier to be compatible with the E.164 number plan standard, in this embodiment. This enables the RC processor circuit **200** directed by block **279** to have a consistent format of callee identifiers for use in searching through the DID bank table records of the type shown in Figure **13** to determine how to route calls for subscriber to subscriber calls on the same system.

#### Subscriber to Non-Subscriber Calls

Not all calls will be subscriber-to-subscriber calls and this will be detected by the RC processor circuit **200** when it executes block **269** of Figure **8B**, and does not find a record that is associated with the callee in the DID bank table. When this occurs, the RC processor circuit **200** is directed to block **408** which



-36-

causes it to set the callee identifier equal to the reformatted callee identifier, i.e., the number compatible with the E.164 standard. Then, block 410 directs the RC processor circuit 200 to address a master list having records of the type shown in Figure 19.

5

Each master list record includes a master list ID field 500, a dialing code field 502, a country code field 504, a national sign number field 506, a minimum length field 508, a maximum length field 510, a NDD field 512, an IDD field 514 and a buffer rate field 516.

10

The master list ID field 500 holds a unique code such as 1019, for example, identifying a route identification (route ID). The dialing code field 502 holds a predetermined number pattern which the RC processor circuit 200 uses at block 410 in Figure 8B to find the master list record having a dialing code matching the first few digits of the reformatted callee identifier. The country code field 504 holds a number representing the country code associated with the record and the national sign number field 506 holds a number representing the area code associated with the record. (It will be observed that the dialing code is a combination of the contents of the country code field 504 and the national sign number field 506.) The minimum length field 508 holds a number representing the minimum number of digits that can be associated with the record and the maximum length field 51 holds a number representing the maximum number of digits in a number with which the record may be compared. The NDD field 512 holds a number representing an access code used to make a call within the country specified by the contents of the country code field 504 and the IDD field 514 holds a number representing the international prefix needed to dial a call from the country indicated by the country code.

15

20

25

30

Thus, for example, a master list record may have a format as shown in Figure 20 with exemplary field contents as shown.

-37-

Referring back to Figure 8B, using the country code and area code portions of the reformatted callee identifier that has been formatted for compatibility with the E.164 standard, block 410 directs the RC processor circuit 200 to find a master list record such as the one shown in Figure 20 having a dialing code that matches the country code and area code of the callee identifier. Thus, in this example, the RC processor circuit 200 would find a master list record having an ID field with the number 1019. This number may be also referred to as a route ID. Thus, a route ID number is found in the master list record associated with a predetermined number pattern in the reformatted callee identifier.

After execution of block 410 in Figure 8B, the process 250 continues as shown in Figure 8D. Referring to Figure 8D, block 412 directs the RC processor circuit 200 to use the route ID number to locate at least one supplier record identifying a supplier operable to supply a communications link for this route. To do this, block 412 directs the RC processor circuit 200 to search a supplier ID table having records of the type shown in Figure 21.

Referring to Figure 21, the supplier list records include a supplier ID field 540, a route ID field 542, an optional prefix field 544, a route identifier field 546, a NDD/IDD rewrite field 548 and a rate field 550. The supplier ID field 540 holds a code identifying the name of the supplier and the route ID field 542 holds a code for associating the supplier record with a route, and hence with a master list record. The prefix field 544 holds a string used to identify the supplier traffic and the route identifier field 546 holds an IP address of a gateway operated by the supplier indicated by the supplier ID field 540. The NDD/IDD rewrite field 548 holds a code and the rate field 550 holds a code indicating the cost per second to the system operator to use the route provided by the gateway specified by the contents of the route identifier field 546. Exemplary supplier records are shown in Figures 22, 23 and 24 for the suppliers shown in Figure 1 which may include Telus, Shaw and Sprint, respectively, for example.

-38-

Referring back to Figure 8D, at block 412 the RC processor circuit 200 finds all supplier records that identify the route ID found at block 410 of Figure 8B.

5 Referring back to Figure 8D, block 560 directs the RC processor circuit 200 to begin to produce routing messages of the type shown in Figure 16. To do this, the RC processor circuit 200 loads a routing message buffer as shown in Figure 25 with a supplier prefix of the least costly supplier where the least  
10 costly supplier is determined from the rate fields 550 of the records associated with respective suppliers.

Referring to Figures 22-24, in the embodiment shown, the supplier "Telus" has the lowest number in the rate field 550 and therefore the prefix 4973 associated with that supplier is loaded into the routing message buffer shown  
15 in Figure 25 first. The prefix 4973 is then delimited by the number sign and the reformatted callee identifier is next loaded into the routing message buffer. Then, the contents of the route identifier field 546 of the record associated with the supplier Telus are added to the message after an @ sign delimiter and then block 564 in Figure 8D directs the RC processor circuit 200 to get a  
20 TTL value, which in this embodiment may be 3600 seconds, for example. Block 566 then directs the RC processor circuit 200 to load this TTL value in the routing message buffer shown in Figure 25. Accordingly, the first part of the routing message is shown generally at 570 in Figure 25.

25 Referring back to Figure 8D, block 568 directs the RC processor circuit 200 back to block 560 and causes it to repeat blocks 560, 562, 564 and 566 for each successive supplier until the routing message buffer is loaded with information pertaining to each supplier. Thus, the second portion of the routing message is shown at 572 in Figure 25 and this second portion relates  
30 to the second supplier identified by the record shown in Figure 23 and referring back to Figure 25, the third portion of the routing message is shown at 574 which is associated with a third supplier as indicated by the supplier

-39-

record shown in Figure **24**. Consequently, referring to Figure **25**, the routing message buffer holds a routing message identifying a plurality of different suppliers able to provide gateways to establish a communication link to permit the caller to contact the callee. Each of the suppliers is identified, in ascending order according to the rates contained in the rate fields **550** of the supplier list records shown in Figures **22-24**, in this embodiment. Other criteria for determining the order in which suppliers are listed in the routing message may include preferred supplier priorities which may be established based on service agreements, for example. In this case additional fields may be provided in respective supplier records to hold values representing supplier priority.

After the routing message buffer has been loaded as shown in Figure **25**, block **567** directs the RC processor circuit **200** to check the caller dialing profile shown in Figure **10** to determine whether or not it contains lawful intercept fields as shown in Figure **9**, and if so, to determine whether or not the intercept criteria are met by checking whether the lawful intercept flag field **702** contains a flag indicating that lawful intercept is enabled and checking whether the current date and time are within the period specified by the LI start date/time field contents **708** and the LI stop date/time field contents **710**. If the intercept criteria are met, block **569** directs the RC processor circuit **200** to append the contents of the lawful intercept fields **702, 704, 706, 708, 710** to the routing message stored in the routing message buffer, as shown in Figure **25A**. Again, the determination of whether or not the destination information meets intercept criteria is done prior to producing the routing message so that when the intercept criteria are met, at least some of the intercept information, in this embodiment all of it, can be included in the routing message.

If at block **567**, it is determined there are no lawful intercept fields associated with the caller dialing profile shown in Figure **10** or that the intercept criteria are not met, the RC processor circuit **200** does not append any lawful

-40-

intercept fields to the routing message stored in the routing message buffer shown in Figure 25.

5 Block 568 then directs the RC processor circuit 200 to send the contents of the routing message buffer, i.e. the routing message shown in Figure 25 or 25A, to the call controller 14 in Figure 1.

#### Subscriber to Subscriber Calls Within the Same Node

10 Referring back to Figure 8A, if at block 275, the callee identifier stored in the callee ID buffer has a prefix that identifies the same supernode as that associated with the caller, block 600 directs the RC processor circuit 200 to use the callee identifier to locate and retrieve a dialing profile for the callee identified by the callee identifier. The dialing profile is of the type shown in Figure 9, and may contain data as shown in Figure 11, for example. Block 602

15 of Figure 8A directs the RC processor circuit 200 to get call block, call forward and voicemail tables from the database 18 based on the username identified in the callee profile retrieved by the RC processor circuit at block 600. Call block, call forward and voicemail tables have records as shown in Figures 26, 28 and 30 for example.

20 Referring to Figure 26, the call block records include a username field 604 and a block pattern field 606. The username field holds a username matching the username in the username field 258 of the dialing profile associated with the callee and the block pattern field 606 holds one or more E.164-compatible

25 numbers or usernames identifying PSTN numbers or system subscribers from whom the subscriber identified by the contents of the username field 604 does not wish to receive calls.

30 Referring back to Figure 8A and referring to Figure 27, block 608 directs the RC processor circuit 200 to determine whether or not the caller identifier matches a block pattern stored in the block pattern field 606 of the call block record associated with the callee identified by the contents of the username

-41-

field **604** in Figure **26**. If the caller identifier matches a block pattern stored in the block pattern field **606**, block **610** directs the RC processor circuit **200** to send a drop call or non-completion message to the call controller (**14**) and the process is ended. If the caller identifier does not match a block pattern associated with the callee, block **612** directs the RC processor circuit **200** to determine whether or not call forwarding is required.

Referring to Figure **28**, records in the call forwarding table include a username field **614**, a destination number field **616**, a destination number field **616** and a sequence number field **618**. The username field **614** stores a code representing a subscriber with which the record is associated. The destination number field **616** holds a username or number representing a number to which the current call should be forwarded and the sequence number field **618** holds an integer number indicating the order in which the username associated with the corresponding destination number field **616** should be attempted for call forwarding. The call forwarding table may have a plurality of records for a given user. The RC processor circuit **200** uses the contents of the sequence number field **618** to consider the records for a given subscriber in order. As will be appreciated below, this enables the call forwarding numbers to be tried in a ordered sequence.

Referring back to Figure **8A** and referring to Figure **28**, if at block **612** in Figure **8A**, the call forwarding record for the callee identified by the callee identifier contains no contents in the destination number field **616** and accordingly no contents in the sequence number field **618**, there are no call forwarding entries and the RC processor circuit **200** is directed to load the routing message buffer shown in Figure **32** with the callee username and domain, as shown at **650** in Figure **32**. The processor is then directed to block **620** in Figure **8C**.

If there are contents in the destination number field of the call forwarding record as shown in Figure **29**, block **622** shown in Figure **8A** directs the RC

-42-

processor circuit **200** to search the dialing profile table to find a dialing profile record of the type shown in Figure **9**, for the user identified in the destination number field **616** in the call forwarding table record of Figure **29** and to store the contents of the destination number field in the routing message buffer shown in Figure **32**. The RC processor circuit **200** is then directed to load the contents of the domain field **260** shown in Figure **9** associated with the username specified by the contents of the destination number field **616** of Figure **29** into the routing message buffer as shown at **652** in Figure **32**. This process is repeated for each call forwarding record associated with the callee identified by the callee identifier to add to the routing message buffer all call forwarding usernames and domains associated with the callee.

Referring to Figure **8C**, at block **620** the processor is directed to determine whether or not the user identified by the callee identifier has paid for voicemail service and this is done by checking to see whether or not a flag is set in a voicemail record of the type shown in Figure **30** in a voicemail table stored in the database **18** in Figure **1**.

Referring to Figure **30**, voicemail table records include a username field **624**, a voicemail server field **626**, a seconds-to-voicemail field **628** and an enable field **630**. The username field **624** stores the username of the subscriber who purchased the service. The voicemail server field **626** holds a code identifying an IP address or a fully qualified domain name (FQDN) of a voicemail server associated with the subscriber identified by the username field **624**. The seconds-to-voicemail field **628** holds a code identifying the time to wait before engaging voicemail and the enable field **630** holds a code representing whether or not voicemail is enabled for the user identified by the contents of the username field **624**. Therefore, referring back to Figure **8C**, at block **620** the processor searches for a voicemail record as shown in Figure **31** having username field **624** contents matching the callee identifier and looks at the contents of the enabled field **630** to determine whether or not voicemail is enabled. If voicemail is enabled, then block **640** in Figure **8C** directs the

-43-

processor to store the contents of the voicemail server field **626** of Figure **31** and the contents of the seconds to voicemail field **628** of Figure **31** in the routing message buffer as shown at **654** in Figure **32**. Referring back to Figure **8C**, block **642** then directs the processor to get time to live (TTL) values for each route specified by the routing message according to any of a plurality of criteria such as, for example, the cost of routing and the user's account balance. These TTL values are then appended to corresponding routes already stored in the routing message buffer.

5

Block **644** of Figure **8C** then directs the RC processor circuit **200** to store the IP address of the current supernode in the routing message buffer as shown at **656** in Figure **32**. An exemplary routing message is shown in the routing message buffer shown in Figure **32**.

10

Block **645** of Figure **8C** then directs the processor to check the caller dialing profile shown in Figure **10** to determine whether or not it contains lawful intercept fields of the type shown in Figure **9** and if so, to determine whether or not the intercept criteria are met. In this embodiment, this includes determining whether the lawful intercept flag field **702** contains a flag indicating that lawful intercept is enabled and checking whether the current date and time is within the period specified by the LI start date/time field contents **708** and the LI stop date/time field contents **710**. If the intercept criteria are met, block **647** directs the RC processor circuit **200** to append the contents of the lawful intercept fields **702**, **704**, **706**, **708**, **710** to the routing message shown in Figure **32A** to produce a routing message with lawful intercept field contents, as shown in Figure **32A**. Again, the determination of whether or not the destination information meets intercept criteria is done prior to producing the routing message so that when the intercept criteria are met, at least some of the intercept information, in this embodiment all of it, can be included in the routing message.

15

20

25

30



-44-

Referring back to Figure 8C, if at block 645, it is determined there are no lawful intercept fields associated with the caller dialing profile of Figure 10 or that the intercept criteria are not met after producing the routing message shown in Figure 32A the processor is directed to block 649 which causes the processor to check the callee dialing profile shown in Figure 11 to determine whether or not it contains lawful intercept fields of the type shown in Figure 9 and if so, to determine whether or not the intercept criteria are met by checking whether the current date and time is within the period specified by the LI start date/time field contents 708 and the LI stop date/time field contents 710 of the callee dialing profile. If the intercept criteria are met, block 651 directs the RC processor circuit 200 to append the contents of the lawful intercept fields 702, 704, 706, 708, 710 associated with the callee dialing profile to the routing message shown in Figure 32A to produce a routing message. If at block 649 of Figure 8C, it is determined there are no lawful intercept fields associated with the callee dialing profile or that the intercept criteria are not met, no lawful intercept fields associated with the callee are appended to the routing message shown in Figure 32 or 32A. Referring back to Figure 8C, block 646 then directs the RC processor circuit 200 to send the routing message to the call controller 14.

20

#### Response to Routing Message

Referring back to Figure 1, the routing message, whether of the type shown in Figures 16, 16A, 25, 25A, 32, 32A or 32B, is received at the call controller 14. Referring to Figure 33, when a routing message is received at the call controller, the routing message handler 122 is invoked at the call controller. The routing message handler is shown in detail in Figure 33.

25

Referring to Figure 33, the routing message handler begins with a first block 1200 that directs the processor circuit to determine whether the routing message includes lawful intercept fields. If not, the processor is directed to block 1206 which causes it to invoke a call handling routine shown in Figure 34. Referring to Figure 34, as a first step in the call handling routine, a

30

-45-

message **1100** is sent from the call controller **14** to the media relay **17**, the message including the caller telephone IP address and UDP port as determined from the caller IP address field **67** and caller UDP port field **69** in the SIP Invite message shown in Figure **3**.

5

The specific media relay **17** to which the message **1100** is sent may be selected from a pool of available media relays and such media relays may be at any geographical location. The purpose of the message **1100** is to advise the media relay that a call is desired to be set up to communicate with the IP address and UDP number of the caller telephone.

10

A media relay selected from media relays located at a geographical location that facilitates communication at a desired quality of service between the media relay **17** and the caller telephone **12** and callee telephone **15** may provide the best service. Alternatively, media relays may be pre-assigned or pre-associated with users by including and populating media relay fields of the dialing profiles of users, such as shown at **1150** in Figure **9**, identifying one or more media relays through which calls associated with the associated user are to be directed. In this case, the identifications of possible media relays obtained from the media relay fields **1150** may be sent to the call controller in additional fields in the routing message. These media relay fields are shown at **1152** in Figures **16**, **16A**, **25**, **25A**, **32**, **32A** and **32B**. In essence, the media relay through which communications involving the communications involving the subscriber will be conducted is identified in response to the routing message.

15

20

25

Referring back to Figure **34**, in this case, the message **1100** may be sent in a polling fashion to all media relays identified by the media relay fields **1150**, until one responds. Alternatively, the message **1100** may be sent simultaneously to all of the media relays.

30

-46-

In response, in the case where the media relay is known or is involved in polling as described above, the media relay **17** to which the message **1100** is sent sends a media relay status message **1102** back to the call controller **14**, the message including a media relay IP address and UDP port number at which the media relay will establish a UDP connection to the callee telephone **15**. Audio data to/from the callee telephone **15** will be transmitted over this connection. In the case where the message **1100** is sent to a plurality of media relays, the first one to respond with a media relay status message is the one through which the call will be carried. Media relay status messages from the remaining media relays can be ignored.

After the media relay status message **1102** is received at the call controller, the call controller **14** then sends a SIP Invite message **1104** of the type shown in Figure **3** to the callee telephone **15**, including the contents of the caller and callee identifier fields (**60** and **62**), the call identifier field (**65**) and the media relay IP address and the media relay UDP port number assigned to the audio path connection with the callee telephone **15**, to invite the callee telephone to establish a connection with the media relay **17**.

The purpose of the SIP Invite message **1104**, is to advise the callee telephone of the caller and call ID and of the IP address and UDP port number of the media relay through which the callee telephone should send and receive audio data.

The callee telephone **15** stores the media relay IP address and assigned UDP port number in the audio path IP address buffer **47** shown in Figure **2** and configures itself to create a socket between the media relay IP/UDP address and the callee telephone IP address and a UDP port number that the callee telephone **15** desires to use as an audio path to the caller telephone. Instead of being sent or received directly to or from the caller telephone, the callee telephone **15** will send and receive audio data from the media relay. To indicate this, the callee telephone **15** sends a SIP OK message **1106** back to

-47-

the call controller **14**, the message including the callee IP address and UDP port number from its IP address field (**53** in Figure **3**) at which the callee telephone **15** will establish an audio path connection with the media relay **17**. The purpose of this SIP OK message **1106** is to advise the call controller of the IP address and UDP port number through which the media relay should send and receive audio data to and from the callee telephone.

The call controller **14** then sends a message **1108** to the media relay **17** including the IP address and UDP port number that the callee telephone **15** will use for the audio path connection with the media relay. The purpose of the message **1108** is to advise the media relay of the IP address and UDP port number through which it should send and receive audio data to and from the callee telephone.

The media relay **17** then determines a UDP port through which it will carry audio data to and from the caller telephone **12** and sends a message **1110** to the call controller (**14**), the message including the media relay IP address and the media relay UDP port number the media relay will use to carry audio to and from the caller telephone **12**. The purpose of this message **1110** is to advise the call controller **14** of the IP address and UDP port number through which it expects to transfer audio data to and from the caller telephone.

The call controller **14** then sends a SIP OK message **1112** to the caller telephone **12** to indicate that the call may now proceed. The SIP OK message includes the caller and callee usernames, the call ID and the media relay **17** IP address and the UDP port number assigned to the audio connection with the caller telephone **12**. The purpose of this SIP OK message **1112** is to advise the caller telephone **12** of the IP address and UDP port number through which it should exchange audio data with the media relay **17**.

If the routing message is of the type shown in Figure **25** where there are a plurality of suppliers available, the call handling routine proceeds as described

-48-

above with the exception that instead of communicating with the callee telephone directly, the call controller **14** communicates with a gateway provided by a supplier. If a SIP OK message is not received back from the first gateway, the processor is directed to send the SIP Invite message **1104** to a gateway of the next indicated supplier. For example, the call controller **14** sends the SIP Invite message **1104** to the first supplier, in this case Telus, to determine whether or not Telus is able to handle the call. If Telus does not send back a SIP OK message **1106** within a specified time or sends a message indicating that it is not able to handle the call, the call controller proceeds to send a SIP Invite message **1104** to the next supplier, in this case Shaw. The process is repeated until one of the suppliers responds with a SIP OK message **1106** indicating that it is available to carry the call and the process proceeds as shown in connection with messages **1108**, **1110** and **1112**. For example, the supplier "Telus" sends back a SIP OK message and thus provides a gateway to the PSTN at IP address **72.64.39.58** as provided by the routing message from the contents of the route identifier field **546** of the corresponding supplier record shown in Figure **22**.

Referring back to Figure **1**, if the call controller **14** receives a message of the type shown in Figure **32**, i.e., a type that has one call forwarding number and/or a voicemail number, the call controller attempts to establish a call (using SIP Invite message **1104**) to the callee telephone **15** and if no call is established (i.e., message **1106** is not received) within a pre-determined time, the call controller **14** attempts to establish a call with the next user identified in the call routing message, by sending a SIP invite message like message **1104** to the next user. This process is repeated until all call forwarding possibilities have been exhausted, in which case an audio path is established with the voicemail server **19** identified in the routing message. The voicemail server **19** sends the SIP OK message **1106** in response to receipt of the SIP invite message **1104** and functions as described above in connection with the callee telephone **15** to permit an outgoing audio message provided by the voicemail

-49-

server to be heard by the caller and to permit the caller to record an audio message on the voicemail server.

5 When audio paths are established, a call timer (not shown) maintained by the call controller logs the start date and time of the call and logs the call ID and adds an active call record of the type shown in Figure 35 to an active call list, maintained by the call controller.

10 In this embodiment, the call controller active call record shown in Figure 35 includes a call ID field 1300, a caller IP address field 1302, a caller port field 1304, a callee IP address field 1306, a callee port field 1308, a media relay ID field 1310, a media relay caller port field 1312 and a media relay callee port field 1314. The contents of the call ID field 1300 are established at block 136 in Figure 5. The contents of the caller IP address field 1302 are established  
15 from the contents of the caller IP address field 67 of the SIP invite message shown in Figure 3. The contents of the caller port field 1304 are established from the caller UDP port field 69 of the SIP invite message shown in Figure 3. The contents of the callee IP address field 1306 and callee port field 1308 are established from the SIP OK message 1106 shown in Figure 34.

20 The media relay ID field 1310 is populated with an identification of the media relay handling the call. In the example shown, the media relay is number 42. The contents of the media relay caller port field are obtained from the message 1110 shown in Figure 34 and the contents in the media relay callee  
25 port field 1314 are obtained from the media relay status message 1102 shown in Figure 34. Each time a call is established, an active call record of the type shown in Figure 35 is added to an active call log maintained by the call controller.

30 The routing controller also maintains an active call log containing active call records however the active call records maintained by the routing controller are different from the active call records held by the call controller. For

-50-

example, referring to Figure 36, an active call record held by the routing controller includes a call ID field 1316, a caller field 1318, a callee field 1320 and a call controller ID field 1322. Information for populating these fields may be received in a message (not shown) transmitted from the call controller to the routing controller after an active call record has been entered into the active call log of the call controller.

The message from the call controller 14 to the routing controller 16, indicating that an active call has been established may include the contents of the call ID field 1300 shown in Figure 35 and a call controller unique ID number held by the call controller. The routing controller 16 matches the call ID with the caller and callee user names contained in the original call routing message (Fig 16, 16A, 25, 25A, 32, 32A, 32B) that caused the call controller 14 to route the call, to populate the caller and callee fields 1318 and 1320 shown in Figure 36, respectively. It will be appreciated that a plurality of call controllers may be associated with a single routing controller, in which case the call controller ID allows the routing controller to uniquely identify the call controller associated with the call ID indicated by the contents of the call ID field 1316. In the example shown, the call controller is number 61.

The active call records facilitate intercepting a call already in progress, as will be described below.

Referring back to Figure 33, if at block 1200 it is determined that the routing message has lawful intercept fields, block 1202 directs the call controller circuit 100 (Figure 4) to send a SIP Invite message as shown in Figure 37 to a mediation device identified by the mediation device IP address in the routing message as obtained from the user dialing profile MD1 address field 704 as shown at 256 in Figure 9. Referring to Figure 37, the SIP Invite message includes caller and callee identifier fields 1020, 1022, a call ID field 1024, a warrant ID field 1026 and other intercept related information fields 1028, if desired. The caller, callee and call ID field contents 1020, 1022, and 1024 are

-51-

obtained from the original SIP Invite message shown in Figure 6. The contents of the warrant ID field **1026** and intercept related info fields **1028** are obtained from the routing message which would be of the type shown in Figures **16A**, **25A**, **32A** or **32B**.

5

Referring back to Figure **33**, block **1204** then directs the call controller **14** to receive a reply message, as shown in Figure **38**, from the mediation device **31**. The reply message is a SIP OK message that includes caller, callee, and call ID fields **1040**, **1042**, **1044** as described above and further includes a mediation device IP address field **1046** and a mediation device UDP caller port number field **1048** and a UDP callee port number field **1050** identifying UDP ports at the mediation device IP address to which the media relay is to send copies of audio data streams received from the caller and callee telephones respectively. Block **1206** then directs the call controller to execute the call handling routine shown in Figure **34** with the exception that the message **1100** additionally includes the contents of the mediation device IP address field **1046**, the mediation device UDP caller port number field **1048** and the UDP callee port number field **1050** of the SIP OK message shown in Figure **38**.

20

All other messages are the same as described above in connection with the call handling routine as shown in Figure **34**, but in response to receiving the additional information in the message **1100**, the media relay automatically configures itself to provide for copying the audio data received from both the caller telephone and the callee telephone to the mediation device IP address and the UDP caller port number and the UDP callee port number respectively.

25

Referring back to Figure **1**, as audio data originating at the caller telephone **12** and callee telephone **15** passes through the media relay **17**, this data is copied to the mediation device UDP port for the caller and the mediation device UDP port for the callee, as indicated by the SIP invite message **1100**. This enables law enforcement agencies to monitor audio communications

30



-52-

between the caller and callee and/or to record such communications at the mediation device.

Thus, when the determination information in the dialing profile meets intercept  
5 criteria, the call controller communicates with the media relay through which  
communications involving the subscriber whose communications are to be  
monitored will be handled to cause the media relay to send a copy of such  
communications to a mediation device specified by the destination information  
included in the intercept information associated with the dialing profile  
10 associated with the subscriber whose communications are to be monitored.

#### Terminating the Call

In the event that either the caller or the callee terminates a call, the telephone  
of the terminating party sends a SIP Bye message to the call controller **14**. An  
15 exemplary SIP Bye message is shown at **900** in Figure **39** and includes a  
caller field **902**, a callee field **904** and a call ID field **906**. The caller field **902**  
holds the caller username, the callee field **904** holds a PSTN compatible  
number or username, and the call ID field **906** holds a unique call identifier  
field of the type shown in the call identifier field **65** of the SIP Invite message  
20 shown in Figure **3**.

Thus, for example, referring to Figure **40**, a SIP Bye message for the Calgary  
callee is shown generally at **908** and the caller field **902** holds a username  
identifying the Vancouver caller, in this case **2001 1050 8667**, the callee field  
25 **904** holds a username identifying the Calgary callee, in this case **2001 1050**  
**2222**, and the call ID field **906** holds the code **FA10@192.168.0.20**, which is  
the call ID for the call.

The SIP Bye message shown in Figure **40** is received at the call controller **14**  
30 and the call controller executes a process as shown generally at **910** in Figure  
**41**. The process includes a first block **912** that directs the call controller circuit  
(**100**) to copy the caller, callee and call ID field contents from the SIP Bye

-53-

message **900** shown in Figure **39** received from the terminating party to corresponding fields of an RC stop message buffer (not shown). Block **914** then directs the call controller circuit **100** to copy the call start time from the call timer and to obtain a Call Stop time from the call timer. Block **916** then  
5 directs the call controller to calculate a communication session time by determining the difference in time between the call start time and the Call Stop time. This communication session time is then stored in a corresponding field of the RC Call Stop message buffer. Block **918** then directs the call controller circuit **100** to populate the route field with the IP address of the gateway supplier, if any. An RC Call Stop message produced as described  
10 above is shown generally at **1000** in Figure **42**. An RC Call Stop message specifically associated with the call made to the Calgary callee is shown generally at **1021** in Figure **43**.

15 Referring to Figure **42**, the RC call stop message **1000** includes a caller field **1002**, callee field **1004**, a call ID field **1006**, an account start time field **1008**, an account stop time field **1010**, a communication session time field **1012** and a route field **1014**. The caller field **1002** holds a username, the callee field **1004** holds a PSTN-compatible number or system number, the call ID field  
20 **1006** holds the unique call identifier received from the SIP Invite message shown in Figure **3**, the account start time field **1008** holds the date and start time of the call, the account stop time field **1010** holds the date and time the call ended, the communication session time field **1012** holds a value representing the difference between the start time and the stop time, in  
25 seconds, and the route field **1014** holds the IP address for a gateway, if a gateway is used to establish the call.

Referring to Figure **43**, an exemplary RC call stop message for the Calgary callee is shown generally at **1021**. In this example the caller field **1002** holds  
30 the username **2001 1050 8667** identifying the Vancouver caller and the callee field **1004** holds the username **2001 1050 2222** identifying the Calgary callee. The contents of the call ID field **1006** are **FA10@192.168.0.20**. The contents

-54-

of the account start time field **1008** are **2006-12-30 12:12:12** and the contents of the account stop time field **1010** are **2006-12-30 12:12:14**. The contents of the communication session time field **1012** are **2** to indicate **2** seconds call duration and the contents of the route field are blank but would be

5 **72.64.39.58** if the "Telus" gateway were used, for example.

Referring back to Figure **41**, after having produced an RC Call Stop message, block **920** directs the call controller circuit **100** to send the RC stop message contained in the RC Call Stop message buffer to the routing controller (**16**).

10

The RC (**16**) receives the Call Stop message and an routing controller Call Stop message process (not shown) is invoked at the routing controller to deal with charges and billing for the call.

15 Block **922** directs the call controller circuit **100** to send a Bye message to the party that did not terminate the call i.e. to the non-terminating party.

Block **924** then directs the call controller circuit **100** to send a SIP Bye message of the type shown in Figure **39** to the media relay **17** to cause the

20 media relay to disconnect the audio path sockets associated with the caller telephone IP/UDP address and the callee telephone IP/UDP address. In disconnecting these communication sockets, the media relay **17** deletes associations between the caller telephone IP/UDP address media relay caller IP/UDP address and between the caller telephone IP/UDP address and media

25 relay callee IP/UDP address.

If the media relay (**17**) was configured for lawful intercept, block **926** of Figure **41** then directs the call controller circuit **100** to send a SIP Bye message of the type shown in Figure **39** to the mediation device **31** to inform the

30 mediation device that the call has ended and to disconnect communication sockets between the media relay caller and callee IP/UDP port addresses and

-55-

the IP/UDP port address to which the audio data received at the caller and callee IP/UDP port addresses were being copied.

5 It will be appreciated that in the foregoing description, the components described cooperate to detect a requirement for intercept at the time a call is set up. In the following description an explanation is provided to describe how to intercept a call while the call is in progress.

#### Intercepting a Call in Progress

10 Referring back to Figure 1, to intercept a call while the call is in progress, the law enforcement authority 293 may communicate with a mediation device, or may communicate with the call controller or may communicate with the routing controller or may communicate with a handover interface that  
15 communicates with any of the foregoing components to cause the routing controller to receive a law enforcement authority (LEA) intercept request message including intercept information. Such as that which would be associated with fields 702-710 in Figure 9, for example..

20 In response to receipt of a, LEA intercept request message, the routing controller LEA request message handler shown at 1400 in Figure 44 is invoked.

25 The LEA request message handler 1400 begins with a first block 1402 that directs the routing controller processor circuit to communicate with the database 18 in which dialing profile records of the type shown in Figure 9 are stored to find a dialing profile associated with the user whose calls are to be monitored.

30 If the username is not known, but a DID number (i.e. a PSTN number) is known, the routing controller may cause a search through the DID bank table records of the type shown in Figure 13, for example to find a username associated with a DID number. If the username is not known but a name and

-56-

address is known, other records such as billing records (not shown) associating names and addresses with usernames may be searched to find a username associated with a given name and/or address of a person whose calls are to be intercepted. Regardless of the information available, to  
5 facilitate call interception any way of finding the unique dialing profile associated with the user whose calls are to be intercepted is a first step to facilitating call interception, in this embodiment.

Once the dialing profile is located, block **1404** directs the routing controller processor circuit to associate the intercept information with the dialing profile  
10 by appending and/or populating the lawful intercept fields of the dialing profile with such information as provided in the LEA intercept request message..

Block **1406** then directs the routing controller processor circuit to determine  
15 whether the intercept criteria are met by the intercept information now included in the dialing profile. This is done by determining whether the LI flag (**702**) is on, and the current date and time is within the LI start stop date/time ranges. If the intercept criteria are not met, the process is ended. Otherwise the processor is directed to block **1408**.

20 Block **1408** directs the routing controller processor circuit to use the username of the dialing profile found at block **1402** to search caller and callee fields of routing controller active call records shown in Figure **36** that have contents matching the username associated with the dialing profile. If no such record is  
25 found, the user is not currently engaged in a call and the process is ended. If the user is engaged in a call, the routing controller active call record will be found. Block **1410** then directs the routing controller processor circuit to find the call controller id and call id of the associated call, from the routing controller active call record shown in Figure **36**.

30 Block **1412** then directs the routing controller processor circuit to transmit an in-call intercept message to the call controller identified by the contents of the

-57-

5 call controller id field **1322** of the routing controller active call record. The in-call intercept message includes the call id as determined from the routing controller active call record and the IP address of the mediation device associated with the law enforcement authority interested in intercepting the call. The IP address of the mediation device may be obtained from the law enforcement authority request message, or the dialing profile, for example.

10 Block **1414** then directs the routing controller processor circuit to wait a specified time to receive a call controller intercept status message back from the call controller indicating whether or not the intercept function has been activated.

15 Referring to Figure **45**, upon receipt of an in-call intercept message at the call controller (**14**) the call controller executes an in-call intercept message handler shown generally at **1450**. The in-call intercept message handler **1450** begins with a first block **1452** that directs the call controller processor circuit to send a SIP invite message to the mediation device associated with the IP address of the mediation device, received in the in-call intercept message.

20 Block **1454** then directs the call controller processor circuit to receive an IP address and callee and caller UDP port numbers from the mediation device, where this IP address and UDP port numbers are network locations at which the mediation device will expect to receive audio data streams from the media relay through which the call is carried.

25 Block **1456** then directs the call controller processor circuit to identify a media relay through which communications to be monitored are being conducted by using the username of the subscriber whose communications are to be monitored to locate an active call record in the call controller active call list to locate a media relay identifier such as the IP address of the media relay indicated by the contents of the media relay ID field **1310** of the call controller active call record shown in Figure **35**. The call controller processor circuit is

30

-58-

then directed to send an intercept request message to the media relay (17) that is handling the call. The intercept request message includes the mediation device IP address and caller and callee UDP port numbers to identify to the media relay (17) the mediation device IP address and UDP port number(s) at which it expects to receive a copy of the audio data stream from the caller and callee respectively.

In response, the media relay establishes internal connections between the caller and callee IP addresses and UDP ports and callee IP address and UDP port of the mediation device. Then, the media relay sends a media relay status message back to the call controller indicating whether or not internal connections have been established and that call intercept has been initiated.

As seen at block 1458, the call controller processor circuit is directed to receive the media relay status message and block 1460 directs the call controller processor circuit to send a call controller intercept status message back to the routing controller to indicate that the call intercept function has been established. The routing controller may communicate this status back to the law enforcement authority that issued the law enforcement authority request message. In the meantime, communications involving the caller or callee whose communications are to be monitored, which travel through the media relay, are copied and sent to the mediation device.

Thus, after associating intercept information with the dialing profile of the subscriber whose communications are to be monitored, when the determination information included in the intercept information meets intercept criteria, the call controller communicates with the media relay through which the communications of the subscriber whose communications are to be monitored to cause such media relay to send a copy of such communications to a mediation device specified by the destination information included in the intercept information.

-59-

When the call is ended, the call is shut down in the same way as described above.

5 Should the law enforcement authority desire to cease interception of the call during the call, an LEA request message requesting that the intercept function be stopped is sent to the routing controller from the law enforcement authority through any of the paths described above. This invokes the LEA request message handler such as shown in Figure 44 which causes the routing controller processor circuit to execute blocks 1402, 1404. At block 1404, the  
10 routing controller processor circuit is directed to change the contents of the lawful intercept fields to at least set the lawful intercept flag (702 in Figure 9) inactive.

15 Then, at block 1406, the intercept criteria are not met and the processor is directed to block 1416, which causes the routing controller processor circuit to determine whether or not an interception function is in progress. This can be determined, for example, by maintaining evidence of the receipt of the confirmation message from the call controller, received at block 1414 of the LEA request message handler 1400.

20 If an intercept is not in progress, the LEA request message handler 1400 is ended.

25 If an intercept is in progress, block 1418 directs the routing controller processor circuit to execute an in-call intercept shut down routine as shown at 1500 in Figure 46. The in-call intercept shut down routine begins with a first block 1502 which directs the routing controller processor circuit to locate the routing controller active call record having caller or callee field contents equal to the username indicated in the dialing profile found at block 1402 of the LEA request message handler 1400 shown in Figure 44. Having found the active  
30 call record, block 1504 directs the routing controller processor circuit to find, in the routing controller active call record shown in Figure 36, the call



-60-

controller id (**1322**) and the call id (**1316**) associated with the call. Block **1506** then directs the routing controller processor circuit to send a cease intercept message (not shown) to the call controller identified by the call controller id determined at block **1504**. This cease intercept message includes the call id  
5 determined at block **1504** and an identification of the mediation device, the identification being obtained from the MD1 address field (**704** in Figure **9**) of the dialing profile for the user whose calls are currently being intercepted. Block **1508** then directs the routing controller processor circuit to wait a specified time to receive a confirmation message from the call controller to  
10 indicate that the intercept function has been shut down.

Referring to Figure **47**, upon receipt of the cease intercept message at the call controller (**14**), a cease intercept message handler **1520** is invoked at the call controller. The cease intercept message handler **1520** begins with a first  
15 block **1522** that directs the call controller processor circuit to send a SIP stop message to the mediation device identified in the cease intercept message received from the routing controller. In response to the SIP stop message, the mediation device stops receiving audio data and sends a confirmation message back to the call controller.

20 Block **1524** directs the call controller processor circuit to receive the confirmation message back from the mediation device.

Block **1526** then directs the call controller processor circuit to send a stop  
25 intercept message to the media relay **17** identified by the contents of the media relay ID field **1310** of the active call record shown in Figure **35**. The stop intercept message includes the contents of the media relay caller port ID field **1312** and media relay callee port field **1314** included in the active call record and identifies to the media relay which ports to shut down. In response  
30 to the stop intercept message, the media relay **17** disconnects the connections between the media relay caller port and the mediation device port that was receiving the audio data from the caller and the connection between

-61-

the media relay callee port and the mediation device port that was receiving audio data from the callee. The media relay then sends an MR stop status message to the call controller.

5       Block **1528** directs the call controller processor circuit to receive the MR stop status message and block **1530** directs the call controller to send a stop status message to the routing controller **16**.

10       In an alternative embodiment, the routing controller does not maintain active call records but each call controller does. In such an embodiment, blocks **1408** and **1410** of Figure **44** are replaced with a single block **1600** that directs the routing controller processor circuit to poll each call controller to determine whether or not its active call list contains an entry having caller or callee field contents equal to the username determined from the dialing profile located at  
15       block **1402**.

If any of the polled call controllers has such a record, that call controller transmits a response message back to the routing controller, the response message including a call controller ID identifying that call controller. More than  
20       one call controller may have an active call record having caller or callee field contents equal to the username determined from the user profile. Such would be the case in a conference call, for example.

The routing controller processor circuit then executes blocks **1412** and **1414**  
25       as described above or the process is ended if none of the polled call controllers contains a call record with caller and callee field contents matching the username determined from the dialing profile located at block **1402**.

In effect therefore, block **1600** provides an alternate way of finding call  
30       controllers that are currently carrying a call associated with the user of interest.

-62-

In another embodiment, an interface to the routing controller and/or the call controller may be provided to enable law enforcement authorities to have direct access or a copy of the active call list maintained by the call controller and/or routing controller.

5

From the foregoing, it will be appreciated that indications of whether or not communications of a subscriber to the system are to be monitored are provided by law enforcement agencies directly into a subscriber dialing profile shown in Figure 9. This dialing profile is used to route a call involving the subscriber and is checked for lawful intercept requirements to determine whether or not the media relay should copy audio data associated with the call to a mediation device for lawful monitoring and/or recording purposes.

10

While the system has been described in connection with the monitoring of audio streams, it may similarly be used for monitoring any other data streams such as pure data and/or video or multimedia data, for example, between subscribers to the system or between a subscriber and a non-subscriber to the system.

15

While specific embodiments of the invention have been described and illustrated, such embodiments should be considered illustrative of the invention only and not as limiting the invention as construed in accordance with the accompanying claims.

20

-63-

What is claimed is:

1. A method for intercepting communications in an Internet Protocol (IP) network, the method comprising:

5

maintaining dialing profiles for respective subscribers to the IP network, each said dialing profile including a username associated with the corresponding subscriber;

10

associating intercept information with the dialing profile of a subscriber whose communications are to be monitored, said intercept information including determination information for determining whether to intercept a communication involving said subscriber, and destination information identifying a device to which intercepted communications involving said subscriber are to be sent; and

15

when said determination information meets intercept criteria, communicating with a media relay through which said communications involving said subscriber will be conducted or are being conducted to cause said media relay to send a copy of said communications to a mediation device specified by said destination information.

20

- 25     **2.** The method of clam 1 wherein associating intercept information comprises associating said intercept information with said dialing profile when communications involving said subscriber are not in progress.

30

- 3.** The method of clam 1 wherein associating intercept information comprises associating said intercept information when communications involving said subscriber are in progress.

-64-

- 5           **4.**    The method of claim **2** or **3** wherein associating said intercept information comprises populating intercept information fields in said dialing profile of the subscriber whose communications are to be monitored.
- 10           **5.**    The method of claim **1** further comprising producing a routing message for routing communications involving the subscriber through components of the IP network and determining whether said determination information meets said intercept criteria prior to producing said routing message and including at least some of said intercept information in said routing message when said determination information meets said intercept criteria.
- 15           **6.**    The method of claim **5** wherein determining whether said determination information meets said intercept criteria comprises determining whether a current date and time is within a range specified by said determination information.
- 20           **7.**    The method of claim **6** further comprising identifying a media relay through which communications involving said subscriber will be conducted in response to said routing message.
- 25           **8.**    The method of claim **7** further comprising pre-associating at least one media relay with said dialing profile of the subscriber whose communications are to be monitored and wherein identifying said media relay comprises identifying the media relay pre-associated with said subscriber whose communications are to be monitored.
- 30           **9.**    The method of claim **8** wherein pre-associating comprises populating media relay fields in said dialing profile with an identification of at least one media relay.

- 5           **10.** The method of claim **1** wherein said intercept information is associated with said dialing profile of the subscriber whose communications are to be monitored, in response to receipt of an intercept request message, wherein said intercept request message comprises said intercept information.
- 10           **11.** The method of claim **10** further comprising invoking an intercept request message handler to:
- 10                   a) find a dialing profile associated with the subscriber whose communications are to be monitored;
  - b) perform the step of associating said intercept information with said dialing profile;
  - c) determine whether said intercept criteria are met; and
  - 15                   d) identify a media relay through which said communications are being conducted.
- 20           **12.** The method of claim **11** further comprising maintaining a active call records for communications in progress, said active call records comprising a username identifier and a media relay identifier identifying the media relay through which said communications are being conducted and wherein identifying a media relay through which said communications are being conducted comprises locating an active call record associated with communications of the subscriber whose
- 25                   communication are to be monitored to find the media relay associated with said communications.
- 30           **13.** The method of claim **12** further comprising maintaining direct inward dialing (DID) records associating PST telephone numbers with usernames of users subscribing to said IP network, and wherein finding a dialing profile associated with the subscriber whose communications are to be monitored comprises finding a username in a DID record

-66-

bearing a PSTN number associated with the subscriber whose communications are to be monitored and using said username to locate a dialing profile associated with said username.

- 5       **14.** An apparatus for intercepting communications in an Internet Protocol (IP) network, the apparatus comprising:

10                   means for maintaining dialing profiles for respective subscribers to the IP network, each said dialing profile including a username associated with the corresponding subscriber;

15                   means for associating intercept information with the dialing profile of a subscriber whose communications are to be monitored, said intercept information including determination information for determining whether to intercept a communication involving said subscriber, and destination information identifying a device to which intercepted communications involving said subscriber are to be sent; and

20                   means for communicating with a media relay through which said communications involving said subscriber will be conducted or are being conducted to cause said media relay to send a copy of said communications to a mediation device specified by said destination information, when said determination information

25                   meets intercept criteria.

- 30       **15.** The apparatus of clam **14** wherein said means for associating intercept information is operably configured to associate said intercept information with said dialing profile when communications involving said subscriber are not in progress.

-67-

- 5
16. The apparatus of claim **14** wherein said means for associating intercept information is operably configured to associate said intercept information when communications involving said subscriber are in progress.
- 10
17. The apparatus of claim **15** or **16** wherein said means for associating said intercept information is operably configured to populate intercept information fields in said dialing profile of the subscriber whose communications are to be monitored.
- 15
18. The apparatus of claim **14** further comprising means for producing a routing message for routing communications involving the subscriber through components of the IP network and means for determining whether said determination information meets said intercept criteria prior to producing said routing message and wherein said means for producing said routing message is operably configured to include at least some of said intercept information in said routing message when said determination information meets said intercept criteria.
- 20
19. The apparatus of claim **18** wherein said means for determining whether said determination information meets said intercept criteria is operably configured to determine whether a current date and time is within a range specified by said determination information.
- 25
20. The apparatus of claim **19** further comprising means for identifying a media relay through which communications involving said subscriber will be conducted in response to said routing message.
- 30
21. The apparatus of claim **20** further comprising means for pre-associating at least one media relay with said dialing profile of the subscriber whose communications are to be monitored and wherein said routing means is operably configured to identify from said dialing



-68-

profile the media relay pre-associated with said subscriber whose communications are to be monitored.

- 5           **22.** The apparatus of claim **21** wherein said means for pre-associating is operably configured to populate media relay fields in said dialing profile with an identification of at least one media relay.
- 10           **23.** The apparatus of claim **14** wherein means for associating said intercept information is operably configured to associate said intercept information associated with said dialing profile of the subscriber whose communications are to be monitored, in response to receipt of an intercept request message, wherein said intercept request message comprises said intercept information.
- 15           **24.** The apparatus of claim **23** further comprising means for handling an intercept request message, said means for handling an intercept request message comprising:
- 20                   a) means for find a dialing profile associated with the subscriber whose communications are to be monitored, said means for finding a dialing profile cooperating with said means for associating said intercept information with said dialing profile to cause said intercept information to be associated with said dialing profile;
- 25                   b) means for determining whether said intercept criteria are met; and
- c) means for identifying a media relay through which said communications are being conducted.
- 30           **25.** The apparatus of claim **24** further comprising means for maintaining active call records for communications in progress, said active call records comprising a username identifier and a media relay identifier identifying the media relay through which said communications are

-69-

5 being conducted and wherein said means for identifying a media relay through which said communications are being conducted is operably configured to locate an active call record associated with communications of the subscriber whose communication are to be monitored to find the media relay associated with said communications.

10 **26.** The apparatus of claim **25** further comprising means for maintaining direct inward dialing (DID) records associating PST telephone numbers with usernames of users subscribing to said IP network, and wherein said means for finding a dialing profile associated with the subscriber whose communications are to be monitored is operably configured to find a username in a DID record bearing a PSTN number associated with the subscriber whose communications are to be monitored and use said username to locate a dialing profile associated with said  
15 username.

**AMENDED CLAIMS received by the International Bureau on 14 May 2008  
(14/05/08)**

What is claimed is:

1. A method for intercepting communications in an Internet Protocol (IP) network, the method comprising:

5

maintaining dialing profiles for respective subscribers to the IP network, each said dialing profile including a username associated with the corresponding subscriber;

10

associating intercept information with a dialing profile of a subscriber whose communications are to be monitored, said intercept information including determination information for determining whether to intercept a communication involving said subscriber, and destination information identifying a mediation device to which intercepted communications involving said subscriber are to be sent; and

15

selecting a media relay through which communications involving said subscriber and a callee or caller of said subscriber will be conducted, by selecting a media relay from a pool of media relays at any of a plurality of geographical locations to identify a selected media relay;

20

when said determination information meets intercept criteria, communicating with said selected media relay through which said communications involving said subscriber will be conducted or are being conducted to cause said selected media relay to send a copy of said communications to a mediation device specified by said destination information.

25

30

2. The method of claim 1 wherein associating intercept information comprises associating said intercept information with said dialing

profile when communications involving said subscriber are not in progress.

- 5
3. The method of claim 1 wherein associating intercept information comprises associating said intercept information when communications involving said subscriber are in progress.
- 10
4. The method of claim 2 or 3 wherein associating said intercept information comprises populating intercept information fields in said dialing profile of the subscriber whose communications are to be monitored.
- 15
5. The method of claim 1 further comprising producing a routing message for routing communications involving the subscriber through components of the IP network and determining whether said determination information meets said intercept criteria prior to producing said routing message and including at least some of said intercept information in said routing message when said determination information meets said intercept criteria.
- 20
6. The method of claim 5 wherein determining whether said determination information meets said intercept criteria comprises determining whether a current date and time is within a range specified by said determination information.
- 25
7. The method of claim 6 wherein producing a routing message comprises identifying a media relay through which communications involving said subscriber will be conducted and including an identification of said media relay in said routing message.
- 30
8. The method of claim 7 further comprising pre-associating at least one media relay with said dialing profile of the subscriber whose

communications are to be monitored and wherein identifying said media relay comprises identifying the media relay pre-associated with said subscriber whose communications are to be monitored.

- 5           **9.**    The method of claim **8** wherein pre-associating comprises populating media relay fields in said dialing profile with an identification of at least one media relay.
- 10           **10.**   The method of claim **1** wherein said intercept information is associated with said dialing profile of the subscriber whose communications are to be monitored, in response to receipt of an intercept request message, wherein said intercept request message comprises said intercept information.
- 15           **11.**   The method of claim **10** further comprising invoking an intercept request message handler to:
- a)    find a dialing profile associated with the subscriber whose communications are to be monitored;
  - b)    perform the step of associating said intercept information with said dialing profile;
  - c)    determine whether said intercept criteria are met; and
  - d)    identify a media relay through which said communications are being conducted.
- 20
- 25           **12.**   The method of claim **11** further comprising maintaining active call records for communications in progress, said active call records comprising a username identifier and a media relay identifier identifying the media relay through which said communications are being conducted and wherein identifying a media relay through which said
- 30           communications are being conducted comprises locating an active call record associated with communications of the subscriber whose

communication are to be monitored to find the media relay associated with said communications.

5 13. The method of claim 12 further comprising maintaining direct-in-dial (DID) records associating PST telephone numbers with usernames of users subscribing to said IP network, and wherein finding a dialing profile associated with the subscriber whose communications are to be monitored comprises finding a username in a DID record bearing a PSTN number associated with the subscriber whose communications are to be monitored and using said username to locate a dialing profile associated with said username.

10 14. An apparatus for intercepting communications in an Internet Protocol (IP) network, the apparatus comprising:

15 means for maintaining dialing profiles for respective subscribers to the IP network, each said dialing profile including a username associated with the corresponding subscriber;

20 means for associating intercept information with a dialing profile of a subscriber whose communications are to be monitored, said intercept information including determination information for determining whether to intercept a communication involving said subscriber, and destination information identifying a mediation device to which intercepted communications involving said subscriber are to be sent; and

25 means for selecting a media relay through which communications involving said subscriber and a callee or caller of said subscriber will be conducted, by selecting a media relay

from a pool of media relays at any of a plurality of geographical locations to identify a selected media relay;

5

means for communicating with said selected media relay through which said communications involving said subscriber will be conducted or are being conducted to cause said selected media relay to send a copy of said communications to a mediation device specified by said destination information, when said determination information meets intercept criteria.

10

15. The apparatus of claim 14 wherein said means for associating intercept information is operably configured to associate said intercept information with said dialing profile when communications involving said subscriber are not in progress.

15

16. The apparatus of claim 14 wherein said means for associating intercept information is operably configured to associate said intercept information when communications involving said subscriber are in progress.

20

17. The apparatus of claim 15 or 16 wherein said means for associating said intercept information is operably configured to populate intercept information fields in said dialing profile of the subscriber whose communications are to be monitored.

25

18. The apparatus of claim 14 further comprising means for producing a routing message for routing communications involving the subscriber through components of the IP network and means for determining whether said determination information meets said intercept criteria prior to producing said routing message and wherein said means for producing said routing message is operably configured to include at

30

least some of said intercept information in said routing message when said determination information meets said intercept criteria.

- 5
19. The apparatus of claim 18 wherein said means for determining whether said determination information meets said intercept criteria is operably configured to determine whether a current date and time is within a range specified by said determination information.
- 10
20. The apparatus of claim 19 wherein said means for producing said routing message is operably configured to identify a media relay through which communications involving said subscriber will be conducted and to include ng an identification of said media relay in said routing message.
- 15
21. The apparatus of claim 20 further comprising means for pre-associating at least one media relay with said dialing profile of the subscriber whose communications are to be monitored and wherein said routing means is operably configured to identify from said dialing profile the media relay pre-associated with said subscriber whose
- 20
- communications are to be monitored.
22. The apparatus of claim 21 wherein said means for pre-associating is operably configured to populate media relay fields in said dialing profile with an identification of at least one media relay.
- 25
23. The apparatus of claim 14 wherein means for associating said intercept information is operably configured to associate said intercept information associated with said dialing profile of the subscriber whose communications are to be monitored, in response to receipt of an intercept request message, wherein said intercept request message
- 30
- comprises said intercept information.



24. The apparatus of claim 23 further comprising means for handling an intercept request message, said means for handling an intercept request message comprising:
- 5 a) means for finding a dialing profile associated with the subscriber whose communications are to be monitored, said means for finding a dialing profile cooperating with said means for associating said intercept information with said dialing profile to cause said intercept information to be associated with said dialing profile;
  - 10 b) means for determining whether said intercept criteria are met; and
  - c) means for identifying a media relay through which said communications are being conducted.
- 15 25. The apparatus of claim 24 further comprising means for maintaining active call records for communications in progress, said active call records comprising a username identifier and a media relay identifier identifying the media relay through which said communications are being conducted and wherein said means for identifying a media relay
- 20 through which said communications are being conducted is operably configured to locate an active call record associated with communications of the subscriber whose communication are to be monitored to find the media relay associated with said communications.
- 25 26. The apparatus of claim 25 further comprising means for maintaining direct-in-dial (DID) records associating PST telephone numbers with usernames of users subscribing to said IP network, and wherein said means for finding a dialing profile associated with the subscriber whose communications are to be monitored is operably configured to find a
- 30 username in a DID record bearing a PSTN number associated with the subscriber whose communications are to be monitored and use said username to locate a dialing profile associated with said username.

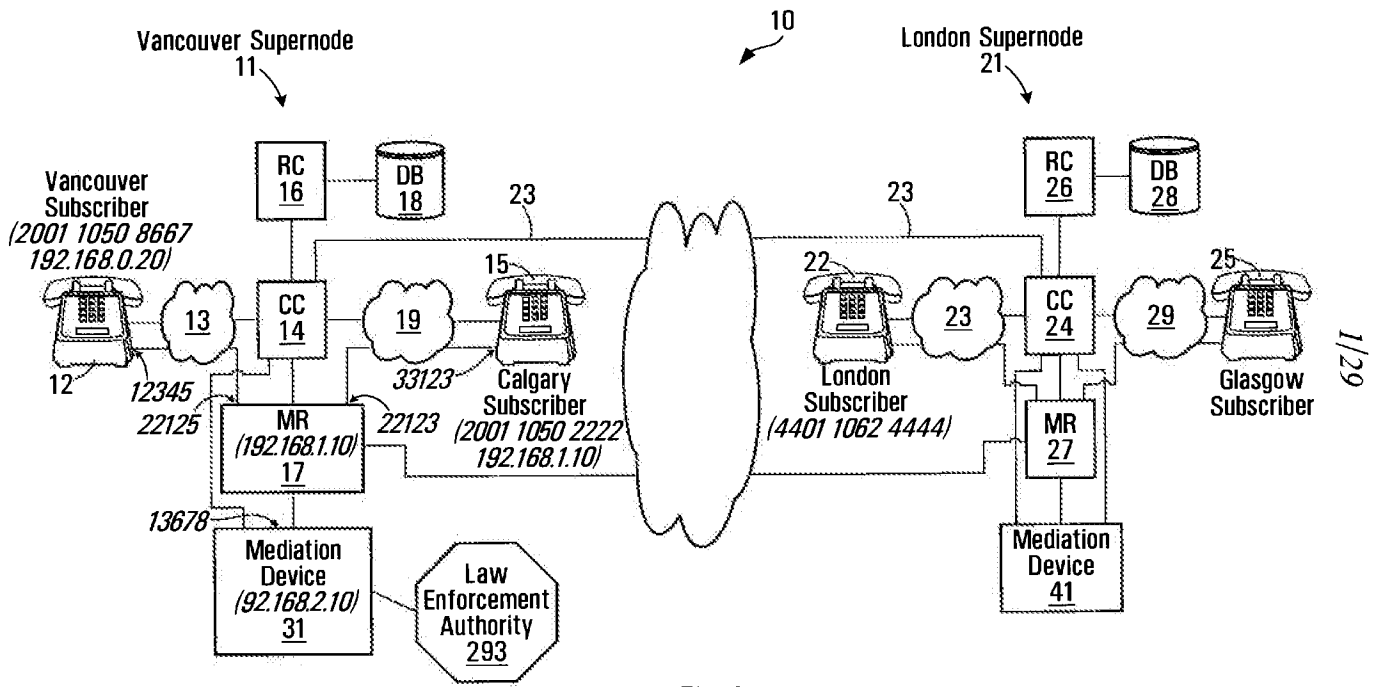


FIG. 1

1/29

2/29

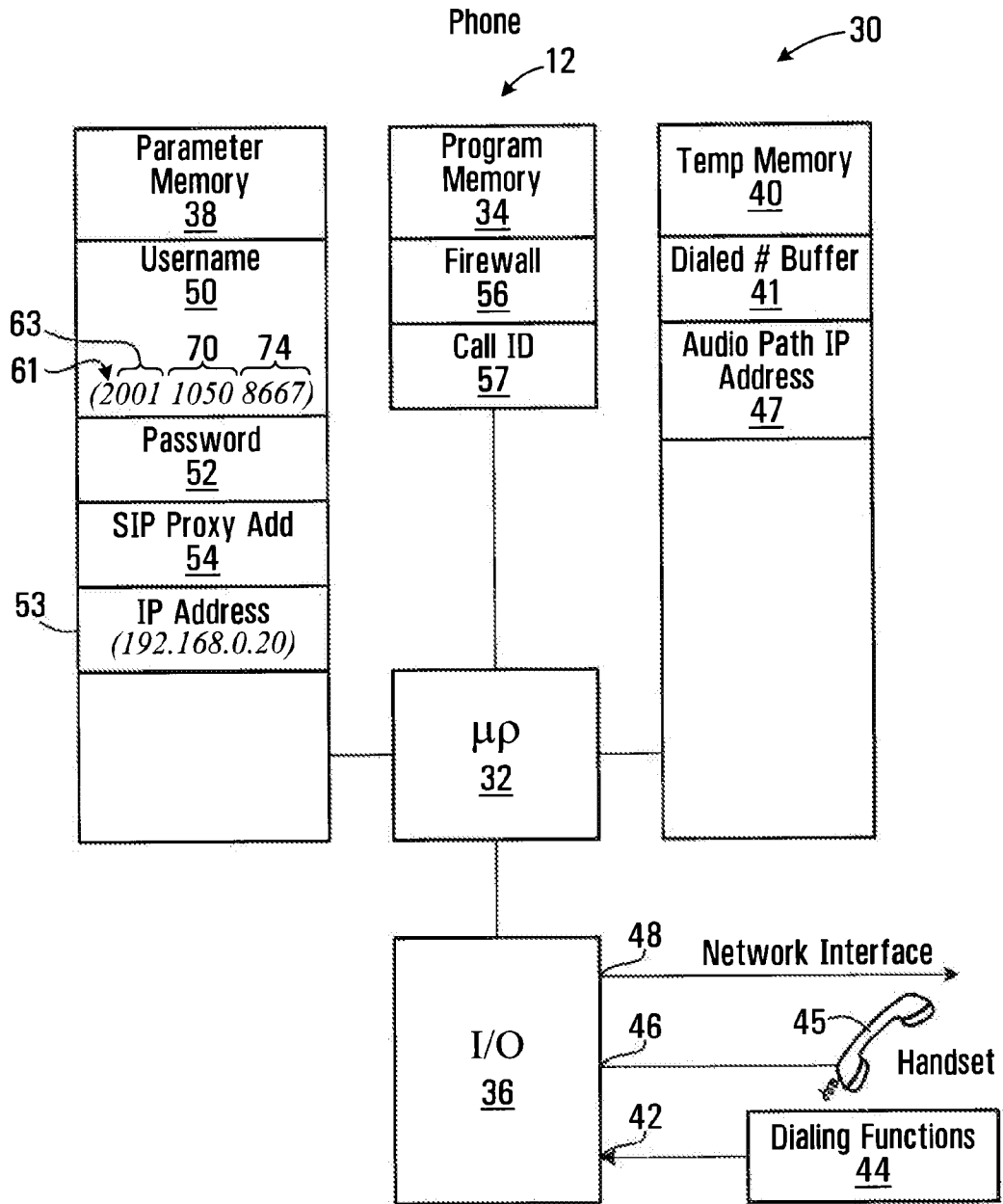


FIG. 2

3/29

SIP Invite Message

60 ~ Caller 2001 1050 8667  
 62 ~ Callee 2001 1050 2222  
 64 ~ Digest Parameters XXXXXXX  
 65 ~ Call ID FF10@ 192.168.0.20  
 67 ~ Caller IP Address 192.168.0.20  
 69 ~ Caller UDP port 12345

FIG. 3

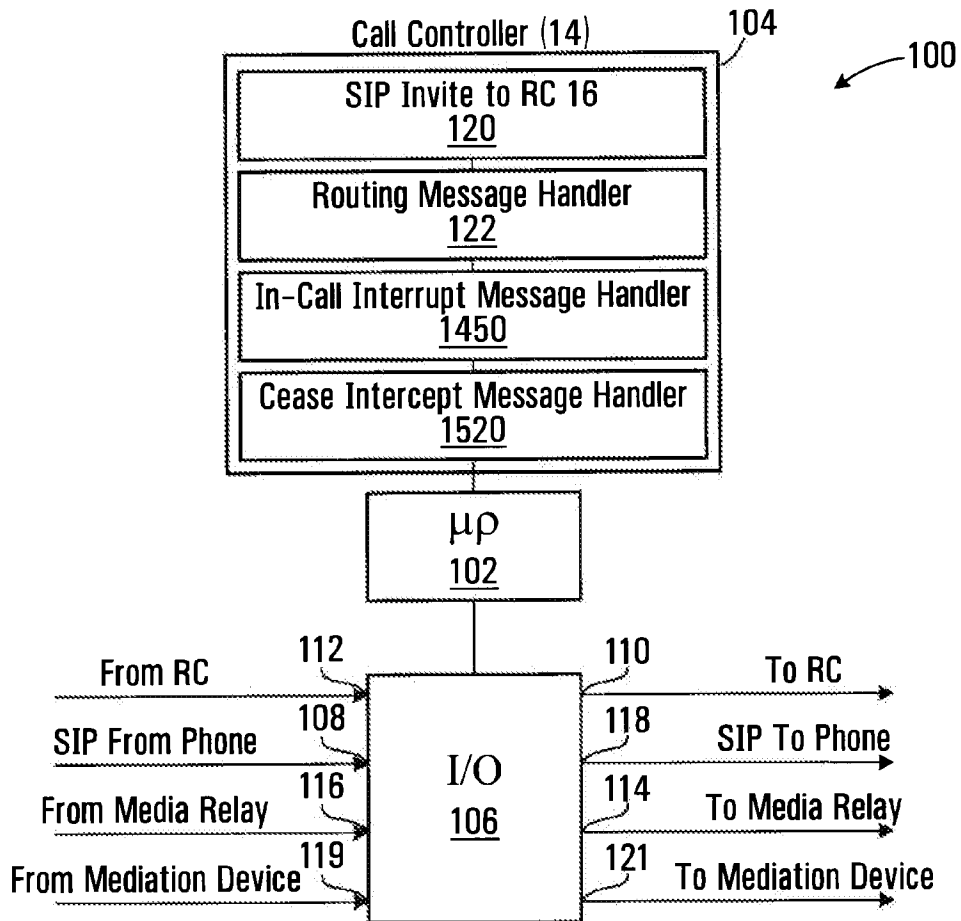
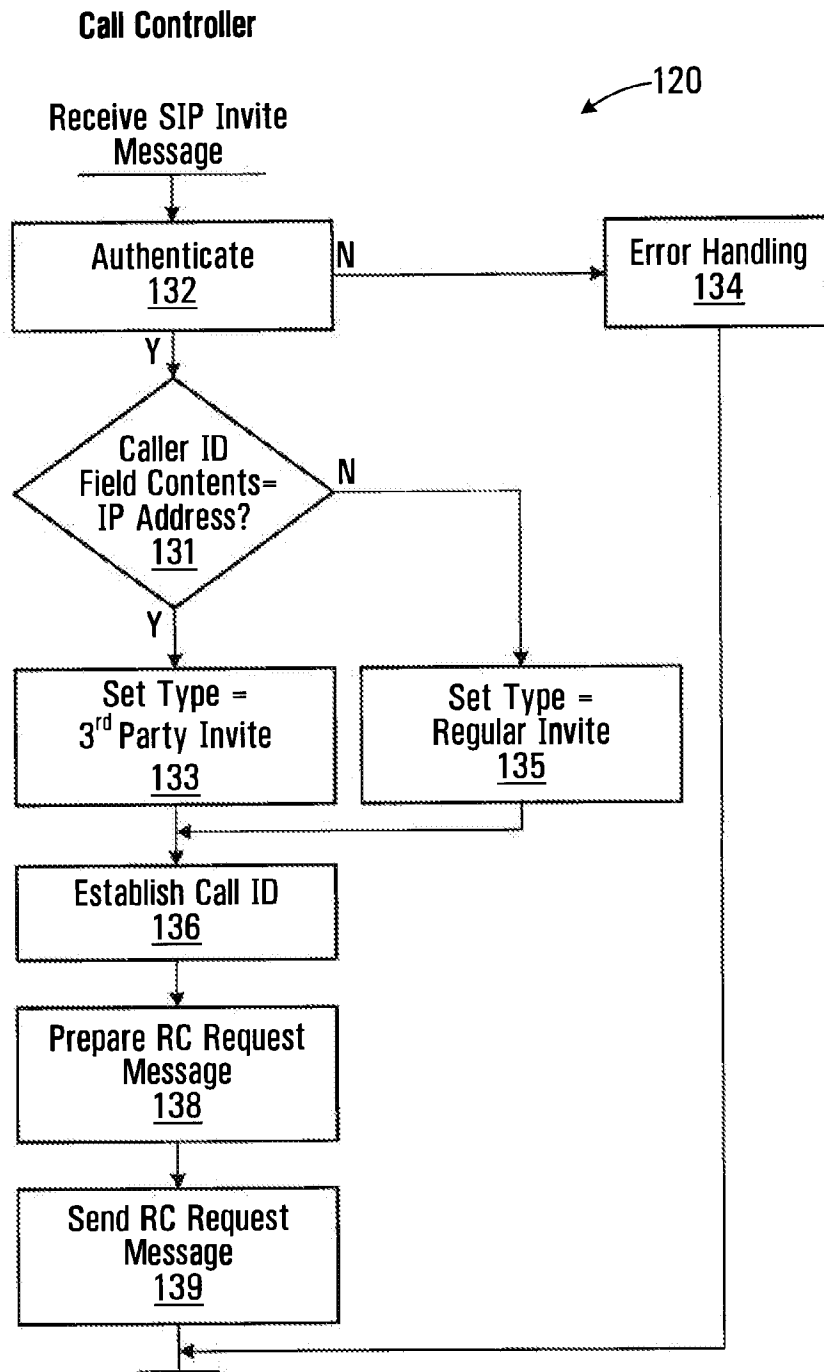


FIG. 4

4/29



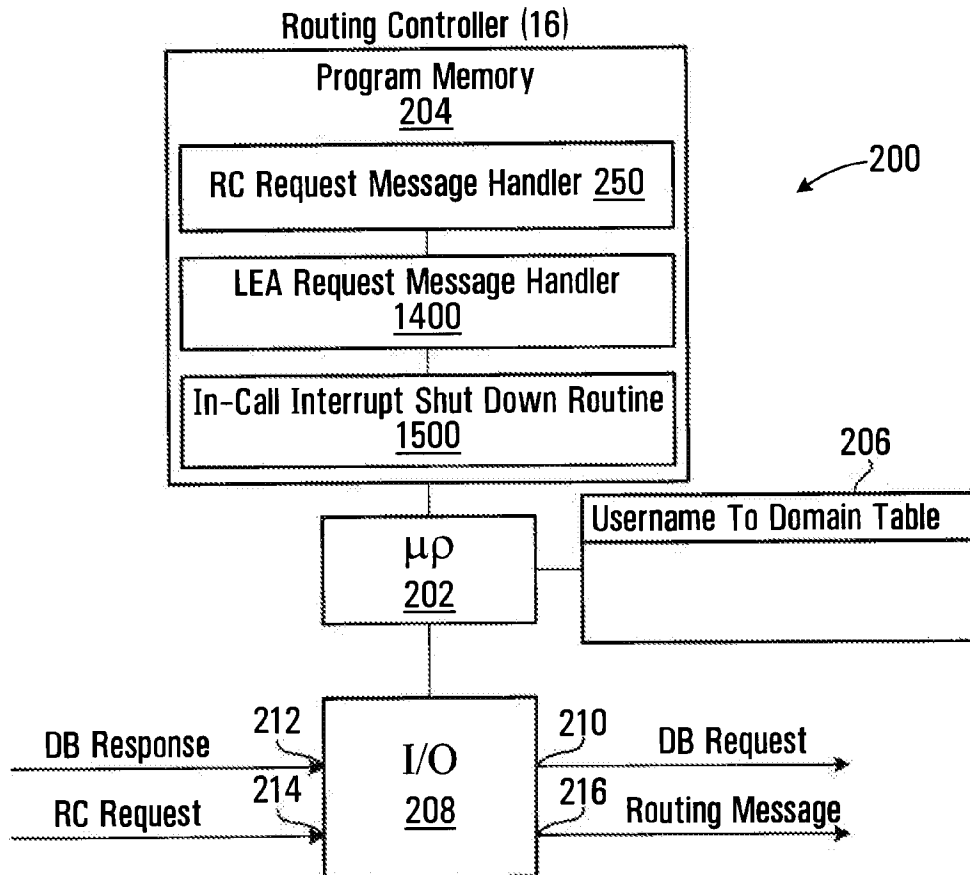
**FIG. 5**

5/29

RC Request Message ↖ 150

152 ~ Caller 2001 1050 8667  
154 ~ Callee 2001 1050 2222  
156 ~ Digest XXXXXXX  
158 ~ Call ID FF10@ 192.168.0.20  
160 ~ Type Subscriber

**FIG. 6**



**FIG. 7**

6/29

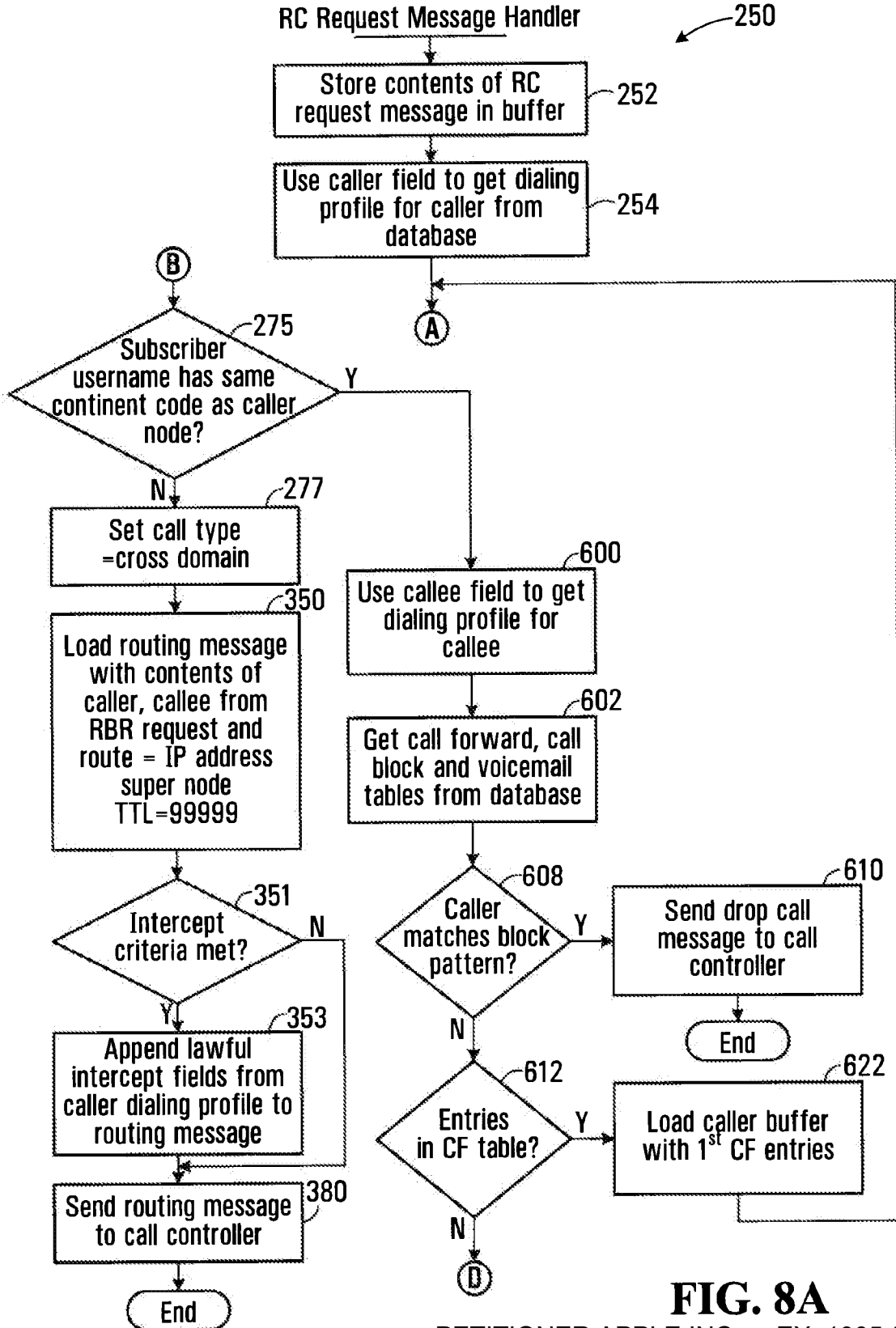


FIG. 8A

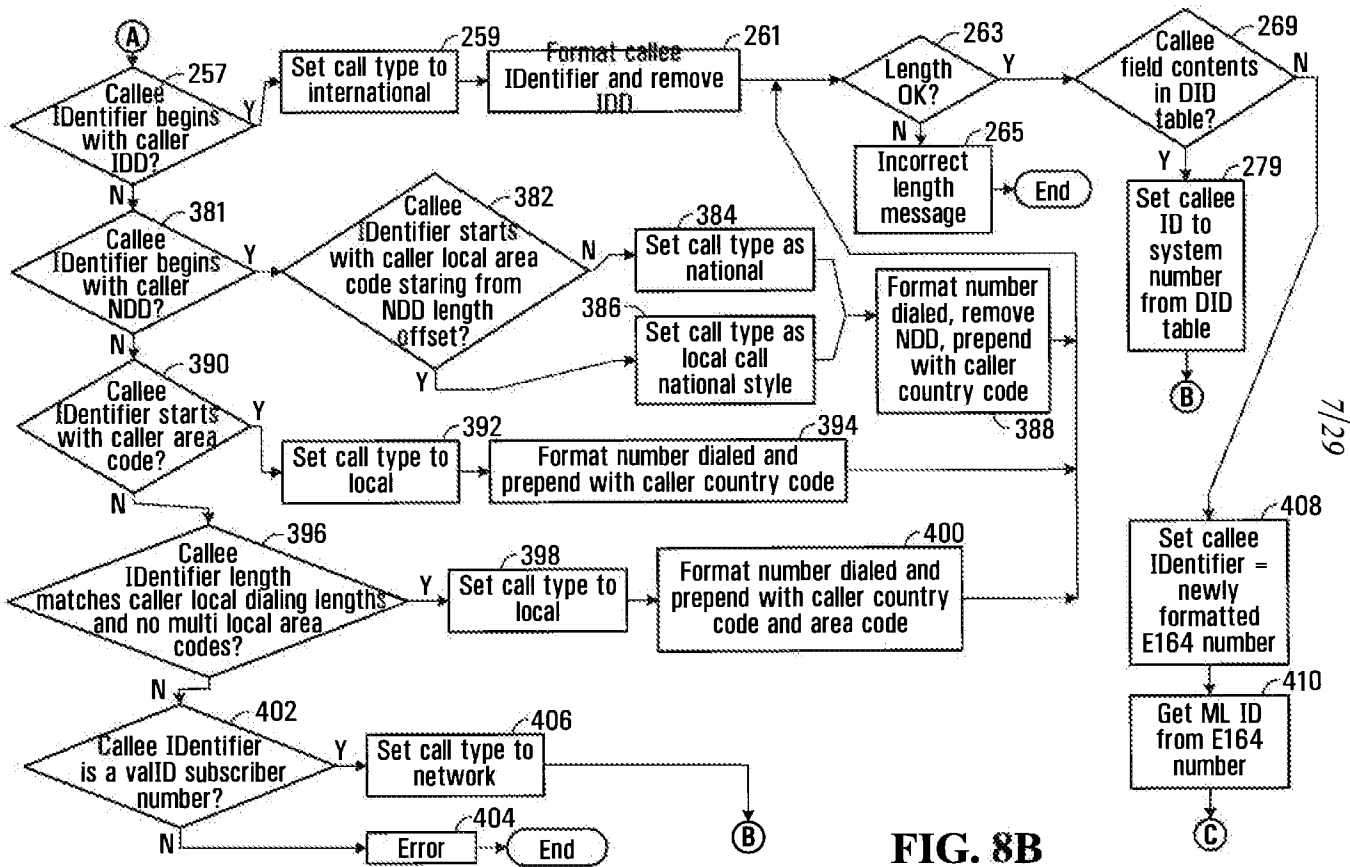


FIG. 8B

7/29



8/29

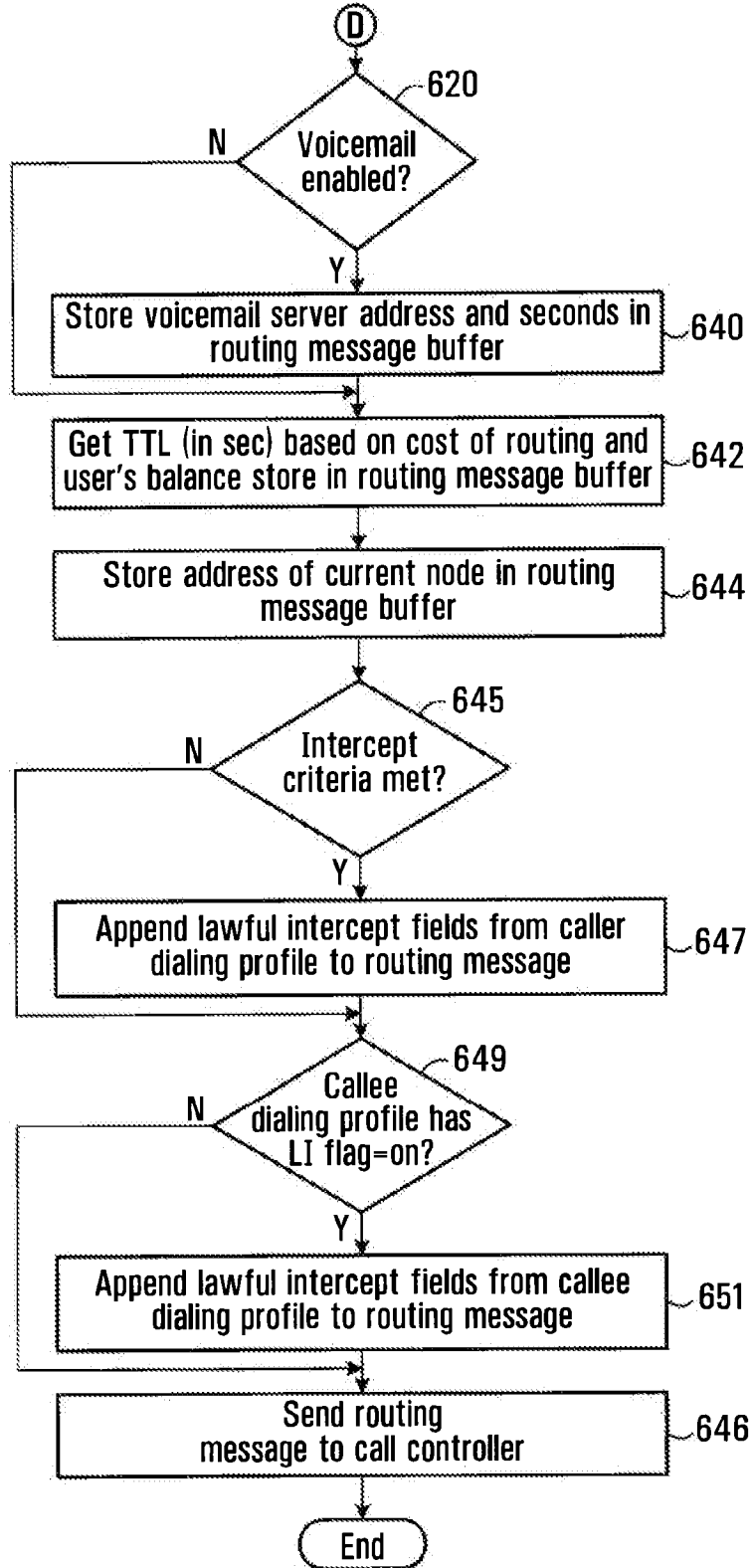


FIG. 8C

9/29

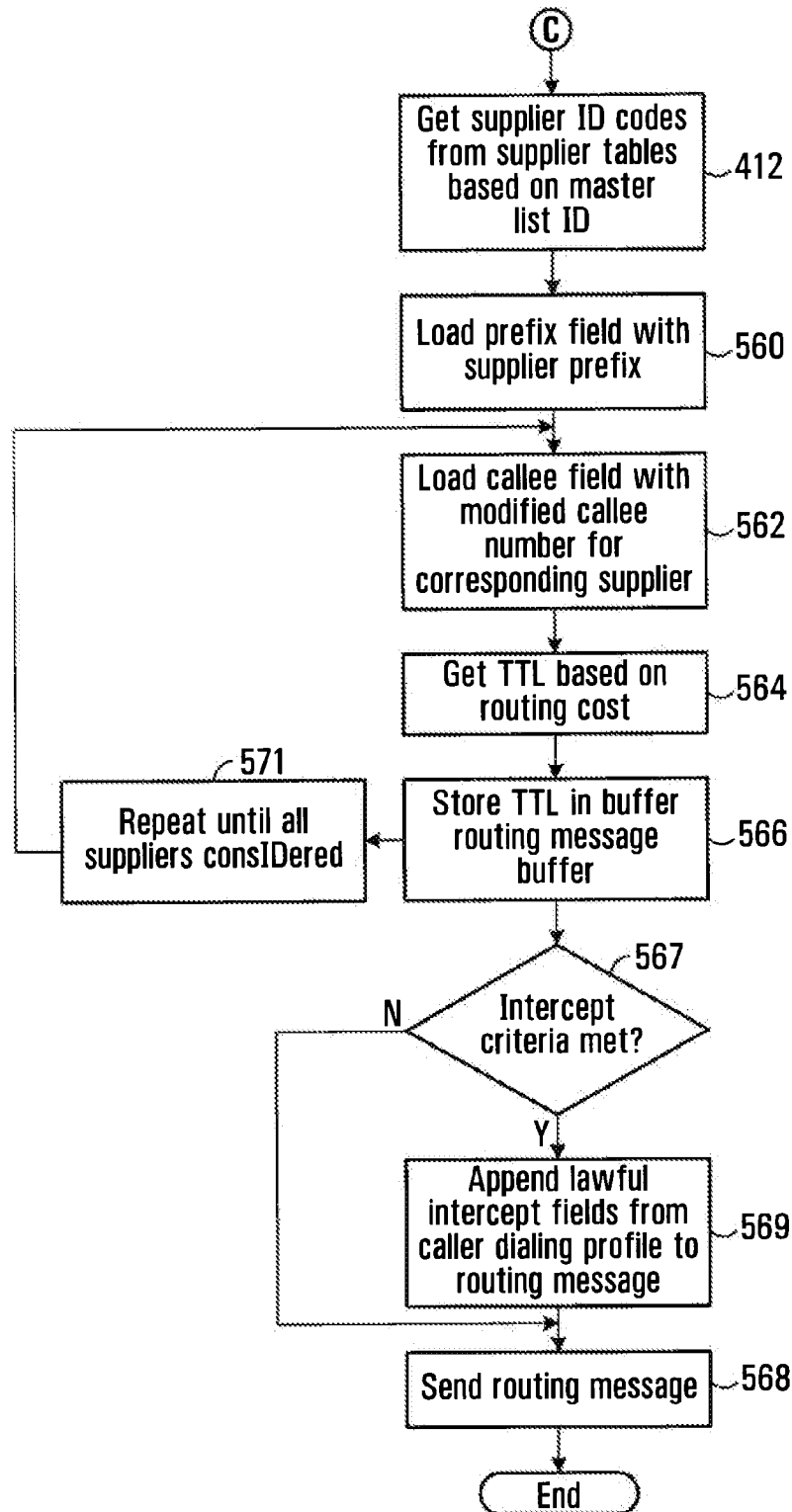


FIG. 8D

10/29

← 256

**Dialing Profile for a User**

|                                   |                                    |
|-----------------------------------|------------------------------------|
| 258 ~ Username                    | Assigned on Subscription           |
| 260 ~ Domain                      | Domain Associated with User        |
| 262 ~ NDD                         | National Dialing Digit Code        |
| 264 ~ IDD                         | International Dialing Digit Code   |
| 266 ~ Country Code                | Country Dependant Code             |
| 267 ~ Local Area Codes            | Numeric                            |
| 268 ~ Caller Minimum Local Length | Numeric                            |
| 270 ~ Caller Maximum Local Length | Numeric                            |
| 273 ~ Reseller                    | Retailer                           |
| 1150 ~ Media Relay 1              | Optional Media relay IDentifier #1 |
| 1150 ~ Media Relay n              | Optional Media relay IDentifier #2 |
| 702 ~ LI flag                     | on or off                          |
| 704 ~ MD1 Address                 | Address of First Mediation Device  |
| 706 ~ Warrant ID                  | From Law Enforcement Agency        |
| 708 ~ LI-Start Date/Time          | When to Begin Monitoring Period    |
| 710 ~ LI-Stop Date/Time           | When to End Monitoring Period      |

**FIG. 9**

**Dialing Profile for Vancouver Subscriber**

← 276

|                                   |                     |            |      |     |    |       |
|-----------------------------------|---------------------|------------|------|-----|----|-------|
| 258 ~ Username                    | 284                 | 61         | 63   | 70  | 74 |       |
| 260 ~ Domain                      | 2001                | 1050       | 8667 |     |    |       |
| 262 ~ NDD                         | sp.yvr              | digifonica | com  |     |    | ← 282 |
| 264 ~ IDD                         | 011                 | 286        | 288  | 290 |    |       |
| 266 ~ Country Code                | 1                   |            |      |     |    |       |
| 267 ~ Local Area Codes            | 604;778 (Vancouver) |            |      |     |    |       |
| 268 ~ Caller Minimum Local Length | 10                  |            |      |     |    |       |
| 270 ~ Caller Maximum Local Length | 10                  |            |      |     |    |       |
| 273 ~ Reseller                    | Klondike            |            |      |     |    |       |
| MR 1                              | 192.168.1.10        |            |      |     |    |       |
| ⋮                                 |                     |            |      |     |    |       |
| MR N                              | 192.168.2.59        |            |      |     |    |       |

**FIG. 10**

11/29

**Dialing Profile for Calgary Subscriber**

|                                    |                       |
|------------------------------------|-----------------------|
| <b>Username</b>                    | 2001 1050 2222        |
| <b>Domain</b>                      | sp.yvr.digifonica.com |
| <b>NDD</b>                         | 1                     |
| <b>IDD</b>                         | 011                   |
| <b>Country Code</b>                | 1                     |
| <b>Local Area Codes</b>            | 403 (Calgary)         |
| <b>Caller Minimum Local Length</b> | 7                     |
| <b>Caller Maximum Local Length</b> | 10                    |
| <b>Reseller</b>                    | ABC                   |
| <b>MR1</b>                         | 192.168.3.60          |
| <b>:</b>                           |                       |
| <b>MRn</b>                         | 192.168.4.69          |

**FIG. 11****Dialing Profile for London Subscriber**

|                                    |                       |
|------------------------------------|-----------------------|
| <b>Username</b>                    | 4401 1062 4444        |
| <b>Domain</b>                      | sp.lhr.digifonica.com |
| <b>NDD</b>                         | 0                     |
| <b>IDD</b>                         | 00                    |
| <b>Country Code</b>                | 44                    |
| <b>Local Area Codes</b>            | 20 (London)           |
| <b>Caller Minimum Local Length</b> | 10                    |
| <b>Caller Maximum Local Length</b> | 11                    |
| <b>Reseller</b>                    | DEF                   |
| <b>MR1</b>                         | 192.168.5.70          |
| <b>:</b>                           |                       |
| <b>MRn</b>                         | 192.168.6.79          |

**FIG. 12**

12/29

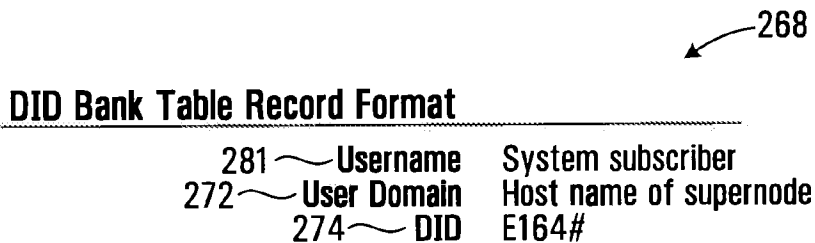


FIG. 13

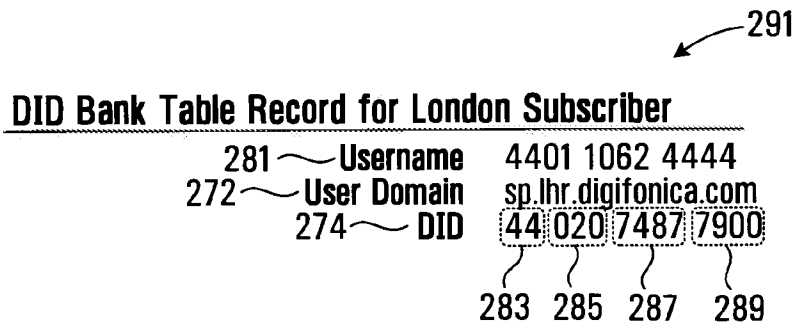


FIG. 14

13/29

352

**Routing Message Format**

|     |                            |                                             |
|-----|----------------------------|---------------------------------------------|
| 354 | Supplier Prefix (optional) | Code Identifying supplier traffic           |
| 356 | Delimiter                  | Symbol separating fields                    |
| 358 | Callee                     | PSTN compatible number or Digifonica number |
| 360 | Route                      | Domain name and IP address                  |
| 362 | Time to Live(TTL)          | In seconds                                  |
| 364 | Other                      | TBD                                         |

**FIG. 15**

366

**Routing Message - Different Node**

440110624444@sp.lhr.digifonica.com;tll=9999

358                      360                      362

1152 ~ Media Relays (optional)

**FIG. 16**

**Routing Message - Different Node with lawful intercept fields**

440110624444@sp.lhr.digifonica.com;tll=999;LIflag=on;MAddress=192.168.1.10;  
 WarrantID=20060515142;  
 LIstart=2006 05 16 00:00:00  
 LIstop=2006 12 31 23:59:59;  
 1152 ~ Media Relays (optional)

**FIG. 16A**

370

**Prefix to Supernode Table Record Format**

|     |                   |                                           |
|-----|-------------------|-------------------------------------------|
| 372 | Prefix            | First n digits of callee IDentifier       |
| 374 | Supernode Address | IP address or fully qualified domain name |

**FIG. 17**

**Prefix to Supernode Table Record for London Subscriber**

Prefix            4  
 Supernode Address    sp.lhr.digifonica.com

**FIG. 18**

14/29

**Master List Record Format**

|       |                       |                                                                                                                                                                                       |
|-------|-----------------------|---------------------------------------------------------------------------------------------------------------------------------------------------------------------------------------|
| 500 ~ | ml_ID                 | 1019                                                                                                                                                                                  |
| 502 ~ | Dialing code          | 1604                                                                                                                                                                                  |
| 504 ~ | Country code          | The country code is the national prefix to be used when dialing TO a particular country FROM another country.                                                                         |
| 506 ~ | Nat Sign #(Area Code) | Numeric                                                                                                                                                                               |
| 508 ~ | Min Length            | Numeric                                                                                                                                                                               |
| 510 ~ | Max Length            | Numeric                                                                                                                                                                               |
| 512 ~ | NDD                   | The NDD prefix is the access code used to make a call <b>WITHIN</b> that country from on city to another (when calling another city in the same vicinity, this may not be necessary). |
| 514 ~ | IDD                   | The <b>IDD</b> prefix is the international prefix needed to dial a call <b>FROM</b> the country listed <b>TO</b> another country.                                                     |
| 516 ~ | Buffer rate           | Safe charge rate above the highest rate charged by suppliers                                                                                                                          |

**FIG. 19****Example: Master List Record with Populated Fields**

|                       |             |
|-----------------------|-------------|
| Route_ID              | 1019        |
| Dialing code          | 1604        |
| Country code          | 1           |
| Nat Sign #(Area Code) | 604         |
| Min Length            | 7           |
| Max Length            | 7           |
| NDD                   | 1           |
| IDD                   | 011         |
| Buffer rate           | \$0.009/min |

**FIG. 20**

15/29

**Suppliers List Record Format**

---

|     |   |                   |                                                 |
|-----|---|-------------------|-------------------------------------------------|
| 540 | ~ | Sup_ID            | Name code                                       |
| 542 | ~ | Route_ID          | Numeric code                                    |
| 544 | ~ | Prefix (optional) | String IDentifying supplier's traffic #         |
| 546 | ~ | Route             | IP address                                      |
| 548 | ~ | NDD/IDD rewrite   |                                                 |
| 550 | ~ | Rate              | Cost per second to Digifonica to use this route |

**FIG. 21****Telus Supplier Record**

---

|     |   |                   |              |
|-----|---|-------------------|--------------|
|     |   | Sup_ID            | 2010 (Telus) |
|     |   | Route_ID          | 1019         |
|     |   | Prefix (optional) | 4973#        |
| 546 | ~ | Route             | 72.64.39.58  |
|     |   | NDD/IDD rewrite   | 011          |
| 550 | ~ | Rate              | \$0.02/min   |

**FIG. 22****Shaw Supplier Record**

---

|     |   |                   |             |
|-----|---|-------------------|-------------|
|     |   | Sup_ID            | 2011 (Shaw) |
|     |   | Route_ID          | 1019        |
|     |   | Prefix (optional) | 4974#       |
|     |   | Route             | 73.65.40.59 |
|     |   | NDD/IDD rewrite   | 011         |
| 550 | ~ | Rate              | \$0.025/min |

**FIG. 23****Sprint Supplier Record**

---

|     |   |                   |               |
|-----|---|-------------------|---------------|
|     |   | Sup_ID            | 2012 (Sprint) |
|     |   | Route_ID          | 1019          |
|     |   | Prefix (optional) | 4975#         |
|     |   | Route             | 74.66.41.60   |
|     |   | NDD/IDD rewrite   | 011           |
| 550 | ~ | Rate              | \$0.03/min    |

**FIG. 24**



16/29

**Routing Message Buffer for Gateway Call**

4973#0116048675309@72.64.39.58;tll=3600 ~ 570  
 4974#0116048675309@73.65.40.59;tll=3600 ~ 572  
 4975#0116048675309@74.66.41.60;tll=3600 ~ 574  
 Media Relays (optional) ~ 1152

**FIG. 25**

**Routing Message Buffer for Gateway Call with Lawful Intercept Fields**

4973#0116048675309@72.64.39.58;tll=3600  
 4974#0116048675309@73.65.40.59;tll=3600  
 4975#0116048675309@74.66.41.60;tll=3600  
 LIflag=on;MAddress=192.168.1.10;WarrantID=20060515142;  
 LIstart=2006051600:00:00;LIstop=2006123123:59:59  
 Media Relays (optional) ~ 1152

**FIG. 25A**

**Call Block Record Format**

604 ~ Username Digifonica #  
 606 ~ Block Pattern PSTN compatible or Digifonica #

**FIG. 26**

**Call Block Record for Calgary Callee**

604 ~ Username of Callee 2001 1050 2222  
 606 ~ Block Pattern 2001 1050 8664

**FIG. 27**

**Call Forwarding Record Format for Callee**

614 ~ Username of Callee Digifonica #  
 616 ~ Destination Number Digifonica #  
 618 ~ Sequence Number Integer indicating order to try this

**FIG. 28**

17/29

**Call Forwarding Table Record for Calgary Callee**

|     |                    |                |
|-----|--------------------|----------------|
| 614 | Username of Callee | 2001 1050 2222 |
| 616 | Destination Number | 2001 1055 2223 |
| 618 | Sequence Number    | 1              |

**FIG. 29****Voicemail Table Record Format**

|     |                      |                                        |
|-----|----------------------|----------------------------------------|
| 624 | Username of Callee   | Digifonica #                           |
| 626 | Vm Server            | domain name                            |
| 628 | Seconds to Voicemail | time to wait before engaging voicemail |
| 630 | Enabled              | yes/no                                 |

**FIG. 30****Voicemail Table Record for Calgary Callee**

|     |                      |                       |
|-----|----------------------|-----------------------|
| 624 | Username of Callee   | 2001 1050 2222        |
| 626 | Vm Server            | vm.yvr.digifonica.com |
| 628 | Seconds to Voicemail | 20                    |
| 630 | Enabled              | 1                     |

**FIG. 31**

18/29

**Routing Message Buffer for CF/VM Routing Message**

650 ~ 200110502222@sp.yvr.digifonica.com;tll=3600  
 652 ~ 200110552223@sp.yvr.digifonica.com;tll=3600  
 654 ~ vm.yvr.digifonica.com;20;tll=60  
 656 ~ sp.yvr.digifonica.com  
 1152 ~ Media Relays (optional)

**FIG. 32****Routing Message Buffer for CF/VM Routing Message with Caller Lawful Interrupt Fields**

200110502222@sp.yvr.digifonica.com;tll=3600  
 200110552223@sp.yvr.digifonica.com;tll=3600  
 vm.yvr.digifonica.com;20;tll=60  
 sp.yvr.digifonica.com  
 LIflag=on;MAddress=192.168.1.10;WarrantID=20060615142;  
 LIstart=2006061500:00:00;LIstop=2006123123:59:59  
 Media Relays (optional) ~ 1152

**FIG. 32A****Routing Message Buffer for CF/VM Routing Message with Caller and Callee Lawful Interrupt Fields**

200110502222@sp.yvr.digifonica.com;tll=3600  
 200110552223@sp.yvr.digifonica.com;tll=3600  
 vm.yvr.digifonica.com;20;tll=60  
 sp.yvr.digifonica.com  
 LI1flag=on;Maddress=192.168.1.10;WarrantID=20060515142;  
 LI1start=2006051600:00:00;LI1stop=2006123123:59:59  
 LI2flag=0;MD2address=192.168.1.20;WarrantID=20060615142;  
 LI2start=2006061500:00:00;LI2stop=2006123123:59:59  
 Media Relays (optional) ~ 1152

**FIG. 32B**

19/29

Routing Message Handler  
Executed by Call Controller

122

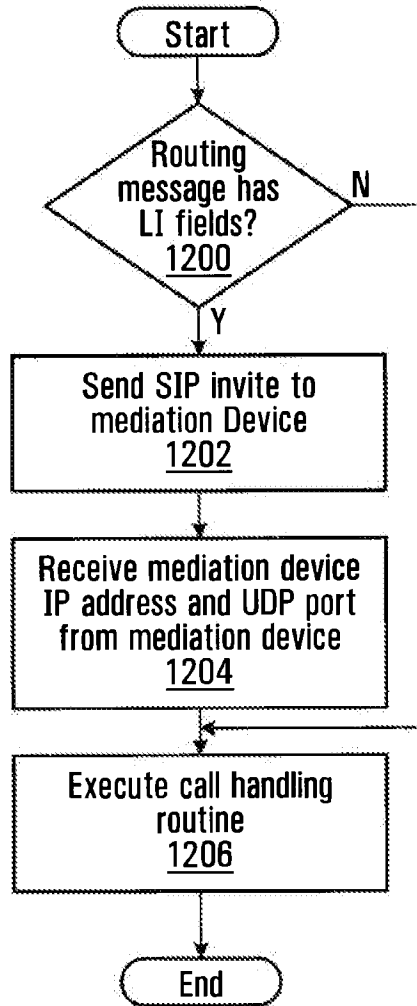
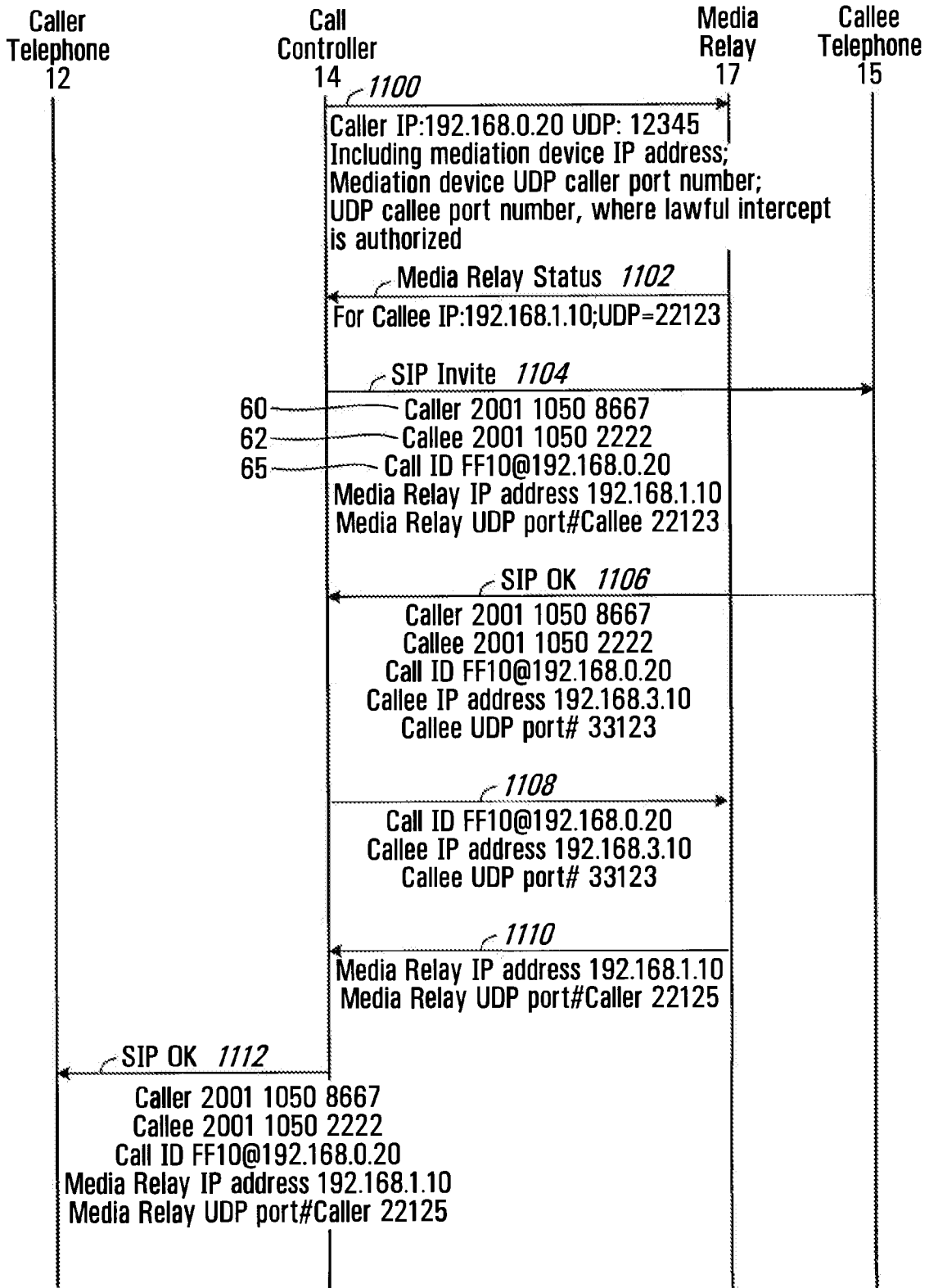


FIG. 33

20/29

123

**Call Handling Routine**



**FIG. 34**

21/29

**Call Controller Active Call Record**

---

|      |                         |                   |
|------|-------------------------|-------------------|
| 1300 | Call ID                 | FF10@192.168.0.20 |
| 1302 | Caller IP Address       | 192.168.0.20      |
| 1304 | Caller Port             | 12345             |
| 1306 | Callee IP Address       | 192.168.3.10      |
| 1308 | Callee Port             | 33123             |
| 1310 | Media Relay ID          | 42                |
| 1312 | Media Relay Caller Port | 22125             |
| 1314 | Media Relay Callee Port | 22123             |

**FIG. 35**

**Routing Controller Active Call Record**

---

|      |                    |                   |
|------|--------------------|-------------------|
| 1316 | Call ID            | FF10@192.168.0.20 |
| 1318 | Caller             | 2001 1050 8667    |
| 1320 | Callee             | 2001 1050 2222    |
| 1322 | Call Controller ID | 61                |

**FIG. 36**

22/29

**Message from Call Controller to Mediation Device - SIP Invite**

|      |                        |                   |
|------|------------------------|-------------------|
| 1020 | Caller                 | 2001 1050 8667    |
| 1022 | Callee                 | 2001 1050 2222    |
| 1024 | Call ID                | FF10@192.168.0.20 |
| 1026 | Warrant ID             | 12345678          |
| 1028 | Intercept Related Info | XXXXXXXX          |

**FIG. 37****Reply Message from Mediation Device - SIP Ok**

|      |                                    |                   |
|------|------------------------------------|-------------------|
| 1040 | Caller                             | 2001 1050 8667    |
| 1042 | Callee                             | 2001 1050 2222    |
| 1044 | Call ID                            | FF10@192.168.0.20 |
| 1046 | Mediation Device IP Address        | 192.138.2.10      |
| 1048 | Mediation Device UDP Port # Caller | 13678             |
| 1050 | Mediation Device UDP Port # Callee | 13679             |

**FIG. 38**

23/29

900  
↙

**SIP Bye Message**

---

|       |                |                                                 |
|-------|----------------|-------------------------------------------------|
| 902 ~ | <b>Caller</b>  | Username                                        |
| 904 ~ | <b>Callee</b>  | PSTN compatible # or Username                   |
| 906 ~ | <b>Call ID</b> | unique call IDentifier (hexadecimal string@IP)) |

**FIG. 39**

908  
↙

**SIP Bye Message**

---

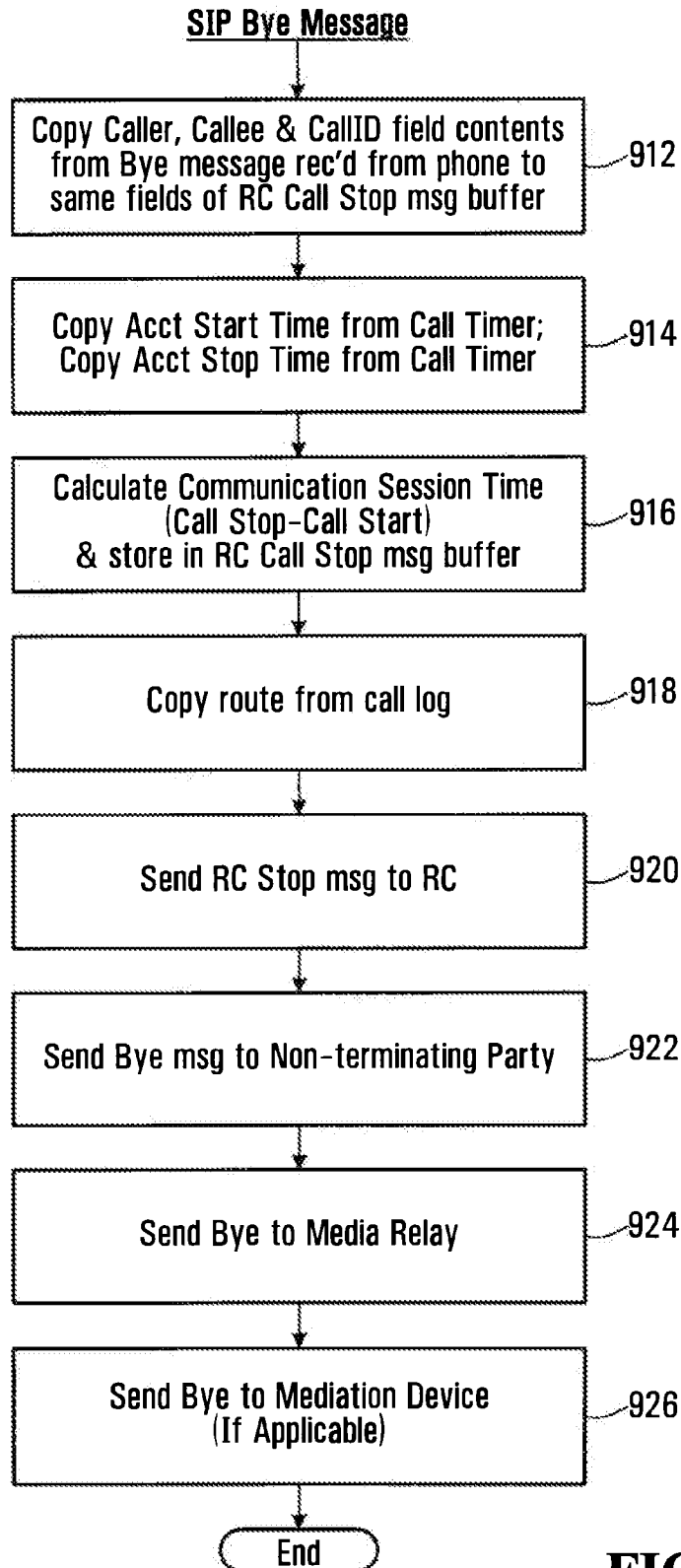
|       |                |                   |
|-------|----------------|-------------------|
| 902 ~ | <b>Caller</b>  | 2001 1050 8667    |
| 904 ~ | <b>Callee</b>  | 2001 1050 2222    |
| 906 ~ | <b>Call ID</b> | FA10@192.168.0.20 |

**FIG. 40**



24/29

910 ↘



**FIG. 41**

25/29

1000 ↙

**RC Call Stop Message**

---

|      |                   |                                                 |
|------|-------------------|-------------------------------------------------|
| 1002 | Caller            | Username                                        |
| 1004 | Callee            | PSTN compatible # or Username                   |
| 1006 | Call ID           | unique call IDentifier (hexadecimal string@IP)  |
| 1008 | Acct Start Time   | start time of call                              |
| 1010 | Acct Stop Time    | time the call ended                             |
| 1012 | Acct Session Time | start time-stop time (in seconds)               |
| 1014 | Route             | IP address for gateway, where a gateway is used |

**FIG. 42**

1021 ↙

**RC Call Stop Message for Calgary Callee**

---

|      |                   |                                        |
|------|-------------------|----------------------------------------|
| 1002 | Caller            | 2001 1050 8667                         |
| 1004 | Callee            | 2001 1050 2222                         |
| 1006 | Call ID           | FA10@192.168.0.20                      |
| 1008 | Acct Start Time   | 2006-12-30 12:12:12                    |
| 1010 | Acct Stop Time    | 2006-12-30 12:12:14                    |
| 1012 | Acct Session Time | 2                                      |
| 1014 | Route             | (72.64.39.58 if Telus gateway is used) |

**FIG. 43**

26/29

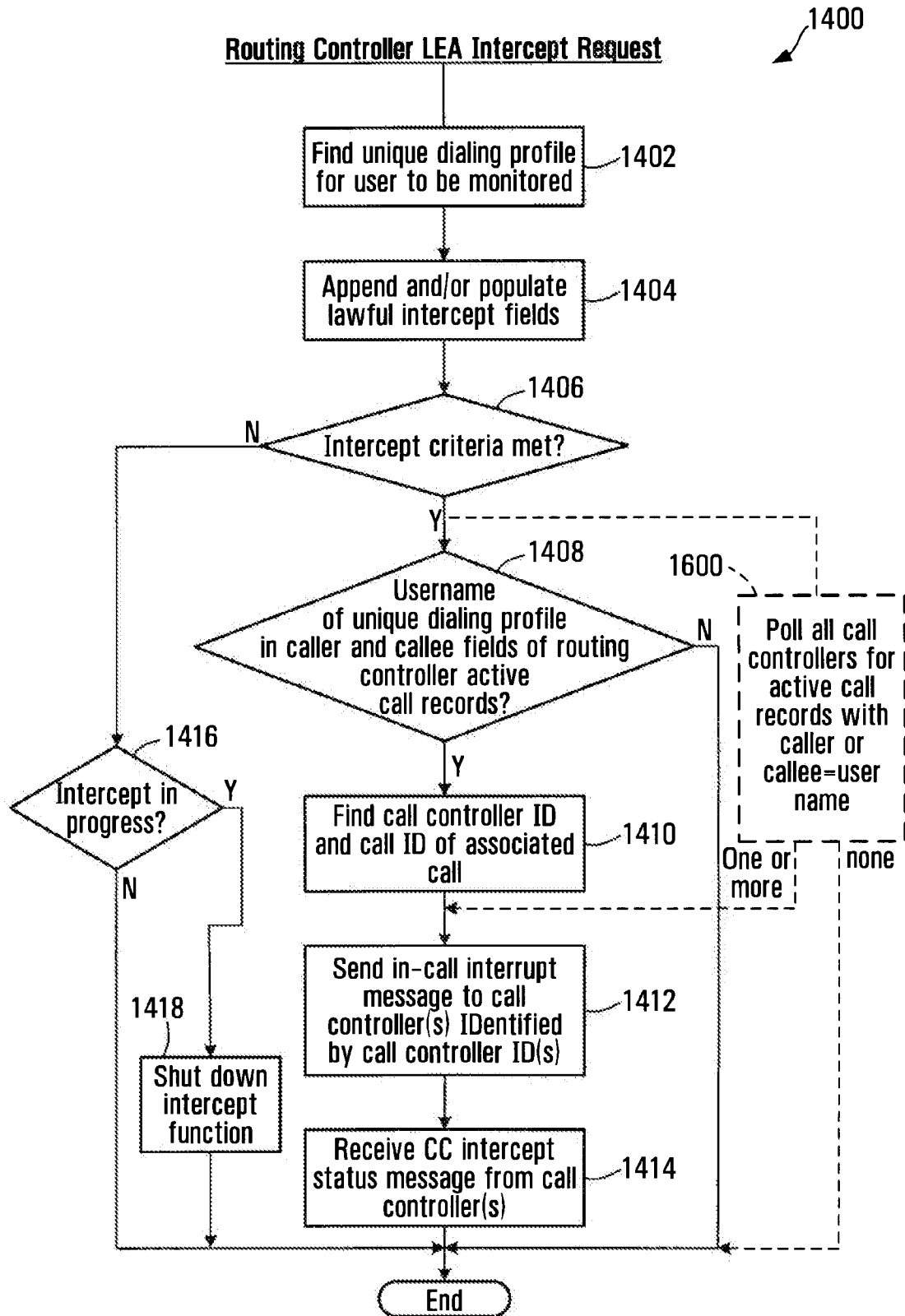
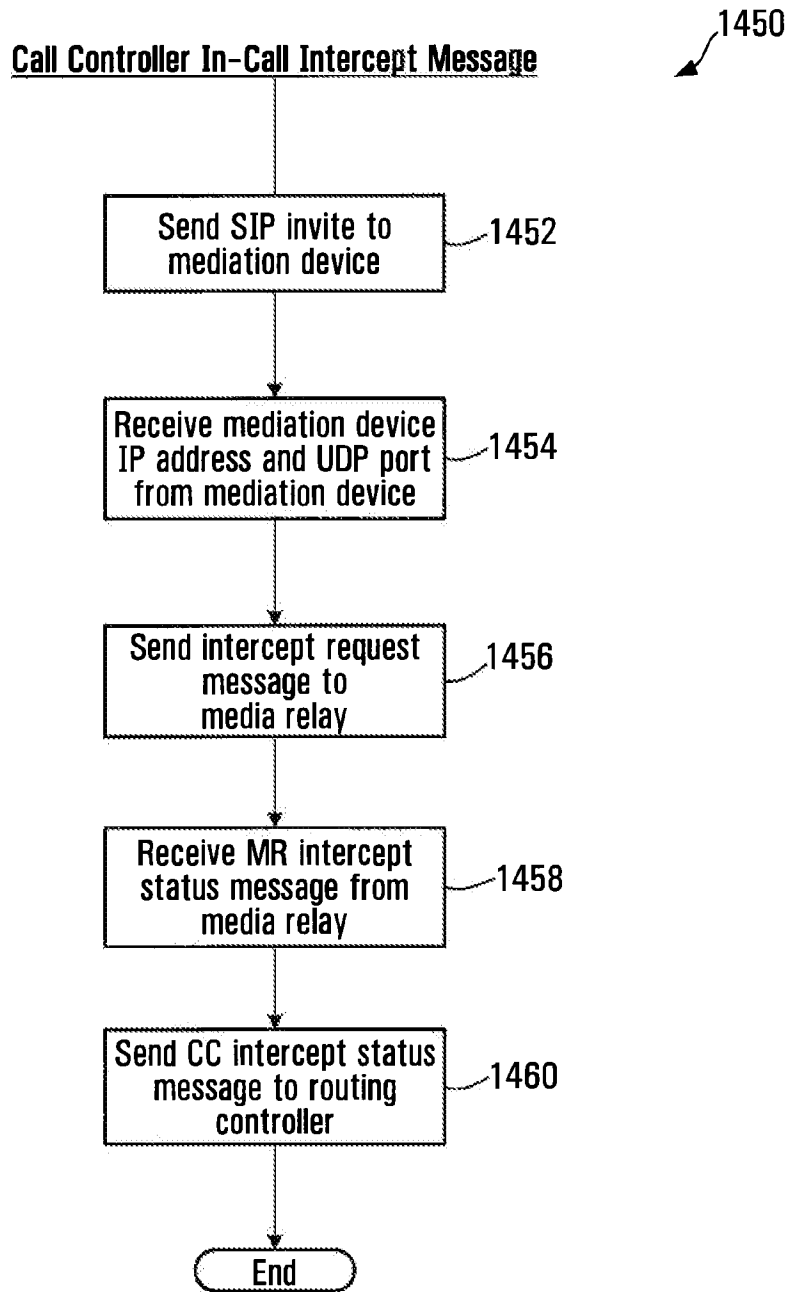


FIG. 44

27/29

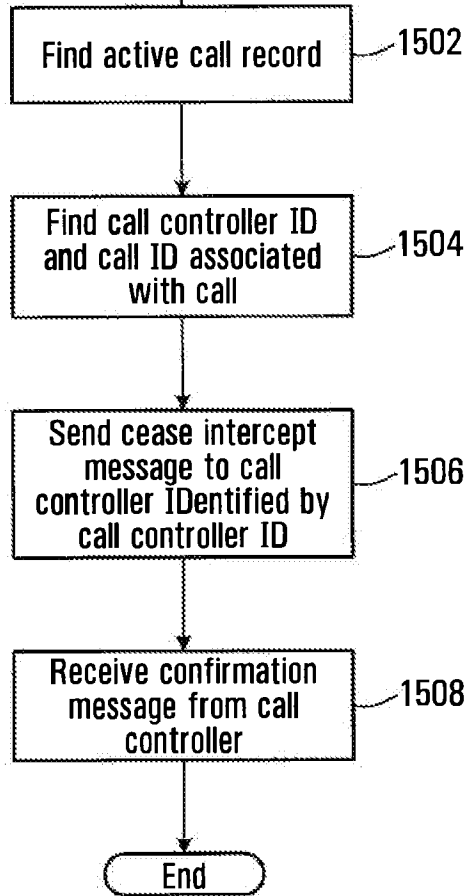


**FIG. 45**

28/29

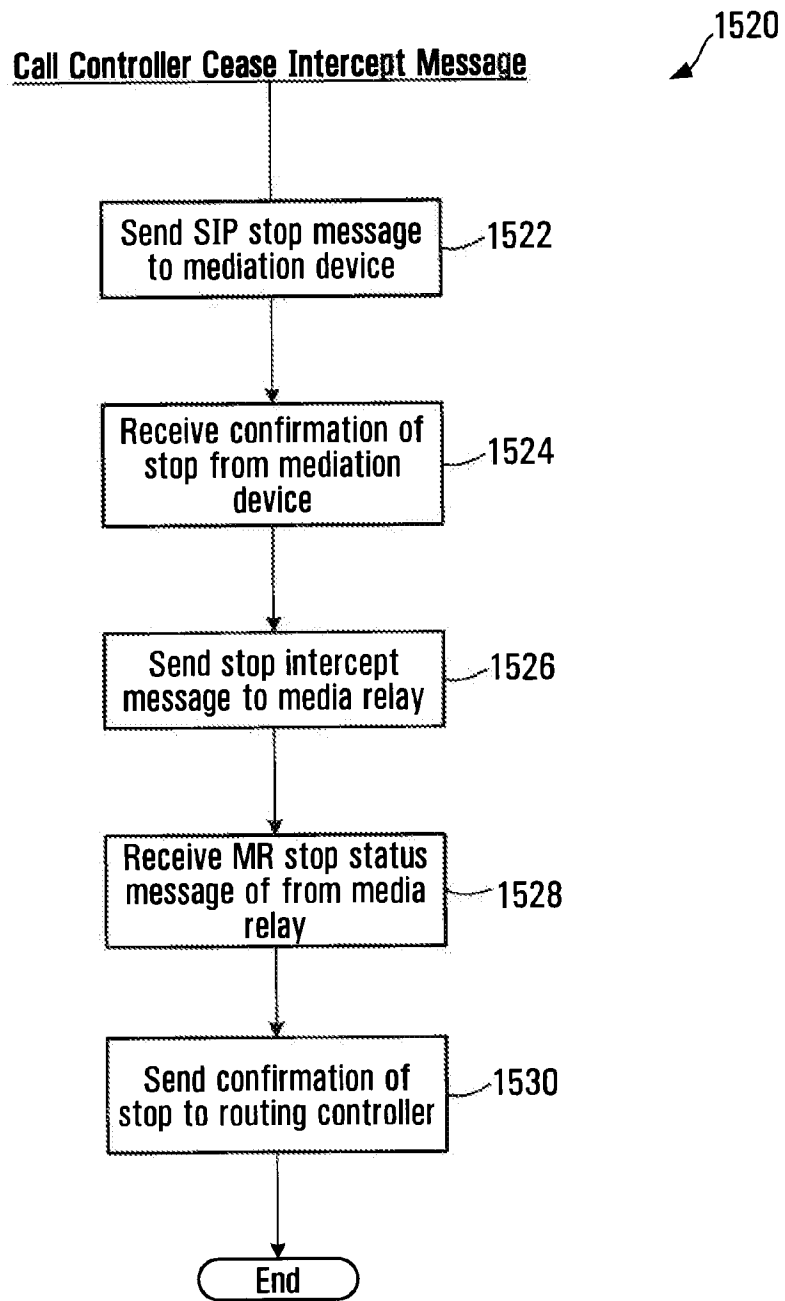
1500

**Routing Controller In-Call Intercept Shut Down Routine**



**FIG. 46**

29/29



**FIG. 47**

**INTERNATIONAL SEARCH REPORT**

International application No.  
PCT/CA2007/002150

A. CLASSIFICATION OF SUBJECT MATTER  
 IPC: **H04L 12/26** (2006.01) , **H04L 12/66** (2006.01) , **H04M 11/06** (2006.01) . **H04M 3/22** (2006.01)  
 According to International Patent Classification (IPC) or to both national classification and IPC

B. FIELDS SEARCHED

Minimum documentation searched (classification system followed by classification symbols)

IPC: **H04L 12/26** (2006.01) , **H04L 12/66** (2006.01) , **H04M 11/06** (2006.01) , **H04M 3/22** (2006.01)

Documentation searched other than minimum documentation to the extent that such documents are included in the fields searched

Electronic database(s) consulted during the international search (name of database(s) and, where practicable, search terms used)

West, Delphion, Canadian Patents Database, IEEEExplore, Google

Keywords: lawful intercept, (monitor\* OR record\* or intercept\*) near (communicat\* OR voip OR phone call\* OR audio OR video), electronic surveillance, intercept\* near device\*, intercept\* same IP network\*, record\* same IP network\*, intercept\* same voip, record\*

C. DOCUMENTS CONSIDERED TO BE RELEVANT

| Category* | Citation of document, with indication, where appropriate, of the relevant passages                                                                                                                                                                 | Relevant to claim No.                              |
|-----------|----------------------------------------------------------------------------------------------------------------------------------------------------------------------------------------------------------------------------------------------------|----------------------------------------------------|
| X<br>Y    | US 2004/0181599 A1 (Kreusch et al.) 16 September 2004 (16-09-2004)<br>*paragraphs [0011]-[0015], [0019]-[0022], [0028], [0034]-[0036], [0048]-[0053], [0055]-[0061], [0067], [0072]-[0074], [0078]-[0083]; Figs. 1, 2a-2b; claims 1-3, 7-8, 25-26* | 1-2, 4-5, 10-15, 17-18, 23-26<br>3, 6-9, 16, 19-22 |
| X         | US 2003/0219103 A1 (Rao et al.) 27 November 2003 (27-11-2003)<br>*Abstract; paragraphs [0005], [0026]-[0037], [0051]-[0062], [0071]-[0079], [0086]-[0090]; Figs. 1-9*                                                                              | 1, 14                                              |
| Y         | US 2002/0051518 A1 (Bondy et al.) 2 May 2002 (02-05-2002)<br>*Abstract; paragraphs [0030]-[0032], [0036]-[0037], [0039], [0044]-[0052], [0055]-[0057], [0060]; Figs 1, 3, 5; claims 1-5*                                                           | 3, 6-9, 16, 19-22                                  |
| A         | EP 1 389 862 B1 (Shen et al.) 3 November 2004 (03-11-2004)<br>*paragraphs [0007]-[0014], [0051]-[0060]; Fig. 2; claim 1*                                                                                                                           | 1-3, 14-16                                         |
| A         | US 2004/0165709 A1 (Pence et al.) 26 August 2004 (26-08-2004)<br>*whole document*                                                                                                                                                                  | 1-26                                               |

Further documents are listed in the continuation of Box C.

See patent family annex.

|                                                                                                                                                                         |                                                                                                                                                                                                                                                  |
|-------------------------------------------------------------------------------------------------------------------------------------------------------------------------|--------------------------------------------------------------------------------------------------------------------------------------------------------------------------------------------------------------------------------------------------|
| * Special categories of cited documents :                                                                                                                               | "T" later document published after the international filing date or priority date and not in conflict with the application but cited to understand the principle or theory underlying the invention                                              |
| "A" document defining the general state of the art which is not considered to be of particular relevance                                                                | "X" document of particular relevance; the claimed invention cannot be considered novel or cannot be considered to involve an inventive step when the document is taken alone                                                                     |
| "E" earlier application or patent but published on or after the international filing date                                                                               | "Y" document of particular relevance; the claimed invention cannot be considered to involve an inventive step when the document is combined with one or more other such documents, such combination being obvious to a person skilled in the art |
| "L" document which may throw doubts on priority claim(s) or which is cited to establish the publication date of another citation or other special reason (as specified) | "&" document member of the same patent family                                                                                                                                                                                                    |
| "O" document referring to an oral disclosure, use, exhibition or other means                                                                                            |                                                                                                                                                                                                                                                  |
| "P" document published prior to the international filing date but later than the priority date claimed                                                                  |                                                                                                                                                                                                                                                  |

Date of the actual completion of the international search

3 March 2008 (03-03-2008)

Date of mailing of the international search report

14 March 2008 (14-03-2008)

Name and mailing address of the ISA/CA  
 Canadian Intellectual Property Office  
 Place du Portage I, C114 - 1st Floor, Box PCT  
 50 Victoria Street  
 Gatineau, Quebec K1A 0C9  
 Facsimile No.: 001-819-953-2476

Authorized officer

Daniela Savin 819- 934-4890

**INTERNATIONAL SEARCH REPORT**

International application No.  
PCT/CA2007/002150

C (Continuation). DOCUMENTS CONSIDERED TO BE RELEVANT

| Category* | Citation of document, with indication, where appropriate, of the relevant passages                                                                                                 | Relevant to claim No. |
|-----------|------------------------------------------------------------------------------------------------------------------------------------------------------------------------------------|-----------------------|
| A         | US 2004/0255126 A1 (Reith) 16 December 2004 (16-12-2004)<br>*paragraphs [0010]-[0014], [0020]-[0031], [0041]-[0046]; Figs. 1-2, 4-6; claims 1, 6-10*                               | 1-26                  |
| A         | US 2004/0157629 A1 (Kallio et al.) 12 August 2004 (12-08-2004)<br>*paragraphs [0006]-[0021], [0050]-[0057], [0080]-[0109]; Figs. 1-12; claims 1, 7-23, 29-43*                      | 1-26                  |
| A         | US 2005/0174937 A1 (Scoggins et al.) 11 August 2005 (11-08-2005)<br>*paragraphs [0068]-[0089], [0112]-[0138], [0153]-[0156], [0173]-[0176], [0184]-[0193]; Figs. 1-11; claims 1-2* | 1-26                  |



**INTERNATIONAL SEARCH REPORT**  
Information on patent family members

International application No.  
**PCT/CA2007/002150**

| Patent Document Cited in Search Report | Publication Date | Patent Family Member(s)                                                                                      | Publication Date                                                                               |
|----------------------------------------|------------------|--------------------------------------------------------------------------------------------------------------|------------------------------------------------------------------------------------------------|
| US2004181599                           | 16-09-2004       | BR0208272 A<br>CN1274114 C<br>DE50211291 D1<br>EP1244250 A1<br>EP1371173 A1<br>RU2280331 C2<br>WO02082728 A1 | 09-03-2004<br>06-09-2006<br>10-01-2008<br>25-09-2002<br>17-12-2003<br>20-07-2006<br>17-10-2002 |
| US2003219103                           | 27-11-2003       | NONE                                                                                                         |                                                                                                |
| US2002051518                           | 02-05-2002       | US7006508 B2<br>US2001052081 A1<br>US2002009973 A1                                                           | 28-02-2006<br>13-12-2001<br>24-01-2002                                                         |
| EP1389862                              | 03-11-2004       | AT281734 T<br>DE60201827 D1<br>DE60201827 T2<br>ES2229073 T3<br>US2004202295 A1                              | 15-11-2004<br>09-12-2004<br>10-11-2005<br>16-04-2005<br>14-10-2004                             |
| US2004165709                           | 26-08-2004       | NONE                                                                                                         |                                                                                                |
| US2004255126                           | 16-12-2004       | DE602004003518 D1<br>EP1484892 A2                                                                            | 18-01-2007<br>08-12-2004                                                                       |
| US2004157629                           | 12-08-2004       | EP1396113 A1<br>WO02093838 A1                                                                                | 10-03-2004<br>21-11-2002                                                                       |
| US2005174937                           | 11-08-2005       | US2006212933 A1                                                                                              | 21-09-2006                                                                                     |

## Electronic Acknowledgement Receipt

|                                             |                                                             |
|---------------------------------------------|-------------------------------------------------------------|
| <b>EFS ID:</b>                              | 18540746                                                    |
| <b>Application Number:</b>                  | 13966096                                                    |
| <b>International Application Number:</b>    |                                                             |
| <b>Confirmation Number:</b>                 | 8712                                                        |
| <b>Title of Invention:</b>                  | PRODUCING ROUTING MESSAGES FOR VOICE OVER IP COMMUNICATIONS |
| <b>First Named Inventor/Applicant Name:</b> | CLAY PERRAULT                                               |
| <b>Customer Number:</b>                     | 20995                                                       |
| <b>Filer:</b>                               | John M Carson/Norman Green                                  |
| <b>Filer Authorized By:</b>                 | John M Carson                                               |
| <b>Attorney Docket Number:</b>              | SMARB19.001C1                                               |
| <b>Receipt Date:</b>                        | 20-MAR-2014                                                 |
| <b>Filing Date:</b>                         | 13-AUG-2013                                                 |
| <b>Time Stamp:</b>                          | 17:36:19                                                    |
| <b>Application Type:</b>                    | Utility under 35 USC 111(a)                                 |

### Payment information:

|                        |    |
|------------------------|----|
| Submitted with Payment | no |
|------------------------|----|

### File Listing:

| Document Number | Document Description | File Name                        | File Size(Bytes)/<br>Message Digest               | Multi Part /.zip | Pages (if appl.) |
|-----------------|----------------------|----------------------------------|---------------------------------------------------|------------------|------------------|
| 1               |                      | IDS_SMARB19_001C1_03_20_2014.pdf | 79336<br>7979cde53b0ce29ed4f52e472996e05d143ba77d | yes              | 2                |

| Multipart Description/PDF files in .zip description |                                                    |       |     |
|-----------------------------------------------------|----------------------------------------------------|-------|-----|
|                                                     | Document Description                               | Start | End |
|                                                     | Transmittal Letter                                 | 1     | 1   |
|                                                     | Information Disclosure Statement (IDS) Form (SB08) | 2     | 2   |

**Warnings:**

**Information:**

|   |                   |                      |                                                     |    |     |
|---|-------------------|----------------------|-----------------------------------------------------|----|-----|
| 2 | Foreign Reference | Ref1_EP2090024A0.pdf | 8168641<br>c410226fbd6fd4a44f5f412ebbc2cdd7e96e97be | no | 110 |
|---|-------------------|----------------------|-----------------------------------------------------|----|-----|

**Warnings:**

**Information:**

|   |                       |                               |                                                   |    |   |
|---|-----------------------|-------------------------------|---------------------------------------------------|----|---|
| 3 | Non Patent Literature | Ref2_EP_EESR_EP07855436_7.pdf | 681617<br>01098ae2cd6851494b2d3cecd5488d754557d40 | no | 8 |
|---|-----------------------|-------------------------------|---------------------------------------------------|----|---|

**Warnings:**

**Information:**

|                                     |  |  |         |  |  |
|-------------------------------------|--|--|---------|--|--|
| <b>Total Files Size (in bytes):</b> |  |  | 8929594 |  |  |
|-------------------------------------|--|--|---------|--|--|

**This Acknowledgement Receipt evidences receipt on the noted date by the USPTO of the indicated documents, characterized by the applicant, and including page counts, where applicable. It serves as evidence of receipt similar to a Post Card, as described in MPEP 503.**

**New Applications Under 35 U.S.C. 111**

**If a new application is being filed and the application includes the necessary components for a filing date (see 37 CFR 1.53(b)-(d) and MPEP 506), a Filing Receipt (37 CFR 1.54) will be issued in due course and the date shown on this Acknowledgement Receipt will establish the filing date of the application.**

**National Stage of an International Application under 35 U.S.C. 371**

**If a timely submission to enter the national stage of an international application is compliant with the conditions of 35 U.S.C. 371 and other applicable requirements a Form PCT/DO/EO/903 indicating acceptance of the application as a national stage submission under 35 U.S.C. 371 will be issued in addition to the Filing Receipt, in due course.**

**New International Application Filed with the USPTO as a Receiving Office**

**If a new international application is being filed and the international application includes the necessary components for an international filing date (see PCT Article 11 and MPEP 1810), a Notification of the International Application Number and of the International Filing Date (Form PCT/RO/105) will be issued in due course, subject to prescriptions concerning national security, and the date shown on this Acknowledgement Receipt will establish the international filing date of the application.**

**INFORMATION DISCLOSURE STATEMENT**

Inventor : Clay Perrault et al.  
App. No. : 13/966,096  
Filed : August 13, 2013  
For : PRODUCING ROUTING MESSAGES FOR  
VOICE OVER IP COMMUNICATIONS  
Examiner : Kizou, Hassan  
Art Unit : 2472  
Conf. No. : 8712

Commissioner for Patents  
P.O. Box 1450  
Alexandria, VA 22313-1450

**References and Listing**

Submitted herewith in the above-identified application is an Information Disclosure Statement listing references for consideration. Copies of any listed foreign and non-patent literature references are being submitted.

**Timing of Disclosure**

This Information Disclosure Statement is being filed before the receipt of a First Office Action on the merits, and presumably no fee is required. If a First Office Action on the merits was mailed before the mailing date of this Statement, the Commissioner is authorized to charge the fee set forth in 37 CFR 1.17(p) to Deposit Account No. 11-1410.

Respectfully submitted,

KNOBBE, MARTENS, OLSON & BEAR, LLP

Dated: 3/20/14

By: 

John M. Carson  
Registration No. 34,303  
Attorney of Record  
Customer No. 20995  
(858) 707-4000

IDS  
17537813  
032014

|                                                          |                      |                     |               |
|----------------------------------------------------------|----------------------|---------------------|---------------|
| <b>INFORMATION DISCLOSURE<br/>STATEMENT BY APPLICANT</b> | Application No.      | 13/966,096          |               |
|                                                          | Filing Date          | August 13, 2013     |               |
|                                                          | First Named Inventor | Perrault, Clay      |               |
|                                                          | Art Unit             | 2472                |               |
| <i>(Multiple sheets used when necessary)</i>             |                      | Examiner            | Kizou, Hassan |
| SHEET 1 OF 1                                             |                      | Attorney Docket No. | SMARBI9.001C1 |

| U.S. PATENT DOCUMENTS |          |                                                                           |                                |                               |                                                                                |
|-----------------------|----------|---------------------------------------------------------------------------|--------------------------------|-------------------------------|--------------------------------------------------------------------------------|
| Examiner Initials     | Cite No. | Document Number<br>Number - Kind Code (if known)<br>Example: 1,234,567 B1 | Publication Date<br>MM-DD-YYYY | Name of Patentee or Applicant | Pages, Columns, Lines Where<br>Relevant Passages or Relevant<br>Figures Appear |
|                       | 1        | 5,719,926                                                                 | 2/17/1998                      | Hill, Vincent F.              |                                                                                |
|                       | 2        | 5,722,067                                                                 | 2/24/1998                      | Fougnes et al.                |                                                                                |
|                       | 3        | 5,915,093                                                                 | 6/22/1999                      | Berlin et al.                 |                                                                                |
|                       | 4        | 6,029,062                                                                 | 2/22/2000                      | Hanson, Daniel A.             |                                                                                |
|                       | 5        | 6,249,573                                                                 | 6/19/2001                      | Hudson, Dan                   |                                                                                |
|                       | 6        | 7,454,200                                                                 | 11/18/2008                     | Cai et al.                    |                                                                                |
|                       | 7        | 8,630,234                                                                 | 1/14/2014                      | Björzell et al.               |                                                                                |
|                       | 8        | 8,675,566                                                                 | 3/18/2014                      | Huttunen et al.               |                                                                                |
|                       | 9        | 2005/0198499 A1                                                           | 9/8/2005                       | Salapaka et al.               |                                                                                |
|                       | 10       | 2010/0150138 A1                                                           | 6/17/2010                      | Björzell et al.               |                                                                                |
|                       | 11       | 2010/0150328 A1                                                           | 6/17/2010                      | Perrault et al.               |                                                                                |
|                       | 12       | 2010/0172345 A1                                                           | 7/8/2010                       | Björzell et al.               |                                                                                |
|                       | 13       | 2011/0122827 A1                                                           | 5/26/2011                      | Björzell et al.               |                                                                                |
|                       | 14       | 2012/0170574 A1                                                           | 7/5/2012                       | Huttunen et al.               |                                                                                |

| FOREIGN PATENT DOCUMENTS |          |                                                                                    |                                |                               |                                                                                |                |
|--------------------------|----------|------------------------------------------------------------------------------------|--------------------------------|-------------------------------|--------------------------------------------------------------------------------|----------------|
| Examiner Initials        | Cite No. | Foreign Patent Document<br>Country Code-Number-Kind Code<br>Example: JP 1234567 A1 | Publication Date<br>MM-DD-YYYY | Name of Patentee or Applicant | Pages, Columns, Lines Where<br>Relevant Passages or<br>Relevant Figures Appear | T <sup>1</sup> |

| NON PATENT LITERATURE DOCUMENTS |          |                                                                                                                                                                                                                                                                 |                |
|---------------------------------|----------|-----------------------------------------------------------------------------------------------------------------------------------------------------------------------------------------------------------------------------------------------------------------|----------------|
| Examiner Initials               | Cite No. | Include name of the author (in CAPITAL LETTERS), title of the article (when appropriate), title of the item (book, magazine, journal, serial, symposium, catalog, etc.), date, page(s), volume-issue number(s), publisher, city and/or country where published. | T <sup>1</sup> |
|                                 | 15       | Extended European Search Report dated December 20, 2013 for European Application No. 09849358.8 dated June 18, 2012.                                                                                                                                            |                |

17407609  
030514

|                    |                 |
|--------------------|-----------------|
| Examiner Signature | Date Considered |
|--------------------|-----------------|

\***Examiner:** Initial if reference considered, whether or not citation is in conformance with MPEP 609. Draw line through citation if not in conformance and not considered. Include copy of this form with next communication to applicant.

T<sup>1</sup> - Place a check mark in this area when an English language PRIORITY REFERENCE IS APPLICABLE. EX. 1005-577

## Electronic Acknowledgement Receipt

|                                             |                                                             |
|---------------------------------------------|-------------------------------------------------------------|
| <b>EFS ID:</b>                              | 18515250                                                    |
| <b>Application Number:</b>                  | 13966096                                                    |
| <b>International Application Number:</b>    |                                                             |
| <b>Confirmation Number:</b>                 | 8712                                                        |
| <b>Title of Invention:</b>                  | PRODUCING ROUTING MESSAGES FOR VOICE OVER IP COMMUNICATIONS |
| <b>First Named Inventor/Applicant Name:</b> | CLAY PERRAULT                                               |
| <b>Customer Number:</b>                     | 20995                                                       |
| <b>Filer:</b>                               | John M Carson/Norman Green                                  |
| <b>Filer Authorized By:</b>                 | John M Carson                                               |
| <b>Attorney Docket Number:</b>              | SMARB19.001C1                                               |
| <b>Receipt Date:</b>                        | 18-MAR-2014                                                 |
| <b>Filing Date:</b>                         | 13-AUG-2013                                                 |
| <b>Time Stamp:</b>                          | 18:59:42                                                    |
| <b>Application Type:</b>                    | Utility under 35 USC 111(a)                                 |

### Payment information:

|                        |    |
|------------------------|----|
| Submitted with Payment | no |
|------------------------|----|

### File Listing:

| Document Number | Document Description | File Name                        | File Size(Bytes)/<br>Message Digest               | Multi Part /.zip | Pages (if appl.) |
|-----------------|----------------------|----------------------------------|---------------------------------------------------|------------------|------------------|
| 1               |                      | IDS_SMARB19_001C1_03_18_2014.pdf | 95976<br>26c3c9b0481edbf675d966bab847c42a0ad0d589 | yes              | 2                |

| Multipart Description/PDF files in .zip description |                                                    |       |     |
|-----------------------------------------------------|----------------------------------------------------|-------|-----|
|                                                     | Document Description                               | Start | End |
|                                                     | Transmittal Letter                                 | 1     | 1   |
|                                                     | Information Disclosure Statement (IDS) Form (SB08) | 2     | 2   |

**Warnings:**

**Information:**

|   |                       |                              |                                                  |    |   |
|---|-----------------------|------------------------------|--------------------------------------------------|----|---|
| 2 | Non Patent Literature | Ref15_EP_EESR_EP09849358.pdf | 470227<br>f53f1c6e6abaa38858e902fdcd371a4916b5ff | no | 5 |
|---|-----------------------|------------------------------|--------------------------------------------------|----|---|

**Warnings:**

**Information:**

|                                     |  |        |
|-------------------------------------|--|--------|
| <b>Total Files Size (in bytes):</b> |  | 566203 |
|-------------------------------------|--|--------|

**This Acknowledgement Receipt evidences receipt on the noted date by the USPTO of the indicated documents, characterized by the applicant, and including page counts, where applicable. It serves as evidence of receipt similar to a Post Card, as described in MPEP 503.**

**New Applications Under 35 U.S.C. 111**

**If a new application is being filed and the application includes the necessary components for a filing date (see 37 CFR 1.53(b)-(d) and MPEP 506), a Filing Receipt (37 CFR 1.54) will be issued in due course and the date shown on this Acknowledgement Receipt will establish the filing date of the application.**

**National Stage of an International Application under 35 U.S.C. 371**

**If a timely submission to enter the national stage of an international application is compliant with the conditions of 35 U.S.C. 371 and other applicable requirements a Form PCT/DO/EO/903 indicating acceptance of the application as a national stage submission under 35 U.S.C. 371 will be issued in addition to the Filing Receipt, in due course.**

**New International Application Filed with the USPTO as a Receiving Office**

**If a new international application is being filed and the international application includes the necessary components for an international filing date (see PCT Article 11 and MPEP 1810), a Notification of the International Application Number and of the International Filing Date (Form PCT/RO/105) will be issued in due course, subject to prescriptions concerning national security, and the date shown on this Acknowledgement Receipt will establish the international filing date of the application.**

**INFORMATION DISCLOSURE STATEMENT**

|           |   |                                                                |
|-----------|---|----------------------------------------------------------------|
| Inventor  | : | Clay Perrault et al.                                           |
| App. No.  | : | 13/966,096                                                     |
| Filed     | : | August 13, 2013                                                |
| For       | : | PRODUCING ROUTING MESSAGES FOR<br>VOICE OVER IP COMMUNICATIONS |
| Examiner  | : | Kizou, Hassan                                                  |
| Art Unit  | : | 2472                                                           |
| Conf. No. | : | 8712                                                           |

Commissioner for Patents  
P.O. Box 1450  
Alexandria, VA 22313-1450

**References and Listing**

Submitted herewith in the above-identified application is an Information Disclosure Statement listing references for consideration. Copies of any listed foreign and non-patent literature references are being submitted.

**Timing of Disclosure**

This Information Disclosure Statement is being filed before the receipt of a First Office Action on the merits, and presumably no fee is required. If a First Office Action on the merits was mailed before the mailing date of this Statement, the Commissioner is authorized to charge the fee set forth in 37 CFR 1.17(p) to Deposit Account No. 11-1410.


Respectfully submitted,

KNOBBE, MARTENS, OLSON & BEAR, LLP

Dated: \_\_\_\_\_

3/18/14

By: \_\_\_\_\_

  
John M. Carson  
Registration No. 34,303  
Attorney of Record  
Customer No. 20995  
(858) 707-4000

IDS  
17407973  
030514



**IN THE UNITED STATES PATENT AND TRADEMARK OFFICE**

|           |   |                                                                |
|-----------|---|----------------------------------------------------------------|
| Inventor  | : | Clay Perrault                                                  |
| App. No.  | : | 13/966,096                                                     |
| Filed     | : | August 13, 2013                                                |
| For       | : | PRODUCING ROUTING MESSAGES FOR<br>VOICE OVER IP COMMUNICATIONS |
| Examiner  | : | Kizou, Hasson                                                  |
| Art Unit  | : | 2472                                                           |
| Conf. No. | : | 8712                                                           |

**PRELIMINARY AMENDMENT**

**Mail Stop Amendment**  
Commissioner for Patents  
P.O. Box 1450  
Alexandria, VA 22313-1450

Dear Sir:

Prior to examination on the merits, please amend the above-referenced patent application as follows:

**Amendments to the Claims** are reflected in the listing of claims which begins on page 2 of this paper.

**Remarks** begin on page 18 of this paper.

**AMENDMENTS TO THE CLAIMS**

1. (Original) A process for producing a routing message for routing communications between a caller and a callee in a communication system, the process comprising:

using a caller identifier associated with the caller to locate a caller dialing profile comprising a plurality of calling attributes associated with the caller;

when at least one of said calling attributes and at least a portion of a callee identifier associated with the callee meet private network classification criteria, producing a private network routing message for receipt by a call controller, said private network routing message identifying an address, on the private network, associated with the callee; and

when at least one of said calling attributes and at least a portion of said callee identifier meet a public network classification criterion, producing a public network routing message for receipt by the call controller, said public network routing message identifying a gateway to the public network.

2. (Original) The process of claim 1, wherein said private network classification criteria include:

a) said callee identifier does not begin with the same digit pattern as an international dialing digit (IDD) attribute of said callee identifier; and

b) said callee identifier does not begin with the same digit pattern as a national dialing digit (NDD) attribute of said callee identifier; and

c) said callee identifier does not begin with the same area code as an area code of said caller; and

d) said callee identifier does not have a length that is within a range of caller local number lengths; and

e) said callee identifier is a valid username.

3. (Original) The process of claim 2, further comprising identifying the call as a cross-domain call on the private network when said callee identifier identifies a callee that is not associated with the same network node as said caller.

4. (Original) The process of claim 2, further comprising:  
locating a callee dialing profile for the callee when said callee identifier identifies a callee that is associated with the same network node as said caller; and  
retrieving call handling information associated with the callee, where said call handling information is available, said call handling information including at least one of call blocking information, call forwarding information, and voicemail information.

5. (Original) The process of claim 4, further comprising, where said call handling information including said call blocking information is available, blocking the call when said call blocking information identifies the caller as a caller from whom calls are to be blocked from being established with the callee.

6. (Original) The process of claim 4, further comprising, where said call handling information including said call forwarding information is available, causing said call forwarding information to be included in said private network routing message.

7. (Original) The process of claim 4, further comprising, where said call handling information including said voicemail information is available, causing said voicemail information to be included in said private network routing message.

8. (Original) The process of claim 1, further comprising associating at least one direct inward dial (DID) record with at least one subscriber to said communication system, each of said at least one direct inward dial records comprising a field storing a direct inward dial number associated with said at least one subscriber.

9. (Original) The process of claim 8, wherein said public network classification criteria include:

**Application No.:** 13/966,096  
**Filing Date:** August 13, 2013

a) said callee identifier begins with the same digit pattern as an international dialing digit (IDD) attribute of said callee identifier; and

b) a reformatted callee identifier produced by removing the IDD attribute from said callee identifier has no DID bank table record.

10. (Original) The process of claim 8, wherein said public network classification criteria include:

a) said callee identifier begins with the same digit pattern as a national dialing digit (NDD) attribute of said callee identifier; and

b) a reformatted callee identifier produced by removing the NDD attribute from said callee identifier and including a caller country code has no DID bank table record.

11. (Original) The process of claim 8, wherein said public network classification criteria include:

a) said callee identifier begins with the same area code as an area code of said caller; and

b) a reformatted callee identifier produced by reformatting the callee identifier to include a caller country code has no DID bank table record.

12. (Original) The process of claim 8, wherein said public network classification criteria include:

a) said callee identifier has a length that is within a range of caller local number lengths; and

b) a reformatted callee identifier produced by reformatting the callee identifier to include a caller country code and area code has no DID bank table record.

13. (Original) The process of claim 1, wherein said plurality of calling attributes includes at least one of an international dialing digits identifier, a national dialing digits identifier, a country code identifier, a local area codes identifier, a caller minimum local length

identifier, a caller maximum local length identifier, a reseller identifier, and a maximum number of concurrent calls identifier.

14. (Original) The process of claim 8, wherein said DID record comprises a user name field, a user domain field and a DID number field.

15. (Original) The process of claim 1, further comprising maintaining a list of public network route suppliers and when said public network classification criterion is met identifying at least one of said public network route suppliers that satisfies public network routing selection criteria.

16. (Original) The process of claim 15, wherein said producing said public network routing message comprises producing a public network routing message identifying said at least one public network route supplier that satisfies said public network routing selection criteria.

17. (Original) The process of claim 16, wherein producing said public network routing message comprises causing said public network routing message to include a gateway supplier identifier identifying a gateway supplier able to establish a communications link in a route through which communications between the caller and callee are to be conducted.

18. (Original) The process of claim 17, further comprising causing said public network routing message to include a time value and a timeout value.

19. (Original) The process of claim 17, wherein causing said public network routing message to include said gateway supplier identifier comprises causing said public network routing message to include a plurality of gateway supplier identifiers identifying a plurality of gateway suppliers able to supply respective communication links through which communications between the caller and callee can be conducted.

20. (Original) The process of claim 19, further comprising causing said public network routing message to include priority information identifying a priority in which gateway suppliers associated with said gateway identifiers are to be considered for selection of a communication link through which communications between the caller and callee can be conducted.

21. (Original) The process of claim 19, wherein causing said public network routing message to include priority information includes arranging said gateway supplier identifiers in said public network routing message in order of rate, where rate is determined from rate fields of respective said gateway supplier records.

22. (Original) The process of claim 21, wherein arranging said gateway supplier identifiers in order of rate comprises arranging said gateway supplier identifiers in order of increasing rate.

23. (Original) The process of claim 17, further comprising arranging said gateway supplier identifiers in an order based on at least one provision in a service agreement.

24. (Original) The process of claim 1, further comprising causing the private network routing message or the public network routing message to be communicated to a call controller to effect routing of the call.

25. (Original) A non-transitory computer readable medium encoded with codes for directing a processor to execute the method of claim 1.

26. (Original) A call routing controller apparatus for producing a routing message for routing communications between a caller and a callee in a communication system, the apparatus comprising:

at least one processor operably configured to:

use a caller identifier associated with the caller to locate a caller dialing profile comprising a plurality of calling attributes associated with the caller;

**Application No.:** 13/966,096  
**Filing Date:** August 13, 2013

when at least one of said calling attributes and at least a portion of a callee identifier associated with the callee meet private network classification criteria, produce a private network routing message for receipt by a call controller, said private network routing message identifying an address, on the private network, associated with the callee; and

when at least one of said calling attributes and at least a portion of said callee identifier meet a public network classification criterion, produce a public network routing message for receipt by the call controller, said public network routing message identifying a gateway to the public network.

27. (Original) The apparatus of claim 26, wherein said private network classification criteria include:

- a) said callee identifier does not begin with the same digit pattern as an international dialing digit (IDD) attribute of said callee identifier; and
- b) said callee identifier does not begin with the same digit pattern as a national dialing digit (NDD) attribute of said callee identifier; and
- c) said callee identifier does not begin with the same area code as an area code of said caller; and
- d) said callee identifier does not have a length that is within a range of caller local number lengths; and
- e) said callee identifier is a valid username.

28. (Original) The apparatus of claim 27, wherein said at least one processor is further operably configured to identify the call as a cross-domain call on the private network when said callee identifier identifies a callee that is not associated with the same network node as said caller.

29. (Original) The apparatus of claim 27, wherein said at least one processor is further configured to:

access the database of caller dialing profiles to locate a callee dialing profile for the callee when said callee identifier identifies a callee that is associated with the same network node as said caller; and

retrieve call handling information associated with the callee, where said call handling information is available, said call handling information including at least one of call blocking information, call forwarding information, and voicemail information.

30. (Original) The apparatus of claim 29, wherein said at least one processor is further operably configured to determine whether said call handling information including said call blocking information is available and to block the call when said call blocking information identifies the caller as a caller from whom calls are to be blocked.

31. (Original) The apparatus of claim 29, wherein said at least one processor is further operably configured to determine whether said call handling information including said call forwarding information is available and to cause said call forwarding information to be included in said private network routing message.

32. (Original) The apparatus of claim 29, wherein said at least one processor is further operably configured to determine whether said call handling information including said voicemail information is available and to cause said voicemail information to be included in said private network routing message.

33. (Original) The apparatus of claim 26, wherein said at least one processor is further operably configured to access a database of direct inward dial records each associating at least one direct inward dial number with at least one subscriber to said communication system.

34. (Original) The apparatus of claim 33, wherein said public network classification criteria include:

- a) said callee identifier begins with the same digit pattern as an international dialing digit (IDD) attribute of said callee identifier; and



**Application No.:** 13/966,096  
**Filing Date:** August 13, 2013

b) a reformatted callee identifier produced by removing the IDD attribute from said callee identifier has no DID record.

35. (Original) The apparatus of claim 33, wherein said public network classification criteria include:

a) said callee identifier begins with the same digit pattern as a national dialing digit (NDD) attribute of said callee identifier; and

b) a reformatted callee identifier produced by removing the NDD attribute from said callee identifier and including a caller country code has no DID record.

36. (Original) The apparatus of claim 33, wherein said public network classification criteria include:

a) said callee identifier begins with the same area code as an area code of said caller; and

b) a reformatted callee identifier produced by reformatting the callee identifier to include a caller country code has no DID record.

37. (Original) The apparatus of claim 33, wherein said public network classification criteria include:

a) said callee identifier has a length that is within a range of caller local number lengths; and

b) a reformatted callee identifier produced by reformatting the callee identifier to include a caller country code and area code has no DID record.

38. (Original) The apparatus of claim 26, wherein said plurality of calling attributes includes at least one of an international dialing digits identifier, a national dialing digits identifier, a country code identifier, a local area codes identifier, a caller minimum local length identifier, a caller maximum local length identifier, a reseller identifier, and a maximum number of concurrent calls identifier.

39. (Original) The apparatus of claim 33, wherein said DID record comprises a user name field, a user domain field and a DID number field.

40. (Original) The apparatus of claim 26, wherein said at least one processor is further operably configured to access a list of public network route suppliers when said public network classification criterion is met and to identify at least one of said public network route suppliers that satisfies public network routing selection criteria.

41. (Original) The apparatus of claim 40, wherein said at least one processor is further operably configured to produce a public network routing message identifying said at least one public network route supplier that satisfies said public network routing selection criteria.

42. (Original) The apparatus of claim 41, wherein said at least one processor is operably configured to cause said public network routing message to include a gateway supplier identifier identifying a gateway supplier able to establish a communications link in a route through which communications between the caller and callee can be conducted.

43. (Original) The apparatus of claim 42, wherein said at least one processor is operably configured to cause said public network routing message to include a time value and a timeout value.

44. (Original) The apparatus of claim 42, wherein said at least one processor is operably configured to cause said public network routing message to include a plurality of gateway supplier identifiers identifying a plurality of gateway suppliers able to supply respective communication links through which communications between the caller and callee can be conducted.

45. (Original) The apparatus of claim 44, wherein said at least one processor is operably configured to cause said public network routing message to include priority information identifying a priority in which gateway suppliers associated with said gateway identifiers are to

be considered for selection of a communication link through which communications between the caller and callee can be conducted.

46. (Original) The apparatus of claim 44, wherein said at least one processor is operably configured to arrange said gateway supplier identifiers in said public network routing message in order of rate, where rate is determined from rate fields of respective said gateway supplier records.

47. (Original) The apparatus of claim 46, wherein said at least one processor is operably configured to arrange said gateway supplier identifiers in order of increasing rate.

48. (Original) The apparatus of claim 42, wherein said at least one processor is operably configured to arrange said gateway supplier identifiers in an order based on at least one provision in a service agreement.

49. (Original) The apparatus of claim 26, wherein said at least one processor is further operably configured to cause the private network routing message or the public network routing message to be communicated to a call controller to effect routing of the call.

50. (Original) A call routing controller apparatus for producing a routing message for routing communications between a caller and a callee in a communication system, the apparatus comprising:

means for using a caller identifier associated with the caller to locate a caller dialing profile comprising a plurality of calling attributes associated with the caller; and

means for, when at least one of said calling attributes and at least a portion of a callee identifier associated with the callee meet private network classification criteria, producing a private network routing message for receipt by a call controller, said private network routing message identifying an address, on the private network, associated with the callee; and

means for, when at least one of said calling attributes and at least a portion of said callee identifier meet a public network classification criterion, producing a public

network routing message for receipt by the call controller, said public network routing message identifying a gateway to the public network.

51. (Original) The apparatus of claim 50, wherein said private network classification criteria include:

- a) said callee identifier does not begin with the same digit pattern as an international dialing digit (IDD) attribute of said callee identifier; and
  - b) said callee identifier does not begin with the same digit pattern as a national dialing digit (NDD) attribute of said callee identifier; and
  - c) said callee identifier does not begin with the same area code as an area code of said caller; and
- said callee identifier does not have a length that is within a range of caller local number lengths; and
- said callee identifier is a valid username.

52. (Original) The apparatus of claim 51, further comprising means for identifying the call as a cross-domain call on the private network when said callee identifier identifies a callee that is not associated with the same network node as said caller.

53. (Original) The apparatus of claim 51, further comprising:

means for accessing the database of caller dialing profiles to locate a callee dialing profile for the callee when said callee identifier identifies a callee that is associated with the same network node as said caller; and

means for retrieving call handling information associated with the callee, where said call handling information is available, said call handling information including at least one of call blocking information, call forwarding information, and voicemail information.

54. (Original) The apparatus of claim 53, further comprising, where said call handling information including said call blocking information is available, means for blocking the call being established with the callee when said call blocking information identifies the caller as a caller from whom calls are to be blocked.

**Application No.:** 13/966,096  
**Filing Date:** August 13, 2013

55. (Original) The apparatus of claim 53, further comprising, means for causing said call forwarding information to be included in said private network routing message, where said call handling information including said call forwarding information is available.

56. (Original) The apparatus of claim 53, further comprising, where said call handling information including said voicemail information is available, means for causing said voicemail information to be included in said private network routing message.

57. (Original) The apparatus of claim 50, further comprising means for accessing a database of direct inward dial records each associating at least one direct inward dial number with at least one subscriber to said communication system.

58. (Original) The apparatus of claim 57, wherein said public network classification criteria include:

- a) said callee identifier begins with the same digit pattern as an international dialing digit (IDD) attribute of said callee identifier; and
- b) a reformatted callee identifier produced by removing the IDD attribute from said callee identifier has no DID record.

59. (Original) The apparatus of claim 57, wherein said public network classification criteria include:

- a) said callee identifier begins with the same digit pattern as a national dialing digit (NDD) attribute of said callee identifier; and
- b) a reformatted callee identifier produced by removing the NDD attribute from said callee identifier and including a caller country code has no DID record.

60. (Original) The apparatus of claim 57, wherein said public network classification criteria include:

- a) said callee identifier begins with the same area code as an area code of said caller; and

**Application No.:** 13/966,096  
**Filing Date:** August 13, 2013

b) a reformatted callee identifier produced by reformatting the callee identifier to include a caller country code has no DID record.

61. (Original) The apparatus of claim 57, wherein said public network classification criteria include:

a) said callee identifier has a length that is within a range of caller local number lengths; and

b) a reformatted callee identifier produced by reformatting the callee identifier to include a caller country code and area code has no DID record.

62. (Original) The apparatus of claim 50, wherein said plurality of calling attributes includes at least one of an international dialing digits identifier, a national dialing digits identifier, a country code identifier, a local area codes identifier, a caller minimum local length identifier, a caller maximum local length identifier, a reseller identifier, and a maximum number of concurrent calls identifier.

63. (Original) The apparatus of claim 57, wherein said DID record comprises a user name field, a user domain field and a DID number field.

64. (Original) The apparatus of claim 50, further comprising means for accessing a list of public network route suppliers when said public network classification criterion is met and means for identifying at least one of said public network route suppliers that satisfies public network routing selection criteria.

65. (Original) The apparatus of claim 64, wherein said means for producing said public network routing message comprises means for producing a public network routing message identifying said at least one public network route supplier that satisfies said public network routing selection criteria.

66. (Original) The apparatus of claim 65, wherein said means for producing said public network routing message comprises means for causing said public network routing

**Application No.:** 13/966,096  
**Filing Date:** August 13, 2013

message to include a gateway supplier identifier identifying a gateway supplier able to establish a communications link in a route through which communications between the caller and callee can be conducted.

67. (Original) The apparatus of claim 66, further comprising means for causing said public network routing message to include a time value and a timeout value.

68. (Original) The apparatus of claim 66, wherein said means for causing said public network routing message to include said gateway supplier identifier comprises means for causing said public network routing message to include a plurality of gateway supplier identifiers identifying a plurality of gateway suppliers able to supply respective communication links through which communications between the caller and callee can be conducted.

69. (Original) The apparatus of claim 68, further comprising means for causing said public network routing message to include priority information identifying a priority in which gateway suppliers associated with said gateway identifiers are to be considered for selection of a communication link through which communications between the caller and callee can be conducted.

70. (Original) The apparatus of claim 68, wherein said means for causing said public network routing message to include priority information includes means for arranging said gateway supplier identifiers in said public network routing message in order of rate, where rate is determined from rate fields of respective said gateway supplier records.

71. (Original) The apparatus of claim 70, wherein said means for arranging said gateway supplier identifiers in order of rate comprises means for arranging said gateway supplier identifiers in order of increasing rate.

72. (Original) The apparatus of claim 66, further comprising means for arranging said gateway supplier identifiers in an order based on at least one provision in a service agreement.

73. (Original) The apparatus of claim 50, further comprising means for causing the private network routing message or the public network routing message to be communicated to a call controller to effect routing of the call.

74. (Original) A non-transitory computer readable medium having stored thereon data structure for associating together a collection of information for use in producing a routing message for routing communications in a communications system, the data structure comprising:

dialing profile records comprising fields for associating a subscriber username with respective subscribers to the system;

direct-in-dial records comprising fields for associating a user domain and a direct-in-dial number with respective subscriber usernames;

prefix to node records comprising fields for associating a node address of a node in said system with at least a portion of said respective subscriber usernames:

whereby said subscriber username can be used to find said user domain, at least a portion of said subscriber username can be used to find said node with which a subscriber identified by said subscriber user name is associated, and said user domain and said subscriber username can be located in response to said direct-in-dial number.

75. (Original) A non-transitory computer readable medium having stored thereon a data structure for associating together a collection of information for use in producing a routing message in a communications system, the data structure comprising:

master list records comprising fields for associating a dialing code with respective master list identifiers; and

supplier list records linked to said master list records by said master list identifiers, said supplier list records comprising fields for associating the following information with a communications services supplier:

a supplier id;

a master list id;

a route identifier; and

a billing rate code,



**Application No.:** 13/966,096  
**Filing Date:** August 13, 2013

whereby at least one communications service supplier is associated with said dialing code, such that said dialing code can be used to locate suppliers capable of providing a communications link associated with a given dialing code.

76. (Original) A non-transitory computer readable medium having stored thereon a data structure for associating together a collection of information for use in producing a routing message for routing communications, the data structure comprising:

- a username field;
- a domain field;
- a national dialing digits (NDD) field;
- an international dialing digits (IDD) field;
- a country code field;
- a local area code field;
- a caller minimum local length field; and
- a caller maximum local length field.

77. (Original) The non-transitory computer readable medium of claim 76, further comprising a reseller field.

78. (Currently amended) The non-transitory computer readable medium of claim 76, further comprising:

- a maximum number of concurrent calls field; and
- a current ~~umber~~ number of concurrent calls field.

**Application No.:** 13/966,096  
**Filing Date:** August 13, 2013

**REMARKS**

Please make the above indicated amendment to the claims, correcting a typographical error in Claim 78, prior to examination.

**Conclusion**

Although the present communication may include alterations to the application or claims, or characterizations of claim scope or referenced art, Applicant is not conceding in this application that previously pending claims are not patentable over the cited references. Rather, any alterations or characterizations are being made to facilitate expeditious prosecution of this application. Applicant reserves the right to pursue at a later date any previously pending or other broader or narrower claims that capture any subject matter supported by the present disclosure, including subject matter found to be specifically disclaimed herein or by any prior prosecution. Accordingly, reviewers of this or any parent, child or related prosecution history shall not reasonably infer that Applicant has made any disclaimers or disavowals of any subject matter supported by the present application.

If the Examiner requires any clarification, the Examiner is respectfully requested to call the undersigned at the provided telephone number in order to resolve any such issue promptly.

Please charge any additional fees, including any fees for additional extension of time, or credit overpayment to Deposit Account No. 11-1410.

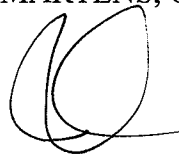
Respectfully submitted,

KNOBBE, MARTENS, OLSON & BEAR, LLP

Dated: \_\_\_\_\_

3/4/14

By: \_\_\_\_\_



John M. Carson  
Registration No. 34,303  
Attorney of Record  
Customer No. 20995  
(858) 707-4000

17372818  
022814

## Electronic Acknowledgement Receipt

|                                             |                                                             |
|---------------------------------------------|-------------------------------------------------------------|
| <b>EFS ID:</b>                              | 18369097                                                    |
| <b>Application Number:</b>                  | 13966096                                                    |
| <b>International Application Number:</b>    |                                                             |
| <b>Confirmation Number:</b>                 | 8712                                                        |
| <b>Title of Invention:</b>                  | PRODUCING ROUTING MESSAGES FOR VOICE OVER IP COMMUNICATIONS |
| <b>First Named Inventor/Applicant Name:</b> | CLAY PERRAULT                                               |
| <b>Customer Number:</b>                     | 20995                                                       |
| <b>Filer:</b>                               | John M Carson/Erica Directo                                 |
| <b>Filer Authorized By:</b>                 | John M Carson                                               |
| <b>Attorney Docket Number:</b>              | SMARB19.001C1                                               |
| <b>Receipt Date:</b>                        | 04-MAR-2014                                                 |
| <b>Filing Date:</b>                         | 13-AUG-2013                                                 |
| <b>Time Stamp:</b>                          | 19:29:51                                                    |
| <b>Application Type:</b>                    | Utility under 35 USC 111(a)                                 |

### Payment information:

|                        |    |
|------------------------|----|
| Submitted with Payment | no |
|------------------------|----|

### File Listing:

| Document Number | Document Description | File Name                            | File Size(Bytes)/<br>Message Digest                               | Multi Part /.zip | Pages (if appl.) |
|-----------------|----------------------|--------------------------------------|-------------------------------------------------------------------|------------------|------------------|
| 1               |                      | SMARB19001C1preliminaryamendment.pdf | 801098<br><small>33600fad5509c6892ea6b8816fb00d077fbc2faf</small> | yes              | 18               |

| <b>Multipart Description/PDF files in .zip description</b> |  |              |            |
|------------------------------------------------------------|--|--------------|------------|
| <b>Document Description</b>                                |  | <b>Start</b> | <b>End</b> |
| Preliminary Amendment                                      |  | 1            | 1          |
| Claims                                                     |  | 2            | 17         |
| Applicant Arguments/Remarks Made in an Amendment           |  | 18           | 18         |

**Warnings:**

**Information:**

|                                     |        |
|-------------------------------------|--------|
| <b>Total Files Size (in bytes):</b> | 801098 |
|-------------------------------------|--------|

This Acknowledgement Receipt evidences receipt on the noted date by the USPTO of the indicated documents, characterized by the applicant, and including page counts, where applicable. It serves as evidence of receipt similar to a Post Card, as described in MPEP 503.

**New Applications Under 35 U.S.C. 111**

If a new application is being filed and the application includes the necessary components for a filing date (see 37 CFR 1.53(b)-(d) and MPEP 506), a Filing Receipt (37 CFR 1.54) will be issued in due course and the date shown on this Acknowledgement Receipt will establish the filing date of the application.

**National Stage of an International Application under 35 U.S.C. 371**

If a timely submission to enter the national stage of an international application is compliant with the conditions of 35 U.S.C. 371 and other applicable requirements a Form PCT/DO/EO/903 indicating acceptance of the application as a national stage submission under 35 U.S.C. 371 will be issued in addition to the Filing Receipt, in due course.

**New International Application Filed with the USPTO as a Receiving Office**

If a new international application is being filed and the international application includes the necessary components for an international filing date (see PCT Article 11 and MPEP 1810), a Notification of the International Application Number and of the International Filing Date (Form PCT/RO/105) will be issued in due course, subject to prescriptions concerning national security, and the date shown on this Acknowledgement Receipt will establish the international filing date of the application.

Under the Paperwork Reduction Act of 1995, no persons are required to respond to a collection of information unless it displays a valid OMB control number.

|                                                                                   |                                                   |                                  |                                       |
|-----------------------------------------------------------------------------------|---------------------------------------------------|----------------------------------|---------------------------------------|
| <b>PATENT APPLICATION FEE DETERMINATION RECORD</b><br>Substitute for Form PTO-875 | Application or Docket Number<br><b>13/966,096</b> | Filing Date<br><b>08/13/2013</b> | <input type="checkbox"/> To be Mailed |
|-----------------------------------------------------------------------------------|---------------------------------------------------|----------------------------------|---------------------------------------|

ENTITY:  LARGE  SMALL  MICRO

**APPLICATION AS FILED – PART I**

| FOR                                                                                       | NUMBER FILED                                                                                                                                                                                                                  | NUMBER EXTRA | RATE (\$) | FEE (\$) |
|-------------------------------------------------------------------------------------------|-------------------------------------------------------------------------------------------------------------------------------------------------------------------------------------------------------------------------------|--------------|-----------|----------|
| <input type="checkbox"/> BASIC FEE<br><small>(37 CFR 1.16(a), (b), or (c))</small>        | N/A                                                                                                                                                                                                                           | N/A          | N/A       |          |
| <input type="checkbox"/> SEARCH FEE<br><small>(37 CFR 1.16(k), (l), or (m))</small>       | N/A                                                                                                                                                                                                                           | N/A          | N/A       |          |
| <input type="checkbox"/> EXAMINATION FEE<br><small>(37 CFR 1.16(o), (p), or (q))</small>  | N/A                                                                                                                                                                                                                           | N/A          | N/A       |          |
| TOTAL CLAIMS<br><small>(37 CFR 1.16(i))</small>                                           | minus 20 =                                                                                                                                                                                                                    | *            | X \$ =    |          |
| INDEPENDENT CLAIMS<br><small>(37 CFR 1.16(h))</small>                                     | minus 3 =                                                                                                                                                                                                                     | *            | X \$ =    |          |
| <input type="checkbox"/> APPLICATION SIZE FEE<br><small>(37 CFR 1.16(s))</small>          | If the specification and drawings exceed 100 sheets of paper, the application size fee due is \$310 (\$155 for small entity) for each additional 50 sheets or fraction thereof. See 35 U.S.C. 41(a)(1)(G) and 37 CFR 1.16(s). |              |           |          |
| <input type="checkbox"/> MULTIPLE DEPENDENT CLAIM PRESENT <small>(37 CFR 1.16(j))</small> |                                                                                                                                                                                                                               |              |           |          |
| * If the difference in column 1 is less than zero, enter "0" in column 2.                 |                                                                                                                                                                                                                               |              | TOTAL     |          |

**APPLICATION AS AMENDED – PART II**

|                                                                                                         | (Column 1)                                                                    | (Column 2)                       | (Column 3)                         | PRESENT EXTRA | RATE (\$)       | ADDITIONAL FEE (\$) |
|---------------------------------------------------------------------------------------------------------|-------------------------------------------------------------------------------|----------------------------------|------------------------------------|---------------|-----------------|---------------------|
| <b>AMENDMENT</b>                                                                                        | <b>03/04/2014</b>                                                             | CLAIMS REMAINING AFTER AMENDMENT | HIGHEST NUMBER PREVIOUSLY PAID FOR |               |                 |                     |
|                                                                                                         | Total <small>(37 CFR 1.16(i))</small>                                         | * 78                             | Minus                              | ** 78         | = 0             | X \$40 = 0          |
|                                                                                                         | Independent <small>(37 CFR 1.16(h))</small>                                   | * 6                              | Minus                              | ***6          | = 0             | X \$210 = 0         |
|                                                                                                         | <input type="checkbox"/> Application Size Fee <small>(37 CFR 1.16(s))</small> |                                  |                                    |               |                 |                     |
| <input type="checkbox"/> FIRST PRESENTATION OF MULTIPLE DEPENDENT CLAIM <small>(37 CFR 1.16(j))</small> |                                                                               |                                  |                                    |               |                 |                     |
|                                                                                                         |                                                                               |                                  |                                    |               | TOTAL ADD'L FEE | <b>0</b>            |

|                                                                                                         | (Column 1)                                                                    | (Column 2)                       | (Column 3)                         | PRESENT EXTRA | RATE (\$)       | ADDITIONAL FEE (\$) |
|---------------------------------------------------------------------------------------------------------|-------------------------------------------------------------------------------|----------------------------------|------------------------------------|---------------|-----------------|---------------------|
| <b>AMENDMENT</b>                                                                                        |                                                                               | CLAIMS REMAINING AFTER AMENDMENT | HIGHEST NUMBER PREVIOUSLY PAID FOR |               |                 |                     |
|                                                                                                         | Total <small>(37 CFR 1.16(i))</small>                                         | *                                | Minus                              | **            | =               | X \$ =              |
|                                                                                                         | Independent <small>(37 CFR 1.16(h))</small>                                   | *                                | Minus                              | ***           | =               | X \$ =              |
|                                                                                                         | <input type="checkbox"/> Application Size Fee <small>(37 CFR 1.16(s))</small> |                                  |                                    |               |                 |                     |
| <input type="checkbox"/> FIRST PRESENTATION OF MULTIPLE DEPENDENT CLAIM <small>(37 CFR 1.16(j))</small> |                                                                               |                                  |                                    |               |                 |                     |
|                                                                                                         |                                                                               |                                  |                                    |               | TOTAL ADD'L FEE |                     |

\* If the entry in column 1 is less than the entry in column 2, write "0" in column 3.  
 \*\* If the "Highest Number Previously Paid For" IN THIS SPACE is less than 20, enter "20".  
 \*\*\* If the "Highest Number Previously Paid For" IN THIS SPACE is less than 3, enter "3".  
 The "Highest Number Previously Paid For" (Total or Independent) is the highest number found in the appropriate box in column 1.

LIE  
/STELLA LITTLE/

This collection of information is required by 37 CFR 1.16. The information is required to obtain or retain a benefit by the public which is to file (and by the USPTO to process) an application. Confidentiality is governed by 35 U.S.C. 122 and 37 CFR 1.14. This collection is estimated to take 12 minutes to complete, including gathering, preparing, and submitting the completed application form to the USPTO. Time will vary depending upon the individual case. Any comments on the amount of time you require to complete this form and/or suggestions for reducing this burden, should be sent to the Chief Information Officer, U.S. Patent and Trademark Office, U.S. Department of Commerce, P.O. Box 1450, Alexandria, VA 22313-1450. DO NOT SEND FEES OR COMPLETED FORMS TO THIS ADDRESS. **SEND TO: Commissioner for Patents, P.O. Box 1450, Alexandria, VA 22313-1450.**

If you need assistance in completing the form, call 1-800-PTO-9199 and select option 2.

PETITIONER APPLE INC. EX. 1005-601



UNITED STATES PATENT AND TRADEMARK OFFICE

UNITED STATES DEPARTMENT OF COMMERCE  
United States Patent and Trademark Office  
Address: COMMISSIONER FOR PATENTS  
P.O. Box 1450  
Alexandria, Virginia 22313-1450  
www.uspto.gov

| APPLICATION NUMBER | FILING OR 371(C) DATE | FIRST NAMED APPLICANT | ATTY. DOCKET NO./TITLE |
|--------------------|-----------------------|-----------------------|------------------------|
| 13/966,096         | 08/13/2013            | CLAY PERRAULT         | SMARB19.001C1          |

**CONFIRMATION NO. 8712**

**POA ACCEPTANCE LETTER**

20995  
KNOBBE MARTENS OLSON & BEAR LLP  
2040 MAIN STREET  
FOURTEENTH FLOOR  
IRVINE, CA 92614



Date Mailed: 02/10/2014

**NOTICE OF ACCEPTANCE OF POWER OF ATTORNEY**

This is in response to the Power of Attorney filed 01/31/2014.

The Power of Attorney in this application is accepted. Correspondence in this application will be mailed to the above address as provided by 37 CFR 1.33.

/ctuazon/

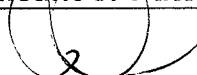
Office of Data Management, Application Assistance Unit (571) 272-4000, or (571) 272-4200, or 1-888-786-0101

## TRANSMITTAL FOR POWER OF ATTORNEY TO ONE OR MORE REGISTERED PRACTITIONERS

NOTE: This form is to be submitted with the Power of Attorney by Applicant form (PTO/AIA/82B) to identify the application to which the Power of Attorney is directed, in accordance with 37 CFR 1.5, unless the application number and filing date are identified in the Power of Attorney by Applicant form. If neither form PTO/AIA/82A nor form PTO/AIA82B identifies the application to which the Power of Attorney is directed, the Power of Attorney will not be recognized in the application.

|                        |                                                             |
|------------------------|-------------------------------------------------------------|
| Application Number     | 13/966,096                                                  |
| Filing Date            | August 13, 2013                                             |
| First Named Inventor   | Clay Perrault et al.                                        |
| Title                  | PRODUCING ROUTING MESSAGES FOR VOICE OVER IP COMMUNICATIONS |
| Art Unit               | 2472                                                        |
| Examiner Name          | Hasson Kizou                                                |
| Attorney Docket Number | SMARB19.001C1                                               |

### SIGNATURE of Applicant or Patent Practitioner

|                                                                                                                                                                                               |                                                                                     |                     |         |
|-----------------------------------------------------------------------------------------------------------------------------------------------------------------------------------------------|-------------------------------------------------------------------------------------|---------------------|---------|
| Signature                                                                                                                                                                                     |  | Date (Optional)     | 1/30/14 |
| Name                                                                                                                                                                                          | John M. Carson                                                                      | Registration Number | 34,303  |
| Title (if Applicant is a juristic entity)                                                                                                                                                     |                                                                                     |                     |         |
| Applicant Name (if Applicant is a juristic entity)                                                                                                                                            |                                                                                     |                     |         |
| <p><b>NOTE:</b> This form must be signed in accordance with 37 CFR 1.33. See 37 CFR 1.4(d) for signature requirements and certifications. If more than one applicant, use multiple forms.</p> |                                                                                     |                     |         |
| <input checked="" type="checkbox"/> *Total of <u>One (1)</u> forms are submitted.                                                                                                             |                                                                                     |                     |         |

This collection of information is required by 37 CFR 1.131, 1.32, and 1.33. The information is required to obtain or retain a benefit by the public which is to file (and by the USPTO to process) an application. Confidentiality is governed by 35 U.S.C. 122 and 37 CFR 1.11 and 1.14. This collection is estimated to take 3 minutes to complete, including gathering, preparing, and submitting the completed application form to the USPTO. Time will vary depending upon the individual case. Any comments on the amount of time you require to complete this form and/or suggestions for reducing this burden, should be sent to the Chief Information Officer, U.S. Patent and Trademark Office, U.S. Department of Commerce, P.O. Box 1450, Alexandria, VA 22313-1450. DO NOT SEND FEES OR COMPLETED FORMS TO THIS ADDRESS. SEND TO: Commissioner for Patents, P.O. Box 1450, Alexandria, VA 22313-1450.

*If you need assistance in completing the form, call 1-800-PTO-9199 and select option 2.*

PETITIONER APPLE INC. EX. 1005-603

Under the Paperwork Reduction Act of 1995, no persons are required to respond to a collection of information unless it displays a valid OMB control number

## POWER OF ATTORNEY BY APPLICANT

I hereby revoke all previous powers of attorney given in the application identified in either the attached transmittal letter or the boxes below.

|                    |             |
|--------------------|-------------|
| Application Number | Filing Date |
|                    |             |

(Note: The boxes above may be left blank if information is provided on form PTO/AIA/82A.)

I hereby appoint the Patent Practitioner(s) associated with the following Customer Number as my/our attorney(s) or agent(s), and to transact all business in the United States Patent and Trademark Office connected therewith for the application referenced in the attached transmittal letter (form PTO/AIA/82A) or identified above:

OR

20995

I hereby appoint Practitioner(s) named in the attached list (form PTO/AIA/82C) as my/our attorney(s) or agent(s), and to transact all business in the United States Patent and Trademark Office connected therewith for the patent application referenced in the attached transmittal letter (form PTO/AIA/82A) or identified above. (Note: Complete form PTO/AIA/82C.)

**Please recognize or change the correspondence address for the application identified in the attached transmittal letter or the boxes above to:**

The address associated with the above-mentioned Customer Number

OR

The address associated with Customer Number:

OR

|                         |       |     |  |  |
|-------------------------|-------|-----|--|--|
| Firm or Individual Name |       |     |  |  |
| Address                 |       |     |  |  |
| City                    | State | Zip |  |  |
| Country                 |       |     |  |  |
| Telephone               | Email |     |  |  |

I am the Applicant (if the Applicant is a juristic entity, list the Applicant name in the box):

Digifonica (International) Limited

- Inventor or Joint Inventor (title not required below)
- Legal Representative of a Deceased or Legally Incapacitated Inventor (title not required below)
- Assignee or Person to Whom the Inventor is Under an Obligation to Assign (provide signer's title if applicant is a juristic entity)
- Person Who Otherwise Shows Sufficient Proprietary Interest (e.g., a petition under 37 CFR 1.46(b)(2) was granted in the application or is concurrently being filed with this document) (provide signer's title if applicant is a juristic entity)

**SIGNATURE of Applicant for Patent**

The undersigned (whose title is supplied below) is authorized to act on behalf of the applicant (e.g., where the applicant is a juristic entity).

|           |  |                 |              |
|-----------|--|-----------------|--------------|
| Signature |  | Date (Optional) | Dec 12, 2013 |
| Name      |  |                 |              |
| Title     |  |                 |              |

**NOTE:** Signature - This form must be signed by the applicant in accordance with 37 CFR 1.33. See 37 CFR 1.4 for signature requirements and certifications. If more than one applicant, use multiple forms.

Total of \_\_\_\_\_ forms are submitted.

This collection of information is required by 37 CFR 1.131, 1.32, and 1.33. The information is required to obtain or retain a benefit by the public which is to file (and by the USPTO to process) an application. Confidentiality is governed by 35 U.S.C. 122 and 37 CFR 1.11 and 1.14. This collection is estimated to take 3 minutes to complete, including gathering, preparing, and submitting the completed application form to the USPTO. Time will vary depending upon the individual case. Any comments on the amount of time you require to complete this form and/or suggestions for reducing this burden, should be sent to the Chief Information Officer, U.S. Patent and Trademark Office, U.S. Department of Commerce, P.O. Box 1450, Alexandria, VA 22313-1450. DO NOT SEND FEES OR COMPLETED FORMS TO THIS ADDRESS. SEND TO: Commissioner for Patents, P.O. Box 1450, Alexandria, VA 22313-1450.

*If you need assistance in completing the form, call 1-800-PTO-9199 and select option 2.*



## Electronic Acknowledgement Receipt

|                                             |                                                             |
|---------------------------------------------|-------------------------------------------------------------|
| <b>EFS ID:</b>                              | 18076386                                                    |
| <b>Application Number:</b>                  | 13966096                                                    |
| <b>International Application Number:</b>    |                                                             |
| <b>Confirmation Number:</b>                 | 8712                                                        |
| <b>Title of Invention:</b>                  | PRODUCING ROUTING MESSAGES FOR VOICE OVER IP COMMUNICATIONS |
| <b>First Named Inventor/Applicant Name:</b> | CLAY PERRAULT                                               |
| <b>Customer Number:</b>                     | 20995                                                       |
| <b>Filer:</b>                               | John M Carson/Sandra Autry                                  |
| <b>Filer Authorized By:</b>                 | John M Carson                                               |
| <b>Attorney Docket Number:</b>              | SMARB19.001C1                                               |
| <b>Receipt Date:</b>                        | 31-JAN-2014                                                 |
| <b>Filing Date:</b>                         | 13-AUG-2013                                                 |
| <b>Time Stamp:</b>                          | 13:06:04                                                    |
| <b>Application Type:</b>                    | Utility under 35 USC 111(a)                                 |

### Payment information:

|                        |    |
|------------------------|----|
| Submitted with Payment | no |
|------------------------|----|

### File Listing:

| Document Number | Document Description | File Name                                | File Size(Bytes)/<br>Message Digest                                     | Multi Part /.zip | Pages (if appl.) |
|-----------------|----------------------|------------------------------------------|-------------------------------------------------------------------------|------------------|------------------|
| 1               |                      | SMARB19001C1responsetoinfo<br>notice.pdf | 1188904<br><small>fbe4173b533781982444095657df1908b1b<br/>49915</small> | yes              | 6                |

| Multipart Description/PDF files in .zip description |                               |       |     |
|-----------------------------------------------------|-------------------------------|-------|-----|
|                                                     | Document Description          | Start | End |
|                                                     | Miscellaneous Incoming Letter | 1     | 1   |
|                                                     | Oath or Declaration filed     | 2     | 6   |

**Warnings:**

**Information:**

|   |                   |                     |                                              |    |   |
|---|-------------------|---------------------|----------------------------------------------|----|---|
| 2 | Power of Attorney | SMARB19001C1poa.pdf | 170602                                       | no | 2 |
|   |                   |                     | 8e090e4fa39690f4aa00934160034d1d0cfe<br>b6f7 |    |   |

**Warnings:**

**Information:**

|                                     |  |         |
|-------------------------------------|--|---------|
| <b>Total Files Size (in bytes):</b> |  | 1359506 |
|-------------------------------------|--|---------|

**This Acknowledgement Receipt evidences receipt on the noted date by the USPTO of the indicated documents, characterized by the applicant, and including page counts, where applicable. It serves as evidence of receipt similar to a Post Card, as described in MPEP 503.**

**New Applications Under 35 U.S.C. 111**

**If a new application is being filed and the application includes the necessary components for a filing date (see 37 CFR 1.53(b)-(d) and MPEP 506), a Filing Receipt (37 CFR 1.54) will be issued in due course and the date shown on this Acknowledgement Receipt will establish the filing date of the application.**

**National Stage of an International Application under 35 U.S.C. 371**

**If a timely submission to enter the national stage of an international application is compliant with the conditions of 35 U.S.C. 371 and other applicable requirements a Form PCT/DO/EO/903 indicating acceptance of the application as a national stage submission under 35 U.S.C. 371 will be issued in addition to the Filing Receipt, in due course.**

**New International Application Filed with the USPTO as a Receiving Office**

**If a new international application is being filed and the international application includes the necessary components for an international filing date (see PCT Article 11 and MPEP 1810), a Notification of the International Application Number and of the International Filing Date (Form PCT/RO/105) will be issued in due course, subject to prescriptions concerning national security, and the date shown on this Acknowledgement Receipt will establish the international filing date of the application.**

Please Direct All Correspondence to Customer Number 20995

---

**RESPONSE TO INFORMATIONAL NOTICE**

|           |   |                                                                |
|-----------|---|----------------------------------------------------------------|
| Inventor  | : | Clay Perrault et al.                                           |
| App. No.  | : | 13/966,096                                                     |
| Filed     | : | August 13, 2013                                                |
| For       | : | PRODUCING ROUTING MESSAGES FOR<br>VOICE OVER IP COMMUNICATIONS |
| Art Unit  | : | 2472                                                           |
| Conf. No. | : | 8712                                                           |

**Commissioner for Patents  
P.O. Box 1450  
Alexandria, VA 22313-1450**

Dear Sir:

The above-captioned application was filed without a Declaration and/or Substitute Statement. Enclosed in compliance with 37 CFR 1.53(f) are the following:

(X) Declaration(s) for:

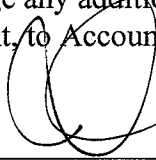
**Clay Perrault, Steve Nicholson, Rod Thomson,  
Johan Emil Viktor Björsell, and Fuad Arafa**

(X) Power of Attorney by Applicant.

The Commissioner is hereby authorized to charge any additional fees which may be required, now or in the future, or credit any overpayment, to Account No. 11-1410.

Date: \_\_\_\_\_

*1/30/14*

  
\_\_\_\_\_  
John M. Carson  
Registration No. 34,303  
Attorney of Record  
Customer No. 20995  
(858) 707-4000

Under the Paperwork Reduction Act of 1995, no persons are required to respond to a collection of information unless it displays a valid OMB control number.

**DECLARATION (37 CFR 1.63) FOR UTILITY OR DESIGN APPLICATION USING AN APPLICATION DATA SHEET (37 CFR 1.76)**

|                               |                                                                    |
|-------------------------------|--------------------------------------------------------------------|
| <b>Title of<br/>Invention</b> | <b>PRODUCING ROUTING MESSAGES FOR VOICE OVER IP COMMUNICATIONS</b> |
|-------------------------------|--------------------------------------------------------------------|

As the below named inventor, I hereby declare that:

This declaration is directed to:  The attached application, or  
 United States application or PCT international application number 13/966,096  
filed on August 13, 2013

The above-identified application was made or authorized to be made by me.


I believe that I am the original inventor or an original joint inventor of a claimed invention in the application.

I hereby acknowledge that any willful false statement made in this declaration is punishable under 18 U.S.C. 1001 by fine or imprisonment of not more than five (5) years, or both.

**WARNING:**

Petitioner/applicant is cautioned to avoid submitting personal information in documents filed in a patent application that may contribute to identity theft. Personal information such as social security numbers, bank account numbers, or credit card numbers (other than a check or credit card authorization form PTO-2038 submitted for payment purposes) is never required by the USPTO to support a petition or an application. If this type of personal information is included in documents submitted to the USPTO, petitioners/applicants should consider redacting such personal information from the documents before submitting them to the USPTO. Petitioner/applicant is advised that the record of a patent application is available to the public after publication of the application (unless a non-publication request in compliance with 37 CFR 1.213(a) is made in the application) or issuance of a patent. Furthermore, the record from an abandoned application may also be available to the public if the application is referenced in a published application or an issued patent (see 37 CFR 1.14). Checks and credit card authorization forms PTO-2038 submitted for payment purposes are not retained in the application file and therefore are not publicly available.

LEGAL NAME OF INVENTOR

Inventor: Clay Perrault Date (Optional): Dec 9/13  
Signature: 

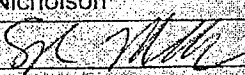
Note: An application data sheet (PTO/SB/14 or equivalent), including naming the entire inventive entity, must accompany this form or must have been previously filed. Use an additional PTO/AIA/01 form for each additional inventor.

This collection of information is required by 35 U.S.C. 115 and 37 CFR 1.63. The information is required to obtain or retain a benefit by the public which is to file (and by the USPTO to process) an application. Confidentiality is governed by 35 U.S.C. 122 and 37 CFR 1.11 and 1.14. This collection is estimated to take 1 minute to complete, including gathering, preparing, and submitting the completed application form to the USPTO. Time will vary depending upon the individual case. Any comments on the amount of time you require to complete this form and/or suggestions for reducing this burden, should be sent to the Chief Information Officer, U.S. Patent and Trademark Office, U.S. Department of Commerce, P.O. Box 1450, Alexandria, VA 22313-1450. DO NOT SEND FEES OR COMPLETED FORMS TO THIS ADDRESS. SEND TO: Commissioner for Patents, P.O. Box 1450, Alexandria, VA 22313-1450.

If you need assistance in completing the form, call 1-800-PTO-9199 and select option 2.

Under the Paperwork Reduction Act of 1995, no persons are required to respond to a collection of information unless it displays a valid OMB control number.

**DECLARATION (37 CFR 1.63) FOR UTILITY OR DESIGN APPLICATION USING AN APPLICATION DATA SHEET (37 CFR 1.76)**

|                                                                                                                                                                                                                                                                                                                                                                                                                                                                                                                                                                                                                                                                                                                                                                                                                                                                                                                                                                                                                                                                                                                                                                                                                                                                                                                                                                                                                                                                                                                                                                                                                                                                                                                                                                                                                                                                                                                                                                                                                                                                                                 |                                                             |
|-------------------------------------------------------------------------------------------------------------------------------------------------------------------------------------------------------------------------------------------------------------------------------------------------------------------------------------------------------------------------------------------------------------------------------------------------------------------------------------------------------------------------------------------------------------------------------------------------------------------------------------------------------------------------------------------------------------------------------------------------------------------------------------------------------------------------------------------------------------------------------------------------------------------------------------------------------------------------------------------------------------------------------------------------------------------------------------------------------------------------------------------------------------------------------------------------------------------------------------------------------------------------------------------------------------------------------------------------------------------------------------------------------------------------------------------------------------------------------------------------------------------------------------------------------------------------------------------------------------------------------------------------------------------------------------------------------------------------------------------------------------------------------------------------------------------------------------------------------------------------------------------------------------------------------------------------------------------------------------------------------------------------------------------------------------------------------------------------|-------------------------------------------------------------|
| Title of<br>Invention                                                                                                                                                                                                                                                                                                                                                                                                                                                                                                                                                                                                                                                                                                                                                                                                                                                                                                                                                                                                                                                                                                                                                                                                                                                                                                                                                                                                                                                                                                                                                                                                                                                                                                                                                                                                                                                                                                                                                                                                                                                                           | PRODUCING ROUTING MESSAGES FOR VOICE OVER IP COMMUNICATIONS |
| <p>As the below named inventor, I hereby declare that:</p> <p>This declaration is directed to: <input type="checkbox"/> The attached application, or<br/> <input checked="" type="checkbox"/> United States application or PCT international application number <u>13/966,096</u><br/> filed on <u>August 13, 2013</u></p> <p>The above-identified application was made or authorized to be made by me.</p> <p>I believe that I am the original inventor or an original joint inventor of a claimed invention in the application.</p> <p>I hereby acknowledge that any willful false statement made in this declaration is punishable under 18 U.S.C. 1001 by fine or imprisonment of not more than five (5) years, or both.</p> <p style="text-align: center;"><b>WARNING:</b></p> <p>Petitioner/applicant is cautioned to avoid submitting personal information in documents filed in a patent application that may contribute to identity theft. Personal information such as social security numbers, bank account numbers, or credit card numbers (other than a check or credit card authorization form PTO-2038 submitted for payment purposes) is never required by the USPTO to support a petition or an application. If this type of personal information is included in documents submitted to the USPTO, petitioners/applicants should consider redacting such personal information from the documents before submitting them to the USPTO. Petitioner/applicant is advised that the record of a patent application is available to the public after publication of the application (unless a non-publication request in compliance with 37 CFR 1.213(a) is made in the application) or issuance of a patent. Furthermore, the record from an abandoned application may also be available to the public if the application is referenced in a published application or an issued patent (see 37 CFR 1.14). Checks and credit card authorization forms PTO-2038 submitted for payment purposes are not retained in the application file and therefore are not publicly available.</p> |                                                             |
| <p>LEGAL NAME OF INVENTOR</p> <p>Inventor: <u>Steve Nicholson</u> Date (Optional) <u>9 Dec 2013</u></p> <p>Signature: </p>                                                                                                                                                                                                                                                                                                                                                                                                                                                                                                                                                                                                                                                                                                                                                                                                                                                                                                                                                                                                                                                                                                                                                                                                                                                                                                                                                                                                                                                                                                                                                                                                                                                                                                                                                                                                                                                                                   |                                                             |
| <p>Note: An application data sheet (PTO/SB/14 or equivalent), including naming the entire inventive entity, must accompany this form or must have been previously filed. Use an additional PTO/AIA/01 form for each additional inventor.</p>                                                                                                                                                                                                                                                                                                                                                                                                                                                                                                                                                                                                                                                                                                                                                                                                                                                                                                                                                                                                                                                                                                                                                                                                                                                                                                                                                                                                                                                                                                                                                                                                                                                                                                                                                                                                                                                    |                                                             |

This collection of information is required by 35 U.S.C. 115 and 37 CFR 1.63. The information is required to obtain or retain a benefit by the public which is to file (and by the USPTO to process) an application. Confidentiality is governed by 35 U.S.C. 122 and 37 CFR 1.11 and 1.14. This collection is estimated to take 1 minute to complete, including gathering, preparing, and submitting the completed application form to the USPTO. Time will vary depending upon the individual case. Any comments on the amount of time you require to complete this form and/or suggestions for reducing this burden, should be sent to the Chief Information Officer, U.S. Patent and Trademark Office, U.S. Department of Commerce, P.O. Box 1450, Alexandria, VA 22313-1450. DO NOT SEND FEES OR COMPLETED FORMS TO THIS ADDRESS. SEND TO: Commissioner for Patents, P.O. Box 1450, Alexandria, VA 22313-1450.

If you need assistance in completing this form, call 1-800-PTO-9199 and select option 2.

Under the Paperwork Reduction Act of 1995, no persons are required to respond to a collection of information unless it displays a valid OMB control number.

**DECLARATION (37 CFR 1.63) FOR UTILITY OR DESIGN APPLICATION USING AN APPLICATION DATA SHEET (37 CFR 1.76)**

|                           |                                                                    |
|---------------------------|--------------------------------------------------------------------|
| <b>Title of Invention</b> | <b>PRODUCING ROUTING MESSAGES FOR VOICE OVER IP COMMUNICATIONS</b> |
|---------------------------|--------------------------------------------------------------------|

As the below named inventor, I hereby declare that:

This declaration is directed to:  The attached application, or  United States application or PCT international application number 13/966,096 filed on August 13, 2013

The above identified application was made or authorized to be made by me.

I believe that I am the original inventor or an original joint inventor of a claimed invention in the application.

I hereby acknowledge that any willful false statement made in this declaration is punishable under 18 U.S.C. 1001 by fine or imprisonment of not more than five (5) years, or both.

**WARNING:**

Petitioner/applicant is cautioned to avoid submitting personal information in documents filed in a patent application that may contribute to identity theft. Personal information such as social security numbers, bank account numbers, or credit card numbers (other than a check or credit card authorization form PTO-2038 submitted for payment purposes) is never required by the USPTO to support a petition or an application. If this type of personal information is included in documents submitted to the USPTO, petitioners/applicants should consider redacting such personal information from the documents before submitting them to the USPTO. Petitioner/applicant is advised that the record of a patent application is available to the public after publication of the application (unless a non-publication request in compliance with 37 CFR 1.213(a) is made in the application) or issuance of a patent. Furthermore, the record from an abandoned application may also be available to the public if the application is referenced in a published application or an issued patent (see 37 CFR 1.14). Checks and credit card authorization forms PTO-2038 submitted for payment purposes are not retained in the application file and therefore are not publicly available.

**LEGAL NAME OF INVENTOR**

Inventor: Rod Thomson Date (Optional): Dec 11, 2013  
Signature: 

Note: An application data sheet (PTO/SB/14 or equivalent), including naming the entire inventive entity, must accompany this form or must have been previously filed. Use an additional PTO/AIA/01 form for each additional inventor.

This collection of information is required by 35 U.S.C. 115 and 37 CFR 1.63. The information is required to obtain or retain a benefit by the public which is to file (and by the USPTO to process) an application. Confidentiality is governed by 35 U.S.C. 122 and 37 CFR 1.11 and 1.14. This collection is estimated to take 1 minute to complete, including gathering, preparing, and submitting the completed application form to the USPTO. Time will vary depending upon the individual case. Any comments on the amount of time you require to complete this form and/or suggestions for reducing this burden, should be sent to the Chief Information Officer, U.S. Patent and Trademark Office, U.S. Department of Commerce, P.O. Box 1450, Alexandria, VA 22313-1450. DO NOT SEND FEES OR COMPLETED FORMS TO THIS ADDRESS. SEND TO: Commissioner for Patents, P.O. Box 1450, Alexandria, VA 22313-1450.  
If you need assistance in completing the form, call 1-800-PTO-9199 and select option 2.

Under the Paperwork Reduction Act of 1995, no persons are required to respond to a collection of information unless it displays a valid OMB control number.

**DECLARATION (37 CFR 1.63) FOR UTILITY OR DESIGN APPLICATION USING AN APPLICATION DATA SHEET (37 CFR 1.76)**

|                           |                                                                    |
|---------------------------|--------------------------------------------------------------------|
| <b>Title of Invention</b> | <b>PRODUCING ROUTING MESSAGES FOR VOICE OVER IP COMMUNICATIONS</b> |
|---------------------------|--------------------------------------------------------------------|

As the below named inventor, I hereby declare that:

This declaration is directed to:  The attached application, or  United States application or PCT international application number 13/966,096 filed on August 13, 2013

The above-identified application was made or authorized to be made by me.

I believe that I am the original inventor or an original joint inventor of a claimed invention in the application.

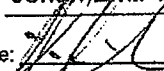
I hereby acknowledge that any willful false statement made in this declaration is punishable under 18 U.S.C. 1001 by fine or imprisonment of not more than five (5) years, or both.

**WARNING:**

Petitioner/applicant is cautioned to avoid submitting personal information in documents filed in a patent application that may contribute to identity theft. Personal information such as social security numbers, bank account numbers, or credit card numbers (other than a check or credit card authorization form PTO-2038 submitted for payment purposes) is never required by the USPTO to support a petition or an application. If this type of personal information is included in documents submitted to the USPTO, petitioners/applicants should consider redacting such personal information from the documents before submitting them to the USPTO. Petitioner/applicant is advised that the record of a patent application is available to the public after publication of the application (unless a non-publication request in compliance with 37 CFR 1.213(a) is made in the application) or issuance of a patent. Furthermore, the record from an abandoned application may also be available to the public if the application is referenced in a published application or an issued patent (see 37 CFR 1.14). Checks and credit card authorization forms PTO-2038 submitted for payment purposes are not retained in the application file and therefore are not publicly available.

**LEGAL NAME OF INVENTOR**

Inventor: Johan Emil Viktor Björsell Date (Optional): 9 Dec 2013

Signature: 

Note: An application data sheet (PTO/SB/14 or equivalent), including naming the entire inventive entity, must accompany this form or must have been previously filed. Use an additional PTO/AIA/01 form for each additional inventor.

This collection of information is required by 35 U.S.C. 115 and 37 CFR 1.63. The information is required to obtain or retain a benefit by the public which is to file (and by the USPTO to process) an application. Confidentiality is governed by 35 U.S.C. 122 and 37 CFR 1.11 and 1.14. This collection is estimated to take 1 minute to complete, including gathering, preparing, and submitting the completed application form to the USPTO. Time will vary depending upon the individual case. Any comments on the amount of time you require to complete this form and/or suggestions for reducing this burden, should be sent to the Chief Information Officer, U.S. Patent and Trademark Office, U.S. Department of Commerce, P.O. Box 1450, Alexandria, VA 22313-1450. DO NOT SEND FEES OR COMPLETED FORMS TO THIS ADDRESS. SEND TO: Commissioner for Patents, P.O. Box 1450, Alexandria, VA 22313-1450.

*If you need assistance in completing the form, call 1-800-PTO-9199 and select option 2.*

Under the Paperwork Reduction Act of 1995, no persons are required to respond to a collection of information unless it displays a valid OMB control number.

**DECLARATION (37 CFR 1.63) FOR UTILITY OR DESIGN APPLICATION USING AN APPLICATION DATA SHEET (37 CFR 1.76)**

Title of Invention: **PRODUCING ROUTING MESSAGES FOR VOICE OVER IP COMMUNICATIONS**

As the below named inventor, I hereby declare that:

This declaration is directed to:  The attached application, or  United States application or PCT international application number 13/966,096 filed on August 13, 2013

The above identified application was made or authorized to be made by me.

I believe that I am the original inventor or an original joint inventor of a claimed invention in the application.

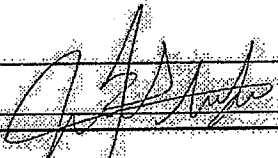
I hereby acknowledge that any willful false statement made in this declaration is punishable under 18 U.S.C. 1001 by fine or imprisonment of not more than five (5) years, or both.

**WARNING:**

Petitioner/applicant is cautioned to avoid submitting personal information in documents filed in a patent application that may contribute to identity theft. Personal information such as social security numbers, bank account numbers, or credit card numbers (other than a check or credit card authorization form PTO-2038 submitted for payment purposes) is never required by the USPTO to support a petition or an application. If this type of personal information is included in documents submitted to the USPTO, petitioners/applicants should consider redacting such personal information from the documents before submitting them to the USPTO. Petitioner/applicant is advised that the record of a patent application is available to the public after publication of the application (unless a non-publication request in compliance with 37 CFR 1.213(a) is made in the application) or issuance of a patent. Furthermore, the record from an abandoned application may also be available to the public if the application is referenced in a published application or an issued patent (see 37 CFR 1.14). Checks and credit card authorization forms PTO-2038 submitted for payment purposes are not retained in the application file and therefore are not publicly available.

**LEGAL NAME OF INVENTOR**

Inventor: Fuad Arafa Date (Optional): Dec. 9, 2013

Signature: 

Note: An application data sheet (PTO/SB/14 or equivalent), including naming the entire inventive entity, must accompany this form or must have been previously filed. Use an additional PTO/AIA/01 form for each additional inventor.

This collection of information is required by 35 U.S.C. 115 and 37 CFR 1.63. The information is required to obtain or retain a benefit by the public which is to file (and by the USPTO to process) an application. Confidentiality is governed by 35 U.S.C. 122 and 37 CFR 1.11 and 1.14. This collection is estimated to take 1 minute to complete, including gathering, preparing, and submitting the completed application form to the USPTO. Time will vary depending upon the individual case. Any comments on the amount of time you require to complete this form and/or suggestions for reducing this burden, should be sent to the Chief Information Officer, U.S. Patent and Trademark Office, U.S. Department of Commerce, P.O. Box 1450, Alexandria, VA 22313-1450. DO NOT SEND FEES OR COMPLETED FORMS TO THIS ADDRESS. SEND TO: Commissioner for Patents, P.O. Box 1450, Alexandria, VA 22313-1450.

If you need assistance in completing the form, call 1-800-PTO-9199 and select option 2.



|                                                          |                      |                     |               |
|----------------------------------------------------------|----------------------|---------------------|---------------|
| <b>INFORMATION DISCLOSURE<br/>STATEMENT BY APPLICANT</b> | Application No.      | 13/966,096          |               |
|                                                          | Filing Date          | August 13, 2013     |               |
|                                                          | First Named Inventor | Perrault, Clay      |               |
|                                                          | Art Unit             | 2472                |               |
| <i>(Multiple sheets used when necessary)</i>             |                      | Examiner            | Kizou, Hassan |
| SHEET 1 OF 1                                             |                      | Attorney Docket No. | SMARB19.001C1 |

| U.S. PATENT DOCUMENTS |          |                                                                                  |                                |                               |                                                                          |
|-----------------------|----------|----------------------------------------------------------------------------------|--------------------------------|-------------------------------|--------------------------------------------------------------------------|
| Examiner Initials     | Cite No. | Document Number<br><i>Number - Kind Code (if known)</i><br>Example: 1,234,567 B1 | Publication Date<br>MM-DD-YYYY | Name of Patentee or Applicant | Pages, Columns, Lines Where Relevant Passages or Relevant Figures Appear |
|                       | 1        | 8,422,507 B2                                                                     | 4/16/2013                      | Björzell et al.               |                                                                          |
|                       | 2        | 8,537,805 B2                                                                     | 9/17/2013                      | Björzell et al.               |                                                                          |
|                       | 3        | 8,542,815 B2                                                                     | 9/24/2013                      | Perreault et al.              |                                                                          |

| FOREIGN PATENT DOCUMENTS |          |                                                                                           |                                |                               |                                                                          |                |
|--------------------------|----------|-------------------------------------------------------------------------------------------|--------------------------------|-------------------------------|--------------------------------------------------------------------------|----------------|
| Examiner Initials        | Cite No. | Foreign Patent Document<br><i>Country Code-Number-Kind Code</i><br>Example: JP 1234567 A1 | Publication Date<br>MM-DD-YYYY | Name of Patentee or Applicant | Pages, Columns, Lines Where Relevant Passages or Relevant Figures Appear | T <sup>1</sup> |
|                          | 4        | WO 2010/012090 A2                                                                         | 2/4/2010                       | Bjorsell et al.               |                                                                          |                |
|                          | 5        | WO 2011/032256 A1                                                                         | 3/24/2011                      | Huttunen, Pentti Kalevi       |                                                                          |                |

| NON PATENT LITERATURE DOCUMENTS |          |                                                                                                                                                                                                                                                                 |                |
|---------------------------------|----------|-----------------------------------------------------------------------------------------------------------------------------------------------------------------------------------------------------------------------------------------------------------------|----------------|
| Examiner Initials               | Cite No. | Include name of the author (in CAPITAL LETTERS), title of the article (when appropriate), title of the item (book, magazine, journal, serial, symposium, catalog, etc.), date, page(s), volume-issue number(s), publisher, city and/or country where published. | T <sup>1</sup> |
|                                 |          |                                                                                                                                                                                                                                                                 |                |

16875512  
121713

|                                                                                                                                                                                                                                                         |                 |
|---------------------------------------------------------------------------------------------------------------------------------------------------------------------------------------------------------------------------------------------------------|-----------------|
| Examiner Signature                                                                                                                                                                                                                                      | Date Considered |
| <p><b>*Examiner:</b> Initial if reference considered, whether or not citation is in conformance with MPEP 609. Draw line through citation if not in conformance and not considered. Include copy of this form with next communication to applicant.</p> |                 |

T<sup>1</sup> - Place a check mark in this area when an English language translation is attached. PENNIONER APPLE INC. EX. 1005-613

(19) World Intellectual Property Organization  
International Bureau



(43) International Publication Date  
4 February 2010 (04.02.2010)

PCT

(10) International Publication Number  
**WO 2010/012090 A2**

- (51) **International Patent Classification:**  
H04W 76/02 (2009.01) H04W 88/16 (2009.01)  
H04W 88/06 (2009.01)
- (21) **International Application Number:**  
PCT/CA2009/001062
- (22) **International Filing Date:**  
28 July 2009 (28.07.2009)
- (25) **Filing Language:** English
- (26) **Publication Language:** English
- (30) **Priority Data:**  
61/129,898 28 July 2008 (28.07.2008) US
- (71) **Applicant (for all designated States except US): DIGI-FONICA (INTERNATIONAL) LIMITED [CA/CA];** Suite #890, 999 West Hastings Street, Vancouver, British Columbia V6C 2W2 (CA).
- (72) **Inventors; and**
- (75) **Inventors/Applicants (for US only): BJORSELL, Johan, Emil, Viktor [SE/CA];** PO Box 29164, RPO South Granville Post, Vancouver, British Columbia V6J 0A6 (CA). **SOBOLYEV, Maksym [UA/CA];** 506-210 Eleventh Street, New Westminster, British Columbia V3M 4C9 (CA). **HUTTUNEN, Pentti, Kalevi [CA/CA];** 76-3180 East 58th Avenue, Vancouver, British Columbia V5S 3S8 (CA).

- (74) **Agent: KNOX, John, W.; SMART & BIGGAR,** 2200-650 West Georgia Street, Vancouver, British Columbia V6B 4N8 (CA).
- (81) **Designated States (unless otherwise indicated, for every kind of national protection available):** AE, AG, AL, AM, AO, AT, AU, AZ, BA, BB, BG, BH, BR, BW, BY, BZ, CA, CH, CL, CN, CO, CR, CU, CZ, DE, DK, DM, DO, DZ, EC, EE, EG, ES, FI, GB, GD, GE, GH, GM, GT, HN, HR, HU, ID, IL, IN, IS, JP, KE, KG, KM, KN, KP, KR, KZ, LA, LC, LK, LR, LS, LT, LU, LY, MA, MD, ME, MG, MK, MN, MW, MX, MY, MZ, NA, NG, NI, NO, NZ, OM, PE, PG, PH, PL, PT, RO, RS, RU, SC, SD, SE, SG, SK, SL, SM, ST, SV, SY, TJ, TM, TN, TR, TT, TZ, UA, UG, US, UZ, VC, VN, ZA, ZM, ZW.
- (84) **Designated States (unless otherwise indicated, for every kind of regional protection available):** ARIPO (BW, GH, GM, KE, LS, MW, MZ, NA, SD, SL, SZ, TZ, UG, ZM, ZW), Eurasian (AM, AZ, BY, KG, KZ, MD, RU, TJ, TM), European (AT, BE, BG, CH, CY, CZ, DE, DK, EE, ES, FI, FR, GB, GR, HR, HU, IE, IS, IT, LT, LU, LV, MC, MK, MT, NL, NO, PL, PT, RO, SE, SI, SK, SM, TR), OAPI (BF, BJ, CF, CG, CI, CM, GA, GN, GQ, GW, ML, MR, NE, SN, TD, TG).

**Declarations under Rule 4.17:**

- as to the identity of the inventor (Rule 4.17(i))
- as to applicant's entitlement to apply for and be granted a patent (Rule 4.17(ii))
- of inventorship (Rule 4.17(iv))

[Continued on next page]

(54) Title: MOBILE GATEWAY

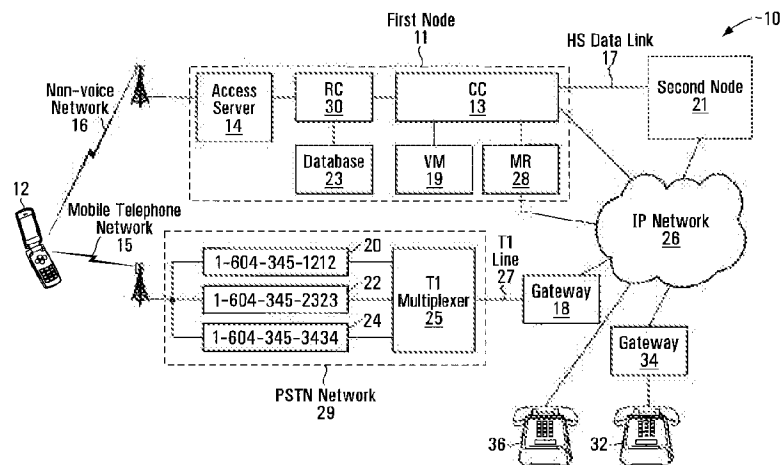


FIG. 1

(57) **Abstract:** A method of initiating a call to a callee using a mobile telephone involves: receiving, from a user of the mobile telephone, a callee identifier associated with the callee; transmitting an access code request message to an access server, said access code request message including said callee identifier; receiving an access code reply message from the access server in response to said access code request message, said access code reply message including an access code different from said callee identifier and associated with said callee identifier; and initiating a call with the mobile telephone using said access code to identify the callee.

WO 2010/012090 A2

**Published:**

- *without international search report and to be republished upon receipt of that report (Rule 48.2(g))*

## MOBILE GATEWAY

### BACKGROUND OF THE INVENTION

#### 1. Field of Invention

5 This invention relates generally to telecommunication, and more particularly to methods, systems, apparatuses, and computer readable media for initiating or enabling a call with a mobile telephone to a callee.

#### 2. Description of Related Art

10 Mobile telephone service providers often charge significant fees for long distance telephone calls, particularly when the mobile telephone is roaming in another mobile telephone service provider's network.

One known technique for avoiding the long distance charges of mobile telephone service providers is to use a "calling card". A "calling card" may permit the user of the mobile telephone to place a call to a local telephone number or to a less-expensive telephone number (such as a toll-free number, for example) instead of placing the call directly to the callee. The user may thus avoid the long distance charges of the mobile telephone service provider, which may be higher than the charges for using the "calling card". However, this technique can be cumbersome and undesirable, because it may require the user of the mobile telephone to follow a number of complicated or cumbersome steps in order to initiate a call to the callee, for example.

#### 25 SUMMARY OF THE INVENTION

In accordance with one aspect of the invention there is provided a method of initiating a call to a callee using a mobile telephone. The method involves receiving, from a user of the mobile telephone, a callee identifier associated with the callee; transmitting an access code request message to an access server, the access code request message including the callee identifier; receiving an access code reply message from the access server in response to the access code request message, the access code reply message including an access code different from the callee identifier and associated

with the callee identifier; and initiating a call with the mobile telephone using the access code to identify the callee.

5 Transmitting may involve transmitting the access code request message to the access server on a non-voice network.

Transmitting may involve transmitting a location identifier of a location associated with the mobile telephone to the access server.

10 Transmitting the location identifier may involve transmitting an IP address of the mobile telephone in a wireless IP network.

15 Transmitting the location identifier may involve transmitting an identifier of a wireless voice signal station in wireless communication with the mobile telephone.

Transmitting the location identifier may involve transmitting a user-configured identifier of a location associated with the mobile telephone.

20 Receiving the access code reply message may involve receiving the access code reply message from the access server on a non-voice network.

25 Receiving the access code reply message may involve receiving, in the access code reply message, an access code temporarily associated with the callee identifier.

30 Receiving the access code reply message may involve receiving, in the access code reply message, a telephone number identifying a channel operably configured to cooperate with an IP network to cause a call involving the mobile telephone and the callee to be routed through the IP network.

Initiating the call may involve engaging a routing controller to route the call on the IP network to the callee.

The method may further involve: receiving from the mobile telephone the access code request message; communicating with a routing controller to obtain from the routing controller the access code wherein the access code  
5 identifies a channel and is useable by the mobile telephone to cause the routing controller to establish a call to the callee using the channel; and transmitting the access code reply message to the mobile telephone.

In accordance with another aspect of the invention, there is provided a mobile  
10 telephone. The mobile telephone includes: provisions for receiving, from a user of the mobile telephone, a callee identifier associated with the callee; transmitting provisions for transmitting an access code request message to an access server, the access code request message including the callee identifier; provisions for receiving an access code reply message from the  
15 access server in response to the access code request message, the access code reply message including an access code different from the callee identifier and associated with the callee identifier; and provisions for initiating a call using the access code to identify the callee.

20 The transmitting provisions may include a non-voice network interface for transmitting the access code request message to the access server on a non-voice network.

The access code request message may further include a location identifier of  
25 a location associated with the mobile telephone.

The location identifier may include an IP address of the mobile telephone in a wireless IP network.

30 The location identifier may include an identifier of a wireless voice signal station in wireless communication with the mobile telephone.

The location identifier may include a user-configured identifier of a location associated with the mobile telephone.

5 The provisions for receiving an access code reply message may include a non-voice network interface for receiving the access code reply message on a non-voice network.

The access code may include a telephone number.

10 The means for initiating may involve a mobile telephone network interface.

In accordance with another aspect of the invention, there is provided a system for initiating a call to a callee. The system includes the mobile telephone, a routing controller, and an access server. The access server includes:  
15 provisions for receiving from the mobile telephone the access code request message; provisions for communicating with the routing controller to obtain from the routing controller the access code wherein the access code identifies a channel and is useable by the mobile telephone to cause the routing controller to establish a call to the callee using the channel; and provisions for  
20 transmitting the access code reply message including the access code to the mobile telephone.

In accordance with another aspect of the invention, there is provided a mobile telephone. The mobile telephone includes a processor circuit, a network  
25 interface in communication with the processor circuit, and a computer readable medium in communication with the processor circuit and encoded with codes for directing the processor circuit to: receive, from a user of the mobile telephone, a callee identifier associated with the callee; cause an access code request message to be transmitted to an access server, the  
30 access code request message including the callee identifier; receive an access code reply message from the access server in response to the access code request message, the access code reply message including an access

code different from the callee identifier and associated with the callee identifier; and initiate a call using the access code to identify the callee.

5 The network interface may include a non-voice network interface, and the codes for directing the processor circuit to cause the access code request message to be transmitted may include codes for directing the processor circuit to cause the access code request message to be transmitted to the access server using the non-voice network interface on a non-voice network.

10 The access code request message may further include a location identifier of a location associated with the mobile telephone.

The location identifier may include an IP address of the mobile telephone in a wireless IP network.

15

The location identifier may include an identifier of a wireless voice signal station in wireless communication with the mobile telephone.

20 The location identifier may include a user-configured identifier of a location associated with the mobile telephone.

25 The network interface may include a non-voice network interface, and the codes for directing the processor circuit to receive an access code reply message may include codes for directing the processor circuit to cause the access code reply message to be received from the access server using the non-voice network interface on a non-voice network.

30 The access code may include a telephone number identifying a channel operably configured to cooperate with an IP network to cause a call involving the mobile telephone and the callee to be routed through the IP network.

The network interface may include a mobile telephone network interface, and the codes for directing the processor circuit to initiate may include codes for



directing the processor circuit to cause a call to be initiated using the mobile telephone network interface on a mobile telephone network.

5 In accordance with another aspect of the invention, there is provided a system for initiating a call to a callee. The system includes: the mobile telephone; a routing controller; and an access server comprising a processor circuit and a computer readable medium in communication with the processor circuit. The computer readable medium is encoded with codes for directing the processor circuit to: receive from the mobile telephone the access code request  
10 message; communicate with the routing controller to obtain from the routing controller the access code wherein the access code identifies a channel and is useable by the mobile telephone to cause the routing controller to establish a call to the callee using the channel; and transmit the access code reply message to the mobile telephone.

15 In accordance with another aspect of the invention, there is provided a computer readable medium encoded with codes for directing a processor circuit to: receive, from a user of a mobile telephone, a callee identifier associated with a callee; transmit an access code request message to an  
20 access server, the access code request message including the callee identifier; receive an access code reply message from the access server in response to the access code request message, the access code reply message including an access code different from the callee identifier and associated with the callee identifier; and initiate a call using the access code  
25 to identify the callee.

In accordance with another aspect of the invention, there is provided a method for enabling a mobile telephone to initiate a call to a callee through a channel. The method involves: receiving from the mobile telephone an  
30 access code request message including a callee identifier associated with the callee; communicating with a routing controller to obtain from the routing controller an access code identifying the channel, the access code being different from the callee identifier and useable by the mobile telephone to

initiate a call to the callee using the channel; and transmitting an access code reply message including the access code to the mobile telephone.

5 Receiving may involve receiving the access code request message on a non-voice network.

The method may further involve causing the routing controller to produce the access code.

10 Producing may involve selecting the access code from a pool of access codes, where each access code in the pool of access codes identifies a respective telephone number.

15 The method may further involve determining a local calling area associated with the mobile telephone.

Determining may involve accessing a dialing profile associated with the caller, the dialing profile including a location field having contents identifying at least a default location of the caller.

20 Determining may involve receiving an IP address of the mobile telephone in a wireless IP network.

25 Determining may involve receiving an identifier of a wireless voice signal station in wireless communication with the mobile telephone.

Determining may involve receiving a user-configured identifier of a location associated with the mobile telephone.

30 Selecting may involve selecting an access code in the local calling area associated with the mobile telephone.

Each access code in the pool of access codes may further identify a respective channel operably configured to cooperate with an IP network to cause a call involving the mobile telephone and the callee to be routed through the IP network.

5

The method may further involve causing the routing controller to establish communication through the IP network in response to a call received on the channel.

10

Producing may further involve storing a caller identifier associated with the mobile telephone in association with the access code.

Causing the routing controller to establish communication may involve causing the routing controller to establish communication only if the caller identifier associated with the access code identifies the mobile telephone.

15

Producing may further involve storing the callee identifier in association with the access code.

20

Producing may further involve searching the pool of access codes for an access code associated with the callee identifier to identify the channel usable by the mobile telephone to initiate a call to the callee.

25

Producing may further involve storing, in association with the access code, a timestamp for use in determining when the usability of the access code to initiate a call to the callee will expire.

30

Causing the routing controller to establish communication may involve causing the routing controller to establish communication only if the usability of the access code to initiate a call to the callee has not expired.

Transmitting may involve transmitting the access code reply message on a non-voice network.

In accordance with another aspect of the invention, there is provided a system for enabling a mobile telephone to initiate a call to a callee through a channel. The system includes: provisions for receiving from the mobile telephone an access code request message including a callee identifier associated with the callee; provisions for communicating with the routing controller to obtain from the routing controller an access code identifying the channel, the access code being different from the callee identifier and useable by the mobile telephone to initiate a call to the callee using the channel; and provisions for transmitting an access code reply message including the access code to the mobile telephone.

The provisions for receiving may include a non-voice network interface for receiving the access code request message on a non-voice network.

The system may further include provisions for producing the access code.

The provisions for producing may include a processor circuit operably configured to select the access code from a pool of access codes, where each access code in the pool of access codes identifies a respective telephone number.

The processor circuit may be operably configured to determine a local calling area associated with the mobile telephone.

The processor circuit may be operably configured to determine a local calling area associated with the mobile telephone using a dialing profile associated with the caller, the dialing profile including a location field having contents identifying at least a default location of the caller.

The processor circuit may be operably configured to determine a local calling area associated with the mobile telephone using an IP address of the mobile telephone in a wireless IP network.

The processor circuit may be operably configured to determine a local calling area associated with the mobile telephone using an identifier of a wireless voice signal station in wireless communication with the mobile telephone.

5

The processor circuit may be operably configured to determine a local calling area associated with the mobile telephone using a user-configured identifier of a location associated with the mobile telephone.

10 The processor circuit may be operably configured to select an access code in the local calling area associated with the mobile telephone.

Each access code in the pool of access codes may further identify a respective channel operably configured to cooperate with an IP network to cause a call involving the mobile telephone and the callee to be routed through the IP network.

15

The processor circuit may be operably configured to establish communication through the IP network in response to a call received on the channel.

20

The processor circuit may be operably configured to store a caller identifier associated with the mobile telephone in association with the access code.

The processor circuit may be operably configured to cause the routing controller to establish communication only if the caller identifier associated with the access code identifies the mobile telephone.

25

The processor circuit may be operably configured to store the callee identifier in association with the access code.

30

The processor circuit may be operably configured to search the pool of access codes for an access code associated with the callee identifier to

identify the channel usable by the mobile telephone to initiate a call to the callee.

5 The processor circuit may be operably configured to store, in association with the access code, a timestamp for use in determining when the usability of the access code to initiate a call to the callee will expire.

10 The processor circuit may operably configured to establish communication only if the usability of the access code to initiate a call to the callee has not expired.

The provisions for transmitting may include a non-voice network interface for transmitting the access code reply message on a non-voice network.

15 In accordance with another aspect of the invention, there is provided a system for enabling a mobile telephone to initiate a call to a callee through a channel. The system includes a processor circuit, a network interface in communication with the processor circuit, and a computer readable medium in communication with the processor circuit and encoded with codes for directing the processor  
20 circuit to: receive from the mobile telephone an access code request message including a callee identifier associated with the callee; communicate with the routing controller to obtain from the routing controller an access code identifying the channel, the access code being different from the callee identifier and useable by the mobile telephone to initiate a call to the callee  
25 using the channel; and cause an access code reply message including the access code to be transmitted to the mobile telephone.

30 The network interface may include a non-voice network interface, and the codes for directing the processor circuit to receive may include codes for directing the processor circuit to cause the access code request message to be received using the non-voice network interface on a non-voice network.

The computer readable medium may be further encoded with codes for directing the processor circuit to cause the access code to be produced.

5 The codes for directing the processor circuit to cause the access code to be produced may cause the access code to be selected from a pool of access codes, where each access code in the pool of access codes identifies a respective telephone number.

10 The computer readable medium may be further encoded with codes for directing the processor circuit to cause to be determined a local calling area associated with the mobile telephone.

15 The codes for directing the processor circuit to cause to be determined may cause a dialing profile associated with the caller to be accessed, the dialing profile including a location field having contents identifying at least a default location of the caller.

20 The codes for directing the processor circuit to cause to be determined may cause to be received an IP address of the mobile telephone in a wireless IP network.

25 The codes for directing the processor circuit to cause to be determined may cause to be received an identifier of a wireless voice signal station in wireless communication with the mobile telephone.

The codes for directing the processor circuit to cause to be determined may cause to be received a user-configured identifier of a location associated with the mobile telephone.

30 The codes for directing the processor circuit to cause the access code to be produced may further cause to be selected an access code in the local calling area associated with the mobile telephone.

Each access code in the pool of access codes may further identify a respective channel operably configured to cooperate with an IP network to cause a call involving the mobile telephone and the callee to be routed through the IP network.

5

The computer readable medium may be further encoded with codes for directing the processor circuit to cause communication through the IP network to be established in response to a call received on the channel.

10

The codes for directing the processor circuit to cause the access code to be produced may cause a caller identifier associated with the mobile telephone to be stored in association with the access code.

15

The codes for directing the processor circuit to cause communication to be established may cause communication to be established only if the caller identifier associated with the access code identifies the mobile telephone.

20

The codes for directing the processor circuit to cause the access code to be produced may cause the callee identifier to be stored in association with the access code.

25

The codes for directing the processor circuit to cause the access code to be produced may cause the pool of access codes to be searched for an access code associated with the callee identifier to identify the channel usable by the mobile telephone to initiate a call to the callee.

30

The codes for directing the processor circuit to cause the access code to be produced may cause a timestamp for use in determining when the usability of the access code to initiate a call to the callee will expire, to be stored in association with the access code.



The codes for directing the processor circuit to cause communication to be established may cause communication to be established only if the usability of the access code to initiate a call to the callee has not expired.

5 The network interface may include a non-voice network interface, and the codes for directing the processor circuit to transmit include codes for directing the processor circuit to cause the access code reply message to be transmitted using the non-voice network interface on a non-voice network.

10 In accordance with another aspect of the invention, there is provided a computer readable medium encoded with codes for directing a processor circuit to: receive from the mobile telephone an access code request message including a callee identifier associated with the callee; communicate with the routing controller to obtain from the routing controller an access code  
15 identifying the channel, the access code being different from the callee identifier and useable by the mobile telephone to initiate a call to the callee using the channel; and cause an access code reply message including the access code to be transmitted to the mobile telephone.

20 Other aspects and features of the present invention will become apparent to those ordinarily skilled in the art upon review of the following description of specific embodiments of the invention in conjunction with the accompanying figures.

## 25 **BRIEF DESCRIPTION OF THE DRAWINGS**

In drawings which illustrate embodiments of the invention,

Figure 1 is a block diagram of a system for enabling a mobile telephone to initiate a call through a channel to a callee in accordance with a first embodiment in the invention;

30 Figure 2 is a block diagram of mobile telephone shown in Figure 1;

Figure 3 is a flow chart of a process executed by the mobile telephone shown in Figure 1;

- Figure 4 is a schematic representation of an access code request message transmitted between the mobile telephone and an access server shown in Figure 1;
- 5 Figure 5 is a schematic representation of an access code reply message transmitted between the mobile telephone and the access server shown in Figure 1;
- Figure 6 is a block diagram of the access server shown in Figure 1;
- Figure 7 is a flow chart of a process executed by the access server shown in Figure 1;
- 10 Figure 8 is a block diagram of a routing controller shown in Figure 1;
- Figure 9 is a tabular representation of a dialing profile stored in a database accessible by the routing controller illustrated in Figure 1;
- Figure 10 is a tabular representation of an access code association table stored in memory accessible by the routing controller shown in Figure 1;
- 15 Figure 11 is a schematic representation of a DID bank table record stored in a database shown in Figure 1;
- Figure 12 is a flow chart of a process executed by the routing controller illustrated in Figure 1;
- 20 Figure 13 is a block diagram of a gateway shown in Figure 1;
- Figure 14 is a tabular representation of an SIP invite message transmitted between the gateway and a call controller illustrated in Figure 1;
- Figure 15 is a block diagram of the call controller illustrated in Figure 1;
- 25 Figure 16 is a flow chart of a process executed by the call controller illustrated in Figure 1;
- Figure 17 is a tabular representation of an RC request message transmitted between the call controller and the routing controller illustrated in Figure 1;
- 30 Figures 18A–18C are a flow chart of a process executed by the routing controller illustrated in Figure 1; and
- Figure 19 is a tabular representation of a gateway node association table stored in the database illustrated in Figure 1.

**DETAILED DESCRIPTION**

Referring to Figure 1, a system for enabling a mobile telephone to initiate a call to a callee is shown generally at **10**. The system **10** includes a first node **11**, a second node **21**, and a mobile telephone **12**.

The first and second nodes **11** and **21** in the illustrated embodiment may support "voice-over-IP" (VoIP) calls between telephones and/or videophones using the internet protocol (IP), as described in PCT Publication No. WO **2008/052340**, which is hereby incorporated by reference in its entirety herein. In the embodiment shown, the first node **11** is located in a geographical area, such as Vancouver, British Columbia, Canada, for example, and the second node **21** is located in London, England, for example. Different nodes may be located in different geographical regions throughout the world to provide telephone/videophone service to subscribers in respective regions. These nodes may be in communication with each other by high speed/high data throughput links including optical fiber, satellite, and/or cable links illustrated generally at **17**, forming a backbone to the system. These nodes may alternatively, or in addition, be in communication with each other through conventional internet services.

In the embodiment shown, the first node **11** provides telephone/videophone service to western Canadian customers from Vancouver Island to Ontario. Another node (not shown) may be located in Eastern Canada to provide services to subscribers in that area, for example.

Other nodes of the type shown may also be employed within the geographical area serviced by a node to provide for call load sharing, for example, within a region of the geographical area serviced by the node. However, in general, all nodes may be similar and have the properties described in connection with the first node **11**.

In this embodiment, the first node **11** includes a call controller (CC) **13**, an access server **14**, a routing controller (RC) **30**, a database **23**, a voicemail server **19**, and a media relay **28**. Each of these may be implemented as separate modules on a common computer system or by separate computers, for example. The voicemail server **19** need not be included in the node and can be provided by a third party service provider. Although the access server **14** is illustrated as being part of the first node **11**, access servers in alternative embodiments may be separate from the node and may be in communication with one or more nodes, for example.

The mobile telephone **12** is configured to place calls over a mobile telephone network, illustrated generally at **15**, in a manner well-known in the art. Furthermore, the mobile telephone **12** and the access server **14** are configured to communicate with each other, preferably on a non-voice network illustrated generally at **16**, such as a "WiFi" wireless IP network or a General Packet Radio Service (GPRS) network, for example. However, in alternative embodiments, the mobile telephone **12** and the access server **14** may communicate with each other over other networks, such as a mobile telephone network using Short Message Service (SMS) messages, for example.

The system **10** further includes a gateway **18** in communication with at least one, and preferably a plurality of, channels, which are illustrated schematically at **20**, **22**, and **24**, to which the mobile telephone **12** may initiate a call over the mobile telephone network **15**. The channels **20**, **22**, and **24** maybe telephone lines in a Public Switched Telephone Network (PSTN) **29**. The channels **20**, **22**, and **24** maybe associated with PSTN telephone numbers in a local calling area associated with the mobile telephone **12**, and thus these channels preferably depend on a geographical location of the mobile telephone. The expression "local calling area" herein refers generally to a set of telephone numbers, typically defined by a geographical region, to which telephone calls may be placed by callers within the local calling area at either no additional charge or at a lower additional charge than would be required for calls to

5 numbers that are outside of the local calling area. However, it will be appreciated that in other embodiments, the gateway **18** may be in communication with any number of channels, which need not be PSTN telephone lines. Also, in the illustrated embodiment, the channels **20**, **22**, and **24** are associated with telephone numbers for Vancouver, British Columbia, Canada and the surrounding area, although it will be appreciated that these channels may include PSTN telephone lines associated with other areas, for example, which may not necessarily be in a local calling area associated with the mobile telephone **12**.

10

In the illustrated embodiment, each of the channels **20**, **22**, and **24** is configured by a PSTN service provider (which, in Canada, may be Bell Canada or Telus, for example) to direct calls that are received on the channels to the gateway **18**. In the illustrated embodiment, the PSTN service provider has configured the channels **20**, **22**, and **24** to communicate with a T1 multiplexer **25**, which multiplexes the channels **20**, **22**, and **24** in a manner known in the art onto one or more T1 lines **27** that are in communication with the gateway **18**. The gateway **18** is in communication with an IP network shown generally at **26**. The channels **20**, **22**, and **24** are thus configured to cooperate with the IP network **26** (via the gateway **18** in the illustrated embodiment) to cause a call involving the mobile telephone **12** and the callee to be routed through the IP network in response to a call received at one of the channels.

15

20

25

Also, in the illustrated embodiment, the access server **14** is in communication with the routing controller **30** of the first node **11**, and the routing controller **30** is configurable to associate a callee identifier with one of the channels **20**, **22**, and **24**, as described below. A callee identifier associated with one of the channels **20**, **22**, and **24** may be a telephone number of a PSTN telephone **32** that is in communication with the IP network **26** through a gateway **34**, or it may be a telephone number of a VoIP telephone **36** that is directly in communication with the IP network **26**, for example. Other routing controllers **30** of other nodes, such as the second node **21**, for example, may also

30

associate callee identifiers with other channels that are in communication with other gateways (not shown).

#### Mobile Telephone

5 Referring to Figure 2, in this embodiment, the mobile telephone (12) includes a processor circuit shown generally at 50. The processor circuit 50 includes a microprocessor 52, a program memory 54, an input/output (I/O) port 56, parameter memory 58, and temporary memory 60. The program memory 54, I/O port 56, parameter memory 58, and temporary memory 60 are all in  
10 communication with the microprocessor 52. The processor circuit 50 may alternatively include a plurality of processors, a plurality of program memories, a plurality of temporary memories, and/or a plurality of I/O ports, or these components may alternatively be combined into a single device. However, for simplicity, the components of the processor circuit 50 are illustrated as shown  
15 in the example of Figure 2.

In the illustrated embodiment, the I/O port 56 includes a dialing input 62 for receiving a callee identifier from a key pad, for example, or from a voice recognition unit, or from pre-stored callee identifiers stored in the parameter  
20 memory 58, for example. For illustration purposes only, a myriad of possible dialing functions for providing a callee identifier are represented by the block entitled dialing function 64. A callee identifier may be a telephone number of a callee, for example.

25 The I/O port 56 also includes a handset interface 66 for receiving and producing signals to and from a handset 68 that may be placed close to the user's ear and mouth, for producing and receiving audible signals for and from the user. It will be appreciated that alternatively, the handset 68 may include a camera and video screen, for example, and that video or other types of  
30 signals may be transmitted additionally or alternatively to audible signals.

The I/O port 56 also includes a non-voice network interface 70 for transmitting information to, and receiving information from, the non-voice network 16

illustrated in Figure 1, for example, and preferably interfaces with a high-speed internet connection.

5 The I/O port 56 in the illustrated embodiment further includes a mobile telephone network interface 72 for transmitting signals to and receiving signals from a mobile telephone service provider over a network such as a Global System for Mobile communications (GSM) or a Code Division Multiple Access (CDMA) network, such as the mobile telephone network 15 illustrated in Figure 1, for example. Again, for simplicity, a mobile telephone network  
10 interface is illustrated, although it will be appreciated that video signals or other signals may be handled similarly when the mobile telephone (12) is facilitating communication of one or more of these types of signals. It will also be appreciated that alternatively, the non-voice network interface 70 and mobile telephone network interface 72 need not be distinct, but may be a  
15 single interface for communication over a single network, for example, or may be configured to communicate over a plurality of different networks, for example.

In the illustrated embodiment, the parameter memory 58 includes a username  
20 field 74 and a password field 76, although it will be appreciated that the username and password may not be necessary, or may be input by the user as required, for example. The parameter memory 58 in the illustrated embodiment also includes a caller identifier field 78 for storing a caller identifier, which may be a telephone number associated with the mobile  
25 telephone (12) for identifying a "channel" such as a telephone line assigned to the mobile telephone that may be used to call back to the mobile telephone, for example. Generally, the contents of the username field 74, the password field 76, and the caller identifier field 78 are set once when the user first subscribes to the system.

30

The usernames referred to herein, such as the username in the username field 74, preferably include a twelve digit number such as 2001 1050 8667, for example, wherein the left-most digit is a continent code (such as "2" to

indicate North America, for example), followed by a three-digit country code (such as "001" to indicate Canada and the United States, for example), a four-digit dealer code (such as "1050", for example), and a unique four-digit number code (such as "8667", for example), as discussed more generally in  
5 PCT Publication No. **2008/052340**. Therefore, a prefix of a username referred to herein preferably indicates a geographical region associated with the user, or with the access code, and more preferably indicates a node associated with the user or access code.

10 The program memory **54** stores blocks of codes for directing the microprocessor **52** to carry out the functions of the mobile telephone (**12**), which are illustrated by example below.

Referring to Figures **2** and **3**, a flow chart representing functions performed by  
15 blocks of code that direct the microprocessor **52** to initiate a call with the mobile telephone **12** to a callee is shown generally at **100**. The blocks shown in Figure **3** generally represent codes that may be stored in the program memory **54** for example, for directing the microprocessor **52** to perform various functions relating to initiating a call with the mobile telephone (**12**) to a  
20 callee. The actual code to implement each block may be written in any suitable programming language, such as Java, C, and/or C++, for example.

The process **100** begins at **102**, in response to an interrupt produced at or for  
25 the microprocessor **52** by the dialing function **64**. Upon initiation of the process **100**, block **104** directs the microprocessor **52** to obtain a callee identifier from the dialing function **64** at the dialing input **62** of the I/O port **56** in the illustrated embodiment. The callee identifier is associated with a desired callee, and may be a telephone number of the callee, for example. The microprocessor **52** thus receives, from a user of the mobile telephone (**12**), a  
30 callee identifier associated with a callee.

Block **106** directs the microprocessor **52** to transmit, using the non-voice network interface **70** in the illustrated embodiment, an access code request



message, the access code request message including the callee identifier obtained at block **104**, to the access server **14** (illustrated in Figure **1**). In general, preferably block **106** directs the microprocessor **52** to cause an access code request message to be transmitted to the access server **14** over a non-voice network, such as an internet, using WiFi or GPRS technology for example. However, it will be appreciated that block **106** may direct the microprocessor **52** to transmit an access code request message to the access server **14** using any suitable technique, which may alternatively include a voice network, for example.

Referring to Figure **4**, an exemplary access code request message is shown generally at **110**. The access code request message **110** includes a username field **112**, a password field **114**, a callee identifier field **116**, and a caller identifier field **118**. In the illustrated embodiment, values for the username, password, and caller identifier fields **112**, **114**, and **118** are retrieved from the username, password, and caller identifier fields **74**, **76**, and **78** respectively in the parameter memory **58** of the processor circuit **50** (illustrated in Figure **2**), and a value for the callee identifier field **116** is obtained from the dialing function **64** in block **104**, and may be stored in the temporary memory (**60**), for example. It will be appreciated that the username field **112**, password field **114**, and caller identifier field **118** are not essential, although these fields are preferable in order to identify the user of the mobile telephone for billing purposes, for example.

Referring to Figures **1** and **4**, it will be appreciated that in order to minimize charges from the mobile telephone service provider of the mobile telephone **12**, the channels **20**, **22**, **24** will preferably be local or relatively inexpensive telephone lines associated with a geographical location, more particularly a pre-defined local calling area, associated with the mobile telephone **12**. Therefore, the exemplary access code request message **110** further includes a location identifier field **119**. The location identifier stored in the location identifier field **119** preferably identifies a location of the mobile telephone **12**

for use in determining a local calling area associated with the mobile telephone **12**.

5 For example, the location identifier in the location identifier field **119** may include an IP address of the mobile telephone **12** in a wireless IP network, such as the non-voice network **16** to which the non-voice network interface **70** shown in Figure **2** is connected, because this IP address may be an indicator of a geographical location of the mobile telephone **12**. The location identifier may also or alternatively include an identifier of a wireless voice signal station  
10 in wireless communication with the mobile telephone. In the illustrated embodiment, the wireless voice signal station is part of the mobile telephone network **15** that is in communication with the mobile telephone **12** through the mobile telephone network interface **72** illustrated in Figure **2**. In still other embodiments, the location identifier may include a user-configured identifier of  
15 a geographical location or local calling area where the mobile telephone **12** is or may be situated. The location identifier may thus be pre-determined and stored in the parameter memory **58** shown in Figure **2** or may be acquired from non-voice network or wireless voice signal station or from user input, for example. Therefore, in summary, the location identifier in the location  
20 identifier field **119** may include one or more of an IP address of the mobile telephone **12** in a wireless IP network, an identifier of a wireless voice signal station in wireless communication with the mobile telephone, and a user-configured identifier.

25 As described below, the location identifier in the location identifier field **119** may be used to determine a local calling area associated with the mobile telephone **12**, within which local calling area channels (illustrated as **20**, **22**, and **24** in Figure **1**) are available to the mobile telephone **12** for the lowest cost to the user. However, it will be appreciated that the location identifier may  
30 only approximately identify a local calling area, and may not necessarily identify the lowest cost channel (illustrated as **20**, **22**, and **24** in Figure **1**) for the mobile telephone **12**. It will also be appreciated that in other embodiments, the location identifier field **119** may be omitted.

Referring back to Figure 3, the process 100 continues at block 130, which directs the microprocessor (52) to receive an access code reply message from the access server (14) in response to the access code request message that was transmitted at block 106.

Referring to Figure 5, an exemplary access code reply message is shown generally at 140. The access code reply message 140 includes an access code field 142 and a timeout field 144. In the illustrated embodiment, the access code field 142 stores an access code which is a telephone number associated with a telephone line associated with one of the channels 20, 22, or 24 in Figure 1. It will be appreciated that the access code is different from the callee identifier in the callee identifier field 116 shown in Figure 4, in that the access code identifies a channel, other than that provided by the callee identifier provided by the dialing function 64 in Figure 2, that the mobile telephone (12) can use to initiate a call to the callee. It will be appreciated that use of the access code facilitates avoidance of long distance or roaming charges that a mobile telephone service provider would charge for a call placed directly using the callee identifier using conventional calling processes, for example.

Still referring to Figure 5, the timeout field 144 in the illustrated embodiment stores a value that indicates a period of time, for example a number of minutes, during which the access code in the access code field 142 is associated with the callee identifier in the callee identifier field 116 of the exemplary access code request message 110 illustrated in Figure 4, such that the access code is only temporarily associated with the callee identifier. In one embodiment, the value stored in the timeout field 144 indicates 10 minutes, for example. It will be appreciated that in other embodiments, the timeout field 144 may not be necessary, but preferably it is included.

In the illustrated embodiment, the program codes in block 130 direct the microprocessor 52 to receive the access code reply message over a non-

voice network, such as a WiFi or GPRS network (illustrated at **16** in Figure **1**) via the non-voice network interface **70** shown in Figure **2**. However, it will be appreciated that the access code reply message may be received on any suitable network, even a voice network, for example.

5

Referring back to Figures **2** and **3**, block **149** directs the microprocessor **52** to initiate a call with the mobile telephone (**12**) on the mobile telephone network **15** (illustrated in Figure **1**) using the access code received in the access code field **142** of the access code reply message **140** (shown in Figure **5**) to identify the callee. In the illustrated embodiment, the codes in block **149** direct the microprocessor **52** to initiate a call to the channel (**20**, **22**, or **24**) identified by the access code, using the mobile telephone network interface **72** of the I/O port **56** of the mobile telephone (**12**), to engage the mobile telephone network (**15**).

15

Referring to Figure **1**, in the embodiment shown, the access code in the access code field (**142**) is a telephone number identifying a channel **20**, **22**, or **24** that is in communication with the gateway **18** to the IP network **26**. Through the gateway **18**, the channel **20**, **22**, or **24** is thus operably configured to cooperate with the IP network **26** to cause a call from the mobile telephone **12** to the callee to be routed through the IP network. Routing the call through the IP network may involve engaging the routing controller **30** to route the call on the IP network **26** to the callee, as described below. However, it will be appreciated that in other embodiments, the access code need not be a telephone number, but may be any code identifying a channel through which the mobile telephone **12** can initiate a call. Alternatively, if the mobile telephone is capable of voice over IP communications, the access code may be used to identify an IP address in the IP network to which the call is routed. In this embodiment, the IP address may act as the access code.

30 The process **100** shown in Figure **3** is then ended.

25

Access Server

Referring to Figure 6, the access server (14) includes a processor circuit shown generally at 150. The processor circuit 150 includes a microprocessor 152, program memory 154, an I/O port 156, parameter memory 158, and temporary memory 160. The program memory 154, I/O port 156, parameter memory 158, and temporary memory 160 are all in communication with the microprocessor 152. The processor circuit 150 may alternatively include a plurality of microprocessors or I/O ports, for example, and the components of the illustrated processor circuit 150 may also alternatively be combined into a single device.

The program memory 154 stores blocks of codes for directing the microprocessor 152 to carry out the functions of the access server 14. The I/O port 156 includes a non-voice network interface 162 for communicating with the non-voice network 16 illustrated in Figure 1. The I/O port 156 also includes a routing controller interface 164 for interfacing with the routing controller 30 illustrated in Figure 1.

Referring to Figures 6 and 7, a flow chart of blocks of code for directing the microprocessor 152 of the access server (14) to provide an access code to the mobile telephone (12) is shown generally at 190. The blocks 190 in Figure 7 generally represent codes that may be stored in the program memory 154 for directing the microprocessor 152 to perform various functions to provide the access to the mobile telephone (12) to enable the mobile telephone to place a call through a channel (20, 22, or 24).

The process 190 begins at 192, in response to an interrupt created by or for the microprocessor 152 when it receives an access code request message 110 (as illustrated in Figure 4) from the mobile telephone (12). In the illustrated embodiment, the access code request message (110) is received via the non-voice network interface 162 through a non-voice network (16) such as a WiFi or GPRS network, for example. However, it will be appreciated that other embodiments may use different techniques for receiving the access code request message (110) from the mobile telephone (12).

The process **190** continues at block **196**, which directs the microprocessor **152** to communicate with the routing controller **30** to obtain from the routing controller an access code identifying a channel (illustrated as **20**, **22**, or **24** in Figure **1**) in communication with the gateway (**18**), wherein the access code is different from the callee identifier in the callee identifier field **116** (shown in Figure **4**) and is usable by the mobile telephone (**12**) to initiate a call to the callee using the channel, as further described below. Therefore, block **196** preferably causes an access code to be produced by retransmitting the access code request message **110** illustrated in Figure **4** that was received at **192** from the mobile telephone (**12**), to the routing controller **30** through the routing controller interface **164** of the I/O port **156**.

The process **190** continues at block **198**, which directs the microprocessor **152** to transmit an access code reply message (**140**), including the access code obtained by block **196**, to the mobile telephone (**12**). An exemplary access code reply message is shown in Figure **5**. In the illustrated embodiment, an access code reply message (**140**) is produced by the routing controller **30** in a manner described below in response to the access code request message (**110**) that was transmitted to the routing controller at block **196**, and the access code reply message (**140**) is received from the routing controller through the routing controller interface **164** of the I/O port **156**. Block **198** then causes the access code reply message that was received from the routing controller to be retransmitted to the mobile telephone (**12**). In the illustrated embodiment, the codes in block **198** direct the microprocessor **152** to transmit the access code reply message (**140**) using the non-voice network interface **162** to the non-voice network **16**, which may be a WiFi or GPRS network, for example. However, it will be appreciated that other embodiments may employ other types of networks for communicating the access code reply message (**140**) to the mobile telephone (**12**). The process **190** is then ended.

In summary, referring to Figure **1**, the access server **14** generally acts as an interface to the routing controller **30** for relaying access code request

messages and access code reply messages between the mobile telephone  
12 and the routing controller. Therefore, it will be appreciated that in  
alternative embodiments, the access server 14 and the routing controller 30  
need not be separate, but may, for example, be combined in a single  
5 component.

#### Routing Controller (RC)

Referring to Figure 1, generally, the routing controller 30 executes a process  
to facilitate communication between callers and callees. The function of a  
10 routing controller generally in a VoIP system is described in PCT Publication  
No. WO 2008/052340.

Referring to Figure 8, the routing controller (30) includes a processor circuit  
shown generally at 230. The processor circuit 230 includes a microprocessor  
15 (or more generally a processor) 232, program memory 234, an I/O port 236,  
table memory 238, temporary memory 240, and a clock 244. The program  
memory 234, I/O port 236, table memory 238, temporary memory 240, and  
clock 244 are all in communication with the processor 232. The processor  
circuit 230 may include a plurality of microprocessors, for example, and the  
20 aforementioned components of the processor circuit 230 may be combined,  
for example. The program memory 234 includes blocks of code for directing  
the processor 232 to carry out the functions of the routing controller (30), and  
the I/O port 236 includes an access server interface 242 for communicating  
with the access server 14.

25 In the illustrated embodiment as described above, the access server (14)  
transmits (at block 196 illustrated in Figure 7) an access code request  
message (110) to the routing controller (30) in order to obtain from the routing  
controller (30) an access code. When an access code request message (110)  
30 is received at the access server interface 242, the processor 232 preferably  
stores certain values from the access code request message in stores in the  
temporary memory 240 for ease of retrieval. In particular, the temporary  
memory 240 includes a callee identifier store 246 for storing the callee

identifier from the callee identifier field **116** in the access code request message **110** illustrated in Figure 4, a caller identifier store **248** for storing the caller identifier that was stored in the caller identifier field **118** of the access code request message **110** illustrated in Figure 4, a caller username store **249**  
5 for storing the caller username that was stored in the caller username field **112** of the access code request message **110** illustrated in Figure 4, and an access code store **250** for storing an access code that is selected when the routing controller (**30**) receives an access code request message (**110**). The temporary memory **240** also includes a local calling area identifier store **245**  
10 for storing an identifier of a local calling area associated with the mobile telephone (**12**). The clock **244** generally maintains and stores a representation of a current date and time.

The I/O port **236** further includes a database request port **256** through which a  
15 request to the database (**23** in Figure 1) can be made, and also includes a database response port **258** for receiving a reply from the database (**23**). The I/O port **236** further includes a routing controller (RC) request message input **260** for receiving an RC request message (illustrated in Figure 17) from the call controller (**13** in Figure 1) and includes a routing message output **262** for  
20 sending a routing message back to the call controller **13**. The I/O port **236** thus acts to receive a caller identifier and a callee identifier contained in an RC request message from the call controller, the RC request message being received in response to initiation of a call by a subscriber of the system, as described below.

25 The program memory **234** includes blocks of codes for directing the processor **232** to carry out various functions of the routing controller (**30**). One of these blocks includes an RC request message handler **380** which directs the routing controller (**30**) to produce a routing message in response to a received RC request message, an example of which is illustrated in Figure 17. The RC request message handler process is shown in greater detail at **380** in Figures **18A** through **18C**. Another of these blocks in the program memory **234**  
30 includes an access code generator, which is described at **270** in Figure 12,



and which directs the routing controller (30) to produce an access code as directed by the program codes in block 196 shown in Figure 7. Yet another of these blocks in the program memory 234 includes a local calling area identifier generator, which directs the routing controller (30) to produce a local calling area identifier using the location identifier from the location identifier field 119 of the access code request message 110 illustrated in Figure 4.

#### 10 Local Calling Area Identifier Generator

Referring to Figure 1, it will be appreciated that preferably, a call made by the mobile telephone 12 using the access code obtained from the access server 14 will be a local call for the mobile telephone 12, based on a geographical location of the mobile telephone. Therefore, blocks in the program memory 15 234 include a local calling area identifier generator, which directs the routing controller 30 to produce a local calling area identifier.

For example, the local calling area identifier generator may direct the microprocessor 152 to access a dialing profile associated with the caller. The dialing profile may be identified using the username in the username field 112 20 in the access code request message 110 illustrated in Figure 4, and to store in the local calling area identifier field 245 a default location of the caller retrieved from the dialing profile associated with the caller.

25 Referring to Figure 9, an exemplary dialing profile is illustrated generally at 200 and includes a username field 202, a domain field 204, and calling attributes comprising a national dialing digits (NDD) field 206, an international dialing digits (IDD) field 208, a country code field 210, a local area codes field 212, a caller minimum local number length field 214, a caller maximum local number length field 216, a reseller field 218, a maximum number of concurrent calls field 220, a current number of concurrent calls field 222, and a default local calling area identifier field 224. Therefore, in some 30 embodiments, the local calling area identifier generator directs the

microprocessor **152** to determine a local calling area associated with the mobile telephone (**12**) by retrieving the default local calling area identifier from the default local calling area identifier field **224** of the dialing profile **200**.

5 Effectively, the dialing profile **200** is a record identifying calling attributes of the caller identified by the username in the username field **202**. More generally, dialing profiles **200** represent calling attributes of respective users, and are discussed in more detail in PCT publication No. WO **2008/052340**. As described in PCT publication No. WO **2008/052340**, a dialing profile of the  
10 type shown in Figure **9**, and also other records such as direct-in-dial (DID) records, call blocking records, call forwarding records, and voicemail records, may be created whenever a user registers with the system or agrees to become a subscriber to the system.

15 Alternatively, the local calling area identifier generator may generate a local calling area identifier to be stored in the local calling area identifier store **245** using the location identifier from the location identifier field **119** of the access code request message **110** illustrated in Figure **4**. As described above, the location identifier field (**119**) may store one or more of an IP address of the  
20 mobile telephone (**12**) in a wireless IP network, an identifier of a wireless voice signal station in wireless communication with the mobile telephone, and a user-configured identifier. One or more of these values may be used to identify a local calling area that is or is likely to be associated with the mobile telephone (**12**) in order to generate a local calling area identifier to be stored  
25 in the local calling area identifier store **245**.

For example, it has been found that services available from web sites such as <http://www.ip2location.com/> and [http://www.serviceobjects.com/products/dots\\_ipgeo.asp](http://www.serviceobjects.com/products/dots_ipgeo.asp), for example, can produce a name of a location, and also  
30 latitude and longitude values, associated with an IP address. Using this information derived from an IP address, or other information from the location identifier field (**119**), a local calling area may be identified by hierarchical jurisdictional designations (such as country, province, and city in Canada or

country, state, and city in the United States) and encoded as codes identifying the local calling area. These codes may then be stored in the local calling area identifier store **245**.

5        Access Code Association Table

In the illustrated embodiment, the table memory **238** (shown in Figure **8**) includes an access code association table **170**, an example of which is illustrated in Figure **10**, for associating access codes with callee identifiers, caller identifiers, caller usernames, timeouts, and timestamps. Although the routing controller (**30**) is illustrated in this embodiment as a separate component from the access server (**14**), it will be appreciated that in other embodiments, the routing controller (**30**) may be part of or integrated with the access server (**14**), and in these other embodiments, the access code association table **170** may be part of or integrated with the access server.

15        Referring to Figures **1** and **10**, the access code association table **170** generally includes a plurality of records, each having an access code field **173** storing an access code. The access codes in the access code association table **170** may thus form a pool of access codes, where each access code may identify a respective telephone number. In the illustrated embodiment, the access codes in the access code fields **173** of records of the access code association table **170** identify respective channels (illustrated by example only as **20**, **22**, and **24**) that are operably configured to cooperate with the IP network **26** via the gateway **18** to cause a call involving the mobile telephone **12** to be routed through the IP network.

20        Referring to Figure **10**, the exemplary access code association table **170** includes records **172**, **174**, **176**, **178**, and **180**, each having respective fields for storing a local calling area identifier **171**, an access code **173**, a channel identifier **175**, a callee identifier **177**, a caller identifier **179**, a caller username **183**, a timeout **181**, and a timestamp **182**. Generally, a record in the access code association table **170** will be created for each access code that identifies a channel (such as the channels **20**, **22**, and **24** illustrated in Figure **1**) that is

configured or configurable to establish communication through a gateway (such as the gateway **18** illustrated in Figure **1**) to an IP network (**26** in Figure **1**) in response to a call received at the channel. When a record is created in respect of a channel, the local calling area identifier field **171** is preferably  
5 initialized with an identifier of a local calling area associated with the channel, the access code field **173** is preferably initialized with an access code associated with the channel, and the channel identifier field **175** is preferably initialized with an identifier of the channel. The remaining fields (for storing a callee identifier **177**, a caller identifier **179**, a caller username **183**, a timeout  
10 **181**, and a timestamp **182**) are preferably initialized with default "null" values when a record is created. The fields for storing a local calling area identifier **171**, an access code **173**, a channel identifier **175** preferably remain generally constant during ordinary operation of the access code association table **170**, although the values stored in the fields for storing a callee identifier **177**, a  
15 caller identifier **179**, a caller username **183**, a timeout **181**, and a timestamp **182** may vary as described below. It will be appreciated that in some embodiments, one or more of the fields for storing a local calling area identifier **171**, a channel identifier **175**, a caller identifier **179**, a caller username **183**, a timeout **181**, and a timestamp **182** may not be required and  
20 be omitted.

As noted above, the local calling area identifier field **171** is preferably initialized with an identifier of a local calling area associated with the channel. The local calling area identifier field **171** preferably stores codes that are  
25 encoded in the same manner as the codes in the local calling area identifier store **245**, as described above, so that an access code in the local calling area identified by the codes in the local calling area identifier store **245** may be identified by searching the access code association table **170** for an access code associated with a local calling area identifier in the associated  
30 local calling area identifier field **171** that matches the local calling area identifier in the local calling area identifier store **245**. It has been found that information available from web sites such as [http://en.wikipedia.org/wiki/List\\_of\\_NANP\\_area\\_codes](http://en.wikipedia.org/wiki/List_of_NANP_area_codes), and services available from web sites such as

<http://www.serviceobjects.com/demos/PhoneExchangeDemo.asp>, for example, may be used to determine a local calling area identifier associated with a given access code where, for example, the access code is a PSTN telephone number.

5

In the exemplary access code association table **170**, the access codes in the access code fields **173** are telephone numbers for PSTN lines, three of which are in the **604** area code in Vancouver, British Columbia, Canada, and two of which are in the **416** area code in Toronto, Ontario, Canada. It will be appreciated that the access code association table **170** is an example only, and other access code association tables may include any number of access codes, which need not be PSTN telephone numbers, and which need not be limited to particular geographical areas.

10

15

In the exemplary access code association table **170**, the access code field **173** in the record **174** stores an access code **1-604-345-2323**, which may be a local telephone number for Vancouver, British Columbia, Canada, and the callee identifier field **177** of the record **174** stores a callee identifier **1-403-789-1234**, which may be a telephone number for a callee in Calgary, Alberta, Canada for example, thereby associating the callee identifier **1-403-789-1234** with the access code **1-604-345-2323**. Furthermore, the caller identifier field **179** of the record **174** stores a caller identifier **1-416-444-1441** and the caller username field **183** stores a caller username **2001 1050 8667**, thereby associating the caller identifier **1-416-444-1441** and caller username **2001 1050 8667** with the aforementioned access code and callee identifier. The caller identifier **1-416-444-1441** may be associated with a mobile telephone normally geographically located in Toronto, Ontario, Canada, but which may be in Vancouver and is therefore using a Vancouver-based access code to place a call to a Calgary-based number, for example. In the example record **174**, the timestamp field **182** indicates that the callee identifier **1-403-789-1234**, the caller identifier **1-416-444-1441**, and the caller username **2001 1050 8667** were associated with the access code **1-604-345-2323** on June 15,

20

25

30

**2008** at **10:31** am, and the timeout field **181** indicates that this association is to expire **10** minutes after the time indicated in the timestamp field.

Likewise, the exemplary record **178** indicates that the callee identifier **1-604-321-1234**, the caller identifier **1-416-444-1234**, and the caller username **2001 1050 4141** were associated with the access code **1-416-234-4646** on June **15, 2008** at **2:21** pm, and the timeout field **181** of the record **178** indicates that this association is to expire within **10** minutes of the time in the timestamp field **182**.

It will also be appreciated that the access code association table **170** may, in other embodiments, be substituted with other data structures or storage media. For example, in alternative embodiments, as described below, a DID record of the type shown at **370** in Figure **11** may associate an access code with a callee identifier and with other information such as a caller identifier, a timeout value, and a timestamp value, additionally or alternatively to the access code association table **170**.

#### DID Bank Table Records

As described in PCT Publication No. **2008/052340**, a DID bank table record may be created and stored in a DID bank table in the database (**23** in Figure **1**) when a user registers with the system, to associate the username of the user and a host name of the node with which the user is associated, with a number on the PSTN network formatted in compliance with the **E.164** standard set by the International Telecommunication Union (ITU). However, as explained below, DID records may, in some embodiments, also associate usernames and host names with respective access codes, and may also associate access codes with respective callee identifiers and with other information such as caller identifiers, timeout values, and timestamp values.

Referring to Figure **11**, an exemplary DID bank table record is shown generally at **370**, and includes a username field **371**, a user domain field **372**, and a DID field **373**. The username field **371** may store a username of a user

of the system, in which case the user domain field **372** stores a host name of the node with which the user is associated, and the DID field **373** stores an E.**164** number on the PSTN network associated with the user. Exemplary host names stored in the user domain field **372** include sp.yvr.digifonica.com for  
5 Vancouver, British Columbia, Canada and sp.lhr.digifonica.com for London England, for example, as described in PCT Publication No. **2008/052340**. If the user has multiple telephone numbers, then multiple records of the type shown at **370** would be included in the DID bank table, each having the same username and user domain, but different DID field **373** contents reflecting the  
10 different telephone numbers associated with that user.

However, DID fields **373** of DID bank table records **370** may also store access codes, in which case the username field **371** may store a username associated with the access code. In these DID bank table records **370**, the  
15 user domain field **372** stores a host name of the node with which the access code is associated. Therefore, DID bank table records **370** may, in some embodiments, associate usernames and host names with respective access codes.

The exemplary DID bank table record **370** further includes a callee identifier field **374**, a caller identifier field **375**, a timeout field **376**, a timestamp field **377**, a local calling area identifier field **378**, a channel identifier field **379**, and a caller username field **381**, which may be used in an analogous manner to the callee identifier field **177**, the caller identifier field **179**, the timeout field  
20 **181**, the timestamp field **182**, the local calling area identifier field **171**, the channel identifier field **175**, and the caller username field **183** respectively of the access code association table **170** illustrated in Figure 10. The DID bank table records **370** may thus associate access codes with respective local calling area identifiers, callee identifiers, caller identifiers, caller usernames,  
25 timeouts, and timestamps, although the caller identifier field **375**, timeout field **376**, timestamp field **377**, local calling area identifier field **378**, channel identifier field **379**, and caller username field **381** may not be necessary, and  
30 one or more of these fields may be omitted in some embodiments.

Furthermore, it will be appreciated that the callee identifier field **374**, caller identifier field **375**, timeout field **376**, and timestamp field **377** of the DID bank table record **370** may be omitted for DID table records that are not in respect of access codes, but rather are in respect of telephone numbers of users of the system, for example, as described in PCT Publication No. **2008/052340**.  
5 The callee identifier field **374**, caller identifier field **375**, timeout field **376**, and timestamp field **377** of the DID bank table record **370** may also be omitted in embodiments where the access code association table **170** includes records with these types of fields.

10 For simplicity, the following description is directed to embodiments wherein an access code association table **170** associates access codes with respective callee identifiers, caller identifiers, timeout values, and timestamp values. However, it will be appreciated that the processes described herein for records in the access code association table **170** may additionally or  
15 alternatively be applied to DID bank table records **370** in an analogous manner.

#### Access Code Generator

20 Referring back to Figures **1**, **4**, and **8** in the illustrated embodiment as described above, the access server **14** transmits (at block **196** illustrated in Figure **7**) an access code request message **110** to the routing controller **30** in order to obtain from the routing controller **30** an access code. When an access code request message **110** is received at the access server interface  
25 **242**, the processor **232** preferably authenticates the user by making various enquiries of databases to which it has access, to determine whether or not the password in the password field **114** of the access code request message **110** matches a password stored in the database in association with the username in the username field **112**. Various functions may be used to pass encryption  
30 keys or hash codes back and forth to ensure that the transmittal of passwords is secure. If the user is successfully authenticated, the processor **232** then preferably produces an access code.



Referring to Figures **8** and **12**, a process for producing an access code is shown generally at **270**. Essentially the process **270** determines whether the access code in a given record (referred to below as the “currently addressed record”) in the access code association table shown at **170** in Figure **10** is within the local calling area identified by the local calling area identifier store **245**, and whether the access code is currently available for association with a callee identifier. In order to produce an access code in response to receiving an access code request message (**110**) from the access server (**14**), the processor **232** of the routing controller (**30**) preferably searches the pool of access codes in the access code association table (**170**) to identify an access code identifying a channel usable by the mobile telephone (**12**) to initiate a call to the callee, using the process **270** until an available access code in the local calling area identified by the local calling area identifier store **245** is identified. The access code generator thus preferably selects an access code from the pool of access codes in the access code association table (**170**), and preferably selects an access code in a local calling area associated with the mobile telephone (**12**).

Starting with the first record in the access code association table, the process **270** begins at block **272**, which directs the processor **232** of the routing controller (**30**) to determine whether the access code in the currently addressed record of the access code association table **170** is associated with the same local calling area as the mobile telephone (**12**) as identified by the contents of the local calling area identifier store **245**. If at block **272** the access code of the currently addressed record is not associated with the same local calling area as the mobile telephone (**12**), the process **270** ends, the next record in the access code association table **170** is addressed, and the process is repeated for the next record in the access code association table.

However, if at block **272** the access code of the currently addressed record is associated with the same local calling area as the mobile telephone (**12**), or if the access code request message **110** (illustrated in Figure **4**) did not include

a local calling area identifier, then the process **270** continues at block **274**, which directs the processor **232** to determine whether the access code of the currently addressed record is associated with a callee identifier. To do this, the processor **232** determines whether the callee identifier field (**177**) of the currently addressed record stores a "null" value that was assigned to it on initialization, or whether the callee identifier field instead stores a callee identifier. In other words the processor checks to see whether the currently addressed record has already been in use.

10 If at block **274** the callee identifier field (**177**) of the currently addressed record in the access code association table (**170**) does store a callee identifier and not the "null" value that was assigned to the callee identifier field on initialization (for example, records **174** and **178** in Figure **10**), then the access code of that record is associated with a callee identifier, and the process **270** continues at block **278**, which directs the processor **232** to determine whether the association of the callee identifier with the access code has expired. In the illustrated embodiment, the codes at block **278** direct the processor **232** to determine whether the sum of the contents of the timestamp field (**182**) and of the timeout field (**181**) in the currently addressed record of the access code association table **170** (shown in Figure **10**) is less than the current time represented by the clock **244**. If at block **278** the sum of the timeout and timestamp fields in the currently addressed record of the access code association table **170** is less than the time represented by the clock **244**, then the association of the callee identifier with the access code is not expired and the process **270** ends, the next record in the access code association table (**170**) is addressed, and the process **270** is repeated for the next record in the access code association table.

30 However, if at block **278** the sum of the contents of the timeout and timestamp fields (**181** and **182**) in the currently addressed record of the access code association table (**170**) is not less than the time represented by the clock **244**, then the association of the callee identifier with the access code has expired, and the process **270** continues at block **276** which directs the processor **232**

to store the contents of the access code field **173** of the currently addressed record in the access code store **250** of the temporary memory **240** of the routing controller **30**.

5 Referring to Figures **8**, **10**, and **12**, if at block **274** the callee identifier field in the currently addressed record does not store a callee identifier but stores instead the “null” value that was assigned to the callee identifier field on initialization (for example, records **172**, **176**, and **180**), then the access code of that record is not associated with a callee identifier, and the process **270**  
10 continues at block **276**, which directs the processor **232** to store the access code from the access code field **173** of the currently addressed record, in the access code store **250** in the temporary memory **240**.

After the selected access code is stored in the access code store **250** at block  
15 **276**, the process **270** continues at block **280**, which directs the processor **232** to store the callee identifier from the callee identifier store **246** in the callee identifier field **177** of the currently addressed record, thereby creating an association of the callee identifier with the selected access code.

20 The process **270** then continues at block **282**, which directs the processor **232** to store the caller identifier from the caller identifier store **248** (which identifies the mobile telephone **12** shown in Figure **1**) in the caller identifier field **179** of the currently addressed record of the access code association table **170**, thereby also storing the caller identifier in association with the selected access  
25 code.

The process **270** then continues at block **283**, which directs the processor **232** to store the caller username from the caller username store **249** in the caller username field **183** of the currently addressed record of the access code  
30 association table **170**, thereby also storing the caller username in association with the selected access code.

The process **270** then continues at block **284**, which directs the processor **232** to store timeout and timestamp values in the timeout and timestamp fields **181** and **182** of the currently addressed record of the access code association table **170**, thus further storing, in association with the selected access code, a  
5 timestamp for use in determining when the usability of the access code to initiate a call to the callee will expire. A default value, such as **10** minutes, for example may be stored in the timeout field **181** of the currently addressed record. Also, the current time indicated by the clock **244** is preferably stored in the timestamp field **182** of the currently addressed record.

10 In alternative embodiments, the access code association table (**170**) might not include fields for a caller identifier, caller username, a timeout, or a timestamp. In these embodiments, one or more of blocks **282**, **283**, and **284** described above are not necessary, and one or more of the caller identifier store **248**  
15 and the caller username store **249** may be omitted.

In summary, the access code generator in the illustrated embodiment responds to receiving an access code request message **110** illustrated in  
20 Figure **4** from the access server (**14**) by first authenticating the user, and then by searching through a pool of access codes, using the process **270** shown in Figure **12**, to identify an access code that is associated with the local calling area identified by the local calling area identifier store (**245**) and that is not previously and validly associated with another callee identifier. It will be appreciated that in alternative embodiments, different data structures and  
25 algorithms may be preferable for identifying an access code that meets the aforementioned criteria. For example, in accordance with conventional database design that is well-known in the art, the records illustrated in the access code association table **170** illustrated in Figure **10** may alternatively be organized in a binary tree according to the value in the local calling area  
30 identifier field **171**, or in separate tables for respective local calling area identifiers, for example, in order to enable a more efficient search of the access code association table for an access code that satisfies the aforementioned criteria. Therefore, the access code association table (**170**)

and the process **270** illustrated in Figure **12** are examples only, and one of ordinary skill in the art will readily appreciate numerous alternative data structures and algorithms.

5        Gateway

Referring to Figure **13**, in this embodiment, the gateway (**18**) includes a processor circuit shown generally at **300**, which includes a microprocessor **302**. The processor circuit **300** also includes a program memory **304**, a memory **305**, and an I/O port **306**, all of which are in communication with the  
10        microprocessor **302**. The processor circuit **300** may include multiple processors etc., and the aforementioned components of the processor circuit **300** may alternatively be combined.

The I/O port **306** includes a channel interface **308**, which, in the illustrated  
15        embodiment, is in communication with the channels **20**, **22**, and **24** that were also illustrated in Figure **1**. Where, as in the illustrated embodiment, the channels **20**, **22**, and **24** are PSTN telephone lines in the PSTN network **29**, the channel interface **308** may, for example, be a T1 port for communication with one or more T1 lines (illustrated at **27** in Figure **1**) of a PSTN service  
20        provider, in a manner well-known in the art. The I/O port in the illustrated embodiment also includes an internet interface **309** for interfacing with the IP network **26** illustrated in Figure **1**. The program memory **304** stores blocks of codes for directing the microprocessor **302** to carry out the functions of the gateway (**18**). It has been found that the AS**5350** Universal Gateway available  
25        from Cisco Systems, Inc. of San Jose, California may, for example, be suitable as the gateway (**18**).

Referring back to Figure **1**, and also still to Figure **13**, when a call is received  
30        on one of the channels **20**, **22**, or **24**, the microprocessor **302** causes the I/O port **306** to use the internet interface **309** to send a Session Initiation Protocol (SIP) Invite message to a pre-determined node with which the gateway **18** is associated, which in the illustrated embodiment is the first node **11**. Generally, the gateway **18** will be associated with a node that is geographically closest to

the gateway, in order to minimize transmission times over the IP network **26**. In response to the SIP Invite message, the call controller **13** sends an RC request message to the routing controller **30** which makes various enquiries of the database **23** to produce a routing message that is sent back to the call controller **13**. The call controller **13** then communicates with the media relay **28** to cause a communications link including an audio path (and a videopath if a videophone call) to be established through the media relay to the same node, a different node, or to a communications supplier gateway as shown generally at **34** to carry audio, and where applicable, video traffic to the call recipient or callee.

Referring to Figure **14**, an exemplary SIP Invite message is shown generally at **310** and includes a caller identifier field **312**, a callee identifier field **314**, a digest parameter field **315**, a call identifier field **316**, an IP address field **317**, and a gateway UDP port field **318**. Examples of values for the fields in the SIP Invite message **310** are shown for illustration purposes only in Figure **14**. The caller identifier in the caller identifier field **312** is preferably in the form of the telephone number of the caller followed by the "@" symbol, which in turn is followed by the IP address of the gateway (**18**) in the IP network (**26**). The caller identifier may be determined by retrieving calling line identification (CLID) information from the signal provided by the PSTN network (**29**) to the gateway (**18**) for example. Where the caller identification information is not available to the gateway (**18**), the caller identifier in the caller identifier field **312** preferably includes a pre-assigned number (such as **11111**, for example) indicating that the caller identification information was not available, followed by the "@" symbol and then by the IP address of the gateway (**18**).

The callee identifier in the callee identifier field **314** is the access code identifying the channel (**20**, **22**, or **24** in the example of Figure **1**) on which the call was placed, and which was received from the access server (**14**). In the illustrated example, the access code is the PSTN telephone number **1-604-345-1212** corresponding to the channel **20** illustrated in Figure **1**, and to the

access code stored in the access code field **173** of the record **172** in the exemplary access code association table **170** illustrated in Figure **10**.

5 The digest parameter in the digest parameter field **315** is generated by the gateway (**18**) and may uniquely identify the SIP session that is initiated with the SIP Invite message **310**.

10 The call identifier in the call identifier field **316** is, in the illustrated embodiment, a four-digit hexadecimal number generated by the gateway (**18**) to identify the call, followed by the "@" symbol, which in turn is followed by the IP address of the gateway.

15 The IP address in the IP address field **317** is the IP address of the gateway (**18**) in the IP network (**26**), and the gateway UDP port number in the gateway UDP port field **318** includes a UDP port identifier identifying a UDP port at which the audio/video path will be terminated at the gateway (**18**).

20 It should be noted that throughout the description of the embodiments of this invention, the IP/UDP addresses of all elements such as the gateway (**18**) will be assumed to be valid IP/UDP addresses directly accessible via the Internet or a private IP network, for example, depending on the specific implementation of the system. As such, it will be assumed, for example, that the gateway (**18**) will have an IP/UDP address directly accessible by the call controllers and the media relays on their respective nodes, and those addresses will not be obscured by Network Address Translation (NAT) or similar mechanisms. In other words, the IP/UDP information contained in SIP messages (for example the SIP Invite message or the RC Request message which will be described below) will match the IP/UDP addresses of the IP packets carrying these SIP messages.

30 It will be appreciated that in many situations, the IP addresses assigned to various elements of the system may be in a private IP address space, and thus not directly accessible from other elements. Furthermore, it will also be

appreciated that NAT is commonly used to share a "public" IP address between multiple devices, for example between home PCs and IP telephones sharing a single Internet connection. For example, the gateway (18) may be assigned an IP address such as **192.168.0.5**. This address is located in so called "non-routable" (IP) address space and cannot be accessed directly from the Internet. In order for this device to communicate with other computers located on the Internet, the IP address has to be converted into a "public" IP address, for example **24.14.102.5** assigned by the Internet Service Provider, by a device performing NAT, typically a router. In addition to translating the IP address, NAT typically also translates UDP port numbers, for example an audio path originating at the gateway (18) and using a UDP port **12378** at its private IP address, may have be translated to a UDP port **23465** associated with the public IP address of the NAT device. In other words, when a packet originating from the gateway (18) arrives at an Internet-based node, the source IP/UDP address contained in the IP packet header will be **24.14.102.5:23465**, whereas the source IP/UDP address information contained in the SIP message inside this IP packet will be **192.168.0.5:12378**. The mismatch in the IP/UDP addresses may cause a problem for SIP-based VoIP systems because, for example, a node will attempt to send messages to a private address but the messages will never get there.

#### Call Controller

Referring to Figure 15, the call controller (13) includes a processor circuit shown generally at **320**. The processor circuit **320** includes a microprocessor **322**, program memory **324**, and an I/O port **326**. The program memory **324** and the I/O port **326** are in communication with the microprocessor **322**. The processor circuit **320** may include a plurality of microprocessors, a plurality of program memories, and a plurality of I/O ports to be able to handle a large volume of calls. However, for simplicity, the processor circuit **320** will be described as having only one microprocessor **322**, program memory **324**, and I/O port **326**, it being understood that there may be more.



Generally, the I/O port **326** includes an input **328** for receiving messages such as the SIP Invite message from the gateway (**18**) or from a VoIP telephone (**36** in Figure 1, for example). The I/O port **326** also has an RC request message output **330** for transmitting an RC request message to the routing controller **30** of Figure 1, an RC message input **332** for receiving routing messages from the routing controller **30**, a gateway output **334** for transmitting messages to the gateway **18** and/or **34** shown in Figure 1 to advise the gateway **18** and/or **34** to establish an audio path, for example, and a gateway input **336** for receiving messages from the gateway **18** and/or **34**.  
The I/O port **326** further includes a SIP output **338** for transmitting messages to the gateway (**18** and/or **34**) or VoIP telephone (**36**, for example) to advise the gateway **18** and/or **34** or IP telephone of the IP addresses of the gateways which will establish the audio/video path. The I/O port **326** further includes a voicemail server input and output **340** and **342** respectively for communicating with the voicemail server **19** shown in Figure 1.

While certain inputs and outputs have been shown as separate, it will be appreciated that some may be a single IP address and IP port. For example, the messages sent to the routing controller (**30**) and received from the routing controller (**30**) may be transmitted and received on the same single IP port.

The program memory **324** includes blocks of code for directing the microprocessor **322** to carry out various functions of the call controller (**13**). For example, these blocks of code include a first block **344** for causing the processor circuit **320** to execute a SIP Invite to RC Request process to produce an RC Request Message in response to a received SIP Invite message. In addition, there is a Routing Message to Gateway message block **346** which causes the processor circuit **320** of the call controller to produce a gateway query message in response to a received routing message from the routing controller (**30**).

Referring to Figures **15** and **16**, the SIP Invite to RC Request process is shown in more detail at **344**. On receipt of a SIP Invite message of the type

shown in Figure 14, block 350 directs the processor circuit 320 to produce an RC Request Message. Block 352 then directs the processor circuit 320 to cause the RC Request Message to be sent to the routing controller 30 illustrated in Figure 1.

5

Referring to Figure 17, an exemplary RC request message is shown generally at 360 and includes a caller identifier field 362, a callee identifier field 364, a digest parameters field 366, and a call identifier field 368. These fields may be populated with the contents of the caller identifier field 312, callee identifier field 314, digest parameter field 315, and call identifier field 316 respectively of the SIP Invite message 310 illustrated in Figure 14. In other embodiments, the RC request message may further include a type field (not shown) containing a type code to indicate whether the call is from a third party or from a system subscriber. Other variations of an RC request message are explained in PCT Publication No. WO 2008/052340. A type field (not shown) in the RC request message 360 may be advantageous in embodiments where SIP Invite messages may also be received from an IP telephone that is using VoIP software to make a voice call. However, in the embodiments that are illustrated herein, SIP Invite messages originate from the gateway (18), and therefore a type designation is not necessary and may be omitted from the RC request message 360. In embodiments where a SIP Invite message may be received from an IP telephone, the SIP invite to RC request process shown in Figure 16 may require additional steps, as illustrated in Figure 5 of PCT Publication No. WO 2008/052340.

10

15

20

25

#### RC Request Message Handler

As illustrated in Figure 8, the program memory 234 includes an RC request message handler 380 which directs the routing controller (30) to produce a routing message in response to a received RC request message (360).

30

Referring to Figure 18A, the RC request message handler 380 begins with a first block 382 that directs the RC processor circuit (230) to separately store the contents of the callee identifier field 364 and caller identifier field 362 of

the RC request message (360) in the callee identifier store 246 and the caller identifier store 248 respectively of Figure 8.

Block 384 then directs the RC processor circuit (230) to use the contents of the caller username store 249 to locate and retrieve from the database (23) a dialing profile 200 associated with the caller, as described above and illustrated in Figure 9, for example. The retrieved dialing profile may then be stored in the temporary memory 240, for example.

The RC request message handler 380 continues at block 386, which directs the processor circuit (230) of the routing controller to determine whether the contents of the current number of concurrent calls field 222 of the dialing profile 200 shown in Figure 9 are less than the contents of the maximum number of concurrent calls field 220 of the dialing profile for the caller and, if so, block 388 directs the processor circuit to increment the contents of the current number of concurrent calls field 222 and the processor circuit (230) is directed to point A in Figure 18B. If the contents of the current number of concurrent calls field 222 are equal to or greater than the contents of the maximum number of concurrent calls field 220, then block 390 directs the processor circuit (230) to send an error message back to the call controller (13) to cause the call controller to notify the caller that the maximum number of concurrent calls has been reached and no further calls can exist concurrently, including the presently requested call.

Assuming that block 386 allows the call to proceed, the RC processor circuit (230) is directed to perform certain checks on the callee identifier in the callee identifier field 246 in Figure 8. These checks are shown in greater detail in Figure 18B.

Referring to Figure 18B, the RC processor circuit (230) is directed to a first block 392 that causes it to determine whether a digit pattern of the callee identifier includes a pattern that matches the contents of the international dialing digits (IDD) field 208 in the dialing profile 200 (shown in Figure 9)

associated with the caller. If so, then block **394** directs the RC processor circuit (**230**) to set a call type code identifier variable maintained by the processor to indicate that the call is an international call, and block **396** directs the processor to produce a reformatted callee identifier by reformatting the callee identifier into a predefined digit format. In this embodiment, this is done by removing the pattern of digits matching the IDD field contents (**208**) of the caller dialing profile **200** to effectively shorten the callee identifier. Then, block **398** directs the RC processor circuit (**230**) to determine whether or not the callee identifier has a length which meets criteria establishing it as a number compliant with the E.164 Standard set by the ITU. If the length does not meet these criteria, then block **400** directs RC processor circuit (**230**) to send back to the call controller (**13**) a message indicating the length is not correct. The process **380** is then ended. At the call controller **13**, routines (not shown) stored in the program memory **324** may direct the processor circuit (**320** of Figure **15**) to respond to the incorrect length message by transmitting a message back to the mobile telephone (**12** shown in Figure **1**) to indicate that an invalid number has been dialled.

If the length of the amended callee identifier meets the criteria set forth at block **398**, then block **402** directs the RC processor circuit (**230**) to make a database request to the database (**23**) to determine whether or not the amended callee identifier is found in the DID field (**373**) of a record such as shown in Figure **11** in the DID bank table. If at block **402** the RC processor circuit (**230**) receives a response from the database (**23**) indicating that the reformatted callee identifier produced at block **396** is found in the DID field (**373**) of a record in the DID bank table, then the callee is a subscriber to the system and the call is classified as a private network call by directing the processor to block **404**, which directs the RC processor circuit (**230**) to copy the contents of the corresponding username field (**371** in Figure **11**) from the callee DID bank table record (**370** in Figure **11**) into the callee identifier store (**246** in Figure **8**). Thus, the RC processor circuit (**230**) locates a subscriber username associated with the reformatted callee identifier. The processor (**232**) is then directed to point B in Figure **18A**.

Calls to Subscribers in Different Nodes

Referring back to Figure 1, as noted above, the gateway **18** is preferably associated with a pre-determined node, which in the illustrated embodiment is the first node **11**. Referring back to Figure **18A**, block **406** directs the processor (**232** of Figure **8**) to execute a process to determine whether or not the node associated with the reformatted callee identifier in the callee identifier store (**246** in Figure **8**, which, at block **404**, was set to be a username of the callee) is the same node that is associated with the gateway **18** illustrated in Figure **1**.

To do this, the processor (**232**) may, for example, identify a node associated with the gateway (**18**) by using an IP address associated with the gateway to determine a node identifier of the gateway. An IP address associated with the gateway (**18**) may, for example, be obtained from either the caller identifier field **362** or the call identifier field **368** of the RC request message **360** illustrated in Figure **17**, as each of these fields includes a portion following an "@" symbol that indicates an IP address of the gateway. In order to determine a node identifier associated with the gateway (**18**) using the IP address associated with gateway (**18**), the processor **232** (illustrated in Figure **8**) may access a gateway node association table stored in the database **23** (illustrated in Figure **1**).

Referring to Figure **19**, an exemplary gateway node association table is shown generally at **480**. The exemplary gateway node association table **480** includes first and second records **482** and **484**, each having a respective gateway IP address field **486** and a respective node identifier field **488**. It will be appreciated that the exemplary gateway node association table **480** is an example for illustration purposes only. The values in the gateway IP address fields **486** are preferably initialized when a gateway (such as the gateway **18** illustrated in Figure **1**) is installed as part of the system (**10**), and are preferably updated as the IP addresses of the respective gateways may change from time to time. The values in the node identifier fields **488** are also

preferably initialized when a gateway (such as the gateway **18** illustrated in Figure **1**) is installed as part of the system (**10**).

As indicated above, the reformatted callee identifier in the callee identifier store (**246** in Figure **8**) was set at block **404** in Figure **18B** to be a username of the callee from the username field **371** (illustrated in Figure **11**), and in this embodiment, a prefix of the username of the callee preferably indicates a node associated with the callee. In the illustrated embodiment, the left-most digit in the username of the callee is a continent code, which is a sufficient prefix to identify a node associated with the callee. However, it will be appreciated that in other embodiments, other prefixes or other information may identify the associated node. Preferably, the values in the node identifier fields **488** correspond to the prefixes of the usernames in the username fields **371** (illustrated in Figure **11**), so that the node associated with the callee is the same node that is associated with the gateway **18** illustrated in Figure **1** if the prefix of the username of the callee matches the node identifier associated with the gateway (**18**). Therefore, in the illustrated embodiment, if the reformatted callee identifier in the callee identifier store (**246** in Figure **8**) is **2001 1050 8667**, for example, then in the example of Figure **19**, the node associated with the callee is the same node as the node identified by the continent code “**2**” that is associated with the gateway associated with the IP address **20.14.102.5** in the record **482**, but is not the same node as the node identified by the continent code “**5**” that is associated with the gateway associated with the IP address **104.12.131.12** in the record **484**.

Referring back to Figure **18A**, if at block **406** the prefix of the username of the callee does not match the node identifier associated with the gateway (**18**), then the call is a “cross-domain” call, and block **408** in Figure **18A** directs the processor (**232** in Figure **8**) to set a call type flag in the temporary memory (**240** in Figure **8**) to indicate the call is a cross-domain call. Then, block **410** of Figure **18A** directs the processor (**232** of Figure **8**) to produce a routing message identifying an address on the private network with which the callee identified by the contents of the callee ID buffer is associated and to set a time

to live for the call at a maximum value of **99999**, for example. Routing messages and time to live values, and also a method of determining the node in the system with which the callee is associated, are further described in PCT Publication No. WO **2008/052340**. Once a routing message is produced at block **410**, block **412** directs the processor (**232** in Figure **8**) to cause the routing message to be sent to the call controller **13** shown in Figure **1**, and the process ends.

Referring back to Figure **18B**, if at block **392**, the callee identifier stored in the callee identifier store (**246** in Figure **8**) does not begin with an international dialing digit, then block **414** directs the processor (**232**) to determine whether or not the callee identifier begins with the same national dial digit code as assigned to the caller. To do this, the processor (**232**) is directed to refer to the retrieved caller dialing profile as shown in Figure **9**. In Figure **9**, the national dialing digit code **206** is the number **1**. Thus, if the callee identifier begins with the number **1**, then the processor (**232**) is directed to block **416** in Figure **18B**.

Block **416** directs the processor (**232** of Figure **8**) to examine the callee identifier to determine whether or not the digits following the NDD digit identify an area code that is the same as any of the area codes identified in the local area codes field **212** of the caller dialing profile **200** shown in Figure **9**. If not, block **418** of Figure **18B** directs the processor (**232**) to set the call type flag to indicate that the call is a national call. If the digits following the NDD digit identify an area code that is the same as a local area code associated with the caller as indicated by the caller dialing profile, block **420** directs the processor (**232**) to set the call type flag to indicate a local call, national style. After executing block **418** or **420**, block **422** directs the processor (**232**) to format the callee identifier into a pre-defined digit format to produce a re-formatted callee identifier by removing the national dialled digit and prepending a caller country code identified by the country code field **210** of the caller dialing profile shown in Figure **9**. The processor (**232**) is then

directed to block **398** of Figure **18B** to perform other processing as already described above.

5 If at block **414**, the callee identifier does not begin with a national dialled digit, block **424** directs the processor (**232**) to determine whether the callee identifier begins with digits that identify the same area code as the caller. Again, the reference for this is the retrieved caller dialing profile shown in Figure **9**. The processor (**232**) determines whether or not the first few digits of the callee identifier identify an area code corresponding to the contents of any  
10 area code identifier stored in the local area code field **212** of the retrieved caller dialing profile **200** (illustrated in Figure **9**). If so, then block **426** directs the processor (**232**) to set the call type flag to indicate that the call is a local call. It should be noted that the call will not necessarily be a local call in every case where the first few digits of the callee identifier identify an area code  
15 corresponding to the contents of an area code identifier stored in the local area code field **212** (illustrated in Figure **9**), and other determinations of when a call is to be considered local may be appropriate. However, it has been found that the determination described above for block **424** is satisfactory for some purposes. Next, block **428** directs the processor (**232**) to format the  
20 callee identifier into a pre-defined digit format to produce a reformatted callee identifier by prepending the caller country code to the callee identifier, the caller country code being determined from the country code field **210** of the retrieved caller dialing profile **200** shown in Figure **9**. The processor (**232**) is then directed to block **398** for further processing as described above.

25 If at block **424**, the callee identifier does not start with the same area code as the caller, block **430** directs the processor (**232** of Figure **8**) to determine whether the number of digits in the callee identifier, *i.e.* the length of the callee identifier, is within the range of digits indicated by the caller minimum local  
30 number length field **214** and the caller maximum local number length field **216** of the retrieved caller dialing profile **200** shown in Figure **9**, and whether there is more than one area code identifier stored in the local area code field **212** of the retrieved caller dialing profile. If the number of digits in the callee identifier



is within the aforementioned range and there is only one area code identifier stored in the local area code field (212), then block 432 directs the processor (232) to set the call type flag to indicate a local call and block 434 directs the processor (232) to format the callee identifier into a pre-defined digit format to produce a reformatted callee identifier by prepending to the callee identifier the caller country code (as indicated by the country code field 210 of the retrieved caller dialing profile 200 shown in Figure 9) followed by the caller area code as indicated by the local area code stored in the local area code field 212 of the caller dialing profile 200 shown in Figure 9. The processor (232) is then directed to block 398 of Figure 18B for further processing as described above.

If at block 430, the callee identifier has a length that does not fall within the range specified by the caller minimum local number length field (214 in Figure 9) and the caller maximum local number length field (216 in Figure 9), or if there is more than one area code identifier stored in the local area code field 212 of the retrieved caller dialing profile 200 illustrated in Figure 9, then block 436 directs the processor (232) to send an error message back to the call controller (13), and the process ends.

In alternative embodiments, such as those illustrated in PCT Publication No. WO 2008/052340, an additional block (402 in Figure 8B of PCT Publication No. WO 2008/052340) may determine whether the callee identifier is a valid username. However, in the embodiment disclosed herein, the callee identifier is assumed to be a telephone number of the callee, and not a username.

From Figure 18B, it will be appreciated that there are certain groups of blocks of codes that direct the processor 232 in Figure 8 to determine whether the callee identifier has certain features such as an international dialing digit, a national dialing digit, an area code and a length that meet certain criteria, and cause the processor 232 to reformat the callee identifier stored in the callee identifier store 246 in Figure 8, as necessary into a predetermined target format including only a country code, area code, and a normal telephone number, for example, to cause the callee identifier to be compatible with the

E.164 number plan standard in this embodiment. This enables block 402 in Figure 18B to have a consistent format of callee identifiers for use in searching through the DID bank table records 370 of the type shown in Figure 11 to determine how to route calls to subscribers on the same system. Effectively, therefore blocks 392, 414, 424, and 430 establish call classification criteria for classifying the call as a public network call or a private network call. Block 402 classifies the call, depending on whether or not the formatted callee identifier has a DID bank table record, and this depends on how the call classification criteria are met.

#### Calls to Non-Subscribers

Not all calls will be to subscribers, and this will be detected by the processor 232 of Figure 8 when it executes block 402 in Figure 18B, and does not find a DID bank table record (370 illustrated in Figure 11) that is associated with the callee, in the DID bank table. When this occurs, the call is classified as a public network call, by directing the processor (232) to point C in Figure 18C.

Referring to Figure 18C, block 438 directs the processor (232) to determine whether the formatted callee identifier in the callee identifier store 246 in Figure 8 corresponds to an access code in the access code field 173 of a record in the access code association table 170 illustrated in Figure 10 that is associated with a callee identifier. Because the callee identifier in the callee identifier store 246 in Figure 8 has been formatted as described above with reference to Figure 18B, block 438 may involve determining whether an access code in the access code field 173 of a record of the access code association table 170 (illustrated in Figure 10) matches the formatted callee identifier in the callee identifier store 246 in Figure 8, and also whether a callee identifier (as opposed to the "null" value assigned on initialization) is stored in the callee identifier field 177 in association with the access code. As noted above, for simplicity, this description is directed to embodiments wherein an access code association table 170 associates access codes with respective callee identifiers, caller identifiers, timeout values, and timestamp values, although it will be appreciated that the processes described herein for

records in the access code association table **170** may additionally or alternatively be applied to DID bank table records **370** in an analogous manner.

5 If at block **438** the formatted callee identifier in the callee identifier store **246** in Figure **8** is the same as an access code in the access code field (**173**) of a record of the access code association table **170** illustrated in Figure **10** that is associated with a callee identifier, then block **440** directs the processor (**232**) to determine whether the caller identifier in the caller identifier store **248**  
10 (illustrated in Figure **8**) is the same as the caller identifier in the caller identifier field (**179**) of the record of the access code association table (**170**), and thus whether the caller identifier in the caller identifier field (**179**) of the record of the access code association table (**170**) identifies the mobile telephone identified by the caller identifier in the caller identifier store **248**. If not, then  
15 block **442** directs the processor (**232**) to send an error message to the call controller (**13**), and the process ends.

But if at block **440** the caller identifier in the caller identifier store **248** (illustrated in Figure **8**) corresponds to the caller identifier in the caller identifier field (**179**) of the record of the access code association table (**170**),  
20 then the routing controller (**30**) will produce a routing message that will cause the call controller to establish communication through the IP network (**26**) to the callee in response to a call received at a channel (**20**, **22**, or **24**). Preferably, block **444** includes codes that direct the processor (**232**) to determine whether the association of the access code with the callee identifier has expired, and thus whether the usability of the access code to initiate a call to the callee has expired, in the manner described above for block **278** in Figure **12**. If at block **444** the association of the access code with the callee identifier has expired, then block **442** directs the processor (**232**) to send an error message to the call controller (**13**), and the process ends. Thus the  
25 routing controller produces a routing message that causes the call controller to establish the call only when the association of the access code with the callee identifier has not expired.  
30

It will be appreciated that in alternative embodiments, one or more of the caller identifier, timeout, and timestamp fields **179**, **181**, and **182** may be omitted from the access code association table **170** illustrated in Figure **10**, and in these embodiments, one or more of the blocks **440**, **442**, and **444** may also be omitted.

If at block **444** the association of the access code with the callee identifier has not expired, or if one or both of blocks **440** and **444** is omitted, then block **446** directs the processor (**232**) to store the callee identifier from the callee identifier field **177** of the record of the access code association table (**170**) in the callee identifier store **246** illustrated in Figure **8**. The processor (**232**) is then directed to point A in Figure **18B** to repeat the steps illustrated in Figure **18B** using the callee identifier retrieved from the callee identifier field (**177**) in the record of the access code association table (**170**).

However, if at block **438** the formatted callee identifier in the callee identifier store **246** in Figure **8** does not correspond to an access code in a record of the access code association table **170** illustrated in Figure **10** that is associated with a callee identifier, then block **448** of Figure **18B** causes the processor (**232**) to set the contents of the callee identifier store **246** of Figure **8** to be the newly formatted callee identifier, i.e., a number compatible with the E.164 standard. Then, block **450** of Figure **18B** directs the processor (**232**) to generate a routing message identifying a gateway to the public network usable by the call controller (**13**) to establish a "public system" call. In one embodiment, block **450** includes codes that, for example, direct the processor (**232**) to search a database of route or master list records and to search a database of supplier records to identify at least one supplier operable to supply a communications link for the call, and to load a routing message buffer with supplier information, time to live values, and timeout values. An example of an implementation of these steps is described with reference to blocks **410**, **412**, **560**, **562**, **563**, **564**, **566**, and **571** in Figures **8B** and **8D** in PCT Publication No. WO **2008/052340**. Next, block **452** directs the processor

232 of Figure 10 to send the routing message to the call controller 13 in Figure 1, and the process ends.

Calls to Subscribers Within the Same Node

5 Referring back to Figure 18A, if at block 406, the prefix of the username of the callee matches the node identifier associated with the gateway (18), then the call is on one domain, and block 454 directs the processor (232) to use the callee identifier in the callee identifier store 246 illustrated in Figure 8 (which, at block 404, was set to be a username of the callee) to locate and retrieve a  
10 dialing profile for the callee. The dialing profile may be of the type shown in Figure 9, for example. Block 456 of Figure 18A then directs the processor 232 of Figure 8 to get call block, call forward, and voicemail records from the database 23 of Figure 1, based on the username identified in the callee dialing profile retrieved by the processor at block 454. Exemplary call block,  
15 call forward, and voicemail records are described in PCT Publication No. WO 2008/052340.

Then block 458 directs the processor 232 of Figure 8 to determine whether or not the caller identifier received in the RC request message matches a block  
20 pattern stored in the call block record associated with the callee and retrieved at block 454. If the caller identifier matches a block pattern, then block 460 directs the processor to send a drop call or non-completion message to the call controller (13) and the process is ended. If the caller identifier does not match a block pattern associated with the callee, then block 462 directs the  
25 processor (232) to determine whether or not call forwarding is required, as described in PCT Publication No. WO 2008/052340.

If at block 462, the call forwarding record for the callee indicates that no call forwarding is required, then the processor (232) is directed to block 464,  
30 which directs the processor (232) to generate a routing message identifying an address on the private network, associated with the callee for a "private system" call. In one embodiment, block 464 includes codes that, for example, direct the processor (232) to store, in a routing message buffer, a username

and domain of the callee, time to live values, and an IP address of the current node, to determine whether or not the user identified by the callee identifier has paid for voicemail service and if so, to store voicemail information in the routing message buffer. An example of an implementation of these steps is described with reference to blocks **609**, **620**, **640**, **642**, and **644** in Figures **8A** and **8C** in PCT Publication No. WO **2008/052340**, which is incorporated herein by reference. Next, block **466** directs the processor **232** of Figure **8** to cause the routing message to be sent to the call controller **13** in Figure **1**, and the process ends.

But if at block **462**, the call forwarding record for the callee indicates that call forwarding is required, then block **468** directs the processor (**232**) to search a dialing profile table to find a dialing profile record as shown in Figure **9**, for the user identified by the destination number field of the call forward record, as illustrated in PCT Publication No. WO **2008/052340**. The processor (**232**) is further directed to store the username and domain for that user and a time to live value in a routing message buffer, an example of which is described in PCT Publication No. WO **2008/052340**. This process is repeated for each call forwarding record associated with the callee identified by the callee identifier store **246** in Figure **8** to add to the routing message buffer all call forwarding usernames and domains associated with the callee.

Referring to Figures **1**, **18A**, and **18C**, the routing message sent at one of blocks **412**, **452**, and **466** is received at the call controller **13** and the call controller interprets the receipt of the routing message as a request to establish a call. Referring to Figure **15**, the program memory **324** of the call controller **13** includes a routing to gateway routine depicted generally at **346**.

Where a routing message received at the call controller **13** is of the type produced at block **464** shown in Figure **18A**, indicating that the callee is a system subscriber on the same node as the gateway (**18**) (such as a user of the VoIP telephone **36** illustrated in Figure **1**), the routing to gateway routine **346** may direct the microprocessor **322** to cause a message to be sent back

through the IP network **26** shown in Figure **1** to the VoIP telephone (**36**), using the IP address of the VoIP telephone (**36**) that is available from the callee username.

5 Alternatively, if the routing message received at the call controller **13** is of the type produced at block **410** shown in Figure **18A**, identifying a domain associated with another node in the system, the call controller **13** may send a SIP invite message along the high speed/high data throughput link **17** in communication with the other node. The other node may function as  
10 explained above and in PCT Publication No. WO **2008/052340**, in response to receipt of a SIP invite message.

If the routing message received at the call controller **13** is of the type produced at block **450** shown in Figure **18C**, indicating that the callee is not a  
15 subscriber to the system (such as a user of the PSTN telephone **32** that is in communication with the IP network **26** through the gateway **34** as illustrated in Figure **1**), the call controller sends one or more SIP invite messages to the suppliers identified in the routing message to identify the IP address of a supplier that is able to carry the call, such as the IP address of the gateway **34**  
20 illustrated in the example of Figure **1**. A process for identifying the IP address of a supplier that is able to carry the call is given in PCT Publication No. WO **2008/052340**, which is incorporated herein by reference. In some cases, the gateway of the supplier that is able to carry the call will be the gateway **18** illustrated in Figure **1**, that is, the same gateway through which the caller telephone (**12**) initiated the call. For simplicity, the following description  
25 assumes that the gateways **18** and **34** are distinct gateways. It will be understood that in some cases, they may be the same gateway, but in these cases, the following steps may still be applied.

30 Referring to Figure **1**, the IP address of the gateway **34** is sent in a message from the call controller **13** to the media relay **28**, which responds with a message indicating an IP address to which the gateway **18** should send its audio/video traffic, and an IP address to which the gateway **34** should send its

audio/video for the call. The call controller conveys the IP address at which the media relay **28** expects to receive audio/video from the gateways **18** and **34**, to the gateways **18** and **34** in one or more messages. The gateway **18** replies to the call controller **13** with an IP address at which it would like to receive audio/video, and the call controller conveys that IP address to the media relay **28**. The call may then be conducted between the caller and callee through the media relay **28** and the gateways **18** and **34**.

If the call controller **13** receives a routing message of the type produced at block **464** shown in Figure **18A**, indicating that the callee is a system subscriber on the same node as the gateway (**18**) (such as a user of the VoIP telephone **36** illustrated in Figure **1**), and which has at least one call forwarding number and/or a voicemail number, the call controller attempts to establish a call to the callee VoIP telephone **36** by seeking from the callee telephone a message indicating an IP address to which the media relay **28** should send audio/video. If no such message is received from the callee telephone, no call is established. If no call is established within a pre-determined time, the call controller **13** attempts to establish a call with the next user identified in the call routing message in the same manner. This process is repeated until all call forwarding possibilities have been exhausted, in which case the call controller communicates with the voicemail server **19** identified in the routing message to obtain an IP address to which the media relay **28** should send audio/video and the remainder of the process mentioned above for establishing IP addresses at the media relay and the caller telephone is carried out to establish audio/video paths to allowing the caller to leave a voicemail message with the voicemail server.

When an audio/video path through the media relay **28** is established, a call timer maintained by the call controller **13** preferably logs the start date and time of the call and logs the call ID and an identification of the route (i.e., audio/video path IP address) for later use in billing.

#### Terminating the Call



Referring back to Figure 1, in the event that the caller terminates a call, the gateway 18 sends a SIP bye message to the call controller 13. Similarly, in the event that the callee terminates the call, the gateway 34 or the VoIP telephone 36 of the callee sends a SIP bye message to the call controller 13.

5 Exemplary SIP bye messages are described in PCT Publication No. WO 2008/052340. The SIP bye message is received at the call controller 13, and the call controller executes a process that involves decrementing the contents of the current number of concurrent calls field 222 dialing profile 200 of the caller as illustrated in Figure 9, generating an RC call stop message (not  
10 shown), sending the RC call stop message to the routing controller 30, and sending a "bye" message to the party that did not terminate the call. An exemplary RC call stop message, and an example of how these steps may be implemented, are described in PCT Publication No. WO 2008/052340, which is incorporated herein by reference.

15

When the routing controller 30 receives the RC call stop message from the call controller 13, the routing controller executes an RC call stop message process that involves making various updates to subscriber, reseller, and supplier account records (not shown) following the call. Examples of  
20 subscriber, reseller, and supplier account records, and of updates to subscriber, reseller, and supplier account records, are described in PCT Publication No. WO 2008/052340, which is incorporated herein by reference.

25 While specific embodiments of the invention have been described and illustrated, such embodiments should be considered illustrative of the invention only and not as limiting the invention.

**What is claimed is:**

1. A method of initiating a call to a callee using a mobile telephone, the method comprising:

5 receiving, from a user of the mobile telephone, a callee identifier associated with the callee;

transmitting an access code request message to an access server, said access code request message including said callee  
10 identifier;

receiving an access code reply message from the access server in response to said access code request message, said access code reply message including an access code different from  
15 said callee identifier and associated with said callee identifier; and

initiating a call with the mobile telephone using said access code to identify the callee.

20

2. The method of claim 1 wherein transmitting comprises transmitting said access code request message to said access server on a non-voice network.

25 3. The method of claim 1 wherein transmitting comprises transmitting a location identifier of a location associated with the mobile telephone to said access server.

30 4. The method of claim 3 wherein transmitting said location identifier comprises transmitting an IP address of the mobile telephone in a wireless IP network.

5. The method of claim 3 wherein transmitting said location identifier comprises transmitting an identifier of a wireless voice signal station in wireless communication with the mobile telephone.
- 5 6. The method of claim 3 wherein transmitting said location identifier comprises transmitting a user-configured identifier of a location associated with the mobile telephone.
- 10 7. The method of claim 1 wherein receiving said access code reply message comprises receiving said access code reply message from said access server on a non-voice network.
- 15 8. The method of claim 1 wherein receiving said access code reply message comprises receiving, in said access code reply message, said access code temporarily associated with said callee identifier.
- 20 9. The method of claim 1 wherein receiving said access code reply message comprises receiving, in said access code reply message, a telephone number identifying a channel operably configured to cooperate with an IP network to cause a call involving the mobile telephone and the callee to be routed through the IP network.
- 25 10. The method of claim 9 wherein initiating said call comprises engaging a routing controller to route said call on said IP network to the callee.
- 30 11. The method of any one of claims 1 to 10 further comprising:
- receiving from the mobile telephone said access code request message;
- communicating with a routing controller to obtain from the routing controller said access code wherein said access code identifies a channel and is useable by the mobile telephone to

cause the routing controller to establish a call to the callee using the channel; and

5 transmitting said access code reply message to the mobile telephone.

**12.** A mobile telephone apparatus comprising:

10 means for receiving, from a user of the mobile telephone, a callee identifier associated with the callee;

transmitting means for transmitting an access code request message to an access server, said access code request message including said callee identifier;

15 means for receiving an access code reply message from the access server in response to said access code request message, said access code reply message including an access code different from said callee identifier and associated with said callee identifier; and

20 means for initiating a call using said access code to identify the callee.

25 **13.** The mobile telephone apparatus of claim **12** wherein said transmitting means comprises a non-voice network interface for transmitting said access code request message to said access server on a non-voice network.

30 **14.** The mobile telephone apparatus of claim **12** wherein said access code request message further includes a location identifier of a location associated with the mobile telephone.

15. The mobile telephone apparatus of claim **14** wherein said location identifier comprises an IP address of the mobile telephone in a wireless IP network.
- 5      16. The mobile telephone apparatus of claim **14** wherein said location identifier comprises an identifier of a wireless voice signal station in wireless communication with the mobile telephone.
- 10      17. The mobile telephone apparatus of claim **14** wherein said location identifier comprises a user-configured identifier of a location associated with the mobile telephone.
- 15      18. The mobile telephone apparatus of claim **12** wherein said means for receiving an access code reply message comprises a non-voice network interface for receiving said access code reply message on a non-voice network.
- 20      19. The mobile telephone apparatus of claim **12** wherein said access code includes a telephone number.
- 25      20. The mobile telephone apparatus of claim **12** wherein said means for initiating comprises a mobile telephone network interface.
- 30      21. A system for initiating a call to a callee, the system comprising:  
the mobile telephone apparatus of any one of claims **12 – 20**,  
and further comprising;  
  
a routing controller; and  
  
an access server comprising:

means for receiving from the mobile telephone said access code request message;

5

means for communicating with said routing controller to obtain from said routing controller said access code wherein said access code identifies a channel and is useable by the mobile telephone to cause the routing controller to establish a call to the callee using the channel; and

10

means for transmitting said access code reply message including said access code to the mobile telephone.

**22.** A mobile telephone apparatus comprising:

15

a processor circuit;

a network interface in communication with said processor circuit; and

20

a computer readable medium in communication with said processor circuit and encoded with codes for directing said processor circuit to:

25

receive, from a user of the mobile telephone, a callee identifier associated with the callee;

30

cause an access code request message to be transmitted to an access server, said access code request message including said callee identifier;

receive an access code reply message from the access server in response to said access code request message,

said access code reply message including an access code different from said callee identifier and associated with said callee identifier; and

5 initiate a call using said access code to identify the callee.

10 **23.** The mobile telephone apparatus of claim **22** wherein said network interface comprises a non-voice network interface, and wherein said codes for directing said processor circuit to cause said access code request message to be transmitted include codes for directing said processor circuit to cause said access code request message to be transmitted to said access server using said non-voice network interface on a non-voice network.

15 **24.** The mobile telephone apparatus of claim **22** wherein said access code request message further includes a location identifier of a location associated with the mobile telephone.

20 **25.** The mobile telephone apparatus of claim **24** wherein said location identifier comprises an IP address of the mobile telephone in a wireless IP network.

25 **26.** The mobile telephone apparatus of claim **24** wherein said location identifier comprises an identifier of a wireless voice signal station in wireless communication with the mobile telephone.

30 **27.** The mobile telephone apparatus of claim **24** wherein said location identifier comprises a user-configured identifier of a location associated with the mobile telephone.

**28.** The mobile telephone apparatus of claim **22** wherein said network interface comprises a non-voice network interface, and wherein said codes for directing said processor circuit to receive an access code

reply message include codes for directing said processor circuit to cause said access code reply message to be received from said access server using said non-voice network interface on a non-voice network.

5

**29.** The mobile telephone apparatus of claim **22** wherein said access code includes a telephone number identifying a channel operably configured to cooperate with an IP network to cause a call involving the mobile telephone and the callee to be routed through the IP network.

10

**30.** The mobile telephone apparatus of claim **22** wherein said network interface comprises a mobile telephone network interface, and wherein said codes for directing said processor circuit to initiate include codes for directing said processor circuit to cause a call to be initiated using said mobile telephone network interface on a mobile telephone network.

15

**31.** A system for initiating a call to a callee, the system comprising:

20

the mobile telephone of any one of claims **22 – 30**, and further comprising;

a routing controller; and

25

an access server comprising a processor circuit and a computer readable medium in communication with the processor circuit, the computer readable medium encoded with codes for directing said processor circuit to:

30

receive from the mobile telephone said access code request message;



communicate with said routing controller to obtain from said routing controller said access code wherein said access code identifies a channel and is useable by the mobile telephone to cause the routing controller to establish a call to the callee using the channel; and

5

transmit said access code reply message to the mobile telephone.

10 **32.** A computer readable medium encoded with codes for directing a processor circuit to initiate a call to a callee using a mobile telephone, said codes being operable to direct the processor circuit to:

15

receive, from a user of a mobile telephone, a callee identifier associated with a callee;

transmit an access code request message to an access server, said access code request message including said callee identifier;

20

receive an access code reply message from the access server in response to said access code request message, said access code reply message including an access code different from said callee identifier and associated with said callee identifier; and

25

initiate a call using said access code to identify the callee.

30 **33.** A method for enabling a mobile telephone to initiate a call to a callee through a channel, the method comprising:

receiving from the mobile telephone an access code request message including a callee identifier associated with the callee;

5 communicating with a routing controller to obtain from the routing controller an access code identifying the channel, said access code being different from the callee identifier and useable by the mobile telephone to initiate a call to the callee using the channel; and

10 transmitting an access code reply message including said access code to the mobile telephone.

34. The method of claim 33 wherein receiving comprises receiving said access code request message on a non-voice network.

15 35. The method of claim 33 further comprising causing the routing controller to produce said access code.

20 36. The method of claim 35 wherein producing comprises selecting said access code from a pool of access codes, where each access code in said pool of access codes identifies a respective telephone number.

37. The method of claim 36 further comprising determining a local calling area associated with the mobile telephone.

25 38. The method of claim 37 wherein determining comprises accessing a dialing profile associated with the caller, said dialing profile including a location field having contents identifying at least a default location of the caller.

30 39. The method of claim 37 wherein determining comprises receiving an IP address of the mobile telephone in a wireless IP network.

40. The method of claim 37 wherein determining comprises receiving an identifier of a wireless voice signal station in wireless communication with the mobile telephone.
- 5 41. The method of claim 37 wherein determining comprises receiving a user-configured identifier of a location associated with the mobile telephone.
42. The method of claim 37 wherein selecting comprises selecting an access code in said local calling area associated with the mobile  
10 telephone.
43. The method of claim 36 wherein each access code in said pool of access codes further identifies a respective channel operably configured to cooperate with an IP network to cause a call involving the  
15 mobile telephone and the callee to be routed through the IP network.
44. The method of claim 43 further comprising causing said routing controller to establish communication through said IP network in  
20 response to a call received on said channel.
45. The method of claim 44 wherein producing further comprises storing a caller identifier associated with the mobile telephone in association with said access code.  
25
46. The method of claim 45 wherein causing said routing controller to establish communication comprises causing said routing controller to establish communication only if said caller identifier associated with said access code identifies the mobile telephone.  
30
47. The method of claim 36 wherein producing further comprises storing said callee identifier in association with said access code.

5  
48. The method of claim 47 wherein producing further comprises searching said pool of access codes for an access code associated with said callee identifier to identify the channel usable by the mobile telephone to initiate a call to the callee.

10  
49. The method of claim 35 wherein producing further comprises storing, in association with said access code, a timestamp for use in determining when the usability of said access code to initiate a call to the callee will expire.

15  
50. The method of claim 49 wherein causing said routing controller to establish communication comprises causing said routing controller to establish communication only if the usability of said access code to initiate a call to the callee has not expired.

20  
51. The method of claim 33 wherein transmitting comprises transmitting said access code reply message on a non-voice network.

25  
52. A system for enabling a mobile telephone to initiate a call to a callee through a channel, the system comprising:

means for receiving from the mobile telephone an access code request message including a callee identifier associated with the callee;

25  
means for communicating with said routing controller to obtain from said routing controller an access code identifying the channel, said access code being different from the callee identifier and useable by the mobile telephone to initiate a call to the callee using the channel; and

30  
means for transmitting an access code reply message including said access code to the mobile telephone.

53. The system of claim 52 wherein said means for receiving comprises a non-voice network interface for receiving said access code request message on a non-voice network.
- 5
54. The system of claim 52 further comprising means for producing said access code.
55. The system of claim 54 wherein said means for producing comprises a processor circuit operably configured to select said access code from a pool of access codes, where each access code in said pool of access codes identifies a respective telephone number.
- 10
56. The system of claim 55 wherein said processor circuit is operably configured to determine a local calling area associated with the mobile telephone.
- 15
57. The system of claim 56 wherein said processor circuit is operably configured to determine a local calling area associated with the mobile telephone using a dialing profile associated with the caller, said dialing profile including a location field having contents identifying at least a default location of the caller.
- 20
58. The system of claim 56 wherein said processor circuit is operably configured to determine a local calling area associated with the mobile telephone using an IP address of the mobile telephone in a wireless IP network.
- 25
59. The system of claim 56 wherein said processor circuit is operably configured to determine a local calling area associated with the mobile telephone using an identifier of a wireless voice signal station in wireless communication with the mobile telephone.
- 30

- 5
60. The system of claim **56** wherein said processor circuit is operably configured to determine a local calling area associated with the mobile telephone using a user-configured identifier of a location associated with the mobile telephone.
61. The system of claim **56** wherein said processor circuit is operably configured to select an access code in said local calling area associated with the mobile telephone.
- 10
62. The system of claim **55** wherein each access code in said pool of access codes further identifies a respective channel operably configured to cooperate with an IP network to cause a call involving the mobile telephone and the callee to be routed through the IP network.
- 15
63. The system of claim **62** wherein said processor circuit is operably configured to establish communication through said IP network in response to a call received on said channel.
- 20
64. The system of claim **63** wherein said processor circuit is operably configured to store a caller identifier associated with the mobile telephone in association with said access code.
- 25
65. The system of claim **64** wherein said processor circuit is operably configured to cause said routing controller to establish communication only if said caller identifier associated with said access code identifies the mobile telephone.
- 30
66. The system of claim **55** wherein said processor circuit is operably configured to store said callee identifier in association with said access code.
67. The system of claim **66** wherein said processor circuit is operably configured to search said pool of access codes for an access code



communicate with said routing controller to obtain from said routing controller an access code identifying the channel, said access code being different from the callee identifier and useable by the mobile telephone to initiate a call to the callee using the channel; and

5

cause an access code reply message including said access code to be transmitted to the mobile telephone.

10 **72.** The system of claim **71** wherein said network interface comprises a non-voice network interface, and wherein said codes for directing said processor circuit to receive include codes for directing said processor circuit to cause said access code request message to be received using said non-voice network interface on a non-voice network.

15

**73.** The system of claim **71** wherein said computer readable medium is further encoded with codes for directing said processor circuit to cause said access code to be produced.

20 **74.** The system of claim **73** wherein said codes for directing said processor circuit to cause said access code to be produced cause said access code to be selected from a pool of access codes, where each access code in said pool of access codes identifies a respective telephone number.

25

**75.** The system of claim **74** wherein said computer readable medium is further encoded with codes for directing said processor circuit to cause to be determined a local calling area associated with the mobile telephone.

30

**76.** The system of claim **75** wherein said codes for directing said processor circuit to cause to be determined cause a dialing profile associated with



the caller to be accessed, said dialing profile including a location field having contents identifying at least a default location of the caller.

- 5
77. The system of claim 75 wherein said codes for directing said processor circuit to cause to be determined cause to be received an IP address of the mobile telephone in a wireless IP network.
- 10
78. The system of claim 75 wherein said codes for directing said processor circuit to cause to be determined cause to be received an identifier of a wireless voice signal station in wireless communication with the mobile telephone.
- 15
79. The system of claim 75 wherein said codes for directing said processor circuit to cause to be determined cause to be received a user-configured identifier of a location associated with the mobile telephone.
- 20
80. The system of claim 75 wherein said codes for directing said processor circuit to cause said access code to be produced further cause to be selected an access code in said local calling area associated with the mobile telephone.
- 25
81. The system of claim 74 wherein each access code in said pool of access codes further identifies a respective channel operably configured to cooperate with an IP network to cause a call involving the mobile telephone and the callee to be routed through the IP network.
- 30
82. The system of claim 81 wherein said computer readable medium is further encoded with codes for directing said processor circuit to cause communication through said IP network to be established in response to a call received on said channel.
83. The system of claim 82 wherein said codes for directing said processor circuit to cause said access code to be produced cause a caller

identifier associated with the mobile telephone to be stored in association with said access code.

- 5           **84.** The system of claim **83** wherein said codes for directing said processor circuit to cause communication to be established cause communication to be established only if said caller identifier associated with said access code identifies the mobile telephone.
- 10           **85.** The system of claim **74** wherein said codes for directing said processor circuit to cause said access code to be produced cause said callee identifier to be stored in association with said access code.
- 15           **86.** The system of claim **85** wherein said codes for directing said processor circuit to cause said access code to be produced cause said pool of access codes to be searched for an access code associated with said callee identifier to identify the channel usable by the mobile telephone to initiate a call to the callee.
- 20           **87.** The system of claim **73** wherein said codes for directing said processor circuit to cause said access code to be produced cause a timestamp for use in determining when the usability of said access code to initiate a call to the callee will expire, to be stored in association with said access code.
- 25           **88.** The system of claim **87** wherein said codes for directing said processor circuit to cause communication to be established cause communication to be established only if the usability of said access code to initiate a call to the callee has not expired.
- 30           **89.** The system of claim **71** wherein said network interface comprises a non-voice network interface, and wherein codes for directing said processor circuit to transmit include codes for directing said processor

circuit to cause said access code reply message to be transmitted using said non-voice network interface on a non-voice network.

5           **90.** A computer readable medium encoded with codes for directing a processor circuit to enable a mobile telephone to initiate a call to a callee through a channel, the codes being operable to direct the processor circuit:

10                           receive from the mobile telephone an access code request message including a callee identifier associated with the callee;

15                           communicate with said routing controller to obtain from said routing controller an access code identifying the channel, said access code being different from the callee identifier and useable by the mobile telephone to initiate a call to the callee using the channel; and

                          cause an access code reply message including said access code to be transmitted to the mobile telephone.

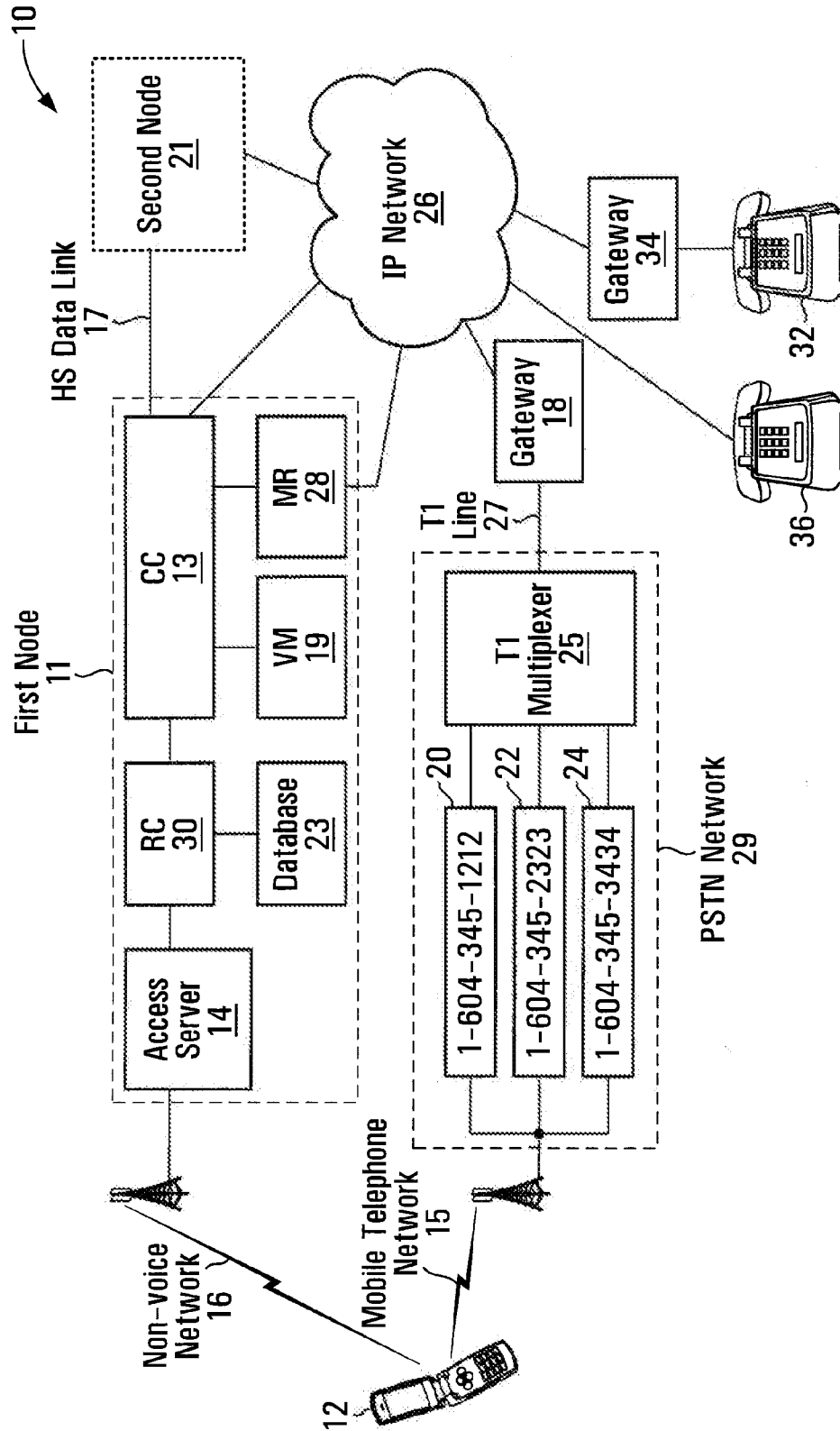


FIG. 1

Mobile Telephone (12)

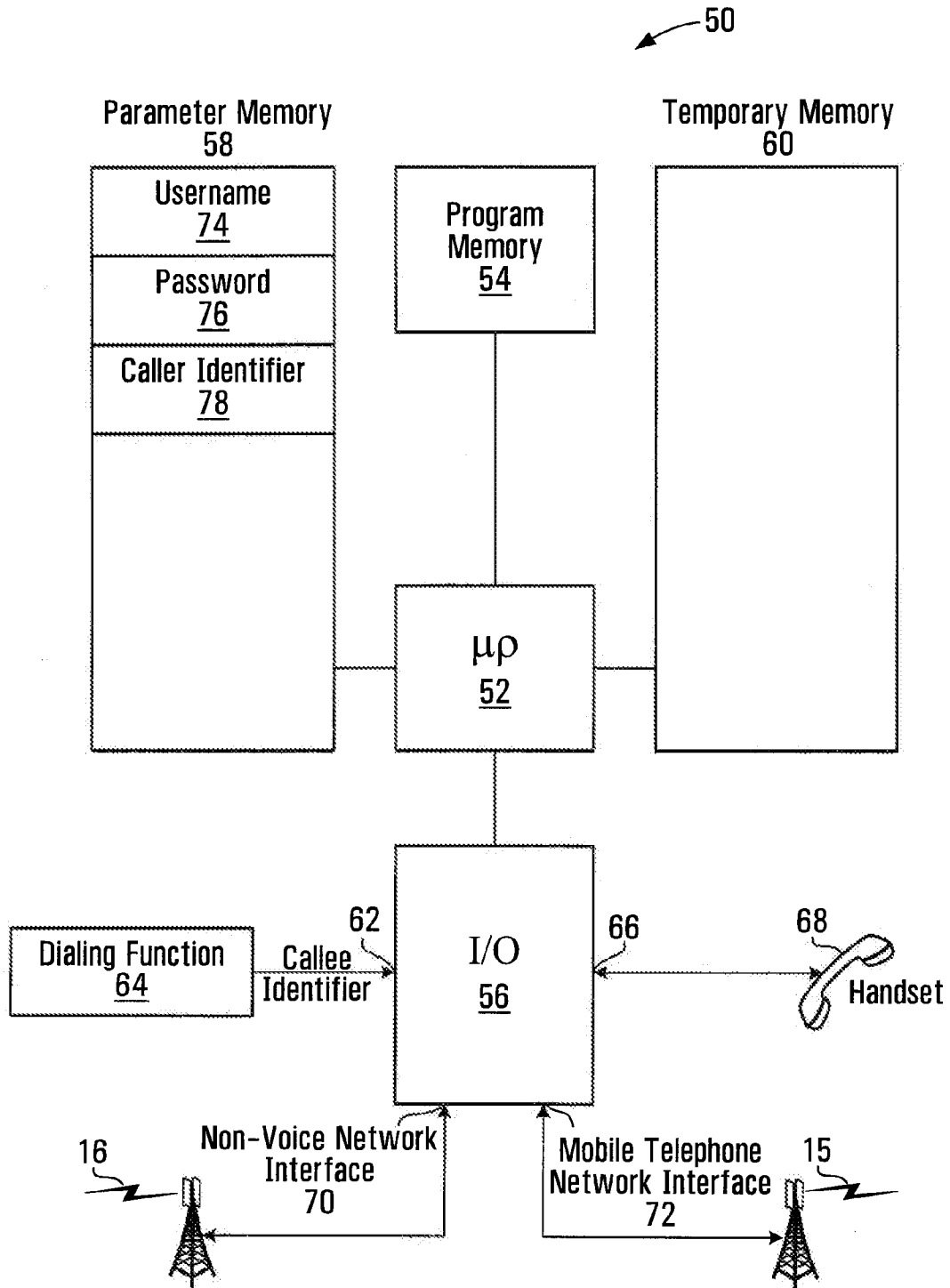


FIG. 2

3/17

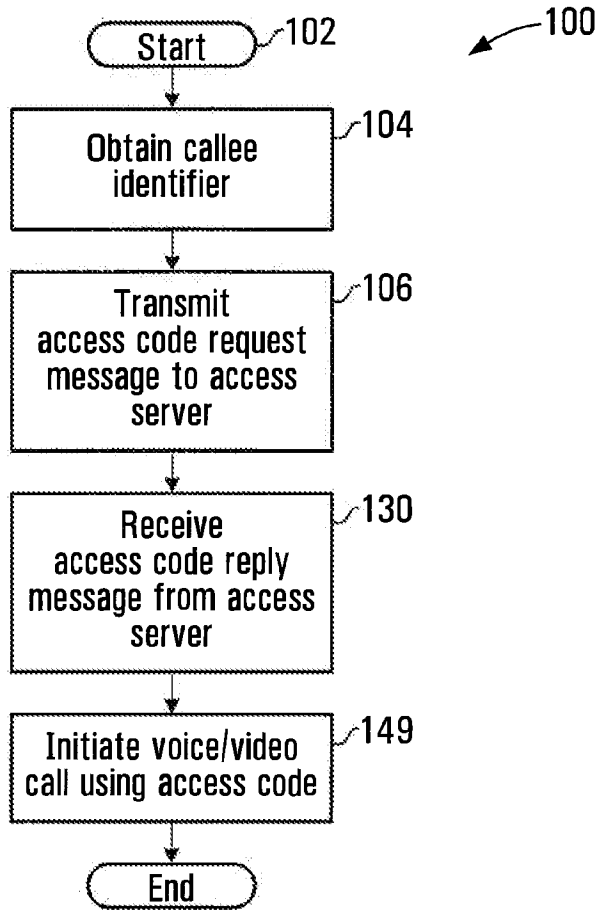


FIG. 3

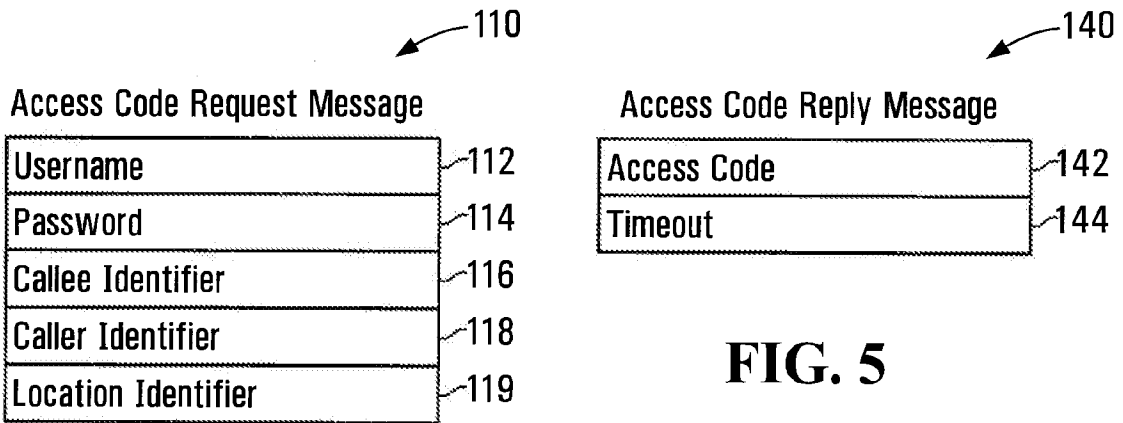


FIG. 4

FIG. 5

4/17

Access Server (14)

150

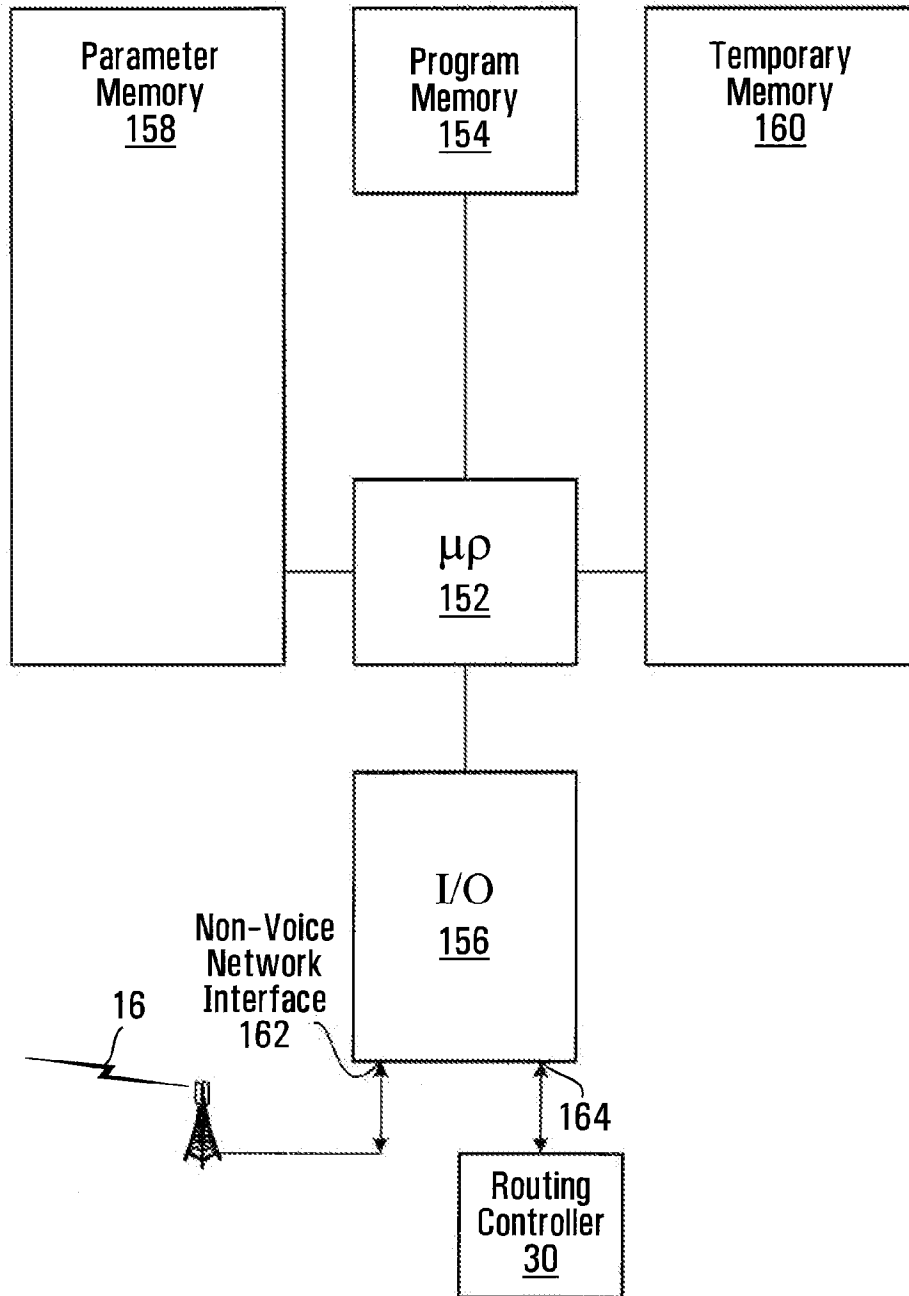
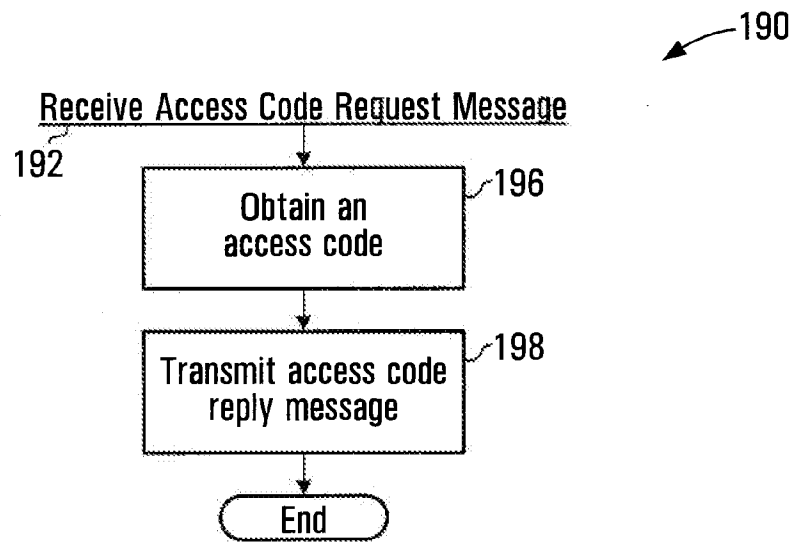


FIG. 6

5/17



**FIG. 7**



6/17

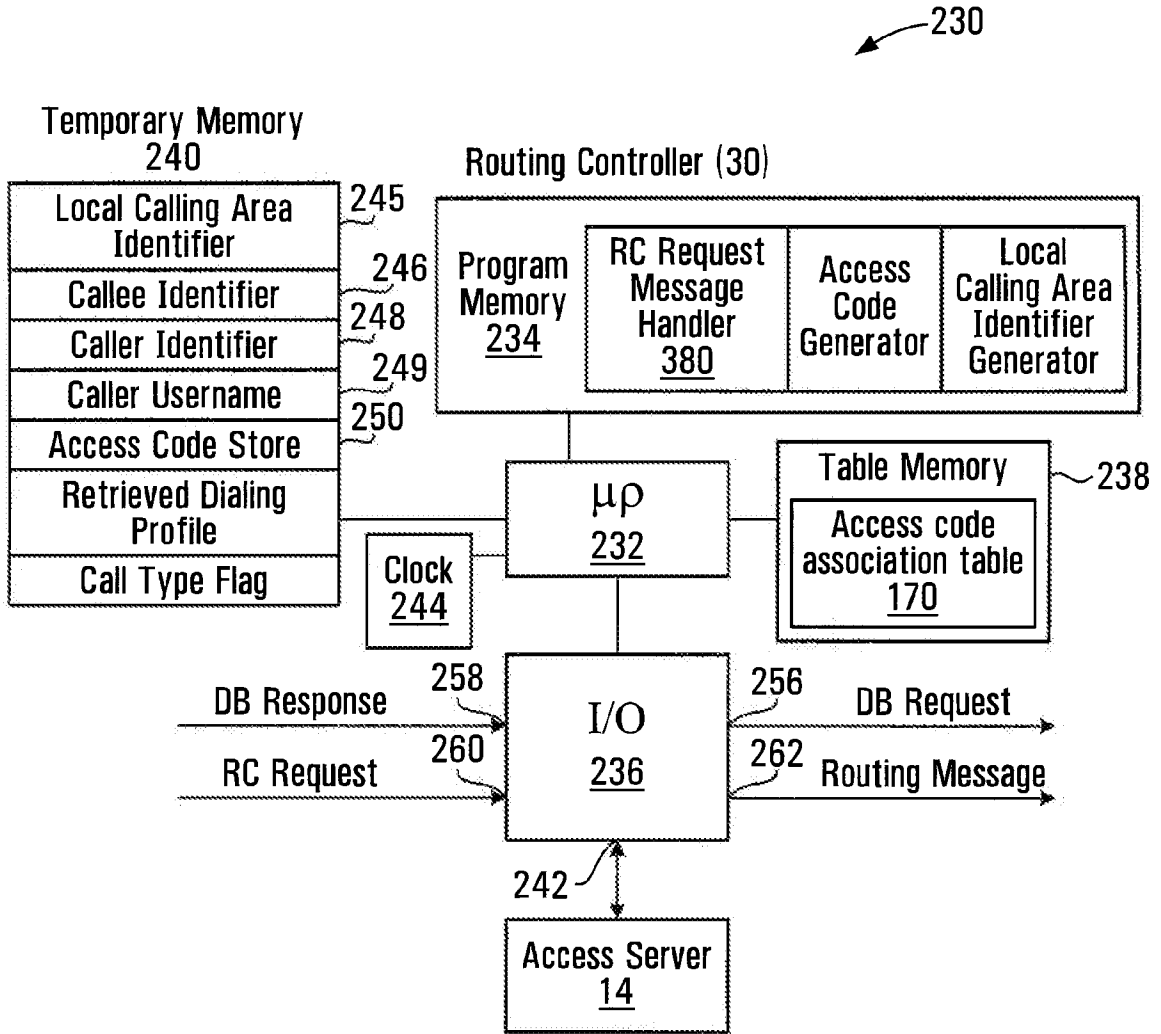


FIG. 8

↖ 200

**Dialing Profile for a User**

---

|       |                                              |                             |
|-------|----------------------------------------------|-----------------------------|
| 202 ~ | <b>Username</b>                              | Assigned on Subscription    |
| 204 ~ | <b>Domain</b>                                | Domain Associated with User |
| 206 ~ | <b>NDD</b>                                   | 1                           |
| 208 ~ | <b>IDD</b>                                   | 011                         |
| 210 ~ | <b>Country Code</b>                          | 1                           |
| 212 ~ | <b>Local Area Codes</b>                      | 604;778                     |
| 214 ~ | <b>Caller Minimum Local # Length</b>         | 10                          |
| 216 ~ | <b>Caller Maximum Local # Length</b>         | 10                          |
| 218 ~ | <b>Reseller</b>                              | Retailer                    |
| 220 ~ | <b>Maximum # of concurrent calls</b>         | Assigned on Subscription    |
| 222 ~ | <b>Current # of concurrent calls</b>         | Assigned on Subscription    |
| 224 ~ | <b>Default Local Calling Area Identifier</b> | Assigned on Subscription    |

**FIG. 9**

170

| 171                           | 173            | 175                | 177               | 179               | 183             |
|-------------------------------|----------------|--------------------|-------------------|-------------------|-----------------|
| Local Calling Area Identifier | Access Code    | Channel Identifier | Callee Identifier | Caller Identifier | Caller Username |
| 172 ~ XXXX                    | 1-604-345-1212 | 20                 |                   |                   |                 |
| 174 ~ XXXX                    | 1-604-345-2323 | 22                 | 1-403-789-1234    | 1-416-444-1441    | 2001 1050 8667  |
| 176 ~ XXXX                    | 1-604-345-3434 | 24                 |                   |                   |                 |
| 178 ~ XXXX                    | 1-416-234-4646 | XX                 | 1-604-321-1234    | 1-416-444-1234    | 2001 1050 4141  |
| 180 ~ XXXX                    | 1-416-234-6868 | XY                 |                   |                   |                 |

| 181     | 182              |
|---------|------------------|
| Timeout | Timestamp        |
| 10      | 06-15-2008 10:31 |
| 10      | 06-15-2008 14:21 |

FIG. 10

9/17

370

**DID Bank Table Record**

|                               |     |
|-------------------------------|-----|
| Username                      | 371 |
| User Domain                   | 372 |
| DID                           | 373 |
| Callee Identifier             | 374 |
| Caller Identifier             | 375 |
| Timeout                       | 376 |
| Timestamp                     | 377 |
| Local Calling Area Identifier | 378 |
| Channel Identifier            | 379 |
| Caller Username               | 381 |

**FIG. 11**

10/17

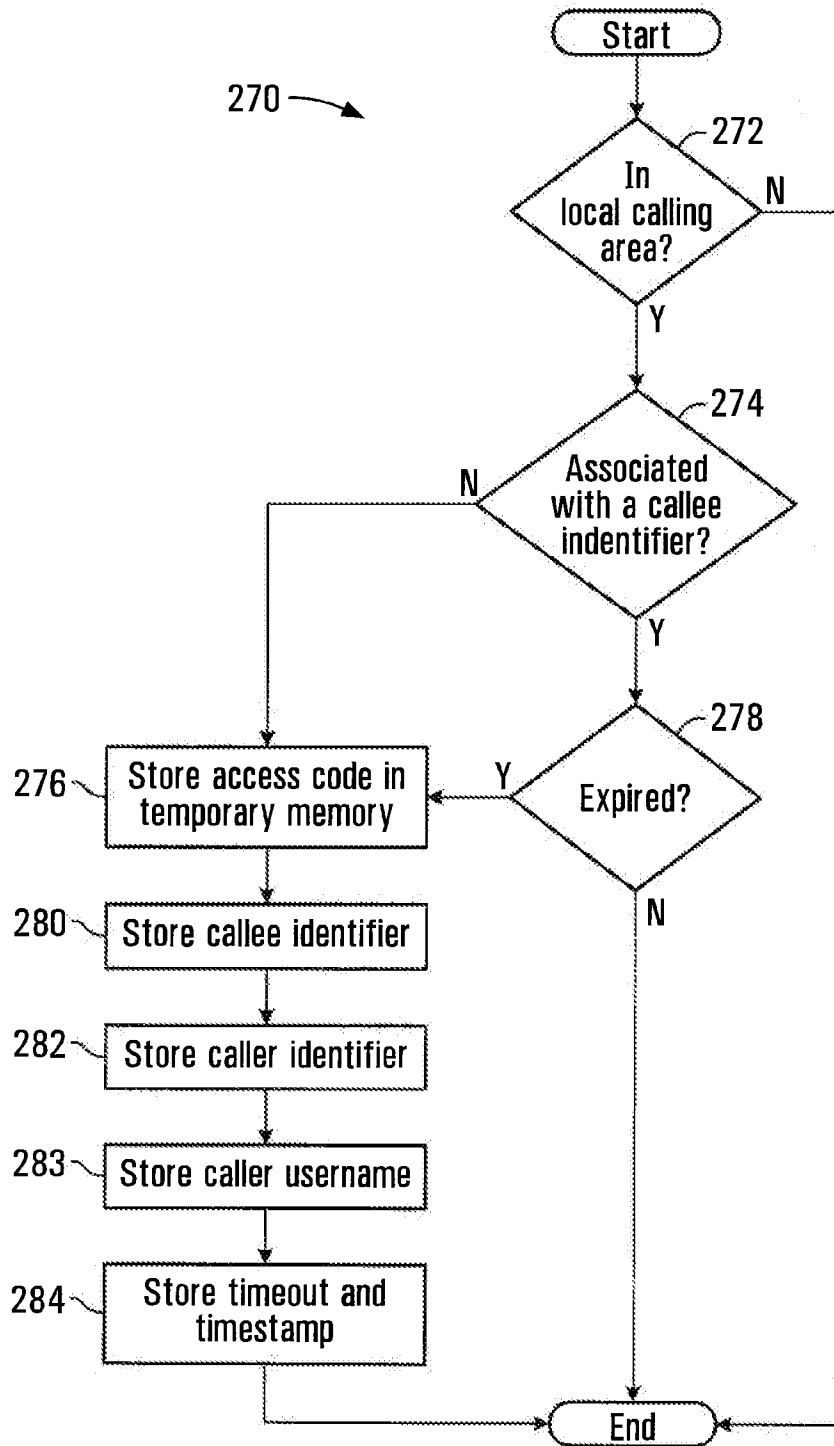
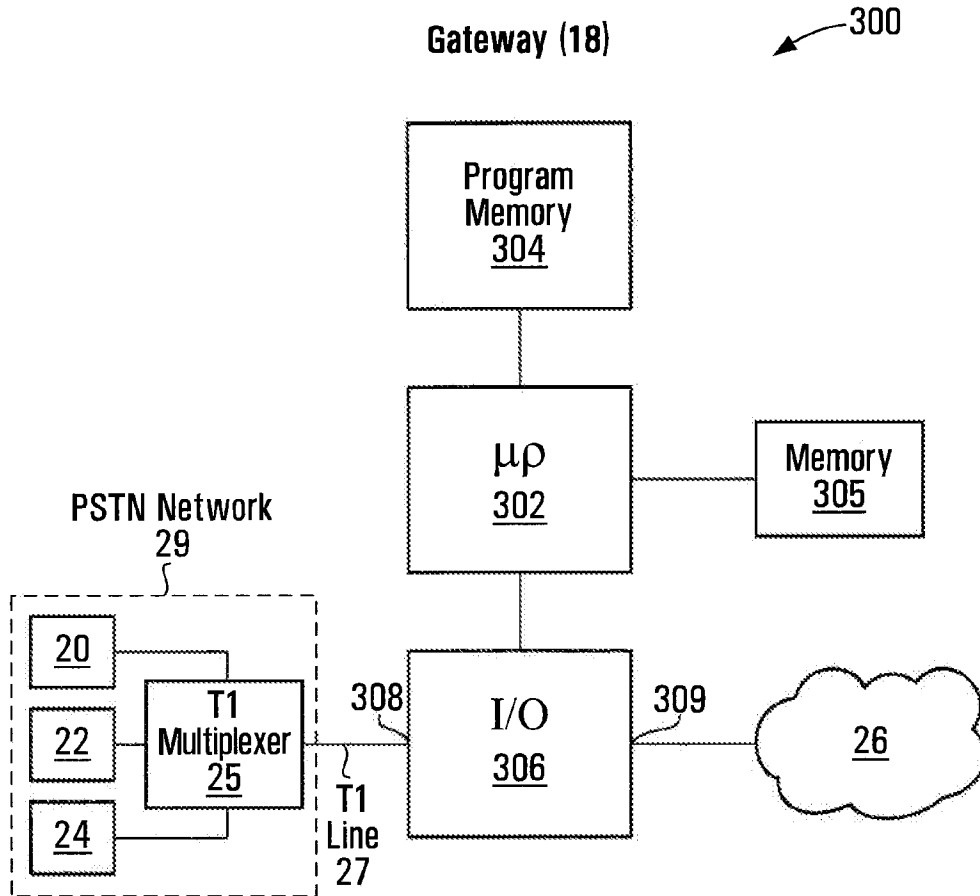
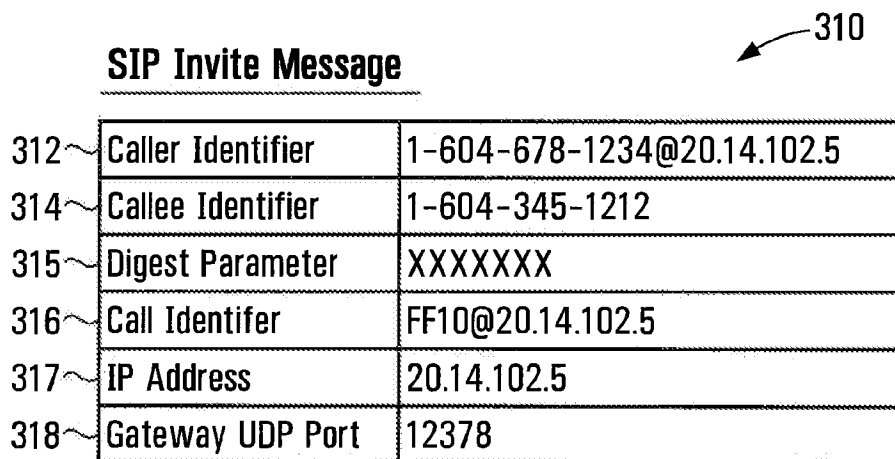


FIG. 12

11/17



**FIG. 13**



**FIG. 14**

12/17

Call Controller (13)

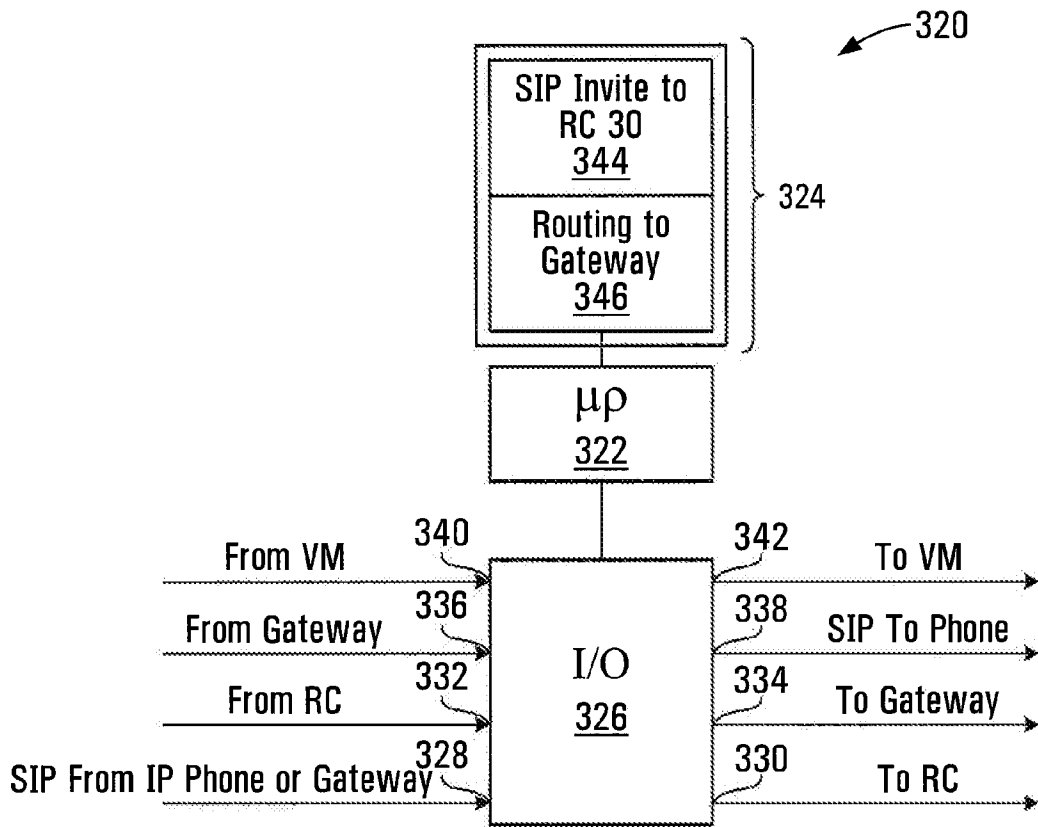
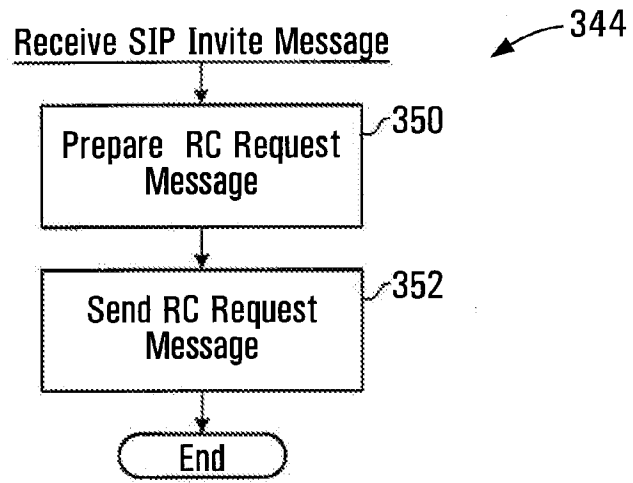


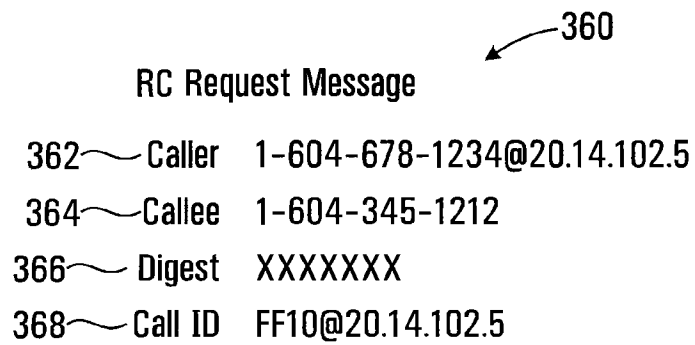
FIG. 15

13/17

**SIP Invite Request Process**



**FIG. 16**



**FIG. 17**



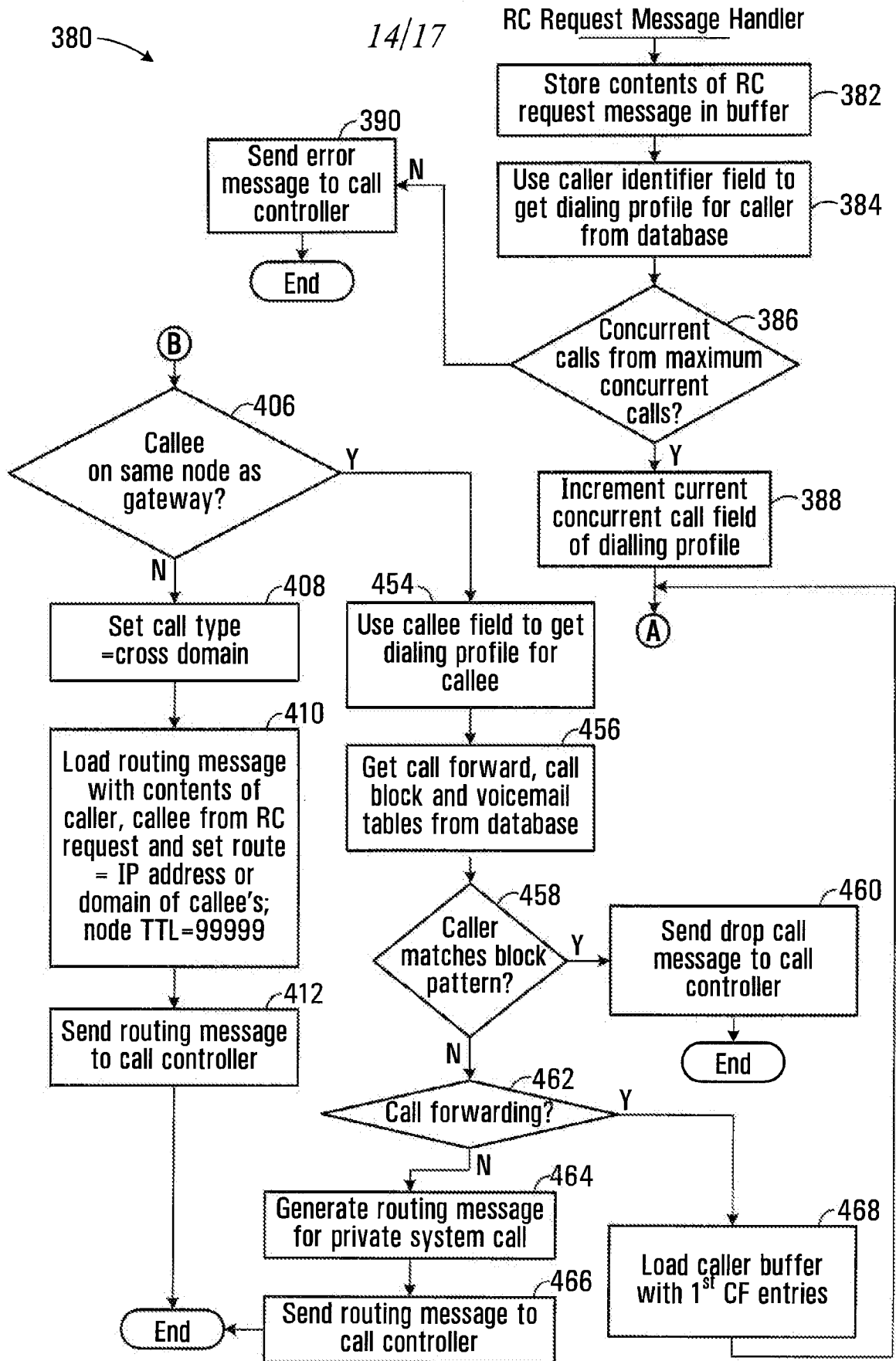
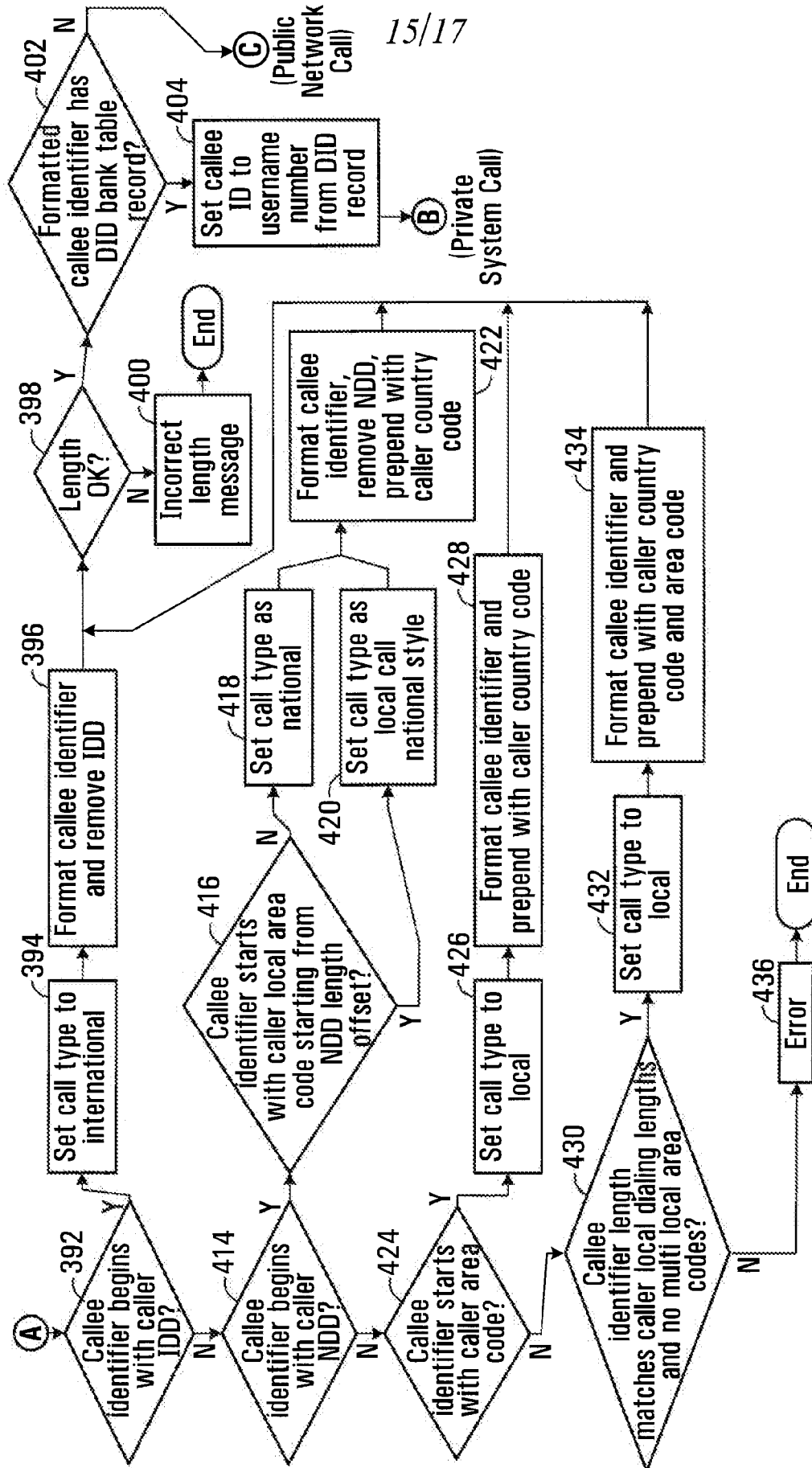


FIG. 18A

+



15/17

FIG. 18B

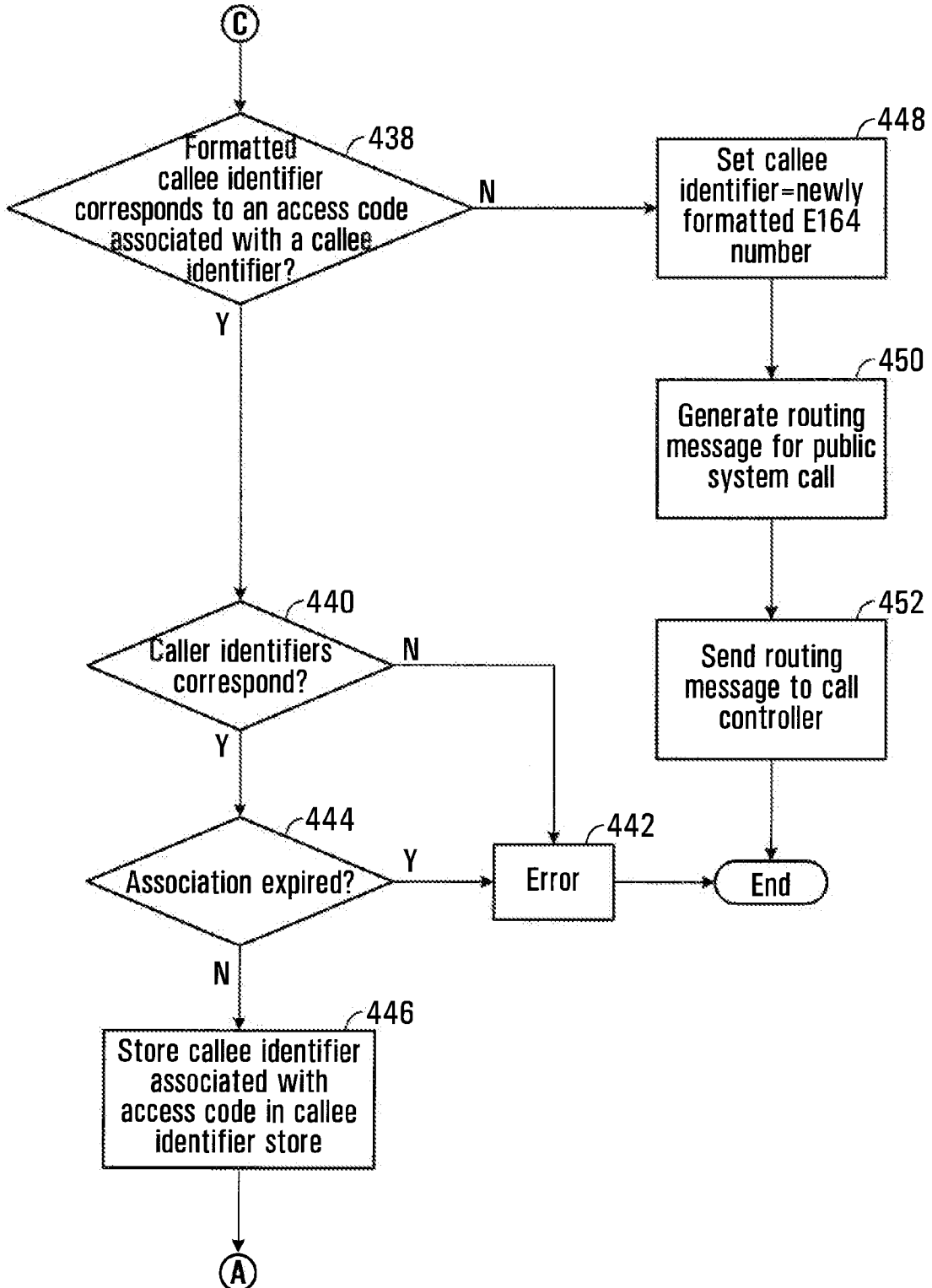


FIG. 18C

17/17

**Gateway Node Association Table**

480

|     | 486                | 488             |
|-----|--------------------|-----------------|
|     | Gateway IP Address | Node Identifier |
| 482 | 20.14.102.5        | 2               |
| 484 | 104.12.131.12      | 5               |

**FIG. 19**

(19) World Intellectual Property Organization  
International Bureau



(43) International Publication Date  
24 March 2011 (24.03.2011)

(10) International Publication Number  
**WO 2011/032256 A1**

- (51) **International Patent Classification:**  
H04L 12/66 (2006.01) H04W 36/02 (2009.01)  
H04L 29/06 (2006.01) H04W 36/18 (2009.01)
- (21) **International Application Number:**  
PCT/CA2009/001317
- (22) **International Filing Date:**  
17 September 2009 (17.09.2009)
- (25) **Filing Language:** English
- (26) **Publication Language:** English
- (71) **Applicant (for all designated States except US): DIGI-FONICA (INTERNATIONAL) LIMITED [CA/CA];** Suite #890, 999 West Hastings Street, Vancouver, British Columbia V6C 2W2 (CA).
- (72) **Inventor; and**
- (75) **Inventor/Applicant (for US only): HUTTUNEN, Pentti Kalevi [CA/CA];** 76-3180 East 58th Avenue, Vancouver, British Columbia V5S 3S8 (CA).
- (74) **Agent: KNOX, John W.;** Smart & Biggar, 2200-650 West Georgia Street, Vancouver, British Columbia V6B 4N8 (CA).

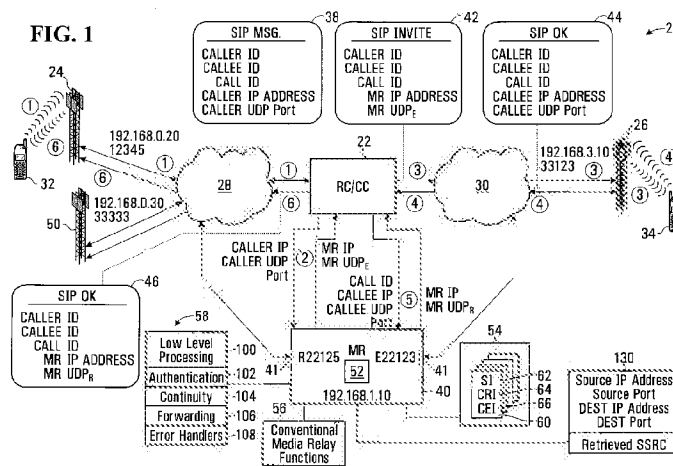
- (81) **Designated States (unless otherwise indicated, for every kind of national protection available):** AE, AG, AL, AM, AO, AT, AU, AZ, BA, BB, BG, BH, BR, BW, BY, BZ, CA, CH, CL, CN, CO, CR, CU, CZ, DE, DK, DM, DO, DZ, EC, EE, EG, ES, FI, GB, GD, GE, GH, GM, GT, HN, HR, HU, ID, IL, IN, IS, JP, KE, KG, KM, KN, KP, KR, KZ, LA, LC, LK, LR, LS, LT, LU, LY, MA, MD, ME, MG, MK, MN, MW, MX, MY, MZ, NA, NG, NI, NO, NZ, OM, PE, PG, PH, PL, PT, RO, RS, RU, SC, SD, SE, SG, SK, SL, SM, ST, SV, SY, TJ, TM, TN, TR, TT, TZ, UA, UG, US, UZ, VC, VN, ZA, ZM, ZW.
- (84) **Designated States (unless otherwise indicated, for every kind of regional protection available):** ARIPO (BW, GH, GM, KE, LS, MW, MZ, NA, SD, SL, SZ, TZ, UG, ZM, ZW), Eurasian (AM, AZ, BY, KG, KZ, MD, RU, TJ, TM), European (AT, BE, BG, CH, CY, CZ, DE, DK, EE, ES, FI, FR, GB, GR, HR, HU, IE, IS, IT, LT, LU, LV, MC, MK, MT, NL, NO, PL, PT, RO, SE, SI, SK, SM, TR), OAPI (BF, BJ, CF, CG, CI, CM, GA, GN, GQ, GW, ML, MR, NE, SN, TD, TG).

**Declarations under Rule 4.17:**

- as to the identity of the inventor (Rule 4.17(i))
- as to applicant's entitlement to apply for and be granted a patent (Rule 4.17(ii))

[Continued on next page]

(54) **Title:** UNINTERRUPTED TRANSMISSION OF INTERNET PROTOCOL TRANSMISSIONS DURING ENDPOINT CHANGES



(57) **Abstract:** A method apparatus and computer readable medium for facilitating uninterrupted transmission of internet protocol (IP) transmissions containing real time transport protocol (RTP) data during endpoint changes. When an IP transmission is received at the caller RTP port or the callee RTP port, a call record having a caller RTP port identifier or a callee RTP port identifier matching a destination port identifier in the IP transmission is located and when the destination port identifier in the IP transmission matches the caller RTP port identifier of the record, a source IP address identifier and source port identifier from the IP transmission are set as the caller IP address identifier and caller port identifier respectively of the record when the caller IP address identifier and caller port identifier do not match the source IP address identifier and source port identifier respectively and a received SSRC identifier in the IP transmission matches the caller SSRC identifier. When the destination port identifier in the IP transmission matches the callee RTP port identifier of the record, the source IP address identifier and source port identifier from the IP transmission are set as the callee IP address identifier and callee port identifier respectively of the record when the callee IP address identifier and callee port identifier do not match the source IP address identifier and source port identifier respectively and the received SSRC identifier in the IP transmission matches the callee SSRC identifier.

WO 2011/032256 A1

— *of inventorship (Rule 4.17(iv))*

**Published:**

— *with international search report (Art. 21(3))*

## UNINTERRUPTED TRANSMISSION OF INTERNET PROTOCOL TRANSMISSIONS DURING ENDPOINT CHANGES

### BACKGROUND OF THE INVENTION

#### 5 1. Field of Invention

This invention relates to internet protocol (IP) transmissions and, more particularly, to uninterrupted transmission of IP transmissions containing real time transport protocol (RTP) data during endpoint changes.

10

#### 2. Description of Related Art

Internet Protocol (IP) transmission systems are known to use media relays to relay IP transmissions from one endpoint to another. In a telephone system, the media relay relays IP transmissions between a caller and a callee. An IP session is established by a call controller, which interacts with the media relay, the caller and the callee to convey to each of these entities the IP addresses and ports to which they should send IP transmissions and from which they should expect IP transmissions. The media relay is configured to accept packets conveyed by IP transmissions from specified caller and callee IP addresses and ports. In some systems, such as mobile telephone systems, a mobile telephone may be in communication with a first base station while in a certain geographical area and there may be a handoff of the call to another base station when the mobile telephone is moved to a different geographical location. Communications between the base stations and the mobile telephones are conducted on a Global System for Mobile Communication (GSM) network or other cellular network, for example, and the base stations convert messages to and from the GSM network and the IP network and thus, the base stations establish the caller and callee IP addresses and ports. Each base station will have a unique IP address and UDP port number that it associates or assigns to the mobile telephone with which it has established communication in the conventional manner over the cellular network. Thus, a conventional media relay will reject IP streams from

30

-2-

the new base station after handoff of the call because such streams are seen as being transmitted by an unauthorized source. This generally prevents voice over IP telephone calls from being made through systems that employ media relays without further call handling.

5

The Session Initiation Protocol (SIP) RFC 3261 provided by the Internet Engineering Task Force (IETF) specifies a mechanism for an endpoint to notify another endpoint if its IP address changes. This mechanism employs a signaling message that conveys an identification of new media properties for the endpoint whose IP address has changed. The use of SIP messages for this purpose, however, adds extra overhead and delays to the call as signaling messages must be routed through the call controller and the call controller must communicate with the media relay and endpoints to re-configure the media relay to accept IP transmissions from the endpoint having the new IP address and to cause IP transmission to be relayed thereto each time a handoff occurs.

10

15

### **SUMMARY OF THE INVENTION**

In accordance with one aspect of the invention, there is provided a method for facilitating uninterrupted transmission of internet protocol (IP) transmissions containing real time transport protocol (RTP) data during endpoint changes. The method involves maintaining records, each record associating session information, caller information and callee information for IP communication sessions. The session information includes caller and callee RTP port identifiers identifying caller and callee RTP ports respectively of a media relay. The caller information includes a caller IP address identifier and a caller port identifier to which IP transmissions received at the callee RTP port are transmitted from the media relay, and a caller synchronization source (SSRC) identifier. The callee information includes a callee IP address identifier and a callee port identifier to which IP transmissions received at the caller RTP port are transmitted from the media relay, and a callee SSRC identifier. When an IP transmission is received at the caller RTP port or the callee RTP port, the record having a caller RTP port identifier or a callee RTP port identifier

20

25

30



matching a destination port identifier in the IP transmission is located. When the record is located and when the destination port identifier in the IP transmission matches the caller RTP port identifier of the record, a source IP address identifier and source port identifier from the IP transmission are set as the caller IP address identifier and caller port identifier respectively of the record when the caller IP address identifier and caller port identifier do not match the source IP address identifier and source port identifier respectively and a received SSRC identifier in the IP transmission matches the caller SSRC identifier. When the destination port identifier in the IP transmission matches the callee RTP port identifier of the record, the source IP address identifier and source port identifier from the IP transmission are set as the callee IP address identifier and callee port identifier respectively of the record when the callee IP address identifier and callee port identifier do not match the source IP address identifier and source port identifier respectively and the received SSRC identifier in the IP transmission matches the callee SSRC identifier.

The method may involve determining whether the IP transmission is a pre-determined transmission and, if so, determining whether the IP transmission is from the caller or callee. When the pre-determined IP transmission is received from the caller, the method involves storing the received SSRC identifier as the caller SSRC identifier in the record and when the pre-determined IP transmission is received from the callee, the method involves storing the received SSRC identifier as the callee SSRC identifier in the record.

The method may involve determining whether the IP transmission is a pre-determined transmission and, if so, where the caller and callee are configured to use the same SSRC identifier, storing the received SSRC identifier as the caller SSRC identifier in the record and as the callee SSRC identifier in the record.

-4-

The method may involve causing the media relay to forward the IP transmission to the callee at the callee IP address and callee UDP port identified by the callee IP address identifier and callee UDP port identifier of the record and identifying the source of the IP transmission forwarded to the callee with the callee RTP port identifier when the IP transmission was received at the caller RTP port, and causing the media relay to forward the IP transmission to the caller at the caller IP address and caller UDP port identified by the caller information of the record and identifying the source of the IP transmission forwarded to the caller with the caller RTP port identifier when the IP transmission was received at the callee RTP port.

In accordance with another aspect of the invention, there is provided a media relay apparatus for facilitating uninterrupted transmission of internet protocol (IP) transmissions containing real time transport protocol (RTP) data during endpoint changes. The apparatus includes a processor, input/output interfaces in communication with the processor to provide for physical connection to an IP network, program memory and storage memory. The program memory is encoded with codes for directing the processor to:

provide a logical input/output interface interacting with the input/output interfaces to define caller and callee RTP ports;

maintain call records in the storage memory, each call record having fields associating session information, caller information and callee information for IP communication sessions, the fields associating session information including caller and callee RTP port identifier fields identifying the caller and callee RTP ports respectively; and the caller information including a caller IP address identifier field and a caller port identifier field to which IP transmissions received at the callee RTP port are to be transmitted, and a caller synchronization source (SSRC) identifier field, and the callee information including a callee IP address identifier field and a callee port identifier field to which IP transmissions

-5-

received at the caller RTP port are to be transmitted, and a callee SSRC identifier field.

5 The codes further direct the processor to identify one of the records having the caller RTP port identifier field contents or the callee RTP port identifier field contents matching a destination port identifier in the IP transmission when an IP transmission is received at the caller RTP port or the callee RTP port.

10 When such a record is respectively located and when the destination port identifier in the IP transmission matches the contents of the caller RTP port identifier field of the record, the codes direct the processor to store a source IP address identifier and source port identifier from the IP transmission in the caller IP address identifier field and caller port identifier field respectively when the contents of the caller IP address identifier field and caller port identifier field do not match the source IP address identifier and source port identifier respectively and a received SSRC identifier in the IP transmission matches the contents of the caller SSRC identifier field.

20 When the destination port identifier in the IP transmission matches the contents of the callee RTP port identifier field of the record, the codes direct the processor to store the source IP address identifier and source port identifier from the IP transmission in the callee IP address identifier field and callee port identifier field respectively when the contents of the callee IP address identifier field and the callee port identifier field do not match the source IP address identifier and source port identifier respectively and the received SSRC identifier in the IP transmission matches the contents of the callee SSRC identifier field.

30 The program memory may be further encoded with codes for directing the processor to determine whether the IP transmission is a pre-determined transmission and, if so, determine whether the IP transmission is from the

5 caller or callee and when the pre-determined IP transmission is received from the caller, store the received SSRC identifier in the caller SSRC identifier field in the record and when the pre-determined IP transmission is received from the callee, store the received SSRC in the callee SSRC identifier field in the record.

10 The program memory may be further encoded with codes for directing the processor to determine whether the IP transmission is a pre-determined transmission and, if so, where the caller and callee are configured to use the same SSRC, store the received SSRC in the caller SSRC identifier field in the record and in the callee SSRC identifier field in the record.

15 The program memory may be further encoded with codes for directing the processor to:

20 when the IP transmission is received at the caller RTP port, forward the IP transmission to the callee identified by the contents of the callee IP address identifier field and the callee port identifier field and identify the source of the IP transmission according to the contents of the callee RTP port identifier field; and

25 when the IP transmission is received at the callee RTP port, forward the IP transmission to the caller identified by the contents of the caller IP address identifier field and the caller port identifier field and identify the source of the IP transmission according to the contents of the caller RTP port identifier field.

30 In accordance with another aspect of the invention, there is provided a media relay apparatus for facilitating uninterrupted transmission of internet protocol (IP) transmissions containing real time transport protocol (RTP) data during endpoint changes. The media relay apparatus includes a processor, physical connection provisions for providing physical connections between the processor and an IP network, provisions interacting with the physical

-7-

connection provisions and the processor for providing a logical input/output interface defining caller and callee RTP ports. The apparatus further includes provisions for maintaining call records in memory, each of the call records having provisions for associating session information, caller information and callee information for IP communication sessions. These provisions include provisions for storing caller and callee RTP port identifiers identifying the caller and callee RTP ports respectively, provisions for storing a caller IP address identifier and a caller port identifier to which IP transmissions received at the callee RTP port are to be transmitted, provisions for storing a caller synchronization source (SSRC) identifier, provisions for storing a callee IP address identifier and a callee port identifier to which IP transmissions received at the caller RTP port are to be transmitted, and provisions for storing a callee SSRC identifier. The apparatus further includes provisions for identifying one of the records having a caller RTP port identifier or a callee RTP port identifier matching a destination port identifier in the IP transmission when an IP transmission is received at the caller RTP port or the callee RTP port. The apparatus further includes provisions for determining whether the destination port identifier in the IP transmission matches the caller RTP port identifier of the record. The apparatus further includes provisions for setting the caller IP address identifier and caller port identifier as the source IP address identifier and source port identifier respectively from the IP transmission when the caller IP address identifier and caller port identifier do not match the source IP address identifier and source port identifier respectively and a received SSRC identifier in the IP transmission matches the contents of the caller SSRC identifier and the destination port identifier in the IP transmission matches the caller RTP port identifier of the record. The apparatus further includes provisions for determining whether the destination port identifier in the IP transmission matches the callee RTP port identifier of the record and provisions for setting the callee IP address identifier and callee port identifier as the source IP address identifier and source port identifier respectively from the IP transmission when the callee IP address identifier and the callee port identifier do not match the source IP address identifier and source port identifier respectively and the received SSRC identifier in the IP

transmission matches the contents of the callee SSRC identifier and the destination port identifier in the IP transmission matches the callee RTP port identifier of the record.

5 The apparatus may further include provisions for determining whether the IP transmission is a pre-determined transmission and, if so, determining whether the IP transmission is from the caller or callee and provisions for storing the received SSRC identifier as the caller SSRC identifier when the pre-determined IP transmission is received from the caller and provisions for  
10 storing the received SSRC identifier as the callee SSRC identifier when the pre-determined IP transmission is received from the callee.

The apparatus may further include provisions for determining whether the IP transmission is a pre-determined transmission and provisions for storing the received SSRC identifier as the caller SSRC identifier and as the callee SSRC  
15 identifier where the caller and callee are configured to use the same SSRC.

The apparatus may further include provisions for forwarding the IP transmission to the callee identified by the callee IP address identifier and the callee port identifier and for identifying the source of the IP transmission with the callee RTP port identifier when the received IP transmission was received  
20 at the caller RTP port and provisions for forwarding the IP transmission to the caller identified by the caller IP address identifier and caller port identifier and for identifying the source of the IP transmission with the caller RTP port identifier when the received IP transmission was received at the callee RTP  
25 port.

In accordance with another aspect of the invention, there is provided a computer readable medium encoded with codes for directing a processor of a media relay to facilitate uninterrupted transmission of internet protocol (IP)  
30 transmissions containing real time transport protocol (RTP) data during endpoint changes, the codes comprising codes for directing the processor to:

maintain records, each record associating session information, caller information and callee information for IP communication sessions;

5 the session information including caller and callee RTP port identifiers identifying caller and callee RTP ports respectively of the media relay;

10 the caller information including a caller IP address identifier and a caller port identifier to which IP transmissions received at the callee RTP port are transmitted from the media relay, a caller synchronization source (SSRC) identifier; and

15 the callee information including a callee IP address identifier and a callee port identifier to which IP transmissions received at the caller RTP port are transmitted from the media relay, a callee SSRC identifier; and

20 when an IP transmission is received at the caller RTP port or the callee RTP port:

identify one of the records having the caller RTP port identifier or the callee RTP port identifier matching a destination port identifier in the IP transmission;

25 when the record is identified and when the destination port identifier in the IP transmission matches the caller RTP port identifier of the record,

30 set a source IP address identifier and source port identifier from the IP transmission as the caller IP address identifier and caller port identifier respectively of the record when:

-10-

the caller IP address identifier and caller port identifier do not match the source IP address identifier and source port identifier respectively; and

5

a received SSRC identifier in the IP transmission matches the caller SSRC identifier; and

10

when the record is identified and when the destination port identifier in the IP transmission matches the callee RTP port identifier of the record,

15

set the source IP address identifier and source port identifier from the IP transmission as the callee IP address identifier and callee port identifier respectively of the record when:

20

the callee IP address identifier and callee port identifier do not match the source IP address identifier and source port identifier respectively; and

25

the received SSRC identifier in the IP transmission matches the callee SSRC identifier.

30

The computer readable medium may further include codes for directing the processor to determine whether the IP transmission is a pre-determined transmission and, if so, determine whether the IP transmission is from the caller or callee and when the pre-determined IP transmission is received from the caller, store the received SSRC identifier as the caller SSRC identifier in the record and when the pre-determined IP transmission is received from the



-11-

callee, store the received SSRC identifier as the callee SSRC identifier in the record.

5 The computer readable medium may further include codes for directing the processor to determine whether the IP transmission is a pre-determined transmission and, if so, where the caller and callee are configured to use the same SSRC, store the received SSRC identifier as the caller SSRC identifier in the record and as the callee SSRC identifier in the record.

10 The computer readable medium may further include codes for directing the processor to:

15 if the IP transmission was received at the caller RTP port, cause the media relay to forward the IP transmission to the callee at the callee IP address and callee UDP port identified by the callee IP address identifier and callee UDP port identifier and identify the source of the IP transmission forwarded to the callee with the callee RTP port identifier; and

20 if the IP transmission was received at the callee RTP port, cause the media relay to forward the IP transmission to the caller at the caller IP address and caller UDP port identified by the caller IP address identifier and caller UDP port identifier and identify the source of the IP transmission forwarded to the caller with the caller RTP port identifier.

25 Other aspects and features of the present invention will become apparent to those ordinarily skilled in the art upon review of the following description of specific embodiments of the invention in conjunction with the accompanying figures.

30

#### **BRIEF DESCRIPTION OF THE DRAWINGS**

In drawings which illustrate embodiments of the invention,

-12-

- Figure 1 is a schematic diagram illustrating a system for facilitating uninterrupted transmission of internet protocol (IP) transmissions containing real time transport protocol (RTP) data during endpoint changes, according to a first embodiment of the invention.
- 5 Figure 2 is a tabular representation of a call record used by the system shown in Figure 1.
- Figure 3 is a flow chart of an authentication routine executed by a processor of a media relay shown in the system shown in Figure 1.
- 10 Figure 4 is a schematic representation of an internet protocol (IP) transmission according to the prior art.
- Figure 5 is a tabular representation of the call record shown in Figure 2 as updated after receipt of an IP transmission at a caller port of the media relay shown in Figure 1.
- 15 Figure 6 is a flow chart of a continuity routine executed by the processor of the media relay shown in Figure 1.
- Figure 7 is a tabular representation of the call record as updated after execution of the continuity routine shown in Figure 6 when a pre-determined packet is received in the IP transmission.
- 20 Figure 8 is a tabular representation of the call record shown in Figure 7 further updated by the continuity routine after an IP transmission received subsequent to the pre-determined packet is received.
- Figure 9 is a flow chart of a forwarding routine executed by the processor of the media relay shown in Figure 1 to relay the received IP transmission to a caller or callee with a source identification provided by the call record as updated by the continuity routine shown in Figure 6.
- 25

#### DETAILED DESCRIPTION

30 Referring to Figure 1, a system for handling voice over internet protocol (IP) transmissions and more generally, IP transmissions, is shown generally at 20. The system 20 includes a routing controller/call controller (RC/CC) system 22 and first, second and third base stations 24, 26 and 50. The base stations 24,

-13-

26 and 50 are operable to communicate with the RC/CC 22 via a network or, as shown in this embodiment, separate networks 28 and 30, which in this embodiment depict the internet. The first and second base stations 24 and 26 in this embodiment are operable to communicate with caller and callee mobile telephones 32 and 34 respectively using a cellular wireless network in a conventional manner as is known in the art. The first and second base stations 24 and 26 thus act as “endpoints” for IP transmissions between the caller and callee.

Generally, to establish a call from the caller mobile telephone 32 to the callee mobile telephone 34, the caller mobile telephone transmits to the first base station 24 a session initiation protocol (SIP) message shown generally at 38. The SIP message 38 is transmitted from the caller mobile telephone 32 to the base station 24 and the first base station 24 formats the SIP message 38 into an IP transmission and transmits the IP transmission through the internet 28 to the RC/CC 22. In this embodiment, the first base station 24 is preconfigured with a network IP address 192.168.0.20 and universal datagram protocol (UDP) port 12345.

In response to receipt of the SIP message 38, the RC/CC 22 communicates with a media relay 40 and sends the caller IP address identifier and caller UDP port identifier contained in the SIP message to the media relay 40 to identify the IP address and UDP port to which the media relay 40 should send communications to the first base station 24 for receipt by the caller mobile telephone 32.

The media relay 40 has input/output interfaces 41 in communication with the processor to provide for physical connection to an IP network such as the internet. The media relay 40 is programmed to provide a logical input/output interface that interacts with the input/output interfaces 41 to define caller and callee real time transport protocol (RTP) ports in the conventional manner.

-14-

In response, the media relay **40** is configured to send a media relay IP address identifier and media relay RTP port identifier that it associates with the callee identified by the contents of the callee ID field in the SIP message **38**. The media relay **40** sends this information to the RC/CC **22** to essentially inform the RC/CC **22** of the media relay IP address identifier and callee RTP port identifier that it should convey to the callee mobile telephone **34** so that the callee telephone can cause IP transmissions to be sent from the second base station **26** to the media relay **40** which can then subsequently forward those transmissions to the caller mobile telephone **32**.

10

In response to receipt of the media relay IP address identifier and the callee RTP port identifier designated by the media relay **40**, the RC/CC **22** transmits a SIP invite message **42** through the internet **30** to the callee mobile telephone **34** through the second base station **26**. In this embodiment, the second base station **26** has an IP address (**192.168.3.10**) and a UDP port number (**33123**). Thus, the RC/CC **22** directs this SIP invite message **42** to the IP address and UDP port associated with the callee mobile telephone **34** by the second base station **26**. The second base station **26** then communicates this SIP invite message **42** to the callee mobile telephone **34** over the wireless network and the callee mobile telephone **34** returns a SIP okay message **44** to the second base station **26**.

15

20

The SIP okay message format is shown at **44** and includes a caller identifier (ID), a callee ID, a call ID, a callee IP address identifier and a callee UDP port identifier. The callee IP address identifier is the IP address of the second base station **26** and the callee UDP port identifier is the UDP port identifier associated with the callee mobile telephone **34** by the second base station **26**. The second base station **26** sends the SIP okay message **44** in an IP transmission through the internet **30** to the RC/CC **22** which communicates the call ID, callee IP address identifier, and callee UDP port identifier contained in the SIP okay message **44** to the media relay **40** to identify to the media relay the IP address and UDP port associated with the callee. In response, the media relay **40** sends a reply message to the RC/CC **22**

25

30

-15-

containing a media relay IP address identifier and caller RTP port identifier of a caller RTP port assigned by the media relay, to which the first base station **24** should direct IP transmissions to the media relay for receipt by the callee mobile telephone **34**. In this embodiment, this message includes a media relay IP address identifier of **192.168.1.10** and a caller RTP port identifier (R**22125**).

The RC/CC **22** transmits a SIP okay message **46**, having a format as shown, through the internet **28** to the first base station **24** and the first base station communicates the media relay IP address identifier and the caller RTP port identifier associated with the caller to the caller mobile telephone **32**.

The above basic communications for establishing a call between the caller and callee mobile telephones **32** and **34** are described in further detail in Applicant's related International Application No. PCT/CA**2007/002150**. Of interest in connection with the present invention is the following way in which the media relay **40** is configured to permit the caller mobile telephone **32** to move to another geographical location in which a handoff occurs between the first base station **24** and the third base station **50** having an IP address identifier and UDP port identifier different from that of the first base station **24**.

When a handoff from the first base station **24** to the third base station **50** occurs, the caller mobile telephone **32** ceases communication with the first base station **24** and establishes communication with the third base station **50**. However, since the third base station **50** has a different IP address identifier and UDP port identifier than the first base station **24**, the media relay **40** will receive IP transmissions from the third base station **50** identifying the source of the transmissions with a different IP address identifier and UDP port identifier than those associated with the first base station. Normally, the media relay **40** would reject such communications as being from an unknown source, however, due to the configuration of the media relay described below, IP transmissions from the third base station **50** are not rejected and the call can continue uninterrupted. To facilitate this, the media relay **40** is configured

-16-

with additional functionality beyond that which merely relays communications between the caller and callee.

5 It is known that in general, a media relay **40** includes a processor **52**, memory **54** operable to be written to and read by the processor **52**, and program memory **56** containing codes readable by the processor **52** that define program instructions for directing the processor **52** to carry out conventional media relay functions for transferring IP transmissions between the caller and the callee. In order to provide the functionality of the present invention, in this  
10 embodiment, the media relay **40** is further configured with additional codes shown generally at **58** that direct the processor **52** to carry out the functionality described below and include functionality for configuring the memory **54** to include call records **60**.

15 These additional codes **58** may be stored on a computer readable medium such as a CD-ROM, flash drive, or in memory at a remotely located computer and may be downloaded to the program memory **56** or the media relay **40** in a conventional manner, for example.

20 Referring to Figure 2, an exemplary call record is shown generally at **60**. Each call record associates session information **62**, caller information **64** and callee information **66** for an IP communication session (i.e. call) handled by the media relay **40**. The session information **62** includes caller and callee RTP port identifier fields **68** and **70** for storing caller and callee RTP port  
25 identifiers identifying caller and callee RTP ports respectively of the media relay **40**. In this embodiment, the caller RTP port identifier is **R22125** and the callee RTP port identifier is **E22123**. The session information **62** may also include a caller RTCP port identifier field and a callee RTCP port identifier field, however, these are optional.

30 The caller information **64** includes a caller IP address identifier field **72** and a caller UDP port identifier field **74** that hold a caller IP address identifier and caller port UDP identifier to which IP transmissions received at the callee RTP

-17-

port are to be transmitted. In this embodiment, the caller IP address identifier is **192.168.0.20** and the caller UDP port identifier is **12345** and correspond to those of the first base station **24**, i.e. that associated with the caller. The caller information **64** further includes a caller sync source (SSRC) identifier field **76** for storing a caller sync source identifier associated with the caller side of the IP communication session. In one embodiment, until a pre-determined packet such as a first packet, for example, is received in connection with the call, this caller SSRC identifier is undefined.

5

In the embodiment shown, the caller information **64** further includes a packets sent field **78** and a packets received field **80** for holding numbers representing the number of packets sent to and received respectively from the caller although these fields are optional and the contents of these fields may be available from other functions on the media relay **40**.

10

15

Referring to Figure **2**, the callee information **66** includes a callee IP address identifier field **82** and a callee UDP port identifier field **84** that hold a callee IP address identifier and callee UDP port identifier identifying a callee address and UDP port to which IP transmissions received at the caller RTP port are to be transmitted. In this embodiment, the callee IP address identifier is **192.168.3.10** and the callee UDP port identifier is **33123** and correspond to those of the second base station **26**, i.e. that associated with the callee. The callee information **66** also includes a callee sync source (SSRC) identifier field **86** for storing a callee sync source identifier associated with the callee side of the IP communication session. In one embodiment, this callee SSRC identifier field **86** may be unpopulated until a predefined packet such as the first packet, for example, of the IP transmissions associated with the call is received.

20

25

In this embodiment, the callee information **66** also includes a packets sent field **88** and a packets received field **90** for storing numbers indicating the number of packets sent to and received from the caller. The call record **60** is populated with the information shown in Figure **2** during the course of the

30

-18-

normal message exchanges between the RC/CC **22**, the caller and callee and the media relay **40** described above that communicate to the caller and callee the media relay IP address and respective RTP port identifiers (**R22125** and **E22123**) to which communications are to be sent.

5

Referring back to Figure 1, the additional codes **58** for directing the processor **52** of the media relay **40** to carry out the functions that facilitate uninterrupted transmissions of IP transmissions include codes **100** for effecting a low level processing routine, codes **102** for effecting an authentication routine, codes **104** for effecting a continuity routine, codes **106** for effecting a forwarding routine and codes **108** for effecting error handler routines. The functionality of the low level processing routine codes **100** is not shown but generally relates to processing associated with layers **0** to **4** of the **7** layer ISO IP transmission protocol.

15

Referring to Figure 3, the functionality of the authentication routine is shown generally at **102**. Before describing this routine, however, please refer to Figure 4 which describes the generic nature of an IP transmission and the important fields of that transmission for effecting the use of the methods described herein.

20

In Figure 4, an IP transmission is shown generally at **110** and includes a PSEUDO header **112**, a UDP header **114**, a RTP header **116**, and a payload **118**. The PSEUDO header **112** includes various fields, the most important of which, in this embodiment, are source IP address identifier and destination address identifier fields **120** and **122** respectively. The UDP header **114** includes source port and destination port identifier fields **124** and **126** and the RTP header **116** includes a SSRC identifier field **128**. The payload **118** includes data representing, in this embodiment, audio and/or video data transmitted between the caller and the callee.

30

Referring back to Figure 3, the authentication routine **102** is executed in response to receipt of an IP transmission **110** at either the caller RTP port



-19-

R22125 of the media relay 40 or at the callee RTP port E22123 of the media relay. In response to receipt of an IP transmission 110 at either of these ports, the processor 52 of the media relay 40 is directed to store the source IP address contained in the source IP address identifier field 120, the source port identifier contained in the source port identifier field 124, the destination IP address contained in the destination IP address identifier field 122 and the destination port identifier contained in the destination port identifier field 126 in fields by the same name in a buffer memory 130 addressable by the processor 52. The low level processing routine codes 100 will perform the necessary functions to cleanly extract this information and in this embodiment, the storing of this information is effected by the authentication routine 102, as shown at 129. Alternatively, the low level processing routine codes 100 may store this information directly in the buffer memory 130. It will be appreciated that the buffer memory 130 may include separately addressable fields storing the respective information.

Referring to Figure 5, upon completion of the execution of block 129 or the low level processing routine codes 100, the call record 60 is updated with the number of packets received as shown at 136 where it is indicated that one packet has been received from the callee, for example.

Referring back to Figure 3, the authentication routine 102 further includes a block 132 that directs the processor 52 to find a call record such as shown at 60 in the memory 54 by matching the destination port identifier with at least one of the contents of the caller RTP port identifier field 74 and the contents of the callee RTP port identifier field 84 of any of the call records. To do this, the codes in block 132 may direct the media relay processor 52 to scan through all of the caller RTP port identifier fields and callee RTP port identifier fields of all of the call records 60 to find a match with the destination port identifier stored in the buffer memory 130.

-20-

Referring to Figure 3, block 134 directs the processor 52 to invoke an error handler as shown at 108 if no record is found and to proceed to execute the code 104 associated with the continuity routine if a record is found.

5 Referring to Figure 6, the continuity routine 104 begins with a first block 140 which directs the processor 52 to determine whether or not the IP transmission 110 has been received at the caller RTP port or the callee RTP port.

10 The identification of whether or not the IP transmission 110 is from the caller or callee can occur in a number of ways. One way, for example, is for the processor 52 to be responsive to interrupt signals that may be produced by the input/output interface circuitry 41 that physically implements the interface between the media relay 40 and the internet. Since the caller RTP port and  
15 callee RTP port have different port identifiers, the input/output interface circuitry 41 may identify the port which has received an IP transmission 110 and cause an interrupt signal and perhaps an interrupt handler (not shown) to be executed by the processor 52 in order to identify the specific port which has received the IP transmission 110.

20 Alternatively, when the processor 52 identifies the call record 60 by matching the destination port identifier received from the IP transmission 110 with at least one of the caller RTP port identifier and callee RTP port identifier in a call record, the matching RTP port identifier is inherently identified and this  
25 information can be used to identify the specific port that has received the IP transmission 110. A flag (not shown) may be set for example, to identify whether the IP transmission 110 is from the caller or callee, depending on whether there is a match of the destination port identifier with the callee or caller RTP identifier. Thus, if there is a match of the destination port identifier  
30 with the callee RTP port identifier, then the source must be the caller and if there is a match of the destination port identifier with the caller RTP port identifier, then the source must be the callee.

-21-

Thus, if a flag is used, block **140** can simply cause the processor **52** to read the flag to determine whether or not the IP transmission **110** is received from the caller or callee.

5 Assuming the IP transmission **110** is received from the caller, optionally, block **142** can direct the processor **52** to determine whether or not a pre-determined packet has been received. In this embodiment, the pre-determined packet is the first packet and thus can be determined by simply reading the contents of the packets received field **80** in the caller information **64** of the call record **60**  
10 identified at block **132** of the authentication routine **102**. Alternatively, the low level processing codes **100** may have previously stored the number of packets received in some other location readable by the processor **52** for use at this stage.

15 In this embodiment, the first packet received from the caller is the pre-determined packet and thus, when the first packet is received, block **144** directs the processor **52** to store the SSRC identifier received in the IP transmission **110** in the caller SSRC field **76** associated with the caller information **64** of the call record **60** as shown at **146** in Figure 7. The  
20 processor **52** is then directed to the forwarding routine **106**. If at block **142**, the IP transmission **110** includes a packet that is not the pre-determined packet, in particular, a packet received subsequent to the pre-determined packet, or where there will be no determination as to whether the received packet is a pre-determined packet, block **147** directs the processor **52**  
25 to determine whether the caller IP address identifier and caller port identifier in the caller information **64** of the call record **60** match the source IP address identifier and source port identifier received in the IP transmission **110**. If so, the IP transmission **110** has been received from the pre-established source (in this embodiment, the first base station **24**) and therefore, the processor **52**  
30 is directed to the forwarding routine **106**.

If at block **147** the caller IP address identifier and caller port identifier do not match the source IP address identifier and source port identifier, then the IP

-22-

transmission **110** is deemed to be originating from a different source (i.e. the third base station **50**) in which case block **148** directs the processor **52** to determine whether or not the IP transmission is associated with the call represented by the call record **60**. To do this, block **148** directs the processor

5 **52** to determine whether the SSRC identifier received in the IP transmission **110** matches the caller SSRC identifier stored in the caller sync source field **76** of the call record **60** shown in Figure 7. If not, the processor **52** is directed to an error handling routine **108**.

10 If the SSRC received in the IP transmission **110** matches the caller SSRC stored in the caller sync source field **76** of the call record **60**, block **150** directs the processor **52** to copy the source IP address identifier and source port identifier respectively to the caller IP address identifier and caller UDP port identifier fields **72** and **74** respectively of the call record **60** to update the call

15 record to identify the IP address and UDP port of the third base station **50** as that of the caller, as shown in Figure 8. The processor **52** is then directed to the call forwarding routine **106**.

Thus, in an IP transmission **110** received subsequent to the pre-determined

20 transmission, or where there is no determination of whether the transmission is a pre-determined one, the source IP address identifier and source port identifier from the IP transmission **110** are set as the caller IP address identifier and caller port identifier respectively of the call record **60** when the caller IP address identifier and caller port identifier of the record do not match

25 the source IP address identifier and source port identifier respectively of the IP transmission **110** and the received SSRC in the IP transmission matches the caller SSRC identifier of the call record.

Similarly, blocks **152**, **154**, **156**, **158**, and **160** function to perform similar

30 functionality when the destination port identifier in the IP transmission **110** matches the callee RTP port identifier of the identified call record **60**. In this case where there is a determination of whether the transmission is a pre-determined one, if the IP transmission is the pre-determined transmission, the

-23-

SSRC identifier received in the IP transmission **110** is set as the callee SSRC identifier associated with the callee information **66** of the record **60** and if the IP transmission is received subsequent to the pre-determined transmission, or where there is no determination of whether the transmission is a pre-determined one, the source IP address identifier and source port identifier from the IP transmission are set as the callee IP address identifier and callee port identifier respectively of the record when the callee IP address identifier and callee port identifier do not match the source IP address identifier and source port identifier respectively and the received SSRC identifier in the IP transmission matches the callee SSRC identifier.

Referring to Figure **9**, the forwarding routine is shown generally at **106**. The forwarding routine includes a first block **170** that directs the processor **52** to again determine whether or not the IP transmission **110** has been received at the caller RTP port or callee RTP port. Again, this may be determined by reading the flag described above or by simply reading a memory location identifying the RTP port that received the IP transmission **110**.

If the IP transmission **110** has been received at the caller RTP port, block **172** directs the processor **52** to transmit the IP transmission from the caller RTP port to the callee IP address and callee UDP port identified by the callee IP address identifier and callee UDP port identifier in the call record **60** and to identify the source IP address and source port of the IP transmission as the media relay IP address and callee RTP port. If on the other hand, the IP transmission **110** was received at the callee RTP port, block **174** directs the processor **52** to transmit the IP transmission from the callee RTP port to the caller IP address identified by the caller IP address identifier and caller UDP port identifier stored in the call record **60** and identify the source IP address and source port of the IP transmission as the media relay IP address and caller RTP port. The IP transmission **110** received at either port is thus relayed by the media relay **40** according to the contents of the call record **60** as previously established by the continuity routine **104** shown in Figure **6**.

-24-

It will be appreciated that in this embodiment, the IP transmissions **110** received from the caller and from the callee may have different SSRC identifiers. Alternatively, they may have the same SSRC identifiers.

**What is claimed is:**

1. A method for facilitating uninterrupted transmission of internet protocol (IP) transmissions containing real time transport protocol (RTP) data during endpoint changes, the method comprising:

5

maintaining records, each record associating session information, caller information and callee information for IP communication sessions;

10

said session information including caller and callee RTP port identifiers identifying caller and callee RTP ports respectively of a media relay;

15

said caller information including a caller IP address identifier and a caller port identifier to which IP transmissions received at said callee RTP port are transmitted from the media relay, and a caller synchronization source (SSRC) identifier; and

20

said callee information including a callee IP address identifier and a callee port identifier to which IP transmissions received at said caller RTP port are transmitted from the media relay, and a callee SSRC identifier; and

25

when an IP transmission is received at said caller RTP port or said callee RTP port:

30

locating one of said records having said caller RTP port identifier or said callee RTP port identifier matching a destination port identifier in said IP transmission;

-26-

when said one of said records is located and when said destination port identifier in said IP transmission matches the caller RTP port identifier of said one of said records,

5                    setting a source IP address identifier and source port identifier from said IP transmission as the caller IP address identifier and caller port identifier respectively of said one of said records when:

10                    said caller IP address identifier and caller port identifier do not match said source IP address identifier and source port identifier respectively; and

15                    a received SSRC identifier in said IP transmission matches said caller SSRC identifier; and

20                    when said one of said records is located and when said destination port identifier in said IP transmission matches the callee RTP port identifier of said one of said records,

25                    setting said source IP address identifier and source port identifier from said IP transmission as the callee IP address identifier and callee port identifier respectively of said one of said records when:

30                    said callee IP address identifier and callee port identifier do not match said source IP address identifier and source port identifier respectively; and



-27-

said received SSRC identifier in said IP transmission matches said callee SSRC identifier.

5

2. The method of claim 1 further comprising determining whether said IP transmission is a pre-determined transmission and, if so, determining whether the IP transmission is from the caller or callee; and

10

when the pre-determined IP transmission is received from the caller, storing said received SSRC identifier as the caller SSRC identifier in said one of said records; and

15

when the pre-determined IP transmission is received from the callee, storing said received SSRC identifier as the callee SSRC identifier in said one of said records.

20

3. The method of claim 1 further comprising determining whether said IP transmission is a pre-determined transmission and, if so, where the caller and callee are configured to use the same SSRC identifier, storing the received SSRC identifier as the caller SSRC identifier in said one of said records and as the callee SSRC identifier in said one of said records.

25

4. The method in claim 1 further comprising:

30

if the IP transmission was received at the caller RTP port, causing the media relay to forward the IP transmission to the callee at the callee IP address and callee UDP port identified by the callee IP address identifier and callee UDP port identifier of the record and identifying the source of said IP transmission forwarded to the callee with the callee RTP port identifier; and

-28-

if the IP transmission was received at the callee RTP port, causing the media relay to forward the IP transmission to the caller at the caller IP address and caller UDP port identified by the caller IP address identifier and caller UDP port identifier of the record and identifying the source of said IP transmission forwarded to the caller with the caller RTP port.

5

5. A media relay apparatus for facilitating uninterrupted transmission of internet protocol (IP) transmissions containing real time transport protocol (RTP) data during endpoint changes, the apparatus comprising:

10

a processor;

input/output interfaces in communication with the processor to provide for physical connection to an IP network;

15

program memory and storage memory, said program memory being encoded with codes for directing the processor to

20

provide a logical input/output interface interacting with said input/output interfaces to define caller and callee RTP ports;

25

maintain call records in said storage memory, each said call records having fields associating session information, caller information and callee information for IP communication sessions;

30

said fields associating session information including caller and callee RTP port identifier fields identifying said caller and callee RTP ports respectively;

-29-

5 said caller information including a caller IP address identifier field and a caller port identifier field to which IP transmissions received at said callee RTP port are to be transmitted, and a caller synchronization source (SSRC) identifier field; and

10 said callee information including a callee IP address identifier field and a callee port identifier field to which IP transmissions received at said caller RTP port are to be transmitted, and a callee SSRC identifier field; and

15 locate one of said records having said caller RTP port identifier field contents or said callee RTP port identifier field contents matching a destination port identifier in said IP transmission when an IP transmission is received at said caller RTP port or said callee RTP port;

20 when said one of said records is located and when said destination port identifier in said IP transmission matches the contents of the caller RTP port identifier field of said one of said records,

25 storing a source IP address identifier and source port identifier from said IP transmission in the caller IP address identifier field and caller port identifier field respectively when:

30 the contents of said caller IP address field and caller port identifier field do not match said source IP address identifier and source port identifier respectively; and

-30-

a received SSRC identifier in said IP transmission matches the contents of said caller SSRC identifier field; and

5 when said one of said records is located and when said destination port identifier in said IP transmission matches the contents of the callee RTP port identifier field of said one of said records,

10 storing said source IP address identifier and source port identifier from said IP transmission in the callee IP address identifier field and callee port identifier field respectively when:

15 said contents of said callee IP address identifier field and said callee port identifier field do not match said source IP address identifier and source port identifier respectively; and

20 said received SSRC identifier in said IP transmission matches the contents of said callee SSRC identifier field.

25 **6.** The apparatus of claim **5** wherein said program memory is further encoded with codes for directing the processor to determine whether said IP transmission is a pre-determined transmission and, if so, determine whether the IP transmission is from the caller or callee; and

30 when the pre-determined IP transmission is received from the caller, store said received SSRC identifier in the caller SSRC identifier field in said one of said records; and

-31-

when the pre-determined IP transmission is received from the callee, store said received SSRC identifier in the callee SSRC identifier field in said one of said records.

5           7.    The apparatus of claim 5 further comprising determining whether said  
IP transmission is a pre-determined transmission and, if so, where the  
caller and callee are configured to use the same SSRC, storing the  
received SSRC in the caller SSRC identifier field in said one of said  
records and in the callee SSRC identifier field in said one of said  
10           records.

8.    The apparatus of claim 5 wherein said program memory is further  
encoded with codes for directing the processor to:

15                    when the IP transmission is received at the caller RTP port,  
forward the IP transmission to the callee identified by the  
contents of the callee IP address identifier field and the callee  
port identifier field and identify the source of said IP transmission  
according to the contents of the callee RTP port identifier field;  
20                    and

                      when the IP transmission is received at the callee RTP port,  
forward the IP transmission to the caller identified by the  
contents of the caller IP address identifier field and the caller  
port identifier field and identify the source of said IP transmission  
25                    according to the contents of the caller RTP port identifier field.

9.    A media relay apparatus for facilitating uninterrupted transmission of  
internet protocol (IP) transmissions containing real time transport protocol  
30                    (RTP) data during endpoint changes, the apparatus comprising:

a processor;

-32-

physical connection means for providing physical connections between the processor and an IP network;

5 means for interacting with said physical connection means and said processor for providing a logical input/output interface defining caller and callee RTP ports;

10 means for maintaining call records in memory, each of said call records having means for associating session information, caller information and callee information for IP communication sessions including:

15 means for storing caller and callee RTP port identifiers identifying said caller and callee RTP ports respectively of the media relay;

20 means for storing a caller IP address identifier and a caller port identifier to which IP transmissions received at said callee RTP port are to be transmitted from the media relay;

25 means for storing a caller synchronization source (SSRC) identifier;

30 means for storing a callee IP address identifier and a callee port identifier to which IP transmissions received at said caller RTP port are to be transmitted from the media relay; and

-33-

means for storing a callee SSRC identifier;  
and

5 means for locating one of said records having a caller  
RTP port identifier or a callee RTP port identifier  
matching a destination port identifier in said IP  
transmission when an IP transmission is received at said  
caller RTP port or said callee RTP port;

10 means for determining whether said destination port  
identifier in said IP transmission matches the caller RTP  
port identifier of said one of said records;

15 means for setting the caller IP address identifier  
and caller port identifier as the source IP address  
identifier and source port identifier respectively  
from said IP transmission when:

20 said caller IP address identifier and caller  
port identifier do not match said source IP  
address identifier and source port identifier  
respectively; and

25 a received SSRC identifier in said IP  
transmission matches said caller SSRC  
identifier; and

30 means for determining whether said destination port  
identifier in said IP transmission matches the callee RTP  
port identifier of said one of said records,

means for setting the callee IP address identifier  
and callee port identifier as the source IP address

-34-

identifier and source port identifier respectively from said IP transmission when:

5                                   said callee IP address identifier and said callee port identifier do not match said source IP address identifier and source port identifier respectively; and

10                                   said received SSRC identifier in said IP transmission matches said callee SSRC identifier.

15                   **10.** The apparatus of claim **9** further comprising means for determining whether said IP transmission is a pre-determined transmission and, if so, determining whether the IP transmission is from the caller or callee; and

20                                   means for storing said received SSRC identifier as the caller SSRC identifier when the pre-determined IP transmission is received from the caller; and

25                                   means for storing said received SSRC identifier as the callee SSRC identifier when the pre-determined IP transmission is received from the callee.

30                   **11.** The apparatus of claim **9** further comprising means for determining whether said IP transmission is a pre-determined transmission and means for storing the received SSRC identifier as the caller SSRC identifier and as the callee SSRC identifier, where the caller and callee are configured to use the same SSRC.

**12.** The apparatus of claim **9** further comprising:



-35-

5 means for forwarding the IP transmission to the callee identified by the callee IP address identifier and the callee UDP port identifier and for identifying the source of said IP transmission with the callee RTP port identifier when the received IP transmission was received at the caller RTP port; and

10 means for forwarding the IP transmission to the caller identified by the caller IP address identifier and caller UDP port identifier and for identifying the source of said IP transmission with the caller RTP port identifier when the received IP transmission was received at the callee RTP port.

13. A computer readable medium encoded with codes for directing a processor of a media relay to facilitate uninterrupted transmission of internet protocol (IP) transmissions containing real time transport protocol (RTP) data during endpoint changes, the codes comprising codes for directing the processor to:

20 maintain records, each record associating session information, caller information and callee information for IP communication sessions;

25 said session information including caller and callee RTP port identifiers identifying caller and callee RTP ports respectively of the media relay;

30 said caller information including a caller IP address identifier and a caller port identifier to which IP transmissions received at said callee RTP port are transmitted from the media relay, a caller synchronization source (SSRC) identifier; and

-36-

5 said callee information including a callee IP address identifier and a callee port identifier to which IP transmissions received at said caller RTP port are transmitted from the media relay, a callee SSRC identifier; and

when an IP transmission is received at said caller RTP port or said callee RTP port:

10 locate one of said records having said caller RTP port identifier or said callee RTP port identifier matching a destination port identifier in said IP transmission;

15 when said one of said records is locate and when said destination port identifier in said IP transmission matches the caller RTP port identifier of said one of said records,

20 set a source IP address identifier and source port identifier from said IP transmission as the caller IP address identifier and caller port identifier respectively of said one of said records when:

25 said caller IP address identifier and caller port identifier do not match said source IP address identifier and source port identifier respectively; and

30 a received SSRC identifier in said IP transmission matches said caller SSRC identifier; and

-37-

when said one of said records is located and when said destination port identifier in said IP transmission matches the callee RTP port identifier of said one of said records,

5 set said source IP address identifier and source port identifier from said IP transmission as the callee IP address identifier and callee port identifier respectively of said one of said records when:

10 said callee IP address identifier and callee port identifier do not match said source IP address identifier and source port identifier respectively; and

15 said received SSRC identifier in said IP transmission matches said callee SSRC identifier.

20 **14.** The computer readable medium of claim **13** wherein said codes further include codes for directing the processor to determine whether said IP transmission is a pre-determined transmission and, if so, determine whether the IP transmission is from the caller or callee; and

25 when the pre-determined IP transmission is received from the caller, store said received SSRC identifier as the caller SSRC identifier in said one of said records; and

30 when the pre-determined IP transmission is received from the callee, store said received SSRC identifier as the callee SSRC identifier in said one of said records.

-38-

5           **15.**   The computer readable medium of claim **13** further comprising codes for directing the processor to determine whether said IP transmission is a pre-determined transmission and, if so, where the caller and callee are configured to use the same SSRC, store the received SSRC identifier as the caller SSRC identifier in said one of said records and as the callee SSRC identifier in said one of said records.

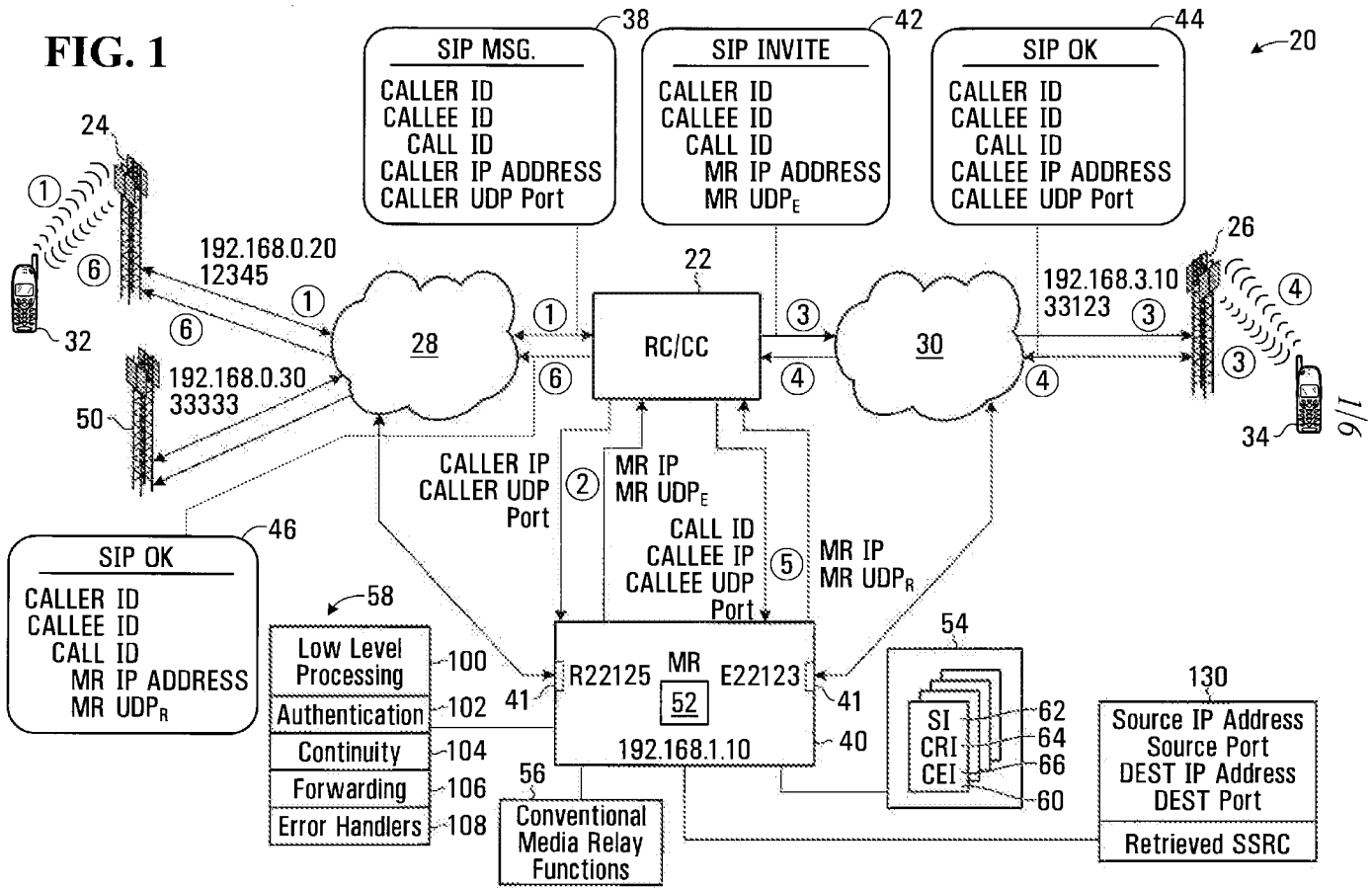
10           **16.**   The computer readable medium of claim **13** further comprising codes for directing the processor to:

15                       if the IP transmission was received at the caller RTP port, cause the media relay to forward the IP transmission to the callee at the callee IP address and callee UDP port identified by the callee IP address identifier and callee UDP port identifier and identify the source of said IP transmission forwarded to the callee with the callee RTP port identifier; and

20                       if the IP transmission was received at the callee RTP port, cause the media relay to forward the IP transmission to the caller at the caller IP address and caller UDP port identified by the caller IP address identifier and caller port identifier and identify the source of said IP transmission forwarded to the caller with the caller RTP port identifier.

25

**FIG. 1**



+

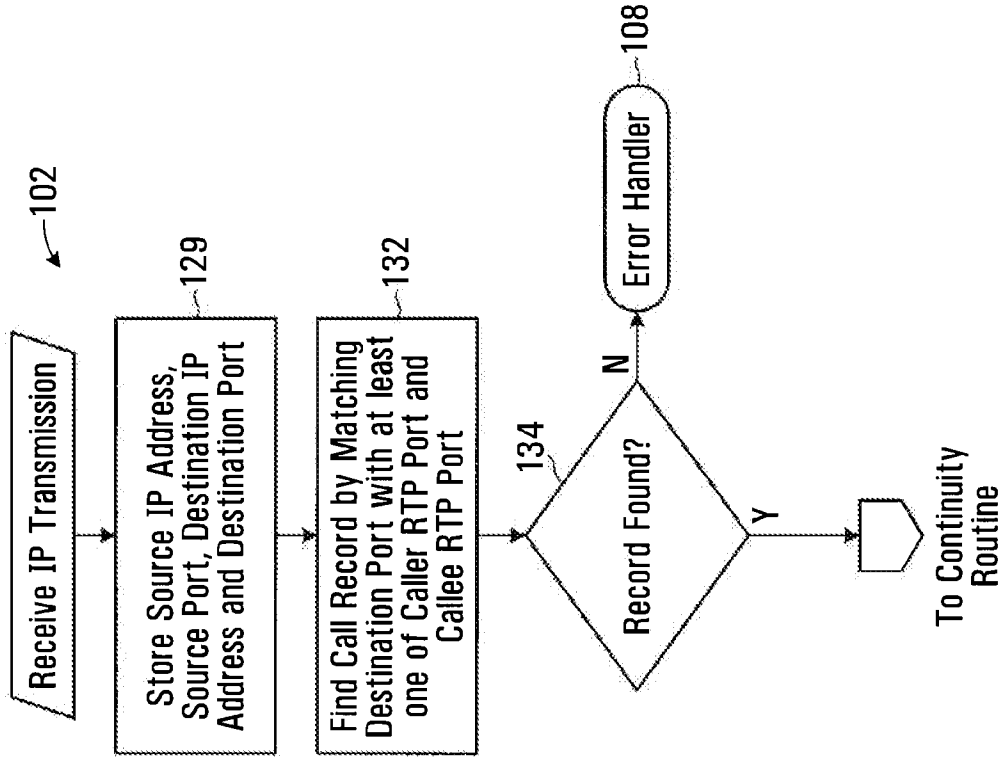


FIG. 3

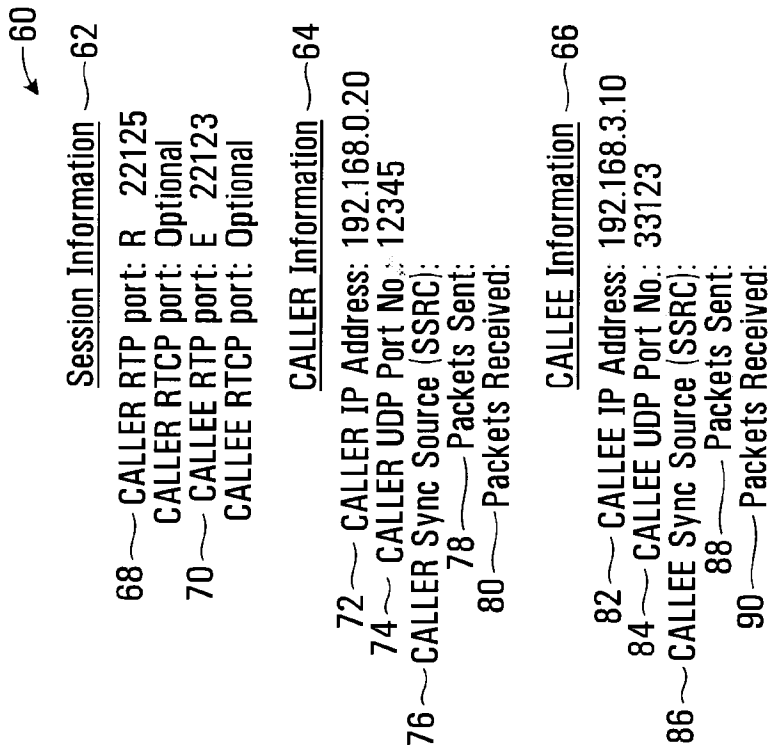
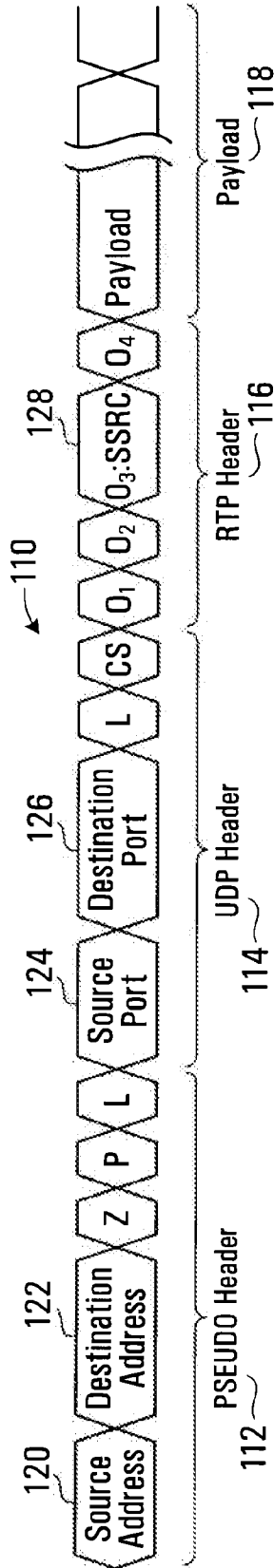


FIG. 2

+



**FIG. 4**  
(Prior Art)

Session Information

CALLER RTP port: R 22125  
 CALLER RTCP port: Optional  
 CALLEE RTP port: E 22123  
 CALLEE RTCP port: Optional

CALLER Information

CALLER IP Address: 192.168.0.20  
 CALLER UDP Port No.: 12345  
 CALLER Sync Source (SSRC):  
 Packets Sent:  
 Packets Received: 1 ~ 136

CALLEE Information

CALLEE IP Address: 192.168.3.10  
 CALLEE UDP Port No.: 33123  
 CALLEE Sync Source (SSRC):  
 Packets Sent:  
 Packets Received:

**FIG. 5**

+

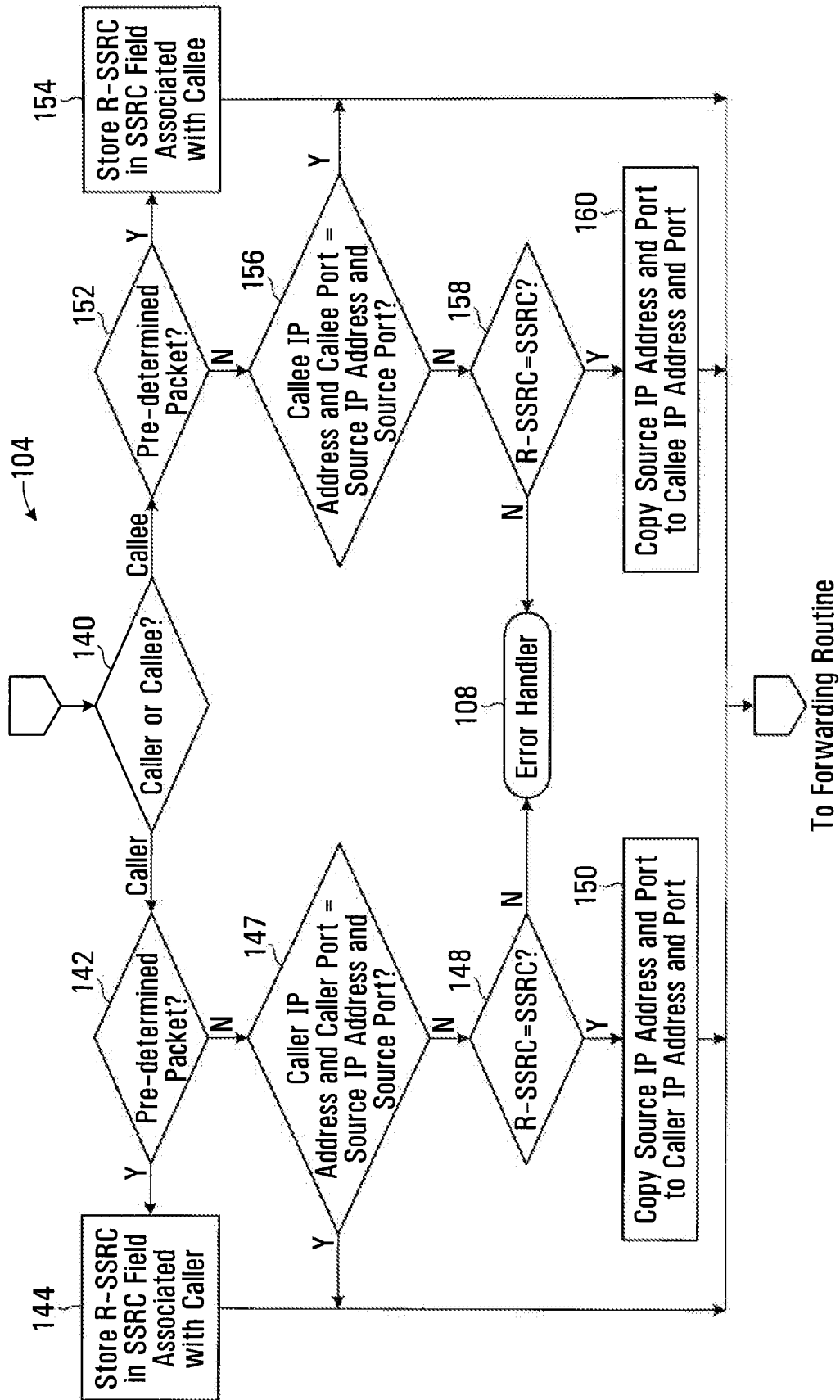


FIG. 6



+

Session Information

CALLER RTP port: R 22125  
CALLER RTCP port: Optional  
CALLEE RTP port: E 22123  
CALLEE RTCP port: Optional

CALLER Information

CALLER IP Address: 192.168.0.30  
CALLER UDP Port No.: 33333  
CALLER Sync Source (SSRC): SSRC<sub>R</sub>  
Packets Sent:  
Packets Received: 2

CALLEE Information

CALLEE IP Address: 192.168.3.10  
CALLEE UDP Port No.: 33123  
CALLEE Sync Source (SSRC):  
Packets Sent:  
Packets Received:

**FIG. 8**

Session Information

CALLER RTP port: R 22125  
CALLER RTCP port: Optional  
CALLEE RTP port: E 22123  
CALLEE RTCP port: Optional

CALLER Information

CALLER IP Address: 192.168.0.20  
CALLER UDP Port No.: 12345  
CALLER Sync Source (SSRC): SSRC<sub>R</sub> ~ 146  
Packets Sent:  
Packets Received: 1

CALLEE Information

CALLEE IP Address: 192.168.3.10  
CALLEE UDP Port No.: 33123  
CALLEE Sync Source (SSRC):  
Packets Sent:  
Packets Received:

**FIG. 7**

+

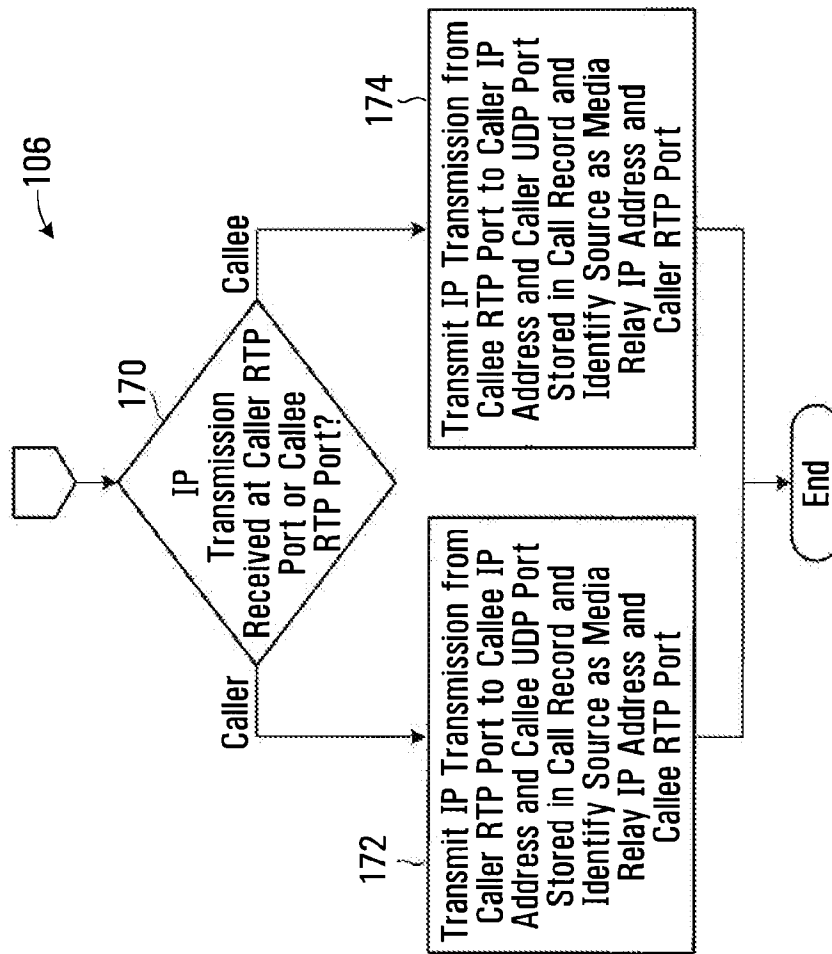


FIG. 9

**INTERNATIONAL SEARCH REPORT**

International application No.  
PCT/CA2009/001317

A. CLASSIFICATION OF SUBJECT MATTER  
IPC: *H04L 12/66* (2006.01) , *H04L 29/06* (2006.01) , *H04W 36/02* (2009.01) , *H04W 36/18* (2009.01)  
According to International Patent Classification (IPC) or to both national classification and IPC

B. FIELDS SEARCHED

Minimum documentation searched (classification system followed by classification symbols)

IPC (2006.01): H04L, H04W

Documentation searched other than minimum documentation to the extent that such documents are included in the fields searched

Electronic database(s) consulted during the international search (name of database(s) and, where practicable, search terms used)  
Canadian patent database, IEEE Xplore, TotalPatent: media relay, Internet Protocol (IP), Real Time Transport Protocol (RTP), endpoint, change, transmissions, data, port identifier, caller, callee, destination, port match, source, destination, address identifier, Caller Synchronization Source (SSRC) identifier, base station, GSM, UDP, record, maintenance, port identifier, matching and all such related

C. DOCUMENTS CONSIDERED TO BE RELEVANT

| Category* | Citation of document, with indication, where appropriate, of the relevant passages | Relevant to claim No. |
|-----------|------------------------------------------------------------------------------------|-----------------------|
| A         | US 2009/0028146 A1 KLEYMAN et al. 29 January 2009 (29-01-2009)<br>Entire document  | 1 to 16               |
| A         | US 7454510 B2 KLEYMAN et al. 18 November 2008 (18-11-2008)<br>Entire document      | 1 to 16               |
| A         | US 2007/0253418 A1 SHIRI et al. 01 November 2007 (01-11-2007)<br>Entire document   | 1 to 16               |
| A         | US 2007/0036143 A1 ALT et al. 15 February 2007 (15-02-2007)<br>Entire document     | 1 to 16               |

Further documents are listed in the continuation of Box C.

See patent family annex.

|                                                                                                                                                                         |                                                                                                                                                                                                                                                  |
|-------------------------------------------------------------------------------------------------------------------------------------------------------------------------|--------------------------------------------------------------------------------------------------------------------------------------------------------------------------------------------------------------------------------------------------|
| * Special categories of cited documents                                                                                                                                 | "T" later document published after the international filing date or priority date and not in conflict with the application but cited to understand the principle or theory underlying the invention                                              |
| "A" document defining the general state of the art which is not considered to be of particular relevance                                                                | "X" document of particular relevance, the claimed invention cannot be considered novel or cannot be considered to involve an inventive step when the document is taken alone                                                                     |
| "E" earlier application or patent but published on or after the international filing date                                                                               | "Y" document of particular relevance, the claimed invention cannot be considered to involve an inventive step when the document is combined with one or more other such documents, such combination being obvious to a person skilled in the art |
| "L" document which may throw doubts on priority claim(s) or which is cited to establish the publication date of another citation or other special reason (as specified) | "&" document member of the same patent family                                                                                                                                                                                                    |
| "O" document referring to an oral disclosure, use, exhibition or other means                                                                                            |                                                                                                                                                                                                                                                  |
| "P" document published prior to the international filing date but later than the priority date claimed                                                                  |                                                                                                                                                                                                                                                  |

Date of the actual completion of the international search

17 July 2010 (17-06-2010)

Date of mailing of the international search report

18 June 2010 (18-06-2010)

Name and mailing address of the ISA/CA  
Canadian Intellectual Property Office  
Place du Portage I, C114 - 1st Floor, Box PCT  
50 Victoria Street  
Gatineau, Quebec K1A 0C9  
Facsimile No.: 001-819-953-2476

Authorized officer

Salvatore Ginese (819) 934-4888

**INTERNATIONAL SEARCH REPORT**  
Information on patent family members

International application No  
PCT/CA2009/001317

| Patent Document Cited in Search Report | Publication Date | Patent Family Member(s) | Publication Date |
|----------------------------------------|------------------|-------------------------|------------------|
| US2009028146A1                         | 29-01-2009       | CN1574798A              | 02-02-2005       |
|                                        |                  | EP1484883A2             | 08-12-2004       |
|                                        |                  | JP2004355628A           | 16-12-2004       |
|                                        |                  | KR20040103441A          | 08-12-2004       |
|                                        |                  | US2004244010A1          | 02-12-2004       |
|                                        |                  | US7454510B2             | 18-11-2008       |
| US7454510B2                            | 18-11-2008       | CN1574798A              | 02-02-2005       |
|                                        |                  | EP1484883A2             | 08-12-2004       |
|                                        |                  | JP2004355628A           | 16-12-2004       |
|                                        |                  | KR20040103441A          | 08-12-2004       |
|                                        |                  | US2004244010A1          | 02-12-2004       |
|                                        |                  | US2009028146A1          | 29-01-2009       |
| US2007253418A1                         | 01-11-2007       | US2007253418A1          | 01-11-2007       |
|                                        |                  | WO2007125530A2          | 08-11-2007       |
|                                        |                  | WO2007125530A3          | 27-12-2007       |
| US2007036143A1                         | 15-02-2007       | AU2005272561A1          | 23-02-2006       |
|                                        |                  | AU2005272561B2          | 01-10-2009       |
|                                        |                  | BRPI0514326A            | 10-06-2008       |
|                                        |                  | CA2577123A1             | 23-02-2006       |
|                                        |                  | CN101084686A            | 05-12-2007       |
|                                        |                  | EP1784959A2             | 16-05-2007       |
|                                        |                  | EP1784959A4             | 26-08-2009       |
|                                        |                  | EP1784999A1             | 16-05-2007       |
|                                        |                  | EP1784999A4             | 09-07-2008       |
|                                        |                  | EP1787441A2             | 23-05-2007       |
|                                        |                  | EP1787441A4             | 23-09-2009       |
|                                        |                  | JP2008510393T           | 03-04-2008       |
|                                        |                  | JP2008510394T           | 03-04-2008       |
|                                        |                  | JP2008515246T           | 08-05-2008       |
|                                        |                  | KR20070104509A          | 26-10-2007       |
|                                        |                  | US2006072542A1          | 06-04-2006       |
|                                        |                  | US7602748B2             | 13-10-2009       |
|                                        |                  | US2006209794A1          | 21-09-2006       |
|                                        |                  | US7706401B2             | 27-04-2010       |
|                                        |                  | US2009279506A1          | 12-11-2009       |
|                                        |                  | WO2006020975A2          | 23-02-2006       |
|                                        |                  | WO2006020975A9          | 06-04-2006       |
|                                        |                  | WO2006020975A3          | 26-05-2006       |
| WO2006020977A1                         | 23-02-2006       |                         |                  |
| WO2006020997A2                         | 23-02-2006       |                         |                  |
| WO2006020997A3                         | 07-08-2008       |                         |                  |

## Electronic Acknowledgement Receipt

|                                             |                                                             |
|---------------------------------------------|-------------------------------------------------------------|
| <b>EFS ID:</b>                              | 17696996                                                    |
| <b>Application Number:</b>                  | 13966096                                                    |
| <b>International Application Number:</b>    |                                                             |
| <b>Confirmation Number:</b>                 | 8712                                                        |
| <b>Title of Invention:</b>                  | PRODUCING ROUTING MESSAGES FOR VOICE OVER IP COMMUNICATIONS |
| <b>First Named Inventor/Applicant Name:</b> | CLAY PERRAULT                                               |
| <b>Customer Number:</b>                     | 20995                                                       |
| <b>Filer:</b>                               | John M Carson/Norman Green                                  |
| <b>Filer Authorized By:</b>                 | John M Carson                                               |
| <b>Attorney Docket Number:</b>              | SMARB19.001C1                                               |
| <b>Receipt Date:</b>                        | 18-DEC-2013                                                 |
| <b>Filing Date:</b>                         | 13-AUG-2013                                                 |
| <b>Time Stamp:</b>                          | 15:10:13                                                    |
| <b>Application Type:</b>                    | Utility under 35 USC 111(a)                                 |

### Payment information:

|                        |    |
|------------------------|----|
| Submitted with Payment | no |
|------------------------|----|

### File Listing:

| Document Number | Document Description | File Name                        | File Size(Bytes)/<br>Message Digest               | Multi Part /.zip | Pages (if appl.) |
|-----------------|----------------------|----------------------------------|---------------------------------------------------|------------------|------------------|
| 1               |                      | IDS_SMARB19_001C1_12_18_2013.pdf | 81860<br>e0a47025458c51f36055d8a74eb4b628d38631fa | yes              | 2                |

| Multipart Description/PDF files in .zip description |                                                    |       |     |
|-----------------------------------------------------|----------------------------------------------------|-------|-----|
|                                                     | Document Description                               | Start | End |
|                                                     | Transmittal Letter                                 | 1     | 1   |
|                                                     | Information Disclosure Statement (IDS) Form (SB08) | 2     | 2   |

**Warnings:**

**Information:**

|   |                   |                         |                                         |    |    |
|---|-------------------|-------------------------|-----------------------------------------|----|----|
| 2 | Foreign Reference | Ref4_WO2010012090A2.pdf | 7688587                                 | no | 99 |
|   |                   |                         | 93ceb3791ca6d43b46ee02fe8e924dfc32c92ae |    |    |

**Warnings:**

**Information:**

|   |                   |                         |                                         |    |    |
|---|-------------------|-------------------------|-----------------------------------------|----|----|
| 3 | Foreign Reference | Ref5_WO2011032256A1.pdf | 3571304                                 | no | 48 |
|   |                   |                         | 85006dddfdb1512fd629791aa7a43ac970a577a |    |    |

**Warnings:**

**Information:**

|                                     |  |  |          |  |  |
|-------------------------------------|--|--|----------|--|--|
| <b>Total Files Size (in bytes):</b> |  |  | 11341751 |  |  |
|-------------------------------------|--|--|----------|--|--|

**This Acknowledgement Receipt evidences receipt on the noted date by the USPTO of the indicated documents, characterized by the applicant, and including page counts, where applicable. It serves as evidence of receipt similar to a Post Card, as described in MPEP 503.**

**New Applications Under 35 U.S.C. 111**

**If a new application is being filed and the application includes the necessary components for a filing date (see 37 CFR 1.53(b)-(d) and MPEP 506), a Filing Receipt (37 CFR 1.54) will be issued in due course and the date shown on this Acknowledgement Receipt will establish the filing date of the application.**

**National Stage of an International Application under 35 U.S.C. 371**

**If a timely submission to enter the national stage of an international application is compliant with the conditions of 35 U.S.C. 371 and other applicable requirements a Form PCT/DO/EO/903 indicating acceptance of the application as a national stage submission under 35 U.S.C. 371 will be issued in addition to the Filing Receipt, in due course.**

**New International Application Filed with the USPTO as a Receiving Office**

**If a new international application is being filed and the international application includes the necessary components for an international filing date (see PCT Article 11 and MPEP 1810), a Notification of the International Application Number and of the International Filing Date (Form PCT/RO/105) will be issued in due course, subject to prescriptions concerning national security, and the date shown on this Acknowledgement Receipt will establish the international filing date of the application.**

**INFORMATION DISCLOSURE STATEMENT**

Inventor : Clay Perrault, et al.  
App. No. : 13/966,096  
Filed : August 13, 2013  
For : PRODUCING ROUTING MESSAGES FOR  
VOICE OVER IP COMMUNICATIONS  
Examiner : Kizou, Hassan  
Art Unit : 2472  
Conf. No. : 8712

Commissioner for Patents  
P.O. Box 1450  
Alexandria, VA 22313-1450

**References and Listing**

Submitted herewith in the above-identified application is an Information Disclosure Statement listing references for consideration. Copies of any listed foreign and non-patent literature references are being submitted.

**Timing of Disclosure**

This Information Disclosure Statement is being filed before the receipt of a First Office Action on the merits, and presumably no fee is required. If a First Office Action on the merits was mailed before the mailing date of this Statement, the Commissioner is authorized to charge the fee set forth in 37 CFR 1.17(p) to Deposit Account No. 11-1410.

Respectfully submitted,  
KNOBBE, MARTENS, OLSON & BEAR, LLP

Dated: \_\_\_\_\_

12/18/13

By: \_\_\_\_\_

John M. Carson  
Registration No. 34,303  
Attorney of Record  
Customer No. 20995  
(858) 707-4000

IDS  
16875589  
121713



UNITED STATES PATENT AND TRADEMARK OFFICE

UNITED STATES DEPARTMENT OF COMMERCE
United States Patent and Trademark Office
Address: COMMISSIONER FOR PATENTS
P.O. Box 1450
Alexandria, Virginia 22313-1450
www.uspto.gov

Table with 4 columns: APPLICATION NUMBER (13/966,096), FILING OR 371(C) DATE (08/13/2013), FIRST NAMED APPLICANT (CLAY PERRAULT), ATTY. DOCKET NO./TITLE (SMARB19.001C1)

CONFIRMATION NO. 8712

PUBLICATION NOTICE

20995
KNOBBE MARTENS OLSON & BEAR LLP
2040 MAIN STREET
FOURTEENTH FLOOR
IRVINE, CA 92614



Title:PRODUCING ROUTING MESSAGES FOR VOICE OVER IP COMMUNICATIONS

Publication No.US-2013-0329722-A1
Publication Date:12/12/2013

NOTICE OF PUBLICATION OF APPLICATION

The above-identified application will be electronically published as a patent application publication pursuant to 37 CFR 1.211, et seq. The patent application publication number and publication date are set forth above.

The publication may be accessed through the USPTO's publically available Searchable Databases via the Internet at www.uspto.gov. The direct link to access the publication is currently http://www.uspto.gov/patft/.

The publication process established by the Office does not provide for mailing a copy of the publication to applicant. A copy of the publication may be obtained from the Office upon payment of the appropriate fee set forth in 37 CFR 1.19(a)(1). Orders for copies of patent application publications are handled by the USPTO's Office of Public Records. The Office of Public Records can be reached by telephone at (703) 308-9726 or (800) 972-6382, by facsimile at (703) 305-8759, by mail addressed to the United States Patent and Trademark Office, Office of Public Records, Alexandria, VA 22313-1450 or via the Internet.

In addition, information on the status of the application, including the mailing date of Office actions and the dates of receipt of correspondence filed in the Office, may also be accessed via the Internet through the Patent Electronic Business Center at www.uspto.gov using the public side of the Patent Application Information and Retrieval (PAIR) system. The direct link to access this status information is currently http://pair.uspto.gov/. Prior to publication, such status information is confidential and may only be obtained by applicant using the private side of PAIR.

Further assistance in electronically accessing the publication, or about PAIR, is available by calling the Patent Electronic Business Center at 1-866-217-9197.

Office of Data Management, Application Assistance Unit (571) 272-4000, or (571) 272-4200, or 1-888-786-0101



|                                                          |                      |                 |
|----------------------------------------------------------|----------------------|-----------------|
| <b>INFORMATION DISCLOSURE<br/>STATEMENT BY APPLICANT</b> | Application No.      | 13/966,096      |
|                                                          | Filing Date          | August 13, 2013 |
|                                                          | First Named Inventor | Perrault, Clay  |
|                                                          | Art Unit             | 2472            |
| <i>(Multiple sheets used when necessary)</i>             | Examiner             | Kizou, Hassan   |
| SHEET 1 OF 7                                             | Attorney Docket No.  | SMARB19.001C1   |

| U.S. PATENT DOCUMENTS |          |                                                                           |                                |                               |                                                                                |
|-----------------------|----------|---------------------------------------------------------------------------|--------------------------------|-------------------------------|--------------------------------------------------------------------------------|
| Examiner Initials     | Cite No. | Document Number<br>Number - Kind Code (if known)<br>Example: 1,234,567 B1 | Publication Date<br>MM-DD-YYYY | Name of Patentee or Applicant | Pages, Columns, Lines Where<br>Relevant Passages or Relevant<br>Figures Appear |
|                       | 1        | 4,916,491                                                                 | 4/10/1990                      | Katoh                         |                                                                                |
|                       | 2        | 4,992,971                                                                 | 2/12/1991                      | Hayashi                       |                                                                                |
|                       | 3        | 5,146,491                                                                 | 9/8/1992                       | Silver et al.                 |                                                                                |
|                       | 4        | 5,247,571                                                                 | 9/21/1993                      | Kay et al.                    |                                                                                |
|                       | 5        | 5,303,297                                                                 | 4/12/1994                      | Hillis                        |                                                                                |
|                       | 6        | 5,359,642                                                                 | 10/25/1994                     | Castro                        |                                                                                |
|                       | 7        | 5,425,085                                                                 | 6/13/1995                      | Weinberger et al.             |                                                                                |
|                       | 8        | 5,440,621                                                                 | 8/8/1995                       | Castro                        |                                                                                |
|                       | 9        | 5,454,030                                                                 | 9/26/1995                      | de Oliveira et al.            |                                                                                |
|                       | 10       | 5,469,497                                                                 | 11/21/1995                     | Pierce et al.                 |                                                                                |
|                       | 11       | 5,506,893                                                                 | 4/9/1996                       | Buscher et al.                |                                                                                |
|                       | 12       | 5,519,769                                                                 | 5/21/1996                      | Weinberger et al.             |                                                                                |
|                       | 13       | 5,559,871                                                                 | 9/24/1996                      | Smith                         |                                                                                |
|                       | 14       | 5,590,133                                                                 | 12/31/1996                     | Billstrom et al.              |                                                                                |
|                       | 15       | 5,608,786                                                                 | 3/4/1997                       | Gordon                        |                                                                                |
|                       | 16       | 5,621,787                                                                 | 4/15/1997                      | McKoy et al.                  |                                                                                |
|                       | 17       | 5,633,913                                                                 | 5/27/1997                      | Talarmo                       |                                                                                |
|                       | 18       | 5,661,790                                                                 | 8/26/1997                      | Hsu                           |                                                                                |
|                       | 19       | 5,712,907                                                                 | 1/27/1998                      | Wegner et al.                 |                                                                                |
|                       | 20       | 5,724,355                                                                 | 3/3/1998                       | Bruno et al.                  |                                                                                |
|                       | 21       | 5,726,984                                                                 | 3/10/1998                      | Kubler et al.                 |                                                                                |
|                       | 22       | 5,737,414                                                                 | 4/7/1998                       | Walker et al.                 |                                                                                |
|                       | 23       | 5,751,961                                                                 | 5/12/1998                      | Smyk                          |                                                                                |
|                       | 24       | 5,793,762                                                                 | 8/11/1998                      | Penners et al.                |                                                                                |
|                       | 25       | 5,799,072                                                                 | 8/25/1998                      | Vulcan et al.                 |                                                                                |
|                       | 26       | 5,802,502                                                                 | 9/1/1998                       | Gell et al.                   |                                                                                |
|                       | 27       | 5,825,863                                                                 | 10/20/1998                     | Walker                        |                                                                                |
|                       | 28       | 5,828,740                                                                 | 10/27/1998                     | Khuc et al.                   |                                                                                |

|                    |                 |
|--------------------|-----------------|
| Examiner Signature | Date Considered |
|--------------------|-----------------|

\***Examiner:** Initial if reference considered, whether or not citation is in conformance with MPEP 609. Draw line through citation if not in conformance and not considered. Include copy of this form with next communication to applicant.

|                                                          |                      |                     |               |
|----------------------------------------------------------|----------------------|---------------------|---------------|
| <b>INFORMATION DISCLOSURE<br/>STATEMENT BY APPLICANT</b> | Application No.      | 13/966,096          |               |
|                                                          | Filing Date          | August 13, 2013     |               |
|                                                          | First Named Inventor | Perrault, Clay      |               |
|                                                          | Art Unit             | 2472                |               |
| <i>(Multiple sheets used when necessary)</i>             |                      | Examiner            | Kizou, Hassan |
| SHEET 2 OF 7                                             |                      | Attorney Docket No. | SMARB19.001C1 |

| U.S. PATENT DOCUMENTS |          |                                                                           |                                |                               |                                                                                |
|-----------------------|----------|---------------------------------------------------------------------------|--------------------------------|-------------------------------|--------------------------------------------------------------------------------|
| Examiner Initials     | Cite No. | Document Number<br>Number - Kind Code (if known)<br>Example: 1,234,567 B1 | Publication Date<br>MM-DD-YYYY | Name of Patentee or Applicant | Pages, Columns, Lines Where<br>Relevant Passages or Relevant<br>Figures Appear |
|                       | 29       | 5,838,682                                                                 | 11/17/1998                     | Dekelbaum et al.              |                                                                                |
|                       | 30       | 5,845,267                                                                 | 12/1/1998                      | Ronen                         |                                                                                |
|                       | 31       | 5,850,433                                                                 | 12/15/1998                     | Rondeau                       |                                                                                |
|                       | 32       | 5,864,610                                                                 | 1/26/1999                      | Ronen                         |                                                                                |
|                       | 33       | 5,867,495                                                                 | 2/2/1999                       | Elliott et al.                |                                                                                |
|                       | 34       | 5,883,891                                                                 | 3/16/1999                      | Williams et al.               |                                                                                |
|                       | 35       | 5,889,774                                                                 | 3/30/1999                      | Mirashrafi et al.             |                                                                                |
|                       | 36       | 5,905,736                                                                 | 5/18/1999                      | Ronen et al.                  |                                                                                |
|                       | 37       | 5,907,547                                                                 | 5/25/1999                      | Foladare et al.               |                                                                                |
|                       | 38       | 5,910,946                                                                 | 6/8/1999                       | Csapo                         |                                                                                |
|                       | 39       | 5,915,005                                                                 | 6/22/1999                      | He                            |                                                                                |
|                       | 40       | 5,923,659                                                                 | 7/13/1999                      | Curry et al.                  |                                                                                |
|                       | 41       | 5,930,343                                                                 | 7/27/1999                      | Vasquez                       |                                                                                |
|                       | 42       | 5,937,045                                                                 | 8/10/1999                      | Yaoya et al.                  |                                                                                |
|                       | 43       | 5,940,598                                                                 | 8/17/1999                      | Strauss et al.                |                                                                                |
|                       | 44       | 5,953,504                                                                 | 9/14/1999                      | Sokal et al.                  |                                                                                |
|                       | 45       | 5,956,391                                                                 | 9/21/1999                      | Melen et al.                  |                                                                                |
|                       | 46       | 5,970,477                                                                 | 10/19/1999                     | Roden                         |                                                                                |
|                       | 47       | 5,974,043                                                                 | 10/26/1999                     | Solomon                       |                                                                                |
|                       | 48       | 5,991,291                                                                 | 11/23/1999                     | Asai et al.                   |                                                                                |
|                       | 49       | 6,005,926                                                                 | 12/21/1999                     | Mashinsky                     |                                                                                |
|                       | 50       | 6,014,379                                                                 | 1/11/2000                      | White et al.                  |                                                                                |
|                       | 51       | 6,021,126                                                                 | 2/1/2000                       | White et al.                  |                                                                                |
|                       | 52       | 6,052,445                                                                 | 4/18/2000                      | Bashoura et al.               |                                                                                |
|                       | 53       | 6,058,300                                                                 | 5/2/2000                       | Hanson                        |                                                                                |
|                       | 54       | 6,069,890                                                                 | 5/30/2000                      | White et al.                  |                                                                                |
|                       | 55       | 6,073,013                                                                 | 6/6/2000                       | Agre et al.                   |                                                                                |
|                       | 56       | 6,078,647                                                                 | 6/20/2000                      | D'Eletto                      |                                                                                |
|                       | 57       | 6,104,704                                                                 | 8/15/2000                      | Buhler et al.                 |                                                                                |

|                                                                                                                                                                                                                                                         |                 |
|---------------------------------------------------------------------------------------------------------------------------------------------------------------------------------------------------------------------------------------------------------|-----------------|
| Examiner Signature                                                                                                                                                                                                                                      | Date Considered |
| <p><b>*Examiner:</b> Initial if reference considered, whether or not citation is in conformance with MPEP 609. Draw line through citation if not in conformance and not considered. Include copy of this form with next communication to applicant.</p> |                 |

|                                                          |                      |                 |
|----------------------------------------------------------|----------------------|-----------------|
| <b>INFORMATION DISCLOSURE<br/>STATEMENT BY APPLICANT</b> | Application No.      | 13/966,096      |
|                                                          | Filing Date          | August 13, 2013 |
|                                                          | First Named Inventor | Perrault, Clay  |
|                                                          | Art Unit             | 2472            |
| <i>(Multiple sheets used when necessary)</i>             | Examiner             | Kizou, Hassan   |
| SHEET 3 OF 7                                             | Attorney Docket No.  | SMARB19.001C1   |

|  |    |           |            |                     |  |
|--|----|-----------|------------|---------------------|--|
|  | 58 | 6,104,711 | 8/15/2000  | Voit                |  |
|  | 59 | 6,115,737 | 9/5/2000   | Ely et al.          |  |
|  | 60 | 6,128,304 | 10/3/2000  | Gardell et al.      |  |
|  | 61 | 6,137,869 | 10/24/2000 | Voit et al          |  |
|  | 62 | 6,141,404 | 10/31/2000 | Westerlage et al.   |  |
|  | 63 | 6,151,385 | 11/21/2000 | Reich et al.        |  |
|  | 64 | 6,188,752 | 2/13/2001  | Lesley              |  |
|  | 65 | 6,282,574 | 8/28/2001  | Voit                |  |
|  | 66 | 6,298,062 | 10/2/2001  | Gardell et al.      |  |
|  | 67 | 6,351,464 | 2/26/2002  | Galvin et al.       |  |
|  | 68 | 6,359,880 | 3/19/2002  | Curry et al.        |  |
|  | 69 | 6,430,275 | 8/6/2002   | Voit et al          |  |
|  | 70 | 6,507,644 | 1/14/2003  | Henderson et al.    |  |
|  | 71 | 6,597,686 | 7/23/2003  | Darek A Smyk        |  |
|  | 72 | 6,674,745 | 1/6/2004   | Schuster et al.     |  |
|  | 73 | 6,724,860 | 4/20/2004  | Stumer et al.       |  |
|  | 74 | 6,744,858 | 6/1/2004   | Ryan et al.         |  |
|  | 75 | 6,766,159 | 7/20/2004  | Lindholm            |  |
|  | 76 | 6,798,767 | 9/29/2004  | Alexander et al.    |  |
|  | 77 | 6,819,929 | 11/16/2004 | Antonucci et al.    |  |
|  | 78 | 6,954,453 | 10/11/2005 | Schindler           |  |
|  | 79 | 6,963,557 | 11/8/2005  | Mark Clinton Knox   |  |
|  | 80 | 7,046,658 | 5/16/2006  | Vinay Kundaje       |  |
|  | 81 | 7,055,174 | 5/30/2006  | Cope et al.         |  |
|  | 82 | 7,068,772 | 6/27/2006  | Widger et al.       |  |
|  | 83 | 7,079,526 | 7/18/2006  | Wipliez et al.      |  |
|  | 84 | 7,120,682 | 10/10/2006 | Salama              |  |
|  | 85 | 7,212,522 | 5/1/2007   | Shankar et al.      |  |
|  | 86 | 7,454,510 | 11/18/2008 | Kleyman et al.      |  |
|  | 87 | 7,950,046 | 5/24/2011  | Kropivny, Alexander |  |
|  | 88 | 8,116,307 | 2/14/2012  | Thesayi et al.      |  |

|                                                                                                                                                                                                                                                         |                 |
|---------------------------------------------------------------------------------------------------------------------------------------------------------------------------------------------------------------------------------------------------------|-----------------|
| Examiner Signature                                                                                                                                                                                                                                      | Date Considered |
| <p><b>*Examiner:</b> Initial if reference considered, whether or not citation is in conformance with MPEP 609. Draw line through citation if not in conformance and not considered. Include copy of this form with next communication to applicant.</p> |                 |

|                                                          |                      |                 |
|----------------------------------------------------------|----------------------|-----------------|
| <b>INFORMATION DISCLOSURE<br/>STATEMENT BY APPLICANT</b> | Application No.      | 13/966,096      |
|                                                          | Filing Date          | August 13, 2013 |
|                                                          | First Named Inventor | Perrault, Clay  |
|                                                          | Art Unit             | 2472            |
| <i>(Multiple sheets used when necessary)</i>             | Examiner             | Kizou, Hassan   |
| SHEET 4 OF 7                                             | Attorney Docket No.  | SMARB19.001C1   |

|  |     |                 |            |                       |  |
|--|-----|-----------------|------------|-----------------------|--|
|  | 89  | 2002/0051518 A1 | 5/2/2002   | Bondy et al.          |  |
|  | 90  | 2002/0116464 A1 | 8/22/2002  | Mak                   |  |
|  | 91  | 2002/0122391 A1 | 9/5/2002   | Shalit, Andrew L.     |  |
|  | 92  | 2003/0200311 A1 | 10/23/2003 | Baum                  |  |
|  | 93  | 2003/0219103 A1 | 11/27/2003 | Rao et al.            |  |
|  | 94  | 2004/0022237 A1 | 2/5/2004   | Elliot et al.         |  |
|  | 95  | 2004/0157629 A1 | 8/12/2004  | Kallio et al.         |  |
|  | 96  | 2004/0165709 a1 | 8/26/2004  | Pence et al.          |  |
|  | 97  | 2004/0181599 A1 | 9/16/2004  | Kreusch et al.        |  |
|  | 98  | 2004/0202295 A1 | 10/14/2004 | Shen et al.           |  |
|  | 99  | 2004/0240439 A1 | 12/2/2004  | Castleberry et al.    |  |
|  | 100 | 2004/0255126 A1 | 12/16/2004 | Reith                 |  |
|  | 101 | 2005/0025043 A1 | 2/3/2005   | Mussman et al         |  |
|  | 102 | 2005/0083911 A1 | 4/21/2005  | Grabelsky et al.      |  |
|  | 103 | 2005/0094651 A1 | 5/5/2005   | Lutz et al.           |  |
|  | 104 | 2005/0169248 A1 | 8/4/2005   | Truesdale et al.      |  |
|  | 105 | 2005/0174937 A1 | 8/11/2005  | Scoggins et al.       |  |
|  | 106 | 2005/0177843 A1 | 8/11/2005  | Williams              |  |
|  | 107 | 2006/0072547 A1 | 4/6/2006   | Florkey et al.        |  |
|  | 108 | 2006/0072550 A1 | 4/6/2006   | Davis et al.          |  |
|  | 109 | 2006/0093135 A1 | 5/4/2006   | Fiatel et al.         |  |
|  | 110 | 2006/0111116 A1 | 5/25/2006  | Palmer et al.         |  |
|  | 111 | 2006/0153342 A1 | 7/13/2006  | Syouichi Sasaki       |  |
|  | 112 | 2006/0160565 A1 | 7/20/2006  | Singh et al.          |  |
|  | 113 | 2006/0177035 A1 | 8/10/2006  | Cope et al.           |  |
|  | 114 | 2006/0209768 A1 | 9/21/2006  | Yan et al.            |  |
|  | 115 | 2006/0258328 A1 | 11/16/2006 | Mario Francisco Godoy |  |
|  | 116 | 2006/0264200 A1 | 11/23/2006 | Laiho et al.          |  |
|  | 117 | 2007/0036143 A1 | 2/15/2007  | Alt et al.            |  |
|  | 118 | 2007/0112964 A1 | 5/17/2007  | Guedalia et al.       |  |
|  | 119 | 2007/0127676 A1 | 6/7/2007   | Khadri                |  |
|  | 120 | 2007/0253418 A1 | 11/1/2007  | Shiri et al.          |  |

|                    |                 |
|--------------------|-----------------|
| Examiner Signature | Date Considered |
|--------------------|-----------------|

\***Examiner:** Initial if reference considered, whether or not citation is in conformance with MPEP 609. Draw line through citation if not in conformance and not considered. Include copy of this form with next communication to applicant.

|                                                          |                      |                     |               |
|----------------------------------------------------------|----------------------|---------------------|---------------|
| <b>INFORMATION DISCLOSURE<br/>STATEMENT BY APPLICANT</b> | Application No.      | 13/966,096          |               |
|                                                          | Filing Date          | August 13, 2013     |               |
|                                                          | First Named Inventor | Perrault, Clay      |               |
|                                                          | Art Unit             | 2472                |               |
| <i>(Multiple sheets used when necessary)</i>             |                      | Examiner            | Kizou, Hassan |
| SHEET 5 OF 7                                             |                      | Attorney Docket No. | SMARB19.001C1 |

|     |                 |            |                   |  |
|-----|-----------------|------------|-------------------|--|
| 121 | 2008/0037715 A1 | 2/14/2008  | Prozeniuk et al.  |  |
| 122 | 2008/0056235 A1 | 3/6/2008   | Albina et al.     |  |
| 123 | 2008/0063153 A1 | 3/13/2008  | Krivorot et al.   |  |
| 124 | 2009/0028146 A1 | 1/29/2009  | Kleyman et al.    |  |
| 125 | 2009/0292539 A1 | 11/26/2009 | Jaroker, Jon      |  |
| 126 | 2009/0325558 A1 | 12/31/2009 | Pridmore et al.   |  |
| 127 | 2010/0086119 A1 | 4/8/2010   | De Luca et al.    |  |
| 128 | 2008/0056302 A1 | 3/6/2008   | Erdal et al.      |  |
| 129 | 2009/0135735 A1 | 5/28/2009  | Zhang et al.      |  |
| 130 | 2009/0141883 A1 | 6/4/2009   | Bastien, Stephane |  |
| 131 | 2010/0128729 A1 | 5/27/2010  | Yazaki et al.     |  |
| 132 | 2012/0099599 A1 | 4/26/2012  | Keränen et al.    |  |
| 133 | 2012/0227101 A1 | 9/6/2012   | Yuan, Wei         |  |
| 134 | 2013/0114589 A1 | 5/9/2013   | Fangman et al.    |  |

## FOREIGN PATENT DOCUMENTS

| Examiner Initials | Cite No. | Foreign Patent Document<br>Country Code-Number-Kind Code<br>Example: JP 1234567 A1 | Publication Date<br>MM-DD-YYYY | Name of Patentee or Applicant | Pages, Columns, Lines<br>Where Relevant Passages or<br>Relevant Figures Appear | T <sup>1</sup> |
|-------------------|----------|------------------------------------------------------------------------------------|--------------------------------|-------------------------------|--------------------------------------------------------------------------------|----------------|
|                   | 135      | CA 2,249,668                                                                       | 4/7/1999                       | Bruno et al.                  |                                                                                |                |
|                   | 136      | EP 1 389 862 A1                                                                    | 2/18/2004                      | Shen et al.                   |                                                                                |                |
|                   | 137      | EP 1 389 862 B1                                                                    | 11/3/2004                      | Shen et al.                   |                                                                                |                |
|                   | 138      | WO 01/89145 A2                                                                     | 11/22/2001                     | Foti, Georges                 |                                                                                |                |
|                   | 139      | WO 2007/044454 A2                                                                  | 4/19/2007                      | Croy et al.                   |                                                                                |                |
|                   | 140      | WO 2008/052340 A1                                                                  | 5/8/2008                       | Perreault et al.              |                                                                                |                |
|                   | 141      | WO 2008/064481 A1                                                                  | 6/5/2008                       | Bjorsell et al.               |                                                                                |                |
|                   | 142      | WO 2008/116296 A1                                                                  | 10/2/2008                      | Bjorsell et al.               |                                                                                |                |

## NON PATENT LITERATURE DOCUMENTS

| Examiner Initials | Cite No. | Include name of the author (in CAPITAL LETTERS), title of the article (when appropriate), title of the item (book, magazine, journal, serial, symposium, catalog, etc.), date, page(s), volume-issue number(s), publisher, city and/or country where published. | T <sup>1</sup> |
|-------------------|----------|-----------------------------------------------------------------------------------------------------------------------------------------------------------------------------------------------------------------------------------------------------------------|----------------|
|                   | 143      | F. Baker et al. "RFC 3924 - Cisco Architecture for Lawful Intercept in IP Networks." October 2004.                                                                                                                                                              |                |

|                    |                 |
|--------------------|-----------------|
| Examiner Signature | Date Considered |
|--------------------|-----------------|

\***Examiner:** Initial if reference considered, whether or not citation is in conformance with MPEP 609. Draw line through citation if not in conformance and not considered. Include copy of this form with next communication to applicant.

|                                                          |                      |                 |
|----------------------------------------------------------|----------------------|-----------------|
| <b>INFORMATION DISCLOSURE<br/>STATEMENT BY APPLICANT</b> | Application No.      | 13/966,096      |
|                                                          | Filing Date          | August 13, 2013 |
|                                                          | First Named Inventor | Perrault, Clay  |
|                                                          | Art Unit             | 2472            |
| <i>(Multiple sheets used when necessary)</i>             | Examiner             | Kizou, Hassan   |
| SHEET 6 OF 7                                             | Attorney Docket No.  | SMARB19.001C1   |

| <b>NON PATENT LITERATURE DOCUMENTS</b> |             |                                                                                                                                                                                                                                                                 |                |
|----------------------------------------|-------------|-----------------------------------------------------------------------------------------------------------------------------------------------------------------------------------------------------------------------------------------------------------------|----------------|
| Examiner<br>Initials                   | Cite<br>No. | Include name of the author (in CAPITAL LETTERS), title of the article (when appropriate), title of the item (book, magazine, journal, serial, symposium, catalog, etc.), date, page(s), volume-issue number(s), publisher, city and/or country where published. | T <sup>1</sup> |
|                                        | 144         | Cisco. "Lawful Intercept Requirements Summary." <a href="http://www.faqs.org/rfcs/rfc3924.html">http://www.faqs.org/rfcs/rfc3924.html</a> .<br>November 8, 2006.                                                                                                |                |
|                                        | 145         | Sippy SIP B2BUA. "About Sippy RTPproxy." <a href="http://www.rtpproxy.org">http://www.rtpproxy.org</a> . July 15, 2009.                                                                                                                                         |                |
|                                        | 146         | ETSI Technical Specification. "Lawful Interception (LI); Handover Interface and Service-Specific Details (SSD) for IP delivery; Part 5: Service-specific details for IP Multimedia Services." Apr 2008, 25 pgs, v.2.3.1, France.                                |                |
|                                        | 147         | M. Handley et al. "RFC 2543 - SIP: Session Initiation Protocol." March 1999.                                                                                                                                                                                    |                |
|                                        | 148         | A copy of the International Search Report and Written Opinion of the International Searching Authority completed June 6, 2008 for related PCT/CA2008/000545.                                                                                                    |                |
|                                        | 149         | A copy of the International Search Report and Written Opinion of the International Searching Authority completed February 6, 2008 for corresponding PCT/CA2007/001956.                                                                                          |                |
|                                        | 150         | A copy of the International Preliminary Report on Patentability mailed May 14, 2009 for corresponding PCT/CA2007/001956.                                                                                                                                        |                |
|                                        | 151         | A copy of the International Search Report and Written Opinion of the International Searching Authority completed March 3, 2008 for related PCT/CA2007/002150.                                                                                                   |                |
|                                        | 152         | A copy of the International Preliminary Report on Patentability mailed February 13, 2009 for related PCT/CA2007/002150.                                                                                                                                         |                |
|                                        | 153         | A copy of the International Preliminary Report on Patentability and Written Opinion of the International Searching Authority mailed February 10, 2011 for related PCT Application No. PCT/CA2009/001062, February 01, 2011.                                     |                |
|                                        | 154         | A copy of the Written Opinion and International Search Report completed on June 18, 2010 for related PCT Application No. PCT/CA2009/001317.                                                                                                                     |                |
|                                        | 155         | A copy of the International Search Report and Written Opinion mailed on March 12, 2010 for corresponding PCT Application No. PCT/CA2009/001062.                                                                                                                 |                |
|                                        | 156         | A copy of the International Preliminary Report on Patentability issued on September 29, 2009 for PCT/CA2008/000545.                                                                                                                                             |                |
|                                        | 157         | A copy of the International Preliminary Report on Patentability issued on March 20, 2012 for PCT/CA2009/001317.                                                                                                                                                 |                |
|                                        | 158         | Townsend, et al.; "RFC 2661 - Layer Two Tunneling Protocol 'L2TP' ", August 1999.                                                                                                                                                                               |                |
|                                        | 159         | IP2Location, <a href="http://www.ip2location.com/">http://www.ip2location.com/</a> ; printed June 20, 2012.                                                                                                                                                     |                |
|                                        | 160         | DOTS IP Address Validation, "Overview", <a href="http://www.serviceobjects.com/products/dots_ipgeo.asp">http://www.serviceobjects.com/products/dots_ipgeo.asp</a> ; printed June 21, 2012.                                                                      |                |
|                                        | 161         | List of North American Numbering Plan area codes, <a href="http://en.wikipedia.org/wiki/List_of_NANP_area_codes">http://en.wikipedia.org/wiki/List_of_NANP_area_codes</a> ; printed June 20, 2012.                                                              |                |

|                                                                                                                                                                                                                                                         |                 |
|---------------------------------------------------------------------------------------------------------------------------------------------------------------------------------------------------------------------------------------------------------|-----------------|
| Examiner Signature                                                                                                                                                                                                                                      | Date Considered |
| <p><b>*Examiner:</b> Initial if reference considered, whether or not citation is in conformance with MPEP 609. Draw line through citation if not in conformance and not considered. Include copy of this form with next communication to applicant.</p> |                 |

T<sup>1</sup> - Place a check mark in this area when an English language PEPERSONER INC. EX. 1005-770

|                                                          |                      |                 |
|----------------------------------------------------------|----------------------|-----------------|
| <b>INFORMATION DISCLOSURE<br/>STATEMENT BY APPLICANT</b> | Application No.      | 13/966,096      |
|                                                          | Filing Date          | August 13, 2013 |
|                                                          | First Named Inventor | Perrault, Clay  |
|                                                          | Art Unit             | 2472            |
| <i>(Multiple sheets used when necessary)</i>             | Examiner             | Kizou, Hassan   |
| SHEET 7 OF 7                                             | Attorney Docket No.  | SMARB19.001C1   |

| NON PATENT LITERATURE DOCUMENTS |             |                                                                                                                                                                                                                                                                                                                                                                         |                |
|---------------------------------|-------------|-------------------------------------------------------------------------------------------------------------------------------------------------------------------------------------------------------------------------------------------------------------------------------------------------------------------------------------------------------------------------|----------------|
| Examiner<br>Initials            | Cite<br>No. | Include name of the author (in CAPITAL LETTERS), title of the article (when appropriate), title of the item (book, magazine, journal, serial, symposium, catalog, etc.), date, page(s), volume-issue number(s), publisher, city and/or country where published.                                                                                                         | T <sup>1</sup> |
|                                 | 162         | DOTS Phone Exchange, "Overview", <a href="http://www.serviceobjects.com/demos/PhoneExchangeDemo.asp">http://www.serviceobjects.com/demos/PhoneExchangeDemo.asp</a> (URL no longer valid, current URL is <a href="http://www.serviceobjects.com/products/phone/phone-exchange">http://www.serviceobjects.com/products/phone/phone-exchange</a> ); printed June 21, 2012. |                |
|                                 | 163         | Rosenberg, et al.; "RFC 3261 - SIP: Session Initiation Protocol", June 2002.                                                                                                                                                                                                                                                                                            |                |
|                                 | 164         | Lind AT&T S: "ENUM Call Flows for VoIP Interworking; draft-lind-enum-callflows-03.txt", 20020201, no. 3, 1 February 2002, pages 1-17, XP015004214, ISSN: 0000-0004.                                                                                                                                                                                                     |                |
|                                 | 165         | IETF ENUM WG R STASTNY OEFEG INFORMATIONAL NUMBERING FOR VOIP AND OTHER IP COMMUNICATIONS: "Numbering for ViOP and other IP Communications, draft-stastny-enum-numbering-voip-00.txt", 20031001, 1 October 2003, pages 1-43, XP015035676, ISSN: 0000-0004.                                                                                                              |                |
|                                 | 166         | Supplementary European Search Report for European Application No. 07816106, dated June 18, 2012.                                                                                                                                                                                                                                                                        |                |
|                                 | 167         | Supplementary European Search Report for European Application No. 07816106, dated November 2, 2012.                                                                                                                                                                                                                                                                     |                |
|                                 | 168         | Wikipedia, "International mobile subscriber identity (IMSI)," <a href="http://en.wikipedia.org/wiki/IMSI">http://en.wikipedia.org/wiki/IMSI</a> , 7-16-2013.                                                                                                                                                                                                            |                |
|                                 | 169         | Wikipedia, "Roaming," <a href="http://en.wikipedia.org/wiki/Roaming">http://en.wikipedia.org/wiki/Roaming</a> , 7-16-2013.                                                                                                                                                                                                                                              |                |

16645405  
111113

|                                                                                                                                                                                                                                                         |                 |
|---------------------------------------------------------------------------------------------------------------------------------------------------------------------------------------------------------------------------------------------------------|-----------------|
| Examiner Signature                                                                                                                                                                                                                                      | Date Considered |
| <p><b>*Examiner:</b> Initial if reference considered, whether or not citation is in conformance with MPEP 609. Draw line through citation if not in conformance and not considered. Include copy of this form with next communication to applicant.</p> |                 |

T<sup>1</sup> - Place a check mark in this area when an English language PENSIONER APP INC. EX. 1005-771

## Electronic Acknowledgement Receipt

|                                             |                                                             |
|---------------------------------------------|-------------------------------------------------------------|
| <b>EFS ID:</b>                              | 17383340                                                    |
| <b>Application Number:</b>                  | 13966096                                                    |
| <b>International Application Number:</b>    |                                                             |
| <b>Confirmation Number:</b>                 | 8712                                                        |
| <b>Title of Invention:</b>                  | PRODUCING ROUTING MESSAGES FOR VOICE OVER IP COMMUNICATIONS |
| <b>First Named Inventor/Applicant Name:</b> | CLAY PERRAULT                                               |
| <b>Customer Number:</b>                     | 20995                                                       |
| <b>Filer:</b>                               | Paul C. Steinhardt/Norman Green                             |
| <b>Filer Authorized By:</b>                 | Paul C. Steinhardt                                          |
| <b>Attorney Docket Number:</b>              | SMARB19.001C1                                               |
| <b>Receipt Date:</b>                        | 12-NOV-2013                                                 |
| <b>Filing Date:</b>                         | 13-AUG-2013                                                 |
| <b>Time Stamp:</b>                          | 18:17:58                                                    |
| <b>Application Type:</b>                    | Utility under 35 USC 111(a)                                 |

### Payment information:

|                        |    |
|------------------------|----|
| Submitted with Payment | no |
|------------------------|----|

### File Listing:

| Document Number | Document Description | File Name                        | File Size(Bytes)/<br>Message Digest                                    | Multi Part /.zip | Pages (if appl.) |
|-----------------|----------------------|----------------------------------|------------------------------------------------------------------------|------------------|------------------|
| 1               |                      | IDS_SMARB19_001C1_11_12_2013.pdf | 475461<br><small>196f792af5abaf2959d22b935ecdecec4b2e<br/>fb47</small> | yes              | 9                |



| Multipart Description/PDF files in .zip description |                                                    |       |     |
|-----------------------------------------------------|----------------------------------------------------|-------|-----|
|                                                     | Document Description                               | Start | End |
|                                                     | Transmittal Letter                                 | 1     | 2   |
|                                                     | Information Disclosure Statement (IDS) Form (SB08) | 3     | 9   |

**Warnings:**

**Information:**

|   |                       |                       |                                                    |    |   |
|---|-----------------------|-----------------------|----------------------------------------------------|----|---|
| 2 | Non Patent Literature | Ref168__WIKI_IMSI.pdf | 316123<br>e2bf56b6db834ff63a7e776c6a468b8e033d7bd2 | no | 4 |
|---|-----------------------|-----------------------|----------------------------------------------------|----|---|

**Warnings:**

**Information:**

|   |                       |                          |                                                    |    |   |
|---|-----------------------|--------------------------|----------------------------------------------------|----|---|
| 3 | Non Patent Literature | Ref169__WIKI_ROAMING.pdf | 837516<br>b56a3eb9a59331bd90d887ce6cbce1ad35e743b4 | no | 8 |
|---|-----------------------|--------------------------|----------------------------------------------------|----|---|

**Warnings:**

**Information:**

|                                     |  |  |         |
|-------------------------------------|--|--|---------|
| <b>Total Files Size (in bytes):</b> |  |  | 1629100 |
|-------------------------------------|--|--|---------|

**This Acknowledgement Receipt evidences receipt on the noted date by the USPTO of the indicated documents, characterized by the applicant, and including page counts, where applicable. It serves as evidence of receipt similar to a Post Card, as described in MPEP 503.**

**New Applications Under 35 U.S.C. 111**

**If a new application is being filed and the application includes the necessary components for a filing date (see 37 CFR 1.53(b)-(d) and MPEP 506), a Filing Receipt (37 CFR 1.54) will be issued in due course and the date shown on this Acknowledgement Receipt will establish the filing date of the application.**

**National Stage of an International Application under 35 U.S.C. 371**

**If a timely submission to enter the national stage of an international application is compliant with the conditions of 35 U.S.C. 371 and other applicable requirements a Form PCT/DO/EO/903 indicating acceptance of the application as a national stage submission under 35 U.S.C. 371 will be issued in addition to the Filing Receipt, in due course.**

**New International Application Filed with the USPTO as a Receiving Office**

**If a new international application is being filed and the international application includes the necessary components for an international filing date (see PCT Article 11 and MPEP 1810), a Notification of the International Application Number and of the International Filing Date (Form PCT/RO/105) will be issued in due course, subject to prescriptions concerning national security, and the date shown on this Acknowledgement Receipt will establish the international filing date of the application.**

**INFORMATION DISCLOSURE STATEMENT**

|           |   |                                                                |
|-----------|---|----------------------------------------------------------------|
| Inventor  | : | Clay Perrault, et al.                                          |
| App. No.  | : | 13/966,096                                                     |
| Filed     | : | August 13, 2013                                                |
| For       | : | PRODUCING ROUTING MESSAGES FOR<br>VOICE OVER IP COMMUNICATIONS |
| Examiner  | : | Kizou, Hassan                                                  |
| Art Unit  | : | 2472                                                           |
| Conf. No. | : | 8712                                                           |

Commissioner for Patents  
P.O. Box 1450  
Alexandria, VA 22313-1450

**References and Listing**

Submitted herewith in the above-identified application is an Information Disclosure Statement listing references for consideration. References numbered 1-127 and 135-167 are of record in U.S. patent application No. 12/513,147, filed March 1, 2010, which is relied upon for an earlier filing date under 35 USC 120. Accordingly, copies of references numbered 1-127 and 135-167 are not submitted pursuant to 37 CFR 1.98(d).

**Timing of Disclosure**

This Information Disclosure Statement is being filed within three months of the filing date or date of national phase entry, with an RCE or before receipt of a First Office Action after an RCE and no fee is required.

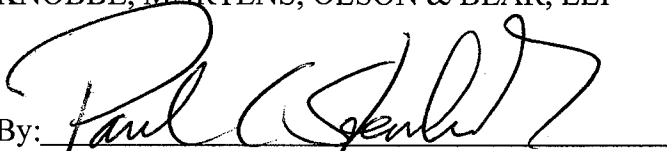
**Application No.: 13/966,096**  
**Filing Date: August 13, 2013**

The Commissioner is hereby authorized to charge any additional fees which may be required, or credit any overpayment, to Account No. 11-1410.

Respectfully submitted,

KNOBBE, MARTENS, OLSON & BEAR, LLP

Dated: Nov. 12, 2013

By: 

Paul C. Steinhardt  
Registration No. 30,806  
Attorney of Record  
Customer No. 20995  
(858) 707-4000

IDS  
16645601  
111113

Please Direct All Correspondence to Customer Number 20995

**RESCISSION OF ANY PRIOR DISCLAIMERS AND REQUEST TO REVISIT ART**

|           |   |                                                             |
|-----------|---|-------------------------------------------------------------|
| Inventor  | : | Clay Perrault et al.                                        |
| App. No.  | : | 13/966,096                                                  |
| Filed     | : | August 13, 2013                                             |
| For       | : | PRODUCING ROUTING MESSAGES FOR VOICE OVER IP COMMUNICATIONS |
| Examiner  | : | Unknown                                                     |
| Art Unit  | : | 2465                                                        |
| Conf. No. | : | 8712                                                        |

Commissioner for Patents  
P.O. Box 1450  
Alexandria, VA 22313-1450

Dear Sir:

The claims of the present application are different and possibly broader in scope than the claims pursued in the parent application(s). To the extent any prior amendments or characterizations of the scope of any claim or referenced art could be construed as a disclaimer of any subject matter supported by the present disclosure, Applicant hereby rescinds and retracts such disclaimer. Accordingly, the references previously considered in the parent application(s) may need to be re-visited.

Please charge any additional fees, including any fees for additional extension of time, or credit overpayment to Deposit Account No. 11-1410.

Knobbe, Martens, Olson & Bear, LLP

Respectfully submitted,



John M. Carson  
Registration No. 34,303  
Attorney of Record  
Customer No. 20995  
(858) 707-4000

Dated: 9/12/13

## Electronic Acknowledgement Receipt

|                                             |                                                             |
|---------------------------------------------|-------------------------------------------------------------|
| <b>EFS ID:</b>                              | 16839909                                                    |
| <b>Application Number:</b>                  | 13966096                                                    |
| <b>International Application Number:</b>    |                                                             |
| <b>Confirmation Number:</b>                 | 8712                                                        |
| <b>Title of Invention:</b>                  | PRODUCING ROUTING MESSAGES FOR VOICE OVER IP COMMUNICATIONS |
| <b>First Named Inventor/Applicant Name:</b> | CLAY PERRAULT                                               |
| <b>Customer Number:</b>                     | 20995                                                       |
| <b>Filer:</b>                               | John M Carson/Tony Do                                       |
| <b>Filer Authorized By:</b>                 | John M Carson                                               |
| <b>Attorney Docket Number:</b>              | SMARB19.001C1                                               |
| <b>Receipt Date:</b>                        | 12-SEP-2013                                                 |
| <b>Filing Date:</b>                         | 13-AUG-2013                                                 |
| <b>Time Stamp:</b>                          | 17:06:31                                                    |
| <b>Application Type:</b>                    | Utility under 35 USC 111(a)                                 |

### Payment information:

|                        |    |
|------------------------|----|
| Submitted with Payment | no |
|------------------------|----|

### File Listing:

| Document Number | Document Description          | File Name                  | File Size(Bytes)/<br>Message Digest              | Multi Part /.zip | Pages (if appl.) |
|-----------------|-------------------------------|----------------------------|--------------------------------------------------|------------------|------------------|
| 1               | Miscellaneous Incoming Letter | SMARB19001C1rescission.pdf | 39927<br>74ccd864aa53e9d79661ee9bffd18c8d5e9b8b4 | no               | 1                |

### Warnings:

### Information:

PETITIONER APPLE INC. EX. 1005-777

This Acknowledgement Receipt evidences receipt on the noted date by the USPTO of the indicated documents, characterized by the applicant, and including page counts, where applicable. It serves as evidence of receipt similar to a Post Card, as described in MPEP 503.

**New Applications Under 35 U.S.C. 111**

If a new application is being filed and the application includes the necessary components for a filing date (see 37 CFR 1.53(b)-(d) and MPEP 506), a Filing Receipt (37 CFR 1.54) will be issued in due course and the date shown on this Acknowledgement Receipt will establish the filing date of the application.

**National Stage of an International Application under 35 U.S.C. 371**

If a timely submission to enter the national stage of an international application is compliant with the conditions of 35 U.S.C. 371 and other applicable requirements a Form PCT/DO/EO/903 indicating acceptance of the application as a national stage submission under 35 U.S.C. 371 will be issued in addition to the Filing Receipt, in due course.

**New International Application Filed with the USPTO as a Receiving Office**

If a new international application is being filed and the international application includes the necessary components for an international filing date (see PCT Article 11 and MPEP 1810), a Notification of the International Application Number and of the International Filing Date (Form PCT/RO/105) will be issued in due course, subject to prescriptions concerning national security, and the date shown on this Acknowledgement Receipt will establish the international filing date of the application.

**PATENT APPLICATION FEE DETERMINATION RECORD**

Substitute for Form PTO-875

Application or Docket Number  
13/966,096

**APPLICATION AS FILED - PART I**

(Column 1) (Column 2)

| FOR                                               | NUMBER FILED                                                                                                                                                                                                                  | NUMBER EXTRA |
|---------------------------------------------------|-------------------------------------------------------------------------------------------------------------------------------------------------------------------------------------------------------------------------------|--------------|
| BASIC FEE<br>(37 CFR 1.16(a), (b), or (c))        | N/A                                                                                                                                                                                                                           | N/A          |
| SEARCH FEE<br>(37 CFR 1.16(k), (l), or (m))       | N/A                                                                                                                                                                                                                           | N/A          |
| EXAMINATION FEE<br>(37 CFR 1.16(o), (p), or (q))  | N/A                                                                                                                                                                                                                           | N/A          |
| TOTAL CLAIMS<br>(37 CFR 1.16(j))                  | 78 minus 20 = *                                                                                                                                                                                                               | 58           |
| INDEPENDENT CLAIMS<br>(37 CFR 1.16(h))            | 6 minus 3 = *                                                                                                                                                                                                                 | 3            |
| APPLICATION SIZE FEE<br>(37 CFR 1.16(s))          | If the specification and drawings exceed 100 sheets of paper, the application size fee due is \$310 (\$155 for small entity) for each additional 50 sheets or fraction thereof. See 35 U.S.C. 41(a)(1)(G) and 37 CFR 1.16(s). |              |
| MULTIPLE DEPENDENT CLAIM PRESENT (37 CFR 1.16(j)) |                                                                                                                                                                                                                               |              |

\* If the difference in column 1 is less than zero, enter "0" in column 2.

**SMALL ENTITY**

| RATE(\$)     | FEE(\$)     |
|--------------|-------------|
| N/A          | 70          |
| N/A          | 300         |
| N/A          | 360         |
| x 40 =       | 2320        |
| x 210 =      | 630         |
|              | 0.00        |
|              | 0.00        |
| <b>TOTAL</b> | <b>3680</b> |

**OR OTHER THAN SMALL ENTITY**

| RATE(\$)     | FEE(\$) |
|--------------|---------|
| N/A          |         |
| N/A          |         |
| N/A          |         |
|              |         |
|              |         |
|              |         |
| <b>TOTAL</b> |         |

**APPLICATION AS AMENDED - PART II**

(Column 1) (Column 2) (Column 3)

| AMENDMENT A                                                     | CLAIMS REMAINING AFTER AMENDMENT      |   | HIGHEST NUMBER PREVIOUSLY PAID FOR | PRESENT EXTRA |
|-----------------------------------------------------------------|---------------------------------------|---|------------------------------------|---------------|
|                                                                 | Total (37 CFR 1.16(i))                | * | Minus **                           | =             |
|                                                                 | Independent (37 CFR 1.16(h))          | * | Minus ***                          | =             |
|                                                                 | Application Size Fee (37 CFR 1.16(s)) |   |                                    |               |
| FIRST PRESENTATION OF MULTIPLE DEPENDENT CLAIM (37 CFR 1.16(j)) |                                       |   |                                    |               |

**SMALL ENTITY**

| RATE(\$)               | ADDITIONAL FEE(\$) |
|------------------------|--------------------|
| x =                    |                    |
| x =                    |                    |
|                        |                    |
|                        |                    |
| <b>TOTAL ADD'L FEE</b> |                    |

**OR OTHER THAN SMALL ENTITY**

| RATE(\$)               | ADDITIONAL FEE(\$) |
|------------------------|--------------------|
| x =                    |                    |
| x =                    |                    |
|                        |                    |
|                        |                    |
| <b>TOTAL ADD'L FEE</b> |                    |

(Column 1) (Column 2) (Column 3)

| AMENDMENT B                                                     | CLAIMS REMAINING AFTER AMENDMENT      |   | HIGHEST NUMBER PREVIOUSLY PAID FOR | PRESENT EXTRA |
|-----------------------------------------------------------------|---------------------------------------|---|------------------------------------|---------------|
|                                                                 | Total (37 CFR 1.16(i))                | * | Minus **                           | =             |
|                                                                 | Independent (37 CFR 1.16(h))          | * | Minus ***                          | =             |
|                                                                 | Application Size Fee (37 CFR 1.16(s)) |   |                                    |               |
| FIRST PRESENTATION OF MULTIPLE DEPENDENT CLAIM (37 CFR 1.16(j)) |                                       |   |                                    |               |

| RATE(\$)               | ADDITIONAL FEE(\$) |
|------------------------|--------------------|
| x =                    |                    |
| x =                    |                    |
|                        |                    |
|                        |                    |
| <b>TOTAL ADD'L FEE</b> |                    |

**OR OTHER THAN SMALL ENTITY**

| RATE(\$)               | ADDITIONAL FEE(\$) |
|------------------------|--------------------|
| x =                    |                    |
| x =                    |                    |
|                        |                    |
|                        |                    |
| <b>TOTAL ADD'L FEE</b> |                    |

\* If the entry in column 1 is less than the entry in column 2, write "0" in column 3.

\*\* If the "Highest Number Previously Paid For" IN THIS SPACE is less than 20, enter "20".

\*\*\* If the "Highest Number Previously Paid For" IN THIS SPACE is less than 3, enter "3".

The "Highest Number Previously Paid For" (Total or Independent) is the highest found in the appropriate box in column 1.



UNITED STATES PATENT AND TRADEMARK OFFICE

UNITED STATES DEPARTMENT OF COMMERCE
United States Patent and Trademark Office
Address: COMMISSIONER FOR PATENTS
P.O. Box 1450
Alexandria, Virginia 22313-1450
www.uspto.gov

Table with 6 columns: APPLICATION NUMBER, FILING or 371(c) DATE, GRP ART UNIT, FIL FEE REC'D, ATTY. DOCKET NO, TOT CLAIMS, IND CLAIMS. Row 1: 13/966,096, 08/13/2013, 2653, 3750, SMARB19.001C1, 78, 6

CONFIRMATION NO. 8712

FILING RECEIPT

20995
KNOBBE MARTENS OLSON & BEAR LLP
2040 MAIN STREET
FOURTEENTH FLOOR
IRVINE, CA 92614



Date Mailed: 09/05/2013

Receipt is acknowledged of this non-provisional patent application. The application will be taken up for examination in due course. Applicant will be notified as to the results of the examination. Any correspondence concerning the application must include the following identification information: the U.S. APPLICATION NUMBER, FILING DATE, NAME OF APPLICANT, and TITLE OF INVENTION. Fees transmitted by check or draft are subject to collection. Please verify the accuracy of the data presented on this receipt. If an error is noted on this Filing Receipt, please submit a written request for a Filing Receipt Correction. Please provide a copy of this Filing Receipt with the changes noted thereon. If you received a "Notice to File Missing Parts" for this application, please submit any corrections to this Filing Receipt with your reply to the Notice. When the USPTO processes the reply to the Notice, the USPTO will generate another Filing Receipt incorporating the requested corrections

Inventor(s)

CLAY PERRAULT, Panama City, PANAMA;
STEVE NICHOLSON, Hamilton, NEW ZEALAND;
ROD THOMSON, North Vancouver, CANADA;
JOHAN EMIL VIKTOR BJÖRSELL, Vancouver, CANADA;
FUAD ARAFA, Vancouver, CANADA;

Applicant(s)

Digifonica (INTERNATIONAL) Limited, Vancouver, CANADA

Assignment For Published Patent Application

Digifonica (INTERNATIONAL) Limited, Vancouver, CANADA

Power of Attorney: None

Domestic Priority data as claimed by applicant

This application is a CON of 12/513,147 03/01/2010 PAT 8542815
which is a 371 of PCT/CA07/01956 11/01/2007
which claims benefit of 60/856,212 11/02/2006

Foreign Applications for which priority is claimed (You may be eligible to benefit from the Patent Prosecution Highway program at the USPTO. Please see http://www.uspto.gov for more information.) - None.

Foreign application information must be provided in an Application Data Sheet in order to constitute a claim to foreign priority. See 37 CFR 1.55 and 1.76.

Permission to Access - A proper Authorization to Permit Access to Application by Participating Offices (PTO/SB/39 or its equivalent) has been received by the USPTO.



**If Required, Foreign Filing License Granted:** 08/28/2013

The country code and number of your priority application, to be used for filing abroad under the Paris Convention, is **US 13/966,096**

**Projected Publication Date:** 12/12/2013

**Non-Publication Request:** No

**Early Publication Request:** No

**\*\* SMALL ENTITY \*\***

**Title**

PRODUCING ROUTING MESSAGES FOR VOICE OVER IP COMMUNICATIONS

**Preliminary Class**

379

**Statement under 37 CFR 1.55 or 1.78 for AIA (First Inventor to File) Transition Applications:** No

### **PROTECTING YOUR INVENTION OUTSIDE THE UNITED STATES**

Since the rights granted by a U.S. patent extend only throughout the territory of the United States and have no effect in a foreign country, an inventor who wishes patent protection in another country must apply for a patent in a specific country or in regional patent offices. Applicants may wish to consider the filing of an international application under the Patent Cooperation Treaty (PCT). An international (PCT) application generally has the same effect as a regular national patent application in each PCT-member country. The PCT process **simplifies** the filing of patent applications on the same invention in member countries, but **does not result** in a grant of "an international patent" and does not eliminate the need of applicants to file additional documents and fees in countries where patent protection is desired.

Almost every country has its own patent law, and a person desiring a patent in a particular country must make an application for patent in that country in accordance with its particular laws. Since the laws of many countries differ in various respects from the patent law of the United States, applicants are advised to seek guidance from specific foreign countries to ensure that patent rights are not lost prematurely.

Applicants also are advised that in the case of inventions made in the United States, the Director of the USPTO must issue a license before applicants can apply for a patent in a foreign country. The filing of a U.S. patent application serves as a request for a foreign filing license. The application's filing receipt contains further information and guidance as to the status of applicant's license for foreign filing.

Applicants may wish to consult the USPTO booklet, "General Information Concerning Patents" (specifically, the section entitled "Treaties and Foreign Patents") for more information on timeframes and deadlines for filing foreign patent applications. The guide is available either by contacting the USPTO Contact Center at 800-786-9199, or it can be viewed on the USPTO website at <http://www.uspto.gov/web/offices/pac/doc/general/index.html>.

For information on preventing theft of your intellectual property (patents, trademarks and copyrights), you may wish to consult the U.S. Government website, <http://www.stopfakes.gov>. Part of a Department of Commerce initiative, this website includes self-help "toolkits" giving innovators guidance on how to protect intellectual property in specific countries such as China, Korea and Mexico. For questions regarding patent enforcement issues, applicants may call the U.S. Government hotline at 1-866-999-HALT (1-866-999-4258).

**LICENSE FOR FOREIGN FILING UNDER**  
**Title 35, United States Code, Section 184**  
**Title 37, Code of Federal Regulations, 5.11 & 5.15**

**GRANTED**

The applicant has been granted a license under 35 U.S.C. 184, if the phrase "IF REQUIRED, FOREIGN FILING LICENSE GRANTED" followed by a date appears on this form. Such licenses are issued in all applications where the conditions for issuance of a license have been met, regardless of whether or not a license may be required as set forth in 37 CFR 5.15. The scope and limitations of this license are set forth in 37 CFR 5.15(a) unless an earlier license has been issued under 37 CFR 5.15(b). The license is subject to revocation upon written notification. The date indicated is the effective date of the license, unless an earlier license of similar scope has been granted under 37 CFR 5.13 or 5.14.

This license is to be retained by the licensee and may be used at any time on or after the effective date thereof unless it is revoked. This license is automatically transferred to any related applications(s) filed under 37 CFR 1.53(d). This license is not retroactive.

The grant of a license does not in any way lessen the responsibility of a licensee for the security of the subject matter as imposed by any Government contract or the provisions of existing laws relating to espionage and the national security or the export of technical data. Licensees should apprise themselves of current regulations especially with respect to certain countries, of other agencies, particularly the Office of Defense Trade Controls, Department of State (with respect to Arms, Munitions and Implements of War (22 CFR 121-128)); the Bureau of Industry and Security, Department of Commerce (15 CFR parts 730-774); the Office of Foreign Assets Control, Department of Treasury (31 CFR Parts 500+) and the Department of Energy.

**NOT GRANTED**

No license under 35 U.S.C. 184 has been granted at this time, if the phrase "IF REQUIRED, FOREIGN FILING LICENSE GRANTED" DOES NOT appear on this form. Applicant may still petition for a license under 37 CFR 5.12, if a license is desired before the expiration of 6 months from the filing date of the application. If 6 months has lapsed from the filing date of this application and the licensee has not received any indication of a secrecy order under 35 U.S.C. 181, the licensee may foreign file the application pursuant to 37 CFR 5.15(b).

---

***SelectUSA***

The United States represents the largest, most dynamic marketplace in the world and is an unparalleled location for business investment, innovation, and commercialization of new technologies. The U.S. offers tremendous resources and advantages for those who invest and manufacture goods here. Through SelectUSA, our nation works to promote and facilitate business investment. SelectUSA provides information assistance to the international investor community; serves as an ombudsman for existing and potential investors; advocates on behalf of U.S. cities, states, and regions competing for global investment; and counsels U.S. economic development organizations on investment attraction best practices. To learn more about why the United States is the best country in the world to develop technology, manufacture products, deliver services, and grow your business, visit <http://www.SelectUSA.gov> or call +1-202-482-6800.



UNITED STATES PATENT AND TRADEMARK OFFICE

UNITED STATES DEPARTMENT OF COMMERCE
United States Patent and Trademark Office
Address: COMMISSIONER FOR PATENTS
P.O. Box 1450
Alexandria, Virginia 22313-1450
www.uspto.gov

Table with 4 columns: APPLICATION NUMBER (13/966,096), FILING OR 371(C) DATE (08/13/2013), FIRST NAMED APPLICANT (CLAY PERRAULT), ATTY. DOCKET NO./TITLE (SMARB19.001C1)

CONFIRMATION NO. 8712

20995
KNOBBE MARTENS OLSON & BEAR LLP
2040 MAIN STREET
FOURTEENTH FLOOR
IRVINE, CA 92614

NOTICE



Date Mailed: 09/05/2013

INFORMATIONAL NOTICE TO APPLICANT

Applicant is notified that the above-identified application contains the deficiencies noted below. No period for reply is set forth in this notice for correction of these deficiencies. However, if a deficiency relates to the inventor's oath or declaration, the applicant must file an oath or declaration in compliance with 37 CFR 1.63, or a substitute statement in compliance with 37 CFR 1.64, executed by or with respect to each actual inventor no later than the expiration of the time period set in the "Notice of Allowability" to avoid abandonment. See 37 CFR 1.53(f).

The item(s) indicated below are also required and should be submitted with any reply to this notice to avoid further processing delays.

- A properly executed inventor's oath or declaration has not been received for the following inventor(s):

CLAY PERRAULT
STEVE NICHOLSON
ROD THOMSON
JOHAN EMIL VIKTOR BJÖRSELL
FUAD ARAFA

Applicant may submit the inventor's oath or declaration at any time before the Notice of Allowance and Fee(s) Due, PTOL-85, is mailed.

Under the Paperwork Reduction Act of 1995, no persons are required to respond to a collection of information unless it contains a valid OMB control number.

|                                                                                                                                                                                                                                                                                                                                                                                                                                                                                                                     |                                                             |                        |               |
|---------------------------------------------------------------------------------------------------------------------------------------------------------------------------------------------------------------------------------------------------------------------------------------------------------------------------------------------------------------------------------------------------------------------------------------------------------------------------------------------------------------------|-------------------------------------------------------------|------------------------|---------------|
| <b>Application Data Sheet 37 CFR 1.76</b>                                                                                                                                                                                                                                                                                                                                                                                                                                                                           |                                                             | Attorney Docket Number | SMARB19.001C1 |
|                                                                                                                                                                                                                                                                                                                                                                                                                                                                                                                     |                                                             | Application Number     |               |
| Title of Invention                                                                                                                                                                                                                                                                                                                                                                                                                                                                                                  | PRODUCING ROUTING MESSAGES FOR VOICE OVER IP COMMUNICATIONS |                        |               |
| <p>The application data sheet is part of the provisional or nonprovisional application for which it is being submitted. The following form contains the bibliographic data arranged in a format specified by the United States Patent and Trademark Office as outlined in 37 CFR 1.76.</p> <p>This document may be completed electronically and submitted to the Office in electronic format using the Electronic Filing System (EFS) or the document may be printed and included in a paper filed application.</p> |                                                             |                        |               |

**Secrecy Order 37 CFR 5.2**

|                          |                                                                                                                                                                                                                                       |
|--------------------------|---------------------------------------------------------------------------------------------------------------------------------------------------------------------------------------------------------------------------------------|
| <input type="checkbox"/> | Portions or all of the application associated with this Application Data Sheet may fall under a Secrecy Order pursuant to 37 CFR 5.2 (Paper filers only. Applications that fall under Secrecy Order may not be filed electronically.) |
|--------------------------|---------------------------------------------------------------------------------------------------------------------------------------------------------------------------------------------------------------------------------------|

**Inventor Information:**

|                                                                                                                                                                                 |                         |                                         |                    |               |                                       |
|---------------------------------------------------------------------------------------------------------------------------------------------------------------------------------|-------------------------|-----------------------------------------|--------------------|---------------|---------------------------------------|
| <b>Inventor 1</b>                                                                                                                                                               |                         |                                         |                    |               | <input type="button" value="Remove"/> |
| <b>Legal Name</b>                                                                                                                                                               |                         |                                         |                    |               |                                       |
| <b>Prefix</b>                                                                                                                                                                   | <b>Given Name</b>       | <b>Middle Name</b>                      | <b>Family Name</b> | <b>Suffix</b> |                                       |
|                                                                                                                                                                                 | CLAY                    |                                         | PERRAULT           |               |                                       |
| <b>Residence Information (Select One)</b> <input type="radio"/> US Residency <input checked="" type="radio"/> Non US Residency <input type="radio"/> Active US Military Service |                         |                                         |                    |               |                                       |
| <b>City</b>                                                                                                                                                                     | PANAMA CITY             | <b>Country of Residence<sup>i</sup></b> | PA                 |               |                                       |
| <b>Mailing Address of Inventor:</b>                                                                                                                                             |                         |                                         |                    |               |                                       |
| <b>Address 1</b>                                                                                                                                                                | 340a COROZAL WEST       |                                         |                    |               |                                       |
| <b>Address 2</b>                                                                                                                                                                |                         |                                         |                    |               |                                       |
| <b>City</b>                                                                                                                                                                     | PANAMA CITY             | <b>State/Province</b>                   |                    |               |                                       |
| <b>Postal Code</b>                                                                                                                                                              |                         | <b>Country<sup>i</sup></b>              | PA                 |               |                                       |
| <b>Inventor 2</b>                                                                                                                                                               |                         |                                         |                    |               | <input type="button" value="Remove"/> |
| <b>Legal Name</b>                                                                                                                                                               |                         |                                         |                    |               |                                       |
| <b>Prefix</b>                                                                                                                                                                   | <b>Given Name</b>       | <b>Middle Name</b>                      | <b>Family Name</b> | <b>Suffix</b> |                                       |
|                                                                                                                                                                                 | STEVE                   |                                         | NICHOLSON          |               |                                       |
| <b>Residence Information (Select One)</b> <input type="radio"/> US Residency <input checked="" type="radio"/> Non US Residency <input type="radio"/> Active US Military Service |                         |                                         |                    |               |                                       |
| <b>City</b>                                                                                                                                                                     | HAMILTON                | <b>Country of Residence<sup>i</sup></b> | NZ                 |               |                                       |
| <b>Mailing Address of Inventor:</b>                                                                                                                                             |                         |                                         |                    |               |                                       |
| <b>Address 1</b>                                                                                                                                                                | 423 TAUWHARE ROAD, RD 3 |                                         |                    |               |                                       |
| <b>Address 2</b>                                                                                                                                                                |                         |                                         |                    |               |                                       |
| <b>City</b>                                                                                                                                                                     | HAMILTON                | <b>State/Province</b>                   |                    |               |                                       |
| <b>Postal Code</b>                                                                                                                                                              | 3283                    | <b>Country<sup>i</sup></b>              | NZ                 |               |                                       |
| <b>Inventor 3</b>                                                                                                                                                               |                         |                                         |                    |               | <input type="button" value="Remove"/> |
| <b>Legal Name</b>                                                                                                                                                               |                         |                                         |                    |               |                                       |

Under the Paperwork Reduction Act of 1995, no persons are required to respond to a collection of information unless it contains a valid OMB control number.

|                                                                                                                                                                          |                                                             |                                   |               |        |
|--------------------------------------------------------------------------------------------------------------------------------------------------------------------------|-------------------------------------------------------------|-----------------------------------|---------------|--------|
| <b>Application Data Sheet 37 CFR 1.76</b>                                                                                                                                |                                                             | Attorney Docket Number            | SMARB19.001C1 |        |
|                                                                                                                                                                          |                                                             | Application Number                |               |        |
| Title of Invention                                                                                                                                                       | PRODUCING ROUTING MESSAGES FOR VOICE OVER IP COMMUNICATIONS |                                   |               |        |
| Prefix                                                                                                                                                                   | Given Name                                                  | Middle Name                       | Family Name   | Suffix |
|                                                                                                                                                                          | ROD                                                         |                                   | THOMSON       |        |
| Residence Information (Select One) <input type="radio"/> US Residency <input checked="" type="radio"/> Non US Residency <input type="radio"/> Active US Military Service |                                                             |                                   |               |        |
| City                                                                                                                                                                     | NORTH VANCOUVER                                             | Country of Residence <sup>i</sup> | CA            |        |
| <b>Mailing Address of Inventor:</b>                                                                                                                                      |                                                             |                                   |               |        |
| Address 1                                                                                                                                                                | 3320 GARABALDI DRIVE                                        |                                   |               |        |
| Address 2                                                                                                                                                                |                                                             |                                   |               |        |
| City                                                                                                                                                                     | NORTH VANCOUVER                                             | State/Province                    | BC            |        |
| Postal Code                                                                                                                                                              | V7H 2N9                                                     | Country <sup>i</sup>              | CA            |        |
| Inventor 4                                                                                                                                                               | <a href="#">Remove</a>                                      |                                   |               |        |
| Legal Name                                                                                                                                                               |                                                             |                                   |               |        |
| Prefix                                                                                                                                                                   | Given Name                                                  | Middle Name                       | Family Name   | Suffix |
|                                                                                                                                                                          | JOHAN                                                       | EMIL VIKTOR                       | BJÖRSELL      |        |
| Residence Information (Select One) <input type="radio"/> US Residency <input checked="" type="radio"/> Non US Residency <input type="radio"/> Active US Military Service |                                                             |                                   |               |        |
| City                                                                                                                                                                     | VANCOUVER                                                   | Country of Residence <sup>i</sup> | CA            |        |
| <b>Mailing Address of Inventor:</b>                                                                                                                                      |                                                             |                                   |               |        |
| Address 1                                                                                                                                                                | 2681 EAST HASTINGS STREET                                   |                                   |               |        |
| Address 2                                                                                                                                                                |                                                             |                                   |               |        |
| City                                                                                                                                                                     | VANCOUVER                                                   | State/Province                    | BC            |        |
| Postal Code                                                                                                                                                              | V5K 1Z5                                                     | Country <sup>i</sup>              | CA            |        |
| Inventor 5                                                                                                                                                               | <a href="#">Remove</a>                                      |                                   |               |        |
| Legal Name                                                                                                                                                               |                                                             |                                   |               |        |
| Prefix                                                                                                                                                                   | Given Name                                                  | Middle Name                       | Family Name   | Suffix |
|                                                                                                                                                                          | FUAD                                                        |                                   | ARAFA         |        |
| Residence Information (Select One) <input type="radio"/> US Residency <input checked="" type="radio"/> Non US Residency <input type="radio"/> Active US Military Service |                                                             |                                   |               |        |
| City                                                                                                                                                                     | VANCOUVER                                                   | Country of Residence <sup>i</sup> | CA            |        |
| <b>Mailing Address of Inventor:</b>                                                                                                                                      |                                                             |                                   |               |        |
| Address 1                                                                                                                                                                | 782 WEST 22ND STREET                                        |                                   |               |        |
| Address 2                                                                                                                                                                |                                                             |                                   |               |        |
| City                                                                                                                                                                     | VANCOUVER                                                   | State/Province                    | BC            |        |
| Postal Code                                                                                                                                                              | V5Z 17Z                                                     | Country <sup>i</sup>              | CA            |        |

Under the Paperwork Reduction Act of 1995, no persons are required to respond to a collection of information unless it contains a valid OMB control number.

|                                           |                                                             |               |
|-------------------------------------------|-------------------------------------------------------------|---------------|
| <b>Application Data Sheet 37 CFR 1.76</b> | Attorney Docket Number                                      | SMARB19.001C1 |
|                                           | Application Number                                          |               |
| Title of Invention                        | PRODUCING ROUTING MESSAGES FOR VOICE OVER IP COMMUNICATIONS |               |

All Inventors Must Be Listed - Additional Inventor Information blocks may be generated within this form by selecting the **Add** button.

### Correspondence Information:

Enter either Customer Number or complete the Correspondence Information section below. For further information see 37 CFR 1.33(a).

An Address is being provided for the correspondence information of this application.

|                 |                    |                                          |                                             |
|-----------------|--------------------|------------------------------------------|---------------------------------------------|
| Customer Number | 20995              |                                          |                                             |
| Email Address   | efiling@knobbe.com | <input type="button" value="Add Email"/> | <input type="button" value="Remove Email"/> |

### Application Information:

|                                         |                                                             |                                           |                                     |
|-----------------------------------------|-------------------------------------------------------------|-------------------------------------------|-------------------------------------|
| Title of the Invention                  | PRODUCING ROUTING MESSAGES FOR VOICE OVER IP COMMUNICATIONS |                                           |                                     |
| Attorney Docket Number                  | SMARB19.001C1                                               | Small Entity Status Claimed               | <input checked="" type="checkbox"/> |
| Application Type                        | Nonprovisional                                              |                                           |                                     |
| Subject Matter                          | Utility                                                     |                                           |                                     |
| Total Number of Drawing Sheets (if any) | 32                                                          | Suggested Figure for Publication (if any) |                                     |

### Publication Information:

Request Early Publication (Fee required at time of Request 37 CFR 1.219)

**Request Not to Publish.** I hereby request that the attached application not be published under 35 U.S.C. 122(b) and certify that the invention disclosed in the attached application **has not and will not** be the subject of an application filed in another country, or under a multilateral international agreement, that requires publication at eighteen months after filing.

### Representative Information:

Representative information should be provided for all practitioners having a power of attorney in the application. Providing this information in the Application Data Sheet does not constitute a power of attorney in the application (see 37 CFR 1.32). Either enter Customer Number or complete the Representative Name section below. If both sections are completed the customer number will be used for the Representative Information during processing.

|                    |                                                  |                                              |                                                         |
|--------------------|--------------------------------------------------|----------------------------------------------|---------------------------------------------------------|
| Please Select One: | <input checked="" type="radio"/> Customer Number | <input type="radio"/> US Patent Practitioner | <input type="radio"/> Limited Recognition (37 CFR 11.9) |
| Customer Number    | 20995                                            |                                              |                                                         |

### Domestic Benefit/National Stage Information:

This section allows for the applicant to either claim benefit under 35 U.S.C. 119(e), 120, 121, or 365(c) or indicate National Stage entry from a PCT application. Providing this information in the application data sheet constitutes the specific reference required by 35 U.S.C. 119(e) or 120, and 37 CFR 1.78.

|                          |         |                                       |
|--------------------------|---------|---------------------------------------|
| Prior Application Status | Pending | <input type="button" value="Remove"/> |
|--------------------------|---------|---------------------------------------|

Under the Paperwork Reduction Act of 1995, no persons are required to respond to a collection of information unless it contains a valid OMB control number.

|                                           |                                                             |               |
|-------------------------------------------|-------------------------------------------------------------|---------------|
| <b>Application Data Sheet 37 CFR 1.76</b> | Attorney Docket Number                                      | SMARB19.001C1 |
|                                           | Application Number                                          |               |
| Title of Invention                        | PRODUCING ROUTING MESSAGES FOR VOICE OVER IP COMMUNICATIONS |               |

| Application Number                                                                                                    | Continuity Type        | Prior Application Number              | Filing Date (YYYY-MM-DD) |
|-----------------------------------------------------------------------------------------------------------------------|------------------------|---------------------------------------|--------------------------|
|                                                                                                                       | Continuation of        | 12/513147                             | 2010-03-01               |
| Prior Application Status                                                                                              | Expired                | <input type="button" value="Remove"/> |                          |
| Application Number                                                                                                    | Continuity Type        | Prior Application Number              | Filing Date (YYYY-MM-DD) |
| 12/513147                                                                                                             | a 371 of international | PCT/CA2007/001956                     | 2007-11-01               |
| Prior Application Status                                                                                              | Expired                | <input type="button" value="Remove"/> |                          |
| Application Number                                                                                                    | Continuity Type        | Prior Application Number              | Filing Date (YYYY-MM-DD) |
| PCT/CA2007/001956                                                                                                     | non provisional of     | 60/856212                             | 2006-11-02               |
| Additional Domestic Benefit/National Stage Data may be generated within this form by selecting the <b>Add</b> button. |                        |                                       |                          |

### Foreign Priority Information:

This section allows for the applicant to claim priority to a foreign application. Providing this information in the application data sheet constitutes the claim for priority as required by 35 U.S.C. 119(b) and 37 CFR 1.55(d). When priority is claimed to a foreign application that is eligible for retrieval under the priority document exchange program (PDX)<sup>i</sup> the information will be used by the Office to automatically attempt retrieval pursuant to 37 CFR 1.55(h)(1) and (2). Under the PDX program, applicant bears the ultimate responsibility for ensuring that a copy of the foreign application is received by the Office from the participating foreign intellectual property office, or a certified copy of the foreign priority application is filed, within the time period specified in 37 CFR 1.55(g)(1).

| Application Number                                                                                     | Country <sup>i</sup> | Filing Date (YYYY-MM-DD) | Access Code <sup>i</sup> (if applicable) |
|--------------------------------------------------------------------------------------------------------|----------------------|--------------------------|------------------------------------------|
| <input type="button" value="Remove"/>                                                                  |                      |                          |                                          |
|                                                                                                        |                      |                          |                                          |
| Additional Foreign Priority Data may be generated within this form by selecting the <b>Add</b> button. |                      |                          |                                          |

### Statement under 37 CFR 1.55 or 1.78 for AIA (First Inventor to File) Transition Applications

This application (1) claims priority to or the benefit of an application filed before March 16, 2013 and (2) also contains, or contained at any time, a claim to a claimed invention that has an effective filing date on or after March 16, 2013.

NOTE: By providing this statement under 37 CFR 1.55 or 1.78, this application, with a filing date on or after March 16, 2013, will be examined under the first inventor to file provisions of the AIA.

Under the Paperwork Reduction Act of 1995, no persons are required to respond to a collection of information unless it contains a valid OMB control number.

|                                           |                                                             |               |
|-------------------------------------------|-------------------------------------------------------------|---------------|
| <b>Application Data Sheet 37 CFR 1.76</b> | Attorney Docket Number                                      | SMARB19.001C1 |
|                                           | Application Number                                          |               |
| Title of Invention                        | PRODUCING ROUTING MESSAGES FOR VOICE OVER IP COMMUNICATIONS |               |

**Authorization to Permit Access:**
 Authorization to Permit Access to the Instant Application by the Participating Offices

If checked, the undersigned hereby grants the USPTO authority to provide the European Patent Office (EPO), the Japan Patent Office (JPO), the Korean Intellectual Property Office (KIPO), the World Intellectual Property Office (WIPO), and any other intellectual property offices in which a foreign application claiming priority to the instant patent application is filed access to the instant patent application. See 37 CFR 1.14(c) and (h). This box should not be checked if the applicant does not wish the EPO, JPO, KIPO, WIPO, or other intellectual property office in which a foreign application claiming priority to the instant patent application is filed to have access to the instant patent application.

In accordance with 37 CFR 1.14(h)(3), access will be provided to a copy of the instant patent application with respect to: 1) the instant patent application-as-filed; 2) any foreign application to which the instant patent application claims priority under 35 U.S.C. 119(a)-(d) if a copy of the foreign application that satisfies the certified copy requirement of 37 CFR 1.55 has been filed in the instant patent application; and 3) any U.S. application-as-filed from which benefit is sought in the instant patent application.

In accordance with 37 CFR 1.14(c), access may be provided to information concerning the date of filing this Authorization.

**Applicant Information:**

|                                                                                                                                                                                                                                                                                                                                                                                                                                                                                                                                                                                                                                                                                                                                                                                                                                                                |                                                                        |                                      |
|----------------------------------------------------------------------------------------------------------------------------------------------------------------------------------------------------------------------------------------------------------------------------------------------------------------------------------------------------------------------------------------------------------------------------------------------------------------------------------------------------------------------------------------------------------------------------------------------------------------------------------------------------------------------------------------------------------------------------------------------------------------------------------------------------------------------------------------------------------------|------------------------------------------------------------------------|--------------------------------------|
| Providing assignment information in this section does not substitute for compliance with any requirement of part 3 of Title 37 of CFR to have an assignment recorded by the Office.                                                                                                                                                                                                                                                                                                                                                                                                                                                                                                                                                                                                                                                                            |                                                                        |                                      |
| <b>Applicant 1</b>                                                                                                                                                                                                                                                                                                                                                                                                                                                                                                                                                                                                                                                                                                                                                                                                                                             |                                                                        |                                      |
| If the applicant is the inventor (or the remaining joint inventor or inventors under 37 CFR 1.45), this section should not be completed. The information to be provided in this section is the name and address of the legal representative who is the applicant under 37 CFR 1.43; or the name and address of the assignee, person to whom the inventor is under an obligation to assign the invention, or person who otherwise shows sufficient proprietary interest in the matter who is the applicant under 37 CFR 1.46. If the applicant is an applicant under 37 CFR 1.46 (assignee, person to whom the inventor is obligated to assign, or person who otherwise shows sufficient proprietary interest) together with one or more joint inventors, then the joint inventor or inventors who are also the applicant should be identified in this section. |                                                                        |                                      |
| <input type="button" value="Clear"/>                                                                                                                                                                                                                                                                                                                                                                                                                                                                                                                                                                                                                                                                                                                                                                                                                           |                                                                        |                                      |
| <input checked="" type="radio"/> Assignee                                                                                                                                                                                                                                                                                                                                                                                                                                                                                                                                                                                                                                                                                                                                                                                                                      | <input type="radio"/> Legal Representative under 35 U.S.C. 117         | <input type="radio"/> Joint Inventor |
| <input type="radio"/> Person to whom the inventor is obligated to assign.                                                                                                                                                                                                                                                                                                                                                                                                                                                                                                                                                                                                                                                                                                                                                                                      | <input type="radio"/> Person who shows sufficient proprietary interest |                                      |
| If applicant is the legal representative, indicate the authority to file the patent application, the inventor is:                                                                                                                                                                                                                                                                                                                                                                                                                                                                                                                                                                                                                                                                                                                                              |                                                                        |                                      |
|                                                                                                                                                                                                                                                                                                                                                                                                                                                                                                                                                                                                                                                                                                                                                                                                                                                                |                                                                        |                                      |
| Name of the Deceased or Legally Incapacitated Inventor : <input type="text"/>                                                                                                                                                                                                                                                                                                                                                                                                                                                                                                                                                                                                                                                                                                                                                                                  |                                                                        |                                      |
| If the Applicant is an Organization check here. <input checked="" type="checkbox"/>                                                                                                                                                                                                                                                                                                                                                                                                                                                                                                                                                                                                                                                                                                                                                                            |                                                                        |                                      |
| Organization Name                                                                                                                                                                                                                                                                                                                                                                                                                                                                                                                                                                                                                                                                                                                                                                                                                                              | DIGIFONICA (INTERNATIONAL) LIMITED                                     |                                      |



Under the Paperwork Reduction Act of 1995, no persons are required to respond to a collection of information unless it contains a valid OMB control number.

|                                           |                                                             |               |
|-------------------------------------------|-------------------------------------------------------------|---------------|
| <b>Application Data Sheet 37 CFR 1.76</b> | Attorney Docket Number                                      | SMARB19.001C1 |
|                                           | Application Number                                          |               |
| Title of Invention                        | PRODUCING ROUTING MESSAGES FOR VOICE OVER IP COMMUNICATIONS |               |

|                                                                                          |                   |                |         |
|------------------------------------------------------------------------------------------|-------------------|----------------|---------|
| <b>Mailing Address Information For Applicant:</b>                                        |                   |                |         |
| Address 1                                                                                | 773 HORNBY STREET |                |         |
| Address 2                                                                                |                   |                |         |
| City                                                                                     | VANCOUVER         | State/Province | BC      |
| Country                                                                                  | CA                | Postal Code    | V6Z 1S4 |
| Phone Number                                                                             |                   | Fax Number     |         |
| Email Address                                                                            |                   |                |         |
| Additional Applicant Data may be generated within this form by selecting the Add button. |                   |                |         |

**Non-Applicant Assignee Information:**

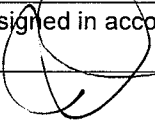
Providing assignment information in this section does not substitute for compliance with any requirement of part 3 of Title 37 of CFR to have an assignment recorded by the Office.

|                                                                                                                                                                                                                                                                                                                                                                                                                                                    |            |                |             |        |
|----------------------------------------------------------------------------------------------------------------------------------------------------------------------------------------------------------------------------------------------------------------------------------------------------------------------------------------------------------------------------------------------------------------------------------------------------|------------|----------------|-------------|--------|
| <b>Assignee 1</b>                                                                                                                                                                                                                                                                                                                                                                                                                                  |            |                |             |        |
| Complete this section only if non-applicant assignee information is desired to be included on the patent application publication in accordance with 37 CFR 1.215(b). Do not include in this section an applicant under 37 CFR 1.46 (assignee, person to whom the inventor is obligated to assign, or person who otherwise shows sufficient proprietary interest), as the patent application publication will include the name of the applicant(s). |            |                |             |        |
| If the Assignee is an Organization check here. <input type="checkbox"/>                                                                                                                                                                                                                                                                                                                                                                            |            |                |             |        |
| Prefix                                                                                                                                                                                                                                                                                                                                                                                                                                             | Given Name | Middle Name    | Family Name | Suffix |
|                                                                                                                                                                                                                                                                                                                                                                                                                                                    |            |                |             |        |
| <b>Mailing Address Information For Non-Applicant Assignee:</b>                                                                                                                                                                                                                                                                                                                                                                                     |            |                |             |        |
| Address 1                                                                                                                                                                                                                                                                                                                                                                                                                                          |            |                |             |        |
| Address 2                                                                                                                                                                                                                                                                                                                                                                                                                                          |            |                |             |        |
| City                                                                                                                                                                                                                                                                                                                                                                                                                                               |            | State/Province |             |        |
| Country                                                                                                                                                                                                                                                                                                                                                                                                                                            |            | Postal Code    |             |        |
| Phone Number                                                                                                                                                                                                                                                                                                                                                                                                                                       |            | Fax Number     |             |        |
| Email Address                                                                                                                                                                                                                                                                                                                                                                                                                                      |            |                |             |        |
| Additional Assignee Data may be generated within this form by selecting the Add button.                                                                                                                                                                                                                                                                                                                                                            |            |                |             |        |

Under the Paperwork Reduction Act of 1995, no persons are required to respond to a collection of information unless it contains a valid OMB control number.

|                                           |                                                             |               |
|-------------------------------------------|-------------------------------------------------------------|---------------|
| <b>Application Data Sheet 37 CFR 1.76</b> | Attorney Docket Number                                      | SMARB19.001C1 |
|                                           | Application Number                                          |               |
| Title of Invention                        | PRODUCING ROUTING MESSAGES FOR VOICE OVER IP COMMUNICATIONS |               |

**Signature:**

|                                                                                                                              |                                                                                   |           |        |                     |            |
|------------------------------------------------------------------------------------------------------------------------------|-----------------------------------------------------------------------------------|-----------|--------|---------------------|------------|
| NOTE: This form must be signed in accordance with 37 CFR 1.33. See 37 CFR 1.4 for signature requirements and certifications. |                                                                                   |           |        |                     |            |
| Signature                                                                                                                    |  |           |        | Date (YYYY-MM-DD)   | 2013-08-13 |
| First Name                                                                                                                   | JOHN                                                                              | Last Name | CARSON | Registration Number | 34303      |
| Additional Signature may be generated within this form by selecting the Add button.                                          |                                                                                   |           |        |                     |            |

This collection of information is required by 37 CFR 1.76. The information is required to obtain or retain a benefit by the public which is to file (and by the USPTO to process) an application. Confidentiality is governed by 35 U.S.C. 122 and 37 CFR 1.14. This collection is estimated to take 23 minutes to complete, including gathering, preparing, and submitting the completed application data sheet form to the USPTO. Time will vary depending upon the individual case. Any comments on the amount of time you require to complete this form and/or suggestions for reducing this burden, should be sent to the Chief Information Officer, U.S. Patent and Trademark Office, U.S. Department of Commerce, P.O. Box 1450, Alexandria, VA 22313-1450. DO NOT SEND FEES OR COMPLETED FORMS TO THIS ADDRESS. **SEND TO: Commissioner for Patents, P.O. Box 1450, Alexandria, VA 22313-1450.**

## PRODUCING ROUTING MESSAGES FOR VOICE OVER IP COMMUNICATIONS

## BACKGROUND OF THE INVENTION

Cross Reference to Related Applications

**[0001]** This application is a continuation of U.S. Application No. 12/513,147, filed March 1, 2010, which is a national phase entry of PCT/CA2007/001956, filed November 1, 2007, which claims priority to U.S. Provisional Application No. 60/856,212, filed November 2, 2006, all of which are incorporated in their entirety.

Field of Invention

**[0002]** This invention relates to voice over IP communications and methods and apparatus for routing and billing.

Description of Related Art

**[0003]** Internet protocol (IP) telephones are typically personal computer (PC) based telephones connected within an IP network, such as the public Internet or a private network of a large organization. These IP telephones have installed “voice-over-IP” (VoIP) software enabling them to make and receive voice calls and send and receive information in data and video formats.

**[0004]** IP telephony switches installed within the IP network enable voice calls to be made within or between IP networks, and between an IP network and a switched circuit network (SCN), such as the public switched telephone network (PSTN). If the IP switch supports the Signaling System 7 (SS7) protocol, the IP telephone can also access PSTN databases.

**[0005]** The PSTN network typically includes complex network nodes that contain all information about a local calling service area including user authentication and call routing. The PSTN network typically aggregates all information and traffic into a single location or node, processes it locally and then passes it on to other network nodes, as necessary, by maintaining route tables at the node. PSTN nodes are redundant by design and thus provide reliable service, but if a node should fail due to an earthquake or other natural

disaster, significant, if not complete service outages can occur, with no other nodes being able to take up the load.

**[0006]** Existing VoIP systems do not allow for high availability and resiliency in delivering Voice Over IP based Session Initiation Protocol (SIP) Protocol service over a geographically dispersed area such as a city, region or continent. Most resiliency originates from the provision of IP based telephone services to one location or a small number of locations such as a single office or network of branch offices.

### SUMMARY OF THE INVENTION

**[0007]** In accordance with one aspect of the invention, there is provided a process for operating a call routing controller to facilitate communication between callers and callees in a system comprising a plurality of nodes with which callers and callees are associated. The process involves, in response to initiation of a call by a calling subscriber, receiving a caller identifier and a callee identifier. The process also involves using call classification criteria associated with the caller identifier to classify the call as a public network call or a private network call. The process further involves producing a routing message identifying an address, on the private network, associated with the callee when the call is classified as a private network call. The process also involves producing a routing message identifying a gateway to the public network when the call is classified as a public network call.

**[0008]** The process may involve receiving a request to establish a call, from a call controller in communication with a caller identified by the callee identifier.

**[0009]** Using the call classification criteria may involve searching a database to locate a record identifying calling attributes associated with a caller identified by the caller identifier.

**[0010]** Locating a record may involve locating a caller dialing profile comprising a username associated with the caller, a domain associated with the caller, and at least one calling attribute.

**[0011]** Using the call classification criteria may involve comparing calling attributes associated with the caller dialing profile with aspects of the callee identifier.

**[0012]** Comparing may involve determining whether the callee identifier includes a portion that matches an IDD associated with the caller dialing profile.

**[0013]** Comparing may involve determining whether the callee identifier includes a portion that matches an NDD associated with the caller dialing profile.

**[0014]** Comparing may involve determining whether the callee identifier includes a portion that matches an area code associated with the caller dialing profile.

**[0015]** Comparing may involve determining whether the callee identifier has a length within a range specified in the caller dialing profile.

**[0016]** The process may involve formatting the callee identifier into a pre-defined digit format to produce a re-formatted callee identifier.

**[0017]** Formatting may involve removing an international dialing digit from the callee identifier, when the callee identifier begins with a digit matching an international dialing digit specified by the caller dialing profile associated with the caller.

**[0018]** Formatting may involve removing a national dialing digit from the callee identifier and prepending a caller country code to the callee identifier when the callee identifier begins with a national dialing digit.

**[0019]** Formatting may involve prepending a caller country code to the callee identifier when the callee identifier begins with digits identifying an area code specified by the caller dialing profile.

**[0020]** Formatting may involve prepending a caller country code and an area code to the callee identifier when the callee identifier has a length that matches a caller dialing number format specified by the caller dialing profile and only one area code is specified as being associated with the caller in the caller dialing profile.

**[0021]** The process may involve classifying the call as a private network call when the re-formatted callee identifier identifies a subscriber to the private network.

**[0022]** The process may involve determining whether the callee identifier complies with a pre-defined username format and if so, classifying the call as a private network call.

**[0023]** The process may involve causing a database of records to be searched to locate a direct in dial (DID) bank table record associating a public telephone number with the

reformatted callee identifier and if the DID bank table record is found, classifying the call as a private network call and if a DID bank table record is not found, classifying the call as a public network call.

**[0024]** Producing the routing message identifying a node on the private network may involve setting a callee identifier in response to a username associated with the DID bank table record.

**[0025]** Producing the routing message may involve determining whether a node associated with the reformatted callee identifier is the same as a node associated the caller identifier.

**[0026]** Determining whether a node associated with the reformatted callee identifier is the same as a node associated the caller identifier may involve determining whether a prefix of the re-formatted callee identifier matches a corresponding prefix of a username associated with the caller dialing profile.

**[0027]** When the node associated with the caller is not the same as the node associated with the callee, the process involves producing a routing message including the caller identifier, the reformatted callee identifier and an identification of a private network node associated with the callee and communicating the routing message to a call controller.

**[0028]** When the node associated with the caller is the same as the node associated with the callee, the process involves determining whether to perform at least one of the following: forward the call to another party, block the call and direct the caller to a voicemail server associated with the callee.

**[0029]** Producing the routing message may involve producing a routing message having an identification of at least one of the callee identifier, an identification of a party to whom the call should be forwarded and an identification of a voicemail server associated with the callee.

**[0030]** Producing a routing message identifying a gateway to the public network may involve searching a database of route records associating route identifiers with dialing codes to find a route record having a dialing code having a number pattern matching at least a portion of the reformatted callee identifier.

**[0031]** The process may involve communicating the routing message to a call controller.

**[0032]** The process may involve searching a database of supplier records associating supplier identifiers with the route identifiers to locate at least one supplier record associated with the route identifier associated with the route record having a dialing code having a number pattern matching at least a portion of the reformatted callee identifier.

**[0033]** The process may involve loading a routing message buffer with the reformatted callee identifier and an identification of specific routes associated respective ones of the supplier records associated with the route record and loading the routing message buffer with a time value and a timeout value.

**[0034]** The process may involve communicating a routing message involving the contents of the routing message buffer to a call controller.

**[0035]** The process may involve causing the dialing profile to include a maximum concurrent call value and a concurrent call count value and causing the concurrent call count value to be incremented when the user associated with the dialing profile initiates a call and causing the concurrent call count value to be decremented when a call with the user associated with the dialing profile is ended.

**[0036]** In accordance with another aspect of the invention, there is provided a call routing apparatus for facilitating communications between callers and callees in a system comprising a plurality of nodes with which callers and callees are associated. The apparatus includes receiving provisions for receiving a caller identifier and a callee identifier, in response to initiation of a call by a calling subscriber. The apparatus also includes classifying provisions for classifying the call as a private network call or a public network call according to call classification criteria associated with the caller identifier. The apparatus further includes provisions for producing a routing message identifying an address, on the private network, associated with the callee when the call is classified as a private network call. The apparatus also includes provisions for producing a routing message identifying a gateway to the public network when the call is classified as a public network call.

**[0037]** The receiving provisions may be operably configured to receive a request to establish a call, from a call controller in communication with a caller identified by the callee identifier.

**[0038]** The apparatus may further include searching provisions for searching a database including records associating calling attributes with subscribers to the private network to locate a record identifying calling attributes associated with a caller identified by the caller identifier.

**[0039]** The records may include dialing profiles each including a username associated with the subscriber, an identification of a domain associated with the subscriber, and an identification of at least one calling attribute associated with the subscriber.

**[0040]** The call classification provisions may be operably configured to compare calling attributes associated with the caller dialing profile with aspects of the callee identifier.

**[0041]** The calling attributes may include an international dialing digit and call classification provisions may be operably configured to determine whether the callee identifier includes a portion that matches an IDD associated with the caller dialing profile.

**[0042]** The calling attributes may include a national dialing digit and the call classification provisions may be operably configured to determine whether the callee identifier includes a portion that matches an NDD associated with the caller dialing profile.

**[0043]** The calling attributes may include an area code and the call classification provisions may be operably configured to determine whether the callee identifier includes a portion that matches an area code associated with the caller dialing profile.

**[0044]** The calling attribute may include a number length range and the call classification provisions may be operably configured to determine whether the callee identifier has a length within a number length range specified in the caller dialing profile.

**[0045]** The apparatus may further include formatting provisions for formatting the callee identifier into a pre-defined digit format to produce a re-formatted callee identifier.

**[0046]** The formatting provisions may be operably configured to remove an international dialing digit from the callee identifier, when the callee identifier begins with a digit matching an international dialing digit specified by the caller dialing profile associated with the caller.



**[0047]** The formatting provisions may be operably configured to remove a national dialing digit from the callee identifier and prepend a caller country code to the callee identifier when the callee identifier begins with a national dialing digit.

**[0048]** The formatting provisions may be operably configured to prepend a caller country code to the callee identifier when the callee identifier begins with digits identifying an area code specified by the caller dialing profile.

**[0049]** The formatting provisions may be operably configured to prepend a caller country code and area code to the callee identifier when the callee identifier has a length that matches a caller dialing number format specified by the caller dialing profile and only one area code is specified as being associated with the caller in the caller dialing profile.

**[0050]** The classifying provisions may be operably configured to classify the call as a private network call when the re-formatted callee identifier identifies a subscriber to the private network.

**[0051]** The classifying provisions may be operably configured to classify the call as a private network call when the callee identifier complies with a pre-defined username format.

**[0052]** The apparatus may further include searching provisions for searching a database of records to locate a direct in dial (DID) bank table record associating a public telephone number with the reformatted callee identifier and the classifying provisions may be operably configured to classify the call as a private network call when the DID bank table record is found and to classify the call as a public network call when a DID bank table record is not found

**[0053]** The private network routing message producing provisions may be operably configured to produce a routing message having a callee identifier set according to a username associated with the DID bank table record.

**[0054]** The private network routing message producing provisions may be operably configured to determine whether a node associated with the reformatted callee identifier is the same as a node associated the caller identifier.

**[0055]** The private network routing provisions may include provisions for determining whether a prefix of the re-formatted callee identifier matches a corresponding prefix of a username associated with the caller dialing profile.

**[0056]** The private network routing message producing provisions may be operably configured to produce a routing message including the caller identifier, the reformatted callee identifier and an identification of a private network node associated with the callee and to communicate the routing message to a call controller.

**[0057]** The private network routing message producing provisions may be operably configured to perform at least one of the following forward the call to another party, block the call and direct the caller to a voicemail server associated with the callee, when the node associated with the caller is the same as the node associated with the callee.

**[0058]** The provisions for producing the private network routing message may be operably configured to produce a routing message having an identification of at least one of the callee identifier, an identification of a party to whom the call should be forwarded and an identification of a voicemail server associated with the callee.

**[0059]** The apparatus further includes provisions for communicating the routing message to a call controller.

**[0060]** The provisions for producing a public network routing message identifying a gateway to the public network may include provisions for searching a database of route records associating route identifiers with dialing codes to find a route record having a dialing code having a number pattern matching at least a portion of the reformatted callee identifier.

**[0061]** The apparatus further includes provisions for searching a database of supplier records associating supplier identifiers with the route identifiers to locate at least one supplier record associated with the route identifier associated with the route record having a dialing code having a number pattern matching at least a portion of the reformatted callee identifier.

**[0062]** The apparatus further includes a routing message buffer and provisions for loading the routing message buffer with the reformatted callee identifier and an identification of specific routes associated respective ones of the supplier records associated with the route record and loading the routing message buffer with a time value and a timeout value.

**[0063]** The apparatus further includes provisions for communicating a routing message including the contents of the routing message buffer to a call controller.

**[0064]** The apparatus further includes means for causing said dialing profile to include a maximum concurrent call value and a concurrent call count value and for causing said concurrent call count value to be incremented when the user associated with said dialing profile initiates a call and for causing said concurrent call count value to be decremented when a call with said user associated with said dialing profile is ended.

**[0065]** In accordance with another aspect of the invention, there is provided a data structure for access by an apparatus for producing a routing message for use by a call routing controller in a communications system. The data structure includes dialing profile records comprising fields for associating with respective subscribers to the system, a subscriber user name, direct-in-dial records comprising fields for associating with respective subscriber usernames, a user domain and a direct-in-dial number, prefix to node records comprising fields for associating with at least a portion of the respective subscriber usernames, a node address of a node in the system, whereby a subscriber name can be used to find a user domain, at least a portion of the a subscriber name can be used to find a node with which the subscriber identified by the subscriber name is associated, and a user domain and subscriber name can be located in response to a direct-in-dial number.

**[0066]** In accordance with another aspect of the invention, there is provided a data structure for access by an apparatus for producing a routing message for use by a call routing controller in a communications system. The data structure includes master list records comprising fields for associating a dialing code with respective master list identifiers and supplier list records linked to master list records by the master list identifiers, said supplier list records comprising fields for associating with a communications services supplier, a supplier id, a master list id, a route identifier and a billing rate code, whereby communications services suppliers are associated with dialing codes, such that dialing codes can be used to locate suppliers capable of providing a communications link associated with a given dialing code.

**[0067]** In accordance with another aspect of the invention, there is provided a method for determining a time to permit a communication session to be conducted. The

method involves calculating a cost per unit time, calculating a first time value as a sum of a free time attributed to a participant in the communication session and the quotient of a funds balance held by the participant to the cost per unit time value and producing a second time value in response to the first time value and a billing pattern associated with the participant, the billing pattern including first and second billing intervals and the second time value being the time to permit a communication session to be conducted.

**[0068]** Calculating the first time value may involve retrieving a record associated with the participant and obtaining from the record at least one of the free time and the funds balance.

**[0069]** Producing the second time value may involve producing a remainder value representing a portion of the second billing interval remaining after dividing the second billing interval into a difference between the first time value and the first billing interval.

**[0070]** Producing the second time value may involve setting a difference between the first time value and the remainder as the second time value.

**[0071]** The method may further involve setting the second time value to zero when the remainder is greater than zero and the first time value is less than the free time associated with the participant.

**[0072]** Calculating the cost per unit time may involve locating a record in a database, the record comprising a markup type indicator, a markup value and a billing pattern and setting a reseller rate equal to the sum of the markup value and the buffer rate.

**[0073]** Locating the record in a database may involve locating at least one of a record associated with a reseller and a route associated with the reseller, a record associated with the reseller and a default reseller markup record.

**[0074]** Calculating the cost per unit time value further may involve locating at least one of an override record specifying a route cost per unit time amount associated with a route associated with the communication session, a reseller record associated with a reseller of the communications session, the reseller record specifying a reseller cost per unit time associated with the reseller for the communication session, a default operator markup record specifying a default cost per unit time.

**[0075]** The method may further involve setting as the cost per unit time the sum of the reseller rate and at least one of the route cost per unit time, the reseller cost per unit time and the default cost per unit time.

**[0076]** The method may further involve receiving a communication session time representing a duration of the communication session and incrementing a reseller balance by the product of the reseller rate and the communication session time.

**[0077]** The method may further involve receiving a communication session time representing a duration of the communication session and incrementing a system operator balance by a product of the buffer rate and the communication session time.

**[0078]** In accordance with another aspect of the invention, there is provided an apparatus for determining a time to permit a communication session to be conducted. The apparatus includes a processor circuit, a computer readable medium coupled to the processor circuit and encoded with instructions for directing the processor circuit to calculate a cost per unit time for the communication session, calculate a first time value as a sum of a free time attributed to a participant in the communication session and the quotient of a funds balance held by the participant to the cost per unit time value and produce a second time value in response to the first time value and a billing pattern associated with the participant, the billing pattern including first and second billing intervals and the second time value being the time to permit a communication session to be conducted.

**[0079]** The instructions may include instructions for directing the processor circuit to retrieve a record associated with the participant and obtain from the record at least one of the free time and the funds balance.

**[0080]** The instructions may include instructions for directing the processor circuit to produce the second time value by producing a remainder value representing a portion of the second billing interval remaining after dividing the second billing interval into a difference between the first time value and the first billing interval.

**[0081]** The instructions may include instructions for directing the processor circuit to produce the second time value comprises setting a difference between the first time value and the remainder as the second time value.

**[0082]** The instructions may include instructions for directing the processor circuit to set the second time value to zero when the remainder is greater than zero and the first time value is less than the free time associated with the participant.

**[0083]** The instructions for directing the processor circuit to calculate the cost per unit time may include instructions for directing the processor circuit to locate a record in a database, the record comprising a markup type indicator, a markup value and a billing pattern and set a reseller rate equal to the sum of the markup value and the buffer rate.

**[0084]** The instructions for directing the processor circuit to locate the record in a database may include instructions for directing the processor circuit to locate at least one of a record associated with a reseller and a route associated with the reseller, a record associated with the reseller, and a default reseller markup record. The instructions for directing the processor circuit to calculate the cost per unit time value may further include instructions for directing the processor circuit to locate at least one of an override record specifying a route cost per unit time amount associated with a route associated with the communication session, a reseller record associated with a reseller of the communications session, the reseller record specifying a reseller cost per unit time associated with the reseller for the communication session, a default operator markup record specifying a default cost per unit time.

**[0085]** The instructions may include instructions for directing the processor circuit to set as the cost per unit time the sum of the reseller rate and at least one of the route cost per unit time, the reseller cost per unit time and the default cost per unit time.

**[0086]** The instructions may include instructions for directing the processor circuit to receive a communication session time representing a duration of the communication session and increment a reseller balance by the product of the reseller rate and the communication session time.

**[0087]** The instructions may include instructions for directing the processor circuit to receive a communication session time representing a duration of the communication session and increment a system operator balance by a product of the buffer rate and the communication session time.

**[0088]** In accordance with another aspect of the invention, there is provided a process for attributing charges for communications services. The process involves

determining a first chargeable time in response to a communication session time and a pre-defined billing pattern, determining a user cost value in response to the first chargeable time and a free time value associated with a user of the communications services, changing an account balance associated with the user in response to a user cost per unit time. The process may further involve changing an account balance associated with a reseller of the communications services in response to a reseller cost per unit time and the communication session time and changing an account balance associated with an operator of the communications services in response to an operator cost per unit time and the communication session time.

**[0089]** Determining the first chargeable time may involve locating at least one of an override record specifying a route cost per unit time and billing pattern associated with a route associated with the communication session, a reseller record associated with a reseller of the communications session, the reseller record specifying a reseller cost per unit time and billing pattern associated with the reseller for the communication session and a default record specifying a default cost per unit time and billing pattern and setting as the pre-defined billing pattern the billing pattern of the record located. The billing pattern of the record located may involve a first billing interval and a second billing interval.

**[0090]** Determining the first chargeable time may involve setting the first chargeable time equal to the first billing interval when the communication session time is less than or equal to the first billing interval.

**[0091]** Determining the first chargeable time may involve producing a remainder value representing a portion of the second billing interval remaining after dividing the second billing interval into a difference between communication session time and the first interval when the communication session time is greater than the communication session time and setting the first chargeable time to a difference between the communication session time and the remainder when the remainder is greater than zero and setting the first chargeable time to the communication session time when the remainder is not greater than zero.

**[0092]** The process may further involve determining a second chargeable time in response to the first chargeable time and the free time value associated with the user of the

communications services when the first chargeable time is greater than or equal to the free time value associated with the user of the communications services.

**[0093]** Determining the second chargeable time may involve setting the second chargeable time to a difference between the first chargeable time.

**[0094]** The process may further involve resetting the free time value associated with the user to zero when the first chargeable time is greater than or equal to the free time value associated with the user of the communications services.

**[0095]** Changing an account balance associated with the user may involve calculating a user cost value in response to the second chargeable time and the user cost per unit time.

**[0096]** The process may further involve changing a user free cost balance in response to the user cost value.

**[0097]** The process may further involve setting the user cost to zero when the first chargeable time is less than the free time value associated with the user.

**[0098]** The process may further involve changing a user free time balance in response to the first chargeable time.

**[0099]** In accordance with another aspect of the invention, there is provided an apparatus for attributing charges for communications services. The apparatus includes a processor circuit, a computer readable medium in communication with the processor circuit and encoded with instructions for directing the processor circuit to determine a first chargeable time in response to a communication session time and a pre-defined billing pattern, determine a user cost value in response to the first chargeable time and a free time value associated with a user of the communications services, change an account balance associated with the user in response to a user cost per unit time.

**[0100]** The instructions may further include instructions for changing an account balance associated with a reseller of the communications services in response to a reseller cost per unit time and the communication session time and changing an account balance associated with an operator of the communications services in response to an operator cost per unit time and the communication session time.



**[0101]** The instructions for directing the processor circuit to determine the first chargeable time may further include instructions for causing the processor circuit to communicate with a database to locate at least one of an override record specifying a route cost per unit time and billing pattern associated with a route associated with the communication session, a reseller record associated with a reseller of the communications session, the reseller record specifying a reseller cost per unit time and billing pattern associated with the reseller for the communication session and a default record specifying a default cost per unit time and billing pattern and instructions for setting as the pre-defined billing pattern the billing pattern of the record located. The billing pattern of the record located may include a first billing interval and a second billing interval.

**[0102]** The instructions for causing the processor circuit to determine the first chargeable time may include instructions for directing the processor circuit to set the first chargeable time equal to the first billing interval when the communication session time is less than or equal to the first billing interval.

**[0103]** The instructions for causing the processor circuit to determine the first chargeable time may include instructions for producing a remainder value representing a portion of the second billing interval remaining after dividing the second billing interval into a difference between communication session time and the first interval when the communication session time is greater than the communication session time and instructions for causing the processor circuit to set the first chargeable time to a difference between the communication session time and the remainder when the remainder is greater than zero and instructions for causing the processor circuit to set the first chargeable time to the communication session time when the remainder is not greater than zero.

**[0104]** The instructions may further include instructions for causing the processor circuit to determine a second chargeable time in response to the first chargeable time and the free time value associated with the user of the communications services when the first chargeable time is greater than or equal to the free time value associated with the user of the communications services.

**[0105]** The instructions for causing the processor circuit to determine the second chargeable time may include instructions for causing the processor circuit to set the second chargeable time to a difference between the first chargeable time.

**[0106]** The instructions may further include instructions for causing the processor circuit to reset the free time value associated with the user to zero when the first chargeable time is greater than or equal to the free time value associated with the user of the communications services.

**[0107]** The instructions for causing the processor circuit to change an account balance associated with the user may include instructions for causing the processor circuit to calculate a user cost value in response to the second chargeable time and the user cost per unit time.

**[0108]** The instructions may further include instructions for causing the processor circuit to change a user free cost balance in response to the user cost value.

**[0109]** The instructions may further include instructions for causing the processor circuit to set the user cost to zero when the first chargeable time is less than the free time value associated with the user.

**[0110]** The instructions may further include instructions for causing the processor circuit to change a user free time balance in response to the first chargeable time.

**[0111]** In accordance with another aspect of the invention, there is provided a computer readable medium encoded with codes for directing a processor circuit to execute one or more of the methods described above and/or variants thereof.

**[0112]** Other aspects and features of the present invention will become apparent to those ordinarily skilled in the art upon review of the following description of specific embodiments of the invention in conjunction with the accompanying figures.

#### BRIEF DESCRIPTION OF THE DRAWINGS

**[0113]** In drawings which illustrate embodiments of the invention,

**[0114]** Figure 1 is a block diagram of a system according to a first embodiment of the invention;

**[0115]** Figure 2 is a block diagram of a caller telephone according to the first embodiment of the invention;

**[0116]** Figure 3 is a schematic representation of a SIP invite message transmitted between the caller telephone and a controller shown in Figure 1;

**[0117]** Figure 4 is a block diagram of a call controller shown in Figure 1;

**[0118]** Figure 5 is a flowchart of a process executed by the call controller shown in Figure 1 ;

**[0119]** Figure 6 is a schematic representation of a routing, billing and rating (RC) request message produced by the call controller shown in Figure 1;

**[0120]** Figure 7 is a block diagram of a processor circuit of a routing, billing, rating element of the system shown in Figure 1;

**[0121]** Figures 8A-8D is a flowchart of a RC request message handler executed by the RC. processor circuit shown in Figure 7;

**[0122]** Figure 9 is a tabular representation of a dialing profile stored in a database accessible by the RC shown in Figure 1;

**[0123]** Figure 10 is a tabular representation of a dialing profile for a caller using the caller telephone shown in Figure 1;

**[0124]** Figure 11 is a tabular representation of a callee profile for a callee located in Calgary;

**[0125]** Figure 12 is a tabular representation of a callee profile for a callee located in London;

**[0126]** Figure 13 is a tabular representation of a Direct-in-Dial (DID) bank table record stored in the database shown in Figure 1;

**[0127]** Figure 14 is a tabular representation of an exemplary DID bank table record for the Calgary callee referenced in Figure 11;

**[0128]** Figure 15 is a tabular representation of a routing message transmitted from the RC to the call controller shown in Figure 1 ;

**[0129]** Figure 16 is a schematic representation of a routing message buffer holding a routing message for routing a call to the Calgary callee referenced in Figure 11 ;

**[0130]** Figure 17 is a tabular representation of a prefix to supernode table record stored in the database shown in Figure 1;

**[0131]** Figure 18 is a tabular representation of a prefix to supernode table record that would be used for the Calgary callee referenced in Figure 11;

**[0132]** Figure 19 is a tabular representation of a master list record stored in a master list table in the database shown in Figure 1;

**[0133]** Figure 20 is a tabular representation of a populated master list record;

**[0134]** Figure 21 is a tabular representation of a suppliers list record stored in the database shown in Figure 1;

**[0135]** Figure 22 is a tabular representation of a specific supplier list record for a first supplier;

**[0136]** Figure 23 is a tabular representation of a specific supplier list record for a second supplier;

**[0137]** Figure 24 is a tabular representation of a specific supplier list record for a third supplier;

**[0138]** Figure 25 is a schematic representation of a routing message, held in a routing message buffer, identifying to the controller a plurality of possible suppliers that may carry the call;

**[0139]** Figure 26 is a tabular representation of a call block table record;

**[0140]** Figure 27 is a tabular representation of a call block table record for the Calgary callee;

**[0141]** Figure 28 is a tabular representation of a call forwarding table record;

**[0142]** Figure 29 is a tabular representation of a call forwarding table record specific for the Calgary callee;

**[0143]** Figure 30 is a tabular representation of a voicemail table record specifying voicemail parameters to enable the caller to leave a voicemail message for the callee;

**[0144]** Figure 31 is a tabular representation of a voicemail table record specific to the Calgary callee;

**[0145]** Figure 32 is a schematic representation of an exemplary routing message, held in a routing message buffer, indicating call forwarding numbers and a voicemail server identifier;

**[0146]** Figures 33A and 33B are respective portions of a flowchart of a process executed by the RC processor for determining a time to live value;

**[0147]** Figure 34 is a tabular representation of a subscriber bundle table record;

**[0148]** Figure 35 is a tabular representation of a subscriber bundle record for the Vancouver caller;

**[0149]** Figure 36 is a tabular representation of a bundle override table record;

**[0150]** Figure 37 is a tabular representation of bundle override record for a located master list ID;

**[0151]** Figure 38 is a tabular representation of a subscriber account table record;

**[0152]** Figure 39 is a tabular representation of a subscriber account record for the Vancouver caller;

**[0153]** Figure 40 is a flowchart of a process for producing a second time value executed by the RC processor circuit shown in Figure 7;

**[0154]** Figure 41 is a flowchart for calculating a call cost per unit time;

**[0155]** Figure 42 is a tabular representation of a system operator special rates table record;

**[0156]** Figure 43 is a tabular representation of a system operator special rates table record for a reseller named Klondike;

**[0157]** Figure 44 is a tabular representation of a system operator mark-up table record;

**[0158]** Figure 45 is a tabular representation of a system operator mark-up table record for the reseller Klondike;

**[0159]** Figure 46 is a tabular representation of a default system operator mark-up table record;

**[0160]** Figure 47 is a tabular representation of a reseller special destinations table record;

**[0161]** Figure 48 is a tabular representation of a reseller special destinations table record for the reseller Klondike;

**[0162]** Figure 49 is a tabular representation of a reseller global mark-up table record;

**[0163]** Figure 50 is a tabular representation of a reseller global mark-up table record for the reseller Klondike;

**[0164]** Figure 51 is a tabular representation of a SIP bye message transmitted from either of the telephones shown in Figure 1 to the call controller;

**[0165]** Figure 52 is a tabular representation of a SIP bye message sent to the controller from the Calgary callee;

**[0166]** Figure 53 is a flowchart of a process executed by the call controller for producing a RC stop message in response to receipt of a SIP bye message;

**[0167]** Figure 54 is a tabular representation of an exemplary RC call stop message;

**[0168]** Figure 55 is a tabular representation of an RC call stop message for the Calgary callee;

**[0169]** Figures 56A and 56B are respective portions of a flowchart of a RC call stop message handling routine executed by the RC shown in Figure 1;

**[0170]** Figure 57 is a tabular representation of a reseller accounts table record;

**[0171]** Figure 58 is a tabular representation of a reseller accounts table record for the reseller Klondike;

**[0172]** Figure 59 is a tabular representation of a system operator accounts table record; and

**[0173]** Figure 60 is a tabular representation of a system operator accounts record for the system operator described herein.

#### DETAILED DESCRIPTION

**[0174]** Referring to Figure 1, a system for making voice over IP telephone/videophone calls is shown generally at 10. The system includes a first super node shown generally at 11 and a second super node shown generally at 21. The first super node

11 is located in geographical area, such as Vancouver, B.C., Canada for example and the second super node 21 is located in London, England, for example. Different super nodes may be located in different geographical regions throughout the world to provide telephone/videophone service to subscribers in respective regions. These super nodes may be in communication with each other by high speed/ high data throughput links including optical fiber, satellite and/or cable links, forming a backbone to the system. These super nodes may alternatively or, in addition, be in communication with each other through conventional internet services.

**[0175]** In the embodiment shown, the Vancouver supernode 11 provides telephone/videophone service to western Canadian customers from Vancouver Island to Ontario. Another node (not shown) may be located in Eastern Canada to provide services to subscribers in that area.

**[0176]** Other nodes of the type shown may also be employed within the geographical area serviced by a supernode, to provide for call load sharing, for example within a region of the geographical area serviced by the supernode. However, in general, all nodes are similar and have the properties described below in connection with the Vancouver supernode 11.

**[0177]** In this embodiment, the Vancouver supernode includes a call controller (C) 14, a routing controller (RC) 16, a database 18 and a voicemail server 19 and a media relay 9. Each of these may be implemented as separate modules on a common computer system or by separate computers, for example. The voicemail server 19 need not be included in the node and can be provided by an outside service provider.

**[0178]** Subscribers such as a subscriber in Vancouver and a subscriber in Calgary communicate with the Vancouver supernode using their own internet service providers which route internet traffic from these subscribers over the internet shown generally at 13 in Figure 1. To these subscribers the Vancouver supernode is accessible at a pre-determined internet protocol (IP) address or a fully qualified domain name that can be accessed in the usual way through a subscriber's internet service provider. The subscriber in Vancouver uses a telephone 12 that is capable of communicating with the Vancouver supernode 11 using

Session Initiation Protocol (SIP) messages and the Calgary subscriber uses a similar telephone 15, in Calgary AB.

**[0179]** It should be noted that throughout the description of the embodiments of this invention, the IP/UDP addresses of all elements such as the caller and callee telephones, call controller, media relay, and any others, will be assumed to be valid IP/UDP addresses directly accessible via the Internet or a private IP network, for example, depending on the specific implementation of the system. As such, it will be assumed, for example, that the caller and callee telephones will have IP/UDP addresses directly accessible by the call controllers and the media relays on their respective supernodes, and those addresses will not be obscured by Network Address Translation (NAT) or similar mechanisms. In other words, the IP/UDP information contained in SIP messages (for example the SIP Invite message or the RC Request message which will be described below) will match the IP/UDP addresses of the IP packets carrying these SIP messages.

**[0180]** It will be appreciated that in many situations, the IP addresses assigned to various elements of the system may be in a private IP address space, and thus not directly accessible from other elements. Furthermore, it will also be appreciated that NAT is commonly used to share a “public” IP address between multiple devices, for example between home PCs and IP telephones sharing a single Internet connection. For example, a home PC may be assigned an IP address such as 192.168.0.101 and a Voice over IP telephone may be assigned an IP address of 192.168.0.103. These addresses are located in so called “non-routable” (IP) address space and cannot be accessed directly from the Internet. In order for these devices to communicate with other computers located on the Internet, these IP addresses have to be converted into a “public” IP address, for example 24.10.10.123 assigned by the Internet Service Provider to the subscriber, by a device performing NAT, typically a home router. In addition to translating the IP addresses, NAT typically also translates UDP port numbers, for example an audio path originating at a VoIP telephone and using a UDP port 12378 at its private IP address, may have be translated to a UDP port 23465 associated with the public IP address of the NAT device. In other words, when a packet originating from the above VoIP telephone arrives at an Internet-based supernode, the source IP/UDP address contained in the IP packet header will be 24.10.10.1 :23465, whereas the source IP/UDP



address information contained in the SIP message inside this IP packet will be 192.168.0.103:12378. The mismatch in the IP/UDP addresses may cause a problem for SIP-based VoIP systems because, for example, a supernode will attempt to send messages to a private address of a telephone but the messages will never get there.

**[0181]** Referring to Figure 1, in an attempt to make a call by the Vancouver telephone/videophone 12 to the Calgary telephone/videophone 15, the Vancouver telephone/videophone sends a SIP invite message to the Vancouver supernode 11 and in response, the call controller 14 sends an RC request message to the RC 16 which makes various enquiries of the database 18 to produce a routing message which is sent back to the call controller 14. The call controller 14 then communicates with the media relay 9 to cause a communications link including an audio path and a videophone (if a videopath call) to be established through the media relay to the same node, a different node or to a communications supplier gateway as shown generally at 20 to carry audio, and where applicable, video traffic to the call recipient or callee.

**[0182]** Generally, the RC 16 executes a process to facilitate communication between callers and callees. The process involves, in response to initiation of a call by a calling subscriber, receiving a callee identifier from the calling subscriber, using call classification criteria associated with the calling subscriber to classify the call as a public network call or a private network call and producing a routing message identifying an address on the private network, associated with the callee when the call is classified as a private network call and producing a routing message identifying a gateway to the public network when the call is classified as a public network call.

#### Subscriber Telephone

**[0183]** In greater detail, referring to Figure 2, in this embodiment, the telephone/videophone 12 includes a processor circuit shown generally at 30 comprising a microprocessor 32, program memory 34, an input/output (I/O) port 36, parameter memory 38 and temporary memory 40. The program memory 34, I/O port 36, parameter memory 38 and temporary memory 40 are all in communication with the microprocessor 32. The I/O port 36 has a dial input 42 for receiving a dialled telephone/videophone number from a keypad, for example, or from a voice recognition unit or from pre-stored telephone/videophone numbers

stored in the parameter memory 38, for example. For simplicity, in Figure 2 a box labelled dialing functions 44 represents any device capable of informing the microprocessor 32 of a callee identifier, e.g., a callee telephone/videophone number.

**[0184]** The processor 32 stores the callee identifier in a dialled number buffer 45. In this case, assume the dialled number is 2001 1050 2222 and that it is a number associated with the Calgary subscriber. The I/O port 36 also has a handset interface 46 for receiving and producing signals from and to a handset that the user may place to his ear. This interface 46 may include a BLUETOOTH™ wireless interface, a wired interface or speaker phone, for example. The handset acts as a termination point for an audio path (not shown) which will be appreciated later. The I/O port 36 also has an internet connection 48 which is preferably a high speed internet connection and is operable to connect the telephone/videophone to an internet service provider. The internet connection 48 also acts as a part of the voice path, as will be appreciated later. It will be appreciated that where the subscriber device is a videophone, a separate video path is established in the same way an audio path is established. For simplicity, the following description refers to a telephone call, but it is to be understood that a videophone call is handled similarly, with the call controller causing the media relay to facilitate both an audio path and a video path instead of only an audio path.

**[0185]** The parameter memory 38 has a username field 50, a password field 52 an IP address field 53 and a SIP proxy address field 54, for example. The user name field 50 is operable to hold a user name, which in this case is 2001 1050 8667. The user name is assigned upon subscription or registration into the system and, in this embodiment, includes a twelve digit number having a continent code 61 , a country code 63, a dealer code 70 and a unique number code 74. The continent code 61 is comprised of the first or left-most digit of the user name in this embodiment. The country code 63 is comprised of the next three digits. The dealer code 70 is comprised of the next four digits and the unique number code 74 is comprised of the last four digits. The password field 52 holds a password of up to 512 characters, in this example. The IP address field 53 stores an IP address of the telephone, which for this explanation is 192.168.0.20. The SIP proxy address field 54 holds an IP protocol compatible proxy address which may be provided to the telephone through the internet connection 48 as part of a registration procedure.

**[0186]** The program memory 34 stores blocks of codes for directing the processor 32 to carry out the functions of the telephone, one of which includes a firewall block 56 which provides firewall functions to the telephone, to prevent access by unauthorized persons to the microprocessor 32 and memories 34, 38 and 40 through the internet connection 48. The program memory 34 also stores codes 57 for establishing a call ID. The call ID codes 57 direct the processor 32 to produce a call identifier having a format comprising a hexadecimal string at an IP address, the IP address being the IP address of the telephone. Thus, an exemplary call identifier might be FF10@192.168.0.20.

**[0187]** Generally, in response to picking up the handset interface 46 and activating a dialing function 44, the microprocessor 32 produces and sends a SIP invite message as shown in Figure 3, to the routing controller 16 shown in Figure 1. This SIP invite message is essentially to initiate a call by a calling subscriber.

**[0188]** Referring to Figure 3, the SIP invite message includes a caller ID field 60, a callee identifier field 62, a digest parameters field 64, a call ID field 65 an IP address field 67 and a caller UDP port field 69. In this embodiment, the caller ID field 60 includes the user name 2001 10508667 that is the Vancouver user name stored in the user name field 50 of the parameter memory 38 in the telephone 12 shown in Figure 2. In addition, referring back to Figure 3, the callee identifier field 62 includes a callee identifier which in this embodiment is the user name 2001 1050 2222 that is the dialled number of the Calgary subscriber stored in the dialled number buffer 45 shown in Figure 2. The digest parameters field 64 includes digest parameters and the call ID field 65 includes a code comprising a generated prefix code (FF10) and a suffix which is the Internet Protocol (IP) address of the telephone 12 stored in the IP address field 53 of the telephone. The IP address field 67 holds the IP address assigned to the telephone, in this embodiment 192.168.0.20, and the caller UDP port field 69 includes a UDP port identifier identifying a UDP port at which the audio path will be terminated at the caller's telephone.

#### Call Controller

**[0189]** Referring to Figure 4, a call controller circuit of the call controller 14 (Figure 1) is shown in greater detail at 100. The call controller circuit 100 includes a microprocessor 102, program memory 104 and an I/O port 106. The circuit 100 may include

a plurality of microprocessors, a plurality of program memories and a plurality of I/O ports to be able to handle a large volume of calls. However, for simplicity, the call controller circuit 100 will be described as having only one microprocessor 102, program memory 104 and I/O port 106, it being understood that there may be more.

**[0190]** Generally, the I/O port 106 includes an input 108 for receiving messages such as the SIP invite message shown in Figure 3, from the telephone shown in Figure 2. The I/O port 106 also has an RC request message output 110 for transmitting an RC request message to the RC 16 of Figure 1, an RC message input 112 for receiving routing messages from the RC 16, a gateway output 114 for transmitting messages to one of the gateways 20 shown in Figure 1 to advise the gateway to establish an audio path, for example, and a gateway input 116 for receiving messages from the gateway. The I/O port 106 further includes a SIP output 118 for transmitting messages to the telephone 12 to advise the telephone of the IP addresses of the gateways which will establish the audio path. The I/O port 106 further includes a voicemail server input and output 117, 119 respectively for communicating with the voicemail server 19 shown in Figure 1.

**[0191]** While certain inputs and outputs have been shown as separate, it will be appreciated that some may be a single IP address and IP port. For example, the messages sent to the RC 16 and received from the RC 16 may be transmitted and received on the same single IP port.

**[0192]** The program memory 104 includes blocks of code for directing the microprocessor 102 to carry out various functions of the call controller 14. For example, these blocks of code include a first block 120 for causing the call controller circuit 100 to execute a SIP invite to RC request process to produce an RC request message in response to a received SIP invite message. In addition, there is a routing message to gateway message block 122 which causes the call controller circuit 100 to produce a gateway query message in response to a received routing message from the RC 16.

**[0193]** Referring to Figure 5, the SIP invite to RC request process is shown in more detail at 120. On receipt of a SIP invite message of the type shown in Figure 3, block 122 of Figure 5 directs the call controller circuit 100 of Figure 4 to authenticate the user. This may be done, for example, by prompting the user for a password, by sending a message back

to the telephone 12 which is interpreted at the telephone as a request for a password entry or the password may automatically be sent to the call controller 14 from the telephone, in response to the message. The call controller 14 may then make enquiries of databases to which it has access, to determine whether or not the user's password matches a password stored in the database. Various functions may be used to pass encryption keys or hash codes back and forth to ensure that the transmittal of passwords is secure.

**[0194]** Should the authentication process fail, the call controller circuit 100 is directed to an error handling routine 124 which causes messages to be displayed at the telephone 12 to indicate there was an authentication problem. If the authentication procedure is passed, block 121 directs the call controller circuit 100 to determine whether or not the contents of the caller ID field 60 of the SIP invite message received from the telephone is an IP address. If it is an IP address, then block 123 directs the call controller circuit 100 to set the contents of a type field variable maintained by the microprocessor 102 to a code representing that the call type is a third party invite. If at block 121 the caller ID field contents do not identify an IP address, then block 125 directs the microprocessor to set the contents of the type field to a code indicating that the call is being made by a system subscriber. Then, block 126 directs the call controller circuit to read the call identifier 65 provided in the SIP invite message from the telephone 12, and at block 128 the processor is directed to produce an RC request message that includes that call ID. Block 129 then directs the call controller circuit 100 to send the RC request to the RC 16.

**[0195]** Referring to Figure 6, an RC request message is shown generally at 150 and includes a caller field 152, a callee field 154, a digest field 156, a call ID field 158 and a type field 160. The caller, callee, digest call ID fields 152, 154, 156 and 158 contain copies of the caller, callee, digest parameters and call ID fields 60, 62, 64 and 65 of the SIP invite message shown in Figure 3. The type field 160 contains the type code established at blocks 123 or 125 of Figure 5 to indicate whether the call is from a third party or system subscriber, respectively. The caller identifier field may include a PSTN number or a system subscriber username as shown, for example.

#### Routing Controller (RC)

**[0196]** Referring to Figure 7, the RC 16 is shown in greater detail and includes an RC processor circuit shown generally at 200. The RC processor circuit 200 includes a processor 202, program memory 204, a table memory 206, buffer memory 207, and an I/O port 208, all in communication with the processor 202. (As earlier indicated, there may be a plurality of processor circuits (202), memories (204), etc.)

**[0197]** The buffer memory 207 includes a caller id buffer 209 and a callee id buffer 211.

**[0198]** The I/O port 208 includes a database request port 210 through which a request to the database (18 shown in Figure 1) can be made and includes a database response port 212 for receiving a reply from the database 18. The I/O port 208 further includes an RC request message input 214 for receiving the RC request message from the call controller (14 shown in Figure 1) and includes a routing message output 216 for sending a routing message back to the call controller 14. The I/O port 208 thus acts to receive caller identifier and a callee identifier contained in the RC request message from the call controller, the RC request message being received in response to initiation of a call by a calling subscriber.

**[0199]** The program memory 204 includes blocks of codes for directing the processor 202 to carry out various functions of the RC (16). One of these blocks includes an RC request message handler 250 which directs the RC to produce a routing message in response to a received RC request message. The RC request message handler process is shown in greater detail at 250 in Figures 8A through 8D.

#### RC Request Message Handler

**[0200]** Referring to Figure 8A, the RC request message handler begins with a first block 252 that directs the RC processor circuit (200) to store the contents of the RC request message (150) in buffers in the buffer memory 207 of Figure 7, one of which includes the caller ID buffer 209 of Figure 7 for separately storing the contents of the callee field 154 of the RC request message. Block 254 then directs the RC processor circuit to use the contents of the caller field 152 in the RC request message shown in Figure 6, to locate and retrieve from the database 18 a record associating calling attributes with the calling subscriber. The located record may be referred to as a dialing profile for the caller. The retrieved dialing profile may then be stored in the buffer memory 207, for example.

**[0201]** Referring to Figure 9, an exemplary data structure for a dialing profile is shown generally at 253 and includes a user name field 258, a domain field 260, and calling attributes comprising a national dialing digits (NDD) field 262, an international dialing digits (IDD) field 264, a country code field 266, a local area codes field 267, a caller minimum local length field 268, a caller maximum local length field 270, a reseller field 273, a maximum number of concurrent calls field 275 and a current number of concurrent calls field 277. Effectively the dialing profile is a record identifying calling attributes of the caller identified by the caller identifier. More generally, dialing profiles represent calling attributes of respective subscribers.

**[0202]** An exemplary caller profile for the Vancouver subscriber is shown generally at 276 in Figure 10 and indicates that the user name field 258 includes the user name (2001 1050 8667) that has been assigned to the subscriber and is stored in the user name field 50 in the telephone as shown in Figure 2.

**[0203]** Referring back to Figure 10, the domain field 260 includes a domain name as shown at 282, including a node type identifier 284, a location code identifier 286, a system provider identifier 288 and a domain portion 290. The domain field 260 effectively identifies a domain or node associated with the user identified by the contents of the user name field 258.

**[0204]** In this embodiment, the node type identifier 284 includes the code “sp” identifying a supernode and the location identifier 286 identifies the supernode as being in Vancouver (YVR). The system provider identifier 288 identifies the company supplying the service and the domain portion 290 identifies the “com” domain.

**[0205]** The national dialled digit field 262 in this embodiment includes the digit “1” and, in general, includes a number specified by the International Telecommunications Union (ITU) Telecommunications Standardization Sector (ITU-T) E. 164 Recommendation which assigns national dialing digits to countries.

**[0206]** The international dialing digit field 264 includes a code also assigned according to the ITU-T according to the country or location of the user.

**[0207]** The country code field 266 also includes the digit “1” and, in general, includes a number assigned according to the ITU-T to represent the country in which the user is located.

**[0208]** The local area codes field 267 includes a list of area codes that have been assigned by the ITU-T to the geographical area in which the subscriber is located. The caller minimum and maximum local number length fields 268 and 270 hold numbers representing minimum and maximum local number lengths permitted in the area code(s) specified by the contents of the local area codes field 267. The reseller field 273 is optional and holds a code identifying a retailer of the services, in this embodiment “Klondike”. The maximum number of concurrent calls field 275 holds a code identifying the maximum number of concurrent calls that the user is entitled to cause to concurrently exist. This permits more than one call to occur concurrently while all calls for the user are billed to the same account. The current number of concurrent calls field 277 is initially 0 and is incremented each time a concurrent call associated with the user is initiated and is decremented when a concurrent call is terminated.

**[0209]** The area codes associated with the user are the area codes associated with the location code identifier 286 of the contents of the domain field 260.

**[0210]** A dialing profile of the type shown in Figure 9 is produced whenever a user registers with the system or agrees to become a subscriber to the system. Thus, for example, a user wishing to subscribe to the system may contact an office maintained by a system operator and personnel in the office may ask the user certain questions about his location and service preferences, whereupon tables can be used to provide office personnel with appropriate information to be entered into the user name 258, domain 260, NDD 262, IDD 264, country code 266, local area codes 267, caller minimum and maximum local length fields 268 and 270 reseller field 273 and concurrent call fields 275 and 277 to establish a dialing profile for the user.

**[0211]** Referring to Figures 11 and 12, callee dialing profiles for users in Calgary and London, respectively for example, are shown.

**[0212]** In addition to creating dialing profiles when a user registers with the system, a direct-in-dial (DID) record of the type shown at 278 in Figure 13 is added to a



direct-in-dial bank table in the database (18 in Figure 1) to associate the username and a host name of the supernode with which the user is associated, with an E.164 number associated with the user on the PSTN network.

**[0213]** An exemplary DID table record entry for the Calgary callee is shown generally at 300 in Figure 14. The user name field 281 and user domain field 272 are analogous to the user name and user domain fields 258 and 260 of the caller dialing profile shown in Figure 10. The contents of the DID field 274 include a E.164 public telephone number including a country code 283, an area code 285, an exchange code 287 and a number 289. If the user has multiple telephone numbers, then multiple records of the type shown at 300 would be included in the DID bank table, each having the same user name and user domain, but different DID field 274 contents reflecting the different telephone numbers associated with that user.

**[0214]** In addition to creating dialing profiles as shown in Figure 9 and DID records as shown in Figure 13 when a user registers with the system, call blocking records of the type shown in Figure 26, call forwarding records of the type shown in Figure 28 and voicemail records of the type shown in Figure 30 may be added to the database 18 when a new subscriber is added to the system.

**[0215]** Referring back to Figure 8A, after retrieving a dialing profile for the caller, such as shown at 276 in Figure 10, the RC processor circuit 200 is directed to block 256 which directs the processor circuit (200) to determine whether the contents of the concurrent call field 277 are less than the contents of the maximum concurrent call field 275 of the dialing profile for the caller and, if so, block 271 directs the processor circuit to increment the contents of the concurrent call field 277. If the contents of concurrent call field 277 are equal to or greater than the contents of the maximum concurrent call field 275, block 259 directs the processor circuit 200 to send an error message back to the call controller (14) to cause the call controller to notify the caller that the maximum number of concurrent calls has been reached and no further calls can exist concurrently, including the presently requested call.

**[0216]** Assuming block 256 allows the call to proceed, the RC processor circuit 200 is directed to perform certain checks on the callee identifier provided by the contents of

the callee field 154 in Figure 6, of the RC request message 150. These checks are shown in greater detail in Figure 8B.

**[0217]** Referring to Figure 8B, the processor (202 in Figure 7) is directed to a first block 257 that causes it to determine whether a digit pattern of the callee identifier (154) provided in the RC request message (150) includes a pattern that matches the contents of the international dialing digits (IDD) field 264 in the caller profile shown in Figure 10. If so, then block 259 directs the processor (202) to set a call type code identifier variable maintained by the processor to indicate that the call is an international call and block 261 directs the processor to produce a reformatted callee identifier by reformatting the callee identifier into a predefined digit format. In this embodiment, this is done by removing the pattern of digits matching the IDD field contents 264 of the caller dialing profile to effectively shorten the callee identifier. Then, block 263 directs the processor 202 to determine whether or not the callee identifier has a length which meets criteria establishing it as a number compliant with the E.164 Standard set by the ITU. If the length does not meet this criteria, block 265 directs the processor 202 to send back to the call controller (14) a message indicating the length is not correct. The process is then ended. At the call controller 14, routines (not shown) stored in the program memory 104 may direct the processor (102 of Figure 4) to respond to the incorrect length message by transmitting a message back to the telephone (12 shown in Figure 1) to indicate that an invalid number has been dialed.

**[0218]** Still referring to Figure 8B, if the length of the amended callee identifier meets the criteria set forth at block 263, block 269 directs the processor (202 of Figure 7) to make a database request to determine whether or not the amended callee identifier is found in a record in the direct-in-dial bank (DID) table. Referring back to Figure 8B, at block 269, if the processor 202 receives a response from the database indicating that the reformatted callee identifier produced at block 261 is found in a record in the DID bank table, then the callee is a subscriber to the system and the call is classified as a private network call by directing the processor to block 279 which directs the processor to copy the contents of the corresponding user name field (281 in Figure 14) from the callee DID bank table record (300 in Figure 14) into the callee ID buffer (211 in Figure 7). Thus, the processor 202 locates a subscriber user

name associated with the reformatted callee identifier. The processor 202 is then directed to point B in Figure 8A.

#### Subscriber to Subscriber Calls Between Different Nodes

**[0219]** Referring to Figure 8A, block 280 directs the processor (202 of Figure 7) to execute a process to determine whether or not the node associated with the reformatted callee identifier is the same node that is associated with the caller identifier. To do this, the processor 202 determines whether or not a prefix (e.g., continent code 61) of the callee name held in the callee ID buffer (211 in Figure 7), is the same as the corresponding prefix of the caller name held in the username field 258 of the caller dialing profile shown in Figure 10. If the corresponding prefixes are not the same, block 302 in Figure 8A directs the processor (202 in Figure 7) to set a call type flag in the buffer memory (207 in Figure 7) to indicate the call is a cross-domain call. Then, block 350 of Figure 8A directs the processor (202 of Figure 7) to produce a routing message identifying an address on the private network with which the callee identified by the contents of the callee ID buffer is associated and to set a time to live for the call at a maximum value of 99999, for example.

**[0220]** Thus the routing message includes a caller identifier, a call identifier set according to a username associated with the located DID bank table record and includes an identifier of a node on the private network with which the callee is associated.

**[0221]** The node in the system with which the callee is associated is determined by using the callee identifier to address a supernode table having records of the type as shown at 370 in Figure 17. Each record 370 has a prefix field 372 and a supernode address field 374. The prefix field 372 includes the first n digits of the callee identifier. In this embodiment n=2. The supernode address field 374 holds a code representing the IP address or a fully qualified domain name of the node associated with the code stored in the callee identifier prefix field 372. Referring to Figure 18, for example, if the prefix is 20, the supernode address associated with that prefix is sp.yvr.digifonica.com.

**[0222]** Referring to Figure 15, a generic routing message is shown generally at 352 and includes an optional supplier prefix field 354, and optional delimiter field 356, a callee user name field 358, at least one route field 360, a time to live field 362 and other fields 364. The optional supplier prefix field 354 holds a code for identifying supplier traffic.

The optional delimiter field 356 holds a symbol that delimits the supplier prefix code from the callee user name field 358. In this embodiment, the symbol is a number sign (#). The route field 360 holds a domain name or IP address of a gateway or node that is to carry the call, and the time to live field 362 holds a value representing the number of seconds the call is permitted to be active, based on subscriber available minutes and other billing parameters.

**[0223]** Referring to Figure 8A and Figure 16, an example of a routing message produced by the processor at block 350 for a caller associated with a different node than the caller is shown generally at 366 and includes only a callee field 359, a route field 361 and a time to live field 362.

**[0224]** Referring to Figure 8A, having produced a routing message as shown in Figure 16, block 381 directs the processor (202 of Figure 7) to send the routing message shown in Figure 16 to the call controller 14 shown in Figure 1.

**[0225]** Referring back to Figure 8B, if at block 257, the callee identifier stored in the callee id buffer (211 in Figure 7) does not begin with an international dialing digit, block 380 directs the processor (202) to determine whether or not the callee identifier begins with the same national dial digit code as assigned to the caller. To do this, the processor (202) is directed to refer to the retrieved caller dialing profile as shown in Figure 10. In Figure 10, the national dialing digit code 262 is the number 1. Thus, if the callee identifier begins with the number 1, then the processor (202) is directed to block 382 in Figure 8B.

**[0226]** Block 382 directs the processor (202 of Figure 7) to examine the callee identifier to determine whether or not the digits following the NDD digit identify an area code that is the same as any of the area codes identified in the local area codes field 267 of the caller dialing profile 276 shown in Figure 10. If not, block 384 of Figure 8B directs the processor 202 to set the call type flag to indicate that the call is a national call. If the digits following the NDD digit identify an area code that is the same as a local area code associated with the caller as indicated by the caller dialing profile, block 386 directs the processor 202 to set the call type flag to indicate a local call, national style. After executing blocks 384 or 386, block 388 directs the processor 202 to format the callee identifier into a pre-defined digit format to produce a re-formatted callee identifier by removing the national dialled digit and prepending a caller country code identified by the country code field 266 of the caller dialing

profile shown in Figure 10. The processor (202) is then directed to block 263 of Figure 8B to perform other processing as already described above.

**[0227]** If at block 380, the callee identifier does not begin with a national dialled digit, block 390 directs the processor (202) to determine whether the callee identifier begins with digits that identify the same area code as the caller. Again, the reference for this is the retrieved caller dialing profile shown in Figure 10. The processor (202) determines whether or not the first few digits of the callee identifier identify an area code corresponding to the local area code field 267 of the retrieved caller dialing profile. If so, then block 392 directs the processor 202 to set the call type flag to indicate that the call is a local call and block 394 directs the processor (202) to format the callee identifier into a pre-defined digit format to produce a reformatted callee identifier by prepending the caller country code to the callee identifier, the caller country code being determined from the country code field 266 of the retrieved caller dialing profile shown in Figure 10. The processor (202) is then directed to block 263 for further processing as described above.

**[0228]** Referring back to Figure 8B, at block 390, the callee identifier does not start with the same area code as the caller, block 396 directs the processor (202 of Figure 7) to determine whether the number of digits in the callee identifier, i.e. the length of the callee identifier, is within the range of digits indicated by the caller minimum local number length field 268 and the caller maximum local number length field 270 of the retrieved caller dialing profile shown in Figure 10. If so, then block 398 directs the processor (202) to set the call type flag to indicate a local call and block 400 directs the processor (202) to format the callee identifier into a pre-defined digit format to produce a reformatted callee identifier by prepending to the callee identifier the caller country code (as indicated by the country code field 266 of the retrieved caller dialing profile shown in Figure 10) followed by the caller area code (as indicated by the local area code field 267 of the caller profile shown in Figure 10). The processor (202) is then directed to block 263 of Figure 8B for further processing as described above.

**[0229]** Referring back to Figure 8B, if at block 396, the callee identifier has a length that does not fall within the range specified by the caller minimum local number length field (268 in Figure 10) and the caller maximum local number length field (270 in

Figure 10), block 402 directs the processor 202 of Figure 7 to determine whether or not the callee identifier identifies a valid user name. To do this, the processor 202 searches through the database (18 of Figure 10) of dialing profiles to find a dialing profile having user name field contents (258 in Figure 10) that match the callee identifier. If no match is found, block 404 directs the processor (202) to send an error message back to the call controller (14). If at block 402, a dialing profile having a user name field 258 that matches the callee identifier is found, block 406 directs the processor 202 to set the call type flag to indicate that the call is a private network call and then the processor is directed to block 280 of Figure 8A. Thus, the call is classified as a private network call when the callee identifier identifies a subscriber to the private network.

**[0230]** From Figure 8B, it will be appreciated that there are certain groups of blocks of codes that direct the processor 202 in Figure 7 to determine whether the callee identifier has certain features such as an international dialing digit, a national dialing digit, an area code and a length that meet certain criteria, and cause the processor 202 to reformat the callee identifier stored in the callee id buffer 211, as necessary into a predetermined target format including only a country code, area code, and a normal telephone number, for example, to cause the callee identifier to be compatible with the E.164 number plan standard in this embodiment. This enables block 269 in Figure 8B to have a consistent format of callee identifiers for use in searching through the DID bank table records of the type shown in Figure 13 to determine how to route calls for subscriber to subscriber calls on the same system. Effectively, therefore blocks 257, 380, 390, 396 and 402 establish call classification criteria for classifying the call as a public network call or a private network call. Block 269 classifies the call, depending on whether or not the formatted callee identifier has a DID bank table record and this depends on how the call classification criteria are met and block 402 directs the processor 202 of Figure 7 to classify the call as a private network call when the callee identifier complies with a pre-defined format, i.e. is a valid user name and identifies a subscriber to the private network, after the callee identifier has been subjected to the classification criteria of blocks 257, 380, 390 and 396.

#### Subscriber to Non-Subscriber Calls

**[0231]** Not all calls will be subscriber to subscriber calls and this will be detected by the processor 202 of Figure 7 when it executes block 269 in Figure 8B, and does not find a DID bank table record that is associated with the callee, in the DID bank table. When this occurs, the call is classified as a public network call by directing the processor 202 to block 408 of Figure 8B which causes it to set the contents of the callee id buffer 211 of Figure 7 equal to the newly formatted callee identifier, i.e., a number compatible with the E.164 standard. Then, block 410 of Figure 8B directs the processor (202) to search a database of route or master list records associating route identifiers with dialing codes shown in Figure 19 to locate a router having a dialing code having a number pattern matching at least a portion of the reformatted callee identifier.

**[0232]** Referring to Figure 19, a data structure for a master list or route list record is shown. Each master list record includes a master list ID field 500, a dialing code field 502, a country code field 504, a national sign number field 506, a minimum length field 508, a maximum length field 510, a national dialled digit field 512, an international dialled digit field 514 and a buffer rate field 516.

**[0233]** The master list ID field 500 holds a unique code such as 1019, for example, identifying the record. The dialing code field 502 holds a predetermined number pattern that the processor 202 of Figure 7 uses at block 410 in Figure 8B to find the master list record having a dialing code matching the first few digits of the amended callee identifier stored in the callee id buffer 211. The country code field 504 holds a number representing the country code associated with the record and the national sign number field 506 holds a number representing the area code associated with the record. (It will be observed that the dialing code is a combination of the contents of the country code field 504 and the national sign number field 506.) The minimum length field 508 holds a number representing the minimum length of digits associated with the record and the maximum length field 51 holds a number representing the maximum number of digits in a number with which the record may be compared. The national dialled digit (NDD) field 512 holds a number representing an access code used to make a call within the country specified by the country code, and the international dialled digit (IDD) field 514 holds a number representing the international prefix needed to dial a call from the country indicated by the country code.

**[0234]** Thus, for example, a master list record may have a format as shown in Figure 20 with exemplary field contents as shown.

**[0235]** Referring back to Figure 8B, using the country code and area code portions of the reformatted callee identifier stored in the callee id buffer 211, block 410 directs the processor 202 of Figure 7 to find a master list record such as the one shown in Figure 20 having a dialing code that matches the country code (1) and area code (604) of the callee identifier. Thus, in this example, the processor (202) would find a master list record having an ID field containing the number 1019. This number may be referred to as a route ID. Thus, a route ID number is found in the master list record associated with a predetermined number pattern in the reformatted callee identifier.

**[0236]** After executing block 410 in Figure 8B, the process continues as shown in Figure 8D. Referring to Figure 8D, block 412 directs the processor 202 of Figure 7 to use the route ID number to search a database of supplier records associating supplier identifiers with route identifiers to locate at least one supplier record associated with the route identifier to identify at least one supplier operable to supply a communications link for the route.

**[0237]** Referring to Figure 21, a data structure for a supplier list record is shown. Supplier list records include a supplier ID field 540, a master list ID field 542, an optional prefix field 544, a specific route identifier field 546, a NDD/IDD rewrite field 548, a rate field 550, and a timeout field 551. The supplier ID field 540 holds a code identifying the name of the supplier and the master list ID field 542 holds a code for associating the supplier record with a master list record. The prefix field 544 holds a string used to identify the supplier traffic and the specific route identifier field 546 holds an IP address of a gateway operated by the supplier indicated by the supplier ID field 540. The NDD/IDD rewrite field 548 holds a code representing a rewritten value of the NDD/IDD associated with this route for this supplier, and the rate field 550 holds a code indicating the cost per second to the system operator to use the route provided by the gateway specified by the contents of the route identifier field 546. The timeout field 551 holds a code indicating a time that the call controller should wait for a response from the associated gateway before giving up and trying the next gateway. This time value may be in seconds, for example. Exemplary supplier



records are shown in Figures 22, 23 and 24 for the exemplary suppliers shown at 20 in Figure 1, namely Telus, Shaw and Sprint.

**[0238]** Referring back to Figure 8D, at block 412 the processor 202 finds all supplier records that identify the master list ID found at block 410 of Figure 8B.

**[0239]** Referring back to Figure 8D, block 560 directs the processor 202 of Figure 7 to begin to produce a routing message of the type shown in Figure 15. To do this, the processor 202 loads a routing message buffer as shown in Figure 25 with a supplier prefix of the least costly supplier where the least costly supplier is determined from the rate fields 550 of Figure 21 of the records associated with respective suppliers.

**[0240]** Referring to Figures 22-24, in the embodiment shown, the supplier “Telus” has the lowest number in the rate field 550 and therefore the prefix 4973 associated with that supplier is loaded into the routing message buffer shown in Figure 25 first.

**[0241]** Block 562 in Figure 8D directs the processor to delimit the prefix 4973 by the number sign (#) and to next load the reformatted callee identifier into the routing message buffer shown in Figure 25. At block 563 of Figure 8D, the contents of the route identifier field 546 of Figure 21 of the record associated with the supplier “Telus” are added by the processor 202 of Figure 7 to the routing message buffer shown in Figure 25 after an @ sign delimiter, and then block 564 in Figure 8D directs the processor to get a time to live value, which in one embodiment may be 3600 seconds, for example. Block 566 then directs the processor 202 to load this time to live value and the timeout value (551) in Figure 21 in the routing message buffer of Figure 25. Accordingly, a first part of the routing message for the Telus gateway is shown generally at 570 in Figure 25.

**[0242]** Referring back to Figure 8D, block 571 directs the processor 202 back to block 560 and causes it to repeat blocks 560, 562, 563, 564 and 566 for each successive supplier until the routing message buffer is loaded with information pertaining to each supplier identified by the processor at block 412. Thus, a second portion of the routing message as shown at 572 in Figure 25 relates to the second supplier identified by the record shown in Figure 23. Referring back to Figure 25, a third portion of the routing message as shown at 574 and is associated with a third supplier as indicated by the supplier record shown in Figure 24.

**[0243]** Consequently, referring to Figure 25, the routing message buffer holds a routing message identifying a plurality of different suppliers able to provide gateways to the public telephone network (i.e. specific routes) to establish at least part of a communication link through which the caller may contact the callee. In this embodiment, each of the suppliers is identified, in succession, according to rate. Other criteria for determining the order in which suppliers are listed in the routing message may include preferred supplier priorities which may be established based on service agreements, for example.

**[0244]** Referring back to Figure 8D, block 568 directs the processor 202 of Figure 7 to send the routing message shown in Figure 25 to the call controller 14 in Figure 1.

#### Subscriber to Subscriber Calls Within the Same Node

**[0245]** Referring back to Figure 8A, if at block 280, the callee identifier received in the RC request message has a prefix that identifies the same node as that associated with the caller, block 600 directs the processor 202 to use the callee identifier in the callee id buffer 211 to locate and retrieve a dialing profile for the callee. The dialing profile may be of the type shown in Figure 11 or 12, for example. Block 602 of Figure 8A then directs the processor 202 of Figure 7 to get call block, call forward and voicemail records from the database 18 of Figure 1 based on the user name identified in the callee dialing profile retrieved by the processor at block 600. Call block, call forward and voicemail records may be as shown in Figures 26, 27, 28 and 30 for example.

**[0246]** Referring to Figure 26, the call block records include a user name field 604 and a block pattern field 606. The user name field holds a user name corresponding to the user name in the user name field (258 in Figure 10) of the callee profile and the block pattern field 606 holds one or more E.164-compatible numbers or user names identifying PSTN numbers or system subscribers from whom the subscriber identified in the user name field 604 does not wish to receive calls.

**[0247]** Referring to Figure 8A and Figure 27, block 608 directs the processor 202 of Figure 7 to determine whether or not the caller identifier received in the RC request message matches a block pattern stored in the block pattern field 606 of the call block record associated with the callee identified by the contents of the user name field 604 in Figure 26. If the caller identifier matches a block pattern, block 610 directs the processor to send a drop

call or non-completion message to the call controller (14) and the process is ended. If the caller identifier does not match a block pattern associated with the callee, block 609 directs the processor to store the username and domain of the callee, as determined from the callee dialing profile, and a time to live value in the routing message buffer as shown at 650 in Figure 32. Referring back to Figure 8A, block 612 then directs the processor 202 to determine whether or not call forwarding is required.

**[0248]** Referring to Figure 28, the call forwarding records include a user name field 614, a destination number field 616, and a sequence number field 618. The user name field 614 stores a code representing a user with which the record is associated. The destination number field 616 holds a user name representing a number to which the current call should be forwarded, and the sequence number field 618 holds an integer number indicating the order in which the user name associated with the corresponding destination number field 616 should be attempted for call forwarding. The call forwarding table may have a plurality of records for a given user. The processor 202 of Figure 7 uses the contents of the sequence number field 618 to place the records for a given user in order. As will be appreciated below, this enables the call forwarding numbers to be tried in an ordered sequence.

**[0249]** Referring to Figure 8A and Figure 29, if at block 612, the call forwarding record for the callee identified by the callee identifier contains no contents in the destination number field 616 and accordingly no contents in the sequence number field 618, there are no call forwarding entries for this callee, and the processor 202 is directed to block 620 in Figure 8C. If there are entries in the call forwarding table 27, block 622 in Figure 8A directs the processor 202 to search the dialing profile table to find a dialing profile record as shown in Figure 9, for the user identified by the destination number field 616 of the call forward record shown in Figure 28. The processor 202 of Figure 7 is further directed to store the username and domain for that user and a time to live value in the routing message buffer as shown at 652 in Figure 32, to produce a routing message as illustrated. This process is repeated for each call forwarding record associated with the callee identified by the callee id buffer 211 in Figure 7 to add to the routing message buffer all call forwarding usernames and domains associated with the callee.

**[0250]** Referring back to Figure 8A, if at block 612 there are no call forwarding records, then at block 620 in Figure 8C the processor 202 is directed to determine whether or not the user identified by the callee identifier has paid for voicemail service. This is done by checking to see whether or not a flag is set in a voicemail record of the type shown in Figure 30 in a voicemail table stored in the database 18 shown in Figure 1.

**[0251]** Referring to Figure 30, voicemail records in this embodiment may include a user name field 624, a voicemail server field 626, a seconds to voicemail field 628 and an enable field 630. The user name field 624 stores the user name of the callee. The voicemail server field 626 holds a code identifying a domain name of a voicemail server associated with the user identified by the user name field 624. The seconds to voicemail field 628 holds a code identifying the time to wait before engaging voicemail, and the enable field 630 holds a code representing whether or not voicemail is enabled for the user. Referring back to Figure 8C, at block 620 if the processor 202 of Figure 7 finds a voicemail record as shown in Figure 30 having user name field 624 contents matching the callee identifier, the processor is directed to examine the contents of the enable field 630 to determine whether or not voicemail is enabled. If voicemail is enabled, then block 640 in Figure 8C directs the processor 202 to Figure 7 to store the contents of the voicemail server field 626 and the contents of the seconds to voicemail field 628 in the routing message buffer, as shown at 654 in Figure 32. Block 642 then directs the processor 202 to get time to live values for each path specified by the routing message according to the cost of routing and the user's balance. These time to live values are then appended to corresponding paths already stored in the routing message buffer.

**[0252]** Referring back to Figure 8C, block 644 then directs the processor 202 of Figure 7 to store the IP address of the current node in the routing message buffer as shown at 656 in Figure 32. Block 646 then directs the processor 202 to send the routing message shown in Figure 32 to the call controller 14 in Figure 1. Thus in the embodiment described the routing controller will produce a routing message that will cause at least one of the following: forward the call to another party, block the call and direct the caller to a voicemail server.

**[0253]** Referring back to Figure 1 , the routing message whether of the type shown in Figures 16, 25 or 32, is received at the call controller 14 and the call controller interprets the receipt of the routing message as a request to establish a call.

**[0254]** Referring to Figure 4, the program memory 104 of the call controller 14 includes a routing to gateway routine depicted generally at 122.

**[0255]** Where a routing message of the type shown in Figure 32 is received by the call controller 14, the routing to gateway routine 122 shown in Figure 4 may direct the processor 102 cause a message to be sent back through the internet 13 shown in Figure 1 to the callee telephone 15, knowing the IP address of the callee telephone 15 from the user name.

**[0256]** Alternatively, if the routing message is of the type shown in Figure 16, which identifies a domain associated with another node in the system, the call controller may send a SIP invite message along the high speed backbone 17 connected to the other node. The other node functions as explained above, in response to receipt of a SIP invite message.

**[0257]** If the routing message is of the type shown in Figure 25 where there are a plurality of gateway suppliers available, the call controller sends a SIP invite message to the first supplier, in this case Telus, using a dedicated line or an internet connection to determine whether or not Telus is able to handle the call. If the Telus gateway returns a message indicating it is not able to handle the call, the call controller 14 then proceeds to send a SIP invite message to the next supplier, in this case Shaw. The process is repeated until one of the suppliers responds indicating that it is available to carry the call. Once a supplier responds indicating that it is able to carry the call, the supplier sends back to the call controller 14 an IP address for a gateway provided by the supplier through which the call or audio path of the call will be carried. This IP address is sent in a message from the call controller 14 to the media relay 9 which responds with a message indicating an IP address to which the caller telephone should send its audio/video, traffic and an IP address to which the gateway should send its audio/video for the call. The call controller conveys the IP address at which the media relay expects to receive audio/video from the caller telephone, to the caller telephone 12 in a message. The caller telephone replies to the call controller with an IP address at which it would like to receive audio/video and the call controller conveys that IP address to the

media relay. The call may then be conducted between the caller and callee through the media relay and gateway.

**[0258]** Referring back to Figure 1 , if the call controller 14 receives a routing message of the type shown in Figure 32, and which has at least one call forwarding number and/or a voicemail number, the call controller attempts to establish a call to the callee telephone 15 by seeking from the callee telephone a message indicating an IP address to which the media relay should send audio/video. If no such message is received from the callee telephone, no call is established. If no call is established within a pre-determined time, the call controller 14 attempts to establish a call with the next user identified in the call routing message in the same manner. This process is repeated until all call forwarding possibilities have been exhausted, in which case the call controller communicates with the voicemail server 19 identified in the routing message to obtain an IP address to which the media relay should send audio/video and the remainder of the process mentioned above for establishing IP addresses at the media relay 9 and the caller telephone is carried out to establish audio/video paths to allowing the caller to leave a voicemail message with the voicemail server.

**[0259]** When an audio/video path through the media relay is established, a call timer maintained by the call controller 14 logs the start date and time of the call and logs the call ID and an identification of the route (i.e., audio/video path IP address) for later use in billing.

#### Time to Live

**[0260]** Referring to Figures 33A and 33B, a process for determining a time to live value for any of blocks 642 in Figure 8C, 350 in Figure 8A or 564 in Figure 8D above is described. The process is executed by the processor 202 shown in Figure 7. Generally, the process involves calculating a cost per unit time, calculating a first time value as a sum of a free time attributed to a participant in the communication session and the quotient of a funds balance held by the participant to the cost per unit time value and producing a second time value in response to the first time value and a billing pattern associated with the participant, the billing pattern including first and second billing intervals and the second time value being the time to permit a communication session to be conducted.

**[0261]** Referring to Figure 33A, in this embodiment, the process begins with a first block 700 that directs the RC processor to determine whether or not the call type set at block 302 in Figure 8A indicates the call is a network or cross-domain call. If the call is a network or cross-domain call, block 702 of Figure 33A directs the RC processor to set the time to live equal to 99999 and the process is ended. Thus, the network or cross-domain call type has a long time to live. If at block 700 the call type is determined not to be a network or cross-domain type, block 704 directs the RC processor to get a subscriber bundle table record from the database 18 in Figure 1 and store it locally in the subscriber bundle record buffer at the RC 14.

**[0262]** Referring to Figure 34, a subscriber bundle table record is shown generally at 706. The record includes a user name field 708 and a services field 710. The user name field 708 holds a code identifying the subscriber user name and the services field 710 holds codes identifying service features assigned to the subscriber, such as free local calling, call blocking and voicemail, for example.

**[0263]** Figure 35 shows an exemplary subscriber bundle record for the Vancouver caller. In this record the user name field 708 is loaded with the user name 2001 1050 8667 and the services field 710 is loaded with codes 10, 14 and 16 corresponding to free local calling, call blocking and voicemail, respectively. Thus, user 2001 1050 8667 has free local calling, call blocking and voicemail features.

**[0264]** Referring back to Figure 33A, after having loaded a subscriber bundle record into the subscriber bundle record buffer, block 712 directs the RC processor to search the database (18) determine whether or not there is a bundle override table record for the master list ID value that was determined at block 410 in Figure 8B. An exemplary bundle override table record is shown at 714 in Figure 36. The bundle table record includes a master list ID field 716, an override type field 718, an override value field 720 a first interval field 722 and a second interval field 724. The master list ID field 716 holds a master list ID code. The override type field 718 holds an override type code indicating a fixed, percent or cent amount to indicate the amount by which a fee will be increased. The override value field 720 holds a real number representing the value of the override type. The first interval field 722

holds a value indicating the minimum number of seconds for a first level of charging and the second interval field 724 holds a number representing a second level of charging.

**[0265]** Referring to Figure 37, a bundle override record for the located master list ID code is shown generally at 726 and includes a master list ID field 716 holding the code 1019 which was the code located in block 410 of Figure 8B. The override type field 718 includes a code indicating the override type is a percentage value and the override value field 720 holds the value 10.0 indicating that the override will be 10.0% of the charged value. The first interval field 722 holds a value representing 30 seconds and the second interval field 724 holds a value representing 6 seconds. The 30 second value in the first interval field 722 indicates that charges for the route will be made at a first rate for 30 seconds and thereafter the charges will be made at a different rate in increments of 6 seconds, as indicated by the contents of the second interval field 724.

**[0266]** Referring back to Figure 33A, if at block 712 the processor finds a bundle override record of the type shown in Figure 37, block 728 directs the processor to store the bundle override record in local memory. In the embodiment shown, the bundle override record shown in Figure 37 is stored in the bundle override record buffer at the RC as shown in Figure 7. Still referring to Figure 33A, block 730 then directs the RC processor to determine whether or not the subscriber bundle table record 706 in Figure 35 has a services field including a code identifying that the user is entitled to free local calling and also directs the processor to determine whether or not the call type is not a cross domain cell, i.e. it is a local or local/national style. If both of these conditions are satisfied, block 732 directs the processor to set the time to live equal to 99999, giving the user a long period of time for the call. The process is then ended. If the conditions associated with block 730 are not satisfied, block 734 of Figure 33B directs the RC processor to retrieve a subscriber account record associated with a participant in the call. This is done by copying and storing in the subscriber account record buffer a subscriber account record for the caller.

**[0267]** Referring to Figure 38, an exemplary subscriber account table record is shown generally at 736. The record includes a user name field 738, a funds balance field 740 and a free time field 742. The user name field 738 holds a subscriber user name, the funds balance field 740 holds a real number representing the dollar value of credit available to the



subscriber and the free time field 742 holds an integer representing the number of free seconds that the user is entitled to.

**[0268]** An exemplary subscriber account record for the Vancouver caller is shown generally at 744 in Figure 39, wherein the user name field 738 holds the user name 2001 1050 8667, the funds balance field 740 holds the value \$10.00, and the free time field 742 holds the value 100. The funds balance field holding the value of \$10.00 indicates the user has \$10.00 worth of credit and the free time field having the value of 100 indicates that the user has a balance of 100 free seconds of call time.

**[0269]** Referring back to Figure 33B, after copying and storing the subscriber account record shown in Figure 39 from the database to the subscriber account record buffer RC, block 746 directs the processor to determine whether or not the subscriber account record funds balance field 740 or free time field 742 are greater than zero. If they are not greater than zero, block 748 directs the processor to set the time to live equal to zero and the process is ended. The RC then sends a message back to the call controller to cause the call controller to deny the call to the caller. If the conditions associated with block 746 are satisfied, block 750 directs the processor to calculate the call cost per unit time. A procedure for calculating the call cost per unit time is described below in connection with Figure 41.

**[0270]** Assuming the procedure for calculating the cost per second returns a number representing the call cost per second, block 752 directs the processor 202 in Figure 7 to determine whether or not the cost per second is equal to zero. If so, block 754 directs the processor to set the time to live to 99999 to give the caller a very long length of call and the process is ended.

**[0271]** If at block 752 the call cost per second is not equal to zero, block 756 directs the processor 202 in Figure 7 to calculate a first time to live value as a sum of a free time attributed to the participant in the communication session and the quotient of the funds balance held by the participant to the cost per unit time value. To do this, the processor 202 of Figure 7 is directed to set a first time value or temporary time to live value equal to the sum of the free time provided in the free time field 742 of the subscriber account record shown in Figure 39 and the quotient of the contents of the funds balance field 740 in the subscriber account record for the call shown in Figure 39 and the cost per second determined

at block 750 of Figure 33B. Thus, for example, if at block 750 the cost per second is determined to be three cents per second and the funds balance field holds the value \$10.00, the quotient of the funds balance and cost per second is 333 seconds and this is added to the contents of the free time field 742, which is 100, resulting in a time to live of 433 seconds.

**[0272]** Block 758 then directs the RC processor to produce a second time value in response to the first time value and the billing pattern associated with the participant as established by the bundle override record shown in Figure 37. This process is shown in greater detail at 760 in Figure 40 and generally involves producing a remainder value representing a portion of the second billing interval remaining after dividing the second billing interval into a difference between the first time value and the first billing interval.

**[0273]** Referring to Figure 40, the process for producing the second time value begins with a first block 762 that directs the processor 202 in Figure 7 to set a remainder value equal to the difference between the time to live value calculated at block 756 in Figure 33B and the contents of the first interval field 722 of the record shown in Figure 37, multiplied by the modulus of the contents of the second interval field 724 of Figure 37. Thus, in the example given, the difference between the time to live field and the first interval field is 433 minus 30, which is 403 and therefore the remainder produced by the mod of 403 divided by 6 is 0.17. Block 764 then directs the processor to determine whether or not this remainder value is greater than zero and, if so, block 766 directs the processor to subtract the remainder from the first time value and set the difference as the second time value. To do this the processor is directed to set the time to live value equal to the current time to live of 403 minus the remainder of 1, i.e., 402 seconds. The processor is then returned back to block 758 of Figure 33B.

**[0274]** Referring back to Figure 40, if at block 764 the remainder is not greater than zero, block 768 directs the processor 202 of Figure 7 to determine whether or not the time to live is less than the contents of the first interval field 722 in the record shown in Figure 37. If so, then block 770 of Figure 40 directs the processor to set the time to live equal to zero. Thus, the second time value is set to zero when the remainder is greater than zero and the first time value is less than the free time associated with the participant in the call. If at

block 768 the conditions of that block are not satisfied, the processor returns the first time to live value as the second time to live value.

[0275] Thus, referring to Figure 33B, after having produced a second time to live value, block 772 directs the processor to set the time to live value for use in blocks 342, 350 or 564.

#### Cost per Second

[0276] Referring back to Figure 33B, at block 750 it was explained that a call cost per unit time is calculated. The following explains how that call cost per unit time value is calculated.

[0277] Referring to Figure 41, a process for calculating a cost per unit time is shown generally at 780. The process is executed by the processor 202 in Figure 7 and generally involves locating a record in a database, the record comprising a markup type indicator, a markup value and a billing pattern and setting a reseller rate equal to the sum of the markup value and the buffer rate, locating at least one of an override record specifying a route cost per unit time amount associated with a route associated with the communication session, a reseller record associated with a reseller of the communications session, the reseller record specifying a reseller cost per unit time associated with the reseller for the communication session and a default operator markup record specifying a default cost per unit time and setting as the cost per unit time the sum of the reseller rate and at least one of the route cost per unit time, the reseller cost per unit time and the default cost per unit time.

[0278] The process begins with a first set of blocks 782, 802 and 820 which direct the processor 202 in Figure 7 to locate at least one of a record associated with a reseller and a route associated with the reseller, a record associated with the reseller, and a default reseller mark-up record. Block 782, in particular, directs the processor to address the database 18 to look for a record associated with a reseller and a route with the reseller by looking for a special rate record based on the master list ID established at block 410 in Figure 8C.

[0279] Referring to Figure 42, a system operator special rate table record is shown generally at 784. The record includes a reseller field 786, a master list ID field 788, a mark-up type field 790, a mark-up value field 792, a first interval field 794 and a second interval field 796. The reseller field 786 holds a reseller ID code and the master list ID field 788 holds

a master list ID code. The mark-up type field 790 holds a mark-up type such as fixed percent or cents and the mark-up value field 792 holds a real number representing the value corresponding to the mark-up type. The first interval field 794 holds a number representing a first level of charging and the second interval field 796 holds a number representing a second level of charging.

**[0280]** An exemplary system operator special rate table for a reseller known as “Klondike” is shown at 798 in Figure 43. In this record, the reseller field 786 holds a code indicating the retailer ID is Klondike, the master list ID field 788 holds the code 1019 to associate the record with the master list ID code 1019. The mark-up type field 790 holds a code indicating the mark-up type is cents and the mark-up value field 792 holds a mark-up value indicating 1/10 of one cent. The first interval field 794 holds the value 30 and the second interval field 796 holds the value 6, these two fields indicating that the operator allows 30 seconds for free and then billing is done in increments of 6 seconds after that.

**[0281]** Referring back to Figure 41, if at block 782 a record such as the one shown in Figure 43 is located in the system operator special rates table, the processor is directed to block 800 in Figure 41. If such a record is not found in the system operator special rates table, block 802 directs the processor to address the database 18 to look in a system operator mark-up table for a mark-up record associated with the reseller.

**[0282]** Referring to Figure 44, an exemplary system operator mark-up table record is shown generally at 804. The record includes a reseller field 806, a mark-up type field 808, a mark-up value field 810, a first interval field 812 and a second interval field 814. The reseller mark-up type, mark-up value, first interval and second interval fields are as described in connection with the fields by the same names in the system operator special rates table shown in Figure 42.

**[0283]** Figure 45 provides an exemplary system operator mark-up table record for the reseller known as Klondike and therefore the reseller field 806 holds the value “Klondike”, the mark-up type field 808 holds the value cents, the markup value field holds the value 0.01, the first interval field 812 holds the value 30 and the second interval field 814 holds the value 6. This indicates that the reseller “Klondike” charges by the cent at a rate of

one cent per minute. The first 30 seconds of the call are free and billing is charged at the rate of one cent per minute in increments of 6 seconds.

**[0284]** Figure 46 provides an exemplary system operator mark-up table record for cases where no specific system operator mark-up table record exists for a particular reseller, i.e., a default reseller mark-up record. This record is similar to the record shown in Figure 45 and the reseller field 806 holds the value “all”, the mark-up type field 808 is loaded with a code indicating mark-up is based on a percentage, the mark-up value field 810 holds the percentage by which the cost is marked up, and the first and second interval fields 812 and 814 identify first and second billing levels.

**[0285]** Referring back to Figure 41 , if at block 802 a specific mark-up record for the reseller identified at block 782 is not located, block 820 directs the processor to get the mark-up record shown in Figure 46, having the “all” code in the reseller field 806. The processor is then directed to block 800.

**[0286]** Referring back to Figure 41, at block 800, the processor 202 of Figure 7 is directed to set a reseller rate equal to the sum of the mark-up value of the record located by blocks 782, 802 or 820 and the buffer rate specified by the contents of the buffer rate field 516 of the master list record shown in Figure 20. To do this, the RC processor sets a variable entitled “reseller cost per second” to a value equal to the sum of the contents of the mark-up value field (792, 810) of the associated record, plus the contents of the buffer rate field (516) from the master list record associated with the master list ID. Then, block 822 directs the processor to set a system operator cost per second variable equal to the contents of the buffer rate field (516) from the master list record. Block 824 then directs the processor to determine whether the call type flag indicates the call is local or national/local style and whether the caller has free local calling. If both these conditions are met, then block 826 sets the user cost per second variable equal to zero and sets two increment variables equal to one, for use in later processing. The cost per second has thus be calculated and the process shown in Figure 41 is ended.

**[0287]** If at block 824 the conditions of that block are not met, the processor 202 of Figure 7 is directed to locate at least one of a bundle override table record specifying a route cost per unit time associated with a route associated with the communication session, a

reseller special destinations table record associated with a reseller of the communications session, the reseller record specifying a reseller cost per unit time associated with the reseller for the communication session and a default reseller global markup record specifying a default cost per unit time.

**[0288]** To do this block 828 directs the processor 202 of Figure 7 to determine whether or not the bundle override record 726 in Figure 37 located at block 712 in Figure 33A has a master list ID equal to the stored master list ID that was determined at block 410 in Figure 8B. If not, block 830 directs the processor to find a reseller special destinations table record in a reseller special destinations table in the database (18), having a master list ID code equal to the master list ID code of the master list ID that was determined at block 410 in Figure 8B. An exemplary reseller special destinations table record is shown in Figure 47 at 832. The reseller special destinations table record includes a reseller field 834, a master list ID field 836, a mark-up type field 838, a mark-up value field 840, a first interval field 842 and a second interval field 844. This record has the same format as the system operator special rates table record shown in Figure 42, but is stored in a different table to allow for different mark-up types and values and time intervals to be set according to resellers' preferences. Thus, for example, an exemplary reseller special destinations table record for the reseller "Klondike" is shown at 846 in Figure 48. The reseller field 834 holds a value indicating the reseller as the reseller "Klondike" and the master list ID field holds the code 1019. The markup type field 838 holds a code indicating the mark-up type is percent and the mark-up value field 840 holds a number representing the mark-up value as 5%. The first and second interval fields identify different billing levels used as described earlier.

**[0289]** Referring back to Figure 41, the record shown in Figure 48 may be located at block 830, for example. If at block 830 such a record is not found, then block 832 directs the processor to get a default operator global mark-up record based on the reseller ID.

**[0290]** Referring to Figure 49, an exemplary default reseller global mark-up table record is shown generally at 848. This record includes a reseller field 850, a mark-up type field 852, a mark-up value field 854, a first interval field 856 and a second interval field 858. The reseller field 850 holds a code identifying the reseller. The mark-up type field 852, the mark-up value field 854 and the first and second interval fields 856 and 858 are of the same

type as described in connection with fields of the same name in Figure 47, for example. The contents of the fields of this record 860 may be set according to system operator preferences, for example.

**[0291]** Referring to Figure 50, an exemplary reseller global mark-up table record is shown generally at 860. In this record, the reseller field 850 holds a code indicating the reseller is “Klondike”, the mark-up type field 852 holds a code indicating the mark-up type is percent, the mark-up value field 854 holds a value representing 10% as the mark-up value, the first interval field 856 holds the value 30 and the second interval field 858 holds the values 30 and 6 respectively to indicate the first 30 seconds are free and billing is to be done in 6 second increments after that.

**[0292]** Referring back to Figure 41, should the processor get to block 832, the reseller global mark-up table record as shown in Figure 50 is retrieved from the database and stored locally at the RC. As seen in Figure 41, it will be appreciated that if the conditions are met in blocks 828 or 830, or if the processor executes block 832, the processor is then directed to block 862 which causes it to set an override value equal to the contents of the mark-up value field of the located record, to set the first increment variable equal to the contents of the first interval field of the located record and to set the second increment variable equal to the contents of the second interval field of the located record. (The increment variables were alternatively set to specific values at block 826 in Figure 41.)

**[0293]** It will be appreciated that the located record could be a bundle override record of the type shown in Figure 37 or the located record could be a reseller special destination record of the type shown in Figure 48 or the record could be a reseller global mark-up table record of the type shown in Figure 50. After the override and first and second increment variables have been set at block 862, the processor 202 if Figure 7 is directed to set as the cost per unit time the sum of the reseller rate and at least one of the route cost per unit time, the reseller cost per unit time and the default cost per unit time, depending on which record was located. To do this, block 864 directs the processor to set the cost per unit time equal to the sum of the reseller cost set at block 800 in Figure 41, plus the contents of the override variable calculated in block 862 in Figure 41. The cost per unit time has thus been

calculated and it is this cost per unit time that is used in block 752 of Figure 33B, for example.

### Terminating the Call

**[0294]** In the event that either the caller or the callee terminates a call, the telephone of the terminating party sends a SIP bye message to the controller 14. An exemplary SIP bye message is shown at 900 in Figure 51 and includes a caller field 902, a callee field 904 and a call ID field 906. The caller field 902 holds a twelve digit user name, the callee field 904 holds a PSTN compatible number or user name, and the call ID field 906 holds a unique call identifier field of the type shown in the call ID field 65 of the SIP invite message shown in Figure 3.

**[0295]** Thus, for example, referring to Figure 52, a SIP bye message for the Calgary callee is shown generally at 908 and the caller field 902 holds a user name identifying the caller, in this case 2001 1050 8667, the callee field 904 holds a user name identifying the Calgary callee, in this case 2001 1050 2222, and the call ID field 906 holds the code FA10 @ 192.168.0.20, which is the call ID for the call.

**[0296]** The SIP bye message shown in Figure 52 is received at the call controller 14 and the call controller executes a process as shown generally at 910 in Figure 53. The process includes a first block 912 that directs the call controller processor 202 of Figure 7 to copy the caller, callee and call ID field contents from the SIP bye message received from the terminating party to corresponding fields of an RC stop message buffer (not shown). Block 914 then directs the processor to copy the call start time from the call timer and to obtain a call stop time from the call timer. Block 916 then directs the call controller to calculate a communication session time by determining the difference in time between the call start time and the call stop time. This session time is then stored in a corresponding field of the RC call stop message buffer. Block 917 then directs the processor to decrement the contents of the current concurrent call field 277 of the dialing profile for the caller as shown in Figure 10, to indicate that there is one less concurrent call in progress. A copy of the amended dialing profile for the caller is then stored in the database 18 of Figure 1. Block 918 then directs the processor to copy the route from the call log. An RC call stop message produced as described



above is shown generally at 1000 in Figure 54. An RC call stop message specifically associated with the call made to the Calgary callee is shown generally at 1020 in Figure 55.

**[0297]** Referring to Figure 54, the RC stop call message includes a caller field 1002, callee field 1004, a call ID field 1006, an account start time field 1008, an account stop time field 1010, a communication session time 1012 and a route field 1014. The caller field 1002 holds a username, the callee field 1004 holds a PSTN-compatible number or system number, the call ID field 1006 hold the unique call identifier received from the SIP invite message shown in Figure 3, the account start time field 1008 holds the date and start time of the call, the account stop time field 1010 holds the date and time the call ended, the communication session time field 1012 holds a value representing the difference between the start time and the stop time, in seconds, and the route field 1014 holds the IP address for the communications link that was established.

**[0298]** Referring to Figure 55, an exemplary RC stop call message for the Calgary callee is shown generally at 1020. In this example the caller field 1002 holds the user name 2001 1050 8667 identifying the Vancouver-based caller and the callee field 1004 holds the user name 2001 1050 2222 identifying the Calgary callee. The contents of the call ID field 1006 are FA10 @ 192.168.0.20. The contents of the account start time field 1008 are 2006-12-30 12:12:12 and the contents of the account stop time field are 2006-12-30 12:12:14. The contents of the communication session time field 1012 are 2 to indicate 2 seconds call duration and the contents of the route field are 72.64.39.58.

**[0299]** Referring back to Figure 53, after having produced an RC call stop message, block 920 directs the processor 202 in Figure 7 to send the RC stop message compiled in the RC call stop message buffer to the RC 16 of Figure 1. Block 922 directs the call controller 14 to send a “bye” message back to the party that did not terminate the call.

**[0300]** The RC 16 of Figure 1 receives the call stop message and an RC call stop message process is invoked at the RC, the process being shown at 950 in Figures 56A, 56B and 56C. Referring to Figure 56A, the RC stop message process 950 begins with a first block 952 that directs the processor 202 in Figure 7 to determine whether or not the communication session time is less than or equal to the first increment value set by the cost calculation routine shown in Figure 41, specifically blocks 826 or 862 thereof. If this condition is met,

then block 954 of Figure 56A directs the RC processor to set a chargeable time variable equal to the first increment value set at block 826 or 862 of Figure 41. If at block 952 of Figure 56A the condition is not met, block 956 directs the RC processor to set a remainder variable equal to the difference between the communication session time and the first increment value mod the second increment value produced at block 826 or 862 of Figure 41. Then, the processor is directed to block 958 of Figure 56A which directs it to determine whether or not the remainder is greater than zero. If so, block 960 directs the RC processor to set the chargeable time variable equal to the difference between the communication session time and the remainder value. If at block 958 the remainder is not greater than zero, block 962 directs the RC processor to set the chargeable time variable equal to the contents of the communication session time from the RC stop message. The processor is then directed to block 964. In addition, after executing block 954 or block 960, the processor is directed to block 964.

**[0301]** Block 964 directs the processor 202 of Figure 7 to determine whether or not the chargeable time variable is greater than or equal to the free time balance as determined from the free time field 742 of the subscriber account record shown in Figure 39. If this condition is satisfied, block 966 of Figure 56A directs the processor to set the free time field 742 in the record shown in Figure 39, to zero. If the chargeable time variable is not greater than or equal to the free time balance, block 968 directs the RC processor to set a user cost variable to zero and Block 970 then decrements the free time field 742 of the subscriber account record for the caller by the chargeable time amount determined by block 954, 960 or 962.

**[0302]** If at Block 964 the processor 202 of Figure 7 was directed to Block 966 which causes the free time field (742 of Figure 39) to be set to zero, referring to Figure 56B, Block 972 directs the processor to set a remaining chargeable time variable equal to the difference between the chargeable time and the contents of the free time field (742 of Figure 39). Block 974 then directs the processor to set the user cost variable equal to the product of the remaining chargeable time and the cost per second calculated at Block 750 in Figure 33B. Block 976 then directs the processor to decrement the funds balance field (740) of the

subscriber account record shown in Figure 39 by the contents of the user cost variable calculated at Block 974.

**[0303]** After completing Block 976 or after completing Block 970 in Figure 56A, block 978 of Figure 56B directs the processor 202 of Figure 7 to calculate a reseller cost variable as the product of the reseller rate as indicated in the mark-up value field 810 of the system operator mark-up table record shown in Figure 45 and the communication session time determined at Block 916 in Figure 53. Then, Block 980 of Figure 56B directs the processor to add the reseller cost to the reseller balance field 986 of a reseller account record of the type shown in Figure 57 at 982.

**[0304]** The reseller account record includes a reseller ID field 984 and the aforementioned reseller balance field 986. The reseller ID field 984 holds a reseller ID code, and the reseller balance field 986 holds an accumulated balance of charges.

**[0305]** Referring to Figure 58, a specific reseller accounts record for the reseller “Klondike” is shown generally at 988. In this record the reseller ID field 984 holds a code representing the reseller “Klondike” and the reseller balance field 986 holds a balance of \$100.02. Thus, the contents of the reseller balance field 986 in Figure 58 are incremented by the reseller cost calculated at block 978 of Figure 56B.

**[0306]** Still referring to Figure 56B, after adding the reseller cost to the reseller balance field as indicated by Block 980, Block 990 directs the processor to 202 of Figure 7 calculate a system operator cost as the product of the system operator cost per second, as set at block 822 in Figure 41, and the communication session time as determined at Block 916 in Figure 53. Block 992 then directs the processor to add the system operator cost value calculated at Block 990 to a system operator accounts table record of the type shown at 994 in Figure 59. This record includes a system operator balance field 996 holding an accumulated charges balance. Referring to Figure 60 in the embodiment described, the system operator balance field 996 may hold the value \$1,000.02 for example, and to this value the system operator cost calculated at Block 990 is added when the processor executes Block 992 of Figure 56B.

**[0307]** Ultimately, the final reseller balance 986 in Figure 58 holds a number representing an amount owed to the reseller by the system operator and the system operator

balance 996 of Figure 59 holds a number representing an amount of profit for the system operator.

**[0308]** While specific embodiments of the invention have been described and illustrated, such embodiments should be considered illustrative of the invention only and not as limiting the invention as construed in accordance with the accompanying claims.

WHAT IS CLAIMED IS:

**1.** A process for producing a routing message for routing communications between a caller and a callee in a communication system, the process comprising:

using a caller identifier associated with the caller to locate a caller dialing profile comprising a plurality of calling attributes associated with the caller;

when at least one of said calling attributes and at least a portion of a callee identifier associated with the callee meet private network classification criteria, producing a private network routing message for receipt by a call controller, said private network routing message identifying an address, on the private network, associated with the callee; and

when at least one of said calling attributes and at least a portion of said callee identifier meet a public network classification criterion, producing a public network routing message for receipt by the call controller, said public network routing message identifying a gateway to the public network.

**2.** The process of claim **1**, wherein said private network classification criteria include:

a) said callee identifier does not begin with the same digit pattern as an international dialing digit (IDD) attribute of said callee identifier; and

b) said callee identifier does not begin with the same digit pattern as a national dialing digit (NDD) attribute of said callee identifier; and

c) said callee identifier does not begin with the same area code as an area code of said caller; and

d) said callee identifier does not have a length that is within a range of caller local number lengths; and

e) said callee identifier is a valid username.

**3.** The process of claim **2**, further comprising identifying the call as a cross-domain call on the private network when said callee identifier identifies a callee that is not associated with the same network node as said caller.

- 4.** The process of claim **2**, further comprising:  
locating a callee dialing profile for the callee when said callee identifier identifies a callee that is associated with the same network node as said caller; and  
retrieving call handling information associated with the callee, where said call handling information is available, said call handling information including at least one of call blocking information, call forwarding information, and voicemail information.
- 5.** The process of claim **4**, further comprising, where said call handling information including said call blocking information is available, blocking the call when said call blocking information identifies the caller as a caller from whom calls are to be blocked from being established with the callee.
- 6.** The process of claim **4**, further comprising, where said call handling information including said call forwarding information is available, causing said call forwarding information to be included in said private network routing message.
- 7.** The process of claim **4**, further comprising, where said call handling information including said voicemail information is available, causing said voicemail information to be included in said private network routing message.
- 8.** The process of claim **1**, further comprising associating at least one direct inward dial (DID) record with at least one subscriber to said communication system, each of said at least one direct inward dial records comprising a field storing a direct inward dial number associated with said at least one subscriber.
- 9.** The process of claim **8**, wherein said public network classification criteria include:

  - a) said callee identifier begins with the same digit pattern as an international dialing digit (IDD) attribute of said callee identifier; and
  - b) a reformatted callee identifier produced by removing the IDD attribute from said callee identifier has no DID bank table record.

**10.** The process of claim **8**, wherein said public network classification criteria include:

- a) said callee identifier begins with the same digit pattern as a national dialing digit (NDD) attribute of said callee identifier; and
- b) a reformatted callee identifier produced by removing the NDD attribute from said callee identifier and including a caller country code has no DID bank table record.

**11.** The process of claim **8**, wherein said public network classification criteria include:

- a) said callee identifier begins with the same area code as an area code of said caller; and
- b) a reformatted callee identifier produced by reformatting the callee identifier to include a caller country code has no DID bank table record.

**12.** The process of claim **8**, wherein said public network classification criteria include:

- a) said callee identifier has a length that is within a range of caller local number lengths; and
- b) a reformatted callee identifier produced by reformatting the callee identifier to include a caller country code and area code has no DID bank table record.

**13.** The process of claim **1**, wherein said plurality of calling attributes includes at least one of an international dialing digits identifier, a national dialing digits identifier, a country code identifier, a local area codes identifier, a caller minimum local length identifier, a caller maximum local length identifier, a reseller identifier, and a maximum number of concurrent calls identifier.

**14.** The process of claim **8**, wherein said DID record comprises a user name field, a user domain field and a DID number field.

**15.** The process of claim **1**, further comprising maintaining a list of public network route suppliers and when said public network classification criterion is met identifying at least one of said public network route suppliers that satisfies public network routing selection criteria.

**16.** The process of claim **15**, wherein said producing said public network routing message comprises producing a public network routing message identifying said at least one public network route supplier that satisfies said public network routing selection criteria.

**17.** The process of claim **16**, wherein producing said public network routing message comprises causing said public network routing message to include a gateway supplier identifier identifying a gateway supplier able to establish a communications link in a route through which communications between the caller and callee are to be conducted.

**18.** The process of claim **17**, further comprising causing said public network routing message to include a time value and a timeout value.

**19.** The process of claim **17**, wherein causing said public network routing message to include said gateway supplier identifier comprises causing said public network routing message to include a plurality of gateway supplier identifiers identifying a plurality of gateway suppliers able to supply respective communication links through which communications between the caller and callee can be conducted.

**20.** The process of claim **19**, further comprising causing said public network routing message to include priority information identifying a priority in which gateway suppliers associated with said gateway identifiers are to be considered for selection of a communication link through which communications between the caller and callee can be conducted.

**21.** The process of claim **19**, wherein causing said public network routing message to include priority information includes arranging said gateway supplier identifiers in said



public network routing message in order of rate, where rate is determined from rate fields of respective said gateway supplier records.

**22.** The process of claim **21**, wherein arranging said gateway supplier identifiers in order of rate comprises arranging said gateway supplier identifiers in order of increasing rate.

**23.** The process of claim **17**, further comprising arranging said gateway supplier identifiers in an order based on at least one provision in a service agreement.

**24.** The process of claim **1**, further comprising causing the private network routing message or the public network routing message to be communicated to a call controller to effect routing of the call.

**25.** A non-transitory computer readable medium encoded with codes for directing a processor to execute the method of claim **1**.

**26.** A call routing controller apparatus for producing a routing message for routing communications between a caller and a callee in a communication system, the apparatus comprising:

at least one processor operably configured to:

use a caller identifier associated with the caller to locate a caller dialing profile comprising a plurality of calling attributes associated with the caller;

when at least one of said calling attributes and at least a portion of a callee identifier associated with the callee meet private network classification criteria, produce a private network routing message for receipt by a call controller, said private network routing message identifying an address, on the private network, associated with the callee; and

when at least one of said calling attributes and at least a portion of said callee identifier meet a public network classification criterion, produce a public network

routing message for receipt by the call controller, said public network routing message identifying a gateway to the public network.

**27.** The apparatus of claim **26**, wherein said private network classification criteria include:

- a) said callee identifier does not begin with the same digit pattern as an international dialing digit (IDD) attribute of said callee identifier; and
- b) said callee identifier does not begin with the same digit pattern as a national dialing digit (NDD) attribute of said callee identifier; and
- c) said callee identifier does not begin with the same area code as an area code of said caller; and
- d) said callee identifier does not have a length that is within a range of caller local number lengths; and
- e) said callee identifier is a valid username.

**28.** The apparatus of claim **27**, wherein said at least one processor is further operably configured to identify the call as a cross-domain call on the private network when said callee identifier identifies a callee that is not associated with the same network node as said caller.

**29.** The apparatus of claim **27**, wherein said at least one processor is further configured to:

access the database of caller dialing profiles to locate a callee dialing profile for the callee when said callee identifier identifies a callee that is associated with the same network node as said caller; and

retrieve call handling information associated with the callee, where said call handling information is available, said call handling information including at least one of call blocking information, call forwarding information, and voicemail information.

**30.** The apparatus of claim **29**, wherein said at least one processor is further operably configured to determine whether said call handling information including said call

blocking information is available and to block the call when said call blocking information identifies the caller as a caller from whom calls are to be blocked.

**31.** The apparatus of claim **29**, wherein said at least one processor is further operably configured to determine whether said call handling information including said call forwarding information is available and to cause said call forwarding information to be included in said private network routing message.

**32.** The apparatus of claim **29**, wherein said at least one processor is further operably configured to determine whether said call handling information including said voicemail information is available and to cause said voicemail information to be included in said private network routing message.

**33.** The apparatus of claim **26**, wherein said at least one processor is further operably configured to access a database of direct inward dial records each associating at least one direct inward dial number with at least one subscriber to said communication system.

**34.** The apparatus of claim **33**, wherein said public network classification criteria include:

- a) said callee identifier begins with the same digit pattern as an international dialing digit (IDD) attribute of said callee identifier; and
- b) a reformatted callee identifier produced by removing the IDD attribute from said callee identifier has no DID record.

**35.** The apparatus of claim **33**, wherein said public network classification criteria include:

- a) said callee identifier begins with the same digit pattern as a national dialing digit (NDD) attribute of said callee identifier; and

b) a reformatted callee identifier produced by removing the NDD attribute from said callee identifier and including a caller country code has no DID record.

**36.** The apparatus of claim **33**, wherein said public network classification criteria include:

a) said callee identifier begins with the same area code as an area code of said caller; and

b) a reformatted callee identifier produced by reformatting the callee identifier to include a caller country code has no DID record.

**37.** The apparatus of claim **33**, wherein said public network classification criteria include:

a) said callee identifier has a length that is within a range of caller local number lengths; and

b) a reformatted callee identifier produced by reformatting the callee identifier to include a caller country code and area code has no DID record.

**38.** The apparatus of claim **26**, wherein said plurality of calling attributes includes at least one of an international dialing digits identifier, a national dialing digits identifier, a country code identifier, a local area codes identifier, a caller minimum local length identifier, a caller maximum local length identifier, a reseller identifier, and a maximum number of concurrent calls identifier.

**39.** The apparatus of claim **33**, wherein said DID record comprises a user name field, a user domain field and a DID number field.

**40.** The apparatus of claim **26**, wherein said at least one processor is further operably configured to access a list of public network route suppliers when said public network classification criterion is met and to identify at least one of said public network route suppliers that satisfies public network routing selection criteria.

**41.** The apparatus of claim **40**, wherein said at least one processor is further operably configured to produce a public network routing message identifying said at least one public network route supplier that satisfies said public network routing selection criteria.

**42.** The apparatus of claim **41**, wherein said at least one processor is operably configured to cause said public network routing message to include a gateway supplier identifier identifying a gateway supplier able to establish a communications link in a route through which communications between the caller and callee can be conducted.

**43.** The apparatus of claim **42**, wherein said at least one processor is operably configured to cause said public network routing message to include a time value and a timeout value.

**44.** The apparatus of claim **42**, wherein said at least one processor is operably configured to cause said public network routing message to include a plurality of gateway supplier identifiers identifying a plurality of gateway suppliers able to supply respective communication links through which communications between the caller and callee can be conducted.

**45.** The apparatus of claim **44**, wherein said at least one processor is operably configured to cause said public network routing message to include priority information identifying a priority in which gateway suppliers associated with said gateway identifiers are to be considered for selection of a communication link through which communications between the caller and callee can be conducted.

**46.** The apparatus of claim **44**, wherein said at least one processor is operably configured to arrange said gateway supplier identifiers in said public network routing message in order of rate, where rate is determined from rate fields of respective said gateway supplier records.

**47.** The apparatus of claim **46**, wherein said at least one processor is operably configured to arrange said gateway supplier identifiers in order of increasing rate.

**48.** The apparatus of claim **42**, wherein said at least one processor is operably configured to arrange said gateway supplier identifiers in an order based on at least one provision in a service agreement.

**49.** The apparatus of claim **26**, wherein said at least one processor is further operably configured to cause the private network routing message or the public network routing message to be communicated to a call controller to effect routing of the call.

**50.** A call routing controller apparatus for producing a routing message for routing communications between a caller and a callee in a communication system, the apparatus comprising:

means for using a caller identifier associated with the caller to locate a caller dialing profile comprising a plurality of calling attributes associated with the caller; and

means for, when at least one of said calling attributes and at least a portion of a callee identifier associated with the callee meet private network classification criteria, producing a private network routing message for receipt by a call controller, said private network routing message identifying an address, on the private network, associated with the callee; and

means for, when at least one of said calling attributes and at least a portion of said callee identifier meet a public network classification criterion, producing a public network routing message for receipt by the call controller, said public network routing message identifying a gateway to the public network.

**51.** The apparatus of claim **50**, wherein said private network classification criteria include:

a) said callee identifier does not begin with the same digit pattern as an international dialing digit (IDD) attribute of said callee identifier; and

b) said callee identifier does not begin with the same digit pattern as a national dialing digit (NDD) attribute of said callee identifier; and

c) said callee identifier does not begin with the same area code as an area code of said caller; and

said callee identifier does not have a length that is within a range of caller local number lengths; and

said callee identifier is a valid username.

**52.** The apparatus of claim **51**, further comprising means for identifying the call as a cross-domain call on the private network when said callee identifier identifies a callee that is not associated with the same network node as said caller.

**53.** The apparatus of claim **51**, further comprising:

means for accessing the database of caller dialing profiles to locate a callee dialing profile for the callee when said callee identifier identifies a callee that is associated with the same network node as said caller; and

means for retrieving call handling information associated with the callee, where said call handling information is available, said call handling information including at least one of call blocking information, call forwarding information, and voicemail information.

**54.** The apparatus of claim **53**, further comprising, where said call handling information including said call blocking information is available, means for blocking the call being established with the callee when said call blocking information identifies the caller as a caller from whom calls are to be blocked.

**55.** The apparatus of claim **53**, further comprising, means for causing said call forwarding information to be included in said private network routing message, where said call handling information including said call forwarding information is available.

**56.** The apparatus of claim **53**, further comprising, where said call handling information including said voicemail information is available, means for causing said voicemail information to be included in said private network routing message.

**57.** The apparatus of claim **50**, further comprising means for accessing a database of direct inward dial records each associating at least one direct inward dial number with at least one subscriber to said communication system.

**58.** The apparatus of claim **57**, wherein said public network classification criteria include:

- a) said callee identifier begins with the same digit pattern as an international dialing digit (IDD) attribute of said callee identifier; and
- b) a reformatted callee identifier produced by removing the IDD attribute from said callee identifier has no DID record.

**59.** The apparatus of claim **57**, wherein said public network classification criteria include:

- a) said callee identifier begins with the same digit pattern as a national dialing digit (NDD) attribute of said callee identifier; and
- b) a reformatted callee identifier produced by removing the NDD attribute from said callee identifier and including a caller country code has no DID record.

**60.** The apparatus of claim **57**, wherein said public network classification criteria include:

- a) said callee identifier begins with the same area code as an area code of said caller; and
- b) a reformatted callee identifier produced by reformatting the callee identifier to include a caller country code has no DID record.



**61.** The apparatus of claim **57**, wherein said public network classification criteria include:

a) said callee identifier has a length that is within a range of caller local number lengths; and

b) a reformatted callee identifier produced by reformatting the callee identifier to include a caller country code and area code has no DID record.

**62.** The apparatus of claim **50**, wherein said plurality of calling attributes includes at least one of an international dialing digits identifier, a national dialing digits identifier, a country code identifier, a local area codes identifier, a caller minimum local length identifier, a caller maximum local length identifier, a reseller identifier, and a maximum number of concurrent calls identifier.

**63.** The apparatus of claim **57**, wherein said DID record comprises a user name field, a user domain field and a DID number field.

**64.** The apparatus of claim **50**, further comprising means for accessing a list of public network route suppliers when said public network classification criterion is met and means for identifying at least one of said public network route suppliers that satisfies public network routing selection criteria.

**65.** The apparatus of claim **64**, wherein said means for producing said public network routing message comprises means for producing a public network routing message identifying said at least one public network route supplier that satisfies said public network routing selection criteria.

**66.** The apparatus of claim **65**, wherein said means for producing said public network routing message comprises means for causing said public network routing message to include a gateway supplier identifier identifying a gateway supplier able to establish a communications link in a route through which communications between the caller and callee can be conducted.

**67.** The apparatus of claim **66**, further comprising means for causing said public network routing message to include a time value and a timeout value.

**68.** The apparatus of claim **66**, wherein said means for causing said public network routing message to include said gateway supplier identifier comprises means for causing said public network routing message to include a plurality of gateway supplier identifiers identifying a plurality of gateway suppliers able to supply respective communication links through which communications between the caller and callee can be conducted.

**69.** The apparatus of claim **68**, further comprising means for causing said public network routing message to include priority information identifying a priority in which gateway suppliers associated with said gateway identifiers are to be considered for selection of a communication link through which communications between the caller and callee can be conducted.

**70.** The apparatus of claim **68**, wherein said means for causing said public network routing message to include priority information includes means for arranging said gateway supplier identifiers in said public network routing message in order of rate, where rate is determined from rate fields of respective said gateway supplier records.

**71.** The apparatus of claim **70**, wherein said means for arranging said gateway supplier identifiers in order of rate comprises means for arranging said gateway supplier identifiers in order of increasing rate.

**72.** The apparatus of claim **66**, further comprising means for arranging said gateway supplier identifiers in an order based on at least one provision in a service agreement.

**73.** The apparatus of claim **50**, further comprising means for causing the private network routing message or the public network routing message to be communicated to a call controller to effect routing of the call.

**74.** A non-transitory computer readable medium having stored thereon data structure for associating together a collection of information for use in producing a routing message for routing communications in a communications system, the data structure comprising:

dialing profile records comprising fields for associating a subscriber username with respective subscribers to the system;

direct-in-dial records comprising fields for associating a user domain and a direct-in-dial number with respective subscriber usernames;

prefix to node records comprising fields for associating a node address of a node in said system with at least a portion of said respective subscriber usernames:

whereby said subscriber username can be used to find said user domain, at least a portion of said subscriber username can be used to find said node with which a subscriber identified by said subscriber user name is associated, and said user domain and said subscriber username can be located in response to said direct-in-dial number.

**75.** A non-transitory computer readable medium having stored thereon a data structure for associating together a collection of information for use in producing a routing message in a communications system, the data structure comprising:

master list records comprising fields for associating a dialing code with respective master list identifiers; and

supplier list records linked to said master list records by said master list identifiers, said supplier list records comprising fields for associating the following information with a communications services supplier:

- a supplier id;
- a master list id;
- a route identifier; and
- a billing rate code,

whereby at least one communications service supplier is associated with said dialing code, such that said dialing code can be used to locate suppliers capable of providing a communications link associated with a given dialing code.

**76.** A non-transitory computer readable medium having stored thereon a data structure for associating together a collection of information for use in producing a routing message for routing communications, the data structure comprising:

- a username field;
- a domain field;
- a national dialing digits (NDD) field;
- an international dialing digits (IDD) field;
- a country code field;
- a local area code field;
- a caller minimum local length field; and
- a caller maximum local length field.

**77.** The non-transitory computer readable medium of claim **76**, further comprising a reseller field.

**78.** The non-transitory computer readable medium of claim **76**, further comprising:

- a maximum number of concurrent calls field; and
- a current number of concurrent calls field.

## PRODUCING ROUTING MESSAGES FOR VOICE OVER IP COMMUNICATIONS

### ABSTRACT OF THE DISCLOSURE

A process and apparatus to facilitate communication between callers and callees in a system comprising a plurality of nodes with which callers and callees are associated is disclosed. In response to initiation of a call by a calling subscriber, a caller identifier and a callee identifier are received. Call classification criteria associated with the caller identifier are used to classify the call as a public network call or a private network call. A routing message identifying an address, on the private network, associated with the callee is produced when the call is classified as a private network call and a routing message identifying a gateway to the public network is produced when the call is classified as a public network call.

15956892  
080613

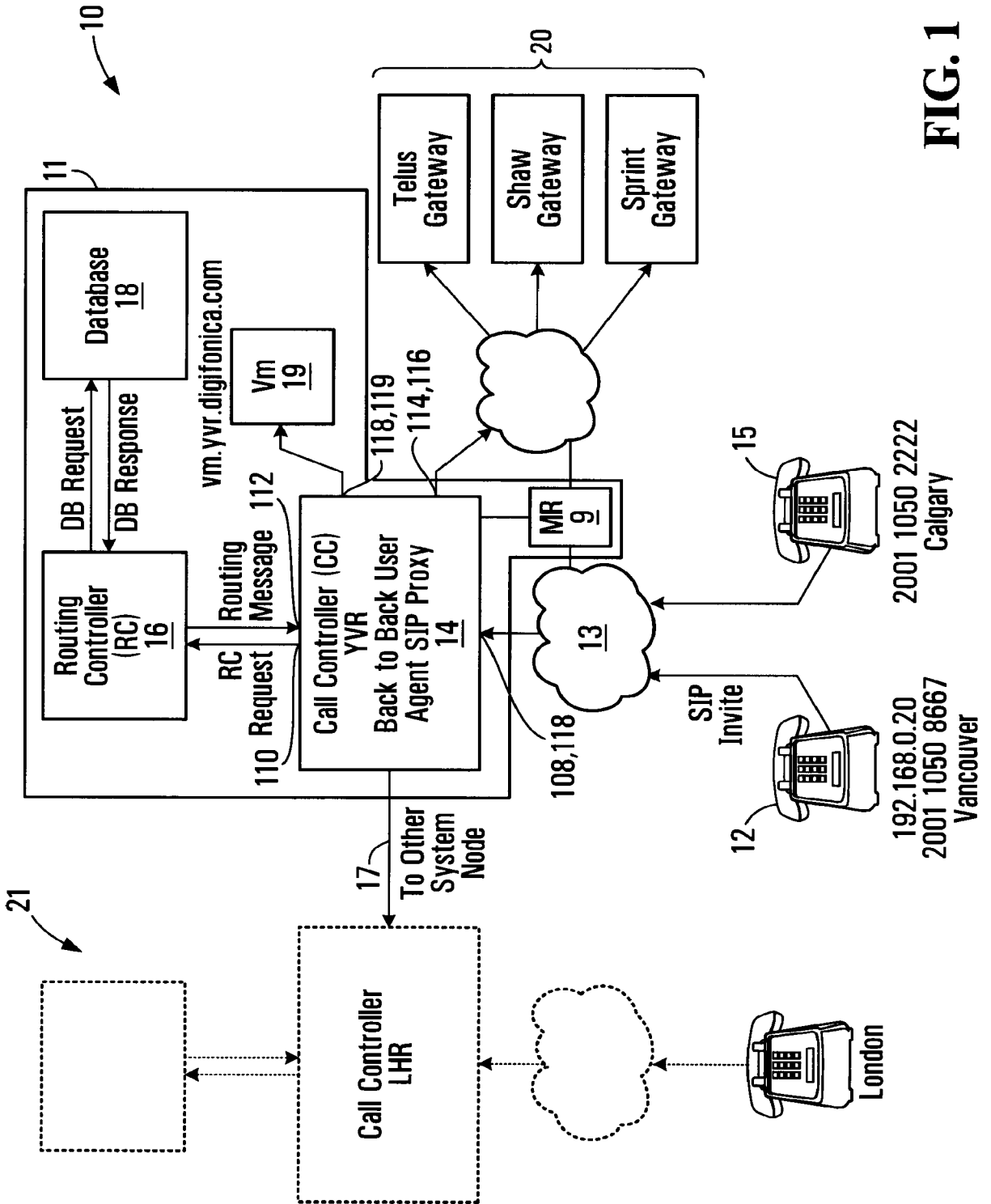
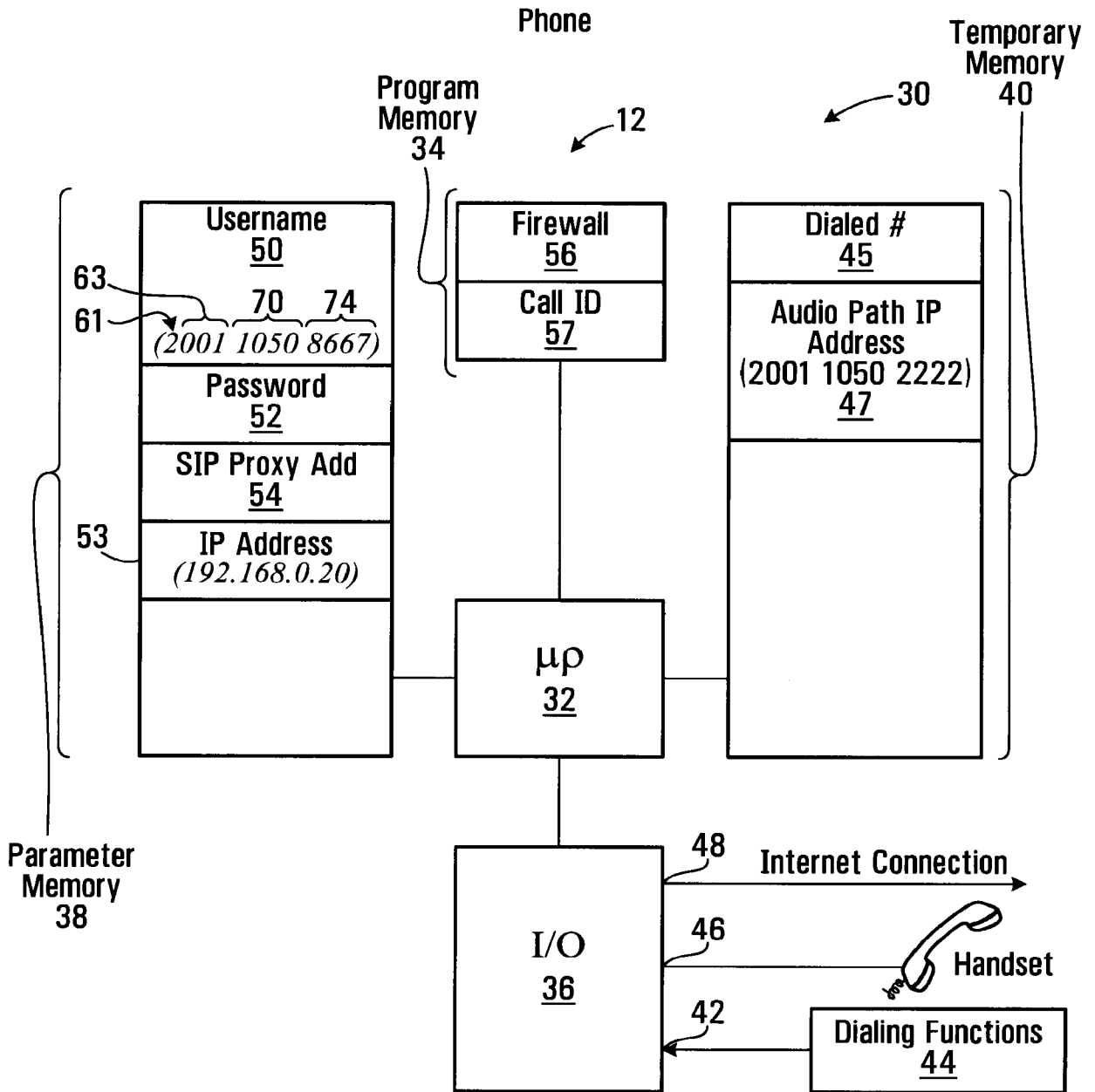


FIG. 1



**FIG. 2**

SIP Invite Message

60 ~ Caller 2001 1050 8667  
62 ~ Callee 2001 1050 2222  
64 ~ Digest Parameters XXXXXX  
65 ~ Call ID FF10@ 192.168.0.20  
67 ~ IP Address 192.168.0.20  
69 ~ Caller UDP Port 1

FIG. 3

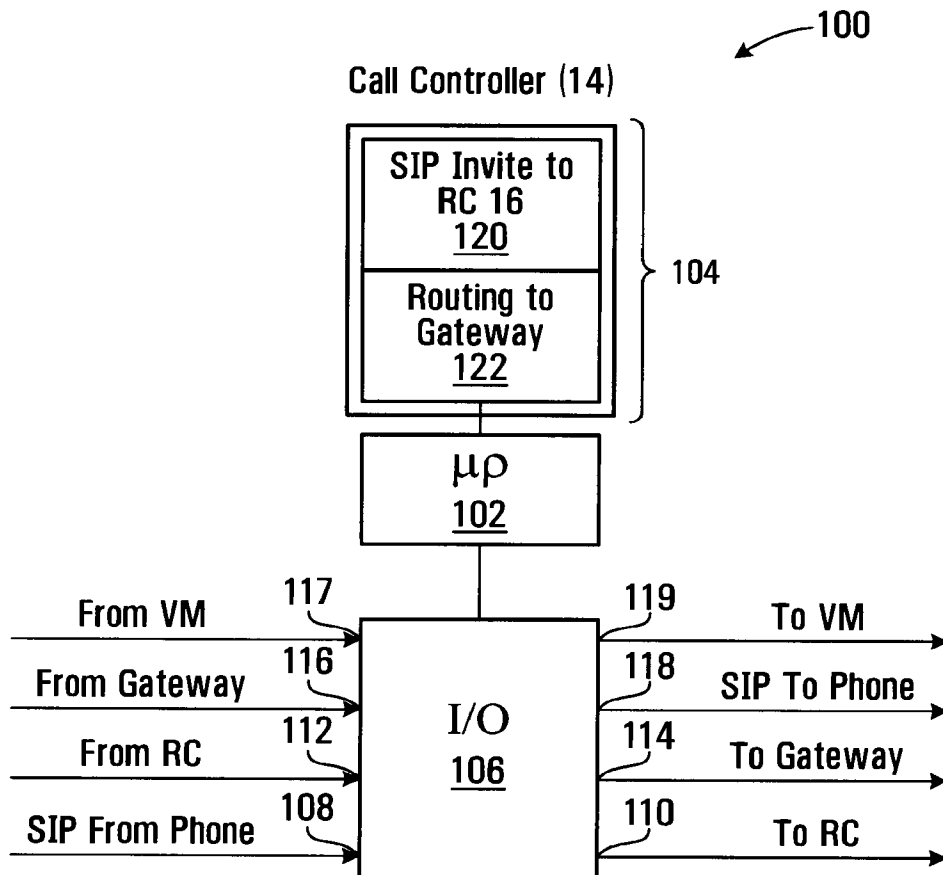


FIG. 4



Call Controller Process

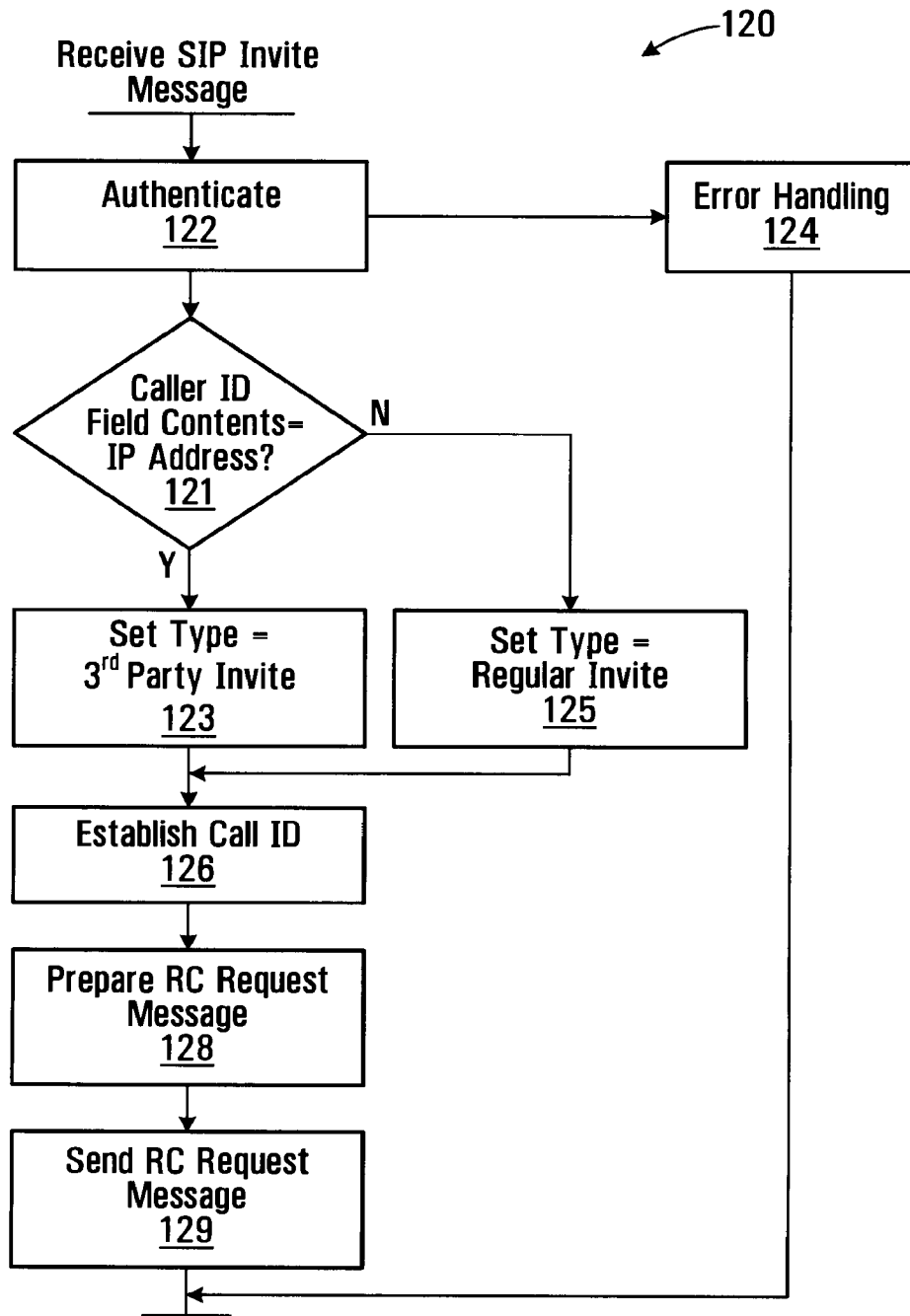


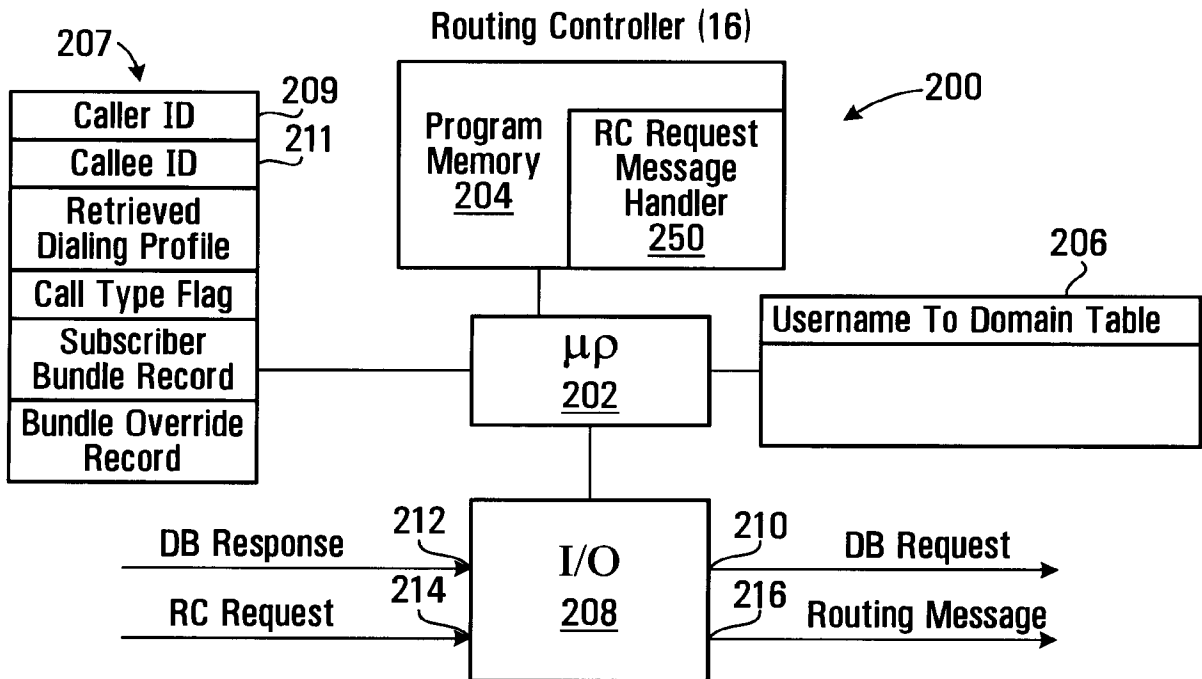
FIG. 5

150 ↙

**RC Request Message**

152 ~ Caller 2001 1050 8667  
 154 ~ Callee 2001 1050 2222  
 156 ~ Digest XXXXXXX  
 158 ~ Call ID FF10@ 192.168.0.20  
 160 ~ Type Subscriber

**FIG. 6**



**FIG. 7**

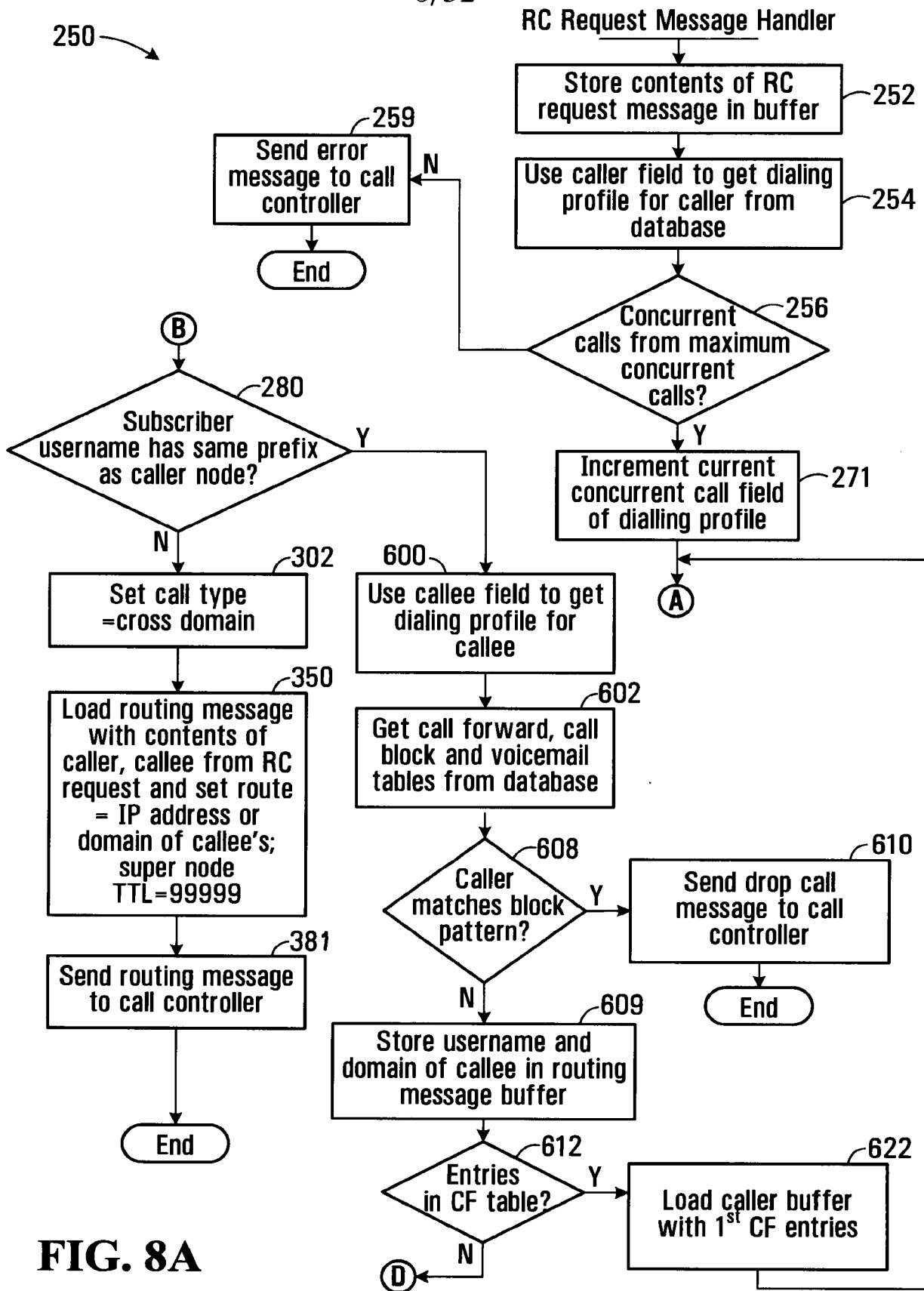
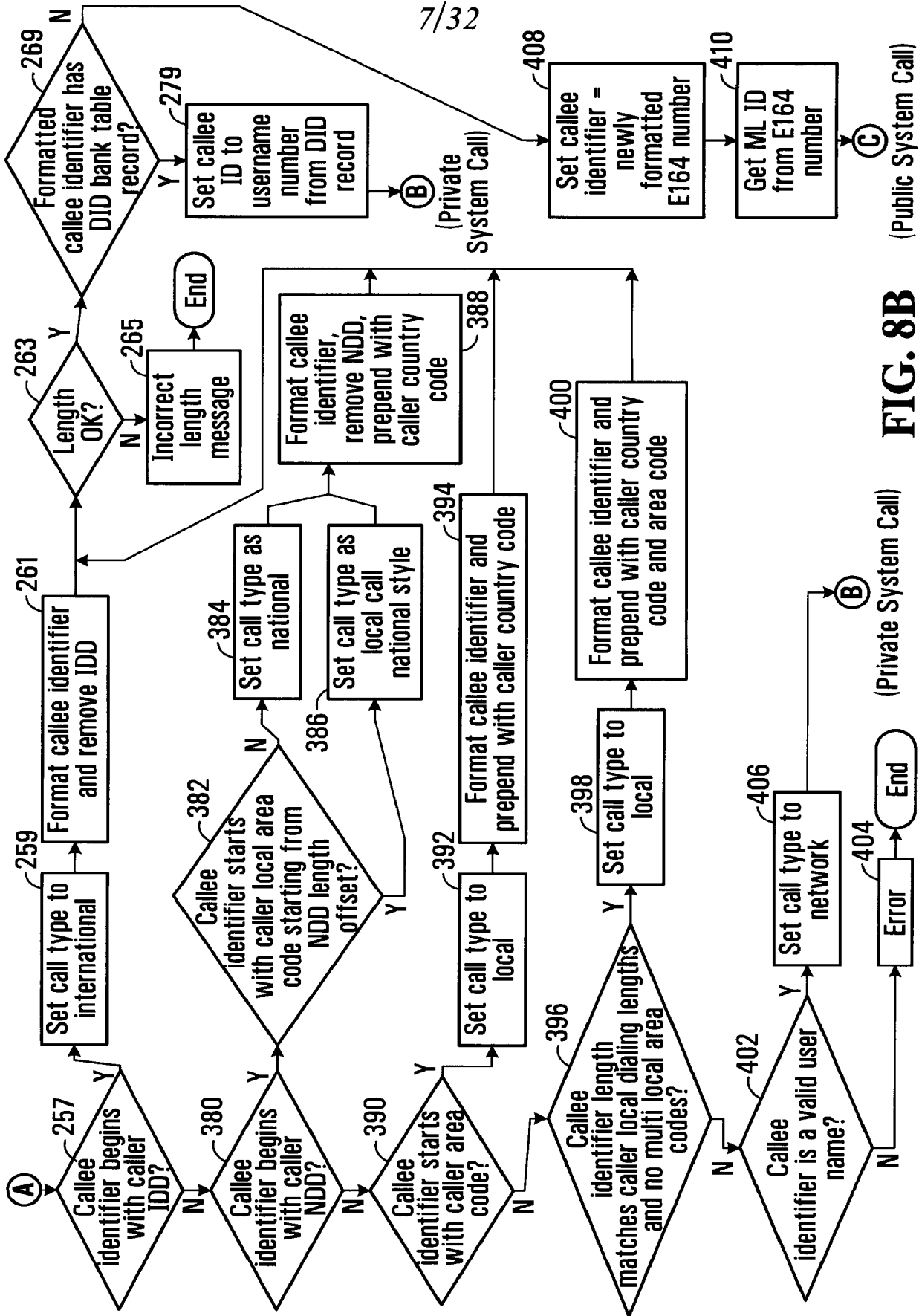


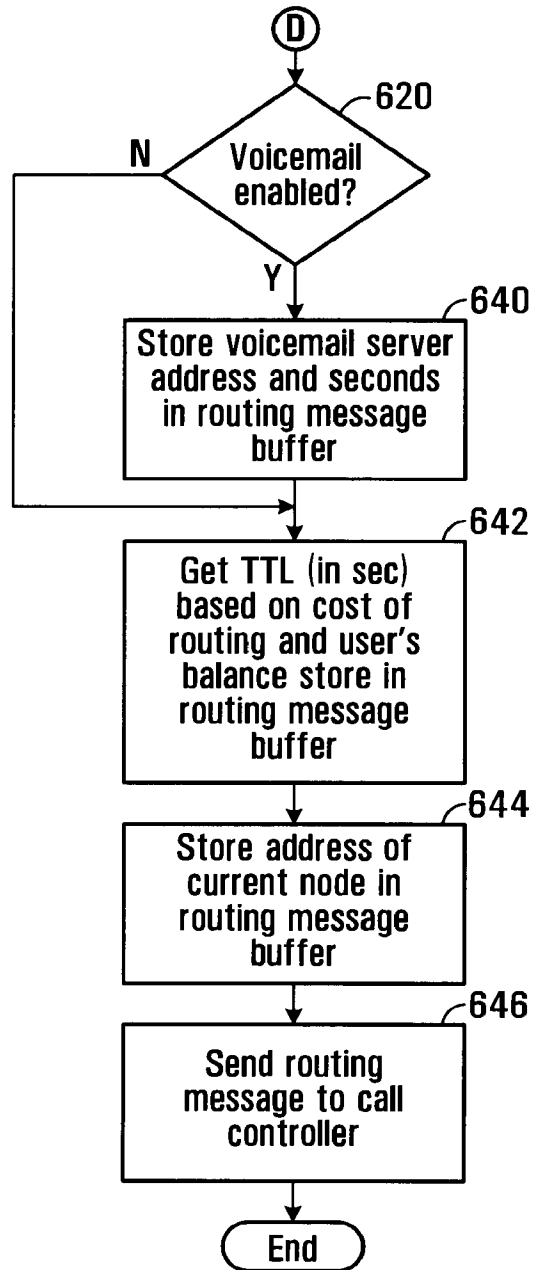
FIG. 8A



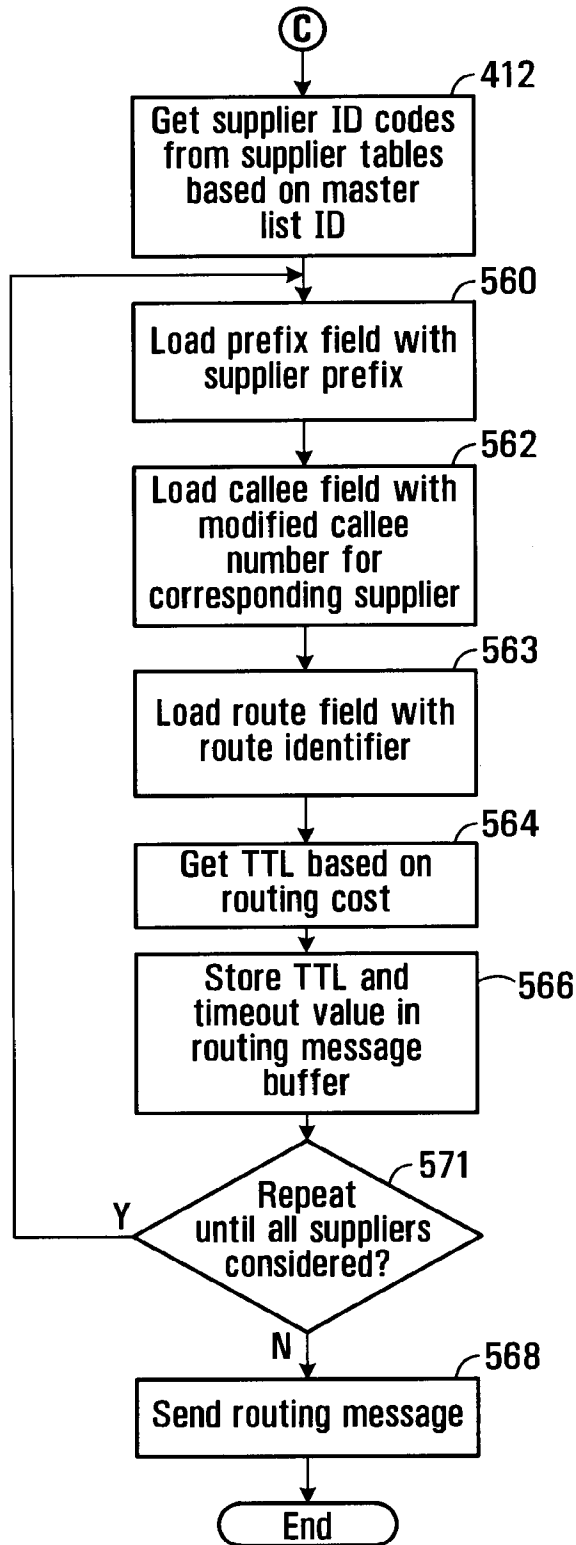
(Public System Call)

(Private System Call)

FIG. 8B



**FIG. 8C**



**FIG. 8D**



**Callee Profile for Calgary Subscriber**

---

|                                      |                       |
|--------------------------------------|-----------------------|
| <b>Username</b>                      | 2001 1050 2222        |
| <b>Domain</b>                        | sp.yvr.digifonica.com |
| <b>NDD</b>                           | 1                     |
| <b>IDD</b>                           | 011                   |
| <b>Country Code</b>                  | 1                     |
| <b>Local Area Codes</b>              | 403 (Calgary)         |
| <b>Caller Minimum Local Length</b>   | 7                     |
| <b>Caller Maximum Local Length</b>   | 10                    |
| <b>Reseller</b>                      | Deerfoot              |
| <b>Maximum # of concurrent calls</b> | 5                     |
| <b>Current # of concurrent calls</b> | 0                     |

**FIG. 11**

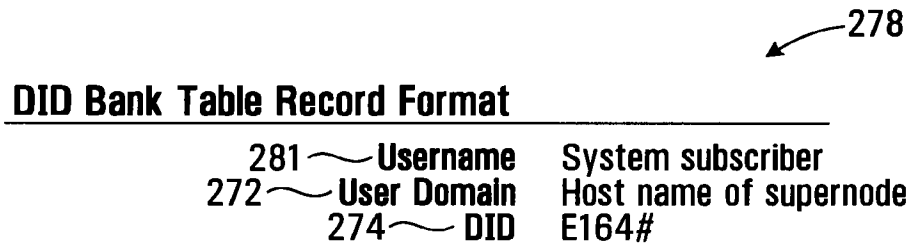
**Callee Profile for London Subscriber**

---

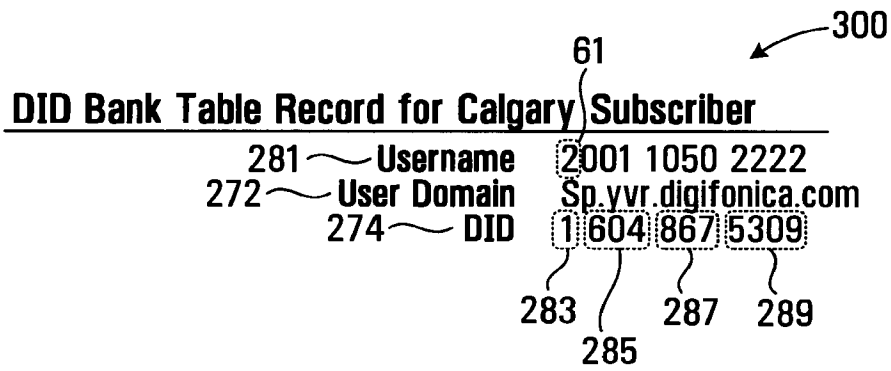
|                                      |                       |
|--------------------------------------|-----------------------|
| <b>Username</b>                      | 4401 1062 4444        |
| <b>Domain</b>                        | sp.lhr.digifonica.com |
| <b>NDD</b>                           | 0                     |
| <b>IDD</b>                           | 00                    |
| <b>Country Code</b>                  | 44                    |
| <b>Local Area Codes</b>              | 20 (London)           |
| <b>Caller Minimum Local Length</b>   | 10                    |
| <b>Caller Maximum Local Length</b>   | 11                    |
| <b>Reseller</b>                      | Marble Arch           |
| <b>Maximum # of concurrent calls</b> | 5                     |
| <b>Current # of concurrent calls</b> | 0                     |

**FIG. 12**

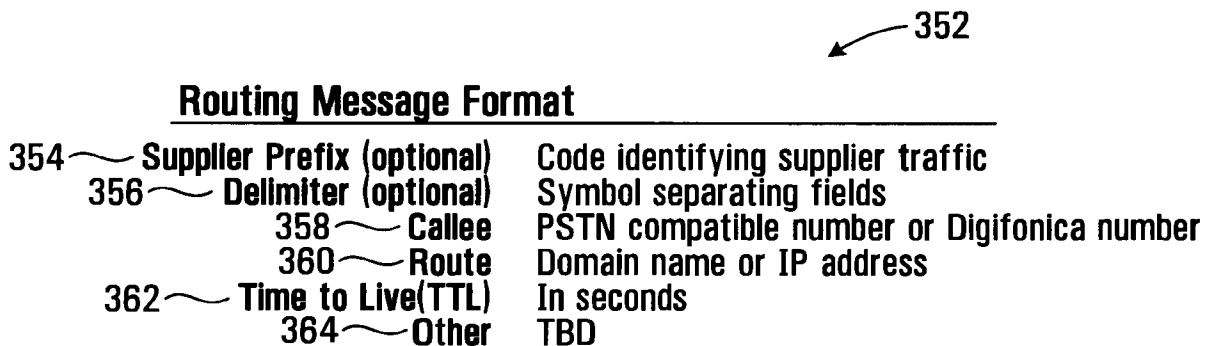




**FIG. 13**



**FIG. 14**



**FIG. 15**



**FIG. 16**



**FIG. 17**



**FIG. 18**

### Master List Record Format

|       |                       |                                                                                                                                                                                 |
|-------|-----------------------|---------------------------------------------------------------------------------------------------------------------------------------------------------------------------------|
| 500 ~ | ml_id                 | Alphanumeric                                                                                                                                                                    |
| 502 ~ | Dialing code          | Number Sequence                                                                                                                                                                 |
| 504 ~ | Country code          | The country code is the national prefix to be used when dialing TO a particular country FROM another country.                                                                   |
| 506 ~ | Nat Sign #(Area Code) | Number Sequence                                                                                                                                                                 |
| 508 ~ | Min Length            | Numeric                                                                                                                                                                         |
| 510 ~ | Max Length            | Numeric                                                                                                                                                                         |
| 512 ~ | NDD                   | The NDD prefix is the access code used to make a call WITHIN that country from one city to another (when calling another city in the same vicinity, this may not be necessary). |
| 514 ~ | IDD                   | The IDD prefix is the international prefix needed to dial a call FROM the country listed TO another country.                                                                    |
| 516 ~ | Buffer rate           | Safe change rate above the highest rate charged by suppliers                                                                                                                    |

**FIG. 19**

### Example: Master List Record with Populated Fields

|                       |             |
|-----------------------|-------------|
| ml_id                 | 1019        |
| Dialing code          | 1604        |
| Country code          | 1           |
| Nat Sign #(Area Code) | 604         |
| Min Length            | 7           |
| Max Length            | 7           |
| NDD                   | 1           |
| IDD                   | 011         |
| Buffer rate           | \$0.009/min |

**FIG. 20**

**Suppliers List Record Format**

---

|       |                   |                                                                  |
|-------|-------------------|------------------------------------------------------------------|
| 540 ~ | Sup_id            | Name code                                                        |
| 542 ~ | MI_id             | Numeric code                                                     |
| 544 ~ | Prefix (optional) | String identifying supplier's traffic #                          |
| 546 ~ | Specific Route    | IP address                                                       |
| 548 ~ | NDD/IDD rewrite   |                                                                  |
| 550 ~ | Rate              | Cost per second to Digifonica to use this route                  |
| 551 ~ | Timeout           | Maximum time to wait for a response when requesting this gateway |

**FIG. 21****Telus Supplier Record**

---

|                   |              |
|-------------------|--------------|
| Sup_id            | 2010 (Telus) |
| MI_id             | 1019         |
| Prefix (optional) | 4973#        |
| Specific Route    | 72.64.39.58  |
| NDD/IDD rewrite   | 011          |
| Rate              | \$0.02/min   |
| Timeout           | 20           |

**FIG. 22****Shaw Supplier Record**

---

|                   |             |
|-------------------|-------------|
| Sup_id            | 2011 (Shaw) |
| MI_id             | 1019        |
| Prefix (optional) | 4974#       |
| Specific Route    | 73.65.40.59 |
| NDD/IDD rewrite   | 011         |
| Rate              | \$0.025/min |
| Timeout           | 30          |

**FIG. 23****Sprint Supplier Record**

---

|                   |               |
|-------------------|---------------|
| Sup_id            | 2012 (Sprint) |
| MI_id             | 1019          |
| Prefix (optional) | 4975#         |
| Specific Route    | 74.66.41.60   |
| NDD/IDD rewrite   | 011           |
| Rate              | \$0.03/min    |
| Timeout           | 40            |

**FIG. 24**

**Routing Message Buffer for Gateway Call**

---

4973#0116048675309@72.64.39.58;tll=3600;to=20 ~ 570  
4974#0116048675309@73.65.40.59;tll=3600;to=30 ~ 572  
4975#0116048675309@74.66.41.60;tll=3600;to=40 ~ 574

**FIG. 25**

**Call Block Table Record Format**

---

604 ~ Username      Digifonica #  
606 ~ Block Pattern      PSTN compatible or Digifonica #

**FIG. 26**

**Call Block Table Record for Calgary Callee**

---

604 ~ Username of Callee      2001 1050 2222  
606 ~ Block Pattern      2001 1050 8664

**FIG. 27**

**Call Forwarding Table Record Format for Callee**

---

614 ~ Username of Callee      Digifonica #  
616 ~ Destination Number      Digifonica #  
618 ~ Sequence Number      Integer indicating order to try this

**FIG. 28**

**Call Forwarding Table Record for Calgary Callee**

---

614 ~ Username of Callee      2001 1050 2222  
616 ~ Destination Number      2001 1055 2223  
618 ~ Sequence Number      1

**FIG. 29**

**Voicemail Table Record Format**

---

|     |                      |                                        |
|-----|----------------------|----------------------------------------|
| 624 | Username of Callee   | Digifonica #                           |
| 626 | Vm Server            | domain name                            |
| 628 | Seconds to Voicemail | time to wait before engaging voicemail |
| 630 | Enabled              | yes/no                                 |

**FIG. 30**

**Voicemail Table Record for Calgary Callee**

---

|                      |                       |
|----------------------|-----------------------|
| Username of Callee   | 2001 1050 2222        |
| Vm Server            | vm.yvr.digifonica.com |
| Seconds to Voicemail | 20                    |
| Enabled              | 1                     |

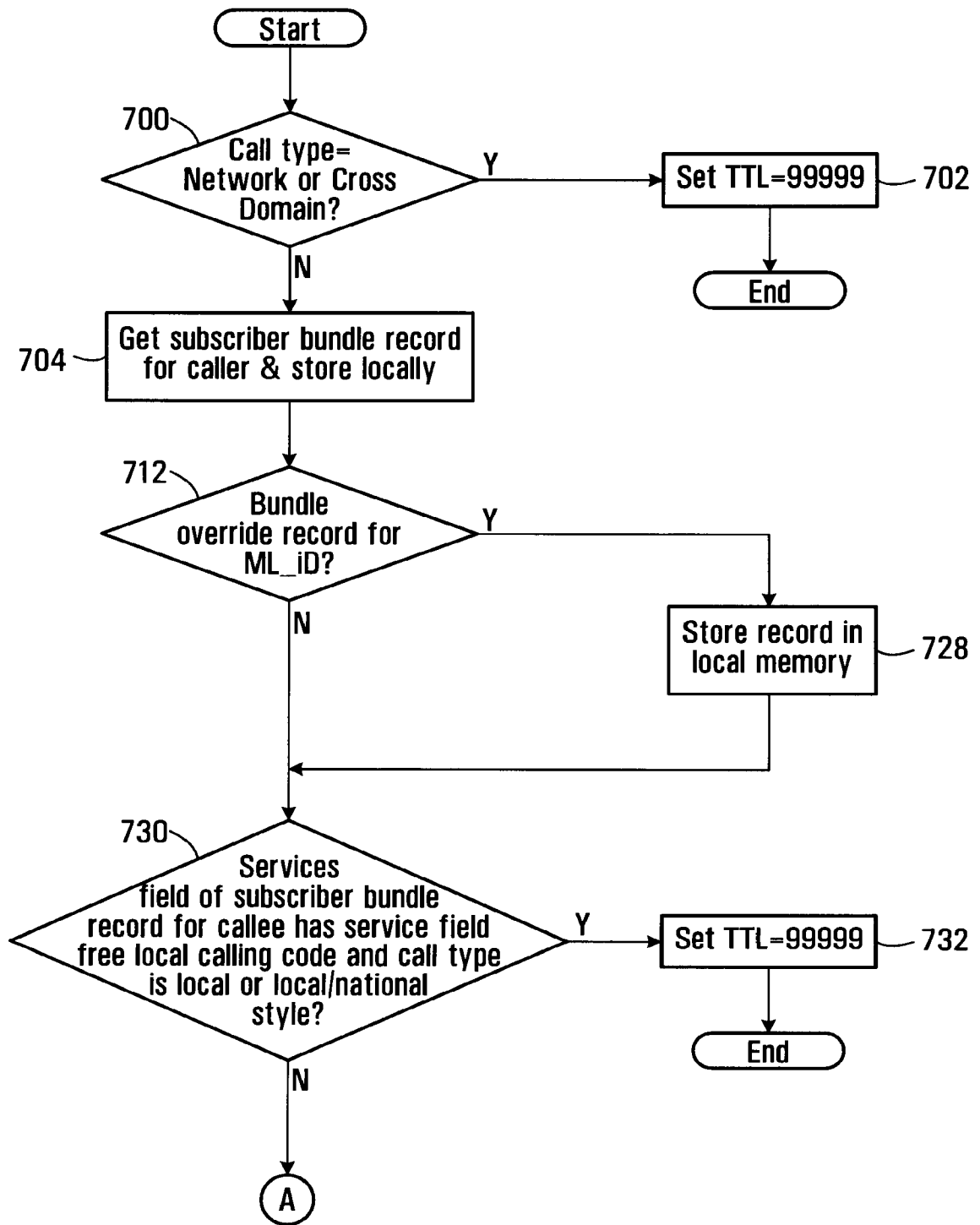
**FIG. 31**

**Routing Message Buffer - Same Node**

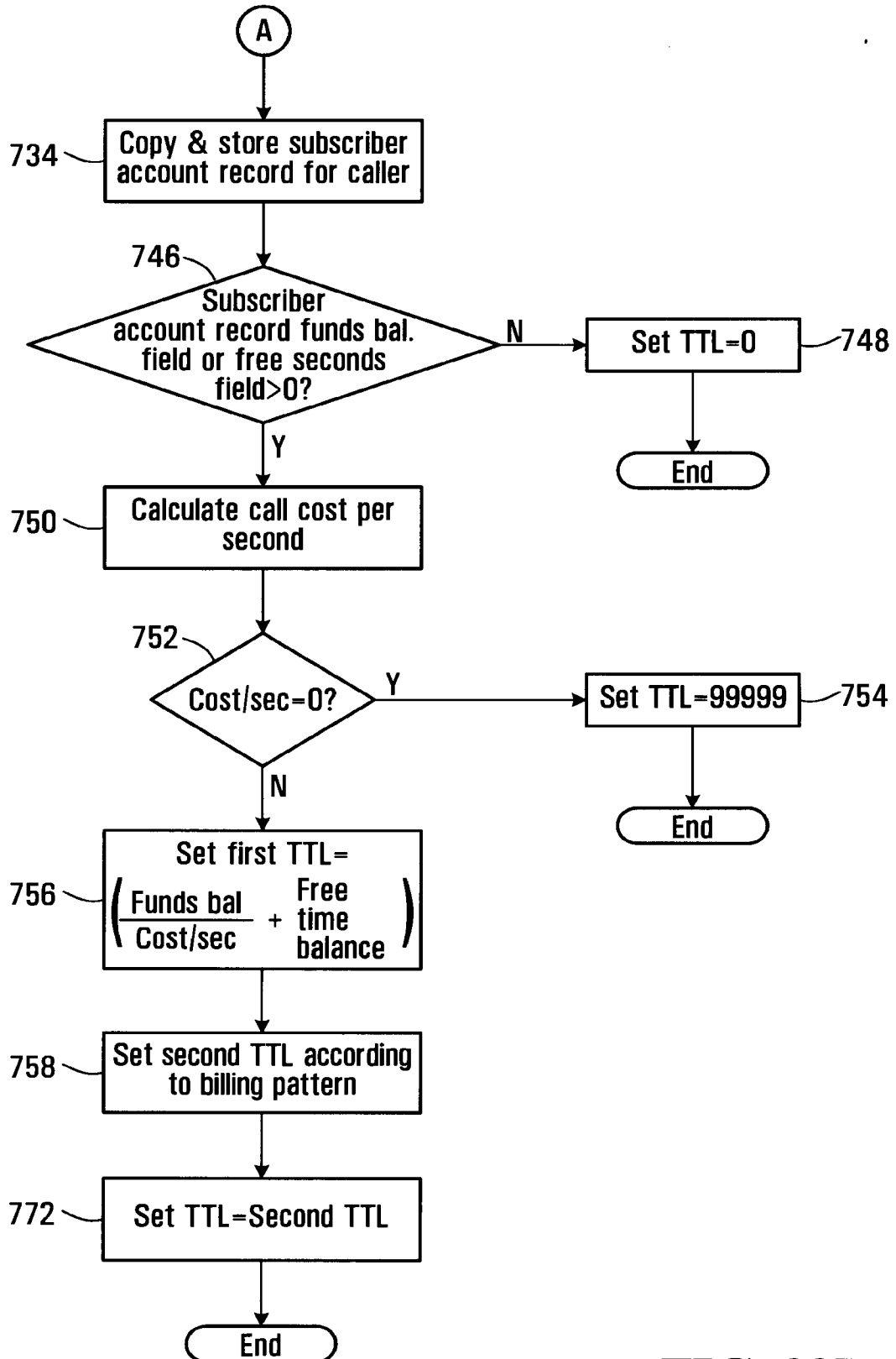
---

|     |                                             |
|-----|---------------------------------------------|
| 650 | 200110502222@sp.yvr.digifonica.com;ttl=3600 |
| 652 | 200110552223@sp.yvr.digifonica.com;ttl=3600 |
| 654 | vm.yvr.digifonica.com;20;ttl=60             |
| 656 | sp.yvr.digifonica.com                       |

**FIG. 32**



**FIG. 33A**



**FIG. 33B**



**Subscriber Bundle Table Record**

708 ~ Username Subscriber username  
 710 ~ Services Codes identifying service features  
 (e.g. Free local calling; call blocking, voicemail)

706

**FIG. 34****Subscriber Bundle Record for Vancouver Caller**

708 ~ Username 2001 1050 8667  
 710 ~ Services 10; 14; 16

**FIG. 35****Bundle Override Table Record**

716 ~ ML\_Id Master list ID code  
 718 ~ Override type Fixed; percent; cents  
 720 ~ Override value real number representing value of override type  
 722 ~ Inc1 first level of charging (minimum # of seconds) charge  
 724 ~ Inc2 second level of charging

714

**FIG. 36****Bundle Override Record for Located ML\_id**

716 ~ ML\_Id 1019  
 718 ~ Override type percent  
 720 ~ Override value 10.0  
 722 ~ Inc1 30 seconds  
 724 ~ Inc2 6 seconds

726

**FIG. 37**

736 ↙

**Subscriber Account Table Record**

---

|       |                          |                                             |
|-------|--------------------------|---------------------------------------------|
| 738 ~ | <b>Username</b>          | Subscriber username                         |
| 740 ~ | <b>Funds balance</b>     | real number representing \$ value of credit |
| 742 ~ | <b>Free time balance</b> | integer representing # of free seconds      |

**FIG. 38**

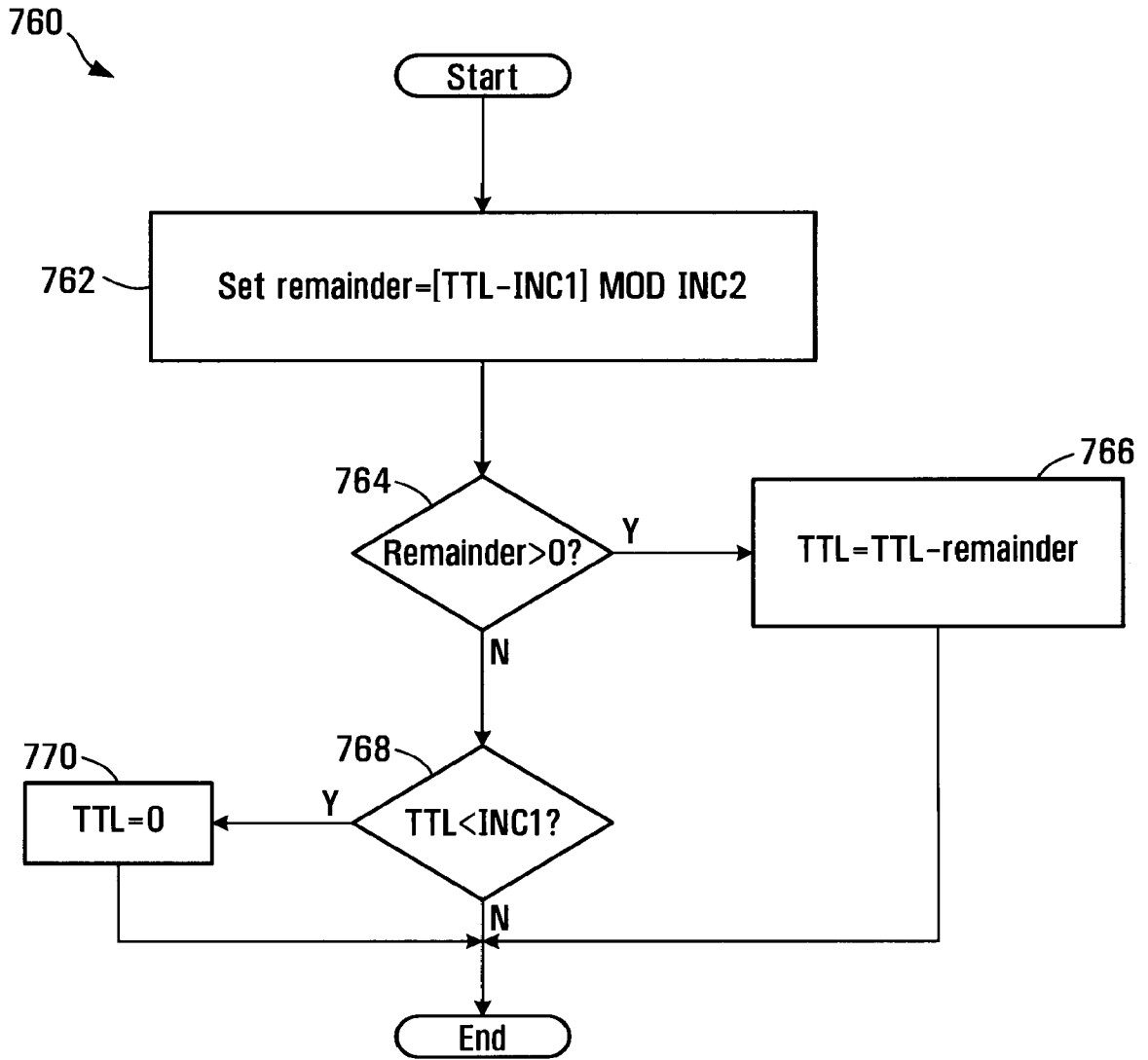
744 ↙

**Subscriber Account Record for Vancouver Caller**

---

|       |                          |                |
|-------|--------------------------|----------------|
| 738 ~ | <b>Username</b>          | 2001 1050 8667 |
| 740 ~ | <b>Funds balance</b>     | \$10.00        |
| 742 ~ | <b>Free time balance</b> | 100            |

**FIG. 39**



**FIG. 40**

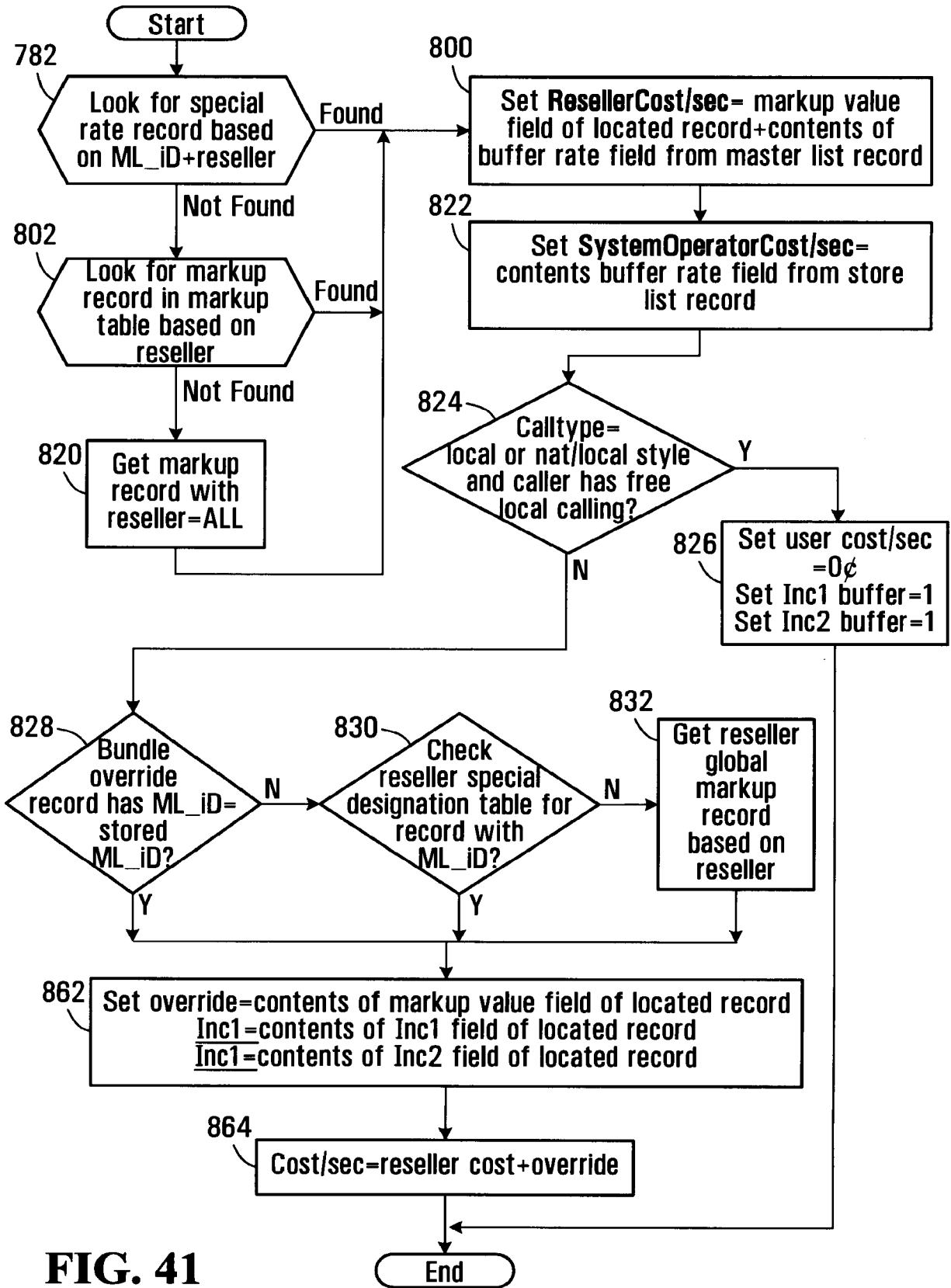


FIG. 41

**System Operator Special Rates Table Record**

|     |              |                                                       |
|-----|--------------|-------------------------------------------------------|
| 786 | Reseller     | retailer id                                           |
| 788 | ML_Id        | master list id                                        |
| 790 | Markup Table | fixed; percent; cents                                 |
| 792 | Markup Value | real number representing value of markup type         |
| 794 | Inc1         | first level of charging (minimum # of seconds) charge |
| 796 | Inc2         | second level of charging                              |

**FIG. 42**

**System Operator Special Rates Table Record for Klondike**

|     |              |          |
|-----|--------------|----------|
| 786 | Reseller     | Klondike |
| 788 | ML_Id        | 1019     |
| 790 | Markup Table | cents    |
| 792 | Markup Value | \$0.001  |
| 794 | Inc1         | 30       |
| 796 | Inc2         | 6        |

**FIG. 43**

**System Operator Markup Table Record**

---

804  
↙

|     |              |                                                       |
|-----|--------------|-------------------------------------------------------|
| 806 | Reseller     | reseller id code                                      |
| 808 | Markup Table | fixed; percent; cents                                 |
| 810 | Markup Value | real number representing value of markup type         |
| 812 | Inc1         | first level of charging (minimum # of seconds) charge |
| 814 | Inc2         | second level of charging                              |

**FIG. 44****System Operator Markup Table Record for the Reseller Klondike**

---

|     |              |          |
|-----|--------------|----------|
| 806 | Reseller     | Klondike |
| 808 | Markup Table | cents    |
| 810 | Markup Value | \$0.01   |
| 812 | Inc1         | 30       |
| 814 | Inc2         | 6        |

**FIG. 45****System Operator Markup Table Record**

---

|     |              |         |
|-----|--------------|---------|
| 806 | Reseller     | all     |
| 808 | Markup Table | percent |
| 810 | Markup Value | 1.0     |
| 812 | Inc1         | 30      |
| 814 | Inc2         | 6       |

**FIG. 46**

**Reseller Special Destinations Table Record**

|     |              |                                                       |
|-----|--------------|-------------------------------------------------------|
| 834 | Reseller     | reseller id code                                      |
| 836 | ML_id        | Master List ID code                                   |
| 838 | Markup Table | fixed; percent; cents                                 |
| 840 | Markup Value | real number representing value of markup type         |
| 842 | Inc1         | first level of charging (minimum # of seconds) charge |
| 844 | Inc2         | second level of charging                              |

**FIG. 47****Reseller Special Destinations Table Record for the Reseller Klondike**

|     |              |          |
|-----|--------------|----------|
| 834 | Reseller     | Klondike |
| 836 | ML_id        | 1019     |
| 838 | Markup Table | percent  |
| 840 | Markup Value | 5%       |
| 842 | Inc1         | 30       |
| 844 | Inc2         | 6        |

**FIG. 48****Reseller Global Markup Table Record**

|     |              |                                                       |
|-----|--------------|-------------------------------------------------------|
| 850 | Reseller     | reseller id code                                      |
| 852 | Markup Table | fixed; percent; cents                                 |
| 854 | Markup Value | real number representing value of markup type         |
| 856 | Inc1         | first level of charging (minimum # of seconds) charge |
| 858 | Inc2         | second level of charging                              |

**FIG. 49****Reseller Global Markup Table Record for the Reseller Klondike**

|     |              |          |
|-----|--------------|----------|
| 850 | Reseller     | Klondike |
| 852 | Markup Table | percent  |
| 854 | Markup Value | 10%      |
| 856 | Inc1         | 30       |
| 858 | Inc2         | 6        |

**FIG. 50**

900

**SIP Bye Message**

---

|       |                |                                                |
|-------|----------------|------------------------------------------------|
| 902 ~ | <b>Caller</b>  | Username                                       |
| 904 ~ | <b>Callee</b>  | PSTN compatible # or Username                  |
| 906 ~ | <b>Call ID</b> | unique call identifier (hexadecimal string@IP) |

**FIG. 51**

908

**SIP Bye Message**

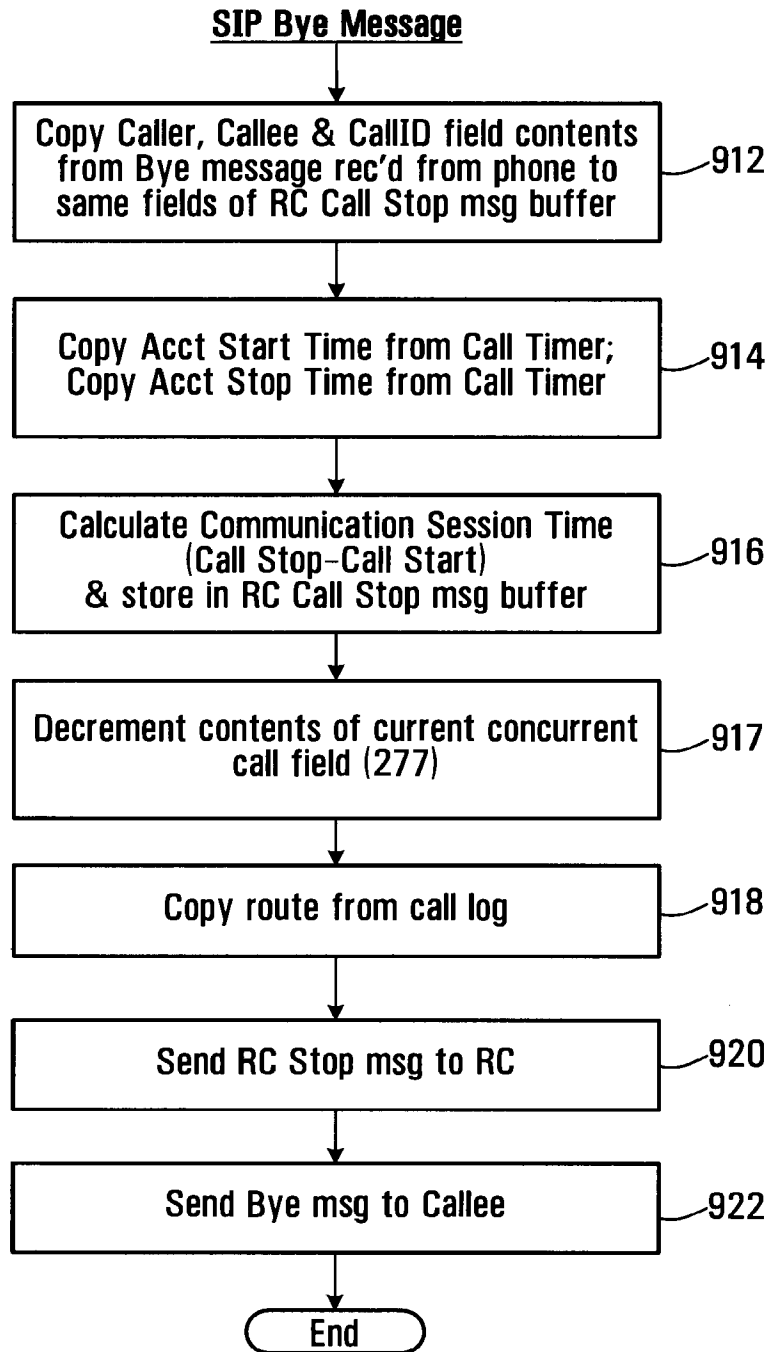
---

|       |                |                          |
|-------|----------------|--------------------------|
| 902 ~ | <b>Caller</b>  | 2001 1050 8667           |
| 904 ~ | <b>Callee</b>  | 2001 1050 2222           |
| 906 ~ | <b>Call ID</b> | <u>FA10@192.168.0.20</u> |

**FIG. 52**



910 ↘



**FIG. 53**

1000  
↙

**RC Call Stop Message**

---

|      |                   |                                                             |
|------|-------------------|-------------------------------------------------------------|
| 1002 | Caller            | Username                                                    |
| 1004 | Callee            | PSTN compatible # or Username                               |
| 1006 | Call ID           | unique call identifier (hexadecimal string@IP)              |
| 1008 | Acct Start Time   | start time of call                                          |
| 1010 | Acct Stop Time    | time the call ended                                         |
| 1012 | Acct Session Time | start time-stop time (in seconds)                           |
| 1014 | Route             | IP address for the communications link that was established |

**FIG. 54**

1020  
↙

**RC Call Stop Message for Calgary Callee**

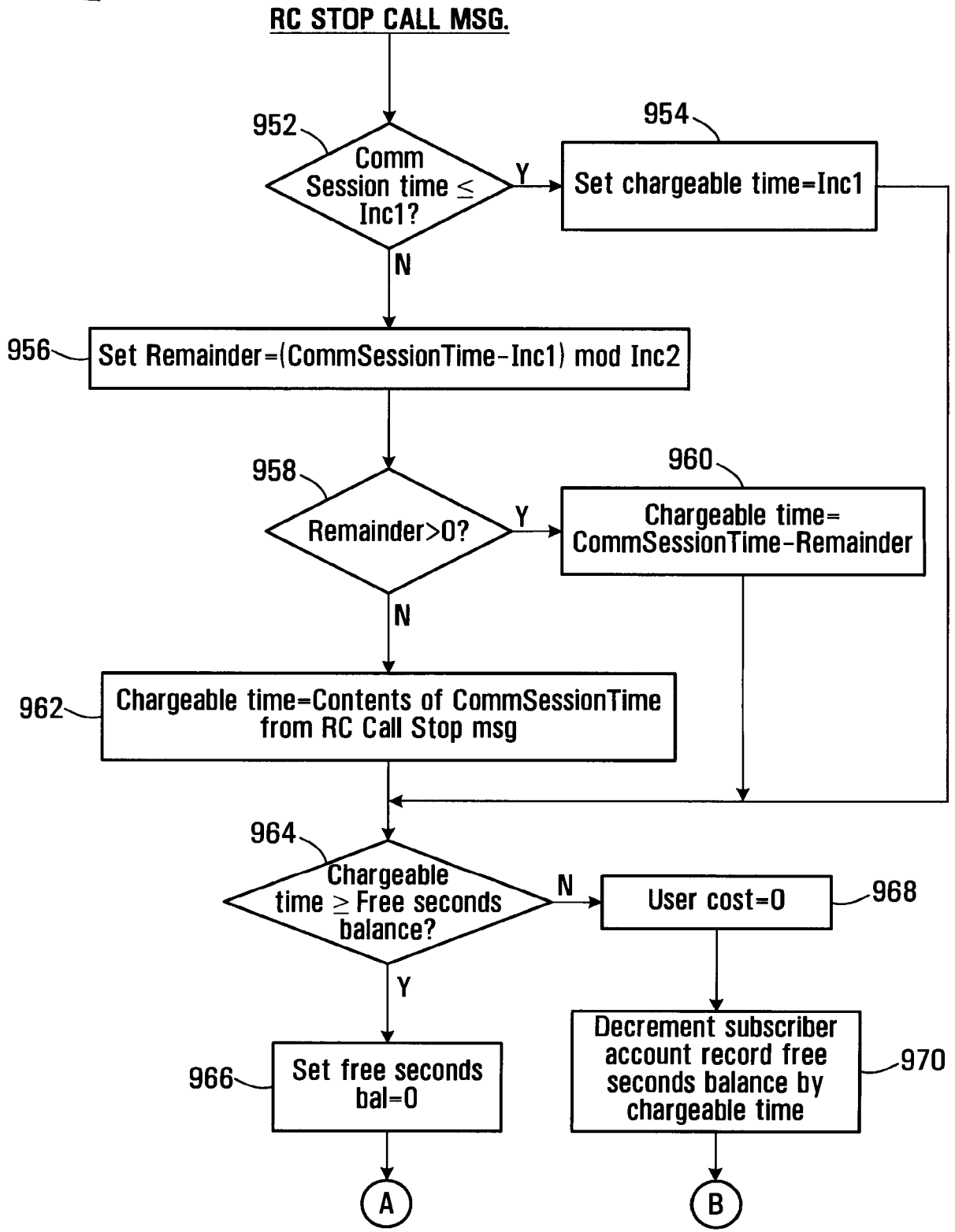
---

|      |                   |                     |
|------|-------------------|---------------------|
| 1002 | Caller            | 2001 1050 8667      |
| 1004 | Callee            | 2001 1050 2222      |
| 1006 | Call ID           | FA10@192.168.0.20   |
| 1008 | Acct Start Time   | 2006-12-30 12:12:12 |
| 1010 | Acct Stop Time    | 2006-12-30 12:12:14 |
| 1012 | Acct Session Time | 2                   |
| 1014 | Route             | 72.64.39.58         |

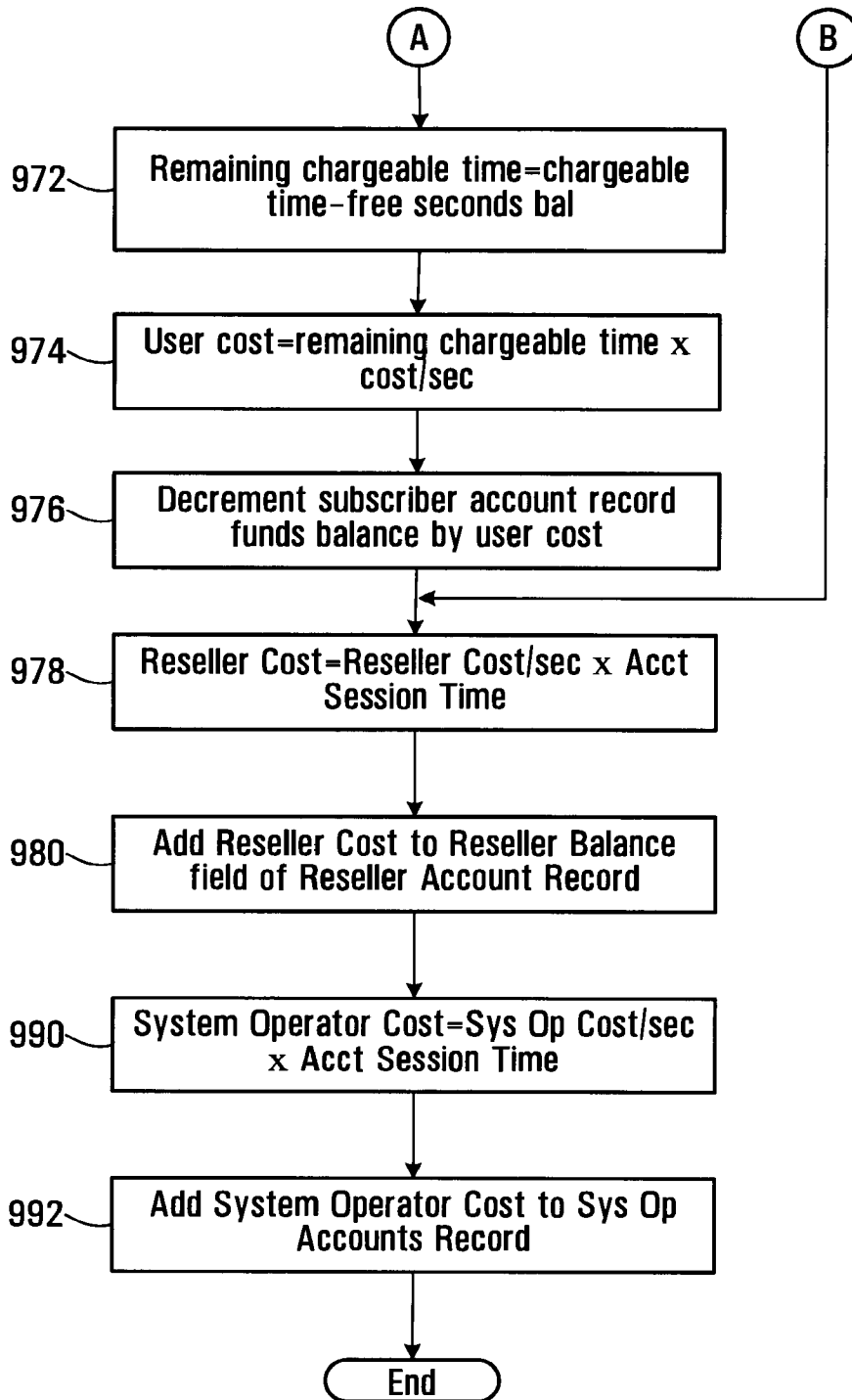
**FIG. 55**

950 ↘

30/32



**FIG. 56A**



**FIG. 56B**

Reseller Accounts Table Record

982  
↙

984 ~ Reseller ID reseller id code  
986 ~ Reseller balance accumulated balance of charges

**FIG. 57**

Reseller Accounts Table Record for Klondike

988  
↙

984 ~ Reseller ID Klondike  
986 ~ Reseller balance \$100.02

**FIG. 58**

System Operator Accounts Table Record

994  
↙

996 ~ System Operator balance accumulated balance of charges

**FIG. 59**

System Operator Accounts Record for this System Operator

996 ~ System Operator balance \$1000.02

**FIG. 60**

## Electronic Patent Application Fee Transmittal

|                                                |                                                             |                 |               |                             |
|------------------------------------------------|-------------------------------------------------------------|-----------------|---------------|-----------------------------|
| <b>Application Number:</b>                     |                                                             |                 |               |                             |
| <b>Filing Date:</b>                            |                                                             |                 |               |                             |
| <b>Title of Invention:</b>                     | PRODUCING ROUTING MESSAGES FOR VOICE OVER IP COMMUNICATIONS |                 |               |                             |
| <b>First Named Inventor/Applicant Name:</b>    | CLAY PERRAULT                                               |                 |               |                             |
| <b>Filer:</b>                                  | John M Carson/Catherine Tolo                                |                 |               |                             |
| <b>Attorney Docket Number:</b>                 | SMARB19.001C1                                               |                 |               |                             |
| Filed as Small Entity                          |                                                             |                 |               |                             |
| <b>Utility under 35 USC 111(a) Filing Fees</b> |                                                             |                 |               |                             |
| <b>Description</b>                             | <b>Fee Code</b>                                             | <b>Quantity</b> | <b>Amount</b> | <b>Sub-Total in USD(\$)</b> |
| <b>Basic Filing:</b>                           |                                                             |                 |               |                             |
| Utility filing Fee (Electronic filing)         | 4011                                                        | 1               | 70            | 70                          |
| Utility Search Fee                             | 2111                                                        | 1               | 300           | 300                         |
| Utility Examination Fee                        | 2311                                                        | 1               | 360           | 360                         |
| <b>Pages:</b>                                  |                                                             |                 |               |                             |
| <b>Claims:</b>                                 |                                                             |                 |               |                             |
| Claims in excess of 20                         | 2202                                                        | 58              | 40            | 2320                        |
| Independent Claims in Excess of 3              | 2201                                                        | 3               | 210           | 630                         |
| <b>Miscellaneous-Filing:</b>                   |                                                             |                 |               |                             |

| Description                              | Fee Code | Quantity | Amount | Sub-Total in USD(\$) |
|------------------------------------------|----------|----------|--------|----------------------|
| Late Filing Fee for Oath or Declaration  | 2051     | 1        | 70     | 70                   |
| <b>Petition:</b>                         |          |          |        |                      |
| <b>Patent-Appeals-and-Interference:</b>  |          |          |        |                      |
| <b>Post-Allowance-and-Post-Issuance:</b> |          |          |        |                      |
| <b>Extension-of-Time:</b>                |          |          |        |                      |
| <b>Miscellaneous:</b>                    |          |          |        |                      |
| <b>Total in USD (\$)</b>                 |          |          |        | <b>3750</b>          |

## Electronic Acknowledgement Receipt

|                                             |                                                             |
|---------------------------------------------|-------------------------------------------------------------|
| <b>EFS ID:</b>                              | 16580231                                                    |
| <b>Application Number:</b>                  | 13966096                                                    |
| <b>International Application Number:</b>    |                                                             |
| <b>Confirmation Number:</b>                 | 8712                                                        |
| <b>Title of Invention:</b>                  | PRODUCING ROUTING MESSAGES FOR VOICE OVER IP COMMUNICATIONS |
| <b>First Named Inventor/Applicant Name:</b> | CLAY PERRAULT                                               |
| <b>Customer Number:</b>                     | 20995                                                       |
| <b>Filer:</b>                               | John M Carson/Kevin Kraus                                   |
| <b>Filer Authorized By:</b>                 | John M Carson                                               |
| <b>Attorney Docket Number:</b>              | SMARB19.001C1                                               |
| <b>Receipt Date:</b>                        | 13-AUG-2013                                                 |
| <b>Filing Date:</b>                         |                                                             |
| <b>Time Stamp:</b>                          | 18:52:42                                                    |
| <b>Application Type:</b>                    | Utility under 35 USC 111(a)                                 |

### Payment information:

|                                          |             |
|------------------------------------------|-------------|
| Submitted with Payment                   | yes         |
| Payment Type                             | Credit Card |
| Payment was successfully received in RAM | \$3750      |
| RAM confirmation Number                  | 5910        |
| Deposit Account                          |             |
| Authorized User                          |             |

### File Listing:

| Document Number | Document Description | File Name             | File Size(Bytes)/<br>Message Digest | Multi Part /Zip | Pages (if appl.) |
|-----------------|----------------------|-----------------------|-------------------------------------|-----------------|------------------|
|                 |                      | PEPPERONER APPLE INC. | EX-1005-900                         |                 |                  |



|                                                 |                                                            |                        |                                                        |            |    |
|-------------------------------------------------|------------------------------------------------------------|------------------------|--------------------------------------------------------|------------|----|
| 1                                               | Application Data Sheet                                     | SMARB19_001C1_ads.pdf  | 385933<br>2c17a3311de5605420618372204d08da6ba<br>26f9a | no         | 7  |
| <b>Warnings:</b>                                |                                                            |                        |                                                        |            |    |
| <b>Information:</b>                             |                                                            |                        |                                                        |            |    |
| This is not an USPTO supplied ADS fillable form |                                                            |                        |                                                        |            |    |
| 2                                               |                                                            | SMARB19_001C1_spec.pdf | 253628<br>0213bf77a1f8a2306bbac38eba165201f99c<br>61d1 | yes        | 75 |
|                                                 | <b>Multipart Description/PDF files in .zip description</b> |                        |                                                        |            |    |
|                                                 | <b>Document Description</b>                                |                        | <b>Start</b>                                           | <b>End</b> |    |
|                                                 | Specification                                              |                        | 1                                                      | 58         |    |
|                                                 | Claims                                                     |                        | 59                                                     | 74         |    |
|                                                 | Abstract                                                   |                        | 75                                                     | 75         |    |
| <b>Warnings:</b>                                |                                                            |                        |                                                        |            |    |
| <b>Information:</b>                             |                                                            |                        |                                                        |            |    |
| 3                                               | Drawings-only black and white line drawings                | SMARB19_001C1_figs.pdf | 570200<br>8cd3df34f363e00fc00c9015df0727c0b902<br>3b28 | no         | 32 |
| <b>Warnings:</b>                                |                                                            |                        |                                                        |            |    |
| <b>Information:</b>                             |                                                            |                        |                                                        |            |    |
| 4                                               | Fee Worksheet (SB06)                                       | fee-info.pdf           | 39790<br>c47b3e9ed064bdab250fbc35b4ca7dc6a53<br>b8d71  | no         | 2  |
| <b>Warnings:</b>                                |                                                            |                        |                                                        |            |    |
| <b>Information:</b>                             |                                                            |                        |                                                        |            |    |
| <b>Total Files Size (in bytes):</b>             |                                                            |                        | 1249551                                                |            |    |

**This Acknowledgement Receipt evidences receipt on the noted date by the USPTO of the indicated documents, characterized by the applicant, and including page counts, where applicable. It serves as evidence of receipt similar to a Post Card, as described in MPEP 503.**

**New Applications Under 35 U.S.C. 111**

**If a new application is being filed and the application includes the necessary components for a filing date (see 37 CFR 1.53(b)-(d) and MPEP 506), a Filing Receipt (37 CFR 1.54) will be issued in due course and the date shown on this Acknowledgement Receipt will establish the filing date of the application.**

**National Stage of an International Application under 35 U.S.C. 371**

**If a timely submission to enter the national stage of an international application is compliant with the conditions of 35 U.S.C. 371 and other applicable requirements a Form PCT/DO/EO/903 indicating acceptance of the application as a national stage submission under 35 U.S.C. 371 will be issued in addition to the Filing Receipt, in due course.**

**New International Application Filed with the USPTO as a Receiving Office**

**If a new international application is being filed and the international application includes the necessary components for an international filing date (see PCT Article 11 and MPEP 1810), a Notification of the International Application Number and of the International Filing Date (Form PCT/RO/105) will be issued in due course, subject to prescriptions concerning national security, and the date shown on this Acknowledgement Receipt will establish the international filing date of the application.**