



APPLICATION NO.	ISSUE DATE	PATENT NO.	ATTORNEY DOCKET NO.	CONFIRMATION NO.
13/966,096	11/03/2015	9179005	DIGIF.001C1	8712

20995 7590 10/14/2015
KNOBBE MARTENS OLSON & BEAR LLP
2040 MAIN STREET
FOURTEENTH FLOOR
IRVINE, CA 92614

ISSUE NOTIFICATION

The projected patent number and issue date are specified above.

Determination of Patent Term Adjustment under 35 U.S.C. 154 (b) (application filed on or after May 29, 2000)

The Patent Term Adjustment is 90 day(s). Any patent to issue from the above-identified application will include an indication of the adjustment on the front page.

If a Continued Prosecution Application (CPA) was filed in the above-identified application, the filing date that determines Patent Term Adjustment is the filing date of the most recent CPA.

Applicant will be able to obtain more detailed information by accessing the Patent Application Information Retrieval (PAIR) WEB site (<http://pair.uspto.gov>).

Any questions regarding the Patent Term Extension or Adjustment determination should be directed to the Office of Patent Legal Administration at (571)-272-7702. Questions relating to issue and publication fee payments should be directed to the Application Assistance Unit (AAU) of the Office of Data Management (ODM) at (571)-272-4200.

APPLICANT(s) (Please see PAIR WEB site <http://pair.uspto.gov> for additional applicants):

Digifonica (INTERNATIONAL) Limited, Vancouver, CANADA;
CLAY PERREAULT, Panama City, PANAMA;
STEVE NICHOLSON, Hamilton, NEW ZEALAND;
ROD THOMSON, North Vancouver, CANADA;
JOHAN EMIL VIKTOR BJÖRSELL, Vancouver, CANADA;
FUAD ARAFA, Vancouver, CANADA;

The United States represents the largest, most dynamic marketplace in the world and is an unparalleled location for business investment, innovation, and commercialization of new technologies. The USA offers tremendous resources and advantages for those who invest and manufacture goods here. Through SelectUSA, our nation works to encourage and facilitate business investment. To learn more about why the USA is the best country in the world to develop technology, manufacture products, and grow your business, visit SelectUSA.gov.

INFORMATION DISCLOSURE STATEMENT BY APPLICANT	Application No.	13/966,096	
	Filing Date	August 13, 2013	
	First Named Inventor	Perreault, Clay	
	Art Unit	2653	
<i>(Multiple sheets used when necessary)</i>		Examiner	8712
SHEET 5 OF 11		Attorney Docket No.	SMARB19.001C1

U.S. PATENT DOCUMENTS					
Examiner Initials	Cite No.	Document Number Number - Kind Code (if known) Example: 1,234,567 B1	Publication Date MM-DD-YYYY	Name	Pages, Columns, Lines Where Relevant Passages or Relevant Figures Appear
	116	2009/0003535 A1	01-01-2009	Grabelsky et al.	
	117	2009/0129566 A1	05-21-2009	Feuer, Donald S.	
	118	2009/0135724 A1	05-28-2009	Zhang et al.	
	119	2009/0135735 A1	05-28-2009	Zhang et al.	
	120	2009/0214000 A1	08-27-2009	Patel et al.	
	121	2009/0268615 A1	10-29-2009	Pelletier, Jeffrey P.	
	122	2009/0296900 A1	12-03-2009	Breen et al.	
	123	2010/0008345 A1	01-14-2010	Lebizay, Gerald	
	124	2010/0039946 A1	02-18-2010	Imbimbo et al.	
	125	2010/0105379 A1	04-29-2010	Bonner et al.	
	126	2010/0177671 A1	07-15-2010	Qiu et al.	
	127	2010/0246589 A1	09-30-2010	Pelletier, Jeffrey P.	
	128	2010/0272242 A1	10-28-2010	Croy et al.	
	129	2011/0013541 A1	01-20-2011	Croy et al.	
	130	2011/0153809 A1	06-23-2011	Ghanem et al.	
	131	2011/0176541 A1	07-21-2011	James, Anthony W.	
	132	2011/0201321 A1	08-18-2011	Bonner, Thomas W.	
	133	2011/0267986 A1	11-03-2011	Grabelsky et al.	
	134	2012/0014383 A1	01-19-2012	Geromel et al.	
	135	2012/0113981 A1	05-10-2012	Feuer, Donald S.	
	136	2012/0195415 A1	08-02-2012	Wyss et al.	
	137	2012/0250624 A1	10-04-2012	Lebizay, Gerald	
	138	2012/0282881 A1	11-08-2012	Mitchell, Don	
	139	2012/0314699 A1	12-13-2012	Qiu et al.	
	140	2013/0272297 A1	10-17-2013	AT&T Intellectual Property I, L.P. BREEN et al.	
	141	2014/0101749 A1	04-10-2014	Rockstar Consortium US LP YUAN	
	142	2014/0211789 A1	07-31-2014	Centre One Feuer	

Change(s) applied
to document,
/Q.N./
8/21/2015

Examiner Signature	/Simon Sing/	Date Considered	04/04/2015
*Examiner: Initial if reference considered, whether or not citation is in conformance with MPEP 609. Draw line through citation if not in conformance and not considered. Include copy of this form with next communication to applicant.			

T¹ - Place a check mark in this area when an English language translation is attached. PETITIONER: APPLE INC. EX. 1002-2

ALL REFERENCES CONSIDERED EXCEPT WHERE LINED THROUGH. /SS/

INFORMATION DISCLOSURE STATEMENT BY APPLICANT	Application No.	13/966,096	
	Filing Date	August 13, 2013	
	First Named Inventor	Perreault, Clay	
	Art Unit	2653	
<i>(Multiple sheets used when necessary)</i>		Examiner	8712
SHEET 3 OF 11		Attorney Docket No.	SMARB19.001C1

U.S. PATENT DOCUMENTS					
Examiner Initials	Cite No.	Document Number Number - Kind Code (if known) Example: 1,234,567 B1	Publication Date MM-DD-YYYY	Name	Pages, Columns, Lines Where Relevant Passages or Relevant Figures Appear
	58	8,605,869 B1	12-10-2013	Mobarak et al.	
	59	8,607,323 B2	12-10-2013	Yuan, Wei	
	60	8,611,354 B2	12-17-2013	Keränen et al.	
	61	8,625,578 B2	01-07-2014	Roy et al.	
	62	8,724,643 B2	05-13-2014	Feuer, Donald S.	
	63	8,750,290 B2	06-10-2014	Vance et al.	
	64	8,763,081 B2	06-24-2014	Bogdanovic et al.	
	65	8,768,951 B2	07-01-2014	Crago, William Barry	
	66	8,774,171 B2	07-08-2014	Mitchell, Don	
	67	8,804,705 B2	08-12-2014	Voxpath Networks, Inc. Fangman et al.	
	68	2001/0052081 A1	12-13-2001	McKibben et al.	
	69	2002/0002041 A1	01-03-2002	Lindgren et al.	
	70	2002/0018445 A1	02-14-2002	Kobayashi, Toshihiko	
	71	2002/0141352 A1	10-03-2002	Fangman et al.	
	72	2003/0012196 A1	01-16-2003	Ramakrishnan, Kadangode K.	
	73	2003/0095539 A1	05-22-2003	Feuer, Donald S.	
	74	2003/0179747 A1	09-25-2003	Pyke et al.	
	75	2003/0219103 A1	11-27-2003	Rao et al.	
	76	2004/0034793 A1	02-19-2004	Yuan, Wei	
	77	2004/0203582 A1	10-14-2004	Dorenbosch et al.	
	78	2004/0203565 A1	10-14-2004	Chin et al.	
	79	2005/0063519 A1	03-24-2005	James, Anthony W.	
	80	2005/0188081 A1	08-25-2005	Gibson et al.	
	81	2005/0190892 A1	09-01-2005	Dawson et al.	
	82	2005/0202799 A1	09-15-2005	Rollender, Douglas Harold	
	83	2005/0287979 A1	12-29-2005	Rollender, Douglas Harold	
	84	2006/0007940 A1	01-12-2006	Sollee et al.	
	85	2006/0013266 A1	01-19-2006	Vega-Garcia et al.	
	86	2006/0030290 A1	02-09-2006	Rudolf et al.	

Change(s) applied
to document,
/Q.N/
9/1/2015

Examiner Signature	/Simon Sing/	Date Considered	04/04/2015
--------------------	--------------	-----------------	------------

*Examiner: Initial if reference considered, whether or not citation is in conformance with MPEP 609. Draw line through citation if not in conformance and not considered. Include copy of this form with next communication to applicant.

T¹ - Place a check mark in this area when an English language translation is attached. PETITIONER APPLE INC. EX. 1002-3

ALL REFERENCES CONSIDERED EXCEPT WHERE LINED THROUGH. /SS/

INFORMATION DISCLOSURE STATEMENT BY APPLICANT	Application No.	13/966,096	
	Filing Date	August 13, 2013	
	First Named Inventor	Perreault, Clay	
	Art Unit	2653	
<i>(Multiple sheets used when necessary)</i>		Examiner	8712
SHEET 1 OF 11		Attorney Docket No.	SMARB19.001C1

U.S. PATENT DOCUMENTS					
Examiner Initials	Cite No.	Document Number Number - Kind Code (if known) Example: 1,234,567 B1	Publication Date MM-DD-YYYY	Name	Pages, Columns, Lines Where Relevant Passages or Relevant Figures Appear
	1	5,325,421	06-28-1994	Hou et al.	
	2	6,553,025 B1	04-22-2003	Kung et al.	
	3	6,560,224 B1	05-06-2003	Kung et al.	
	4	6,650,641 B1	11-18-2003	Albert et al.	
	5	6,775,534 B2	08-10-2004	Lindgren et al.	
	6	6,934,279 B1	08-23-2005	Sollee et al.	
	7	6,963,739 B2	11-08-2005	Dorenbosch et al.	
	8	6,985,440 B1	01-10-2006	Albert et al.	
	9	6,993,015 B2	01-31-2006	Kobayashi, Toshihiko	
	10	7,006,508 B2	02-28-2006	Bondy et al.	
	11	7,027,564 B2	04-11-2006	James, Anthony W.	
	12	7,068,668 B2	06-27-2006	Feuer, Donald S.	
	13	7,151,772 B1	12-19-2006	Kalmanek, Jr. et al.	
	14	7,177,399 B2	02-13-2007	Dawson et al.	
	15	7,277,528 B2	10-02-2007	Rao et al.	
	16	7,400,881 B2	07-15-2008	Kallio, Juha	
	17	7,436,835 B2	10-14-2008	Castleberry et al.	
	18	7,440,442 B2	10-21-2008	Grabelsky et al.	
	19	7,486,667 B2	02-03-2009	Feuer, Donald S.	
Change(s) applied to document, /Q.N./ 9/1/2015	20	7,507,131 B2 7,565,131	07-21-2009	Rollender et al.	
	21	7,573,982 B2	08-11-2009	Breen et al.	
	22	7,593,390 B2	09-22-2009	Lebizay, Gerald	
	23	7,639,792 B2	12-29-2009	Qiu et al.	
	24	7,657,011 B1	02-02-2010	Zielinski et al.	
	25	7,664,495 B1	02-16-2010	Bonner et al.	
	26	7,676,215 B2	03-09-2010	Chin et al.	
	27	7,680,114 B2	03-16-2010	Yazaki et al.	
	28	7,702,308 B2	04-20-2010	Rollender, Douglas Harold	

Examiner Signature /Simon Sing/	Date Considered /Simon Sing/
---------------------------------	------------------------------

*Examiner: Initial if reference considered, whether or not citation is in conformance with MPEP 609. Draw line through citation if not in conformance and not considered. Include copy of this form with next communication to applicant.

T¹ - Place a check mark in this area when an English language Translation is attached. TRANSLATION BY APPLE INC. EX. 1002-4

ALL REFERENCES CONSIDERED EXCEPT WHERE LINED THROUGH. /SS/

INFORMATION DISCLOSURE STATEMENT BY APPLICANT	Application No.	13/966,096	
	Filing Date	August 13, 2013	
	First Named Inventor	Perreault, Clay	
	Art Unit	2653	
<i>(Multiple sheets used when necessary)</i>		Examiner	Sing, Simon P.
SHEET 1 OF 2		Attorney Docket No.	DIGIF.001CI

Change(s)

applied
to

document,

/Q.N./

9/11/2015

U.S. PATENT DOCUMENTS

Examiner Initials	Cite No.	Document Number Number - Kind Code (if known) Example: 1,234,567 B1	Publication Date MM-DD-YYYY	Name	Pages, Columns, Lines Where Relevant Passages or Relevant Figures Appear
	1	5,877,965 A1	10/1997 10-14-1995	Doggett et al.	
	2	5,883,810 A1	03-16-1999	Franklin et al.	
	3	6,173,272 B1	01-09-2001	Thomas et al.	
	4	6,243,689 B1	06-05-2001	Norton, Robert G.	
	5	6,636,833 B1	10-21-2003	Flitcroft et al. Flitcroft, et al.	
	6	6,772,188 B1	08-03-2004	Cheng-Cheng et al. Cloutier	
	7	6,892,184 B1	05-10-2005	Komen et al.	
	8	7,051,072 B2	05-23-2006	Stewart et al.	
	9	7,330,835 B2	02-12-2008	Deggendorf, Theresa M.	
	10	7,426,492 B2	09-16-2008	Bishop et al.	
	11	7,437,665 B2	10-14-2008	Perham, Michael	
	12	7,447,707 B2	11-04-2008	Gaurav et al.	
	13	7,580,886 B1	08-25-2009	Schulz, Larry	
	14	7,593,884 B2	09-22-2009	Rothman et al.	
	15	7,599,944 B2	10-06-2009	Gaurav et al.	
	16	7,644,037 B1	01-05-2010	Ostrovsky, Vladimir	
	17	7,647,500 B2	01-12-2010	Machiraju et al.	
	18	7,676,431 B2	03-09-2010	O'Leary et al.	
	19	7,680,737 B2	03-16-2010	Smith et al.	
	20	7,734,544 B2	06-08-2010	Schleicher, Joerg	
	21	7,765,261 B2	07-27-2010	Kropivny, Alexander	
	22	7,765,266 B2	07-27-2010	Kropivny, Alexander	
	23	7,882,011 B2	02-01-2011	Sandhu et al.	
	24	7,899,742 B2	03-11-2011	Berkert et al.	
	25	8,060,887 B2	11-15-2011	Kropivny, Alexander	
	26	8,161,078 B2	04-17-2012	Gaurav et al.	
	27	8,200,575 B2	06-12-2012	Torres et al.	
	28	8,543,477 B2	09-24-2013	Love et al.	
	29	8,627,211 B2	01-07-2014	Kropivny, Alexander	

Change(s) applied

to document,

/Q.N./

9/1/2015

Examiner Signature	/Simon Sing/	Date Considered	08/24/2015
*Examiner: Initial if reference considered, whether or not citation is in conformance with MPEP 609. Draw line through citation if not in conformance and not considered. Include copy of this form with next communication to applicant.			

T¹ - Place a check mark in this area when an English language Translation is attached.

INFORMATION DISCLOSURE STATEMENT BY APPLICANT	Application No.	13/966,096	
	Filing Date	August 13, 2013	
	First Named Inventor	Perreault, Clay	
	Art Unit	2653	
<i>(Multiple sheets used when necessary)</i>		Examiner	Sing, Simon P.
SHEET 1 OF 1		Attorney Docket No.	DIGIF.001C1

U.S. PATENT DOCUMENTS					
Examiner Initials	Cite No.	Document Number <i>Number - Kind Code (if known)</i> Example: 1,234,567 B1	Publication Date MM-DD-YYYY	Name	Pages, Columns, Lines Where Relevant Passages or Relevant Figures Appear

FOREIGN PATENT DOCUMENTS						
Examiner Initials	Cite No.	Foreign Patent Document <i>Country Code-Number-Kind Code</i> Example: JP 1234567 A1	Publication Date MM-DD-YYYY	Name	Pages, Columns, Lines Where Relevant Passages or Relevant Figures Appear	T ¹
/SS/	1	CA 2,598,200 A1	02-21-2008	Connexon Telecom Inc.		
/SS/	2	W00200902627 ID (Indonesia)	09-17-2009	Digifonica International Ltd	<i>Corresponding International Publication No. WO 2008/116296 A1 previously disclosed</i>	Abstract Only

NON PATENT LITERATURE DOCUMENTS			
Examiner Initials	Cite No.	Include name of the author (in CAPITAL LETTERS), title of the article (when appropriate), title of the item (book, magazine, journal, serial, symposium, catalog, etc.), date, page(s), volume-issue number(s), publisher, city and/or country where published.	T ¹
/SS/	3	Canadian Office Action dated January 27, 2015 for Canadian Patent Application No. CA 2,681,984.	

20995995
 Change(s) applied
 to document,
 /Q.N./
 9/11/2015

Examiner Signature	/Simon Sing/	Date Considered	07/31/2015
--------------------	--------------	-----------------	------------

*Examiner: Initial if reference considered, whether or not citation is in conformance with MPEP 609. Draw line through citation if not in conformance and not considered. Include copy of this form with next communication to applicant.

T¹ - Place a check mark in this area when an English language Translation is Applicable. EX. 1002-6

DIGIF.001C1

PATENT

IN THE UNITED STATES PATENT AND TRADEMARK OFFICE

Inventor	: Clay Perreault
App. No.	: 13/966,096
Filed	: August 13, 2013
For	: PRODUCING ROUTING MESSAGES FOR VOICE OVER IP COMMUNICATIONS
Examiner	: Sing, Simon P.
Art Unit	: 2653
Conf. No.	: 8712

AMENDMENT AFTER ALLOWANCE UNDER 37 C.F.R. 1.312

Mail Stop Issue Fee

Commissioner for Patents
P.O. Box 1450
Alexandria, VA 22313-1450

Dear Sir:

Further to the Notice of Allowance dated August 13, 2015, and the Supplemental Notice of Allowability dated August 27, 2015, Applicant requests the following amendments in the above-captioned patent application.

Amendments to the Claims are reflected in the listing of claims which begins on page 2 of this paper.

Remarks begin on page 22 of this paper.

OK TO ENTER: /SS/



UNITED STATES PATENT AND TRADEMARK OFFICE

UNITED STATES DEPARTMENT OF COMMERCE
United States Patent and Trademark Office
Address: COMMISSIONER FOR PATENTS
P.O. Box 1450
Alexandria, Virginia 22313-1450
www.uspto.gov

Table with 5 columns: APPLICATION NO., FILING DATE, FIRST NAMED INVENTOR, ATTORNEY DOCKET NO., CONFIRMATION NO.
13/966,096 08/13/2013 CLAY PERREAULT DIGIF.001C1 8712

20995 7590 09/15/2015
KNOBBE MARTENS OLSON & BEAR LLP
2040 MAIN STREET
FOURTEENTH FLOOR
IRVINE, CA 92614

EXAMINER

SING, SIMON P

ART UNIT PAPER NUMBER

2653

NOTIFICATION DATE DELIVERY MODE

09/15/2015

ELECTRONIC

Please find below and/or attached an Office communication concerning this application or proceeding.

The time period for reply, if any, is set in the attached communication.

Notice of the Office communication was sent electronically on above-indicated "Notification Date" to the following e-mail address(es):

jayna.cartee@knobbe.com
efiling@knobbe.com

**Supplemental
Notice of Allowability**

Application No. 13/966,096	Applicant(s) PERREAULT ET AL.	
Examiner SIMON SING	Art Unit 2653	AIA (First Inventor to File) Status No

-- The MAILING DATE of this communication appears on the cover sheet with the correspondence address--

All claims being allowable, PROSECUTION ON THE MERITS IS (OR REMAINS) CLOSED in this application. If not included herewith (or previously mailed), a Notice of Allowance (PTOL-85) or other appropriate communication will be mailed in due course. **THIS NOTICE OF ALLOWABILITY IS NOT A GRANT OF PATENT RIGHTS.** This application is subject to withdrawal from issue at the initiative of the Office or upon petition by the applicant. See 37 CFR 1.313 and MPEP 1308.

- This communication is responsive to 312 amendment filed on 09/08/2015.
 A declaration(s)/affidavit(s) under **37 CFR 1.130(b)** was/were filed on _____.
- An election was made by the applicant in response to a restriction requirement set forth during the interview on _____; the restriction requirement and election have been incorporated into this action.
- The allowed claim(s) is/are _____. As a result of the allowed claim(s), you may be eligible to benefit from the **Patent Prosecution Highway** program at a participating intellectual property office for the corresponding application. For more information, please see http://www.uspto.gov/patents/init_events/pph/index.jsp or send an inquiry to PPHfeedback@uspto.gov.
- Acknowledgment is made of a claim for foreign priority under 35 U.S.C. § 119(a)-(d) or (f).

Certified copies:

- a) All b) Some *c) None of the:
- Certified copies of the priority documents have been received.
 - Certified copies of the priority documents have been received in Application No. _____.
 - Copies of the certified copies of the priority documents have been received in this national stage application from the International Bureau (PCT Rule 17.2(a)).

* Certified copies not received: _____.

Applicant has **THREE MONTHS FROM THE "MAILING DATE"** of this communication to file a reply complying with the requirements noted below. Failure to timely comply will result in **ABANDONMENT** of this application.

THIS THREE-MONTH PERIOD IS NOT EXTENDABLE.

- CORRECTED DRAWINGS** (as "replacement sheets") must be submitted.
 including changes required by the attached Examiner's Amendment / Comment or in the Office action of Paper No./Mail Date _____.
Identifying indicia such as the application number (see 37 CFR 1.84(c)) should be written on the drawings in the front (not the back) of each sheet. Replacement sheet(s) should be labeled as such in the header according to 37 CFR 1.121(d).
- DEPOSIT OF and/or INFORMATION** about the deposit of **BIOLOGICAL MATERIAL** must be submitted. Note the attached Examiner's comment regarding **REQUIREMENT FOR THE DEPOSIT OF BIOLOGICAL MATERIAL**.

Attachment(s)

- | | |
|--|---|
| 1. <input type="checkbox"/> Notice of References Cited (PTO-892) | 5. <input type="checkbox"/> Examiner's Amendment/Comment |
| 2. <input type="checkbox"/> Information Disclosure Statements (PTO/SB/08),
Paper No./Mail Date _____ | 6. <input type="checkbox"/> Examiner's Statement of Reasons for Allowance |
| 3. <input type="checkbox"/> Examiner's Comment Regarding Requirement for Deposit
of Biological Material | 7. <input checked="" type="checkbox"/> Other <u>PTO-271</u> . |
| 4. <input type="checkbox"/> Interview Summary (PTO-413),
Paper No./Mail Date _____. | |

/SIMON SING/
Primary Examiner, Art Unit 2653

DIGIF.001C1

PATENT

IN THE UNITED STATES PATENT AND TRADEMARK OFFICE

Inventor	: Clay Perreault
App. No.	: 13/966,096
Filed	: August 13, 2013
For	: PRODUCING ROUTING MESSAGES FOR VOICE OVER IP COMMUNICATIONS
Examiner	: Sing, Simon P.
Art Unit	: 2653
Conf. No.	: 8712

AMENDMENT AFTER ALLOWANCE UNDER 37 C.F.R. 1.312

Mail Stop Issue Fee

Commissioner for Patents
P.O. Box 1450
Alexandria, VA 22313-1450

Dear Sir:

Further to the Notice of Allowance dated August 13, 2015, and the Supplemental Notice of Allowability dated August 27, 2015, Applicant requests the following amendments in the above-captioned patent application.

Amendments to the Claims are reflected in the listing of claims which begins on page 2 of this paper.

Remarks begin on page 22 of this paper.

Response to Rule 312 Communication	Application No. 13/966,096	Applicant(s) PERREAULT ET AL.
	Examiner SIMON SING	Art Unit 2653

-- The MAILING DATE of this communication appears on the cover sheet with the correspondence address --

1. The amendment filed on 08 September 2015 under 37 CFR 1.312 has been considered, and has been:
- a) entered.
 - b) entered as directed to matters of form not affecting the scope of the invention.
 - c) disapproved because the amendment was filed after the payment of the issue fee.
Any amendment filed after the date the issue fee is paid must be accompanied by a petition under 37 CFR 1.313(c)(1) and the required fee to withdraw the application from issue.
 - d) disapproved. See explanation below.
 - e) entered in part. See explanation below.

	/SIMON SING/ Primary Examiner, Art Unit 2653
--	---

PART B - FEE(S) TRANSMITTAL

Complete and send this form, together with applicable fee(s), to: **Mail** Mail Stop ISSUE FEE
 Commissioner for Patents
 P.O. Box 1450
 Alexandria, Virginia 22313-1450
or Fax (571)-273-2885

INSTRUCTIONS: This form should be used for transmitting the ISSUE FEE and PUBLICATION FEE (if required). Blocks 1 through 5 should be completed where appropriate. All further correspondence including the Patent, advance orders and notification of maintenance fees will be mailed to the current correspondence address as indicated unless corrected below or directed otherwise in Block 1, by (a) specifying a new correspondence address; and/or (b) indicating a separate "FEE ADDRESS" for maintenance fee notifications.

CURRENT CORRESPONDENCE ADDRESS (Note: Use Block 1 for any change of address)

20995 7590 08/13/2015
KNOBBE MARTENS OLSON & BEAR LLP
 2040 MAIN STREET
 FOURTEENTH FLOOR
 IRVINE, CA 92614

Note: A certificate of mailing can only be used for domestic mailings of the Fee(s) Transmittal. This certificate cannot be used for any other accompanying papers. Each additional paper, such as an assignment or formal drawing, must have its own certificate of mailing or transmission.

Certificate of Mailing or Transmission

I hereby certify that this Fee(s) Transmittal is being deposited with the United States Postal Service with sufficient postage for first class mail in an envelope addressed to the Mail Stop ISSUE FEE address above, or being facsimile transmitted to the USPTO (571) 273-2885, on the date indicated below.

(Depositor's name)
(Signature)
(Date)

APPLICATION NO.	FILING DATE	FIRST NAMED INVENTOR	ATTORNEY DOCKET NO.	CONFIRMATION NO.
13/966,096	08/13/2013	CLAY PERREAULT	DIGIF.001C1	8712

TITLE OF INVENTION: PRODUCING ROUTING MESSAGES FOR VOICE OVER IP COMMUNICATIONS

APPLN. TYPE	ENTITY STATUS	ISSUE FEE DUE	PUBLICATION FEE DUE	PREV. PAID ISSUE FEE	TOTAL FEE(S) DUE	DATE DUE
nonprovisional	SMALL	\$480	\$0	\$0	\$480	11/13/2015

EXAMINER	ART UNIT	CLASS-SUBCLASS
SING. SIMON P	2653	379-142040

1. Change of correspondence address or indication of "Fee Address" (37 CFR 1.363).

Change of correspondence address (or Change of Correspondence Address form PTO/SB/122) attached.

"Fee Address" indication (or "Fee Address" Indication form PTO/SB/47; Rev 03-02 or more recent) attached. Use of a Customer Number is required.

2. For printing on the patent front page, list

(1) The names of up to 3 registered patent attorneys or agents OR, alternatively,

(2) The name of a single firm (having as a member a registered attorney or agent) and the names of up to 2 registered patent attorneys or agents. If no name is listed, no name will be printed.

1. Knobbe Martens Olson & Bear, LLP

2. _____

3. _____

3. ASSIGNEE NAME AND RESIDENCE DATA TO BE PRINTED ON THE PATENT (print or type)

PLEASE NOTE: Unless an assignee is identified below, no assignee data will appear on the patent. If an assignee is identified below, the document has been filed for recordation as set forth in 37 CFR 3.11. Completion of this form is NOT a substitute for filing an assignment.

(A) NAME OF ASSIGNEE: Digifonica (International) Limited

(B) RESIDENCE: (CITY and STATE OR COUNTRY) Vancouver, Canada

Please check the appropriate assignee category or categories (will not be printed on the patent): Individual Corporation or other private group entity Government

4a. The following fee(s) are submitted:

Issue Fee

Publication Fee (No small entity discount permitted)

Advance Order - # of Copies _____

4b. Payment of Fee(s): (Please first reapply any previously paid issue fee shown above)

A check is enclosed,

Payment by credit card. Form PTO-2038 is attached.

The director is hereby authorized to charge the required fee(s); any deficiency, or credits any overpayment, to Deposit Account Number 11-1410 (enclose an extra copy of this form).

5. Change in Entity Status (from status indicated above)

Applicant certifying micro entity status. See 37 CFR 1.29

Applicant asserting small entity status. See 37 CFR 1.27

Applicant changing to regular undiscounted fee status.

NOTE: Absent a valid certification of Micro Entity Status (see forms PTO/SB/15A and 15B), issue fee payment in the micro entity amount will not be accepted at the risk of application abandonment.

NOTE: If the application was previously under micro entity status, checking this box will be taken to be a notification of loss of entitlement to micro entity status.

NOTE: Checking this box will be taken to be a notification of loss of entitlement to small or micro entity status, as applicable.

NOTE: This form must be signed in accordance with 37 CFR 1.31 and 1.33. See 37 CFR 1.4 for signature requirements and certifications.

Authorized Signature _____ Date 9/8/15

Typed or printed name John Carson Registration No. 34,303

IN THE UNITED STATES PATENT AND TRADEMARK OFFICE

Inventor	: Clay Perreault
App. No.	: 13/966,096
Filed	: August 13, 2013
For	: PRODUCING ROUTING MESSAGES FOR VOICE OVER IP COMMUNICATIONS
Examiner	: Sing, Simon P.
Art Unit	: 2653
Conf. No.	: 8712

AMENDMENT AFTER ALLOWANCE UNDER 37 C.F.R. 1.312**Mail Stop Issue Fee**

Commissioner for Patents
P.O. Box 1450
Alexandria, VA 22313-1450

Dear Sir:

Further to the Notice of Allowance dated August 13, 2015, and the Supplemental Notice of Allowability dated August 27, 2015, Applicant requests the following amendments in the above-captioned patent application.

Amendments to the Claims are reflected in the listing of claims which begins on page 2 of this paper.

Remarks begin on page 22 of this paper.

AMENDMENTS TO THE CLAIMS

1. (Original) A process for producing a routing message for routing communications between a caller and a callee in a communication system, the process comprising:

using a caller identifier associated with the caller to locate a caller dialing profile comprising a plurality of calling attributes associated with the caller;

when at least one of said calling attributes and at least a portion of a callee identifier associated with the callee meet private network classification criteria, producing a private network routing message for receipt by a call controller, said private network routing message identifying an address, on the private network, associated with the callee; and

when at least one of said calling attributes and at least a portion of said callee identifier meet a public network classification criterion, producing a public network routing message for receipt by the call controller, said public network routing message identifying a gateway to the public network.

2. (Original) The process of claim 1, wherein said private network classification criteria include:

- a) said callee identifier does not begin with the same digit pattern as an international dialing digit (IDD) attribute of said callee identifier; and
- b) said callee identifier does not begin with the same digit pattern as a national dialing digit (NDD) attribute of said callee identifier; and
- c) said callee identifier does not begin with the same area code as an area code of said caller; and
- d) said callee identifier does not have a length that is within a range of caller local number lengths; and
- e) said callee identifier is a valid username.

Application No.: 13/966,096
Filing Date: August 13, 2013

3. (Original) The process of claim 2, further comprising identifying the call as a cross-domain call on the private network when said callee identifier identifies a callee that is not associated with the same network node as said caller.
4. (Original) The process of claim 2, further comprising:
 - locating a callee dialing profile for the callee when said callee identifier identifies a callee that is associated with the same network node as said caller; and
 - retrieving call handling information associated with the callee, where said call handling information is available, said call handling information including at least one of call blocking information, call forwarding information, and voicemail information.
5. (Original) The process of claim 4, further comprising, where said call handling information including said call blocking information is available, blocking the call when said call blocking information identifies the caller as a caller from whom calls are to be blocked from being established with the callee.
6. (Original) The process of claim 4, further comprising, where said call handling information including said call forwarding information is available, causing said call forwarding information to be included in said private network routing message.
7. (Original) The process of claim 4, further comprising, where said call handling information including said voicemail information is available, causing said voicemail information to be included in said private network routing message.
8. (Original) The process of claim 1, further comprising associating at least one direct inward dial (DID) record with at least one subscriber to said communication system, each of said at least one direct inward dial records comprising a field storing a direct inward dial number associated with said at least one subscriber.

Application No.: 13/966,096
Filing Date: August 13, 2013

9. (Original) The process of claim 8, wherein said public network classification criteria include:
- a) said callee identifier begins with the same digit pattern as an international dialing digit (IDD) attribute of said callee identifier; and
 - b) a reformatted callee identifier produced by removing the IDD attribute from said callee identifier has no DID bank table record.
10. (Original) The process of claim 8, wherein said public network classification criteria include:
- a) said callee identifier begins with the same digit pattern as a national dialing digit (NDD) attribute of said callee identifier; and
 - b) a reformatted callee identifier produced by removing the NDD attribute from said callee identifier and including a caller country code has no DID bank table record.
11. (Original) The process of claim 8, wherein said public network classification criteria include:
- a) said callee identifier begins with the same area code as an area code of said caller; and
 - b) a reformatted callee identifier produced by reformatting the callee identifier to include a caller country code has no DID bank table record.
12. (Original) The process of claim 8, wherein said public network classification criteria include:
- a) said callee identifier has a length that is within a range of caller local number lengths; and
 - b) a reformatted callee identifier produced by reformatting the callee identifier to include a caller country code and area code has no DID bank table record.
13. (Original) The process of claim 1, wherein said plurality of calling attributes includes at least one of an international dialing digits identifier, a national dialing digits identifier, a

Application No.: 13/966,096
Filing Date: August 13, 2013

country code identifier, a local area codes identifier, a caller minimum local length identifier, a caller maximum local length identifier, a reseller identifier, and a maximum number of concurrent calls identifier.

14. (Original) The process of claim 8, wherein said DID record comprises a user name field, a user domain field and a DID number field.

15. (Original) The process of claim 1, further comprising maintaining a list of public network route suppliers and when said public network classification criterion is met identifying at least one of said public network route suppliers that satisfies public network routing selection criteria.

16. (Original) The process of claim 15, wherein said producing said public network routing message comprises producing a public network routing message identifying said at least one public network route supplier that satisfies said public network routing selection criteria.

17. (Original) The process of claim 16, wherein producing said public network routing message comprises causing said public network routing message to include a gateway supplier identifier identifying a gateway supplier able to establish a communications link in a route through which communications between the caller and callee are to be conducted.

18. (Original) The process of claim 17, further comprising causing said public network routing message to include a time value and a timeout value.

19. (Original) The process of claim 17, wherein causing said public network routing message to include said gateway supplier identifier comprises causing said public network routing message to include a plurality of gateway supplier identifiers identifying a plurality of gateway suppliers able to supply respective communication links through which communications between the caller and callee can be conducted.

Application No.: 13/966,096
Filing Date: August 13, 2013

20. (Original) The process of claim 19, further comprising causing said public network routing message to include priority information identifying a priority in which gateway suppliers associated with said gateway identifiers are to be considered for selection of a communication link through which communications between the caller and callee can be conducted.

21. (Original) The process of claim 19, wherein causing said public network routing message to include priority information includes arranging said gateway supplier identifiers in said public network routing message in order of rate, where rate is determined from rate fields of respective said gateway supplier records.

22. (Original) The process of claim 21, wherein arranging said gateway supplier identifiers in order of rate comprises arranging said gateway supplier identifiers in order of increasing rate.

23. (Original) The process of claim 17, further comprising arranging said gateway supplier identifiers in an order based on at least one provision in a service agreement.

24. (Original) The process of claim 1, further comprising causing the private network routing message or the public network routing message to be communicated to a call controller to effect routing of the call.

25. (Original) A non-transitory computer readable medium encoded with codes for directing a processor to execute the method of claim 1.

26. (Original) A call routing controller apparatus for producing a routing message for routing communications between a caller and a callee in a communication system, the apparatus comprising:

at least one processor operably configured to:

use a caller identifier associated with the caller to locate a caller dialing profile comprising a plurality of calling attributes associated with the caller;

when at least one of said calling attributes and at least a portion of a callee identifier associated with the callee meet private network classification criteria, produce a private network routing message for receipt by a call controller, said private network routing message identifying an address, on the private network, associated with the callee; and

when at least one of said calling attributes and at least a portion of said callee identifier meet a public network classification criterion, produce a public network routing message for receipt by the call controller, said public network routing message identifying a gateway to the public network.

27. (Original) The apparatus of claim 26, wherein said private network classification criteria include:

- a) said callee identifier does not begin with the same digit pattern as an international dialing digit (IDD) attribute of said callee identifier; and
- b) said callee identifier does not begin with the same digit pattern as a national dialing digit (NDD) attribute of said callee identifier; and
- c) said callee identifier does not begin with the same area code as an area code of said caller; and
- d) said callee identifier does not have a length that is within a range of caller local number lengths; and
- e) said callee identifier is a valid username.

28. (Original) The apparatus of claim 27, wherein said at least one processor is further operably configured to identify the call as a cross-domain call on the private network when said callee identifier identifies a callee that is not associated with the same network node as said caller.

Application No.: 13/966,096
Filing Date: August 13, 2013

29. (Original) The apparatus of claim 27, wherein said at least one processor is further configured to:

access the database of caller dialing profiles to locate a callee dialing profile for the callee when said callee identifier identifies a callee that is associated with the same network node as said caller; and

retrieve call handling information associated with the callee, where said call handling information is available, said call handling information including at least one of call blocking information, call forwarding information, and voicemail information.

30. (Original) The apparatus of claim 29, wherein said at least one processor is further operably configured to determine whether said call handling information including said call blocking information is available and to block the call when said call blocking information identifies the caller as a caller from whom calls are to be blocked.

31. (Original) The apparatus of claim 29, wherein said at least one processor is further operably configured to determine whether said call handling information including said call forwarding information is available and to cause said call forwarding information to be included in said private network routing message.

32. (Original) The apparatus of claim 29, wherein said at least one processor is further operably configured to determine whether said call handling information including said voicemail information is available and to cause said voicemail information to be included in said private network routing message.

33. (Original) The apparatus of claim 26, wherein said at least one processor is further operably configured to access a database of direct inward dial records each associating at least one direct inward dial number with at least one subscriber to said communication system.

Application No.: 13/966,096
Filing Date: August 13, 2013

34. (Original) The apparatus of claim 33, wherein said public network classification criteria include:

- a) said callee identifier begins with the same digit pattern as an international dialing digit (IDD) attribute of said callee identifier; and
- b) a reformatted callee identifier produced by removing the IDD attribute from said callee identifier has no DID record.

35. (Original) The apparatus of claim 33, wherein said public network classification criteria include:

- a) said callee identifier begins with the same digit pattern as a national dialing digit (NDD) attribute of said callee identifier; and
- b) a reformatted callee identifier produced by removing the NDD attribute from said callee identifier and including a caller country code has no DID record.

36. (Original) The apparatus of claim 33, wherein said public network classification criteria include:

- a) said callee identifier begins with the same area code as an area code of said caller; and
- b) a reformatted callee identifier produced by reformatting the callee identifier to include a caller country code has no DID record.

37. (Original) The apparatus of claim 33, wherein said public network classification criteria include:

- a) said callee identifier has a length that is within a range of caller local number lengths; and
- b) a reformatted callee identifier produced by reformatting the callee identifier to include a caller country code and area code has no DID record.

Application No.: 13/966,096
Filing Date: August 13, 2013

38. (Original) The apparatus of claim 26, wherein said plurality of calling attributes includes at least one of an international dialing digits identifier, a national dialing digits identifier, a country code identifier, a local area codes identifier, a caller minimum local length identifier, a caller maximum local length identifier, a reseller identifier, and a maximum number of concurrent calls identifier.

39. (Original) The apparatus of claim 33, wherein said DID record comprises a user name field, a user domain field and a DID number field.

40. (Original) The apparatus of claim 26, wherein said at least one processor is further operably configured to access a list of public network route suppliers when said public network classification criterion is met and to identify at least one of said public network route suppliers that satisfies public network routing selection criteria.

41. (Original) The apparatus of claim 40, wherein said at least one processor is further operably configured to produce a public network routing message identifying said at least one public network route supplier that satisfies said public network routing selection criteria.

42. (Original) The apparatus of claim 41, wherein said at least one processor is operably configured to cause said public network routing message to include a gateway supplier identifier identifying a gateway supplier able to establish a communications link in a route through which communications between the caller and callee can be conducted.

43. (Original) The apparatus of claim 42, wherein said at least one processor is operably configured to cause said public network routing message to include a time value and a timeout value.

44. (Original) The apparatus of claim 42, wherein said at least one processor is operably configured to cause said public network routing message to include a plurality of gateway supplier identifiers identifying a plurality of gateway suppliers able to supply respective

Application No.: 13/966,096
Filing Date: August 13, 2013

communication links through which communications between the caller and callee can be conducted.

45. (Original) The apparatus of claim 44, wherein said at least one processor is operably configured to cause said public network routing message to include priority information identifying a priority in which gateway suppliers associated with said gateway identifiers are to be considered for selection of a communication link through which communications between the caller and callee can be conducted.

46. (Original) The apparatus of claim 44, wherein said at least one processor is operably configured to arrange said gateway supplier identifiers in said public network routing message in order of rate, where rate is determined from rate fields of respective said gateway supplier records.

47. (Original) The apparatus of claim 46, wherein said at least one processor is operably configured to arrange said gateway supplier identifiers in order of increasing rate.

48. (Original) The apparatus of claim 42, wherein said at least one processor is operably configured to arrange said gateway supplier identifiers in an order based on at least one provision in a service agreement.

49. (Original) The apparatus of claim 26, wherein said at least one processor is further operably configured to cause the private network routing message or the public network routing message to be communicated to a call controller to effect routing of the call.

50. (Original) A call routing controller apparatus for producing a routing message for routing communications between a caller and a callee in a communication system, the apparatus comprising:

means for using a caller identifier associated with the caller to locate a caller dialing profile comprising a plurality of calling attributes associated with the caller; and

means for, when at least one of said calling attributes and at least a portion of a callee identifier associated with the callee meet private network classification criteria, producing a private network routing message for receipt by a call controller, said private network routing message identifying an address, on the private network, associated with the callee; and

means for, when at least one of said calling attributes and at least a portion of said callee identifier meet a public network classification criterion, producing a public network routing message for receipt by the call controller, said public network routing message identifying a gateway to the public network.

51. **(Currently amended)** The apparatus of claim 50, wherein said private network classification criteria include:

- a) said callee identifier does not begin with the same digit pattern as an international dialing digit (IDD) attribute of said callee identifier; and
- b) said callee identifier does not begin with the same digit pattern as a national dialing digit (NDD) attribute of said callee identifier; and
- c) said callee identifier does not begin with the same area code as an area code of said caller; and
- d) _____ said callee identifier does not have a length that is within a range of caller local number lengths; and
- e) _____ said callee identifier is a valid username.

52. **(Original)** The apparatus of claim 51, further comprising means for identifying the call as a cross-domain call on the private network when said callee identifier identifies a callee that is not associated with the same network node as said caller.

53. **(Original)** The apparatus of claim 51, further comprising:

means for accessing the database of caller dialing profiles to locate a callee dialing profile for the callee when said callee identifier identifies a callee that is associated with the same network node as said caller; and

Application No.: 13/966,096
Filing Date: August 13, 2013

means for retrieving call handling information associated with the callee, where said call handling information is available, said call handling information including at least one of call blocking information, call forwarding information, and voicemail information.

54. (Original) The apparatus of claim 53, further comprising, where said call handling information including said call blocking information is available, means for blocking the call being established with the callee when said call blocking information identifies the caller as a caller from whom calls are to be blocked.

55. (Original) The apparatus of claim 53, further comprising, means for causing said call forwarding information to be included in said private network routing message, where said call handling information including said call forwarding information is available.

56. (Original) The apparatus of claim 53, further comprising, where said call handling information including said voicemail information is available, means for causing said voicemail information to be included in said private network routing message.

57. (Original) The apparatus of claim 50, further comprising means for accessing a database of direct inward dial records each associating at least one direct inward dial number with at least one subscriber to said communication system.

58. (Original) The apparatus of claim 57, wherein said public network classification criteria include:

- a) said callee identifier begins with the same digit pattern as an international dialing digit (IDD) attribute of said callee identifier; and
- b) a reformatted callee identifier produced by removing the IDD attribute from said callee identifier has no DID record.

Application No.: 13/966,096
Filing Date: August 13, 2013

59. (Original) The apparatus of claim 57, wherein said public network classification criteria include:

- a) said callee identifier begins with the same digit pattern as a national dialing digit (NDD) attribute of said callee identifier; and
- b) a reformatted callee identifier produced by removing the NDD attribute from said callee identifier and including a caller country code has no DID record.

60. (Original) The apparatus of claim 57, wherein said public network classification criteria include:

- a) said callee identifier begins with the same area code as an area code of said caller; and
- b) a reformatted callee identifier produced by reformatting the callee identifier to include a caller country code has no DID record.

61. (Original) The apparatus of claim 57, wherein said public network classification criteria include:

- a) said callee identifier has a length that is within a range of caller local number lengths; and
- b) a reformatted callee identifier produced by reformatting the callee identifier to include a caller country code and area code has no DID record.

62. (Original) The apparatus of claim 50, wherein said plurality of calling attributes includes at least one of an international dialing digits identifier, a national dialing digits identifier, a country code identifier, a local area codes identifier, a caller minimum local length identifier, a caller maximum local length identifier, a reseller identifier, and a maximum number of concurrent calls identifier.

63. (Original) The apparatus of claim 57, wherein said DID record comprises a user name field, a user domain field and a DID number field.

Application No.: 13/966,096
Filing Date: August 13, 2013

64. (Original) The apparatus of claim 50, further comprising means for accessing a list of public network route suppliers when said public network classification criterion is met and means for identifying at least one of said public network route suppliers that satisfies public network routing selection criteria.

65. (Original) The apparatus of claim 64, wherein said means for producing said public network routing message comprises means for producing a public network routing message identifying said at least one public network route supplier that satisfies said public network routing selection criteria.

66. (Original) The apparatus of claim 65, wherein said means for producing said public network routing message comprises means for causing said public network routing message to include a gateway supplier identifier identifying a gateway supplier able to establish a communications link in a route through which communications between the caller and callee can be conducted.

67. (Original) The apparatus of claim 66, further comprising means for causing said public network routing message to include a time value and a timeout value.

68. (Original) The apparatus of claim 66, wherein said means for causing said public network routing message to include said gateway supplier identifier comprises means for causing said public network routing message to include a plurality of gateway supplier identifiers identifying a plurality of gateway suppliers able to supply respective communication links through which communications between the caller and callee can be conducted.

69. (Original) The apparatus of claim 68, further comprising means for causing said public network routing message to include priority information identifying a priority in which gateway suppliers associated with said gateway identifiers are to be considered for selection of a communication link through which communications between the caller and callee can be conducted.

Application No.: 13/966,096
Filing Date: August 13, 2013

70. (Original) The apparatus of claim 68, wherein said means for causing said public network routing message to include priority information includes means for arranging said gateway supplier identifiers in said public network routing message in order of rate, where rate is determined from rate fields of respective said gateway supplier records.

71. (Original) The apparatus of claim 70, wherein said means for arranging said gateway supplier identifiers in order of rate comprises means for arranging said gateway supplier identifiers in order of increasing rate.

72. (Original) The apparatus of claim 66, further comprising means for arranging said gateway supplier identifiers in an order based on at least one provision in a service agreement.

73. (Original) The apparatus of claim 50, further comprising means for causing the private network routing message or the public network routing message to be communicated to a call controller to effect routing of the call.

74. (Canceled).

75. (Canceled).

76. (Canceled).

77. (Canceled).

78. (Canceled).

Application No.: 13/966,096
Filing Date: August 13, 2013

79. (Previously Presented) A method of routing communications in a packet switched network in which a first participant identifier is associated with a first participant and a second participant identifier is associated with a second participant in a communication, the method comprising:

after the first participant has accessed the packet switched network to initiate the communication, using the first participant identifier to locate a first participant profile comprising a plurality of attributes associated with the first participant;

when at least one of the first participant attributes and at least a portion of the second participant identifier meet a first network classification criterion, producing a first network routing message for receipt by a controller, the first network routing message identifying an address in a first portion of the packet switched network, the address being associated with the second participant, the first portion being controlled by an entity; and

when at least one of the first participant attributes and at least a portion of the second participant identifier meet a second network classification criterion, producing a second network routing message for receipt by the controller, the second network routing message identifying an address in a second portion of the packet switched network, the second portion not controlled by the entity.

80. (Previously Presented) The method of Claim 79, wherein the packet switched network comprises the Internet.

81. (Previously Presented) The method of Claim 79, wherein the first participant identifier comprises a first participant telephone number or username.

82. (Previously Presented) The method of Claim 79, wherein the second participant identifier comprises a second participant telephone number or username.

83. (Previously Presented) The method of Claim 79, wherein the communication comprises a voice-over-IP communication.

Application No.: 13/966,096
Filing Date: August 13, 2013

84. (Previously Presented) The method of Claim 79, wherein the packet switched network is accessed via an Internet service provider.
85. (Previously Presented) The method of Claim 79, wherein the first participant profile further comprises a username and a domain associated with first participant.
86. (Previously Presented) The method of Claim 79, wherein the attributes comprise at least one of an international dialing digit (IDD), a national dialing digit (NDD), an area code, a country code and a number length range.
87. **(Currently amended)** The method of Claim 79, wherein the first network classification criterion is satisfied when the first participant identifier does not begin with the same international dialing digit (IDD) digit pattern as the second participant identifier.
88. **(Currently amended)** The method of Claim 79, wherein the first network classification criterion is satisfied when an address associated with the first participant and the address associated with the second participant are both in the first portion of the packet switched network.
89. (Previously Presented) The method of Claim 79, wherein the address in the first portion is accessible through the first participant's Internet service provider.
90. (Previously Presented) The method of Claim 79, wherein the first portion comprises one or more supernodes.
91. (Previously Presented) The method of Claim 79, further comprising storing in a database a direct inward dial (DID) record associated with at least one of the first participant and the second participant.

Application No.: 13/966,096
Filing Date: August 13, 2013

92. (Previously Presented) The method of Claim 91, wherein the stored DID record for the second participant comprises a username, a user domain and a record number.

93. (Previously Presented) The method of Claim 79, wherein the entity is an entity supplying communication services for the first portion.

94. (Previously Presented) The method of Claim 79, wherein the second network classification criterion is satisfied when access to the second participant requires routing through a portion of the packet switched network operated by a communication service supplier.

95. (Previously Presented) The method of Claim 91, wherein the second network classification criterion is satisfied when the second participant identifier is not associated with a stored DID record in the database.

96. (Previously Presented) The method of Claim 91, wherein the second network classification criterion is satisfied when:

the second participant identifier begins with the same international dialing digit (IDD) digit pattern as the first participant identifier; and

the second participant identifier, without considering the IDD digit pattern, has no stored DID record in the database.

97. (Previously Presented) The method of Claim 79, wherein the address in the second portion of the packet switched network comprises an address accessed by a communication service supplier.

98. (Previously Presented) The method of Claim 79, wherein producing the second network routing message identifying the address in the second portion comprises searching a database of route records associating route identifiers with dialing codes, in an attempt to find a route record having a dialing code with a number pattern matching at least a portion of second participant identifier.

Application No.: 13/966,096
Filing Date: August 13, 2013

99. (Previously Presented) A system for routing communications in a packet switched network in which a first participant in a communication has an associated first participant identifier and a second participant in the communication has an associated second participant identifier, the system comprising:

a controller comprising:

a processor operably configured to access a memory,
wherein the processor is configured to:

after the first participant has accessed the packet switched network to initiate the communication, locate a first participant profile in the memory using the first participant identifier, the first participant profile comprising a plurality of attributes associated with the first participant;

produce a first network routing message when at least one of the first participant attributes and at least a portion of the second participant identifier meet a first network classification criterion, the first network routing message identifying an address in a first portion of the packet switched network, the address being associated with the second participant, the first portion being controlled by an entity; and

produce a second network routing message when at least one of the first participant attributes and at least a portion of the second participant identifier meet a second network classification criterion, the second network routing message identifying an address in a second portion of the packet switched network, the second portion not controlled by the entity.

100. (Previously Presented) The system of Claim 99, wherein the communication comprises a voice-over-IP communication.

101. (Previously Presented) The system of Claim 99, wherein the packet switched network is accessed via an Internet service provider.

Application No.: 13/966,096
Filing Date: August 13, 2013

102. **(Currently amended)** The system of Claim 99, wherein the first network classification criterion is satisfied when the first participant identifier does not begin with the same international dialing digit (IDD) digit pattern as the second participant identifier.

103. (Previously Presented) The system of Claim 99, wherein the second network classification criterion is satisfied when access to the second participant requires routing through a portion of the packet switched network operated by a communication service supplier.

104. (Previously Presented) A non-transitory computer readable medium comprising instructions that when executed cause a processor to perform a method of routing communications in a packet switched network in which a first participant identifier is associated with a first participant and a second participant identifier is associated with a second participant in a communication, the method comprising:

after the first participant has accessed the packet switched network to initiate the communication, using the first participant identifier to locate a first participant profile comprising a plurality of attributes associated with the first participant;

when at least one of the first participant attributes and at least a portion of the second participant identifier meet a first network classification criterion, producing a first network routing message for receipt by a controller, the first network routing message identifying an address in a first portion of the packet switched network, the address being associated with the second participant, the first portion being controlled by an entity; and

when at least one of the first participant attributes and at least a portion of the second participant identifier meet a second network classification criterion, producing a second network routing message for receipt by the controller, the second network routing message identifying an address in a second portion of the packet switched network, the second portion not controlled by the entity.

Application No.: 13/966,096
Filing Date: August 13, 2013

REMARKS

The allowed claims are Claims 1-73 and 79-104. Claims 51, 87, 88 and 102 are amended by this paper. Claim 51 is amended is to correct a clerical error by adding the missing labels d) and e) for the last two steps. Claims 87, 88 and 102 are amended to add the inadvertently omitted word "network" prior to "classification" for proper antecedent basis.

Applicant respectfully submits that reasons for the amendments have been provided and that a) this amendment does not necessitate an additional search, b) no more than a cursory review of the record is necessary, and c) the amendment does not involve materially added work on the part of the Office. MPEP §714.16. Applicant respectfully submits that the amendments should be entered and all claims remain patentable.

Co-Pending Applications of Assignee

Applicant wishes to draw the Examiner's attention to the following co-pending applications owned by the same assignee.

Docket No.	Serial No.	Title	Filed
DIGIF.002C2	14/802929	Intercepting Voice Over IP Communications and Other Data Communications	07/17/15
DIGIF.005C2	14/802872	Uninterrupted Transmission of Internet Protocol Transmissions During Endpoint Changes	07/17/15

Application No.: 13/966,096
Filing Date: August 13, 2013

Conclusion

Although the present communication may include alterations to the application or claims, or characterizations of claim scope or referenced art, Applicant is not conceding in this application that previously pending claims are not patentable over the cited references. Rather, any alterations or characterizations are being made to facilitate expeditious prosecution of this application. Applicant reserves the right to pursue at a later date any previously pending or other broader or narrower claims that capture any subject matter supported by the present disclosure, including subject matter found to be specifically disclaimed herein or by any prior prosecution. Accordingly, reviewers of this or any parent, child or related prosecution history shall not reasonably infer that Applicant has made any disclaimers or disavowals of any subject matter supported by the present application.

If the Examiner has any questions which may be answered by telephone, the Examiner is invited to call the undersigned directly.

Please charge any additional fees, including any fees for additional extension of time, or credit overpayment to Deposit Account No. 11-1410.

Respectfully submitted,

KNOBBE, MARTENS, OLSON & BEAR, LLP

Dated: 9/18/15

By: 

John M. Carson
Registration No. 34,303
Attorney of Record
Customer No. 20995
(858) 707-4000

21489317
090115

Electronic Patent Application Fee Transmittal

Application Number:	13966096
Filing Date:	13-Aug-2013
Title of Invention:	PRODUCING ROUTING MESSAGES FOR VOICE OVER IP COMMUNICATIONS
First Named Inventor/Applicant Name:	CLAY PERREAULT
Filer:	John M Carson/Noriko Cook
Attorney Docket Number:	DIGIF.001C1

Filed as Small Entity

Filing Fees for Utility under 35 USC 111(a)

Description	Fee Code	Quantity	Amount	Sub-Total in USD(\$)
Basic Filing:				
Pages:				
Claims:				
Miscellaneous-Filing:				
Petition:				
Patent-Appeals-and-Interference:				
Post-Allowance-and-Post-Issuance:				
Utility Appl Issue Fee	2501	1	480	480

Description	Fee Code	Quantity	Amount	Sub-Total in USD(\$)
Extension-of-Time:				
Miscellaneous:				
Total in USD (\$)				480

Electronic Acknowledgement Receipt

EFS ID:	23432597
Application Number:	13966096
International Application Number:	
Confirmation Number:	8712
Title of Invention:	PRODUCING ROUTING MESSAGES FOR VOICE OVER IP COMMUNICATIONS
First Named Inventor/Applicant Name:	CLAY PERREULT
Customer Number:	20995
Filer:	John M Carson/Sandra Autry
Filer Authorized By:	John M Carson
Attorney Docket Number:	DIGIF.001C1
Receipt Date:	08-SEP-2015
Filing Date:	13-AUG-2013
Time Stamp:	19:57:30
Application Type:	Utility under 35 USC 111(a)

Payment information:

Submitted with Payment	yes
Payment Type	Credit Card
Payment was successfully received in RAM	\$480
RAM confirmation Number	7864
Deposit Account	111410
Authorized User	KNOBBE MARTENS OLSON AND BEAR

The Director of the USPTO is hereby authorized to charge indicated fees and credit any overpayment as follows:

Charge any Additional Fees required under 37 C.F.R. Section 1.16 (National application filing, search, and examination fees)

Charge any Additional Fees required under 37 C.F.R. Section 1.17 (Patent Application and Examination processing fees)

PETITIONER APPLE INC. EX: 1002-38

File Listing:					
Document Number	Document Description	File Name	File Size(Bytes)/ Message Digest	Multi Part /.zip	Pages (if appl.)
1	Issue Fee Payment (PTO-85B)	DIGIF_001C1_IssueFee.pdf	156332 1fa1e43a7021772a7a3d82a8a1a77b3c57c92c7c	no	1
Warnings:					
Information:					
2		DIGIF_001C1_Amend.pdf	1064283 f761642f8b559df030b57f5de07cd354fd162e28	yes	23
	Multipart Description/PDF files in .zip description				
	Document Description		Start	End	
	Amendment after Notice of Allowance (Rule 312)		1	1	
	Claims		2	21	
Applicant Arguments/Remarks Made in an Amendment		22	23		
Warnings:					
Information:					
3	Fee Worksheet (SB06)	fee-info.pdf	30603 099cd7dbee4324ee3007707b64cd517b95cad5c8	no	2
Warnings:					
Information:					
Total Files Size (in bytes):			1251218		

This Acknowledgement Receipt evidences receipt on the noted date by the USPTO of the indicated documents, characterized by the applicant, and including page counts, where applicable. It serves as evidence of receipt similar to a Post Card, as described in MPEP 503.

New Applications Under 35 U.S.C. 111

If a new application is being filed and the application includes the necessary components for a filing date (see 37 CFR 1.53(b)-(d) and MPEP 506), a Filing Receipt (37 CFR 1.54) will be issued in due course and the date shown on this Acknowledgement Receipt will establish the filing date of the application.

National Stage of an International Application under 35 U.S.C. 371

If a timely submission to enter the national stage of an international application is compliant with the conditions of 35 U.S.C. 371 and other applicable requirements a Form PCT/DO/EO/903 indicating acceptance of the application as a national stage submission under 35 U.S.C. 371 will be issued in addition to the Filing Receipt, in due course.

New International Application Filed with the USPTO as a Receiving Office

If a new international application is being filed and the international application includes the necessary components for an international filing date (see PCT Article 11 and MPEP 1810), a Notification of the International Application Number and of the International Filing Date (Form PCT/RO/105) will be issued in due course, subject to prescriptions concerning national security, and the date shown on this Acknowledgement Receipt will establish the international filing date of the application.

INFORMATION DISCLOSURE STATEMENT BY APPLICANT	Application No.	13/966,096	
	Filing Date	August 13, 2013	
	First Named Inventor	Perreault, Clay	
	Art Unit	2653	
<i>(Multiple sheets used when necessary)</i>		Examiner	Sing, Simon P.
SHEET 1 OF 2		Attorney Docket No.	DIGIF.001C1

U.S. PATENT DOCUMENTS					
Examiner Initials	Cite No.	Document Number Number - Kind Code (if known) Example: 1,234,567 B1	Publication Date MM-DD-YYYY	Name	Pages, Columns, Lines Where Relevant Passages or Relevant Figures Appear
	1	5,677,955 A1	10-14-1995	Doggett et al.	
	2	5,883,810 A1	03-16-1999	Franklin et al.	
	3	6,173,272 B1	01-09-2001	Thomas et al.	
	4	6,243,689 B1	06-05-2001	Norton, Robert G.	
	5	6,636,833 B1	10-21-2003	Fitcroft et al.	
	6	6,772,188 B1	08-03-2004	Cheng-Sheng et al.	
	7	6,892,184 B1	05-10-2005	Komen et al.	
	8	7,051,072 B2	05-23-2006	Stewart et al.	
	9	7,330,835 B2	02-12-2008	Deggendorf, Theresa M.	
	10	7,426,492 B2	09-16-2008	Bishop et al.	
	11	7,437,665 B2	10-14-2008	Perham, Michael	
	12	7,447,707 B2	11-04-2008	Gaurav et al.	
	13	7,580,886 B1	08-25-2009	Schulz, Larry	
	14	7,593,884 B2	09-22-2009	Rothman et al.	
	15	7,599,944 B2	10-06-2009	Gaurav et al.	
	16	7,644,037 B1	01-05-2010	Ostrovsky, Vladimir	
	17	7,647,500 B2	01-12-2010	Machiraju et al.	
	18	7,676,431 B2	03-09-2010	O'Leary et al.	
	19	7,680,737 B2	03-16-2010	Smith et al.	
	20	7,734,544 B2	06-08-2010	Schleicher, Joerg	
	21	7,765,261 B2	07-27-2010	Kropivny, Alexander	
	22	7,765,266 B2	07-27-2010	Kropivny, Alexander	
	23	7,882,011 B2	02-01-2011	Sandhu et al.	
	24	7,899,742 B2	03-11-2011	Berkert et al.	
	25	8,060,887 B2	11-15-2011	Kropivny, Alexander	
	26	8,161,078 B2	04-17-2012	Gaurav et al.	
	27	8,200,575 B2	06-12-2012	Torres et al.	
	28	8,543,477 B2	09-24-2013	Love et al.	
	29	8,627,211 B2	01-07-2014	Kropivny, Alexander	

Examiner Signature	/Simon Sing/	Date Considered	08/24/2015
--------------------	--------------	-----------------	------------

*Examiner: Initial if reference considered, whether or not citation is in conformance with MPEP 609. Draw line through citation if not in conformance and not considered. Include copy of this form with next communication to applicant.

T¹ - Place a check mark in this area when an English language Translation is attached.

INFORMATION DISCLOSURE STATEMENT BY APPLICANT	Application No.	13/966,096	
	Filing Date	August 13, 2013	
	First Named Inventor	Perreault, Clay	
	Art Unit	2653	
<i>(Multiple sheets used when necessary)</i>		Examiner	Sing, Simon P.
SHEET 2 OF 2		Attorney Docket No.	DIGIF.001C1

U.S. PATENT DOCUMENTS					
Examiner Initials	Cite No.	Document Number Number - Kind Code (if known) Example: 1,234,567 B1	Publication Date MM-DD-YYYY	Name	Pages, Columns, Lines Where Relevant Passages or Relevant Figures Appear
	30	8,702,505 B2	04-22-2014	Kropivny, Alexander	
	31	2005/0131813 A1	06-16-2005	Gallagher et al.	
	32	2005/0171898 A1	08-04-2005	Bishop et al.	
	33	2005/0192897 A1	09-01-2005	Rogers et al.	
	34	2005/0192901 A1	09-01-2005	McCoy et al.	
	35	2005/0222952 A1	10-06-2005	Garrett et al.	
	36	2005/0267842 A1	12-01-2005	Weichert et al.	
	37	2006/0006224 A1	01-12-2006	Modi, Vikram	
	38	2006/0036522 A1	02-15-2006	Perham, Michael	
	39	2006/0095320 A1	05-04-2006	Jones, Lisa	
	40	2006/0116892 A1	06-01-2006	Grimes et al.	
	41	2006/0195398 A1	08-31-2006	Dheer et al.	
	42	2007/0016524 A1	01-18-2007	Diveley, et al.	
	43	2014/0141884 A1	05-22-2014	Kropivny, Alexander	

FOREIGN PATENT DOCUMENTS						
Examiner Initials	Cite No.	Foreign Patent Document Country Code-Number-Kind Code Example: JP 1234567 A1	Publication Date MM-DD-YYYY	Name	Pages, Columns, Lines Where Relevant Passages or Relevant Figures Appear	T ¹

NON PATENT LITERATURE DOCUMENTS			
Examiner Initials	Cite No.	Include name of the author (in CAPITAL LETTERS), title of the article (when appropriate), title of the item (book, magazine, journal, serial, symposium, catalog, etc.), date, page(s), volume-issue number(s), publisher, city and/or country where published.	T ¹
	44	Ketchpel <i>et al.</i> "U-PAI: A universal payment application interface" <i>Second USENIX Workshop on Electronic Commerce Proceedings</i> , 1996-8, pages 1-17.	
	45	Moberg & Drummond, "MIME-Based Secure Peer-to-Peer Business Data Interchange Using HTTP, Applicability Statement 2 (AS2)," <i>Network Working Group, Request for Comments: 4130, Category: Standards Track</i> , Copyright © The Internet Society July 2005, pages 1-47.	
	46	Abrazhevich, Dennis. "Electronic Payment Systems: a User-Centered Perspective and Interaction Design," <i>Thesis under the auspices of the J.F. Schouten School for User-System Interaction Research</i> , Technische Universiteit Eindhoven, Netherlands, 2004, pages Cover page - page 189.	

21269338
080315

Examiner Signature	/Simon Sing/	Date Considered	08/24/2015
--------------------	--------------	-----------------	------------

*Examiner: Initial if reference considered, whether or not citation is in conformance with MPEP 609. Draw line through citation if not in conformance and not considered. Include copy of this form with next communication to applicant.

T¹ - Place a check mark in this area when an English language Translation is attached

PETITIONER APPLE INC. EX. 1002-42

ALL REFERENCES CONSIDERED EXCEPT WHERE LINED THROUGH. /SS/



UNITED STATES PATENT AND TRADEMARK OFFICE

UNITED STATES DEPARTMENT OF COMMERCE
United States Patent and Trademark Office
Address: COMMISSIONER FOR PATENTS
P.O. Box 1450
Alexandria, Virginia 22313-1450
www.uspto.gov

Table with 5 columns: APPLICATION NO., FILING DATE, FIRST NAMED INVENTOR, ATTORNEY DOCKET NO., CONFIRMATION NO.
13/966,096 08/13/2013 CLAY PERREAULT DIGIF.001C1 8712

20995 7590 08/27/2015
KNOBBE MARTENS OLSON & BEAR LLP
2040 MAIN STREET
FOURTEENTH FLOOR
IRVINE, CA 92614

EXAMINER

SING, SIMON P

ART UNIT PAPER NUMBER

2653

NOTIFICATION DATE DELIVERY MODE

08/27/2015

ELECTRONIC

Please find below and/or attached an Office communication concerning this application or proceeding.

The time period for reply, if any, is set in the attached communication.

Notice of the Office communication was sent electronically on above-indicated "Notification Date" to the following e-mail address(es):

jayna.cartee@knobbe.com
efiling@knobbe.com

**Supplemental
Notice of Allowability**

Application No. 13/966,096	Applicant(s) PERREAULT ET AL.	
Examiner SIMON SING	Art Unit 2653	AIA (First Inventor to File) Status No

-- The MAILING DATE of this communication appears on the cover sheet with the correspondence address--

All claims being allowable, PROSECUTION ON THE MERITS IS (OR REMAINS) CLOSED in this application. If not included herewith (or previously mailed), a Notice of Allowance (PTOL-85) or other appropriate communication will be mailed in due course. **THIS NOTICE OF ALLOWABILITY IS NOT A GRANT OF PATENT RIGHTS.** This application is subject to withdrawal from issue at the initiative of the Office or upon petition by the applicant. See 37 CFR 1.313 and MPEP 1308.

- This communication is responsive to IDS filed on 08/03/2015.
 A declaration(s)/affidavit(s) under **37 CFR 1.130(b)** was/were filed on _____.
- An election was made by the applicant in response to a restriction requirement set forth during the interview on _____; the restriction requirement and election have been incorporated into this action.
- The allowed claim(s) is/are _____. As a result of the allowed claim(s), you may be eligible to benefit from the **Patent Prosecution Highway** program at a participating intellectual property office for the corresponding application. For more information, please see http://www.uspto.gov/patents/init_events/pph/index.jsp or send an inquiry to PPHfeedback@uspto.gov.
- Acknowledgment is made of a claim for foreign priority under 35 U.S.C. § 119(a)-(d) or (f).

Certified copies:

- a) All b) Some *c) None of the:
- Certified copies of the priority documents have been received.
 - Certified copies of the priority documents have been received in Application No. _____.
 - Copies of the certified copies of the priority documents have been received in this national stage application from the International Bureau (PCT Rule 17.2(a)).

* Certified copies not received: _____.

Applicant has **THREE MONTHS FROM THE "MAILING DATE"** of this communication to file a reply complying with the requirements noted below. Failure to timely comply will result in **ABANDONMENT** of this application.

THIS THREE-MONTH PERIOD IS NOT EXTENDABLE.

- CORRECTED DRAWINGS** (as "replacement sheets") must be submitted.
 including changes required by the attached Examiner's Amendment / Comment or in the Office action of Paper No./Mail Date _____.
Identifying indicia such as the application number (see 37 CFR 1.84(c)) should be written on the drawings in the front (not the back) of each sheet. Replacement sheet(s) should be labeled as such in the header according to 37 CFR 1.121(d).
- DEPOSIT OF and/or INFORMATION** about the deposit of **BIOLOGICAL MATERIAL** must be submitted. Note the attached Examiner's comment regarding **REQUIREMENT FOR THE DEPOSIT OF BIOLOGICAL MATERIAL**.

Attachment(s)

- | | |
|--|---|
| 1. <input type="checkbox"/> Notice of References Cited (PTO-892) | 5. <input type="checkbox"/> Examiner's Amendment/Comment |
| 2. <input checked="" type="checkbox"/> Information Disclosure Statements (PTO/SB/08),
Paper No./Mail Date <u>08/03/2015</u> | 6. <input type="checkbox"/> Examiner's Statement of Reasons for Allowance |
| 3. <input type="checkbox"/> Examiner's Comment Regarding Requirement for Deposit
of Biological Material | 7. <input type="checkbox"/> Other _____. |
| 4. <input type="checkbox"/> Interview Summary (PTO-413),
Paper No./Mail Date _____. | |

/SIMON SING/
Primary Examiner, Art Unit 2653

INFORMATION DISCLOSURE STATEMENT BY APPLICANT	Application No.	13/966,096	
	Filing Date	August 13, 2013	
	First Named Inventor	Perreault, Clay	
	Art Unit	2653	
<i>(Multiple sheets used when necessary)</i>		Examiner	Sing, Simon P.
SHEET 1 OF 2		Attorney Docket No.	DIGIF.001C1

U.S. PATENT DOCUMENTS					
Examiner Initials	Cite No.	Document Number Number - Kind Code (if known) Example: 1,234,567 B1	Publication Date MM-DD-YYYY	Name	Pages, Columns, Lines Where Relevant Passages or Relevant Figures Appear
	1	5,677,955 A1	10-14-1995	Doggett et al.	
	2	5,883,810 A1	03-16-1999	Franklin et al.	
	3	6,173,272 B1	01-09-2001	Thomas et al.	
	4	6,243,689 B1	06-05-2001	Norton, Robert G.	
	5	6,636,833 B1	10-21-2003	Fitcroft et al.	
	6	6,772,188 B1	08-03-2004	Cheng-Sheng et al.	
	7	6,892,184 B1	05-10-2005	Komen et al.	
	8	7,051,072 B2	05-23-2006	Stewart et al.	
	9	7,330,835 B2	02-12-2008	Deggendorf, Theresa M.	
	10	7,426,492 B2	09-16-2008	Bishop et al.	
	11	7,437,665 B2	10-14-2008	Perham, Michael	
	12	7,447,707 B2	11-04-2008	Gaurav et al.	
	13	7,580,886 B1	08-25-2009	Schulz, Larry	
	14	7,593,884 B2	09-22-2009	Rothman et al.	
	15	7,599,944 B2	10-06-2009	Gaurav et al.	
	16	7,644,037 B1	01-05-2010	Ostrovsky, Vladimir	
	17	7,647,500 B2	01-12-2010	Machiraju et al.	
	18	7,676,431 B2	03-09-2010	O'Leary et al.	
	19	7,680,737 B2	03-16-2010	Smith et al.	
	20	7,734,544 B2	06-08-2010	Schleicher, Joerg	
	21	7,765,261 B2	07-27-2010	Kropivny, Alexander	
	22	7,765,266 B2	07-27-2010	Kropivny, Alexander	
	23	7,882,011 B2	02-01-2011	Sandhu et al.	
	24	7,899,742 B2	03-11-2011	Berkert et al.	
	25	8,060,887 B2	11-15-2011	Kropivny, Alexander	
	26	8,161,078 B2	04-17-2012	Gaurav et al.	
	27	8,200,575 B2	06-12-2012	Torres et al.	
	28	8,543,477 B2	09-24-2013	Love et al.	
	29	8,627,211 B2	01-07-2014	Kropivny, Alexander	

Examiner Signature	/Simon Sing/	Date Considered	08/24/2015
--------------------	--------------	-----------------	------------

*Examiner: Initial if reference considered, whether or not citation is in conformance with MPEP 609. Draw line through citation if not in conformance and not considered. Include copy of this form with next communication to applicant.

T¹ - Place a check mark in this area when an English language Translation is attached.

PETITIONER APPLE INC. EX. 1002-45

ALL REFERENCES CONSIDERED EXCEPT WHERE LINED THROUGH. /SS/

INFORMATION DISCLOSURE STATEMENT BY APPLICANT	Application No.	13/966,096	
	Filing Date	August 13, 2013	
	First Named Inventor	Perreault, Clay	
	Art Unit	2653	
<i>(Multiple sheets used when necessary)</i>		Examiner	Sing, Simon P.
SHEET 2 OF 2		Attorney Docket No.	DIGIF.001C1

U.S. PATENT DOCUMENTS					
Examiner Initials	Cite No.	Document Number Number - Kind Code (if known) Example: 1,234,567 B1	Publication Date MM-DD-YYYY	Name	Pages, Columns, Lines Where Relevant Passages or Relevant Figures Appear
	30	8,702,505 B2	04-22-2014	Kropivny, Alexander	
	31	2005/0131813 A1	06-16-2005	Gallagher et al.	
	32	2005/0171898 A1	08-04-2005	Bishop et al.	
	33	2005/0192897 A1	09-01-2005	Rogers et al.	
	34	2005/0192901 A1	09-01-2005	McCoy et al.	
	35	2005/0222952 A1	10-06-2005	Garrett et al.	
	36	2005/0267842 A1	12-01-2005	Weichert et al.	
	37	2006/0006224 A1	01-12-2006	Modi, Vikram	
	38	2006/0036522 A1	02-15-2006	Perham, Michael	
	39	2006/0095320 A1	05-04-2006	Jones, Lisa	
	40	2006/0116892 A1	06-01-2006	Grimes et al.	
	41	2006/0195398 A1	08-31-2006	Dheer et al.	
	42	2007/0016524 A1	01-18-2007	Diveley, et al.	
	43	2014/0141884 A1	05-22-2014	Kropivny, Alexander	

FOREIGN PATENT DOCUMENTS						
Examiner Initials	Cite No.	Foreign Patent Document Country Code-Number-Kind Code Example: JP 1234567 A1	Publication Date MM-DD-YYYY	Name	Pages, Columns, Lines Where Relevant Passages or Relevant Figures Appear	T ¹

NON PATENT LITERATURE DOCUMENTS			
Examiner Initials	Cite No.	Include name of the author (in CAPITAL LETTERS), title of the article (when appropriate), title of the item (book, magazine, journal, serial, symposium, catalog, etc.), date, page(s), volume-issue number(s), publisher, city and/or country where published.	T ¹
	44	Ketchpel <i>et al.</i> "U-PAI: A universal payment application interface" <i>Second USENIX Workshop on Electronic Commerce Proceedings</i> , 1996-8, pages 1-17.	
	45	Moberg & Drummond, "MIME-Based Secure Peer-to-Peer Business Data Interchange Using HTTP, Applicability Statement 2 (AS2)," <i>Network Working Group, Request for Comments: 4130, Category: Standards Track</i> , Copyright © The Internet Society July 2005, pages 1-47.	
	46	Abrazhevich, Dennis. "Electronic Payment Systems: a User-Centered Perspective and Interaction Design," <i>Thesis under the auspices of the J.F. Schouten School for User-System Interaction Research</i> , Technische Universiteit Eindhoven, Netherlands, 2004, pages Cover page - page 189.	

21269338
080315

Examiner Signature	/Simon Sing/	Date Considered	08/24/2015
--------------------	--------------	-----------------	------------

*Examiner: Initial if reference considered, whether or not citation is in conformance with MPEP 609. Draw line through citation if not in conformance and not considered. Include copy of this form with next communication to applicant.

T¹ - Place a check mark in this area when an English language translation is attached

PETITIONER APPLE INC. EX. 1002-46

ALL REFERENCES CONSIDERED EXCEPT WHERE LINED THROUGH. /SS/



NOTICE OF ALLOWANCE AND FEE(S) DUE

20995 7590 08/13/2015
KNOBBE MARTENS OLSON & BEAR LLP
2040 MAIN STREET
FOURTEENTH FLOOR
IRVINE, CA 92614

Table with 2 columns: EXAMINER (SING, SIMON P), ART UNIT (2653), PAPER NUMBER (8712)

DATE MAILED: 08/13/2015

Table with 5 columns: APPLICATION NO. (13/966,096), FILING DATE (08/13/2013), FIRST NAMED INVENTOR (CLAY PERREAULT), ATTORNEY DOCKET NO. (DIGIF.001C1), CONFIRMATION NO. (8712)

TITLE OF INVENTION: PRODUCING ROUTING MESSAGES FOR VOICE OVER IP COMMUNICATIONS

Table with 7 columns: APPLN. TYPE (nonprovisional), ENTITY STATUS (SMALL), ISSUE FEE DUE (\$480), PUBLICATION FEE DUE (\$0), PREV. PAID ISSUE FEE (\$0), TOTAL FEE(S) DUE (\$480), DATE DUE (11/13/2015)

THE APPLICATION IDENTIFIED ABOVE HAS BEEN EXAMINED AND IS ALLOWED FOR ISSUANCE AS A PATENT. PROSECUTION ON THE MERITS IS CLOSED. THIS NOTICE OF ALLOWANCE IS NOT A GRANT OF PATENT RIGHTS. THIS APPLICATION IS SUBJECT TO WITHDRAWAL FROM ISSUE AT THE INITIATIVE OF THE OFFICE OR UPON PETITION BY THE APPLICANT. SEE 37 CFR 1.313 AND MPEP 1308.

THE ISSUE FEE AND PUBLICATION FEE (IF REQUIRED) MUST BE PAID WITHIN THREE MONTHS FROM THE MAILING DATE OF THIS NOTICE OR THIS APPLICATION SHALL BE REGARDED AS ABANDONED. THIS STATUTORY PERIOD CANNOT BE EXTENDED. SEE 35 U.S.C. 151. THE ISSUE FEE DUE INDICATED ABOVE DOES NOT REFLECT A CREDIT FOR ANY PREVIOUSLY PAID ISSUE FEE IN THIS APPLICATION. IF AN ISSUE FEE HAS PREVIOUSLY BEEN PAID IN THIS APPLICATION (AS SHOWN ABOVE), THE RETURN OF PART B OF THIS FORM WILL BE CONSIDERED A REQUEST TO REAPPLY THE PREVIOUSLY PAID ISSUE FEE TOWARD THE ISSUE FEE NOW DUE.

HOW TO REPLY TO THIS NOTICE:

I. Review the ENTITY STATUS shown above. If the ENTITY STATUS is shown as SMALL or MICRO, verify whether entitlement to that entity status still applies. If the ENTITY STATUS is the same as shown above, pay the TOTAL FEE(S) DUE shown above. If the ENTITY STATUS is changed from that shown above, on PART B - FEE(S) TRANSMITTAL, complete section number 5 titled "Change in Entity Status (from status indicated above)". For purposes of this notice, small entity fees are 1/2 the amount of undiscounted fees, and micro entity fees are 1/2 the amount of small entity fees.

II. PART B - FEE(S) TRANSMITTAL, or its equivalent, must be completed and returned to the United States Patent and Trademark Office (USPTO) with your ISSUE FEE and PUBLICATION FEE (if required). If you are charging the fee(s) to your deposit account, section "4b" of Part B - Fee(s) Transmittal should be completed and an extra copy of the form should be submitted. If an equivalent of Part B is filed, a request to reapply a previously paid issue fee must be clearly made, and delays in processing may occur due to the difficulty in recognizing the paper as an equivalent of Part B.

III. All communications regarding this application must give the application number. Please direct all communications prior to issuance to Mail Stop ISSUE FEE unless advised to the contrary.

IMPORTANT REMINDER: Utility patents issuing on applications filed on or after Dec. 12, 1980 may require payment of maintenance fees. It is patentee's responsibility to ensure timely payment of maintenance fees when due.

PART B - FEE(S) TRANSMITTAL

**Complete and send this form, together with applicable fee(s), to: Mail Mail Stop ISSUE FEE
 Commissioner for Patents
 P.O. Box 1450
 Alexandria, Virginia 22313-1450
 or Fax (571)-273-2885**

INSTRUCTIONS: This form should be used for transmitting the ISSUE FEE and PUBLICATION FEE (if required). Blocks 1 through 5 should be completed where appropriate. All further correspondence including the Patent, advance orders and notification of maintenance fees will be mailed to the current correspondence address as indicated unless corrected below or directed otherwise in Block 1, by (a) specifying a new correspondence address; and/or (b) indicating a separate "FEE ADDRESS" for maintenance fee notifications.

Note: A certificate of mailing can only be used for domestic mailings of the Fee(s) Transmittal. This certificate cannot be used for any other accompanying papers. Each additional paper, such as an assignment or formal drawing, must have its own certificate of mailing or transmission.

CURRENT CORRESPONDENCE ADDRESS (Note: Use Block 1 for any change of address)

20995 7590 08/13/2015
KNOBBE MARTENS OLSON & BEAR LLP
 2040 MAIN STREET
 FOURTEENTH FLOOR
 IRVINE, CA 92614

Certificate of Mailing or Transmission

I hereby certify that this Fee(s) Transmittal is being deposited with the United States Postal Service with sufficient postage for first class mail in an envelope addressed to the Mail Stop ISSUE FEE address above, or being facsimile transmitted to the USPTO (571) 273-2885, on the date indicated below.

(Depositor's name)
(Signature)
(Date)

APPLICATION NO.	FILING DATE	FIRST NAMED INVENTOR	ATTORNEY DOCKET NO.	CONFIRMATION NO.
13/966,096	08/13/2013	CLAY PERREAULT	DIGIF.001C1	8712

TITLE OF INVENTION: PRODUCING ROUTING MESSAGES FOR VOICE OVER IP COMMUNICATIONS

APPLN. TYPE	ENTITY STATUS	ISSUE FEE DUE	PUBLICATION FEE DUE	PREV. PAID ISSUE FEE	TOTAL FEE(S) DUE	DATE DUE
nonprovisional	SMALL	\$480	\$0	\$0	\$480	11/13/2015

EXAMINER	ART UNIT	CLASS-SUBCLASS
SING, SIMON P	2653	379-142040

<p>1. Change of correspondence address or indication of "Fee Address" (37 CFR 1.363).</p> <p><input type="checkbox"/> Change of correspondence address (or Change of Correspondence Address form PTO/SB/122) attached.</p> <p><input type="checkbox"/> "Fee Address" indication (or "Fee Address" Indication form PTO/SB/47; Rev 03-02 or more recent) attached. Use of a Customer Number is required.</p>	<p>2. For printing on the patent front page, list</p> <p>(1) The names of up to 3 registered patent attorneys or agents OR, alternatively, 1 _____</p> <p>(2) The name of a single firm (having as a member a registered attorney or agent) and the names of up to 2 registered patent attorneys or agents. If no name is listed, no name will be printed. 2 _____</p> <p>3 _____</p>
---	---

3. ASSIGNEE NAME AND RESIDENCE DATA TO BE PRINTED ON THE PATENT (print or type)

PLEASE NOTE: Unless an assignee is identified below, no assignee data will appear on the patent. If an assignee is identified below, the document has been filed for recordation as set forth in 37 CFR 3.11. Completion of this form is NOT a substitute for filing an assignment.

(A) NAME OF ASSIGNEE _____ (B) RESIDENCE: (CITY and STATE OR COUNTRY) _____

Please check the appropriate assignee category or categories (will not be printed on the patent) : Individual Corporation or other private group entity Government

<p>4a. The following fee(s) are submitted:</p> <p><input type="checkbox"/> Issue Fee</p> <p><input type="checkbox"/> Publication Fee (No small entity discount permitted)</p> <p><input type="checkbox"/> Advance Order - # of Copies _____</p>	<p>4b. Payment of Fee(s): (Please first reapply any previously paid issue fee shown above)</p> <p><input type="checkbox"/> A check is enclosed.</p> <p><input type="checkbox"/> Payment by credit card. Form PTO-2038 is attached.</p> <p><input type="checkbox"/> The director is hereby authorized to charge the required fee(s), any deficiency, or credits any overpayment, to Deposit Account Number _____ (enclose an extra copy of this form).</p>
---	--

5. **Change in Entity Status** (from status indicated above)

Applicant certifying micro entity status. See 37 CFR 1.29

Applicant asserting small entity status. See 37 CFR 1.27

Applicant changing to regular undiscounted fee status.

NOTE: Absent a valid certification of Micro Entity Status (see forms PTO/SB/15A and 15B), issue fee payment in the micro entity amount will not be accepted at the risk of application abandonment.

NOTE: If the application was previously under micro entity status, checking this box will be taken to be a notification of loss of entitlement to micro entity status.

NOTE: Checking this box will be taken to be a notification of loss of entitlement to small or micro entity status, as applicable.

NOTE: This form must be signed in accordance with 37 CFR 1.31 and 1.33. See 37 CFR 1.4 for signature requirements and certifications.

Authorized Signature _____ Date _____

Typed or printed name _____ Registration No. _____



UNITED STATES PATENT AND TRADEMARK OFFICE

UNITED STATES DEPARTMENT OF COMMERCE
United States Patent and Trademark Office
Address: COMMISSIONER FOR PATENTS
P.O. Box 1450
Alexandria, Virginia 22313-1450
www.uspto.gov

Table with 5 columns: APPLICATION NO., FILING DATE, FIRST NAMED INVENTOR, ATTORNEY DOCKET NO., CONFIRMATION NO.
Values: 13/966,096, 08/13/2013, CLAY PERREAULT, DIGIF.001C1, 8712

20995 7590 08/13/2015
KNOBBE MARTENS OLSON & BEAR LLP
2040 MAIN STREET
FOURTEENTH FLOOR
IRVINE, CA 92614

EXAMINER
SING, SIMON P

ART UNIT PAPER NUMBER
2653

DATE MAILED: 08/13/2015

Determination of Patent Term Adjustment under 35 U.S.C. 154 (b)

(Applications filed on or after May 29, 2000)

The Office has discontinued providing a Patent Term Adjustment (PTA) calculation with the Notice of Allowance.

Section 1(h)(2) of the AIA Technical Corrections Act amended 35 U.S.C. 154(b)(3)(B)(i) to eliminate the requirement that the Office provide a patent term adjustment determination with the notice of allowance. See Revisions to Patent Term Adjustment, 78 Fed. Reg. 19416, 19417 (Apr. 1, 2013). Therefore, the Office is no longer providing an initial patent term adjustment determination with the notice of allowance. The Office will continue to provide a patent term adjustment determination with the Issue Notification Letter that is mailed to applicant approximately three weeks prior to the issue date of the patent, and will include the patent term adjustment on the patent. Any request for reconsideration of the patent term adjustment determination (or reinstatement of patent term adjustment) should follow the process outlined in 37 CFR 1.705.

Any questions regarding the Patent Term Extension or Adjustment determination should be directed to the Office of Patent Legal Administration at (571)-272-7702. Questions relating to issue and publication fee payments should be directed to the Customer Service Center of the Office of Patent Publication at 1-(888)-786-0101 or (571)-272-4200.

OMB Clearance and PRA Burden Statement for PTOL-85 Part B

The Paperwork Reduction Act (PRA) of 1995 requires Federal agencies to obtain Office of Management and Budget approval before requesting most types of information from the public. When OMB approves an agency request to collect information from the public, OMB (i) provides a valid OMB Control Number and expiration date for the agency to display on the instrument that will be used to collect the information and (ii) requires the agency to inform the public about the OMB Control Number's legal significance in accordance with 5 CFR 1320.5(b).

The information collected by PTOL-85 Part B is required by 37 CFR 1.311. The information is required to obtain or retain a benefit by the public which is to file (and by the USPTO to process) an application. Confidentiality is governed by 35 U.S.C. 122 and 37 CFR 1.14. This collection is estimated to take 12 minutes to complete, including gathering, preparing, and submitting the completed application form to the USPTO. Time will vary depending upon the individual case. Any comments on the amount of time you require to complete this form and/or suggestions for reducing this burden, should be sent to the Chief Information Officer, U.S. Patent and Trademark Office, U.S. Department of Commerce, P.O. Box 1450, Alexandria, Virginia 22313-1450. DO NOT SEND FEES OR COMPLETED FORMS TO THIS ADDRESS. SEND TO: Commissioner for Patents, P.O. Box 1450, Alexandria, Virginia 22313-1450. Under the Paperwork Reduction Act of 1995, no persons are required to respond to a collection of information unless it displays a valid OMB control number.

Privacy Act Statement

The Privacy Act of 1974 (P.L. 93-579) requires that you be given certain information in connection with your submission of the attached form related to a patent application or patent. Accordingly, pursuant to the requirements of the Act, please be advised that: (1) the general authority for the collection of this information is 35 U.S.C. 2(b)(2); (2) furnishing of the information solicited is voluntary; and (3) the principal purpose for which the information is used by the U.S. Patent and Trademark Office is to process and/or examine your submission related to a patent application or patent. If you do not furnish the requested information, the U.S. Patent and Trademark Office may not be able to process and/or examine your submission, which may result in termination of proceedings or abandonment of the application or expiration of the patent.

The information provided by you in this form will be subject to the following routine uses:

1. The information on this form will be treated confidentially to the extent allowed under the Freedom of Information Act (5 U.S.C. 552) and the Privacy Act (5 U.S.C. 552a). Records from this system of records may be disclosed to the Department of Justice to determine whether disclosure of these records is required by the Freedom of Information Act.
2. A record from this system of records may be disclosed, as a routine use, in the course of presenting evidence to a court, magistrate, or administrative tribunal, including disclosures to opposing counsel in the course of settlement negotiations.
3. A record in this system of records may be disclosed, as a routine use, to a Member of Congress submitting a request involving an individual, to whom the record pertains, when the individual has requested assistance from the Member with respect to the subject matter of the record.
4. A record in this system of records may be disclosed, as a routine use, to a contractor of the Agency having need for the information in order to perform a contract. Recipients of information shall be required to comply with the requirements of the Privacy Act of 1974, as amended, pursuant to 5 U.S.C. 552a(m).
5. A record related to an International Application filed under the Patent Cooperation Treaty in this system of records may be disclosed, as a routine use, to the International Bureau of the World Intellectual Property Organization, pursuant to the Patent Cooperation Treaty.
6. A record in this system of records may be disclosed, as a routine use, to another federal agency for purposes of National Security review (35 U.S.C. 181) and for review pursuant to the Atomic Energy Act (42 U.S.C. 218(c)).
7. A record from this system of records may be disclosed, as a routine use, to the Administrator, General Services, or his/her designee, during an inspection of records conducted by GSA as part of that agency's responsibility to recommend improvements in records management practices and programs, under authority of 44 U.S.C. 2904 and 2906. Such disclosure shall be made in accordance with the GSA regulations governing inspection of records for this purpose, and any other relevant (i.e., GSA or Commerce) directive. Such disclosure shall not be used to make determinations about individuals.
8. A record from this system of records may be disclosed, as a routine use, to the public after either publication of the application pursuant to 35 U.S.C. 122(b) or issuance of a patent pursuant to 35 U.S.C. 151. Further, a record may be disclosed, subject to the limitations of 37 CFR 1.14, as a routine use, to the public if the record was filed in an application which became abandoned or in which the proceedings were terminated and which application is referenced by either a published application, an application open to public inspection or an issued patent.
9. A record from this system of records may be disclosed, as a routine use, to a Federal, State, or local law enforcement agency, if the USPTO becomes aware of a violation or potential violation of law or regulation.

Notice of Allowability	Application No. 13/966,096	Applicant(s) PERREAULT ET AL.	
	Examiner SIMON SING	Art Unit 2653	AIA (First Inventor to File) Status No

-- The MAILING DATE of this communication appears on the cover sheet with the correspondence address--

All claims being allowable, PROSECUTION ON THE MERITS IS (OR REMAINS) CLOSED in this application. If not included herewith (or previously mailed), a Notice of Allowance (PTOL-85) or other appropriate communication will be mailed in due course. **THIS NOTICE OF ALLOWABILITY IS NOT A GRANT OF PATENT RIGHTS.** This application is subject to withdrawal from issue at the initiative of the Office or upon petition by the applicant. See 37 CFR 1.313 and MPEP 1308.

1. This communication is responsive to terminal disclaimer filed on 06/29/2015.
 A declaration(s)/affidavit(s) under **37 CFR 1.130(b)** was/were filed on _____.
2. An election was made by the applicant in response to a restriction requirement set forth during the interview on _____; the restriction requirement and election have been incorporated into this action.
3. The allowed claim(s) is/are 1-73 and 79-104. As a result of the allowed claim(s), you may be eligible to benefit from the **Patent Prosecution Highway** program at a participating intellectual property office for the corresponding application. For more information, please see http://www.uspto.gov/patents/init_events/oph/index.jsp or send an inquiry to PPHfeedback@uspto.gov.
4. Acknowledgment is made of a claim for foreign priority under 35 U.S.C. § 119(a)-(d) or (f).

Certified copies:

- a) All b) Some *c) None of the:
1. Certified copies of the priority documents have been received.
 2. Certified copies of the priority documents have been received in Application No. _____.
 3. Copies of the certified copies of the priority documents have been received in this national stage application from the International Bureau (PCT Rule 17.2(a)).

* Certified copies not received: _____.

Applicant has **THREE MONTHS FROM THE "MAILING DATE"** of this communication to file a reply complying with the requirements noted below. Failure to timely comply will result in **ABANDONMENT** of this application.

THIS THREE-MONTH PERIOD IS NOT EXTENDABLE.

5. CORRECTED DRAWINGS (as "replacement sheets") must be submitted.
 including changes required by the attached Examiner's Amendment / Comment or in the Office action of Paper No./Mail Date _____.
Identifying indicia such as the application number (see 37 CFR 1.84(c)) should be written on the drawings in the front (not the back) of each sheet. Replacement sheet(s) should be labeled as such in the header according to 37 CFR 1.121(d).
6. DEPOSIT OF and/or INFORMATION about the deposit of BIOLOGICAL MATERIAL must be submitted. Note the attached Examiner's comment regarding REQUIREMENT FOR THE DEPOSIT OF BIOLOGICAL MATERIAL.

Attachment(s)

- | | |
|---|---|
| <ol style="list-style-type: none"> 1. <input type="checkbox"/> Notice of References Cited (PTO-892) 2. <input checked="" type="checkbox"/> Information Disclosure Statements (PTO/SB/08),
Paper No./Mail Date <u>05/15/15, 06/11/15, 06/25/15, 06/30/15</u> 3. <input type="checkbox"/> Examiner's Comment Regarding Requirement for Deposit of Biological Material 4. <input type="checkbox"/> Interview Summary (PTO-413),
Paper No./Mail Date _____. | <ol style="list-style-type: none"> 5. <input type="checkbox"/> Examiner's Amendment/Comment 6. <input type="checkbox"/> Examiner's Statement of Reasons for Allowance 7. <input type="checkbox"/> Other _____. |
|---|---|

/SIMON SING/
Primary Examiner, Art Unit 2653

Issue Classification 	Application/Control No. 13966096	Applicant(s)/Patent Under Reexamination PERREAU ET AL.	
	Examiner SIMON SING	Art Unit 2653	

CPC						
Symbol					Type	Version
H04M		15		51	F	2013-01-01
H04L		9		3226	I	2013-01-01
H04L		12		14	I	2013-01-01
H04L		12		1439	I	2013-01-01
H04L		12		1496	I	2013-01-01
H04L		12		66	I	2013-01-01
H04Q		3		66	I	2013-01-01
H04Q		3		70	I	2013-01-01
H04Q		2213		13091	A	2013-01-01
H04Q		2213		13141	A	2013-01-01
H04Q		2213		13196	A	2013-01-01
H04Q		2213		1322	A	2013-01-01
H04Q		2213		13384	A	2013-01-01
H04M		7		0075	I	2013-01-01
H04M		15		56	I	2013-01-01

CPC Combination Sets				
Symbol	Type	Set	Ranking	Version

NONE		Total Claims Allowed:	
(Assistant Examiner)	(Date)	99	
/SIMON SING/ Primary Examiner.Art Unit 2653	08/01/2015	O.G. Print Claim(s)	O.G. Print Figure
(Primary Examiner)	(Date)	1	1

Issue Classification 	Application/Control No. 13966096	Applicant(s)/Patent Under Reexamination PERREAULT ET AL.
	Examiner SIMON SING	Art Unit 2653

US ORIGINAL CLASSIFICATION						INTERNATIONAL CLASSIFICATION											
CLASS		SUBCLASS				CLAIMED				NON-CLAIMED							
CROSS REFERENCE(S)																	
CLASS	SUBCLASS (ONE SUBCLASS PER BLOCK)																

NONE		Total Claims Allowed:	
		99	
(Assistant Examiner)	(Date)		
/SIMON SING/ Primary Examiner. Art Unit 2653	08/01/2015	O.G. Print Claim(s)	O.G. Print Figure
(Primary Examiner)	(Date)	1	1

Issue Classification 	Application/Control No. 13966096	Applicant(s)/Patent Under Reexamination PERREAULT ET AL.
	Examiner SIMON SING	Art Unit 2653

<input type="checkbox"/> Claims renumbered in the same order as presented by applicant		<input type="checkbox"/> CPA		<input checked="" type="checkbox"/> T.D.		<input type="checkbox"/> R.1.47									
Final	Original	Final	Original	Final	Original	Final	Original	Final	Original	Final	Original	Final	Original	Final	Original
1	1	17	17	33	33	49	49	65	65	76	81	92	97		
2	2	18	18	34	34	50	50	66	66	77	82	93	98		
3	3	19	19	35	35	51	51	67	67	78	83	94	99		
4	4	20	20	36	36	52	52	68	68	79	84	95	100		
5	5	21	21	37	37	53	53	69	69	80	85	96	101		
6	6	22	22	38	38	54	54	70	70	81	86	97	102		
7	7	23	23	39	39	55	55	71	71	82	87	98	103		
8	8	24	24	40	40	56	56	72	72	83	88	99	104		
9	9	25	25	41	41	57	57	73	73	84	89				
10	10	26	26	42	42	58	58	-	74	85	90				
11	11	27	27	43	43	59	59	-	75	86	91				
12	12	28	28	44	44	60	60	-	76	87	92				
13	13	29	29	45	45	61	61	-	77	88	93				
14	14	30	30	46	46	62	62	-	78	89	94				
15	15	31	31	47	47	63	63	74	79	90	95				
16	16	32	32	48	48	64	64	75	80	91	96				

NONE		Total Claims Allowed:	
		99	
(Assistant Examiner)	(Date)	O.G. Print Claim(s)	O.G. Print Figure
/SIMON SING/ Primary Examiner.Art Unit 2653	08/01/2015	1	1
(Primary Examiner)	(Date)		

Search Notes 	Application/Control No. 13966096	Applicant(s)/Patent Under Reexamination PERREault ET AL.
	Examiner SIMON SING	Art Unit 2653

CPC- SEARCHED		
Symbol	Date	Examiner
H04M: 1/573, 3/42059; H04Q: 3/0025, 2213/13091	07/31/2015	SS

CPC COMBINATION SETS - SEARCHED		
Symbol	Date	Examiner

US CLASSIFICATION SEARCHED			
Class	Subclass	Date	Examiner

SEARCH NOTES		
Search Notes	Date	Examiner
EAST	04/03/2015	SS
EAST	07/31/2015	SS

INTERFERENCE SEARCH			
US Class/ CPC Symbol	US Subclass / CPC Group	Date	Examiner
H04M	1/573, 3/42059	07/31/2015	SS
H04Q	3/0025, 2213/13091	07/31/2015	SS

--	--

INFORMATION DISCLOSURE STATEMENT BY APPLICANT <i>(Multiple sheets used when necessary)</i> SHEET 1 OF 1	Application No.	13/966,096
	Filing Date	August 13, 2013
	First Named Inventor	Perreault, Clay
	Art Unit	2633
	Examiner	Sing, Simon P.
	Attorney Docket No.	DIGIF.001C1

U.S. PATENT DOCUMENTS					
Examiner Initials	Cite No.	Document Number Number - Kind Code (if known) Example: 1,234,567 B1	Publication Date MM-DD-YYYY	Name	Pages, Columns, Lines Where Relevant Passages or Relevant Figures Appear
/SS/	1	6,327,351 B1	12-04-2001	Walker et al.	
/SS/	2	7,203,478 B2	04-10-2007	Benco et al.	

FOREIGN PATENT DOCUMENTS						
Examiner Initials	Cite No.	Foreign Patent Document Country Code-Number-Kind Code Example: JP 1234567 A1	Publication Date MM-DD-YYYY	Name	Pages, Columns, Lines Where Relevant Passages or Relevant Figures Appear	T ¹

NON PATENT LITERATURE DOCUMENTS			
Examiner Initials	Cite No.	Include name of the author (in CAPITAL LETTERS), title of the article (when appropriate), title of the item (book, magazine, journal, serial, symposium, catalog, etc.), date, page(s), volume-issue number(s), publisher, city and/or country where published.	T ¹

21034262
063015

Examiner Signature	/Simon Sing/	Date Considered	07/31/2015
--------------------	--------------	-----------------	------------

*Examiner: Initial if reference considered, whether or not citation is in conformance with MPEP 609. Draw line through citation if not in conformance and not considered. Include copy of this form with next communication to applicant.

INFORMATION DISCLOSURE STATEMENT BY APPLICANT	Application No.	13/966,096
	Filing Date	August 13, 2013
	First Named Inventor	Perreault, Clay
	Art Unit	2653
<i>(Multiple sheets used when necessary)</i>	Examiner	Sing, Simon P.
SHEET 1 OF 5	Attorney Docket No.	DIGIF.001C1

U.S. PATENT DOCUMENTS					
Examiner Initials	Cite No.	Document Number <i>Number - Kind Code (if known)</i> Example: 1,234,567 B1	Publication Date MM-DD-YYYY	Name	Pages, Columns, Lines Where Relevant Passages or Relevant Figures Appear
	1	7,958,233 B2	06-07-2011	Gutierrez, Alvaro Fernández	
	2	8,078,164 B2	12-13-2011	Ganesan, Vasudevan	
	3	8,127,005 B2	02-28-2012	Gutierrez, Alvaro Fernández	
	4	8,166,547 B2	04-24-2012	Bevan et al.	
	5	8,190,739 B2	05-29-2012	Gutierrez, Alvaro Fernández	
	6	8,223,927 B2	07-17-2012	Di Serio et al.	
	7	8,300,632 B2	10-30-2012	Davis et al.	
	8	8,315,521 B2	11-20-2012	Leiden et al.	
	9	8,396,445 B2	03-12-2013	Crawford et al.	
	10	8,526,306 B2	09-03-2013	Jungck et al.	
	11	8,542,815 B2	09-24-2013	Perreault et al.	
	12	8,599,747 B1	12-03-2013	Saleem et al.	
	13	8,599,837 B2	12-03-2013	Kyle, Andre B.	
	14	8,634,838 B2	01-21-2014	Hellwig et al.	
	15	8,774,378 B2	07-08-2014	Björsell et al.	
	16	8,819,566 B2	08-26-2014	Mehin et al.	
	17	8,848,887 B2	09-30-2014	Willman et al.	
	18	8,862,701 B2	10-14-2014	Havriluk, George	
	19	8,885,609 B2	11-11-2014	Nix, John A.	
	20	8,903,051 B2	12-02-2014	Li et al.	
	21	8,903,360 B2	12-02-2014	Celi, Jr. et al.	
	22	8,909,556 B2	12-09-2014	Huxham, Horatio Nelson	
	23	8,938,209 B2	01-20-2015	Crawford et al.	
	24	8,938,534 B2	01-20-2015	Le et al.	
	25	8,948,061 B2	02-03-2015	Sridhar, Sriram	
	26	8,972,612 B2	03-03-2015	Le et al.	
	27	8,982,719 B2	03-17-2015	Seetharaman et al.	
	28	8,995,428 B2	03-31-2015	Haster, Lars-Olof	

Examiner Signature	/Simon Sing/	Date Considered	07/31/2015
*Examiner: Initial if reference considered, whether or not citation is in conformance with MPEP 609. Draw line through citation if not in conformance and not considered. Include copy of this form with next communication to applicant.			

T¹ - Place a check mark in this area when an English language translation is attached. EX. 1002-57

ALL REFERENCES CONSIDERED EXCEPT WHERE LINED THROUGH. /S/

INFORMATION DISCLOSURE STATEMENT BY APPLICANT	Application No.	13/966,096	
	Filing Date	August 13, 2013	
	First Named Inventor	Perreault, Clay	
	Art Unit	2653	
<i>(Multiple sheets used when necessary)</i>		Examiner	Sing, Simon P.
SHEET 2 OF 5		Attorney Docket No.	DIGIF.001C1

U.S. PATENT DOCUMENTS					
Examiner Initials	Cite No.	Document Number <i>Number - Kind Code (if known)</i> Example: 1,234,567 B1	Publication Date MM-DD-YYYY	Name	Pages, Columns, Lines Where Relevant Passages or Relevant Figures Appear
	29	9,003,306 B2	04-07-2015	Mehin et al.	
	30	2007/0053382 A1	03-08-2007	Bevan et al.	
	31	2009/0213839 A1	08-27-2009	Davis et al.	
	32	2010/0083364 A1	04-01-2010	Gutierrez, Alvaro Fernández	
	33	2010/0114896 A1	05-06-2010	Clark et al.	
	34	2010/0115018 A1	05-06-2010	Yoon et al.	
	35	2010/0142382 A1	06-10-2010	Jungck et al.	
	36	2010/0220852 A1	09-02-2010	Willman et al.	
	37	2010/0233991 A1	09-16-2010	Crawford et al.	
	38	2010/0278534 A1	11-04-2010	Leiden et al.	
	39	2010/0316195 A1	12-16-2010	Di Serio et al.	
	40	2011/0072095 A1	03-24-2011	Havriluk, George	
	41	2011/0167164 A1	07-07-2011	Gutierrez, Alvaro Fernández	
	42	2011/0208859 A1	08-25-2011	Gutierrez, Alvaro Fernández	
	43	2011/0235543 A1	09-29-2011	Seetharaman et al.	
	44	2011/0273526 A1	11-10-2011	Mehin et al.	
	45	2011/0276903 A1	11-10-2011	Mehin et al.	
	46	2011/0276904 A1	11-10-2011	Mehin et al.	
	47	2011/0292929 A1	12-01-2011	Haster, Lars-Olof	
	48	2012/0089717 A1	04-12-2012	Chen, Yanheng	
	49	2012/0096145 A1	04-19-2012	Le et al.	
	50	2012/0155333 A1	06-21-2012	Yoon et al.	
	51	2012/0195236 A1	08-02-2012	Knight, Eric	
	52	2012/0259975 A1	10-11-2012	Le et al.	
	53	2012/0270554 A1	10-25-2012	Hellwig et al.	
	54	2013/0039226 A1	02-14-2013	Sridhar, Sriram	
	55	2013/0097308 A1	04-18-2013	Le et al.	
	56	2013/0128879 A1	05-23-2013	Kyle, Andre B.	
	57	2013/0148549 A1	06-13-2013	Crawford et al.	

Examiner Signature	/Simon Sing/	Date Considered	07/31/2015
<p>*Examiner: Initial if reference considered, whether or not citation is in conformance with MPEP 609. Draw line through citation if not in conformance and not considered. Include copy of this form with next communication to applicant.</p>			

T¹ - Place a check mark in this area when an English language PRIORITY CLAIM IS MADE. EX. 1002-58

ALL REFERENCES CONSIDERED EXCEPT WHERE LINED THROUGH. /SS/

INFORMATION DISCLOSURE STATEMENT BY APPLICANT	Application No.	13/966,096	
	Filing Date	August 13, 2013	
	First Named Inventor	Perreault, Clay	
	Art Unit	2653	
<i>(Multiple sheets used when necessary)</i>		Examiner	Sing, Simon P.
SHEET 3 OF 5		Attorney Docket No.	DIGIF.001C1

U.S. PATENT DOCUMENTS					
Examiner Initials	Cite No.	Document Number Number - Kind Code (if known) Example: 1,234,567 B1	Publication Date MM-DD-YYYY	Name	Pages, Columns, Lines Where Relevant Passages or Relevant Figures Appear
	58	2013/0173534 A1	07-04-2013	Nelakonda et al.	
	59	2013/0229950 A1	09-05-2013	Björzell et al.	
	60	2013/0287006 A1	10-31-2013	Nix, John A.	
	61	2013/0310002 A1	11-21-2013	Celi, Jr. et al.	
	62	2013/0318166 A1	11-28-2013	Jungck et al.	
	63	2013/0329864 A1	12-12-2013	Björzell et al.	
	64	2014/0010119 A1	01-09-2014	Björzell et al.	
	65	2014/0016764 A1	01-16-2014	Björzell et al.	
	66	2014/0024367 A1	01-23-2014	Björzell et al.	
	67	2014/0153477 A1	06-05-2014	Huttunen et al.	
	68	2014/0215642 A1	07-31-2014	Huxham, Horatio Nelson	
	69	2014/0307858 A1	10-16-2014	Li et al.	
	70	2014/0321333 A1	10-30-2014	Björzell et al.	

FOREIGN PATENT DOCUMENTS						
Examiner Initials	Cite No.	Foreign Patent Document Country Code-Number-Kind Code Example: JP 1234567 A1	Publication Date MM-DD-YYYY	Name	Pages, Columns, Lines Where Relevant Passages or Relevant Figures Appear	T ¹
	71	BR PI 0718312-7 A2	11-26-2013	Digifonica International Ltd	<i>Corresponds to International Publication No. WO 2008-052340 A1 previously disclosed</i>	Abstract
	72	BR PI 0719682-2 A2	01-14-2014	Digifonica International Ltd	<i>Corresponds to International Publication No. WO 2008/064481 A1 previously disclosed</i>	Abstract
	73	CA 2,668,025 A1	05-08-2008	Digifonica International Ltd	<i>Corresponds to International Publication No. WO 2008-052340 A1 previously disclosed</i>	Abstract
	74	CA 2,670,510 A1	06-05-2008	Digifonica International Ltd	<i>Corresponds to International Publication No. WO 2008-064481 A1; previously disclosed</i>	Abstract

Examiner Signature	/Simon Sing/	Date Considered	07/31/2015
--------------------	--------------	-----------------	------------

*Examiner: Initial if reference considered, whether or not citation is in conformance with MPEP 609. Draw line through citation if not in conformance and not considered. Include copy of this form with next communication to applicant.

T¹ - Place a check mark in this area when an English language translation is available. **PERFORMANCE APPLES INC. EX. 1002-59**

ALL REFERENCES CONSIDERED EXCEPT WHERE LINED THROUGH. /SS/

INFORMATION DISCLOSURE STATEMENT BY APPLICANT	Application No.	13/966,096
	Filing Date	August 13, 2013
	First Named Inventor	Perreault, Clay
	Art Unit	2653
<i>(Multiple sheets used when necessary)</i>	Examiner	Sing, Simon P.
SHEET 4 OF 5	Attorney Docket No.	DIGIF.001C1

FOREIGN PATENT DOCUMENTS						
Examiner Initials	Cite No.	Foreign Patent Document Country Code-Number-Kind Code Example: JP 1234567 A1	Publication Date MM-DD-YYYY	Name	Pages, Columns, Lines Where Relevant Passages or Relevant Figures Appear	T ¹
	75	CA 2,681,984 A1	10-02-2008	Digifonica International Ltd	<i>Corresponds to International Publication No. WO 2008/116296 A1; previously disclosed</i>	Abstract
	76	CA 2,732,148 A1	02-04-2010	Digifonica International Ltd	<i>Corresponds to International Publication No. WO 2010/012090 A2; previously disclosed</i>	Abstract
	77	CA 2,812,174 A1	03-24-2011	Digifonica International Ltd	<i>Corresponds to International Publication No. WO 2011/032256 A1; previously disclosed</i>	Abstract
	78	CN 101584150 A	11-18-2009	Digifonica International Ltd	<i>Corresponds to International Publication No. WO 2008/064481 A1 previously disclosed</i>	Abstract
	79	CN 101584166 A	11-18-2009	Digifonica International Ltd	<i>Corresponds to International Publication No. WO 2008-052340 A1 previously disclosed</i>	Abstract
	80	CN 101605342 A	12-16-2009	ZTE Corp [CN]		Abstract
	81	CN 102457494 A	05-16-2012	China Mobile Comm Corp Sichuan Co Ltd		Abstract
	82	CN 102572123 A	07-11-2012	Chengdu 30RTOM Mobile Comm Co Ltd		Abstract
	83	CN 101605342 B	12-19-2012	ZTE Corp [CN]	<i>Corresponds to Chinese Publication No. CN 101605342 A shown above</i>	
	84	CN 102457494 B	10-01-2014	China Mobile Comm Corp Sichuan Co Ltd	<i>Corresponds to Chinese Publication No. CN 102457494 A shown above</i>	
	85	EP 2 084 868 A0	08-05-2009	Digifonica International Ltd	<i>Corresponds to International Publication No. WO 2008-052340 A1 previously disclosed</i>	Abstract
	86	EP 2 227 048 A1	09-08-2010	France Telecom [FR]		Abstract

Examiner Signature	/Simon Sing/	Date Considered	07/31/2015
--------------------	--------------	-----------------	------------

*Examiner: Initial if reference considered, whether or not citation is in conformance with MPEP 609. Draw line through citation if not in conformance and not considered. Include copy of this form with next communication to applicant.

T¹ - Place a check mark in this area when an English language translation is applicable. EX. 1002-60

ALL REFERENCES CONSIDERED EXCEPT WHERE LINED THROUGH. /SS/

INFORMATION DISCLOSURE STATEMENT BY APPLICANT	Application No.	13/966,096	
	Filing Date	August 13, 2013	
	First Named Inventor	Perreault, Clay	
	Art Unit	2653	
<i>(Multiple sheets used when necessary)</i>		Examiner	Sing, Simon P.
SHEET 5 OF 5		Attorney Docket No.	DIGIF.001C1

FOREIGN PATENT DOCUMENTS						
Examiner Initials	Cite No.	Foreign Patent Document Country Code-Number-Kind Code Example: JP 1234567 A1	Publication Date MM-DD-YYYY	Name	Pages, Columns, Lines Where Relevant Passages or Relevant Figures Appear	T ¹
	87	EP 2 311 292 A0	04-20-2011	Digifonica International Ltd	<i>Corresponds to International Publication No. WO 2010/012090 A2 previously disclosed</i>	Abstract
	88	EP 2 478 678 A0	07-25-2012	Digifonica International Ltd	<i>Corresponds to International Publication No. WO 2011/032256 A1 previously disclosed</i>	Abstract
	89	KR 10-2009-0086428 (A)	08-12-2009	Digifonica International Ltd	<i>Korean Publication Unavailable Corresponds to International Publication No. WO 2008-052340 A1 previously disclosed</i>	Abstract
	90	KR 10-2009-0095621 (A)	09-09-2009	Digifonica International Ltd	<i>Corresponds to International Publication No. WO 2008-064481 A1 previously disclosed</i>	Abstract
	91	MX 2009005751 A	08-26-2009	Digifonica International Ltd	<i>Corresponds to International Publication No. WO 2008-064481 A1 previously disclosed</i>	Abstract
	92	MX 2009004811 A	08-28-2009	Digifonica International Ltd	<i>Corresponds to International Publication No. WO 2008-052340 A1 previously disclosed</i>	Abstract
	93	WO 2013/013189 A2	01-24-2013	VISA Int Service ASS [US]		

NON PATENT LITERATURE DOCUMENTS			
Examiner Initials	Cite No.	Include name of the author (in CAPITAL LETTERS), title of the article (when appropriate), title of the item (book, magazine, journal, serial, symposium, catalog, etc.), date, page(s), volume-issue number(s), publisher, city and/or country where published.	T ¹

20682667
051415

Examiner Signature	/Simon Sing/	Date Considered	07/31/2015
--------------------	--------------	-----------------	------------

*Examiner: Initial if reference considered, whether or not citation is in conformance with MPEP 609. Draw line through citation if not in conformance and not considered. Include copy of this form with next communication to applicant.

T¹ - Place a check mark in this area when an English language translation is attached. PERREAU, CLAY INC. EX. 1002-61

ALL REFERENCES CONSIDERED EXCEPT WHERE LINED THROUGH. /SS/

INFORMATION DISCLOSURE STATEMENT BY APPLICANT	Application No.	13/966,096	
	Filing Date	August 13, 2013	
	First Named Inventor	Perreault, Clay	
	Art Unit	2653	
<i>(Multiple sheets used when necessary)</i>		Examiner	Sing, Simon P.
SHEET 1 OF 2		Attorney Docket No.	DIGIF.001C1

U.S. PATENT DOCUMENTS					
Examiner Initials	Cite No.	Document Number <i>Number - Kind Code (if known)</i> Example: 1,234,567 B1	Publication Date MM-DD-YYYY	Name	Pages, Columns, Lines Where Relevant Passages or Relevant Figures Appear

FOREIGN PATENT DOCUMENTS						
Examiner Initials	Cite No.	Foreign Patent Document <i>Country Code-Number-Kind Code</i> Example: JP 1234567 A1	Publication Date MM-DD-YYYY	Name	Pages, Columns, Lines Where Relevant Passages or Relevant Figures Appear	T ¹
	1	IN 24/2009	06-12-2009	Digifonica International Ltd	<i>Corresponding International Publication No. WO 2008-052340 A1 previously disclosed</i>	
	2	IN 29/2009	07-17-2009	Digifonica International Ltd	<i>Corresponding International Publication No. WO 2008/064481 A1 previously disclosed</i>	
	3	SG151991A1	06-29-2009	Digifonica International Ltd	<i>Corresponding International Publication No. WO 2008-052340 A1 previously disclosed</i>	✓
	4	SG152752A1	06-29-2009	Digifonica International Ltd	<i>Corresponding International Publication No. WO 2008/064481 A1 previously disclosed</i>	✓
	5	SG155474	10-29-2009	Digifonica International Ltd	<i>Corresponding International Publication No. WO 2008/116296 A1 previously disclosed</i>	Abstract

NON PATENT LITERATURE DOCUMENTS			
Examiner Initials	Cite No.	Include name of the author (in CAPITAL LETTERS), title of the article (when appropriate), title of the item (book, magazine, journal, serial, symposium, catalog, etc.), date, page(s), volume-issue number(s), publisher, city and/or country where published.	T ¹
	6	Chinese Office Action dated March 24, 2011 for Chinese Patent Application No. CN 200780049791.5	✓
	7	Chinese Office Action dated June 23, 2011 for Chinese Patent Application No. CN 200780049136.X.	✓
	8	Indonesian Examination Report dated July 5, 2012 for Indonesian Patent Application No. W-00200901414.	✓
	9	Indonesian Examination Report dated February 8, 2013 for Indonesian Patent Application No. W-00200901165.	✓

Examiner Signature	/Simon Sing/	Date Considered	07/31/2015
--------------------	--------------	-----------------	------------

*Examiner: Initial if reference considered, whether or not citation is in conformance with MPEP 609. Draw line through citation if not in conformance and not considered. Include copy of this form with next communication to applicant.

T¹ - Place a check mark in this area when an English language translation is available. PERINSONE INC. EX. 1002-62

ALL REFERENCES CONSIDERED EXCEPT WHERE LINED THROUGH. /SS/

INFORMATION DISCLOSURE STATEMENT BY APPLICANT	Application No.	13/966,096
	Filing Date	August 13, 2013
	First Named Inventor	Perreault, Clay
	Art Unit	2653
<i>(Multiple sheets used when necessary)</i>	Examiner	Sing, Simon P.
SHEET 2 OF 2	Attorney Docket No.	DIGIF.001C1

NON PATENT LITERATURE DOCUMENTS			
Examiner Initials	Cite No.	Include name of the author (in CAPITAL LETTERS), title of the article (when appropriate), title of the item (book, magazine, journal, serial, symposium, catalog, etc.), date, page(s), volume-issue number(s), publisher, city and/or country where published.	T ¹
	10	Mexican Exam Report dated July 11, 2011 for Mexican Patent Application No. MX/a/2009/004811.	✓
	11	Mexican Notice of Allowance dated September 2, 2011 for Mexican Patent Application No. MX/a/2009/005751.	✓

20811010
060215

Examiner Signature	/Simon Sing/	Date Considered	07/31/2015
<p>*Examiner: Initial if reference considered, whether or not citation is in conformance with MPEP 609. Draw line through citation if not in conformance and not considered. Include copy of this form with next communication to applicant.</p>			

T¹ - Place a check mark in this area when an English language PATEX/08 Equivalent

INFORMATION DISCLOSURE STATEMENT BY APPLICANT	Application No.	13/966,096	
	Filing Date	August 13, 2013	
	First Named Inventor	Perreault, Clay	
	Art Unit	2653	
<i>(Multiple sheets used when necessary)</i>		Examiner	Sing, Simon P.
SHEET 1 OF 1		Attorney Docket No.	DIGIF.001C1

U.S. PATENT DOCUMENTS					
Examiner Initials	Cite No.	Document Number <i>Number - Kind Code (if known)</i> Example: 1,234,567 B1	Publication Date MM-DD-YYYY	Name	Pages, Columns, Lines Where Relevant Passages or Relevant Figures Appear

FOREIGN PATENT DOCUMENTS						
Examiner Initials	Cite No.	Foreign Patent Document <i>Country Code-Number-Kind Code</i> Example: JP 1234567 A1	Publication Date MM-DD-YYYY	Name	Pages, Columns, Lines Where Relevant Passages or Relevant Figures Appear	T ¹
/SS/	1	CA 2,598,200 A1	02-21-2008	Connexon Telecom Inc.		
/SS/	2	W00200902627 <i>(Indonesia)</i>	09-17-2009	Digifonica International Ltd	<i>Corresponding International Publication No. WO 2008/116296 A1 previously disclosed</i>	Abstract Only

NON PATENT LITERATURE DOCUMENTS			
Examiner Initials	Cite No.	Include name of the author (in CAPITAL LETTERS), title of the article (when appropriate), title of the item (book, magazine, journal, serial, symposium, catalog, etc.), date, page(s), volume-issue number(s), publisher, city and/or country where published.	T ¹
/SS/	3	Canadian Office Action dated January 27, 2015 for Canadian Patent Application No. CA 2,681,984.	

20995995
062515

Examiner Signature /Simon Sing/	Date Considered 07/31/2015
------------------------------------	-------------------------------

*Examiner: Initial if reference considered, whether or not citation is in conformance with MPEP 609. Draw line through citation if not in conformance and not considered. Include copy of this form with next communication to applicant.

EAST Search History

EAST Search History (Prior Art)

Ref #	Hits	Search Query	DBs	Default Operator	Plurals	Time Stamp
L1	187	attribute with (caller or (calling adj party)) with ((called adj party) or receipt)	US-PGPUB; USPAT; USOCR; FPRS; EPO; JPO; DERWENT; IBM_TDB	OR	ON	2015/07/31 17:14
L2	34	1 same rout\$	US-PGPUB; USPAT; USOCR; FPRS; EPO; JPO; DERWENT; IBM_TDB	OR	ON	2015/07/31 17:14
L3	0	2 same (internal or external)	US-PGPUB; USPAT; USOCR; FPRS; EPO; JPO; DERWENT; IBM_TDB	OR	ON	2015/07/31 17:18
L4	6	1 same match\$3	US-PGPUB; USPAT; USOCR; FPRS; EPO; JPO; DERWENT; IBM_TDB	OR	ON	2015/07/31 17:23
L5	9	H04M1/573.CPC. and 1	US-PGPUB; USPAT; USOCR; FPRS; EPO; JPO; DERWENT; IBM_TDB	OR	ON	2015/07/31 17:44
L6	5	H04M3/42059.CPC. and 1	US-PGPUB; USPAT; USOCR; FPRS; EPO; JPO; DERWENT; IBM_TDB	OR	ON	2015/07/31 17:45
L7	3	H04Q3/0025.CPC. and 1	US-PGPUB; USPAT; USOCR; FPRS; EPO; JPO; DERWENT; IBM_TDB	OR	ON	2015/07/31 17:47
L8	2	H04Q2213/13091.CPC. and 1	US-PGPUB; USPAT; USOCR; FPRS; EPO; JPO; DERWENT; IBM_TDB	OR	ON	2015/07/31 17:49
L9	381	rout\$3 same (caller or (calling adj party)) same ((called adj party) or receipt) same (internal or external)	US-PGPUB; USPAT; USOCR; FPRS; EPO; JPO; DERWENT; IBM_TDB	OR	ON	2015/07/31 17:50
L10	0	H04M1/573.CPC. and 9	US-PGPUB; USPAT; USOCR; FPRS; EPO; JPO; DERWENT; IBM_TDB	OR	ON	2015/07/31 17:50
L11	25	H04M3/42059.CPC. and 9	US-PGPUB; USPAT; USOCR; FPRS; EPO; JPO; DERWENT; IBM_TDB	OR	ON	2015/07/31 17:51
L12	0	H04M2213/13091.CPC. and 9	US-PGPUB; USPAT; USOCR; FPRS; EPO; JPO; DERWENT; IBM_TDB	OR	ON	2015/07/31 17:58

7/31/2015 6:52:21 PM

C:\Users\ssing\Documents\EAST\Workspaces\default.wsp

INFORMATION DISCLOSURE STATEMENT BY APPLICANT	Application No.	13/966,096	
	Filing Date	August 13, 2013	
	First Named Inventor	Perreault, Clay	
	Art Unit	2653	
<i>(Multiple sheets used when necessary)</i>		Examiner	Sing, Simon P.
SHEET 1 OF 2		Attorney Docket No.	DIGIF.001C1

U.S. PATENT DOCUMENTS					
Examiner Initials	Cite No.	Document Number Number - Kind Code (if known) Example: 1,234,567 B1	Publication Date MM-DD-YYYY	Name	Pages, Columns, Lines Where Relevant Passages or Relevant Figures Appear
	1	5,677,955 A1	10-14-1995	Doggett et al.	
	2	5,883,810 A1	03-16-1999	Franklin et al.	
	3	6,173,272 B1	01-09-2001	Thomas et al.	
	4	6,243,689 B1	06-05-2001	Norton, Robert G.	
	5	6,636,833 B1	10-21-2003	Fitcroft et al.	
	6	6,772,188 B1	08-03-2004	Cheng-Sheng et al.	
	7	6,892,184 B1	05-10-2005	Komen et al.	
	8	7,051,072 B2	05-23-2006	Stewart et al.	
	9	7,330,835 B2	02-12-2008	Deggendorf, Theresa M.	
	10	7,426,492 B2	09-16-2008	Bishop et al.	
	11	7,437,665 B2	10-14-2008	Perham, Michael	
	12	7,447,707 B2	11-04-2008	Gaurav et al.	
	13	7,580,886 B1	08-25-2009	Schulz, Larry	
	14	7,593,884 B2	09-22-2009	Rothman et al.	
	15	7,599,944 B2	10-06-2009	Gaurav et al.	
	16	7,644,037 B1	01-05-2010	Ostrovsky, Vladimir	
	17	7,647,500 B2	01-12-2010	Machiraju et al.	
	18	7,676,431 B2	03-09-2010	O'Leary et al.	
	19	7,680,737 B2	03-16-2010	Smith et al.	
	20	7,734,544 B2	06-08-2010	Schleicher, Joerg	
	21	7,765,261 B2	07-27-2010	Kropivny, Alexander	
	22	7,765,266 B2	07-27-2010	Kropivny, Alexander	
	23	7,882,011 B2	02-01-2011	Sandhu et al.	
	24	7,899,742 B2	03-11-2011	Berkert et al.	
	25	8,060,887 B2	11-15-2011	Kropivny, Alexander	
	26	8,161,078 B2	04-17-2012	Gaurav et al.	
	27	8,200,575 B2	06-12-2012	Torres et al.	
	28	8,543,477 B2	09-24-2013	Love et al.	
	29	8,627,211 B2	01-07-2014	Kropivny, Alexander	

Examiner Signature	Date Considered
*Examiner: Initial if reference considered, whether or not citation is in conformance with MPEP 609. Draw line through citation if not in conformance and not considered. Include copy of this form with next communication to applicant.	

T¹ - Place a check mark in this area when an English language translation is attached.

INFORMATION DISCLOSURE STATEMENT BY APPLICANT	Application No.	13/966,096	
	Filing Date	August 13, 2013	
	First Named Inventor	Perreault, Clay	
	Art Unit	2653	
<i>(Multiple sheets used when necessary)</i>		Examiner	Sing, Simon P.
SHEET 2 OF 2		Attorney Docket No.	DIGIF.001C1

U.S. PATENT DOCUMENTS					
Examiner Initials	Cite No.	Document Number Number - Kind Code (if known) Example: 1,234,567 B1	Publication Date MM-DD-YYYY	Name	Pages, Columns, Lines Where Relevant Passages or Relevant Figures Appear
	30	8,702,505 B2	04-22-2014	Kropivny, Alexander	
	31	2005/0131813 A1	06-16-2005	Gallagher et al.	
	32	2005/0171898 A1	08-04-2005	Bishop et al.	
	33	2005/0192897 A1	09-01-2005	Rogers et al.	
	34	2005/0192901 A1	09-01-2005	McCoy et al.	
	35	2005/0222952 A1	10-06-2005	Garrett et al.	
	36	2005/0267842 A1	12-01-2005	Weichert et al.	
	37	2006/0006224 A1	01-12-2006	Modi, Vikram	
	38	2006/0036522 A1	02-15-2006	Perham, Michael	
	39	2006/0095320 A1	05-04-2006	Jones, Lisa	
	40	2006/0116892 A1	06-01-2006	Grimes et al.	
	41	2006/0195398 A1	08-31-2006	Dheer et al.	
	42	2007/0016524 A1	01-18-2007	Diveley, et al.	
	43	2014/0141884 A1	05-22-2014	Kropivny, Alexander	

FOREIGN PATENT DOCUMENTS						
Examiner Initials	Cite No.	Foreign Patent Document Country Code-Number-Kind Code Example: JP 1234567 A1	Publication Date MM-DD-YYYY	Name	Pages, Columns, Lines Where Relevant Passages or Relevant Figures Appear	T ¹

NON PATENT LITERATURE DOCUMENTS			
Examiner Initials	Cite No.	Include name of the author (in CAPITAL LETTERS), title of the article (when appropriate), title of the item (book, magazine, journal, serial, symposium, catalog, etc.), date, page(s), volume-issue number(s), publisher, city and/or country where published.	T ¹
	44	Ketchpel <i>et al.</i> "U-PAI: A universal payment application interface" <i>Second USENIX Workshop on Electronic Commerce Proceedings</i> , 1996-8, pages 1-17.	
	45	Moberg & Drummond, "MIME-Based Secure Peer-to-Peer Business Data Interchange Using HTTP, Applicability Statement 2 (AS2)," <i>Network Working Group, Request for Comments: 4130, Category: Standards Track</i> , Copyright © The Internet Society July 2005, pages 1-47.	
	46	Abrazhevich, Dennis. "Electronic Payment Systems: a User-Centered Perspective and Interaction Design," <i>Thesis under the auspices of the J.F. Schouten School for User-System Interaction Research</i> , Technische Universiteit Eindhoven, Netherlands, 2004, pages Cover page - page 189.	

21269338
080315

Examiner Signature	Date Considered
--------------------	-----------------

***Examiner:** Initial if reference considered, whether or not citation is in conformance with MPEP 609. Draw line through citation if not in conformance and not considered. Include copy of this form with next communication to applicant.

T¹ - Place a check mark in this area when an English language Translation is attached

PETITIONER APPLE INC. EX. 1002-68

U-PAI: A Universal Payment Application Interface *

Steven P. Ketchpel, Hector Garcia-Molina, Andreas Paepcke, Scott Hassan, Steve Cousins
Stanford University
Computer Science Department
Stanford, CA 94305
{ketchpel, hector, paepcke, hassan, cousins}@cs.stanford.edu

Abstract

The progress of electronic commerce has been stymied by the lack of widely accepted network payment mechanisms. A number of proposals have been put forward, and each one offers a slightly different protocol and set of features. Yet none has achieved the critical mass to become an accepted standard. We believe that there will continue to be a variety of payment mechanisms, so in this paper we propose U-PAI, a universal payment application interface that will enable a programmer to write for one interface, and then interact with any payment mechanism. Each payment mechanism can support the universal API directly, or a *proxy* or wrapper can be built to translate U-PAI calls to the appropriate native calls supported by the payment mechanisms. In this paper we illustrate how two such proxies could be built. We also provide, in the appendix, a full CORBA specification of U-PAI.

1 Introduction

A payment mechanism is a means by which economic value is transferred between two parties, possibly using some intermediaries. It should be secure, easy to use, and have low transaction costs. Even though all electronic payment mechanisms have these same goals, there are many variations between mechanisms, (see for example, [9, 4, 7, 6]). Some of the variations can be minor, e.g., the order or nature of parameters in a function call. Other differences are more substantial, such as using different transport mechanisms and protocols like HTTP, telnet or e-

mail. The most significant difference, however, is the order of steps required to execute a payment. One payment mechanism, Millicent[7], requires the payer to acquire “scrip” from a broker before an interaction, while a second, the anonymous credit card[6], channels all communications through a re-mailer to keep identities hidden. If a merchant wants to support several payment mechanisms, not only must the merchant have accounts with each, but he or she must also tailor the application software to determine which mechanism is in use by the customer and generate the proper payment protocol steps to the customer and intermediaries.

The diversity of payment mechanisms may be beneficial in the long run because it encourages competition and enables an exploration of a broader space of solutions. However, this diversity is also a significant barrier to commerce: customers must maintain accounts with several different payment mechanisms. Furthermore, merchants and customers both find that there is no standard way for payment mechanisms to interact with application software such as a browser or electronic storefront.

Our goal in this paper is not to add to the diversity by introducing another payment mechanism, but rather to define a common set of functions that act as a layer of abstraction between application software and payment mechanisms. This Universal Payment Application Interface (U-PAI) will ease the burden on software developers at both the consumer and merchant level. Merchants and customers do not need to customize their applications to support each individual payment mechanism, since an application supporting this one universal API will interact with a broad range of payment mechanisms.

We hope that the benefits of standardization will encourage payment mechanism providers to support U-PAI (perhaps in addition to their own API which provides additional or different functionality). However, we recognize that payment systems providers see their proprietary protocols as a differentiating fac-

*This material is based upon work supported by the National Science Foundation under Cooperative Agreement IRI-9411306. Funding for this cooperative agreement is also provided by DARPA, NASA, and the industrial partners of the Stanford Digital Libraries Project. The first author was partially supported by a National Defense Science and Engineering Graduate Fellowship.

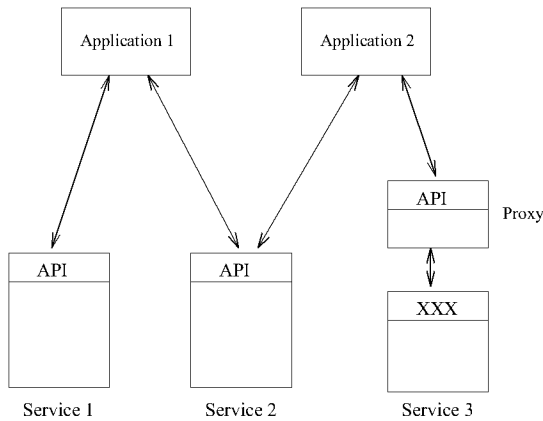

Figure 1: Universal Payment Application Interface abstracts payment mechanism internals

tor and way to retain market share. One approach to achieve widespread use of the U-PAI protocol would be to propose it to the relevant standards bodies and proceed through the ratification process.

An alternative approach is to build *proxies* or wrappers or gateways to popular payment mechanisms, as illustrated in Figure 1. Each proxy translates U-PAI calls into native calls to the underlying payment mechanism. This notion of proxy is widely used when accessing heterogeneous resources, be they databases, search engines, or other services [8]. By developing proxies and distributing them freely for the most popular payment mechanisms, we can encourage application developers to experience the benefits of using a single protocol, which may result in their reluctance to devote implementation effort to systems which do not support the protocol. This type of pressure may effectively encourage other payment systems providers to support the interface.

Of course, since each payment mechanism offers different features, it is impossible for a single API to capture all of the functionality of all of the mechanisms. Thus, the challenge we face in designing the common API is to identify the essential features that are used in the vast majority of interactions. A second challenge is to design, for these common features, an elegant interface that simplifies the programming task. One significant aspect of this challenge is that important steps need to be asynchronous, non-blocking calls. Asynchrony permits multiple payments to be in process at the same time, or may allow a payment to be aborted after it has been authorized, but before it has been completed. We believe that U-PAI meets those goals.

Having defined U-PAI, the next challenge is to show that one can build proxies to existing payment

mechanisms, and that these proxies can support the necessary common functionality even if the underlying mechanism uses a different payment model or ordering of steps. We have studied a number of existing mechanisms and shown how U-PAI can support the basic functionality of all these schemes. We will illustrate two such proxies, one supporting First Virtual, the second, DigiCash's ecash product.

In the following section we describe some related work. Section 3 defines all of the functions which are part of the interface. Section 4 shows a sample transaction, giving each step from start to finish. Section 5 shows how a proxy might be constructed for the First Virtual payment mechanism. An equivalent ecash proxy appears in Section 6. In Section 7, the case of failed transactions is considered in greater detail, along with security concerns. Finally, Section 8 offers a summary. The full CORBA specification in ISL, the interface specification language of Xerox PARC's ILU, appears in the Appendix.

2 Related Work

It is important to note that payment mechanisms and U-PAI are only one part of a larger electronic commerce environment. U-PAI only covers the basic functionality of accounts and payments, e.g., checking the balance of an account or transferring funds from one account to another. It does not cover price negotiation, return of defective goods, bidding, and other commerce issues. These require other APIs that would work in conjunction with U-PAI. A broader view of the issues related to electronic payments may be found in [1], which presents the Generic Electronic Payment Services framework. Of the five modules discussed there, U-PAI performs "Capability Management" tasks, some of which may appear in the higher level "Payment Interface Manager".

Another attempt to address the diversity of payment mechanisms is the Joint Electronic Payment Initiative (JEPI) project, co-sponsored by CommerceNet and W3C. The focus of JEPI is reaching agreement between the customer and merchant on a payment mechanism[2]. JEPI is built on top of Eastlake's Universal Payment Preamble (UPP)[5]. Neither of these systems achieves the level of integration that is proposed in U-PAI. Application developers must still implement a different protocol for all of the payment mechanisms they choose to support; JEPI and UPP merely allow the customer and merchant to select the protocol that a particular transaction will use. Therefore, it would be possible to employ JEPI to select a payment mechanism and then use U-PAI

to control the processing within that mechanism.

Finally, we note that our work is being done in the context of the Stanford Digital Libraries Project, where we are studying how to provide access to the resources and services being developed under the NSF/DARPA/NASA Digital Libraries Initiative (see <http://www.dlib.org/projects.html>). Clearly, payment is one of the central issues in such an environment. This work was performed in collaboration with EIT/VeriFone, under the auspices of CommerceNet (see <http://www.commerce.net/>), where again, facilitating interactions among customers and merchants with different payment mechanisms is crucial.

3 API Definition

U-PAI was designed from an object-oriented point of view. The interface offers a set of active objects, with their associated methods. Making a call to U-PAI involves calling a method on one of these objects. Similarly, the interface specifies certain objects that the application is expected to have that can be called by U-PAI, for example, to notify the application when a payment transaction terminates.

The equivalent functionality of the interface can be captured through non-object-oriented means as well. Entities which are objects in the API would be construed as records, with the object ID representing an identifying index for the record. Method invocations are replaced with a remote procedure call that passes the record which is to be acted upon as an explicit parameter of the call. In the interest of clear presentation, the object-oriented method will be used throughout the rest of the exposition.

In this section we describe the main object types in the API and their methods. Some of the methods are used to access what conceptually are “internal fields” of the object. For example, as we will see later, a payment control record (PCR) named **P** has an **Amount** field that gives the amount of money being paid. This value can be read by invoking **P.GetAmount()** and can be set by **P.SetAmount()**. In reality, **P** may not have a field with this value (in which case we say it is not *materialized*), but **P.GetAmount()** may invoke a function to compute the amount based on other internal or external information. However, for understanding the interface, it is useful to think of **Amount** as a field in **P**. Also, note that often the **Set** method will be disabled for some fields, e.g., the application may not set the balance of an account. Thus, to describe each of our objects, we first define their “fields” and then other methods they may have. (Full formal

definitions may be found in the Appendix.)

3.1 Account Handles

An *AccountHandle* instance is a representation of a real-world account. For example, a user may have several VISA **AccountHandles**, corresponding to the cards issued by different merchant banks belonging to the VISA network. The user creates an **AccountHandle** when he wishes to start making electronic payments with the account. He may query balance and credit limits on the account by making appropriate calls on the **AccountHandle** object.

A helpful analogy to clarify the notion of accounts and **AccountHandles** is that of UNIX files (see Figure 2). A file can be created and deleted, which corresponds to the creation and closing of a real world account. When the file exists, it is possible for a program to reference it by opening the file, making read and write accesses to it, and closing the file. In the payments world, this corresponds to generating an **AccountHandle**, making transfers, and erasing the **AccountHandle**. The real world account continues to exist even after the electronic **AccountHandle** representation has been deleted, just as a UNIX file exists after a program referencing it closes the file and deletes the file handle.

Conceptually, an **AccountHandle**, **ah**, has the following internal fields, although as noted below, some of them may not be actually materialized.

- **Balance:** This is the amount of available money available at **ah**'s account for payments. A positive amount indicates that the account holder has a positive stored balance. For example, Digi-Cash's ecash would be represented as a positive balance, since the user has already “purchased” the ecash. In contrast, a negative amount indicates the account owner owes money. Charges against a credit card would result in a negative balance that would be brought (closer) to zero when a payment was made to the card issuer. A query to this field, via **ah.GetBalance()**, will often require a real-time query to the account issuer, such as the bank that issued a MasterCard, in order to determine if non-electronic payments have been made. (In this case, we say that **Balance** is not materialized at **ah**.)
- **CreditLimit:** This is the amount of credit that may be charged on a credit-based payment mechanism. It is a negative value, and the balance on an account should never go below it. For non-credit instruments, its value is zero.

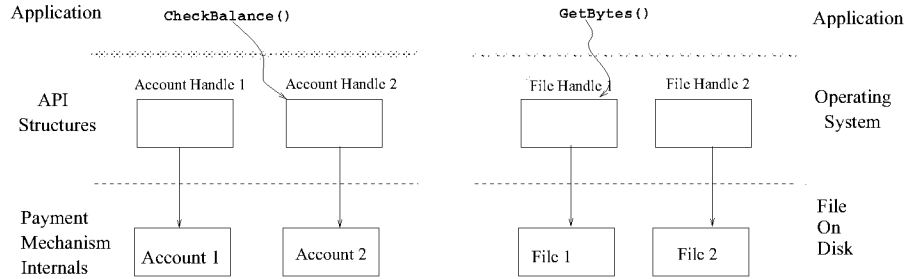

Figure 2: The similarities between an account handle and a file handle

- **AccountType:** This is an identifier (ID) of the type of account, e.g., First Virtual, VISA/SET, DigiCash, and so on. The value is of type **AccountTypeID**.
- **TransferAccountTypesFrom:** This is a list of **AccountTypeID**'s that this account can receive transfers from. So, for instance, a Mark Twain Bank ecash account can receive transfers either from another ecash account, or from the account holder's checking account.
- **TransferAccountTypesTo:** This is a list of **AccountTypeID**'s to which this account can make transfers.
- **MechanismProperties:** This is a *property set* that includes descriptive traits of the payment mechanism used by this account. Each entry in the property set is a property name and value. These properties assist the user in choosing which payment mechanism to use for a particular transaction. The name of the payment mechanism is stored in the string property **name**. The **fixed-cost** property is an amount which describes the fixed portion of the overhead cost for using this payment mechanism. The **percentage-fee** property records the variable cost. The expected time for one payment may be found in the **time** property. The boolean property **anonymous** records whether payments made using this mechanism may be linked to the user. Any other property may be added at the discretion of the payment system provider.

AccountHandles are typically subclassed with the specific type of the payment mechanism. The interface is inherited from the base class **AccountHandle**, but the methods are overridden with the specific details appropriate for that payment mechanism. For example, if a user wanted to create an **AccountHandle** for his First Virtual (FV) account, he would create an instance of a **FVAccountHandle**,

which is in turn a subclass of **AccountHandle**. **FVAccountHandle** must have all the methods of an **AccountHandle** (though they will be implemented in a way idiosyncratic to First Virtual).

The following methods can also be invoked on an **AccountHandle**, **ah**:

- **OpenAccount(PropertySet acctinfo): Any**
Typically, an application first creates a new **AccountHandle** object **ah** and then invokes **OpenAccount** on it to "initialize" **ah** to identify the appropriate real world account. The **acctinfo** parameter contains the necessary information to identify the real world account. The parameter is a property set that associates arbitrary field names with different types of parameter objects. For example, if we are opening a VISA account, **acctinfo** may contain the associations "type: VISA", "account: 123-456-789" and "expiration: 03/99." If we are opening a First Virtual account, we may need "type: FV", "name: John Doe" and "email: doe@whitehouse.gov." This method will then set up the **AccountHandle** as indicated, for instance, it will initialize field **TransferAccountTypesFrom** to indicate what type of account this FV account can receive funds from. We stress that this process does not establish a new FV account, it merely creates a representation of an existing FV account so that it may be used for payments through U-PAI calls. The return value of opening an account may be used as a security/authorization token to allow the object creator to identify itself to the account in the future.
- **CreateAccount(PropertySet acctinfo): Any**
This method creates a new real world account using **acctinfo** and updates the internal fields of **ah** to refer to it. Not all payment mechanisms will offer the option of creating a real world account through purely electronic means invoked

remotely by a user. The return value may be used for authorization.

- **CloseAccount()**
This method deletes the handle **ah**. The underlying real world account is unaffected. Future references to **ah** will result in an error.
- **DeleteAccount()**
This method deletes both the **AccountHandle** and the real world account which it represents. Again, not all payment mechanisms will support this method.
- **GetStatus(RefIDType Ref):PaymentStatus**
This method provides direct access to the payment mechanism's records concerning a particular transaction. In the event that the PCR (described next) is unavailable, an alternative (though probably more expensive) entry point exists. Not all payment mechanisms will support this method.

3.2 Payment Control Records

A *Payment Control Record* (PCR) instance is a representation of a single payment transaction. An application creates a new PCR for each individual transfer between two accounts. The PCR is then the locus of control for all activities regarding that payment.

Conceptually, a PCR, **p**, has the following fields:

- **RefID**: Provides a unique identifier for this payment. The value is of type **RefIDType**.
- **ContextID**: Identifies the context for this payment. The value, of type **RefIDType**, contains application specific information such as the invoice for which this payment is being made.
- **Amount**: the amount of money that is being paid by **p**.
- **DestAccountHandle**: Identifies the account receiving the funds.
- **DestAccountAuthorization**: Conveys the authority to deposit money in the destination account.
- **SourceAccountHandle**: Identifies the account supplying the funds.
- **SourceAccountAuthorization**: Conveys the authority to withdraw money from the source account.

- **Receipts**: Information, such as a receipt or decrypting key, that is given to **p** at the start of the transfer, and should be revealed to all participants upon successful completion. The payment mechanism may add additional receipts to this field.
- **Status**: The status of **p** is a list of entries representing the history of this payment. Each entry is made up of two components, a **MajorStatus**, which takes one of three values (**PaymentComplete**, **InProgress**, or **Failed**), and a **MinorStatus**, which provides greater detail about the current status. The entries are ordered with the most recent appearing at the front of the list.

Applications may make use of these values, though in many cases, the values will be payment-mechanism specific. Some sample entry values are shown in Table 1.

- **MonitorList**: **Monitor** objects (described in the next section) provide a way for applications to request notifications of status changes, rather than directly poll the status of **p** through the method **p.GetStatus()**. The **MonitorList** field of **p** is a list of **Monitor** objects that must be notified when the status of **p** changes.

To perform a payment, an application creates a PCR object, call it **p**, with the information that describes the desired operation. Then it invokes methods on the object to start or abort the payment.

- **StartTransfer()**
This method initiates the transfer of funds in order to effect the transfer described in PCR **p**. This call is non-blocking, so that customer processing may continue even before the payment has completed. A transfer requires authorization from both account holders to withdraw funds from one account and deposit them in another. This method should be invoked only once per PCR.
- **TryToAbortTransfer()**
This function attempts to abort a transaction which was previously initiated by a **StartTransfer**. The payment may have been already completed, or reached some commit point so that it is too late to abort. Feedback is given to the calling application only via the status of the PCR and the **Monitor** objects.
- **UpdateStatus(StatusEntry stat)**
This last method is invoked by whatever entity

Table 1: Payment Transaction Status Values

MajorStatus	MinorStatus	Description
PaymentComplete		Money transferred from payer to payee
InProgress		Transfer started, not completed
Failed	Aborted	The payment was aborted
Failed	NotSufficientFunds	Not Sufficient Funds for payer to make payment
Failed	NoSourceAccountSelected	The AccountHandle has not yet been associated with an account by <code>create()</code> or <code>open()</code> .
Failed	UnauthorizedSourceAccount	Payer not authorized to make payments from this account
Failed	UnauthorizedDestAccount	Payer not authorized to make deposits to this account
Failed	NonExistentDestinationAccount	Payee account not recognized
Failed	UnabletoTransferToAccountType	Payee account wrong type

is actually performing the payment transaction to report a change in status. Parameter `stat` is a `MajorStatus`, `MinorStatus` pair which is appended to `p`'s `status` field.

Incidentally, in some cases an application may wish to make more than one payment to cover a single invoice. For example, having received a bill for some delivered good, the application may wish to pay half of the amount due with a credit card and the other half with a check. In this case, the application creates two separate `PCR`s, each with the appropriate amount to pay. In this case, each record could have the same `ContextID` field since the same invoice is involved.

3.3 Monitors

A *Monitor* instance is an object used to supplement the status tracking feature of a `PCR`. Rather than requiring the application to routinely poll the status of the `PCR`, the application programmer may choose to implement a `Monitor` object which receives notifications whenever the payment mechanism updates the status of the `PCR`. Several such `Monitor` instances may be active at any time. For example, monitors acting on behalf of the payer and payee (and any other parties to the transactions, such as a state tax board) act as the recipients of messages which the `PCR` re-broadcasts as the transfer proceeds. For instance, if a bank refuses a check due to insufficient funds, the `PCR` reflects a failed status, and passes that information to each active `Monitor`. `Monitor` objects are written by the application programmer, providing the linkage between the result of the payment mechanism and the desired behavior of the application.

A `Monitor` object, `m`, conceptually has a `status` field just like a `PCR`. The following method can be invoked on `m` to update the field:

- `Notify(PCR p, StatusEntry s)`

This function updates the record of the transaction's status as recorded at `m`. In practice, this method also performs application specific tasks, depending on the nature of the notification.

In many cases, this basic `Monitor` class will be subclassed by the application programmer to provide additional functionality. For instance, one common usage will be to provide monitors with timeout capabilities. In this case the subclass may add methods such as `register` to define a timeout and `unregister` to cancel it. If a timeout occurs without the payment completing successfully, then the monitor can automatically attempt to abort the payment.

3.4 Additional Payment Functions

From the point of view of the application, a payment is initiated by calling on method `StartTransfer` of the appropriate `PCR`, say for instance, `p`. This is natural since the `PCR` is the locus of control for the payment. However, it is difficult for a method in a generic payment record to actually execute the transaction, since it depends on the specific account types involved. We solve this problem by having `p.StartTransfer()` call a method `ah.StartTransfer(p)`, where `ah` is the source `AccountHandle`, i.e., where `ah = p.GetSourceAccountHandle()`. This latter method then actually makes the necessary calls to the underlying payment mechanism(s).

In summary, the following two methods of an `AccountHandle` can be invoked by the system, but should not be by the application programmer:

- `StartTransfer(PCR p)`
This method is invoked by the PCR. All transfers should be initiated through the `StartTransfer` method of the PCR.
- `TryToAbortTransfer(PCR p)`
This method is invoked by the PCR. All transfers should be aborted through the `TryToAbortTransfer` method of the PCR.

4 Sample Transaction

In this section, we will walk through the steps required for a typical transaction. These involve:

1. Creating an `AccountHandle` (done once)
2. Creating a `Monitor` object (done once or once per transaction)
3. Creating the PCR (Payment Control Record)
4. Initiating the transfer at the PCR
5. Initiating the transfer at the `AccountHandle`
6. Updating the status at the PCR
7. Calling back to the `Monitor` object

This transaction will be a typical “mail-order” one, with the merchant dictating the terms of the purchase, the customer placing an order and sending payment, and finally, the merchant sending the goods.

4.1 Creating an `AccountHandle`

In this example, the customer wishes to enable his First Virtual account to make payments within this system. His FV account has the account identifier “jsmith”. There is a subclass of `AccountHandle`, called `FVAccountHandle`, for creating First Virtual accounts (developed by the people at First Virtual or a third party proxy-generator).

- `FVAccountHandle jmsFVAccthandle;`
(* This creates a new object *)
- `FVAuth =`
`jmsFVAccthandle.OpenAccount({"type:`
`FV", "user-id: jsmith", "e-mail:`
`jsmith@nowhere.net"})`

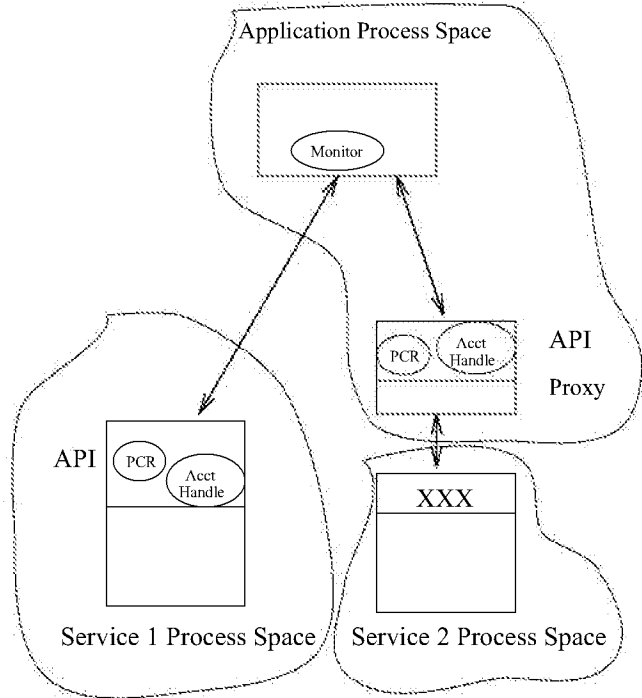

Figure 3: Location of system components in the system.

This `jmsFVAccthandle` object is a representation of the First Virtual account in the payment system. Its type is `FVAccountHandle`. The method implementations were written by the First Virtual development staff or proxy writers, but this object is now customized with J. Smith’s account information. Further messages to it will result in communication with the First Virtual system to perform the desired operation and may rely on the return value of the `OpenAccount` method to provide authentication. The `AccountHandle` is located on the payment service side, or at the proxy, which may be running locally on the customer’s machine. Figure 3 shows the location of key components in the distributed system.

4.2 Create a Monitor object

The buyer needs to have some method of keeping track of the status of various transactions. The `Monitor` object performs this role, located on the customer’s machine, receiving updates as to the transaction status, and triggering application actions accordingly. For instance, if the payment is complete, the `Monitor` object should set up a process to receive the goods or complain if they are not received in a timely fashion. If payment stalls due to a problem such as insufficient funds, the `Monitor` object should

choose an alternative payment mechanism if it is so authorized, or alert the application program to the problem.

In this example, we assume that the buyer will create a **Monitor** object exclusively for this transaction. The application programmer has developed a **CustomerMonitor** class which inherits from the **Monitor** object of U-PAI. The **CustomerMonitor** must support the one method of a **Monitor** object, **Notify**. The implementation details are application specific. A small piece of a typical monitor's **Notify** method is given here:

```
Notify(PCR whom, StatusEntry s):
```

```
if s.MajorStatus == PaymentComplete:
    DeliveryMon.expect(whom.GetInvoice())
elseif (s.MajorStatus == Failed) &&
    s.MinorStatus == "NotSufficientFunds"):
    self.SelectNewPaymentMech(whom)
```

The **StatusEntry** record has a **MajorStatus** field of enumerated type (**PaymentComplete**, **InProgress**, or **Failed**) and a **MinorStatus** which provides additional detail about the update. The **Monitor** object is responsible for determining what to do based on this new status. In the fragment above, it calls the application specific **DeliveryMon** if payment is complete, or tries to select a new payment mechanism if this one failed due to insufficient funds. These routines are both outside the scope of U-PAI.

The new **CustomerMonitor** object (fulfilling the role of the **Monitor** object) is created in the declarations before the transfer is started.

- **CustomerMonitor CM;**

The **Monitor** object should, at a minimum, support actions for each of the three **MajorStatus** values. If the application programmer knows in advance about specific payment mechanisms that will be used and the status values that they report (through the **MinorStatus** descriptions), the application can use this information in determining what step to take next.

4.3 Creating the PCR (Payment Control Record)

By creating a **PCR**, the application tells the payment component how much money should be sent to whom, from which account, and how to inform the application and other interested parties of updates. In this example, the customer has obtained the merchant's **FVAccountHandle**, authorization to deposit

into that account, and a **Monitor** object (probably from an invoice or advertisement provided by the merchant) and has stored them in application variables **MerchantAcctHandle**, **MerchantAuth** and **MerchantMonitors** respectively. The amount that the customer intends to pay is \$4.00. The authorization code to use this source **FVAccountHandle** was generated by the **OpenAccount** method from Section 4.1 and was stored in **FVAuth**. Neither customer nor merchant needs to create a receipt for this transaction. The reference number is XE-2909, and is a payment for invoice number AXP-309. Due to the close relation between the **PCR** and the payment, the **PCR** is also typically located at the server or proxy.

- **PCR pay;**
(*Creates the pay object of PCR type*)
- **pay.SetDestAccountHandle**
(**MerchantAcctHandle**)
- **pay.SetDestAuthorization**(**MerchantAuth**)
- **pay.SetSourceAccountHandle**
(**jmsFVAccthandle**)
- **pay.SetSourceAuthorization**(**FVAuth**)
- **pay.SetMonitorList**(**MerchantMonitors** ∪
{**CM**})
- **pay.SetReceipts**([])
- **pay.SetRefID**("XE-2909")
- **pay.SetContextID**("AXP-309")
- **pay.SetAmount**(4.00, "USD")

4.4 Initiating the transfer at the PCR

Once the buyer has completed the **PCR** object, he is ready to make a payment, and only one command is necessary.

- **pay.StartTransfer()**

If the buyer has filled in the **SourceAuthorization** field, anyone, including the merchant, can invoke the **StartTransfer** method. Once the **PCR** receives a request to initiate the payment, it passes it through to the **AccountHandle**, which has the appropriate payment mechanism-specific code to continue the operation.

4.5 Initiating the transfer at the AccountHandle

The PCR notifies the **Monitor** objects that the payment has been initiated, and they should expect additional updates on it. Then it interacts with the payment mechanism to accomplish the funds transfer. In this case, the **AccountHandle**, acting as a proxy, mimics the First Virtual protocol, generating, sending, receiving and processing e-mail messages (details in Section 5). Status updates will be sent to each **Monitor** object mentioned in the PCR's **MonitorList**, namely the **CustomerMonitor** instance **CM** and each **Monitor** object that the merchant supplied.

- for m in self.MonitorList:
m.Notify(self, [InProgress, "Payment Initiated"])
- (self.getSourceAccountHandle()).StartTransfer(self);

4.6 Updating the status of the PCR

As the payment mechanism progresses through the steps of its internal process, it may periodically issue status updates to the PCR. It does this by means of the **UpdateStatus** method, invoked on the PCR. The PCR passes its own identity to the **Monitor** objects so that they can distinguish among the multiple transactions they may be monitoring. The payment mechanism interacts with the **AccountHandle** to trigger the status updates in the rest of the payment system.

- thisPCR.UpdateStatus([PaymentComplete, "termination normal"])

The identifier **thisPCR** is set to the PCR that was passed to the **AccountHandle** in the **StartTransfer** call. A payment mechanism may issue as many **InProgress** updates as it wishes, each with a different **MinorStatus** value. The payment mechanism or its proxy must make the **UpdateStatus** call when the payment terminates, either successfully or unsuccessfully.

4.7 Calling Back to the Monitor Objects

When the PCR receives a status update, it is responsible for echoing that update to each **Monitor** in its **MonitorList** field. When the transaction is successfully completed, the PCR's **Receipts** field is broadcasted to the monitors.

- for m in self.MonitorList:
m.Notify(self, [PaymentComplete, self.Receipts])

The application may need to map back to the payment details of this transfer by getting its associated context object (such as the invoice), by invoking the **GetContextID** method on the PCR. When the **Monitor** object learns that the payment has completed, it takes the application specific behavior dictated in the **Notify** method. In our example, that involves calling the **DeliveryMonitor** to await the arrival of the ordered goods. The merchant's **Monitor** object would initiate the delivery of the order.

The transaction continues with the payment mechanism possibly making several **UpdateStatus** calls which are re-broadcast as **Notify** to the monitor list, until eventually the transaction completes with either a **Failed** or **PaymentComplete** status. At that time, the PCR is still accessible to the application, if it wishes to **GetStatus**, or the application may de-allocate the space (garbage collect) the PCR.

5 Sample First Virtual Proxy

In this section, we show how one real world payment system can support this API without changing its current operation. The First Virtual (FV) payment mechanism (see <http://www.fv.com/>) was the first service which allowed consumers to transfer real money across the network, requiring both payer and payee to hold FV accounts. It works by assigning each user a new account name, and obtaining the user's credit card information in a secure, out-of-band channel. Designed primarily for information goods that merchants can produce and distribute for effectively zero marginal cost, the FV management encourages its merchants to give consumers a chance to "try before you buy", with the opportunity to refuse payment for the goods.

The full structure of a FV transaction (see Figure 4) is:

1. The customer sends his FV account information to the seller via e-mail.
2. The seller can optionally verify the existence of the account with FV, again by e-mail (optional, not shown in figure).
3. The seller delivers the goods to the buyer's e-mail address (which should match that of the FV account). This step is outside the scope of the payment process, and not shown in the figure.

4. The seller sends a charge request (via e-mail or telnet) to FV asking FV to bill the buyer.
5. FV sends an invoice to the holder of the FV account via e-mail.
6. The buyer responds by e-mail either indicating that he accepts the charge, acknowledges requesting the merchandise but does not want to pay for it, or does not recognize the charge and suspects fraud.
7. FV updates account balances if payment was approved, and informs the merchant of the resolution, using e-mail.

Some time later, FV aggregates the charges made by the user into a single charge to be levied on the associated credit card and paid to FV. Some time much later (90 days), the money is deposited in the appropriate merchant's checking account.

Figure 5 shows how the FV payment mechanism could interact with U-PAI. Steps labeled "A", "B", "C", and "D" correspond to the steps described in Sections 4.4, 4.5, 4.6, and 4.7 respectively. We assume for the sake of this example that the creation of the `AccountHandle` and the `Monitor` have been completed already. The application begins by creating a `PCR` (producing the object labeled as such in the figure) and then initiating a fund transfer (Step A), on the new `PCR`. In Step B, the `PCR` re-directs the call to the `AccountHandle` which acts as a proxy for First Virtual, receiving U-PAI messages, then translating them into the e-mail forms which are required by the First Virtual process. Forming another part of the FV proxy, the merchant's `AccountHandle` intercepts this mail message (Fig. 5, Step 1) and forms a FV invoice, which is sent to the FV commerce server (Step 4), possibly issuing a status update to the `PCR` as well. The FV service, ignorant that the e-mail invoice was automatically generated by the proxy, proceeds as it would if the invoice had come from a human, sending a copy of the invoice on to the specified customer, asking for approval (Step 5). Here part of the FV proxy working on the payer's machine intercepts the mail message and (assuming no `TryToAbortTransfer` invocation has been made) sends its approval to the FV server (Step 6), again with a possible update to the `PCR`. The FV server once again completes the processing, actually transfers the money, and sends the merchant e-mail describing the resolution. Here again, the merchant-side piece of the FV proxy intercepts the mail (Step 7), and must in this case `UpdateStatus` on the `PCR` (Step C) with the final resolution of the transaction, either

`PaymentComplete` or `Failed`. After each status update at the `PCR`, the new information is passed to the `Monitor` objects (Step D) which take application specific behavior, possibly ignoring the `InProgress` updates, or informing the user. If the payment status is complete, then the `PCR` sends the information held in its `Receipts` field.

It is important to note that everything above the dotted line in Figure 5 is independent of the particular payment mechanism. In Figure 4, the application needed to know how to form e-mail messages to First Virtual. With the abstraction of an `AccountHandle` and `PCR`, however, (as we will see in the next section) a different payment mechanism could be substituted below the dotted line with no disruption to the application. This flexibility is the goal of U-PAI.

6 Sample Ecash Proxy

Developed by David Chaum of DigiCash, ecash is an electronic "coin"-based payment mechanism which provides anonymity for the purchaser. Although the technical details are complex [4], they are not directly of concern to U-PAI, which interacts with ecash at the level of the user operations. For this discussion, we assume the text-based interface to the system used in the cyberbucks ecash trial. The steps in an ecash payment are enumerated below, and shown graphically in Figure 6.

1. The payer initiates the payment by entering a command either in the ecash process or directly at the UNIX shell. The command specifies an amount, a destination host and port, and a reference string.
2. The ecash software withdraws an appropriate number of coins from the user's account to make the payment, and transmits them to an approved bank for verification.
3. Assuming the coins are legitimate and have not been spent, the payee (merchant) is asked to approve the the deposit.
4. The payee approves the deposit, sending a message to the ecash bank.
5. The bank sends the coins to the merchant, for deposit into the merchant's core account.
6. The payee application queries the payee account to determine whether the coins have arrived, using an ecash command entered directly from the UNIX shell or via the ecash interface.

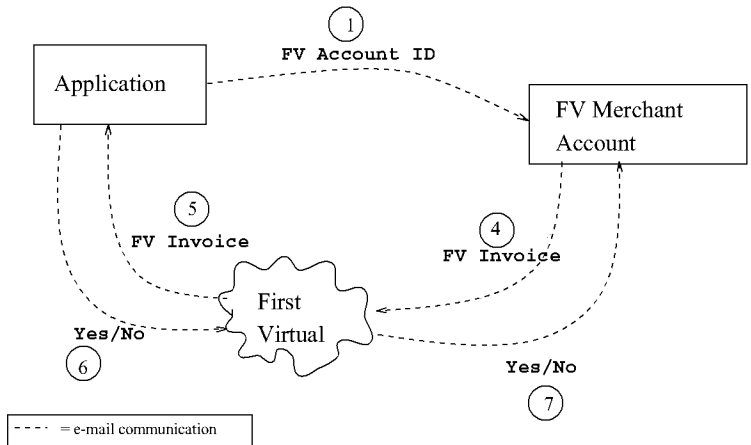

Figure 4: The steps involved in a First Virtual payment.

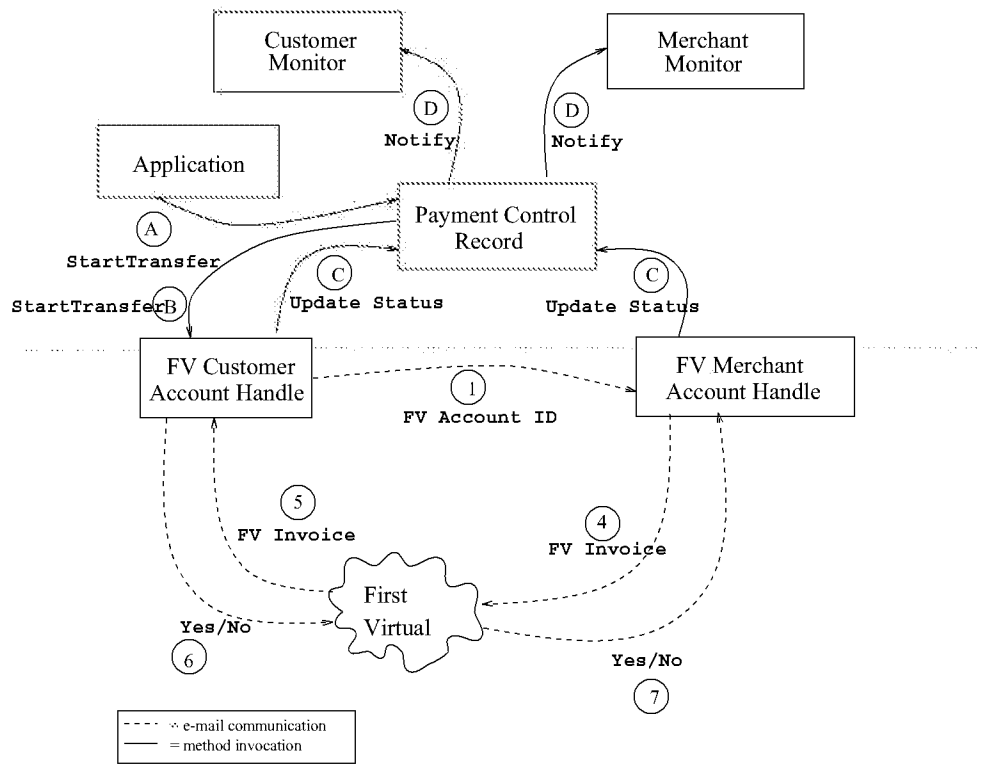

Figure 5: The steps involved in a First Virtual payment used with U-PAI.

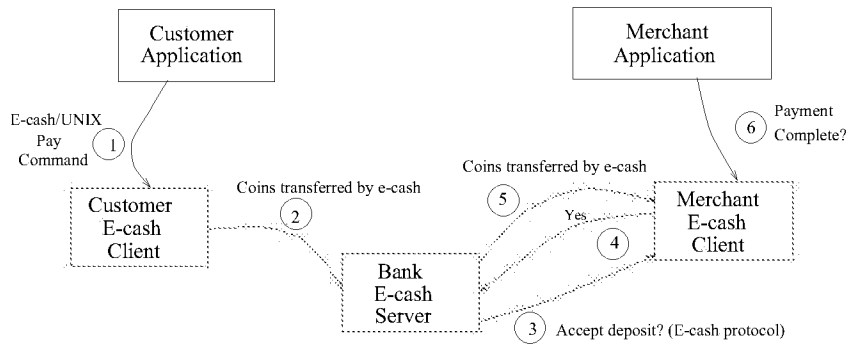

Figure 6: The steps involved in an ecash payment.

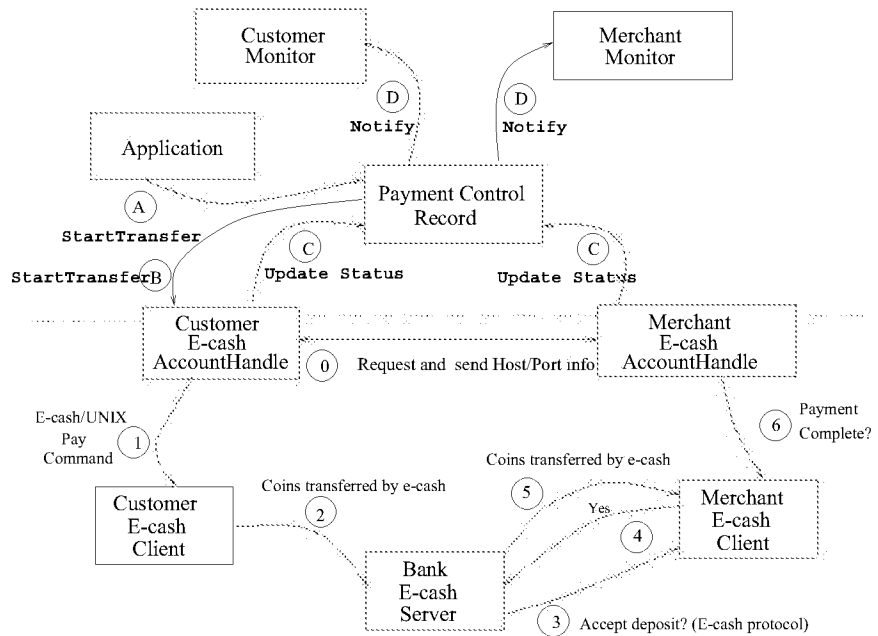

Figure 7: The steps involved in an ecash payment used with U-PAI.

The **AccountHandles** act as the proxy to the payment mechanism, as with the First Virtual system. When the **StartTransfer** is invoked, the destination **AccountHandle** is available to the source **AccountHandle**. The source **AccountHandle** calls a mechanism-specific method (not part of the definition of U-PAI) defined on ecash **AccountHandles** to learn the host address and port of the destination account (Fig. 7, Step 0). With this information, the source **AccountHandle** formats and executes an ecash pay command (Step 1). At this point, the ecash module takes over, contacts the bank, and verifies the coins (Step 2). The request for approval which the ecash bank sends to the payee (Step 3) is intercepted by the proxy on the merchant side, and automatically approved in Step 4 (if automatic approval is not acceptable on all payments, the source **AccountHandle** can notify the destination **AccountHandle** of the coming payment). The coins are then transferred to the merchant (Step 5), again through ecash specific code. The merchant's ecash **AccountHandle** determines when the payment is complete (Step 6) and triggers an update to the PCR (Step C). The status update from the PCR is sent to the monitors on the **MonitorList** (Step D), allowing the applications to be informed of the final disposition of the ecash payment, using the same status values (**PaymentComplete**, **Failed**, or **InProgress**) from the First Virtual proxies. If the status is **PaymentComplete**, then the PCR distributes the information recorded in its **Receipts** field. The interaction of the ecash system with the U-PAI interface is shown in Figure 7. Again, notice that the machinery above the dotted line is identical to that in Figure 5.

7 Failed Transactions and Security

In this section, we consider the behavior of the system in a few selected failure modes, such as network disturbances or frozen accounts. In some cases, the system design allows completion of a commercial transaction even under adverse circumstances. For instance, in the event that the ecash bank server is down, the **StartTransfer** method will recognize its inability to contact the bank, and notify the listening **Monitor** objects, perhaps enabling the buyer to select a different payment mechanism which is currently operable. Similarly, an ecash charge for which there are insufficient funds will result in an error condition being sent to the **Monitor** object, enabling alternative arrangements to be made.

The system is not foolproof, however. If a user initiates a payment using First Virtual and then receives no update because the e-mail was delayed, the user is uncertain of what to do. The status may show only **InProgress** with no indication of what step is currently ongoing, or how much longer is required before the process will be resolved. This ambiguity highlights one of the design decisions of U-PAI. In an effort to promote ease of implementation, no guarantees are offered about the completion of transactions—the mechanism and system operate on the “best effort” principal. In particular, under certain failure conditions with certain payment mechanisms, it may be impossible for the payer to prove that the payee received payment. By providing fine-grained specification of the transaction status to the **Monitor** objects through the **MinorStatus** values, however, along with the power to abort a transfer, the system provides maximum flexibility to its users. If a payment mechanism provides the capability to query the status of a particular transaction, an additional level of recovery is possible, because a **Monitor** object can use the **AccountHandle**'s **GetStatus** method if the PCR fails.

Also, security is not explicitly discussed in this paper. For the CORBA-based U-PAI methods (above the dotted line in Figs. 5 and 7), we assume the presence of a mechanism which provides access control on a per-method, per-object basis. This may be implemented using access capabilities building on the **Authorization** fields of the PCR. Other mechanisms such as digital signatures may be substituted. The desired result is that certain objects are prevented from reading or modifying data fields or executing methods, while other objects are permitted partial or total access. For example, the **UpdateStatus** method on a PCR should only be called by **AccountHandles** involved in the transaction.

For those steps below the dotted line, we assume that the underlying payment mechanism handles security appropriately. Properties such as confidentiality and non-repudiation that are provided by the payment mechanism may require additional work to ensure they persist through U-PAI. The messages should also be encoded in such a way to resist eavesdroppers and replay attacks.

8 Conclusion

We have proposed a Universal Payment Application Interface, which allows a variety of payment mechanisms to be accessed by the same interface, easing the use of multiple payment mechanisms or the pro-

cess of switching between payment mechanisms. We have outlined how payment mechanism proxies (combination of modules on both user and merchant side) allow this API to be supported without modification of the underlying payment mechanism. Finally, we have provided a CORBA ISL file for programmers interested in supporting or using this interface.

9 Acknowledgments

The authors wish to thank Ali Bahreman for thought-provoking discussions and helpful suggestions. Also, Martin Röscheisen contributed to the design of InterPay[3], a preliminary version of this work. Finally, changes suggested by the referees improved the completeness and clarity of this work.

References

- [1] Alireza Bahreman. Generic payment services: Framework and functional specification. Technical report, 1996. Proceedings of the Second USENIX Electronic Commerce Workshop.
- [2] Alireza Bahreman and Rajkumar Narayanaswamy. Payment method negotiation service: Framework and programming interface. Technical report, 1996. Proceedings of the Second USENIX Electronic Commerce Workshop.
- [3] Steve B. Cousins, Steven P. Ketchpel, Andreas Paepcke, Hector Garcia-Molina, Scott W. Hassan, and Martin Röscheisen. InterPay: Managing multiple payment mechanisms in digital libraries. In *DL '95 proceedings*, 1995.
- [4] DigiCash. DigiCash brochure. Available at <http://www.digicash.com/publish/digibro.html>, 1994.
- [5] Donald E. Eastlake, 3rd. Universal payment preamble. Technical report, CyberCash, Mar 1996.
- [6] Steven H. Low, Nicholas F. Maxemchuk, and Sanjoy Paul. Anonymous credit cards. In *Proceedings of the 2nd ACM Conference on Computer and Communication Security*, 1994.
- [7] Mark S. Manasse. The Millicent protocols for electronic commerce. In *Proceedings of the 1st USENIX workshop on Electronic Commerce*, 1995.
- [8] Andreas Paepcke, Steve B. Cousins, Hector Garcia-Molina, Scott W. Hassan, Steven P. Ketchpel, Martin Röscheisen, and Terry Winograd. Towards interoperability in digital libraries: Overview and selected highlights of the Stanford digital library project. *IEEE Computer Magazine*, 29(5), May 1996.
- [9] L.H. Stein, E.A. Stefferud, N.S. Borenstein, and M.T. Rose. The Green commerce model. Technical report, First Virtual Holdings Incorporated, October 1994. Available at <http://www.fv.com/tech/green-model.html>.

10 Appendix: CORBA Payment Mechanism ISL

```
INTERFACE UPAI (* Version 1.0. For current version see:
                http://www-diglib.stanford.edu/diglib/software/UPAI.isl *)
IMPORTS
  IAny, (* See: http://www-diglib.stanford.edu/diglib/software/IAny.isl *)
  CosPropertyService
    (* See: http://www-diglib.stanford.edu/diglib/software/CosProp.isl *)
END;

TYPE String = ilu.CString;

TYPE Amount = RECORD
  Number : REAL,
  Units : String (* dollars, yen, etc *)
END;

TYPE RefIDType = String;

TYPE AccountTypeID = String;

TYPE AccountTypeIDList = SEQUENCE OF AccountTypeID;

TYPE Monitor = OBJECT
METHODS

  Notify(whom : PCR, status : StatusEntry)
    (* Notify is called whenever the status of the transaction 'whom'
       changes & this Monitor object was in the PCR. *)
END;

TYPE MonitorList = SEQUENCE OF Monitor;

TYPE AccountHandle = OBJECT
METHODS

  CreateAccount(NewAccountInfo : CosPropertyService.PropertySet): IAny.Any,
    (* Creates a new real-world account, with the appropriate identifying
       information. Optionally returns an authentication token.*)

  OpenAccount(AccountInfo : CosPropertyService.PropertySet): IAny.Any,
    (* Creates a new electronic representation of the existing real-world
       account with the appropriate identifying information.
       Optionally returns an authentication token.*)

  GetAccountType() : AccountTypeID,
    (* returns the type of this account. *)

  GetTransferAccountTypesFrom() : AccountTypeIDList,
    (* returns a list of account types that this account can receive
       money from. *)

  GetTransferAccountTypesTo() : AccountTypeIDList,
    (* returns a list of account types that this account can transfer to. *)

  GetBalance() : Amount,
    (* returns the amount of funds available for payment in this account. *)

  GetCreditLimit() : Amount,
    (* returns the credit limit for credit-based accounts. *)

  GetMechanismProperties() : CosPropertyService.PropertySet,
    (* returns the meta-data properties like cost, time, anonymity. *)

  CloseAccount(),
```

```

    (* close this account.  No further transfers can be made. *)

DeleteAccount(),
    (* close this account & eliminate the real world account, too*)

StartTransfer(p : PCR),
    (* Called by the system, not application programmer, to start
       the money transfer *)

TryToAbortTransfer(p : PCR),
    (* Called by the system, not application programmer, to try to abort
       the money transfer *)

GetStatus(RefID : RefIDType) : PaymentStatus
    (* Returns the current status of the payment identified by RefID. *)

END;

TYPE MajorType = ENUMERATION
    PaymentComplete,      (* Money transferred from payer to payee*)
    InProgress,          (* Transfer started, not completed *)
    Failed                (* Error in payment, see description field*)
END;

TYPE StatusEntry = RECORD
    MajorStatus : MajorType,
    MinorStatus : IAny.Any

(*Typical Values are strings:
    Aborted                -- Payer requested abort
    NotSufficientFunds,    -- Not Sufficient Funds for payer
    UnauthorizedSourceAccount, -- Payer not authorized to make payments
                               from this account
    UnauthorizedDestAccount, -- Payer not authorized to make deposits
                               to this account
    NonExistentDestinationAccount -- Payee account not recognized
    UnableToTransferToAccountType -- Payee account wrong type
    NoSourceAccountSelected  -- Neither open () nor create()
                               has been invoked on this handle
*)

END;

TYPE PaymentStatus = SEQUENCE OF StatusEntry;

TYPE PCR = OBJECT

METHODS

    SetRefID(RefID : RefIDType),
    SetContextID(ConID : RefIDType),
    SetAmount(amt : Amount),
    SetMonitorList(Mlist : MonitorList),
    SetDestAccountHandle(dest : AccountHandle),
    SetDestAccountAuthorization(auth : IAny.Any),
    SetSourceAccountHandle(src : AccountHandle),
    SetSourceAccountAuthorization(auth : IAny.Any),
    SetReceipts(rcptlist : IAny.Any),

    GetRefID() : RefIDType,
    GetContextID() : RefIDType,
    GetAmount() : Amount,
    GetMonitorList() : MonitorList,
    GetDestAccountHandle() : AccountHandle,

```

```
GetDestAccountAuthorization() : IAny.Any,
GetSourceAccountHandle() : AccountHandle,
GetSourceAccountAuthorization() : IAny.Any,
GetReceipts() : IAny.Any,

StartTransfer(),
(* Initiates the transfer described in the other fields of the
  data structure. Asynchronous, returning immediately, doesn't wait
  for funds to be transferred. *)

GetStatus() : PaymentStatus,
(* Returns the current status of this transaction. *)

TryToAbortTransfer(),
(* Attempts to abort the transfer of funds initiated
  for this PCR. There is no guarantee the abort
  will be successful. *)

UpdateStatus(stat : StatusEntry)
(* Called by payment specific level to report progress *)
END;
```

Network Working Group
Request for Comments: 4130
Category: Standards Track

D. Moberg
Cyclone Commerce
R. Drummond
Drummond Group Inc.
July 2005

MIME-Based Secure Peer-to-Peer
Business Data Interchange Using HTTP,
Applicability Statement 2 (AS2)

Status of This Memo

This document specifies an Internet standards track protocol for the Internet community, and requests discussion and suggestions for improvements. Please refer to the current edition of the "Internet Official Protocol Standards" (STD 1) for the standardization state and status of this protocol. Distribution of this memo is unlimited.

Copyright Notice

Copyright (C) The Internet Society (2005).

Abstract

This document provides an applicability statement (RFC 2026, Section 3.2) that describes how to exchange structured business data securely using the HTTP transfer protocol, instead of SMTP; the applicability statement for SMTP is found in RFC 3335. Structured business data may be XML; Electronic Data Interchange (EDI) in either the American National Standards Committee (ANSI) X12 format or the UN Electronic Data Interchange for Administration, Commerce, and Transport (UN/EDIFACT) format; or other structured data formats. The data is packaged using standard MIME structures. Authentication and data confidentiality are obtained by using Cryptographic Message Syntax with S/MIME security body parts. Authenticated acknowledgements make use of multipart/signed Message Disposition Notification (MDN) responses to the original HTTP message. This applicability statement is informally referred to as "AS2" because it is the second applicability statement, produced after "AS1", RFC 3335.

Table of Contents

1. Introduction	3
1.1. Applicable RFCs	3
1.2. Terms	3
2. Overview	5
2.1. Overall Operation	5
2.2. Purpose of a Security Guideline for MIME EDI	5
2.3. Definitions	5
2.4. Assumptions	7
3. Referenced RFCs and Their Contributions	9
3.1. RFC 2616 HTTP v1.1 [3]	9
3.2. RFC 1847 MIME Security Multiparts [6]	9
3.3. RFC 3462 Multipart/Report [8]	10
3.4. RFC 1767 EDI Content [2]	10
3.5. RFC 2045, 2046, and 2049 MIME [1]	10
3.6. RFC 3798 Message Disposition Notification [5]	10
3.7. RFC 3851 and 3852 S/MIME Version 3.1 Message Specifications and Cryptographic Message Syntax (CMS) [7]..	10
3.8. RFC 3023 XML Media Types [10]	10
4. Structure of an AS2 Message	10
4.1. Introduction	10
4.2. Structure of an Internet EDI MIME Message	11
5. HTTP Considerations	12
5.1. Sending EDI in HTTP POST Requests	12
5.2. Unused MIME Headers and Operations	12
5.3. Modification of MIME or Other Headers or Parameters Used ..	13
5.4. HTTP Response Status Codes	14
5.5. HTTP Error Recovery	14
6. Additional AS2-Specific HTTP Headers	14
6.1. AS2 Version Header	15
6.2. AS2 System Identifiers	15
7. Structure and Processing of an MDN Message	17
7.1. Introduction	17
7.2. Synchronous and Asynchronous MDNs	19
7.3. Requesting a Signed Receipt	21
7.4. MDN Format and Values	25
7.5. Disposition Mode, Type, and Modifier	30
7.6. Receipt Reply Considerations in an HTTP POST	35
8. Public Key Certificate Handling	35
9. Security Considerations	36
9.1. NRR Cautions	37
9.2. HTTPS Remark	38
9.3. Replay Remark	39
10. IANA Considerations	39
10.1. Registration	39
11. Acknowledgements	40
12. References	40

12.1. Normative References	40
12.2. Informative References	41
Appendix A: Message Examples	42

1. Introduction

1.1. Applicable RFCs

Previous work on Internet EDI focused on specifying MIME content types for EDI data [2] and extending this work to support secure EC/EDI transport over SMTP [4]. This document expands on RFC 1767 to specify a comprehensive set of data security features, specifically data confidentiality, data integrity/authenticity, non-repudiation of origin, and non-repudiation of receipt over HTTP. This document also recognizes contemporary RFCs and is attempting to "re-invent" as little as possible. Although this document focuses on EDI data, any other data types describable in a MIME format are also supported.

Internet MIME-based EDI can be accomplished by using and complying with the following RFCs:

- o RFC 2616 Hyper Text Transfer Protocol
- o RFC 1767 EDI Content Type
- o RFC 3023 XML Media Types
- o RFC 1847 Security Multiparts for MIME
- o RFC 3462 Multipart/Report
- o RFC 2045 to 2049 MIME RFCs
- o RFC 3798 Message Disposition Notification
- o RFC 3851, 3852 S/MIME v3.1 Specification

Our intent here is to define clearly and precisely how these are used together, and what is required by user agents to be compliant with this document.

The key words "MUST", "MUST NOT", "REQUIRED", "SHALL", "SHALL NOT", "SHOULD", "SHOULD NOT", "RECOMMENDED", "MAY", and "OPTIONAL" in this document are to be interpreted as described in RFC 2119 [13].

1.2. Terms

AS2: Applicability Statement 2 (this document); see RFC 2026 [11], Section 3.2

EDI: Electronic Data Interchange

EC: Business-to-Business Electronic Commerce

B2B: Business to Business

Receipt: The functional message that is sent from a receiver to a sender to acknowledge receipt of an EDI/EC interchange. This message may be either synchronous or asynchronous in nature.

Signed Receipt: A receipt with a digital signature.

Synchronous Receipt: A receipt returned to the sender during the same HTTP session as the sender's original message.

Asynchronous Receipt: A receipt returned to the sender on a different communication session than the sender's original message session.

Message Disposition Notification (MDN): The Internet messaging format used to convey a receipt. This term is used interchangeably with receipt. A MDN is a receipt.

Non-repudiation of receipt (NRR): A "legal event" that occurs when the original sender of an signed EDI/EC interchange has verified the signed receipt coming back from the receiver. The receipt contains data identifying the original message for which it is a receipt, including the message-ID and a cryptographic hash (MIC). The original sender must retain suitable records providing evidence concerning the message content, its message-ID, and its hash value. The original sender verifies that the retained hash value is the same as the digest of the original message, as reported in the signed receipt. NRR is not considered a technical message, but instead is thought of as an outcome of possessing relevant evidence.

S/MIME: A format and protocol for adding cryptographic signature and/or encryption services to Internet MIME messages.

Cryptographic Message Syntax (CMS): An encapsulation syntax used to digitally sign, digest, authenticate, or encrypt arbitrary messages.

SHA-1: A secure, one-way hash algorithm used in conjunction with digital signature. This is the recommended algorithm for AS2.

MD5: A secure, one-way hash algorithm used in conjunction with digital signature. This algorithm is allowed in AS2.

MIC: The message integrity check (MIC), also called the message digest, is the digest output of the hash algorithm used by the digital signature. The digital signature is computed over the MIC.

User Agent (UA): The application that handles and processes the AS2 request.

2. Overview

2.1. Overall Operation

A HTTP POST operation [3] is used to send appropriately packaged EDI, XML, or other business data. The Request-URI ([3], Section 9.5) identifies a process for unpacking and handling the message data and for generating a reply for the client that contains a message disposition acknowledgement (MDN), either signed or unsigned. The MDN is either returned in the HTTP response message body or by a new HTTP POST operation to a URL for the original sender.

This request/reply transactional interchange can provide secure, reliable, and authenticated transport for EDI or other business data using HTTP as a transfer protocol.

The security protocols and structures used also support auditable records of these document data transmissions, acknowledgements, and authentication.

2.2. Purpose of a Security Guideline for MIME EDI

The purpose of these specifications is to ensure interoperability between B2B EC user agents, invoking some or all of the commonly expected security features. This document is also NOT limited to strict EDI use; it applies to any electronic commerce application for which business data needs to be exchanged over the Internet in a secure manner.

2.3. Definitions

2.3.1. The Secure Transmission Loop

This document's focus is on the formats and protocols for exchanging EDI/EC content securely in the Internet's HTTP environment.

In the "secure transmission loop" for EDI/EC, one organization sends a signed and encrypted EDI/EC interchange to another organization and

requests a signed receipt, and later the receiving organization sends this signed receipt back to the sending organization. In other words, the following transpires:

- o The organization sending EDI/EC data signs and encrypts the data using S/MIME. In addition, the message will request that a signed receipt be returned to the sender. To support NRR, the original sender retains records of the message, message-ID, and digest (MIC) value.
- o The receiving organization decrypts the message and verifies the signature, resulting in verified integrity of the data and authenticity of the sender.
- o The receiving organization then returns a signed receipt using the HTTP reply body or a separate HTTP POST operation to the sending organization in the form of a signed message disposition notification. This signed receipt will contain the hash of the received message, allowing the original sender to have evidence that the received message was authenticated and/or decrypted properly by the receiver.

The above describes functionality that, if implemented, will satisfy all security requirements and implement non-repudiation of receipt for the exchange. This specification, however, leaves full flexibility for users to decide the degree to which they want to deploy those security features with their trading partners.

2.3.2. Definition of Receipts

The term used for both the functional activity and the message for acknowledging delivery of an EDI/EC interchange is "receipt" or "signed receipt". The first term is used if the acknowledgment is for an interchange resulting in a receipt that is NOT signed. The second term is used if the acknowledgement is for an interchange resulting in a receipt that IS signed.

The term non-repudiation of receipt (NRR) is often used in combination with receipts. NRR refers to a legal event that occurs only when the original sender of an interchange has verified the signed receipt coming back from recipient of the message, and has verified that the returned MIC value inside the MDN matches the previously recorded value for the original message.

NRR is best established when both the original message and the receipt make use of digital signatures. See the Security Considerations section for some cautions regarding NRR.

For information on how to format and process receipts in AS2, refer to Section 7.

2.4. Assumptions

2.4.1. EDI/EC Process Assumptions

- o Encrypted object is an EDI/EC Interchange.

This specification assumes that a typical EDI/EC interchange is the lowest-level object that will be subject to security services.

Specifically, in EDI ANSI X12, this means that anything between and including, segments ISA and IEA is secured. In EDIFACT, this means that anything between, and including, segments UNA/UNB and UNZ is secured. In other words, the EDI/EC interchanges including envelope segments remain intact and unreadable during fully secured transport.

- o EDI envelope headers are encrypted.

Congruent with the above statement, EDI envelope headers are NOT visible in the MIME package.

In order to optimize routing from existing commercial EDI networks (called Value Added Networks or VANs) to the Internet, it would be useful to make some envelope information visible. This specification, however, provides no support for this optimization.

- o X12.58 and UN/EDIFACT Security Considerations

The most common EDI standards bodies, ANSI X12 and EDIFACT, have defined internal provisions for security. X12.58 is the security mechanism for ANSI X12, and AUTACK provides security for EDIFACT. This specification does NOT dictate use or non-use of these security standards. They are both fully compatible, though possibly redundant, with this specification.

2.4.2. Flexibility Assumptions

- o Encrypted or Unencrypted Data

This specification allows for EDI/EC message exchange in which the EDI/EC data can be either unprotected or protected by means of encryption.

- o Signed or Unsigned Data

This specification allows for EDI/EC message exchange with or without digital signature of the original EDI transmission.

- o Optional Use of Receipt

This specification allows for EDI/EC message transmission with or without a request for receipt notification. A signed receipt notification is requested; however, a MIC value is REQUIRED as part of the returned receipt, except when a severe error condition prevents computation of the digest value. In the exceptional case, a signed receipt should be returned with an error message that effectively explains why the MIC is absent.

- o Use of Synchronous or Asynchronous Receipts

In addition to a receipt request, this specification allows the specification of the type of receipt that should be returned. It supports synchronous or asynchronous receipts in the MDN format specified in Section 7 of this document.

- o Security Formatting

This specification relies on the guidelines set forth in RFC 3851/3852 [7] "S/MIME Version 3.1 Message Specification; Cryptographic Message Syntax".

- o Hash Function, Message Digest Choices

When a signature is used, it is RECOMMENDED that the SHA-1 hash algorithm be used for all outgoing messages, and that both MD5 and SHA-1 be supported for incoming messages.

- o Permutation Summary

In summary, the following twelve security permutations are possible in any given trading relationship:

1. Sender sends un-encrypted data and does NOT request a receipt.
2. Sender sends un-encrypted data and requests an unsigned receipt. Receiver sends back the unsigned receipt.
3. Sender sends un-encrypted data and requests a signed receipt. Receiver sends back the signed receipt.
4. Sender sends encrypted data and does NOT request a receipt.

5. Sender sends encrypted data and requests an unsigned receipt. Receiver sends back the unsigned receipt.
6. Sender sends encrypted data and requests a signed receipt. Receiver sends back the signed receipt.
7. Sender sends signed data and does NOT request a signed or unsigned receipt.
8. Sender sends signed data and requests an unsigned receipt. Receiver sends back the unsigned receipt.
9. Sender sends signed data and requests a signed receipt. Receiver sends back the signed receipt.
10. Sender sends encrypted and signed data and does NOT request a signed or unsigned receipt.
11. Sender sends encrypted and signed data and requests an unsigned receipt. Receiver sends back the unsigned receipt.
12. Sender sends encrypted and signed data and requests a signed receipt. Receiver sends back the signed receipt.

Users can choose any of the twelve possibilities, but only the last example (12), when a signed receipt is requested, offers the whole suite of security features described in Section 2.3.1, "The Secure Transmission Loop".

Additionally, the receipts discussed above may be either synchronous or asynchronous depending on the type requested. The use of either the synchronous or asynchronous receipts does not change the nature of the secure transmission loop in support of NRR.

3. Referenced RFCs and Their Contributions

3.1. RFC 2616 HTTP v1.1 [3]

This document specifies how data is transferred using HTTP.

3.2. RFC 1847 MIME Security Multiparts [6]

This document defines security multipart for MIME: multipart/encrypted and multipart/signed.

3.3. RFC 3462 Multipart/Report [8]

This RFC defines the use of the multipart/report content type, something that the MDN RFC 3798 builds upon.

3.4. RFC 1767 EDI Content [2]

This RFC defines the use of content type "application" for ANSI X12 (application/EDI-X12), EDIFACT (application/EDIFACT), and mutually defined EDI (application/EDI-Consent).

3.5. RFC 2045, 2046, and 2049 MIME [1]

These are the basic MIME standards, upon which all MIME related RFCs build, including this one. Key contributions include definitions of "content type", "sub-type", and "multipart", as well as encoding guidelines, which establish 7-bit US-ASCII as the canonical character set to be used in Internet messaging.

3.6. RFC 3798 Message Disposition Notification [5]

This Internet RFC defines how an MDN is requested, and the format and syntax of the MDN. The MDN is the basis upon which receipts and signed receipts are defined in this specification.

3.7. RFC 3851 and 3852 S/MIME Version 3.1 Message Specifications and Cryptographic Message Syntax (CMS) [7]

This specification describes how S/MIME will carry CMS Objects.

3.8. RFC 3023 XML Media Types [10]

This RFC defines the use of content type "application" for XML (application/xml).

4. Structure of an AS2 Message

4.1. Introduction

The basic structure of an AS2 message consists of MIME format inside an HTTP message with a few additional specific AS2 headers. The structures below are described hierarchically in terms of which RFCs are applied to form the specific structure. For details of how to code in compliance with all RFCs involved, turn directly to the RFCs referenced. Any difference between AS2 implementations and RFCs are mentioned specifically in the sections below.

4.2. Structure of an Internet EDI MIME Message

No encryption, no signature

-RFC2616/2045

-RFC1767/RFC3023 (application/EDIxxxx or /xml)

No encryption, signature

-RFC2616/2045

-RFC1847 (multipart/signed)

-RFC1767/RFC3023 (application/EDIxxxx or /xml)

-RFC3851 (application/pkcs7-signature)

Encryption, no signature

-RFC2616/2045

-RFC3851 (application/pkcs7-mime)

-RFC1767/RFC3023 (application/EDIxxxx or /xml) (encrypted)

Encryption, signature

-RFC2616/2045

-RFC3851 (application/pkcs7-mime)

-RFC1847 (multipart/signed) (encrypted)

-RFC1767/RFC3023 (application/EDIxxxx or /xml) (encrypted)

-RFC3851 (application/pkcs7-signature) (encrypted)

MDN over HTTP, no signature

-RFC2616/2045

-RFC3798 (message/disposition-notification)

MDN over HTTP, signature

-RFC2616/2045

-RFC1847 (multipart/signed)

-RFC3798 (message/disposition-notification)

-RFC3851 (application/pkcs7-signature)

MDN over SMTP, no signature

MDN over SMTP, signature

Refer to the EDI over SMTP standard [4].

Although all MIME content types SHOULD be supported, the following MIME content types MUST be supported:

Content-type: multipart/signed

Content-Type: multipart/report

Content-type: message/disposition-notification

Content-Type: application/PKCS7-signature

Content-Type: application/PKCS7-mime

Content-Type: application/EDI-X12

Content-Type: application/EDIFACT
Content-Type: application/edi-consent
Content-Type: application/XML

5. HTTP Considerations

5.1. Sending EDI in HTTP POST Requests

The request line will have the form: "POST Request-URI HTTP/1.1", with spaces and followed by a CRLF. The Request URI is typically exchanged out of band, as part of setting up a bilateral trading partner agreement. Applications SHOULD be prepared to deal with an initial reply containing a status indicating a need for authentication of the usual types used for authorizing access to the Request-URI ([3], Section 10.4.2 and elsewhere).

The request line is followed by entity headers specifying content length ([3], Section 14.14) and content type ([3], Section 14.18). The Host request header ([3], Sections 9 and 14.23) is also included.

When using Transport Layer Security [15] or SSLv3, the request-URI SHOULD indicate the appropriate scheme value, HTTPS. Usually only a multipart/signed message body would be sent using TLS, as encrypted message bodies would be redundant. However, encrypted message bodies are not prohibited.

The receiving AS2 system MAY disconnect from the sending AS2 system before completing the reception of the entire entity if it determines that the entity being sent is too large to process.

For HTTP version 1.1, TCP persistent connections are the default, ([3] Sections 8.1.2, 8.2, and 19.7.1). A number of other differences exist because HTTP does not conform to MIME [1] as used in SMTP transport. Relevant differences are summarized below.

5.2. Unused MIME Headers and Operations

5.2.1. Content-Transfer-Encoding Not Used in HTTP Transport

HTTP can handle binary data and so there is no need to use the content transfer encodings of MIME [1]. This difference is discussed in [3], Section 19.4.5. However, a content transfer encoding value of binary or 8-bit is permissible but not required. The absence of this header MUST NOT result in transaction failure. Content transfer encoding of MIME bodyparts within the AS2 message body is also allowed.

5.2.2. Message Bodies

In [3], Section 3.7.2, it is explicitly noted that multipart MUST have null epilogues.

In [4], Section 5.4.1, options for large file processing are discussed for SMTP transport. For HTTP, large files SHOULD be handled correctly by the TCP layer. However, in [3], Sections 3.5 and 3.6 discuss some options for compressing or chunking entities to be transferred. In [3], Section 8.1.2.2 discusses a pipelining option that is useful for segmenting large amounts of data.

5.3. Modification of MIME or Other Headers or Parameters Used

5.3.1. Content-Length

The use of the content-length header MUST follow the guidelines of [3], specifically Sections 4.4 and 14.13.

5.3.2. Final Recipient and Original Recipient

The final and original recipient values SHOULD be the same value. These values MUST NOT be aliases or mailing lists.

5.3.3. Message-Id and Original-Message-Id

Message-Id and Original-Message-Id is formatted as defined in RFC 2822 [9]:

"<" id-left "@" id-right ">" (RFC 2822, 3.6.4)

Message-Id length is a maximum of 998 characters. For maximum backward compatibility, Message-Id length SHOULD be 255 characters or less. Message-Id SHOULD be globally unique, and id-right SHOULD be something unique to the sending host environment (e.g., a host name).

When sending a message, always include the angle brackets. Angle brackets are not part of the Message-Id value. For maximum backward compatibility, when receiving a message, do not check for angle brackets. When creating the Original-Message-Id header in an MDN, always use the exact syntax as received on the original message; don't strip or add angle brackets.

5.3.4. Host Header

The host request header field MUST be included in the POST request made when sending business data. This field is intended to allow one server IP address to service multiple hostnames, and potentially to conserve IP addresses. See [3], Sections 14.23 and 19.5.1.

5.4. HTTP Response Status Codes

The status codes return status concerning HTTP operations. For example, the status code 401, together with the WWW-Authenticate header, is used to challenge the client to repeat the request with an Authorization header. Other explicit status codes are documented in [3], Section 6.1.1 and throughout Section 10.

For errors in the request-URI, 400 ("Bad Request"), 404 ("Not Found"), and similar codes are appropriate status codes. These codes and their semantics are specified by [3]. A careful examination of these codes and their semantics should be made before implementing any retry functionality. Retries SHOULD NOT be made if the error is not transient or if retries are explicitly discouraged.

5.5. HTTP Error Recovery

If the HTTP client fails to read the HTTP server response data, the POST operation with identical content, including same Message-ID, SHOULD be repeated, if the condition is transient.

The Message-ID on a POST operation can be reused if and only if all of the content (including the original Date) is identical.

Details of the retry process (including time intervals to pause, number of retries to attempt, and timeouts for retrying) are implementation dependent. These settings are selected as part of the trading partner agreement.

Servers SHOULD be prepared to receive a POST with a repeated Message-ID. The MIME reply body previously sent SHOULD be resent, including the MDN and other MIME parts.

6. Additional AS2-Specific HTTP Headers

The following headers are to be included in all AS2 messages and all AS2 MDNs, except for asynchronous MDNs that are sent using SMTP and that follow the AS1 semantics[4].

6.1. AS2 Version Header

To promote backward compatibility, AS2 includes a version header:

AS2-Version: 1.0 - Used in all implementations of this specification. 1.x will be interpreted as 1.0 by all implementations with the "AS2 Version: 1.0" header. That is, only the most significant digit is used as the version identifier for those not implementing additional non-AS2-specified functionality. "AS2-Version: 1.0 through 1.9" MAY be used. All implementations MUST interpret "1.0 through 1.9" as implementing this specification. However, an implementation MAY extend this specification with additional functionality by specifying versions 1.1 through 1.9. If this mechanism is used, the additional functionality MUST be completely transparent to implementations with the "AS2-Version: 1.0" designation.

AS2-Version: 1.1 - Designates those implementations that support compression as defined by RFC 3274.

Receiving systems MUST NOT fail due to the absence of the AS2-Version header. Its absence would indicate that the message is from an implementation based on a previous version of this specification.

6.2. AS2 System Identifiers

To aid the receiving system in identifying the sending system, AS2-From and AS2-To headers are used.

```
AS2-From: < AS2-name >  
AS2-To: < AS2-name >
```

These AS2 headers contain textual values, as described below, identifying the sender/receiver of a data exchange. Their values may be company specific, such as Data Universal Numbering System (DUNS) numbers, or they may be simply identification strings agreed upon between the trading partners.

```

AS2-text = "!" /           ; printable ASCII characters
           %d35-91 /       ; except double-quote (%d34)
           %d93-126       ; or backslash (%d92)

AS2-qttext = AS2-text / SP ; allow space only in quoted text

AS2-quoted-pair = "\" DQUOTE / ; \" or
                 "\" "\""   ; \\

AS2-quoted-name = DQUOTE 1*128( AS2-qttext /
                                AS2-quoted-pair) DQUOTE

AS2-atomic-name = 1*128AS2-text

AS2-name = AS2-atomic-name / AS2-quoted-name

```

The AS2-From header value and the AS2-To header value MUST each be an AS2-name, MUST each be comprised of from 1 to 128 printable ASCII characters, and MUST NOT be folded. The value in each of these headers is case-sensitive. The string definitions given above are in ABNF format [14].

The AS2-quoted-name SHOULD be used only if the AS2-name does not conform to AS2-atomic-name.

The AS2-To and AS2-From header fields MUST be present in all AS2 messages and AS2 MDNs whether asynchronous or synchronous in nature, except for asynchronous MDNs, which are sent using SMTP.

The AS2-name for the AS2-To header in a response or MDN MUST match the AS2-name of the AS2-From header in the corresponding request message. Likewise, the AS2-name for the AS2-From header in a response or MDN MUST match the AS2-name of the AS2-To header in the corresponding AS2 request message.

The sending system may choose to limit the possible AS2-To/AS2-From textual values but MUST not exceed them. The receiving system MUST make no restrictions on the textual values and SHOULD handle all possible implementations. However, implementers must be aware that older AS2 products may not adhere to this convention. Trading partner agreements should be made to ensure that older products can support the system identifiers that are used.

There is no required response to a client request containing invalid or unknown AS2-From or AS2-To header values. The receiving AS2 system MAY return an unsigned MDN with an explanation of the error, if the sending system requested an MDN.

7. Structure and Processing of an MDN Message

7.1. Introduction

In order to support non-repudiation of receipt, a signed receipt, based on digitally signing a message disposition notification, is to be implemented by a receiving trading partner's UA. The message disposition notification, specified by RFC 3798, is digitally signed by a receiving trading partner as part of a multipart/signed MIME message.

The following support for signed receipts is REQUIRED:

1. The ability to create a multipart/report; where the report-type = disposition-notification.
2. The ability to calculate a message integrity check (MIC) on the received message. The calculated MIC value will be returned to the sender of the message inside the signed receipt.
3. The ability to create a multipart/signed content with the message disposition notification as the first body part, and the signature as the second body part.
4. The ability to return the signed receipt to the sending trading partner.
5. The ability to return either a synchronous or an asynchronous receipt as the sending party requests.

The signed receipt is used to notify a sending trading partner that requested the signed receipt that:

1. The receiving trading partner acknowledges receipt of the sent EC Interchange.
2. If the sent message was signed, then the receiving trading partner has authenticated the sender of the EC Interchange.
3. If the sent message was signed, then the receiving trading partner has verified the integrity of the sent EC Interchange.

Regardless of whether the EDI/EC Interchange was sent in S/MIME format, the receiving trading partner's UA MUST provide the following basic processing:

1. If the sent EDI/EC Interchange is encrypted, then the encrypted symmetric key and initialization vector (if applicable) is decrypted using the receiver's private key.
2. The decrypted symmetric encryption key is then used to decrypt the EDI/EC Interchange.
3. The receiving trading partner authenticates signatures in a message using the sender's public key. The authentication algorithm performs the following:
 - a. The message integrity check (MIC or Message Digest), is decrypted using the sender's public key.
 - b. A MIC on the signed contents (the MIME header and encoded EDI object, as per RFC 1767) in the message received is calculated using the same one-way hash function that the sending trading partner used.
 - c. The MIC extracted from the message that was sent and the MIC calculated using the same one-way hash function that the sending trading partner used are compared for equality.
4. The receiving trading partner formats the MDN and sets the calculated MIC into the "Received-content-MIC" extension field.
5. The receiving trading partner creates a multipart/signed MIME message according to RFC 1847.
6. The MDN is the first part of the multipart/signed message, and the digital signature is created over this MDN, including its MIME headers.
7. The second part of the multipart/signed message contains the digital signature. The "protocol" option specified in the second part of the multipart/signed is as follows:

S/MIME: protocol = "application/pkcs-7-signature"
8. The signature information is formatted according to S/MIME specifications.

The EC Interchange and the RFC 1767 MIME EDI content header can actually be part of a multi-part MIME content-type. When the EDI Interchange is part of a multi-part MIME content-type, the MIC MUST be calculated across the entire multi-part content, including the MIME headers.

The signed MDN, when received by the sender of the EDI Interchange, can be used by the sender as follows:

- o As an acknowledgement that the EDI Interchange sent was delivered and acknowledged by the receiving trading partner. The receiver does this by returning the original-message-id of the sent message in the MDN portion of the signed receipt.
- o As an acknowledgement that the integrity of the EDI Interchange was verified by the receiving trading partner. The receiver does this by returning the calculated MIC of the received EC Interchange (and 1767 MIME headers) in the "Received-content-MIC" field of the signed MDN.
- o As an acknowledgement that the receiving trading partner has authenticated the sender of the EDI Interchange.
- o As a non-repudiation of receipt when the signed MDN is successfully verified by the sender with the receiving trading partner's public key and the returned MIC value inside the MDN is the same as the digest of the original message.

7.2. Synchronous and Asynchronous MDNs

The AS2-MDN exists in two varieties: synchronous and asynchronous.

The synchronous AS2-MDN is sent as an HTTP response to an HTTP POST or as an HTTPS response to an HTTPS POST. This form of AS2-MDN is called synchronous because the AS2-MDN is returned to the originator of the POST on the same TCP/IP connection.

The asynchronous AS2-MDN is sent on a separate HTTP, HTTPS, or SMTP TCP/IP connection. Logically, the asynchronous AS2-MDN is a response to an AS2 message. However, at the transfer-protocol layer, assuming that no HTTP pipelining is utilized, the asynchronous AS2-MDN is delivered on a unique TCP/IP connection, distinct from that used to deliver the original AS2 message. When handling an asynchronous request, the HTTP response MUST be sent back before the MDN is processed and sent on the separate connection.

When an asynchronous AS2-MDN is requested by the sender of an AS2 message, the synchronous HTTP or HTTPS response returned to the sender prior to terminating the connection MUST be a transfer-layer response indicating the success or failure of the data transfer. The format of such a synchronous response MAY be the same as that response returned when no AS2-MDN is requested.

The following diagram illustrates the synchronous versus asynchronous varieties of AS2-MDN delivery using HTTP:

Synchronous AS2-MDN

```
[Peer1] ----( connect )----> [Peer2]
[Peer1] -----( send )-----> [Peer2]   [HTTP Request [AS2-Message]]
[Peer1] <---( receive )----- [Peer2]   [HTTP Response [AS2-MDN]]
```

Asynchronous AS2-MDN

```
[Peer1] ----( connect )----> [Peer2]
[Peer1] -----( send )-----> [Peer2]   [HTTP Request [AS2-Message]]
[Peer1] <---( receive )----- [Peer2]   [HTTP Response]

[Peer1]*<---( connect )----- [Peer2]
[Peer1] <--- ( send )----- [Peer2]   [HTTP Request [AS2-MDN]]
[Peer1] ----( receive )-----> [Peer2]   [HTTP Response]
```

* Note: An AS2-MDN may be directed to a host different from that of the sender of the AS2 message. It may utilize a transfer protocol different from that used to send the original AS2 message.

The advantage of the synchronous MDN is that it can provide the sender of the AS2 Message with a verifiable confirmation of message delivery within a synchronous logic flow. However, if the message is relatively large, the time required to process this message and to return an AS2-MDN to the sender on the same TCP/IP connection may exceed the maximum configured time permitted for an IP connection.

The advantage of the asynchronous MDN is that it provides for the rapid return of a transfer-layer response from the receiver, confirming the receipt of data, therefore not requiring that a TCP/IP connection necessarily remain open for very long. However, this design requires that the asynchronous AS2-MDN contain enough information to identify the original message uniquely so that, when received by the AS2 Message originator, the status of the original AS2 Message can be properly updated based on the contents of the AS2-MDN.

Synchronous or asynchronous HTTP or HTTPS MDNs are handled according to the requirements of this specification.

However, SMTP MDNs are formatted according to the requirements of RFC 3335 [4].

7.3. Requesting a Signed Receipt

Message disposition notifications are requested as per RFC 3798. A request that the receiving user agent issue a message disposition notification is made by placing the following header into the message to be sent:

```
MDN-request-header = "Disposition-notification-to"  
                    ":" mail-address
```

The following example is for requesting an MDN:

```
Disposition-notification-to: xxx@example.com
```

This syntax is a residue of the use of MDNs using SMTP transfer. Because this specification is adjusting the functionality from SMTP to HTTP while retaining as much as possible from the [4] functionality, the mail-address MUST be present. The mail-address field is specified as an RFC 2822 localpart@domain [addr-spec] address. However, the address is not used to identify where to return the MDN. Receiving applications MUST ignore the value and MUST not complain about RFC 2822 address syntax violations.

When requesting MDN-based receipts, the originator supplies additional extension headers that precede the message body. These header "tags" are as follows:

A Message-ID header is added to support message reconciliation, so that an Original-Message-Id value can be returned in the body part of MDN. Other headers, especially "Subject" and "Date", SHOULD be supplied; the values of these headers are often mentioned in the human-readable section of a MDN to aid in identifying the original message.

MDNs will be returned in the HTTP response when requested, unless an asynchronous return is requested.

To request an asynchronous message disposition notification, the following header is placed into the message that is sent:

```
Receipt-Delivery-Option: return-URL
```

Here is an example requesting that the MDN be asynchronous:

```
Receipt-Delivery-Option: http://www.example.com/Path
```

Receipt-delivery-option syntax allows return-url to use some schemes other than HTTP using the POST method.

The "receipt-delivery-option: return-url" string indicates the URL to use for an asynchronous MDN. This header is NOT present if the receipt is to be synchronous. The email value in Disposition-notification-to is not used in this specification because it was limited to RFC 2822 addresses; the extension header "Receipt-delivery-option" has been introduced to provide a URL for the MDN return by several transfer options.

The receipt-delivery-option's value MUST be a URL indicating the delivery transport destination for the receipt.

An example request for an asynchronous MDN via an HTTP transport:

```
Receipt-delivery-option: http://www.example.com
```

An example request for an asynchronous MDN via an HTTP/S transport:

```
Receipt-delivery-option: https://www.example.com
```

An example request for an asynchronous MDN via an SMTP transport:

```
Receipt-delivery-option: mailto:as2@example.com
```

For more information on requesting SMTP MDNs, refer to RFC 3335 [4].

Finally, the header, Disposition-notification-options, identifies characteristics of message disposition notification as in [5]. The most important of these options is for indicating the signing options for the MDN, as in the following example:

```
Disposition-notification-options:  
  signed-receipt-protocol=optional,pkcs7-signature;  
  signed-receipt-micalg=optional,sha1,md5
```

For signing options, consider the disposition-notification-options syntax:

```
Disposition-notification-options =  
  "Disposition-Notification-Options" ":"  
  disposition-notification-parameters
```

where

```
disposition-notification-parameters =
    parameter *("; " parameter)
```

where

```
parameter = attribute "=" importance ", " 1#value"
```

where

```
importance = "required" | "optional"
```

So the Disposition-notification-options string could be:

```
signed-receipt-protocol=optional,<protocol symbol>;
signed-receipt-micalg=optional,<micalg1>,<micalg2>,...;
```

The currently used value for <protocol symbol> is "pkcs7-signature" for the S/MIME detached signature format.

The currently supported values for MIC algorithm <micalg> values are:

Algorithm	Value Used
-----	-----
SHA-1	sha1
MD5	md5

The semantics of the "signed-receipt-protocol" and the "signed-receipt-micalg" parameters are as follows:

1. The "signed-receipt-protocol" parameter is used to request a signed receipt from the recipient trading partner. The "signed-receipt-protocol" parameter also specifies the format in which the signed receipt SHOULD be returned to the requester.

The "signed-receipt-micalg" parameter is a list of MIC algorithms preferred by the requester for use in signing the returned receipt. The list of MIC algorithms SHOULD be honored by the recipient from left to right.

Both the "signed-receipt-protocol" and the "signed-receipt-micalg" option parameters are REQUIRED when requesting a signed receipt.

The lack of the presence of the "Receipt-Delivery-Option" indicates that a receipt is synchronous in nature. The presence of the "Receipt-Delivery-Option: return-url" indicates that an asynchronous receipt is requested and SHOULD be sent to the "return-url".

2. The "importance" attribute of "Optional" is defined in RFC 3798, Section 2.2, and has the following meaning:

Parameters with an importance of "Optional" permit a UA that does not understand the particular options parameter to still generate an MDN in response to a request for a MDN.

A UA that does not understand the "signed-receipt-protocol" parameter or the "signed-receipt-micalg" will obviously not return a signed receipt.

The importance of "Optional" is used for the signed receipt parameters because it is RECOMMENDED that an MDN be returned to the requesting trading partner even if the recipient could not sign it.

The returned MDN will contain information on the disposition of the message and on why the MDN could not be signed. See the Disposition field in Section 7.5 for more information.

Within an EDI trading relationship, if a signed receipt is expected and is not returned, then the validity of the transaction is up to the trading partners to resolve.

In general, if a signed receipt is required in the trading relationship and is not received, the transaction will likely not be considered valid.

7.3.1. Signed Receipt Considerations

The method used to request a receipt or a signed receipt is defined in RFC 3798, "An Extensible Message Format for Message Disposition Notifications".

The "rules" are as follows:

1. When a receipt is requested, explicitly specifying that the receipt be signed, then the receipt MUST be returned with a signature.
2. When a receipt is requested, explicitly specifying that the receipt be signed, but the recipient cannot support either the requested protocol format or the requested MIC algorithms, then either a signed or unsigned receipt SHOULD be returned.

3. When a signature is not explicitly requested, or if the signed receipt request parameter is not recognized by the UA, then no receipt, an unsigned receipt, or a signed receipt MAY be returned by the recipient.

NOTE: For Internet EDI, it is RECOMMENDED that when a signature is not explicitly requested, or if parameters are not recognized, the UA send back, at a minimum, an unsigned receipt. If, however, a signed receipt was always returned as a policy, whether requested or not, then any false unsigned receipts can be repudiated.

When a request for a signed receipt is made, but there is an error in processing the contents of the message, a signed receipt MUST still be returned. The request for a signed receipt SHALL still be honored, though the transaction itself may not be valid. The reason why the contents could not be processed MUST be set in the "disposition-field".

When a signed receipt request is made, the "Received-content-MIC" MUST always be returned to the requester (except when corruption prevents computation of the digest in accordance with the following specification). The "Received-content-MIC" MUST be calculated as follows:

- o For any signed messages, the MIC to be returned is calculated on the RFC1767/RFC3023 MIME header and content. Canonicalization on the MIME headers MUST be performed before the MIC is calculated, since the sender requesting the signed receipt was also REQUIRED to canonicalize.
- o For encrypted, unsigned messages, the MIC to be returned is calculated on the decrypted RFC 1767/RFC3023 MIME header and content. The content after decryption MUST be canonicalized before the MIC is calculated.
- o For unsigned, unencrypted messages, the MIC MUST be calculated over the message contents without the MIME or any other RFC 2822 headers, since these are sometimes altered or reordered by Mail Transport Agents (MTAs).

7.4. MDN Format and Values

This section defines the format of the AS2 Message Disposition Notification (AS2-MDN).

7.4.1. AS2-MDN General Formats

The AS2-MDN follows the MDN specification [5] except where noted in this section. The modified ABNF definitions in this document use the vertical-bar character, '|', to denote a logical "OR" construction. This usage follows RFC 2616 [3]. HTTP entities referred to below are not further defined in this document. Refer to RFC 2616 [3] for complete definitions of HTTP entities. The format of the AS2-MDN is:

```
AS2-MDN = AS2-sync-MDN | AS2-async-http-MDN |
          AS2-async-smtp-MDN
```

```
AS2-sync-MDN =
  Status-Line
  *(( general-header | response-header | entity-header )
  CRLF )
  CRLF
  AS2-MDN-body
```

```
Status-Line =
  HTTP-Version SP Status-Code SP Reason-Phrase CRLF
```

```
AS2-async-http-MDN =
  Request-Line
  *(( general-header | request-header | entity-header )
  CRLF )
  CRLF
  AS2-MDN-body
```

```
Request-Line =
  Method SP Request-URI SP HTTP-Version CRLF
```

```
AS2-async-smtp-MDN =
  *(( general-header | request-header ; entity-header )
  CRLF )
  CRLF
  AS2-MDN-body
```

```
AS2-MDN-body =
  AS2-signed-MDN-body | AS2-unsigned-MDN-body
```

7.4.2. AS2-MDN Construction

The AS2-MDN-body is formatted as a MIME multipart/report with a report-type of "disposition-notification". When the message is unsigned, the transfer-layer ("outermost") entity-headers of the AS2-MDN contain the content-type header that specifies a content-type

of "multipart/report" and parameters indicating the report-type, and the value of the outermost multipart boundary.

When the AS2-MDN is signed, the transfer-layer ("outermost") entity-headers of the AS2-MDN contain a content-type header that specifies a content-type of "multipart/signed" and parameters indicating the algorithm used to compute the message digest, the signature-formatting protocol (e.g., pkcs7-signature), and the value of the outermost multipart boundary. The first part of the MIME multipart/signed message is an embedded MIME multipart/report of type "disposition-notification". The second part of the multipart/signed message contains a MIME application/pkcs7-signature message.

The first part of the MIME multipart/report is a "human-readable" portion that contains a general description of the message disposition. The second part of the MIME multipart/report is a "machine-readable" portion that is defined as:

```
AS2-disposition-notification-content ::=
  [ reporting-ua-field CRLF ]
  [ mdn-gateway-field CRLF ]
  final-recipient-field CRLF
  [ original-message-id-field CRLF ]
  AS2-disposition-field CRLF
  *( failure-field CRLF )
  *( error-field CRLF )
  *( warning-field CRLF )
  *( extension-field CRLF )
  [ AS2-received-content-MIC-field CRLF ]
```

7.4.3. AS2-MDN Fields

The rules for constructing the AS2-disposition-notification content are identical to the disposition-notification-content rules provided in Section 7 of RFC 3798 [5], except that the RFC 3798 disposition-field has been replaced with the AS2-disposition-field and that the AS2-received-content-MIC field has been added. The differences between the RFC 3798 disposition-field and the AS2-disposition-field are described below. Where there are differences between this document and RFC 3798, those entity names have been changed by prepending "AS2-". Entities that do not differ from RFC 3798 are not necessarily further defined in this document; refer to RFC 3798, Section 7, "Collected Grammar", for the original grammar.

```

AS2-disposition-field =
    "Disposition" ":" disposition-mode ";"
    AS2-disposition-type [ '/' AS2-disposition-modifier ]

disposition-mode =
    action-mode "/" sending-mode

action-mode =
    "manual-action" | "automatic-action"

sending-mode =
    "MDN-sent-manually" | "MDN-sent-automatically"

AS2-disposition-type =
    "processed" | "failed"

AS2-disposition-modifier =
    ( "error" | "warning" ) | AS2-disposition-modifier-extension

AS2-disposition-modifier-extension =
    "error: authentication-failed" |
    "error: decompression-failed" |
    "error: decryption-failed" |
    "error: insufficient-message-security" |
    "error: integrity-check-failed" |
    "error: unexpected-processing-error" |
    "warning: " AS2-MDN-warning-description |
    "failure: " AS2-MDN-failure-description

AS2-MDN-warning-description = *( TEXT )

AS2-MDN-failure-description = *( TEXT )

AS2-received-content-MIC-field =
    "Received-content-MIC" ":" encoded-message-digest ","
    digest-alg-id CRLF

encoded-message-digest =
    1*( 'A'-'Z' | 'a'-'z' | '0'-'9' | '/' | '+' | '=' ) (
    i.e. base64( message-digest ) )

digest-alg-id = "sha1" | "md5"

```

"Insufficient-message-security" and "decompression-failed" are new error codes that are not mentioned in the AS1 RFC 3335, and may not be compatible with earlier implementations of AS2.

The "Received-content-MIC" extension field is set when the integrity of the received message is verified. The MIC is the base64-encoded message-digest computed over the received message with a hash function. This field is required for signed receipts but optional for unsigned receipts. For details defining the specific content over which the message digest is to be computed, see Section 7.3.1 of this document.

For signed messages, the algorithm used to calculate the MIC MUST be the same as that used on the message that was signed. If the message is not signed, then the SHA-1 algorithm SHOULD be used. This field is set only when the contents of the message are processed successfully. This field is used in conjunction with the recipient's signature on the MDN so that the sender can verify non-repudiation of receipt.

AS2-MDN field names (e.g., "Disposition:", "Final-Recipient:") are case insensitive (cf. RFC 3798, Section 3.1.1). AS2-MDN action-modes, sending-modes, AS2-disposition-types, and AS2-disposition-modifier values, which are defined above, and user-supplied *(TEXT) values are also case insensitive. AS2 implementations MUST NOT make assumptions regarding the values supplied for AS2-MDN-warning-description or AS2-MDN-failure-description, or for the values of any (optional) error, warning, or failure fields.

7.4.4. Additional AS2-MDN Programming Notes

- o Unlike SMTP, for HTTP transactions, Original-Recipient and Final-Recipient SHOULD not be different. The value in Original-Message-ID SHOULD match the original Message-ID header value.
- o Refer to RFC 3798 for the formatting of the MDN, except for the specific deviations mentioned above.
- o Refer to RFC 3462 and RFC 3798 for the formatting of the content-type entity-headers for the MDN.
- o Use an action-mode of "automatic-action" when the disposition described by the disposition type was a result of an automatic action rather than that of an explicit instruction by the user for this message.
- o Use an action-mode of "manual-action" when the disposition described by the disposition type was a result of an explicit instruction by the user rather than some sort of automatically performed action.

- o Use a sending-mode of "MDN-sent-automatically" when the MDN is sent because the UA had previously been configured to do so.
- o Use a sending-mode of "MDN-sent-manually" when the user explicitly gave permission for this particular MDN to be sent.
- o The sending-mode "MDN-sent-manually" is meaningful ONLY with "manual-action", not with "automatic-action".
- o The "failed" disposition type MUST NOT be used for the situation in which there is some problem in processing the message other than interpreting the request for an MDN. The "processed" or other disposition type with appropriate disposition modifiers is to be used in such situations.

7.5. Disposition Mode, Type, and Modifier

7.5.1. Disposition Mode Overview

This section provides a brief overview of how "processed", "error", "failure", and "warning" are used.

7.5.2. Successful Processing Status Indication

When the request for a receipt or signed receipt, and the received message contents are successfully processed by the receiving EDI UA, a receipt or MDN SHOULD be returned with the disposition-type set to "processed". When the MDN is sent automatically by the EDI UA, and there is no explicit way for a user to control the sending of the MDN, then the first part of the "disposition-mode" SHOULD be set to "automatic-action". When the MDN is being sent under user-configurable control, then the first part of the "disposition-mode" SHOULD be set to "manual-action". Since a request for a signed receipt should always be honored, the user MUST not be allowed to configure the UA not to send a signed receipt when the sender requests one.

The second part of the disposition-mode is set to "MDN-sent-manually" if the user gave explicit permission for the MDN to be sent. Again, the user MUST not be allowed to explicitly refuse to send a signed receipt when the sender requests one. The second part of the "disposition-mode" is set to "MDN-sent-automatically" whenever the EDI UA sends the MDN automatically, regardless of whether the sending was under the control of a user, administrator, or software.

Because EDI content is generally handled automatically by the EDI UA, a request for a receipt or signed receipt will generally return the following in the "disposition-field":

Disposition: automatic-action/MDN-sent-automatically; processed

Note that this specification does not restrict the use of the "disposition-mode" just to automatic actions. Manual actions are valid as long as it is kept in mind that a request for a signed receipt MUST be honored.

7.5.3. Unsuccessful Processed Content

The request for a signed receipt requires the use of two "disposition-notification-options", which specify the protocol format of the returned signed receipt, and the MIC algorithm used to calculate the MIC over the message contents. The "disposition-field" values that should be used if the message content is being rejected or ignored (for instance, if the EDI UA determines that a signed receipt cannot be returned because it does not support the requested protocol format, the EDI UA chooses not to process the message contents itself) MUST be specified in the MDN "disposition-field" as follows:

Disposition: "disposition-mode"; failed/Failure:
unsupported format

The "failed" AS2-disposition-type MUST be used when a failure occurs that prevents the proper generation of an MDN. For example, this disposition-type would apply if the sender of the message requested the application of an unsupported message-integrity-check (MIC) algorithm.

The "failure:" AS2-disposition-modifier-extension SHOULD be used with an implementation-defined description of the failure. Further information about the failure may be contained in a failure-field.

The syntax of the "failed" disposition-type is general, allowing the sending of any textual information along with the "failed" disposition-type. Implementations MUST support any printable textual characters after the Failure disposition-type. For use in Internet EDI, the following "failed" values are pre-defined and MUST be supported:

"Failure: unsupported format"

"Failure: unsupported MIC-algorithms"

7.5.4. Unsuccessful Non-Content Processing

When errors occur in processing the received message (other than content), the "disposition-field" MUST be set to the "processed" value for disposition-type and the "error" value for disposition-modifier.

The "error" AS2-disposition-modifier with the "processed" disposition-type MUST be used to indicate that an error of some sort occurred that prevented successful processing of the message. Further information may be contained in an error-field.

An "error:" AS2-disposition-modifier-extension SHOULD be used to combine the indication of an error with a predefined description of a specific, well-known error. Further information about the error may be contained in an error field.

For internet EDI use, the following "error" AS2-disposition-modifier values are defined:

- o "Error: decryption-failed" - the receiver could not decrypt the message contents.
- o "Error: authentication-failed" - the receiver could not authenticate the sender.
- o "Error: integrity-check-failed" - the receiver could not verify content integrity.
- o "Error: unexpected-processing-error" - a catch-all for any additional processing errors.

An example of how the "disposition-field" would look when errors other than those in content processing are detected is as follows:

```
Disposition: "disposition-mode"; processed/Error:
  decryption-failed
```

7.5.5. Processing Warnings

Situations arise in EDI when, even if a trading partner cannot be authenticated correctly, the trading partners still agree to continue processing the EDI transactions. Transaction reconciliation is done between the trading partners at a later time. In the content

processing warning situations as described above, the "disposition-field" MUST be set to the "processed" disposition-type value, and the "warning" to the "disposition-modifier" value.

The "warning" AS2-disposition-modifier MUST be used with the "processed" disposition-type to indicate that the message was successfully processed but that an exceptional condition occurred. Further information may be contained in a warning-field.

A "warning:" AS2-disposition-modifier-extension SHOULD be used to combine the indication of a warning with an implementation-defined description of the warning. Further information about the warning may be contained in a warning-field.

For use in Internet EDI, the following "warning" disposition-modifier-extension value is defined:

```
"Warning: authentication-failed, processing continued"
```

An example of how the "disposition-field" would look when warning other than those for content processing are detected is as follows:

Example:

```
Disposition: "disposition-mode"; processed/Warning:
authentication-failed, processing continued
```

7.5.6. Backward Compatibility with Disposition Type, Modifier, and Extension

The following set of examples represents typical constructions of the Disposition field that have been in use by AS2 implementations. This is NOT an exhaustive list of possible constructions. However, AS2 implementations MUST accept constructions of this type to be backward compatible with earlier AS2 versions.

```
Disposition: automatic-action/MDN-sent-automatically; processed
```

```
Disposition: automatic-action/MDN-sent-automatically;
processed/error: authentication-failed
```

```
Disposition: automatic-action/MDN-sent-automatically;
processed/warning: duplicate-document
```

```
Disposition: automatic-action/MDN-sent-automatically;
failed/failure: sender-equals-receiver
```

The following set of examples represents allowable constructions of the Disposition field that combine the historic constructions above with optional RFC 3798 error, warning, and failure fields. AS2 implementations MAY produce these constructions. However, AS2 servers are not required to recognize or process optional error, warning, or failure fields at this time. Note that the use of the multiple error fields in the second example below provides for the indication of multiple error conditions.

Disposition: automatic-action/MDN-sent-automatically; processed

Disposition: automatic-action/MDN-sent-automatically;

processed/error: decryption-failed

Error: The signature did not decrypt into a valid PKCS#1 Type-2 block.

Error: The length of the decrypted key does not equal the octet length of the modulus.

Disposition: automatic-action/MDN-sent-automatically;

processed/warning: duplicate-document

Warning: An identical message already exists at the destination server.

Disposition: automatic-action/MDN-sent-automatically;

failed/failure: sender-equals-receiver

Failure: The AS2-To name is identical to the AS2-From name.

The following set of examples represents allowable constructions of the Disposition field that employ pure RFC 3798 Disposition-modifiers with optional error, warning, and failure fields. These examples are provided as informational only. These constructions are not guaranteed to be backward compatible with AS2 implementations prior to version 1.1.

Disposition: automatic-action/MDN-sent-automatically; processed

Disposition: automatic-action/MDN-sent-automatically;

processed/error

Error: authentication-failed

Error: The signature did not decrypt into a valid PKCS#1 Type-2 block.

Error: The length of the decrypted key does not equal the octet length of the modulus.

Disposition: automatic-action/MDN-sent-automatically;

processed/warning

Warning: duplicate-document

Disposition: automatic-action/MDN-sent-automatically; failed
Failure: sender-equals-receiver

7.6. Receipt Reply Considerations in an HTTP POST

The details of the response to the POST command vary depending upon whether a receipt has been requested.

With no extended header requesting a receipt, and with no errors accessing the request-URI specified processing, the status line in the Response to the POST request SHOULD be in the 200 range. Status codes in the 200 range SHOULD also be used when an entity is returned (a signed receipt in a multipart/signed content type or an unsigned receipt in a multipart/report). Even when the disposition of the data was an error condition at the authentication, decryption or other higher level, the HTTP status code SHOULD indicate success at the HTTP level.

The HTTP server-side application may respond with an unsolicited multipart/report as a message body that the HTTP client might not have solicited, but the client may discard this. Applications SHOULD avoid emitting unsolicited receipt replies because bandwidth or processing limitations might have led administrators to suspend asking for acknowledgements.

Message Disposition Notifications, when used in the HTTP reply context, will closely parallel a SMTP MDN. For example, the disposition field is a required element in the machine-readable second part of a multipart/report for a MDN. The final-recipient-field ([5], Section 3.1) value SHOULD be derived from the entity headers of the request.

In an MDN, the first part of the multipart/report (the human-readable part) SHOULD include items such as the subject, the date, and other information when those fields are present in entity header fields following the POST request. An application MUST report the Message-ID of the request in the second part of the multipart/report (the machine-readable part). Also, an MDN SHOULD have its own unique Message-ID HTTP header. The HTTP reply SHOULD normally omit the third optional part of the multipart/report (used to return the original message or its headers in the SMTP context).

8. Public Key Certificate Handling

In the near term, the exchange of public keys and certification of these keys MUST be handled as part of the process of establishing a trading partnership. The UA and/or EDI application interface must maintain a database of public keys used for encryption or signatures,

in addition to the mapping between the EDI trading partner ID and the RFC 2822 [9] email address and HTTP URL/URI. The procedures for establishing a trading partnership and configuring the secure EDI messaging system might vary among trading partners and software packages.

X.509 certificates are REQUIRED. It is RECOMMENDED that trading partners self-certify each other if an agreed-upon certification authority is not used. This applicability statement does NOT require the use of a certification authority. The use of a certification authority is therefore OPTIONAL. Certificates may be self-signed.

It is RECOMMENDED that when trading partners are using S/MIME they also exchange public key certificates, considering advice provided in [12].

The message formats useful for certificate exchange are found in [7] and [13].

In the long term, additional standards may be developed to simplify the process of establishing a trading partnership, including the third-party authentication of trading partners, as well as the attributes of the trading relationship.

9. Security Considerations

This entire document is concerned with secure transport of business to business data, and it considers both data confidentiality and authentication issues.

Extracted from RFC 3851 [7]:

40-bit encryption is considered weak by most cryptographers. Using weak cryptography in S/MIME offers little actual security over sending plaintext. However, other features of S/MIME, such as the specification of Triple DES and the ability to announce stronger cryptographic capabilities to parties with whom you communicate, allow senders to create messages that use strong encryption. Using weak cryptography is never recommended unless the only alternative is no cryptography. When feasible, sending and receiving agents SHOULD inform senders and recipients of the relative cryptographic strength of messages.

Extracted from RFC 3850 [12]:

When processing certificates, there are many situations where the processing might fail. Because the processing may be done by a user agent, a security gateway, or other program, there is no single way to handle such failures. Just because the methods to handle the failures have not been listed, however, the reader should not assume

that they are not important. The opposite is true: if a certificate is not provably valid and associated with the message, the processing software should take immediate and noticeable steps to inform the end user about it.

Some of the many situations in which signature and certificate checking might fail include the following:

- o No certificate chain leads to a trusted CA.
- o No ability to check the Certificate Revocation List (CRL) for a certificate.
- o An invalid CRL was received.
- o The CRL being checked is expired.
- o The certificate is expired.
- o The certificate has been revoked.

There are certainly other instances where a certificate may be invalid, and it is the responsibility of the processing software to check them all thoroughly, and to decide what to do if the check fails. See RFC 3280 for additional information on certificate path validation.

The following are additional security considerations to those listed in [7] and [12].

9.1. NRR Cautions

This specification seeks to provide multiple mechanisms that can be combined in accordance with local policies to achieve a wide range of security needs as determined by threat and risk analyses of the business peers. It is required that all these mechanisms be implemented by AS2 software so that the software has capabilities that promote strong interoperability, no matter what policies are adopted.

One strong cluster of mechanisms (the secure transmission loop) can provide good support for meeting the evidentiary needs of non-repudiation of receipt by the original sender and by a third party supplied with all stated evidence. However, this specification does not itself define non-repudiation of receipt nor enumerate its essential properties because NRR is a business analysis and/or legal requirement, and not relevantly defined by a technical applicability statement.

Some analyses observe that non-repudiation of receipt presupposes that non-repudiation of the sender of the original message is obtained, and further that non-repudiation should be implemented by means of digital signature on the original message. To satisfy strict NRR evidence, authentication and integrity MUST be provided by some mechanism, and the RECOMMENDED mechanism is digital signatures on both the original message and the receipt message.

Given that this specification has selected several mechanisms that can be combined in several ways, it is important to realize that if a digital signature is omitted from the original message, in order to satisfy the preceding analysis of NRR requirements, some authentication mechanism MUST accompany the request for a signed receipt and its included Received-content-MIC value. This authentication might come from using client-side SSL, authentication via IPsec, or HTTP authentication (while using SSL). In any case, records of the message content, its security basis, and the digest value need to be retained for the NRR process.

Therefore, if NRR is one of the goals of the policy that is adopted, by using the mechanisms of the secure transmission loop mentioned above and by retaining appropriate records of authentication at the original message sender site, strong evidentiary requirements proposed for NRR can be fulfilled.

Other ways of proceeding may fall short of fulfilling the most stringent sets of evidence required for NRR to obtain, but may nevertheless be part of a commercial trading agreement and, as such, are good enough for the parties involved. However, if MDNs are returned unsigned, evidentiary requirements for NRR are weak; some authentication of the identity of the receiver is needed.

9.2. HTTPS Remark

The following certificate types MUST be supported for SSL server-side certificates:

- o with URL in the Distinguished Name Common Name attribute
- o without URL in the Distinguished Name Common Name attribute
- o self-signed (self-issued)
- o certification authority certified

The URL, which matches the source server identity, SHOULD be carried in the certificate. However, it is not required that DNS checks or reverse lookups to vouch for the accuracy of the URL or server value.

Because server-side certificates are exchanged, and also trust is established during the configuration of the trading partner relationship, runtime checks are not required by implementations of this specification.

The complete certification chain MUST be included in all certificates. All certificate verifications MUST "chain to root" or to an accepted trust anchor. Additionally, the certificate hash SHOULD match the hash recomputed by the receiver.

9.3. Replay Remark

Because business data documents normally contain transaction ids, replays (such as resends of not-yet-acknowledged messages) are discarded as part of the normal process of duplicate detection. Detection of duplicates by Message-Id or by business transaction identifiers is recommended.

10. IANA Considerations

RFC 3335 registered two Disposition-Notification-Options parameters

Parameter-name: signed-receipt-protocol
Parameter-name: signed-receipt-micalg

that are also used by this specification (see Section 7.3).

RFC 3335 also registered on MDN Extension field name

Extension field name: Received-content-MIC

that is also used by this specification (see Section 7.4.3).
Registration of the above is therefore NOT needed.

10.1. Registration

This specification defines an extension to the Message Disposition Notification (MDN) protocol for a disposition-modifier in the Disposition field of a body of content-type "message/disposition-notification".

10.1.1. Disposition Modifier 'warning'

Parameter-name: warning
Semantics: See Sections 7.4.3 and 7.5.5 of this document.

11. Acknowledgements

Carl Hage, Karen Rosenfeld, Chuck Fenton, and many others have provided valuable suggestions that improved this applicability statement. The authors would also like to thank the vendors who participated in the Drummond Group Inc. AS2 interoperability testing. Their contributions led to great improvement in the clarity of this document.

12. References

12.1. Normative References

- [1] Freed, N. and N. Borenstein, "Multipurpose Internet Mail Extensions (MIME) Part One: Format of Internet Message Bodies", RFC 2045, November 1996.

Freed, N. and N. Borenstein, "Multipurpose Internet Mail Extensions (MIME) Part Two: Media Types", RFC 2046, November 1996.

Freed, N. and N. Borenstein, "Multipurpose Internet Mail Extensions (MIME) Part Five: Conformance Criteria and Examples", RFC 2049, November 1996.
- [2] Crocker, D., "MIME Encapsulation of EDI Objects", RFC 1767, March 1995.
- [3] Fielding, R., Gettys, J., Mogul, J., Frystyk, H., Masinter, L., Leach, P., and T. Berners-Lee, "Hypertext Transfer Protocol -- HTTP/1.1", RFC 2616, June 1999.
- [4] Harding, T., Drummond, R., and C. Shih, "MIME-based Secure Peer-to-Peer Business Data Interchange over the Internet", RFC 3335, September 2002.
- [5] Hansen, T. and G. Vaudreuil, "Message Disposition Notification", RFC 3798, May 2004.
- [6] Galvin, J., Murphy, S., Crocker, S., and N. Freed, "Security Multiparts for MIME: Multipart/Signed and Multipart/Encrypted", RFC 1847, October 1995.
- [7] Ramsdell, B., "Secure/Multipurpose Internet Mail Extensions (S/MIME) Version 3.1 Message Specification", RFC 3851, July 2004.

- [8] Vaudreuil, G., "The Multipart/Report Content Type for the Reporting of Mail System Administrative Messages", RFC 3462, January 2003.
- [9] Resnick, P., "Internet Message Format", RFC 2822, April 2001.
- [10] Murata, M., Laurent, S. St., and D. Kohn, "XML Media Types", RFC 3023, January 2001.
- [11] Bradner, S., "The Internet Standards Process -- Revision 3", BCP 9, RFC 2026, October 1996.
- [12] Ramsdell, B., "Secure/Multipurpose Internet Mail Extensions (S/MIME) Version 3.1 Certificate Handling", RFC 3850, July 2004.
- [13] Housley, R., "Cryptographic Message Syntax (CMS)", RFC 3852, July 2004.
- [14] Crocker, D. and P. Overell, "Augmented BNF for Syntax Specifications: ABNF", RFC 2234, November 1997.

12.2. Informative References

- [15] Dierks, T. and C. Allen, "The TLS Protocol Version 1.0", RFC 2246, January 1999.

Appendix A: Message Examples

NOTE: All examples are provided for illustration only, and are not considered part of the protocol specification. If an example conflicts with the protocol definitions specified above or in the other referenced RFCs, the example is wrong.

A.1. Signed Message Requesting a Signed, Synchronous Receipt

```
POST /receive HTTP/1.0
Host: 10.234.160.12:80
User-Agent: AS2 Company Server
Date: Wed, 31 Jul 2002 13:34:50 GMT
From: mrAS2@example.com
AS2-Version: 1.1
AS2-From: "\" as2Name \""
AS2-To: 0123456780000
Subject: Test Case
Message-Id: <200207310834482A70BF63@\"~~foo~~\">
Disposition-Notification-To: mrAS2@example.com
Disposition-Notification-Options: signed-receipt-protocol=optional,
  pkcs7-signature; signed-receipt-micalg=optional,sha1
Content-Type: multipart/signed; boundary="as2BouNdarylas2";
  protocol="application/pkcs7-signature"; micalg=sha1
Content-Length: 2464

--as2BouNdarylas2
Content-Type: application/edi-x12
Content-Disposition: Attachment; filename=rfc1767.dat
  [ISA ...EDI transaction data...IEA...]

--as2BouNdarylas2
Content-Type: application/pkcs7-signature

  [omitted binary pkcs7 signature data]
--as2BouNdarylas2--
```

A.2. MDN for Message A.1, Above

```
HTTP/1.0 200 OK
AS2-From: 0123456780000
AS2-To: "\" as2Name \""
AS2-Version: 1.1
Message-ID: <709700825.1028122454671.JavaMail@ediXchange>
Content-Type: multipart/signed; micalg=sha1;
  protocol="application/pkcs7-signature";
  boundary="-----_Part_57_648441049.1028122454671"
Connection: Close
```

Content-Length: 1980

-----=_Part_57_648441049.1028122454671

```
& Content-Type: multipart/report;
& Report-Type=disposition-notification;
&   boundary="-----=_Part_56_1672293592.1028122454656"
&
&-----=_Part_56_1672293592.1028122454656
&Content-Type: text/plain
&Content-Transfer-Encoding: 7bit
&
&MDN for -
& Message ID: <200207310834482A70BF63@\"~~foo~~\">
& From: "\" as2Name \""
& To: "0123456780000"
& Received on: 2002-07-31 at 09:34:14 (EDT)
& Status: processed
& Comment: This is not a guarantee that the message has
& been completely processed or &understood by the receiving
& translator
&
&-----=_Part_56_1672293592.1028122454656
&Content-Type: message/disposition-notification
&Content-Transfer-Encoding: 7bit
&
&Reporting-UA: AS2 Server
&Original-Recipient: rfc822; 0123456780000
&Final-Recipient: rfc822; 0123456780000
&Original-Message-ID: <200207310834482A70BF63@\"~~foo~~\">
&Received-content-MIC: 7v7F++fQaNB1sVLFtMRp+dF+eG4=, sha1
&Disposition: automatic-action/MDN-sent-automatically;
& processed
&
&-----=_Part_56_1672293592.1028122454656--
```

-----=_Part_57_648441049.1028122454671

```
Content-Type: application/pkcs7-signature; name=smime.p7s
Content-Transfer-Encoding: base64
Content-Disposition: attachment; filename=smime.p7s
```

```
MIAGCSqGSIb3DQEHAQCAMIACAQExCzAJBgUrDgMCGGUAMIAGCSqGSIb3DQ
cp24hMJNbxDKHnlB9jTiQzLwSwo+/90Pc87x+Sc6EpFSUYWGAAAAAAAAA
```

-----=_Part_57_648441049.1028122454671--

Notes:

1. The lines proceeded with "&" are what the signature is calculated over.
2. For details on how to prepare the multipart/signed with protocol = "application/pkcs7-signature", see the "S/MIME Message Specification, PKCS Security Services for MIME".)
3. Note that the textual first body part of the multipart/report can be used to include a more detailed explanation of the error conditions reported by the disposition headers. The first body part of the multipart/report, when used in this way, allows a person to better diagnose a problem in detail.
4. As specified by RFC 3462 [8], returning the original or portions of the original message in the third body part of the multipart/report is not required. This is an optional body part. However, it is RECOMMENDED that this body part be omitted or left blank.

A.3. Signed, Encrypted Message Requesting a Signed, Asynchronous Receipt

```
Message-ID: <#as2_company#01#a4260as2_companyout#>
Date: Thu, 19 Dec 2002 15:04:18 GMT
From: me@example.com
Subject: Async MDN request
Mime-Version: 1.0
Content-Type: application/pkcs7-mime;
  smime-type=enveloped-data; name=smime.p7m
Content-Transfer-Encoding: binary
Content-Disposition: attachment; filename=smime.p7m
Recipient-Address: 10.240.1.2//
Disposition-Notification-To:
  http://10.240.1.2:8201/exchange/as2_company
Disposition-Notification-Options: signed-receipt-protocol=optional,
  pkcs7-signature; signed-receipt-micalg=optional,shal
Receipt-Delivery-Option:
  http://10.240.1.2:8201/exchange/as2...company
AS2-From: as2_company
AS2-To: "AS2 Test"
AS2-Version: 1.1
Host: 10.240.1.2:8101
Connection: close
Content-Length: 3428
```

[omitted binary encrypted data]

A.4. Asynchronous MDN for Message A.3, Above

```
POST / HTTP/1.1
Host: 10.240.1.2:8201
Connection: close, TE
TE: trailers, deflate, gzip, compress
User-Agent: RPT-HTTPClient/0.3-3I (Windows 2000)
Date: Thu, 19 Dec 2002 15:03:38 GMT
Message-ID: <AS2-20021219_030338@as2_company.dgi_th>
AS2-Version: 1.1
Mime-Version: 1.0
Recipient-Address:
http://10.240.1.2:8201/exchange/as2_company
AS2-To: as2_company
AS2-From: "AS2 Test"
Subject: Your Requested MDN Response
From: as2debug@example.com
Accept-Encoding: deflate, gzip, x-gzip, compress, x-compress
Content-Type: multipart/signed; micalg=sha1;
  protocol="application/pkcs7-signature";
  boundary="-----_Part_337_6452266.1040310218750"
Content-Length: 3103
```

```
-----_Part_337_6452266.1040310218750
Content-Type: multipart/report;
  report-type=disposition-notification;
  boundary="-----_Part_336_6069110.1040310218718"
```

```
-----_Part_336_6069110.1040310218718
Content-Type: text/plain; charset=us-ascii
Content-Transfer-Encoding: 7bit
```

The message <x12.edi> sent to Recipient <AS2 Test> on Thu, 19 Dec 2002 15:04:18 GMT with Subject <async MDN request> has been received. The EDI Interchange was successfully decrypted, and its integrity was verified. In addition, the sender of the message, Sender <as2_company> at Location http://10.240.1.2:8201/exchange/as2_company was authenticated as the originator of the message. There is no guarantee, however, that the EDI interchange was syntactically correct, or that it was received by the EDI application/translator.

-----=_Part_336_6069110.1040310218718
Content-Type: message/disposition-notification
Content-Transfer-Encoding: 7bit

Reporting-UA: AS2@test:8101
Original-Recipient: rfc822; "AS2 Test"
Final-Recipient: rfc822; "AS2 Test"
Original-Message-ID: <#as2_company#01#a4260as2_companyout#>
Disposition: automatic-action/MDN-sent-automatically;
processed
Received-Content-MIC: Hes6my+vIxIYxmvsA+MNpEOTPAc=, sha1

-----=_Part_336_6069110.1040310218718--

-----=_Part_337_6452266.1040310218750
Content-Type: application/pkcs7-signature; name=smime.p7s
Content-Transfer-Encoding: base64
Content-Disposition: attachment; filename=smime.p7s

BhbWjEfbyXoTAS/H0zpnEqLqbaBh29y2v82b8bdeGw8pipBQWmf53hIcqHGM
4ZBF3CHw5Wrf1JIE+8TwOzdbal30zeChw88WfRfD7c/j1fIA8sxsujvf2d9j
UxCUga8BVdVB9kH0Geexytyt0KvWQXfaEEcgZGUAAAAAAAAA=

-----=_Part_337_6452266.1040310218750-

Authors' Addresses

Dale Moberg
Cyclone Commerce
8388 E. Hartford Drive, Suite 100
Scottsdale, AZ 85255 USA

E-Mail: dmoberg@cyclonecommerce.com

Rik Drummond
Drummond Group Inc.
4700 Bryant Irvin Court, Suite 303
Fort Worth, TX 76107 USA

E-Mail: rvd2@drummondgroup.com

Full Copyright Statement

Copyright (C) The Internet Society (2005).

This document is subject to the rights, licenses and restrictions contained in BCP 78, and except as set forth therein, the authors retain all their rights.

This document and the information contained herein are provided on an "AS IS" basis and THE CONTRIBUTOR, THE ORGANIZATION HE/SHE REPRESENTS OR IS SPONSORED BY (IF ANY), THE INTERNET SOCIETY AND THE INTERNET ENGINEERING TASK FORCE DISCLAIM ALL WARRANTIES, EXPRESS OR IMPLIED, INCLUDING BUT NOT LIMITED TO ANY WARRANTY THAT THE USE OF THE INFORMATION HEREIN WILL NOT INFRINGE ANY RIGHTS OR ANY IMPLIED WARRANTIES OF MERCHANTABILITY OR FITNESS FOR A PARTICULAR PURPOSE.

Intellectual Property

The IETF takes no position regarding the validity or scope of any Intellectual Property Rights or other rights that might be claimed to pertain to the implementation or use of the technology described in this document or the extent to which any license under such rights might or might not be available; nor does it represent that it has made any independent effort to identify any such rights. Information on the procedures with respect to rights in RFC documents can be found in BCP 78 and BCP 79.

Copies of IPR disclosures made to the IETF Secretariat and any assurances of licenses to be made available, or the result of an attempt made to obtain a general license or permission for the use of such proprietary rights by implementers or users of this specification can be obtained from the IETF on-line IPR repository at <http://www.ietf.org/ipr>.

The IETF invites any interested party to bring to its attention any copyrights, patents or patent applications, or other proprietary rights that may cover technology that may be required to implement this standard. Please address the information to the IETF at ietf-ipr@ietf.org.

Acknowledgement

Funding for the RFC Editor function is currently provided by the Internet Society.

Electronic Payment Systems: a User-Centered Perspective and Interaction Design

Dennis Abrazhevich

The work described in this thesis has been carried out under the auspices of the J.F. Schouten School for User-System Interaction Research.

© Dennis Abrazhevich– Eindhoven – The Netherlands.

CIP-DATA LIBRARY TECHNISCHE UNIVERSITEIT EINDHOVEN

Abrazhevich, Dennis

Electronic payment systems : a user-centered perspective and interaction design / by Denis Abrazhevich. – Eindhoven : Technische Universiteit Eindhoven, 2004. – Proefschrift. -

ISBN 90-386-1948-0

NUR 788

Keywords: Electronic payment systems / Online payments / E-commerce / User acceptance / Technology acceptance / User-centered engineering / Interaction design / Usability / Human-computer Interaction

Cover design: Jan-Willem Luiten, JWL Producties.

Printing: Universiteitsdrukkerij Technische Universiteit Eindhoven.

Electronic Payment Systems: a User-Centered Perspective and Interaction Design

PROEFSCHRIFT

ter verkrijging van de graad van doctor aan de
Technische Universiteit Eindhoven, op gezag van de
Rector Magnificus, prof.dr. R.A. van Santen, voor een
commissie aangewezen door het College voor
Promoties in het openbaar te verdedigen
op maandag 19 april 2004 om 16.00 uur

door

Denis Abrazhevich

geboren te Kerch, Rusland

Dit proefschrift is goedgekeurd door de promotoren:

prof. dr. G.W.M. Rauterberg

en

prof. dr. P.M.A. Ribbers

Copromotor:

dr. P. Markopoulos

Acknowledgements

I would like to express my gratitude to people who supported me in the course of my work. I thank my colleagues at Industrial Design, IPO, TM, and SOBU for interesting and productive work together.

This research would not have been complete without the participation of Comsys BV and Postbank. My special thanks to Diederik Husslage and Jan-Joost Bouwman, who helped me greatly with establishing the experimental environment. I am thankful to Simon Lelieveldt who has brought me in contact with the right people in the right time, and supported me with his valuable advice.

Great thanks go to my family and friends, especially to Bogdan Raducanu, Tim Marsh and dear Diana Flood who supported me in the final phase on my research. My best regards to Florian Egger and Rik Geurts to commemorate our discussions and work together. Great thanks to Wolmet Barendregt for helping with the numerous translations to Dutch.

And finally, I would like to express my most gratitude to my supervisors, to prof. Matthias Rauterberg, who supported me through the course of my research, and especially to my daily supervisor, dr. Panos Markopoulos, who helped me immensely with his advice and to the great extent contributed to the success of this thesis.

Contents

Chapter 1. Introduction	1
1.1 Electronic payment systems and their place in electronic commerce	1
1.1.1 E-commerce and electronic payment systems	1
1.1.2 Limitations of traditional payment systems in the context of online payments	4
1.1.3 The need for new payment systems designed for e-commerce	6
1.2 User acceptance: understanding and issues	8
1.3 Research objectives	12
1.4 Research scope	13
1.4.1 The role of electronic payments in customer e-commerce activities	14
1.4.2 Approach and methodology	18
Chapter 2. Classification and characteristics of electronic payment systems	23
2.1 Classification of payment systems	23
2.1.1 Introduction	23
2.1.2 Primary classification of payment systems	24
2.1.3 Further classification of account-based systems	25
2.1.4 Further classification of electronic cash systems	28
2.1.5 Payment mediation services vs. payment systems	29
2.2 Identifying the characteristics of payment systems	33
2.3 Advantages and limitations of payment models	39
2.3.1 Advantages and limitations of the electronic cash model	39
2.3.2 Advantages and limitations of the account-based model	40

2.4	PayPal.com: Using characteristics for analysis of payment systems	41
2.5	Conclusions	44
Chapter 3. User survey of electronic payment systems		47
3.1	User acceptance of electronic payment systems	47
3.2	Survey of users' attitudes towards characteristics of payment systems	51
3.2.1	Survey participants	52
3.2.2	Questionnaire design and analysis	52
3.2.3	Survey results and discussion	53
3.2.4	Implications for user acceptance	56
Chapter 4. Diary study: a qualitative investigation of user experiences with EPSs		59
4.1	Introduction	59
4.2	Set-up of the diary study	61
4.2.1	Selection of subjects	62
4.2.2	Process and instrumentation	64
4.2.3	Diary study results	66
4.3	Analysis of the results	67
4.4	Conclusions	78
Chapter 5. Validating the design recommendations		81
5.1	Introduction	81
5.1.1	Expert review of the design recommendations	81
5.1.2	Method	83
5.1.3	Hypothesis	83
5.1.4	The system under test	84
5.1.5	Changes made to the Postbank Betaalijn based on the DRs	87
5.1.6	Subjects	89
5.2	Experimental setup	91
5.2.1	Overview	91
5.2.2	Dependent and independent variables	91
5.2.3	Experimental design	92
5.2.4	Tasks and instructions	93
5.2.5	Procedure	94
5.3	Results and Analysis	96
5.3.1	Results: repeated measures	96
5.3.2	Results: task specific measurements	109

5.4	Discussion	113
5.4.1	Validation of the design recommendations	113
5.4.2	Revision of not validated design recommendations	118
5.4.3	Limitations of the experimental study	119
5.5	Conclusions	121
Chapter 6. Discussion and conclusions		123
6.1	Summary of the thesis	123
6.2	Validity issues and limitations	127
6.2.1	Cause-effect validity	127
6.2.2	Generality issues	128
6.2.3	Conclusions	132
6.3	Future work	132
Appendix A		135
Appendix B		147
Appendix C		151
Appendix D		153
Appendix E		173
References		179
Samenvatting (summary in Dutch)		187
Curriculum Vitae		189

Chapter 1

Introduction

1.1 Electronic payment systems and their place in electronic commerce

In the early 1990s the business and consumer world encountered a new way of conducting trade business, which was named *electronic commerce* (e-commerce). Over the years electronic commerce has evolved into a popular and acknowledged way of conducting business. While researchers are still trying to understand it and gauge its importance and turnover, e-commerce is changing and growing incredibly quickly, producing such extraordinary results from both business and customer perspective that its phenomenon cannot be overlooked by anyone who has ever thought of conducting business, whether in online or offline environments. With many organisations and people labouring in the field of e-commerce it has become very clear that e-commerce is here to stay and organisations and customers are trying to get maximum benefit from it.

E-commerce has become especially important in two interrelated dimensions, namely business-to-consumer (B2C) and business-to-business (B2B) e-commerce. Business-

to-consumer e-commerce is enabling customers to have an increasing influence on products created, how products are customised, and how services are delivered. E-commerce offers customers convenient shopping methods for products, information and services, electronic banking, and personal finance management. It is making it easier for consumers to find the desired products and services, match them more precisely to their requirements, and compare prices, (Vulkan, 2003). Several business models have been developed to support various customers' needs, among them are online portals, content providers, transaction brokers and community creators.

For business-to-business relations e-commerce facilitates the form of organisation where companies rely on suppliers and product distribution to respond more effectively to the changing market and customers demand and to achieve more efficient operation. This type of e-commerce relationships offers organisations the possibility to work in the direct contact with producers, giving more room for customization and control over business activities. This helps to reduce the costs significantly by removing 'middlemen' from the supply chain. Good examples of companies that employ this business model are Dell and Cisco, (Guttman, 2003; Laudon & Traver, 2002).

Consequences that e-commerce brings for business-to-business relationships are eliminating inventory, and operational and distributional costs that indirectly provide customers with lower prices. E-commerce can help businesses to increase production flexibility by ensuring timely availability of components from suppliers, to improve quality of the products by increasing cooperation between buyers and sellers and reducing quality issues, to increase opportunities for collaborating with suppliers and distributors, and to create greater price transparency — the ability to see the actual prices on the market, (Laudon & Traver, 2002). In this way e-commerce responds to the customer demand of lower prices and greater convenience.

1.1.1 E-commerce and electronic payment systems

The most popular definition of e-commerce is based on the *online* perspective of the conducted business. E-commerce provides the capability of buying and selling products, information and services on the Internet and other online environments. As for any trading activity, the issue of safe and reliable money exchange between transacting parties is essential. In an e-commerce environment, payments take the form of money exchange in an electronic form, and are therefore called *electronic payments*. Electronic payments are an integral part of e-commerce and are one of its most critical as-

pects. Generally defined, electronic payment is a form of a financial exchange that takes place between the buyer and seller facilitated by means of electronic communications. An e-commerce electronic payment is a financial exchange that takes place in an online environment, (Kalakota & Whinston, 1997).

Electronic payment systems (EPSs) are summoned to facilitate the most important action after the customer's decision to pay for a product or service – to deliver payments from customers to vendors in a most effective, efficient and problem-free way. The role of e-commerce electronic payment systems is pivotal for future of e-commerce, whose further growth depends on the timely development of EPSs.

The development of new types of e-commerce purchasing relationships and business models has created the need for new ways of money exchange and new EPSs. For instance, online auctions, (Ribbers & Heck, 2004), has spurred the necessity for person-to-person payment systems to allow online money exchange between individuals. Certain types of information products and services require small payments and micropayments. Businesses would like to sell information content that costs very little, accumulating revenues with high turnover. E-commerce EPSs can be designed for selling specific types of products, for example for trading copyrighted online content, such as music. Another unforeseen earlier requirement is conducting e-commerce using wireless mobile devices, such as mobile phones or personal digital assistants (PDA). The need for paying with mobile devices has urged the development of payment systems for mobile electronic commerce, (Laudon & Traver, 2002). In addition, e-commerce provides the possibility to enhance current payment systems or substitute them with online variants.

The need for online payments was first addressed by using extant payment methods of the offline world for online payments. For example credit cards, originally intended as an offline credit instrument, have become the major payment instrument for e-commerce. As e-commerce and online purchasing grows, the weaknesses of credit and debit cards, and cheques are becoming more apparent. These limitations are discussed in section 1.1.2. The lack of the fit-for purpose payment mechanisms and infrastructure is one of the main restricting factors that hold back the growth and evolution of e-commerce, (Guttman, 2003; Laudon & Traver, 2002; O'Mahony, Peirce, & Tewari, 1997).

1.1.2 Limitations of traditional payment systems in the context of online payments

Three factors are stimulating the development of electronic payment systems: reduced operational and payments processing costs, growing online commerce and decreasing the costs of technology, (Kalakota & Whinston, 1997). Reduction of costs is one of the major reasons for research and development of EPSs. The central impetus for e-commerce and e-business is to provide a more efficient service, primarily in terms of costs. In this light, paying online with traditional payment systems such as credit cards is rather paradoxical, given that credit cards are one of the most expensive of all available mainstream payment means for both end consumers and merchants, defeated perhaps only by paper checks, (Lietaer, 2002; Laudon & Traver, 2002).

Several limitations of traditional payment systems in the context of e-commerce can be outlined. Existing payment systems, such as credit cards, are inadequate for retail customer digital business from the following viewpoints:

Lack of usability. Existing payment systems for the Internet require from the end user to provide a large amount of information, or make payments using complex elaborated web site interfaces. E.g. credit card payments via a web site are not the easiest way to pay, as these require entering extensive amounts of personal data and contact details in a web form, (Kalakota & Whinston, 1997).

Lack of security. Existing payment systems for the Internet are an easy target for stealing money and personal information. Customers have to provide credit card or payment account details and other personal information online. This data is sometimes transmitted in an un-secured way, (Kalakota & Whinston, 1997). In practice this happens even in spite of introduction of secure transactions mechanisms, such as Secured Socket Layer. Providing these details by mail or over the telephone also entails security risks, (Guttmann, 2003; Laudon & Traver, 2002).

Lack of trust. Users tend not to trust existing systems with the long history of fraud, misuse or low reliability, as well as novel systems without established positive reputation. In the present situation, money loss by customers is quite possible when using existing payment systems, such as credit cards, for Internet payments. Potential customers often mention this risk as the key reason why they do not trust a payment service and therefore do not make Internet purchases, (Lietaer, 2002).

Lack of applicability. Not all web sites support a particular payment method, thus limiting customers' ability to pay. Credit cards work only with merchants who have signed-up to the services of the corresponding credit card company, and do not support direct business-to-business or interpersonal payments, (Kalakota & Whinston, 1997).

Lack of eligibility. Not every potential customer with money and intention to pay can make use of certain payment methods. Not all potential buyers can obtain credit cards due to credit history limitations, low income or other reasons, (ibid).

Lack of efficiency. Some payments over the Internet can be too small to be handled by existing payment systems, because of overheads included in the processing of payments and transaction. Credit cards are too expensive for effecting small payments and are unsuited for small transactions. The minimum fixed fee charged to the retailer for processing a transaction could even surpass the value of the goods sold, (Guttman, 2003).

High usage costs for customers and merchants. Existing payment systems use a rather expensive infrastructure to facilitate the payment process. Credit cards are very expensive for end users, not in the least because of the enormous and growing size of fraud, which amounts to billions dollars per year. This loss is invisibly re-financed by users by the higher costs of credit card services. In addition, credit card payments are still heavily paper-dependent. Most credit card bills are sent in a paper form to customers by post, and the bills are mostly settled by posting paper documents, like checks of giro payments, which makes the whole cycle rather expensive. As mentioned above, this means that resources employed in processing of credit cards transactions render them rather ineffective for small payments, because the high overhead of credit cards, (Laudon & Traver, 2002; Guttman, 2003).

In online credit card payments credit cards are not physically available for inspection by the payee, (this situation is referred as 'card not present'). This imposes higher charges for merchants, because the chance of fraud is higher; see section 2.1.3 for more discussion. Credit cards have low finality of payments because users can refute or repudiate credit cards payments in certain situations. Moreover, financial regulations in certain countries, e.g. in the USA and the UK, place the risks of repudiation, fraud, or non-payment largely on the merchant and issuing banks, (Laudon & Traver, 2002; APACS, 2002). These issues make credit cards less attractive to merchants. Certain authentication schemes, e.g. Verified by Visa

and SecureCode from MasterCard allow to shift fraud liability from merchant to credit cards issuing banks, and can ease this burden for merchants, (see www.verifiedbyvisa.com and www.mastercard.com). However, end users can find themselves paying more for the cards issued by the banks to refinance bank's losses due to fraud.

There are more concerns related to the credit card use in online e-commerce that are responsible for reluctant users acceptance of credit cards and e-commerce. According to the report published by marketing research firm IDC, (Asmussen, Raschke, & Ar-end, 2002), almost half of European users of the Internet do not buy goods online because they either do not trust the Web merchants or fear their credit card details will not be secure. According to analysts, total credit card fraud rose to \$4 billion in 2002 (i.e. \$2 for every card issued). Industry estimates that the amount of online credit card fraud could be in the \$500 million range, (Laudon & Traver, 2002).

Authorities believe that hackers have stolen more than one million credit card numbers from E-commerce sites. It would not be a surprise that many customers use their credit cards with reservations. A survey by Visa of 15 Banks from 12 EU countries in 2002 found that online credit card payments account for nearly half of all complaints. More than one in five of these came from people who had not even shopped on the Internet, but were billed for online transactions, (Philippsohn & Thomas, 2003).

Privacy issues are also associated with the use of existing payment systems. There are cases when users' identities (i.e. personal data such as credit card numbers, names and addresses) were stolen when hackers break into websites' databases and obtain personal information of the customers. Fraudsters then attempt to use this information to open new credit and bank accounts using the stolen identity, (Philippsohn & Thomas, 2003). These and other issues with existing payment systems such as credit cards render them not very suitable for online payments.

1.1.3 The need for new payment systems designed for e-commerce

Despite that electronic commerce is a growing phenomenon, its future development is, to a large extent, hampered by the lack of appropriate payment systems. Since most of business-to-consumer payments over the Internet are performed currently via credit cards, an admittedly problematic payment medium due to costs, security and trust

problems, the need for new payment systems clearly emerges from the existing situation, (Lynch & Lundquist, 1996; Wayner, 1997; Laudon & Traver, 2002; Guttman, 2003).

Research and development in Internet-based payments tried to resolve this situation by conjuring numerous online EPSs, a good proportion of which has been put to use. This was possible due to the stimulating factors listed above, and in the first place due to the availability and reduced costs of the enabling technology. However, the new payment systems, purposely crafted for the Internet, also could not avoid their own share of problems. This has led to the reluctant use of new online electronic payment systems, i.e. resulted in low *user acceptance* of newly introduced payment systems by customers, (see section 1.2).

User acceptance of electronic payment systems

At this stage the situation with the development of online EPSs is far from ideal. A survey on electronic money developments by the Bank for International Settlement reports a rather low level of EPSs use, even in the most advanced countries, (BIS, 2000).

According to the European Central Bank, the proportion of online payments among cashless payment instruments in the European Union is rather low. The report admits that although there has been a lot of discussion on the use of EPSs and their importance “it is still not a widely used medium”, (ECB, 2001). The lack of customer demand, the diversity of technological standards and the lack of support by financial institutions are mentioned among the reasons preventing the development of electronic payment systems, (ECB, 2003).

Some experts estimate that about 85% of all Internet transactions are done with credit cards that were not originally designed for the Internet, (Philippsohn & Thomas, 2003). According to a survey by marketing research firm Jupiter Research, credit cards are still the dominant payment method for online purchases, accounting up to 95% of online transactions in the United States, (Jupiter Media Metrix, 2000). This demonstrates still low user acceptance of alternative electronic payment systems, designed specifically for e-commerce.

1.2 User acceptance: understanding and issues

End user acceptance of such sensitive technology as money-circulating payment systems is the critical key aspect of the whole path of payment systems' establishment. Without such acceptance no technology can successfully exist on the market, and payment systems are not an exception. According to Dillon & Morris (1996) user acceptance is "the demonstrable willingness within a user group to employ information technology for the tasks it is designed to support".

This definition can be enhanced with the understanding that the user perception of information technology (IT) can be influenced by objective characteristics of technology, as well as by human factors and interaction with other users and related parties. For example, the social information processing model (SIPM), (Salancik & Pfeffer, 1978), suggests that attitudes towards technology are influenced by opinions, information, and behaviour of others.

User acceptance is a pivotal factor determining the success or failure of any information system project, (Davis, 1993). Many studies on information technology report that user attitudes and human factors are important aspects affecting the success of an information system, (Davis, 1989, Burkhardt, 1994, Rice & Adyn, 1991). The arguments in section 1.1 and in the following paragraphs suggest that this is the case also with EPSs.

Besides SIPM, a well-known approach to explaining and modelling user acceptance is the Technology Acceptance Model (TAM), (Davis, 1989). TAM suggests that users formulate attitudes toward the technology that depends on whether they perceive the IT to be useful and easy to use.

However, TAM does not take into account other factors that may be critical to user acceptance or rejection of such specific technology as EPSs, such as security, trust, privacy and involved risks. Extending the SIPM assumption, user acceptance of online EPSs could be affected by a number of factors and parties, creating a broader sense of the social context of EPSs in the Internet environment. User experience with an EPS can be influenced or manipulated by various aspects, such as marketing, publicity, the reputation of the bank behind the system, trust towards the company operating the system and technology behind the system, and convenience of the user interface, see also Guttman (2003), Kalakota & Whinston (1997), Egger (2003).

Figure 1.1 attempts to illustrate the social context in which parties and factors could possibly influence user perception and experience with electronic payment systems. These parties and factors should be taken into consideration when exploring issues of user acceptance of online EPSs. They are either required for a successful operation of a payment system (banks), its promotion (marketing organisations), or monitor and regulate its operation (government). For example, the company operating the payment service will have to address users' concerns about security, privacy and trust. Users can be influenced in their experience by other parties than the operator itself, e.g. the bank or financial institution that facilitates the payment transactions, see Figure 1.1. Customers can be influenced by the user interface, or by other parties involved in the payment service, such as technical partners. Since e-commerce EPSs operate in the Internet environment, the reputation and impression of the system can be easily communicated to other users via online communities, creating yet another social impact on the system. Therefore, *social influences*, e.g. opinions and behaviour of other users, like family and friends, and reputation of banks and the parties involved, should be taken into account for user acceptance of EPSs. This argument can be supported by above-mentioned SIPM, (Salancik & Pfeffer, 1978).

Issues such as trust, usability, applicability, security, and convertibility are extremely important because they can influence subsequent decisions of people whether to use a payment system or not.

There are several obstacles to user acceptance of EPSs: developers not only have to sell the service to potential users, they also have to convince the users to entrust their money to a third party institution, to rely on the payment system in their business and personal finance, and to use it frequently for convenience, reliability, specific applications, services and for a variety of other reasons. To achieve this high standard of user acceptance, the creators of a payment system should bear in mind *user-related factors* from the very beginning of the conception of the payment system. Designing for user acceptance of online electronic payment systems is thus the main issue put forward by research described in this thesis.

An open challenge remains for designers and developers of novel Internet-based payment systems to meet user expectations, requirements, preferences and needs in design and operation of the systems. Resolving these issues is critical for the development and operation of new payment systems and future growth of e-commerce.

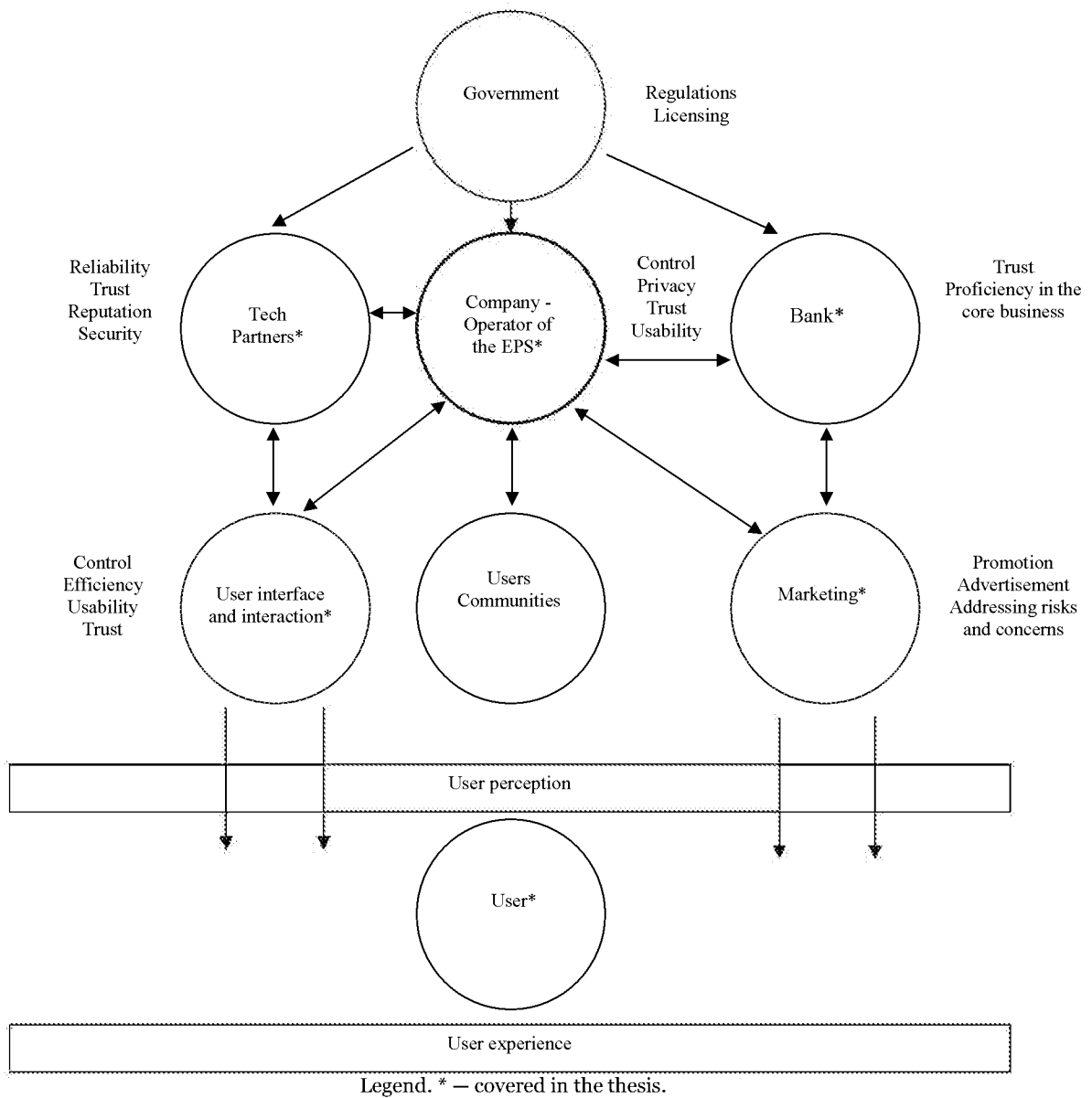

Figure 1.1 Factors influencing user perception of online electronic payment systems.

1.2.1 User factors in payment technology

The importance of user-related factors can be demonstrated in the example of the notorious problem of security of information systems. There are thousands of security mechanisms, matched with a growing number of hacks and security breaches, (Flynn, 2001, p. 61).

However, the nature of security issues is changing with the constant improvement of information technology. While security technology is becoming increasingly sophisticated and tamper-proof, experts in information security admit that user factors are the most important issues for security problems. The vast majority of all security issues in IT environments is caused or assisted by users inside organisations, rather than hackers and other outsiders. Security experts know many stories about people exchanging their passwords, or IT managers attaching notes with logins and passwords to their monitors, or about hackers finding these notes in the trash. To avoid this kind of mistakes, experts are talking about enforcing security policies in organisations, to be able to address user-related factors in security, (Flynn, 2001). Therefore, security practices have embraced user-related factors. This example helps to illustrate the importance of user-related factors in the design and operation of information systems.

The following example illustrates a failure of a payment system due to neglecting to focus on user and market needs. The Chipknip™ and Chipper™ smart card payment technologies, (Nannery, 1998), were introduced in the Netherlands in early 90s. Both systems were intended to provide a way of paying small amounts in everyday transactions, which people would normally pay with cash. However, these two systems competed with each other for some time, being incompatible, so customers could not pay with the competitor's card at certain shops, (BIS, 2001). Eventually, this created problems of interoperability and limited the user base for both systems.

Another obstacle was that the card readers were installed in shops where people already had another method of payment – debit cards, which worked very effectively and efficiently and which were used by most people for all kinds of payments. In a way, Chipknip and Chipper duplicated the functions and applications of debit cards. On the other hand, the real need for Chipknip and Chipper for small payments at parking lots, vending, and public transport tickets machines was not met. A serious situation arose regarding the high costs of accepting Chipknip for merchants. As the result, the union of Small and Medium Enterprises in the Netherlands threatened to boycott Chipknip, (Het Financieele Dagblad, 2001). In this case, an important factor

stimulating the development of EPSs was not met, namely the reduced operational and processing costs. Despite of a certain potential for uses acceptance of e-purse technology (Van Hove, 2004), this situation is changing slowly.

All these issues led to a low acceptance of Chipper and Chipknip technologies. Chipper International decided to stop operations and support of Chipper in the Dutch market, (Libbenga, 2001; BIS, 2001); Chipper has fused with Chipknip, and while some issues have been addressed, the expected applications for this smart-card technology are yet to come.

The example above helps to illustrate the complexity of human and marketing factors in the context of payment systems and their crucial influence on the eventual success of a payment system. Therefore, for successful design of electronic payment systems from the user perspective it is important to find out what user-related factors and systems' aspects have the most direct impact on user acceptance and which of them can cause problems when neglected in design.

1.3 Research objectives

There are several factors that can contribute to user acceptance of an EPS: innovative and reliable technology, effective business practices, smart marketing and promotion, good usability, and a carefully carried out interaction design.

The previous sections illustrate the complex issues that surround online EPSs. They suggest that problems with user factors in the context of EPSs and their crucial influence on the eventual success of EPSs have the design, marketing, and business organisation nature.

This research has been pursuing an interesting and daring task: to explore issues of design and user acceptance of e-commerce EPSs, and to suggest how to design EPSs in such a manner that their acceptance by end users will be maximised, and the number of joined users will justify the system's rollout and its further development. Without ignoring the importance of marketing, business and technological factors, this research focuses on user acceptance and user-centered design of e-commerce EPSs.

The methodology of this research is strongly inclined to human-computer interaction and user-centered interaction design. Human-Computer Interaction (HCI) is a disci-

pline concerned with the design, evaluation and implementation of interactive computing systems for human use, and with the study of major phenomena surrounding them, (Hewett et al., 1992). For discussions of HCI as a scientific discipline see Long & Dowell (1989).

The issue of user acceptance of e-commerce EPSs could equally concern marketing research and user-centered design. The differences between marketing research and user-centered design are discussed extensively in Siegel & Dray (2001), Table 1.1. The goals of this research conform with the objectives of user-centered design to deliver “usage satisfaction by determining how to build identified product to facilitate user's task goals”, Table 1.1, Siegel & Dray (2001). Although certain practices of marketing research are still adopted in the research activities reported hereby, (despite of the distinctions of Table 1.1), the objectives of this research is to assist in the creation and improvement of e-commerce EPSs based on user-centred approach and human-computer interaction, rather than suggesting how to position, market, and promote EPSs as commercial products.

This research seeks not only design solutions, but also how to provide a scientific foundation for such solutions. I.e. it is investigated what kind of *validated design knowledge* shall be communicated to designers and developers of EPSs so that users will be willing to use the newly introduced EPSs in an e-commerce environment for payments and personal finance.

1.4 Research scope

Payment systems can be classified from a business relations viewpoint on various types of e-commerce as described in Figure 1.3. The scope of payment systems and payment tasks is defined based on business relationships model in Figure 1.2, and the classification framework of electronic payment systems, presented in Chapter 2.

Table 1.1 Differences in approach of marketing research and user-centered design.
Adapted from Siegel & Dray, (2001, p. 24).

Dimension	Marketing Research	User-Centered Design
Purpose	Strategic: to guide product mix, positioning.	Tactical: to guide product realization via design input.
Goal	Build product attractiveness by deciding what products and product features to build to meet perceived needs; develop concise messages and clear global strategies that will quickly influence mass perceptions, at corporate level and product level, to differentiate products from competitors.	Ensure continuing usage satisfaction by determining how to build identified product to facilitate user's task goals.
Who acts on input	Executives, brand and advertising professionals, product managers.	Users, Designers, Engineers, IT developers
Most interested in	Broad patterns of purchasing behaviour, and attitudinal variables that influence it. Based on trends and significant attitudinal differences between groups.	Specific details of design that influence reactions to structure, in-depth analysis of individual differences in performance, cognitive processes, problem-solving approaches, confusions. More interest in idiosyncratic responses.
Phenomena measured	Subjective: perceptions, opinions, expectations, feelings, and preferences, attention, affective reactions as clues to product attractiveness and likelihood of buying.	Objective: Task flows and task performance, usage behaviour, cognitive processes, affective reactions such as confusion or frustration as clues to cognitive processes and performance problems.
Type of data	Survey and self-report, often retrospective; behavioural measures related to purchasing. Preferences, attention, and purchasing.	Real-time behavioural data regarding usage and task performance. Self-report (diary records, thinking aloud) construed only as an indirect clue to inferred cognitive process.
Sampling	Large samples selected to reflect the demographics of purchasers.	Small samples selected to reflect people who are similar to targets in terms of technology usage.
Data analysis	Statistics usually required, often quite sophisticated analyses.	Statistics rarely done, other than descriptive statistics on completion rate, error frequency.

1.4.1 The role of electronic payments in customer e-commerce activities

The process of paying is an essential part of customers' online buying activities. These activities are well described by the Consumer Mercantile Activities Model, (Kalakota & Whinston, 1997). The model comprises prepurchase interaction, purchase consumma-

tion and postpurchase interaction phases. The payment activity takes place within the purchase consummation phase, Figure 1.2.

“The purchase consummation phase specifies the flow of information and documents associated with purchasing and negotiating with merchants for suitable terms, such as price, availability, and delivery dates; and electronic payment mechanisms that integrate payment into the purchasing process”, (Kalakota & Whinston, 1997).

The buyer arrives to payment activities after identifying products of services to be purchased. The buyer and seller conduct then a *mercantile transaction*. In a mercantile transaction the buyer and the seller exchange information followed by the necessary payment. The payment methods they use should be mutually negotiated and agreed on (ibid). Therefore, in order to conduct a successful e-commerce mercantile transaction the buyer should at least be willing to use the payment method offered by merchants. From this viewpoint, user acceptance of e-commerce EPSs is critical for the completion of the purchase consummation phase and the whole purchasing process. It can be therefore observed that the payment process and the user involvement in it are highly important for e-commerce activities.

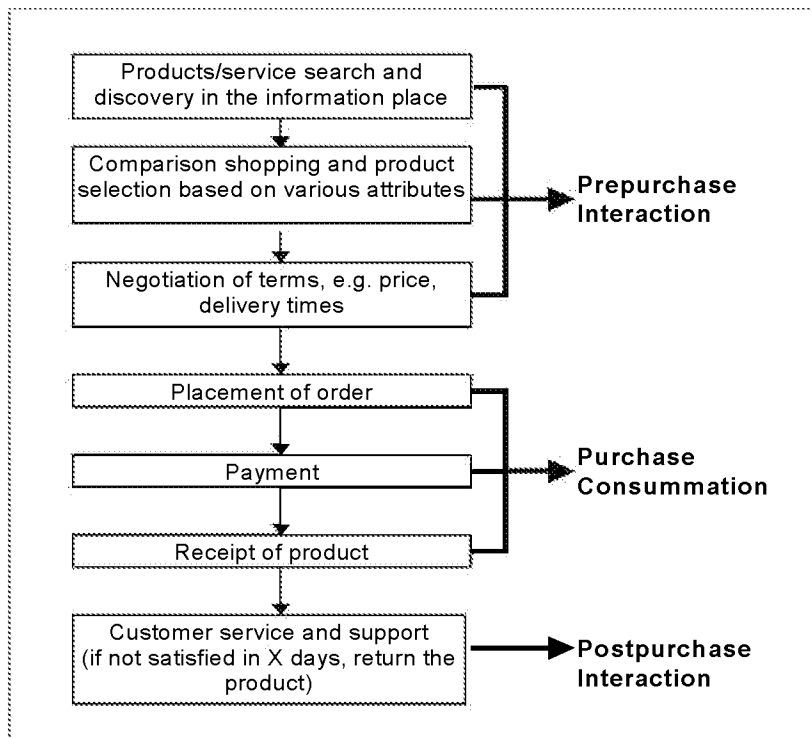

Figure 1.2 Consumer Mercantile Activities Model, Kalakota and Whinston (1997).

Scope of payment systems

Business-to-consumer Payment Systems

This research is focused on user acceptance of new payment systems in consumer e-commerce environments. The main focus of the presented work is therefore Business-to-Consumer e-commerce EPSs, which are designed with the main purpose to facilitate payments for consumer e-commerce. Taking into account the B2B systems would have made the scope too broad to handle within this research.

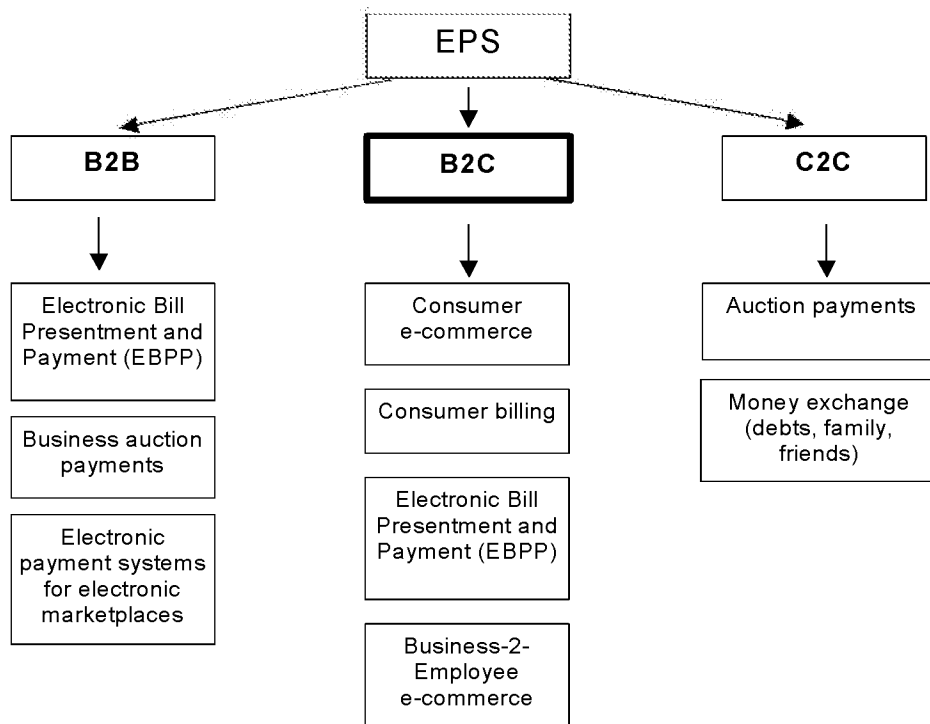

Figure 1.3 *Electronic payments for different types of e-commerce.*

Payment Systems designed for the Web

Currently, consumer e-commerce is done mainly via the WWW (Web) service of the Internet. The market for conducting e-commerce payments via wireless PDAs, mobile phones and other Internet services is still under development, (Bohle, 2001a), and therefore does not have a wide user basis and usage experience. Thus, in the scope are Web-oriented online e-commerce EPSs and Web e-commerce applications.

Scope of payment tasks

Because the scope of the defined business relations is Business-to-Consumer, the *payment tasks* in the focus of this thesis are related to *consumer* e-commerce and trade of goods and services. In these tasks there should be at least one 1) business party involved and 2) one physical person, who is conducting purchasing activities in an e-commerce environment.

Scope of target activities

These activities include those that are related to buying goods and services, and essentially represent consumer e-commerce. The scope of these activities is embracing a significant and, arguably, the most important part of the consumer e-commerce represented by B2C relations.

- Purchasing goods: tangible, require shipping, intermediated (by shipping companies).
- Purchasing information and software: intangible, immediate, not intermediated (by shipping companies).
- Purchasing services: intangible/tangible, not always immediate, can be intermediated (by service companies).

The following activities are therefore excluded from the scope because they are not in line with the defined scope of electronic payment systems, namely B2C consumer e-commerce.

- Consumer-to-Consumer (C2C) money payments and exchange. C2C payments do not belong to B2C e-commerce, (Figure 1.3), e.g. personal auctions payments, debt settlement.
- Specific payment applications, for instance, gambling or adult-content sites. In this context the sites place specific requirements on B2C relations and user-related factors, e.g. on privacy.

Related activities

Additional activities that have to be explored are the influence of pre- and post-purchase interaction phases, according to Kalakota and Winston (1997) on the user experience with a payment system on the whole. It is very likely that correct introduction, application and follow up of payment products and services in retail e-commerce

are important for user acceptance of EPSs, and therefore the pre- and post-purchase interaction phases cannot be reasonably disregarded when investigating the payment process. The user experience within these phases could affect their decision as to whether to use the e-commerce service at all, without even arriving at the payment process itself.

Amount of money

The minimum amount of money within the scope was chosen to be above €2. This means excluding small and micropayments. The nature of payment tasks in case of micropayments is different from higher amounts. For instance, users may wish to automate this kind of payments to avoid the need to authorize a payment of €0.01 every time, while with bigger amounts they are likely to have control over each transaction. Furthermore, different researches show that at this moment there is little market for services that support small and micropayments, (Bohle, 2001b). In the focus are therefore small to medium sized payments, e.g. from €2 to €1,000.

The upper payment limit is set to €1,000 to indicate that highest amount within the scope of this research. The suggested range of payment amounts is typical for the current status of the domain and is similar to range of payments with existing offline EPSs, like credit, debit and smart cards, (Lelieveldt, 2001; Bohle, 2001a). Larger payments can be expected to raise different user acceptance issues, because of more user attention to risks, security, efficiency and other aspects of transactions with such amounts, (Humphrey, 1995).

1.4.2 Approach and methodology

This research employs practices of the multidisciplinary scientific field of Human-Computer Interaction in order to research issues of user acceptance and user-related factors in online e-commerce electronic payment systems.

Specifics of HCI research

The nature of Human-Computer Interaction is such that it has to employ various scientific, research and design disciplines and cross borders between them for successful research. HCI is different from other disciplines in that it studies interaction between

people and artificially created artefacts, and not an independent natural phenomenon, like in other disciplines.

This complex nature of HCI and its research goals compel researchers to adopt both inductive and deductive approaches to science, as described in Mackay & Fayard (1997). In the deductive approach the purpose is to generate a set of hypothesis that can explain real world phenomena. The scientist proposes a theory about a phenomenon, and formulates a hypothesis to be tested in an empirical research. In order to verify the hypothesis, an experiment is conducted, and with the revision of its results the theory is re-examined and an updated hypothesis is created. This approach is employed by the experimental study of this thesis.

The inductive model aims to construct the most precise *description* of the real world, as opposed to explanation. The scientist observes phenomena in the real world without having a preconception or theory of what they are looking for. Then the scientist attempts to create a model of the world that explains the phenomena. By returning to the real world the model can be validated and changed if there are contradictions between the model and the studied phenomena. The qualitative study in this thesis employ this approach for requirements elicitation and creation of the design recommendations.

The research process applied in this thesis, aimed to gain validated design knowledge, can be described as an iterative circular or spiral movement. This process is best described by Figure 1.4, adapted from the work of Rauterberg (2000). This approach asserts to combine “analytical strength of empirical validation methods (e.g., observation, experiment, inquiry, etc.) with the synthetic strength of system design”. This triangle structure conceptualizes the three most important components of HCI research: “(1) the collection of ‘design relevant knowledge’, (2) the ‘interactive system’ in different possible representation forms, and (3) the several possibilities to represent a ‘user’ for (empirical) validation”, (ibid). The following sections describe how using diverse research activities helped to combine these components in the research reported in this thesis.

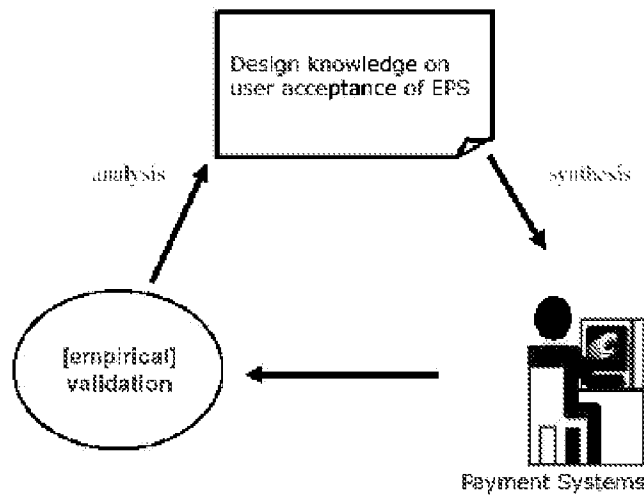

Figure 1.4 Triangle structure for a research approach with a rigorous validation component. Adapted from Rauterberg (2000).

Outline of the thesis

The diagram in Figure 1.5 illustrates a combination of the research and design activities of this thesis. These activities included acquiring design knowledge on e-commerce EPSs, applying the knowledge to a commercial payment system designed by an industrial party, and empirical validation of the design knowledge.

Chapter 2 presents a survey of literature on EPSs, which was necessary for understanding EPSs. The outcome this survey is a classification and a set of characteristics of EPSs.

The importance of the characteristics of EPSs had to be confirmed with potential users of EPSs. Chapter 3 describes an investigation into the importance of the characteristics of EPSs to end users by means of a survey of consumer attitudes towards EPSs. The user survey helped to identify what characteristics should be given more attention in the design of EPSs. However, the knowledge about the importance of the characteristics did not inform how they should be realised in design of EPSs.

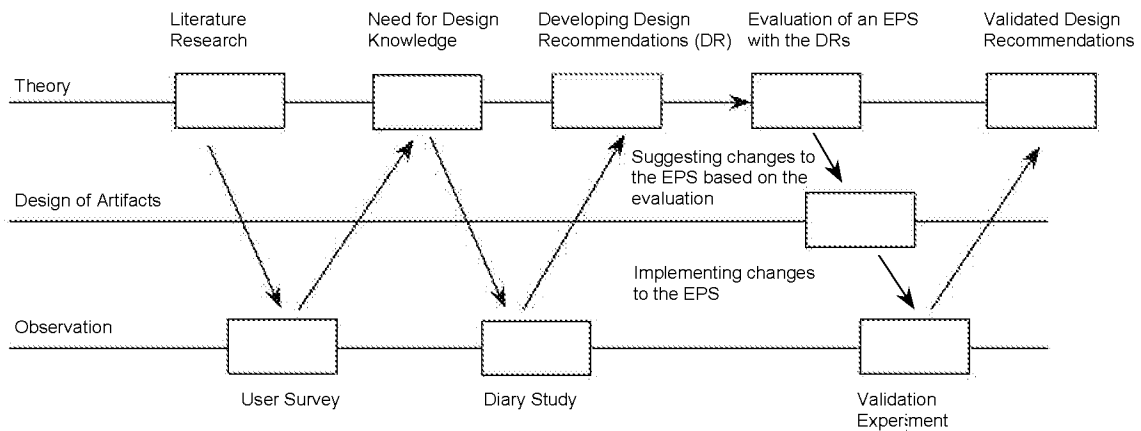

Figure 1.5 Diagram of the activities of this thesis. Developing design recommendations using various research and design methodologies.

To acquire a deeper understanding of these issues, a qualitative research in the form of a diary study was conducted, Chapter 4. The diary study aimed to understand how EPSs are experienced and perceived by users in the context of actual use and how EPSs can be designed to meet users’ needs. As the outcome of the diary study, implications for design of Internet-based payment systems have been derived and formulated as design recommendations.

To ensure that the application of the design recommendations benefits user acceptance of EPSs, an experimental study was conducted, that is described in Chapter 5. This study helped to substantiate the validity of a subset of the design recommendations. It was hoped to find the ideal situation where it is possible to apply the hypothesised design knowledge to a real-life system, rather than testing them in the laboratory, in order to achieve high realism of the results. Due to the participation of industrial parties, this situation has become available. The experimental study involved two parts: 1) a real-life EPS was redesigned in accordance with the proposed DRs, 2) an experimental comparison of the redesigned system with the old one has indicated improvements of user attitudes in several aspects, thus demonstrating the validity of the design recommendations.

Chapter 6 describes the contribution and discusses possible validity threats and limitations of this thesis.

Triangulation of research approaches

In this thesis a combination of many research activities of both inductive and deductive models was used: literature research, a user survey, qualitative research in a form of a diary study, and empirical research in the form of a laboratory experiment. More than one research approach is employed to address the same question: how to design for user acceptance of e-commerce EPSs.

Triangulation, which can be defined as using more than one research approach to address a research question, (Mackay & Fayard, 1997), is the proper way to achieve valid results in such specific environments as money-transacting electronic payment system for e-commerce. Mackay et al. (1997) argue that triangulation across scientific and design disciplines is likely to be beneficial in the multidisciplinary field of HCI.

In addition, Gray & Salzman (1998) suggest another type of triangulation, that is replicating an experiment with a different design approach (e.g. interface, interaction design) greatly increases construct validity and generality of the results. This type of triangulation applied in the thesis can be referred to a redesign of a payment system into a new version in accordance with the design recommendations and evaluating the both systems' version in an empirical study, described in Chapter 5.

Yet another type of triangulation is examining different form of *data representation*, collected within the same study. This approach was used in the diary study (chapter 4), combining users' diaries with qualitative interview techniques. Thus, addressing individual problems with multiple research and design methods, as well as different types of data, should produce more generalisable, valid and useful results.

Mackay & Fayard (1997) mention in addition, that individual researchers cannot embrace all disciplines involved in triangulation research, accrediting triangulation research to scientific laboratories and to bigger research programs. Therefore, the combination of several disciplines and data collection methods employed in this thesis adds to the validity of the results and makes this research quite distinctive.

Chapter 2

Classification and characteristics of electronic payment systems

2.1 Classification of payment systems

2.1.1 Introduction

This chapter presents a framework for classification and characterising of electronic systems that facilitate paying in an e-commerce environment. This framework is an attempt to describe and to relate the wide variety of the payment systems, with more than 150 payment mechanisms invented worldwide. This chapter also presents a survey of literature on EPSs, which has been a necessary step for understanding payment systems. The outcome of this phase of the research is a classification and characterisation of electronic payment systems.

2.1.2 Primary classification of payment systems

The principal classification of EPSs is based on the form of money representation and the principle of money transfer. Existing payment systems can be divided into two groups: electronic cash mechanisms (or electronic currency) and credit-debit systems, (Medvinsky & Neuman, 1993).

Electronic cash resembles conventional cash, when parties exchange electronic tokens that represent value, just as banknotes and coins determine the nominal value of conventional cash money. The *credit-debit* approach in the context of electronic payments means that money is represented by records in bank accounts, and this information is electronically transferred between parties over computer networks.

Another terminological approach offered by Wayner (1997), based on the type of information that is exchanged, distinguishes between ‘*account-based*’ and ‘*token-based*’ systems, which, respectively, corresponds to credit-debit systems and electronic cash in the definition of Medvinsky and Neuman. A similar distinction is found in Camp et al. (1995), who distinguish between *notational* and *token* forms of money. A different view on classification of EPSs is offered in Asokan et al. (1997), where payment mechanisms are classified based on the temporal sequence of money flows between the payer and receiver of the payments. Various attempts of classification of payment systems are also reported in Kuttner and McAndrews (2001), and Schreft (2002).

These references are aggregated into the classification of electronic payment systems, illustrated in Figure 2.1, which was first reported in Abrazhevich (2001b). The figure illustrates the further classification of EPSs, described in the following sections. It provides examples of EPSs in each subcategory; some of these systems are described further in the text. The figure illustrates if the systems are only theoretical developments, that were only tested as limited pilots, and that have never been implemented for the commercial use. Payment mediation services that aggregate various EPSs in one payment infrastructure are described in section 2.1.5.

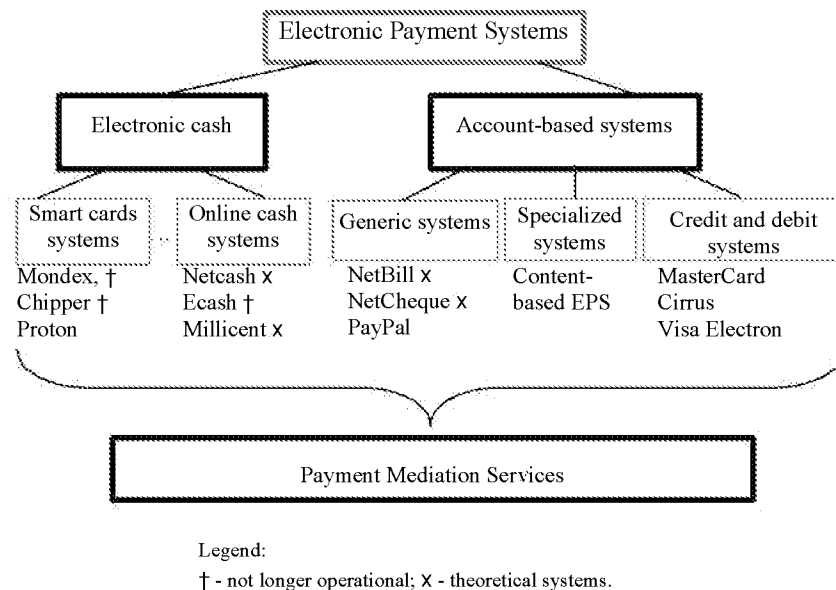

Figure 2.1 Classification of electronic payment systems

2.1.3 Further classification of account-based systems

In the group of account-based systems, one can distinguish between 1) generic online EPSs that use simple account-based model for serving Internet payments, 2) systems that use the debit and credit cards model, and 3) specialized payment systems that, for instance, were designed for trading content online such as music. Some researchers consider credit cards systems as a separate group of payment models, (Medvinsky and Neuman, 1993), others consider them to be a variant of the credit-debit type. This classification adopts the latter distinction.

The basic principle of account-based systems is that the exchange of money between accounts is maintained by a payment service provider. Users can authorize charges against their EPS accounts, as they would do with usual bank accounts, though the ways of authorization are different for various systems. With the debit approach, the customer maintains a positive balance of the account and money is subtracted when a debit transaction is performed. With the credit approach, charges are posted against the customer's account and the customer is billed for this amount later or subsequently pays the balance of the account to the payment service.

One of the most widely used systems for electronic payments is the debit card, which as the name suggest, is a clear example of a debit system, (Evans & Schmalensee, 1999). Debit cards combine the service of Automatic Teller Machines (ATM) cards and cheques. When customers pay with a debit card, the money is automatically deducted from their checking bank account. In contrast with the credit cards, the spent money comes from the bank account directly. Many banks issue a combined ATM/debit card that looks like a credit card and can be used in places where credit cards are accepted. In this case, when users pay with a debit card, the payment will still be processed as a debit transaction.

Other payment mechanisms that use the credit-debit model are Yahoo PayDirect, PayPal.com, and theoretical payment projects like NetBill (Sirbu and Tygar, 1995), and NetCheque (Medvinsky and Neuman, 1993). A special group of account-based instruments that are currently in wide use are credit card systems. A great part of trade on the Internet is done using credit cards and these payment systems should not be overlooked. The biggest advantage of this approach is that the customers, who have already received credit cards offline, can use them directly for online payments. This also results in high scalability, as no additional installations are necessary. Credit cards provide a large customer base for merchants who accept them, thus their applicability is quite high.

There are critical security issues associated with the use of credit cards in an online environment. When using credit cards over open networks, encryption mechanisms, such as widely used Secure Socket Layer (SSL), in principle can prevent a hacker or eavesdropper from intercepting the customer's credit card number. There are some schemes that even hide card numbers from the merchant, providing protection against intercepting the card details from merchant databases or against fraud by the merchant. Nevertheless, these incidents happen regularly (Caunter, 2001; IFCC, 2003; Wales, 2003).

It is important to note, however, that without some form of customer registration with a payment service or substantial proofs of identity, credit cards can be very risky to pay with and can be easily abused. Even encrypted Internet credit card transactions do not include the owner's signature, and anyone with knowledge of the customer's credit card number and expiration date can create a payment order. An important aspect of credit card payments in the online world is referred to as *card-not-present* (CNP) transactions. CNP transactions are those where neither the card, nor its holder are present at the point of sale, e.g. in orders by mail, telephone, fax or the Internet. The

buyer does not have to demonstrate the physical presence of the card, or the card and the buyer do not have to be co-located. This imposes issues with card validation, security and fraud.

CNP transactions are widely used in mail order/telephone order purchasing (MOTO) which also do not require co-location of buyer and seller. To secure transactions of this type, credit card companies ask for additional information, such as name, address, etc., that can be used to verify their identity, for instance, if the ordered goods should be mailed to the billing address associated with the credit card. Other information often required is the additional 3-4 digits code, printed on the back side of the card and not present in the credit card number. Merchants ask the customer to read this code from the card in a card-not-present order. The merchant then asks for verification during the authorization process. The issuer (or credit card processor) validates the code and relays the decision to decline or approve the transaction to the merchant. Nevertheless, the MOTO transactions incorporate limited protection against credit card fraud. Credit card CNP transactions could sometimes employ even less identity verification information.

Since no signature involved in CNP transactions, the buyers can opt out of any order, if they claim they did not agree with the purchase, (O'Mahony, Peirce, & Tewari, 1997). The charges for orders cancellation are borne by merchants in the form of the higher costs for processing of CNP transactions. In addition, merchants could be liable for the whole amount of the disputed order, (APACS, 2002). Furthermore, because online payments are administered as standard credit card charges, the costs are too high to make this method unsuitable for payments below €1 and hence inefficient. Credit card companies are constantly lowering the minimum amount that can be paid to enable small payments, but charges for merchants still remain high.

It should be also taken into account that cards are issued by banks and organisations, which after a screening, decide whether they can issue credit cards to certain customers. Customers with a low income, an imperfect credit history, might not be eligible for a credit card. This may restrict the customer base to a certain degree and limit user and merchant acceptance of credit cards as a payment method.

2.1.4 Further classification of electronic cash systems

Electronic cash is stored in a digital form and serves as a cash substitute for the Internet or other information systems. Electronic cash represents value in some form and can be spent with merchants, who deposit money in their own accounts or can spend it in other places. It can be represented by electronic 'bills' and 'coins', certificates, packets of data, or electronic tokens in one form or another. When using electronic cash systems, customers purchase electronic digital tokens from the issuing company using a conventional payment system, e.g. credit cards, electronic checks, or even paper currency (for example, via a reverse automatic teller machine which accepts cash, or when purchasing prepaid cards). Some of the systems allow converting electronic cash back into another form of money (Medvinsky and Neuman, 1993), which is very important for convertibility of the systems.

Another distinction amongst electronic cash systems is between those that use smart cards for the storage of tokens and those where tokens reside only on user's accounts and computer networks. The former are often called electronic purses (*e-purses*), the latter are sometimes addressed as '*online cash*' or '*Web cash*'.

Examples of e-purse electronic cash systems are CAFE project, (Boly et al., 1994) and Mondex (Martin, 1994). Tokens in these systems exist and travel in the computer environment, for example, on a currency server or customers' hard disk. Mondex is a smart card payment system that was designed to enable person-to-person as well as Internet payments, (Van Hove, 1999, p. 141). The card can be used to make small payments, store personal and application-specific information, and serve as a telephone card. Web cash representatives are E-cash, E-gold, Millicent (Glassman & Manasse, 1995), PayWord and MicroMint (Rivest & Shamir, 1996), and NetCash system (Medvinsky and Neuman, 1993). It has to be noted that these systems are mostly theoretical work and have not been implemented on the market.

Systems that employ smart cards e.g., Chipknip, Chipper in the Netherlands, Proton in Belgium, and Visa Cash can be also placed in the category of electronic cash and also called e-purses, however, in representing money they hardly use tokens. In this case, the numerical data stored on the card is changed when a payment takes place. Judged by the principle of the operation and use they act like electronic purses. The value is stored on a card and if the card is lost, the money is gone, in a fashion similar to cash. It has to be noted that smart cards like Chipknip are not principally designed for Internet payments and are used mainly at point-of-sale terminals. There have been

nevertheless pilot tests of facilitating paying over the Internet with Belgian Proton smart card EPS, but the use of Proton on the Internet is now discontinued.

An important development towards standardisation of e-purses is establishing Common Electronic Purse Specifications with the goal to define requirements needed to implement a globally interoperable electronic purse program, while maintaining full accountability, (see www.cepsco.org). CEPS, which were made available in March of 1999, outline overall system security and certification. Being established by the key parties in electronic purse cards, and supported by organisations from over 30 countries, CEPS paved the way for the creation of an open global electronic purse standard. For cardholders it means that they will be able to use their electronic purse cards domestically and internationally with the knowledge that the card will be accepted wherever the acceptance mark is displayed. Visa Cash is an example of CEPS implementation, (see www.visa.com).

Prepaid card EPSs can be also included in the same category of electronic cash, because the principle of their work resembles the use of e-purses, such as Chipknip. Users can buy a prepaid card for a specified amount. Prepaid card systems are specifically designed for Internet payments. Users can pay with a prepaid card by entering on merchant sites the card's unique number, which corresponds to the card's nominal. The value of the card is decreased by the amount paid to the merchant.

To better understand what issues that surround electronic payment systems, it makes certain sense to introduce a definition of payment mediation services, which use existing payment systems as mediators to provide extra services.

2.1.5 Payment mediation services vs. payment systems

To further refine the focus of this research, we have to make one important distinction, which is between *payment mediation services* and payment systems. This distinction particularly makes sense in the context of electronic and Internet payment mechanisms. Payment mediating services have appeared as a response to the imperfection and inefficiency of current payment systems for the Internet. They extend the services of the existing systems and operate as mediators between merchant, payment systems and users. Their goal is to help merchants to accept as many payment systems users could possibly want to use when paying over the Internet. In payment mediation services the existing payment infrastructure from many payments providers is aggre-

gated to provide broader services, or to overcome shortcomings of the available payment options. Figure 2.2 describes the relations between merchants, EPSs and payment mediation services.

The difference between payment mediation services and payment systems can be summarized in that a payment mediation service is as an *intermediary* between payer, business, and payment system, while there is no such middle tire for payment systems.

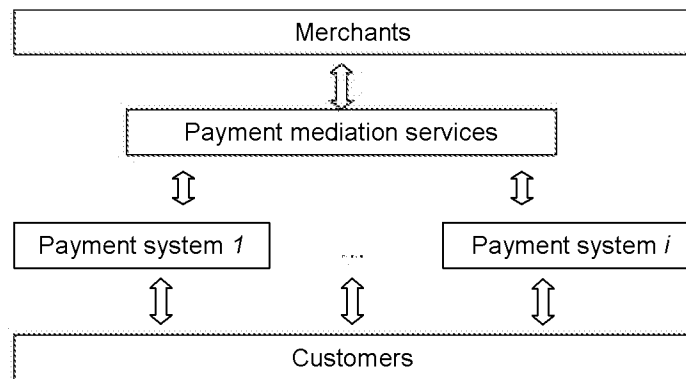

Figure 2.2 Relationships between payment systems and payment mediation services

The payment process in this case is transparent to the users of a site. A mediating service provider ‘intercepts’ payments from users, processes them, and credits the account of the owner of the site when the authorization and transactions are completed. For example, there are numerous companies among mediating services providers that facilitate acceptance and processing of various credit cards.

A special class of payment mediation services has emerged, that provides convenience for paying bills for businesses and end users. An example of payment mediation services is providing bill payments for end users and companies, for instance, utilities or telephone bills. Over a Web front-end provided by the billing systems, customers and companies can pay bills that are normally paid offline by paper cheques or bank transfers. Some systems even provide additional services such as automated accounting merged with online payment facilities.

Syndication of payment services

Another angle on payment mediating systems is viewing them as a form of *syndication* of payment services in an online environment. The notion of syndication originates from the entertainment world, where it forms the fundamental organizing principle. With the advent of the 'new economy' and the use of the power of Internet distribution, syndication can be recognised as an emerging model for e-commerce. In this context syndication would mean selling the same information to many different customers, who render and integrate it with other information in various value-adding ways and then redistribute it.

According to this principle, businesses involved can play three or more roles: originators, who create original content; syndicators, who collect and package digital information to meet specific customers' needs; and distributors who deliver digital content to customers, (Werbach, 2000). In the context of online payments, payment mediation services can be seen as syndicators of the original services offered by payment systems. Payment mediation services syndicate e-commerce EPSs, offering merchants the way to accept a variety of payment systems.

Examples of payment mediation services

A good illustration a payment mediation service is Bibit Billing Services (www.bibit.com). This Dutch company specializes in Internet payment and billing services. The service supported about 70 payment methods from 18 countries by 2004. When customers want to pay on a Web site of a Bibit's client, they select one of the provided payment methods. The payment process goes as follows:

1. A customer selects products on sale in a virtual shop.
2. For payment, the customer is then redirected to Bibit Payment Service.
3. Within Bibit Payment Service, the customer can select a payment system he or she would like to pay with, provided it is supported by Bibit. The customer makes the payment with the system of his or her choice.
4. After a successful payment, Bibit notifies the merchant that the order can be shipped and transfers the money to the merchant.

The processing of the transactions, which is conducted entirely by Bibit, is therefore transparent to the customers of the site and the client company. The company business model, which utilizes a number of payment systems, relies on providing extra services to facilitate payments, and therefore it fits into the definition of a mediating

system. It is interesting to note that the service allows the use of micropayments, by accumulating charges for products like news, articles, stock and research reports, online games and charging users on a subscription basis. Examples of other payment mediation services are Orbiscom (www.orbiscom.com), iBill (Ibill.com), PayTrust, (www.paytrust.com), DataCash (www.datacash.com), PayNet (www.paynet.ch).

Systems that conceal real customer's credit card numbers by providing them a unique temporary card number for each transaction have gained certain popularity among payment mediation services. The customers can then use this unique number in a normal credit card transaction, and their real credit card will be charged. This temporary card number expires after every transaction and would not be approved for the subsequent use. The data of real credit cards of customers is not exposed to parties online in online transactions. In this case the payment mediation services are using credit cards infrastructure to provide extra security and anonymity (ABN-Amro e-wallet, O-Card by Orbiscom.com). By using these measures merchants expect to accept more secured payments without changing the way shoppers pay and without changing existing payment processes or infrastructure.

The research summarized in this thesis is concerned mainly with payment systems and not with mediating solutions for existing payment infrastructure. Payment mediation services on the Internet emerged because of the absence of relevant payment solutions or have problems that prevent their successful use by merchants and users. Many of EPSs are probably transitory systems, unable to completely solve problems that appear in the context of the Internet paying process, because the problems originate in the payment systems they use; see discussion on PayPal.com in section 2.4. While syndication of EPSs by payment mediation services provides in the end a better level of service than individual EPSs they use, it also places the payment mediation systems out of the scope of this research, which is exploring ways to design better individual EPSs.

2.2 Identifying the characteristics of payment systems

As observed in the example with Chipknip and Chipper in the previous chapter, there are a lot of factors that determine the success or failure of payment systems, and not all of them are of technical nature. As mentioned already, user acceptance depends on many issues, such as consumer choice, preferences, advertisement, a state of the market, etc. The discussion of diverse aspects of electronic payment systems can be found in many works on development and research of payment systems. Attempts to classify and describe the requirements and characteristics of payment systems such as security, reliability, convertibility, efficiency, traceability, and others can be found, among others, in the works of Medvinsky & Neuman (1995), Langdon et al. (2000), Lynch & Lundquist (1996), Wayner (1997). It has to be noted however, that these studies are mainly focused on technical aspects of electronic payment systems, which is not the only facet that is important in this field. Below the characteristics of payment systems are extended to account for user-related aspects of EPSs. These characteristics can be also used for assessment of payment systems, as described further.

The list of characteristics of payment systems

Anonymity, privacy

This characteristic reflects the desire of users to protect their privacy, identity and personal information. In some transactions, the identities of the parties could be protected by anonymity. Anonymity suggests that it is not possible to discover someone's identity or to monitor an individual's spending patterns. Where anonymity is important, the cost of tracking a transaction should outweigh the value of the information that can be obtained by doing so. As an illustration, when a customer pays with a debit card, the purchase is registered at the vendor and bank's databases. It is possible to find out what amount was paid and what actually was purchased. Thus debit card payments are not anonymous.

On the contrary, when one pays with cash at a shop or in a marketplace, no one can say by examining the cash that money came from the payer, as there is no direct information about this payer's personality associated with the banknotes. Thus, cash is an anonymous payment system. Currently, the right of users to choose how their per-

sonal information is disclosed is viewed as *privacy*. There are privacy laws in several countries that limit usage of personal information by banks, authorities and other parties, including online businesses and payment systems, like European privacy acts or similar directives, e.g. European Commission Data Protection Directive.

Applicability

The added value of a payment mechanism is dependent upon how useful it is for buying something. Applicability (or acceptability, as it is often referred in literature, (Medvinsky & Neuman, 1995)) of a payment system is defined as the extent to which it is accepted for payments at points of sale, or at online e-commerce sites in this case. For instance, cash is accepted widely and virtually everywhere in the offline world and thus has a very high level of applicability. Debit cards and credit cards have a very high applicability, as one can pay with them in a variety of places. The applicability of a payment system may vary from country to country. For example, in Germany and in the Netherlands cheques are no longer common due to the steady growth of other payment methods. However, in the UK and the USA cheques are still quite a common method of payment and the level of their applicability is quite high.

Authorization type

Authorization type is referred in the literature as the form of a control over the validity of transactions, (Lynch and Lundquist, 1996; Asokan et al., 1997). The authorization type can be offline or online. Offline authorization means that users of the system can exchange money while not connected to a network, without a third party mediating for the transaction. Paper cheques are an illustration of offline authorization.

The ability to make peer-to-peer payments, however, is not fully dependent on the authorization type. It is possible with both online or offline authorization. However, for peer-to-peer payments with offline authorization users should be physically connected with each other. Payments with conventional cash are an example of peer-to-peer payments with offline authorisation. Some electronic payment systems, e.g. Mondex, also offer this kind of service. Users can exchange money offline by connecting their Mondex cards via hardware card-reading devices.

Convertibility

Naturally, users will select payment mechanisms as financial instruments according to their needs. Numerous payment schemes have emerged up to this date and users can expect new systems to appear, all providing an assorted variety of services and appli-

cations for various purposes. Funds represented by one payment mechanism should be easily convertible into funds represented by other payment systems. Users should be able to transfer money from electronic payment systems to another accepted money form, e.g. receive it in cash, or transfer to a bank account.

Efficiency

Much discussion is going about the ability of systems to accept 'micropayments' and small payments, (Rivest & Shamir, 1996; Hauser, Steiner, & Waidner, 1996). Small payments are amounts less than one euro; micropayments are amounts of a fraction of a cent. A system which entertains the characteristic of efficiency should be able to process small payments and micropayments without performance degradation, and without imposing the high transaction costs, (Low, Maxemchuk and Paul, 1994). The costs per transaction should be reasonable for processing small amounts. Adherents of small payment promote numerous applications, from paying for articles, news and stock reports to pay-per-view sites.

Interoperability

A payment system is interoperable if it is not dependent on one company, but is open and allows other interested parties to join. This can be achieved by means of open standards for data transmission protocols and infrastructure. An interoperable system can faster gain the necessary customer base for future development and will have a higher level of applicability. The example of Chipknip and Chipper in the previous chapter illustrates the consequence of low interoperability. It is natural, though, that companies that implement new technologies treat them as know-how, because of the added value they create by investing in new technologies; therefore, it is not always sensible to demand interoperability. Examples of theoretical interoperable initiatives are the SEMPER project (www.semper.org), CEPS (www.cepsco.org), and the CAFE project (Boly et al., 1994). For instance, the last two initiatives were conceived to facilitate interoperability between diverse electronic purse systems.

Multi-currency

Effective and efficient payments between different countries are possible when a system allows processing multiple currencies, as it is currently done with credit cards. This feature however is not implemented or foreseen in payment systems of many countries, binding them to a particular currency region. Multi-currency payments are decidedly required for payments in cross-border electronic business and e-commerce.

Reliability

Naturally, users and businesses want a system that is **reliable**, because the availability of services and the smooth running of an enterprise will depend on the availability and successful operation of the payment infrastructure, (Medvinsky and Neuman, 1993, 1995). Whether in the result of a hackers' attack or simply poor engineering, the costs of breakdowns can be substantial, and the failure to maintain reliable operations can be unrecoverable.

Scalability

As the commercial use of the Internet grows, the demands placed on payment infrastructure will also increase. The payment infrastructure should be scalable, to be able to handle the addition of new users and merchants, so that systems will perform normally without performance degradation and maintain the required quality of service, (Medvinsky and Neuman, 1993). Among the least scalable systems are those that require from merchants to purchase and install additional software and hardware, because this increases the costs of accepting the payment system for the merchants. This often hampers development of token-based systems and e-purses.

Security

One of the most crucial and well-researched issues in payment systems is security, (Wayner, 1997; Lynch & Lundquist, 1996; Chaum, 1992; Brands, 1995). Since the Internet is an open network with no centralised control, the infrastructure, supporting electronic commerce and payment systems in particular, must be resistant to attacks in the Internet environment.

Security can be viewed as a two-fold issue. On the one hand, users would like to be sure that their money is safe when paying online. On the other hand, banks and payment services organisations would like to protect themselves so that no money, financial, or personal information can be stolen or misused. Security of electronic cash systems has an aspect of counterfeiting: no one should be able to produce electronic tokens on their own, otherwise banks or governments will have to pay for such counterfeiting. Another aspect of security of electronic cash is *double spending*, (Chaum, 1992). What cash transactions achieve by the physical nature of cash, is that money can be spent only once. In the computing environment, where copying information and modifying records is easy, this property becomes a challenge for engineers. An EPS operator should ensure that electronic cash cannot be spent twice. In this aspect, security is often viewed in connection to anonymity, cryptography, and unforgeability,

(the inability to create ‘counterfeit money’ for the use in the system), (Asokan et al., 1997).

Traceability and linkability

Traceability indicates how easy it is to trace money flows and sources of funds that are going through a payment system and used for purchases. In electronic payment systems money can be traced by records that are kept of a payment activity. For example, information about credit card payments is stored by banks and credit card companies, and it is possible to find out what money was used for, and where it came from. In this research traceability is associated with anonymity and privacy of a payment system.

Traceability is related to linkability of payments. Linkability of an EPS implies that payments can be associated with a particular user, or that it is possible to recognize several payments originating from the same user, (Schoenmakers, 1998). Users can be linked to their spending even if the system they use is anonymous. This can be done by using information that is indirectly associated with users, e.g. the physical location where payments take place. Despite that individual payments are anonymous, a relation between a user and his payments can be established based on this indirect information associated with the user.

Trust

Due attention and proper implementation of the above-mentioned characteristics can help to build up the vital attribute of trust, (Wayner, 1997; Lynch & Lundquist, 1996; Egger, 2003). Trust, in this context, refers to the degree of customers’ confidence that their money and personal information will be safe, and that all parties involved will not act against users’ interests. From the perspective of using a payment system, users need to trust that payments will be conducted in a proper way, and that their money will not be stolen or misused. On the other hand, even if we use an imperfect system, we want to believe that vendors, banks, and credit cards companies will not use the information they hold against us in any harmful way. Conversely, another essential aspect of trust is that other parties *accepting* our payments should trust the payment systems we want to use. On the basis of such trust, they will be willing to accept our payments and conduct commerce.

Usability

It should not be a sophisticated or complex task to pay online, payments are to be done in an easy and user-friendly way, (Guttman, 2003, p.89). This requirement can

be manifested in *ease of use* of the system, (Lynch & Lundquist, 1996). In such a responsible task as a payment process, users should have minimum factors that make paying complicated or distract them. An overly complex payment process, accompanied by other complications associated with EPSs or an e-commerce payment environment, can turn customers away from a financial transaction and even future e-commerce activities. For example, the processes of paying when you have to fill in a lengthy form with name, address details, a 16-digit credit card number plus expiration date cannot be called an easy one when compared with cash payments. This is the very process that most Internet shoppers have to go through to make their online credit card payments. Poor usability of a web shop or a payment method could also discourage spontaneous purchases. Certain e-commerce companies demonstrate understanding of the importance of this issue. To remedy this situation for credit card payments renown online bookseller Amazon.com has devised a '1-Click' checkout method, (Enos, 2000) to allow customers to make payments with the minimum of authorisation steps and information input, (Source: Amazon.com). Usability is an important characteristic of an interactive product and is defined as "the extent to which a product can be used by specified users to achieve specified goals with effectiveness, efficiency and satisfaction in a specified context of use", (ISO 9241, 1996).

Using the characteristics as an assessment framework of EPSs

As it can be seen from the literature, (Medvinsky & Neuman, 1995), the characteristics can be used for describing and evaluating EPSs. The list of the characteristics compiled in this thesis can serve as a framework for assessment of EPSs. Such use of the characteristics can help to obtain a picture about how well a payment system measures against these characteristics, highlight possible limitations of the system, and suggest in what aspects the system can be improved. This kind of information can be used as an input for design of EPSs. Section 2.4 uses the assessment framework for describing a payment system.

2.3 Advantages and limitations of payment models

Having described payment systems and their various characteristics, these characteristics will be used to illustrate advantages and limitations of different payment models.

2.3.1 Advantages and limitations of the electronic cash model

An important advantage of electronic cash is its potential for anonymity. Some systems, like eCash, (Schoenmakers, 1998), (see also Brands (1995)), can block attempts to identify the user to whom a specific token was issued, even if all parties conspire. However, in an attempt of double spending, the user will not be able to use the same electronic 'coin' twice. In the context of offline electronic cash, if a user were attempting to spend the same tokens twice, the systems would reveal enough information to determine the user identity.

Certain systems, such as NetCash and Mondex, provide a weaker form of anonymity, which has to do with linkability, see section 2.2. Theoretically, if all parties join together, it is possible to determine who has spent the 'coin'. However, with NetCash, a user can choose the currency server and can instruct the one he trusts not to retain information needed to track such transactions. In contrast, although Mondex is an electronic cash system, it is not anonymous, because each card has a unique identification number that is linked to the person to whom the card was issued at the bank. Users cannot buy a Mondex card without revealing their identities.

One particular advantage of electronic cash systems is the possibility of payer-to-receiver exchange without the need to contact a central control system. This can reduce the costs of transactions and facilitate micropayments. The system becomes more efficient, because of less information processing, and eventually less organisational overheads.

A significant disadvantage of current electronic cash mechanisms is the need to maintain a large database of past transactions to prevent double spending. For example, in currently discontinued eCash, it was necessary to track all tokens that had been deposited. With the NetCash approach, it is necessary to keep track of all tokens that have been issued, but not yet deposited. Double spending can be an obstacle for system ex-

pansion, because it can reduce the scalability of the system, (Medvinsky and Neuman, 1993).

Another factor that may be perceived as a disadvantage is the necessity to purchase and install extra hardware and software, sometimes for both merchants and customers. While for consumers it means complications with technical issues and learning a new system, for merchants it may suggest even more costs and efforts for integrating new systems into their accounting and financial reporting. This can also lower merchant acceptance of electronic cash systems. However, dedicated hardware may help to solve various problems with security and authentication of this type of EPSs, (Brands, 1995).

2.3.2 Advantages and limitations of the account-based model

Wayner (1997) notes that, at the first stage of the development of electronic payment mechanisms, account-based systems will prevail, as long as the credit card business is well computerised and it is much easier to implement these kinds of systems with the existing technology. As long as a payment system employs existing infrastructure and a computer as a payment terminal, there is no need for creating new hardware or software infrastructure.

EPSs built on the basis of this model have therefore a potential for good scalability, which allows more users to join the system without great loss of performance. The reason is that to support more users, a system should only increase the number of accounts, which can be done relatively easily; there is no need to support large databases tracking all issued tokens to avoid fraud, as it is done in electronic cash systems. An advantage of the account-based model is a potential for usability of payment systems, because the existing infrastructure, familiar to users and merchants can be used for making payments.

There are several limitations of this type of systems. Account-based systems are usually traceable and not anonymous, so clients' spending and money sources can be easily identified. Because account-based systems usually have centralized authorization type, the overhead costs for transaction processing could be rather high. Credit card transactions, for instance, could involve up to five participants: the purchaser and the purchaser's bank, the vendor and the vendor's bank and the settlement company. This leads to the high overhead costs, making credit cards inefficient for small payments.

An important point to mention is that the low level of security of such systems affects banks, users and vendors. Another issue are credit risks imposed on banks or credit card companies when they extend the credit for their clients who are using credit cards.

Account management for EPSs of this model is often under control of a single company that provides service by account-based model; this can affect interoperability, if it is difficult for other parties to join due to closed or proprietary standards, and decrease reliability, because the company may have a single point of failure. This type of systems usually requires a network connection and servicing offline payments can be complex, which is also a limitation in certain contexts of use.

Payment systems, built according to this model have potential for multi-currency support and high scalability. It depends on details of realisation if a payment system will gain enough trust, will have features of convertibility, or how secure and reliable would it be.

2.4 PayPal.com: Using characteristics for analysis of payment systems

As an example, let us look at PayPal.com, one of the most successful online payment systems on the market in the beginning of the 21st century. PayPal.com is a good example of the alternative to credit card payments, providing the payment link between buyers and sellers. A user has to open an account with PayPal.com to be able to pay and receive money. The account then should be funded with credit or debit cards, electronic wire transfers or by other methods. The registered customers can then transfer funds between their accounts, pay at the web sites that accept PayPal.com payments, and receive money from other users, Box 2.1. The PayPal business model is based on charging merchants for accepting PayPal payments. By 2004 it has also become possible to use PayPal credits with the 19 million MasterCard and Visa merchants worldwide, without ever having to go through a bank account. This system is used by big online companies such as e-Bay or Amazon.com and has already attracted more than thirty million users by 2003. Let us see how PayPal.com measures against the characteristics of payment systems described above.

PayPal users can expect a high level of *anonymity* and *privacy* when paying directly from a PayPal.com account. The company claims that “PayPal is committed to protecting the privacy of our users. When you send or request money using PayPal, the only information the recipient sees is your email address, date of sign-up, and whether you have completed PayPal's verification process by confirming an account at another financial institution. Recipients never see your financial information, such as your credit card or bank account numbers”, (Source: PayPal.com Help, 2003).

However, privacy of users can be easily compromised upon interference of governmental institutions, such as the police, (Cox, 2001). While these interferences can be justified to fight fraud, they still can still prevent users from adopting PayPal, because they may feel their privacy is compromised.

Incidents when governmental agencies access the records of EPSs operators may be very damaging to the company reputation and undermine user *trust*. Angry customers have formed a number of bodies to inform and protect themselves and new users against the questionable company policies and practices. Among such are www.paypalwarning.com, www.paypalsucks.com, PayPal Victims Club at Yahoo! Groups, and www.aboutpaypal.org.

These problems can also lower the *applicability* of the system. The main reasons for merchants refusing to accept PayPal.com payments, reported at the above-mentioned Internet communities, are periodic changes in the PayPal's policy regulating which products or services can be sold with using the system. For example, one of the policy changes banned selling modern firearms with PayPal. While the company is concerned about its reputation, the measures the firm has taken have irritated many merchants and users.

PayPal.com is a system with a centralised *authorisation type*. What is important from the user viewpoint is that a single company has control over all accounts and transactions, and not being monitored by other parties. It is harder for customers to appeal to the company's decisions, as PayPal.com is the final authority in their own business.

The system has a high degree of *efficiency*, as transaction processing is automated, is done electronically, does not rely on expensive transaction channels as paper checks, and the costs of transactions are not correlated to the transferred amount. The system allows transactions with small and micropayments.

PayPal.com is a quite *convertible* system. Users are able to withdraw money from the system to their checking account, or request a check: “You can withdraw funds from

your PayPal account by requesting an electronic funds transfer to your bank account or by requesting that a check be sent to you by U.S. mail. When you withdraw to your bank account, your money should become available within 3-4 business days, but may take more time depending on your bank's policies... You will receive an automatic email acknowledgement every time you request to withdraw funds”, (Source: PayPal.com Help, 2003). PayPal.com supports *multiple-currency* transactions. By the end of 2003 the Multiple Currencies feature of PayPal.com “includes the ability to send and receive PayPal payments in Canadian Dollars, Euros, Pounds Sterling, or Yen, as well as U.S. Dollars”, (Source: PayPal.com Help, 2003).

It is assessed that *interoperability* of PayPal is rather low, as there are no signs that other parties, such as financial institutions will join the payment system. Because of its authorisation type, the system is quite *scalable*, at least in theory. The possible user base is limited mostly by technical constraints and the administrative overhead. There was not enough data available to this research to assess how *reliable* is the system.

Due credit should be given to the PayPal.com help, which describes the system in many details for both novel and experienced users, and was widely used to write the current analysis, see Box 2.1. For instance, the relevant help section provides with explanation what measures are used to ensure *security*. Availability of such information can be critical for potential customers considering whether they should use the system for payments. PayPal.com demonstrates understanding of the importance of security to end users stating that “the security of your information, transactions, and money is the core of our business and our top priority at PayPal”.

The interaction design of PayPal.com resembles a typical e-commerce shop, and usability guidelines for this type of websites can be applied to the design. There are, however, issues with *usability* of the PayPal's design. For example, design firm 37signals.com suggests redesigning the PayPal's payment confirmation screen, as seen in Box 2.2.

PayPal's close integration with credit cards creates the greatest threat for the business. Legions of fraudsters all over the world with stolen credit card information and identifications are using PayPal.com as a ‘money-laundering’ system to cash upon the situation when the card is not present. Credit card transactions where the card is not present and personally examined by a human controller account for the overwhelming majority of fraudulent credit card transactions. These and the other issues mentioned in this section can be very damaging to company reputation with users, merchants and

financial circles. Once again, it demonstrates how critical user-related factors could be for the success of an electronic payment system.

Making Payments

How do I send money?

You can send money by going to the **Send Money** tab, clicking the Pay Anyone or Pay for eBay Items subtab, and filling out the form. When you send money through the Pay Anyone subtab, you will be asked to choose a payment type. The payment types are:

- **eBay Items:** Use for eBay purchases and you will be taken to an additional form to enter information such as your item URL, eBay Buyer ID, and a message for the seller
- **Auction Goods (non-eBay):** Use for non-eBay online auction purchase and you will be taken to an additional form to enter information such as your item URL, auction site, and a message for the seller
- **Goods (other):** A purchase of goods in a non-auction context
- **Service:** A payment for the performance of a service.

Quasi-Cash: The transmission of money not involving an underlying service or good. The bank that issued your credit card may treat this 'Quasi-Cash' transaction as a cash advance and charge you cash advance fees. PayPal has no control over these fees. If you select 'Quasi-Cash' you may want to use a payment method other than Credit Card (Instant Transfer or eCheck) to avoid potential fees.

Box 2.1 Making payments with PayPal.com. Source: PayPal.com Help, 2003.

2.5 Conclusions

In this chapter important aspects of electronic payment systems have been identified. They are summarized in Box 2.3. It is clear that the current state of online EPSs is far from ideal and that there are problems that can affect user acceptance of EPSs. Another important observation is that it makes little sense to focus on payment mediation services, because they are trying to compensate for problems that should be resolved in the existing payment systems these mediation services aggregate.

This research aims to define the ways in which user acceptance and, consequently, the success of new EPSs can be improved. The characteristics of EPSs can be used as initial guiding directions for design of EPSs. It can be suggested that designing an EPS

Before: PayPal Confirmation Screen	After: 37signals' Better PayPal
<p>What's wrong with this screen?</p>	<p>How we made it better</p>
<p>This PayPal screen, which confirms payment information, suffers from a lack of focus. This is an important issue since it is the last screen you see before money is sent.</p>	<p>We made the dollar amount the most obvious element on the page.</p>
<p>On the existing page (above), the dollar amount and the recipient's email address are treated in the same font size, style, and weight as less significant information like "type," "email subject," "note," etc. This dilutes the page and, in effect, de-emphasizes the critical information. PayPal should strive to make it immediately obvious why you're there and where the focus should be, even at a glance.</p>	<p>We used more conversational wording to make it easier to understand exactly what's going on and the purpose of the page.</p>
<p>Further, the "Check Payment Details" is confusing because some people may think "Check" means bank check when it really just means verify.</p>	<p>We rearranged the data so the information flows more naturally (dollar amount, then recipient, then type of transaction, then funding source, etc.).</p>
	<p>We grouped the dollar amount and the funding source into the same content block (currently they are too far apart for bits of info that are so closely related).</p>
	<p>We separated the email subject and body into its own data grouping.</p>
	<p>We labelled the "Send Money" button with the actual dollar amount ("Send the \$37") for clarity's sake. Further, we grouped the edit and cancel buttons on the right while keeping the primary send money action button on the left in order to reduce the likelihood of clicking the wrong button.</p>

Box 2.2 PayPal payment confirmation screen: usability issues and solutions.

Source: 37signals.com, March 2004.

that is reliable, secure, trustworthy and usable would benefit user acceptance of the EPS. However, the contribution of the characteristics to user acceptance and their importance should be confirmed with potential users of EPSs.

Anonymity/privacy	Reliability
Applicability	Scalability
Authorization type	Security
Convertibility	Traceability
Efficiency	Trust
Interoperability	Usability
Multi-currency	

Box 2.3 Summary of characteristics of electronic payment systems.

Designers of future EPSs should be convinced that the characteristics would provide adequate support of user activities and needs. To answer these questions, before suggesting to employ the characteristics for design of payment systems, it has to be found out that they make sense to end users and to establish what importance the users attach to the characteristics. It is quite likely that the users would find some characteristics more important than the others. In this case, it will be more effort- and cost-effective for designers to concentrate mainly on the characteristics that are considered important by the users. With such an approach designers can ensure that their system has a built-in potential for user acceptance from the very beginning of the system's development. The following chapter describes an investigation into the importance of the characteristics of EPSs to end users in more detail.

Chapter 3

User survey of electronic payment systems

3.1 User acceptance of electronic payment systems

The previous chapters suggested that there are a lot of factors that determine the success or failure of payment systems, and not all of them are of a technical nature. Several attempts have been made to describe electronic payment systems, mainly from a technological point of view, (Medvinsky & Neuman, 1993; Asokan et al., 1997). However, the characteristics used to describe EPSs should be validated with end users. It has to be found out how the characteristics of payment systems relate to users acceptance.

User acceptance of new information technology has been extensively studied in the context of information systems management, as mentioned in section 1.2. For instance, the Technology Acceptance Model (TAM), introduced by Davis (1989), has gained much popularity for predicting information systems acceptance. TAM serves to

explain and predict information technology acceptance and diagnose problems before users experience the technology. Following TAM, perceived usefulness and perceived ease of use are thought to be able to predict user behaviour that leads to user acceptance of technology, see Figure 3.1.

Perceived usefulness, defined by Davis, et al. (1989), is the user's subjective opinion that using a system will increase the user's job performance within an organisational context. *Perceived ease of use* refers to users' expectations that software use will be free of effort. Perceived ease of use has direct impact on perceived usefulness, but not vice versa. In their work on validating TAM Davis et al. (1989) have discovered stronger relationships between perceived usefulness and behavioural intentions to use, than between perceived ease of use and behavioural intentions. TAM is a theoretic model based on extensive empirical evidence. In the work of Davis (1989) a validated scale for measuring user acceptance along the two model's constructs was presented and substantiated with sufficient empirical evidence.

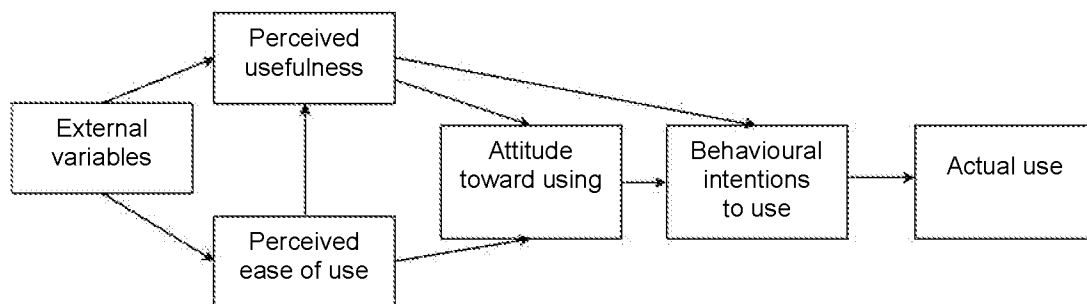

Figure 3.1 *Technology Acceptance Model, (Davis, 1989).*

While TAM is a good predictor of the intentions to use a software package, it would not be enough to describe the specific nature of user attitudes towards EPSs. The context of use of EPSs, where money transactions are involved, is different from usual information technology applications, where the productivity at work is mainly concerned. Plouffe et al. (2001, p. 209), express concerns that TAM does not take into account the context use in predicting information systems acceptance. It cannot be assumed that TAM will take the specifics of this context of use into account, for instance, in aspects of trust, reputation, or beliefs about technology. Therefore, in this research employs the theory of reasoned action, which is arguably better suited for predicting user acceptance of EPSs. The theory of reasoned action (TRA), originating in social physiology, defines relationships among beliefs, attitudes, norms, intentions and be-

haviour, (Fishbein & Ajzen, 1975). According to TRA, behaviour, e.g. the use or rejection of technology, is determined by the person’s intention to perform the behaviour, and this intention is influenced by the persons’ attitude and subjective norms. Subjective norms are defined as “the person’s perception that most people who are important to him think he should or should not perform the behaviour in question”, (Fishbein & Ajzen, 1975, p. 302). Attitude towards a behaviour is determined by beliefs and evaluation of consequences of the behaviour. Figure 3.2 describes the theory components and their relationships. This theory justifies a generalised model for understanding of human behaviour, and demonstrated strong predictive utility, even in the situations which fall outside of the original conditions of the theory, such as predicting non-voluntary behaviour, (Dillon & Morris, 1996).

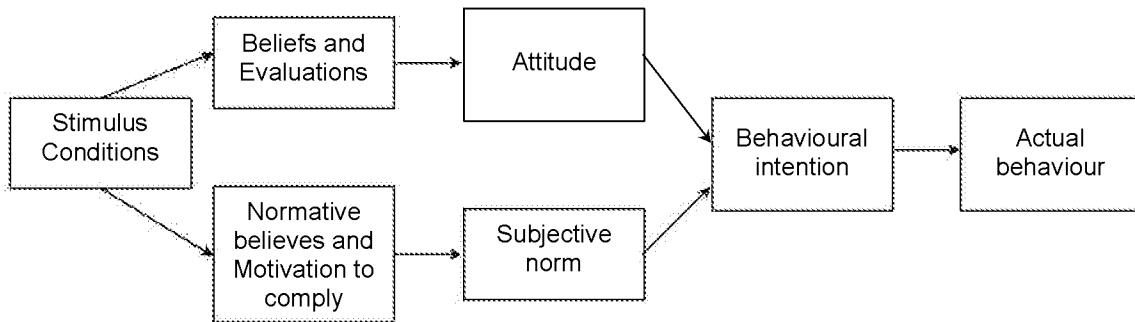

Figure 3.2 Theory of reasoned action (TRA), based on Fishbein & Ajzen (1975).

TRA, which is applicable to a much wider range of situations than only information technology, seems to be better suitable to describe how user attitudes can influence acceptance of payment technology in an e-commerce environment than TAM. Unlike TAM, TRA takes into account social influences (e.g. shared subjective norms) on users of various factors surrounding the usage of EPSs in online e-commerce environments. Since EPSs are intended for personal use, factors such as reputation can be highly important to end users and influence their attitudes. In addition, since perceived usefulness and perceived ease of use are seen to have a significant impact on attitude towards the system, in TAM attitude is not tied to beliefs about technology. Overlooking user beliefs can be misleading for EPSs. Social influences and user beliefs about technology, such as trust in the technology or understanding of technology, can be very influential on the adoption of the technology.

This thesis argues that for user acceptance of electronic payment systems in an e-commerce environment other factors, in addition to perceived ease of use and perceived usefulness, could be responsible for user acceptance. User beliefs and attitudes towards privacy, security and trust could be determinants for the final users' decision to utilize a system for payments. Taking into account social influences in the context of e-commerce EPSs can further substantiate the understanding of user acceptance of EPSs. Therefore, it has to be found out what aspects of electronic payment systems are important to end users, and could determine user attitudes, behaviour and intentions to accept the payment technology.

Based on TRA, behavioural intention and consequently the actual system use are determined by user attitudes. It has to be investigated what attitudes users have towards certain aspect of EPSs. Discovering these attitudes will let us understand what are the factors that influence user acceptance of EPSs.

3.1.1 Characteristics of electronic payment systems as determinants of user acceptance

The list of characteristics identified in Chapter 2 was taken as a starting point of exploring what is important for end users in interaction with EPSs. While the list of characteristics originated from the literature, that embraces many aspects of EPSs, hardly any empirical evidence of their importance to end users of online EPSs has been reported. To find empirical evidence a consumer survey was conducted. This survey tried to gauge the extent to which users are influenced in their decision to use systems by the characteristics described in Chapter 2.

The validation step will cover only those characteristics described in Chapter 2 that can be perceived and experienced by users directly. As this research aims to generate knowledge about designing interaction with EPSs, it would not make sense to include e.g. interoperability or scalability, because users do not perceive the aspect of the system described by this characteristic directly in the interaction. Therefore, several characteristics were not included in the survey. These characteristics may be also important for user acceptance over the long-term use, but they are mainly transparent for end users, because they do not have direct interaction or perception of these characteristics in payment activities. Instead, these characteristics should be given attention from an engineering or business perspective.

The characteristics that were selected for validation with users are listed below. See section 2.2 for detailed descriptions of the characteristics.

- Anonymity, privacy, traceability
- Applicability
- Convertibility
- Efficiency
- Reliability
- Security
- Trust
- Usability (ease of use).

This research had to justify the relevance and importance for user acceptance of the characteristics of EPSs described in Chapter 2. It was not aimed to model the decision process of users, but to identify which factors affect user acceptance of EPSs and to use this knowledge to inform design of EPSs.

Hypothesised determinants of user acceptance of EPSs are characteristics which:

- are relevant for user behaviour, attitudes, perception and experience when using EPSs, (i.e. if they make sense to end users).
- are important descriptors of systems' aspects to end users.
- are important for systems' features or functionality.
- are important for describing aspects of social influences and interactions.

3.2 Survey of users' attitudes towards characteristics of payment systems

To reveal how important and well understood are the characteristics of payment systems to end users a survey was conducted in the beginning of 2001 in cooperation with De Consumentenbond, the largest consumer organisation in the Netherlands. In this survey conventional (cash, offline credit cards) and electronic payment systems (debit and smart cards, and credit cards on the Internet) were examined. The EPSs studied were not necessarily online EPSs. The study was performed as a survey of consumer

attitudes. It was previously published in Abrazhevich (2001a) and Abrazhevich (2002). This research did not aim to create an instrument for measuring user acceptance. The main goal was to gain design knowledge and ensure it can be applied to real-world EPSs.

3.2.1 Survey participants

The survey was conducted in a form of self-administered questionnaires sent out by post. Respondents were selected from the database of subjects of De Consumentenbond, which has been assembled in the past from people who reacted to a newspaper advertisement.

Of the 1328 respondents 94.1% were users of electronic payment systems. The respondents were daily users of several offline payment systems, including debit, credit and smart cards and cash. 19.4% had already made payments on the Internet before the study. The sample was balanced in demographic aspects: the respondents were employed in diverse industries and social institutions, there was no bias on sex (women 51.8%), age (mean is close to 50). Occupation of 94.8% of the respondents was not related to payment systems.

3.2.2 Questionnaire design and analysis

Several questionnaire items elucidated each characteristic of payment systems. Users were required to express their opinions on a 5-point scale for most of the questions (e.g. 1 – very important; 2 – quite important, 3 – neutral, 4 – quite unimportant, 5 – not important at all). Certain questions were introduced by De Consumentenbond in line with their own research interests, see Appendix A for the survey questionnaire. The survey results are presented in Appendix B. The most important highlights of the survey are summarised in Table 3.1. It has been assessed whether answers contribute to importance or unimportance of a particular characteristic according to the percentage of responses.

3.2.3 Survey results and discussion

Characteristics of less importance

The most interesting finding was the users' reaction to the questions on **anonymity**. Despite that numerous publications emphasize the high importance of anonymity as a requirement for EPSs, (Lynch & Lundquist, 1996; Chaum, 1992), most of the respondents indicated that anonymity is not very important for them. 72.8% of the respondents are never stopped by the fact that they are revealing their identity. Only 13.5% are concerned that vendors can find out what they buy when paying with an electronic payment system. The respondents were quite satisfied with the level of anonymity provided by debit cards, one of the least anonymous systems (52.2%). 72.9% of the respondents would prefer their purchases to be registered, to avoid disputes with merchants and 50.4% agree that this can be used to provide a better service.

The vision of this research of the characteristic of **efficiency** (ability of a payment system to service small payments) is influenced by another interesting survey result. The prevailing number of the respondents (61.4%) did not think that small payments are necessary for shopping on the Internet. This is especially remarkable in view of many attempts to introduce small payments solutions for online trade. The first analysis suggests that users do not regard small payments as an important function of an EPS, because most information commodities that could have been traded for a small fee are given out for free, with the business model relying on online advertisement. This suggests that micropayments are not among the important characteristics for user acceptance in the scope of this research. The efficiency of a payment system cannot be considered an obstacle (at least in the Netherlands) for user acceptance of EPSs. It is possible that efficiency is critical for new business models that the surveyed consumers have not yet experienced.

It can be argued that user attitudes are dependent on the *context* where payments take place for payment applications. For example, for certain applications anonymity may be less important than other factors, as it is shown for debit cards payments, while in other cases the situation may be the opposite. Therefore, payment systems should be designed by taking into account specifics and requirements of concrete applications for specific contexts of use.

Another conclusion in relation to efficiency suggests that consumers may not yet understand well the potential and the benefits of a particular functionality being offered

by industries to support a specific business model. Thus, for future design, attention should be focused on adjusting payment systems for a specific context of use and thoughtful introduction of new applications and business models to customers.

Characteristics of high importance

Ease of use was rated as a characteristic of high priority. The respondents prefer debit cards (75.2%) and cash (10.4%) to other systems, because they find them easy to use. However, users noted that it is quite easy to use credit cards for Internet payments. Among 19.4% of the users who had experience with online credit card payments, 96.2% suggested that credit cards are easy to use. This is despite the fact that an online credit card payment requires a user to fill in lengthy forms with personal data and credit card details, and therefore cannot be regarded as an easy one. Thus, it seems that while paying with credit cards is not a convenient process, users perceive it differently. A possible explanation could be that users have become accustomed to these types of payment over years, or that researchers in usability overestimate the complexity and workload of credit card payments. The results on ease of use can imply importance of usability of EPSs for users.

Convertibility of funds to another payment system turned out as expected. Users demonstrated relatively high dissatisfaction with the lack of convertibility of money from smart cards systems: 53.9%. At the same time satisfaction of convertibility from bank accounts to cash is high at 87.1%. Since in the Netherlands bank accounts are linked with debit cards, it can be concluded that convertibility of debit cards is higher, which confirms the reality, because bank accounts are designed to be convertible into cash.

Security is an issue of high importance for most of the respondents (98.4%). 75.3% of the respondents would stop using a payment system if they heard about a security breach in the system.

Expected results were received regarding **reliability** of payment systems; many respondents are aware of and concerned about the incidents of payment systems failures. 55.3% prefer debit cards, and 15.1% prefer cash, because they think that these systems are more reliable than others.

Table 3.1 Summary of the survey results
 Legend. * – questions' numbers in Appendix B.
 † – summary of percentages of two extremes of the scale

Characteristic	Questions	Responses (%)	Total N (1328)
Anonymity/ Privacy	4*. <i>Concerned and very concerned</i> that shops can register their purchases [†]	13.5%	1297
	6. Would like to have registration of purchases so that shops can use the records to provide with better customer service [†]	50.4%	1257
	3. <i>Satisfied and quite satisfied</i> with the level of anonymity provided by debit cards [†]	52.2%	1238
	2. <i>Never refrain</i> from paying because of revealing identity when paying [†]	72.8%	1312
	5. Would prefer that their purchases are registered to avoid disputes [†]	72.9%	1268
Applicability	24. Agree that a good shop should offer the choice to pay with any payment system users would like	85.8%	1313
Convertibility	8. Convertibility of funds from bank accounts to cash is satisfactory [†]	87.1%	1285
	8. Convertibility of funds from smart card systems to bank accounts is unsatisfactory [†]	53.9%	449
Ease of use	9. Preference because of ease of use: Cash	10.4%	1253
	Debit cards	75.2%	
	10. Credit cards on the Internet are easy to use [†]	96.2%	132
Efficiency	13. Small payments on the Internet are necessary [†]	13.4%	246
	14. Small payments on the Internet can be used for: Various applications	45.2%	197
	No need for small payments	54.8%	
Reliability	15. Preference due to higher reliability: Cash	15.1%	990
	Debit cards	55.3%	
Security	16. <i>Important and very important</i> [†]	98.4%	1295
	17. Would stop using a payment system if hear about a security breach in the system [†]	75.3%	1302
Traceability	20. Concerned that sources of their income can be known by vendors [†]	45.3%	1262
Trust	21. Important that other people also trust the payment system they use [†]	72.4%	1271
	23. Would stop using a system if they felt that it's not trustworthy [†]	94.4%	1311
	22. Will trust the system introduced <i>only</i> by an established organisation [†]	97.6%	1289

Trust was considered to be a very important issue: 97.6% would trust only a payment system introduced by an established organisation. 94.4% would refrain from using a system if they felt it was not trustworthy. For 72.4% of the respondents it was important that other people trust the systems they use. This supports the prediction that social influences are important for the user acceptance of EPSs.

Questions about **traceability**, i.e. the ability to trace money flows and sources of income, indicated that 45.3% are concerned if such information would become known to merchants. 58.3% find important that they do not leave personal information (name, bank account, address) to merchants (question 19 in Appendix A). While the participants are not concerned about strong anonymity of payments, these reactions to traceability suggest that consumers still would like to have certain privacy.

The respondents place significant emphasis (85.8%) on **applicability** of payment systems, i.e. the ability to pay with a payment system at multiple and diverse points of sale.

In summary, according to the user responses, characteristics of primary importance are: applicability, convertibility, ease of use (usability), reliability, security, traceability, and trust. Lower level of importance was attributed to anonymity and efficiency.

3.2.4 Implications for user acceptance

Based on the results of the survey the list of user-related characteristics of payment systems can be revised further. In refining the original list, the survey results are combined with literature sources, reviewed in previous chapters.

The survey has clearly shown that efficiency is not of a high priority for consumers, though this might be simply a result of the satisfactory status of the current situation in this respect. Efficiency is more relevant where small and micropayments are concerned, which are out of the focus of this thesis, as discussed in section 1.4. Consequently, efficiency of EPSs should not be included in the final list of characteristics that can impact acceptance of EPSs.

Reactions to anonymity bring us to another observation. Users said they are quite satisfied with the level of anonymity provided by debit cards, which is one of the least anonymous payment systems. To explain this interesting result, a distinction should be made between *a)* full anonymity of users and their payments and *b)* privacy on the

level of restricting of access to personal information for non-authorized parties. In this respect, the results on traceability of sources of money actually relate to privacy rather than to full anonymity of payments. Using the term privacy will also cover the characteristic of traceability. Based on the survey results anonymity and traceability are replaced by privacy in the list of characteristics. The characteristics of primary importance are the following:

- Applicability
- Convertibility
- Privacy
- Reliability
- Security
- Trust
- Usability.

Influence of context of use in relation to user acceptance

The survey described in this chapter has assessed how users perceive the importance of different aspects of EPSs as a reason to use them or not. However, this description is independent of any context where payments take place. Clearly this is an insufficient account of the phenomenon. While most of the time users are not concerned about anonymity, they might actually want to be anonymous when engaging in financial transactions they prefer to keep private. The relative ratings, while informative in general, can be misleading if applied to the whole variety of EPSs and payment situations. Therefore, it makes sense to be more specific in targeting payment systems for various applications and contexts of use.

On the other hand, user can perceive certain system's aspects differently from how they are actually realized in the system. This was expressed by the survey respondents, who were quite satisfied with anonymity provided by debit cards, despite that debit cards are among the least anonymous systems. A potential explanation is that these attitudes pertain to situations where anonymity is not the prerequisite for engaging in transactions, or users are unaware about the actual situation, or do not find anonymity important in this situation.

This reasoning has the implication that different systems should be designed for various applications and payment situations, and it is unlikely that there is one solution that covers all emerging user and business requirements, mentioned in section 1.1.

User acceptance of EPSs is therefore dependent on:

- Perception of various aspects of payment systems.
- Contexts of use of specific applications for payment systems.
- Social influences and perception and attitudes towards influencing parties. User acceptance can be manipulated by various factors: technical partners, government, marketing, and user interface, and social influences, e.g. opinions of other users, family and friends, and reputation of banks and the parties involved, see Figure 1.1. Discovering these influencing factors can highlight what is necessary for systems' design.

Implications for design of electronic payment systems

This survey was a necessary step required to find out user opinions and highlight factors of electronic payment systems that are important to the users and can influence user acceptance.

The survey had given a picture what people's attitudes are, and suggested that these attitudes can determine users acceptance of the systems. However, this survey did not discover why users have their opinions and experience, or how they experience the payments online, nor does it help us to prescribe what designers should do to ensure user acceptance and design good EPSs. Using the characteristics or viewing them as requirements can grant a better understanding what aspects a payment system should have. However, there is a need to substantiate the way the characteristics are manifested in the system at the design stage. There is still the lack of specific design knowledge that will prescribe how to construct payment systems and what aspects should be implemented to achieve user acceptance. Moreover, this survey did not sufficiently focus on the issues of social influences and social interactions that also may affect users in their decisions to use payment technology.

One of the reasons for this is that the focus of the study was limited by the original set of the characteristics and the data collection method (user survey). On the other hand, the survey results are based on a sufficiently high number of respondents and should be therefore taken very seriously. The following chapter describes a diary study that aimed to understand how EPSs are experienced and perceived in the context of actual use and how they can be designed to meet users' needs.

Chapter 4

Diary study: **a Qualitative investigation of user experiences with electronic payment systems**

4.1 Introduction

Chapter 3 has given an account of current consumer attitudes towards EPSs. The survey had a very broad scope and did not look into user experience with specific payment systems and did not examine the reasons for the reported attitudes.

In this chapter a qualitative study of Internet-based payment systems is discussed, that aimed to gain an insight of what makes users develop positive or negative attitudes towards payment systems, and discovering explanations for user attitudes, experiences and behaviour. This chapter motivates the diary study and the qualitative research approach, discusses its set-up and presents results and implications for design of EPSs. These findings can serve as a foundation for proposing recommendations for design of future electronic payment systems. Preliminary results of the diary study were previously published in Abrazhevich & Markopoulos (2002).

4.1.1 Motivation behind the diary study

The challenge in researching user behaviour during e-commerce activities lies in the sensitive nature of payments and money. Compared to the other types of user-system interaction, Internet-based payments are a very delicate type of interaction, since money transactions are involved. When people deal with money in real life, their behaviour could be different from the one during fictional money transactions in a laboratory, when they are asked to work with mock-ups or to stop interaction right before committing to an actual payment. In other words, a study of fictional payments lacks ecological validity. It was therefore decided to study actual payments by experienced and novice users of Internet-based payment systems through a diary study.

Diaries are increasingly popular as a research method in the field of HCI, as they offer the possibility to capture user opinions and experiences in the context of actual system use and throughout the day, close in time to the phenomenon studied, (Rieman, 1993). Diary studies have origins in multiple disciplines, such as psychology, health and medicine research, education, anthropology, and architecture. From the early 1990s the diary study method was introduced to the HCI community by the works of (Chin, Herring, & Elliott-Familant, 1992; Rieman, 1993; Carayon & Hajnal, 1993).

Palen & Salzman (2002) found diary studies to be effective and non-intrusive data collection methods, that yield informative, naturalistic data for research in the areas of HCI and computer-supported cooperative work (CSCW). They found that “diary studies can impose useful experimental constraints while maintaining ecological validity, because they are conducted in natural settings, but retain some level of researcher control”, (Palen & Salzman, 2002). The diary study method can serve as a middle-ground solution to the limitations of laboratory studies and observation studies, (Rieman, 1993). Diaries are linked to the actual usage and experience, and from the viewpoint of EPSs this technique is more realistic and valid than, for instance, interviews, focus groups, or questionnaires, based on hypothetical situations. During an interview informant might tend to generalise, forget, give attitude statements rather than report facts and experiences. Focus groups have similar limitations; they also can suffer from social influences between participants.

The previous research has identified several likely problems that users may experience of electronic payment systems, (Chapter 3). The survey of user attitudes towards payment systems, revealed no empirically supported evidence for the importance of certain requirements that seem to preoccupy current research on electronic payments

technology. For example, the survey reported that the ability to make micropayments was not considered very important by the respondents.

The goal of the study was acquiring insight on the actual user experience, and discovering and explaining user behaviour and attitudes towards online EPSs. The study searched for problems and positive aspects users can experience with EPSs, what functionality do they need for their payment activity, and how do they prefer to see EPSs designed. This study aimed to generate design knowledge on the user interaction with e-commerce EPSs.

The goals of the study are best answered by the qualitative approach to the data collection and analysis. The qualitative approach presumes broad, holistic, explanatory focus, tries to grasp complex interaction of factors, (Sigel and Dray, 2002). In contrast, a quantitative analysis would require a very reduced and concrete hypothesis to be tested, and may fail to uncover subtle issues, relevant to user acceptance of EPSs. Qualitative research employs inductive strategies that presume creating concepts based on the phenomena studied, rather than starting from theories and testing them, (Flick, 1998). Therefore the qualitative approach is appropriate for the goal of generating design knowledge using the diary study.

The diary study helped to find out what problems really concern users of EPSs, what are users needs and preferences in payment systems, and the ways users interact and experience EPSs. The analysis of the diary study looked into how these findings can inform design of future payment systems and from this viewpoint it complements the user survey and literature research described in the previous chapters.

4.2 Set-up of the diary study

The diary study investigated five account-based payment systems in the middle of 2002. These are 1) 'Internet Bankieren' (Postbank), 2) 'Internet Bankieren' (ABN-AMRO), 3) 'Electronic Banking' (ABN-AMRO), the older version of 'Internet Bankieren', 4) 'Direct Betalen' (Rabobank), and 5) PayPal.com. The first four systems are components of electronic banking systems of reputable Dutch banks. Apart from electronic payments they support many other functions, such as investments, savings and other banking products. Users of these payment systems have prior client relations with the banks, which might influence user perception of the payment systems.

PayPal.com is a representative of a purely Internet payment system, discussed in section 2.4. PayPal users can create payment accounts and use the system for money transfers and payments on affiliated web sites. The system also provides the ability to accept payments from other users or shoppers with credit cards. PayPal is neither a part of a banking system, nor supported by an established financial institution. From this viewpoint, this system provides an interesting contrast with the bank-supported payment systems. This should shed light on how trust towards the payment system is formed.

4.2.1 Selection of subjects

The participants were recruited by means of email and poster advertisement, distributed at the university campus. A web page providing an explanation of the study with requirements of the user profile was established to support participants' enquiries, Figure 4.1.

Individuals interested to participate were screened on the frequency of their electronic payments, so that they would be likely to make 5 or more actual payments within a few weeks. It was not possible to find expert users of PayPal willing to participate in the diary, because none of PayPal users reacted to the advertisement. Thus, for PayPal the diary data for only novice users was collected. The study did not aim for a big sample but rather was concerned to find subjects who would be committed to filling in diaries for several weeks, or who would be using EPSs for actual payments rather than for managing their personal finances.

Among the participants there were 4 students of various departments, 4 educational employees and 2 administrative workers. Five of them were users of Internet banking systems, employing them for most of their payment and banking activities. Five participants reported themselves as experts in online activities, while 5 were at intermediate level of internet experience, measured with appropriate excerpts from the questionnaire used for GVU World Wide Web User Survey (2003), see Appendix C. Four participants had moderate, the other 6 had high computer experience, gauged by the questionnaire adapted from Mayhew (1999), Appendix C.

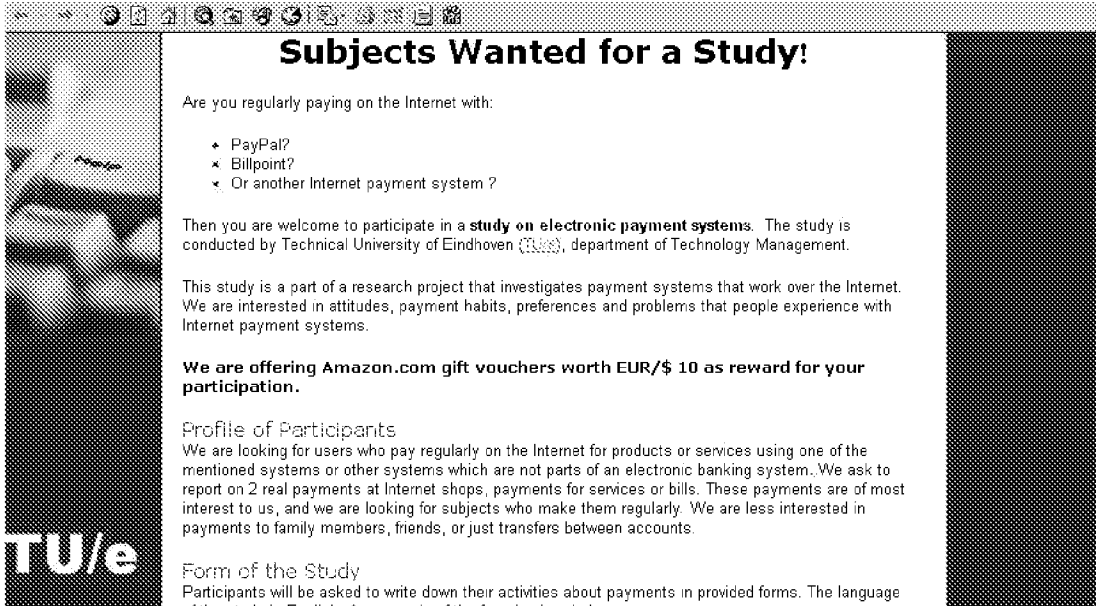

Subjects Wanted for a Study!

Are you regularly paying on the Internet with:

- PayPal?
- Billpoint?
- Or another Internet payment system ?

Then you are welcome to participate in a **study on electronic payment systems**. The study is conducted by Technical University of Eindhoven (TU/e), department of Technology Management.

This study is a part of a research project that investigates payment systems that work over the Internet. We are interested in attitudes, payment habits, preferences and problems that people experience with Internet payment systems.

We are offering Amazon.com gift vouchers worth EUR/\$ 10 as reward for your participation.

Profile of Participants
We are looking for users who pay regularly on the Internet for products or services using one of the mentioned systems or other systems which are not parts of an electronic banking system. We ask to report on 2 real payments at Internet shops, payments for services or bills. These payments are of most interest to us, and we are looking for subjects who make them regularly. We are less interested in payments to family members, friends, or just transfers between accounts.

Form of the Study
Participants will be asked to write down their activities about payments in provided forms. The language of the study is English. An example of the form is given below.

TU/e

Figure 4.1 Diary study advertisement on the Web.

This sample may be limited to people related to the university and may not be fully representative of the general public. Since the intention of this study was to obtain an exploratory account of aspects of interaction design of online EPSs that affect user acceptance, and not to generalise to any target population, this bias is not considered to be a threat to the validity of the findings. The diary study had to trade the breadth of coverage to the detail of investigation, as the aim was not to reach the final conclusion, but to create a hypothesis to be validated with another research approach. The final number of participants has met the goal of the study. The return rate of the diaries was 83%, among the 12 persons applied for the participation. The subjects were awarded a participation fee after they had completed the diaries and interviews.

Another part of the diary study was conducted to embrace users of other online EPSs. This part of the diary study attempted to collect similar data, but used a different form of data collection. The participants were recruited online and filled diaries in electronic forms. At the end of the study they were interviewed by email. However, the most participants were strongly affiliated with the studied EPSs, e.g. as employees or researchers. This demographic bias has disqualified the data collected in this part of the diary study, and therefore it was not included in the final results of the study, to preserve the quality of the data.

4.2.2 Process and instrumentation

The diary was given to the participants in a briefing session where the purpose of the study and the use of the data they would provide were explained to them, and informed consent was obtained. In the briefing section a preliminary interview was conducted, aiming to collect general information about the participants, e.g., demographics, and experience with the Internet and payment systems.

The diary design is defined by the specifics of research. According to Palen & Salzman (2002) diaries can be structured, with specific pre-defined categories of activities to be registered and later counted. They can also be unstructured, with spaces for recording participants impressions, activities, possibly linked to the time flow, e.g. see Adler, et al. (1998). This diary had a mixed design, because it combined place for recording participants' impressions with open questions defined by the characteristics of EPSs. The paper diary consisted of several sections: instructions, a separate section where a number of open questions was asked about each payment, and a blank space for writing the diary notes. No pre-filled examples were provided to avoid biasing the participants, where it might draw their attention to issues that otherwise do not really concern them during actual payments. For instance, if an example mentioning privacy had been given, this might have drawn participants' attention to privacy issues. An example of the diary page is given in Figure 4.2.

The participants were asked to write in the provided forms their problems, opinions, observations and expectations of the interaction process. They were asked to record payments to online shops, bills and services. Payments to relatives, friends, or just money transfers between accounts were of less interest, due to the focus of this research on Business-to-Consumer e-commerce, and users were asked not to fill them in the diary forms.

The diary study was informed by the characteristics of EPSs, discovered in the previous research. Subsequent items asked participants directly to express their impressions about security, usability, trust and privacy. The following open questions included in the diary:

- Have you experienced any problems when using the payment system?
- Was there something you especially liked or disliked about using the payment system this time?
- Do you feel there are any risks in using this payment system?

- Were you asked by the payment system to provide any information that was not strictly necessary for the payment activity?
- Are you worried that the company or bank that operate your payment system can misuse the information you provide?
- Do you feel that information about you is safe from third parties?
- Do you feel that your money is safe with this payment system?
- Do you find the authentication (passwords, security questions, calculator) annoying?
- Was interaction with the payment system easy?
- Do any security or privacy measures make it more complicated to use the payment system than you would like?

The subjects were asked to contact the researcher after recording 2 to 3 payments to ensure they are on the right track. In cases where the participants did not contact the researcher within a week, they were contacted anew to bolster the interest in the study and ask them to update their diaries. The participants needed to be reminded of the importance of keeping diary records. Such investigator's involvement is critical to avert declining dedication of participants and is important for the eventual success of diary studies, (Palen & Salzman, 2002).

A debriefing interview was conducted after the diary had been completed, and was used as another data collection method. Notes taken during the interviews were used in the analysis process. The interviews were tape-recorded and the records were reviewed by the researcher after the interview, if there was a need for clarification. The debriefing interviews consisted of going through the diary entries of the participants, and discussing impressions and experiences they reported verbally. The interviews employed the following qualitative interviewing techniques: in-depth interviewing, interviewing with open ended-questions and follow-ups, (Rubin & Rubin, 1995), combined with different types of probing, such as the silent probe, immediate and retrospective clarification and elaboration, and encouragement, (Keats, 2000).

5TH PAYMENT / INTERACTION

Time 12.05 Date 09/05 /2002

What did you do with your payment system?
Please write in the space below

Bought a car. (a lease) shop.
w/ bank

If this was a payment whom did you pay?

A business An organisation An individual

Internet auction | Other (please describe) _____

internet business.

Did you experience any problems when using the payment system? Please note them:

Other than that the system didn't want to make certain letters a capital instead of a small letter, no problems.

Figure 4.2 A snapshot of a diary page.

4.2.3 Diary study results

The time spent on filling the diaries ranged from 4 to 6 weeks. Ten people have completed the study; they performed in total more than 30 payments or registration procedures. Those participants who were recording payments have made the target 4-5 payments that conformed to the goals of the study. The participants reported more than 70 problems (issues that users did not like, or experienced difficulty with) and positive findings (issues that users liked, thought as a success, etc). There were about 10 problems or positive findings that were mentioned by more than one user. Most frequently mentioned were the positive comments that the participants trust the bank they use, and that the banks do not ask too much personal information, because they already have client relationships with the participants.

Analysing the execution of the diary study, it has to be noted that the participants were quite responsible in filling the diaries. They have accurately reported the desired number of payments, and were open and willing to go into details in the debriefing inter-

views. The in-depth interviews have not found out many discrepancies with the diaries records, which supports the conclusion that the participants were honest and conscious in their reporting. As the result, a substantial amount of qualitative data was available for analysis. It gave the study the desired depth and met the researcher's expectations for the study.

4.3 Analysis of the results

The analysis of the diary study's raw data has borrowed elements of the Grounded Theory (GT) methodology, (Strauss & Corbin, 1990). GT is used for analysis of qualitative data. This data analysis method is employed widely in social science and psychology research, however, its application to HCI research is quite novel, (Elliott, Jones, & Barker, 2002). To give the reader an overview of GT its method and rationale are discussed in this section.

Grounded Theory overview

(Strauss & Corbin, 1990) define GT as follows: "The grounded theory approach is a qualitative research method that uses a systematic set of procedures to develop an inductively derived grounded theory about a phenomenon". The primary objective of grounded theory is the discovery of theoretically comprehensive explanations about a phenomenon by identifying the key elements of that phenomenon and then categorising the relationships of those elements in the context and process of the study. The techniques and analytical procedures enable investigators to develop a theory that is significant, theory-observation compatible, generalisable, reproducible and rigorous.

GT specifically attempts to generate theory to explain the phenomena to which it has been applied. GT is most accurately described as a research method in which the theory is developed from the data, rather than the other way around. This can be contrasted to hypothesis testing. GT is an inductive approach, meaning that it moves from the specific to the more general. Such approach to understanding of EPSs is important for this research phase, where explanatory accounts of phenomena of user attitudes and experiences with EPSs are needed to prompt the generation of design knowledge, and is not easily achievable by controlled studies. GT is especially renowned for its application on study of human behaviour under field and close-to-real-life conditions.

GT therefore suggests the importance of findings and theorising based on reality, rather than hypothesis testing. In this research phase it is too early to propose a hypothesis that would scale down this research to a study of a particular phenomenon. At this point in the research the overall ontological picture of user interactions with electronic payment systems had to be built. While the diary study was guided and informed by the previously conducted research, for instance, taking into account the characteristics of EPSs, it was believed that applying an open-minded approach of GT to the analysis of the diary data would gain many valuable and interesting results.

GT has established guidelines for conducting research and analysis. It is able to incorporate diverse types of data such as users' notes in diaries, interviews, questionnaires, literature, users' self reports, and personal experiences of the researchers.

An important reason for choosing GT is making use of its systematic and, to an extent, traceable process, by which literature and survey results are combined with the findings of the diary study. Such analysis and synthesis, aimed to propose design guidelines is typically done ad hoc by researchers, which makes the validity of conclusions weaker than grounding the conclusions in the data. Reliance on GT methodology can counter possible threats to validity of the conclusions based on the study data.

In their work of applying GT in HCI research (Elliott, Jones, & Barker, 2002, p. 566) suggest that "HCI research as science, based on hypothetico-deductive methodology, leads to fine distinctions or observations which may not be as generalisable as desired. HCI as engineering science enables the identification of problems but does not add to the development of a deeper understanding of phenomena".

GT analysis process

There are three distinct processes of analysis involved in grounded theory, 1) open coding, 2) axial coding and 3) selective coding. These processes can be overlapping in analysis activities.

1) In GT, the process of categorising the data is called 'open coding'. Open coding is the process of scrutinizing, examination, comparing and conceptualising data. Open coding tries to establish concepts, relevant categories and their properties in raw data. For example, the codes of the diaries data in this phase could be 'trust in a bank', and 'fear of security risks'.

2) The process to investigate the relationship between categories is called ‘axial coding’. Axial coding is most often used when categories are in an advanced stage of development. Axial coding is the process of relating categories and their properties to each other, via a combination of inductive and deductive thinking. Grounded theorists are trying to identify and emphasize causal relationships, and fit observations into a basic frame of generic relationships.

Table 4.1 Axial coding features, adapted from Strauss & Corbin (1990).

Element	Description
Phenomenon	The central idea, even, happening towards which a set of action or interactions is directed. In grounded theory it is sometimes the outcome of interest, or it can be the subject.
Causal conditions	The events or incidents that lead to the occurrence or development of a phenomenon.
Context	Represents a set of properties that pertains to a phenomenon. A set of conditions influencing the action or strategy.
Intervening conditions	The broad and general conditions bearing upon action/interaction strategies. These conditions include: time, space, culture, economic status, career, history, and individual biography, etc.
Action strategies	The purposeful, goal-oriented activities that are performed in response to the phenomenon and conditions.
Consequences	Outcomes or results of action and interaction, intended and unintended.

In the process of analysis the memo system proposed by Strauss and Corbin was used: “Writing theoretical memos is an integral part of doing grounded theory. Since the analyst cannot readily keep track of all the categories, properties, hypotheses, and generative questions that evolve from the analytical process, there must be a system for doing so. The use of memos constitutes such a system. Memos are not simply ‘ideas’, They are involved in the formulation and revision of theory during the research process”, (Corbin & Strauss, 1990, p. 10).

3) Selective coding is used to identify one central category, or ‘core category’ that correlates to all other categories in the theory. The process continues by relating all other categories to the core category, validating these relationships, and filling in categories that needed further refinement and development. The core category is the central category around all the other categories are integrated. “The core category must be the sun, standing in orderly systematic relationships to its planets”, (Strauss & Corbin, 1990). There is a belief that such a core category always exists. The essential idea is to develop a single storyline to form the initial theoretical framework. The storyline de-

scribes the core category, and relationships of other categories to it. Selective coding is about finding the driver of the story. Theory is then based on the storyline and is its expression. For example, for the story line explaining how users develop trust for EPSs, ‘Trust development’ can be selected as the core category, while “Risk management” and ‘Privacy Management’ categories would be related to it.

Analysis of the diary study

In the analysis of this study open coding and axial coding stages were performed by the researcher. Open coding has identified basic categories. The set of the categories was open, and not predefined according to a preconceived theory. Axial coding has linked categories together, established subcategories and proposed explanation of users behaviour when using the systems.

The codes based on the diary entries reported by the participants were grouped into categories by the researcher. During the analysis the codes and then, consequently, the categories were written on paper cards and arranged in groups in the categorisation process. In the axial coding phase memos of relationships between the categories were written. A memo is an inductive step in generating theory from axial coding. An example of a memo is presented in Box 4.1.

Taking into account these findings, generic problem descriptions were identified and solutions were proposed on the basis of users opinions, positive findings of the study, practices of existing payment and e-commerce systems, causal relationships, or practices of human-computer interaction. For example, the users reported that they are inclined to use the payment systems with more confidence when they pay on behalf of their employing organisation or company. The conclusion can be drawn that fostering trust becomes more important for a system supporting personal payments.

Memo: Risks Management strategies

Users use several diverse strategies to alleviate risks, i.e. to convince themselves the risks are not likely to harm them. Risks Management is therefore a collection of strategies the users are employing to achieve comfort and accept the systems. (The strategies for Risks Management can be used for Trust Development and are important for user acceptance).

These strategies include reliance on:

- Absence of own negative experiences.
- Absence of negative experiences by others.
- The fact that there is little money on the bank account: risks are low and would not be financially damaging.
- The system is run by the bank (or an organisation), which they trust.
- Professionalism of the bank.
- A conversation with a bank employee who has assured it is safe.
- Guarantee from the operator that the money is safe with the system.
- Information in the booklet explaining the benefits of the EPS.
- The fact that the bank has won a prize for electronic banking services.
- Good previous client relationships with the bank.
- The EPS is safe — has never failed the user.
- Trust that the bank will make corrections and return money in case of an error. The system (and what happens with money within it) is the bank's responsibility.
- Users are not worried about what may happen.
- Reliance on mass media, which treat the system as a safe one.
- Nothing can go wrong with the bank, default in the banking system won't happen in our country.
- The bank would supply the system only if it were safe, and would not otherwise. Trust in safety measures: no one has broken in the system yet.

Box 4.1 Example of a memo on risk management.

Table 4.2 illustrates a snapshot of the analysis process. The right column describes the concepts found in the data, the left column represents categories of the identified problems. For example the finding coded as 'The user did not want to disclose her email address, because she was afraid they'll spam her' was related to problem category 'Absence of a policy on privacy can undermine trust in the system' with subcategory 'Lack of clarity or explanation how the personal details are used', Table 4.2. This problem could be related to problem 'Users may not trust the system that does not provide explanation on how personal details are used and why they are necessary, fearing misuse'. The problem categories were attempted to be related to wider concepts or characteristics of EPSs, as indicated by the letters in the beginning of a prob-

lem category. For example, ‘TP’ means that this problem relates to trust and privacy issues, and ‘U’ indicates a usability category.

The GT analysis looked into strategies, actions, thinking and reasoning behind user actions and behaviour, and tried to establish how they can be used to formulate solutions to the problems and to take into account the positive findings. In this respect, the solutions that inform design are grounded in the data and would fit the user behaviour and needs. These solutions were meant to be evaluated in the consequent validation experiment.

While this study employed GT for analysis, this methodology was not applied fully. GT was used to categorise problems and positive findings, and generate explanations about user attitudes, behaviour and experiences. GT in this respect was used as a structured approach for analysis of the raw data, which produced results that can be used in future analysis. This use of GT that stops at the concept generation is consistent with (Strauss & Corbin, 1990) who suggest that application of GT can stop at the stage of axial coding. It is not required that a theory should be the final output of the research if the concept development or theme analysis is enough for the further use of results.

More thorough application of GT would use parallel and iterative data collection. This study used one iteration in the collection of the qualitative data via the diary study. However, the initial analysis has started after the first diaries were finished and therefore the researcher was able to highlight and explore interesting points in the interviews.

The actual details of the analysis are too detailed and uninformative to be presented verbatim in the thesis. The analysis of more than 90 pages of the diaries and interview notes has discovered about 100 open codes and categories, and produced more than 80 memos. The analysis has produced a substantial amount of output, not all of which was relevant to the scope of this research.

Table 4.2 Example of the snapshot of axial coding with relationships identified in the data.
 Legend. Codes of problem categories: TP – trust privacy, U – usability.

Problem categories	Information from the diaries and interviews
TP1. Unexpected or unexplained use of privacy data destroys trusts.	Banks are not supposed to draw conclusions from the information they know based on the client relationships
TP 2. Users may not trust the system that does not provide explanation on how personal details are used and why they are necessary, fearing misuse	
U2. Unnatural and not intuitive interaction process lowers performance and usability.	Acceptgiro, [a standard paper based transfer form] can be filled electronically. The system asks information not in the same order as the original paper version. E.g. users have to enter a code, which they normally are not aware of. >The user could not still get used to it after several months of payments.
U7. Low ease of use on the long term lowers performance (and make people long for an alternative)	Design of hardware should be better: the buttons on the code calculator are too small, hard to press and fingers hurt
U8. Too 'strong' measures to ensure security, reliability, or anonymity may lower usability and performance	
TP 4. Absence of a policy on privacy can undermine trust in the system + Lack of clarity or explanation how the details are used	The user did not like the question about her nationality, fearing some unexpected or harmful use.
U8. Too 'strong' measures to ensure security, reliability, or anonymity may lower ease of use and performance	The user did not want to give email, because is afraid they'll spam her.
New U9. Poor design of dedicated hardware may hamper usability and lower user acceptance	Use of the code calculator <ul style="list-style-type: none"> ◦ makes authentication more difficult (you have to have the calculator and carry it with you) ◦ is annoying, because you have to press small buttons ◦ is annoying, because you have to fill in several codes to make payments ◦ not ergonomic design BUT Users understand importance of authentication and are willing to use it.
TP 4. Absence of a policy on privacy can undermine trust in the system	Feeling of safety is based on: <ul style="list-style-type: none"> ◦ Information in the booklet ◦ Absence of an own negative experience ◦ Absence of negative experiences of others ◦ The fact that there is little money on the bank account: risks are low and would not be financially damaging.

Automatisation features:

- Enable saving of incomplete payments to be completed at a later date.
- Provide the functionality of triggering payments by time or event (e.g. email, SMS message, etc.)
- Provide the functionality of paying for subscriptions for content or services.
- Provide the functionality of scheduled or recurrent payments to be executed on a given date over a certain period of time.
- Provide the ability to make group payments to several parties at once.

Personalisation:

- Provide the functionality of: address books, profiling, retaining session information to avoid frequent re-logins, and saving users' preferences, that are helpful for efficiency of payments tasks.
- Provide support for currency conversion and different languages.
- Provide the functionality of: multiple logins, restricted access for employees or family members.

Control over the payment process and information

- Provide means to easily modify and control personal data, to recover passwords, or alternative authentication systems (e.g. biometrics, code calculators).
- Provide easy access to transaction statements to make control over transition easier and to help to detect problems.
- Provide clear and visible feedback on all payment task and actions.
- Provide possibility of error recovery, e.g. the ability to roll back to the default configuration of the system, or discard all information for a payment order.

Interaction and interface

- The duration of the payment procedure should be in proportion with the duration of the pre-purchase interaction phase, (see section 1.4.1), e.g., a fast purchase should not require a long payment.
- Avoid changes in the logic of interaction over time.
- Avoid frequent changes of user interface.

Privacy, security and help

- Provide clear and extensive help on critical questions such as fraud, security, insurance of funds, handling of personal information.
- Provide with explanations why the system is secure.
- Provide a clear privacy policy.
- User should have a minimal need in reliance on documentation (help, manuals).

Box 4.2 Subset of the proposals for design of EPSs.

The following section illustrates the findings of the analysis. The solutions for design of EPSs were identified on the basis of the data analysis. Following the practice of GT a theoretical memo with implications for payment systems was composed separately. The summary of certain findings is presented in Box 4.2.

Based on the way the diary study was conducted it can be concluded that it has discovered a sufficient number of problems and positive findings, that are comprehensive in their coverage, and therefore are a good basis of design recommendations. In the next stage of the analysis, the results were taken as an input to formulate design recommendations.

Summary of the results

This section renders interesting examples from the diary study in a concise form. The discovered problems and positive findings are grouped into corresponding categories.

Problems

- Users complained about usability aspects of the payment systems, especially with regard to the registration process. Certain security measures reported (long passwords, security questions, 1-hour long registration/installation process, entering multiple security codes) were perceived as “excessive” and “annoying”, and even prevented two participants from completing the registration.
- Inconsistency of online forms in comparison with the previous experience of the users (e.g., different order of filling of information compared to the paper form) was a problem. One payer could not get used to the electronic payment form, even after already using it for several months.
- Users were worried that third parties can get access to their personal information or their money (though this does not deter them from using the system). Others felt that their money is safe, but the personal information is not, and can be revealed to third parties in one way or another.
- Two participants who used PayPal trusted it very little. Their initial impression was that it is hard to trust PayPal, because of possible security risks.
- One user did not like to reveal her nationality and email; she felt the questions threaten her privacy.

Positive findings

- The expert payers found that Internet-based payment of bills, which would normally be paid by post, “saves time and brings convenience”.
- Paying the exact amounts electronically was considered easier than in cash, because no change or exact amount of cash money is required.
- Preparing payments in a ‘batch’ and paying them later was convenient from the efficiency viewpoint, as well as for the user connecting to the Internet via a modem.
- The “address book” function for saving account details of payees was found convenient for repetitive payments, because it makes “it easier to fill in details of [frequent] payees”.
- The integrated reporting system allowed easy overview for payment activities over time.
- Scheduled payments were welcomed as they give more control and flexibility over payments activities and improve efficiency. Executing payments on the previously set time was considered to be convenient.
- Participants trusted the banking payment systems because they relied on the bank behind the system and its ability to solve problems.

Design recommendations

The diary study has identified 36 problems that users experienced with online EPSs that could undermine user acceptance of these systems. The study has discovered also positive findings of users’ experience with the systems. Implications for the design were, in some cases, directly recommended by the participants. A number of proposals that can inform EPSs design were outlined, Box 4.2. Taking this output to inform interaction design a set of 12 *design recommendations* (DR) has been defined.

The DRs were formulated based on the information originating mainly from the diary study as well as based on the knowledge obtained in earlier research of this thesis. To develop the design recommendations the data from the diary study, user survey and literature sources was grouped, analysed, and the prescriptive design recommendations were hypothesised based on this input. The design recommendations attempted to incorporate solutions to the problems discovered in the study, have taken into account positive findings of the diary study, and embraced the strategies that users employed in the interaction with the systems.

Each of these guidelines was written in an expanded form, adapting the templates used by Smith & Mosier (1986) and ISO 9241 (1996) for presenting user interface design guidelines. A design recommendation has a high level definition and detailed description that tries to embrace possible situations and propose related solutions. The short high-level definition of a guideline is shown as a header, typed in boldface. The detailed description, intended to specify and operationalise a guideline, is presented as bulleted points. The type of the design recommendation describes the relation of a DR to the characteristics of trust, privacy and usability, while general problem depicts what issues this DR is addressing. A design recommendation concludes with comments by an expert in development of new electronic payment systems and payment product at the Dutch bank Postbank.

An example of design recommendation 1 on security policy is presented in Box 4.3. The detailed description of all design recommendations is given in Appendix D. Below the design recommendations are presented in a concise form.

- DR 1. Inform users about security measures and provide a security policy.
- DR 2. Explain what type and details of personal information are to be retained, why, and how they will be used.
- DR 3. Provide clear and explicit policy on privacy and make it noticeable to users.
- DR 4. Give users control over the costs of the payment system usage.
- DR 5. Allow users to control critical actions and information.
- DR 6. Seek reputation and trust transference from reputed partners and technology providers, and communicate trust transference to users.
- DR 7. Take measures to address risks and inform users about these measures.
- DR 8. Interaction with the payment system should resemble users' expectations about the payments process.
- DR 9. The interfaces should be presented in a logical, clear and understandable way.
- DR 10. Provide features of automatisations of payments.
- DR 11. Provide features of customization of payment environments.
- DR 12. Provide well-designed authentication.

Till today, no such set of guidelines has been published for e-commerce EPSs. However, there is a clear overlap with general guidelines for the design of e-commerce web sites. For instance, a Nielsen-Norman Group (NN/g) report on e-commerce user experience suggests similar guidelines on privacy, costs and trust transference, (Nielsen, et al., 2000). Their guidelines “Build on the trust customers have for existing merchants and brands” and “Link to reputable independent sources” overlap with DR 6 on trust transference. Guidelines on Fair Pricing, “Show total cost, as soon as possible”, and “Justify prices that appear odd”, partially overlap with DR 4 on control over the costs of the EPS’ use.

The guidelines defined in the NN/g report are widely applied as state of the art practices for the design of e-commerce web sites. Still, the design recommendations developed in this research discover additional aspects and attempt to resolve issues, not covered by the NN/g report. For example, DR 5, 7, 8, 10, 11, 12, are novel and very specific in covering the design of online EPSs. Therefore, these design recommendations would be a highly valuable and concrete contribution to the field, if their validity can be demonstrated.

4.4 Conclusions

The diary study has recorded several usage problems and positive findings of end users, based on their experience with actual payments and in the context of actual use. This study was more concerned with actual design details that influence perceived ease of use, usability, privacy, trust and the eventual decision to use the system, rather than attitudinal variables affecting consumer behaviour, which were captured by user survey, reported in Chapter 3.

On the other hand, this study was able to elaborate more on social influences. The diary study has provided for this thesis a view of payments in the context of actual use and captured relevant user experiences and opinions. The study has uncovered positive aspects that users liked in the systems and what they thought can be improved. In certain cases, the users took the initiative in suggesting solutions for the problems they encountered. The diary study has found explanations about how and base on what reasons people develop their attitudes towards online EPSs. While many of the experiences recorded by the users could have been anticipated, this study is a valuable con-

tribution, also because a diary study of the user experience of EPS has not been reported before.

DR 1. Inform users about security measures and provide a security policy.

- Security policy: the existence and strength of security measures used in the payment system to protect users should be clearly explained to the users. This can be done by providing information in e.g. a paper manual, online help, or dedicating a part of the web site to the security policy.
- Provide clear visibility of security measures employed. This can be done by describing which security measures and technology have been implemented.
- Explain why the system is secure for transactions.
- Provide customer support (online or telephone) on security-related issues.
- Supply regular information updates on changes and upgrades in security and the security policy; show the date of the latest update.
- Address security issues specific to 1) a single payment (e.g. communicate to the users security of transactions), and to 2) the system's operations in general, (e.g. provide ability to deactivate passwords or block accounts offline by phone).
- If using services or technology from reputed security institutions or companies, inform the users about this cooperation, e.g. demonstrate security seals or logos of the security organisations.
- Explain which security measures are employed for information management and storage, provided that such information will not compromise security.
- Do not try to cheat hackers by providing wrong and misleading information. Hackers will know the real situation via different means, however the potential harm of misinforming the users may be inestimable for the reputation.

Example: Global Collect provides textual information in a dedicated help section describing which security solutions and measures have been implemented. It explains why the system is secure for transactions.

Since RSA 155 is cracked, does this compromise Global Collect's security
For Internet consumer payment transactions, we have low risk profile. Since the average transaction in our systems is in the order of tens of Euro's, the efforts required to crack the encryption are too high compared to the possible gain.

Source: Global Collect, July 2002.

Expert comments

The comments below belong to the expert consultant of the Postbank Department of New Business Technology:

'This design recommendation is testable by showing two different product brochures or websites (from accepting merchants).

In our test we have used:

- Our trusted brand,
- Brochure with information,
- No [security] signs, logos.'

Box 4.3 Structured description of the DR 1 on security policy "Inform users about security measures and provide a security policy".

Implications for the design of Internet-based payment systems have been established. It has to be noted that only account-based systems were investigated in the diary study, but the results of the analysis can be possibly applied for other types of EPSs. The approach to the data analysis was systematic, based on the application of GT. It has resulted in a set of recommendations for design of EPSs, which are grounded in the data collected in this phase of the research.

The design recommendations at this point are hypothesised and their validity and applicability cannot be generalised outside the set of data used for the GT analysis. Based on the triangulation of research approaches taken by this thesis, the design knowledge should be validated from another research approach. Therefore, the design recommendations have to be validated in the subsequent experimental study before proposing their application for design of EPSs.

Chapter 5

Validating the Design Recommendations

5.1 Introduction

To verify the claim that the proposed design recommendations can actually benefit user acceptance of e-commerce electronic payment systems, a validation experiment was conducted. In this validation study the design recommendations were first applied to a redesign of an existing payment system, the Postbank Betaallijn (the Postbank Payment Line), and then an experiment was carried out to compare the old version and the redesigned version of the system.

5.1.1 Expert review of the design recommendations

In order to validate the design recommendations it is necessary to see if they can be applied to design or redesign of e-commerce EPSs, and if this will have an improving impact on how users perceive EPSs and on their subsequent acceptance.

An important requirement for design guidelines is that experts, who will apply them to design of payment systems, should be able to understand and apply them as a part of

their established design practice. Because it was difficult to consult experts in payment systems design, it was only possible to get the opinion of one practitioner in EPS design. This expert was asked to comment about applicability of the design recommendations.

This expert was a consultant at the Department of New Business Technology at the Dutch bank Postbank, responsible for the development and the proof of the concept of their new payment system ‘the Postbank Betaallijn’ designed to facilitate Internet and telephone-order payments. This expert tried to recognize the way in which the current implementation of the Postbank Betaallijn complies with the design recommendations and how they can be applied with the current version of the Betaallijn (see section 5.1.4 for the detailed explanation of the system). Since the reaction of only one expert was obtained, the agreement of other experts cannot be safely assumed. However, this opinion is presented along with the design recommendations, because the opinion of potential users of the DRs is valuable to qualify them. The experts’ comments are included in the detailed account on the design recommendations in Appendix D.

The expert discovered that it was possible to evaluate most of the design recommendations with their system. The expert concluded that recommendations DR 1, DR 4, DR 5, DR 6, DR 7, DR 8, DR 9, and DR 11 (see Appendix D) were applicable and the system already complied with the recommendations in one way or another.

DR2 and DR3 on personal information and privacy policy were considered to be applicable, but the Betaallijn did not comply with the recommendations, because the information on privacy was not provided in the system at the test stage. The possibility of the evaluation of DR 12 on authentication with the Betaallijn was questioned by the expert, who suggested that their password policy was already an established “model used for years”. The correctness of DR 12 itself was not doubted.

According to the expert, the automatisations of payments, and therefore DR 10, was out of the intended scope of the Postbank Betaallijn, and is rather related to the domain of electronic banking, than to EPSs. The diary study has nevertheless demonstrated that automatisations may be beneficial to users of EPSs, therefore this recommendation was not excluded from the further validation.

5.1.2 Method

The following method was chosen to validate the 12 design recommendations:

- An existing payment system was evaluated against the set of the hypothesised DRs. This system was the Postbank Betaallijn; the version the Betaallijn before the redesign described below in section 5.1.4.
- A number of changes were proposed to be made to the system where it fails to meet the DRs of Appendix D, or does not meet them at the appropriate level. A new version of the system was created, implementing the relevant changes.
- Experimental tasks, that would let users experience and form an opinion about those aspects of the system that are affected by the DRs, were devised; see section 5.2.4 for more information about the experimental tasks.
- A questionnaire for measuring user attitudes was developed.
- Pilot testing, which included performing all tasks by 3 pilot subjects, was carried out in order to correct errors, and refine the test environment. The pilot tests were run on the final experimental design and the questionnaire. The setting was improved accordingly.
- The validation experiments were performed.
- The two versions of the EPS were compared along user attitudes, measured by means of the questionnaire. The differences between the systems were analysed statistically.

5.1.3 Hypothesis

The main hypothesis suggests that there will be a difference in users' attitudes towards the two versions of the system, which are caused by the design recommendations.

- H₁ The application of the DRs significantly influences users' attitudes towards the redesigned system.
- H₀ There is no effect of the application of the DRs, and no difference between user attitudes towards the systems.

User attitudes were measured by means of a questionnaire. See Appendix E for the detailed description of the questionnaire used in the experiment.

5.1.4 The system under test

The experiment was built on the basis of an EPS product called 'Payphone', developed by the Dutch company Comsys BV. The purpose of Comsys is to sell the payment system to banks. The payment system was adapted by Postbank, one of the top 5 Dutch banks, which was interested in the potential introduction of the payment system to its clients, branding it with the Postbank name. The adapted system was named 'De Postbank Betaallijn', (the Postbank Payment Line). Comsys and Postbank were interested in discovering the potential level of success of the system among users. At the moment the researcher contacted the company and Postbank, the payment system had finished the first trial of the concept among Postbank clients, which was a test of functionality, rather than a usability evaluation. By the time this study was conducted the Betaallijn system had not undergone rigorous user testing. Therefore the experiment provided a good opportunity for the parties to test the system against real users. The Postbank Betaallijn can be used for Internet and call center payments, in this thesis the focus was on Internet payments. In the remainder of this thesis, the initial version of the system is called 'Old system', and the redesigned version is called 'New system'.

After initiating payment orders on a merchant's web site, users interact with the system and authorise payments via telephone. From the user viewpoint, the system consists of two parts, the Payphone Betaallijn and the Postbank Betaallijn. When making telephone calls, the users are first connected to the Payphone part of the system, where they can manage and confirm their orders. After the initial confirmation, the users are connected, within the same telephone call, to the Postbank's part of the system where they can actually authorise payments.

The generic process of purchasing on the Internet with the Betaalijn works as following:

- After a customer has selected products to buy at an online shopping web site, he enters his own telephone number at the 'checkout' of the merchant's web site, which is an online form where the order and payment details are entered, and gives a confirmation to pay the products by submitting the form to the merchant's web site, (e.g. pressed button 'confirm payment').
- Then the customer dials the Betaalijn using the same telephone number he entered at the web site. The customer is greeted by the Payphone's part of the system.
- The customer's telephone number is recognised by the system and the matching amount(s) of the purchases made at the web site is played back to the customer.
- The customer interacts with the payment system via a fully automated Interactive Voice Response System (IVR). The customer selects options on a voice menu by pressing buttons on the phone, corresponding to the menu options.
- After a confirmation of the order, the customer is put through to the Postbank's part of system where he or she enters his/her account number at Postbank and the password of the Betaalijn system, and gives authorisation to actually make the payment.
- If the payment is done successfully, the confirmation about the payment is played back to the customer, describing the details of the effected payment.

Suppose a user wants to order a wall poster for €14.95 from web site Posters.nl. The user proceeds to the checkout, enters his or her fixed or mobile telephone number on the web site (e.g. 0401234567), confirms the payment and calls the Betaalijn number (0201234567) from the telephone, corresponding to the telephone number he or she has entered on the web site, (0401234567). The user will be connected to the first part of the dialog system, Payphone IVR (Interactive Voice Response System).

The dialog for one payment using the old system version as it was before the application of the design recommendations would look like the following:

Legend (V: Voice menu playback, A: User action).

V: Welcome to the Payphone Betaallijn system for the payment of your order.

We have an order for you for the amount of 14 euros 95 cents from Posters.nl.

To pay press 1, to repeat press 4, to cancel press 9.

A: By pressing 1 the user is connected to the Postbank Betaallijn IVR.

V: One moment please, we are transferring you to the Postbank Betaallijn.

Welcome to the Postbank Betaallijn.

Please enter your Postbank account number.

A: The user enters the account number.

V: Enter your PIN code.

A: The user enters the PIN code.

V: For the payment of the amount of 14 euros 95 cents to Posters.nl press 1, to cancel the payment press 9.

A: The user presses 1.

V: After your confirmation the payment will be immediately processed and transferred to Posters.nl. To authorise the payment of the amount of 14 euros 95 cents to Posters.nl press 1, to cancel the payment press 9.

A: The user presses 1.

V: Your payment is being processed, one moment please.

<Beep> Your payment has been processed successfully. Thank you for your payment.

(The user is transferred back to the first voice menu system of the Payphone Betaallijn).

V: Welcome back to Payphone Betaallijn system. Your payment has been received, thank you for your payment. There are no more orders for you. The connection will now be broken.

A: At this point the user hangs up.

The web shop receives the confirmation of the payment from Postbank and ships the goods. The amount is immediately deducted from the user's Postbank account.

According to the classification of EPSs, presented in Chapter 2 the Betaallijn system is an account-based debit system. The system has low anonymity, because all transactions are recorded in the user's bank account. The authorisation type is online and centralised. Interoperability of the system is assessed as low, because it is not likely that Postbank would allow other banks or parties to join the Betaallijn system. The values of the other characteristics of the Betaallijn system, such as trust or privacy, were not known at the time of the study and had to be investigated.

5.1.5 Changes made to the Postbank Betaallijn based on the DRs

The Postbank Betaallijn payment system was evaluated against the set of design recommendations, described in Appendix D. Changes that are applicable to this system and to the context of its use, were proposed. Subsequently, the relevant changes were effected into a new version of the system. This means that the validation experiment was restricted to the corresponding design recommendations. Below it is examined how the design recommendations were implemented in the redesigned system. Table 5.1 describes the differences between the systems after the design recommendations were applied.

DR1. Inform users about security measures and provide a security policy; and DR7. Take measures to address risks and inform users about these measures.

A security policy was introduced in the New system.

DR2. Explain what type and details of personal information are to be retained, why and how they will be used.

The privacy policy in the New system explained how personal details will be used.

DR3. Provide a clear and explicit policy on privacy and make it noticeable to users.

An extended privacy policy was introduced in the New system. Links to the privacy policy were added to the payment web pages in the New system.

DR4. Give users control over the costs of the payment system usage.

The users of the New system were informed by the system that they are calling a free number when connecting to the Betaallijn. Since the users of the Old system were call-

ing the Betaalijn from the laboratory telephone, they were informed by the system that they were calling a paid number, and were told by the experimenter in advance that the connection costs would be deducted from their participation fee, to stimulate thinking of the number as a paid one and to make them as cost-sensitive as for real-life payments (actually, no costs were deducted after the experiment).

DR5. Allow users to control critical actions and information.

The ability to block the passwords via the IVR menu was introduced in the New system.

DR6. Seek reputation and trust transference from reputed partners and technology providers, and communicate trust transference to users.

The logotype of Postbank was exposed on the web site for the New system.

DR8. Interaction with the payment system should resemble users' expectations about the payments process.

This design recommendation presumes that the interaction process could be rendered in a familiar way to users. From this respect the Betaalijn is similar to the existing telephone banking system of Postbank. It was hoped that the above-mentioned changes introduced by the DRs would result in a better interaction design and usability of the redesigned system. In case the system would not be intuitively understood by the users, the more detailed explanation of how the system operates was introduced for the New system in online help and the paper brochure.

DR10. Provide features of automatisisation of payments.

The functionality of multiple (batch) payments was implemented, i.e. ability to make several payments with one authorization. The functionality of scheduled payments was implemented, i.e. ability to set the date for the payments execution.

DR12. Provide well-designed authentication.

The password length was changed: the PIN code for authorisation was reduced to 4 digits in the New system. The authentication process was augmented: the number of confirmations of a payment was reduced from 3 to 2 steps in the New system.

Table 5.1 Changes made to the system, the corresponding design recommendations, and the tasks designed to test the changes, (see tasks in section 5.2.4 below).

DRs	Old system	New system	Task
DR 1, DR 7. Security policy	Absent/ or minimal	Added / Present	Tasks 1-5
DR 2. Links to the privacy policy on payment screens at the merchant shop	Absent	Made salient on the payment page	Tasks 1-5
DR 3. Privacy policy	Standard Postbank style	Made more salient at Postbank web site	Tasks 1
DR 4. Costs	Paid number notification	Free number notification	Tasks 3, 5
DR 5. Blocking passwords	Via customer service only	Blocking passwords via the system	Task 2
DR 6. Logos	No (Postbank) logos at the payment page	Postbank logos are present at the payment page	Tasks 1-5
DR 8. Help means	Standard	Enhanced with information about security, blocking passwords, etc.	Tasks 1-5
DR 8. Interaction design	Standard	Enhanced by the DRs	Tasks 1-5
DR 10. Batch payments	No	Yes	Task 5
DR 10. Scheduled payments	No	Yes	Task 3
DR 12. Password length	6	4	Tasks 1-5
DR 12. Authentication	Standard: 3 steps	2 steps (1 step less)	Tasks 1-5

5.1.6 Subjects

The 46 subjects were recruited by the Postbank call center among the banks’ clients who are familiar with Postbank’s existing payment systems (e.g. Girofoon, Girotel; see Postbank.nl for more information). 25 subjects used the Old, and 21 used the New system. All participants had a good understanding of English. The summary of the demographic data collected through a pre-test questionnaire is listed in Table 5.2. In general, this sample is quite balanced to represent the most users’ groups of interest well.

Table 5.2 Profiling of the participants of the study

Demographic parameter	Dimensions	System Version	
		Old	New
Age	<30	8	9
	31-50	11	10
	>50	6	2
Gender	Female	11	5
	Male	14	16
Internet payment systems experience	No	14	14
	Yes	11	7
Credit cards on the Internet	No	14	11
	Yes	10	9
Yearly income (€)	< 26 000	9	8
	27 000 - 36 000	5	2
	> 36 000	7	6
Computer experience	Low	2	0
	Moderate Low	5	3
	Moderately High	11	10
	High	7	7

The participants were divided in two groups based on the demographic criteria, although it was not always possible to ensure that the groups are completely balanced, due to scheduling constraints of the participants. The groups were checked on a demographic bias. Based on the statistical analysis of the comparison of the two groups, no significant difference for any of the six demographic criteria was found, see Table 5.3. It can be assumed that the samples are properly balanced along the demographic factors and experience with payment systems.

Table 5.3 Chi-Square Tests of the data sample

Demographic parameter	N	CHI ²	df	p
Age	46	1.772	2	.41 ns
Gender	46	2.051	1	.15 ns
Internet payment system experience	46	.545	1	.46 ns
Credit cards on the Internet	44	.049	1	.82 ns
Yearly income (€)	37	.760	2	.68 ns
Computer experience	45	2.017	3	.56 ns

5.2 Experimental setup

5.2.1 Overview

To simulate the online shopping experience, a working prototype of the website of an actual business that sells wall posters was created. The participants were requested to use the Betaalijn to purchase goods on this site. In order to bring realism to the experimental tasks it was not mentioned that the test web site is just a copy of the real one. The subjects were using a test Postbank account, and no money transfer was effected in reality, but this fact was not mentioned to the participants. All transactions were realistic in that they were experienced exactly as they would be during the actual use of the system in reality. The tests were conducted at the usability laboratory of the Eindhoven University of Technology (TU/e). The author of the thesis acted as an experimenter, i.e. facilitating the process, receiving subjects, introducing the system and the tasks, and keeping observation notes. During the tasks he was seated behind a one-way mirror.

The subjects were asked to find the best way for them to do the tasks. They were advised to use the paper brochure that was given to them, and online help, if necessary, but they were not obliged to do so. After each task they were required to fill in a questionnaire that assessed their attitudes towards the system, see Appendix E. When finished, the subjects were interviewed about their experience and were able to comment freely about the system. In the end they were given the full participation fee.

It took subjects from 56 to 140 minutes to complete the tasks. Subjects' interactions with the system were video-recorded. The videos were used as a back up and reference to the notes taken.

5.2.2 Dependent and independent variables

Dependent variables are measures of subjects' attitudes regarding the following system's aspects: batch payments, scheduled payments, password length, authentication, help means, security policy, blocking passwords, privacy policy, costs, usefulness, usability, trust, etc. The system version and the tasks are the *independent variables*.

Users' attitudes and opinions about aspects of the payment system under test were measured by means of a questionnaire, Appendix E. The questionnaire was designed to evaluate user attitudes to those aspects that were changed according to the design recommendations. Answers to the questions were measured by semantic differentials scales. Questions that can be interpreted as bipolar had scales ranging from -3 to $+3$; monopolar questions had scales from 1 to 7. The questions assessing usability of the system are a subset of SUS questionnaire, (Brooke, 1996); questions on perceived usefulness and perceived ease of use were adapted from Davis (1989). These questionnaires are validated tools that have been shown to be reliable, and are widely used, (Perlman, 2000). In addition, they are both quite short and generic which helped to create a concise questionnaire.

5.2.3 Experimental design

In this experiment there were a number of dependent measurements repeated for each task. The task is the independent within-subjects factor. The system version is the independent between subjects factor. The mixed experimental design can be described as $A \times (B)$; where A is the system version and B is the task factor. It is a 2×5 design, where the repeated factor has five levels, according to the 5 specified tasks, (Maxwell & Delaney, 2000).

- 1) System version (Two levels: Old version, New version)
- 2) Repeated measurements (Five levels: Task1, Task2, Task3, Task4, Task5).

To analyse the differences between the two systems, a general linear model analysis of ANOVA for repeated measures was performed with SPSS version 11.0. In this experiment there were a number of dependent measures taken only after certain tasks. They were used to gauge user attitudes to the systems' aspects specific to a particular task. For these measures, a one-way ANOVA was conducted, with only the system version as the independent variable.

5.2.4 Tasks

The subjects were provided with a 10-minute introduction to the system. They were told that Betaallijn is a payment system for Internet payments designed by Postbank and that the system gives the ability to pay online via a bank account of Postbank. The subjects were informed that the study would like to find out their attitudes, opinions, impressions and feelings about the Betaallijn.

The subjects had to perform five different tasks with the payment system. The reason that only 5 tasks were chosen for evaluation of 12 DRs is that certain systems aspects, (e.g. privacy, trust) are better evaluated in the contexts, rather than in a dedicated task, to avoid threats to ecological validity.

Task 1. Paying at a web site. Please browse Posters.nl web site, select and pay for an item you would like to purchase.

Task 2. Suppose you suspect that the PIN-code (payment code) of your account is stolen. Please find the best way to block your payment code, so that no one else can use it anymore.

Task 3. Suppose you have to pay rent for your house for a certain period of time. Please find the best way to arrange paying rent of €100 every month for 2 months (e.g. April and May). The rent has to be paid on the first day of the month, and should not be paid in one payment.

Task 4. Suppose that the PIN-code of your account is blocked and you would like to reactivate it. Please find out what would be the best way to reactivate the account.

Note. The users were asked only to find out how to do the task, since the reactivation of the account would require a physical or postal communication with the customer service, which could not be simulated.

Task 5. Suppose that you have to make 3-4 payments. Please go to *Posters.nl* web site, and select 3-4 items to purchase. Pay for these items in a way you think is the most efficient and fast.

Table 5.4 describes how the DRs map to the tasks and measures that are intended to test the desired effect of the DRs applied (measures are described in section 5.3).

5.2.5 Procedure

During the introduction a couple of examples were given to illustrate how the Betaal-lijn works. The participants were told how to select products and make payments at the web site. They were instructed how to use the telephone.

The participants were given a paper brochure and shown the Postbank Betaal-lijn web site describing how the system works. They could read this information if they wanted to, but were not obliged to do so. By this it was intended to simulate a real-life situation, e.g. at home, where the users would refer to help only in case of problems.

The participants were given the tasks and questionnaires in the paper form and were instructed to fill the questionnaire after every task. The subjects were told that they could ask a question whenever they did not know how to proceed, however, they were encouraged to find a solution on their own first. The experimenter communicated with the participants from the control room via an intercom system whenever it was necessary, this setup minimised possible influence on users of the experimenter's presence in the laboratory during the experiment.

The subjects who got confused or stuck were given about 5 minutes to find a solution. Then a general high-level hint was given to them, e.g. where to look at the web site on their own, or what they could try to do the task. If this did not help, they were given a more detailed instruction on how they could solve the problem.

If the subjects attempted to start filling the questions before completing the task, e.g. not making enough or any attempts to complete the task, they were asked why they did not do the task first. If necessary, they were given a hint, and requested to finish the task.

Experimental situations

Task1

Task1 was naturally understood by the participants and they had very little problems doing it. The most common issue was typing a wrong telephone number at the web site checkout, which was not recognised by the Betaal-lijn afterwards. This was remedied by checking the number and re-entering it again.

Table 5.4 Relationships between DRs, measures and tasks

Design recommendations	Measure	Tasks
DR 1. Security policy	RM2	1-5
	SM4	4
DR 2. Personal details	RM3	1-5
DR 3. Privacy policy	SM1	1
DR 4. Costs	SM17	3
	SM18, SM19	5
DR 5. Control of critical actions and information	SM3	2
	SM15	2
DR 6. Trust transference	SM7	5
DR 7. Risks	RM1	1-5
	SM2	2
	SM16	2
DR 8. Interaction design/ Help means	RM 4, RM5, RM6-10	1-5
	SM8	5
DR 10. Batch payments	SM9-11	3
DR 10. Scheduled payments	SM12-14	5
DR 12. Authentication / Password length	SM5	5
	SM6	5
	SM20	5

Tasks 2 and 4.

During task 2, which required blocking their account password, 10 participants tried to call the customer service line to do that. They were stopped at the moment they tried to dial the number. (During the experiment there was no actual and active customer service line with Postbank for the Betaallijn). Some of the participants asked the experimenter if they have to call service line and were instructed not to do so. When users had to reactivate their password in task 4, none tried to call the service line again, as instructed.

Task 3: Paying rent.

Task 3 was unnatural for some people and they refused to do it (2 participants), saying they would not pay rent in such way. In addition, the Old system did not have the option to enter the date for the payments' execution and therefore payments could not be made on the respective dates, which could make the task awkward for some users.

Task5: Multiple payments

The New system had the functionality of batch payments where users could pay several payments by grouping them together, and then giving a single authorisation about the whole amount. Eight users chose to do it in the 'old' way, paying the orders one by one, and 3 combined the two ways of paying multiple payments, the rest used the multiple payments feature.

5.3 Results and Analysis

5.3.1 Results: Repeated measures

This section presents the most interesting results of the *repeated measures* (RMs) component of the experiment. The repeated measures are based on the users' answers to the five questions that were repeatedly asked as a part of the post-task questionnaire, thus there are 5 levels for every repeated measure. For example, the question "How do you assess your trust in the system?" was asked after each of the five tasks, to provide a standard measure of trust. Below the significant results are presented. The number of participants varies for different measures, because of the cases excluded due to missing data, where the participants opted for the 'don't know' answer.

RM1. A significant difference was observed between the systems in the *trust* measure, $F(1, 40) = 4.195, p = 0.047$. Users tend to trust the New system (mean 5.26) more than the Old one (mean 4.57). Figure 5.1 and Table 5.5 show the statistics and the chart of the results. There was a significant main effect in the within-subjects variable Task in this measure, $F(1, 4) = 3.083, p = 0.018$, which is based on a significant 4th order effect, $F(1,1) = 5.997, p = 0.019$. There was no interaction effect between the 'system version' factor and the 'tasks' factor, $F(1, 4) = 0.563, p = 0.690$.

RM2. Overall the participants felt that it is *safer to use* the New system (mean 1.52) than the Old one (mean 0.82), see Figure 5.2 and Table 5.6, and this difference is significant, $F(1, 40) = 4.293, p = 0.045$. There was a significant main effect in the within-subjects variable task in this measure, $F(1, 4) = 3.262, p = 0.023$, which is based on a significant cubic order effect, $F(1,1) = 9.54, p = 0.004$. There was no interaction effect between the 'system version' factor and the 'tasks' factor, $F(1, 4) = 0.119, p = 0.952$.

RM3. The New system scored higher in user perception about *how personal information is protected* than the Old one, (Old 4.76, New 5.42), $F(1, 35) = 4.487$, $p = 0.041$. This is illustrated by Figure 5.3 and Table 5.7. There was no significant main effect in the within-subjects factor task in this measure, $F(1, 2.38) = 1.676$, $p = 0.188$, and no interaction effect between the 'system version' factor and the 'tasks' factor, $F(1, 4) = 0.326$, $p = 0.759$.

RM4. The participants *would use* the New system more *frequently* (New 1.04 vs. Old 0.06) than the Old one, (see Figure 5.4 and Table 5.8), $F(1, 36) = 4.368$, $p = 0.044$. There also was a significant main effect in the within-subjects variable task in this measure, $F(1, 4) = 3.497$, $p = 0.023$, which is based on a significant 4th order effect, $F(1,1) = 6.913$, $p = 0.013$. There was no interaction effect between the 'system version' factor and the 'tasks' factor, $F(1, 4) = 0.574$, $p = 0.611$.

RM5. The Old system scored surprisingly higher in users' evaluation of *ease of use* than the redesigned New system (Old 2.20 vs. New 1.61, Figure 5.5 and Table 5.9), and this difference is significant $F(1, 34) = 5.353$, $p = 0.027$. There was a significant main effect in the within-subjects factor task in this measure, $F(1, 4) = 3.31$, $p = 0.013$, which is based on a significant linear effect, $F(1,1) = 5.705$, $p = 0.023$ and a significant 4th order effect $F(1,1) = 4.64$, $p = 0.038$. There was no interaction effect between the 'system version' factor and the 'tasks' factor, $F(1, 4) = 0.574$, $p = 0.611$.

For all remaining repeated measures (RM6-10), no significant between-subjects main effect in differences between the systems was found. Tables 5.10 - 5.14 and corresponding Figures 5.6 - 5.10 summarise the non-significant results of the repeated measures analysis.

RM6. *Found the system complex*. There was a significant main effect in the within-subjects factor 'task' in this measure, $F(1, 4) = 6.747$, $p = 0.0$, which is based on a significant linear effect, $F(1,1) = 11.762$, $p = 0.01$ and a significant cubic effect $F(1,1) = 6.915$, $p = 0.012$. There was no interaction effect between the 'system version' factor and the 'tasks' factor, $F(1, 4) = 0.29$, $p = 0.865$.

RM7. *System's functions are well integrated*. There was a significant main effect in the within-subjects factor 'task' in this measure, $F(1, 4) = 4.400$, $p = 0.002$, which is based on a significant linear effect, $F(1,1) = 8.540$, $p = 0.006$ and a significant 4th order

effect $F(1,1) = 6.767$, $p = 0.014$. There was no interaction effect between the 'system version' factor and the 'tasks' factor, $F(1, 4) = 0.966$, $p = 0.333$.

RM8. *Felt confident using the system.* There was a significant main effect in the within-subjects factor 'task' in this measure, $F(1, 4) = 3.575$, $p = 0.008$, which is based on a 4th order effect, $F(1,1) = 6.510$, $p = 0.015$. There was no interaction effect between the 'system version' factor and the 'tasks' factor, $F(1, 4) = 0.067$, $p = 0.796$.

RM9. *Need to learn a lot of things before using the system.* There was a significant main effect in the within-subjects factor 'task' in this measure, $F(1, 3.15) = 2.996$, $p = 0.031$, which is based on a significant linear effect, $F(1,1) = 6.986$, $p = 0.011$. There was no interaction effect between the 'system version' factor and the 'tasks' factor, $F(1, 4) = 0.966$, $p = 0.333$.

RM10. *The instructions on the web page and the paper help were useful for the task.* There was a significant main effect in the within-subjects factor 'task' in this measure, $F(1, 4) = 10.506$, $p = 0.0$, which is based on a significant linear effect, $F(1,1) = 11.692$, $p = 0.002$ and a significant 4th order effect $F(1,1) = 20.011$, $p = 0.0$. There was no interaction effect between the 'system version' factor and the 'tasks' factor, $F(1, 4) = 0.334$, $p = 0.855$.

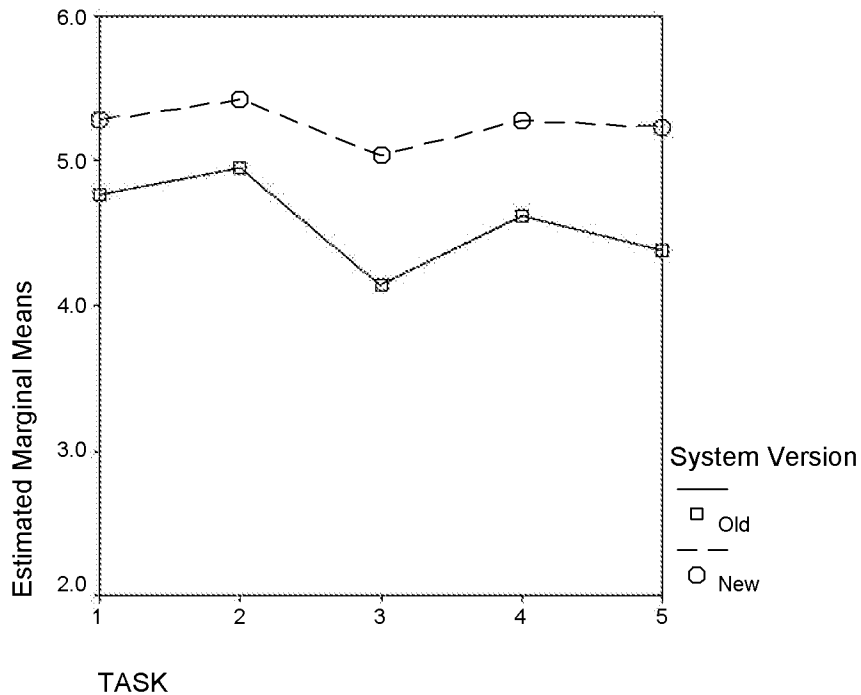

Figure 5.1 RM1. Measure 'trust in the system' (monopolar scale [1..7])

Table 5.5 RM1. Measure 'trust in the system'.

	Sum of Squares		df	Mean Square	F	Sig.
Between Groups	24.69		1	24.685	4.195	.047
Within Groups	235.37		40	5.88		

	Task1		Task2		Task3		Task4		Task5		Total	
System Version	Old	New	Old	New	Old	New	Old	New	Old	New	Old	New
Mean	4.76	5.29	4.95	5.43	4.14	5.05	4.62	5.29	4.38	5.24	4.57	5.26
Std. Dev.	1.64	.96	1.28	.81	1.82	1.24	1.28	.90	1.69	1.09		
N	21	21	21	21	21	21	21	21	21	21	21	21

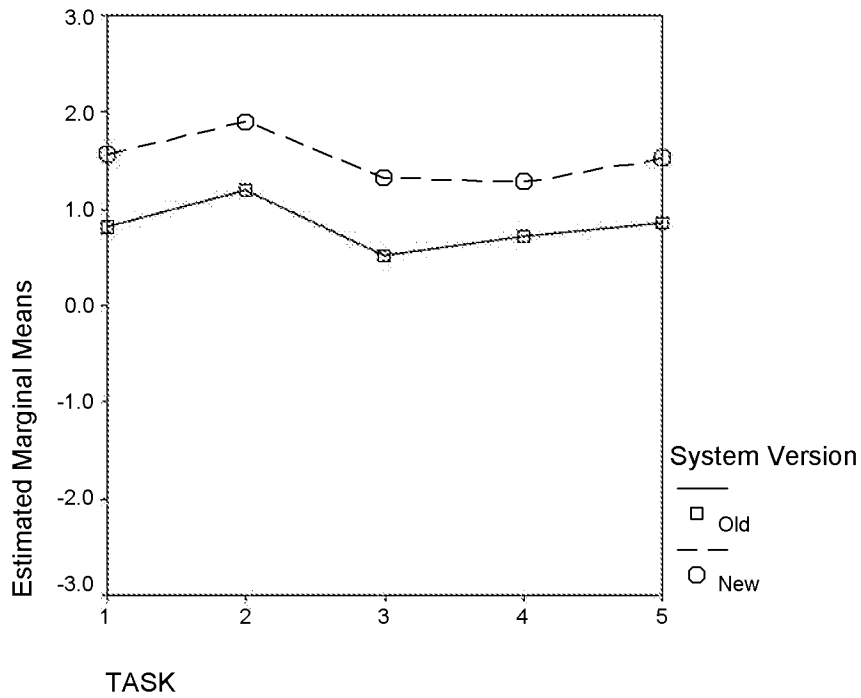

Figure 5.2 RM2. Measure 'Safe to use the system', (bipolar scale [-3..0..+3]).

Table 5.6 RM2. Measure 'Safe to use the system'.

	Sum of Squares		df		Mean Square		F		Sig.	
Between Groups	26.076		1		26.076		4.293		.045	
Within Groups	242.952		40		6.074					

	Task1		Task2		Task3		Task4		Task5		Total	
System Version	Old	New	Old	New	Old	New	Old	New	Old	New	Old	New
Mean	.81	1.57	1.19	1.90	.52	1.33	.71	1.29	.86	1.52	.82	1.52
Std. Dev.	1.78	.87	1.29	.83	1.78	1.35	1.68	1.06	1.42	.93		
N	21	21	21	21	21	21	21	21	21	21	21	21

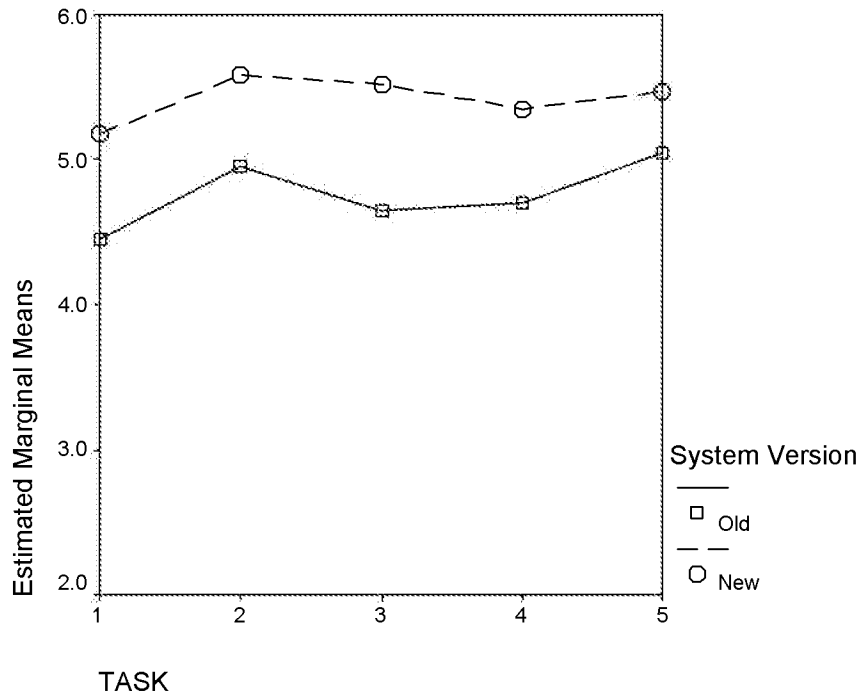

Figure 5.3 RM3. Measure 'how personal information is protected', (monopolar scale [1..7]).

Table 5.7 RM3. Measure 'how personal information is protected'.

	Sum of Squares		df		Mean Square		F		Sig.			
Between Groups	2.229		1		2.229		4.487		.041			
Within Groups	157.793		35		4.508							
	Task1		Task2		Task3		Task4		Task5		Total	
System Version	Old	New	Old	New	Old	New	Old	New	Old	New	Old	New
Mean	4.45	5.18	4.95	5.59	4.65	5.53	4.70	5.35	5.05	5.47	4.76	5.42
Std. Dev.	1.64	1.01	1.39	1.06	1.76	.72	1.34	.86	1.05	.80		
N	20	17	20	17	20	17	20	17	20	17	21	17

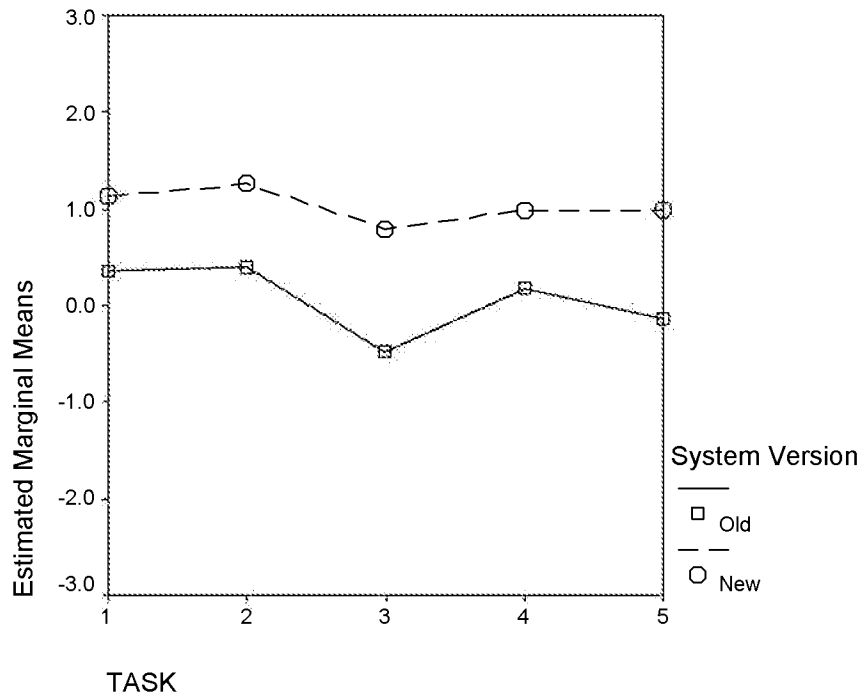

Figure 5.4 RM4. Measure ‘Would use the system frequently’, (bipolar scale [-3..0..+3]).

Table 5.8 RM4. Measure ‘Would like to use the system frequently’.

	Sum of Squares		df	Mean Square	F	Sig.
Between Groups	43.520		1	43.520	4.368	.044
Within Groups	358.654		36	9.963		

	Task1		Task2		Task3		Task4		Task5		Total	
System Version	Old	New	Old	New	Old	New	Old	New	Old	New	Old	New
Mean	.35	1.13	.39	1.27	-.48	.80	.17	1.00	-.13	1.00	0.06	1.04
Std. Dev.	1.85	1.06	1.80	.80	1.90	1.15	1.83	1.13	2.01	1.00		
N	23	15	23	15	23	15	23	15	23	15	23	15

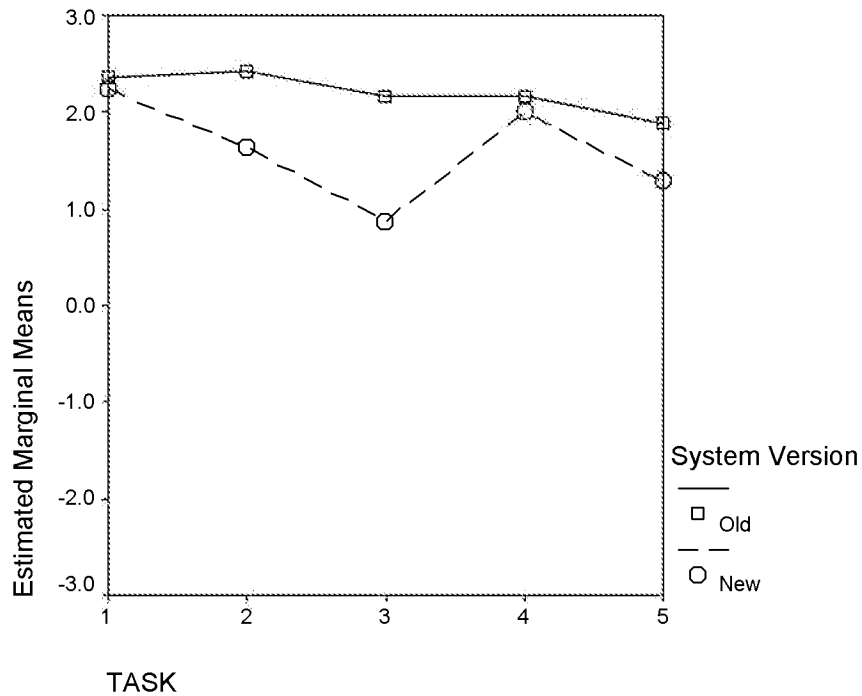

Figure 5.5 RM5. Measure 'Ease of use of the system', (bipolar scale [-3..0..+3]).

Table 5.9 RM5. Measure 'Ease of use of the system'.

	Sum of Squares		df		Mean Square		F		Sig.	
Between Groups	15.523		1		15.523		5.353		.027	
Within Groups	98.588		34		2.900					

	Task1		Task2		Task3		Task4		Task5		Total	
System Version	Old	New	Old	New	Old	New	Old	New	Old	New	Old	New
Mean	2.37	2.24	2.42	1.65	2.16	.88	2.16	2.00	1.89	1.29	2.20	1.61
Std. Dev.	.76	.75	.61	1.50	1.07	1.87	1.01	1.17	1.29	1.86		
N	19	17	19	17	19	17	19	17	19	17	19	17

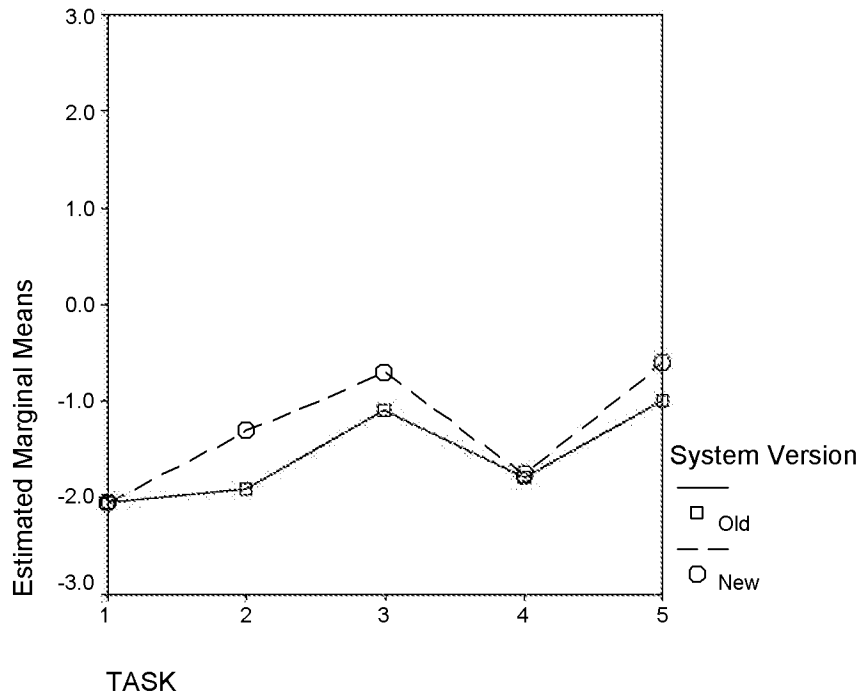

Figure 5.6 RM6. Measure ‘Found the system complex’, (bipolar scale [-3..0..+3]).

Table 5.10 RM6. Measure ‘Found the system complex’.

	Sum of Squares		df	Mean Square	F	Sig.
Between Groups	4.351		1	4.351	.591	.447, ns.
Within Groups	302.021		41	7.366		

	Task1		Task2		Task3		Task4		Task5		Total	
System Version	Old	New	Old	New	Old	New	Old	New	Old	New	Old	New
Mean	-2.04	-2.05	-1.91	-1.30	-1.09	-.70	-1.78	-1.75	-1.00	-.60	-1.56	-1.28
Std. Dev.	1.11	1.00	1.70	1.78	1.98	2.08	1.54	1.68	2.11	1.98		
N	23	20	23	20	23	20	23	20	23	20	23	20

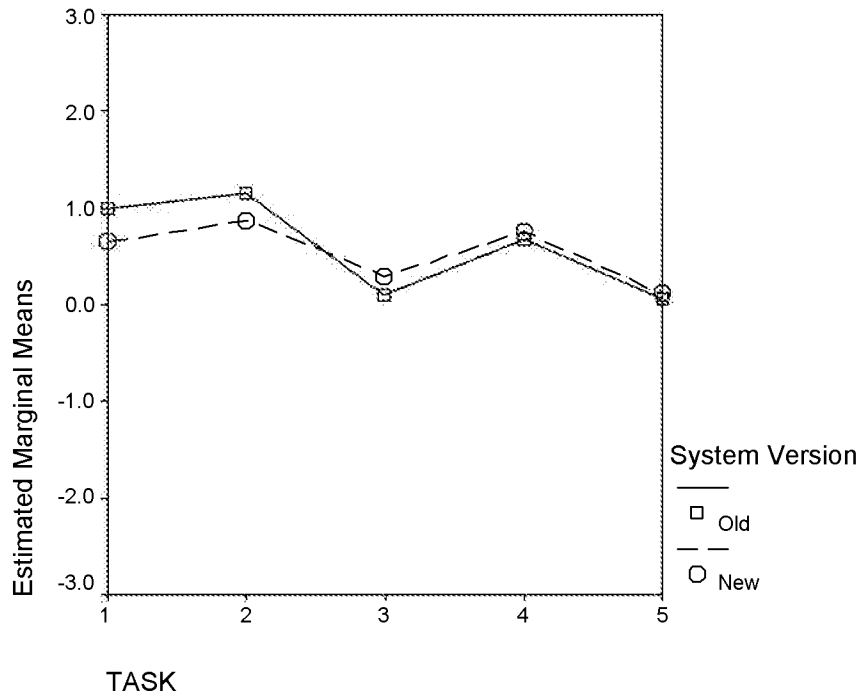

Figure 5.7 RM7. Measure ‘System’s functions are well integrated’, (bipolar scale [-3..0..+3]).

Table 5.11 RM7. Measure ‘System’s functions are well integrated.

	Sum of Squares	df	Mean Square	F	Sig.
Between Groups	.155	1	.155	.023	.88, ns.
Within Groups	229.506	34	6.75		

	Task1		Task2		Task3		Task4		Task5		Total	
System Version	Old	New	Old	New	Old	New	Old	New	Old	New	Old	New
Mean	1	.65	1.16	.88	.11	.29	.68	.76	.05	.12	.60	.54
Std. Dev.	1.56	1.46	1.30	1.69	2.03	1.45	1.34	1.30	1.72	1.58		
N	19	17	19	17	19	17	19	17	19	17	19	17

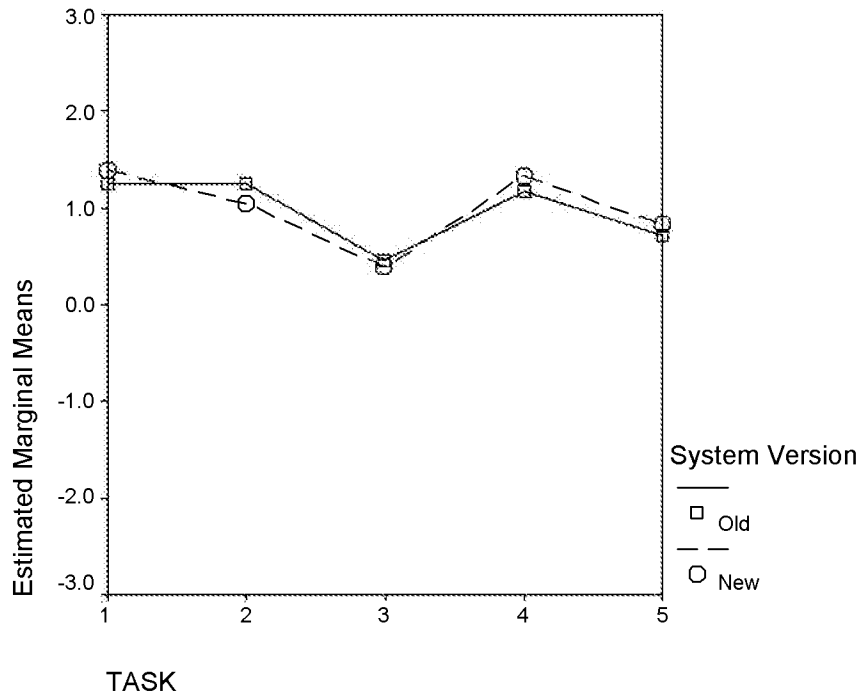

Figure 5.8 RM8. Measure ‘Felt confident using the system’, (bipolar scale [-3..0..+3]).

Table 5.12 RM8. Measure ‘Felt confident using the system’.

	Sum of Squares	df	Mean Square	F	Sig.
Between Groups	.057	1	.057	.009	.927, ns.
Within Groups	268.267	40	6.707		

	Task1		Task2		Task3		Task4		Task5		Total	
System Version	Old	New	Old	New	Old	New	Old	New	Old	New	Old	New
Mean	1.25	1.39	1.25	1.06	.46	.39	1.17	1.33	.71	.83	.97	1.00
Std. Dev.	1.94	1.09	1.75	1.43	1.91	1.75	1.49	1.37	1.73	1.34		
N	24	18	24	18	24	18	24	18	24	18	24	18

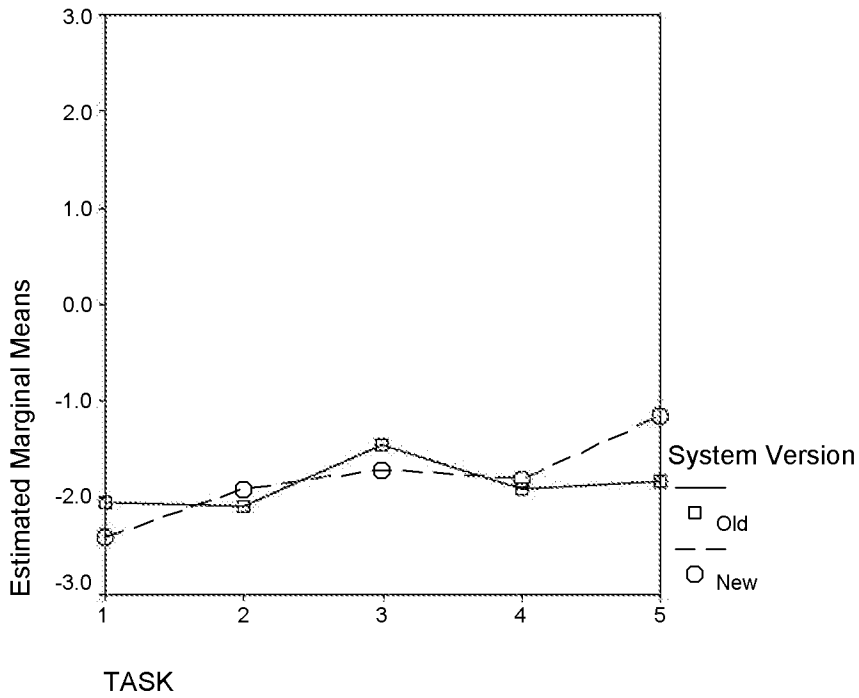

Figure 5.9 RM9. Measure ‘Need to learn a lot of things before using the system’, (bipolar scale [-3..0..+3]).

Table 5.13 RM9. Measure ‘Need to learn a lot of things before using the system’.

	Sum of Squares		df		Mean Square		F		Sig.	
Between Groups	.321		1		.321		.037		.848, ns.	
Within Groups	362.057		42		8.62					

	Task1		Task2		Task3		Task4		Task5		Total	
System Version	Old	New	Old	New	Old	New	Old	New	Old	New	Old	New
Mean	-2.04	-2.4	-2.08	-1.9	-1.46	-1.7	-1.92	-1.8	-1.83	-1.15	-1.87	-1.79
Std. Dev.	1.63	1.10	1.47	1.83	1.72	1.78	1.67	1.61	1.74	1.95		
N	24	20	24	20	24	20	24	20	24	20	24	20

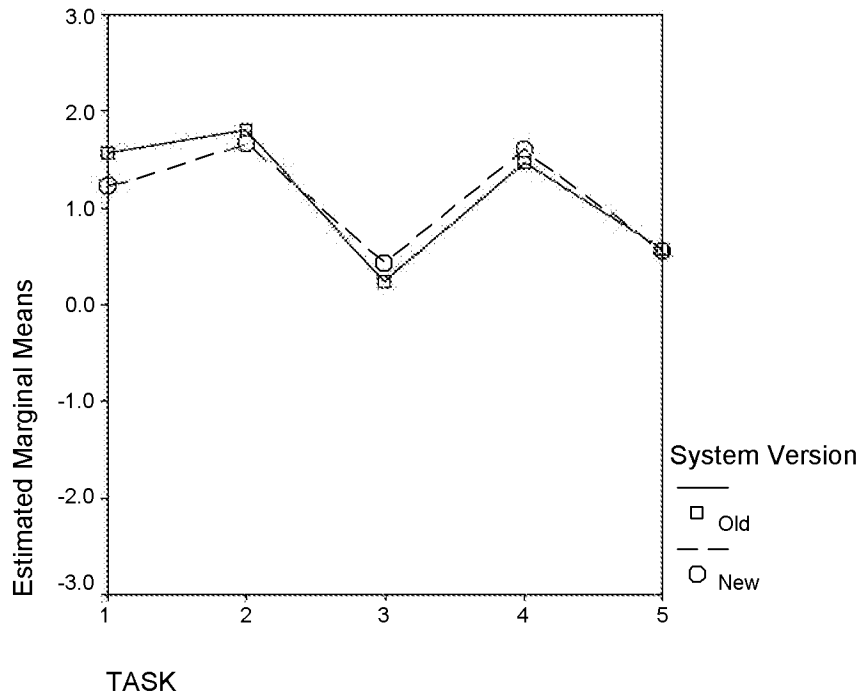

Figure 5.10 RM10. Measure ‘The instructions on the web page and the paper help were useful for the task’, (bipolar scale [-3..0..+3]).

Table 5.14 RM10. Measure ‘The instructions on the web page and the paper help were useful for the task’.

	Sum of Squares		df	Mean Square	F	Sig.
Between Groups	.053		1	.053	.01	.921, ns.
Within Groups	198.633		37	5.368		

	Task1		Task2		Task3		Task4		Task5		Total	
System Version	Old	New	Old	New	Old	New	Old	New	Old	New	Old	New
Mean	1.57	1.22	1.81	1.67	.24	.44	1.48	1.61	.57	.56	1.13	1.10
Std. Dev.	1.08	1.31	1.44	1.41	1.90	1.58	1.44	1.54	1.57	1.50		
N	21	18	21	18	21	18	21	18	21	18	21	18

5.3.2 Results: Task Specific Measurements

After each task several measurements of user' attitudes, *specific* to the task (SMs), were collected. These measurements were intended to evaluate users' opinions about particular aspects of the systems after each task; see Table 5.4 for the mapping of the questions to the tasks. For these measurements the two systems were compared with a one-way ANOVA. The ANOVA was performed with users' responses as the dependent variable and the system version as the independent variable (between-subject factor). Several measures indicated significant differences between the two system's versions.

1. Personal information

SM1. The participants indicated that they were significantly more comfortable to use personal information with the New system than with the Old system, $F(1, 42) = 5.106$, $p = 0.029$, see Table 5.15.

2. Influence of security information upon trust in the system

SM2. The information about security provided to the users of the payment system contributed to higher trust of the New system in this aspect, $F(1, 43) = 4.389$, $p = 0.042$, see Table 5.15.

3. Ability to block the payment code gives a sense of control over the situation

SM3. The users of the New system considered that the way the payment code can be blocked in the New system gave them significantly more sense of control than using the Old system, $F(1, 44) = 5.161$, $p = 0.028$, see Table 5.15.

4. Safety of the system use

SM4. The participants considered that it is significantly safer to use the New system than the Old system, $F(1, 39) = 5.067$, $p = 0.030$, see Table 5.15.

5. Authorisation in the system

SM5. The users were more **comfortable** with the way they can **identify themselves** to the New system than to the Old one, $F(1, 41) = 5.451$, $p = 0.024$, see Table 5.15.

6. The length of the payment code

SM6. The differences in the length of the payment code (6 in the Old version, and 4 in the New system) are considered to be significant. The 6-digit password appears a bit

too long (-0.33), while the 4-digit password appears a little too short (0.24), $F(1, 43) = 6.795$, $p = 0.013$, see Table 5.15. However, the length of the 4-digit password is closer to the middle of the bipolar scale, which is zero (0.00), and this is a slightly better result for the New system than for the Old one.

7. The branding of Postbank influences trust

SM7. The fact that the system was introduced by Postbank influenced positively users' opinion about the trust in the New system (Old 1.52, New 2.10), $F(1, 41) = 4.650$, $p = 0.037$, see Table 5.15.

8. Would use the system in the future (perceived usefulness)

SM8. The New system scored significantly higher than the Old one in perceived usefulness of the system, $F(1, 43) = 7.363$, $p = 0.01$, see Table 5.15.

9. Multiple payments

SM9. The users' perception of the speed of making several payments was significantly better in the New system than in the Old system, $F(1, 44) = 4.169$, $p = 0.047$, see Table 5.15.

SM10. This can be linked to perceived usefulness of the multiple payment feature in the New system version. It showed significant results $F(1, 41) = 5.100$, $p = 0.02$, see Table 5.15.

SM11. For ease of use of multiple payments there was no significant differences between the systems, $F(1, 42) = 0.096$, ns., see Table 5.15.

10. Scheduled payments

SM12. The usefulness of scheduled payments in the New system was considered significantly higher in the New system than in the Old one, which can be attributed to the scheduled payment functionality implemented in the New system, $F(1, 41) = 5.500$, $p = 0.023$, see Table 5.15.

SM13. There was no significant difference between the systems for ease of use of scheduled payments, $F(1, 39) = 0.165$, ns., see Table 5.15.

SM14. There was no significant difference between the systems in speed of scheduled payments, $F(1, 41) = 0.089$, ns., see Table 5.15.

11. Other results

SM15. The attempt to assess if the ability to block the payment code influences trust, has not delivered significant results $F(1, 44) = 0.053$, ns., see Table 5.15.

SM16. The question how a customer service line operated by real people would affect trust has not indicated a significant difference between the systems, $F(1, 43) = 0.284$, ns., see Table 5.15.

There was no significant difference between the systems in the measure if paying for the telephone call to the Betaallijn would be appropriate for the users, SM18, $F(1, 44) = 0.675$, ns., or how much the users of both systems would be prepared to pay for the call, SM17, $F(1, 41) = 0.045$, ns., see Table 5.15. The means indicate that the users would be prepared to pay about 2-3 cents for the call, which equals to the standard tariff for the short-distance calls in the Netherlands on January 2004.

SM19. There was no difference between the systems in the measure if the users felt they would be in control of the costs of the Betaallijn usage, $F(1, 42) = 0.225$, ns., see Table 5.15.

SM20. In task 5, where the users had to make multiple payments, the number of confirmations was considered to be slightly excessive for both systems without a significant difference, $F(1, 42) = 0.147$, ns., see Table 5.15.

Table 5.15 summarises these results, listing the means for the measures, the level of significance and F-statistics. The number of answers N varies for various measures, because of the cases excluded due to missing values, where the participants opted for the 'don't know' answer.

Table 5.15 Results of task specific tests
 (* – bipolar scale [-3..0..+3], † – monopolar scale [1..7])

Dependent variable	System version	N	Mean	Std. dev.	df	F	p																																																																																																																																																																																
SM1. Comfortable to use personal Information with the system†	Old	24	4.79	1.91	1, 42	5.106	.029																																																																																																																																																																																
	New	20	5.85	.93				SM2. Security information provided influences trust*	Old	24	.33	1.52	1, 43	4.389	.042	New	21	1.14	.96	SM3. Ability to block the payment code gives control over the situation*	Old	25	1.04	1.56	1, 44	5.161	.028	New	21	1.90	.83	SM4. Safe to use the system†	Old	22	4.64	1.49	1, 39	5.067	.030	New	19	5.58	1.12	SM5. Are comfortable with the way they can identify themselves in the system*	Old	25	.52	1.96	1, 43	5.451	.024	New	21	1.05	1.19	SM6. The length of the payment code (too long, too short)*	Old	24	-.33	.70	1, 43	6.795	.013	New	21	.24	.76	SM7. The branding of Postbank influences trust*	Old	23	1.52	.94	1, 41	4.650	.037	New	20	2.10	.78	SM8. Would use the payment system in the future*	Old	25	-.12	1.98	1, 43	7.363	.010	New	20	1.30	1.38	SM9. Multiple (batch) payments: speed†	Old	25	2.28	1.76	1, 44	4.169	.047	New	21	3.38	1.88	SM10. Multiple (batch) payments: usefulness*	Old	24	-.71	1.87	1, 42	5.100	.002	New	20	1.11	1.66	SM11. Multiple (batch) payments: ease of use†	Old	24	4.54	2.10	1, 42	.096	.758, ns.	New	20	4.35	1.95	SM12. Scheduled payments: usefulness*	Old	23	-.35	1.96	1, 41	5.55	.023	New	20	.90	1.41	SM13. Scheduled payments: ease of use*	Old	22	-.35	2.17	1, 39	.165	.687, ns.	New	19	.90	1.70	SM14. Scheduled payments: speed†	Old	23	1.52	1.85	1, 41	.089	.767, ns.	New	20	2.10	1.97	SM15. Ability to block the payment code influences trust*	Old	25	1.04	1.18	1, 44	.053	.819, ns.	New	21	1.9	1.22	SM16. Customer service line operated by real people influences trust*	Old	21	1.24	1.10	1, 43	.284	.597, ns.
SM2. Security information provided influences trust*	Old	24	.33	1.52	1, 43	4.389	.042																																																																																																																																																																																
	New	21	1.14	.96				SM3. Ability to block the payment code gives control over the situation*	Old	25	1.04	1.56	1, 44	5.161	.028	New	21	1.90	.83	SM4. Safe to use the system†	Old	22	4.64	1.49	1, 39	5.067	.030	New	19	5.58	1.12	SM5. Are comfortable with the way they can identify themselves in the system*	Old	25	.52	1.96	1, 43	5.451	.024	New	21	1.05	1.19	SM6. The length of the payment code (too long, too short)*	Old	24	-.33	.70	1, 43	6.795	.013	New	21	.24	.76	SM7. The branding of Postbank influences trust*	Old	23	1.52	.94	1, 41	4.650	.037	New	20	2.10	.78	SM8. Would use the payment system in the future*	Old	25	-.12	1.98	1, 43	7.363	.010	New	20	1.30	1.38	SM9. Multiple (batch) payments: speed†	Old	25	2.28	1.76	1, 44	4.169	.047	New	21	3.38	1.88	SM10. Multiple (batch) payments: usefulness*	Old	24	-.71	1.87	1, 42	5.100	.002	New	20	1.11	1.66	SM11. Multiple (batch) payments: ease of use†	Old	24	4.54	2.10	1, 42	.096	.758, ns.	New	20	4.35	1.95	SM12. Scheduled payments: usefulness*	Old	23	-.35	1.96	1, 41	5.55	.023	New	20	.90	1.41	SM13. Scheduled payments: ease of use*	Old	22	-.35	2.17	1, 39	.165	.687, ns.	New	19	.90	1.70	SM14. Scheduled payments: speed†	Old	23	1.52	1.85	1, 41	.089	.767, ns.	New	20	2.10	1.97	SM15. Ability to block the payment code influences trust*	Old	25	1.04	1.18	1, 44	.053	.819, ns.	New	21	1.9	1.22	SM16. Customer service line operated by real people influences trust*	Old	21	1.24	1.10	1, 43	.284	.597, ns.	New	46	1.28	1.14								
SM3. Ability to block the payment code gives control over the situation*	Old	25	1.04	1.56	1, 44	5.161	.028																																																																																																																																																																																
	New	21	1.90	.83				SM4. Safe to use the system†	Old	22	4.64	1.49	1, 39	5.067	.030	New	19	5.58	1.12	SM5. Are comfortable with the way they can identify themselves in the system*	Old	25	.52	1.96	1, 43	5.451	.024	New	21	1.05	1.19	SM6. The length of the payment code (too long, too short)*	Old	24	-.33	.70	1, 43	6.795	.013	New	21	.24	.76	SM7. The branding of Postbank influences trust*	Old	23	1.52	.94	1, 41	4.650	.037	New	20	2.10	.78	SM8. Would use the payment system in the future*	Old	25	-.12	1.98	1, 43	7.363	.010	New	20	1.30	1.38	SM9. Multiple (batch) payments: speed†	Old	25	2.28	1.76	1, 44	4.169	.047	New	21	3.38	1.88	SM10. Multiple (batch) payments: usefulness*	Old	24	-.71	1.87	1, 42	5.100	.002	New	20	1.11	1.66	SM11. Multiple (batch) payments: ease of use†	Old	24	4.54	2.10	1, 42	.096	.758, ns.	New	20	4.35	1.95	SM12. Scheduled payments: usefulness*	Old	23	-.35	1.96	1, 41	5.55	.023	New	20	.90	1.41	SM13. Scheduled payments: ease of use*	Old	22	-.35	2.17	1, 39	.165	.687, ns.	New	19	.90	1.70	SM14. Scheduled payments: speed†	Old	23	1.52	1.85	1, 41	.089	.767, ns.	New	20	2.10	1.97	SM15. Ability to block the payment code influences trust*	Old	25	1.04	1.18	1, 44	.053	.819, ns.	New	21	1.9	1.22	SM16. Customer service line operated by real people influences trust*	Old	21	1.24	1.10	1, 43	.284	.597, ns.	New	46	1.28	1.14																				
SM4. Safe to use the system†	Old	22	4.64	1.49	1, 39	5.067	.030																																																																																																																																																																																
	New	19	5.58	1.12				SM5. Are comfortable with the way they can identify themselves in the system*	Old	25	.52	1.96	1, 43	5.451	.024	New	21	1.05	1.19	SM6. The length of the payment code (too long, too short)*	Old	24	-.33	.70	1, 43	6.795	.013	New	21	.24	.76	SM7. The branding of Postbank influences trust*	Old	23	1.52	.94	1, 41	4.650	.037	New	20	2.10	.78	SM8. Would use the payment system in the future*	Old	25	-.12	1.98	1, 43	7.363	.010	New	20	1.30	1.38	SM9. Multiple (batch) payments: speed†	Old	25	2.28	1.76	1, 44	4.169	.047	New	21	3.38	1.88	SM10. Multiple (batch) payments: usefulness*	Old	24	-.71	1.87	1, 42	5.100	.002	New	20	1.11	1.66	SM11. Multiple (batch) payments: ease of use†	Old	24	4.54	2.10	1, 42	.096	.758, ns.	New	20	4.35	1.95	SM12. Scheduled payments: usefulness*	Old	23	-.35	1.96	1, 41	5.55	.023	New	20	.90	1.41	SM13. Scheduled payments: ease of use*	Old	22	-.35	2.17	1, 39	.165	.687, ns.	New	19	.90	1.70	SM14. Scheduled payments: speed†	Old	23	1.52	1.85	1, 41	.089	.767, ns.	New	20	2.10	1.97	SM15. Ability to block the payment code influences trust*	Old	25	1.04	1.18	1, 44	.053	.819, ns.	New	21	1.9	1.22	SM16. Customer service line operated by real people influences trust*	Old	21	1.24	1.10	1, 43	.284	.597, ns.	New	46	1.28	1.14																																
SM5. Are comfortable with the way they can identify themselves in the system*	Old	25	.52	1.96	1, 43	5.451	.024																																																																																																																																																																																
	New	21	1.05	1.19				SM6. The length of the payment code (too long, too short)*	Old	24	-.33	.70	1, 43	6.795	.013	New	21	.24	.76	SM7. The branding of Postbank influences trust*	Old	23	1.52	.94	1, 41	4.650	.037	New	20	2.10	.78	SM8. Would use the payment system in the future*	Old	25	-.12	1.98	1, 43	7.363	.010	New	20	1.30	1.38	SM9. Multiple (batch) payments: speed†	Old	25	2.28	1.76	1, 44	4.169	.047	New	21	3.38	1.88	SM10. Multiple (batch) payments: usefulness*	Old	24	-.71	1.87	1, 42	5.100	.002	New	20	1.11	1.66	SM11. Multiple (batch) payments: ease of use†	Old	24	4.54	2.10	1, 42	.096	.758, ns.	New	20	4.35	1.95	SM12. Scheduled payments: usefulness*	Old	23	-.35	1.96	1, 41	5.55	.023	New	20	.90	1.41	SM13. Scheduled payments: ease of use*	Old	22	-.35	2.17	1, 39	.165	.687, ns.	New	19	.90	1.70	SM14. Scheduled payments: speed†	Old	23	1.52	1.85	1, 41	.089	.767, ns.	New	20	2.10	1.97	SM15. Ability to block the payment code influences trust*	Old	25	1.04	1.18	1, 44	.053	.819, ns.	New	21	1.9	1.22	SM16. Customer service line operated by real people influences trust*	Old	21	1.24	1.10	1, 43	.284	.597, ns.	New	46	1.28	1.14																																												
SM6. The length of the payment code (too long, too short)*	Old	24	-.33	.70	1, 43	6.795	.013																																																																																																																																																																																
	New	21	.24	.76				SM7. The branding of Postbank influences trust*	Old	23	1.52	.94	1, 41	4.650	.037	New	20	2.10	.78	SM8. Would use the payment system in the future*	Old	25	-.12	1.98	1, 43	7.363	.010	New	20	1.30	1.38	SM9. Multiple (batch) payments: speed†	Old	25	2.28	1.76	1, 44	4.169	.047	New	21	3.38	1.88	SM10. Multiple (batch) payments: usefulness*	Old	24	-.71	1.87	1, 42	5.100	.002	New	20	1.11	1.66	SM11. Multiple (batch) payments: ease of use†	Old	24	4.54	2.10	1, 42	.096	.758, ns.	New	20	4.35	1.95	SM12. Scheduled payments: usefulness*	Old	23	-.35	1.96	1, 41	5.55	.023	New	20	.90	1.41	SM13. Scheduled payments: ease of use*	Old	22	-.35	2.17	1, 39	.165	.687, ns.	New	19	.90	1.70	SM14. Scheduled payments: speed†	Old	23	1.52	1.85	1, 41	.089	.767, ns.	New	20	2.10	1.97	SM15. Ability to block the payment code influences trust*	Old	25	1.04	1.18	1, 44	.053	.819, ns.	New	21	1.9	1.22	SM16. Customer service line operated by real people influences trust*	Old	21	1.24	1.10	1, 43	.284	.597, ns.	New	46	1.28	1.14																																																								
SM7. The branding of Postbank influences trust*	Old	23	1.52	.94	1, 41	4.650	.037																																																																																																																																																																																
	New	20	2.10	.78				SM8. Would use the payment system in the future*	Old	25	-.12	1.98	1, 43	7.363	.010	New	20	1.30	1.38	SM9. Multiple (batch) payments: speed†	Old	25	2.28	1.76	1, 44	4.169	.047	New	21	3.38	1.88	SM10. Multiple (batch) payments: usefulness*	Old	24	-.71	1.87	1, 42	5.100	.002	New	20	1.11	1.66	SM11. Multiple (batch) payments: ease of use†	Old	24	4.54	2.10	1, 42	.096	.758, ns.	New	20	4.35	1.95	SM12. Scheduled payments: usefulness*	Old	23	-.35	1.96	1, 41	5.55	.023	New	20	.90	1.41	SM13. Scheduled payments: ease of use*	Old	22	-.35	2.17	1, 39	.165	.687, ns.	New	19	.90	1.70	SM14. Scheduled payments: speed†	Old	23	1.52	1.85	1, 41	.089	.767, ns.	New	20	2.10	1.97	SM15. Ability to block the payment code influences trust*	Old	25	1.04	1.18	1, 44	.053	.819, ns.	New	21	1.9	1.22	SM16. Customer service line operated by real people influences trust*	Old	21	1.24	1.10	1, 43	.284	.597, ns.	New	46	1.28	1.14																																																																				
SM8. Would use the payment system in the future*	Old	25	-.12	1.98	1, 43	7.363	.010																																																																																																																																																																																
	New	20	1.30	1.38				SM9. Multiple (batch) payments: speed†	Old	25	2.28	1.76	1, 44	4.169	.047	New	21	3.38	1.88	SM10. Multiple (batch) payments: usefulness*	Old	24	-.71	1.87	1, 42	5.100	.002	New	20	1.11	1.66	SM11. Multiple (batch) payments: ease of use†	Old	24	4.54	2.10	1, 42	.096	.758, ns.	New	20	4.35	1.95	SM12. Scheduled payments: usefulness*	Old	23	-.35	1.96	1, 41	5.55	.023	New	20	.90	1.41	SM13. Scheduled payments: ease of use*	Old	22	-.35	2.17	1, 39	.165	.687, ns.	New	19	.90	1.70	SM14. Scheduled payments: speed†	Old	23	1.52	1.85	1, 41	.089	.767, ns.	New	20	2.10	1.97	SM15. Ability to block the payment code influences trust*	Old	25	1.04	1.18	1, 44	.053	.819, ns.	New	21	1.9	1.22	SM16. Customer service line operated by real people influences trust*	Old	21	1.24	1.10	1, 43	.284	.597, ns.	New	46	1.28	1.14																																																																																
SM9. Multiple (batch) payments: speed†	Old	25	2.28	1.76	1, 44	4.169	.047																																																																																																																																																																																
	New	21	3.38	1.88				SM10. Multiple (batch) payments: usefulness*	Old	24	-.71	1.87	1, 42	5.100	.002	New	20	1.11	1.66	SM11. Multiple (batch) payments: ease of use†	Old	24	4.54	2.10	1, 42	.096	.758, ns.	New	20	4.35	1.95	SM12. Scheduled payments: usefulness*	Old	23	-.35	1.96	1, 41	5.55	.023	New	20	.90	1.41	SM13. Scheduled payments: ease of use*	Old	22	-.35	2.17	1, 39	.165	.687, ns.	New	19	.90	1.70	SM14. Scheduled payments: speed†	Old	23	1.52	1.85	1, 41	.089	.767, ns.	New	20	2.10	1.97	SM15. Ability to block the payment code influences trust*	Old	25	1.04	1.18	1, 44	.053	.819, ns.	New	21	1.9	1.22	SM16. Customer service line operated by real people influences trust*	Old	21	1.24	1.10	1, 43	.284	.597, ns.	New	46	1.28	1.14																																																																																												
SM10. Multiple (batch) payments: usefulness*	Old	24	-.71	1.87	1, 42	5.100	.002																																																																																																																																																																																
	New	20	1.11	1.66				SM11. Multiple (batch) payments: ease of use†	Old	24	4.54	2.10	1, 42	.096	.758, ns.	New	20	4.35	1.95	SM12. Scheduled payments: usefulness*	Old	23	-.35	1.96	1, 41	5.55	.023	New	20	.90	1.41	SM13. Scheduled payments: ease of use*	Old	22	-.35	2.17	1, 39	.165	.687, ns.	New	19	.90	1.70	SM14. Scheduled payments: speed†	Old	23	1.52	1.85	1, 41	.089	.767, ns.	New	20	2.10	1.97	SM15. Ability to block the payment code influences trust*	Old	25	1.04	1.18	1, 44	.053	.819, ns.	New	21	1.9	1.22	SM16. Customer service line operated by real people influences trust*	Old	21	1.24	1.10	1, 43	.284	.597, ns.	New	46	1.28	1.14																																																																																																								
SM11. Multiple (batch) payments: ease of use†	Old	24	4.54	2.10	1, 42	.096	.758, ns.																																																																																																																																																																																
	New	20	4.35	1.95				SM12. Scheduled payments: usefulness*	Old	23	-.35	1.96	1, 41	5.55	.023	New	20	.90	1.41	SM13. Scheduled payments: ease of use*	Old	22	-.35	2.17	1, 39	.165	.687, ns.	New	19	.90	1.70	SM14. Scheduled payments: speed†	Old	23	1.52	1.85	1, 41	.089	.767, ns.	New	20	2.10	1.97	SM15. Ability to block the payment code influences trust*	Old	25	1.04	1.18	1, 44	.053	.819, ns.	New	21	1.9	1.22	SM16. Customer service line operated by real people influences trust*	Old	21	1.24	1.10	1, 43	.284	.597, ns.	New	46	1.28	1.14																																																																																																																				
SM12. Scheduled payments: usefulness*	Old	23	-.35	1.96	1, 41	5.55	.023																																																																																																																																																																																
	New	20	.90	1.41				SM13. Scheduled payments: ease of use*	Old	22	-.35	2.17	1, 39	.165	.687, ns.	New	19	.90	1.70	SM14. Scheduled payments: speed†	Old	23	1.52	1.85	1, 41	.089	.767, ns.	New	20	2.10	1.97	SM15. Ability to block the payment code influences trust*	Old	25	1.04	1.18	1, 44	.053	.819, ns.	New	21	1.9	1.22	SM16. Customer service line operated by real people influences trust*	Old	21	1.24	1.10	1, 43	.284	.597, ns.	New	46	1.28	1.14																																																																																																																																
SM13. Scheduled payments: ease of use*	Old	22	-.35	2.17	1, 39	.165	.687, ns.																																																																																																																																																																																
	New	19	.90	1.70				SM14. Scheduled payments: speed†	Old	23	1.52	1.85	1, 41	.089	.767, ns.	New	20	2.10	1.97	SM15. Ability to block the payment code influences trust*	Old	25	1.04	1.18	1, 44	.053	.819, ns.	New	21	1.9	1.22	SM16. Customer service line operated by real people influences trust*	Old	21	1.24	1.10	1, 43	.284	.597, ns.	New	46	1.28	1.14																																																																																																																																												
SM14. Scheduled payments: speed†	Old	23	1.52	1.85	1, 41	.089	.767, ns.																																																																																																																																																																																
	New	20	2.10	1.97				SM15. Ability to block the payment code influences trust*	Old	25	1.04	1.18	1, 44	.053	.819, ns.	New	21	1.9	1.22	SM16. Customer service line operated by real people influences trust*	Old	21	1.24	1.10	1, 43	.284	.597, ns.	New	46	1.28	1.14																																																																																																																																																								
SM15. Ability to block the payment code influences trust*	Old	25	1.04	1.18	1, 44	.053	.819, ns.																																																																																																																																																																																
	New	21	1.9	1.22				SM16. Customer service line operated by real people influences trust*	Old	21	1.24	1.10	1, 43	.284	.597, ns.	New	46	1.28	1.14																																																																																																																																																																				
SM16. Customer service line operated by real people influences trust*	Old	21	1.24	1.10	1, 43	.284	.597, ns.																																																																																																																																																																																
	New	46	1.28	1.14																																																																																																																																																																																			

Dependent variable	System version	N	Mean	Std. dev.	df	F	p
SM17. How much would you be prepared to pay for the call? †	Old	23	2.22	1.08	1, 41	.045	.833, ns.
	New	20	2.15	.98			
SM18. Would paying for the telephone call be appropriate for you? †	Old	25	3.68	1.77	1, 44	.675	.416, ns.
	New	21	3.24	1.86			
SM19. Do you feel you would be in control of the costs of the Betaalijn usage? †	Old	25	3.8	1.75	1, 43	.225	.638, ns.
	New	20	4.05	1.76			
SM20. Number of confirmations is appropriate*	Old	24	-.71	1.80	1, 42	.147	.704, ns.
	New	20	-.9	1.44			

5.4 Discussion

This section discusses how the findings of the experiment reflect upon the validity of the design recommendations. The summary provided in Table 5.16 and Table 5.17 illustrates the relation between the experimental measures and the design recommendations.

5.4.1 Validation of the design recommendations

DR 1. Security measures, applied to the redesign of the New system have resulted in a better assessment of the New system by the participants. The information about security contributed to the better rating of the New system in the aspect how *safe it is to use the system*, RM2, Figure 5.2 and Table 5.6. The participants have also considered that it was safer to use the New system in measure SM4, Table 5.15. It can be interpreted as an evidence of the successful validation of DR 1 on security measures and security policy.

DR 2. As the proof of DR 2 on personal information, the observation can be exploited that the New system scored higher in users' perception about how *personal information* is protected in the system, RM3, Figure 5.3 and Table 5.7.

Table 5.16 Design recommendations with confirmed validation

Design recommendations	Experiment Results	Validation Status	
DR 1. Inform users about security measures and provide a security policy	RM2. It is 'safer to use' the New system. SM4. 'Safe to use the system' is rated higher in the New system.	Confirmed	✓
DR 2. Explain what type and details of personal information are to be retained, why, and how they will be used	RM3. Personal information is protected better in the New system.	Confirmed	✓
DR 3. Provide clear and explicit policy on privacy and make it noticeable to users	SM1. More comfortable to use personal information with in the New system.	Confirmed	✓
DR 5. Allow users to control critical actions and information	SM3. Ability to block the payment code gives more control over the situation in the New system.	Confirmed	✓
DR 6. Seek reputation and trust transference from reputed partners and technology providers, and inform users about such partnerships	SM7. The branding of Postbank influences trust: higher in the New system.	Confirmed	✓
DR 7. Take measures to address risks and inform users about these measures	RM1. Trust in the New system is rated higher. SM2. Security information influences trust: higher in the New system.	Confirmed	✓
DR 10. Provide features of automation of payments	SM0. Speed of the multiple payments is perceived higher in the New system. SM10. The usefulness of the scheduled payments is perceived higher in the New system.	Confirmed	✓
DR 12. Well-designed Authentication	SM5. Users are comfortable with the way they can identify themselves in the system. SM6. The length of the payment code makes difference between the two systems.	Confirmed	✓

Table 5.17 Design recommendations which were not confirmed during the experiment

Design recommendations	Experiment Results	Validation Status	
DR 4. Give users control over the costs of the payment system usage	SM17-19. Measurement against validation: No significant difference between the systems in control over costs.	Not confirmed	X
DR 8. Interaction with the payment system should resemble users' expectations about the payments process	RM5. Measurement against validation: Ease of use is higher for the Old system.	Not confirmed	X
DR 9. The interfaces should be presented in a logical, clear and understandable way	Out of the scope of the study.	Not confirmed	X
DR 11. Provide features of customisation of payment environments	Out of the scope of the study.	Not confirmed	X

DR 3. As the proof of DR 3 on privacy policy the results of measure SM1 can be used, see Table 5.15, which indicated that participants of the New system are more comfortable to use personal information than in the Old system, and this can be interpreted as an evidence of the validation of DR 3 on privacy policy.

DR 5. The participants of the New system have considered that the way the *payment code* can be blocked in the New system gave them more control than in the Old system, SM3, Table 5.15. This corroborates the validity of DR 5 on control of critical actions and information. Another supporting evidence for the validity of DR 5 are users' attitudes on *how safe it is to use the system*, RM2, Figure 5.2. Based on the significance of within-subjects main effect for the tasks and the cubic effect in this measure, it can be suggested that task 2 (exploring DR 5) indicated a higher rating of safety of the system than the rest of the tasks, and this measure is higher for the New system than for the Old one.

DR 6. The fact that the system was introduced by Postbank has influenced positively users' opinions about the trustworthiness of the system, and it is in favour of the New system, SM7, Table 5.15. This supports the validity of DR 6 on trust transference.

DR 7. The overall improvement of the participants' opinions on *trust* in the New system can be interpreted as an evidence of the validation of DR 7 on taking measures to address risks, RM1, Figure 5.1 and Table 5.5.

It cannot be though completely excluded that the higher trust in the New system was a consequence of the whole complex of changes applied according to the design recommendations. Taking into account a significant main effect for the difference between the tasks and significance of the 4-th order effect of factor tasks in measuring trust in the system, RM1, it can be concluded that task 3 indicated relatively lower trust in the system, while tasks 2 and 4 indicated relatively higher trust, Figure 5.1 and Table 5.5. Since tasks 2 and 4 were focused mainly on the privacy and security policies and control over the critical information (DRs 1, 2, 3, 5), it can be inferred that these aspects were important in increasing trust and alleviating risks for both systems. The fact that the New system performed better in the *trust* measure than the Old one gives another supporting evidence to the validity of these DRs.

DR 10. The experiment has demonstrated that the feature of *multiple payments* brings benefits to users in terms of speed and usefulness, SM10 and SM12, Table 5.15. This serves as evidence for validation of DR 10 on automatisation of payments.

Regarding the other aspect of automatisation of payments, pertaining to scheduled payments, which were tested in the form of paying a rent for a house, the conclusion about its contribution to the evaluation of DR 10 should be drawn carefully. A proper execution of this task was supported only in the New system, while the participants of the Old system had to pay individual rent payments repeatedly, which was considered a bit artificial by the participants.

On the other hand, scheduled payments have significantly decreased *ease of use* in the New system, RM5, see task 3 in Figure 5.5, which is demonstrated by the significance of the differences between the tasks in the 4th order effect. The possible reasons of this outcome are the incorrect implementation of the task or the correspondent design recommendation. Rent payments could be a wrong way to test the task, or the participants may have experienced difficulties understanding the task. Some of the participants even refused to do the task, saying they would not pay rent in this way. This experimental task arguably favours the New system, which automated the task completely, while in the Old system the task is not supported as such. Not surprisingly, the subjects reported the higher usefulness for this task in the New system, SM12, Table 5.15. Clearly, this seems a rather circular experiment, and the validity of advice on scheduled payments cannot be confidently concluded. However, repeated payments are an actual and frequent task for users, and it is justified to use them for drawing comparisons between the two systems.

DR 12. The difference in the length of the PIN code has indicated the importance of authentication and suggests that a shorter 4-digit *payment code* could be better than the longer 6-digit. Perhaps the 5-digit code could be recommended as the optimum in this case. This result, in combination with the observation that the participants were more comfortable with the *way they can identify themselves* in the New system, Table 5.15, supports the validity of DR 12 concerning authentication.

It has not been possible to find convincing evidence for validity of the other design recommendations in this experiment.

DR 4. The results on control over the costs of the EPS' use, (SM 17 and SM 18, Table 5.15) do not significantly distinguish between the systems, and therefore this DR cannot be considered as validated.

DR 8. The participants would be more willing to use the New system than the Old one, RM4, SM8, and this perceived usefulness could be partially attributed to the improved interaction design. However, another interesting result demonstrates that despite that the changes to the system were aimed to improve its usability, they did not create an observable improvement in the usability goal *ease of use*, RM5. The better rating for *ease of use* of the Old system than for the New one prevents from making claims about the validity of this DR, Table 5.9 and Figure 5.5. Despite that there is supporting evidence for the validity of DR 8 on interaction design, has not been validated sufficiently in the experiment.

DR9 and DR 11. This experiment was not designed to evaluate of DR 9 on the logic of interfaces. DR 11, regarding the customisation of payment environments, was not evaluated within the scope of this experiment.

In conclusion, the application of the design recommendations has resulted in improvement of users' attitudes towards the New system and has raised the overall user acceptance of the redesigned system. The New system has scored higher than the Old one in *trust* and *perceived usefulness*. The analysis of the results has indicated that the participants would be more likely to accept the New system. This is a good indicator of positive influence on user acceptance of the set of design recommendations on the whole.

While certain design recommendations could not be sufficiently validated, this does not undermine the success of the experiment. Literature on EPSs and the research activities of this thesis reported in Chapters 3 and 4 emphasise the high relative importance of the aspects of trust, privacy and usefulness for end users. The improvements

in these aspects that have been made with the application of the design recommendations indicate the high positive impact of the recommendations on design of e-commerce EPSs.

A word of caution must be said regarding the validation experiment. The design recommendations as described in Appendix D include the detailed description that serves to operationalise them. The experiment has not attempted to validate each and every detail of the DRs. Rather, the DRs were applied by selecting the applicable details, and the impact this had on the system, has been evaluated. However, in all cases this validation is subject to the way these details were applied and to the personal interpretation and application of the DRs by the experimenter.

It is also hard to conclude that certain system's aspects were affected solely by the correspondent design recommendations, other factors may have influenced the participants' attitudes. However, applying the set of recommendations as a whole has shown the overall positive impact that cannot be disputed. In conclusion, the experimental results provide supporting evidence for the validity of DRs 1, 2, 3, 5, 6, 7, 10, 12, but this should not be taken that every detail of these design recommendations is proven to be valid.

5.4.2 Revision of not validated design recommendations

Regarding the design recommendations that were not validated in this experiment some considerations should be given about how they can be revised, so that the chance of their validity will be improved in future validation studies. DR 4 on control over the costs of the payment system usage failed to be validated. A possible explanation might be that the issue of costs may be not as important as it seemed prior to the validation experiment, but this would disagree with other studies on costs of electronic payments, (Humphrey et al., 2001).

Assuming that this DR has some potential, one of the reasons it is not validated is that the DR was not applied sufficiently, or that the context of the experiment did not allow to observe the benefit of its application, which might still develop, e.g. over time. One of the possible changes that can be made to this DR is suggesting more salient exposure of the fact that the use of the system to customers is free of charge. Another way to improve the effect of this DR would be awarding costumers incentives for using EPSs, e.g. via loyalty schemes such as Air Miles.

DR 8 on interaction design has failed to be validated due to decreased usability of the New system. In spite of possible problems in the way this DR was implemented, such as limitations in implementing the changes to the New system, or limitations of the experimental setup, described in section 5.4.3, there is still a room for improvement of this DR. Interaction design is a broad and complex issue, and existing knowledge about it can be applied to the context of e-commerce EPSs. For instance, various practices of interaction design for successful EPSs, payment products and electronic banking could be referred to, and adapted to online EPSs. Another way to revise this DR would be employing guidelines for interaction design applied to the related technology, such as mentioned earlier guidelines on e-commerce user experience, (Nielsen, et al., 2000), or heuristics for Web design, (Nielsen, 1999).

The analysis of the results demonstrates that task 3, which was designed to evaluate scheduled payments, resulted in the lower ratings of users' attitudes than the other tasks, section 5.3.1. It can be the case that task 3 was the most complex, or it exposed most limitations of the systems. It may suggest that a better specification of DR 10 that advises on scheduled payments is needed. DR 10 could be revised and extended to include practices of scheduled payments of existing EPSs or related technology. It can be iteratively implemented and evaluated to find the best way to formulate this DR. In addition, research for relevant applications for scheduled payments could be conducted.

5.4.3 Limitations of the experimental study

In some cases, the design recommendations were applied to the design of the New system, but no improvement was shown in the users' rating of the system. They are listed in Table 5.17. Of course, a simple explanation would be that there are inherent flaws in the design recommendations. Alternatively, these DRs might not create an impact large enough to affect users' attitudes. They might have also been applied incorrectly, or a too small sample of users was taken. DRs might be too abstract to guide the design, or be conflicting. However, this is not true for all cases, as application of some design recommendations still showed improvement in users' attitudes. Chapter 6 discusses validity issues of the results in more detail. Possible reasons for not being able to validate all DRs are discussed here. Let's look at them in detail step by step.

Too little impact of the changes on the system.

The Old system could be already well designed in some of the aspects, therefore the changes made to the system might not have been able to improve significantly the already good design of the Old system.

Let's illustrate the last statement on the implication that there is no improvement of usefulness of help in the New system. The systems could be understood quite well intuitively, therefore subjects did not have the need to revert to the help means in both systems, and the improvements made to the help system were not salient enough to find a difference in the aspect of help.

Limitations in implementation of the design recommendations in the New system

A number of changes to the system according to the design recommendations were not implemented in the completely right manner. For example, it was not possible to record some of the new Payphone IVR voice menu items, due to the absence of the person who had recorded the original items, therefore the developers had to cut and paste existing audio files to make the new menu items. This workaround made some voice menu items sounding a bit unnaturally. This and several other implementation problems could be responsible for the lack of statistically significant improvement in users' opinions and may even account for the lower users rating of usability of the New system.

Limitations of the experimental setup

There were constraints in the ability to replicate the actual context of use and operation of the payment system, e.g. a customer support line, a full-fledged web site for help and support, seamlessly integrated into the Postbank's online help system, etc. Therefore the findings may be limited due to these compromises.

Gap between the design recommendations and their actual realisation

A high-level design recommendation might omit important details of the problem it is addressing. The design recommendations may not be describing particularly important aspects of the systems' implementation, and being correct in general might not target certain minor but still important facets of payment systems.

Lack of specifications how the design recommendations should be implemented

The design recommendations do not specify the exact formulation and manifestation of the system's aspects they suggest to change or improve. For example, suggesting to use privacy and security policies, the design recommendations do not give specific in-depth instruction about how these policies should be implemented. The experimenters had to refer to the industrial practice, reference sources and their best practice. This may confound with the experimental results, as it can be argued that all findings (positive or negative) are predicated upon the way the DRs are applied to the design of the New system. On the other hand, it is exactly the problem that will accompany the application of the design recommendations by practitioners in real life, and this is why the study has a high degree of realism.

5.5 Conclusions

This empirical study has succeeded in demonstrating the potential validity of certain design recommendations, acquiring new validated design knowledge, which was not available before the study. This experiment has given us a better insight in the design of user acceptance of electronic payment system from the user perspective. The design recommendations are a valuable output of the study, suggesting a design approach to e-commerce EPSs unmatched by any previous work in this direction, as far as it was possible to establish.

Chapter 6

Discussion and conclusions

6.1 Summary of the thesis

With the rapid development of Internet e-commerce the need for appropriate electronic payment systems (EPSs) to support online trade clearly emerges. An open challenge remains for developers of novel Internet-based payment systems to meet users' expectations, requirements, preferences and needs in design and exploitation of payment systems. Failure to meet them results in low usability, insecurity and inefficiency of payment systems and in eventual refusal of customers to use such systems. Design of new electronic payment systems from the user perspective is critical for the development and operation of payment systems that are well accepted by users, Chapter 1.

This thesis has described research activities aimed to investigate how e-commerce EPSs could be designed from the user-centered perspective in order to achieve user acceptance. The research has explored what validated design knowledge that should be communicated to designers of EPSs, so that end users will be willing to use the newly introduced EPSs for payments and personal finance in an e-commerce environment. This research aimed to understand the notion of user acceptance in the con-

text of e-commerce EPSs, which is defined as the demonstrable willingness of users to employ information technology for the tasks it is designed to support, (Dillon & Morris, 1996). This research has taken into account various factors that determine user acceptance of electronic payment systems, such as usability, privacy, security, trust and others, (Chapter 2).

A combination of various scientific and design activities, and practices of Human-Computer Interaction were involved: a literature study, a consumer survey, a qualitative diary study, and experimental research. These research activities helped to develop an in-depth view of user experience with payment systems and have suggested how to design or redesign EPSs to improve their chances of acceptance by end users.

In the first phase of the research, the characteristics and classification of EPSs were discovered, based on literature research. The literature review helped to generate ideas about why user acceptance is important for e-commerce EPSs. One of the challenges of this phase was conceptualising and understanding user acceptance in the specific context of EPSs.

To reveal actual user attitudes to the hypothesised determinants of user acceptance of EPSs, a consumer survey was conducted. It helped to identify what characteristics should be given more attention in the design of EPSs:

- applicability
- usability
- convertibility
- privacy
- reliability
- security
- trust.

However, the knowledge of the characteristics and their importance did not inform interaction design in terms of how the characteristics should be realised in EPSs. To acquire a deeper understanding of these issues, qualitative research in the method of a diary study was conducted.

The qualitative diary study investigated the user experience with e-commerce EPSs in the context of real use and over time. It helped to reveal problems that end users experience with electronic payment systems. Moreover, the study has discovered a number of positive findings. In many instances users took the initiative in suggesting solu-

tions for certain problems they encountered, and said what could be improved in the payment systems they used. This study was able to obtain more insight on social influences on users of online EPSs, a highly significant factor for users acceptance.

Implications for design of Internet-based payment systems have been derived and formulated as design recommendations. This stage marked the end of the data collection and the start of the development of design recommendations.

Design recommendations

A set of *recommendations for design* of e-commerce EPSs has been developed on the basis of research findings of this thesis, to assist design of future and improve current payment systems, Chapter 4. However, before suggesting to apply these recommendations for actual design of electronic payment systems there was a need to find evidence that their application would improve user acceptance of e-commerce EPSs.

To ensure the validity of these design recommendations, an experimental study of their application on an actual system from Postbank (the Netherlands) was conducted, Chapter 5. It helped to substantiate the validity of a subset of the design recommendations, gaining validated design knowledge that was not available beforehand. The design recommendations validated in the course of this work are the following (Chapter 5 and Appendix D):

DR 1. Inform users about security measures and provide a security policy.

DR 2. Explain what type and details of personal information are to be retained, why, and how they will be used.

DR 3. Provide a clear and explicit policy on privacy and make it noticeable to users.

DR 5. Allow users to control critical actions and information.

DR 6. Seek reputation and trust transference from reputed partners and technology providers, and communicate trust transference to users.

DR 7. Take measures to address risks and inform users about these measures.

DR 10. Provide features of automatization of payments.

DR 12. Provide well-designed Authentication.

The design recommendations that were not validated or were out of the scope of the experiment, described in Chapter 5, are the following:

DR 4. Give users control over the costs of the payment system usage.

DR 8. Interaction with the payment system should resemble users' expectations about the payments process.

DR 9. The interfaces should be presented in a logical, clear and understandable way.

DR 11. Provide features of customisation of payment environments.

Contributions

The contribution of this research is deeper knowledge about the user experience and users acceptance of EPSs. This research has discovered empirical evidence of the importance to users of various characteristics of EPSs, which have been traditionally used to describe electronic payment systems. The main contribution of this thesis is the set of recommendations for interaction design of electronic payment systems, with the scientific evidence of their validity.

The studies described in this thesis were conducted in realistic conditions and with potential users. The user survey, eliciting user attitudes towards EPSs, was able to embrace more than 1300 Netherlands-based respondents nation-wide. The recommendations for design were reviewed and applied by the actual developers of a commercially produced electronic payment system. This suggests the high realism of the application of the design recommendations and the high ecological validity of the research.

Before this research, the creation of the user experience and design for user-related factors of EPSs were mainly based on ad hoc practices, coming from related industries, such as banking. Interaction design was based on the models of banking web sites, e-commerce portals, online shops and similar applications. For instance interaction design of payment system Paypal.com resembles to a great degree a typical online shop, in both layout and interaction design. Designers of existing EPSs could use state-of-the-art methods to guide interaction design, for instance Nielsen's heuristics for Web design, (Nielsen, 1999). However, there have been no specific prescriptions for the design of e-commerce EPSs from the user perspective, besides technical or high-level requirements.

From the technical viewpoint, research and development of EPSs used to concentrate on general requirements for EPSs, such as functionality and technology, cryptography, networking, etc. However, the critique of literature in Chapter 2 has demonstrated

that this approach does not inform design for user acceptance of online EPSs sufficiently.

The in-depth knowledge received during this research about interaction design, understanding of user-related factors and issues of user acceptance in the context of online e-commerce EPSs was not available or well systematised prior to this thesis. This research has provided a more elaborate knowledge regarding design of electronic payment systems from a human-centered perspective compared to what was available before. This knowledge has been validated. Validity issues are described in the following sections.

6.2 Validity issues and limitations

There are several possible threats to validity of any empirical research. Gray & Salzman (1998) define two important issues that could permit making valid inferences from experimental results: cause-effect and generality. Let us look at these issues in the light of the empirical research activities of this thesis. The discussion below is based on work of Cook & Campbell (1979) and Gray & Salzman (1998).

6.2.1 Cause-effect validity

Cause-effect validity is concerned with making false inferences from the results, either false right or false wrong conclusions. The validation experiment was conducted to determine an effect of the design recommendations on users' attitudes and preferences of the systems under test. Causality lets us infer that the users' attitudes and preferences were influenced by the application of the DRs, and not other some other confounding factors.

An important aspect of cause-effect validity is internal validity, which is the approximate truth about inferences, regarding cause-effect or causal relationships. The question for internal validity is whether we can conclude if the controlled independent variable caused changes in the dependent variable, or whether another unaccounted covariate is responsible for the results.

Selection of users

One of the possible threats to internal validity of the experimental study, described in Chapter 5, is the selection of certain types of users and assigning them to experimental groups in such a way, that the effect is due to the individual differences between users, rather than the treatment, (Gray & Salzman, 1998).

To avoid a possible confounding effect of demographic parameters and experience, the participants were screened using demographics filters. The sample was further balanced based on these parameters and the users were divided in groups. The sampling model presumed further random assigning of the participants to the groups. This was done to avoid the bias of the selection, when participants assigned to the groups are unequal in some characteristics. The sample was checked for a possible imbalance of the demographics factors between the two groups, and no significant covariating variables were discovered.

In the user survey described in Chapter 3, the large sample size of more than 1300 respondents can be treated as representative of the population of Dutch users of payment systems, and can justify the conclusion about the stable effect. The large sample size also minimizes the influence of *wildcards*, i.e. people who significantly differ in positive or negative opinions from the average respondents, and whose responses to the conditions of the study reflect only their wildcard status.

6.2.2 Generality issues

Apart from the internal cause-effect validity, it is important to consider if we are allowed to *generalise* the results of the research activities to different types of systems, settings and times. Cook & Campbell (1979) refer to generality issues as *construct validity* and *external validity*.

Construct validity

Construct validity concerns if the experimenters manipulating what they claim to be manipulating, and if they are measuring what they claim to be measuring. Some of the design recommendations prescribe in what direction the system's functionality, features or content should be implemented. Different developers of e-commerce EPSs may have a varied understanding of a particular functionality or features. The exact

interpretation of the advice can be different from one practicing designer to another specifications developer. For example, when implementing a privacy policy according to the correspondent design recommendation, DR 3, there could be an endless number of variations for policies, based on how organisations view their attitudes to privacy. The reason for this is that the design recommendation, while prescribing the use of a privacy policy, does not specify the content of the privacy policy in every detail for every situation. The detailed description of a design recommendation is used to highlight the general direction of its use.

Claiming that the design recommendations are validated for *all* their detailed features is therefore not possible, because only some of these features were tried in the validation experiment. The multifaceted design recommendations were applied in one single way only. E.g. an alternative form of the privacy policy was not examined with the payment system under test. This limits the generalizing power of the results to some extent because of the threat of applying the design recommendations with *mono-operation bias*. Therefore, the design recommendations can be generalised only at the high level, where concrete details of realization do not step down from the general high-level advice. This is the cost one has to pay in order to test the application of design guidelines for the prescriptive use.

In addition, the design recommendations were applied to the validation of only *one* type of payment systems. From construct validity viewpoint this may comprise a limitation of *mono-method bias*. To avoid this threat to validity, validation experiments with other systems could have been conducted.

There was a little room for the threat of statistical *interaction* of different treatments in the validation experiment, because the participants worked with only one version of the payment system, i.e. were given only one treatment, which is determined by the between-subjects design, Chapter 5. However, a possible threat to generalisation is the interaction between system's features and their consequent influence on users' attitudes, especially between those features that were implemented in the New system. It is not always possible to draw the conclusion that a particular change in the system resulted in the intended change of user attitudes towards the EPS. For example, the claim that the design recommendations on trust are the only source of increased trust in the New system would have been unjustified due to the possible influence of other system's features and factors, such as reliability, new functionality or interaction design.

Finally, it should be considered whether the test users entertained the idea of *hypothesis-guessing*, i.e. the guesses participants make about how they should behave to make experimenters happy. While this threat cannot be completely dismissed, it is expected to have a low effect on the results, because the between-subjects experimental design presumes that the users were exercising with only one version of the system, and were not aware about existence of the other version, nor did they know which version they were using. The participants could of course have tried to give better marks to both systems than these would deserve, in order to please the experimenter. However, the New system has scored nevertheless better in many instances, and the differences are significant.

External validity

The results of the study may be prone to threats of external validity. External validity concerns the correctness of generalising towards particular target users, settings and times. Let us look at the possible threats to external validity of the generalisation of the research results.

Target users

One of the possible threats to external validity is a choice of certain types of users, who may be not representative of the target population of potential end users. It has been attempted to collect the most representative sample available. Some limitations are noted in this respect.

The participants for the diary study (Chapter 4) were selected mainly from the employees of the university campus. The reason for this was a very low reaction to the advertisement placed in the local newspaper. Participation of university administrative employees was a solution. The diary study involved 10 people who cannot possibly be considered representative of a population as large as the market for online EPSs. The participants related to the university may be a rather homogenous group in many respects, but their involvement in the university is irrelevant to their relation to EPSs. They were of course geographically very similar, but this seems to be a difficult effect to avoid. However, the diary study served as a data collection technique, and attempted to provide explanations of users' opinions and experiences, rather than generalise to a target population. The focus of the study was on the detail and depth of explanations, rather on the breadth of coverage. The final number of the participants was in accordance with the goals of the study.

To address this type of threat in the experimental study (Chapter 5) the users were carefully selected by the call centre of Postbank, based on the requirements of the study. The users of the nation-wide consumer survey (Chapter 3) with the sample size of more than 1300 respondents can be treated as representative of the population of potential users of payment systems in the Netherlands.

It would be possible to generalise the results to the heterogeneous population represented by all participants, and not possible to single out specific subpopulations. It cannot be said that the payment system under test would successfully appeal to e.g. just young people, pensioners, or students. It would be an error of external validity to generalise across these subgroups of the whole sample. Consequently, the DRs can be assumed to hold for the average user and not to be applied to any subgroup.

Context of use and the scope

The studies of this research attempted to be as realistic as possible. However, we should be cautious in claiming that generalisation of the results could transcend the setting and the context of the studies and be generalised to a wider range of settings, i.e. other EPSs, applications and context of use.

While admitting this, it has to be noted that the scope of the research was clearly defined from the very start and followed through the whole course of the research activities. Moreover, this research has identified a number of cases where the context of use is highly important for certain systems' requirements, users' attitudes towards EPSs, and consequently user acceptance. Therefore, the implications for design can be treated as valid only for the given scope and the context of use, described in Chapter 1.

The design recommendations emerged out of the qualitative research that considered electronic payments in real life situations, with the diary study recording real payments. The design recommendations were applied to a commercial payment system by the company-developer and therefore their application is tested in a realistic context. It can be said with confidence that the validation experiment and the diary study had a quite high degree of realism. In both studies the setting was consistent throughout the process of the studies and data collection. It can be concluded that the studies in this thesis are done with the high degree of ecological validity.

6.2.3 Conclusions

Having examined a comprehensive list of potential threats to the validity and generaliseability of the research presented in this thesis, it is argued that the design knowledge provided is useful and valid. The research activities of this thesis have a high degree of realism. The research included the nation-wide consumer survey, eliciting user attitudes towards EPSs of a large sample of Netherlands-based respondents. The qualitative diary study was able to investigate the actual user experience with online EPSs, and has provided grounded data, used for the hypothesising of the design recommendations.

For the validation of the design recommendations it was possible to form an alliance with the actual developers of an EPS and validate the DRs with a commercial payment system. The outcome of the experiment makes it possible to draw conclusions about the validity of certain DRs and the possibility to use them for the design of e-commerce EPSs. The high ecological validity and realism of the studies allow us to conclude about the success of this research.

6.3 Future work

This research attempted to embrace a wide spectrum of possible issues with user acceptance of e-commerce EPSs. Future research may focus on the further development and validation of the concept of user acceptance of EPSs. For instance a model of user acceptance of e-commerce EPSs may be developed and validated to become a reliable tool for gauging user acceptance of electronic payment systems and similar related technology. Future work can be concentrated on the validation of specific factors that can influence user acceptance. It can concern itself solely with just one of the issues, e.g. privacy, trust or security, usability.

Of course, the most natural continuation of this research would be to take the design recommendations even further. They can be further validated, enhanced and substantiated in the context of actual use or in larger scale experiments. It would be an interesting long term study to observe the effect of the design recommendations in a real life system on the market, to observe their relevance in a longer span of time, and to track down their development.

Further work on the design recommendations should try to resolve potential threats to their validity. On the one hand, the design recommendations can be used differently than in the presented study. Another way of the application and implementation of the design recommendations can improve a chance to avoid mono-operation bias, i.e. applying the design recommendations only in one way. This can also help to refine the details of the design recommendations. On the other hand, the design recommendations should be applied to other types of payment systems in order to avoid mono-method bias that could emerge if applying the DRs only to one type of EPSs. While the system used for the experimental study suits the scope of this research well, it would be interesting to test the design recommendations with a different type of payment systems. This will allow generalising the validity of the design recommendations to different EPSs and contexts of use.

A promising direction of future research is developing a system for evaluation of EPSs. This direction presumes creating evaluation models, methods, tools and techniques, etc. For instance, heuristic evaluations or checklists can be created for revealing problems with EPSs at the design stage, paving the way for improvements and changes in the current and future systems. These evaluation methods and tools can be then validated empirically.

In conclusion, future research has a great number of exciting opportunities. It can transcend the field of online EPSs and delve into other areas of e-commerce and future information technology.

Appendix A

User Survey Questionnaire

ALGEMEEN

1. Heeft u beroepsmatig te maken met betalingssystemen, bijvoorbeeld als bankmedewerker, onderzoeker of als software ontwikkelaar?

- 1 Ja
- 2 Nee

1a. In welke branche bent u werkzaam?

- 1 Landbouw & Visserij
- 2 Industrie en bouwnijverheid
- 3 Handel
- 4 Horeca
- 5 Vervoer & Communicatie
- 6 Financiële instellingen
- 7 Zakelijke dienstverlening
- 8 Openbaar bestuur
- 9 Onderwijs
- 10 Gezondheids- en welzijnszorg
- 11 Cultuur en overige dienstverlening
- 12 Wetenschap & Onderzoek
- 13 Anders

2. Wat is uw beroep?

GEBRUIK BETAALMIDDELEN

Wilt u de juiste getallen invullen en de relevante tijdsperiode omcirkelen. Indien u van een bepaald betaalsysteem geen gebruik maakt, kunt u een 0 invullen.

3a. Hoe vaak gebruikt u contant geld?

_____ keren per dag /week /maand/ jaar

3b. Hoe vaak gebruikt u een bankpas (of giropas)?

_____ keren per dag /week /maand/ jaar

3c. Hoe vaak gebruikt u een creditcard?

_____ keren per dag /week /maand/ jaar

3d. Hoe vaak gebruikt u een Chipknip/ chipper?

_____ keren per dag /week /maand/ jaar

3e. Hoe vaak gebruikt u een ander betaalmiddel, namelijk _____?

_____ keren per dag /week /maand/ jaar

4. Vindt u het belangrijk dat u met één betaalmiddel op de meeste plaatsen kunt betalen?

- 1 Zeer belangrijk
2 Enigszins belangrijk
3 niet belangrijk, niet onbelangrijk
4 Enigszins onbelangrijk
5 Zeer onbelangrijk

5. Wilt u voor onderstaande betaalmiddelen de mogelijkheid hebben om op meer plaatsen te betalen (dan u nu doet)?

		Helemaal niet	Enigszins	Zeker wel	Niet van toepassing
1	Contant	1	2	3	4
2	Bankpas/Giropas	1	2	3	4
3	Creditcard	1	2	3	4
4	Chipper	1	2	3	4
5	Creditcard op internet	1	2	3	4

Hieronder staan enkele soorten uitgaven. Wilt u voor elke uitgave aangeven op welke wijze u meestal betaalt?

		Contant	Pinnen	Eurocheque/giro-betaalkaart	Chipper	Creditcard	Klantenkaart	Anders ¹⁾
1	Dagelijkse levensmiddelen	1	2	3	4	5	6	7
2	Wekelijkse levensmiddelen	1	2	3	4	5	6	7
3	Meubelen	1	2	3	4	5	6	7
4	Duurzame huishoudelijke app. (audio video/tv/koelkast/etc.)	1	2	3	4	5	6	7

5	Kleding	1	2	3	4	5	6	7
6	Benzine	1	2	3	4	5	6	7
7	uit eten	1	2	3	4	5	6	7
8	Vakantie/dagje uit BINNENLAND	1	2	3	4	5	6	7
9	BINNENLAND geldopnames	1	2	3	4	5	6	7
10	BUITENLAND betalingen	1	2	3	4	5	6	7
11	BUITENLAND geldopnames	1	2	3	4	5	6	7

1) Namelijk:

7. Met welk betaalmiddel betaalt u meestal bij onderstaande bedragen?

	Bedrag:	Contant	Pinnen	Eurocheque/giro-betaalkaart	Chipper	Creditcard	Klantenkaart	Anders
1	Tot fl. 25,00	1	2	3	4	5	6	7
2	Van fl. 25,00 tot fl. 50,00	1	2	3	4	5	6	7
3	van fl. 50,00 tot fl. 100,00	1	2	3	4	5	6	7
4	van fl. 100,00 tot fl. 150,00	1	2	3	4	5	6	7
5	van fl. 150,00 tot fl. 250,00	1	2	3	4	5	6	7
6	van fl. 250,00 of meer	1	2	3	4	5	6	7

8. Bij welke bank heeft u uw belangrijkste betaalrekening?

- 1 Postbank
- 2 ABN Amro
- 3 Rabobank
- 4 Fortis Bank
- 5 SNS Bank
- 6 ING Bank
- 7 Andere bank, nl. _____

9. Hoeveel betaalrekeningen heeft u?

- 1 één betaalrekening
- 2 twee betaalrekeningen
- 3 drie betaalrekeningen
- 4 vier of meer betaalrekeningen

10. Hoe neemt u meestal contant geld op, aan de balie of bij de geldautomaat?

- 1 altijd aan de balie
- 2 meestal aan de balie
- 3 soms aan de balie, soms bij de geldautomaat
- 4 meestal bij de geldautomaat
- 5 altijd bij de geldautomaat

11. Hoeveel belang hecht u eraan om aan de balie van uw bank uw geld op te nemen?

- 1 zeer veel belang
- 2 redelijk belang
- 3 maakt niet zoveel uit
- 4 matig belang
- 5 geen belang

12. Wist u dat banken en winkels bijhouden wat uw betalingen zijn als u gebruik maakt van een bankpasje of een ander elektronisch betaalmiddel?

- 1 Ja
- 2 Nee

13. Als u gebruik maakt van elektronisch betalen wordt soms uw identiteit bekend bij de winkel. Weerhoudt u dat om gebruik te maken van een elektronisch betaalmiddel?

- 1 Ja, altijd
- 2 Soms
- 3 Nee, nooit

14. Bent u tevreden over de mate waarin een bankpas/ giropas u privacy biedt?

- 1 Zeer tevreden
- 2 Tevreden
- 3 Niet tevreden, niet ontevreden
- 4 Ontevreden
- 5 Zeer ontevreden
- 6 Weet niet

15. Bent u bezorgd over het feit dat een winkel weet wat u koopt als u elektronisch betaalt via een creditcard of bankpas?

- 1 Zeer bezorgd
- 2 bezorgd
- 3 Niet bezorgd, niet onbezorgd
- 4 Onbezorgd
- 5 Zeer onbezorgd
- 6 Weet niet

16. Banken en winkels kunnen fouten maken met uw geld. Zou u registratie willen van uw aankopen om deze fouten te kunnen aantonen, zoals verkeerde bedragen?

- 1 Zeker wel
- 2 Waarschijnlijk wel
- 3 Misschien wel, misschien niet
- 4 Waarschijnlijk niet
- 5 Zeker niet
- 6 Weet niet

17. Denkt u dat winkels de informatie over uw betalingsverkeer kunnen gebruiken om tot een betere dienstverlening te komen?

- 1 Zeker wel
- 2 Waarschijnlijk wel
- 3 Misschien wel, misschien niet
- 4 Waarschijnlijk niet
- 5 Zeker niet
- 6 Weet niet

18. Hoe belangrijk is het voor u dat gelden gemakkelijk overgezet kunnen worden van het ene naar het andere betaalsysteem bijv. van rekening naar contant geld?

		Ze er belang- rijk	Enigszins belangrijk	Niet belang- rijk, niet onbelangrijk	Enigszins onbelangrijk	Ze er onbe- langrijk	Niet van toepassing
1	Contant -> Rekening	1	2	3	4	5	5
2	Rekening -> Contant	1	2	3	4	5	5
3	Rekening -> Chipper	1	2	3	4	5	5
4	Chipper -> Rekening	1	2	3	4	5	5

19. In hoeverre bent u tevreden over de huidige situatie met betrekking tot het overzetten van geld tussen de verschillende betalingssystemen?

		Ze er tevreden	Tevreden	Niet tevre- den, niet ontevreden	Ontevreden	Ze er onte- vreden	Niet van toepassing
1	Contant -> Rekening	1	2	3	4	5	5
2	Rekening -> Contant	1	2	3	4	5	5
3	Rekening -> Chipper	1	2	3	4	5	5
4	Chipper -> Rekening	1	2	3	4	5	5

GEBRUIKSGEMAK

20. Soms functioneren betaalmiddelen niet zoals het hoort. Wat voor problemen heeft u wel eens ervaren met onderstaande betaalmiddelen bij een betalingsactiviteit?

		Bank- pas/Giropas	Chipper	Creditcard
1	Betalapparaat werkte niet waardoor ik niet met pas kon betalen	1	2	3
2	Transactie werd niet geaccepteerd	1	2	3
3	Mijn pas werd niet geaccepteerd	1	2	3
4	Er is meer van mijn rekening afgeschreven dan ik heb betaald	1	2	3
5	Anders, nl.	1	2	3
6	Geen problemen	1	2	3

21. Heeft u een voorkeur voor een bepaald betaalmiddel omdat het makkelijk in het gebruik is?

- 1 Ja, voorkeur voor bankpas/ giro pas
- 2 Ja, voorkeur voor Chipper
- 3 Ja, voorkeur voor Creditcard
- 4 Ja, voorkeur voor contant geld
- 5 Ja, voorkeur voor ander betaalmiddel, namelijk _____
- 6 Nee, geen voorkeur

BETALEN VIA INTERNET

22. Bestelt u wel eens via Internet artikelen of diensten, die vervolgens betaald moeten worden?

- 1 Ja
- 2 nee => ga door naar vraag 34

23. Wanneer u wel eens via Internet bestelt, op welke wijze betaalt u dan meestal?

- 1 Creditcard
- 2 Credit card met SET-certificaat
- 3 Maestro met SET-certificaat
- 4 Betalen met digi-pas
- 5 Telebankieren
- 6 Contante betaling
- 7 Betaalcheque
- 8 Pinpas
- 9 Chipper
- 10 Via een eenmalige machtiging
- 11 D.m.v. een factuur of acceptgiro
- 12 Op rekening
- 13 Anders

24. Welke betalingswijze bij internet-aankopen heeft in het algemeen uw voorkeur?

- 1 Creditcard
- 2 Credit card met SET-certificaat
- 3 Maestro met SET-certificaat
- 4 Betalen met digi-pas
- 5 Telebankieren
- 6 Contante betaling
- 7 Betaalcheque
- 8 Pinpas
- 9 Chipper
- 10 Via een eenmalige machtiging
- 11 D.m.v. een factuur of acceptgiro
- 12 Op rekening
- 13 Anders

25. Bent u bezorgd, wanneer u via Internet betaalt, dat er misbruik kan worden gemaakt van uw gegevens?

- 1 Nee
 - 2 Ja, omdat
-
-

26a. Wat is volgens u het meest veilige betaalmiddel voor betalingen via Internet?

- 1 Creditcard
- 2 Credit card met SET-certificaat
- 3 Maestro met SET-certificaat
- 4 Betalen met digi-pas
- 5 Telebankieren
- 6 Contante betaling
- 7 Betaalcheque
- 8 Pinpas
- 9 Chipper
- 10 Via een eenmalige machtiging
- 11 D.m.v. een factuur of acceptgiro
- 12 Op rekening
- 13 Anders

26b. Wat is volgens u het minst veilige betaalmiddel voor betalingen via Internet?

- 1 Creditcard
- 2 Credit card met SET-certificaat
- 3 Maestro met SET-certificaat
- 4 Betalen met digi-pas
- 5 Telebankieren
- 6 Contante betaling
- 7 Betaalcheque
- 8 Pinpas
- 9 Chipper
- 10 Via een eenmalige machtiging
- 11 D.m.v. een factuur of acceptgiro
- 12 Op rekening
- 13 Anders

27. Heeft u ooit een creditcard gebruikt om te betalen op het Internet?

- 1 Ja
- 2 Nee => ga door naar vraag 30

28. Hoe gemakkelijk was het om op het Internet met een creditcard te betalen?

- 1 Zeer gemakkelijk
- 2 Gemakkelijk
- 3 Niet moeilijk, niet makkelijk
- 4 Moeilijk
- 5 Zeer moeilijk

29. Wat zijn de voornaamste problemen die u heeft ervaren bij creditcard betalingen via Internet?

- 1 Weigering Creditcard
- 2 Verkeerd bedrag afgeschreven
- 3 Creditcardnummer gestolen
- 4 Het moeten opgeven van allerlei persoonsgegevens voordat transactie plaats kon vinden
- 5 Anders, namelijk _____
- 6 Geen problemen

30. Hoe belangrijk vindt u het om kleine betalingen (minder dan fl. 3,00) te kunnen doen via Internet?

- 1 Zeer belangrijk
- 2 Enigszins belangrijk
- 3 niet belangrijk, niet onbelangrijk
- 4 Enigszins onbelangrijk
- 5 Zeer onbelangrijk

31. Voor wat voor producten zou u het handig vinden kleine betalingen via Internet te kunnen doen?

- 1 Artikelen
- 2 Rapporten en verslagen
- 3 Advies over producten en diensten
- 4 Kranten en tijdschriften
- 5 Bieden bij veilingen
- 6 Muziek, video op internet
- 7 Anders, namelijk _____
- 8 Ik vind kleine betalingen via internet niet nodig
- 9 Weet niet

32. Heeft u ooit geld verloren als gevolg van een beveiligingsprobleem op het Internet?

- 1 Ja
- 2 Nee => ga door naar vraag 34

33. Heeft dit u weerhouden van verdere betalingen via dit Internet betaalmiddel?

- 1 Ja
- 2 Nee

BETROUWBAARHEID & VEILIGHEID

34. Heeft u een voorkeur voor een bepaald betaalmiddel omdat het betrouwbaarder is?

- 1 Ja, voorkeur voor bankpas/ giropas
- 2 Ja, voorkeur voor Chipper
- 3 Ja, voorkeur voor Creditcard
- 4 Ja, voorkeur voor contant
- 5 Ja, voorkeur voor ander betaalmiddel, namelijk _____
- 6 Nee, geen voorkeur

35. Is de beveiliging van betalingen belangrijk voor u als u gebruik maakt van een elektronisch betaalmiddel?

- 1 Zeer belangrijk
- 2 Enigszins belangrijk
- 3 niet belangrijk, niet onbelangrijk
- 4 Enigszins onbelangrijk
- 5 Zeer onbelangrijk
- 6 Weet niet

36. Houdt u op met gebruik te maken van een betaalmiddel als u hoort dat er beveiligingsproblemen mee zijn?

- 1 Zeker wel
- 2 Waarschijnlijk wel
- 3 Misschien wel, misschien niet
- 4 Waarschijnlijk niet
- 5 Zeker niet
- 6 Weet niet

37. Welke van genoemde elektronische betaalmiddelen vermijdt u omdat u de beveiliging ervan wantrouwt?

(meerdere antwoorden mogelijk)

- 1 bankpas/ giropas
- 2 Chipper
- 3 Creditcard
- 4 Ander betaalmiddel, namelijk _____
- 5 Geen

38. Is het belangrijk voor u dat er geen sporen zijn van uw elektronische betalingen, zoals uw naam, rekeningnummer, of adres?

- 1 Zeer belangrijk
- 2 Enigszins belangrijk
- 3 niet belangrijk, niet onbelangrijk
- 4 Enigszins onbelangrijk
- 5 Zeer onbelangrijk
- 6 Weet niet

39. Bent u bezorgd over het feit dat uw bronnen van inkomsten bekend zijn bij organisaties waar u koopt?

- 1 Zeer bezorgd
- 2 bezorgd
- 3 Niet bezorgd, niet onbezorgd
- 4 Onbezorgd
- 5 Zeer onbezorgd
- 6 Weet niet

VERTROUWEN

40. Is het belangrijk voor u dat andere mensen vertrouwen in het betalingssysteem hebben dat u gebruikt?

- 1 Zeer belangrijk
- 2 Enigszins belangrijk
- 3 niet belangrijk, niet onbelangrijk
- 4 Enigszins onbelangrijk
- 5 Zeer onbelangrijk
- 6 Weet niet

41. Als een nieuw systeem wordt geïntroduceerd, vertrouwt u dan elk willekeurig organisatie, of alleen gevestigde organisaties zoals banken?

- 1 Elk
- 2 Alleen gevestigde organisaties

42. Houdt u op om een betaalmiddel te gebruiken als u er vertrouwen in verliest?

- 1 Zeker wel
- 2 Waarschijnlijk wel
- 3 Misschien wel, misschien niet
- 4 Waarschijnlijk niet
- 5 Zeker niet
- 6 Weet niet

43. Vindt u dat een winkel u de keus moet bieden om te kunnen betalen met het betaalmiddel van uw keuze?

- 1 Ja
- 2 Soms
- 3 Nee
- 4 Weet niet

44. Voelt u zich meer op uw gemak bij betalingen waar u gebruik maakt van iets tastbaars (bijv. een bankpas)?

- 1 Zeker wel
- 2 Enigszins
- 3 Helemaal niet
- 4 Weet niet

45. Is het belangrijk voor u dat u op elk moment kunt zien hoeveel geld u heeft?

- 1 Zeer belangrijk
- 2 Enigszins belangrijk
- 3 niet belangrijk, niet onbelangrijk
- 4 Enigszins onbelangrijk
- 5 Zeer onbelangrijk.

Appendix B

Survey Results

Demographic data

Number of participants N = 1328.
Mean age= 53.26 years, std. deviation = 10.9, N = 1328.
Gender: Men = 48.2% (640), Women = 51.8% (688).
Occupation related to payment systems: Yes= 5.2%, (69 participants).
Have performed Internet payments: 19.4%, (258 participants).

Legend

N = number of responses. Smart cards are: Chipper and Chipknip.
Questions marked with * were answered only by those who made Internet payments (19.4%).
The questionnaire was translated from Dutch.

Anonymity

1. Are you aware that banks or shops can keep records about your payments when you use debit cards and other electronic payment systems?

Yes	No	Total N
60.5%	39.5%	1320

2. When using an electronic payment, you can reveal your identity to a shop. Does it sometimes stop you from using the particular payment system?

Yes	Sometimes	Never	Total N
4.0%	23.2%	72.8%	1312

3. Are you comfortable with the level of privacy that is provided by debit cards?

Very much	Quite comfortable	Neutral	Not really	Not at all	Total N
5.4%	46.8%	39.6%	6.4%	1.9%	1238

4. Are you concerned that a shop may know what kind of things you buy when you pay electronically, e.g., with a credit card or debit card?

Very much	Quite likely	Neutral	Not really	Not at all	Total N
2.5%	11.0%	54.5%	24.9%	7.0%	1297

5. Banks and shops can make mistakes with your money. Do you want to have records of your purchases to be able to prove these mistakes, like overbilling?

Very much	Quite likely	Neutral	Not really	Not at all	Total N
38.7%	34.2%	14.6%	9.9%	2.5%	1268

6. Do you think that shops can use your payment records to provide you with better customer service?

Very much	Quite likely	Neutral	Not really	Not at all	Total N
9.8%	40.6%	24.8%	19.0%	5.8%	1257

Convertibility

7. Is it important for you, when using a payment system, that funds can be easily converted into other payment systems?

	Cash -> Account	Account -> Cash	Account -> Smart cards	Smart cards -> Account
Very important	49.6 %	73.4 %	15.6 %	10.5 %
Quite important	31.3 %	20.7 %	19.3 %	13.8 %
Neutral	11.5%	4.6 %	20.5 %	23.9 %
Quite unimportant	4.3 %	.5 %	9.7 %	12.1 %
Very unimportant	3.3%	.8 %	34.9 %	39.8 %
Total N	1292	1294	834	812

8. Are you satisfied with how your money is converted between different payment systems?

	Cash -> Account	Account -> Cash	Account -> Smart cards	Smart cards -> Account
Very satisfied	16.5%	32.1%	12.7%	3.6%
Satisfied	53.3%	55.0%	34.5%	17.6%
Neutral	19.6%	9.1%	20.1%	24.9%
Dissatisfied	7.6%	2.7%	6.3%	7.1%
Very dissatisfied	3.1%	1.0%	26.4%	46.8%
Total N	1243	1285	527	449

Ease of use

9. Do you prefer using one particular payment system over another because it's easier to use?

Debit cards	Cash	Credit cards	Smart cards	Other	Total N
75.2%	10.4%	5.0%	3.0%	8%	1253

10. To what extent did you find it easy to pay over the internet with a credit card? *

Very easy	Easy	Neutral	Difficult	Total N
68.2%	28.0%	3.0%	8%	132

11. Do you feel more comfortable with payments when you are using something tangible to pay with (e.g. a debit card)?

Very much so	Quite likely	Not at all	Total N
46.5%	35.2%	18.4%	1166

12. Is it important that you are able to find out at any moment how much money you have?

Quite important	Very important	Neutral	Quite unimportant	Very unimportant	Total N
36.0%	42.1%	15.0%	4.8%	2.2%	1310

Efficiency

13. How important it is for you to be able to make small payments over the Internet? *

Very important	Quite important	Neutral	Quite unimportant	Very unimportant	Total N
2.0%	11.4%	25.2%	13.0%	48.4%	246

14. Can you think of cases where small payments over the Internet can be useful? *

Don't need small payments	Bidding at auctions	Goods	Advice on products and services	Total N
54.8%	5.1%	17.8%	3.6%	197
Stock research, report	Press	8.6%	1.5%	
Music/video	Other	7.1%	1.5%	

Reliability

15. Do you prefer one particular payment system to another because it is more reliable?

Debit cards	Credit cards	No preference	Other	Total N
55.3%	2.8%	24.7%	1.3%	990
Cash	Smart cards	15.1%	.8%	

Security

16. Is security of payments important for you when you use an electronic payment system?

Very important	Quite important	Neutral	Quite unimportant	Very unimportant	Total N
84.7%	13.7%	1.2%	.3%	0%	1295

17. Will you stop using a payment system if you hear about a security breach in the payment system?

Absolutely yes	Quite likely	Neutral	Probably not	Not at all	Total N
25.9%	49.4%	19.7%	4.1%	.8%	1302

18. Would you refrain from using any electronic payment system because you think it's not secure?

	Debit cards	Smart cards	Credit cards	Other	No preference
Yes	3.3%	17.1%	18.8%	5.0%	62.4%
No	96.7%	82.9%	81.2%	95.0%	37.6%
Total N	1314	1314	1314	1314	1311

Traceability

19. Is it important that no traces are left of your electronic payments, like your name, bank account, or address?

Very important	Quite important	Neutral	Quite unimportant	Very unimportant	Total N
27.0%	31.3%	27.5%	8.0%	6.1%	1269

20. Are you concerned that sources of your income can be known by vendors, i.e. the organisations you buy from?

Very concerned	Concerned	Neutral	Not concerned	Not at all	Total N
16.1%	29.2%	41.4%	10.4%	2.9%	1262

Trust

21. Is it important that other people also trust the payment system you use?

Very important	Quite important	Neutral	Quite unimportant	Very unimportant	Total N
34.9%	37.3%	19.3%	3.9%	4.4%	1271

22. If a new payment system is introduced, will you trust *any* organisation that issues it, or only an established one, like a bank?

Established	Any	Total N
97.6%	2.4%	1289

23. Would you stop using a system if you feel that it's not trustworthy?

Certainly	Quite likely	Neutral	Rather not	Not at all	Total N
46.1%	48.3%	4.8%	.8%	.1%	1311

Applicability

24. Do you think a good shop should offer you the choice to pay with any payment system you like?

Agree	Partly agree	Disagree	Total N
85.8%	12.0%	1.3%	1313

25. Is it important that you can use one single particular payment system in most places you have to pay?

Very important	Quite important	Neutral	Quite unimportant	Very unimportant	Total N
59.8%	28.3%	9.6%	1.2%	1.0%	1285

26. Which of the following payment systems you would like to use in more points of sale?

	Cash	Debit cards	Credit cards	Smart cards	Credit cards on the Internet
Not at all	52.4%	21.3%	31.0%	48.3%	65.7%
Sometimes	11.8%	25.5%	31.4%	17.3%	23.5%
Certainly	35.7%	53.2%	37.6%	34.4%	10.8%
Total	1123	1255	827	729	591

Appendix C

Questionnaire for measuring computer and Internet experience in the diary study (Chapter 4).

How do you feel about working with computers?

- I don't like working with computers
- I have no strong like of dislike working for with computers
- I like working with computers
- Other

Do you enjoy learning how to use new software applications?

- Yes Sometimes Never
- Other (please describe)

How enthusiastic you are about technology?

- Very little ① ② ③ ④ Very enthusiastic

Have you performed the following activities online? (check all that apply)

- ordered a product/service from a business, government or educational entity by filling out a form on the web
- made a purchase online for more than €50/fl.100
- created a web page
- customized a web page for yourself (e.g. MyYahoo, CNN Custom News)
- changed your browser's "start-up" or "home" page
- changed your "cookie" preferences
- participated in an online chat or discussion (not including email)
- listened to a radio broadcast online

- made a telephone call online
- used a nationwide online directory to find an address or telephone number
- taken a seminar or class about the Web or Internet
- bought a book to learn more about the Web or Internet

How would you describe your general level of computer experience?

- None (I have never used any software applications)
- Low (I have used only one two software applications)
- Moderately low (I have used between three and ten software applications)
- Moderately high (I have used more than ten software applications)
- High (I have used more than ten software applications and have programming experience)
- Other

Do you have experience with one or more of the following? (check all that apply)

- Credit cards on the Internet
- Credit cards offline
- Credit or Debit cards with pin-code
- An electronic payment system on the Internet

What is the name of the payment system you are going to use for this study?

How long have you been using the system (tick one time period that applies)?

_____ **weeks** **months** **years**

How frequently do you use your payment system for payments (tick one time period that applies)?

..... times per: **day** **week** **month** **year**

How many payments on average do you do in one session (tick one time period that applies)?

_____ payments **per session**

Appendix D

Design recommendations

Structure of a design recommendation

The design recommendations are laid out in a structured template form:

- Number and title
- Detailed description
- Recommendation type
- General problem
- Examples, known uses
- Expert comments.

The following section lists all design recommendations in detail. For the ease of the overview a summary is provided below.

Overview of the design recommendations

- DR 1. Inform users about security measures and provide a security policy.
- DR 2. Explain what type and details of personal information are to be retained, why, and how they will be used.
- DR 3. Provide a clear and explicit policy on privacy and make it noticeable to users.
- DR 4. Give users control over the costs of the payment system usage.
- DR 5. Allow users to control critical actions and information.
- DR 6. Seek reputation and trust transference from reputed partners and technology providers, and communicate trust transference to users.
- DR 7. Take measures to address risks and inform users about these measures.
- DR 8. Interaction with the payment system should resemble users' expectations about the payments process.
- DR 9. The interface should be presented in a logical, clear and understandable way.
- DR 10. Provide features of automatisations of payments.
- DR 11. Provide features of customization of payment environments.
- DR 12. Provide well-designed authentication.

The expert comments on the recommendations were made by an expert consultant of the Postbank's Department of New Business Technology in relation to Postbank Betaallijn (Chapter 5), and quoted as personal communication, (Krabbenbos, 2003).

Design recommendations in detail

DR 1. Inform users about security measures and provide security policy.

Detailed description:

- Security policy: the existence and strength of security measures used in the payment system to protect users should be clearly explained to the users. This can be done by providing information in e.g. a paper manual, online help, or dedicating a part of the web site to the security policy.
- Provide clear visibility of security measures employed. This can be done by describing which security measures and technology have been used and implemented.
- Explain why the system is secure for transactions.
- Provide customer support (online or telephone) on security-related issues.
- Supply regular information updates on changes and upgrades in security and the security policy; show the date of the latest update.
- Address security issues specific to 1) a single payment (e.g. communicate to the users security of transactions), and to 2) the system's operations in general, (e.g. provide ability to deactivate passwords or block accounts offline by phone).
- If using services or technology from reputed security institutions or companies, inform the users about this cooperation, e.g. demonstrate security seals or logos of the security organisations.
- Explain which security measures are employed for information management and storage, provided that such information will not compromise security.
- Do not try to cheat hackers by providing wrong and misleading information about the system. Hackers will know the real situation via different means, however the potential harm of misinforming the users may damage the reputation severely.

Recommendation type: trust, security.

General Problem: Without believing or understanding that the payment system is secure, users will not use it because they may fear certain risks, be afraid they could lose

their money, and as a result will not trust the system. Even a secure system is not necessarily perceived as such, because security technologies and measures are not always visible to the users. This can be repaired by this recommendation.

Example: Dutch payment system Global Collect provides textual information in a dedicated web site section describing which security solutions and measures have been implemented. It explains why the system is secure for transactions, Figure D1. Example of a security logotype is presented in Figure D2.



Figure D1. Example of a security policy and help.
Source: Global Collect, July 2002.

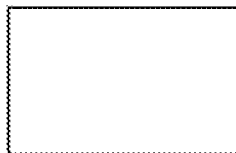

Figure D2. SSL security logo. Source: Thawte

Expert comments: "This design recommendation is testable by showing two different product brochures or websites (from accepting merchants).

In our test (the proof of concept of the Betaalijn) we have used:

- Our trusted brand
- A brochure with information
- FAQ list online
- No [security] signs, logos.'

DR 2. Explain what type and details of personal information are asked, why, and how they will be used and retained

Detailed description:

- Provide explanations why the requested personal details are necessary and how these details will be used in the system.
- Do not request users to supply more personal information than necessary, even if you do not consider this information to be of (critical) importance to the users.
- Be sure that information asked is within context of this particular payment situation, and no unrelated or loosely connected information is asked.
- Take into consideration how critical the personal information is 1) to the *users* in the given payment situation and 2) to the *context and types of payments* which the users are planning to make. If the requested information is too critical in any of these cases, the users may refrain from paying with the system.

Recommendation type: trust, privacy.

General Problem: Users may not trust and avoid using a system that does not provide explanation on how personal details are used and why they are necessary, fearing misuse and possible risks associated with revealing their personal information.

Example: Payment system for ebay.com auctions Billpoint provided the detailed explanation about what information is collected, Figure D3.

Expert comments: "Testable by showing two different product brochures or websites (from accepting merchants). In our test we have used: No information about personal information".

<p>Help</p> <p>Who will see my information?</p> <p>eBay Payments / Billpoint is fully committed to protecting the privacy of all of your personal information, as well as information related to your transactions. eBay Payments / Billpoint does not sell or share any of your personal information.</p> <p>eBay Payments / Billpoint only provides the seller with the information necessary to communicate with you effectively and to successfully complete your order. eBay Payments /</p> <p>Billpoint shows the seller the following information:</p> <p>Name Telephone Number E-mail Address Billing Address Shipping Address</p> <p>eBay Payments / Billpoint does NOT show the seller your credit card number or your checking account number, and the seller will not need to collect it from you for any reason in order to complete a transaction.</p> <p>To find out more about how eBay Payments / Billpoint safeguards your privacy, please visit the eBay Payments / Billpoint Privacy Policy.</p>	<p>Privacy policy</p> <p>Our Commitment to Privacy</p> <p>To help customers better understand the personal information we gather and the practices we employ, Billpoint has developed a set of privacy policies. These policies encompass several categories and attempt to answer the following questions:</p> <p>How is personal information collected, used, and disclosed? How can users cancel the service? How does Billpoint use cookies? How does Billpoint secure your information?</p> <p>How is Personal Information Collected?</p> <p>Personal information might be collected from you in several ways:</p> <p>When you first registered with Billpoint</p> <p>When you initially open a Billpoint account, we require your name, phone number, e-mail address, mailing address, billing address, credit card number, and credit card expiration date.</p> <p>When you buy</p> <p>When you purchase an item from a Billpoint seller, we require your name, e-mail address, phone number, billing address and shipping address. For credit card transactions, we require your credit card number and credit card expiration date.</p> <p>When you register with co-branded partners</p> <p>Billpoint is sometimes offered through other Internet services. We refer to these services as "our co-branded partners". If you pre-register for the Billpoint service through one of our co-branded partners, that website may provide personal information about you to Billpoint.</p>
---	--

Figure D3. Example of help and a privacy policy. Source: BillPoint, a payment service for e-bay auctions, July 2002.

DR 3. Provide a clear and explicit policy on privacy and make it noticeable to users

Detailed description:

- Have a privacy policy for the payment system; explain the privacy policy in a clear and understandable way. Explain how personal information is stored and protected and who will have access to it, taking into account DR 2. Convince users that you will not sell or give out the personal information.
- Make the privacy policy visible and easily accessible by providing a link to it on all pages of the web site, include it in the manual, other documentation and in press advertising campaigns. Even if the users do not read the privacy policy, its presence could support a more trustworthy impression.
- Expose 'seals of privacy' issued by privacy monitoring organisations, or other similar privacy-related attributes.
- If the privacy policy is compliant with privacy laws or directives inform users about that (European privacy acts or directives, e.g. European Commission Data Protection Directive 95/46/EC).
- Do not use any personal information in another way than is stated in the privacy policy, unless the different use of this information is regulated or imposed by laws, (e.g. ordered by court).
- Provide regular updates on changes in the payment system's privacy policy.

Recommendation type: trust.

General Problem: Absence of a policy on privacy can undermine trust in the system. Unexpected or unexplained use of the personal information destroys trusts.

Examples: Most e-commerce web sites, e.g. Amazon.com, provide links to privacy at the registration pages. A considered privacy policy is present at the biggest e-commerce and business web sites, (e.g. ebay.com, idc.com, Amazon.com), see Figure D3 for the privacy policy of ebay.com's Billpoint payment system. An example of a privacy seal is in Figure D4.

Expert comments: "Testable by showing two different product brochures or websites (from accepting merchants). In our test we have used: No information on privacy/anonymity".

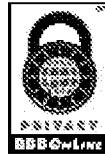

Figure D4. Privacy seal of BBBOnline.org

DR 4. Give users control over the costs of the payment system usage

Detailed description:

- Give users a complete and transparent overview of the costs associated with the use of the payment system.
- Provide a clear explanation of the costs involved in using the system (ownership costs, transaction costs). Hiding the costs can initially attract a number of users, but may also create bad publicity, which could be very harmful for the reputation.
- In costs calculations include all the taxes that a physical person should pay, e.g. VAT.
- If possible, offer sponsoring of any new EPS hardware and software required for the payment system, or consider providing it free charge.
- If the business model allows it, consider providing free use of the payment system to end users, relaying the transaction fees onto the merchants or the payees.

Recommendation type: control, trust.

General Problem: Promotion and usage costs that are placed on users may make the system less attractive to them. Hidden costs that appear in the course of later use may undermine trust in the payment system.

Example: Dutch banks ABN-AMRO and Rabobank provide hardware code calculators required for authentication in their e-banking services for free, as on June 2003. Online payment system PayPal is clear about the fee schedule for payments and offers discounts for loyal users. PayPal does not charge end users for sending and receiving

money; instead the merchant side pays the transaction fee. Figure D5 illustrates the fee schedule of PayPal.com.

	Personal Account	Premier/Business Account
Open an Account	Free	Free
Send Money	Free	Free
Withdraw Funds	Free for U.S. bank accounts Fees for non-U.S. banks	Free for U.S. bank accounts Fees for non-U.S. banks
Add Funds	Free	Free
Receive Funds	Free	0.7% + 30¢ to 2.9% + 30¢†
Multiple Currency Transactions	Exchange rate may apply*	Exchange rate may apply*

Figure D5. Example of the fee schedule of PayPal.com, August 2002.
Source: PayPal.com.

Another interesting example of promotion of a payment system through the cost reduction for consumers is the use of Dutch payment system Moxmo for SMS payments on a Dutch TV show web site. It was possible to submit a vote to the show by sending SMS messages via the web site, paying for the messages with money from the Moxmo-wallet, instead of sending them via telecom operators. As a result, an SMS was 10 cents cheaper. Moxmo offered a clear overview and control over the costs of the paid SMS messages, Figure D6. This feature might attract some customers to use the payment system in the future.

Expert comments: “Testable by offering two different product brochures or different online information.

In our test we have used:

- 020 – phone number as only cost.
- Testable by offering [free] 0800 and [paid] 0900 number”.

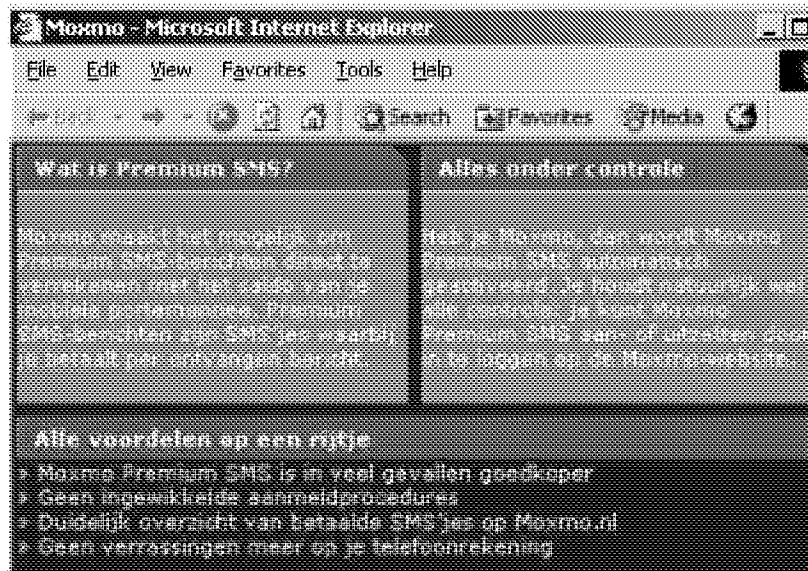

Figure D6. Promoting Moxmo payment system via cost benefits,
Source: www.idols.nl

DR 5. Allow users to control critical actions and information

Detailed description:

- Users should have ability to rollback and cancel a payment any time before finally committing to it. The 'point of no return' when the payment is definitely made should be delayed as far as possible. A common practice of respectable Internet shops is to charge for an order just before the shipping is ready, e.g. even if the order is placed users may want to cancel it before it is dispatched. Despite the fact that merchants want to receive the payment as soon as possible, cancelling the payment may be easier and cheaper for the merchant than refunding it.
- Provide the ability to change all personal information, such as names, addresses, email, contact details, etc. Provide reasonably easy ways to change the data, for example, make it easier than going through the registration process once again to create a new account.
- Provide the possibility to recover passwords that is relatively easier in comparison to the registration process to create a new account.

- Provide the ability to deactivate passwords or block accounts offline, for instance by telephone.
- Provide alternative ways of authentication (e.g. biometrics, code calculators).
- Provide a clear and visible feedback on all payment tasks and actions. Provide transactions statements to make control over transactions easier and to help to detect problems.

Recommendation type: control, trust, usability.

General Problem: The inability to correct errors or cancel wrong actions deprives users from the feeling of control over the situation and can eventually undermine trust. Unable to recover passwords, or change their personal data, users may have to register once more, which is unacceptable from the perspectives of usability and performance. Limited ability to change, modify and remove data can undermine trust and lower usability.

Example: Rollback and order cancellation of an order are implemented at the web site of bookseller Amazon.com, and in most of Internet shops. An example of account management is presented in Figure D7.

Expert comments: “Testable by offering two different processes or two different product brochures. In our test we have used:

- 1a. [Possibility of a] rollback
- 1b. ‘Point of no return’ is very late
- 1c. Cancellation is possible.
- 2a. Refund is not possible within the system, paid = paid
- 2b. Deactivate and block the code was a test-period-only procedure”.

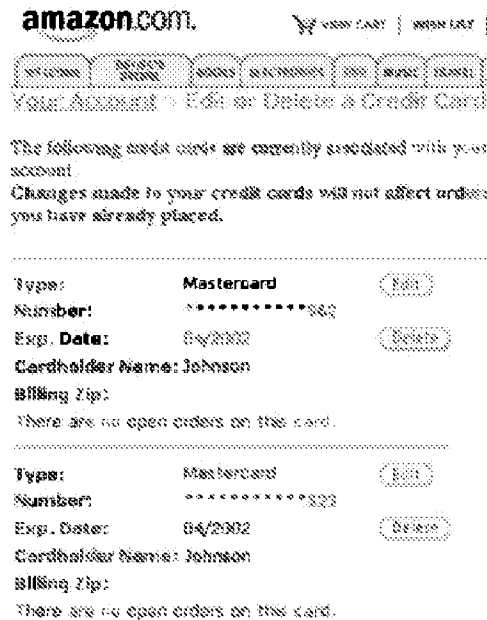

Figure D7. Updating credit card information in the account management of the web site. Source: Amazon.com, account management, July 2002.

DR 6. Seek reputation and trust transference from reputed partners and technology providers, and communicate trust transference to users

Detailed description:

- Seek cooperation and backing from reputed organisations to achieve transference of their reputation and users' trust to the payment system.
- Inform users about partnerships or business relationships with reputed technology, financial, business and government institutions.
- The place to communicate this information to users is help, about, documentation, FAQ sections, etc.
- Be reviewed by trusted third parties, display their logos for and provide links to their websites. Expose 'seals of trust' or other similar trust related attributes.

Recommendation type: trust

General Problem: The lack of trust from other organisations can undermine users' trust. A new, unknown company may fail to gain user trust without trust transference from other trusted organisations.

Example: See Figures D2 and D4 for examples of using logos of reputed organisations for trust transference.

Expert comments: "Testable by showing two different product brochures or websites (from accepting merchants) with and without logo, brand, etc. In our test we have used:

- Our own trusted brand with an unknown product name;
- No additional [trusted] signs".

DR 7. Take measures to address risks and inform users about these measures

Detailed description:

- Make sure that customers are aware of the risks associated with the use of the payment system, communication channels, with the destination and amount of payment, with revealing personal information to a payee, etc. Communicate these risks to users in an understandable manner. Explain what measures are taken to counter these risks and reassure users it is safe to use the payment system.
- Demonstrate the image of the company operating the system as professional and competent. Provide detailed company and contact information.
- The system should create its added value to justify the risk taking, and it should be clearly communicated and evident to users.
- There should be a clear statement that the money used in the system originate from a real government monetary system and will be accepted by other parties.
- Create a policy to resolve situations when feared events happen (e.g. define a refund policy in case of losses).
- If applicable, provide users and merchants with an insuring coverage for losses, damages, etc., caused by the use of the payment system.
- Communicate to users encouraging publicity about the system. It can help to alleviate certain users' fears about risks.

- Address risks associated with the use of novel or controversial technology, such as biometrics systems for authentication, explain how EPS customers are protected from these risks and how they will benefit from the new technology.

Recommendation type: trust.

General Problem: Not addressing risks undermines trust. Misconception about risks can lead to insecure user behaviour, and can eventually decrease trust.

Examples: Insurance provided by online stock broker E*Trade provides protection of customers' money in case of calamities. Many web sites, e.g. Amazon.com, PayPal, Global Collect, provide protection of transactions with a secure SLL connection and explain in detail why paying at their sites is secure.

Expert comments: "Testable by showing two different product brochures or websites (from accepting merchants). In our test we have used:

- Our trusted brand
- Brochure with information and product conditions
- FAQ list online".

DR 8. Interaction with the payment system should resemble users' expectations about the payments process

Detailed description:

- Interaction should resemble users' model and expectations of payments process based on their previous experience and current needs. If the system introduces new concepts and models of paying, the users should be educated to get used to these innovations.
- Employ user testing to find out if users perceive the interaction with the system adequately.
- Avoid frequent changes in the logic of interaction over time.
- Ask user input in a sequence of simple and well-explained steps.
- Render the interaction and user interface in a form of familiar payment applications (e.g. automatic teller machine, bank payment blanks and records, credit cards, etc.). Consider if it is appropriate to render user interactions in a way that

resembles corresponding types of payments (bills, Internet payments, etc), or if it would be better to provide a uniform interaction process for all types of payments.

- Interaction should be presented in a style that is familiar to users, e.g. that is adopted from existing popular payment services and e-commerce sites, (in a similar fashion as Amazon's style is copied by many booksellers).
- 'Wizards' guiding users step-by-step in the interaction process may be helpful to educate them on how to perform novel or previously inexperienced sequences of tasks.

Recommendation type: usability.

General Problem: Unnatural and unintuitive interaction lowers performance and eventual acceptance. If a system works in a different way than users expect from a system of its kind, it may create a steeper learning curve. Time to adapt may grow, and reduce performance. Example of a problem: the sequence of the input fields for giro payments in ABN-AMRO Internet Banking does not resemble a real-life paper giro form. A customer had problems getting used to this interaction sequence.

Example: The step-by-step payment process in Rabobank Direct Betalen (online banking) resembles the familiar offline payment procedure (as recorded on June, 2002).

Expert comments: "Testable by showing two different product brochures. In our test we have used:

- A similar user model of standard voice banking functionalities.
- A step-by-step example in the brochure.

Our interaction system is based on a model used for years and resembles the popular PIN-system".

DR 9. The interfaces should be presented in a logical, clear and understandable way

Detailed description:

- Minimise the number of steps (consecutive web pages) and actions (e.g. authorisation procedures) to complete a payment. For example, minimise the number of consecutive web pages for registration and authorisation, informing the users about the numbers of pages beforehand.
- The duration of a payment should not be too long. It should be proportional to the whole process (on average) of purchase interaction phase (see section 1.4.1).
- Render the interface style according to industry standards, or in a style familiar to the users from similar web sites of the correspondent domain. For instance many online booksellers render their interface similar to Amazon.com, which is becoming an interface standard for online bookshops.

Recommendation type: usability.

General Problem: A messy, clumsy interface will result in low usability and performance.

Example: In ABN-AMRO Electronic Banking details of completed transactions are presented in a form similar to bank's paper records sent to customers by regular post, this makes it easy to read and find information.

Expert comments: "Testable by offering two different interfaces. Our interface is not visible but audible. Our interaction system is based on a model used for years and resembles the popular PIN-system".

DR 10. Provide features of automatisation of payments

Detailed description:

- Provide the functionality of *scheduled payments*, or periodic payments, enabling users to set time and time span for the payments execution. Enable setting exceptions to the payment schedules.
- Provide the functionality of *multiple (batch) payments*: executing several payments at once, with one authorisation.

- Provide the functionality of *address books*, a user-managed contacts database for quick access to frequent payees' information, such as account number, addressed, and frequent payment details.
- For standard payments like utilities, bills, or direct debits provide templates that resemble well-known offline forms, where users can quickly fill in required fields.

Recommendation type: usability.

General Problem: Absence of automatisation of payment actions could decrease performance and eventual user acceptance.

Example: The address book function in ABN-AMRO Electronic banking. In ABN-AMRO Electronic banking payments can be effected by a scheduled time period.

Expert comments: "Not testable [at the current stage]. We offer a "direct payment", belonging to "direct purchasing". Your recommendation have to do with transferring money instead of paying money ("e-banking systems" instead of "payment systems"). A payment includes a direct notification to the receiving party. Comsys [the company developer of the EPS] shall investigate if it's possible to do any automatisation".

DR 11. Provide features of customization of payment environments

Detailed description:

For improving ease of use, satisfaction and performance provide the following features of the payment environment:

- Provide features of locale customisation: currency conversion, language.
- Provide ability to personalize payments with details of payments, (personal) messages, gift cards, etc.
- Provide ability to attach invoices, bills, etc. in electronic form along with a payment.
- Provide the functionality of multiple logins, restricted access for employees, family members.

Recommendation type: usability.

General Problem: Lack of customisation and features could lower performance and (perceived) usefulness.

Example: For different family members a parent could set up restricted logins e.g. setting payment limits and selecting adequate web sites for payments of the children.

Expert comments:

“Testable. [...] We do not yet provide utilities to recover passwords, or alternative authentication (e.g. biometrics, code calculators) systems”.

Protect your password.

Don't write down your password - memorize it. In particular, don't write it down and leave it anywhere, and don't place it in an unencrypted file! Use unrelated passwords for systems controlled by different organisations. Don't give or share your password, in particular to someone claiming to be from computer support or a vendor unless you are sure that are who they say they are. Don't let anyone watch you enter your password. Don't enter your password to a computer you don't trust or if things Use the password for a limited time and change it periodically.

Choose a hard-to-guess password.

[Our system] will try to prevent you from choosing a really bad password, but it isn't foolproof; create your password wisely. Don't use something you'd find in a dictionary (in any language or jargon). Don't use a name (including that of a spouse, parent, child, pet, fantasy character, famous person, and location) or any variation of your personal or account name. Don't use accessible information about you (such as your phone number, license plate, or social security number) or your environment. Don't use a birthday or a simple pattern (such as backwards, followed by a digit, or preceded by a digit. Instead, use a mixture of upper and lower case letters, as well as digits or punctuation. When choosing a new password, make sure it's unrelated to any previous password. Use long passwords (say 8 characters long). You might use a word pair with punctuation inserted, a pass phrase (an understandable sequence of words), or the first letter of each word in a pass phrase.

Figure D8. *Example of password guidelines.* Source: cPanel X, January 2004.

DR 12. Provide well-designed authentication

Detailed description:

- Preserve login status or retain session information for access to non-critical operations so that users do not have to authenticate themselves unnecessarily frequently. Do not require users to re-log in or authenticate themselves prior to less significant operations, such as viewing account status.
- Refer to the industry practice (such as employing authentications mechanisms used at the popular e-commerce and EPS web sites) in managing authentication and passwords, including practices for recovering lost passwords, caching passwords in the web browser for further use, retrieving, resetting, and renewal of passwords. Even if the password is lost, its retrieval or resetting should be done as quickly and easily as possible, and with minimal workload for users without compromising security.
- Limit the number of authentication steps (a password or challenge-response authorisation) required for access to the system (for logins, account overview, payments) to preferably not more than 2 steps.
- Suggest guidelines on selecting effective and easy to remember passwords.
- Strive to balance password length, symbols, and case sensitivity. E.g. too short passwords are dangerous, too long are hard to remember. If users are afraid of losing their passwords, and have to rely on recording passwords in any form (e.g. written down on paper) this can compromise their passwords.
- Warn users to avoid using symbols that can be dependent on the language layout, such as logins and passwords in their own language. This can limit or complicate access to the EPS in other countries with a different language.
- Take into account the relation of the system's login to existing passwords (e.g. for an EPS based on electronic banking examine if it would be reasonable to a use the existing e-banking PIN-code). Consider if this can compromise security.
- Provide ability to change passwords easily and quickly, without compromising security.

Recommendation type: usability, trust.

Example: To ensure high security, Paypal.com never allows saving the password in the browser cash in the default mode, users will have to re-enter it again. Figures D8 and D9 suggest password guidelines.

General Problem: Users are ready to go through authentication, even if they find it inconvenient, because they understand its need and importance. However, excessively hard authentication can still lower usability and scare the users away, especially if compared with relatively easier authorisation in other systems.

Expert comment: “Our authentication process is based on a model used for years. The code used in the test is 6 digits (for test reasons), the real code will be the already known and [there will be] used 5-figure Girofoon-code or a new code”.

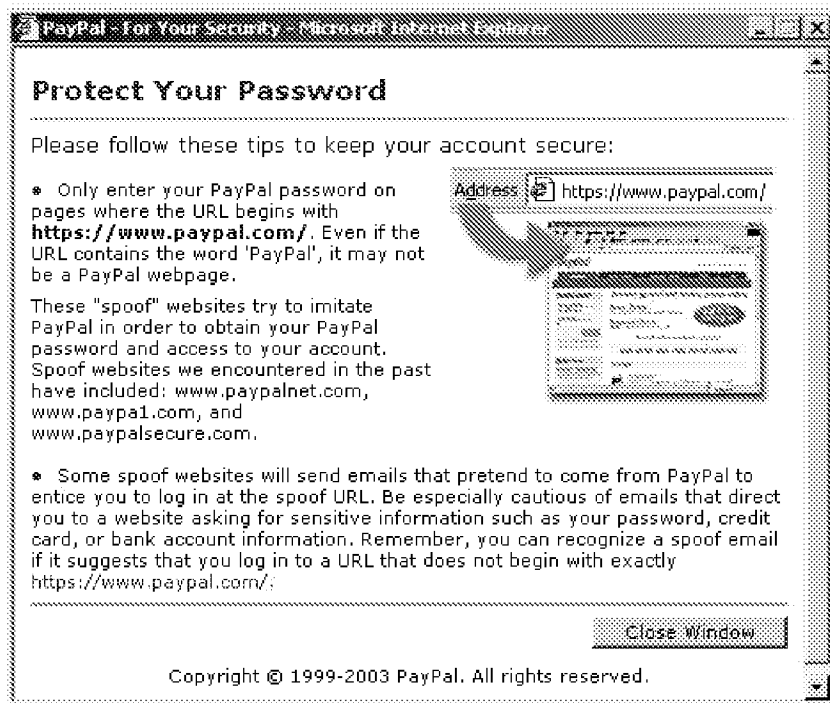

*Figure D9. PayPal password tips.
Source PayPal, 2003.*

Appendix E

Questionnaire for the experimental study

Repeated measures

The following questions were repeated after each task, this would let see how user attitudes change from task to task and run repeated measures analysis.

Q1 How high would you rate your trust in the system at this moment?

Very low Very High

1	2	3	4	5	6	7
---	---	---	---	---	---	---

 Don't know

Q2 Do you feel it would be safe to make transaction with your money using this system?

Completely unsafe Completely safe

-3	-2	-1	0	+1	+2	+3
----	----	----	---	----	----	----

 Don't know

Q3 Do you feel your personal information is sufficiently protected in this system?

Completely un-protected Completely protected

1	2	3	4	5	6	7
---	---	---	---	---	---	---

 Don't know

Q4 I think I would like to use this system frequently (often).

Strongly Disagree Strongly Agree

-3	-2	-1	0	+1	+2	+3
----	----	----	---	----	----	----

 Don't know

Q5 I found the system complex.

Strongly Disagree Strongly Agree

-3	-2	-1	0	+1	+2	+3
----	----	----	---	----	----	----

 Don't know

- Q6 I thought the system was easy to use.
 Strongly Disagree Strongly Agree

-3	-2	-1	0	+1	+2	+3
----	----	----	---	----	----	----

 Don't know
- Q7 I think that I would need the support of a technical person to use this system.
 Strongly Disagree Strongly Agree

-3	-2	-1	0	+1	+2	+3
----	----	----	---	----	----	----

 Don't know
- Q8 I found the various functions in this system were well integrated.
 Strongly Disagree Strongly Agree

-3	-2	-1	0	+1	+2	+3
----	----	----	---	----	----	----

 Don't know
- Q9 I felt very confident using the system.
 Strongly Disagree Strongly Agree

-3	-2	-1	0	+1	+2	+3
----	----	----	---	----	----	----

 Don't know
- Q10 I need to learn a lot of things before I could get going with this system.
 Strongly Disagree Strongly Agree

-3	-2	-1	0	+1	+2	+3
----	----	----	---	----	----	----

 Don't know
- Q11 The instructions on the web page and the paper help are useful for the task.
 Strongly Disagree Strongly Agree

-3	-2	-1	0	+1	+2	+3
----	----	----	---	----	----	----

 Don't know

Task-specific questions

Task 1

- Q13 Do you find the system fast to use?
 Very slow Very Fast

1	2	3	4	5	6	7
---	---	---	---	---	---	---

 Don't know
- Q14 How quick could you do the task?
 Very slow Very quick

1	2	3	4	5	6	7
---	---	---	---	---	---	---

 Don't know
- Q15 Are you comfortable using your personal information with this system?
 Not comfortable at all Very comfortable

1	2	3	4	5	6	7
---	---	---	---	---	---	---

 Don't know
- Q16 What do you think about the number of confirmations you have to make for one payment?
 Too many confirmations (bevestigingen) Too few confirmations (bevestigingen)

-3	-2	-1	0	+1	+2	+3
----	----	----	---	----	----	----

 Don't know

Task2

- Q13 Do you feel sufficiently informed about security in the Betaallijn?
 Not informed at all Fully informed

1	2	3	4	5	6	7
---	---	---	---	---	---	---

 Don't know
- Q14 How does the information provided about security measures influence your trust in the Betaallijn as a payment system?
 Decreases your feeling of trust Increases your feeling of trust

-3	-2	-1	0	+1	+2	+3
----	----	----	---	----	----	----

 Don't know
- Q15 How does the ability to block your betaalcode give you a feeling of control over the situation?
 Decreases the feeling of control Increases the feeling of control

-3	-2	-1	0	+1	+2	+3
----	----	----	---	----	----	----

 Don't know
- Q16 How does the ability to block the betaalcode influence your trust?
 Decreases your trust Increases your trust

-3	-2	-1	0	+1	+2	+3
----	----	----	---	----	----	----

 Don't know
- Q17 Do you feel you were in control over the situation when using the Betaallijn for this task?
 Completely out of control Completely in control

1	2	3	4	5	6	7
---	---	---	---	---	---	---

 Don't know
- Q18 How does the fact that there is a customer service line operated by real people influence your trust?
 Decreases your trust Increases your trust

-3	-2	-1	0	+1	+2	+3
----	----	----	---	----	----	----

 Don't know

Task3

- Q13 What's your opinion about the way you had to do these rent payments?
 Very difficult Very easy

-3	-2	-1	0	+1	+2	+3
----	----	----	---	----	----	----

 Don't know
- Q14
 Very slow Very fast

1	2	3	4	5	6	7
---	---	---	---	---	---	---

 Don't know
- Q15 Rather useless function Very useful function

-3	-2	-1	0	+1	+2	+3
----	----	----	---	----	----	----

 Don't know
- Q16 Do you feel that the costs associated with using the Betaallijn (paying for the call) are appropriate?
 Completely inappropriate Completely appropriate

-3	-2	-1	0	+1	+2	+3
----	----	----	---	----	----	----

 Don't know
- Q17 How much you would be prepared to pay for the call to the Betaallijn, per minute?

1	2	3	4	5	6	7	<input type="checkbox"/> Don't know
0 cents p/m	2-3 cents p/m	10-15 cents p/m	15-25 cents p/m	25-50 cents p/m	51cents - €1 p/m	as much as I'm asked	

Q18 Do you think the length of the betaalcode is appropriate?

Too long Too short

-3	-2	-1	0	+1	+2	+3
----	----	----	---	----	----	----

 Don't know

Task 4

Q13 I think that the procedure to re-activate the betaalcode would be easier than to register again.

Strongly Disagree Strongly Agree

-3	-2	-1	0	+1	+2	+3
----	----	----	---	----	----	----

 Don't know

Q14 Do you feel you were in control when using the Betaallijn for this task?

Completely out of control Completely in control

1	2	3	4	5	6	7
---	---	---	---	---	---	---

 Don't know

Q15 How does the way you can reactivate the betaalcode influence your trust?

Decreases your trust Increases your trust

-3	-2	-1	0	+1	+2	+3
----	----	----	---	----	----	----

 Don't know

Q16 How does the ability to reactivate the betaalcode give you a feeling of control over the situation?

Decreases the feeling of control Increases the feeling of control

-3	-2	-1	0	+1	+2	+3
----	----	----	---	----	----	----

 Don't know

Q17 Do you feel it's safe to use the system?

Completely unsafe Completely safe

1	2	3	4	5	6	7
---	---	---	---	---	---	---

 Don't know

Task 5

Q13 What's your opinion about the way you had to make these several payments in the system?

Very difficult Very easy

-3	-2	-1	0	+1	+2	+3
----	----	----	---	----	----	----

 Don't know

Q14

Very slow Very fast

1	2	3	4	5	6	7
---	---	---	---	---	---	---

 Don't know

Q15 Rather useless function Very useful function

-3	-2	-1	0	+1	+2	+3
----	----	----	---	----	----	----

 Don't know

Q16 Would paying for the telephone call to de Betaallijn be suitable for you (if you you'd use de Betaallijn for your payments)?

I would definitely not pay for the call I would certainly pay for the call

1	2	3	4	5	6	7
---	---	---	---	---	---	---

 Don't know

Q17 Are you comfortable with the way you have to identify yourself in the system?

Very uncomfortable Very comfortable

-3	-2	-1	0	+1	+2	+3
----	----	----	---	----	----	----

 Don't know

Q18 Do you feel that the telephone costs associated with using the payment system are appropriate?

Completely inappropriate Completely appropriate

-3	-2	-1	0	+1	+2	+3
----	----	----	---	----	----	----

 Don't know

Q19 Do you feel that you are in control of the costs of when using the Betaallijn?

Completely out of control Completely in control

1	2	3	4	5	6	7
---	---	---	---	---	---	---

 Don't know

Q20 Do you think the number of confirmations is appropriate to do your payment?
Too many confirmations (bevestigingen) Too few confirmations (bevestigingen)
-3 -2 -1 0 +1 +2 +3 Don't know

Q21 Do you think the length of the betaalcode is appropriate?
Too long Too short
-3 -2 -1 0 +1 +2 +3 Don't know

Q22 Does the fact that the system is offered by Postbank influence your trust in the system?
Decreases your trust Increases your trust
-3 -2 -1 0 +1 +2 +3 Don't know

Q23 Would you be likely to use the system for your Internet payments?
Very likely Very unlikely
-3 -2 -1 0 +1 +2 +3 Don't know

References

- Abrazhevich, D. & Markopoulos, P. (2002). Diary study on internet payment systems. In Sharp, H., Chalk, P., LePeuple, J. & Rosbottom, J. (Ed.), *Proceedings of the Conference on Human Computer Interaction HCI 2002*, London, UK, September 2-6, 2002. (pp. 42-46). London: HCI 2002.
- Abrazhevich, D. (2001a). A survey of user attitudes towards electronic payment systems. *The 15th Annual Conference of the Human Computer Interaction Group of the British Computer Society, IHM-HCI-2001*, vol. 2. (pp. 69-71). Toulouse, France: Cepadues-Editions.
- Abrazhevich, D. (2001b). Classification and characteristics of electronic payment systems. In K.Bauknecht, S. K. Madria, & G. Pernul (Eds.), *Lecture Notes in Computer Science 2115*, (pp. 81-90). Berlin: Springer-Verlag,.
- Abrazhevich, D. (2001c). Electronic payment systems: issues of user acceptance. In B.Stanford-Smith and E.Chiozza (Eds.), *E-work and E-commerce*, (pp. 354-360). IOS Press .
- Abrazhevich, D. (2002). Importance of user-related factors in electronic payment systems. In J.E.J.Prins, P. M. A. Ribbers, H. C. A. van Tilborg, A. F. L. Veth, & J. G. L. van der Wees (Eds.), *Trust in Electronic Commerce - The Role of Trust From a Legal, an Organisational and a Technical Point of View*, The Hague : Kluwer Law International.
- Adler, A., Gujar, A., Harrison, B. L., O'Hara, K., & Sellen, A. (1998). A diary study of work-related reading: design implications for digital reading devices. In C.Karat, A. Lund, J. Coutaz, & J. Karat (Eds.), *Human Factors in Computing Systems. CHI 98 Conference Proceedings*, (pp. 241-248). New York, NY, USA: ACM.

- APACS (2002). Card-not-Present (CNP) Transactions. Fraud prevention guidelines for CNP retailers. London: Association for Payment Clearing Services.
- Asmussen, C. G., Raschke, T., & Arend, C. (2002). User perception of internet security - European consumer survey 2002, IDC Report, IDC.
- Asokan, N., Janson, P., Steiner, M., & Waidner, M. (1997). The state of the art in electronic payment systems. *IEEE Computer*, 30(9), 28-35.
- BIS (2000). Survey of electronic money developments, May 2000. Switzerland: Bank for International Settlements.
- BIS (2001). Survey of electronic money developments, November 2001. Switzerland: Bank for International Settlements.
- Bohle, K. (2001a). Electronic Payments 2001 – Food for thought. Electronic Payment Systems Observatory (ePSO). Seville, Spain: Joint Research Center of the European Commission.
- Bohle, K. (2001b). The Potential of server-based internet payment systems. Electronic Payment Systems Observatory (ePSO). Seville, Spain: Joint Research Center of the European Commission.
- Boly, J. P., Bosselaers, A., Cramer, R., Michelsen, R., Mjolsnes, S., Muller, F., Pedersen, T., Pfitzmann, B., Rooij, P. de., Schoenmakers, B., Schunter, M., Vallée, L. & Waidner, M. (1994). The ESPRIT Project CAFE - High security digital payment systems. *Lecture Notes in Computer Science 875*, (pp. 217-230). Springer.
- Brands, S. A. (1995). Off-line electronic cash based on secret-key certificates. Amsterdam: Centrum voor Wiskunde en Informatica.
- Brooke, J. (1996). SUS: a Quick and dirty usability scale. In P.W.Jordan, B. Thomas, B. A. Weerdmeester, & I. L. McClelland (Eds.), *Usability Evaluation in Industry*, London: Taylor & Francis.
- Burkhardt, M. E. (1994). Social interaction effects following a technological change: A longitudinal investigation. *Academy of Management Journal*, 37 (4), 869-898.
- Carayon, P. & Hajnal, C. (1993). A diary study of computer use and worker stress: preliminary results. In G.Salvendy & M. J. Smith (Eds.), *Human Computer Interaction. Proceedings of the Fifth International Conference on Human Computer Interaction HCI International '93*, (pp. 715-720). Amsterdam, Netherlands: Elsevier.
- Caunter, N. (2001). The real cost of fraud to E-tailers. *Computer Fraud & Security*, 2001 (1), p. 17.
- Chaum, D. (1992). Achieving electronic privacy. *Scientific American*, August 1992, 96-101.
- Chin, J. P., Herring, R. D., & Elliott-Familant, M. (1992). A usability and diary study assessing the effectiveness of call acceptance lists. In *Proceedings of the Human Fac-*

- tors Society 36th Annual Meeting. Innovations for Interactions, (pp. 216-220). Santa Monica, CA, USA: Human Factors Society.
- Cook, T. D. & Campbell, D. T. (1979). Quasi-experimentation: design and analysis issues for field settings. Rand McNally.
- Corbin, J. & Strauss, A. (1990). Grounded theory research: procedures, canons, and evaluative criteria. *Qualitative Sociology*, 13, 3-21.
- Cox, P. (2001, June 22). PayPal and FBI team up. *Wall Street Journal*. WSJ Online, US edition.
- Davis, F. (1989). Perceived usefulness, perceived ease of use, and user acceptance of information technology. *MIS Quarterly*, 13 (3), 319-340.
- Davis, F. (1993). User acceptance of information technology: systems characteristics, user perceptions and behavioral impacts. *International Journal of Man-Machine Studies*, 38 (3), 475-487.
- Davis, F., Bagozzi, R. P., & Warshaw, P. R. (1989). User acceptance of computer technology: a comparison of two theoretical models. *Management Science*, 35, 982-1003.
- Dillon, A. & Morris, M. G. (1996). User acceptance of information technology: Theories and models. *Annual Review of Information Science and Technology*, 31, 3-32.
- ECB (2001). Payment and securities settlement systems in the European Union. European Central Bank.
- ECB (2003). E-payments in Europe – the Eurosystem's perspective. European Central Bank.
- Egger, F. N. (2003). From interactions to transactions: designing the trust experience for business-to-consumer electronic commerce. PhD Thesis. The Netherlands: Eindhoven University of Technology.
- Elliott, G. J., Jones, E., & Barker, P. (2002). A grounded theory approach to modelling learnability of hypermedia authoring tools. *Interacting with Computers*, 14, 547-574.
- Enos, L. (2000). Apple licenses Amazon's 1-click technology. *E-Commerce Times*. Retrieved Jan. 12, 2004, Available from: <http://www.ecommercetimes.com/perl/story/4322.html>
- Evans, D. S. & Schmalensee, R. (1999). *Paying with plastic: the digital revolution in buying and borrowing*. Cambridge: MIT Press.
- Fishbein, M. & Ajzen, I. (1975). *Belief, attitude, intention and behavior: an introduction to theory and research*. Reading, Mass.: Addison-Wesley.
- Flick, U. (1998). *An Introduction to qualitative research*. London: Sage.

- Flynn, N. L. (2001). *The E-policy handbook : designing and implementing effective E-mail, Internet, and software policies*. New York: Amacom.
- Glassman, S. & Manasse, M. (1995). The Millicent protocol for inexpensive electronic commerce. In *Proc. of the 4th International World Wide Web Conference*, (pp. 603-618), Boston, Massachusetts, USA.
- Gray, W. D. & Salzman, M. C. (1998). Damaged merchandise? A review of experiments that compare usability evaluation methods. *Human-Computer Interaction*, 13(3), 203-261.
- Guttman, R. (2003). *Cybercash: the coming era of electronic money*. Basingstoke: Palgrave.
- GVU (1998). *GVU's 10th WWW User Survey*. GVU. Retrieved Jan. 12, 2004, Available from: http://www.gvu.gatech.edu/user_surveys/survey-1998-10/
- Hauser, R., Steiner, M., & Waidner, M. (1996). Micro-payments based on iKP. In *Proceedings of the 14th Worldwide Congress on Computer and Communications Security Protection*, (pp. 67-84).
- Het Financieele Dagblad (2001, March 20). MKB dreigt met boycot chipknip. *The Netherlands: Het Financieele Dagblad*.
- Hewett, T. T., Baecker, R., Card, S., Carey, T., Gasen, J., Mantei, M., Perlman, G., Strong, G., & Verplank, W. (1992). *ACM SIGCHI Curricula for Human-Computer Interaction*. New York: ACM.
- Humphrey, D. B. (1995). *Payment systems: principles, practice, and improvements*. Technical paper 260. Washington, D.C.: The World Bank.
- Humphrey, D. B., M. Kim, M. & Vale, B. (2001). Realizing the gains from electronic payments: costs, pricing, and payment choice, *Journal of Money, Credit and Banking*, 33(2), 216-234.
- IFCC (2003). *IFCC 2002 Internet fraud report*. The Internet Fraud Complaint Center.
- ISO 9241 (1996). *ISO 9241. Ergonomic requirements for office work with visual display terminals, Part 11*.
- Jupiter Media Metrix (2000). *Internet Payments*. Jupiter Media Metrix.
- Kalakota, R. & Whinston, A. (1997). *Electronic commerce: a manager's guide*. Addison-Wesley.
- Keats, D. M. (2000). *Interviewing: a practical guide for students and professionals*. Buckingham: Open University Press.
- Krabbenbos, M. (2003). *Personal communication*.

- Kuttner, K. N. & McAndrews, J. J. (2001). Personal on-line payments. *Economic Policy Review*, New York Federal Reserve Bank, December 2001, (pp. 35-50).
- Langdon, C. S., Roghe, F., & Shaw, M. J. (2000). Consumer mass market online payment solutions. In M.J. Shaw, R. Blanning, & T. Strader (Eds.), *Handbook On Electronic Commerce*, (pp. 273-288).
- Laudon, K. C. & Traver, C. G. (2002). *E-commerce: business, technology, society*. London: Addison Wesley.
- Lelieveldt, S. (2001). E-Purses and Chip Cards in the Netherlands. *ePSO-Newsletter*, 3. Seville, Spain: ePSO.
- Libbenga, J. (2001, March 9). Ondergang Chipper markeert nieuw begin. *Automatisering Gids*, No. 10. The Netherlands.
- Lietaer, B. (2002). *The Future of Payment Systems*. Unisys Corporation.
- Long, J. B. & Dowell, J. (1989). Conceptions of the discipline of HCI: craft, applied science, and engineering. In A. Sutcliffe & L. Macaulay (Eds.), *People and Computers: The theory and practice of HCI*. British Computer Society Human-Computer Interaction Specialist Group, (pp. 9-32), Cambridge: CUP.
- Lynch, D. C. & Lundquist, L. (1996). *Digital money: the new era of Internet commerce*. Chichester: Wiley.
- Mackay, W. E. & Fayard, A. L. (1997). HCI, natural science and design: a framework for triangulation across disciplines. In *Proceedings of Designing Interactive Systems, DIS'97*, (pp.223-234) Amsterdam, the Netherlands: ACM.
- Martin, R. (1994). Mondex: the way forward? *Cards International*, 104, 9-14.
- Maxwell, S. E. & Delaney, H. D. (2000). *Designing experiments and analyzing data: a model comparison perspective*. London: Lawrence Erlbaum Associates.
- Mayhew, D. J. (1999). *The usability engineering lifecycle: a practitioner's handbook for user interface design*. San Francisco: Morgan Kaufmann.
- Medvinsky, G. & Neuman, B. C. (1993). Netcash: A design for practical electronic currency on the internet. *Proceedings Of First ACM Conference On Computer and Communication Security*, ACM.
- Medvinsky, G. & Neuman, B. C. (1995). Requirements for network payment: the netcheque perspective. *Proceedings of IEEE Compcon 95*, San Francisco.
- Nannery, M. (1998). Smart cards: stalled in Holland? *Chain Store Age*, 74 (11), p. 172.
- Nielsen, J. (1999). *Designing web usability*. Indianapolis: New Riders Publishing.
- Nielsen, J., Molich, R., Snyder, C., & Farrell, S. (2000). *E-commerce user experience*. Fremont, CA: Nielsen Norman Group.

- Palen, L. & Salzman, M. (2002). Voice-mail diary studies for naturalistic data capture under mobile conditions. Proceedings of CSCW '02, (pp. 87-95), New Orleans, Louisiana, USA.
- Perlman, G. (2000). Web-Based user interface evaluation with questionnaires. G.Pperlman's Home Page. Retrieved Dec. 20, 2003, Available from: <http://www.acm.org/~perlman/question.html>
- Philippsohn, S. & Thomas, S. (2003). E-fraud - what companies face today. *Computer Fraud & Security*, 1, 7-9.
- Plouffe, C. R., Hulland, J. S. and Vandenbosch, M. (2001). Research report: Richness versus parsimony in modelling technology adoption decisions - Understanding merchant adoption of a smart card-based payment system, *Information Systems Research*, 12 (2), 208-222.
- Rauterberg, G. W. M. (2000). How to characterize a research line for user-system interaction. *IPO Annual Progress Report*, 35, 66-86.
- Ribbers, P. M. A. & Heck, E. v. (2004). Introducing electronic auction systems in the Dutch flower industry - a comparison of two initiatives. *Wirtschaftsinformatik*, 40 (3), 223-231.
- Rice, R. & Aydin, C. (2004). Attitudes toward new organisational technology: network proximity as a mechanism for social information processing. *Administrative Science Quarterly*, 36(2), 219-244.
- Rieman, J. (1993). The diary study: a workplace-oriented tool to guide laboratory studies. Proceedings CHI'93, Conference on Human Factors in Computer Systems, (pp. 321-326), New York: ACM Press.
- Rivest, R. L. & Shamir, A. (1996). Payword and Micromint: two simple micropayment schemes, (pp. 69-87). Cambridge, UK.
- Rubin, H. J. & Rubin, I. S. (1995). *Qualitative interviewing: the art of hearing data*. London: Sage.
- Salancik, G. R. & Pfeffer, J. (1978). A social information processing approach to job attitudes and task design. *Administrative Science Quarterly*, 23, 224-253.
- Schoenmakers, B. (1998). Basic security of the ecash payment system. In B.Preneel & V. Rijmen (Eds.), *Computer Security and Industrial Cryptography: State of the Art and Evolution*, (pp. 342-356). Springer-Verlag.
- Schreft, S. (2002) Clicking with dollars: how consumers can pay for purchases from e-tailers, *Economic Review*, Federal Reserve Bank of Kansas City, First Quarter 2002, (pp. 37-64).

- Siegel, D. & Dray, S. M. (2001). New kid on the block: marketing organisations and interaction design. *Interactions*, March+April 2001, 19-24.
- Siegel, D. & Dray, S. M. (2002). Exploring and using qualitative data. Tutorial presented at BCS-HCI 2002.
- Smith, S. L. & Mosier, J. N. (1986). Guidelines for designing user interface software. MA, USA: Mitre Corporation.
- Strauss, A. & Corbin, J. (1990). *Basics of qualitative research: grounded theory procedures and techniques*. London: Sage.
- Van Hove, L. (1999). Electronic money and the network externalities theory: lessons for real life. *Netnomics*, 1 (2), 137-171.
- Van Hove, L. (2004). Cost-based pricing of payment instruments: the state of the debate. M&F working paper nr. 2002-02, Free University of Brussels, December 2002, to be published in *De Economist*, vol. 152, No. 1.
- Vulkan, N. (2003). *The economics of e-commerce: a strategic guide to understanding and designing the online marketplace*. Princeton, NJ: Princeton University Press.
- Wales, E. (2003). E-commerce counts cost of online card fraud. *Computer Fraud & Security*, 2003, 1, 9-11.
- Wayner, P. (1997). *Digital cash: commerce on the Net*, (2nd ed.) London: AP Professional.
- Werbach, K. (2000). Syndication: the emerging model for business in the internet era. *Harvard Business Review*, May-June 2000, 85-93.

Samenvatting

(Summary in Dutch)

Door de snelle ontwikkelingen op het gebied van elektronische commercie op het Internet ontstaat de behoefte aan elektronische betalingssystemen die deze on-line commercie ondersteunen. Dergelijke elektronische betalingssystemen vormen een integraal onderdeel van de elektronische commercie en zijn een van de meest kritieke aspecten van een e-commerce omgeving.

Het blijft voor ontwikkelaars van nieuwe Internetgebaseerde betalingssystemen een open uitdaging om te voldoen aan de verwachtingen, eisen, voorkeuren en behoeften van de gebruikers met betrekking tot het ontwerp en gebruik van deze systemen. Als hieraan niet wordt voldaan zal dit resulteren in een lage bruikbaarheid, onveiligheid en inefficiëntie van de betalingssystemen en uiteindelijk in de weigering van klanten om deze systemen te gebruiken. Het ontwerpen van elektronische betalingssystemen vanuit het perspectief van de gebruiker is van levensbelang voor de ontwikkeling en het gebruik van systemen die geaccepteerd worden door de gebruikers.

Dit proefschrift beschrijft onderzoek dat verricht is met als doel te bepalen hoe elektronische betalingssystemen ontworpen kunnen worden vanuit het perspectief van de gebruiker en welke gevalideerde ontwerpkenis overgedragen kan worden aan ontwerpers van dergelijke systemen waardoor eindgebruikers de nieuwe betalingssystemen willen gebruiken in een e-commerce omgeving voor betalingen en hun persoonlijke financiën.

Dit onderzoek bekijkt elektronische betalingssystemen vanuit het perspectief van de gebruiker en betreft daarbij onder andere menselijke factoren zoals bruikbaarheid, privacy, veiligheid en vertrouwen. Verschillende onderdelen van het multidisciplinaire vakgebied Mens-Computer Interactie worden gebruikt om de juiste invalshoek op de onderzoeksdoelen te bepalen en om de complexe problemen die hiermee samenhangen te adresseren.

Dit onderzoek omvat een combinatie van verschillende onderzoeks- en ontwerpactiviteiten: een literatuurstudie, een gebruikersonderzoek, kwalitatief onderzoek en experimenteel onderzoek. Toepassing van deze onderzoeks- en ontwerpactiviteiten heeft ertoe bijgedragen dat grondige kennis is opgebouwd met betrekking tot de gebruikerservaring van elektronische betalingssystemen. Bovendien heeft het suggesties opgeleverd voor het ontwerp en herontwerp van elektronische betalingssystemen, waarmee acceptatie door de eindgebruikers kan worden gewaarborgd. Om het ontwerp van elektronische betalingssystemen te ondersteunen is een verzameling van ontwerpaanbevelingen van elektronische betalingssystemen ontwikkeld.

Om de validiteit van deze ontwerpaanbevelingen te garanderen is experimenteel onderzoek gedaan naar de toepassing ervan op een bestaand systeem van de Postbank (Nederland). Dit onderzoek droeg bij aan de substantiëring van de validiteit van een subset van deze ontwerpaanbevelingen en genereerde gevalideerde ontwerpkenis die voorheen niet voorhanden was. De belangrijkste bijdragen van dit onderzoek is, aan de ene kant, de nieuwe kennis van het ontwerp voor gebruikersacceptatie van elektronische betalingssystemen vanuit het perspectief van de gebruiker, en aan de andere kant, de ontwerpaanbevelingen met de wetenschappelijke evidentie voor hun validiteit.

Curriculum Vitae

Dennis Abrazhevich

- 1974, August 17 Born in Kerch, Crimea.
- 1991 – 1996 Belarusian State University of Informatics and
Radioelectronics, Minsk, Belarus,
MSc in Computer Science and Engineering.
- 1999 – 2004 Eindhoven University of Technology, the Netherlands
PhD in Human Computer Interaction.

Website: www.epayresearch.com
Contact: dennis@epayresearch.com

Electronic Patent Application Fee Transmittal

Application Number:	13966096
Filing Date:	13-Aug-2013
Title of Invention:	PRODUCING ROUTING MESSAGES FOR VOICE OVER IP COMMUNICATIONS
First Named Inventor/Applicant Name:	CLAY PERREAULT
Filer:	Paul S. Brockland/Norman Green
Attorney Docket Number:	DIGIF.001C1

Filed as Small Entity

Filing Fees for Utility under 35 USC 111(a)

Description	Fee Code	Quantity	Amount	Sub-Total in USD(\$)
Basic Filing:				
Pages:				
Claims:				
Miscellaneous-Filing:				
Petition:				
Patent-Appeals-and-Interference:				
Post-Allowance-and-Post-Issuance:				
Extension-of-Time:				

Description	Fee Code	Quantity	Amount	Sub-Total in USD(\$)
Miscellaneous:				
Submission- Information Disclosure Stmt	2806	1	90	90
Total in USD (\$)				90

Electronic Acknowledgement Receipt

EFS ID:	23102469
Application Number:	13966096
International Application Number:	
Confirmation Number:	8712
Title of Invention:	PRODUCING ROUTING MESSAGES FOR VOICE OVER IP COMMUNICATIONS
First Named Inventor/Applicant Name:	CLAY PERREULT
Customer Number:	20995
Filer:	Paul S. Brockland/Norman Green
Filer Authorized By:	Paul S. Brockland
Attorney Docket Number:	DIGIF.001C1
Receipt Date:	03-AUG-2015
Filing Date:	13-AUG-2013
Time Stamp:	19:21:59
Application Type:	Utility under 35 USC 111(a)

Payment information:

Submitted with Payment	yes
Payment Type	Credit Card
Payment was successfully received in RAM	\$90
RAM confirmation Number	6101
Deposit Account	111410
Authorized User	KNOBBE MARTENS OLSON AND BEAR

The Director of the USPTO is hereby authorized to charge indicated fees and credit any overpayment as follows:

Charge any Additional Fees required under 37 C.F.R. Section 1.16 (National application filing, search, and examination fees)

Charge any Additional Fees required under 37 C.F.R. Section 1.17 (Patent application and examination processing fees)

PETITIONER APPLE INC. PEX: 1902337

File Listing:					
Document Number	Document Description	File Name	File Size(Bytes)/ Message Digest	Multi Part /.zip	Pages (if appl.)
1		IDS_DIGIF_001C1_08_03_2015.pdf	197803 fa85930406d4fcc07a9224b729b559dddcb5a14f	yes	4
Multipart Description/PDF files in .zip description					
	Document Description		Start	End	
	Transmittal Letter		1	2	
	Information Disclosure Statement (IDS) Form (SB08)		3	4	
Warnings:					
Information:					
2	Foreign Reference	Ref44_Ketchpel_U_PAI_1996.pdf	1651947 4b63607eda118f5a951c977ab8f89fc2867fa601	no	17
Warnings:					
Information:					
3	Foreign Reference	Ref45_Moberg_MIME_Based_July_2005.pdf	3541379 076126a8cc567e0a04610824d48a06aad446f5ca	no	47
Warnings:					
Information:					
4	Foreign Reference	Ref46_Abrazhevich_Elec_Pay_Sys_2004.pdf	15745553 1297206b1690e9c4399031d7d4378c7554750e34	no	202
Warnings:					
Information:					
5	Fee Worksheet (SB06)	fee-info.pdf	30527 5f45167d8a51d8a981f8ada294e4f7797280d33	no	2
Warnings:					
Information:					
Total Files Size (in bytes):			21167209		

This Acknowledgement Receipt evidences receipt on the noted date by the USPTO of the indicated documents, characterized by the applicant, and including page counts, where applicable. It serves as evidence of receipt similar to a Post Card, as described in MPEP 503.

New Applications Under 35 U.S.C. 111

If a new application is being filed and the application includes the necessary components for a filing date (see 37 CFR 1.53(b)-(d) and MPEP 506), a Filing Receipt (37 CFR 1.54) will be issued in due course and the date shown on this Acknowledgement Receipt will establish the filing date of the application.

National Stage of an International Application under 35 U.S.C. 371

If a timely submission to enter the national stage of an international application is compliant with the conditions of 35 U.S.C. 371 and other applicable requirements a Form PCT/DO/EO/903 indicating acceptance of the application as a national stage submission under 35 U.S.C. 371 will be issued in addition to the Filing Receipt, in due course.

New International Application Filed with the USPTO as a Receiving Office

If a new international application is being filed and the international application includes the necessary components for an international filing date (see PCT Article 11 and MPEP 1810), a Notification of the International Application Number and of the International Filing Date (Form PCT/RO/105) will be issued in due course, subject to prescriptions concerning national security, and the date shown on this Acknowledgement Receipt will establish the international filing date of the application.

INFORMATION DISCLOSURE STATEMENT

Inventor	:	Clay Perreault, et al.
App. No.	:	13/966,096
Filed	:	August 13, 2013
For	:	PRODUCING ROUTING MESSAGES FOR VOICE OVER IP COMMUNICATIONS
Examiner	:	Sing, Simon P.
Art Unit	:	2653
Conf. No.	:	8712

Commissioner for Patents
P.O. Box 1450
Alexandria, VA 22313-1450

References and Listing

Pursuant to 37 CFR 1.56, an Information Disclosure Statement listing references is provided herewith. Copies of any listed foreign and non-patent literature references are being submitted.

No Disclaimers

To the extent that anything in the Information Disclosure Statement or the listed references could be construed as a disclaimer of any subject matter supported by the present application, Applicant hereby rescinds and retracts such disclaimer.

Timing of Disclosure

This Information Disclosure Statement is being filed after receipt of a First Office Action, but before the mailing date of a Final Action and before the mailing date of a Notice of Allowance. This Statement is accompanied by the fees set forth in 37 CFR 1.17(p). The

Application No.: 13/966,096
Filing Date: August 13, 2013

Commissioner is hereby authorized to charge any additional fees which may be required or to credit any overpayment to Account No. 11-1410.

Respectfully submitted,
KNOBBE, MARTENS, OLSON & BEAR, LLP

Dated: 8/3/2015

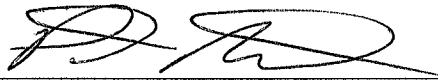
By: 
Paul Brockland
Registration No. 61,130
Attorney of Record
Customer No. 20995
(858) 707-4000

IDS
21273187
080315

INFORMATION DISCLOSURE STATEMENT BY APPLICANT	Application No.	13/966,096	
	Filing Date	August 13, 2013	
	First Named Inventor	Perreault, Clay	
	Art Unit	2653	
<i>(Multiple sheets used when necessary)</i>		Examiner	Sing, Simon P.
SHEET 1 OF 2		Attorney Docket No.	DIGIF.001C1

U.S. PATENT DOCUMENTS					
Examiner Initials	Cite No.	Document Number Number - Kind Code (if known) Example: 1,234,567 B1	Publication Date MM-DD-YYYY	Name	Pages, Columns, Lines Where Relevant Passages or Relevant Figures Appear
	1	5,677,955 A1	10-14-1995	Doggett et al.	
	2	5,883,810 A1	03-16-1999	Franklin et al.	
	3	6,173,272 B1	01-09-2001	Thomas et al.	
	4	6,243,689 B1	06-05-2001	Norton, Robert G.	
	5	6,636,833 B1	10-21-2003	Fitcroft et al.	
	6	6,772,188 B1	08-03-2004	Cheng-Sheng et al.	
	7	6,892,184 B1	05-10-2005	Komen et al.	
	8	7,051,072 B2	05-23-2006	Stewart et al.	
	9	7,330,835 B2	02-12-2008	Deggendorf, Theresa M.	
	10	7,426,492 B2	09-16-2008	Bishop et al.	
	11	7,437,665 B2	10-14-2008	Perham, Michael	
	12	7,447,707 B2	11-04-2008	Gaurav et al.	
	13	7,580,886 B1	08-25-2009	Schulz, Larry	
	14	7,593,884 B2	09-22-2009	Rothman et al.	
	15	7,599,944 B2	10-06-2009	Gaurav et al.	
	16	7,644,037 B1	01-05-2010	Ostrovsky, Vladimir	
	17	7,647,500 B2	01-12-2010	Machiraju et al.	
	18	7,676,431 B2	03-09-2010	O'Leary et al.	
	19	7,680,737 B2	03-16-2010	Smith et al.	
	20	7,734,544 B2	06-08-2010	Schleicher, Joerg	
	21	7,765,261 B2	07-27-2010	Kropivny, Alexander	
	22	7,765,266 B2	07-27-2010	Kropivny, Alexander	
	23	7,882,011 B2	02-01-2011	Sandhu et al.	
	24	7,899,742 B2	03-11-2011	Berkert et al.	
	25	8,060,887 B2	11-15-2011	Kropivny, Alexander	
	26	8,161,078 B2	04-17-2012	Gaurav et al.	
	27	8,200,575 B2	06-12-2012	Torres et al.	
	28	8,543,477 B2	09-24-2013	Love et al.	
	29	8,627,211 B2	01-07-2014	Kropivny, Alexander	

Examiner Signature	Date Considered
*Examiner: Initial if reference considered, whether or not citation is in conformance with MPEP 609. Draw line through citation if not in conformance and not considered. Include copy of this form with next communication to applicant.	

T¹ - Place a check mark in this area when an English language translation is attached.

INFORMATION DISCLOSURE STATEMENT BY APPLICANT	Application No.	13/966,096	
	Filing Date	August 13, 2013	
	First Named Inventor	Perreault, Clay	
	Art Unit	2653	
(Multiple sheets used when necessary)		Examiner	Sing, Simon P.
SHEET 2 OF 2		Attorney Docket No.	DIGIF.001C1

U.S. PATENT DOCUMENTS					
Examiner Initials	Cite No.	Document Number Number - Kind Code (if known) Example: 1,234,567 B1	Publication Date MM-DD-YYYY	Name	Pages, Columns, Lines Where Relevant Passages or Relevant Figures Appear
	30	8,702,505 B2	04-22-2014	Kropivny, Alexander	
	31	2005/0131813 A1	06-16-2005	Gallagher et al.	
	32	2005/0171898 A1	08-04-2005	Bishop et al.	
	33	2005/0192897 A1	09-01-2005	Rogers et al.	
	34	2005/0192901 A1	09-01-2005	McCoy et al.	
	35	2005/0222952 A1	10-06-2005	Garrett et al.	
	36	2005/0267842 A1	12-01-2005	Weichert et al.	
	37	2006/0006224 A1	01-12-2006	Modi, Vikram	
	38	2006/0036522 A1	02-15-2006	Perham, Michael	
	39	2006/0095320 A1	05-04-2006	Jones, Lisa	
	40	2006/0116892 A1	06-01-2006	Grimes et al.	
	41	2006/0195398 A1	08-31-2006	Dheer et al.	
	42	2007/0016524 A1	01-18-2007	Diveley, et al.	
	43	2014/0141884 A1	05-22-2014	Kropivny, Alexander	

FOREIGN PATENT DOCUMENTS						
Examiner Initials	Cite No.	Foreign Patent Document Country Code-Number-Kind Code Example: JP 1234567 A1	Publication Date MM-DD-YYYY	Name	Pages, Columns, Lines Where Relevant Passages or Relevant Figures Appear	T ¹

NON PATENT LITERATURE DOCUMENTS			
Examiner Initials	Cite No.	Include name of the author (in CAPITAL LETTERS), title of the article (when appropriate), title of the item (book, magazine, journal, serial, symposium, catalog, etc.), date, page(s), volume-issue number(s), publisher, city and/or country where published.	T ¹
	44	Ketchpel et al. "U-PAI: A universal payment application interface" <i>Second USENIX Workshop on Electronic Commerce Proceedings</i> , 1996-8, pages 1-17.	
	45	Moberg & Drummond, "MIME-Based Secure Peer-to-Peer Business Data Interchange Using HTTP, Applicability Statement 2 (AS2)," <i>Network Working Group, Request for Comments: 4130, Category: Standards Track</i> , Copyright © The Internet Society July 2005, pages 1-47.	
	46	Abrazhevich, Dennis. "Electronic Payment Systems: a User-Centered Perspective and Interaction Design," <i>Thesis under the auspices of the J.F. Schouten School for User-System Interaction Research</i> , Technische Universiteit Eindhoven, Netherlands, 2004, pages Cover page - page 189.	

21269338
080315

Examiner Signature	Date Considered
--------------------	-----------------

*Examiner: Initial if reference considered, whether or not citation is in conformance with MPEP 609. Draw line through citation if not in conformance and not considered. Include copy of this form with next communication to applicant.

T¹ - Place a check mark in this area when an English language translation is attached

PETITIONER APPLE INC. EX. 1002-343

Electronic Patent Application Fee Transmittal

Application Number:	13966096
Filing Date:	13-Aug-2013
Title of Invention:	PRODUCING ROUTING MESSAGES FOR VOICE OVER IP COMMUNICATIONS
First Named Inventor/Applicant Name:	CLAY PERREAULT
Filer:	Paul S. Brockland/Norman Green
Attorney Docket Number:	DIGIF.001C1

Filed as Small Entity

Filing Fees for Utility under 35 USC 111(a)

Description	Fee Code	Quantity	Amount	Sub-Total in USD(\$)
Basic Filing:				
Pages:				
Claims:				
Miscellaneous-Filing:				
Petition:				
Patent-Appeals-and-Interference:				
Post-Allowance-and-Post-Issuance:				
Extension-of-Time:				

Description	Fee Code	Quantity	Amount	Sub-Total in USD(\$)
Miscellaneous:				
Submission- Information Disclosure Stmt	2806	1	90	90
Total in USD (\$)				90

Electronic Acknowledgement Receipt

EFS ID:	23102375
Application Number:	13966096
International Application Number:	
Confirmation Number:	8712
Title of Invention:	PRODUCING ROUTING MESSAGES FOR VOICE OVER IP COMMUNICATIONS
First Named Inventor/Applicant Name:	CLAY PERREAULT
Customer Number:	20995
Filer:	Paul S. Brockland/Norman Green
Filer Authorized By:	Paul S. Brockland
Attorney Docket Number:	DIGIF.001C1
Receipt Date:	03-AUG-2015
Filing Date:	13-AUG-2013
Time Stamp:	19:13:59
Application Type:	Utility under 35 USC 111(a)

Payment information:

Submitted with Payment	no
------------------------	----

File Listing:

Document Number	Document Description	File Name	File Size(Bytes)/ Message Digest	Multi Part /.zip	Pages (if appl.)
1		IDS_DIGIF_001C1_08_03_2015.pdf	197803 <small>fa85930406d4fcc07a9224b729b559dddcb5a14f</small>	yes	4

Multipart Description/PDF files in .zip description					
Document Description			Start	End	
Transmittal Letter			1	2	
Information Disclosure Statement (IDS) Form (SB08)			3	4	
Warnings:					
Information:					
2	Non Patent Literature	Ref44_Ketchpel_U_PAI_1996.pdf	1651947	no	17
			4b63607eda118f5a951c977ab8f89fc2867fa601		
Warnings:					
Information:					
3	Non Patent Literature	Ref45_Moberg_MIME_Based_July_2005.pdf	3541379	no	47
			076126a8cc567e0a04610824d48a06aad446f5ca		
Warnings:					
Information:					
4	Non Patent Literature	Ref46_Abrazhevich_Elec_Pay_Sys_2004.pdf	15745553	no	202
			1297206b1690e9c4399031d7d4378c7554750e34		
Warnings:					
Information:					
5	Fee Worksheet (SB06)	fee-info.pdf	30527	no	2
			0d6a55393d7f48a157ca028958053b76a2da9813		
Warnings:					
Information:					
Total Files Size (in bytes):			21167209		

This Acknowledgement Receipt evidences receipt on the noted date by the USPTO of the indicated documents, characterized by the applicant, and including page counts, where applicable. It serves as evidence of receipt similar to a Post Card, as described in MPEP 503.

New Applications Under 35 U.S.C. 111

If a new application is being filed and the application includes the necessary components for a filing date (see 37 CFR 1.53(b)-(d) and MPEP 506), a Filing Receipt (37 CFR 1.54) will be issued in due course and the date shown on this Acknowledgement Receipt will establish the filing date of the application.

National Stage of an International Application under 35 U.S.C. 371

If a timely submission to enter the national stage of an international application is compliant with the conditions of 35 U.S.C. 371 and other applicable requirements a Form PCT/DO/EO/903 indicating acceptance of the application as a national stage submission under 35 U.S.C. 371 will be issued in addition to the Filing Receipt, in due course.

New International Application Filed with the USPTO as a Receiving Office

If a new international application is being filed and the international application includes the necessary components for an international filing date (see PCT Article 11 and MPEP 1810), a Notification of the International Application Number and of the International Filing Date (Form PCT/RO/105) will be issued in due course, subject to prescriptions concerning national security, and the date shown on this Acknowledgement Receipt will establish the international filing date of the application.

INFORMATION DISCLOSURE STATEMENT

Inventor	:	Clay Perreault, et al.
App. No.	:	13/966,096
Filed	:	August 13, 2013
For	:	PRODUCING ROUTING MESSAGES FOR VOICE OVER IP COMMUNICATIONS
Examiner	:	Sing, Simon P.
Art Unit	:	2653
Conf. No.	:	8712

Commissioner for Patents
P.O. Box 1450
Alexandria, VA 22313-1450

References and Listing

Pursuant to 37 CFR 1.56, an Information Disclosure Statement listing references is provided herewith. Copies of any listed foreign and non-patent literature references are being submitted.

No Disclaimers

To the extent that anything in the Information Disclosure Statement or the listed references could be construed as a disclaimer of any subject matter supported by the present application, Applicant hereby rescinds and retracts such disclaimer.

Timing of Disclosure

This Information Disclosure Statement is being filed after receipt of a First Office Action, but before the mailing date of a Final Action and before the mailing date of a Notice of Allowance. This Statement is accompanied by the fees set forth in 37 CFR 1.17(p). The

Application No.: 13/966,096
Filing Date: August 13, 2013

Commissioner is hereby authorized to charge any additional fees which may be required or to credit any overpayment to Account No. 11-1410.

Respectfully submitted,
KNOBBE, MARTENS, OLSON & BEAR, LLP

Dated: 8/3/2015

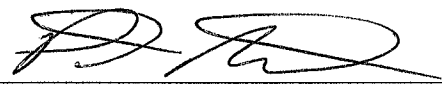
By: 
Paul Brockland
Registration No. 61,130
Attorney of Record
Customer No. 20995
(858) 707-4000

IDS
21273187
080315

INFORMATION DISCLOSURE STATEMENT BY APPLICANT <i>(Multiple sheets used when necessary)</i> SHEET 1 OF 1	Application No.	13/966,096
	Filing Date	August 13, 2013
	First Named Inventor	Perreault, Clay
	Art Unit	2633
	Examiner	Sing, Simon P.
	Attorney Docket No.	DIGIF.001C1

U.S. PATENT DOCUMENTS					
Examiner Initials	Cite No.	Document Number Number - Kind Code (if known) Example: 1,234,567 B1	Publication Date MM-DD-YYYY	Name	Pages, Columns, Lines Where Relevant Passages or Relevant Figures Appear
	1	6,327,351 B1	12-04-2001	Walker et al.	
	2	7,203,478 B2	04-10-2007	Benco et al.	

FOREIGN PATENT DOCUMENTS						
Examiner Initials	Cite No.	Foreign Patent Document Country Code-Number-Kind Code Example: JP 1234567 A1	Publication Date MM-DD-YYYY	Name	Pages, Columns, Lines Where Relevant Passages or Relevant Figures Appear	T ¹

NON PATENT LITERATURE DOCUMENTS			
Examiner Initials	Cite No.	Include name of the author (in CAPITAL LETTERS), title of the article (when appropriate), title of the item (book, magazine, journal, serial, symposium, catalog, etc.), date, page(s), volume-issue number(s), publisher, city and/or country where published.	T ¹

21034262
063015

Examiner Signature	Date Considered
*Examiner: Initial if reference considered, whether or not citation is in conformance with MPEP 609. Draw line through citation if not in conformance and not considered. Include copy of this form with next communication to applicant.	

T¹ - Place a check mark in this area when an English language PETITIONER: APPLE INC. EX. 1002-351

Electronic Patent Application Fee Transmittal

Application Number:	13966096
Filing Date:	13-Aug-2013
Title of Invention:	PRODUCING ROUTING MESSAGES FOR VOICE OVER IP COMMUNICATIONS
First Named Inventor/Applicant Name:	CLAY PERREAULT
Filer:	John M Carson/Norman Green
Attorney Docket Number:	DIGIF.001C1

Filed as Small Entity

Filing Fees for Utility under 35 USC 111(a)

Description	Fee Code	Quantity	Amount	Sub-Total in USD(\$)
Basic Filing:				
Pages:				
Claims:				
Miscellaneous-Filing:				
Petition:				
Patent-Appeals-and-Interference:				
Post-Allowance-and-Post-Issuance:				
Extension-of-Time:				

Description	Fee Code	Quantity	Amount	Sub-Total in USD(\$)
Miscellaneous:				
Submission- Information Disclosure Stmt	2806	1	90	90
Total in USD (\$)				90

Electronic Acknowledgement Receipt

EFS ID:	22794407
Application Number:	13966096
International Application Number:	
Confirmation Number:	8712
Title of Invention:	PRODUCING ROUTING MESSAGES FOR VOICE OVER IP COMMUNICATIONS
First Named Inventor/Applicant Name:	CLAY PERREAULT
Customer Number:	20995
Filer:	John M Carson/Norman Green
Filer Authorized By:	John M Carson
Attorney Docket Number:	DIGIF.001C1
Receipt Date:	30-JUN-2015
Filing Date:	13-AUG-2013
Time Stamp:	19:06:36
Application Type:	Utility under 35 USC 111(a)

Payment information:

Submitted with Payment	yes
Payment Type	Credit Card
Payment was successfully received in RAM	\$90
RAM confirmation Number	7217
Deposit Account	111410
Authorized User	KNOBBE MARTENS OLSON AND BEAR

The Director of the USPTO is hereby authorized to charge indicated fees and credit any overpayment as follows:

Charge any Additional Fees required under 37 C.F.R. Section 1.16 (National application filing, search, and examination fees)

Charge any Additional Fees required under 37 C.F.R. Section 1.17 (Patent application and examination processing fees)

PETITIONER APPLE INC. PEX: 1902354

--	--	--	--	--	--

File Listing:

Document Number	Document Description	File Name	File Size(Bytes)/ Message Digest	Multi Part /.zip	Pages (if appl.)
1		IDS_DIGIF_001C1_06_30_2015.pdf	220562 4888eb3e0ce8037036c11973fdac8857d4fd a09e	yes	3

Multipart Description/PDF files in .zip description				
Document Description		Start	End	
Transmittal Letter		1	2	
Information Disclosure Statement (IDS) Form (SB08)		3	3	

Warnings:

Information:

2	Fee Worksheet (SB06)	fee-info.pdf	30465 94d822a6e13c1edc809dadbcc0c1b4a0c6b a6866	no	2
---	----------------------	--------------	---	----	---

Warnings:

Information:

Total Files Size (in bytes):	251027
-------------------------------------	--------

This Acknowledgement Receipt evidences receipt on the noted date by the USPTO of the indicated documents, characterized by the applicant, and including page counts, where applicable. It serves as evidence of receipt similar to a Post Card, as described in MPEP 503.

New Applications Under 35 U.S.C. 111

If a new application is being filed and the application includes the necessary components for a filing date (see 37 CFR 1.53(b)-(d) and MPEP 506), a Filing Receipt (37 CFR 1.54) will be issued in due course and the date shown on this Acknowledgement Receipt will establish the filing date of the application.

National Stage of an International Application under 35 U.S.C. 371

If a timely submission to enter the national stage of an international application is compliant with the conditions of 35 U.S.C. 371 and other applicable requirements a Form PCT/DO/EO/903 indicating acceptance of the application as a national stage submission under 35 U.S.C. 371 will be issued in addition to the Filing Receipt, in due course.

New International Application Filed with the USPTO as a Receiving Office

If a new international application is being filed and the international application includes the necessary components for an international filing date (see PCT Article 11 and MPEP 1810), a Notification of the International Application Number and of the International Filing Date (Form PCT/RO/105) will be issued in due course, subject to prescriptions concerning national security, and the date shown on this Acknowledgement Receipt will establish the international filing date of the application.

INFORMATION DISCLOSURE STATEMENT

Inventor : Clay Perreault, et al.
App. No. : 13/966,096
Filed : August 13, 2013
For : PRODUCING ROUTING MESSAGES FOR
VOICE OVER IP COMMUNICATIONS
Examiner : Sing, Simon P.
Art Unit : 2653
Conf. No. : 8712

Commissioner for Patents
P.O. Box 1450
Alexandria, VA 22313-1450

References and Listing

Pursuant to 37 CFR 1.56, an Information Disclosure Statement listing references is provided herewith. Copies of any listed foreign and non-patent literature references are being submitted.

No Disclaimers

To the extent that anything in the Information Disclosure Statement or the listed references could be construed as a disclaimer of any subject matter supported by the present application, Applicant hereby rescinds and retracts such disclaimer.

Timing of Disclosure

This Information Disclosure Statement is being filed after receipt of a First Office Action, but before the mailing date of a Final Action and before the mailing date of a Notice of Allowance. This Statement is accompanied by the fees set forth in 37 CFR 1.17(p). The

Application No.: 13/966,096
Filing Date: August 13, 2013

Commissioner is hereby authorized to charge any additional fees which may be required or to credit any overpayment to Account No. 11-1410.

Respectfully submitted,
KNOBBE, MARTENS, OLSON & BEAR, LLP

Dated: 6/30/15

By: 
John M. Carson
Registration No. 34,303
Attorney of Record
Customer No. 20995
(858) 707-4000

IDS
21034347
063015

IN THE UNITED STATES PATENT AND TRADEMARK OFFICE

Inventor	: Clay Perreault
App. No.	: 13/966,096
Filed	: August 13, 2013
For	: PRODUCING ROUTING MESSAGES FOR VOICE OVER IP COMMUNICATIONS
Examiner	: Sing, Simon P.
Art Unit	: 2653
Conf. No.	: 8712

STATEMENT OF THE SUBSTANCE OF INTERVIEW

Mail Stop Amendment

Commissioner for Patents
P.O. Box 1450
Alexandria, VA 22313-1450

Dear Sir:

Further to the Office Communication dated June 2, 2015, containing the Examiner's Interview Summary, Applicant provides herein a summary statement of the substance of the interview pursuant to MPEP 713.04.

Summary of Interview begins on page 2 of this paper.

Application No.: 13/966,096
Filing Date: August 13, 2013

SUMMARY OF INTERVIEW

Attendees, Date and Type of Interview

The personal interview was conducted on May 28, 2015 and was attended by Primary Examiner Simon Sing and Applicant's representative, John M. Carson, Reg. No. 34,303.

Identification of Claims Discussed

Claim 1 was discussed as a representative claim.

Identification of Prior Art Discussed

U.S. Patent No. 6,798,767 (Alexander et al.) was discussed.

Proposed Amendments

No amendments were proposed.

Principal Arguments and Other Matters

The cited art does not disclose all the features of the pending claims.

Results of Interview

The Examiner agreed that the cited art does not disclose all the features of the pending claims. The Examiner will perform an update search and determine patentability based on the new search.

Application No.: 13/966,096
Filing Date: August 13, 2013

Please charge any additional fees, including any fees for additional extension of time, or credit overpayment to Deposit Account No. 11-1410.

Respectfully submitted,

KNOBBE, MARTENS, OLSON & BEAR, LLP

Dated: 6/29/15

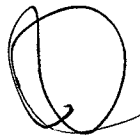
By:  _____

John M. Carson
Registration No. 34,303
Attorney of Record
Customer No. 20995
(858) 707-4000

21007903
062615

Electronic Acknowledgement Receipt

EFS ID:	22771507
Application Number:	13966096
International Application Number:	
Confirmation Number:	8712
Title of Invention:	PRODUCING ROUTING MESSAGES FOR VOICE OVER IP COMMUNICATIONS
First Named Inventor/Applicant Name:	CLAY PERREAULT
Customer Number:	20995
Filer:	John M Carson/Kevin Kraus
Filer Authorized By:	John M Carson
Attorney Docket Number:	DIGIF.001C1
Receipt Date:	29-JUN-2015
Filing Date:	13-AUG-2013
Time Stamp:	18:00:19
Application Type:	Utility under 35 USC 111(a)

Payment information:

Submitted with Payment	no
------------------------	----

File Listing:

Document Number	Document Description	File Name	File Size(Bytes)/ Message Digest	Multi Part /.zip	Pages (if appl.)
1	Applicant summary of interview with examiner	DIGIF001C1interviewsummary.pdf	62382 b7f8339f4ca838a74b909fbc997f291df8c5d9e2	no	3

Warnings:

Information:

PETITIONER APPLE INC. EX. 1002-361

This Acknowledgement Receipt evidences receipt on the noted date by the USPTO of the indicated documents, characterized by the applicant, and including page counts, where applicable. It serves as evidence of receipt similar to a Post Card, as described in MPEP 503.

New Applications Under 35 U.S.C. 111

If a new application is being filed and the application includes the necessary components for a filing date (see 37 CFR 1.53(b)-(d) and MPEP 506), a Filing Receipt (37 CFR 1.54) will be issued in due course and the date shown on this Acknowledgement Receipt will establish the filing date of the application.

National Stage of an International Application under 35 U.S.C. 371

If a timely submission to enter the national stage of an international application is compliant with the conditions of 35 U.S.C. 371 and other applicable requirements a Form PCT/DO/EO/903 indicating acceptance of the application as a national stage submission under 35 U.S.C. 371 will be issued in addition to the Filing Receipt, in due course.

New International Application Filed with the USPTO as a Receiving Office

If a new international application is being filed and the international application includes the necessary components for an international filing date (see PCT Article 11 and MPEP 1810), a Notification of the International Application Number and of the International Filing Date (Form PCT/RO/105) will be issued in due course, subject to prescriptions concerning national security, and the date shown on this Acknowledgement Receipt will establish the international filing date of the application.

Electronic Petition Request	TERMINAL DISCLAIMER TO OBIATE A DOUBLE PATENTING REJECTION OVER A "PRIOR" PATENT
Application Number	13966096
Filing Date	13-Aug-2013
First Named Inventor	CLAY PERREAUULT
Attorney Docket Number	DIGIF.001C1
Title of Invention	PRODUCING ROUTING MESSAGES FOR VOICE OVER IP COMMUNICATIONS

- Filing of terminal disclaimer does not obviate requirement for response under 37 CFR 1.111 to outstanding Office Action
- This electronic Terminal Disclaimer is not being used for a Joint Research Agreement.

Owner	Percent Interest
Digifonica (International) Limited	100%

The owner(s) with percent interest listed above in the instant application hereby disclaims, except as provided below, the terminal part of the statutory term of any patent granted on the instant application which would extend beyond the expiration date of the full statutory term of prior patent number(s)

8542815

as the term of said prior patent is presently shortened by any terminal disclaimer. The owner hereby agrees that any patent so granted on the instant application shall be enforceable only for and during such period that it and the prior patent are commonly owned. This agreement runs with any patent granted on the instant application and is binding upon the grantee, its successors or assigns.

In making the above disclaimer, the owner does not disclaim the terminal part of the term of any patent granted on the instant application that would extend to the expiration date of the full statutory term of the prior patent, "as the term of said prior patent is presently shortened by any terminal disclaimer," in the event that said prior patent later:

- expires for failure to pay a maintenance fee;
- is held unenforceable;
- is found invalid by a court of competent jurisdiction;
- is statutorily disclaimed in whole or terminally disclaimed under 37 CFR 1.321;
- has all claims canceled by a reexamination certificate;
- is reissued; or
- is in any manner terminated prior to the expiration of its full statutory term as presently shortened by any terminal disclaimer.

Terminal disclaimer fee under 37 CFR 1.20(d) is included with Electronic Terminal Disclaimer request.

PETITIONER APPLE INC. EX. 1002-363

I certify, in accordance with 37 CFR 1.4(d)(4), that the terminal disclaimer fee under 37 CFR 1.20(d) required for this terminal disclaimer has already been paid in the above-identified application.

Applicant claims the following fee status:

- Small Entity
- Micro Entity
- Regular Undiscounted

I hereby declare that all statements made herein of my own knowledge are true and that all statements made on information and belief are believed to be true; and further that these statements were made with the knowledge that willful false statements and the like so made are punishable by fine or imprisonment, or both, under Section 1001 of Title 18 of the United States Code and that such willful false statements may jeopardize the validity of the application or any patent issued thereon.

THIS PORTION MUST BE COMPLETED BY THE SIGNATORY OR SIGNATORIES

I certify, in accordance with 37 CFR 1.4(d)(4) that I am:

- An attorney or agent registered to practice before the Patent and Trademark Office who is of record in this application

Registration Number 34303
- A sole inventor
- A joint inventor; I certify that I am authorized to sign this submission on behalf of all of the inventors as evidenced by the power of attorney in the application
- A joint inventor; all of whom are signing this request

Signature	/John M. Carson/
Name	John M. Carson

*Statement under 37 CFR 3.73(b) is required if terminal disclaimer is signed by the assignee (owner).
Form PTO/SB/96 may be used for making this certification. See MPEP § 324.

Electronic Patent Application Fee Transmittal

Application Number:	13966096
Filing Date:	13-Aug-2013
Title of Invention:	PRODUCING ROUTING MESSAGES FOR VOICE OVER IP COMMUNICATIONS
First Named Inventor/Applicant Name:	CLAY PERREAULT
Filer:	John M Carson/Anthony Bonilla
Attorney Docket Number:	DIGIF.001C1

Filed as Small Entity

Filing Fees for Utility under 35 USC 111(a)

Description	Fee Code	Quantity	Amount	Sub-Total in USD(\$)
Basic Filing:				
Statutory or Terminal Disclaimer	1814	1	160	160

Pages:

Claims:

Miscellaneous-Filing:

Petition:

Patent-Appeals-and-Interference:

Post-Allowance-and-Post-Issuance:

Description	Fee Code	Quantity	Amount	Sub-Total in USD(\$)
Extension-of-Time:				
Miscellaneous:				
Total in USD (\$)				160

Doc Code: DISQ.E.FILE

Document Description: Electronic Terminal Disclaimer – Approved

Application No.: 13966096

Filing Date: 13-Aug-2013

Applicant/Patent under Reexamination: PERREAULT et al.

Electronic Terminal Disclaimer filed on June 29, 2015

APPROVED

This patent is subject to a terminal disclaimer

DISAPPROVED

Approved/Disapproved by: Electronic Terminal Disclaimer automatically approved by EFS-Web

U.S. Patent and Trademark Office

Electronic Acknowledgement Receipt

EFS ID:	22777858
Application Number:	13966096
International Application Number:	
Confirmation Number:	8712
Title of Invention:	PRODUCING ROUTING MESSAGES FOR VOICE OVER IP COMMUNICATIONS
First Named Inventor/Applicant Name:	CLAY PERREAULT
Customer Number:	20995
Filer:	John M Carson/Anthony Bonilla
Filer Authorized By:	John M Carson
Attorney Docket Number:	DIGIF.001C1
Receipt Date:	29-JUN-2015
Filing Date:	13-AUG-2013
Time Stamp:	19:19:19
Application Type:	Utility under 35 USC 111(a)

Payment information:

Submitted with Payment	yes
Payment Type	Credit Card
Payment was successfully received in RAM	\$160
RAM confirmation Number	6583
Deposit Account	111410
Authorized User	KNOBBE MARTENS OLSON AND BEAR

The Director of the USPTO is hereby authorized to charge indicated fees and credit any overpayment as follows:

Charge any Additional Fees required under 37 C.F.R. Section 1.16 (National application filing, search, and examination fees)

Charge any Additional Fees required under 37 C.F.R. Section 1.17 (Patent application and examination processing fees)

PETITIONER APPLE INC. PEX: 1902368

--	--	--	--	--	--

File Listing:

Document Number	Document Description	File Name	File Size(Bytes)/ Message Digest	Multi Part /.zip	Pages (if appl.)
1	Electronic Terminal Disclaimer-Filed	eTerminal-Disclaimer.pdf	33429	no	2
			af7bbe18303fd60686cc027738dbae05d3268b05		

Warnings:

Information:

2	Fee Worksheet (SB06)	fee-info.pdf	30470	no	2
			248e9b4e8e1602643763fbb9ba9629a0ee798121		

Warnings:

Information:

Total Files Size (in bytes):	63899
-------------------------------------	-------

This Acknowledgement Receipt evidences receipt on the noted date by the USPTO of the indicated documents, characterized by the applicant, and including page counts, where applicable. It serves as evidence of receipt similar to a Post Card, as described in MPEP 503.

New Applications Under 35 U.S.C. 111

If a new application is being filed and the application includes the necessary components for a filing date (see 37 CFR 1.53(b)-(d) and MPEP 506), a Filing Receipt (37 CFR 1.54) will be issued in due course and the date shown on this Acknowledgement Receipt will establish the filing date of the application.

National Stage of an International Application under 35 U.S.C. 371

If a timely submission to enter the national stage of an international application is compliant with the conditions of 35 U.S.C. 371 and other applicable requirements a Form PCT/DO/EO/903 indicating acceptance of the application as a national stage submission under 35 U.S.C. 371 will be issued in addition to the Filing Receipt, in due course.

New International Application Filed with the USPTO as a Receiving Office

If a new international application is being filed and the international application includes the necessary components for an international filing date (see PCT Article 11 and MPEP 1810), a Notification of the International Application Number and of the International Filing Date (Form PCT/RO/105) will be issued in due course, subject to prescriptions concerning national security, and the date shown on this Acknowledgement Receipt will establish the international filing date of the application.

INFORMATION DISCLOSURE STATEMENT BY APPLICANT	Application No.	13/966,096	
	Filing Date	August 13, 2013	
	First Named Inventor	Perreault, Clay	
	Art Unit	2653	
<i>(Multiple sheets used when necessary)</i>		Examiner	Sing, Simon P.
SHEET 1 OF 1		Attorney Docket No.	DIGIF.001C1

U.S. PATENT DOCUMENTS					
Examiner Initials	Cite No.	Document Number <i>Number - Kind Code (if known)</i> Example: 1,234,567 B1	Publication Date MM-DD-YYYY	Name	Pages, Columns, Lines Where Relevant Passages or Relevant Figures Appear

FOREIGN PATENT DOCUMENTS						
Examiner Initials	Cite No.	Foreign Patent Document <i>Country Code-Number-Kind Code</i> Example: JP 1234567 A1	Publication Date MM-DD-YYYY	Name	Pages, Columns, Lines Where Relevant Passages or Relevant Figures Appear	T ¹
	1	CA 2,598,200 A1	02-21-2008	Connexon Telecom Inc.		
	2	W00200902627 <i>(Indonesia)</i>	09-17-2009	Digifonica International Ltd	<i>Corresponding International Publication No. WO 2008/116296 A1 previously disclosed</i>	Abstract Only

NON PATENT LITERATURE DOCUMENTS			
Examiner Initials	Cite No.	Include name of the author (in CAPITAL LETTERS), title of the article (when appropriate), title of the item (book, magazine, journal, serial, symposium, catalog, etc.), date, page(s), volume-issue number(s), publisher, city and/or country where published.	T ¹
	3	Canadian Office Action dated January 27, 2015 for Canadian Patent Application No. CA 2,681,984.	

20995995
062515

Examiner Signature	Date Considered
<p>*Examiner: Initial if reference considered, whether or not citation is in conformance with MPEP 609. Draw line through citation if not in conformance and not considered. Include copy of this form with next communication to applicant.</p>	

T¹ - Place a check mark in this area when an English language PUBLISHER: PETITIONER: APPLE INC. EX. 1002-370



(12) **DEMANDE DE BREVET CANADIEN
CANADIAN PATENT APPLICATION**

(13) **A1**

(22) Date de dépôt/Filing Date: 2007/08/21

(41) Mise à la disp. pub./Open to Public Insp.: 2008/02/21

(30) Priorité/Priority: 2006/08/21 (US60/838,868)

(51) Cl.Int./Int.Cl. *H04L 12/66* (2006.01),
H04M 11/06 (2006.01), *H04M 3/42* (2006.01),
H04Q 3/00 (2006.01), *H04Q 3/64* (2006.01)

(71) Demandeur/Applicant:
CONNEXON TELECOM INC., CA

(72) Inventeurs/Inventors:
KRIVOROT, ZOHAR, CA;
KRIVOROT, ARI, CA;
DEICH, LEV, CA

(74) Agent: ROBIC

(54) Titre : SYSTEME ET METHODE DE LIVRAISON DE NUMEROS DE RAPPEL AUTOMATIQUE POUR APPELS
D'URGENCE D'UN RESEAU VOIP

(54) Title: SYSTEM AND METHOD FOR DELIVERING CALLBACK NUMBERS FOR EMERGENCY CALLS IN A VOIP
SYSTEM

(57) **Abrégé/Abstract:**

In a VoIP system, a method and apparatus for tracking emergency callers is provided. A VoIP service provider network includes a plurality of VoIP phones and is connected to an emergency service provider system. The emergency service provider system includes a call server connected to the VoIP service provider network; a subscriber database; a VPC SBC; and a media gateway for connection to a PSTN. The call server is adapted to receive an emergency call from a VoIP telephone in the VoIP network; verify if the SIP URI has a DID bound to the SIP URI; if the SIP URI does not have a DID bound to the SIP URI, obtain a temporary DID from a DID pool and temporarily bind the temporary DID to said SIP URI; and forward the call to an appropriate PSAP in the PSTN. Should the emergency call be dropped, a person at the PSAP can call back the emergency caller without unnecessary delays.



ABSTRACT

5 In a VoIP system, a method and apparatus for tracking emergency callers is provided. A VoIP service provider network includes a plurality of VoIP phones and is connected to an emergency service provider system. The emergency service provider system includes a call server connected to the VoIP service provider network; a subscriber database; a VPC SBC; and a media gateway for connection to a PSTN. The call server is adapted to receive an emergency call from a VoIP
10 telephone in the VoIP network; verify if the SIP URI has a DID bound to the SIP URI; if the SIP URI does not have a DID bound to the SIP URI, obtain a temporary DID from a DID pool and temporarily bind the temporary DID to said SIP URI; and forward the call to an appropriate PSAP in the PSTN. Should the emergency call be dropped, a person at the PSAP can call back the emergency caller without
15 unnecessary delays.

**SYSTEM AND METHOD FOR DELIVERING CALLBACK NUMBERS FOR
EMERGENCY CALLS IN A VOIP SYSTEM**

5 FIELD OF THE INVENTION

In most areas of the world, a unique number is used to make an emergency call. For North America, this number is "911", and when this number is dialed, the call is automatically routed to a Public Safety Answering Point (PSAP).

10

In some cases, an emergency call will be dropped, for any number of reasons. If this occurs, most jurisdictions require that the PSAP be able to call back the person that made the call.

15

Currently, when a 9-1-1 call is placed by a customer in a VOIP context, a server forwards the call to a 9-1-1 gateway (3rd party call server) which routes the call to the correct Public Safety Answering Point (PSAP) that answers the call. The call delivery is generally done using NENA i1, i2, or i3 standards. The PSAP must be able to call back the caller in case the call is disconnected.

20

Many VoIP users have a Direct Inward Dial (DID) associated with their phone line. This allows anyone connected to the Public Switch Telephone Network (PSTN) to call the the VoIP user. For such users, the 911 system can obtain the caller's callback number from the SIP signaling messages by reading the SIP URI field.

25

The field is in the form DID@provider.com, where the DID is the VoIP user's DID, and the provider.com is the user's domain.

30

In many cases, it is becoming more common to see VoIP phones without assigned DID numbers. This is often the case in Multi-Line Telephone Systems (MLTS) and peer to peer VoIP service providers. For such users, The SIP URI originating from

call will be a phone extension or an alphanumeric username. Since the phone does not have a direct PSTN callback number that can be reached by the PSAP, these users cannot be adequately serviced.

5 The traditional solution to this problem is to assign a static phone number to the VoIP phone. This solution increases costs to maintain a VoIP phone lines and can be complex to administer in large enterprises.

10 It is required to route the 9-1-1 calls from the different extensions to the correct PSAPs based on the subscriber location and provide this PSAP with a callback number that can call the extension directly without permanently assigning a DID to each extension.

15 SUMMARY OF THE INVENTION

An object of the invention is to provide a system and method to deliver a callback number for emergency calls in a VOIP system. To achieve this objective, when an extension makes a call, a DID is selected from a pool and bound to it for a finite duration. This DID is used as the callback number to call the phone extension directly. If the PSAP initiates a callback, the call is originated by the 911 service provider, and translated back to the VoIP phone's SIP address.

25 More specifically, according to one aspect of the invention, this object is achieved with a method for delivering callback numbers for emergency calls in a VoIP system, comprising the steps of:

- (a) providing a pool of callback numbers consisting of a plurality of individual DIDs;
 - (b) providing a plurality of IP phones, each phone being provided with a unique SIP URI;
- 30

(c) at an emergency service provider, temporarily binding a DID to the SIP URI when an emergency call is made from at least one of the phones if the SIP URI is not already bound to a DID; and

(d) marking the DID that is bound to the SIP URI as unavailable.

5

In another aspect, the invention provides a method for delivering callback numbers for emergency calls in a VoIP system, comprising temporarily assigning a DID from a pool of DIDs to a VoIP endpoint during a 911 call, the DID mapping a callback number to an IP phone in a VoIP system.

10

In yet another aspect of the invention, there is provided an emergency service provider system, comprising:

a call server for connection to a VoIP service provider network;

a subscriber database;

15

a VPC SBC; and

a media gateway for connection to a PSTN;

the call server being adapted to:

receive an emergency call from a VoIP telephone in the VoIP network;

20

verify if the SIP URI has a DID bound to the SIP URI;

if the SIP URI does not have a DID bound to the SIP URI, obtain a temporary DID from a DID pool and temporarily bind the temporary DID to said SIP URI; and

forward the call to an appropriate PSAP in the PSTN.

25

DESCRIPTION OF THE DRAWINGS

30

The present invention will be better understood after reading a description of a preferred embodiment thereof, made in reference to the following drawings in which:

Figure 1 is a schematic representation of a VoIP system according to one embodiment of the present invention; and

Figure 2 is a sequence diagram of a 911 call, according to a preferred embodiment of the invention.

5

DESCRIPTION OF A PREFERRED EMBODIMENT OF THE INVENTION

VoIP E-911 Solution Overview

10

The solution is designed for

- VoIP service providers that supply enterprises with hosted PBX solutions
- VoIP service providers that supply enterprises with SIP trunks
- VoIP service providers that offer peer to peer voice communications (on-net)
- VoIP service providers that need to offer E911 service to roaming international users without a North American Numbering Plan (NANP).
- Enterprises with single or multiple onsite IP-PBXs
- Enterprises with digital VoIP gateways connected to legacy PBXs

15

20

The solution routes 9-1-1 calls to the appropriate Public Safety Answering Point (PSAP) and provides the PSAP with the precise information of the origin of a 9-1-1 call. This information includes the phone's exact geographical location and direct callback number.

25

Compliance with FCC and NENA

All enterprises that use VoIP telephony must have a 9-1-1 solution in place in order to comply with the FCC's mandate concerning emergency calling. The present invention is fully FCC compliant and follows all approved standards of

30 **NENA** (The National Emergency Number Association). This ensures full

interoperability with the PSAPs, Selective Routers and other infrastructure which makes up the existing emergency services network.

Key Features

5 *Temporary binding of a DID number to a VoIP endpoint*

By temporarily assigning a DID to a VoIP endpoint during a 911 call, the present invention makes it possible for a PSAP to directly call back the phone in case of a dropped 9-1-1 call. This unique feature offers the following significant benefits:

- 10 • For enterprises, it ensures that dispatchers can quickly reach the person that made the emergency call without having to go through an intervening IVR system or receptionist.
- For enterprises, it eliminates the need to assign and manage emergency location identifier numbers (ELINs) to each phone.
- 15 • For users without a DID or not using a 10 digit North American Numbering Plan (NANP), a DID can be displayed at the PSAP control screen and used to call back the user.

Deployment Diagram

20 The following sections describe generally the deployment diagram for the invention. Figure 1 shows the various components of the system according to a preferred embodiment of the invention, and are described hereinafter.

IP Phone

25 The solution supports any type of IP phone. The phone's location must be pre-registered in the 911 Service provider database, or obtained from a local LIS. An IP phone is identified by a unique endpoint identifier. Examples of an endpoint identifier can be a phone number, an extension number, or a MAC address.

Softphone

A softphone is an IP phone running as software on a PC or handheld device. The phone's location must be pre-registered in the 911 Service provider database, or obtained from a local LIS. A softphone is identified by a unique endpoint identifier.

5 Examples of an endpoint identifier can be a phone number, an extension number, or a MAC address.

Local Location Information Server (LIS)

A local LIS maintains the IP phone or softphone location information. Generally,

10 the local LIS has location acquisition technology, such as crawling layer 2 switches to detect phones and their location. The local LIS is an optional component in the solution of the present invention.

IP-PBX or Softswitch

15 The IP-PBX or Softswitch is used to deliver the calls to the 911 service provider. The 911 calls can be delivered using standard VoIP protocols such as SIP and RTP. The equipment must deliver the caller's endpoint identifier, originating address (i.e. SIP address), and can optionally include a location object (PIDF-LO). The IP-PBX must be able to ring the caller's endpoint when the call is destined to

20 the phone's address (i.e. ext 5150@acme.com must ring extension 5150).

Call Server

The 911 provider receives 911 calls on their call servers. Call servers are generally session border controllers (SBC) that support the VoIP protocols

25 interfacing with the IP-PBX and softswitches. The call server is responsible to setup call. It obtains an available DID from the DID pool, looks up the customer location in the subscriber database, and routes the call to the VPC/Gateways using standard i2 call signaling.

DID Pool

The DID pool is a database of 10 digit NANP numbers from various markets. The pool is shared with all customers. When a 911 call is made, any free DID is assigned to the endpoint for a finite period before it is released back into the pool.

- 5 The DID is assigned to the user populated in the ALI display as the callback number field. The DID pool maintains the associations of the DID to endpoints, allowing the call server to easily map from one to the other.

Subscriber database

- 10 The subscriber database maintains the data related to emergency responder locations (ERL) and endpoints associated to these ERLs. The subscriber database is not used if the endpoint is able to deliver its location information in a location object (PIDF-LO). Generally, the subscriber database is updated either through a web interface, or by a local LIS.

15

VPC SBC

The VoIP Positioning Center (VPC) Session Border Controller (SBC) corresponds to the SIP proxy server described in the NENA i2 standard

20 *VPC*

The VoIP Positioning Center (VPC) performs the functions described in the NENA i2 standard

ERDB

- 25 The Emergency Routing Database (ERDB) performs the functions described in the NENA i2 standard

LIS

- 30 The Location Information Server (LIS) performs the functions described in the NENA i2 standard

Media Gateway

The Media Gateway interfaces between the IP and the PSTN networks. It performs the functions of an emergency services gateway (ESGW) described in the NENA i2 standard. The Media gateway also handles PSAP callbacks and routes them to the call server for processing.

Selective Router:

The selective router is managed by the Local Exchange Carrier (LEC) and is used to route 911 calls to the appropriate PSAP based on the Emergency Services Number (ESN).

PSAP

The Public Safety Answering Point (PSAP) is staffed by trained professionals to answer emergency 911 calls. The PSAP has access to an automatic location information database (ALI) to retrieve the caller's address and callback number.

ALI

The automatic location information database (ALI) contains a list of phone numbers and corresponding locations. For VoIP users, the ALI only holds a shell record that points to the VPC ALI-Link. When a 911 call is received the ALI queries the VPC to obtain a caller's record.

25 1. Overview

The solution according to an embodiment of the present invention is applicable in the following cases:

- VoIP service providers that supply enterprises with hosted IP-PBX solutions
- VoIP service providers that supply enterprises with SIP trunks
- Enterprises with single or multiple onsite IP-PBXs

- Peer to Peer VoIP Service providers that do not assign DIDs to each account.
- VoIP Service providers that offer service to international users without assigning them to a North American Numbering plan.

5

An enterprise customer is defined as an entity that uses a VoIP PBX and requires E911 service for each of their extensions. Some enterprise customers will only have one office location. Others will have multiple office locations. In many cases, these extensions will not have DIDs assigned to them.

10

A VoIP service provider (VSP) is defined as an entity that provides VoIP calling service and requires E911 service for each customer.

15

Enhanced 911 services are provided by routing 9-1-1 calls using the NENA i2 standard to the appropriate Public Safety Answering Point (PSAP). This method provides the PSAP of the caller's precise location and callback number during the call setup. This information includes the phone exact geographical location and callback number.

20

Without the present invention, the PSAP is unable to call the distressed caller if it does not have a callback number. MTLN solutions offer certain workarounds to do this:

25

- Some MTLN systems map phone extensions to a main number. However, the callback number rings the company IVR or receptionist, wasting valuable time for the dispatchers trying to reach the person that made the emergency call.

30

- Some MTLN systems map Emergency Location Identification Numbers (ELINs) to each location. This is done by assigning a permanent DID for each emergency responder location (ERL) such as a floor, wing, or suite. This requires the MTLN administrator to purchase DIDs for each location

and ensure that the system maps the extension to the correct DID based on the caller's location. This is highly impractical for MTLIS systems that have users in many dispersed locations, particularly for work at home employees, and traveling workers.

5

By temporarily binding a DID to an VoIP phone during a 911 call, the invention makes it possible for a PSAP to directly call back the extension in case of a dropped 9-1-1 call while reducing costs and administration efforts. This is possible even though the extension does not have a permanently bound DID.

10

2. Configuration

This section describes the configuration parameters required to enable this feature, according to an embodiment of the present invention.

15

2.1 Emergency Responder Location

A caller's Emergency Responder Location (ERL) must be provisioned in a location identifier server (LIS). The ERL data consists of a valid civic address that can be matched to a PSAP Master Street Address Guide (MSAG) record and additional location information such as floor, suite, cubicle data. An ERL is identified and indexed by the Location Key (LK).

20

2.2 SIP URI mapping table

Each enterprise extension is associated to a location. This grouping is configured in the softswitch. The softswitch has a SIP URI mapping table that can remap the phone's SIP URI to the SIP URI of the location key (LK) for 9-1-1 calls. SIP URIs are unique across the system.

25

2.3 E911 DID pool

The softswitch is configured with a list of DIDs that can be dynamically bound to a SIP URIs during the 911 call setup process. These DIDs must be obtained from a local carrier, but can be shared among a large number of users since the occurrence of 911 calls is very low.

2.4 911 Call rules

Each trunk (or resource) must be configured with rules that allow it to process 9-1-1 calls.

The rule will normally be applied to calls that dial 9-1-1 and arrive from IP addresses that are registered as 911Enable clients.

If the call matches the 9-1-1 rule, the following actions must be taken:

- Bind a DID from the E911 DID Pool to the SIP URI (if not already bound to a DID.)
- Insert the corresponding DID in the P-Asserted-Identity as a TEL URI.
- Remap the caller's SIP URI to a location key (LK)

For example, a 9-1-1 call from SIP URI 02123456john@company X is placed. The 911 call rule will bound to +12121234567, put the DID in the P-Asserted-Identity and replace the SIP URI with locationx@911provider.com.

2.5 DID Binding Duration

The DID binding duration is configurable for each trunk. The default value will be 48 hours.

3. Sequence Diagrams

3.1 Normal E-911 call scenario with Emergency Callback

A normal E-911 call scenario with Emergency Callback is illustrated in Figure 2, and follows the sequence outlined below.

5

Sequence Number	Description
1	The phone with an endpoint identifier of 250 (i.e. extension 250) makes a 911 call.
2	The IP-PBX/Softswitch is configured to forward the call to the 911 Call Server. The softswitch converts the call to the appropriate protocol (i.e. SIP/RTP) and sets the SIP URI from field to 250@domain.com
3	911Enable session controller receives the call and requests an available DID from the DID Pool Database.
4	DID Pool Database returns an available DID that is not bound to another user.
5	911 Call Server inserts the dynamically assigned DID in the P-Asserted-Identity field as a TEL URI, and remaps the FROM SIP URI from the endpoint address, to the caller's location key <u>locationa@911enable.com</u> . The call is forwarded to the NENA i2 infrastructure A person skilled in the art will readily recognize that the NENA interim 2 standard for detailed call flows between the various components is applicable.
6	The call is forwarded to the appropriate PSAP using NENA i2 call signaling. PSAP queries the ALI database to retrieve receives the subscriber information and the callback number to call the extension directly. The callback number is the dynamically assigned DID from the DID pool.

7	Voice communication is established.
8	Call hangs up normally using standard SIP signaling.
9	PSAP attempts to callback the user based on the callback number provided in the original call (5141234567). Carrier forwards call to the 911 call server.
10	The 911 Call Server remaps the dynamic DID (5141234567) to the endpoint's SIP address.
11	The IP-PBX/Sofswitch uses the endpoint's SIP address to forward the call to the appropriate phone.
12	Call is re-established between the 9-1-1 caller extension and the PSAP. When the conversation is completed, the call hangs up normally using standard SIP signaling.
13	After the configured binding time, the DID is released and put back into the pool of available DIDs

3.2 E911 call made form the same extension in 48 hours

Since the SIP URI is already bound to the DID, the DID will be reused for the call and the 48 hour timer is reset. Otherwise this case is handled exactly the same way as described in sequence 3.1 Normal E-911 call scenario with Emergency Callback

The following is a list of acronyms used in the description of the present invention, and are reproduced for the reader's convenience, although persons skilled in the art will recognize the significance of these acronyms.

Acronyms:

15 DID

Direct Inward Dialing: The number assigned to a VoIP user that allows that user to connect to the old PSTN Networks around the world.

E911

Enhanced 911: E911 services connect VoIP services to the existing 911 infrastructure. This allows for a VoIP emergency call to provide the same emergency-relevant location information that traditional telephony provides.

5

PSTN

Public Switched Telephone Network: The world's public circuit-switched telephone networks. The PSTN is largely governed by technical standards created by the International Telecommunication Union.

10

SIP

Session Initiation Protocol: A protocol and standard for initiating, modifying, and terminating a multimedia (voice, video, etc) interactive session. SIP was accepted in 2000 as the 3GPP signaling element and a permanent element of IMS architecture.

15

URI

(Uniform Resource Identifier) The address of an Internet resource. A URI is the unique name used to access the resource. It is not necessarily a specific file location (it may be a call to an application or a database, for example), which is why it is preferred over the similar acronym URL (Uniform Resource Locator).

20

Although the present invention has been explained hereinabove by way of a preferred embodiment thereof, it should be pointed out that any modifications to this preferred embodiment within the scope of the appended claims is not deemed to alter or change the nature and scope of the present invention.

25

CLAIMS

1. A method for delivering callback numbers for emergency calls in a VoIP system,
5 comprising the steps of:
- (a) providing a pool of callback numbers consisting of a plurality of individual DIDs;
 - (b) providing a plurality of IP phones, each phone being provided with a unique SIP URI;
 - 10 (c) at an emergency service provider, temporarily binding a DID to said SIP URI when an emergency call is made from at least one of said phones if said SIP URI is not already bound to a DID; and
 - (d) marking said DID that is bound to said SIP URI as unavailable.
- 15 2. A method according to claim 1, wherein said DID is bound to said SIP URI for a maximum of 48 hours, and is subsequently marked as available in said pool of callback numbers.
3. A method according to claim 1, wherein said emergency service provider is
20 a 911 service provider.
4. A method for delivering callback numbers for emergency calls in a VoIP system, comprising temporarily assigning a DID from a pool of DIDs to a VoIP endpoint during a 911 call, said DID mapping a callback number to an IP phone in
25 a VoIP system.
5. An emergency service provider system, comprising:
- a call server for connection to a VoIP service provider network;
 - a subscriber database;
 - 30 a VPC SBC; and
 - a media gateway for connection to a PSTN;

said call server being adapted to:

receive an emergency call from a VoIP telephone in said VoIP network;

verify if the SIP URI has a DID bound to said SIP URI;

5 if the SIP URI does not have a DID bound to said SIP URI, obtain a temporary DID from a DID pool and temporarily bind said temporary DID to said SIP URI; and

forward the call to an appropriate PSAP in said PSTN.

10 6. An emergency system according to claim 6, wherein said emergency system is a 911 system.

7. An emergency system according to claim 6, wherein said temporary DID is bound to said SIP URI for a period of 48 hours.

15

8. A VoIP system comprising:

a VoIP service provider network, said VoIP service provider network including a plurality of VoIP phones;

an emergency service provider system, said emergency service provider system including:

20

a call server for connection to said VoIP service provider network;

a subscriber database;

a VPC SBC; and

a media gateway for connection to a PSTN;

25

said call server being adapted to:

receive an emergency call from a VoIP telephone in said VoIP network;

verify if the SIP URI has a DID bound to said SIP URI;

30

if the SIP URI does not have a DID bound to said SIP URI, obtain a temporary DID from a DID pool and temporarily bind said temporary DID to said SIP URI; and

forward the call to an appropriate PSAP in said PSTN.

9. A system according to claim 9, wherein at least one of said plurality of VoIP phones is a softphone.

Application number / numéro de demande: 2598200

Figures: 1 & 2

Pages: _____

Unscannable item(s)
received with this application

To inquire if you can order a copy of the unscannable items, please visit the
CIPO WebSite at [HTTP://CIPO.GC.CA](http://CIPO.GC.CA)

Item(s) ne pouvant être balayés

Documents reçus avec cette demande ne pouvant être balayés.

Pour vous renseigner si vous pouvez commander une copie des items ne
pouvant être balayés, veuillez visiter le site web de l'OPIC au [HTTP://CIPO.GC](http://CIPO.GC).



W00200902627

Search Results: 4 items
Sorted by: RELEVANCE



APPLICATION TYPE

- Patent
- Brand
- Industrial Designs

CATEGORY

- All Kinds of Patent
- Patent
- Simple Patents

SORT

APPLICATION NUMBER

ASC

STATUS

- Rejected
- Ex. given
- Cancelled

CALLS FOR EMERGENCY RESCUE THROUGH VOICE IP COMMUNICATIONS SYSTEMS

IPC: H04 L 1266, H 04 M 1106, H 04 M 342, H 04 G 3/09, H... BULLETIN DATE: January 14, 2010
 APPLICATION NUMBER: W00200902627 DATE OF REGISTRATION:
 PATENT NUMBER: EXPIRED DATE:
 ADMISSION DATE: September 17, 2009 INVENTOR NAME: BJORSELL, Johan, Emil, Viktor, SOBOLY, ...
 ABSTRACT

ABSTRACT

According to one aspect of the present invention are given a process for handling emergency calls from the caller in voice over IP system. The process involves receiving the routing request message includes the caller identifier and an identifier called. The process also involves setting the emergency call identifier called active as a suitable response to the emergency call identifier associated previously with the caller. The process further involves generating identifiers emergency response centers in response to an emergency call identifier. The process also involves determining whether the caller identifier associated with the identifier penulisan direction in direct (DID), which has been associated previously. The process further involves generating identifiers penulisan direction in direct (DID) to the caller by associating identifiers with an identifier DID while the caller during an emergency call sign of the active and determined that the caller does not have DID which has been associated previously. The process also involves generating a routing message includes an emergency response center identifier and temporary identifier DID to receive the routing controller operable to cause a route to be established between the caller and the emergency response center.

STATUS	(PA) Dianggap Ditarik Kembali (Direktur)
NOMOR PERMOHONAN	W00200902627
TANGGAL PENERIMAAN	17 Sep 2009
TANGGAL PENGUMUMAN	14 Jan 2010
NOMOR PATEN	
TANGGAL PENDAFTARAN	
TANGGAL KEPEMILIKAN	
TANGGAL KADALUARSA	
IPC	- H 04 L 12/66 - H 04 M 11/06 - H 04 M 3/42 - H 04 Q 3/00 - H 04 Q 3/64
PRIORITAS	- 60/907,224 / 26 Mar 2007 / US
NAMA PEMILIK	- DIGIFONICA (INTERNATIONAL) LIMITED (CA)
NAMA PENEMU	- BJORSELL, Johan, Emil, Viktor (SE) - SOBOLYEV, Maksym (RU)
NAMA KONSULTAN	ACHMAD FATCHY, S.H.
ALAMAT KONSULTAN	AFFA INTELLECTUAL PROPERTY RIGHTS, GRAHA PRATAMA Lantai 15, JL. MT Haryono Kav.15, Jakarta 12810 (ID)
JUDUL	PANGGILAN BANTUAN DARURAT UNTUK SISTEM KOMUNIKASI SUARA MELALUI IP
ABSTRAK	Menurut satu aspek dari invensi ini diberikan proses untuk menangani panggilan-panggilan darurat dari pemanggil dalam sistem suara melalui IP. Proses tersebut melibatkan menerima pesan permintaan perutean mencakup pengidentifikasi pemanggil dan pengidentifikasi terpanggil. Proses tersebut juga melibatkan mengatur tanda panggilan darurat aktif sebagai tanggapan pengidentifikasi terpanggil yang cocok dengan pengidentifikasi panggilan darurat yang berkaitan sebelumnya dengan pemanggil. Proses tersebut lebih lanjut melibatkan menghasilkan pengidentifikasi-pusat tanggapan darurat sebagai tanggapan pengidentifikasi panggilan darurat. Proses tersebut juga melibatkan menentukan apakah pengidentifikasi pemanggil berkaitan dengan pengidentifikasi pendialan arah dalam langsung (DID) yang telah dikaitkan sebelumnya. Proses tersebut lebih lanjut melibatkan menghasilkan pengidentifikasi pendialan arah dalam langsung (DID) untuk pemanggil dengan mengaitkan pengidentifikasi DID sementara dengan pengidentifikasi pemanggil saat tanda panggilan darurat aktif dan ditentukan bahwa pemanggil tidak memiliki DID yang telah dikaitkan sebelumnya. Proses tersebut juga melibatkan menghasilkan pesan perutean mencakup pengidentifikasi pusat tanggapan darurat dan pengidentifikasi DID sementara untuk menerima dengan pengontrol perutean yang dapat dioperasikan sehingga menyebabkan suatu rute akan dibentuk antara pemanggil dan pusat tanggapan darurat.

JUMLAH KLAIM	43
GAMBAR	<input checked="" type="checkbox"/>

Electronic Patent Application Fee Transmittal

Application Number:	13966096
Filing Date:	13-Aug-2013
Title of Invention:	PRODUCING ROUTING MESSAGES FOR VOICE OVER IP COMMUNICATIONS
First Named Inventor/Applicant Name:	CLAY PERREAULT
Filer:	John M Carson/Norman Green
Attorney Docket Number:	DIGIF.001C1

Filed as Small Entity

Filing Fees for Utility under 35 USC 111(a)

Description	Fee Code	Quantity	Amount	Sub-Total in USD(\$)
Basic Filing:				
Pages:				
Claims:				
Miscellaneous-Filing:				
Petition:				
Patent-Appeals-and-Interference:				
Post-Allowance-and-Post-Issuance:				
Extension-of-Time:				

Description	Fee Code	Quantity	Amount	Sub-Total in USD(\$)
Miscellaneous:				
Submission- Information Disclosure Stmt	2806	1	90	90
Total in USD (\$)				90

Electronic Acknowledgement Receipt

EFS ID:	22747646
Application Number:	13966096
International Application Number:	
Confirmation Number:	8712
Title of Invention:	PRODUCING ROUTING MESSAGES FOR VOICE OVER IP COMMUNICATIONS
First Named Inventor/Applicant Name:	CLAY PERREAULT
Customer Number:	20995
Filer:	John M Carson/Norman Green
Filer Authorized By:	John M Carson
Attorney Docket Number:	DIGIF.001C1
Receipt Date:	25-JUN-2015
Filing Date:	13-AUG-2013
Time Stamp:	20:12:42
Application Type:	Utility under 35 USC 111(a)

Payment information:

Submitted with Payment	yes
Payment Type	Credit Card
Payment was successfully received in RAM	\$90
RAM confirmation Number	10764
Deposit Account	111410
Authorized User	KNOBBE MARTENS OLSON AND BEAR

The Director of the USPTO is hereby authorized to charge indicated fees and credit any overpayment as follows:

Charge any Additional Fees required under 37 C.F.R. Section 1.16 (National application filing, search, and examination fees)

Charge any Additional Fees required under 37 C.F.R. Section 1.17 (Patent application and examination processing fees)

PETITIONER APPLE INC. PEX: 1902396

File Listing:					
Document Number	Document Description	File Name	File Size(Bytes)/ Message Digest	Multi Part /.zip	Pages (if appl.)
1		IDS_06_25_2015_DIGIF_001C1.pdf	92104 67be98c1d32905d3f59d3aa011ded3137649368c	yes	3
	Multipart Description/PDF files in .zip description				
	Document Description		Start		End
	Transmittal Letter		1		2
	Information Disclosure Statement (IDS) Form (SB08)		3		3
Warnings:					
Information:					
2	Foreign Reference	Ref1_CA2598200.pdf	1360191 af57de8cdba6de54ddb7f4b10e48dd939d78fae3	no	20
Warnings:					
Information:					
3	Foreign Reference	Ref2_W00200902627.pdf	324443 00aa4f6a017baab01c1cd0a3c3344b968c9740947	no	3
Warnings:					
Information:					
4	Non Patent Literature	Ref3_CA_OA_CA2681984.pdf	358492 3428281b43b6b4ee05e9734f16ceef9ab6d83333	no	8
Warnings:					
Information:					
5	Fee Worksheet (SB06)	fee-info.pdf	30465 0caf15da257fce84a09baf72f13931d4554eb750	no	2
Warnings:					
Information:					
Total Files Size (in bytes):			2165695		

This Acknowledgement Receipt evidences receipt on the noted date by the USPTO of the indicated documents, characterized by the applicant, and including page counts, where applicable. It serves as evidence of receipt similar to a Post Card, as described in MPEP 503.

New Applications Under 35 U.S.C. 111

If a new application is being filed and the application includes the necessary components for a filing date (see 37 CFR 1.53(b)-(d) and MPEP 506), a Filing Receipt (37 CFR 1.54) will be issued in due course and the date shown on this Acknowledgement Receipt will establish the filing date of the application.

National Stage of an International Application under 35 U.S.C. 371

If a timely submission to enter the national stage of an international application is compliant with the conditions of 35 U.S.C. 371 and other applicable requirements a Form PCT/DO/EO/903 indicating acceptance of the application as a national stage submission under 35 U.S.C. 371 will be issued in addition to the Filing Receipt, in due course.

New International Application Filed with the USPTO as a Receiving Office

If a new international application is being filed and the international application includes the necessary components for an international filing date (see PCT Article 11 and MPEP 1810), a Notification of the International Application Number and of the International Filing Date (Form PCT/RO/105) will be issued in due course, subject to prescriptions concerning national security, and the date shown on this Acknowledgement Receipt will establish the international filing date of the application.

INFORMATION DISCLOSURE STATEMENT

Inventor	:	Clay Perreault, et al.
App. No.	:	13/966,096
Filed	:	August 13, 2013
For	:	PRODUCING ROUTING MESSAGES FOR VOICE OVER IP COMMUNICATIONS
Examiner	:	Sing, Simon P.
Art Unit	:	2653
Conf. No.	:	8712

Commissioner for Patents
P.O. Box 1450
Alexandria, VA 22313-1450

References and Listing

Pursuant to 37 CFR 1.56, an Information Disclosure Statement listing references is provided herewith. Copies of any listed foreign and non-patent literature references are being submitted.

No Disclaimers

To the extent that anything in the Information Disclosure Statement or the listed references could be construed as a disclaimer of any subject matter supported by the present application, Applicant hereby rescinds and retracts such disclaimer.

Timing of Disclosure

This Information Disclosure Statement is being filed after receipt of a First Office Action, but before the mailing date of a Final Action and before the mailing date of a Notice of Allowance. This Statement is accompanied by the fees set forth in 37 CFR 1.17(p). The

Application No.: 13/966,096
Filing Date: August 13, 2013

Commissioner is hereby authorized to charge any additional fees which may be required or to credit any overpayment to Account No. 11-1410.

Respectfully submitted,

KNOBBE, MARTENS, OLSON & BEAR, LLP

Dated: 6/25/15

By: _____

John M. Carson
Registration No. 34,303
Attorney of Record
Customer No. 20995
(858) 707-4000

IDS
20996114
062515

INFORMATION DISCLOSURE STATEMENT BY APPLICANT	Application No.	13/966,096	
	Filing Date	August 13, 2013	
	First Named Inventor	Perreault, Clay	
	Art Unit	2653	
<i>(Multiple sheets used when necessary)</i>		Examiner	Sing, Simon P.
SHEET 1 OF 2		Attorney Docket No.	DIGIF.001C1

U.S. PATENT DOCUMENTS					
Examiner Initials	Cite No.	Document Number <i>Number - Kind Code (if known)</i> Example: 1,234,567 B1	Publication Date MM-DD-YYYY	Name	Pages, Columns, Lines Where Relevant Passages or Relevant Figures Appear

FOREIGN PATENT DOCUMENTS						
Examiner Initials	Cite No.	Foreign Patent Document <i>Country Code-Number-Kind Code</i> Example: JP 1234567 A1	Publication Date MM-DD-YYYY	Name	Pages, Columns, Lines Where Relevant Passages or Relevant Figures Appear	T ¹
	1	IN 24/2009	06-12-2009	Digifonica International Ltd	<i>Corresponding International Publication No. WO 2008-052340 A1 previously disclosed</i>	
	2	IN 29/2009	07-17-2009	Digifonica International Ltd	<i>Corresponding International Publication No. WO 2008/064481 A1 previously disclosed</i>	
	3	SG151991A1	06-29-2009	Digifonica International Ltd	<i>Corresponding International Publication No. WO 2008-052340 A1 previously disclosed</i>	✓
	4	SG152752A1	06-29-2009	Digifonica International Ltd	<i>Corresponding International Publication No. WO 2008/064481 A1 previously disclosed</i>	✓
	5	SG155474	10-29-2009	Digifonica International Ltd	<i>Corresponding International Publication No. WO 2008/116296 A1 previously disclosed</i>	Abstract

NON PATENT LITERATURE DOCUMENTS			
Examiner Initials	Cite No.	Include name of the author (in CAPITAL LETTERS), title of the article (when appropriate), title of the item (book, magazine, journal, serial, symposium, catalog, etc.), date, page(s), volume-issue number(s), publisher, city and/or country where published.	T ¹
	6	Chinese Office Action dated March 24, 2011 for Chinese Patent Application No. CN 200780049791.5	✓
	7	Chinese Office Action dated June 23, 2011 for Chinese Patent Application No. CN 200780049136.X.	✓
	8	Indonesian Examination Report dated July 5, 2012 for Indonesian Patent Application No. W-00200901414.	✓
	9	Indonesian Examination Report dated February 8, 2013 for Indonesian Patent Application No. W-00200901165.	✓

Examiner Signature	Date Considered
--------------------	-----------------

***Examiner:** Initial if reference considered, whether or not citation is in conformance with MPEP 609. Draw line through citation if not in conformance and not considered. Include copy of this form with next communication to applicant.

INFORMATION DISCLOSURE STATEMENT BY APPLICANT	Application No.	13/966,096
	Filing Date	August 13, 2013
	First Named Inventor	Perreault, Clay
	Art Unit	2653
<i>(Multiple sheets used when necessary)</i>	Examiner	Sing, Simon P.
SHEET 2 OF 2	Attorney Docket No.	DIGIF.001C1

NON PATENT LITERATURE DOCUMENTS

Examiner Initials	Cite No.	Include name of the author (in CAPITAL LETTERS), title of the article (when appropriate), title of the item (book, magazine, journal, serial, symposium, catalog, etc.), date, page(s), volume-issue number(s), publisher, city and/or country where published.	T ¹
	10	Mexican Exam Report dated July 11, 2011 for Mexican Patent Application No. MX/a/2009/004811.	✓
	11	Mexican Notice of Allowance dated September 2, 2011 for Mexican Patent Application No. MX/a/2009/005751.	✓

20811010
060215

Examiner Signature	Date Considered
<p>*Examiner: Initial if reference considered, whether or not citation is in conformance with MPEP 609. Draw line through citation if not in conformance and not considered. Include copy of this form with next communication to applicant.</p>	

T¹ - Place a check mark in this area when an English language translation is attached. PETITIONER: APPLE INC. EX. 1002-402

(12) PATENT APPLICATION PUBLICATION

(21) Application No. : 1047/MUMNP/2009

(19) INDIA

(22) Date of filing of Application :29/05/2009

(43) Publication Date : 12/06/2009
Journal No. - 24/2009

(54) Title of the invention : "PRODUCING ROUTING MESSAGES FOR VOICE OVER IP COMMUNICATIONS"

(51) International classification :H04L12/66
 (31) Priority Document No :60/856,212
 (32) Priority Date :02/11/2006
 (33) Name of priority country :U.S.A.
 (86) International Application No :PCT/CA2007/001956
 Filing Date :01/11/2007
 (87) International Publication No : NA
 (61) Patent of Addition to Application Number :NA
 Filing Date :NA
 (62) Divisional to Application Number :NA
 Filing Date :NA

(71)Name of Applicant :
1)DIGIFONICA (INTERNATIONAL) LIMITED
 Address of Applicant :Suite #890 999 West Hastings
 Street Vancouver British Columbia V6C 2W2, Canada
 Canada
 (72)Name of Inventor :
1)PERREAULT Clay (Panama)
2)NICHOLSON Steve (New Zealand)
3)THOMSON Rod (Canada)
4)BJORSELL Johan Emil Victor (Canada)
5)ARAFU Fuad (Canada)

(57) Abstract :

A process and apparatus to facilitate communication between callers and callees in a system comprising a plurality of nodes with which callers and callees are associated is disclosed. In response to initiation of a call by a calling subscriber, a caller identifier and a callee identifier are received. Call classification criteria associated with the caller identifier are used to classify the call as a public network call or a private network call. A routing message identifying an address, on the private network, associated with the callee is produced when the call is classified as a private network call and a routing message identifying a gateway to the public network is produced when the call is classified as a public network call.

Number of Pages = 120

Best View in Resolution of 1024x768 or later. Enable Javascript for Better Performance.

72 73

~~What is claimed is:~~ WE CLAIM:-

5 1. A process for operating a call routing controller to facilitate communication between callers and callees in a system comprising a plurality of nodes with which callers and callees are associated, the process comprising:

10 in response to initiation of a call by a calling subscriber, receiving a caller identifier and a callee identifier;

 using call classification criteria associated with the caller identifier to classify the call as a public network call or a private network call;

15 producing a routing message identifying an address, on the private network, associated with the callee when the call is classified as a private network call; and

20 producing a routing message identifying a gateway to the public network when the call is classified as a public network call.

25 2. The process of claim 1 further comprising receiving a request to establish a call, from a call controller in communication with a caller identified by said callee identifier.

 3. The process of claim 1 wherein using said call classification criteria comprises searching a database to locate a record identifying calling attributes associated with a caller identified by said caller identifier.

30 4. The process of claim 3 wherein locating a record comprises locating a caller dialing profile comprising a username associated with said caller, a domain associated with said caller, and at least one calling attribute.

5 JUN 2009

73-74

- 5
- 6
- 10
- 15
- 20
- 25
- 30
5. The process of claim 4 wherein using said call classification criteria comprises comparing calling attributes associated with said caller dialing profile with aspects of said callee identifier.
 6. The process of claim 4 wherein comparing comprises determining whether said callee identifier includes a portion that matches an IDD associated with said caller dialing profile.
 7. The process of claim 4 wherein comparing comprises determining whether said callee identifier includes a portion that matches an NDD associated with said caller dialing profile.
 8. The process of claim 4 wherein comparing comprises determining whether said callee identifier includes a portion that matches an area code associated with said caller dialing profile.
 9. The process of claim 4 wherein comparing comprises determining whether said callee identifier has a length within a range specified in said caller dialing profile.
 10. The process of claim 4 further comprising formatting said callee identifier into a pre-defined digit format to produce a re-formatted callee identifier.
 11. The process of claim 10 wherein formatting comprises removing an international dialing digit from said callee identifier, when said callee identifier begins with a digit matching an international dialing digit specified by said caller dialing profile associated with said caller.
 12. The process of claim 10 wherein formatting comprises removing a national dialing digit from said callee identifier and prepending a caller

5 JUN 2009

~~74~~ 75

country code to said callee identifier when said callee identifier begins with a national dialing digit.

- 5
13. The process of claim 10 wherein formatting comprises prepending a caller country code to said callee identifier when said callee identifier begins with digits identifying an area code specified by said caller dialing profile.
- 10
14. The process of claim 10 wherein formatting comprises prepending a caller country code and area code to said callee identifier when said callee identifier has a length that matches a caller dialing number format specified by said caller dialing profile and only one area code is specified as being associated with said caller in said caller dialing profile.
- 15
15. The process of claim 10 further comprising classifying said call as a private network call when said re-formatted callee identifier identifies a subscriber to the private network.
- 20
16. The process of claim 10 further comprising determining whether said callee identifier complies with a pre-defined username format and if so classifying the call as a private network call.
- 25
17. The process of claim 10 further comprising causing a database of records to be searched to locate a direct in dial (DID) bank table record associating a public telephone number with said reformatted callee identifier and if said DID bank table record is found classifying the call as a private network call and if a DID bank table record is not found classifying the call as a public network call.
- 30
18. The process of claim 17 wherein producing said routing message identifying a node on the private network comprises setting a callee

JUN 5 2009

-75-76

identifier in response to a username associated with said DID bank table record.

- 5
19. The process of claim 18 wherein producing said routing message comprises determining whether a node associated with the reformatted callee identifier is the same as a node associated the caller identifier.
- 10
20. The process of claim 19 wherein determining whether a node associated with the reformatted callee identifier is the same as a node associated the caller identifier comprises determining whether a prefix of said re-formatted callee identifier matches a corresponding prefix of a username associated with said caller dialing profile.
- 15
21. The process of claim 20 wherein when said node associated with said caller is not the same as the node associated with the callee, producing a routing message including said caller identifier, said reformatted callee identifier and an identification of a private network node associated with said callee and communicating said routing message to a call controller.
- 20
22. The process of claim 19 wherein when said node associated with said caller is the same as the node associated with said callee, determining whether to perform at least one of the following: forward said call to another party, block the call and direct the caller to a voicemail server associated with the callee.
- 25
23. The process of claim 22 wherein producing said routing message comprises producing a routing message having an identification of at least one of the callee identifier, an identification of a party to whom the call should be forwarded and an identification of a voicemail server associated with the callee.
- 30

5 JUN 2009

PETITIONER APPLE INC. EX. 1002-407

76-77

24. The process of claim 23 further comprising communicating said routing message to a call controller.
- 5 25. The process of claim 10 wherein producing a routing message identifying a gateway to the public network comprises searching a database of route records associating route identifiers with dialing codes to find a route record having a dialing code having a number pattern matching at least a portion of said reformatted callee identifier.
- 10 26. The process of claim 25 further comprising searching a database of supplier records associating supplier identifiers with said route identifiers to locate at least one supplier record associated with said route identifier associated with said route record having a dialing code having a number pattern matching at least a portion of said reformatted callee identifier.
- 15 27. The process of claim 26 further comprising loading a routing message buffer with the reformatted callee identifier and an identification of specific routes associated respective ones of the supplier records associated with said route record and loading said routing message buffer with a time value and a timeout value.
- 20 28. The process of claim 27 further comprising communicating a routing message comprising the contents of said routing message buffer to a call controller.
- 25 29. The process of claim 4 further comprising causing said dialing profile to include a maximum concurrent call value and a concurrent call count value and causing said concurrent call count value to be incremented when the user associated with said dialing profile initiates a call and causing said concurrent call count value to be decremented when a call with said user associated with said dialing profile is ended.
- 30

5 JUN 2009

~~77~~ 78

30. A computer readable medium encoded with codes for directing a processor to execute the method of any one of claims 1-29.
- 5 31. A call routing apparatus for facilitating communications between callers and callees in a system comprising a plurality of nodes with which callers and callees are associated, the apparatus comprising:
- 10 receiving means for receiving a caller identifier and a callee identifier, in response to initiation of a call by a calling subscriber;
- 15 classifying means for classifying the call as a private network call or a public network call according to call classification criteria associated with the caller identifier;
- 20 means for producing a routing message identifying an address, on the private network, associated with the callee when the call is classified as a private network call; and
- means for producing a routing message identifying a gateway to the public network if the call is classified as a public network call.
- 25 32. The apparatus of claim 31 wherein said receiving means is operably configured to receive a request to establish a call, from a call controller in communication with a caller identified by said callee identifier.
- 30 33. The apparatus of claim 31 further comprising searching means for searching a database comprising records associating calling attributes with subscribers to said private network to locate a record identifying calling attributes associated with a caller identified by said caller identifier.

5 JUN 2009

-78-79

- 5 **34.** The apparatus of claim **33** wherein said records include dialing profiles each comprising a username associated with said subscriber, an identification of a domain associated with said subscriber, and an identification of at least one calling attribute associated with said subscriber.
- 10 **35.** The apparatus of claim **34** wherein said call classification means is operably configured to compare calling attributes associated with said caller dialing profile with aspects of said callee identifier.
- 15 **36.** The apparatus of claim **35** wherein said calling attributes include an international dialing digit and wherein said call classification means is operably configured to determine whether said callee identifier includes a portion that matches an IDD associated with said caller dialing profile.
- 20 **37.** The apparatus of claim **34** wherein said calling attributes include an national dialing digit and wherein said call classification means is operably configured to determine whether said callee identifier includes a portion that matches an NDD associated with said caller dialing profile.
- 25 **38.** The apparatus of claim **34** wherein said calling attributes include an area code and wherein said call classification means is operably configured to determine whether said callee identifier includes a portion that matches an area code associated with said caller dialing profile.
- 30 **39.** The apparatus of claim **34** wherein said calling attribute include a number length range and wherein said call classification means is operably configured to determine whether said callee identifier has a length within a range specified in said caller dialing profile.

~~29~~ 30

- 5
40. The apparatus of claim **34** further comprising formatting means for formatting said callee identifier into a pre-defined digit format to produce a re-formatted callee identifier.
- 10
41. The apparatus of claim **40** wherein said formatting means is operably configured to remove an international dialing digit from said callee identifier, when said callee identifier begins with a digit matching an international dialing digit specified by said caller dialing profile associated with said caller.
- 15
42. The apparatus of claim **40** wherein said formatting means is operably configured to remove a national dialing digit from said callee identifier and prepend a caller country code to said callee identifier when said callee identifier begins with a national dialing digit.
- 20
43. The apparatus of claim **40** wherein said formatting means is operably configured to prepend a caller country code to said callee identifier when said callee identifier begins with digits identifying an area code specified by said caller dialing profile.
- 25
44. The apparatus of claim **40** wherein said formatting means is operably configured to prepend a caller country code and area code to said callee identifier when said callee identifier has a length that matches a caller dialing number format specified by said caller dialing profile and only one area code is specified as being associated with said caller in said caller dialing profile.
- 30
45. The apparatus of claim **40** wherein said classifying means is operably configured to classifying said call as a private network call when said re-formatted callee identifier identifies a subscriber to the private network.

5 JUN 2009

-80- 81

- 5
46. The apparatus of claim 40 wherein said classifying means is operably configured to classify the call as a private network call when said callee identifier complies with a pre-defined username format.
- 10
47. The apparatus of claim 40 further comprising searching means for searching a database of records to locate a direct in dial (DID) bank table record associating a public telephone number with said reformatted callee identifier and wherein said classifying means is operably configured to classify the call as a private network call when said DID bank table record is found and to classify the call as a public network call when a DID bank table record is not found
- 15
48. The apparatus of claim 47 wherein said private network routing message producing means is operably configured to produce a routing message having a callee identifier set according to a username associated with said DID bank table record.
- 20
49. The apparatus of claim 48 wherein said private network routing message producing means is operably configured to determine whether a node associated with the reformatted callee identifier is the same as a node associated the caller identifier.
- 25
50. The apparatus of claim 49 wherein said private network routing means includes means for determining whether a prefix of said re-formatted callee identifier matches a corresponding prefix of a username associated with said caller dialing profile.
- 30
51. The apparatus of claim 50 wherein said private network routing message producing means is operably configured to produce a routing message including said caller identifier, said reformatted callee identifier and an identification of a private network node associated with

-81-92

said callee and communicating said routing message to a call controller.

- 5
52. The apparatus of claim 49 wherein said private network routing message producing means is operably configured to perform at least one of the following: forward said call to another party, block the call and direct the caller to a voicemail server associated with the callee, when said node associated with said caller is the same as the node associated with said callee.
- 10
53. The apparatus of claim 52 wherein said means for producing said private network routing message is operably configured to produce a routing message having an identification of at least one of the callee identifier, an identification of a party to whom the call should be forwarded and an identification of a voicemail server associated with the callee.
- 15
54. The apparatus of claim 53 further comprising means for communicating said routing message to a call controller.
- 20
55. The apparatus of claim 40 wherein said means for producing a public network routing message identifying a gateway to the public network comprises means for searching a database of route records associating route identifiers with dialing codes to find a route record having a dialing code having a number pattern matching at least a portion of said reformatted callee identifier.
- 25
56. The apparatus of claim 55 further comprising means for searching a database of supplier records associating supplier identifiers with said route identifiers to locate at least one supplier record associated with said route identifier associated with said route record having a dialing
- 30

-82- 83

code having a number pattern matching at least a portion of said reformatted callee identifier.

5 **57.** The apparatus of claim **56** further comprising a routing message buffer and means for loading said routing message buffer with the reformatted callee identifier and an identification of specific routes associated respective ones of the supplier records associated with said route record and loading said routing message buffer with a time value and a timeout value.

10

58. The apparatus of claim **57** further comprising means for communicating a routing message comprising the contents of said routing message buffer to a call controller.

15

59. The apparatus of claim **34** further comprising means for causing said dialing profile to include a maximum concurrent call value and a concurrent call count value and for causing said concurrent call count value to be incremented when the user associated with said dialing profile initiates a call and for causing said concurrent call count value to be decremented when a call with said user associated with said dialing profile is ended.

20

25 **60.** A data structure for access by an apparatus for producing a routing message for use by a call routing controller in a communications system, the data structure comprising:

30

dialing profile records comprising fields for associating with respective subscribers to the system:

a subscriber user name

5 JUN 2009

~~83~~ 84

direct-in-dial records comprising fields for associating with respective subscriber usernames:

5

a user domain; and

a direct-in-dial number;

10

prefix to node records comprising fields for associating with at least a portion of said respective subscriber usernames:

a node address of a node in said system,

15

whereby a subscriber name can be used to find a user domain, at least a portion of said a subscriber name can be used to find a node with which the subscriber identified by the subscriber name is associated, and a user domain and subscriber name can be located in response to a direct-in-dial number.

20

61. A data structure for access by an apparatus for producing a routing message for use by a call routing controller in a communications system, the data structure comprising:

25

master list records comprising fields for associating a dialing code with respective master list identifiers; and

supplier list records linked to master list records by said master list identifiers, and supplier list records comprising fields for associating with a communications services supplier:

30

a supplier id;

5 JUN 2009

86
:84:

a master list id;

a route identifier; and

a billing rate code,

whereby communications services suppliers are associated with dialing codes, such that dialing codes can be used to locate suppliers capable of providing a communications link associated with a given dialing code.

62. A method of determining a time to permit a communication session to be conducted, the method comprising:

calculating a cost per unit time;

calculating a first time value as a sum of a free time attributed to a participant in the communication session and the quotient of a funds balance held by said participant to said cost per unit time value; and

producing a second time value in response to said first time value and a billing pattern associated with said participant, said billing pattern including first and second billing intervals and said second time value being said time to permit a communication session to be conducted.

63. An apparatus for determining a time to permit a communication sessions to be conducted, the apparatus comprising:

a processor circuit:

F 5 11 2009

a computer readable medium coupled to the processor circuit and encoded with instructions for directing the processor circuit to:

calculate a cost per unit time for the communication sessions;

calculate a first time value as a sum of a free time attributed to a participant in the communication session and the quotient of a funds balance held by said participant to said cost per unit time value; and

produce a second time value in response to said first time value and a billing pattern associated with said participant, said billing pattern including first and second billing intervals and said second time value being said time to permit a communication session to be conducted.

64. A process for attributing charges for communications services, the process comprising:

determining a first chargeable time in response to a communication session time and a pre-defined billing pattern;

determining a user cost value in response to said first chargeable time and a free time value associated with a user of said communications services;

changing an account balance associated with said user in response to a user cost per unit time.

changing an account balance associated with a reseller of said communications services in response to a reseller cost per unit time and said communication session time; and

5 JUN 2009

87
:88:

changing an account balance associated with an operator of said communications services in response to an operator cost per unit time and said communication session time.

65. An apparatus for attributing charges for communications services, the apparatus comprising:

a processor circuit;

a computer readable medium in communication with the processor circuit and encoded with instructions for directing said processor circuit to;

determine a first chargeable time in response to a communication session time and a pre-defined billing pattern;

determine a user cost value in response to said first chargeable time and a free time value associated with a user of said communications services;

change an account balance associated with said user in response to a user cost per unit time.

change an account balance associated with a reseller of said communications services in response to a reseller cost per unit time and said communication session time; and

change an account balance associated with an operator of said communications services in response to an operator cost per unit time and said communication session time.

Dated this the 29th day of May, 2009

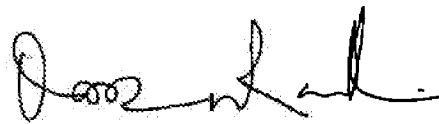

OMANA RAMAKRISHNAN
Of K&S Partners
Agent for the Applicant(s)

5 JUN 2009

PETITIONER APPLE INC. EX. 1002-418

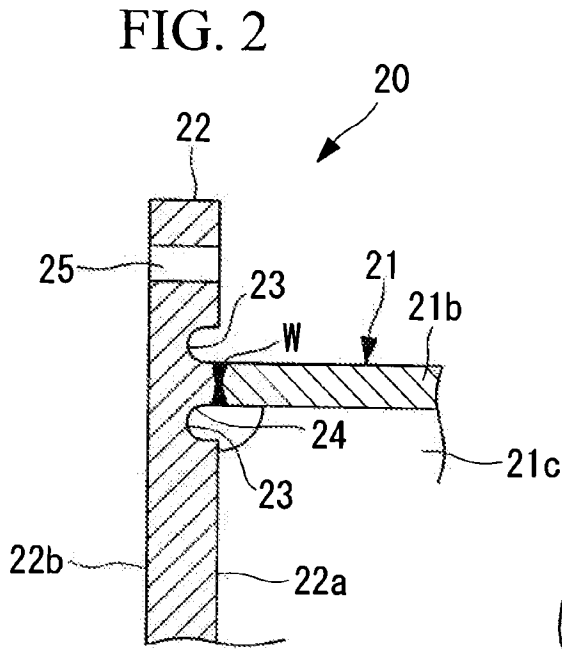
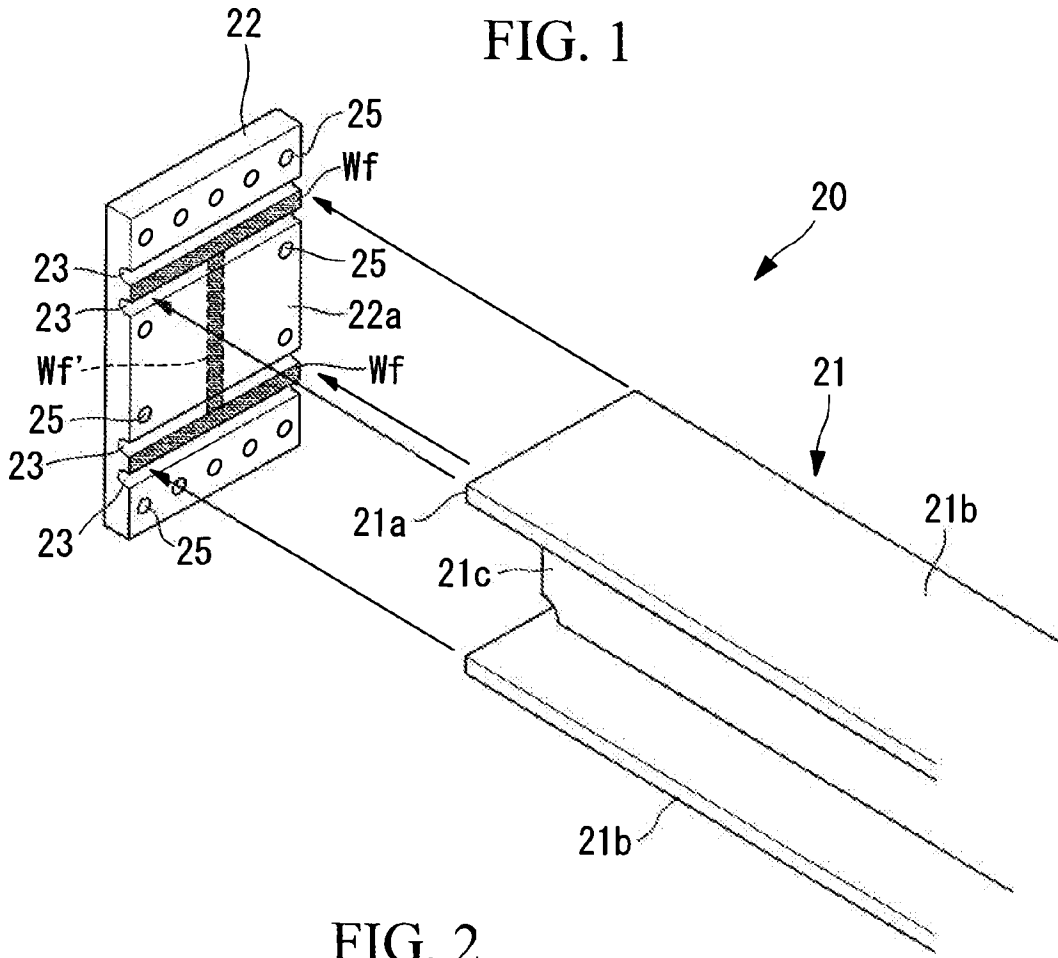

Choubey

ANAND CHOUBEY
OF K & S PARTNERS
AGENT FOR THE APPLICANT(S)

(12) PATENT APPLICATION PUBLICATION

(21) Application No. : 1227/MUMNP/2009

(19) INDIA

(22) Date of filing of Application :29/06/2009

(43) Publication Date : 17/07/2009
Journal No. - 29/2009

(54) Title of the invention : "INTERCEPTING VOICE OVER IP COMMUNICATIONS AND OTHER DATA COMMUNICATIONS"

(51) International classification	:H04L12/26
(31) Priority Document No	:60/861,431
(32) Priority Date	:29/11/2006
(33) Name of priority country	:U.S. A.
(86) International Application No	:PCT/CA2007/002150
Filing Date	:29/11/2007
(87) International Publication No	: NA
(61) Patent of Addition to Application Number	:NA
Filing Date	:NA
(62) Divisional to Application Number	:NA
Filing Date	:NA

(71)Name of Applicant :
1)DIGIFONICA (INTERNATIONAL) LIMITED
Address of Applicant :Suite 890 999 West Hastings
Street Vancouver British Columbia Canada V6C 2W2
CANADA Canada
(72)Name of Inventor :
1)BJORSELL Johan Emil Victor (Canada)
2)SOBOLYEV Maksym (Canada)

(57) Abstract :

Methods and apparatus for intercepting communications in an Internet Protocol (IP) network involve maintaining dialing profiles for respective subscribers to the IP network, each dialing profile including a username associated with the corresponding subscriber, and associating intercept information with the dialing profile of a subscriber whose communications are to be monitored. Intercept information will include determination information for determining whether to intercept a communication involving the subscriber, and destination information identifying a device to which intercepted communications involving the subscriber are to be sent. When the determination information meets intercept criteria communications are established with a media relay through which communications involving the subscriber will be conducted or are being conducted to cause the media relay to send a copy of the communications involving the subscriber to a mediation device specified by the destination information.

Number of Pages = 101

Best View in Resolution of 1024x768 or later. Enable Javascript for Better Performance.

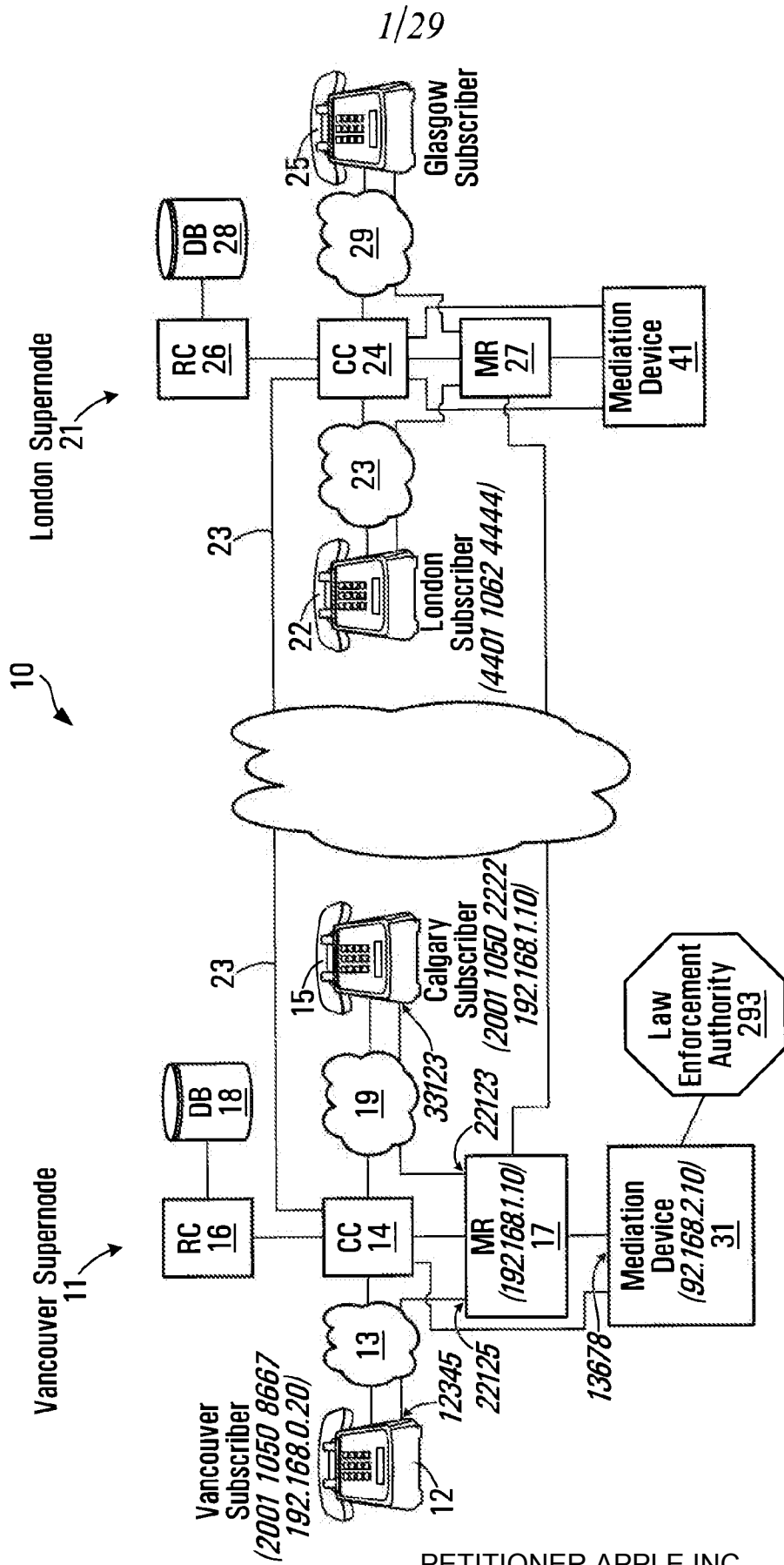

FIG. 1

2/29

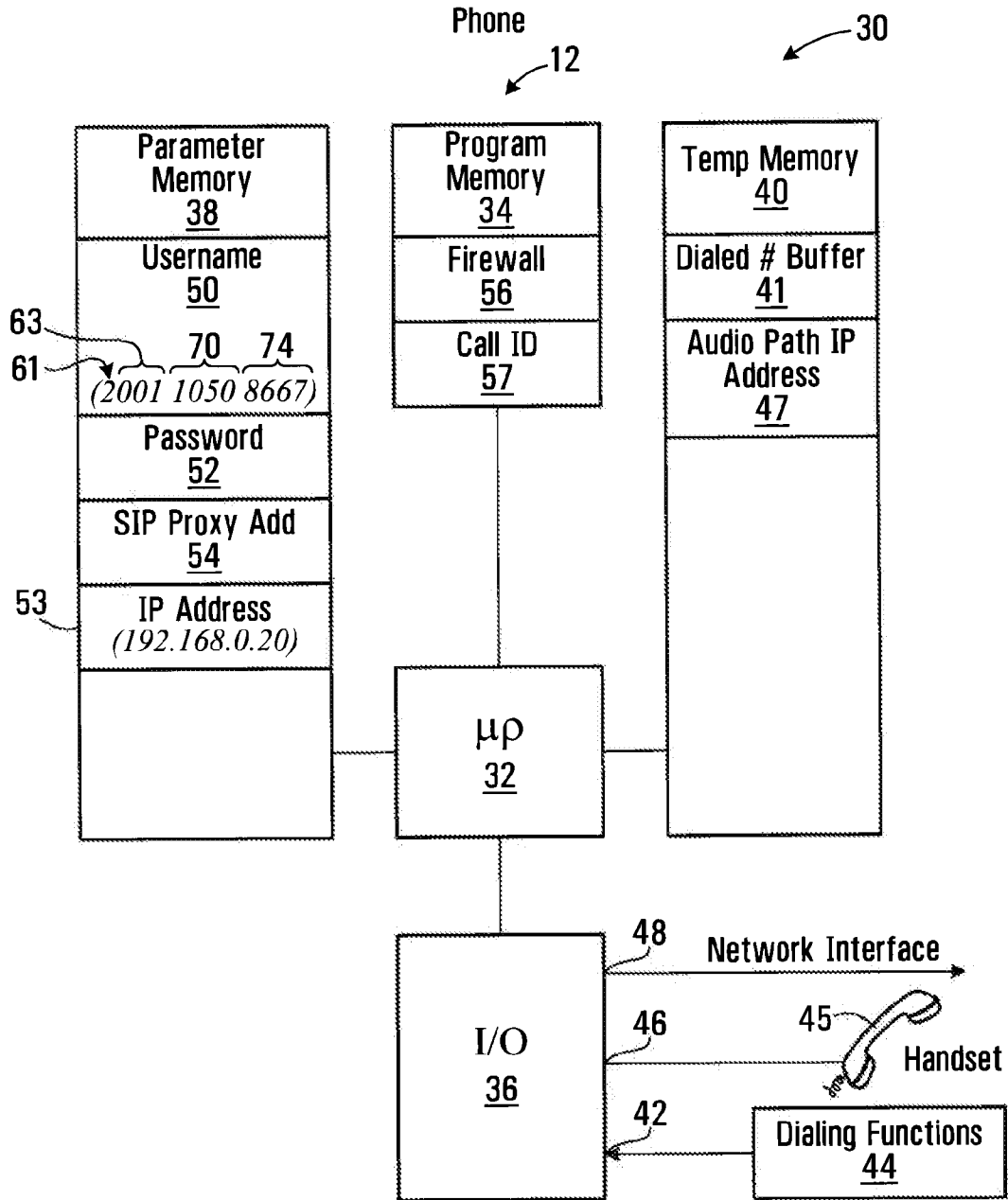

FIG. 2

3/29

SIP Invite Message

60 ~ Caller 2001 1050 8667
 62 ~ Callee 2001 1050 2222
 64 ~ Digest Parameters XXXXXX
 65 ~ Call ID FF10@ 192.168.0.20
 67 ~ Caller IP Address 192.168.0.20
 69 ~ Caller UDP port 12345

FIG. 3

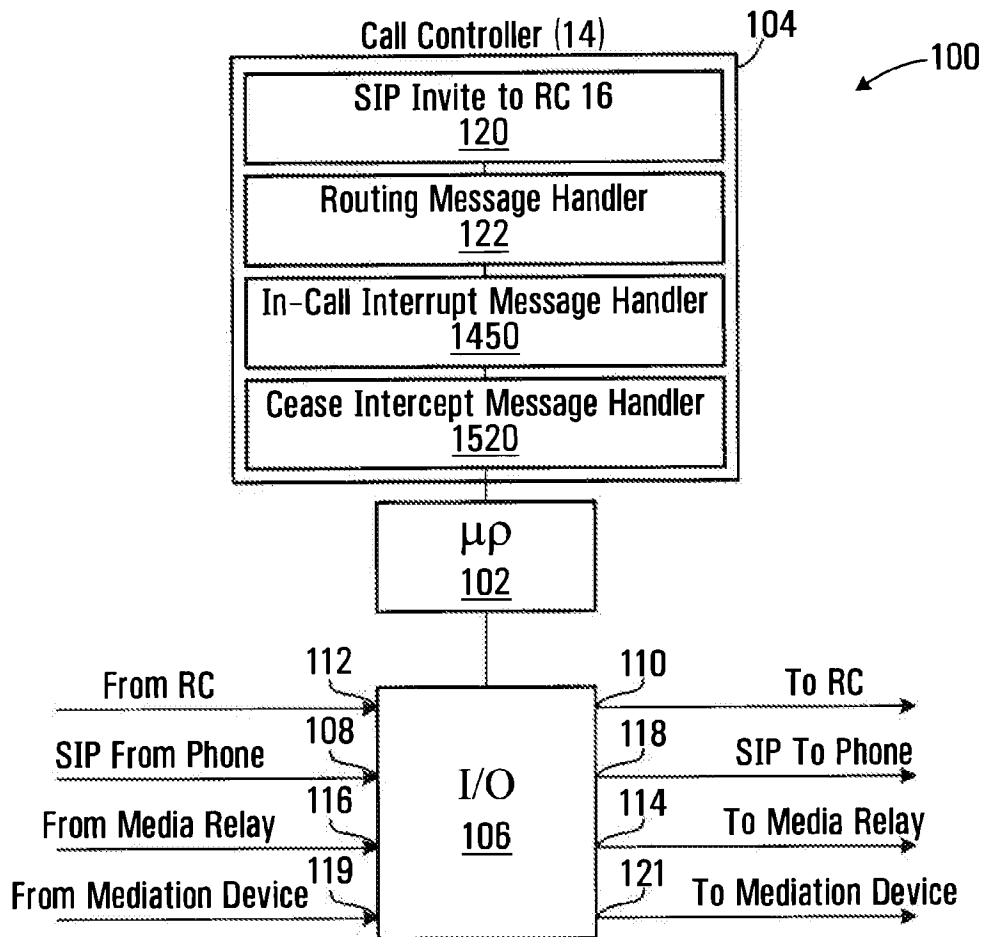

FIG. 4

4/29

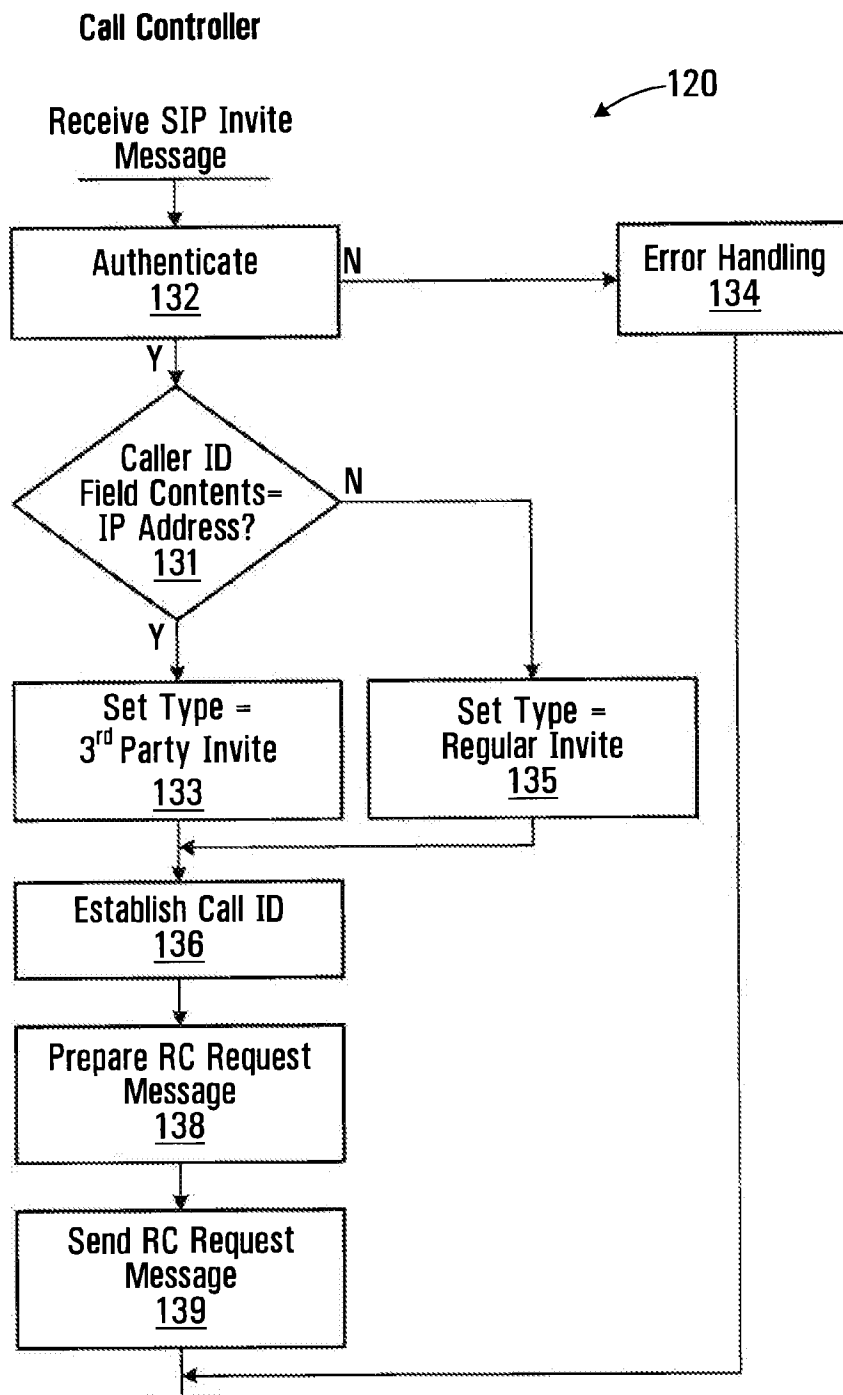

FIG. 5

5/29

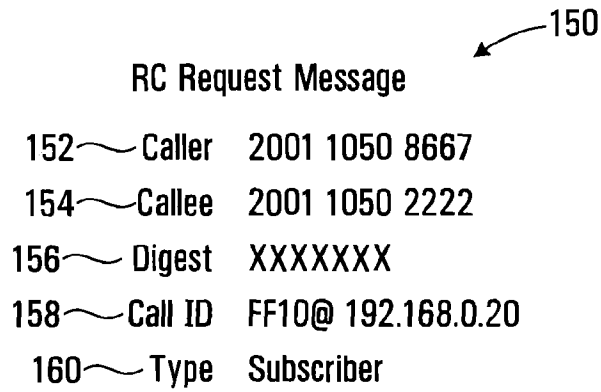

FIG. 6

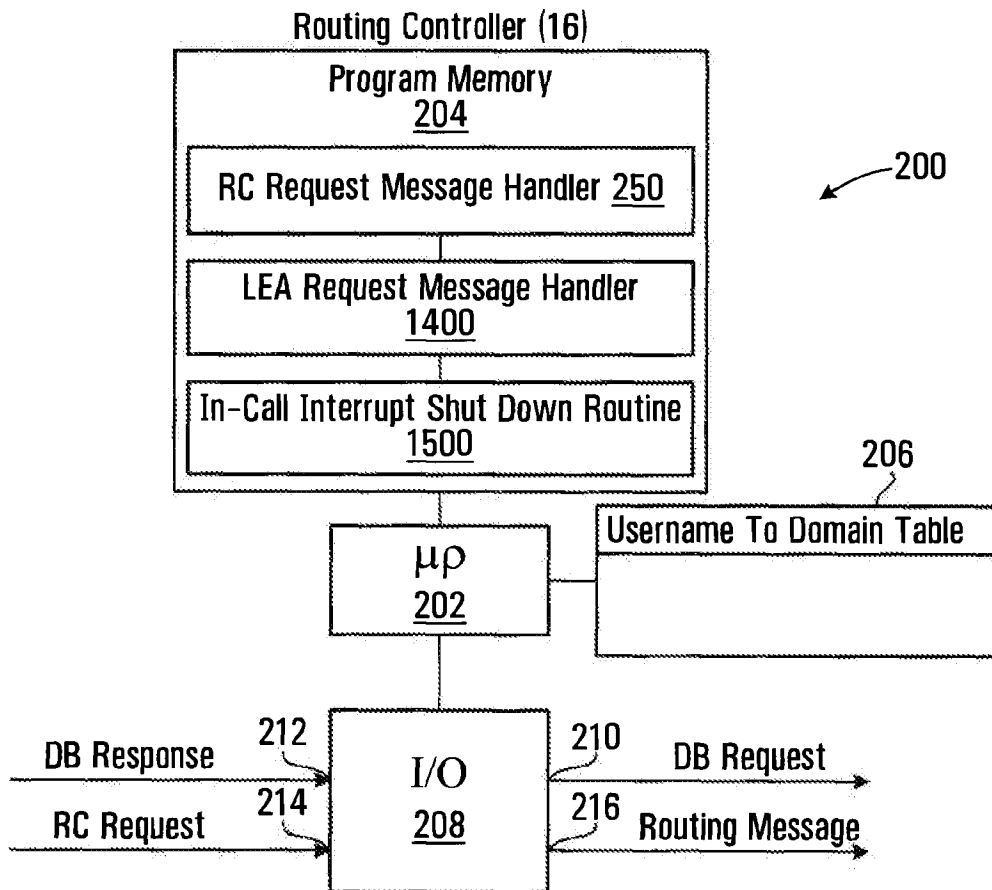

FIG. 7

6/29

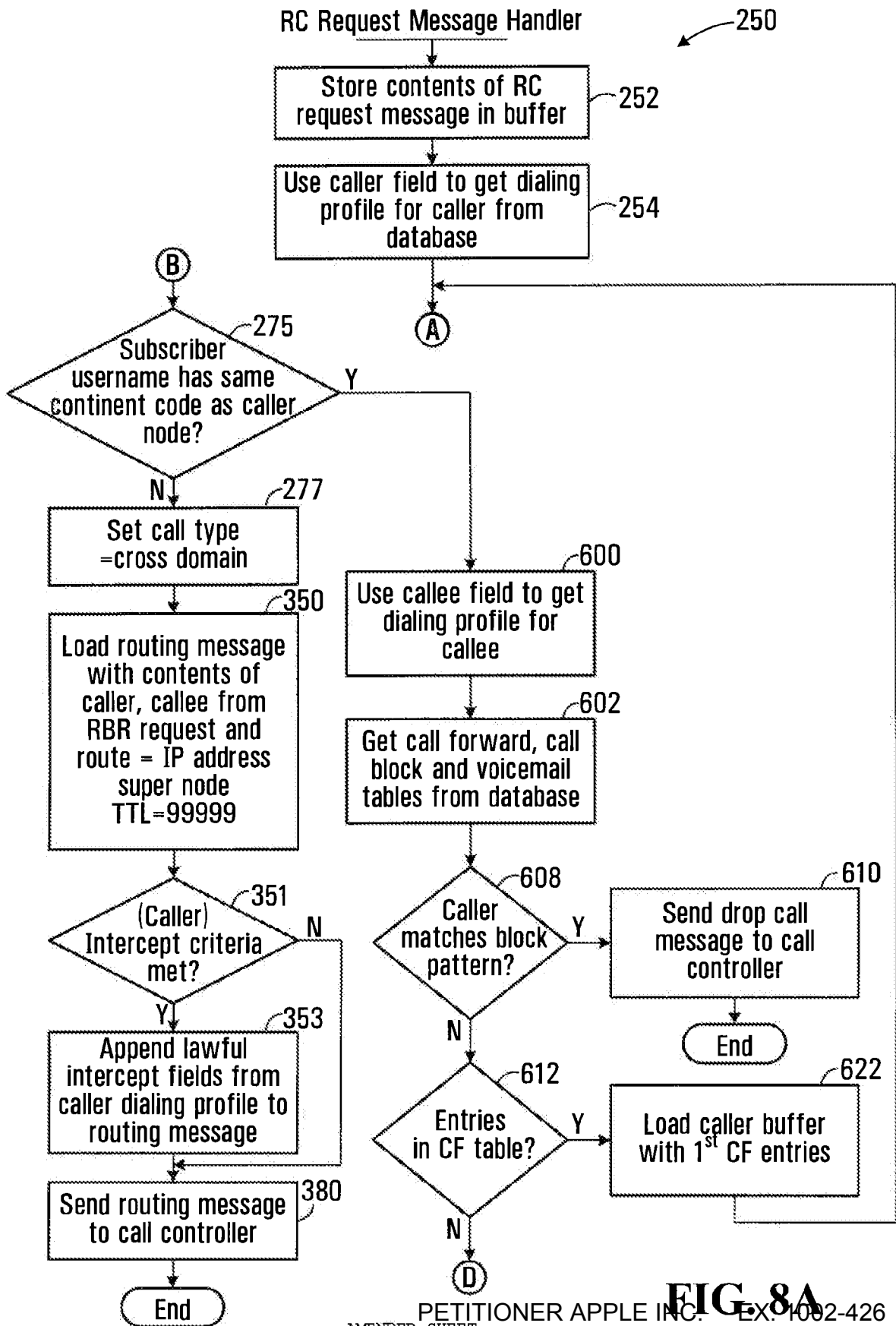

FIG. 8A

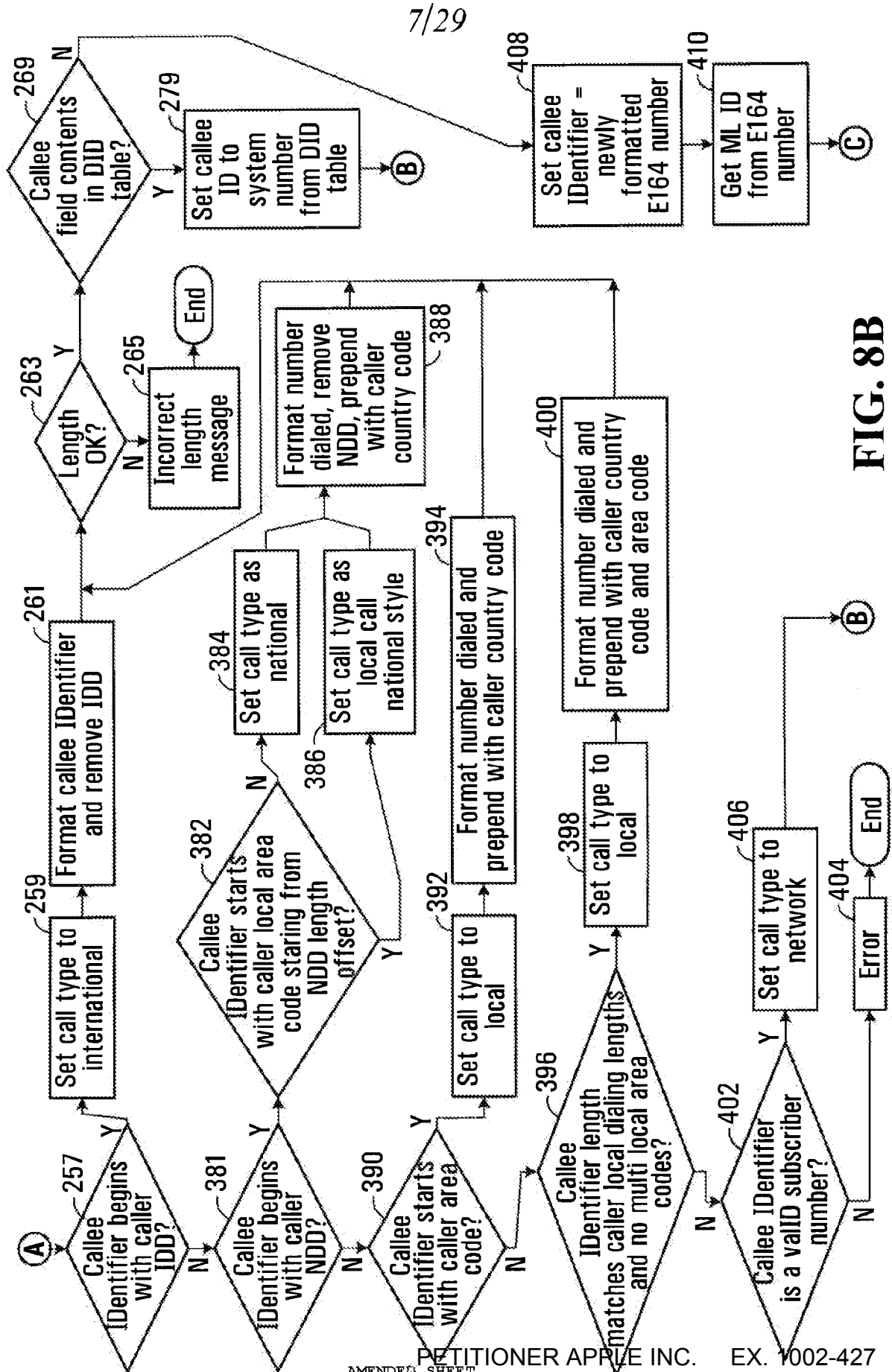
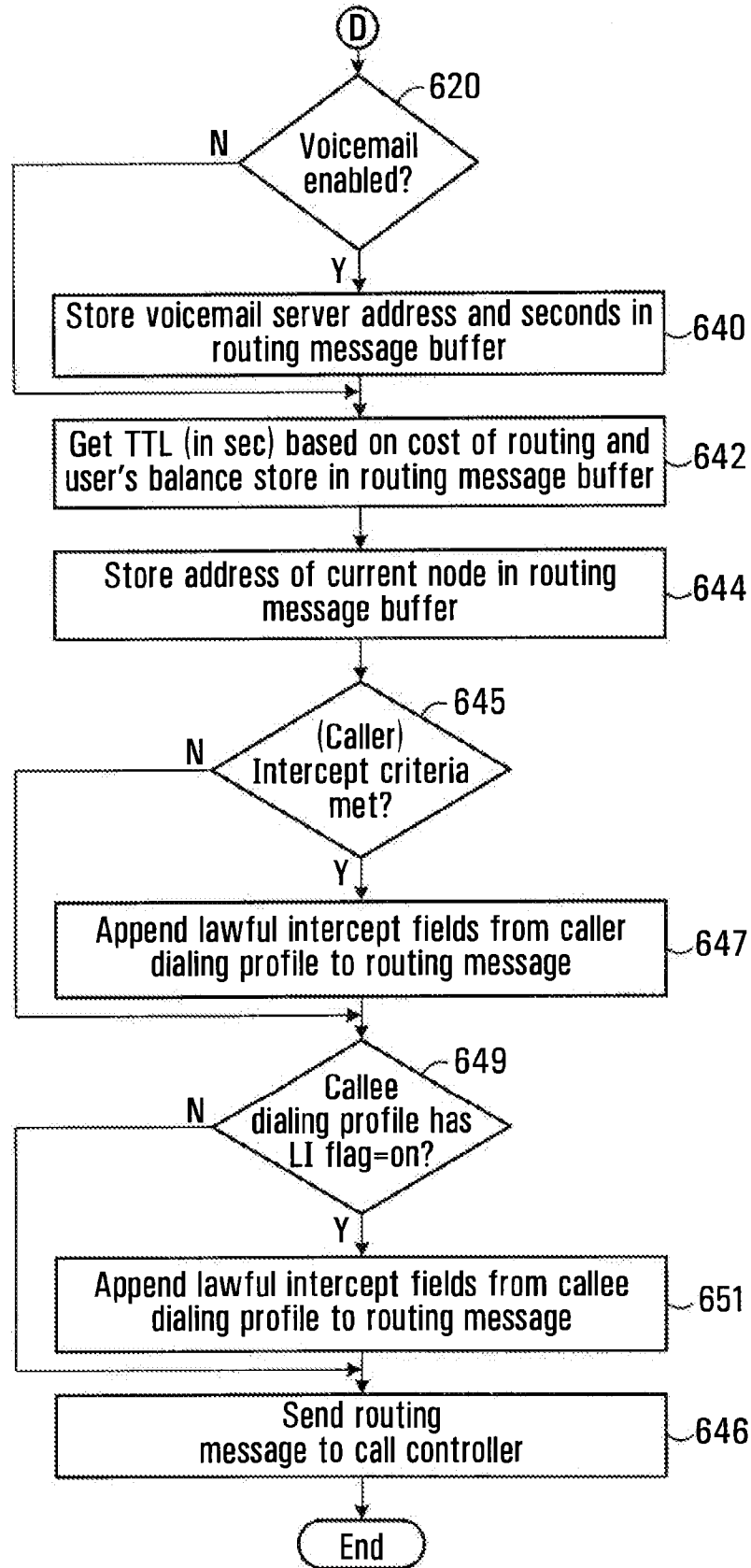

FIG. 8B

8/29



9/29

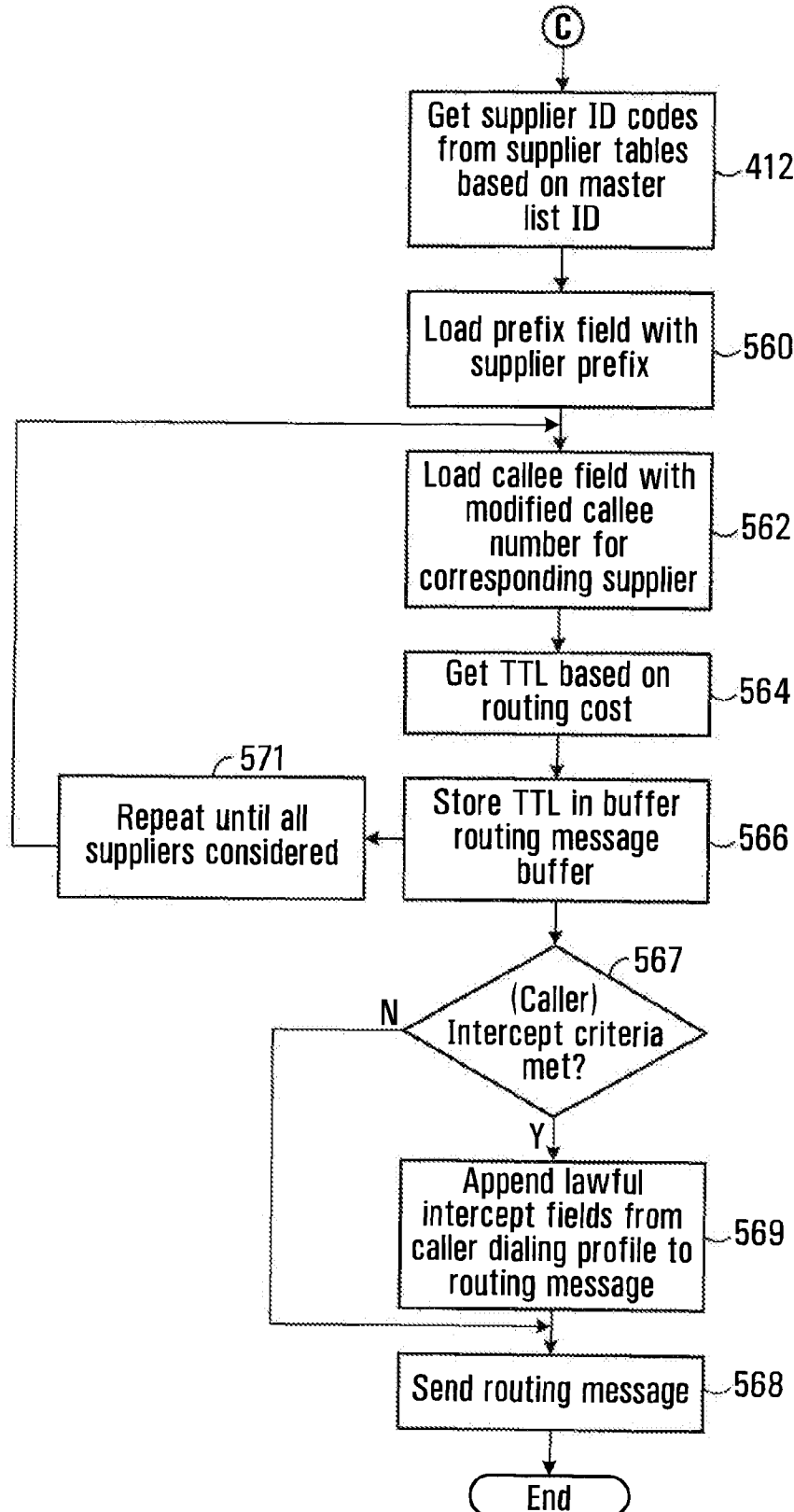

FIG. 8D

10/29

↖ 256

Dialing Profile for a User

258 ~	Username	Assigned on Subscription
260 ~	Domain	Domain Associated with User
262 ~	NDD	National Dialing Digit Code
264 ~	IDD	International Dialing Digit Code
266 ~	Country Code	Country Dependant Code
267 ~	Local Area Codes	Numeric
268 ~	Caller Minimum Local Length	Numeric
270 ~	Caller Maximum Local Length	Numeric
273 ~	Reseller	Retailer
1150 ~	Media Relay 1	Optional Media relay Identifier #1
1150 ~	Media Relay n	Optional Media relay Identifier #2
702 ~	LI flag	on or off
704 ~	MD1 Address	Address of First Mediation Device
706 ~	Warrant ID	From Law Enforcement Agency
708 ~	LI-Start Date/Time	When to Begin Monitoring Period
710 ~	LI-Stop Date/Time	When to End Monitoring Period

FIG. 9

Dialing Profile for Vancouver Subscriber

258 ~	Username	2001 1050 8667	↖ 276
260 ~	Domain	sp.yvr.digifonica.com	← 282
262 ~	NDD	1	
264 ~	IDD	011	
266 ~	Country Code	1	
267 ~	Local Area Codes	604;778 (Vancouver)	
268 ~	Caller Minimum Local Length	10	
270 ~	Caller Maximum Local Length	10	
273 ~	Reseller	Klondike	
	MR 1	192.168.1.10	
	⋮		
	MR N	192.168.2.59	

Annotations: 284 points to '2001', 61 points to '1050', 63 points to '8667', 70 points to 'sp', 74 points to 'yvr', 286 points to 'digifonica', 288 points to 'com', 290 points to '.com'.

FIG. 10

11/29

Dialing Profile for Calgary Subscriber

Username	2001 1050 2222
Domain	sp.yvr.digifonica.com
NDD	1
IDD	011
Country Code	1
Local Area Codes	403 (Calgary)
Caller Minimum Local Length	7
Caller Maximum Local Length	10
Reseller	ABC
MR1	192.168.3.60
:	
MRn	192.168.4.69

FIG. 11**Dialing Profile for London Subscriber**

Username	4401 1062 4444
Domain	sp.lhr.digifonica.com
NDD	0
IDD	00
Country Code	44
Local Area Codes	20 (London)
Caller Minimum Local Length	10
Caller Maximum Local Length	11
Reseller	DEF
MR1	192.168.5.70
:	
MRn	192.168.6.79

FIG. 12

12/29

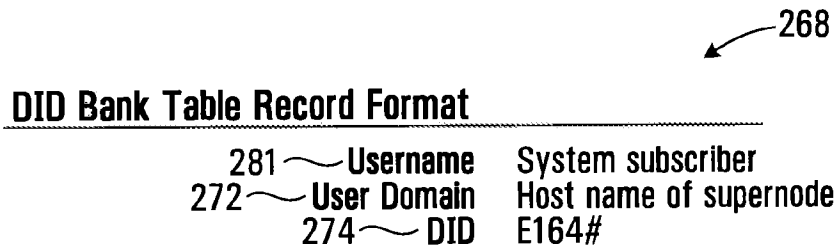

FIG. 13

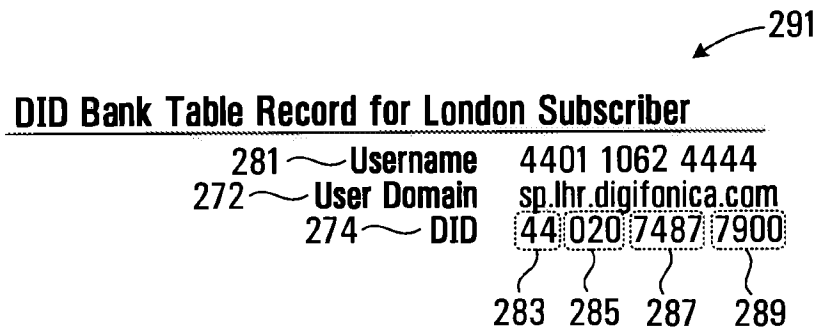

FIG. 14

13/29

352

Routing Message Format

354	Supplier Prefix (optional)	Code identifying supplier traffic
356	Delimiter	Symbol separating fields
358	Callee	PSTN compatible number or Digifonica number
360	Route	Domain name and IP address
362	Time to Live(TTL)	In seconds
364	Other	TBD

FIG. 15

366

Routing Message - Different Node

440110624444@sp.lhr.digifonica.com;tll=9999

358
360
362

1152 Media Relays (optional)

FIG. 16

Routing Message - Different Node with lawful intercept fields

440110624444@sp.lhr.digifonica.com;tll=999;LIflag=on;MAddress=192.168.1.10;
 WarrantID=20060515142;
 Lstart=2006 05 16 00:00:00
 Lstop=2006 12 31 23:59:59;
 1152 Media Relays (optional)

FIG. 16A

370

Prefix to Supernode Table Record Format

372	Prefix	First n digits of callee identifier
374	Supernode Address	IP address or fully qualified domain name

FIG. 17

Prefix to Supernode Table Record for London Subscriber

Prefix	4
Supernode Address	sp.lhr.digifonica.com

FIG. 18

14/29

Master List Record Format

500	~ ml_ID	1019
502	~ Dialing code	1604
504	~ Country code	The country code is the national prefix to be used when dialing TO a particular country FROM another country.
506	~ Nat Sign #(Area Code)	Numeric
508	~ Min Length	Numeric
510	~ Max Length	Numeric
512	~ NDD	The NDD prefix is the access code used to make a call WITHIN that country from on city to another (when calling another city in the same vicinity, this may not be necessary).
514	~ IDD	The IDD prefix is the international prefix needed to dial a call FROM the country listed TO another country.
516	~ Buffer rate	Safe charge rate above the highest rate charged by suppliers

FIG. 19

Example: Master List Record with Populated Fields

Route_ID	1019
Dialing code	1604
Country code	1
Nat Sign #(Area Code)	604
Min Length	7
Max Length	7
NDD	1
IDD	011
Buffer rate	\$0.009/min

FIG. 20

15/29

Suppliers List Record Format

540	~	Sup_ID	Name code
542	~	Route_ID	Numeric code
544	~	Prefix (optional)	String identifying supplier's traffic #
546	~	Route	IP address
548	~	NDD/IDD rewrite	
550	~	Rate	Cost per second to Digifonica to use this route

FIG. 21

Telus Supplier Record

		Sup_ID	2010 (Telus)
		Route_ID	1019
		Prefix (optional)	4973#
546	~	Route	72.64.39.58
		NDD/IDD rewrite	011
550	~	Rate	\$0.02/min

FIG. 22

Shaw Supplier Record

		Sup_ID	2011 (Shaw)
		Route_ID	1019
		Prefix (optional)	4974#
		Route	73.65.40.59
		NDD/IDD rewrite	011
550	~	Rate	\$0.025/min

FIG. 23

Sprint Supplier Record

		Sup_ID	2012 (Sprint)
		Route_ID	1019
		Prefix (optional)	4975#
		Route	74.66.41.60
		NDD/IDD rewrite	011
550	~	Rate	\$0.03/min

16/29

Routing Message Buffer for Gateway Call

4973#0116048675309@72.64.39.58;tli=3600 ~ 570
4974#0116048675309@73.65.40.59;tli=3600 ~ 572
4975#0116048675309@74.66.41.60;tli=3600 ~ 574
Media Relays (optional) ~ 1152

FIG. 25

Routing Message Buffer for Gateway Call with Lawful Intercept Fields

4973#0116048675309@72.64.39.58;tli=3600
4974#0116048675309@73.65.40.59;tli=3600
4975#0116048675309@74.66.41.60;tli=3600
LIflag=on;MAddress=192.168.1.10;WarrantID=20060515142;
Llstart=2006051600:00:00;Llstop=2006123123:59:59
Media Relays (optional) ~ 1152

FIG. 25A

Call Block Record Format

604 ~ Username Digifonica #
606 ~ Block Pattern PSTN compatible or Digifonica #

FIG. 26

Call Block Record for Calgary Callee

604 ~ Username of Callee 2001 1050 2222
606 ~ Block Pattern 2001 1050 8664

FIG. 27

Call Forwarding Record Format for Callee

614 ~ Username of Callee Digifonica #
616 ~ Destination Number Digifonica #
618 ~ Sequence Number Integer indicating order to try this

FIG. 28

17/29

Call Forwarding Table Record for Calgary Callee

614 ~ Username of Callee 2001 1050 2222
 616 ~ Destination Number 2001 1055 2223
 618 ~ Sequence Number 1

FIG. 29

Voicemail Table Record Format

624 ~ Username of Callee Digifonica #
 626 ~ Vm Server domain name
 628 ~ Seconds to Voicemail time to wait before engaging voicemail
 630 ~ Enabled yes/no

FIG. 30

Voicemail Table Record for Calgary Callee

624 ~ Username of Callee 2001 1050 2222
 626 ~ Vm Server vm.yvr.digifonica.com
 628 ~ Seconds to Voicemail 20
 630 ~ Enabled 1

FIG. 31

18/29

Routing Message Buffer for CF/VM Routing Message

650 ~ 200110502222@sp.yvr.digifonica.com;ttl=3600
652 ~ 200110552223@sp.yvr.digifonica.com;ttl=3600
654 ~ vm.yvr.digifonica.com;20;ttl=60
656 ~ sp.yvr.digifonica.com
1152 ~ Media Relays (optional)

FIG. 32

Routing Message Buffer for CF/VM Routing Message with Caller Lawful Intercept Fields

200110502222@sp.yvr.digifonica.com;ttl=3600
200110552223@sp.yvr.digifonica.com;ttl=3600
vm.yvr.digifonica.com;20;ttl=60
sp.yvr.digifonica.com
LIflag=on;MDaddress=192.168.1.10;WarrantID=20060615142;
LIstart=2006061500:00:00;LIstop=2006123123:59:59
Media Relays (optional) ~ 1152

FIG. 32A

Routing Message Buffer for CF/VM Routing Message with Caller and Callee Lawful Intercept Fields

200110502222@sp.yvr.digifonica.com;ttl=3600
200110552223@sp.yvr.digifonica.com;ttl=3600
vm.yvr.digifonica.com;20;ttl=60
sp.yvr.digifonica.com
LI1flag=on;Mdaddress=192.168.1.10;WarrantID=20060515142;
LI1start=2006051600:00:00;LI1stop=2006123123:59:59
LI2flag=0;MD2address=192.168.1.20;WarrantID=20060615142;
LI2start=2006061500:00:00;LI2stop=2006123123:59:59
Media Relays (optional) ~ 1152

FIG. 32B

19/29

Routing Message Handler
Executed by Call Controller

122

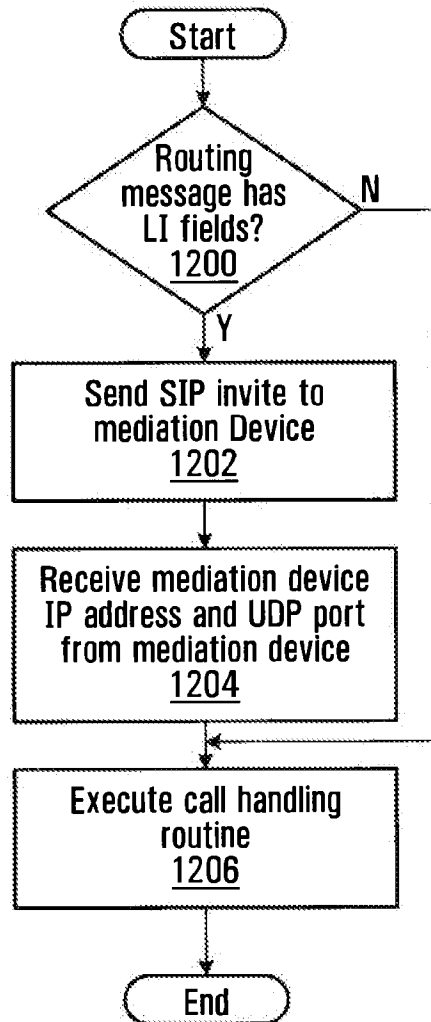
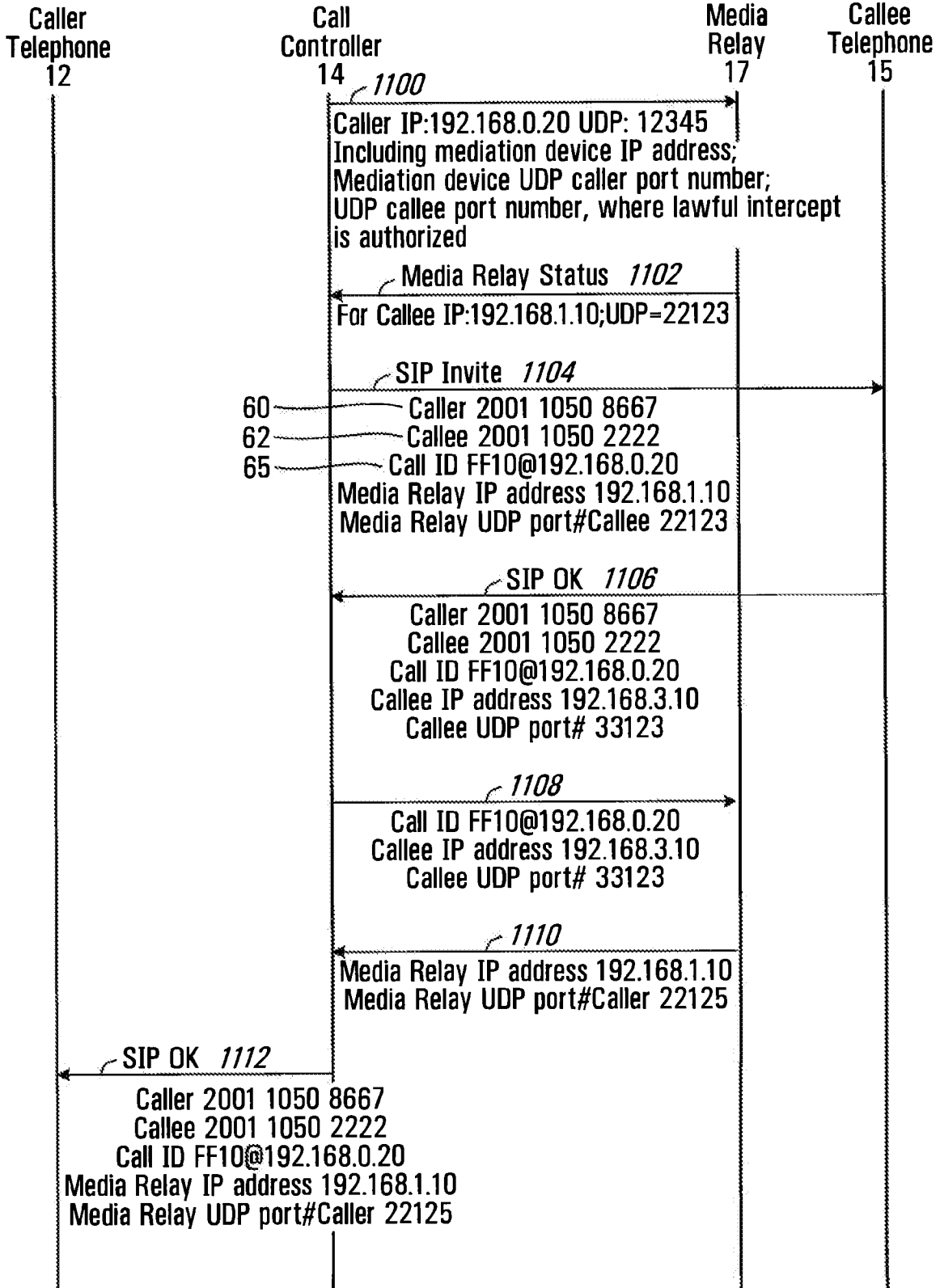

FIG. 33

20/29

123

Call Handling Routine



21/29

Call Controller Active Call Record

1300	Call ID	FF10@192.168.0.20
1302	Caller IP Address	192.168.0.20
1304	Caller Port	12345
1306	Callee IP Address	192.168.3.10
1308	Callee Port	33123
1310	Media Relay ID	42
1312	Media Relay Caller Port	22125
1314	Media Relay Callee Port	22123

FIG. 35**Routing Controller Active Call Record**

1316	Call ID	FF10@192.168.0.20
1318	Caller	2001 1050 8667
1320	Callee	2001 1050 2222
1322	Call Controller ID	61

FIG. 36

22/29

Message from Call Controller to Mediation Device - SIP Invite

1020	~	Caller	2001 1050 8667
1022	~	Callee	2001 1050 2222
1024	~	Call ID	FF10@192.168.0.20
1026	~	Warrant ID	12345678
1028	~	Intercept Related Info	XXXXXXXX

FIG. 37**Reply Message from Mediation Device - SIP Ok**

1040	~	Caller	2001 1050 8667
1042	~	Callee	2001 1050 2222
1044	~	Call ID	FF10@192.168.0.20
1046	~	Mediation Device IP Address	192.138.2.10
1048	~	Mediation Device UDP Port # Caller	13678
1050	~	Mediation Device UDP Port # Callee	13679

FIG. 38

23/29

900
↙

SIP Bye Message

902 ~	Caller	Username
904 ~	Callee	PSTN compatible # or Username
906 ~	Call ID	unique call identifier (hexadecimal string@IP))

FIG. 39

908
↙

SIP Bye Message

902 ~	Caller	2001 1050 8667
904 ~	Callee	2001 1050 2222
906 ~	Call ID	FA10@192.168.0.20

FIG. 40

24/29

910 ↘

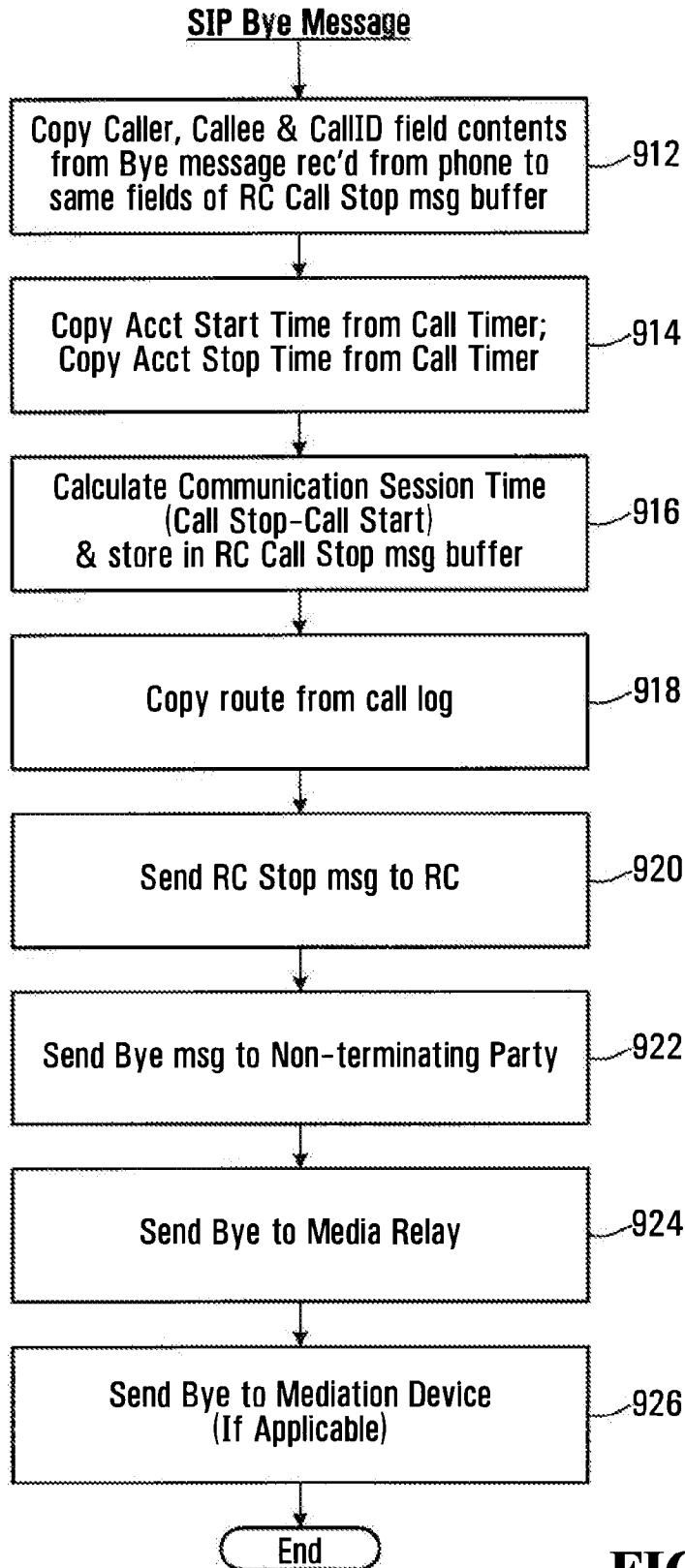

FIG. 41

25/29

1000

RC Call Stop Message

1002	Caller	Username
1004	Callee	PSTN compatible # or Username
1006	Call ID	unique call identifier (hexadecimal string@IP)
1008	Acct Start Time	start time of call
1010	Acct Stop Time	time the call ended
1012	Acct Session Time	start time-stop time (in seconds)
1014	Route	IP address for gateway, where a gateway is used

FIG. 42

1021

RC Call Stop Message for Calgary Callee

1002	Caller	2001 1050 8667
1004	Callee	2001 1050 2222
1006	Call ID	FA10@192.168.0.20
1008	Acct Start Time	2006-12-30 12:12:12
1010	Acct Stop Time	2006-12-30 12:12:14
1012	Acct Session Time	2
1014	Route	(72.64.39.58 if Telus gateway is used)

FIG. 43

26/29

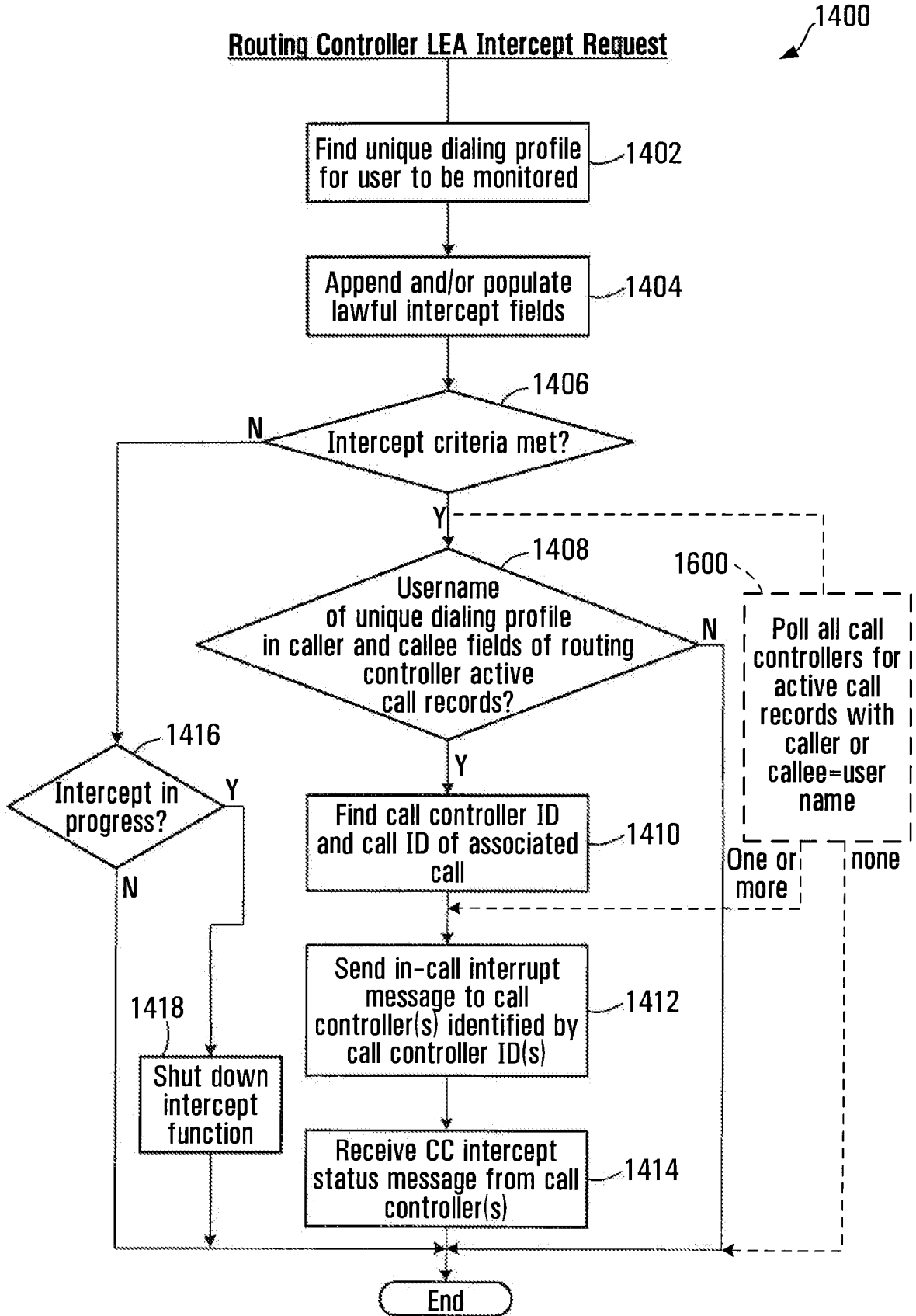

27/29

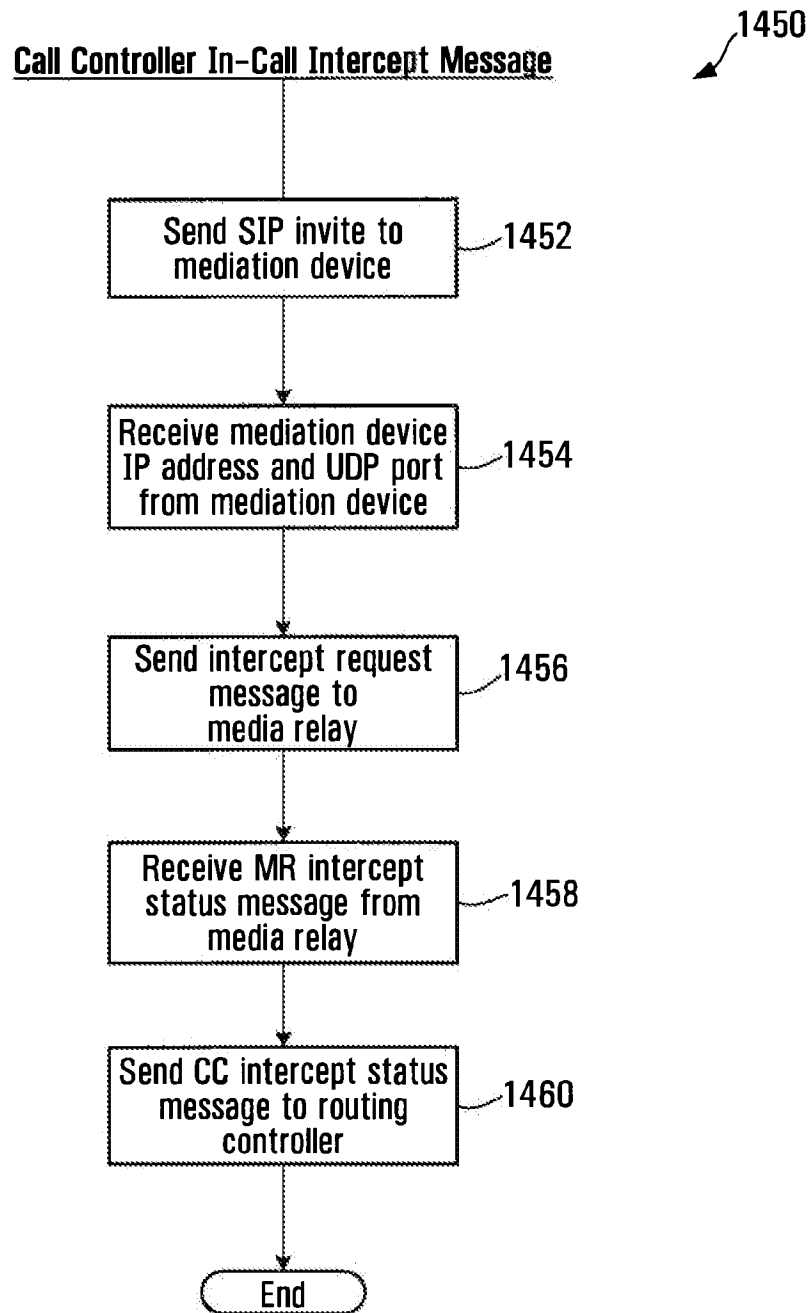

FIG. 45

28/29

1500

Routing Controller In-Call Intercept Shut Down Routine

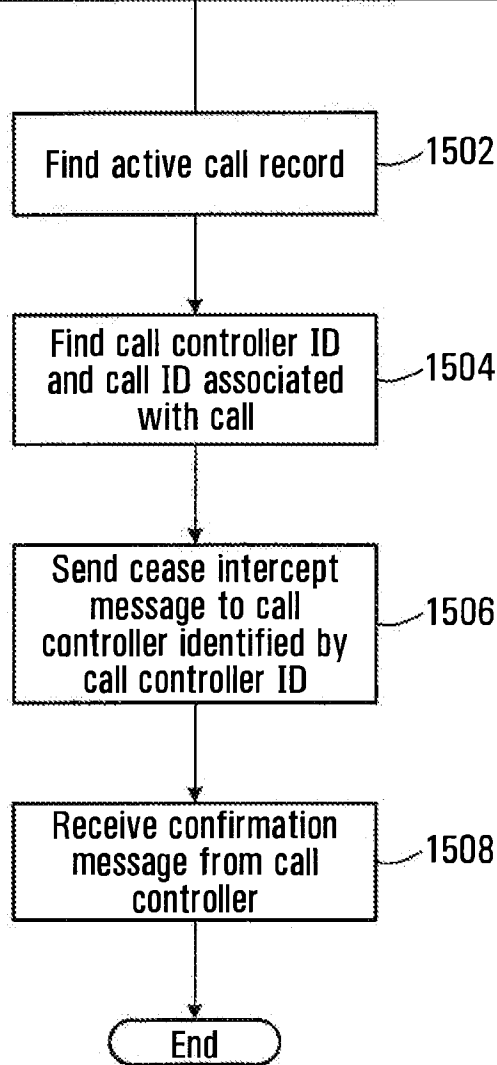

FIG. 46

29/29

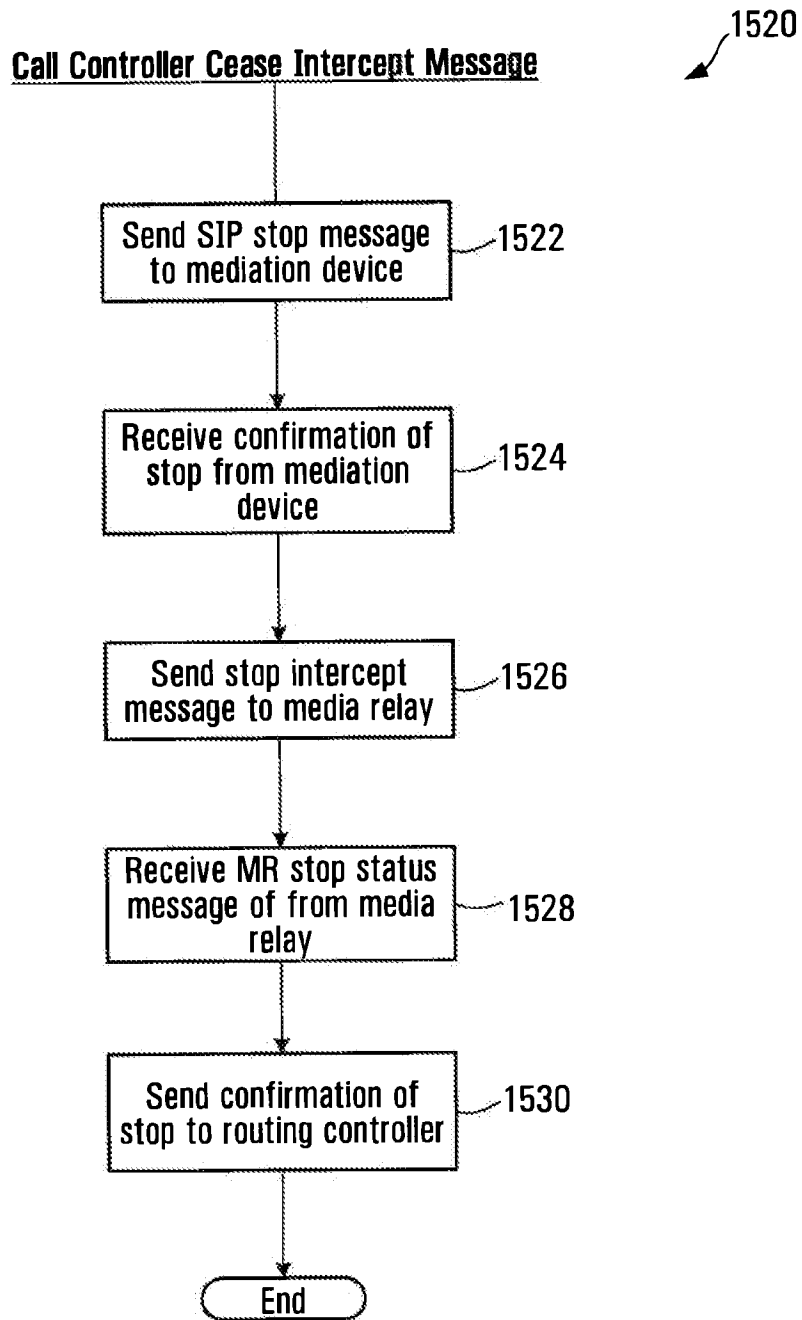

FIG. 47

This document is an excerpt compiled from various documents to create a standardized display of selected information. It may not include all of the information available about such patent. It is provided for informational purposes only. Those interested in viewing original documents should obtain a full copy of the original documents from the issuing authority.

Patent Record Full View

Wednesday, June 3 2015

THOMSON INNOVATION

Patent/Publication: SG151991A1**Bibliography****DWPI Title**

Method for operating call routing controller for facilitating communication between callers and callees, involves producing routing message identifying gateway to public network, when call is classified as public network call

Assignee/Applicant

Original: DIGIFONICA, CA

DWPI Assignee/Applicant

ACCELERON PHARMA INC (ACCE-N); ARAFA F (ARAF-I); BJOERSELL J E V (BJOE-I); DIGIFONICA (DIGI-N); DIGIFONICA INT LTD (DIGI-N)

Inventor

PERREault CLAY, PA NICHOLSON STEVE, GB THOMSON ROD, CA BJORSELL JOHAN EMIL VICTOR, CA ARAFA FUAD, CA

Publication Date (Kind Code)

2009-06-29 (A1)

Application Number / Date

SG20092949A / 2007-11-01

Priority Number / Date / Country

US2006856212P / 2006-11-02 / US

Translation of / Language

- /English

Abstract**DWPI Abstract**

(WO2008052340A1)

Novelty

A caller identifier and callee identifier is received in response to initiation of call by a calling subscriber. A call classification criteria associated with the caller identifier is used to classify the call as a public network call or private network call. A routing message identifying an address associated with the callee is produced on the private network, when the call is classified as a private network call. A routing message identifying a gateway to the public network is produced, when the call is classified as a public network call.

Detailed Description

INDEPENDENT CLAIMS are included for the following:

1. computer readable medium storing program for operating call routing controller;
2. call routing apparatus;
3. data structure for access by apparatus;

PETITIONER APPLE INC. EX. 1002-451

4. method for determining time to permit a communication session to be conducted;
5. computer readable medium storing program for determining time to permit a communication session to be conducted;
6. apparatus for determining time to permit a communication session to be conducted;
7. method for attributing charges for communication services;
8. computer readable medium storing program for attributing charges for communication services; and
9. apparatus for attributing charges for communication services.

Use

Method for operating call routing controller for facilitating communication between callers and callees such as voice over internet protocol (VoIP) communication.

Advantage

The call routing controller can be controlled effectively so that communication between callers and callees in a system can be realized.

Drawing Description

The drawing shows the block diagram of the system facilitating communication.

- 11 - Vancouver node.
- 12 - Vancouver telephone.
- 15 - Calgary telephone.
- 16 - Routing controller.
- 18 - Database.

Technology Focus

INDUSTRIAL STANDARDS - The interface used in the system conforms to Bluetooth standard. The national dialed digit field includes a number that conforms to E.164 standard.

Abstract

(WO2008052340A1)

A process and apparatus to facilitate communication between callers and callees in a system comprising a plurality of nodes with which callers and callees are associated is disclosed. In response to initiation of a call by a calling subscriber, a caller identifier and a callee identifier are received. Call classification criteria associated with the caller identifier are used to classify the call as a public network call or a private network call. A routing message identifying an address, on the private network, associated with the callee is produced when the call is classified as a private network call and a routing message identifying a gateway to the public network is produced when the call is classified as a public network call.

A process and apparatus to facilitate communication between callers and callees in a system comprising a plurality of nodes with which callers and callees are associated is disclosed. In response to initiation of a call by a calling subscriber, a caller identifier and a callee identifier are received. Call classification criteria associated with the caller

identifier are used to classify the call as a public network call or a private network call. A routing message identifying an address, on the private network, associated with the callee is produced when the call is classified as a private network call and a routing message identifying a gateway to the public network is produced when the call is classified as a public network call.

Classes/Indexing

No Classes/Indexing exists for this Record

Legal Status

INPADOC Legal Status

Get Family Legal Status

Family

Family

INPADOC Family (0)

Expand DWPI Family (22); Countries (121)

Claims

Claims

All Claims (106)

(WO2008052340A1)

Claims (English)

What is claimed is:

1. A process for operating a call routing controller to facilitate communication between callers and callees in a system comprising a plurality of nodes with which callers and callees are associated, the process comprising: in response to initiation of a call by a calling subscriber, receiving a caller identifier and a callee identifier; using call classification criteria associated with the caller identifier to classify the call as a public network call or a private network call; producing a routing message identifying an address, on the private network, associated with the callee when the call is classified as a private network call; and producing a routing message identifying a gateway to the public network when the call is classified as a public network call.
2. The process of claim 1 further comprising receiving a request to establish a call, from a call controller in communication with a caller identified by said callee identifier.
3. The process of claim 1 wherein using said call classification criteria comprises searching a database to locate a record identifying calling attributes associated with a caller identified by said caller identifier.
4. The process of claim 3 wherein locating a record comprises locating a caller dialing profile comprising a username associated with said caller, a domain associated with said caller, and at least one calling attribute.
5. The process of claim 4 wherein using said call classification criteria comprises comparing calling attributes associated with said caller dialing profile with aspects of said callee identifier.
6. The process of claim 4 wherein comparing comprises determining whether said callee identifier includes a portion that matches an IDD associated with said caller dialing profile.
7. The process of claim 4 wherein comparing comprises determining whether said callee identifier includes a portion that matches an NDD associated with said caller dialing profile.
8. The process of claim 4 wherein comparing comprises determining whether said callee identifier includes a portion that matches an area code associated with said caller dialing profile.

9. The process of claim 4 wherein comparing comprises determining whether said callee identifier has a length within a range specified in said caller dialing profile.
10. The process of claim 4 further comprising formatting said callee identifier into a pre-defined digit format to produce a re-formatted callee identifier.
11. The process of claim 10 wherein formatting comprises removing an international dialing digit from said callee identifier, when said callee identifier begins with a digit matching an international dialing digit specified by said caller dialing profile associated with said caller.
12. The process of claim 10 wherein formatting comprises removing a national dialing digit from said callee identifier and prepending a caller country code to said callee identifier when said callee identifier begins with a national dialing digit.
13. The process of claim 10 wherein formatting comprises prepending a caller country code to said callee identifier when said callee identifier begins with digits identifying an area code specified by said caller dialing profile.
14. The process of claim 10 wherein formatting comprises prepending a caller country code and area code to said callee identifier when said callee identifier has a length that matches a caller dialing number format specified by said caller dialing profile and only one area code is specified as being associated with said caller in said caller dialing profile.
15. The process of claim 10 further comprising classifying said call as a private network call when said re-formatted callee identifier identifies a subscriber to the private network.
16. The process of claim 10 further comprising determining whether said callee identifier complies with a pre-defined username format and if so classifying the call as a private network call.
17. The process of claim 10 further comprising causing a database of records to be searched to locate a direct in dial (DID) bank table record associating a public telephone number with said reformatted callee identifier and if said DID bank table record is found classifying the call as a private network call and if a DID bank table record is not found classifying the call as a public network call.
18. The process of claim 17 wherein producing said routing message identifying a node on the private network comprises setting a callee identifier in response to a username associated with said DID bank table record.
19. The process of claim 18 wherein producing said routing message comprises determining whether a node associated with the reformatted callee identifier is the same as a node associated the caller identifier.
20. The process of claim 19 wherein determining whether a node associated with the reformatted callee identifier is the same as a node associated the caller identifier comprises determining whether a prefix of said re-formatted callee identifier matches a corresponding prefix of a username associated with said caller dialing profile.
21. The process of claim 20 wherein when said node associated with said caller is not the same as the node associated with the callee, producing a routing message including said caller identifier, said reformatted callee identifier and an identification of a private network node associated with said callee and communicating said routing message to a call controller.
22. The process of claim 19 wherein when said node associated with said caller is the same as the node associated with said callee, determining whether to perform at least one of the following: forward said call to another party, block the call and direct the caller to a voicemail server associated with the callee.
23. The process of claim 22 wherein producing said routing message comprises producing a routing message having an identification of at least one of the callee identifier, an identification of a party to whom the call should be forwarded and an identification of a voicemail server associated with the callee.
24. The process of claim 23 further comprising communicating said routing message to a call controller.
25. The process of claim 10 wherein producing a routing message identifying a gateway to the public network comprises searching a database of route records associating route identifiers with dialing codes to find a route record having a dialing code having a number pattern matching at least a portion of said reformatted callee identifier.
26. The process of claim 25 further comprising searching a database of supplier records associating supplier identifiers with said route identifiers to locate at least one supplier record associated with said route identifier associated with said route record having a dialing code having a number pattern matching at least a portion of said reformatted callee identifier.

27. The process of claim 26 further comprising loading a routing message buffer with the reformatted callee identifier and an identification of specific routes associated respective ones of the supplier records associated with said route record and loading said routing message buffer with a time value and a timeout value.

28. The process of claim 27 further comprising communicating a routing message comprising the contents of said routing message buffer to a call controller.

29. The process of claim 4 further comprising causing said dialing profile to include a maximum concurrent call value and a concurrent call count value and causing said concurrent call count value to be incremented when the user associated with said dialing profile initiates a call and causing said concurrent call count value to be decremented when a call with said user associated with said dialing profile is ended.

30. A computer readable medium encoded with codes for directing a processor to execute the method of any one of claims 1-29.

31. A call routing apparatus for facilitating communications between callers and callees in a system comprising a plurality of nodes with which callers and callees are associated, the apparatus comprising: receiving means for receiving a caller identifier and a callee identifier, in response to initiation of a call by a calling subscriber; classifying means for classifying the call as a private network call or a public network call according to call classification criteria associated with the caller identifier; means for producing a routing message identifying an address, on the private network, associated with the callee when the call is classified as a private network call; and means for producing a routing message identifying a gateway to the public network if the call is classified as a public network call.

32. The apparatus of claim 31 wherein said receiving means is operably configured to receive a request to establish a call, from a call controller in communication with a caller identified by said callee identifier.

33. The apparatus of claim 31 further comprising searching means for searching a database comprising records associating calling attributes with subscribers to said private network to locate a record identifying calling attributes associated with a caller identified by said caller identifier.

34. The apparatus of claim 33 wherein said records include dialing profiles each comprising a username associated with said subscriber, an identification of a domain associated with said subscriber, and an identification of at least one calling attribute associated with said subscriber.

35. The apparatus of claim 34 wherein said call classification means is operably configured to compare calling attributes associated with said caller dialing profile with aspects of said callee identifier.

36. The apparatus of claim 35 wherein said calling attributes include an international dialing digit and wherein said call classification means is operably configured to determine whether said callee identifier includes a portion that matches an IDD associated with said caller dialing profile.

37. The apparatus of claim 34 wherein said calling attributes include an national dialing digit and wherein said call classification means is operably configured to determine whether said callee identifier includes a portion that matches an NDD associated with said caller dialing profile.

38. The apparatus of claim 34 wherein said calling attributes include an area code and wherein said call classification means is operably configured to determine whether said callee identifier includes a portion that matches an area code associated with said caller dialing profile.

39. The apparatus of claim 34 wherein said calling attribute include a number length range and wherein said call classification means is operably configured to determine whether said callee identifier has a length within a range specified in said caller dialing profile.

40. The apparatus of claim 34 further comprising formatting means for formatting said callee identifier into a pre-defined digit format to produce a re-formatted callee identifier.

41. The apparatus of claim 40 wherein said formatting means is operably configured to remove an international dialing digit from said callee identifier, when said callee identifier begins with a digit matching an international dialing digit specified by said caller dialing profile associated with said caller.

42. The apparatus of claim 40 wherein said formatting means is operably configured to remove a national dialing digit from said callee identifier and prepend a caller country code to said callee identifier when said callee identifier begins with a national dialing digit.

43. The apparatus of claim 40 wherein said formatting means is operably configured to prepend a caller country code to said callee identifier when said callee identifier begins with digits identifying an area code specified by said caller dialing profile.

44. The apparatus of claim 40 wherein said formatting means is operably configured to prepend a caller country code and area code to said callee identifier when said callee identifier has a length that matches a caller dialing

number format specified by said caller dialing profile and only one area code is specified as being associated with said caller in said caller dialing profile.

45. The apparatus of claim 40 wherein said classifying means is operably configured to classifying said call as a private network call when said re-formatted callee identifier identifies a subscriber to the private network.

46. The apparatus of claim 40 wherein said classifying means is operably configured to classify the call as a private network call when said callee identifier complies with a pre-defined username format.

47. The apparatus of claim 40 further comprising searching means for searching a database of records to locate a direct in dial (DID) bank table record associating a public telephone number with said reformatted callee identifier and wherein said classifying means is operably configured to classify the call as a private network call when said DID bank table record is found and to classify the call as a public network call when a DID bank table record is not found

48. The apparatus of claim 47 wherein said private network routing message producing means is operably configured to produce a routing message having a callee identifier set according to a username associated with said DID bank table record.

49. The apparatus of claim 48 wherein said private network routing message producing means is operably configured to determine whether a node associated with the reformatted callee identifier is the same as a node associated the caller identifier.

50. The apparatus of claim 49 wherein said private network routing means includes means for determining whether a prefix of said re-formatted callee identifier matches a corresponding prefix of a username associated with said caller dialing profile.

51. The apparatus of claim 50 wherein said private network routing message producing means is operably configured to produce a routing message including said caller identifier, said reformatted callee identifier and an identification of a private network node associated with said callee and communicating said routing message to a call controller.

52. The apparatus of claim 49 wherein said private network routing message producing means is operably configured to perform at least one of the following: forward said call to another party, block the call and direct the caller to a voicemail server associated with the callee, when said node associated with said caller is the same as the node associated with said callee.

53. The apparatus of claim 52 wherein said means for producing said private network routing message is operably configured to produce a routing message having an identification of at least one of the callee identifier, an identification of a party to whom the call should be forwarded and an identification of a voicemail server associated with the callee.

54. The apparatus of claim 53 further comprising means for communicating said routing message to a call controller.

55. The apparatus of claim 40 wherein said means for producing a public network routing message identifying a gateway to the public network comprises means for searching a database of route records associating route identifiers with dialing codes to find a route record having a dialing code having a number pattern matching at least a portion of said reformatted callee identifier.

56. The apparatus of claim 55 further comprising means for searching a database of supplier records associating supplier identifiers with said route identifiers to locate at least one supplier record associated with said route identifier associated with said route record having a dialing code having a number pattern matching at least a portion of said reformatted callee identifier.

57. The apparatus of claim 56 further comprising a routing message buffer and means for loading said routing message buffer with the reformatted callee identifier and an identification of specific routes associated respective ones of the supplier records associated with said route record and loading said routing message buffer with a time value and a timeout value.

58. The apparatus of claim 57 further comprising means for communicating a routing message comprising the contents of said routing message buffer to a call controller.

59. The apparatus of claim 34 further comprising means for causing said dialing profile to include a maximum concurrent call value and a concurrent call count value and for causing said concurrent call count value to be incremented when the user associated with said dialing profile initiates a call and for causing said concurrent call count value to be decremented when a call with said user associated with said dialing profile is ended. Data Structure

60. A data structure for access by an apparatus for producing a routing message for use by a call routing controller in a communications system, the data structure comprising a profile record comprising fields

for associating with respective subscribers to the system: a subscriber user name direct-in-dial records comprising fields for associating with respective subscriber usernames: a user domain; and a direct-in-dial number; prefix to node records comprising fields for associating with at least a portion of said respective subscriber usernames: a node address of a node in said system, whereby a subscriber name can be used to find a user domain, at least a portion of said a subscriber name can be used to find a node with which the subscriber identified by the subscriber name is associated, and a user domain and subscriber name can be located in response to a direct-in-dial number.

61. A data structure for access by an apparatus for producing a routing message for use by a call routing controller in a communications system, the data structure comprising: master list records comprising fields for associating a dialing code with respective master list identifiers; and supplier list records linked to master list records by said master list identifiers, aid supplier list records comprising fields for associating with a communications services supplier: a supplier id; a master list id; a route identifier; and a billing rate code, whereby communications services suppliers are associated with dialing codes, such that dialing codes can be used to locate suppliers capable of providing a communications link associated with a given dialing code.

62. A method of determining a time to permit a communication session to be conducted, the method comprising: calculating a cost per unit time; calculating a first time value as a sum of a free time attributed to a participant in the communication session and the quotient of a funds balance held by said participant to said cost per unit time value; and producing a second time value in response to said first time value and a billing pattern associated with said participant, said billing pattern including first and second billing intervals and said second time value being said time to permit a communication session to be conducted.

63. The method of claim 62 wherein calculating said first time value comprises retrieving a record associated with said participant and obtaining from said record at least one of said free time and said funds balance.

64. The method of claim 62 wherein producing said second time value comprises producing a remainder value representing a portion of said second billing interval remaining after dividing said second billing interval into a difference between said first time value and said first billing interval.

65. The method of claim 64 wherein producing said second time value comprises setting a difference between said first time value and said remainder as said second time value.

66. The method of claim 62 further comprising setting said second time value to zero when said remainder is greater than zero and said first time value is less than said free time associated with said participant.

67. The method of claim 62 wherein calculating said cost per unit time comprises: locating a record in a database, said record comprising a markup type indicator, a markup value and a billing pattern; and setting a reseller rate equal to the sum of said markup value and said buffer rate.

68. The method of claim 67 wherein locating said record in a database comprises locating at least one of: a record associated with a reseller and a route associated with the reseller; a record associated with the reseller; and a default reseller markup record.

69. The method of claim 67 wherein calculating said cost per unit time value further comprises locating at least one of: an override record specifying a route cost per unit time amount associated with a route associated with the communication session; a reseller record associated with a reseller of said communications session, said reseller record specifying a reseller cost per unit time associated with said reseller for the communication session; a default operator markup record specifying a default cost per unit time.

70. The method of claim 69 further comprising setting as said cost per unit time the sum of said reseller rate and at least one of said route cost per unit time, said reseller cost per unit time and said default cost per unit time.

71. The method of claim 69 further comprising receiving a communication session time representing a duration of said communication session and incrementing a reseller balance by the product of said reseller rate and said communication session time.

72. The method of claim 69 further comprising receiving a communication session time representing a duration of said communication session and incrementing a system operator balance by a product of said buffer rate and said communication session time.

73. A computer readable medium encoded with instructions for directing a processor circuit to execute the method of any one of claims 62-72.

74. An apparatus for determining a time to permit a communication session to be conducted, the apparatus comprising: a processor circuit; a computer readable medium coupled to the processor circuit and encoded with instructions for directing the processor circuit to: calculate a cost per unit time for the communication session; calculate a first time value as a sum of a free time attributed to a participant in the communication session and the quotient of a funds balance held by said participant to said cost per unit time value; and produce a second time value in response to said first time value and a billing pattern associated with said participant, said

pattern including first and second billing intervals and said second time value being said time to permit a communication session to be conducted.

75. The apparatus of claim 74 wherein said instructions include instructions for directing the processor circuit to retrieve a record associated with said participant and obtain from said record at least one of said free time and said funds balance.

76. The apparatus of claim 74 wherein said instructions include instructions for directing the processor circuit to produce said second time value by producing a remainder value representing a portion of said second billing interval remaining after dividing said second billing interval into a difference between said first time value and said first billing interval.

77. The apparatus of claim 76 wherein said instructions include instructions for directing the processor circuit to produce said second time value comprises setting a difference between said first time value and said remainder as said second time value.

78. The apparatus of claim 74 wherein said instructions include instructions for directing the processor circuit to set said second time value to zero when said remainder is greater than zero and said first time value is less than said free time associated with said participant.

79. The apparatus of claim 74 wherein said instructions for directing said processor circuit to calculate said cost per unit time comprises instructions for directing the processor circuit to: locate a record in a database, said record comprising a markup type indicator, a markup value and a billing pattern; and set a reseller rate equal to the sum of said markup value and said buffer rate.

80. The apparatus of claim 79 wherein said instructions for directing the processor circuit to locate said record in a database comprises instruction for directing the processor circuit to locate at least one of: a record associated with a reseller and a route associated with the reseller; a record associated with the reseller; a default reseller markup record;

81. The apparatus of claim 79 wherein said instructions for directing the processor circuit to calculate said cost per unit time value further comprises instructions for directing the processor circuit to locate at least one of: an override record specifying a route cost per unit time amount associated with a route associated with the communication session; a reseller record associated with a reseller of said communications session, said reseller record specifying a reseller cost per unit time associated with said reseller for the communication session; a default operator markup record specifying a default cost per unit time.

82. The apparatus of claim 81 wherein said instructions include instructions for directing the processor circuit to set as said cost per unit time the sum of said reseller rate and at least one of said route cost per unit time, said reseller cost per unit time and said default cost per unit time.

83. The apparatus of claim 81 wherein said instructions include instructions for directing the processor circuit to receive a communication session time representing a duration of said communication session and increment a reseller balance by the product of said reseller rate and said communication session time.

84. The apparatus of claim 81 wherein said instructions include instructions for directing the processor circuit to receive a communication session time representing a duration of said communication session and increment a system operator balance by a product of said buffer rate and said communication session time. Attributing Charges to a User

85. A process for attributing charges for communications services, the process comprising: determining a first chargeable time in response to a communication session time and a pre-defined billing pattern; determining a user cost value in response to said first chargeable time and a free time value associated with a user of said communications services; changing an account balance associated with said user in response to a user cost per unit time. changing an account balance associated with a reseller of said communications services in response to a reseller cost per unit time and said communication session time; and changing an account balance associated with an operator of said communications services in response to an operator cost per unit time and said communication session time.

86. The process of claim 85 wherein determining said first chargeable time comprises: locating at least one of: an override record specifying a route cost per unit time and billing pattern associated with a route associated with the communication session; a reseller record associated with a reseller of said communications session, said reseller record specifying a reseller cost per unit time and billing pattern associated with said reseller for the communication session; and a default record specifying a default cost per unit time and billing pattern; and setting as said pre-defined billing pattern the billing pattern of the record located, wherein the billing pattern of the record located comprises a first billing interval and a second billing interval.

87. The process of claim 85 wherein determining said first chargeable time comprises setting said first chargeable time equal to said first billing interval when said communication session time is less than or equal to said first billing interval.

88. The process of claim 86 wherein determining said first chargeable time comprises producing a remainder value representing a portion of said second billing interval remaining after dividing said second billing interval into a difference between communication session time and said first interval when said communication session time is greater than said communication session time; and setting said first chargeable time to a difference between said communication session time and said remainder when said remainder is greater than zero; and setting said first chargeable time to said communication session time when said remainder is not greater than zero.

89. The process of claim 88 further comprising determining a second chargeable time in response to said first chargeable time and said free time value associated with said user of said communications services when said first chargeable time is greater than or equal to said free time value associated with said user of said communications services.

90. The process of claim 89 wherein determining said second chargeable time comprises setting said second chargeable time to a difference between said first chargeable time.

91. The process of claim 89 further comprising resetting said free time value associated with the user to zero when said first chargeable time is greater than or equal to said free time value associated with said user of said communications services.

92. The process of claim 90 wherein changing an account balance associated with the user comprises calculating a user cost value in response to said second chargeable time and said user cost per unit time.

93. The process of claim 92 further comprising changing a user free cost balance in response to said user cost value.

94. The process of claim 85 further comprising setting said user cost to zero when said first chargeable time is less than said free time value associated with the user.

95. The process of claim 85 further comprising changing a user free time balance in response to said first chargeable time.

96. A computer readable medium encoded with instructions for directing a processor circuit to execute the process of any one of claims 85-95.

97. An apparatus for attributing charges for communications services, the apparatus comprising: a processor circuit; a computer readable medium in communication with the processor circuit and encoded with instructions for directing said processor circuit to; determine a first chargeable time in response to a communication session time and a pre-defined billing pattern; determine a user cost value in response to said first chargeable time and a free time value associated with a user of said communications services; change an account balance associated with said user in response to a user cost per unit time. change an account balance associated with a reseller of said communications services in response to a reseller cost per unit time and said communication session time; and change an account balance associated with an operator of said communications services in response to an operator cost per unit time and said communication session time.

98. The apparatus of claim 97 wherein said instructions for directing the processor circuit to determine said first chargeable time comprises: instructions for causing said processor circuit to communicate with a database to locate at least one of: an override record specifying a route cost per unit time and billing pattern associated with a route associated with the communication session; a reseller record associated with a reseller of said communications session, said reseller record specifying a reseller cost per unit time and billing pattern associated with said reseller for the communication session; and a default record specifying a default cost per unit time and billing pattern; and instructions for setting as said pre-defined billing pattern the billing pattern of the record located, wherein the billing pattern of the record located comprises a first billing interval and a second billing interval.

99. The apparatus of claim 97 wherein said instructions causing the processor circuit to determine said first chargeable time comprises instructions for directing the processor circuit to set said first chargeable time equal to said first billing interval when said communication session time is less than or equal to said first billing interval.

100. The apparatus of claim 98 wherein said instructions for causing the processor circuit to determine said first chargeable time comprises instructions for producing a remainder value representing a portion of said second billing interval remaining after dividing said second billing interval into a difference between communication session time and said first interval when said communication session time is greater than said communication session time; and instructions for causing the processor circuit to set said first chargeable time to a difference between said communication session time and said remainder when said remainder is greater than zero; and instructions for causing the processor circuit to set said first chargeable time to said communication session time when said remainder is not greater than zero.

101. The apparatus of claim 100 wherein the computer readable medium is further encoded with instructions for causing the processor circuit to determine a second chargeable time in response to said first chargeable time

and said free time value associated with said user of said communications services when said first chargeable time is greater than or equal to said free time value associated with said user of said communications services.

102. The apparatus of claim 101 wherein said instructions for causing the processor circuit to determine said second chargeable time comprises instructions for causing the processor circuit to set said second chargeable time to a difference between said first chargeable time.

103. The apparatus of claim 101 wherein the computer readable medium is further encoded with instructions for causing the processor circuit to reset said free time value associated with the user to zero when said first chargeable time is greater than or equal to said free time value associated with said user of said communications services.

104. The apparatus of claim 102 wherein said instructions for causing the processor circuit to change an account balance associated with the user comprises instructions for causing the processor circuit to calculate a user cost value in response to said second chargeable time and said user cost per unit time.

105. The apparatus of claim 104 wherein the computer readable medium is further encoded with instructions for causing the processor circuit to change a user free cost balance in response to said user cost value.

106. The apparatus of claim 97 wherein the computer readable medium is further encoded with instructions for causing the processor circuit to set said user cost to zero when said first chargeable time is less than said free time value associated with the user. The apparatus of claim 97 wherein the computer readable medium is further encoded with instructions for causing the processor circuit to change a user free time balance in response to said first chargeable time.

Description

Background/ Summary

Background/Summary

-

Drawing Description

Drawing Description

-

Description

Description

(WO2008052340A1)

PRODUCING ROUTING MESSAGES FOR VOICE OVER IP

COMMUNICATIONS

BACKGROUND OF THE INVENTION

1. Field of Invention This invention relates to voice over IP communications and methods and apparatus for routing and billing.

2. Description of Related Art Internet protocol (IP) telephones are typically personal computer (PC) based telephones connected within an IP network, such as the public Internet or a private network of a large organization. These IP telephones have installed "voice-over-IP" (VoIP) software enabling them to make and receive voice calls and send and receive information in data and video formats.

IP telephony switches installed within the IP network enable voice calls to be made within or between IP networks, and between an IP network and a switched circuit network (SCN), such as the public switched telephone network (PSTN). If the IP switch supports the Signaling System 7 (SS7) protocol, the IP telephone can also access PSTN databases.

PETITIONER APPLE INC. EX. 1002-460

The PSTN network typically includes complex network nodes that contain all information about a local calling service area including user authentication and call routing. The PSTN network typically aggregates all information and traffic into a single location or node, processes it locally and then passes it on to other network nodes, as necessary, by maintaining route tables at the node. PSTN nodes are redundant by design and thus provide reliable service, but if a node should fail due to an earthquake or other natural disaster, significant, if not complete service outages can occur, with no other nodes being able to take up the load.

Existing VoIP systems do not allow for high availability and resiliency in delivering Voice Over IP based Session Initiation Protocol (SIP) Protocol service over a geographically dispersed area such as a city, region or continent. Most resiliency originates from the provision of IP based telephone services to one location or a small number of locations such as a single office or network of branch offices.

SUMMARY OF THE INVENTION

In accordance with one aspect of the invention, there is provided a process for operating a call routing controller to facilitate communication between callers and callees in a system comprising a plurality of nodes with which callers and callees are associated. The process involves, in response to initiation of a call by a calling subscriber, receiving a caller identifier and a callee identifier.

The process also involves using call classification criteria associated with the caller identifier to classify the call as a public network call or a private network call. The process further involves producing a routing message identifying an address, on the private network, associated with the callee when the call is classified as a private network call. The process also involves producing a routing message identifying a gateway to the public network when the call is classified as a public network call.

The process may involve receiving a request to establish a call, from a call controller in communication with a caller identified by the callee identifier.

Using the call classification criteria may involve searching a database to locate a record identifying calling attributes associated with a caller identified by the caller identifier.

Locating a record may involve locating a caller dialing profile comprising a username associated with the caller, a domain associated with the caller, and at least one calling attribute.

Using the call classification criteria may involve comparing calling attributes associated with the caller dialing profile with aspects of the callee identifier.

Comparing may involve determining whether the callee identifier includes a portion that matches an IDD associated with the caller dialing profile.

Comparing may involve determining whether the callee identifier includes a portion that matches an NDD associated with the caller dialing profile.

Comparing may involve determining whether the callee identifier includes a portion that matches an area code associated with the caller dialing profile.

Comparing may involve determining whether the callee identifier has a length within a range specified in the caller dialing profile.

The process may involve formatting the callee identifier into a pre-defined digit format to produce a re-formatted callee identifier.

Formatting may involve removing an international dialing digit from the callee identifier, when the callee identifier begins with a digit matching an international dialing digit specified by the caller dialing profile associated with the caller.

Formatting may involve removing a national dialing digit from the callee identifier and prepending a caller country code to the callee identifier when the callee identifier begins with a national dialing digit.

Formatting may involve prepending a caller country code to the callee identifier when the callee identifier begins with digits identifying an area code specified by the caller dialing profile.

Formatting may involve prepending a caller country code and an area code to the callee identifier when the callee identifier has a length that matches a caller dialing number format specified by the caller dialing profile and only one area code is specified as being associated with the caller in the caller dialing profile.

The process may involve classifying the call as a private network call when the re-formatted callee identifier identifies a subscriber to the private network.

The process may involve determining whether the callee identifier complies with a pre-defined username format and if so, classifying the call as a private network call.

The process may involve causing a database of records to be searched to locate a direct in dial (DID) bank table record associating a public telephone number with the reformatted callee identifier and if the DID bank table record is found, classifying the call as a private network call and if a DID bank table record is not found, classifying the call as a public network call.

Producing the routing message identifying a node on the private network may involve setting a callee identifier in response to a username associated with the DID bank table record.

Producing the routing message may involve determining whether a node associated with the reformatted callee identifier is the same as a node associated the caller identifier.

Determining whether a node associated with the reformatted callee identifier is the same as a node associated the caller identifier may involve determining whether a prefix of the re-formatted callee identifier matches a corresponding prefix of a username associated with the caller dialing profile.

When the node associated with the caller is not the same as the node associated with the callee, the process involves producing a routing message including the caller identifier, the reformatted callee identifier and an identification of a private network node associated with the callee and communicating the routing message to a call controller.

When the node associated with the caller is the same as the node associated with the callee, the process involves determining whether to perform at least one of the following: forward the call to another party, block the call and direct the caller to a voicemail server associated with the callee.

Producing the routing message may involve producing a routing message having an identification of at least one of the callee identifier, an identification of a party to whom the call should be forwarded and an identification of a voicemail server associated with the callee.

The process may involve communicating the routing message to a call controller.

Producing a routing message identifying a gateway to the public network may involve searching a database of route records associating route identifiers with dialing codes to find a route record having a dialing code having a number pattern matching at least a portion of the reformatted callee identifier.

The process may involve searching a database of supplier records associating supplier identifiers with the route identifiers to locate at least one supplier record associated with the route identifier associated with the route record having a dialing code having a number pattern matching at least a portion of the reformatted callee identifier.

The process may involve loading a routing message buffer with the reformatted callee identifier and an identification of specific routes associated respective ones of the supplier records associated with the route record and loading the routing message buffer with a time value and a timeout value.

The process may involve communicating a routing message involving the contents of the routing message buffer to a call controller.

The process may involve causing the dialing profile to include a maximum concurrent call value and a concurrent call count value and causing the concurrent call count value to be incremented when the user associated with the dialing profile initiates a call and causing the concurrent call count value to be decremented when a call with the user associated with the dialing profile is ended.

In accordance with another aspect of the invention, there is provided a call routing apparatus for facilitating communications between callers and callees in a system comprising a plurality of nodes with which callers and callees are associated. The apparatus includes receiving provisions for receiving a caller identifier and a callee identifier, in response to initiation of a call by a calling subscriber. The apparatus also includes classifying provisions for classifying the call as a private network call or a public network call according to call classification criteria associated with the caller identifier. The apparatus further includes provisions for producing a routing message identifying an address, on the private network, associated with the callee when the call is classified as a private network call. The apparatus also includes provisions for producing a routing message identifying a gateway to the public network when the call is classified as a public network call.

The receiving provisions may be operably configured to receive a request to establish a call, from a call controller in communication with a caller identified by the callee identifier.

The apparatus may further include searching provisions for searching a database including records associating calling attributes with subscribers to the private network to locate a record identifying calling attributes associated with a caller identified by the caller identifier.

The records may include dialing profiles each including a username associated with the subscriber, an identification of a domain associated with the subscriber, and an identification of at least one calling attribute associated with the subscriber.

The call classification provisions may be operably configured to compare calling attributes associated with the caller dialing profile with aspects of the callee identifier.

The calling attributes may include an international dialing digit and call classification provisions may be operably configured to determine whether the callee identifier includes a portion that matches an IDD associated with the caller dialing profile.

The calling attributes may include an national dialing digit and the call classification provisions may be operably configured to determine whether the callee identifier includes a portion that matches an NDD associated with the caller dialing profile.

The calling attributes may include an area code and the call classification provisions may be operably configured to determine whether the callee identifier includes a portion that matches an area code associated with the caller dialing profile.

The calling attribute may include a number length range and the call classification provisions may be operably configured to determine whether the callee identifier has a length within a number length range specified in the caller dialing profile.

The apparatus may further include formatting provisions for formatting the callee identifier into a pre-defined digit format to produce a re-formatted callee identifier.

The formatting provisions may be operably configured to remove an international dialing digit from the callee identifier, when the callee identifier begins with a digit matching an international dialing digit specified by the caller dialing profile associated with the caller.

The formatting provisions may be operably configured to remove a national dialing digit from the callee identifier and prepend a caller country code to the callee identifier when the callee identifier begins with a national dialing digit.

The formatting provisions may be operably configured to prepend a caller country code to the callee identifier when the callee identifier begins with digits identifying an area code specified by the caller dialing profile.

The formatting provisions may be operably configured to prepend a caller country code and area code to the callee identifier when the callee identifier has a length that matches a caller dialing number format specified by the caller dialing profile and only one area code is specified as being associated with the caller in the caller dialing profile.

The classifying provisions may be operably configured to classify the call as a private network call when the re-formatted callee identifier identifies a subscriber to the private network.

The classifying provisions may be operably configured to classify the call as a private network call when the callee identifier complies with a pre-defined username format.

The apparatus may further include searching provisions for searching a database of records to locate a direct in dial (DID) bank table record associating a public telephone number with the reformatted callee identifier and the classifying provisions may be operably configured to classify the call as a private network call when the DID bank table record is found and to classify the call as a public network call when a DID bank table record is not found. The private network routing message producing provisions may be operably configured to produce a routing message having a callee identifier set according to a username associated with the DID bank table record.

The private network routing message producing provisions may be operably configured to determine whether a node associated with the reformatted callee identifier is the same as a node associated the caller identifier.

The private network routing provisions may include provisions for determining whether a prefix of the re-formatted callee identifier matches a corresponding prefix of a username associated with the caller dialing profile.

The private network routing message producing provisions may be operably configured to produce a routing message including the caller identifier, the reformatted callee identifier and an identification of a private network node associated with the callee and to communicate the routing message to a call controller.

The private network routing message producing provisions may be operably configured to perform at least one of the following forward the call to another party, block the call and direct the caller to a voicemail server associated with the callee, when the node associated with the caller is the same as the node associated with the callee.

The provisions for producing the private network routing message may be operably configured to produce a routing message having an identification of at least one of the callee identifier, an identification of a party to whom the call should be forwarded and an identification of a voicemail server associated with the callee.

The apparatus further includes provisions for communicating the routing message to a call controller.

The provisions for producing a public network routing message identifying a gateway to the public network may include provisions for searching a database of route records associating route identifiers with dialing codes to find a route record having a dialing code having a number pattern matching at least a portion of the reformatted callee identifier.

The apparatus further includes provisions for searching a database of supplier records associating supplier identifiers with the route identifiers to locate at least one supplier record associated with the route identifier associated with the route record having a dialing code having a number pattern matching at least a portion of the reformatted callee identifier.

The apparatus further includes a routing message buffer and provisions for loading the routing message buffer with the reformatted callee identifier and an identification of specific routes associated respective ones of the supplier records associated with the route record and loading the routing message buffer with a time value and a timeout value.

The apparatus further includes provisions for communicating a routing message including the contents of the routing message buffer to a call controller.

The apparatus further includes means for causing said dialing profile to include a maximum concurrent call value and a concurrent call count value and for causing said concurrent call count value to be incremented when the user associated with said dialing profile initiates a call and for causing said concurrent call count value to be decremented when a call with said user associated with said dialing profile is ended.

In accordance with another aspect of the invention, there is provided a data structure for access by an apparatus for producing a routing message for use by a call routing controller in a communications system. The data structure includes dialing profile records comprising fields for associating with respective subscribers to the system, a subscriber user name, direct-in-dial records comprising fields for associating with respective subscriber usernames, a user domain and a direct-in-dial number, prefix to node records comprising fields for associating with at least a portion of the respective subscriber usernames, a node address of a node in the system, whereby a subscriber name can be used to find a user domain, at least a portion of the a subscriber name can be used to find a node with which the subscriber identified by the subscriber name is associated, and a user domain and subscriber name can be located in response to a direct-in-dial number.

In accordance with another aspect of the invention, there is provided a data structure for access by an apparatus for producing a routing message for use by a call routing controller in a communications system. The data structure includes master list records comprising fields for associating a dialing code with respective master list identifiers and supplier list records linked to master list records by the master list identifiers, said supplier list records comprising fields for associating with a communications services supplier, a supplier id, a master list id, a route identifier and a billing rate code, whereby communications services suppliers are associated with dialing codes, such that dialing codes can be used to locate suppliers capable of providing a communications link associated with a given dialing code.

In accordance with another aspect of the invention, there is provided a method for determining a time to permit a communication session to be conducted. The method involves calculating a cost per unit time, calculating a first time value as a sum of a free time attributed to a participant in the communication session and the quotient of a funds balance held by the participant to the cost per unit time value and producing a second time value in response to the first time value and a billing pattern associated with the participant, the billing pattern including first and second billing intervals and the second time value being the time to permit a communication session to be conducted.

Calculating the first time value may involve retrieving a record associated with the participant and obtaining from the record at least one of the free time and the funds balance.

Producing the second time value may involve producing a remainder value representing a portion of the second billing interval remaining after dividing the second billing interval into a difference between the first time value and the first billing interval.

Producing the second time value may involve setting a difference between the first time value and the remainder as the second time value.

The method may further involve setting the second time value to zero when the remainder is greater than zero and the first time value is less than the free time associated with the participant.

Calculating the cost per unit time may involve locating a record in a database, the record comprising a markup type indicator, a markup value and a billing pattern and setting a reseller rate equal to the sum of the markup value and the buffer rate.

Locating the record in a database may involve locating at least one of a record associated with a reseller and a route associated with the reseller, a record associated with the reseller and a default reseller markup record.

Calculating the cost per unit time value further may involve locating at least one of an override record specifying a route cost per unit time amount associated with a route associated with the communication session, a reseller record associated with a reseller of the communications session, the reseller record specifying a reseller cost per unit time associated with the reseller for the communication session, a default operator markup record specifying a default cost per unit time.

The method may further involve setting as the cost per unit time the sum of the reseller rate and at least one of the route cost per unit time, the reseller cost per unit time and the default cost per unit time.

The method may further involve receiving a communication session time representing a duration of the communication session and incrementing a reseller balance by the product of the reseller rate and the communication session time.

The method may further involve receiving a communication session time representing a duration of the communication session and incrementing a system operator balance by a product of the buffer rate and the communication session time.

In accordance with another aspect of the invention, there is provided an apparatus for determining a time to permit a communication session to be conducted. The apparatus includes a processor circuit, a computer readable medium coupled to the processor circuit and encoded with instructions for directing the processor circuit to calculate a cost per unit time for the communication session, calculate a first time value as a sum of a free time attributed to a participant in the communication session and the quotient of a funds balance held by the participant to the cost per unit time value and produce a second time value in response to the first time value and a billing pattern associated with the participant, the billing pattern including first and second billing intervals and the second time value being the time to permit a communication session to be conducted.

The instructions may include instructions for directing the processor circuit to retrieve a record associated with the participant and obtain from the record at least one of the free time and the funds balance.

The instructions may include instructions for directing the processor circuit to produce the second time value by producing a remainder value representing a portion of the second billing interval remaining after dividing the second billing interval into a difference between the first time value and the first billing interval.

The instructions may include instructions for directing the processor circuit to produce the second time value comprises setting a difference between the first time value and the remainder as the second time value.

The instructions may include instructions for directing the processor circuit to set the second time value to zero when the remainder is greater than zero and the first time value is less than the free time associated with the participant.

The instructions for directing the processor circuit to calculate the cost per unit time may include instructions for directing the processor circuit to locate a record in a database, the record comprising a markup type indicator, a markup value and a billing pattern and set a reseller rate equal to the sum of the markup value and the buffer rate.

The instructions for directing the processor circuit to locate the record in a database may include instructions for directing the processor circuit to locate at least one of a record associated with a reseller and a route associated with the reseller, a record associated with the reseller, and a default reseller markup record. The instructions for directing the processor circuit to calculate the cost per unit time value may further include instructions for directing the processor circuit to locate at least one of an override record specifying a route cost per unit time amount associated with a route associated with the communication session, a reseller record associated with a reseller of the communications session, the reseller record specifying a reseller cost per unit time associated with the reseller for the communication session, a default operator markup record specifying a default cost per unit time.

The instructions may include instructions for directing the processor circuit to set as the cost per unit time the sum of the reseller rate and at least one of the route cost per unit time, the reseller cost per unit time and the default cost per unit time.

The instructions may include instructions for directing the processor circuit to receive a communication session time representing a duration of the communication session and increment a reseller balance by the product of the reseller rate and the communication session time.

The instructions may include instructions for directing the processor circuit to receive a communication session time representing a duration of the communication session and increment a system operator balance by a product of the buffer rate and the communication session time.

In accordance with another aspect of the invention, there is provided a process for attributing charges for communications services. The process involves determining a first chargeable time in response to a communication session time and a pre-defined billing pattern, determining a user cost value in response to the first chargeable time and a free time value associated with a user of the communications services, charging an

account balance associated with the user in response to a user cost per unit time. The process may further involve changing an account balance associated with a reseller of the communications services in response to a reseller cost per unit time and the communication session time and changing an account balance associated with an operator of the communications services in response to an operator cost per unit time and the communication session time.

Determining the first chargeable time may involve locating at least one of an override record specifying a route cost per unit time and billing pattern associated with a route associated with the communication session, a reseller record associated with a reseller of the communications session, the reseller record specifying a reseller cost per unit time and billing pattern associated with the reseller for the communication session and a default record specifying a default cost per unit time and billing pattern and setting as the pre-defined billing pattern the billing pattern of the record located. The billing pattern of the record located may involve a first billing interval and a second billing interval.

Determining the first chargeable time may involve setting the first chargeable time equal to the first billing interval when the communication session time is less than or equal to the first billing interval.

Determining the first chargeable time may involve producing a remainder value representing a portion of the second billing interval remaining after dividing the second billing interval into a difference between communication session time and the first interval when the communication session time is greater than the communication session time and setting the first chargeable time to a difference between the communication session time and the remainder when the remainder is greater than zero and setting the first chargeable time to the communication session time when the remainder is not greater than zero.

The process may further involve determining a second chargeable time in response to the first chargeable time and the free time value associated with the user of the communications services when the first chargeable time is greater than or equal to the free time value associated with the user of the communications services.

Determining the second chargeable time may involve setting the second chargeable time to a difference between the first chargeable time.

The process may further involve resetting the free time value associated with the user to zero when the first chargeable time is greater than or equal to the free time value associated with the user of the communications services.

Changing an account balance associated with the user may involve calculating a user cost value in response to the second chargeable time and the user cost per unit time.

The process may further involve changing a user free cost balance in response to the user cost value.

The process may further involve setting the user cost to zero when the first chargeable time is less than the free time value associated with the user.

The process may further involve changing a user free time balance in response to the first chargeable time.

In accordance with another aspect of the invention, there is provided an apparatus for attributing charges for communications services. The apparatus includes a processor circuit, a computer readable medium in communication with the processor circuit and encoded with instructions for directing the processor circuit to determine a first chargeable time in response to a communication session time and a pre-defined billing pattern, determine a user cost value in response to the first chargeable time and a free time value associated with a user of the communications services, change an account balance associated with the user in response to a user cost per unit time.

The instructions may further include instructions for changing an account balance associated with a reseller of the communications services in response to a reseller cost per unit time and the communication session time and changing an account balance associated with an operator of the communications services in response to an operator cost per unit time and the communication session time.

The instructions for directing the processor circuit to determine the first chargeable time may further include instructions for causing the processor circuit to communicate with a database to locate at least one of an override record specifying a route cost per unit time and billing pattern associated with a route associated with the communication session, a reseller record associated with a reseller of the communications session, the reseller record specifying a reseller cost per unit time and billing pattern associated with the reseller for the communication session and a default record specifying a default cost per unit time and billing pattern and instructions for setting as the pre-defined billing pattern the billing pattern of the record located. The billing pattern of the record located may include a first billing interval and a second billing interval.

The instructions for causing the processor circuit to determine the first chargeable time may include instructions for directing the processor circuit to set the first chargeable time equal to the first billing interval when the communication session time is less than or equal to the first billing interval.

The instructions for causing the processor circuit to determine the first chargeable time may include instructions for producing a remainder value representing a portion of the second billing interval remaining after dividing the second billing interval into a difference between communication session time and the first interval when the communication session time is greater than the communication session time and instructions for causing the processor circuit to set the first chargeable time to a difference between the communication session time and the remainder when the remainder is greater than zero and instructions for causing the processor circuit to set the first chargeable time to the communication session time when the remainder is not greater than zero.

The instructions may further include instructions for causing the processor circuit to determine a second chargeable time in response to the first chargeable time and the free time value associated with the user of the communications services when the first chargeable time is greater than or equal to the free time value associated with the user of the communications services.

The instructions for causing the processor circuit to determine the second chargeable time may include instructions for causing the processor circuit to set the second chargeable time to a difference between the first chargeable time.

The instructions may further include instructions for causing the processor circuit to reset the free time value associated with the user to zero when the first chargeable time is greater than or equal to the free time value associated with the user of the communications services.

The instructions for causing the processor circuit to change an account balance associated with the user may include instructions for causing the processor circuit to calculate a user cost value in response to the second chargeable time and the user cost per unit time.

The instructions may further include instructions for causing the processor circuit to change a user free cost balance in response to the user cost value.

The instructions may further include instructions for causing the processor circuit to set the user cost to zero when the first chargeable time is less than the free time value associated with the user.

The instructions may further include instructions for causing the processor circuit to change a user free time balance in response to the first chargeable time.

In accordance with another aspect of the invention, there is provided a computer readable medium encoded with codes for directing a processor circuit to execute one or more of the methods described above and/or variants thereof.

Other aspects and features of the present invention will become apparent to those ordinarily skilled in the art upon review of the following description of specific embodiments of the invention in conjunction with the accompanying figures.

BRIEF DESCRIPTION OF THE DRAWINGS

In drawings which illustrate embodiments of the invention, Figure 1 is a block diagram of a system according to a first embodiment of the invention; Figure 2 is a block diagram of a caller telephone according to the first embodiment of the invention; Figure 3 is a schematic representation of a SIP invite message transmitted between the caller telephone and a controller shown in Figure 1; Figure 4 is a block diagram of a call controller shown in Figure 1; Figure 5 is a flowchart of a process executed by the call controller shown in Figure 1; Figure 6 is a schematic representation of a routing, billing and rating (RC) request message produced by the call controller shown in Figure 1; Figure 7 is a block diagram of a processor circuit of a routing, billing, rating element of the system shown in Figure 1; Figures 8A-8D is a flowchart of a RC request message handler executed by the RC processor circuit shown in Figure 7; Figure 9 is a tabular representation of a dialing profile stored in a database accessible by the RC shown in Figure 1; Figure 10 is a tabular representation of a dialing profile for a caller using the caller telephone shown in Figure 1; Figure 11 is a tabular representation of a callee profile for a callee located in Calgary; Figure 12 is a tabular representation of a callee profile for a callee located in London; Figure 13 is a tabular representation of a Direct-in-Dial (DID) bank table record stored in the database shown in Figure 1; Figure 14 is a tabular representation of an exemplary DID bank table record for the Calgary callee referenced in Figure 11; Figure 15 is a tabular representation of a routing message transmitted from the RC to the call controller shown in Figure 1; Figure 16 is a schematic representation of a routing message buffer holding a routing message for routing a call to the Calgary callee referenced in Figure 11; Figure 17 is a tabular representation of a prefix to supernode table record stored in the database shown in Figure 1; Figure 18 is a tabular representation of a prefix to supernode table record that would be used for the Calgary callee referenced in Figure 11; Figure 19 is a tabular representation of a master list record stored in a master list table in the database shown in Figure 1; Figure 20 is a tabular representation of a populated master list record; Figure 21 is a tabular representation of a suppliers list record stored in the database shown in Figure 1; Figure 22 is a tabular representation of a specific supplier list record for a first supplier; Figure 23 is a tabular representation of a specific supplier list record for a second supplier; Figure 24 is a tabular representation of a specific supplier list record for a third supplier; Figure 25 is a schematic representation of a routing message, held in a routing message buffer, identifying to the controller a plurality of possible suppliers that may carry the

call; Figure 26 is a tabular representation of a call block table record; Figure 27 is a tabular representation of a call block table record for the Calgary callee; Figure 28 is a tabular representation of a call forwarding table record; Figure 29 is a tabular representation of a call forwarding table record specific for the Calgary callee; Figure 30 is a tabular representation of a voicemail table record specifying voicemail parameters to enable the caller to leave a voicemail message for the callee; Figure 31 is a tabular representation of a voicemail table record specific to the Calgary callee; Figure 32 is a schematic representation of an exemplary routing message, held in a routing message buffer, indicating call forwarding numbers and a voicemail server identifier; Figures 33A and 33B are respective portions of a flowchart of a process executed by the RC processor for determining a time to live value; Figure 34 is a tabular representation of a subscriber bundle table record; Figure 35 is a tabular representation of a subscriber bundle record for the Vancouver caller; Figure 36 is a tabular representation of a bundle override table record; Figure 37 is a tabular representation of bundle override record for a located master list ID; Figure 38 is a tabular representation of a subscriber account table record; Figure 39 is a tabular representation of a subscriber account record for the Vancouver caller; Figure 40 is a flowchart of a process for producing a second time value executed by the RC processor circuit shown in Figure 7; Figure 41 is a flowchart for calculating a call cost per unit time; Figure 42 is a tabular representation of a system operator special rates table record; Figure 43 is a tabular representation of a system operator special rates table record for a reseller named Klondike; Figure 44 is a tabular representation of a system operator mark-up table record; Figure 45 is a tabular representation of a system operator mark-up table record for the reseller Klondike; Figure 46 is a tabular representation of a default system operator mark-up table record; Figure 47 is a tabular representation of a reseller special destinations table record; Figure 48 is a tabular representation of a reseller special destinations table record for the reseller Klondike; Figure 49 is a tabular representation of a reseller global mark-up table record; Figure 50 is a tabular representation of a reseller global mark-up table record for the reseller Klondike; Figure 51 is a tabular representation of a SIP bye message transmitted from either of the telephones shown in Figure 1 to the call controller; Figure 52 is a tabular representation of a SIP bye message sent to the controller from the Calgary callee; Figure 53 is a flowchart of a process executed by the call controller for producing an RC stop message in response to receipt of a SIP bye message; Figure 54 is a tabular representation of an exemplary RC call stop message; Figure 55 is a tabular representation of an RC call stop message for the Calgary callee; Figures 56A and 56B are respective portions of a flowchart of a RC call stop message handling routine executed by the RC shown in Figure 1; Figure 57 is a tabular representation of a reseller accounts table record; Figure 58 is a tabular representation of a reseller accounts table record for the reseller Klondike; Figure 59 is a tabular representation of a system operator accounts table record; and Figure 60 is a tabular representation of a system operator accounts record for the system operator described herein.

DETAILED DESCRIPTION

Referring to Figure 1, a system for making voice over IP telephone/videophone calls is shown generally at 10. The system includes a first super node shown generally at 11 and a second super node shown generally at 2 1. The first super node 11 is located in geographical area, such as Vancouver, B.C., Canada for example and the second super node 2 1 is located in London, England, for example. Different super nodes may be located in different geographical regions throughout the world to provide telephone/videophone service to subscribers in respective regions. These super nodes may be in communication with each other by high speed/ high data throughput links including optical fiber, satellite and/or cable links, forming a backbone to the system. These super nodes may alternatively or, in addition, be in communication with each other through conventional internet services.

In the embodiment shown, the Vancouver supernode 11 provides telephone/videophone service to western Canadian customers from Vancouver Island to Ontario. Another node (not shown) may be located in Eastern Canada to provide services to subscribers in that area.

Other nodes of the type shown may also be employed within the geographical area serviced by a supernode, to provide for call load sharing, for example within a region of the geographical area serviced by the supernode. However, in general, all nodes are similar and have the properties described below in connection with the Vancouver supernode 11.

In this embodiment, the Vancouver supernode includes a call controller (C) 14, a routing controller (RC) 16, a database 18 and a voicemail server 19 and a media relay 9. Each of these may be implemented as separate modules on a common computer system or by separate computers, for example. The voicemail server 19 need not be included in the node and can be provided by an outside service provider.

Subscribers such as a subscriber in Vancouver and a subscriber in Calgary communicate with the Vancouver supernode using their own internet service providers which route internet traffic from these subscribers over the internet shown generally at 13 in Figure 1. To these subscribers the Vancouver supernode is accessible at a pre-determined internet protocol (IP) address or a fully qualified domain name that can be accessed in the usual way through a subscriber's internet service provider. The subscriber in Vancouver uses a telephone 12 that is capable of communicating with the Vancouver supernode 11 using Session Initiation Protocol (SIP) messages and the Calgary subscriber uses a similar telephone 15, in Calgary AB.

It should be noted that throughout the description of the embodiments of this invention, the IP/UDP addresses of all elements such as the caller and callee telephones, call controller, media relay, and any others, will be assumed to be valid IP/UDP addresses directly accessible via the Internet or a private IP network, for example,

depending on the specific implementation of the system. As such, it will be assumed, for example, that the caller and callee telephones will have IP/UDP addresses directly accessible by the call controllers and the media relays on their respective supernodes, and those addresses will not be obscured by Network Address Translation (NAT) or similar mechanisms. In other words, the IP/UDP information contained in SIP messages (for example the SIP Invite message or the RC Request message which will be described below) will match the IP/UDP addresses of the IP packets carrying these SIP messages.

It will be appreciated that in many situations, the IP addresses assigned to various elements of the system may be in a private IP address space, and thus not directly accessible from other elements. Furthermore, it will also be appreciated that NAT is commonly used to share a "public" IP address between multiple devices, for example between home PCs and IP telephones sharing a single Internet connection. For example, a home PC may be assigned an IP address such as 192.168.0.101 and a Voice over IP telephone may be assigned an IP address of 192.168.0.103. These addresses are located in so called "non-routable" (IP) address space and cannot be accessed directly from the Internet. In order for these devices to communicate with other computers located on the Internet, these IP addresses have to be converted into a "public" IP address, for example 24.10.10.123 assigned by the Internet Service Provider to the subscriber, by a device performing NAT, typically a home router. In addition to translating the IP addresses, NAT typically also translates UDP port numbers, for example an audio path originating at a VoIP telephone and using a UDP port 12378 at its private IP address, may have been translated to a UDP port 23465 associated with the public IP address of the NAT device. In other words, when a packet originating from the above VoIP telephone arrives at an Internet-based supernode, the source IP/UDP address contained in the IP packet header will be 24.10.10.1 :23465, whereas the source IP/UDP address information contained in the SIP message inside this IP packet will be 192.168.0.103:12378. The mismatch in the IP/UDP addresses may cause a problem for SIP-based VoIP systems because, for example, a supernode will attempt to send messages to a private address of a telephone but the messages will never get there.

Referring to Figure 1, in an attempt to make a call by the Vancouver telephone/videophone 12 to the Calgary telephone/videophone 15, the Vancouver telephone/videophone sends a SIP invite message to the Vancouver supernode 11 and in response, the call controller 14 sends an RC request message to the RC 16 which makes various enquiries of the database 18 to produce a routing message which is sent back to the call controller 14. The call controller 14 then communicates with the media relay 9 to cause a communications link including an audio path and a videophone (if a videopath call) to be established through the media relay to the same node, a different node or to a communications supplier gateway as shown generally at 20 to carry audio, and where applicable, video traffic to the call recipient or callee.

Generally, the RC 16 executes a process to facilitate communication between callers and callees. The process involves, in response to initiation of a call by a calling subscriber, receiving a callee identifier from the calling subscriber, using call classification criteria associated with the calling subscriber to classify the call as a public network call or a private network call and producing a routing message identifying an address on the private network, associated with the callee when the call is classified as a private network call and producing a routing message identifying a gateway to the public network when the call is classified as a public network call.

Subscriber Telephone In greater detail, referring to Figure 2, in this embodiment, the telephone/videophone 12 includes a processor circuit shown generally at 30 comprising a microprocessor 32, program memory 34, an input/output (I/O) port 36, parameter memory 38 and temporary memory 40. The program memory 34, I/O port 36, parameter memory 38 and temporary memory 40 are all in communication with the microprocessor 32. The I/O port 36 has a dial input 42 for receiving a dialled telephone/videophone number from a keypad, for example, or from a voice recognition unit or from pre-stored telephone/videophone numbers stored in the parameter memory 38, for example. For simplicity, in Figure 2 a box labelled dialing functions 44 represents any device capable of informing the microprocessor 32 of a callee identifier, e.g., a callee telephone/videophone number.

The processor 32 stores the callee identifier in a dialled number buffer 45. In this case, assume the dialled number is 2001 1050 2222 and that it is a number associated with the Calgary subscriber. The I/O port 36 also has a handset interface 46 for receiving and producing signals from and to a handset that the user may place to his ear. This interface 46 may include a BLUETOOTH™ wireless interface, a wired interface or speaker phone, for example. The handset acts as a termination point for an audio path (not shown) which will be appreciated later. The I/O port 36 also has an internet connection 48 which is preferably a high speed internet connection and is operable to connect the telephone/videophone to an internet service provider.

The internet connection 48 also acts as a part of the voice path, as will be appreciated later. It will be appreciated that where the subscriber device is a videophone, a separate video path is established in the same way an audio path is established. For simplicity, the following description refers to a telephone call, but it is to be understood that a videophone call is handled similarly, with the call controller causing the media relay to facilitate both an audio path and a video path instead of only an audio path.

The parameter memory 38 has a username field 50, a password field 52 an IP address field 53 and a SIP proxy address field 54, for example. The user name field 50 is operable to hold a user name, which in this case is 2001 1050 8667. The user name is assigned upon subscription or registration into the system and, in this embodiment, includes a twelve digit number having a continent code 61, a country code 63, a dealer code 70 and a unique number code 74. The continent code 61 is comprised of the first or felt-most digit of the user name

in this embodiment. The country code 63 is comprised of the next three digits. The dealer code 70 is comprised of the next four digits and the unique number code 74 is comprised of the last four digits. The password field 52 holds a password of up to 512 characters, in this example. The IP address field 53 stores an IP address of the telephone, which for this explanation is 192.168.0.20. The SIP proxy address field 54 holds an IP protocol compatible proxy address which may be provided to the telephone through the internet connection 48 as part of a registration procedure.

The program memory 34 stores blocks of codes for directing the processor 32 to carry out the functions of the telephone, one of which includes a firewall block 56 which provides firewall functions to the telephone, to prevent access by unauthorized persons to the microprocessor 32 and memories 34, 38 and 40 through the internet connection 48. The program memory 34 also stores codes 57 for establishing a call ID. The call ID codes 57 direct the processor 32 to produce a call identifier having a format comprising a hexadecimal string at an IP address, the IP address being the IP address of the telephone. Thus, an exemplary call identifier might be FF10@1 92.1 68.0.20.

Generally, in response to picking up the handset interface 46 and activating a dialing function 44, the microprocessor 32 produces and sends a SIP invite message as shown in Figure 3, to the routing controller 16 shown in Figure 1.

This SIP invite message is essentially to initiate a call by a calling subscriber.

Referring to Figure 3, the SIP invite message includes a caller ID field 60, a callee identifier field 62, a digest parameters field 64, a call ID field 65 an IP address field 67 and a caller UDP port field 69. In this embodiment, the caller ID field 60 includes the user name 2001 1050 8667 that is the Vancouver user name stored in the user name field 50 of the parameter memory 38 in the telephone 12 shown in Figure 2. In addition, referring back to Figure 3, the callee identifier field 62 includes a callee identifier which in this embodiment is the user name 2001 1050 2222 that is the dialled number of the Calgary subscriber stored in the dialled number buffer 45 shown in Figure 2. The digest parameters field 64 includes digest parameters and the call ID field 65 includes a code comprising a generated prefix code (FF10) and a suffix which is the Internet Protocol (IP) address of the telephone 12 stored in the IP address field 53 of the telephone. The IP address field 67 holds the IP address assigned to the telephone, in this embodiment 192.168.0.20, and the caller UDP port field 69 includes a UDP port identifier identifying a UDP port at which the audio path will be terminated at the caller's telephone.

Call Controller Referring to Figure 4, a call controller circuit of the call controller 14 (Figure 1) is shown in greater detail at 100. The call controller circuit 100 includes a microprocessor 102, program memory 104 and an I/O port 106. The circuit 100 may include a plurality of microprocessors, a plurality of program memories and a plurality of I/O ports to be able to handle a large volume of calls. However, for simplicity, the call controller circuit 100 will be described as having only one microprocessor 102, program memory 104 and I/O port 106, it being understood that there may be more.

Generally, the I/O port 106 includes an input 108 for receiving messages such as the SIP invite message shown in Figure 3, from the telephone shown in Figure 2. The I/O port 106 also has an RC request message output 110 for transmitting an RC request message to the RC 16 of Figure 1, an RC message input 112 for receiving routing messages from the RC 16, a gateway output 114 for transmitting messages to one of the gateways 20 shown in Figure 1 to advise the gateway to establish an audio path, for example, and a gateway input 116 for receiving messages from the gateway. The I/O port 106 further includes a SIP output 118 for transmitting messages to the telephone 12 to advise the telephone of the IP addresses of the gateways which will establish the audio path. The I/O port 106 further includes a voicemail server input and output 117, 119 respectively for communicating with the voicemail server 19 shown in Figure 1.

While certain inputs and outputs have been shown as separate, it will be appreciated that some may be a single IP address and IP port. For example, the messages sent to the RC 16 and received from the RC 16 may be transmitted and received on the same single IP port.

The program memory 104 includes blocks of code for directing the microprocessor 102 to carry out various functions of the call controller 14. For example, these blocks of code include a first block 120 for causing the call controller circuit 100 to execute a SIP invite to RC request process to produce an RC request message in response to a received SIP invite message. In addition, there is a routing message to gateway message block 122 which causes the call controller circuit 100 to produce a gateway query message in response to a received routing message from the RC 16.

Referring to Figure 5, the SIP invite to RC request process is shown in more detail at 120. On receipt of a SIP invite message of the type shown in Figure 3, block 122 of Figure 5 directs the call controller circuit 100 of Figure 4 to authenticate the user. This may be done, for example, by prompting the user for a password, by sending a message back to the telephone 12 which is interpreted at the telephone as a request for a password entry or the password may automatically be sent to the call controller 14 from the telephone, in response to the message. The call controller 14 may then make enquiries of databases to which it has access, to determine whether or not the user's password matches a password stored in the database. Various functions may be used to pass encryption keys or hash codes back and forth to ensure that the transmittal of passwords is secure.

Should the authentication process fail, the call controller circuit 100 is directed to an error handling routine 124 which causes messages to be displayed at the telephone 12 to indicate there was an authentication problem. If the authentication procedure is passed, block 121 directs the call controller circuit 100 to determine whether or not the contents of the caller ID field 60 of the SIP invite message received from the telephone is an IP address. If it is an IP address, then block 123 directs the call controller circuit 100 to set the contents of a type field variable maintained by the microprocessor 102 to a code representing that the call type is a third party invite. If at block 121 the caller ID field contents do not identify an IP address, then block 125 directs the microprocessor to set the contents of the type field to a code indicating that the call is being made by a system subscriber. Then, block 126 directs the call controller circuit to read the call identifier 65 provided in the SIP invite message from the telephone 12, and at block 128 the processor is directed to produce an RC request message that includes that call ID. Block 129 then directs the call controller circuit 100 to send the RC request to the RC 16.

Referring to Figure 6, an RC request message is shown generally at 150 and includes a caller field 152, a callee field 154, a digest field 156, a call ID field 158 and a type field 160. The caller, callee, digest call ID fields 152, 154, 156 and 158 contain copies of the caller, callee, digest parameters and call ID fields 60, 62, 64 and 65 of the SIP invite message shown in Figure 3. The type field 160 contains the type code established at blocks 123 or 125 of Figure 5 to indicate whether the call is from a third party or system subscriber, respectively. The caller identifier field may include a PSTN number or a system subscriber username as shown, for example.

Routing Controller (RC) Referring to Figure 7, the RC 16 is shown in greater detail and includes an RC processor circuit shown generally at 200. The RC processor circuit 200 includes a processor 202, program memory 204, a table memory 206, buffer memory 207, and an I/O port 208, all in communication with the processor 202. (As earlier indicated, there may be a plurality of processor circuits (202), memories (204), etc.) The buffer memory 207 includes a caller id buffer 209 and a callee id buffer 211.

The I/O port 208 includes a database request port 210 through which a request to the database (18 shown in Figure 1) can be made and includes a database response port 212 for receiving a reply from the database 18. The I/O port 208 further includes an RC request message input 214 for receiving the RC request message from the call controller (14 shown in Figure 1) and includes a routing message output 216 for sending a routing message back to the call controller 14. The I/O port 208 thus acts to receive caller identifier and a callee identifier contained in the RC request message from the call controller, the RC request message being received in response to initiation of a call by a calling subscriber.

The program memory 204 includes blocks of codes for directing the processor 202 to carry out various functions of the RC (16). One of these blocks includes an RC request message handler 250 which directs the RC to produce a routing message in response to a received RC request message.

The RC request message handler process is shown in greater detail at 250 in Figures 8A through 8D.

RC Request Message Handler Referring to Figure 8A, the RC request message handler begins with a first block 252 that directs the RC processor circuit (200) to store the contents of the RC request message (150) in buffers in the buffer memory 207 of Figure 7, one of which includes the caller ID buffer 209 of Figure 7 for separately storing the contents of the callee field 154 of the RC request message. Block 254 then directs the RC processor circuit to use the contents of the caller field 152 in the RC request message shown in Figure 6, to locate and retrieve from the database 18 a record associating calling attributes with the calling subscriber. The located record may be referred to as a dialing profile for the caller. The retrieved dialing profile may then be stored in the buffer memory 207, for example.

Referring to Figure 9, an exemplary data structure for a dialing profile is shown generally at 253 and includes a user name field 258, a domain field 260, and calling attributes comprising a national dialing digits (NDD) field 262, an international dialing digits (IDD) field 264, a country code field 266, a local area codes field 267, a caller minimum local length field 268, a caller maximum local length field 270, a reseller field 273, a maximum number of concurrent calls field 275 and a current number of concurrent calls field 277.

Effectively the dialing profile is a record identifying calling attributes of the caller identified by the caller identifier. More generally, dialing profiles represent calling attributes of respective subscribers.

An exemplary caller profile for the Vancouver subscriber is shown generally at 276 in Figure 10 and indicates that the user name field 258 includes the user name (2001 1050 8667) that has been assigned to the subscriber and is stored in the user name field 50 in the telephone as shown in Figure 2.

Referring back to Figure 10, the domain field 260 includes a domain name as shown at 282, including a node type identifier 284, a location code identifier 286, a system provider identifier 288 and a domain portion 290. The domain field 260 effectively identifies a domain or node associated with the user identified by the contents of the user name field 258.

In this embodiment, the node type identifier 284 includes the code "sp" identifying a supernode and the location identifier 286 identifies the supernode as being in Vancouver (YVR). The system provider identifier 288 identifies the company supplying the service and the domain portion 290 identifies the "com" domain.

The national dialled digit field 262 in this embodiment includes the digit "1" and, in general, includes a number specified by the International Telecommunications Union (ITU) Telecommunications Standardization Sector (ITU-T) E. 164 Recommendation which assigns national dialing digits to countries.

The international dialing digit field 264 includes a code also assigned according to the ITU-T according to the country or location of the user.

The country code field 266 also includes the digit "1" and, in general, includes a number assigned according to the ITU-T to represent the country in which the user is located.

The local area codes field 267 includes a list of area codes that have been assigned by the ITU-T to the geographical area in which the subscriber is located. The caller minimum and maximum local number length fields 268 and 270 hold numbers representing minimum and maximum local number lengths permitted in the area code(s) specified by the contents of the local area codes field 267. The reseller field 273 is optional and holds a code identifying a retailer of the services, in this embodiment "Klondike". The maximum number of concurrent calls field 275 holds a code identifying the maximum number of concurrent calls that the user is entitled to cause to concurrently exist. This permits more than one call to occur concurrently while all calls for the user are billed to the same account. The current number of concurrent calls field 277 is initially 0 and is incremented each time a concurrent call associated with the user is initiated and is decremented when a concurrent call is terminated.

The area codes associated with the user are the area codes associated with the location code identifier 286 of the contents of the domain field 260.

A dialing profile of the type shown in Figure 9 is produced whenever a user registers with the system or agrees to become a subscriber to the system.

Thus, for example, a user wishing to subscribe to the system may contact an office maintained by a system operator and personnel in the office may ask the user certain questions about his location and service preferences, whereupon tables can be used to provide office personnel with appropriate information to be entered into the user name 258, domain 260, NDD 262, IDD 264, country code 266, local area codes 267, caller minimum and maximum local length fields 268 and 270 reseller field 273 and concurrent call fields 275 and 277 to establish a dialing profile for the user.

Referring to Figures 11 and 12, callee dialing profiles for users in Calgary and London, respectively for example, are shown.

In addition to creating dialing profiles when a user registers with the system, a direct-in-dial (DID) record of the type shown at 278 in Figure 13 is added to a direct-in-dial bank table in the database (18 in Figure 1) to associate the username and a host name of the supemode with which the user is associated, with an E.164 number associated with the user on the PSTN network.

An exemplary DID table record entry for the Calgary callee is shown generally at 300 in Figure 14. The user name field 281 and user domain field 272 are analogous to the user name and user domain fields 258 and 260 of the caller dialing profile shown in Figure 10. The contents of the DID field 274 include a E.164 public telephone number including a country code 283, an area code 285, an exchange code 287 and a number 289. If the user has multiple telephone numbers, then multiple records of the type shown at 300 would be included in the DID bank table, each having the same user name and user domain, but different DID field 274 contents reflecting the different telephone numbers associated with that user.

In addition to creating dialing profiles as shown in Figure 9 and DID records as shown in Figure 13 when a user registers with the system, call blocking records of the type shown in Figure 26, call forwarding records of the type shown in Figure 28 and voicemail records of the type shown in Figure 30 may be added to the database 18 when a new subscriber is added to the system.

Referring back to Figure 8A, after retrieving a dialing profile for the caller, such as shown at 276 in Figure 10, the RC processor circuit 200 is directed to block 256 which directs the processor circuit (200) to determine whether the contents of the concurrent call field 277 are less than the contents of the maximum concurrent call field 275 of the dialing profile for the caller and, if so, block 271 directs the processor circuit to increment the contents of the concurrent call field 277. If the contents of concurrent call field 277 are equal to or greater than the contents of the maximum concurrent call field 275, block 259 directs the processor circuit 200 to send an error message back to the call controller (14) to cause the call controller to notify the caller that the maximum number of concurrent calls has been reached and no further calls can exist concurrently, including the presently requested call.

Assuming block 256 allows the call to proceed, the RC processor circuit 200 is directed to perform certain checks on the callee identifier provided by the contents of the callee field 154 in Figure 6, of the RC request message 150.

These checks are shown in greater detail in Figure 8B.

Referring to Figure 8B, the processor (202 in Figure 7) is directed to a first block 257 that causes it to determine whether a digit pattern of the callee identifier (154) provided in the RC request message (150) includes a pattern that matches the contents of the international dialing digits (IDD) field 264 in the caller profile shown in Figure 10. If so, then block 259 directs the processor (202) to set a call type code identifier variable maintained by the processor to indicate that the call is an international call and block 261 directs the processor to produce a reformatted callee identifier by reformatting the callee identifier into a predefined digit format. In this embodiment, this is done by removing the pattern of digits matching the IDD field contents 264 of the caller dialing profile to effectively shorten the callee identifier. Then, block 263 directs the processor 202 to determine whether or not the callee identifier has a length which meets criteria establishing it as a number compliant with the E.164 Standard set by the ITU. If the length does not meet this criteria, block 265 directs the processor 202 to send back to the call controller (14) a message indicating the length is not correct. The process is then ended. At the call controller 14, routines (not shown) stored in the program memory 104 may direct the processor (102 of Figure 4) to respond to the incorrect length message by transmitting a message back to the telephone (12 shown in Figure 1) to indicate that an invalid number has been dialed.

Still referring to Figure 8B, if the length of the amended callee identifier meets the criteria set forth at block 263, block 269 directs the processor (202 of Figure 7) to make a database request to determine whether or not the amended callee identifier is found in a record in the direct-in-dial bank (DID) table. Referring back to Figure 8B, at block 269, if the processor 202 receives a response from the database indicating that the reformatted callee identifier produced at block 261 is found in a record in the DID bank table, then the callee is a subscriber to the system and the call is classified as a private network call by directing the processor to block 279 which directs the processor to copy the contents of the corresponding user name field (281 in Figure 14) from the callee DID bank table record (300 in Figure 14) into the callee ID buffer (211 in Figure 7). Thus, the processor 202 locates a subscriber user name associated with the reformatted callee identifier. The processor 202 is then directed to point B in Figure 8A.

Subscriber to Subscriber Calls Between Different Nodes Referring to Figure 8A, block 280 directs the processor (202 of Figure 7) to execute a process to determine whether or not the node associated with the reformatted callee identifier is the same node that is associated with the caller identifier. To do this, the processor 202 determines whether or not a prefix (e.g., continent code 61) of the callee name held in the callee ID buffer (211 in Figure 7), is the same as the corresponding prefix of the caller name held in the username field 258 of the caller dialing profile shown in Figure 10. If the corresponding prefixes are not the same, block 302 in Figure 8A directs the processor (202 in Figure 7) to set a call type flag in the buffer memory (207 in Figure 7) to indicate the call is a cross-domain call. Then, block 350 of Figure 8A directs the processor (202 of Figure 7) to produce a routing message identifying an address on the private network with which the callee identified by the contents of the callee ID buffer is associated and to set a time to live for the call at a maximum value of 99999, for example.

Thus the routing message includes a caller identifier, a call identifier set according to a username associated with the located DID bank table record and includes an identifier of a node on the private network with which the callee is associated.

The node in the system with which the callee is associated is determined by using the callee identifier to address a supernode table having records of the type as shown at 370 in Figure 17. Each record 370 has a prefix field 372 and a supernode address field 374. The prefix field 372 includes the first n digits of the callee identifier. In this embodiment n=2. The supernode address field 374 holds a code representing the IP address or a fully qualified domain name of the node associated with the code stored in the callee identifier prefix field 372. Referring to Figure 18, for example, if the prefix is 20, the supernode address associated with that prefix is sp.yvr.digifonica.com.

Referring to Figure 15, a generic routing message is shown generally at 352 and includes an optional supplier prefix field 354, and optional delimiter field 356, a callee user name field 358, at least one route field 360, a time to live field 362 and other fields 364. The optional supplier prefix field 354 holds a code for identifying supplier traffic. The optional delimiter field 356 holds a symbol that delimits the supplier prefix code from the callee user name field 358. In this embodiment, the symbol is a number sign (#). The route field 360 holds a domain name or IP address of a gateway or node that is to carry the call, and the time to live field 362 holds a value representing the number of seconds the call is permitted to be active, based on subscriber available minutes and other billing parameters.

Referring to Figure 8A and Figure 16, an example of a routing message produced by the processor at block 350 for a caller associated with a different node than the caller is shown generally at 366 and includes only a callee field 359, a route field 361 and a time to live field 362.

Referring to Figure 8A, having produced a routing message as shown in Figure 16, block 381 directs the processor (202 of Figure 7) to send the routing message shown in Figure 16 to the call controller 14 shown in Figure 1.

Referring back to Figure 8B, if at block 257, the callee identifier stored in the callee id buffer (211 in Figure 7) does not begin with an international dialing digit, block 380 directs the processor (202) to determine whether or not the callee identifier begins with the same national dialing code as assigned to the caller. To do this, the

processor (202) is directed to refer to the retrieved caller dialing profile as shown in Figure 10. In Figure 10, the national dialing digit code 262 is the number 1. Thus, if the callee identifier begins with the number 1, then the processor (202) is directed to block 382 in Figure 8B.

Block 382 directs the processor (202 of Figure 7) to examine the callee identifier to determine whether or not the digits following the NDD digit identify an area code that is the same as any of the area codes identified in the local area codes field 267 of the caller dialing profile 276 shown in Figure 10. If not, block 384 of Figure 8B directs the processor 202 to set the call type flag to indicate that the call is a national call. If the digits following the NDD digit identify an area code that is the same as a local area code associated with the caller as indicated by the caller dialing profile, block 386 directs the processor 202 to set the call type flag to indicate a local call, national style.

After executing blocks 384 or 386, block 388 directs the processor 202 to format the callee identifier into a pre-defined digit format to produce a re-formatted callee identifier by removing the national dialled digit and prepending a caller country code identified by the country code field 266 of the caller dialing profile shown in Figure 10. The processor (202) is then directed to block 263 of Figure 8B to perform other processing as already described above.

If at block 380, the callee identifier does not begin with a national dialled digit, block 390 directs the processor (202) to determine whether the callee identifier begins with digits that identify the same area code as the caller.

Again, the reference for this is the retrieved caller dialing profile shown in Figure 10. The processor (202) determines whether or not the first few digits of the callee identifier identify an area code corresponding to the local area code field 267 of the retrieved caller dialing profile. If so, then block 392 directs the processor 202 to set the call type flag to indicate that the call is a local call and block 394 directs the processor (202) to format the callee identifier into a pre-defined digit format to produce a reformatted callee identifier by prepending the caller country code to the callee identifier, the caller country code being determined from the country code field 266 of the retrieved caller dialing profile shown in Figure 10. The processor (202) is then directed to block 263 for further processing as described above.

Referring back to Figure 8B, at block 390, the callee identifier does not start with the same area code as the caller, block 396 directs the processor (202 of Figure 7) to determine whether the number of digits in the callee identifier, i.e.

the length of the callee identifier, is within the range of digits indicated by the caller minimum local number length field 268 and the caller maximum local number length field 270 of the retrieved caller dialing profile shown in Figure 10. If so, then block 398 directs the processor (202) to set the call type flag to indicate a local call and block 400 directs the processor (202) to format the callee identifier into a pre-defined digit format to produce a reformatted callee identifier by prepending to the callee identifier the caller country code (as indicated by the country code field 266 of the retrieved caller dialing profile shown in Figure 10) followed by the caller area code (as indicated by the local area code field 267 of the caller profile shown in Figure 10). The processor (202) is then directed to block 263 of Figure 8B for further processing as described above.

Referring back to Figure 8B, if at block 396, the callee identifier has a length that does not fall within the range specified by the caller minimum local number length field (268 in Figure 10) and the caller maximum local number length field (270 in Figure 10), block 402 directs the processor 202 of Figure 7 to determine whether or not the callee identifier identifies a valid user name.

To do this, the processor 202 searches through the database (18 of Figure 10 of dialing profiles to find a dialing profile having user name field contents (258 in Figure 10) that match the callee identifier. If no match is found, block 404 directs the processor (202) to send an error message back to the call controller (14). If at block 402, a dialing profile having a user name field 258 that matches the callee identifier is found, block 406 directs the processor 202 to set the call type flag to indicate that the call is a private network call and then the processor is directed to block 280 of Figure 8A. Thus, the call is classified as a private network call when the callee identifier identifies a subscriber to the private network.

From Figure 8B, it will be appreciated that there are certain groups of blocks of codes that direct the processor 202 in Figure 7 to determine whether the callee identifier has certain features such as an international dialing digit, a national dialing digit, an area code and a length that meet certain criteria, and cause the processor 202 to reformat the callee identifier stored in the callee id buffer 211, as necessary into a predetermined target format including only a country code, area code, and a normal telephone number, for example, to cause the callee identifier to be compatible with the E.164 number plan standard in this embodiment. This enables block 269 in Figure 8B to have a consistent format of callee identifiers for use in searching through the DID bank table records of the type shown in Figure 13 to determine how to route calls for subscriber to subscriber calls on the same system. Effectively, therefore blocks 257, 380, 390, 396 and 402 establish call classification criteria for classifying the call as a public network call or a private network call.

Block 269 classifies the call, depending on whether or not the formatted callee identifier has a DID bank table record and this depends on how the call classification criteria are met and block 402 directs the processor 202 of Figure 7 to classify the call as a private network call if the callee identifier complies with a pre-defined

format, i.e. is a valid user name and identifies a subscriber to the private network, after the callee identifier has been subjected to the classification criteria of blocks 257, 380, 390 and 396.

Subscriber to Non-Subscriber Calls Not all calls will be subscriber to subscriber calls and this will be detected by the processor 202 of Figure 7 when it executes block 269 in Figure 8B, and does not find a DID bank table record that is associated with the callee, in the DID bank table. When this occurs, the call is classified as a public network call by directing the processor 202 to block 408 of Figure 8B which causes it to set the contents of the callee id buffer 211 of Figure 7 equal to the newly formatted callee identifier, i.e., a number compatible with the E.164 standard.

Then, block 410 of Figure 8B directs the processor (202) to search a database of route or master list records associating route identifiers with dialing codes shown in Figure 19 to locate a router having a dialing code having a number pattern matching at least a portion of the reformatted callee identifier.

Referring to Figure 19, a data structure for a master list or route list record is shown. Each master list record includes a master list ID field 500, a dialing code field 502, a country code field 504, a national sign number field 506, a minimum length field 508, a maximum length field 510, a national dialled digit field 512, an international dialled digit field 514 and a buffer rate field 516.

The master list ID field 500 holds a unique code such as 1019, for example, identifying the record. The dialing code field 502 holds a predetermined number pattern that the processor 202 of Figure 7 uses at block 410 in Figure 8B to find the master list record having a dialing code matching the first few digits of the amended callee identifier stored in the callee id buffer 211. The country code field 504 holds a number representing the country code associated with the record and the national sign number field 506 holds a number representing the area code associated with the record. (It will be observed that the dialing code is a combination of the contents of the country code field 504 and the national sign number field 506.) The minimum length field 508 holds a number representing the minimum length of digits associated with the record and the maximum length field 510 holds a number representing the maximum number of digits in a number with which the record may be compared. The national dialled digit (NDD) field 512 holds a number representing an access code used to make a call within the country specified by the country code, and the international dialled digit (IDD) field 514 holds a number representing the international prefix needed to dial a call from the country indicated by the country code.

Thus, for example, a master list record may have a format as shown in Figure 20 with exemplary field contents as shown.

Referring back to Figure 8B, using the country code and area code portions of the reformatted callee identifier stored in the callee id buffer 211, block 410 directs the processor 202 of Figure 7 to find a master list record such as the one shown in Figure 20 having a dialing code that matches the country code (1) and area code (604) of the callee identifier. Thus, in this example, the processor (202) would find a master list record having an ID field containing the number 1019. This number may be referred to as a route ID. Thus, a route ID number is found in the master list record associated with a predetermined number pattern in the reformatted callee identifier.

After executing block 410 in Figure 8B, the process continues as shown in Figure 8D. Referring to Figure 8D, block 412 directs the processor 202 of Figure 7 to use the route ID number to search a database of supplier records associating supplier identifiers with route identifiers to locate at least one supplier record associated with the route identifier to identify at least one supplier operable to supply a communications link for the route.

Referring to Figure 21, a data structure for a supplier list record is shown.

Supplier list records include a supplier ID field 540, a master list ID field 542, an optional prefix field 544, a specific route identifier field 546, a NDD/IDD rewrite field 548, a rate field 550, and a timeout field 551. The supplier ID field 540 holds a code identifying the name of the supplier and the master list ID field 542 holds a code for associating the supplier record with a master list record. The prefix field 544 holds a string used to identify the supplier traffic and the specific route identifier field 546 holds an IP address of a gateway operated by the supplier indicated by the supplier ID field 540. The NDD/IDD rewrite field 548 holds a code representing a rewritten value of the NDD/IDD associated with this route for this supplier, and the rate field 550 holds a code indicating the cost per second to the system operator to use the route provided by the gateway specified by the contents of the route identifier field 546. The timeout field 551 holds a code indicating a time that the call controller should wait for a response from the associated gateway before giving up and trying the next gateway. This time value may be in seconds, for example. Exemplary supplier records are shown in Figures 22, 23 and 24 for the exemplary suppliers shown at 20 in Figure 1, namely Telus, Shaw and Sprint.

Referring back to Figure 8D, at block 412 the processor 202 finds all supplier records that identify the master list ID found at block 410 of Figure 8B.

Referring back to Figure 8D, block 560 directs the processor 202 of Figure 7 to begin to produce a routing message of the type shown in Figure 15. To do this, the processor 202 loads a routing message buffer as shown in Figure 25 with a supplier prefix of the least costly supplier where the least costly supplier is determined from the rate fields 550 of Figure 21 of the records associated with respective suppliers.

Referring to Figures 22-24, in the embodiment shown, the supplier "Telus" has the lowest number in the rate field 550 and therefore the prefix 4973 associated with that supplier is loaded into the routing message buffer shown in Figure 25 first.

Block 562 in Figure 8D directs the processor to delimit the prefix 4973 by the number sign (#) and to next load the reformatted callee identifier into the routing message buffer shown in Figure 25. At block 563 of Figure 8D, the contents of the route identifier field 546 of Figure 21 of the record associated with the supplier "Telus" are added by the processor 202 of Figure 7 to the routing message buffer shown in Figure 25 after an @ sign delimiter, and then block 564 in Figure 8D directs the processor to get a time to live value, which in one embodiment may be 3600 seconds, for example. Block 566 then directs the processor 202 to load this time to live value and the timeout value (551) in Figure 21 in the routing message buffer of Figure 25. Accordingly, a first part of the routing message for the Telus gateway is shown generally at 570 in Figure 25.

Referring back to Figure 8D, block 571 directs the processor 202 back to block 560 and causes it to repeat blocks 560, 562, 563, 564 and 566 for each successive supplier until the routing message buffer is loaded with information pertaining to each supplier identified by the processor at block 412. Thus, a second portion of the routing message as shown at 572 in Figure 25 relates to the second supplier identified by the record shown in Figure 23. Referring back to Figure 25, a third portion of the routing message as shown at 574 and is associated with a third supplier as indicated by the supplier record shown in Figure 24.

Consequently, referring to Figure 25, the routing message buffer holds a routing message identifying a plurality of different suppliers able to provide gateways to the public telephone network (i.e. specific routes) to establish at least part of a communication link through which the caller may contact the callee. In this embodiment, each of the suppliers is identified, in succession, according to rate. Other criteria for determining the order in which suppliers are listed in the routing message may include preferred supplier priorities which may be established based on service agreements, for example.

Referring back to Figure 8D, block 568 directs the processor 202 of Figure 7 to send the routing message shown in Figure 25 to the call controller 14 in Figure 1.

Subscriber to Subscriber Calls Within the Same Node Referring back to Figure 8A, if at block 280, the callee identifier received in the RC request message has a prefix that identifies the same node as that associated with the caller, block 600 directs the processor 202 to use the callee identifier in the callee id buffer 211 to locate and retrieve a dialing profile for the callee. The dialing profile may be of the type shown in Figure 11 or 12, for example. Block 602 of Figure 8A then directs the processor 202 of Figure 7 to get call block, call forward and voicemail records from the database 18 of Figure 1 based on the user name identified in the callee dialing profile retrieved by the processor at block 600. Call block, call forward and voicemail records may be as shown in Figures 26, 27, 28 and 30 for example.

Referring to Figure 26, the call block records include a user name field 604 and a block pattern field 606. The user name field holds a user name corresponding to the user name in the user name field (258 in Figure 10) of the callee profile and the block pattern field 606 holds one or more E.164-compatible numbers or user names identifying PSTN numbers or system subscribers from whom the subscriber identified in the user name field 604 does not wish to receive calls.

Referring to Figure 8A and Figure 27, block 608 directs the processor 202 of Figure 7 to determine whether or not the caller identifier received in the RC request message matches a block pattern stored in the block pattern field 606 of the call block record associated with the callee identified by the contents of the user name field 604 in Figure 26. If the caller identifier matches a block pattern, block 610 directs the processor to send a drop call or non-completion message to the call controller (14) and the process is ended. If the caller identifier does not match a block pattern associated with the callee, block 609 directs the processor to store the username and domain of the callee, as determined from the callee dialing profile, and a time to live value in the routing message buffer as shown at 650 in Figure 32. Referring back to Figure 8A, block 612 then directs the processor 202 to determine whether or not call forwarding is required.

Referring to Figure 28, the call forwarding records include a user name field 614, a destination number field 616, and a sequence number field 618. The user name field 614 stores a code representing a user with which the record is associated. The destination number field 616 holds a user name representing a number to which the current call should be forwarded, and the sequence number field 618 holds an integer number indicating the order in which the user name associated with the corresponding destination number field 616 should be attempted for call forwarding. The call forwarding table may have a plurality of records for a given user. The processor 202 of Figure 7 uses the contents of the sequence number field 618 to place the records for a given user in order. As will be appreciated below, this enables the call forwarding numbers to be tried in an ordered sequence.

Referring to Figure 8A and Figure 29, if at block 612, the call forwarding record for the callee identified by the callee identifier contains no contents in the destination number field 616 and accordingly no contents in the sequence number field 618, there are no call forwarding entries for this callee, and the processor 202 is directed to block 620 in Figure 8C. If there are entries in the call forwarding table 27, block 622 in Figure 8A directs the processor 202 to search the dialing profile table to find a dialing profile record as shown in Figure 10B-476 user

identified by the destination number field 616 of the call forward record shown in Figure 28. The processor 202 of Figure 7 is further directed to store the username and domain for that user and a time to live value in the routing message buffer as shown at 652 in Figure 32, to produce a routing message as illustrated. This process is repeated for each call forwarding record associated with the callee identified by the callee id buffer 211 in Figure 7 to add to the routing message buffer all call forwarding usernames and domains associated with the callee.

Referring back to Figure 8A, if at block 612 there are no call forwarding records, then at block 620 in Figure 8C the processor 202 is directed to determine whether or not the user identified by the callee identifier has paid for voicemail service. This is done by checking to see whether or not a flag is set in a voicemail record of the type shown in Figure 30 in a voicemail table stored in the database 18 shown in Figure 1.

Referring to Figure 30, voicemail records in this embodiment may include a user name field 624, a voicemail server field 626, a seconds to voicemail field 628 and an enable field 630. The user name field 624 stores the user name of the callee. The voicemail server field 626 holds a code identifying a domain name of a voicemail server associated with the user identified by the user name field 624. The seconds to voicemail field 628 holds a code identifying the time to wait before engaging voicemail, and the enable field 630 holds a code representing whether or not voicemail is enabled for the user. Referring back to Figure 8C, at block 620 if the processor 202 of Figure 7 finds a voicemail record as shown in Figure 30 having user name field 624 contents matching the callee identifier, the processor is directed to examine the contents of the enable field 630 to determine whether or not voicemail is enabled. If voicemail is enabled, then block 640 in Figure 8C directs the processor 202 to Figure 7 to store the contents of the voicemail server field 626 and the contents of the seconds to voicemail field 628 in the routing message buffer, as shown at 654 in Figure 32. Block 642 then directs the processor 202 to get time to live values for each path specified by the routing message according to the cost of routing and the user's balance. These time to live values are then appended to corresponding paths already stored in the routing message buffer.

Referring back to Figure 8C, block 644 then directs the processor 202 of Figure 7 to store the IP address of the current node in the routing message buffer as shown at 656 in Figure 32. Block 646 then directs the processor 202 to send the routing message shown in Figure 32 to the call controller 14 in Figure 1. Thus in the embodiment described the routing controller will produce a routing message that will cause at least one of the following: forward the call to another party, block the call and direct the caller to a voicemail server.

Referring back to Figure 1, the routing message whether of the type shown in Figures 16, 25 or 32, is received at the call controller 14 and the call controller interprets the receipt of the routing message as a request to establish a call.

Referring to Figure 4, the program memory 104 of the call controller 14 includes a routing to gateway routine depicted generally at 122.

Where a routing message of the type shown in Figure 32 is received by the call controller 14, the routing to gateway routine 122 shown in Figure 4 may direct the processor 102 cause a message to be sent back through the internet 13 shown in Figure 1 to the callee telephone 15, knowing the IP address of the callee telephone 15 from the user name.

Alternatively, if the routing message is of the type shown in Figure 16, which identifies a domain associated with another node in the system, the call controller may send a SIP invite message along the high speed backbone 17 connected to the other node. The other node functions as explained above, in response to receipt of a SIP invite message.

If the routing message is of the type shown in Figure 25 where there are a plurality of gateway suppliers available, the call controller sends a SIP invite message to the first supplier, in this case Telus, using a dedicated line or an internet connection to determine whether or not Telus is able to handle the call. If the Telus gateway returns a message indicating it is not able to handle the call, the call controller 14 then proceeds to send a SIP invite message to the next supplier, in this case Shaw. The process is repeated until one of the suppliers responds indicating that it is available to carry the call. Once a supplier responds indicating that it is able to carry the call, the supplier sends back to the call controller 14 an IP address for a gateway provided by the supplier through which the call or audio path of the call will be carried. This IP address is sent in a message from the call controller 14 to the media relay 9 which responds with a message indicating an IP address to which the caller telephone should send its audio/video, traffic and an IP address to which the gateway should send its audio/video for the call. The call controller conveys the IP address at which the media relay expects to receive audio/video from the caller telephone, to the caller telephone 12 in a message. The caller telephone replies to the call controller with an IP address at which it would like to receive audio/video and the call controller conveys that IP address to the media relay. The call may then be conducted between the caller and callee through the media relay and gateway.

Referring back to Figure 1, if the call controller 14 receives a routing message of the type shown in Figure 32, and which has at least one call forwarding number and/or a voicemail number, the call controller attempts to establish a call to the callee telephone 15 by seeking from the callee telephone a message indicating an IP address to which the media relay should send audio/video. The call controller 14 receives from the callee

telephone, no call is established. If no call is established within a pre-determined time, the call controller 14 attempts to establish a call with the next user identified in the call routing message in the same manner. This process is repeated until all call forwarding possibilities have been exhausted, in which case the call controller communicates with the voicemail server 19 identified in the routing message to obtain an IP address to which the media relay should send audio/video and the remainder of the process mentioned above for establishing IP addresses at the media relay 9 and the caller telephone is carried out to establish audio/video paths to allowing the caller to leave a voicemail message with the voicemail server.

When an audio/video path through the media relay is established, a call timer maintained by the call controller 14 logs the start date and time of the call and logs the call ID and an identification of the route (i.e., audio/video path IP address) for later use in billing.

Time to Live Referring to Figures 33A and 33B, a process for determining a time to live value for any of blocks 642 in Figure 8C, 350 in Figure 8A or 564 in Figure 8D above is described. The process is executed by the processor 202 shown in Figure 7. Generally, the process involves calculating a cost per unit time, calculating a first time value as a sum of a free time attributed to a participant in the communication session and the quotient of a funds balance held by the participant to the cost per unit time value and producing a second time value in response to the first time value and a billing pattern associated with the participant, the billing pattern including first and second billing intervals and the second time value being the time to permit a communication session to be conducted.

Referring to Figure 33A, in this embodiment, the process begins with a first block 700 that directs the RC processor to determine whether or not the call type set at block 302 in Figure 8A indicates the call is a network or cross-domain call. If the call is a network or cross-domain call, block 702 of Figure 33A directs the RC processor to set the time to live equal to 99999 and the process is ended. Thus, the network or cross-domain call type has a long time to live. If at block 700 the call type is determined not to be a network or cross-domain type, block 704 directs the RC processor to get a subscriber bundle table record from the database 18 in Figure 1 and store it locally in the subscriber bundle record buffer at the RC 14.

Referring to Figure 34, a subscriber bundle table record is shown generally at 706. The record includes a user name field 708 and a services field 710. The user name field 708 holds a code identifying the subscriber user name and the services field 710 holds codes identifying service features assigned to the subscriber, such as free local calling, call blocking and voicemail, for example.

Figure 35 shows an exemplary subscriber bundle record for the Vancouver caller. In this record the user name field 708 is loaded with the user name 2001 1050 8667 and the services field 710 is loaded with codes 10, 14 and 16 corresponding to free local calling, call blocking and voicemail, respectively.

Thus, user 2001 1050 8667 has free local calling, call blocking and voicemail features.

Referring back to Figure 33A, after having loaded a subscriber bundle record into the subscriber bundle record buffer, block 712 directs the RC processor to search the database (18) determine whether or not there is a bundle override table record for the master list ID value that was determined at block 410 in Figure 8B. An exemplary bundle override table record is shown at 714 in Figure 36. The bundle table record includes a master list ID field 716, an override type field 718, an override value field 720 a first interval field 722 and a second interval field 724. The master list ID field 716 holds a master list ID code. The override type field 718 holds an override type code indicating a fixed, percent or cent amount to indicate the amount by which a fee will be increased. The override value field 720 holds a real number representing the value of the override type. The first interval field 722 holds a value indicating the minimum number of seconds for a first level of charging and the second interval field 724 holds a number representing a second level of charging.

Referring to Figure 37, a bundle override record for the located master list ID code is shown generally at 726 and includes a master list ID field 716 holding the code 1019 which was the code located in block 410 of Figure 8B. The override type field 718 includes a code indicating the override type is a percentage value and the override value field 720 holds the value 10.0 indicating that the override will be 10.0% of the charged value. The first interval field 722 holds a value representing 30 seconds and the second interval field 724 holds a value representing 6 seconds. The 30 second value in the first interval field 722 indicates that charges for the route will be made at a first rate for 30 seconds and thereafter the charges will be made at a different rate in increments of 6 seconds, as indicated by the contents of the second interval field 724.

Referring back to Figure 33A, if at block 712 the processor finds a bundle override record of the type shown in Figure 37, block 728 directs the processor to store the bundle override record in local memory. In the embodiment shown, the bundle override record shown in Figure 37 is stored in the bundle override record buffer at the RC as shown in Figure 7. Still referring to Figure 33A, block 730 then directs the RC processor to determine whether or not the subscriber bundle table record 706 in Figure 35 has a services field including a code identifying that the user is entitled to free local calling and also directs the processor to determine whether or not the call type is not a cross domain cell, i.e. it is a local or local/national style. If both of these conditions are satisfied, block 732 directs the processor to set the time to live equal to 99999, giving the user a long period of time for the call. The process is then ended. If the conditions associated with block 730 are not satisfied, block 734 of Figure 33B directs the RC processor to retrieve a subscriber account record associated with a

participant in the call. This is done by copying and storing in the subscriber account record buffer a subscriber account record for the caller.

Referring to Figure 38, an exemplary subscriber account table record is shown generally at 736. The record includes a user name field 738, a funds balance field 740 and a free time field 742. The user name field 738 holds a subscriber user name, the funds balance field 740 holds a real number representing the dollar value of credit available to the subscriber and the free time field 742 holds an integer representing the number of free seconds that the user is entitled to.

An exemplary subscriber account record for the Vancouver caller is shown generally at 744 in Figure 39, wherein the user name field 738 holds the user name 2001 1050 8667, the funds balance field 740 holds the value \$10.00, and the free time field 742 holds the value 100. The funds balance field holding the value of \$10.00 indicates the user has \$10.00 worth of credit and the free time field having the value of 100 indicates that the user has a balance of 100 free seconds of call time.

Referring back to Figure 33B, after copying and storing the subscriber account record shown in Figure 39 from the database to the subscriber account record buffer RC, block 746 directs the processor to determine whether or not the subscriber account record funds balance field 740 or free time field 742 are greater than zero. If they are not greater than zero, block 748 directs the processor to set the time to live equal to zero and the process is ended. The RC then sends a message back to the call controller to cause the call controller to deny the call to the caller. If the conditions associated with block 746 are satisfied, block 750 directs the processor to calculate the call cost per unit time. A procedure for calculating the call cost per unit time is described below in connection with Figure 41.

Assuming the procedure for calculating the cost per second returns a number representing the call cost per second, block 752 directs the processor 202 in Figure 7 to determine whether or not the cost per second is equal to zero. If so, block 754 directs the processor to set the time to live to 99999 to give the caller a very long length of call and the process is ended.

If at block 752 the call cost per second is not equal to zero, block 756 directs the processor 202 in Figure 7 to calculate a first time to live value as a sum of a free time attributed to the participant in the communication session and the quotient of the funds balance held by the participant to the cost per unit time value. To do this, the processor 202 of Figure 7 is directed to set a first time value or temporary time to live value equal to the sum of the free time provided in the free time field 742 of the subscriber account record shown in Figure 39 and the quotient of the contents of the funds balance field 740 in the subscriber account record for the call shown in Figure 39 and the cost per second determined at block 750 of Figure 33B. Thus, for example, if at block 750 the cost per second is determined to be three cents per second and the funds balance field holds the value \$10.00, the quotient of the funds balance and cost per second is 333 seconds and this is added to the contents of the free time field 742, which is 100, resulting in a time to live of 433 seconds.

Block 758 then directs the RC processor to produce a second time value in response to the first time value and the billing pattern associated with the participant as established by the bundle override record shown in Figure 37.

This process is shown in greater detail at 760 in Figure 40 and generally involves producing a remainder value representing a portion of the second billing interval remaining after dividing the second billing interval into a difference between the first time value and the first billing interval.

Referring to Figure 40, the process for producing the second time value begins with a first block 762 that directs the processor 202 in Figure 7 to set a remainder value equal to the difference between the time to live value calculated at block 756 in Figure 33B and the contents of the first interval field 722 of the record shown in Figure 37, multiplied by the modulus of the contents of the second interval field 724 of Figure 37. Thus, in the example given, the difference between the time to live field and the first interval field is 433 minus 30, which is 403 and therefore the remainder produced by the mod of 403 divided by 6 is 0.17. Block 764 then directs the processor to determine whether or not this remainder value is greater than zero and, if so, block 766 directs the processor to subtract the remainder from the first time value and set the difference as the second time value. To do this the processor is directed to set the time to live value equal to the current time to live of 403 minus the remainder of 1, i.e., 402 seconds. The processor is then returned back to block 758 of Figure 33B.

Referring back to Figure 40, if at block 764 the remainder is not greater than zero, block 768 directs the processor 202 of Figure 7 to determine whether or not the time to live is less than the contents of the first interval field 722 in the record shown in Figure 37. If so, then block 770 of Figure 40 directs the processor to set the time to live equal to zero. Thus, the second time value is set to zero when the remainder is greater than zero and the first time value is less than the free time associated with the participant in the call. If at block 768 the conditions of that block are not satisfied, the processor returns the first time to live value as the second time to live value.

Thus, referring to Figure 33B, after having produced a second time to live value, block 772 directs the processor to set the time to live value for use in blocks 342, 350 or 564.

Cost per Second Referring back to Figure 33B, at block 750 it was explained that a call cost per unit time is calculated. The following explains how that call cost per unit time value is calculated.

Referring to Figure 41, a process for calculating a cost per unit time is shown generally at 780. The process is executed by the processor 202 in Figure 7 and generally involves locating a record in a database, the record comprising a markup type indicator, a markup value and a billing pattern and setting a reseller rate equal to the sum of the markup value and the buffer rate, locating at least one of an override record specifying a route cost per unit time amount associated with a route associated with the communication session, a reseller record associated with a reseller of the communications session, the reseller record specifying a reseller cost per unit time associated with the reseller for the communication session and a default operator markup record specifying a default cost per unit time and setting as the cost per unit time the sum of the reseller rate and at least one of the route cost per unit time, the reseller cost per unit time and the default cost per unit time.

The process begins with a first set of blocks 782, 802 and 820 which direct the processor 202 in Figure 7 to locate at least one of a record associated with a reseller and a route associated with the reseller, a record associated with the reseller, and a default reseller mark-up record. Block 782, in particular, directs the processor to address the database 18 to look for a record associated with a reseller and a route with the reseller by looking for a special rate record based on the master list ID established at block 410 in Figure 8C.

Referring to Figure 42, a system operator special rate table record is shown generally at 784. The record includes a reseller field 786, a master list ID field 788, a mark-up type field 790, a mark-up value field 792, a first interval field 794 and a second interval field 796. The reseller field 786 holds a reseller ID code and the master list ID field 788 holds a master list ID code. The mark-up type field 790 holds a mark-up type such as fixed percent or cents and the mark-up value field 792 holds a real number representing the value corresponding to the mark-up type. The first interval field 794 holds a number representing a first level of charging and the second interval field 796 holds a number representing a second level of charging.

An exemplary system operator special rate table for a reseller known as "Klondike" is shown at 798 in Figure 43. In this record, the reseller field 786 holds a code indicating the retailer ID is Klondike, the master list ID field 788 holds the code 1019 to associate the record with the master list ID code 1019.

The mark-up type field 790 holds a code indicating the mark-up type is cents and the mark-up value field 792 holds a mark-up value indicating 1/10 of one cent. The first interval field 794 holds the value 30 and the second interval field 796 holds the value 6, these two fields indicating that the operator allows 30 seconds for free and then billing is done in increments of 6 seconds after that.

Referring back to Figure 41, if at block 782 a record such as the one shown in Figure 43 is located in the system operator special rates table, the processor is directed to block 800 in Figure 41. If such a record is not found in the system operator special rates table, block 802 directs the processor to address the database 18 to look in a system operator mark-up table for a mark-up record associated with the reseller.

Referring to Figure 44, an exemplary system operator mark-up table record is shown generally at 804. The record includes a reseller field 806, a mark-up type field 808, a mark-up value field 810, a first interval field 812 and a second interval field 814. The reseller mark-up type, mark-up value, first interval and second interval fields are as described in connection with the fields by the same names in the system operator special rates table shown in Figure 42.

Figure 45 provides an exemplary system operator mark-up table record for the reseller known as Klondike and therefore the reseller field 806 holds the value "Klondike", the mark-up type field 808 holds the value cents, the mark-up value field holds the value 0.01, the first interval field 812 holds the value 30 and the second interval field 814 holds the value 6. This indicates that the reseller "Klondike" charges by the cent at a rate of one cent per minute. The first 30 seconds of the call are free and billing is charged at the rate of one cent per minute in increments of 6 seconds.

Figure 46 provides an exemplary system operator mark-up table record for cases where no specific system operator mark-up table record exists for a particular reseller, i.e., a default reseller mark-up record. This record is similar to the record shown in Figure 45 and the reseller field 806 holds the value "all", the mark-up type field 808 is loaded with a code indicating mark-up is based on a percentage, the mark-up value field 810 holds the percentage by which the cost is marked up, and the first and second interval fields 812 and 814 identify first and second billing levels.

Referring back to Figure 41, if at block 802 a specific mark-up record for the reseller identified at block 782 is not located, block 820 directs the processor to get the mark-up record shown in Figure 46, having the "all" code in the reseller field 806. The processor is then directed to block 800.

Referring back to Figure 41, at block 800, the processor 202 of Figure 7 is directed to set a reseller rate equal to the sum of the mark-up value of the record located by blocks 782, 802 or 820 and the buffer rate specified by the contents of the buffer rate field 516 of the master list record shown in Figure 20. To do this, the RC processor sets a variable entitled "reseller cost per second" to a value equal to the sum of the contents of the mark-up value field (792, 810) of the associated record, plus the contents of the buffer rate field (516) from the

master list record associated with the master list ID. Then, block 822 directs the processor to set a system operator cost per second variable equal to the contents of the buffer rate field (516) from the master list record. Block 824 then directs the processor to determine whether the call type flag indicates the call is local or national/local style and whether the caller has free local calling. If both these conditions are met, then block 826 sets the user cost per second variable equal to zero and sets two increment variables equal to one, for use in later processing. The cost per second has thus be calculated and the process shown in Figure 4 1 is ended.

If at block 824 the conditions of that block are not met, the processor 202 of Figure 7 is directed to locate at least one of a bundle override table record specifying a route cost per unit time associated with a route associated with the communication session, a reseller special destinations table record associated with a reseller of the communications session, the reseller record specifying a reseller cost per unit time associated with the reseller for the communication session and a default reseller global markup record specifying a default cost per unit time.

To do this block 828 directs the processor 202 of Figure 7 to determine whether or not the bundle override record 726 in Figure 37 located at block 712 in Figure 33A has a master list ID equal to the stored master list ID that was determined at block 410 in Figure 8B. If not, block 830 directs the processor to find a reseller special destinations table record in a reseller special destinations table in the database (18), having a master list ID code equal to the master list ID code of the master list ID that was determined at block 410 in Figure 8B. An exemplary reseller special destinations table record is shown in Figure 47 at 832. The reseller special destinations table record includes a reseller field 834, a master list ID field 836, a mark-up type field 838, a mark-up value field 840, a first interval field 842 and a second interval field 844. This record has the same format as the system operator special rates table record shown in Figure 42, but is stored in a different table to allow for different mark-up types and values and time intervals to be set according to resellers' preferences. Thus, for example, an exemplary reseller special destinations table record for the reseller "Klondike" is shown at 846 in Figure 48. The reseller field 834 holds a value indicating the reseller as the reseller "Klondike" and the master list ID field holds the code 1019. The mark-up type field 838 holds a code indicating the mark-up type is percent and the mark-up value field 840 holds a number representing the mark-up value as 5%. The first and second interval fields identify different billing levels used as described earlier.

Referring back to Figure 4 1, the record shown in Figure 48 may be located at block 830, for example. If at block 830 such a record is not found, then block 832 directs the processor to get a default operator global mark-up record based on the reseller ID.

Referring to Figure 49, an exemplary default reseller global mark-up table record is shown generally at 848. This record includes a reseller field 850, a mark-up type field 852, a mark-up value field 854, a first interval field 856 and a second interval field 858. The reseller field 850 holds a code identifying the reseller. The mark-up type field 852, the mark-up value field 854 and the first and second interval fields 856 and 858 are of the same type as described in connection with fields of the same name in Figure 47, for example. The contents of the fields of this record 860 may be set according to system operator preferences, for example.

Referring to Figure 50, an exemplary reseller global mark-up table record is shown generally at 860. In this record, the reseller field 850 holds a code indicating the reseller is "Klondike", the mark-up type field 852 holds a code indicating the mark-up type is percent, the mark-up value field 854 holds a value representing 10% as the mark-up value, the first interval field 856 holds the value 30 and the second interval field 858 holds the values 30 and 6 respectively to indicate the first 30 seconds are free and billing is to be done in 6 second increments after that.

Referring back to Figure 4 1, should the processor get to block 832, the reseller global mark-up table record as shown in Figure 50 is retrieved from the database and stored locally at the RC. As seen in Figure 4 1, it will be appreciated that if the conditions are met in blocks 828 or 830, or if the processor executes block 832, the processor is then directed to block 862 which causes it to set an override value equal to the contents of the mark-up value field of the located record, to set the first increment variable equal to the contents of the first interval field of the located record and to set the second increment variable equal to the contents of the second interval field of the located record. (The increment variables were alternatively set to specific values at block 826 in Figure 41.) It will be appreciated that the located record could be a bundle override record of the type shown in Figure 37 or the located record could be a reseller special destination record of the type shown in Figure 48 or the record could be a reseller global mark-up table record of the type shown in Figure 50. After the override and first and second increment variables have been set at block 862, the processor 202 of Figure 7 is directed to set as the cost per unit time the sum of the reseller rate and at least one of the route cost per unit time, the reseller cost per unit time and the default cost per unit time, depending on which record was located. To do this, block 864 directs the processor to set the cost per unit time equal to the sum of the reseller cost set at block 800 in Figure 41, plus the contents of the override variable calculated in block 862 in Figure 41. The cost per unit time has thus been calculated and it is this cost per unit time that is used in block 752 of Figure 33B, for example.

Terminating the Call In the event that either the caller or the callee terminates a call, the telephone of the terminating party sends a SIP bye message to the controller 14. An exemplary SIP bye message is shown at 900 in Figure 51 and includes a caller field 902, a callee field 904 and a call ID field 906. The caller field 902 holds a twelve digit user name, the callee field 904 holds a PSTN compatible number or user name, and the call ID field

906 holds a unique call identifier field of the type shown in the call ID field 65 of the SIP invite message shown in Figure 3.

Thus, for example, referring to Figure 52, a SIP bye message for the Calgary callee is shown generally at 908 and the caller field 902 holds a user name identifying the caller, in this case 2001 1050 8667, the callee field 904 holds a user name identifying the Calgary callee, in this case 2001 1050 2222, and the call ID field 906 holds the code FA10 @ 192.168.0.20, which is the call ID for the call.

The SIP bye message shown in Figure 52 is received at the call controller 14 and the call controller executes a process as shown generally at 910 in Figure 53. The process includes a first block 912 that directs the call controller processor 202 of Figure 7 to copy the caller, callee and call ID field contents from the SIP bye message received from the terminating party to corresponding fields of an RC stop message buffer (not shown). Block 914 then directs the processor to copy the call start time from the call timer and to obtain a call stop time from the call timer. Block 916 then directs the call controller to calculate a communication session time by determining the difference in time between the call start time and the call stop time. This session time is then stored in a corresponding field of the RC call stop message buffer. Block 917 then directs the processor to decrement the contents of the current concurrent call field 277 of the dialing profile for the caller as shown in Figure 10, to indicate that there is one less concurrent call in progress. A copy of the amended dialing profile for the caller is then stored in the database 18 of Figure 1. Block 918 then directs the processor to copy the route from the call log. An RC call stop message produced as described above is shown generally at 1000 in Figure 54. An RC call stop message specifically associated with the call made to the Calgary callee is shown generally at 1020 in Figure 55.

Referring to Figure 54, the RC stop call message includes a caller field 1002, callee field 1004, a call ID field 1006, an account start time field 1008, an account stop time field 1010, a communication session time 1012 and a route field 1014. The caller field 1002 holds a username, the callee field 1004 holds a PSTN-compatible number or system number, the call ID field 1006 hold the unique call identifier received from the SIP invite message shown in Figure 3, the account start time field 1008 holds the date and start time of the call, the account stop time field 1010 holds the date and time the call ended, the communication session time field 1012 holds a value representing the difference between the start time and the stop time, in seconds, and the route field 1014 holds the IP address for the communications link that was established.

Referring to Figure 55, an exemplary RC stop call message for the Calgary callee is shown generally at 1020. In this example the caller field 1002 holds the user name 2001 1050 8667 identifying the Vancouver-based caller and the callee field 1004 holds the user name 2001 1050 2222 identifying the Calgary callee. The contents of the call ID field 1006 are FA10 @ 192.168.0.20. The contents of the account start time field 1008 are 2006-12-30 12:12:12 and the contents of the account stop time field are 2006-12-30 12:12:14. The contents of the communication session time field 1012 are 2 to indicate 2 seconds call duration and the contents of the route field are 72.64.39.58.

Referring back to Figure 53, after having produced an RC call stop message, block 920 directs the processor 202 in Figure 7 to send the RC stop message compiled in the RC call stop message buffer to the RC 16 of Figure 1. Block 922 directs the call controller 14 to send a "bye" message back to the party that did not terminate the call.

The RC 16 of Figure 1 receives the call stop message and an RC call stop message process is invoked at the RC, the process being shown at 950 in Figures 56A, 56B and 56C. Referring to Figure 56A, the RC stop message process 950 begins with a first block 952 that directs the processor 202 in Figure 7 to determine whether or not the communication session time is less than or equal to the first increment value set by the cost calculation routine shown in Figure 41, specifically blocks 826 or 862 thereof. If this condition is met, then block 954 of Figure 56A directs the RC processor to set a chargeable time variable equal to the first increment value set at block 826 or 862 of Figure 41. If at block 952 of Figure 56A the condition is not met, block 956 directs the RC processor to set a remainder variable equal to the difference between the communication session time and the first increment value mod the second increment value produced at block 826 or 862 of Figure 41. Then, the processor is directed to block 958 of Figure 56A which directs it to determine whether or not the remainder is greater than zero. If so, block 960 directs the RC processor to set the chargeable time variable equal to the difference between the communication session time and the remainder value.

If at block 958 the remainder is not greater than zero, block 962 directs the RC processor to set the chargeable time variable equal to the contents of the communication session time from the RC stop message. The processor is then directed to block 964. In addition, after executing block 954 or block 960, the processor is directed to block 964.

Block 964 directs the processor 202 of Figure 7 to determine whether or not the chargeable time variable is greater than or equal to the free time balance as determined from the free time field 742 of the subscriber account record shown in Figure 39. If this condition is satisfied, block 966 of Figure 56A directs the processor to set the free time field 742 in the record shown in Figure 39, to zero. If the chargeable time variable is not greater than or equal to the free time balance, block 968 directs the RC processor to set a user cost variable to zero and Block 970 then decrements the free time field 742 of the subscriber account record for the caller by the chargeable time amount determined by block 954, 960 or 962.

If at Block 964 the processor 202 of Figure 7 was directed to Block 966 which causes the free time field (742 of Figure 39) to be set to zero, referring to Figure 56B, Block 972 directs the processor to set a remaining chargeable time variable equal to the difference between the chargeable time and the contents of the free time field (742 of Figure 39). Block 974 then directs the processor to set the user cost variable equal to the product of the remaining chargeable time and the cost per second calculated at Block 750 in Figure 33B. Block 976 then directs the processor to decrement the funds balance field (740) of the subscriber account record shown in Figure 39 by the contents of the user cost variable calculated at Block 974.

After completing Block 976 or after completing Block 970 in Figure 56A, block 978 of Figure 56B directs the processor 202 of Figure 7 to calculate a reseller cost variable as the product of the reseller rate as indicated in the mark-up value field 810 of the system operator mark-up table record shown in Figure 45 and the communication session time determined at Block 916 in Figure 53. Then, Block 980 of Figure 56B directs the processor to add the reseller cost to the reseller balance field 986 of a reseller account record of the type shown in Figure 57 at 982.

The reseller account record includes a reseller ID field 984 and the aforementioned reseller balance field 986. The reseller ID field 984 holds a reseller ID code, and the reseller balance field 986 holds an accumulated balance of charges.

Referring to Figure 58, a specific reseller accounts record for the reseller "Klondike" is shown generally at 988. In this record the reseller ID field 984 holds a code representing the reseller "Klondike" and the reseller balance field 986 holds a balance of \$100.02. Thus, the contents of the reseller balance field 986 in Figure 58 are incremented by the reseller cost calculated at block 978 of Figure 56B.

Still referring to Figure 56B, after adding the reseller cost to the reseller balance field as indicated by Block 980, Block 990 directs the processor to 202 of Figure 7 calculate a system operator cost as the product of the system operator cost per second, as set at block 822 in Figure 41, and the communication session time as determined at Block 916 in Figure 53. Block 992 then directs the processor to add the system operator cost value calculated at Block 990 to a system operator accounts table record of the type shown at 994 in Figure 59. This record includes a system operator balance field 996 holding an accumulated charges balance. Referring to Figure 60 in the embodiment described, the system operator balance field 996 may hold the value \$1,000.02 for example, and to this value the system operator cost calculated at Block 990 is added when the processor executes Block 992 of Figure 56B.

Ultimately, the final reseller balance 986 in Figure 58 holds a number representing an amount owed to the reseller by the system operator and the system operator balance 996 of Figure 59 holds a number representing an amount of profit for the system operator.

While specific embodiments of the invention have been described and illustrated, such embodiments should be considered illustrative of the invention only and not as limiting the invention as construed in accordance with the accompanying claims.

Citations

Citation *Record level*

Citing Patents (0)

Cited Patents (0)

Cited Non-patents (0)

DPCI Citation *Patent family level*

Expand DPCI Citing Patents (3)

Expand DPCI Cited Patents (155)

Expand DPCI Cited Non-patents (35)

Expand DPCI Citation Counts

DPCI Field of Search

-

DPCI Citing Patents Country

US

DPCI Cited Patents Country

WO; EP; US; CA

Other

Attorney / Agent

SPRUSON & FERGUSON (ASIA) PTE LTD

PCT Application / Publication

WO2007CA1956A / 2007-11-01

WO2008052340A1 / 2008-05-08

Copyright 2007-2015 THOMSON REUTERS

Public Search & Enquiry

Disclaimer

This search facility ("this facility") makes available information related to IP applications and registrations at Intellectual Property Office of Singapore ("IPOS"). Whilst IPOS takes reasonable care in the provision of this facility and information, it does not guarantee or in any way represent the accuracy or completeness of this facility or information, nor accept any responsibility for errors or omissions or their consequences. Nevertheless, all reasonable efforts have been made within the limits of hardware and internet bandwidth to provide as much information as possible.

Users should also note that some documents like patent specifications and abstracts have undergone automated optical character recognition (OCR) to render them text-searchable by this facility. Due to the nature of OCR, these documents may contain discrepancies when compared with the original document images.

Fast Search Simple Search Advanced Search

Search Type

Forms
 IP
 Journals
 Trade Marks Classification of Goods or Services
 Patents Abstract & Specification

Search Category

Designs
 Patents
 Trade Marks

Application No.	<input type="text"/>
Filing Date From	<input type="text"/> To <input type="text"/> (dd/mm/yyyy)
Applicant / Proprietor Name	<input type="text" value="Digifonica"/>
Agent Name	<input type="text"/>
Case No.	<input type="text"/>

Additional Information for Patent

Publication No.	<input type="text"/>
Title	<input type="text"/>
Inventor	<input type="text"/>
International Patent Classification	<input type="text"/>
Application Status	<input checked="" type="checkbox"/> All Status <input checked="" type="checkbox"/> Abandoned

PETITIONER: APPLE INC. (Extension of 1002-485)

	<input checked="" type="checkbox"/> Abandoned (Extension of Time Possible) <input checked="" type="checkbox"/> Expired <input checked="" type="checkbox"/> Lapsed <input checked="" type="checkbox"/> Lapsed (Late Renewal Possible) <input checked="" type="checkbox"/> Lapsed (Restoration Pending) <input checked="" type="checkbox"/> Lapsed (Restoration Possible) <input checked="" type="checkbox"/> Patent In Force <input checked="" type="checkbox"/> Pending (Not Published) <input checked="" type="checkbox"/> Pending (Published) <input checked="" type="checkbox"/> Refused <input checked="" type="checkbox"/> Refused (Extension of Time Pending) <input checked="" type="checkbox"/> Refused (Extension of Time Possible) <input checked="" type="checkbox"/> Revoked <input checked="" type="checkbox"/> Surrendered <input checked="" type="checkbox"/> Withdrawn
Earliest Claimed Priority Date From	<input type="text"/> To <input type="text"/> (dd/mm/yyyy)
Lodgement Date From	<input type="text"/> To <input type="text"/> (dd/mm/yyyy)
Optional Fields	<input type="checkbox"/> Inventor(s) <input type="checkbox"/> International Patent Classification <input type="checkbox"/> PCT Application Number <input type="checkbox"/> Publication Number <input type="checkbox"/> Earliest Claimed Priority Date <input type="checkbox"/> Application Type

Search Result

S/No	Application No.	App Status	Filing Date	Lodgement Date	Applicant/Proprietor Name	Title	Agent Name
1	2009050872	Abandoned	20/03/2008	14/09/2009	1) DIGIFONICA (INTERNATIONAL) LIMITED	EMERGENCY ASSISTANCE CALLING FOR VOICE OVER IP COMMUNICATIONS SYSTEMS	1) SPRUSON & FERGUSON (ASIA) PTE LTD
2	2009035841	Abandoned	29/11/2007	27/05/2009	1) DIGIFONICA (INTERNATIONAL) LIMITED	INTERCEPTING VOICE OVER IP COMMUNICATIONS AND OTHER DATA COMMUNICATIONS	1) SPRUSON & FERGUSON (ASIA) PTE LTD
3	2009029497	Abandoned	01/11/2007	29/04/2009	1) DIGIFONICA (INTERNATIONAL) LIMITED	PRODUCING ROUTING MESSAGES FOR VOICE OVER IP COMMUNICATIONS	1) SPRUSON & FERGUSON (ASIA) PTE LTD

Page 1 / 1 of 3 record(s)

[<<](#) [<](#) [1](#) [>](#) [>>](#)

Rows per page:

Details of Patent

Application No. 2009029497
Application Status Abandoned
Filing Date 01/11/2007
SG Publication No. 151991
PCT Application No. PCT/CA2007/001956
Entry Date 29/04/2009
Priority Claimed 02/11/2006 US 60/856,212
Title of Invention PRODUCING ROUTING MESSAGES FOR VOICE OVER IP COMMUNICATIONS
International Patent Classification
PCT Publication No. WO 2008/052340
Date of Publication of Entry into National Phase 29/06/2009

☛ Current Applicant or Proprietor Details

1) Name DIGIFONICA (INTERNATIONAL) LIMITED
UEN / Company Code E00056891A
Country Canada
Address SUITE #890 999 WEST HASTINGS STREET VANCOUVER, BRITISH COLUMBIA V6C 2V1
 Canada
Sole Proprietor Or Partners' Names

☛ Inventor Details

Name PERREAULT, CLAY
Address 340A COROZAL WEST PANAMA CITY

PETITIONER APPLE INC. EX. 1002-487

Country of Residence Panama

Name NICHOLSON, STEVE

Address SUITE #5 KEATS AVENUE LONDON E161TW

Country of Residence United Kingdom

Name THOMSON, ROD

Address 3320 GARABALDI DRIVE NORTH VANCOUVER, BRITISH COLUMBIA V7H 2N9

Country of Residence Canada

Name BJORSELL, JOHAN EMIL VICTOR

Address PO BOX 29164 RPO SOUTH GRANVILLE POST VANCOUVER, BRITISH COLUMBIA V6J

Country of Residence Canada

Name ARAFA, FUAD

Address 782 WEST 22ND AVENUE VANCOUVER, BRITISH COLUMBIA V5Z 1Z7

Country of Residence Canada

☛ Agent/Correspondence Details

1) Agent Name SPRUSON & FERGUSON (ASIA) PTE LTD

UEN / Company Code 200100515C

Representative Name

Address For Service P.O. BOX 1531
ROBINSON ROAD POST OFFICE
Singapore 903031

Action Representing For all matters relating to the application, registration/grant, except those matters e:

☛ Other Entries

S/No.	Event
1	Patent application abandoned
2	Bibliographic publication of application filed
3	Request for extension of periods under sections 29(7) and 30(1)(a) filed
4	Notification of PCT national phase entry

PETITIONER APPLE INC. EX. 1002-488

6/3/2015

5 ELLA CHEONG SPRUSON & FERGUSON (SINGAPORE) PTE LTD, P.O. BOX 1531, ROBINSON ROAD POST OFFICE, SINGAPORE
Registered as patent agent

6 Application lodged on 29/04/2009

➤ **Specification Documents**

1 [Description \(with claims\)](#)

2 [Drawing\(s\)](#)

➤ **Abstract Documents**

1 [Abstract](#)

(19) World Intellectual Property Organization
International Bureau



(43) International Publication Date
8 May 2008 (08.05.2008)

(10) International Publication Number
WO 2008/052340 A1

(51) International Patent Classification:

H04L 12/66 (2006.01) H04M 15/00 (2006.01)
H04L 12/14 (2006.01) H04Q 3/64 (2006.01)
H04M 11/06 (2006.01)

(21) International Application Number:

PCT/CA2007/001956

(22) International Filing Date:

1 November 2007 (01.11.2007)

(25) Filing Language:

English

(26) Publication Language:

English

(30) Priority Data:

60/856,212 2 November 2006 (02.11.2006) US

(71) Applicant (for all designated States except US): DIGI-FONICA (INTERNATIONAL) LIMITED [CA/CA]; Suite 1401, 4710 Kingsway Avenue, Burnaby, British Columbia V5H 4M2 (CA).

(72) Inventors; and

(75) Inventors/Applicants (for US only): PERREAULT, Clay [CA/GB]; Suite #5 Keats Avenue, London, E161TW (GB). NICHOLSON, Steve [CA/CA]; Suite #5 Keats Avenue, London, E161TW (CA). THOMSON, Rod [CA/CA]; 3320 Garabaldi Drive, North Vancouver, British

Columbia V7H 2N9 (CA). BJORSELL, Johan Emil Victor [SE/CA]; 273 West 5th Street, North Vancouver, British Columbia V7M 1J9 (CA). ARAFA, Fuad [CA/CA]; 305 - 3199 Willow Street, Vancouver, British Columbia V5Z 4L5 (CA).

(74) Agents: KNOX, John, W. et al.; SMART & BIGGAR, Box 11560, Vancouver Centre, 650 West Georgia Street, Suite 2200, Vancouver, British Columbia V6B 4N8 (CA).

(81) Designated States (unless otherwise indicated, for every kind of national protection available): AE, AG, AL, AM, AT, AU, AZ, BA, BB, BG, BH, BR, BW, BY, BZ, CA, CH, CN, CO, CR, CU, CZ, DE, DK, DM, DO, DZ, EC, EE, EG, ES, FI, GB, GD, GE, GI, GM, GT, HN, HR, HU, ID, IL, IN, IS, JP, KE, KG, KM, KN, KP, KR, KZ, LA, LC, LK, LR, LS, LT, LU, LY, MA, MD, ME, MG, MK, MN, MW, MX, MY, MZ, NA, NG, NI, NO, NZ, OM, PG, PI, PL, PT, RO, RS, RU, SC, SD, SE, SG, SK, SL, SM, SV, SY, TJ, TM, TN, TR, TT, TZ, UA, UG, US, UZ, VC, VN, ZA, ZM, ZW.

(84) Designated States (unless otherwise indicated, for every kind of regional protection available): ARIPO (BW, GH, GM, KE, LS, MW, MZ, NA, SD, SL, SZ, TZ, UG, ZM, ZW), Eurasian (AM, AZ, BY, KG, KZ, MD, RU, TJ, TM), European (AT, BE, BG, CH, CY, CZ, DE, DK, EE, ES, FI, FR, GB, GR, HU, IE, IS, IT, LT, LU, LV, MC, MT, NL, PL,

[Continued on next page]

(54) Title: PRODUCING ROUTING MESSAGES FOR VOICE OVER IP COMMUNICATIONS

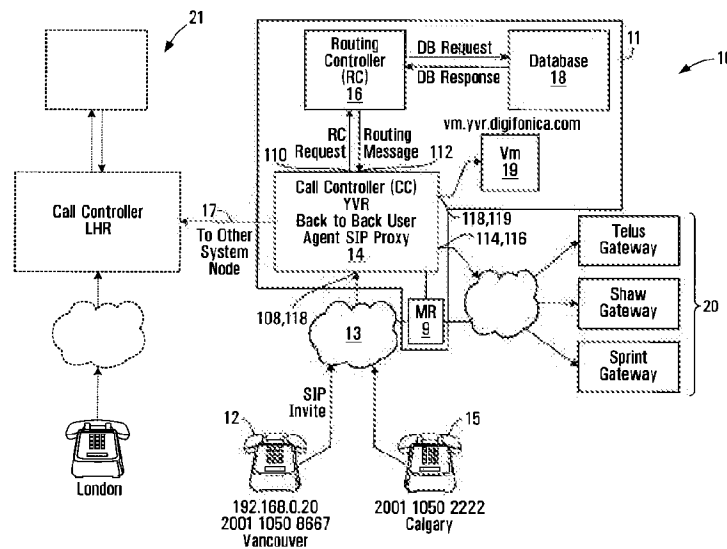

(57) Abstract: A process and apparatus to facilitate communication between callers and callees in a system comprising a plurality of nodes with which callers and callees are associated is disclosed. In response to initiation of a call by a calling subscriber, a caller identifier and a callee identifier are received. Call classification criteria associated with the caller identifier are used to classify the call as a public network call or a private network call. A routing message identifying an address, on the private network, associated with the callee is produced when the call is classified as a private network call and a routing message identifying a gateway to the public network is produced when the call is classified as a public network call.

WO 2008/052340 A1



PT, RO, SE, SI, SK, TR), OAPI (BF, BJ, CF, CG, CI, CM,
GA, GN, GQ, GW, ML, MR, NE, SN, TD, TG).

Published:

- *with international search report*
- *with amended claims*

-1-

PRODUCING ROUTING MESSAGES FOR VOICE OVER IP COMMUNICATIONS

BACKGROUND OF THE INVENTION

5 1. Field of Invention

This invention relates to voice over IP communications and methods and apparatus for routing and billing.

2. Description of Related Art

10 Internet protocol (IP) telephones are typically personal computer (PC) based telephones connected within an IP network, such as the public Internet or a private network of a large organization. These IP telephones have installed "voice-over-IP" (VoIP) software enabling them to make and receive voice calls and send and receive information in data and video formats.

15

IP telephony switches installed within the IP network enable voice calls to be made within or between IP networks, and between an IP network and a switched circuit network (SCN), such as the public switched telephone network (PSTN). If the IP switch supports the Signaling System 7 (SS7) protocol, the IP telephone can also access PSTN databases.

20

The PSTN network typically includes complex network nodes that contain all information about a local calling service area including user authentication and call routing. The PSTN network typically aggregates all information and traffic into a single location or node, processes it locally and then passes it on to other network nodes, as necessary, by maintaining route tables at the node. PSTN nodes are redundant by design and thus provide reliable service, but if a node should fail due to an earthquake or other natural disaster, significant, if not complete service outages can occur, with no other nodes being able to take up the load.

30

-2-

Existing VoIP systems do not allow for high availability and resiliency in delivering Voice Over IP based Session Initiation Protocol (SIP) Protocol service over a geographically dispersed area such as a city, region or continent. Most resiliency originates from the provision of IP based telephone services to one location or a small number of locations such as a single office or network of branch offices.

SUMMARY OF THE INVENTION

In accordance with one aspect of the invention, there is provided a process for operating a call routing controller to facilitate communication between callers and callees in a system comprising a plurality of nodes with which callers and callees are associated. The process involves, in response to initiation of a call by a calling subscriber, receiving a caller identifier and a callee identifier. The process also involves using call classification criteria associated with the caller identifier to classify the call as a public network call or a private network call. The process further involves producing a routing message identifying an address, on the private network, associated with the callee when the call is classified as a private network call. The process also involves producing a routing message identifying a gateway to the public network when the call is classified as a public network call.

The process may involve receiving a request to establish a call, from a call controller in communication with a caller identified by the callee identifier.

Using the call classification criteria may involve searching a database to locate a record identifying calling attributes associated with a caller identified by the caller identifier.

Locating a record may involve locating a caller dialing profile comprising a username associated with the caller, a domain associated with the caller, and at least one calling attribute.

-3-

Using the call classification criteria may involve comparing calling attributes associated with the caller dialing profile with aspects of the callee identifier.

5 Comparing may involve determining whether the callee identifier includes a portion that matches an IDD associated with the caller dialing profile.

Comparing may involve determining whether the callee identifier includes a portion that matches an NDD associated with the caller dialing profile.

10 Comparing may involve determining whether the callee identifier includes a portion that matches an area code associated with the caller dialing profile.

Comparing may involve determining whether the callee identifier has a length within a range specified in the caller dialing profile.

15 The process may involve formatting the callee identifier into a pre-defined digit format to produce a re-formatted callee identifier.

20 Formatting may involve removing an international dialing digit from the callee identifier, when the callee identifier begins with a digit matching an international dialing digit specified by the caller dialing profile associated with the caller.

25 Formatting may involve removing a national dialing digit from the callee identifier and prepending a caller country code to the callee identifier when the callee identifier begins with a national dialing digit.

30 Formatting may involve prepending a caller country code to the callee identifier when the callee identifier begins with digits identifying an area code specified by the caller dialing profile.

-4-

5 Formatting may involve prepending a caller country code and an area code to the callee identifier when the callee identifier has a length that matches a caller dialing number format specified by the caller dialing profile and only one area code is specified as being associated with the caller in the caller dialing profile.

The process may involve classifying the call as a private network call when the re-formatted callee identifier identifies a subscriber to the private network.

10 The process may involve determining whether the callee identifier complies with a pre-defined username format and if so, classifying the call as a private network call.

15 The process may involve causing a database of records to be searched to locate a direct in dial (DID) bank table record associating a public telephone number with the reformatted callee identifier and if the DID bank table record is found, classifying the call as a private network call and if a DID bank table record is not found, classifying the call as a public network call.

20 Producing the routing message identifying a node on the private network may involve setting a callee identifier in response to a username associated with the DID bank table record.

25 Producing the routing message may involve determining whether a node associated with the reformatted callee identifier is the same as a node associated the caller identifier.

30 Determining whether a node associated with the reformatted callee identifier is the same as a node associated the caller identifier may involve determining whether a prefix of the re-formatted callee identifier matches a corresponding prefix of a username associated with the caller dialing profile.

-5-

5 When the node associated with the caller is not the same as the node associated with the callee, the process involves producing a routing message including the caller identifier, the reformatted callee identifier and an identification of a private network node associated with the callee and communicating the routing message to a call controller.

10 When the node associated with the caller is the same as the node associated with the callee, the process involves determining whether to perform at least one of the following: forward the call to another party, block the call and direct the caller to a voicemail server associated with the callee.

15 Producing the routing message may involve producing a routing message having an identification of at least one of the callee identifier, an identification of a party to whom the call should be forwarded and an identification of a voicemail server associated with the callee.

The process may involve communicating the routing message to a call controller.

20 Producing a routing message identifying a gateway to the public network may involve searching a database of route records associating route identifiers with dialing codes to find a route record having a dialing code having a number pattern matching at least a portion of the reformatted callee identifier.

25 The process may involve searching a database of supplier records associating supplier identifiers with the route identifiers to locate at least one supplier record associated with the route identifier associated with the route record having a dialing code having a number pattern matching at least a portion of the reformatted callee identifier.

30 The process may involve loading a routing message buffer with the reformatted callee identifier and an identification of specific routes associated

-6-

respective ones of the supplier records associated with the route record and loading the routing message buffer with a time value and a timeout value.

5 The process may involve communicating a routing message involving the contents of the routing message buffer to a call controller.

10 The process may involve causing the dialing profile to include a maximum concurrent call value and a concurrent call count value and causing the concurrent call count value to be incremented when the user associated with the dialing profile initiates a call and causing the concurrent call count value to be decremented when a call with the user associated with the dialing profile is ended.

15 In accordance with another aspect of the invention, there is provided a call routing apparatus for facilitating communications between callers and callees in a system comprising a plurality of nodes with which callers and callees are associated. The apparatus includes receiving provisions for receiving a caller identifier and a callee identifier, in response to initiation of a call by a calling subscriber. The apparatus also includes classifying provisions for classifying
20 the call as a private network call or a public network call according to call classification criteria associated with the caller identifier. The apparatus further includes provisions for producing a routing message identifying an address, on the private network, associated with the callee when the call is classified as a private network call. The apparatus also includes provisions for
25 producing a routing message identifying a gateway to the public network when the call is classified as a public network call.

30 The receiving provisions may be operably configured to receive a request to establish a call, from a call controller in communication with a caller identified by the callee identifier.

-7-

The apparatus may further include searching provisions for searching a database including records associating calling attributes with subscribers to the private network to locate a record identifying calling attributes associated with a caller identified by the caller identifier.

5

The records may include dialing profiles each including a username associated with the subscriber, an identification of a domain associated with the subscriber, and an identification of at least one calling attribute associated with the subscriber.

10

The call classification provisions may be operably configured to compare calling attributes associated with the caller dialing profile with aspects of the callee identifier.

15

The calling attributes may include an international dialing digit and call classification provisions may be operably configured to determine whether the callee identifier includes a portion that matches an IDD associated with the caller dialing profile.

20

The calling attributes may include a national dialing digit and the call classification provisions may be operably configured to determine whether the callee identifier includes a portion that matches an NDD associated with the caller dialing profile.

25

The calling attributes may include an area code and the call classification provisions may be operably configured to determine whether the callee identifier includes a portion that matches an area code associated with the caller dialing profile.

30

The calling attribute may include a number length range and the call classification provisions may be operably configured to determine whether the

-8-

callee identifier has a length within a number length range specified in the caller dialing profile.

5 The apparatus may further include formatting provisions for formatting the callee identifier into a pre-defined digit format to produce a re-formatted callee identifier.

10 The formatting provisions may be operably configured to remove an international dialing digit from the callee identifier, when the callee identifier begins with a digit matching an international dialing digit specified by the caller dialing profile associated with the caller.

15 The formatting provisions may be operably configured to remove a national dialing digit from the callee identifier and prepend a caller country code to the callee identifier when the callee identifier begins with a national dialing digit.

20 The formatting provisions may be operably configured to prepend a caller country code to the callee identifier when the callee identifier begins with digits identifying an area code specified by the caller dialing profile.

25 The formatting provisions may be operably configured to prepend a caller country code and area code to the callee identifier when the callee identifier has a length that matches a caller dialing number format specified by the caller dialing profile and only one area code is specified as being associated with the caller in the caller dialing profile.

30 The classifying provisions may be operably configured to classify the call as a private network call when the re-formatted callee identifier identifies a subscriber to the private network.

-9-

The classifying provisions may be operably configured to classify the call as a private network call when the callee identifier complies with a pre-defined username format.

5 The apparatus may further include searching provisions for searching a database of records to locate a direct in dial (DID) bank table record associating a public telephone number with the reformatted callee identifier and the classifying provisions may be operably configured to classify the call as a private network call when the DID bank table record is found and
10 to classify the call as a public network call when a DID bank table record is not found

The private network routing message producing provisions may be operably configured to produce a routing message having a callee identifier set
15 according to a username associated with the DID bank table record.

The private network routing message producing provisions may be operably configured to determine whether a node associated with the reformatted callee identifier is the same as a node associated the caller identifier.
20

The private network routing provisions may include provisions for determining whether a prefix of the re-formatted callee identifier matches a corresponding prefix of a username associated with the caller dialing profile.

25 The private network routing message producing provisions may be operably configured to produce a routing message including the caller identifier, the reformatted callee identifier and an identification of a private network node associated with the callee and to communicate the routing message to a call controller.

30 The private network routing message producing provisions may be operably configured to perform at least one of the following forward the call to another

-10-

party, block the call and direct the caller to a voicemail server associated with the callee, when the node associated with the caller is the same as the node associated with the callee.

5 The provisions for producing the private network routing message may be operably configured to produce a routing message having an identification of at least one of the callee identifier, an identification of a party to whom the call should be forwarded and an identification of a voicemail server associated with the callee.

10

The apparatus further includes provisions for communicating the routing message to a call controller.

15 The provisions for producing a public network routing message identifying a gateway to the public network may include provisions for searching a database of route records associating route identifiers with dialing codes to find a route record having a dialing code having a number pattern matching at least a portion of the reformatted callee identifier.

20 The apparatus further includes provisions for searching a database of supplier records associating supplier identifiers with the route identifiers to locate at least one supplier record associated with the route identifier associated with the route record having a dialing code having a number pattern matching at least a portion of the reformatted callee identifier.

25

The apparatus further includes a routing message buffer and provisions for loading the routing message buffer with the reformatted callee identifier and an identification of specific routes associated respective ones of the supplier records associated with the route record and loading the routing message buffer with a time value and a timeout value.

30

-11-

The apparatus further includes provisions for communicating a routing message including the contents of the routing message buffer to a call controller.

5 The apparatus further includes means for causing said dialing profile to include a maximum concurrent call value and a concurrent call count value and for causing said concurrent call count value to be incremented when the user associated with said dialing profile initiates a call and for causing said concurrent call count value to be decremented when a call with said user
10 associated with said dialing profile is ended.

In accordance with another aspect of the invention, there is provided a data structure for access by an apparatus for producing a routing message for use by a call routing controller in a communications system. The data structure
15 includes dialing profile records comprising fields for associating with respective subscribers to the system, a subscriber user name, direct-in-dial records comprising fields for associating with respective subscriber usernames, a user domain and a direct-in-dial number, prefix to node records comprising fields for associating with at least a portion of the respective
20 subscriber usernames, a node address of a node in the system, whereby a subscriber name can be used to find a user domain, at least a portion of the a subscriber name can be used to find a node with which the subscriber identified by the subscriber name is associated, and a user domain and subscriber name can be located in response to a direct-in-dial number.

25
In accordance with another aspect of the invention, there is provided a data structure for access by an apparatus for producing a routing message for use by a call routing controller in a communications system. The data structure includes master list records comprising fields for associating a dialing code
30 with respective master list identifiers and supplier list records linked to master list records by the master list identifiers, said supplier list records comprising fields for associating with a communications services supplier, a supplier id, a

-12-

master list id, a route identifier and a billing rate code, whereby communications services suppliers are associated with dialing codes, such that dialing codes can be used to locate suppliers capable of providing a communications link associated with a given dialing code.

5

In accordance with another aspect of the invention, there is provided a method for determining a time to permit a communication session to be conducted. The method involves calculating a cost per unit time, calculating a first time value as a sum of a free time attributed to a participant in the communication session and the quotient of a funds balance held by the participant to the cost per unit time value and producing a second time value in response to the first time value and a billing pattern associated with the participant, the billing pattern including first and second billing intervals and the second time value being the time to permit a communication session to be conducted.

10
15

Calculating the first time value may involve retrieving a record associated with the participant and obtaining from the record at least one of the free time and the funds balance.

20

Producing the second time value may involve producing a remainder value representing a portion of the second billing interval remaining after dividing the second billing interval into a difference between the first time value and the first billing interval.

25

Producing the second time value may involve setting a difference between the first time value and the remainder as the second time value.

The method may further involve setting the second time value to zero when the remainder is greater than zero and the first time value is less than the free time associated with the participant.

30

-13-

Calculating the cost per unit time may involve locating a record in a database, the record comprising a markup type indicator, a markup value and a billing pattern and setting a reseller rate equal to the sum of the markup value and the buffer rate.

5

Locating the record in a database may involve locating at least one of a record associated with a reseller and a route associated with the reseller, a record associated with the reseller and a default reseller markup record.

10

Calculating the cost per unit time value further may involve locating at least one of an override record specifying a route cost per unit time amount associated with a route associated with the communication session, a reseller record associated with a reseller of the communications session, the reseller record specifying a reseller cost per unit time associated with the reseller for the communication session, a default operator markup record specifying a default cost per unit time.

15

The method may further involve setting as the cost per unit time the sum of the reseller rate and at least one of the route cost per unit time, the reseller cost per unit time and the default cost per unit time.

20

The method may further involve receiving a communication session time representing a duration of the communication session and incrementing a reseller balance by the product of the reseller rate and the communication session time.

25

The method may further involve receiving a communication session time representing a duration of the communication session and incrementing a system operator balance by a product of the buffer rate and the communication session time.

30

-14-

In accordance with another aspect of the invention, there is provided an apparatus for determining a time to permit a communication session to be conducted. The apparatus includes a processor circuit, a computer readable medium coupled to the processor circuit and encoded with instructions for directing the processor circuit to calculate a cost per unit time for the communication session, calculate a first time value as a sum of a free time attributed to a participant in the communication session and the quotient of a funds balance held by the participant to the cost per unit time value and produce a second time value in response to the first time value and a billing pattern associated with the participant, the billing pattern including first and second billing intervals and the second time value being the time to permit a communication session to be conducted.

The instructions may include instructions for directing the processor circuit to retrieve a record associated with the participant and obtain from the record at least one of the free time and the funds balance.

The instructions may include instructions for directing the processor circuit to produce the second time value by producing a remainder value representing a portion of the second billing interval remaining after dividing the second billing interval into a difference between the first time value and the first billing interval.

The instructions may include instructions for directing the processor circuit to produce the second time value comprises setting a difference between the first time value and the remainder as the second time value.

The instructions may include instructions for directing the processor circuit to set the second time value to zero when the remainder is greater than zero and the first time value is less than the free time associated with the participant.

-15-

5 The instructions for directing the processor circuit to calculate the cost per unit time may include instructions for directing the processor circuit to locate a record in a database, the record comprising a markup type indicator, a markup value and a billing pattern and set a reseller rate equal to the sum of the markup value and the buffer rate.

10 The instructions for directing the processor circuit to locate the record in a database may include instructions for directing the processor circuit to locate at least one of a record associated with a reseller and a route associated with the reseller, a record associated with the reseller, and a default reseller markup record. The instructions for directing the processor circuit to calculate the cost per unit time value may further include instructions for directing the processor circuit to locate at least one of an override record specifying a route
15 cost per unit time amount associated with a route associated with the communication session, a reseller record associated with a reseller of the communications session, the reseller record specifying a reseller cost per unit time associated with the reseller for the communication session, a default operator markup record specifying a default cost per unit time.

20 The instructions may include instructions for directing the processor circuit to set as the cost per unit time the sum of the reseller rate and at least one of the route cost per unit time, the reseller cost per unit time and the default cost per unit time.

25 The instructions may include instructions for directing the processor circuit to receive a communication session time representing a duration of the communication session and increment a reseller balance by the product of the reseller rate and the communication session time.

30 The instructions may include instructions for directing the processor circuit to receive a communication session time representing a duration of the

-16-

communication session and increment a system operator balance by a product of the buffer rate and the communication session time.

5 In accordance with another aspect of the invention, there is provided a process for attributing charges for communications services. The process involves determining a first chargeable time in response to a communication session time and a pre-defined billing pattern, determining a user cost value in response to the first chargeable time and a free time value associated with a user of the communications services, changing an account balance associated with the user in response to a user cost per unit time. The process may further involve changing an account balance associated with a reseller of the communications services in response to a reseller cost per unit time and the communication session time and changing an account balance associated with an operator of the communications services in response to an operator cost per unit time and the communication session time.

10

15

Determining the first chargeable time may involve locating at least one of an override record specifying a route cost per unit time and billing pattern associated with a route associated with the communication session, a reseller record associated with a reseller of the communications session, the reseller record specifying a reseller cost per unit time and billing pattern associated with the reseller for the communication session and a default record specifying a default cost per unit time and billing pattern and setting as the pre-defined billing pattern the billing pattern of the record located. The billing pattern of the record located may involve a first billing interval and a second billing interval.

20

25

Determining the first chargeable time may involve setting the first chargeable time equal to the first billing interval when the communication session time is less than or equal to the first billing interval.

30

-17-

5 Determining the first chargeable time may involve producing a remainder value representing a portion of the second billing interval remaining after dividing the second billing interval into a difference between communication session time and the first interval when the communication session time is greater than the communication session time and setting the first chargeable time to a difference between the communication session time and the remainder when the remainder is greater than zero and setting the first chargeable time to the communication session time when the remainder is not greater than zero.

10

The process may further involve determining a second chargeable time in response to the first chargeable time and the free time value associated with the user of the communications services when the first chargeable time is greater than or equal to the free time value associated with the user of the communications services.

15

Determining the second chargeable time may involve setting the second chargeable time to a difference between the first chargeable time.

20 The process may further involve resetting the free time value associated with the user to zero when the first chargeable time is greater than or equal to the free time value associated with the user of the communications services.

25 Changing an account balance associated with the user may involve calculating a user cost value in response to the second chargeable time and the user cost per unit time.

The process may further involve changing a user free cost balance in response to the user cost value.

30

The process may further involve setting the user cost to zero when the first chargeable time is less than the free time value associated with the user.

-18-

The process may further involve changing a user free time balance in response to the first chargeable time.

5 In accordance with another aspect of the invention, there is provided an apparatus for attributing charges for communications services. The apparatus includes a processor circuit, a computer readable medium in communication with the processor circuit and encoded with instructions for directing the processor circuit to determine a first chargeable time in response to a
10 communication session time and a pre-defined billing pattern, determine a user cost value in response to the first chargeable time and a free time value associated with a user of the communications services, change an account balance associated with the user in response to a user cost per unit time.

15 The instructions may further include instructions for changing an account balance associated with a reseller of the communications services in response to a reseller cost per unit time and the communication session time and changing an account balance associated with an operator of the communications services in response to an operator cost per unit time and
20 the communication session time.

The instructions for directing the processor circuit to determine the first chargeable time may further include instructions for causing the processor circuit to communicate with a database to locate at least one of an override
25 record specifying a route cost per unit time and billing pattern associated with a route associated with the communication session, a reseller record associated with a reseller of the communications session, the reseller record specifying a reseller cost per unit time and billing pattern associated with the reseller for the communication session and a default record specifying a
30 default cost per unit time and billing pattern and instructions for setting as the pre-defined billing pattern the billing pattern of the record located. The billing

-19-

pattern of the record located may include a first billing interval and a second billing interval.

5 The instructions for causing the processor circuit to determine the first chargeable time may include instructions for directing the processor circuit to set the first chargeable time equal to the first billing interval when the communication session time is less than or equal to the first billing interval.

10 The instructions for causing the processor circuit to determine the first chargeable time may include instructions for producing a remainder value representing a portion of the second billing interval remaining after dividing the second billing interval into a difference between communication session time and the first interval when the communication session time is greater than the communication session time and instructions for causing the
15 processor circuit to set the first chargeable time to a difference between the communication session time and the remainder when the remainder is greater than zero and instructions for causing the processor circuit to set the first chargeable time to the communication session time when the remainder is not greater than zero.

20 The instructions may further include instructions for causing the processor circuit to determine a second chargeable time in response to the first chargeable time and the free time value associated with the user of the communications services when the first chargeable time is greater than or
25 equal to the free time value associated with the user of the communications services.

The instructions for causing the processor circuit to determine the second chargeable time may include instructions for causing the processor circuit to
30 set the second chargeable time to a difference between the first chargeable time.

-20-

The instructions may further include instructions for causing the processor circuit to reset the free time value associated with the user to zero when the first chargeable time is greater than or equal to the free time value associated with the user of the communications services.

5

The instructions for causing the processor circuit to change an account balance associated with the user may include instructions for causing the processor circuit to calculate a user cost value in response to the second chargeable time and the user cost per unit time.

10

The instructions may further include instructions for causing the processor circuit to change a user free cost balance in response to the user cost value.

15

The instructions may further include instructions for causing the processor circuit to set the user cost to zero when the first chargeable time is less than the free time value associated with the user.

20

The instructions may further include instructions for causing the processor circuit to change a user free time balance in response to the first chargeable time.

25

In accordance with another aspect of the invention, there is provided a computer readable medium encoded with codes for directing a processor circuit to execute one or more of the methods described above and/or variants thereof.

30

Other aspects and features of the present invention will become apparent to those ordinarily skilled in the art upon review of the following description of specific embodiments of the invention in conjunction with the accompanying figures.

-21-

BRIEF DESCRIPTION OF THE DRAWINGS

In drawings which illustrate embodiments of the invention,

- 5 **Figure 1** is a block diagram of a system according to a first embodiment of the invention;
- Figure 2** is a block diagram of a caller telephone according to the first embodiment of the invention;
- 10 **Figure 3** is a schematic representation of a SIP invite message transmitted between the caller telephone and a controller shown in **Figure 1**;
- Figure 4** is a block diagram of a call controller shown in **Figure 1**;
- 15 **Figure 5** is a flowchart of a process executed by the call controller shown in **Figure 1**;
- Figure 6** is a schematic representation of a routing, billing and rating (RC) request message produced by the call controller shown in **Figure 1**;
- 20 **Figure 7** is a block diagram of a processor circuit of a routing, billing, rating element of the system shown in **Figure 1**;
- 25 **Figures 8A-8D** is a flowchart of a RC request message handler executed by the RC processor circuit shown in **Figure 7**;
- Figure 9** is a tabular representation of a dialing profile stored in a database accessible by the RC shown in **Figure 1**;
- 30 **Figure 10** is a tabular representation of a dialing profile for a caller using the caller telephone shown in **Figure 1**;

-22-

- Figure 11 is a tabular representation of a callee profile for a callee located in Calgary;
- 5 Figure 12 is a tabular representation of a callee profile for a callee located in London;
- Figure 13 is a tabular representation of a Direct-in-Dial (DID) bank table record stored in the database shown in Figure 1;
- 10 Figure 14 is a tabular representation of an exemplary DID bank table record for the Calgary callee referenced in Figure 11;
- Figure 15 is a tabular representation of a routing message transmitted from the RC to the call controller shown in Figure 1;
- 15 Figure 16 is a schematic representation of a routing message buffer holding a routing message for routing a call to the Calgary callee referenced in Figure 11;
- 20 Figure 17 is a tabular representation of a prefix to supernode table record stored in the database shown in Figure 1;
- Figure 18 is a tabular representation of a prefix to supernode table record that would be used for the Calgary callee referenced in Figure 11;
- 25 Figure 19 is a tabular representation of a master list record stored in a master list table in the database shown in Figure 1;
- 30 Figure 20 is a tabular representation of a populated master list record;

-23-

- Figure 21 is a tabular representation of a suppliers list record stored in the database shown in Figure 1;
- 5 Figure 22 is a tabular representation of a specific supplier list record for a first supplier;
- Figure 23 is a tabular representation of a specific supplier list record for a second supplier;
- 10 Figure 24 is a tabular representation of a specific supplier list record for a third supplier;
- Figure 25 is a schematic representation of a routing message, held in a routing message buffer, identifying to the controller a plurality of possible suppliers that may carry the call;
- 15 Figure 26 is a tabular representation of a call block table record;
- Figure 27 is a tabular representation of a call block table record for the Calgary callee;
- 20 Figure 28 is a tabular representation of a call forwarding table record;
- Figure 29 is a tabular representation of a call forwarding table record specific for the Calgary callee;
- 25 Figure 30 is a tabular representation of a voicemail table record specifying voicemail parameters to enable the caller to leave a voicemail message for the callee;
- 30 Figure 31 is a tabular representation of a voicemail table record specific to the Calgary callee;

- 5
Figure **32** is a schematic representation of an exemplary routing message, held in a routing message buffer, indicating call forwarding numbers and a voicemail server identifier;
- Figures **33A** and **33B** are respective portions of a flowchart of a process executed by the RC processor for determining a time to live value;
- 10
Figure **34** is a tabular representation of a subscriber bundle table record;
- Figure **35** is a tabular representation of a subscriber bundle record for the Vancouver caller;
- 15
Figure **36** is a tabular representation of a bundle override table record;
- Figure **37** is a tabular representation of bundle override record for a located master list ID;
- 20
Figure **38** is a tabular representation of a subscriber account table record;
- Figure **39** is a tabular representation of a subscriber account record for the Vancouver caller;
- 25
Figure **40** is a flowchart of a process for producing a second time value executed by the RC processor circuit shown in Figure 7;
- Figure **41** is a flowchart for calculating a call cost per unit time;
- 30
Figure **42** is a tabular representation of a system operator special rates table record;

-25-

- Figure 43 is a tabular representation of a system operator special rates table record for a reseller named Klondike;
- 5 Figure 44 is a tabular representation of a system operator mark-up table record;
- Figure 45 is a tabular representation of a system operator mark-up table record for the reseller Klondike;
- 10 Figure 46 is a tabular representation of a default system operator mark-up table record;
- Figure 47 is a tabular representation of a reseller special destinations table record;
- 15 Figure 48 is a tabular representation of a reseller special destinations table record for the reseller Klondike;
- Figure 49 is a tabular representation of a reseller global mark-up table record;
- 20 Figure 50 is a tabular representation of a reseller global mark-up table record for the reseller Klondike;
- Figure 51 is a tabular representation of a SIP bye message transmitted from either of the telephones shown in Figure 1 to the call controller;
- 25 Figure 52 is a tabular representation of a SIP bye message sent to the controller from the Calgary callee;
- 30

-26-

- Figure 53 is a flowchart of a process executed by the call controller for producing a RC stop message in response to receipt of a SIP bye message;
- 5 Figure 54 is a tabular representation of an exemplary RC call stop message;
- Figure 55 is a tabular representation of an RC call stop message for the Calgary callee;
- 10 Figures 56A and 56B are respective portions of a flowchart of a RC call stop message handling routine executed by the RC shown in Figure 1;
- Figure 57 is a tabular representation of a reseller accounts table record;
- 15 Figure 58 is a tabular representation of a reseller accounts table record for the reseller Klondike;
- Figure 59 is a tabular representation of a system operator accounts table record; and
- 20 Figure 60 is a tabular representation of a system operator accounts record for the system operator described herein.

25 **DETAILED DESCRIPTION**

Referring to Figure 1, a system for making voice over IP telephone/videophone calls is shown generally at 10. The system includes a first super node shown generally at 11 and a second super node shown generally at 21. The first super node 11 is located in geographical area, such as Vancouver, B.C., Canada for example and the second super node 21 is located in London, England, for example. Different super nodes may be located in different geographical regions throughout the world to provide

30

-27-

5 telephone/videophone service to subscribers in respective regions. These super nodes may be in communication with each other by high speed/ high data throughput links including optical fiber, satellite and/or cable links, forming a backbone to the system. These super nodes may alternatively or, in addition, be in communication with each other through conventional internet services.

10 In the embodiment shown, the Vancouver supernode 11 provides telephone/videophone service to western Canadian customers from Vancouver Island to Ontario. Another node (not shown) may be located in Eastern Canada to provide services to subscribers in that area.

15 Other nodes of the type shown may also be employed within the geographical area serviced by a supernode, to provide for call load sharing, for example within a region of the geographical area serviced by the supernode. However, in general, all nodes are similar and have the properties described below in connection with the Vancouver supernode 11.

20 In this embodiment, the Vancouver supernode includes a call controller (C) 14, a routing controller (RC) 16, a database 18 and a voicemail server 19 and a media relay 9. Each of these may be implemented as separate modules on a common computer system or by separate computers, for example. The voicemail server 19 need not be included in the node and can be provided by an outside service provider.

25

30 Subscribers such as a subscriber in Vancouver and a subscriber in Calgary communicate with the Vancouver supernode using their own internet service providers which route internet traffic from these subscribers over the internet shown generally at 13 in Figure 1. To these subscribers the Vancouver supernode is accessible at a pre-determined internet protocol (IP) address or a fully qualified domain name that can be accessed in the usual way through a subscriber's internet service provider. The subscriber in Vancouver uses a

-28-

telephone **12** that is capable of communicating with the Vancouver supernode **11** using Session Initiation Protocol (SIP) messages and the Calgary subscriber uses a similar telephone **15**, in Calgary AB.

5 It should be noted that throughout the description of the embodiments of this invention, the IP/UDP addresses of all elements such as the caller and callee telephones, call controller, media relay, and any others, will be assumed to be valid IP/UDP addresses directly accessible via the Internet or a private IP network, for example, depending on the specific implementation of the system. As such, it will be assumed, for example, that the caller and callee telephones will have IP/UDP addresses directly accessible by the call controllers and the media relays on their respective supernodes, and those addresses will not be obscured by Network Address Translation (NAT) or similar mechanisms. In other words, the IP/UDP information contained in SIP messages (for example the SIP Invite message or the RC Request message which will be described below) will match the IP/UDP addresses of the IP packets carrying these SIP messages.

10

15

It will be appreciated that in many situations, the IP addresses assigned to various elements of the system may be in a private IP address space, and thus not directly accessible from other elements. Furthermore, it will also be appreciated that NAT is commonly used to share a "public" IP address between multiple devices, for example between home PCs and IP telephones sharing a single Internet connection. For example, a home PC may be assigned an IP address such as **192.168.0.101** and a Voice over IP telephone may be assigned an IP address of **192.168.0.103**. These addresses are located in so called "non-routable" (IP) address space and cannot be accessed directly from the Internet. In order for these devices to communicate with other computers located on the Internet, these IP addresses have to be converted into a "public" IP address, for example **24.10.10.123** assigned by the Internet Service Provider to the subscriber, by a device performing NAT, typically a home router. In addition to translating the IP addresses, NAT

20

25

30

-29-

typically also translates UDP port numbers, for example an audio path originating at a VoIP telephone and using a UDP port **12378** at its private IP address, may have be translated to a UDP port **23465** associated with the public IP address of the NAT device. In other words, when a packet
5 originating from the above VoIP telephone arrives at an Internet-based supernode, the source IP/UDP address contained in the IP packet header will be **24.10.10.1:23465**, whereas the source IP/UDP address information contained in the SIP message inside this IP packet will be **192.168.0.103:12378**. The mismatch in the IP/UDP addresses may cause a
10 problem for SIP-based VoIP systems because, for example, a supernode will attempt to send messages to a private address of a telephone but the messages will never get there.

Referring to Figure 1, in an attempt to make a call by the Vancouver
15 telephone/videophone **12** to the Calgary telephone/videophone **15**, the Vancouver telephone/videophone sends a SIP invite message to the Vancouver supernode **11** and in response, the call controller **14** sends an RC request message to the RC **16** which makes various enquiries of the database **18** to produce a routing message which is sent back to the call
20 controller **14**. The call controller **14** then communicates with the media relay **9** to cause a communications link including an audio path and a videophone (if a videopath call) to be established through the media relay to the same node, a different node or to a communications supplier gateway as shown generally at **20** to carry audio, and where applicable, video traffic to the call recipient or
25 callee.

Generally, the RC **16** executes a process to facilitate communication between callers and callees. The process involves, in response to initiation of a call by a calling subscriber, receiving a callee identifier from the calling subscriber,
30 using call classification criteria associated with the calling subscriber to classify the call as a public network call or a private network call and producing a routing message identifying an address on the private network,

-30-

associated with the callee when the call is classified as a private network call and producing a routing message identifying a gateway to the public network when the call is classified as a public network call.

5 Subscriber Telephone

In greater detail, referring to Figure 2, in this embodiment, the telephone/videophone 12 includes a processor circuit shown generally at 30 comprising a microprocessor 32, program memory 34, an input/output (I/O) port 36, parameter memory 38 and temporary memory 40. The program
10 memory 34, I/O port 36, parameter memory 38 and temporary memory 40 are all in communication with the microprocessor 32. The I/O port 36 has a dial input 42 for receiving a dialled telephone/videophone number from a keypad, for example, or from a voice recognition unit or from pre-stored telephone/videophone numbers stored in the parameter memory 38, for
15 example. For simplicity, in Figure 2 a box labelled dialing functions 44 represents any device capable of informing the microprocessor 32 of a callee identifier, e.g., a callee telephone/videophone number.

The processor 32 stores the callee identifier in a dialled number buffer 45. In
20 this case, assume the dialled number is **2001 1050 2222** and that it is a number associated with the Calgary subscriber. The I/O port 36 also has a handset interface 46 for receiving and producing signals from and to a handset that the user may place to his ear. This interface 46 may include a BLUETOOTH™ wireless interface, a wired interface or speaker phone, for
25 example. The handset acts as a termination point for an audio path (not shown) which will be appreciated later. The I/O port 36 also has an internet connection 48 which is preferably a high speed internet connection and is operable to connect the telephone/videophone to an internet service provider. The internet connection 48 also acts as a part of the voice path, as will be
30 appreciated later. It will be appreciated that where the subscriber device is a videophone, a separate video path is established in the same way an audio path is established. For simplicity, the following description refers to a

-31-

telephone call, but it is to be understood that a videophone call is handled similarly, with the call controller causing the media relay to facilitate both an audio path and a video path instead of only an audio path.

5 The parameter memory **38** has a username field **50**, a password field **52** an IP address field **53** and a SIP proxy address field **54**, for example. The user name field **50** is operable to hold a user name, which in this case is **2001 1050 8667**. The user name is assigned upon subscription or registration into the system and, in this embodiment, includes a twelve digit number having a
10 continent code **61**, a country code **63**, a dealer code **70** and a unique number code **74**. The continent code **61** is comprised of the first or left-most digit of the user name in this embodiment. The country code **63** is comprised of the next three digits. The dealer code **70** is comprised of the next four digits and the unique number code **74** is comprised of the last four digits. The password
15 field **52** holds a password of up to **512** characters, in this example. The IP address field **53** stores an IP address of the telephone, which for this explanation is **192.168.0.20**. The SIP proxy address field **54** holds an IP protocol compatible proxy address which may be provided to the telephone through the internet connection **48** as part of a registration procedure.

20 The program memory **34** stores blocks of codes for directing the processor **32** to carry out the functions of the telephone, one of which includes a firewall block **56** which provides firewall functions to the telephone, to prevent access by unauthorized persons to the microprocessor **32** and memories **34**, **38** and
25 **40** through the internet connection **48**. The program memory **34** also stores codes **57** for establishing a call ID. The call ID codes **57** direct the processor **32** to produce a call identifier having a format comprising a hexadecimal string at an IP address, the IP address being the IP address of the telephone. Thus, an exemplary call identifier might be **FF10@192.168.0.20**.

30 Generally, in response to picking up the handset interface **46** and activating a dialing function **44**, the microprocessor **32** produces and sends a SIP invite

-32-

message as shown in Figure 3, to the routing controller 16 shown in Figure 1. This SIP invite message is essentially to initiate a call by a calling subscriber.

5 Referring to Figure 3, the SIP invite message includes a caller ID field 60, a
callee identifier field 62, a digest parameters field 64, a call ID field 65 an IP
address field 67 and a caller UDP port field 69. In this embodiment, the caller
ID field 60 includes the user name 2001 1050 8667 that is the Vancouver user
name stored in the user name field 50 of the parameter memory 38 in the
10 telephone 12 shown in Figure 2. In addition, referring back to Figure 3, the
callee identifier field 62 includes a callee identifier which in this embodiment is
the user name 2001 1050 2222 that is the dialled number of the Calgary
subscriber stored in the dialled number buffer 45 shown in Figure 2. The
digest parameters field 64 includes digest parameters and the call ID field 65
15 includes a code comprising a generated prefix code (FF10) and a suffix which
is the Internet Protocol (IP) address of the telephone 12 stored in the IP
address field 53 of the telephone. The IP address field 67 holds the IP
address assigned to the telephone, in this embodiment 192.168.0.20, and the
caller UDP port field 69 includes a UDP port identifier identifying a UDP port
at which the audio path will be terminated at the caller's telephone.

20

Call Controller

Referring to Figure 4, a call controller circuit of the call controller 14 (Figure 1)
is shown in greater detail at 100. The call controller circuit 100 includes a
microprocessor 102, program memory 104 and an I/O port 106. The circuit
25 100 may include a plurality of microprocessors, a plurality of program
memories and a plurality of I/O ports to be able to handle a large volume of
calls. However, for simplicity, the call controller circuit 100 will be described as
having only one microprocessor 102, program memory 104 and I/O port 106,
it being understood that there may be more.

30

Generally, the I/O port 106 includes an input 108 for receiving messages such
as the SIP invite message shown in Figure 3, from the telephone shown in

-33-

Figure 2. The I/O port **106** also has an RC request message output **110** for transmitting an RC request message to the RC **16** of Figure 1, an RC message input **112** for receiving routing messages from the RC **16**, a gateway output **114** for transmitting messages to one of the gateways **20** shown in Figure 1 to advise the gateway to establish an audio path, for example, and a gateway input **116** for receiving messages from the gateway. The I/O port **106** further includes a SIP output **118** for transmitting messages to the telephone **12** to advise the telephone of the IP addresses of the gateways which will establish the audio path. The I/O port **106** further includes a voicemail server input and output **117**, **119** respectively for communicating with the voicemail server **19** shown in Figure 1.

While certain inputs and outputs have been shown as separate, it will be appreciated that some may be a single IP address and IP port. For example, the messages sent to the RC **16** and received from the RC **16** may be transmitted and received on the same single IP port.

The program memory **104** includes blocks of code for directing the microprocessor **102** to carry out various functions of the call controller **14**. For example, these blocks of code include a first block **120** for causing the call controller circuit **100** to execute a SIP invite to RC request process to produce an RC request message in response to a received SIP invite message. In addition, there is a routing message to gateway message block **122** which causes the call controller circuit **100** to produce a gateway query message in response to a received routing message from the RC **16**.

Referring to Figure 5, the SIP invite to RC request process is shown in more detail at **120**. On receipt of a SIP invite message of the type shown in Figure 3, block **122** of Figure 5 directs the call controller circuit **100** of Figure 4 to authenticate the user. This may be done, for example, by prompting the user for a password, by sending a message back to the telephone **12** which is interpreted at the telephone as a request for a password entry or the

-34-

password may automatically be sent to the call controller **14** from the telephone, in response to the message. The call controller **14** may then make enquiries of databases to which it has access, to determine whether or not the user's password matches a password stored in the database. Various
5 functions may be used to pass encryption keys or hash codes back and forth to ensure that the transmittal of passwords is secure.

Should the authentication process fail, the call controller circuit **100** is directed to an error handling routine **124** which causes messages to be displayed at
10 the telephone **12** to indicate there was an authentication problem. If the authentication procedure is passed, block **121** directs the call controller circuit **100** to determine whether or not the contents of the caller ID field **60** of the SIP invite message received from the telephone is an IP address. If it is an IP address, then block **123** directs the call controller circuit **100** to set the
15 contents of a type field variable maintained by the microprocessor **102** to a code representing that the call type is a third party invite. If at block **121** the caller ID field contents do not identify an IP address, then block **125** directs the microprocessor to set the contents of the type field to a code indicating that the call is being made by a system subscriber. Then, block **126** directs
20 the call controller circuit to read the call identifier **65** provided in the SIP invite message from the telephone **12**, and at block **128** the processor is directed to produce an RC request message that includes that call ID. Block **129** then directs the call controller circuit **100** to send the RC request to the RC **16**.

25 Referring to Figure **6**, an RC request message is shown generally at **150** and includes a caller field **152**, a callee field **154**, a digest field **156**, a call ID field **158** and a type field **160**. The caller, callee, digest call ID fields **152**, **154**, **156** and **158** contain copies of the caller, callee, digest parameters and call ID fields **60**, **62**, **64** and **65** of the SIP invite message shown in Figure **3**. The
30 type field **160** contains the type code established at blocks **123** or **125** of Figure **5** to indicate whether the call is from a third party or system subscriber,

-35-

respectively. The caller identifier field may include a PSTN number or a system subscriber username as shown, for example.

Routing Controller (RC)

5 Referring to Figure 7, the RC **16** is shown in greater detail and includes an RC processor circuit shown generally at **200**. The RC processor circuit **200** includes a processor **202**, program memory **204**, a table memory **206**, buffer memory **207**, and an I/O port **208**, all in communication with the processor **202**. (As earlier indicated, there may be a plurality of processor circuits (**202**),
10 memories (**204**), etc.)

The buffer memory **207** includes a caller id buffer **209** and a callee id buffer **211**.

15 The I/O port **208** includes a database request port **210** through which a request to the database (**18** shown in Figure 1) can be made and includes a database response port **212** for receiving a reply from the database **18**. The I/O port **208** further includes an RC request message input **214** for receiving the RC request message from the call controller (**14** shown in Figure 1) and
20 includes a routing message output **216** for sending a routing message back to the call controller **14**. The I/O port **208** thus acts to receive caller identifier and a callee identifier contained in the RC request message from the call controller, the RC request message being received in response to initiation of a call by a calling subscriber.

25 The program memory **204** includes blocks of codes for directing the processor **202** to carry out various functions of the RC (**16**). One of these blocks includes an RC request message handler **250** which directs the RC to produce a routing message in response to a received RC request message.
30 The RC request message handler process is shown in greater detail at **250** in Figures **8A** through **8D**.

-36-

RC Request Message Handler

Referring to Figure 8A, the RC request message handler begins with a first block 252 that directs the RC processor circuit (200) to store the contents of the RC request message (150) in buffers in the buffer memory 207 of Figure 7, one of which includes the caller ID buffer 209 of Figure 7 for separately storing the contents of the callee field 154 of the RC request message. Block 254 then directs the RC processor circuit to use the contents of the caller field 152 in the RC request message shown in Figure 6, to locate and retrieve from the database 18 a record associating calling attributes with the calling subscriber. The located record may be referred to as a dialing profile for the caller. The retrieved dialing profile may then be stored in the buffer memory 207, for example.

Referring to Figure 9, an exemplary data structure for a dialing profile is shown generally at 253 and includes a user name field 258, a domain field 260, and calling attributes comprising a national dialing digits (NDD) field 262, an international dialing digits (IDD) field 264, a country code field 266, a local area codes field 267, a caller minimum local length field 268, a caller maximum local length field 270, a reseller field 273, a maximum number of concurrent calls field 275 and a current number of concurrent calls field 277. Effectively the dialing profile is a record identifying calling attributes of the caller identified by the caller identifier. More generally, dialing profiles represent calling attributes of respective subscribers.

An exemplary caller profile for the Vancouver subscriber is shown generally at 276 in Figure 10 and indicates that the user name field 258 includes the user name (2001 1050 8667) that has been assigned to the subscriber and is stored in the user name field 50 in the telephone as shown in Figure 2.

Referring back to Figure 10, the domain field 260 includes a domain name as shown at 282, including a node type identifier 284, a location code identifier 286, a system provider identifier 288 and a domain portion 290. The domain

-37-

field **260** effectively identifies a domain or node associated with the user identified by the contents of the user name field **258**.

5 In this embodiment, the node type identifier **284** includes the code "sp" identifying a supernode and the location identifier **286** identifies the supernode as being in Vancouver (YVR). The system provider identifier **288** identifies the company supplying the service and the domain portion **290** identifies the "com" domain.

10 The national dialled digit field **262** in this embodiment includes the digit "1" and, in general, includes a number specified by the International Telecommunications Union (ITU) Telecommunications Standardization Sector (ITU-T) E. **164** Recommendation which assigns national dialing digits to countries.

15 The international dialing digit field **264** includes a code also assigned according to the ITU-T according to the country or location of the user.

20 The country code field **266** also includes the digit "1" and, in general, includes a number assigned according to the ITU-T to represent the country in which the user is located.

25 The local area codes field **267** includes a list of area codes that have been assigned by the ITU-T to the geographical area in which the subscriber is located. The caller minimum and maximum local number length fields **268** and **270** hold numbers representing minimum and maximum local number lengths permitted in the area code(s) specified by the contents of the local area codes field **267**. The reseller field **273** is optional and holds a code identifying a retailer of the services, in this embodiment "Klondike". The maximum number
30 of concurrent calls field **275** holds a code identifying the maximum number of concurrent calls that the user is entitled to cause to concurrently exist. This permits more than one call to occur concurrently while all calls for the user are

-38-

billed to the same account. The current number of concurrent calls field **277** is initially **0** and is incremented each time a concurrent call associated with the user is initiated and is decremented when a concurrent call is terminated.

5 The area codes associated with the user are the area codes associated with the location code identifier **286** of the contents of the domain field **260**.

A dialing profile of the type shown in Figure **9** is produced whenever a user registers with the system or agrees to become a subscriber to the system.
10 Thus, for example, a user wishing to subscribe to the system may contact an office maintained by a system operator and personnel in the office may ask the user certain questions about his location and service preferences, whereupon tables can be used to provide office personnel with appropriate information to be entered into the user name **258**, domain **260**, NDD **262**, IDD
15 **264**, country code **266**, local area codes **267**, caller minimum and maximum local length fields **268** and **270** reseller field **273** and concurrent call fields **275** and **277** to establish a dialing profile for the user.

Referring to Figures **11** and **12**, callee dialing profiles for users in Calgary and
20 London, respectively for example, are shown.

In addition to creating dialing profiles when a user registers with the system, a direct-in-dial (DID) record of the type shown at **278** in Figure **13** is added to a direct-in-dial bank table in the database (**18** in Figure **1**) to associate the
25 username and a host name of the supernode with which the user is associated, with an E.164 number associated with the user on the PSTN network.

An exemplary DID table record entry for the Calgary callee is shown generally
30 at **300** in Figure **14**. The user name field **281** and user domain field **272** are analogous to the user name and user domain fields **258** and **260** of the caller dialing profile shown in Figure **10**. The contents of the DID field **274** include a

-39-

5 E.164 public telephone number including a country code **283**, an area code **285**, an exchange code **287** and a number **289**. If the user has multiple telephone numbers, then multiple records of the type shown at **300** would be included in the DID bank table, each having the same user name and user domain, but different DID field **274** contents reflecting the different telephone numbers associated with that user.

10 In addition to creating dialing profiles as shown in Figure **9** and DID records as shown in Figure **13** when a user registers with the system, call blocking records of the type shown in Figure **26**, call forwarding records of the type shown in Figure **28** and voicemail records of the type shown in Figure **30** may be added to the database **18** when a new subscriber is added to the system.

15 Referring back to Figure **8A**, after retrieving a dialing profile for the caller, such as shown at **276** in Figure **10**, the RC processor circuit **200** is directed to block **256** which directs the processor circuit (**200**) to determine whether the contents of the concurrent call field **277** are less than the contents of the maximum concurrent call field **275** of the dialing profile for the caller and, if so, block **271** directs the processor circuit to increment the contents of the concurrent call field **277**. If the contents of concurrent call field **277** are equal to or greater than the contents of the maximum concurrent call field **275**, block **259** directs the processor circuit **200** to send an error message back to the call controller (**14**) to cause the call controller to notify the caller that the maximum number of concurrent calls has been reached and no further calls can exist concurrently, including the presently requested call.

20 Assuming block **256** allows the call to proceed, the RC processor circuit **200** is directed to perform certain checks on the callee identifier provided by the contents of the callee field **154** in Figure **6**, of the RC request message **150**.
30 These checks are shown in greater detail in Figure **8B**.

-40-

Referring to Figure 8B, the processor (202 in Figure 7) is directed to a first block 257 that causes it to determine whether a digit pattern of the callee identifier (154) provided in the RC request message (150) includes a pattern that matches the contents of the international dialing digits (IDD) field 264 in the caller profile shown in Figure 10. If so, then block 259 directs the processor (202) to set a call type code identifier variable maintained by the processor to indicate that the call is an international call and block 261 directs the processor to produce a reformatted callee identifier by reformatting the callee identifier into a predefined digit format. In this embodiment, this is done by removing the pattern of digits matching the IDD field contents 264 of the caller dialing profile to effectively shorten the callee identifier. Then, block 263 directs the processor 202 to determine whether or not the callee identifier has a length which meets criteria establishing it as a number compliant with the E.164 Standard set by the ITU. If the length does not meet this criteria, block 265 directs the processor 202 to send back to the call controller (14) a message indicating the length is not correct. The process is then ended. At the call controller 14, routines (not shown) stored in the program memory 104 may direct the processor (102 of Figure 4) to respond to the incorrect length message by transmitting a message back to the telephone (12 shown in Figure 1) to indicate that an invalid number has been dialled.

Still referring to Figure 8B, if the length of the amended callee identifier meets the criteria set forth at block 263, block 269 directs the processor (202 of Figure 7) to make a database request to determine whether or not the amended callee identifier is found in a record in the direct-in-dial bank (DID) table. Referring back to Figure 8B, at block 269, if the processor 202 receives a response from the database indicating that the reformatted callee identifier produced at block 261 is found in a record in the DID bank table, then the callee is a subscriber to the system and the call is classified as a private network call by directing the processor to block 279 which directs the processor to copy the contents of the corresponding user name field (281 in Figure 14) from the callee DID bank table record (300 in Figure 14) into the

-41-

callee ID buffer (211 in Figure 7). Thus, the processor 202 locates a subscriber user name associated with the reformatted callee identifier. The processor 202 is then directed to point B in Figure 8A.

5 Subscriber to Subscriber Calls Between Different Nodes

Referring to Figure 8A, block 280 directs the processor (202 of Figure 7) to execute a process to determine whether or not the node associated with the reformatted callee identifier is the same node that is associated with the caller identifier. To do this, the processor 202 determines whether or not a prefix (e.g., continent code 61) of the callee name held in the callee ID buffer (211 in Figure 7), is the same as the corresponding prefix of the caller name held in the username field 258 of the caller dialing profile shown in Figure 10. If the corresponding prefixes are not the same, block 302 in Figure 8A directs the processor (202 in Figure 7) to set a call type flag in the buffer memory (207 in Figure 7) to indicate the call is a cross-domain call. Then, block 350 of Figure 8A directs the processor (202 of Figure 7) to produce a routing message identifying an address on the private network with which the callee identified by the contents of the callee ID buffer is associated and to set a time to live for the call at a maximum value of 99999, for example.

20

Thus the routing message includes a caller identifier, a call identifier set according to a username associated with the located DID bank table record and includes an identifier of a node on the private network with which the callee is associated.

25

The node in the system with which the callee is associated is determined by using the callee identifier to address a supernode table having records of the type as shown at 370 in Figure 17. Each record 370 has a prefix field 372 and a supernode address field 374. The prefix field 372 includes the first n digits of the callee identifier. In this embodiment n=2. The supernode address field 374 holds a code representing the IP address or a fully qualified domain name of the node associated with the code stored in the callee identifier prefix field

30

-42-

372. Referring to Figure **18**, for example, if the prefix is **20**, the supernode address associated with that prefix is sp.yvr.digifonica.com.

5 Referring to Figure **15**, a generic routing message is shown generally at **352** and includes an optional supplier prefix field **354**, and optional delimiter field **356**, a callee user name field **358**, at least one route field **360**, a time to live field **362** and other fields **364**. The optional supplier prefix field **354** holds a code for identifying supplier traffic. The optional delimiter field **356** holds a symbol that delimits the supplier prefix code from the callee user name field **358**. In this embodiment, the symbol is a number sign (#). The route field **360** holds a domain name or IP address of a gateway or node that is to carry the call, and the time to live field **362** holds a value representing the number of seconds the call is permitted to be active, based on subscriber available minutes and other billing parameters.

15

Referring to Figure **8A** and Figure **16**, an example of a routing message produced by the processor at block **350** for a caller associated with a different node than the caller is shown generally at **366** and includes only a callee field **359**, a route field **361** and a time to live field **362**.

20

Referring to Figure **8A**, having produced a routing message as shown in Figure **16**, block **381** directs the processor (**202** of Figure **7**) to send the routing message shown in Figure **16** to the call controller **14** shown in Figure **1**.

25

Referring back to Figure **8B**, if at block **257**, the callee identifier stored in the callee id buffer (**211** in Figure **7**) does not begin with an international dialing digit, block **380** directs the processor (**202**) to determine whether or not the callee identifier begins with the same national dial digit code as assigned to the caller. To do this, the processor (**202**) is directed to refer to the retrieved caller dialing profile as shown in Figure **10**. In Figure **10**, the national dialing

30

-43-

digit code **262** is the number **1**. Thus, if the callee identifier begins with the number **1**, then the processor (**202**) is directed to block **382** in Figure **8B**.

5 Block **382** directs the processor (**202** of Figure **7**) to examine the callee identifier to determine whether or not the digits following the NDD digit identify an area code that is the same as any of the area codes identified in the local area codes field **267** of the caller dialing profile **276** shown in Figure **10**. If not, block **384** of Figure **8B** directs the processor **202** to set the call type flag to indicate that the call is a national call. If the digits following the NDD digit
10 identify an area code that is the same as a local area code associated with the caller as indicated by the caller dialing profile, block **386** directs the processor **202** to set the call type flag to indicate a local call, national style. After executing blocks **384** or **386**, block **388** directs the processor **202** to format the callee identifier into a pre-defined digit format to produce a re-
15 formatted callee identifier by removing the national dialled digit and prepending a caller country code identified by the country code field **266** of the caller dialing profile shown in Figure **10**. The processor (**202**) is then directed to block **263** of Figure **8B** to perform other processing as already described above.

20

If at block **380**, the callee identifier does not begin with a national dialled digit, block **390** directs the processor (**202**) to determine whether the callee identifier begins with digits that identify the same area code as the caller. Again, the reference for this is the retrieved caller dialing profile shown in
25 Figure **10**. The processor (**202**) determines whether or not the first few digits of the callee identifier identify an area code corresponding to the local area code field **267** of the retrieved caller dialing profile. If so, then block **392** directs the processor **202** to set the call type flag to indicate that the call is a local call and block **394** directs the processor (**202**) to format the callee
30 identifier into a pre-defined digit format to produce a reformatted callee identifier by prepending the caller country code to the callee identifier, the caller country code being determined from the country code field **266** of the

-44-

retrieved caller dialing profile shown in Figure 10. The processor (202) is then directed to block 263 for further processing as described above.

5 Referring back to Figure 8B, at block 390, the callee identifier does not start with the same area code as the caller, block 396 directs the processor (202 of Figure 7) to determine whether the number of digits in the callee identifier, i.e. the length of the callee identifier, is within the range of digits indicated by the caller minimum local number length field 268 and the caller maximum local number length field 270 of the retrieved caller dialing profile shown in Figure 10. If so, then block 398 directs the processor (202) to set the call type flag to indicate a local call and block 400 directs the processor (202) to format the callee identifier into a pre-defined digit format to produce a reformatted callee identifier by prepending to the callee identifier the caller country code (as indicated by the country code field 266 of the retrieved caller dialing profile shown in Figure 10) followed by the caller area code (as indicated by the local area code field 267 of the caller profile shown in Figure 10). The processor (202) is then directed to block 263 of Figure 8B for further processing as described above.

20 Referring back to Figure 8B, if at block 396, the callee identifier has a length that does not fall within the range specified by the caller minimum local number length field (268 in Figure 10) and the caller maximum local number length field (270 in Figure 10), block 402 directs the processor 202 of Figure 7 to determine whether or not the callee identifier identifies a valid user name. 25 To do this, the processor 202 searches through the database (18 of Figure 10) of dialing profiles to find a dialing profile having user name field contents (258 in Figure 10) that match the callee identifier. If no match is found, block 404 directs the processor (202) to send an error message back to the call controller (14). If at block 402, a dialing profile having a user name field 258 that matches the callee identifier is found, block 406 directs the processor 202 30 to set the call type flag to indicate that the call is a private network call and then the processor is directed to block 280 of Figure 8A. Thus, the call is

-45-

classified as a private network call when the callee identifier identifies a subscriber to the private network.

5 From Figure 8B, it will be appreciated that there are certain groups of blocks of codes that direct the processor 202 in Figure 7 to determine whether the callee identifier has certain features such as an international dialing digit, a national dialing digit, an area code and a length that meet certain criteria, and cause the processor 202 to reformat the callee identifier stored in the callee id buffer 211, as necessary into a predetermined target format including only a country code, area code, and a normal telephone number, for example, to cause the callee identifier to be compatible with the E.164 number plan standard in this embodiment. This enables block 269 in Figure 8B to have a consistent format of callee identifiers for use in searching through the DID bank table records of the type shown in Figure 13 to determine how to route calls for subscriber to subscriber calls on the same system. Effectively, therefore blocks 257, 380, 390, 396 and 402 establish call classification criteria for classifying the call as a public network call or a private network call. Block 269 classifies the call, depending on whether or not the formatted callee identifier has a DID bank table record and this depends on how the call classification criteria are met and block 402 directs the processor 202 of Figure 7 to classify the call as a private network call when the callee identifier complies with a pre-defined format, i.e. is a valid user name and identifies a subscriber to the private network, after the callee identifier has been subjected to the classification criteria of blocks 257, 380, 390 and 396.

25

Subscriber to Non-Subscriber Calls

30 Not all calls will be subscriber to subscriber calls and this will be detected by the processor 202 of Figure 7 when it executes block 269 in Figure 8B, and does not find a DID bank table record that is associated with the callee, in the DID bank table. When this occurs, the call is classified as a public network

-46-

5 call by directing the processor **202** to block **408** of Figure **8B** which causes it to set the contents of the callee id buffer **211** of Figure **7** equal to the newly formatted callee identifier, i.e., a number compatible with the E.164 standard. Then, block **410** of Figure **8B** directs the processor (**202**) to search a database of route or master list records associating route identifiers with dialing codes shown in Figure **19** to locate a router having a dialing code having a number pattern matching at least a portion of the reformatted callee identifier.

10 Referring to Figure **19**, a data structure for a master list or route list record is shown. Each master list record includes a master list ID field **500**, a dialing code field **502**, a country code field **504**, a national sign number field **506**, a minimum length field **508**, a maximum length field **510**, a national dialled digit field **512**, an international dialled digit field **514** and a buffer rate field **516**.

15 The master list ID field **500** holds a unique code such as **1019**, for example, identifying the record. The dialing code field **502** holds a predetermined number pattern that the processor **202** of Figure **7** uses at block **410** in Figure **8B** to find the master list record having a dialing code matching the first few
20 digits of the amended callee identifier stored in the callee id buffer **211**. The country code field **504** holds a number representing the country code associated with the record and the national sign number field **506** holds a number representing the area code associated with the record. (It will be observed that the dialing code is a combination of the contents of the country code field **504** and the national sign number field **506**.) The minimum length field **508** holds a number representing the minimum length of digits associated with the record and the maximum length field **51** holds a number representing the maximum number of digits in a number with which the record may be compared. The national dialled digit (NDD) field **512** holds a number
25 representing an access code used to make a call within the country specified by the country code, and the international dialled digit (IDD) field **514** holds a
30

-47-

number representing the international prefix needed to dial a call from the country indicated by the country code.

5 Thus, for example, a master list record may have a format as shown in Figure 20 with exemplary field contents as shown.

10 Referring back to Figure 8B, using the country code and area code portions of the reformatted callee identifier stored in the callee id buffer 211, block 410 directs the processor 202 of Figure 7 to find a master list record such as the one shown in Figure 20 having a dialing code that matches the country code (1) and area code (604) of the callee identifier. Thus, in this example, the processor (202) would find a master list record having an ID field containing the number 1019. This number may be referred to as a route ID. Thus, a route ID number is found in the master list record associated with a predetermined number pattern in the reformatted callee identifier.

15 After executing block 410 in Figure 8B, the process continues as shown in Figure 8D. Referring to Figure 8D, block 412 directs the processor 202 of Figure 7 to use the route ID number to search a database of supplier records associating supplier identifiers with route identifiers to locate at least one supplier record associated with the route identifier to identify at least one supplier operable to supply a communications link for the route.

20 Referring to Figure 21, a data structure for a supplier list record is shown. Supplier list records include a supplier ID field 540, a master list ID field 542, an optional prefix field 544, a specific route identifier field 546, a NDD/IDD rewrite field 548, a rate field 550, and a timeout field 551. The supplier ID field 540 holds a code identifying the name of the supplier and the master list ID field 542 holds a code for associating the supplier record with a master list record. The prefix field 544 holds a string used to identify the supplier traffic and the specific route identifier field 546 holds an IP address of a gateway operated by the supplier indicated by the supplier ID field 540. The NDD/IDD

30

-48-

rewrite field **548** holds a code representing a rewritten value of the NDD/IDD associated with this route for this supplier, and the rate field **550** holds a code indicating the cost per second to the system operator to use the route provided by the gateway specified by the contents of the route identifier field **546**. The timeout field **551** holds a code indicating a time that the call controller should wait for a response from the associated gateway before giving up and trying the next gateway. This time value may be in seconds, for example. Exemplary supplier records are shown in Figures **22**, **23** and **24** for the exemplary suppliers shown at **20** in Figure **1**, namely Telus, Shaw and Sprint.

Referring back to Figure **8D**, at block **412** the processor **202** finds all supplier records that identify the master list ID found at block **410** of Figure **8B**.

Referring back to Figure **8D**, block **560** directs the processor **202** of Figure **7** to begin to produce a routing message of the type shown in Figure **15**. To do this, the processor **202** loads a routing message buffer as shown in Figure **25** with a supplier prefix of the least costly supplier where the least costly supplier is determined from the rate fields **550** of Figure **21** of the records associated with respective suppliers.

Referring to Figures **22-24**, in the embodiment shown, the supplier "Telus" has the lowest number in the rate field **550** and therefore the prefix **4973** associated with that supplier is loaded into the routing message buffer shown in Figure **25** first.

Block **562** in Figure **8D** directs the processor to delimit the prefix **4973** by the number sign (#) and to next load the reformatted callee identifier into the routing message buffer shown in Figure **25**. At block **563** of Figure **8D**, the contents of the route identifier field **546** of Figure **21** of the record associated with the supplier "Telus" are added by the processor **202** of Figure **7** to the routing message buffer shown in Figure **25** after an @ sign delimiter, and then

-49-

block **564** in Figure **8D** directs the processor to get a time to live value, which in one embodiment may be **3600** seconds, for example. Block **566** then directs the processor **202** to load this time to live value and the timeout value (**551**) in Figure **21** in the routing message buffer of Figure **25**. Accordingly, a first part of the routing message for the Telus gateway is shown generally at **570** in Figure **25**.

Referring back to Figure **8D**, block **571** directs the processor **202** back to block **560** and causes it to repeat blocks **560**, **562**, **563**, **564** and **566** for each successive supplier until the routing message buffer is loaded with information pertaining to each supplier identified by the processor at block **412**. Thus, a second portion of the routing message as shown at **572** in Figure **25** relates to the second supplier identified by the record shown in Figure **23**. Referring back to Figure **25**, a third portion of the routing message as shown at **574** and is associated with a third supplier as indicated by the supplier record shown in Figure **24**.

Consequently, referring to Figure **25**, the routing message buffer holds a routing message identifying a plurality of different suppliers able to provide gateways to the public telephone network (i.e. specific routes) to establish at least part of a communication link through which the caller may contact the callee. In this embodiment, each of the suppliers is identified, in succession, according to rate. Other criteria for determining the order in which suppliers are listed in the routing message may include preferred supplier priorities which may be established based on service agreements, for example.

Referring back to Figure **8D**, block **568** directs the processor **202** of Figure **7** to send the routing message shown in Figure **25** to the call controller **14** in Figure **1**.

30

Subscriber to Subscriber Calls Within the Same Node

-50-

Referring back to Figure 8A, if at block 280, the callee identifier received in the RC request message has a prefix that identifies the same node as that associated with the caller, block 600 directs the processor 202 to use the callee identifier in the callee id buffer 211 to locate and retrieve a dialing profile for the callee. The dialing profile may be of the type shown in Figure 11 or 12, for example. Block 602 of Figure 8A then directs the processor 202 of Figure 7 to get call block, call forward and voicemail records from the database 18 of Figure 1 based on the user name identified in the callee dialing profile retrieved by the processor at block 600. Call block, call forward and voicemail records may be as shown in Figures 26, 27, 28 and 30 for example.

Referring to Figure 26, the call block records include a user name field 604 and a block pattern field 606. The user name field holds a user name corresponding to the user name in the user name field (258 in Figure 10) of the callee profile and the block pattern field 606 holds one or more E.164-compatible numbers or user names identifying PSTN numbers or system subscribers from whom the subscriber identified in the user name field 604 does not wish to receive calls.

Referring to Figure 8A and Figure 27, block 608 directs the processor 202 of Figure 7 to determine whether or not the caller identifier received in the RC request message matches a block pattern stored in the block pattern field 606 of the call block record associated with the callee identified by the contents of the user name field 604 in Figure 26. If the caller identifier matches a block pattern, block 610 directs the processor to send a drop call or non-completion message to the call controller (14) and the process is ended. If the caller identifier does not match a block pattern associated with the callee, block 609 directs the processor to store the username and domain of the callee, as determined from the callee dialing profile, and a time to live value in the routing message buffer as shown at 650 in Figure 32. Referring back to

-51-

Figure **8A**, block **612** then directs the processor **202** to determine whether or not call forwarding is required.

5 Referring to Figure **28**, the call forwarding records include a user name field **614**, a destination number field **616**, and a sequence number field **618**. The user name field **614** stores a code representing a user with which the record is associated. The destination number field **616** holds a user name representing a number to which the current call should be forwarded, and the sequence number field **618** holds an integer number indicating the order in
10 which the user name associated with the corresponding destination number field **616** should be attempted for call forwarding. The call forwarding table may have a plurality of records for a given user. The processor **202** of Figure **7** uses the contents of the sequence number field **618** to place the records for a given user in order. As will be appreciated below, this enables the call
15 forwarding numbers to be tried in an ordered sequence.

Referring to Figure **8A** and Figure **29**, if at block **612**, the call forwarding record for the callee identified by the callee identifier contains no contents in the destination number field **616** and accordingly no contents in the sequence
20 number field **618**, there are no call forwarding entries for this callee, and the processor **202** is directed to block **620** in Figure **8C**. If there are entries in the call forwarding table **27**, block **622** in Figure **8A** directs the processor **202** to search the dialing profile table to find a dialing profile record as shown in Figure **9**, for the user identified by the destination number field **616** of the call
25 forward record shown in Figure **28**. The processor **202** of Figure **7** is further directed to store the username and domain for that user and a time to live value in the routing message buffer as shown at **652** in Figure **32**, to produce a routing message as illustrated. This process is repeated for each call forwarding record associated with the callee identified by the callee id buffer
30 **211** in Figure **7** to add to the routing message buffer all call forwarding usernames and domains associated with the callee.

-52-

Referring back to Figure 8A, if at block 612 there are no call forwarding records, then at block 620 in Figure 8C the processor 202 is directed to determine whether or not the user identified by the callee identifier has paid for voicemail service. This is done by checking to see whether or not a flag is set in a voicemail record of the type shown in Figure 30 in a voicemail table stored in the database 18 shown in Figure 1.

Referring to Figure 30, voicemail records in this embodiment may include a user name field 624, a voicemail server field 626, a seconds to voicemail field 628 and an enable field 630. The user name field 624 stores the user name of the callee. The voicemail server field 626 holds a code identifying a domain name of a voicemail server associated with the user identified by the user name field 624. The seconds to voicemail field 628 holds a code identifying the time to wait before engaging voicemail, and the enable field 630 holds a code representing whether or not voicemail is enabled for the user. Referring back to Figure 8C, at block 620 if the processor 202 of Figure 7 finds a voicemail record as shown in Figure 30 having user name field 624 contents matching the callee identifier, the processor is directed to examine the contents of the enable field 630 to determine whether or not voicemail is enabled. If voicemail is enabled, then block 640 in Figure 8C directs the processor 202 to Figure 7 to store the contents of the voicemail server field 626 and the contents of the seconds to voicemail field 628 in the routing message buffer, as shown at 654 in Figure 32. Block 642 then directs the processor 202 to get time to live values for each path specified by the routing message according to the cost of routing and the user's balance. These time to live values are then appended to corresponding paths already stored in the routing message buffer.

Referring back to Figure 8C, block 644 then directs the processor 202 of Figure 7 to store the IP address of the current node in the routing message buffer as shown at 656 in Figure 32. Block 646 then directs the processor 202 to send the routing message shown in Figure 32 to the call controller 14 in

-53-

Figure 1. Thus in the embodiment described the routing controller will produce a routing message that will cause at least one of the following: forward the call to another party, block the call and direct the caller to a voicemail server.

5 Referring back to Figure 1, the routing message whether of the type shown in Figures 16, 25 or 32, is received at the call controller 14 and the call controller interprets the receipt of the routing message as a request to establish a call.

10 Referring to Figure 4, the program memory 104 of the call controller 14 includes a routing to gateway routine depicted generally at 122.

15 Where a routing message of the type shown in Figure 32 is received by the call controller 14, the routing to gateway routine 122 shown in Figure 4 may direct the processor 102 cause a message to be sent back through the internet 13 shown in Figure 1 to the callee telephone 15, knowing the IP address of the callee telephone 15 from the user name.

20 Alternatively, if the routing message is of the type shown in Figure 16, which identifies a domain associated with another node in the system, the call controller may send a SIP invite message along the high speed backbone 17 connected to the other node. The other node functions as explained above, in response to receipt of a SIP invite message.

25 If the routing message is of the type shown in Figure 25 where there are a plurality of gateway suppliers available, the call controller sends a SIP invite message to the first supplier, in this case Telus, using a dedicated line or an internet connection to determine whether or not Telus is able to handle the call. If the Telus gateway returns a message indicating it is not able to handle the call, the call controller 14 then proceeds to send a SIP invite message to
30 the next supplier, in this case Shaw. The process is repeated until one of the suppliers responds indicating that it is available to carry the call. Once a supplier responds indicating that it is able to carry the call, the supplier sends

-54-

5 back to the call controller **14** an IP address for a gateway provided by the
supplier through which the call or audio path of the call will be carried. This IP
address is sent in a message from the call controller **14** to the media relay **9**
which responds with a message indicating an IP address to which the caller
10 telephone should send its audio/video, traffic and an IP address to which the
gateway should send its audio/video for the call. The call controller conveys
the IP address at which the media relay expects to receive audio/video from
the caller telephone, to the caller telephone **12** in a message. The caller
telephone replies to the call controller with an IP address at which it would like
15 to receive audio/video and the call controller conveys that IP address to the
media relay. The call may then be conducted between the caller and callee
through the media relay and gateway.

15 Referring back to Figure **1**, if the call controller **14** receives a routing message
of the type shown in Figure **32**, and which has at least one call forwarding
number and/or a voicemail number, the call controller attempts to establish a
call to the callee telephone **15** by seeking from the callee telephone a
message indicating an IP address to which the media relay should send
audio/video. If no such message is received from the callee telephone, no call
20 is established. If no call is established within a pre-determined time, the call
controller **14** attempts to establish a call with the next user identified in the call
routing message in the same manner. This process is repeated until all call
forwarding possibilities have been exhausted, in which case the call controller
communicates with the voicemail server **19** identified in the routing message
25 to obtain an IP address to which the media relay should send audio/video and
the remainder of the process mentioned above for establishing IP addresses
at the media relay **9** and the caller telephone is carried out to establish
audio/video paths to allowing the caller to leave a voicemail message with the
voicemail server.

30

When an audio/video path through the media relay is established, a call timer
maintained by the call controller **14** logs the start date and time of the call and

-55-

logs the call ID and an identification of the route (i.e., audio/video path IP address) for later use in billing.

Time to Live

5 Referring to Figures **33A** and **33B**, a process for determining a time to live value for any of blocks **642** in Figure **8C**, **350** in Figure **8A** or **564** in Figure **8D** above is described. The process is executed by the processor **202** shown in Figure **7**. Generally, the process involves calculating a cost per unit time, calculating a first time value as a sum of a free time attributed to a participant
10 in the communication session and the quotient of a funds balance held by the participant to the cost per unit time value and producing a second time value in response to the first time value and a billing pattern associated with the participant, the billing pattern including first and second billing intervals and the second time value being the time to permit a communication session to be
15 conducted.

Referring to Figure **33A**, in this embodiment, the process begins with a first block **700** that directs the RC processor to determine whether or not the call type set at block **302** in Figure **8A** indicates the call is a network or cross-
20 domain call. If the call is a network or cross-domain call, block **702** of Figure **33A** directs the RC processor to set the time to live equal to **99999** and the process is ended. Thus, the network or cross-domain call type has a long time to live. If at block **700** the call type is determined not to be a network or cross-domain type, block **704** directs the RC processor to get a subscriber bundle table record from the database **18** in Figure **1** and store it locally in the
25 subscriber bundle record buffer at the RC **14**.

Referring to Figure **34**, a subscriber bundle table record is shown generally at **706**. The record includes a user name field **708** and a services field **710**. The
30 user name field **708** holds a code identifying the subscriber user name and the services field **710** holds codes identifying service features assigned to the subscriber, such as free local calling, call blocking and voicemail, for example.

-56-

Figure 35 shows an exemplary subscriber bundle record for the Vancouver caller. In this record the user name field 708 is loaded with the user name 2001 1050 8667 and the services field 710 is loaded with codes 10, 14 and 16 corresponding to free local calling, call blocking and voicemail, respectively. Thus, user 2001 1050 8667 has free local calling, call blocking and voicemail features.

Referring back to Figure 33A, after having loaded a subscriber bundle record into the subscriber bundle record buffer, block 712 directs the RC processor to search the database (18) determine whether or not there is a bundle override table record for the master list ID value that was determined at block 410 in Figure 8B. An exemplary bundle override table record is shown at 714 in Figure 36. The bundle table record includes a master list ID field 716, an override type field 718, an override value field 720 a first interval field 722 and a second interval field 724. The master list ID field 716 holds a master list ID code. The override type field 718 holds an override type code indicating a fixed, percent or cent amount to indicate the amount by which a fee will be increased. The override value field 720 holds a real number representing the value of the override type. The first interval field 722 holds a value indicating the minimum number of seconds for a first level of charging and the second interval field 724 holds a number representing a second level of charging.

Referring to Figure 37, a bundle override record for the located master list ID code is shown generally at 726 and includes a master list ID field 716 holding the code 1019 which was the code located in block 410 of Figure 8B. The override type field 718 includes a code indicating the override type is a percentage value and the override value field 720 holds the value 10.0 indicating that the override will be 10.0% of the charged value. The first interval field 722 holds a value representing 30 seconds and the second interval field 724 holds a value representing 6 seconds. The 30 second value in the first interval field 722 indicates that charges for the route will be made at

-57-

a first rate for **30** seconds and thereafter the charges will be made at a different rate in increments of **6** seconds, as indicated by the contents of the second interval field **724**.

5 Referring back to Figure **33A**, if at block **712** the processor finds a bundle override record of the type shown in Figure **37**, block **728** directs the processor to store the bundle override record in local memory. In the embodiment shown, the bundle override record shown in Figure **37** is stored in the bundle override record buffer at the RC as shown in Figure **7**. Still
10 referring to Figure **33A**, block **730** then directs the RC processor to determine whether or not the subscriber bundle table record **706** in Figure **35** has a services field including a code identifying that the user is entitled to free local calling and also directs the processor to determine whether or not the call type is not a cross domain cell, i.e. it is a local or local/national style. If both of
15 these conditions are satisfied, block **732** directs the processor to set the time to live equal to **99999**, giving the user a long period of time for the call. The process is then ended. If the conditions associated with block **730** are not satisfied, block **734** of Figure **33B** directs the RC processor to retrieve a subscriber account record associated with a participant in the call. This is
20 done by copying and storing in the subscriber account record buffer a subscriber account record for the caller.

Referring to Figure **38**, an exemplary subscriber account table record is shown generally at **736**. The record includes a user name field **738**, a funds
25 balance field **740** and a free time field **742**. The user name field **738** holds a subscriber user name, the funds balance field **740** holds a real number representing the dollar value of credit available to the subscriber and the free time field **742** holds an integer representing the number of free seconds that the user is entitled to.

30

An exemplary subscriber account record for the Vancouver caller is shown generally at **744** in Figure **39**, wherein the user name field **738** holds the user

-58-

5 name **2001 1050 8667**, the funds balance field **740** holds the value **\$10.00**, and the free time field **742** holds the value **100**. The funds balance field holding the value of **\$10.00** indicates the user has **\$10.00** worth of credit and the free time field having the value of **100** indicates that the user has a balance of **100** free seconds of call time.

10 Referring back to Figure **33B**, after copying and storing the subscriber account record shown in Figure **39** from the database to the subscriber account record buffer RC, block **746** directs the processor to determine whether or not the subscriber account record funds balance field **740** or free time field **742** are greater than zero. If they are not greater than zero, block **748** directs the processor to set the time to live equal to zero and the process is ended. The RC then sends a message back to the call controller to cause the call controller to deny the call to the caller. If the conditions associated with block **746** are satisfied, block **750** directs the processor to calculate the call cost per unit time. A procedure for calculating the call cost per unit time is described below in connection with Figure **41**.

20 Assuming the procedure for calculating the cost per second returns a number representing the call cost per second, block **752** directs the processor **202** in Figure **7** to determine whether or not the cost per second is equal to zero. If so, block **754** directs the processor to set the time to live to **99999** to give the caller a very long length of call and the process is ended.

25 If at block **752** the call cost per second is not equal to zero, block **756** directs the processor **202** in Figure **7** to calculate a first time to live value as a sum of a free time attributed to the participant in the communication session and the quotient of the funds balance held by the participant to the cost per unit time value. To do this, the processor **202** of Figure **7** is directed to set a first time value or temporary time to live value equal to the sum of the free time provided in the free time field **742** of the subscriber account record shown in Figure **39** and the quotient of the contents of the funds balance field **740** in the

30

-59-

subscriber account record for the call shown in Figure 39 and the cost per second determined at block 750 of Figure 33B. Thus, for example, if at block 750 the cost per second is determined to be three cents per second and the funds balance field holds the value \$10.00, the quotient of the funds balance and cost per second is 333 seconds and this is added to the contents of the free time field 742, which is 100, resulting in a time to live of 433 seconds.

Block 758 then directs the RC processor to produce a second time value in response to the first time value and the billing pattern associated with the participant as established by the bundle override record shown in Figure 37. This process is shown in greater detail at 760 in Figure 40 and generally involves producing a remainder value representing a portion of the second billing interval remaining after dividing the second billing interval into a difference between the first time value and the first billing interval.

Referring to Figure 40, the process for producing the second time value begins with a first block 762 that directs the processor 202 in Figure 7 to set a remainder value equal to the difference between the time to live value calculated at block 756 in Figure 33B and the contents of the first interval field 722 of the record shown in Figure 37, multiplied by the modulus of the contents of the second interval field 724 of Figure 37. Thus, in the example given, the difference between the time to live field and the first interval field is 433 minus 30, which is 403 and therefore the remainder produced by the mod of 403 divided by 6 is 0.17. Block 764 then directs the processor to determine whether or not this remainder value is greater than zero and, if so, block 766 directs the processor to subtract the remainder from the first time value and set the difference as the second time value. To do this the processor is directed to set the time to live value equal to the current time to live of 403 minus the remainder of 1, i.e., 402 seconds. The processor is then returned back to block 758 of Figure 33B.

-60-

Referring back to Figure 40, if at block 764 the remainder is not greater than zero, block 768 directs the processor 202 of Figure 7 to determine whether or not the time to live is less than the contents of the first interval field 722 in the record shown in Figure 37. If so, then block 770 of Figure 40 directs the processor to set the time to live equal to zero. Thus, the second time value is set to zero when the remainder is greater than zero and the first time value is less than the free time associated with the participant in the call. If at block 768 the conditions of that block are not satisfied, the processor returns the first time to live value as the second time to live value.

10

Thus, referring to Figure 33B, after having produced a second time to live value, block 772 directs the processor to set the time to live value for use in blocks 342, 350 or 564.

15

Cost per Second

Referring back to Figure 33B, at block 750 it was explained that a call cost per unit time is calculated. The following explains how that call cost per unit time value is calculated.

20

Referring to Figure 41, a process for calculating a cost per unit time is shown generally at 780. The process is executed by the processor 202 in Figure 7 and generally involves locating a record in a database, the record comprising a markup type indicator, a markup value and a billing pattern and setting a reseller rate equal to the sum of the markup value and the buffer rate, locating at least one of an override record specifying a route cost per unit time amount associated with a route associated with the communication session, a reseller record associated with a reseller of the communications session, the reseller record specifying a reseller cost per unit time associated with the reseller for the communication session and a default operator markup record specifying a default cost per unit time and setting as the cost per unit time the sum of the reseller rate and at least one of the route cost per unit time, the reseller cost per unit time and the default cost per unit time.

30

-61-

5 The process begins with a first set of blocks **782**, **802** and **820** which direct the processor **202** in Figure 7 to locate at least one of a record associated with a reseller and a route associated with the reseller, a record associated with the reseller, and a default reseller mark-up record. Block **782**, in particular, directs the processor to address the database **18** to look for a record associated with a reseller and a route with the reseller by looking for a special rate record based on the master list ID established at block **410** in Figure **8C**.

10

Referring to Figure **42**, a system operator special rate table record is shown generally at **784**. The record includes a reseller field **786**, a master list ID field **788**, a mark-up type field **790**, a mark-up value field **792**, a first interval field **794** and a second interval field **796**. The reseller field **786** holds a reseller ID code and the master list ID field **788** holds a master list ID code. The mark-up type field **790** holds a mark-up type such as fixed percent or cents and the mark-up value field **792** holds a real number representing the value corresponding to the mark-up type. The first interval field **794** holds a number representing a first level of charging and the second interval field **796** holds a number representing a second level of charging.

15
20

An exemplary system operator special rate table for a reseller known as "Klondike" is shown at **798** in Figure **43**. In this record, the reseller field **786** holds a code indicating the retailer ID is Klondike, the master list ID field **788** holds the code **1019** to associate the record with the master list ID code **1019**. The mark-up type field **790** holds a code indicating the mark-up type is cents and the mark-up value field **792** holds a mark-up value indicating **1/10** of one cent. The first interval field **794** holds the value **30** and the second interval field **796** holds the value **6**, these two fields indicating that the operator allows **30** seconds for free and then billing is done in increments of **6** seconds after that.

25
30

-62-

Referring back to Figure 41, if at block 782 a record such as the one shown in Figure 43 is located in the system operator special rates table, the processor is directed to block 800 in Figure 41. If such a record is not found in the system operator special rates table, block 802 directs the processor to address the database 18 to look in a system operator mark-up table for a mark-up record associated with the reseller.

Referring to Figure 44, an exemplary system operator mark-up table record is shown generally at 804. The record includes a reseller field 806, a mark-up type field 808, a mark-up value field 810, a first interval field 812 and a second interval field 814. The reseller mark-up type, mark-up value, first interval and second interval fields are as described in connection with the fields by the same names in the system operator special rates table shown in Figure 42.

Figure 45 provides an exemplary system operator mark-up table record for the reseller known as Klondike and therefore the reseller field 806 holds the value "Klondike", the mark-up type field 808 holds the value cents, the mark-up value field holds the value 0.01, the first interval field 812 holds the value 30 and the second interval field 814 holds the value 6. This indicates that the reseller "Klondike" charges by the cent at a rate of one cent per minute. The first 30 seconds of the call are free and billing is charged at the rate of one cent per minute in increments of 6 seconds.

Figure 46 provides an exemplary system operator mark-up table record for cases where no specific system operator mark-up table record exists for a particular reseller, i.e., a default reseller mark-up record. This record is similar to the record shown in Figure 45 and the reseller field 806 holds the value "all", the mark-up type field 808 is loaded with a code indicating mark-up is based on a percentage, the mark-up value field 810 holds the percentage by which the cost is marked up, and the first and second interval fields 812 and 814 identify first and second billing levels.

-63-

Referring back to Figure 41, if at block 802 a specific mark-up record for the reseller identified at block 782 is not located, block 820 directs the processor to get the mark-up record shown in Figure 46, having the "all" code in the reseller field 806. The processor is then directed to block 800.

5

Referring back to Figure 41, at block 800, the processor 202 of Figure 7 is directed to set a reseller rate equal to the sum of the mark-up value of the record located by blocks 782, 802 or 820 and the buffer rate specified by the contents of the buffer rate field 516 of the master list record shown in Figure 20. To do this, the RC processor sets a variable entitled "reseller cost per second" to a value equal to the sum of the contents of the mark-up value field (792, 810) of the associated record, plus the contents of the buffer rate field (516) from the master list record associated with the master list ID. Then, block 822 directs the processor to set a system operator cost per second variable equal to the contents of the buffer rate field (516) from the master list record. Block 824 then directs the processor to determine whether the call type flag indicates the call is local or national/local style and whether the caller has free local calling. If both these conditions are met, then block 826 sets the user cost per second variable equal to zero and sets two increment variables equal to one, for use in later processing. The cost per second has thus be calculated and the process shown in Figure 41 is ended.

10

15

20

25

30

If at block 824 the conditions of that block are not met, the processor 202 of Figure 7 is directed to locate at least one of a bundle override table record specifying a route cost per unit time associated with a route associated with the communication session, a reseller special destinations table record associated with a reseller of the communications session, the reseller record specifying a reseller cost per unit time associated with the reseller for the communication session and a default reseller global markup record specifying a default cost per unit time.

-64-

To do this block **828** directs the processor **202** of Figure **7** to determine whether or not the bundle override record **726** in Figure **37** located at block **712** in Figure **33A** has a master list ID equal to the stored master list ID that was determined at block **410** in Figure **8B**. If not, block **830** directs the processor to find a reseller special destinations table record in a reseller special destinations table in the database (**18**), having a master list ID code equal to the master list ID code of the master list ID that was determined at block **410** in Figure **8B**. An exemplary reseller special destinations table record is shown in Figure **47** at **832**. The reseller special destinations table record includes a reseller field **834**, a master list ID field **836**, a mark-up type field **838**, a mark-up value field **840**, a first interval field **842** and a second interval field **844**. This record has the same format as the system operator special rates table record shown in Figure **42**, but is stored in a different table to allow for different mark-up types and values and time intervals to be set according to resellers' preferences. Thus, for example, an exemplary reseller special destinations table record for the reseller "Klondike" is shown at **846** in Figure **48**. The reseller field **834** holds a value indicating the reseller as the reseller "Klondike" and the master list ID field holds the code **1019**. The mark-up type field **838** holds a code indicating the mark-up type is percent and the mark-up value field **840** holds a number representing the mark-up value as 5%. The first and second interval fields identify different billing levels used as described earlier.

Referring back to Figure **41**, the record shown in Figure **48** may be located at block **830**, for example. If at block **830** such a record is not found, then block **832** directs the processor to get a default operator global mark-up record based on the reseller ID.

Referring to Figure **49**, an exemplary default reseller global mark-up table record is shown generally at **848**. This record includes a reseller field **850**, a mark-up type field **852**, a mark-up value field **854**, a first interval field **856** and a second interval field **858**. The reseller field **850** holds a code identifying the

-65-

reseller. The mark-up type field **852**, the mark-up value field **854** and the first and second interval fields **856** and **858** are of the same type as described in connection with fields of the same name in Figure **47**, for example. The contents of the fields of this record **860** may be set according to system operator preferences, for example.

Referring to Figure **50**, an exemplary reseller global mark-up table record is shown generally at **860**. In this record, the reseller field **850** holds a code indicating the reseller is "Klondike", the mark-up type field **852** holds a code indicating the mark-up type is percent, the mark-up value field **854** holds a value representing **10%** as the mark-up value, the first interval field **856** holds the value **30** and the second interval field **858** holds the values **30** and **6** respectively to indicate the first **30** seconds are free and billing is to be done in **6** second increments after that.

Referring back to Figure **41**, should the processor get to block **832**, the reseller global mark-up table record as shown in Figure **50** is retrieved from the database and stored locally at the RC. As seen in Figure **41**, it will be appreciated that if the conditions are met in blocks **828** or **830**, or if the processor executes block **832**, the processor is then directed to block **862** which causes it to set an override value equal to the contents of the mark-up value field of the located record, to set the first increment variable equal to the contents of the first interval field of the located record and to set the second increment variable equal to the contents of the second interval field of the located record. (The increment variables were alternatively set to specific values at block **826** in Figure **41**.)

It will be appreciated that the located record could be a bundle override record of the type shown in Figure **37** or the located record could be a reseller special destination record of the type shown in Figure **48** or the record could be a reseller global mark-up table record of the type shown in Figure **50**. After the override and first and second increment variables have been set at block

-66-

5 **862**, the processor **202** if Figure 7 is directed to set as the cost per unit time the sum of the reseller rate and at least one of the route cost per unit time, the reseller cost per unit time and the default cost per unit time, depending on which record was located. To do this, block **864** directs the processor to set the cost per unit time equal to the sum of the reseller cost set at block **800** in Figure 41, plus the contents of the override variable calculated in block **862** in Figure 41. The cost per unit time has thus been calculated and it is this cost per unit time that is used in block **752** of Figure 33B, for example.

10 Terminating the Call

In the event that either the caller or the callee terminates a call, the telephone of the terminating party sends a SIP bye message to the controller **14**. An exemplary SIP bye message is shown at **900** in Figure 51 and includes a caller field **902**, a callee field **904** and a call ID field **906**. The caller field **902** holds a twelve digit user name, the callee field **904** holds a PSTN compatible number or user name, and the call ID field **906** holds a unique call identifier field of the type shown in the call ID field **65** of the SIP invite message shown in Figure 3.

20 Thus, for example, referring to Figure 52, a SIP bye message for the Calgary callee is shown generally at **908** and the caller field **902** holds a user name identifying the caller, in this case **2001 1050 8667**, the callee field **904** holds a user name identifying the Calgary callee, in this case **2001 1050 2222**, and the call ID field **906** holds the code **FA10 @ 192.168.0.20**, which is the call ID for the call.

25 The SIP bye message shown in Figure 52 is received at the call controller **14** and the call controller executes a process as shown generally at **910** in Figure 53. The process includes a first block **912** that directs the call controller processor **202** of Figure 7 to copy the caller, callee and call ID field contents from the SIP bye message received from the terminating party to corresponding fields of an RC stop message buffer (not shown). Block **914**

30

-67-

then directs the processor to copy the call start time from the call timer and to obtain a call stop time from the call timer. Block **916** then directs the call controller to calculate a communication session time by determining the difference in time between the call start time and the call stop time. This session time is then stored in a corresponding field of the RC call stop message buffer. Block **917** then directs the processor to decrement the contents of the current concurrent call field **277** of the dialing profile for the caller as shown in Figure **10**, to indicate that there is one less concurrent call in progress. A copy of the amended dialing profile for the caller is then stored in the database **18** of Figure **1**. Block **918** then directs the processor to copy the route from the call log. An RC call stop message produced as described above is shown generally at **1000** in Figure **54**. An RC call stop message specifically associated with the call made to the Calgary callee is shown generally at **1020** in Figure **55**.

Referring to Figure **54**, the RC stop call message includes a caller field **1002**, callee field **1004**, a call ID field **1006**, an account start time field **1008**, an account stop time field **1010**, a communication session time **1012** and a route field **1014**. The caller field **1002** holds a username, the callee field **1004** holds a PSTN-compatible number or system number, the call ID field **1006** hold the unique call identifier received from the SIP invite message shown in Figure **3**, the account start time field **1008** holds the date and start time of the call, the account stop time field **1010** holds the date and time the call ended, the communication session time field **1012** holds a value representing the difference between the start time and the stop time, in seconds, and the route field **1014** holds the IP address for the communications link that was established.

Referring to Figure **55**, an exemplary RC stop call message for the Calgary callee is shown generally at **1020**. In this example the caller field **1002** holds the user name **2001 1050 8667** identifying the Vancouver-based caller and the callee field **1004** holds the user name **2001 1050 2222** identifying the

-68-

5 Calgary callee. The contents of the call ID field **1006** are **FA10 @ 192.168.0.20**. The contents of the account start time field **1008** are **2006-12-30 12:12:12** and the contents of the account stop time field are **2006-12-30 12:12:14**. The contents of the communication session time field **1012** are **2** to indicate **2** seconds call duration and the contents of the route field are **72.64.39.58**.

10 Referring back to Figure **53**, after having produced an RC call stop message, block **920** directs the processor **202** in Figure **7** to send the RC stop message compiled in the RC call stop message buffer to the RC **16** of Figure **1**. Block **922** directs the call controller **14** to send a "bye" message back to the party that did not terminate the call.

15 The RC **16** of Figure **1** receives the call stop message and an RC call stop message process is invoked at the RC, the process being shown at **950** in Figures **56A**, **56B** and **56C**. Referring to Figure **56A**, the RC stop message process **950** begins with a first block **952** that directs the processor **202** in Figure **7** to determine whether or not the communication session time is less than or equal to the first increment value set by the cost calculation routine shown in Figure **41**, specifically blocks **826** or **862** thereof. If this condition is met, then block **954** of Figure **56A** directs the RC processor to set a chargeable time variable equal to the first increment value set at block **826** or **862** of Figure **41**. If at block **952** of Figure **56A** the condition is not met, block **956** directs the RC processor to set a remainder variable equal to the difference between the communication session time and the first increment value mod the second increment value produced at block **826** or **862** of Figure **41**. Then, the processor is directed to block **958** of Figure **56A** which directs it to determine whether or not the remainder is greater than zero. If so, block **960** directs the RC processor to set the chargeable time variable equal to the difference between the communication session time and the remainder value. If at block **958** the remainder is not greater than zero, block **962** directs the RC processor to set the chargeable time variable equal to the contents of the

20

25

30

-69-

communication session time from the RC stop message. The processor is then directed to block **964**. In addition, after executing block **954** or block **960**, the processor is directed to block **964**.

5 Block **964** directs the processor **202** of Figure **7** to determine whether or not the chargeable time variable is greater than or equal to the free time balance as determined from the free time field **742** of the subscriber account record shown in Figure **39**. If this condition is satisfied, block **966** of Figure **56A**
10 directs the processor to set the free time field **742** in the record shown in Figure **39**, to zero. If the chargeable time variable is not greater than or equal to the free time balance, block **968** directs the RC processor to set a user cost variable to zero and Block **970** then decrements the free time field **742** of the subscriber account record for the caller by the chargeable time amount determined by block **954**, **960** or **962**.

15 If at Block **964** the processor **202** of Figure **7** was directed to Block **966** which causes the free time field (**742** of Figure **39**) to be set to zero, referring to Figure **56B**, Block **972** directs the processor to set a remaining chargeable time variable equal to the difference between the chargeable time and the
20 contents of the free time field (**742** of Figure **39**). Block **974** then directs the processor to set the user cost variable equal to the product of the remaining chargeable time and the cost per second calculated at Block **750** in Figure **33B**. Block **976** then directs the processor to decrement the funds balance field (**740**) of the subscriber account record shown in Figure **39** by the
25 contents of the user cost variable calculated at Block **974**.

 After completing Block **976** or after completing Block **970** in Figure **56A**, block **978** of Figure **56B** directs the processor **202** of Figure **7** to calculate a
30 reseller cost variable as the product of the reseller rate as indicated in the mark-up value field **810** of the system operator mark-up table record shown in Figure **45** and the communication session time determined at Block **916** in Figure **53**. Then, Block **980** of Figure **56B** directs the processor to add the

-70-

reseller cost to the reseller balance field **986** of a reseller account record of the type shown in Figure **57** at **982**.

5 The reseller account record includes a reseller ID field **984** and the aforementioned reseller balance field **986**. The reseller ID field **984** holds a reseller ID code, and the reseller balance field **986** holds an accumulated balance of charges.

10 Referring to Figure **58**, a specific reseller accounts record for the reseller "Klondike" is shown generally at **988**. In this record the reseller ID field **984** holds a code representing the reseller "Klondike" and the reseller balance field **986** holds a balance of **\$100.02**. Thus, the contents of the reseller balance field **986** in Figure **58** are incremented by the reseller cost calculated at block **978** of Figure **56B**.

15 Still referring to Figure **56B**, after adding the reseller cost to the reseller balance field as indicated by Block **980**, Block **990** directs the processor to **202** of Figure **7** calculate a system operator cost as the product of the system operator cost per second, as set at block **822** in Figure **41**, and the
20 communication session time as determined at Block **916** in Figure **53**. Block **992** then directs the processor to add the system operator cost value calculated at Block **990** to a system operator accounts table record of the type shown at **994** in Figure **59**. This record includes a system operator balance field **996** holding an accumulated charges balance. Referring to Figure **60** in
25 the embodiment described, the system operator balance field **996** may hold the value **\$1,000.02** for example, and to this value the system operator cost calculated at Block **990** is added when the processor executes Block **992** of Figure **56B**.

30 Ultimately, the final reseller balance **986** in Figure **58** holds a number representing an amount owed to the reseller by the system operator and the

-71-

system operator balance **996** of Figure **59** holds a number representing an amount of profit for the system operator.

5 While specific embodiments of the invention have been described and illustrated, such embodiments should be considered illustrative of the invention only and not as limiting the invention as construed in accordance with the accompanying claims.

-72-

What is claimed is:

- 5 1. A process for operating a call routing controller to facilitate communication between callers and callees in a system comprising a plurality of nodes with which callers and callees are associated, the process comprising:
- 10 in response to initiation of a call by a calling subscriber, receiving a caller identifier and a callee identifier;
- using call classification criteria associated with the caller identifier to classify the call as a public network call or a private network call;
- 15 producing a routing message identifying an address, on the private network, associated with the callee when the call is classified as a private network call; and
- producing a routing message identifying a gateway to the public network when the call is classified as a public network call.
- 20
2. The process of claim 1 further comprising receiving a request to establish a call, from a call controller in communication with a caller identified by said callee identifier.
- 25
3. The process of claim 1 wherein using said call classification criteria comprises searching a database to locate a record identifying calling attributes associated with a caller identified by said caller identifier.
- 30 4. The process of claim 3 wherein locating a record comprises locating a caller dialing profile comprising a username associated with said caller, a domain associated with said caller, and at least one calling attribute.

-73-

- 5
5. The process of claim 4 wherein using said call classification criteria comprises comparing calling attributes associated with said caller dialing profile with aspects of said callee identifier.
- 10
6. The process of claim 4 wherein comparing comprises determining whether said callee identifier includes a portion that matches an IDD associated with said caller dialing profile.
- 15
7. The process of claim 4 wherein comparing comprises determining whether said callee identifier includes a portion that matches an NDD associated with said caller dialing profile.
- 20
8. The process of claim 4 wherein comparing comprises determining whether said callee identifier includes a portion that matches an area code associated with said caller dialing profile.
- 25
9. The process of claim 4 wherein comparing comprises determining whether said callee identifier has a length within a range specified in said caller dialing profile.
- 30
10. The process of claim 4 further comprising formatting said callee identifier into a pre-defined digit format to produce a re-formatted callee identifier.
11. The process of claim 10 wherein formatting comprises removing an international dialing digit from said callee identifier, when said callee identifier begins with a digit matching an international dialing digit specified by said caller dialing profile associated with said caller.
12. The process of claim 10 wherein formatting comprises removing a national dialing digit from said callee identifier and prepending a caller

-74-

country code to said callee identifier when said callee identifier begins with a national dialing digit.

- 5
- 13.** The process of claim **10** wherein formatting comprises prepending a caller country code to said callee identifier when said callee identifier begins with digits identifying an area code specified by said caller dialing profile.
- 10
- 14.** The process of claim **10** wherein formatting comprises prepending a caller country code and area code to said callee identifier when said callee identifier has a length that matches a caller dialing number format specified by said caller dialing profile and only one area code is specified as being associated with said caller in said caller dialing profile.
- 15
- 15.** The process of claim **10** further comprising classifying said call as a private network call when said re-formatted callee identifier identifies a subscriber to the private network.
- 20
- 16.** The process of claim **10** further comprising determining whether said callee identifier complies with a pre-defined username format and if so classifying the call as a private network call.
- 25
- 17.** The process of claim **10** further comprising causing a database of records to be searched to locate a direct in dial (DID) bank table record associating a public telephone number with said reformatted callee identifier and if said DID bank table record is found classifying the call as a private network call and if a DID bank table record is not found classifying the call as a public network call.
- 30
- 18.** The process of claim **17** wherein producing said routing message identifying a node on the private network comprises setting a callee

-75-

identifier in response to a username associated with said DID bank table record.

- 5 **19.** The process of claim **18** wherein producing said routing message comprises determining whether a node associated with the reformatted callee identifier is the same as a node associated the caller identifier.
- 10 **20.** The process of claim **19** wherein determining whether a node associated with the reformatted callee identifier is the same as a node associated the caller identifier comprises determining whether a prefix of said re-formatted callee identifier matches a corresponding prefix of a username associated with said caller dialing profile.
- 15 **21.** The process of claim **20** wherein when said node associated with said caller is not the same as the node associated with the callee, producing a routing message including said caller identifier, said reformatted callee identifier and an identification of a private network node associated with said callee and communicating said routing message to a call controller.
- 20 **22.** The process of claim **19** wherein when said node associated with said caller is the same as the node associated with said callee, determining whether to perform at least one of the following: forward said call to another party, block the call and direct the caller to a voicemail server associated with the callee.
- 25 **23.** The process of claim **22** wherein producing said routing message comprises producing a routing message having an identification of at least one of the callee identifier, an identification of a party to whom the call should be forwarded and an identification of a voicemail server associated with the callee.
- 30

-76-

24. The process of claim **23** further comprising communicating said routing message to a call controller.
- 5 25. The process of claim **10** wherein producing a routing message identifying a gateway to the public network comprises searching a database of route records associating route identifiers with dialing codes to find a route record having a dialing code having a number pattern matching at least a portion of said reformatted callee identifier.
- 10 26. The process of claim **25** further comprising searching a database of supplier records associating supplier identifiers with said route identifiers to locate at least one supplier record associated with said route identifier associated with said route record having a dialing code having a number pattern matching at least a portion of said reformatted
- 15 callee identifier.
27. The process of claim **26** further comprising loading a routing message buffer with the reformatted callee identifier and an identification of specific routes associated respective ones of the supplier records
- 20 associated with said route record and loading said routing message buffer with a time value and a timeout value.
28. The process of claim **27** further comprising communicating a routing message comprising the contents of said routing message buffer to a
- 25 call controller.
29. The process of claim **4** further comprising causing said dialing profile to include a maximum concurrent call value and a concurrent call count value and causing said concurrent call count value to be incremented
- 30 when the user associated with said dialing profile initiates a call and causing said concurrent call count value to be decremented when a call with said user associated with said dialing profile is ended.

-77-

- 30.** A computer readable medium encoded with codes for directing a processor to execute the method of any one of claims **1-29**.
- 5 **31.** A call routing apparatus for facilitating communications between callers and callees in a system comprising a plurality of nodes with which callers and callees are associated, the apparatus comprising:
- 10 receiving means for receiving a caller identifier and a callee identifier, in response to initiation of a call by a calling subscriber;
- 15 classifying means for classifying the call as a private network call or a public network call according to call classification criteria associated with the caller identifier;
- 20 means for producing a routing message identifying an address, on the private network, associated with the callee when the call is classified as a private network call; and
- 25 means for producing a routing message identifying a gateway to the public network if the call is classified as a public network call.
- 32.** The apparatus of claim **31** wherein said receiving means is operably configured to receive a request to establish a call, from a call controller in communication with a caller identified by said callee identifier.
- 30 **33.** The apparatus of claim **31** further comprising searching means for searching a database comprising records associating calling attributes with subscribers to said private network to locate a record identifying calling attributes associated with a caller identified by said caller identifier.

-78-

- 5 **34.** The apparatus of claim **33** wherein said records include dialing profiles each comprising a username associated with said subscriber, an identification of a domain associated with said subscriber, and an identification of at least one calling attribute associated with said subscriber.
- 10 **35.** The apparatus of claim **34** wherein said call classification means is operably configured to compare calling attributes associated with said caller dialing profile with aspects of said callee identifier.
- 15 **36.** The apparatus of claim **35** wherein said calling attributes include an international dialing digit and wherein said call classification means is operably configured to determine whether said callee identifier includes a portion that matches an IDD associated with said caller dialing profile.
- 20 **37.** The apparatus of claim **34** wherein said calling attributes include an national dialing digit and wherein said call classification means is operably configured to determine whether said callee identifier includes a portion that matches an NDD associated with said caller dialing profile.
- 25 **38.** The apparatus of claim **34** wherein said calling attributes include an area code and wherein said call classification means is operably configured to determine whether said callee identifier includes a portion that matches an area code associated with said caller dialing profile.
- 30 **39.** The apparatus of claim **34** wherein said calling attribute include a number length range and wherein said call classification means is operably configured to determine whether said callee identifier has a length within a range specified in said caller dialing profile.

-79-

- 5
40. The apparatus of claim **34** further comprising formatting means for formatting said callee identifier into a pre-defined digit format to produce a re-formatted callee identifier.
- 10
41. The apparatus of claim **40** wherein said formatting means is operably configured to remove an international dialing digit from said callee identifier, when said callee identifier begins with a digit matching an international dialing digit specified by said caller dialing profile associated with said caller.
- 15
42. The apparatus of claim **40** wherein said formatting means is operably configured to remove a national dialing digit from said callee identifier and prepend a caller country code to said callee identifier when said callee identifier begins with a national dialing digit.
- 20
43. The apparatus of claim **40** wherein said formatting means is operably configured to prepend a caller country code to said callee identifier when said callee identifier begins with digits identifying an area code specified by said caller dialing profile.
- 25
44. The apparatus of claim **40** wherein said formatting means is operably configured to prepend a caller country code and area code to said callee identifier when said callee identifier has a length that matches a caller dialing number format specified by said caller dialing profile and only one area code is specified as being associated with said caller in said caller dialing profile.
- 30
45. The apparatus of claim **40** wherein said classifying means is operably configured to classifying said call as a private network call when said re-formatted callee identifier identifies a subscriber to the private network.

-80-

- 5
46. The apparatus of claim **40** wherein said classifying means is operably configured to classify the call as a private network call when said callee identifier complies with a pre-defined username format.
- 10
47. The apparatus of claim **40** further comprising searching means for searching a database of records to locate a direct in dial (DID) bank table record associating a public telephone number with said reformatted callee identifier and wherein said classifying means is operably configured to classify the call as a private network call when said DID bank table record is found and to classify the call as a public network call when a DID bank table record is not found
- 15
48. The apparatus of claim **47** wherein said private network routing message producing means is operably configured to produce a routing message having a callee identifier set according to a username associated with said DID bank table record.
- 20
49. The apparatus of claim **48** wherein said private network routing message producing means is operably configured to determine whether a node associated with the reformatted callee identifier is the same as a node associated the caller identifier.
- 25
50. The apparatus of claim **49** wherein said private network routing means includes means for determining whether a prefix of said re-formatted callee identifier matches a corresponding prefix of a username associated with said caller dialing profile.
- 30
51. The apparatus of claim **50** wherein said private network routing message producing means is operably configured to produce a routing message including said caller identifier, said reformatted callee identifier and an identification of a private network node associated with

-81-

said callee and communicating said routing message to a call controller.

- 5
- 52.** The apparatus of claim **49** wherein said private network routing message producing means is operably configured to perform at least one of the following: forward said call to another party, block the call and direct the caller to a voicemail server associated with the callee, when said node associated with said caller is the same as the node associated with said callee.
- 10
- 53.** The apparatus of claim **52** wherein said means for producing said private network routing message is operably configured to produce a routing message having an identification of at least one of the callee identifier, an identification of a party to whom the call should be forwarded and an identification of a voicemail server associated with the callee.
- 15
- 54.** The apparatus of claim **53** further comprising means for communicating said routing message to a call controller.
- 20
- 55.** The apparatus of claim **40** wherein said means for producing a public network routing message identifying a gateway to the public network comprises means for searching a database of route records associating route identifiers with dialing codes to find a route record having a dialing code having a number pattern matching at least a portion of said reformatted callee identifier.
- 25
- 56.** The apparatus of claim **55** further comprising means for searching a database of supplier records associating supplier identifiers with said route identifiers to locate at least one supplier record associated with said route identifier associated with said route record having a dialing
- 30

-82-

code having a number pattern matching at least a portion of said reformatted callee identifier.

- 5 **57.** The apparatus of claim **56** further comprising a routing message buffer and means for loading said routing message buffer with the reformatted callee identifier and an identification of specific routes associated respective ones of the supplier records associated with said route record and loading said routing message buffer with a time value and a timeout value.
- 10 **58.** The apparatus of claim **57** further comprising means for communicating a routing message comprising the contents of said routing message buffer to a call controller.
- 15 **59.** The apparatus of claim **34** further comprising means for causing said dialing profile to include a maximum concurrent call value and a concurrent call count value and for causing said concurrent call count value to be incremented when the user associated with said dialing profile initiates a call and for causing said concurrent call count value to be decremented when a call with said user associated with said dialing profile is ended.
- 20

Data Structure

- 25 **60.** A data structure for access by an apparatus for producing a routing message for use by a call routing controller in a communications system, the data structure comprising:

30 dialing profile records comprising fields for associating with respective subscribers to the system:

 a subscriber user name

-83-

direct-in-dial records comprising fields for associating with respective subscriber usernames:

5 a user domain; and

a direct-in-dial number;

10 prefix to node records comprising fields for associating with at least a portion of said respective subscriber usernames:

a node address of a node in said system,

15 whereby a subscriber name can be used to find a user domain, at least a portion of said a subscriber name can be used to find a node with which the subscriber identified by the subscriber name is associated, and a user domain and subscriber name can be located in response to a direct-in-dial number.

20 **61.** A data structure for access by an apparatus for producing a routing message for use by a call routing controller in a communications system, the data structure comprising:

25 master list records comprising fields for associating a dialing code with respective master list identifiers; and

supplier list records linked to master list records by said master list identifiers, and supplier list records comprising fields for associating with a communications services supplier:

30 a supplier id;

-84-

a master list id;

a route identifier; and

5 a billing rate code,

whereby communications services suppliers are associated with dialing codes, such that dialing codes can be used to locate suppliers capable of providing a communications link associated with a given dialing code.

10

62. A method of determining a time to permit a communication session to be conducted, the method comprising:

15 calculating a cost per unit time;

calculating a first time value as a sum of a free time attributed to a participant in the communication session and the quotient of a funds balance held by said participant to said cost per unit time value; and

20

producing a second time value in response to said first time value and a billing pattern associated with said participant, said billing pattern including first and second billing intervals and said second time value being said time to permit a communication session to be conducted.

25

63. The method of claim **62** wherein calculating said first time value comprises retrieving a record associated with said participant and obtaining from said record at least one of said free time and said funds balance.

30

-85-

- 5 **64.** The method of claim **62** wherein producing said second time value comprises producing a remainder value representing a portion of said second billing interval remaining after dividing said second billing interval into a difference between said first time value and said first billing interval.
- 10 **65.** The method of claim **64** wherein producing said second time value comprises setting a difference between said first time value and said remainder as said second time value.
- 66.** The method of claim **62** further comprising setting said second time value to zero when said remainder is greater than zero and said first time value is less than said free time associated with said participant.
- 15 **67.** The method of claim **62** wherein calculating said cost per unit time comprises:
- locating a record in a database, said record comprising a markup type indicator, a markup value and a billing pattern;
- 20 and
- setting a reseller rate equal to the sum of said markup value and said buffer rate.
- 25 **68.** The method of claim **67** wherein locating said record in a database comprises locating at least one of:
- a record associated with a reseller and a route associated with the reseller;
- 30 a record associated with the reseller; and

a default reseller markup record.

5 **69.** The method of claim **67** wherein calculating said cost per unit time value further comprises locating at least one of:

10 an override record specifying a route cost per unit time amount associated with a route associated with the communication session;

15 a reseller record associated with a reseller of said communications session, said reseller record specifying a reseller cost per unit time associated with said reseller for the communication session;

 a default operator markup record specifying a default cost per unit time.

20 **70.** The method of claim **69** further comprising setting as said cost per unit time the sum of said reseller rate and at least one of said route cost per unit time, said reseller cost per unit time and said default cost per unit time.

25 **71.** The method of claim **69** further comprising receiving a communication session time representing a duration of said communication session and incrementing a reseller balance by the product of said reseller rate and said communication session time.

30 **72.** The method of claim **69** further comprising receiving a communication session time representing a duration of said communication session and incrementing a system operator balance by a product of said buffer rate and said communication session time.

-87-

73. A computer readable medium encoded with instructions for directing a processor circuit to execute the method of any one of claims **62-72**.
- 5 74. An apparatus for determining a time to permit a communication session to be conducted, the apparatus comprising:
- a processor circuit;
- 10 a computer readable medium coupled to the processor circuit and encoded with instructions for directing the processor circuit to:
- calculate a cost per unit time for the communication session;
- 15 calculate a first time value as a sum of a free time attributed to a participant in the communication session and the quotient of a funds balance held by said participant to said cost per unit time value; and
- 20 produce a second time value in response to said first time value and a billing pattern associated with said participant, said billing pattern including first and second billing intervals and said second time value being said time to permit a communication
- 25 session to be conducted.
- 30 75. The apparatus of claim **74** wherein said instructions include instructions for directing the processor circuit to retrieve a record associated with said participant and obtain from said record at least one of said free time and said funds balance.

-88-

- 5 **76.** The apparatus of claim **74** wherein said instructions include instructions for directing the processor circuit to produce said second time value by producing a remainder value representing a portion of said second billing interval remaining after dividing said second billing interval into a difference between said first time value and said first billing interval.
- 10 **77.** The apparatus of claim **76** wherein said instructions include instructions for directing the processor circuit to produce said second time value comprises setting a difference between said first time value and said remainder as said second time value.
- 15 **78.** The apparatus of claim **74** wherein said instructions include instructions for directing the processor circuit to set said second time value to zero when said remainder is greater than zero and said first time value is less than said free time associated with said participant.
- 20 **79.** The apparatus of claim **74** wherein said instructions for directing said processor circuit to calculate said cost per unit time comprises instructions for directing the processor circuit to:
- 25 locate a record in a database, said record comprising a markup type indicator, a markup value and a billing pattern;
- and
- set a reseller rate equal to the sum of said markup value and said buffer rate.

30

-89-

80. The apparatus of claim **79** wherein said instructions for directing the processor circuit to locate said record in a database comprises instruction for directing the processor circuit to locate at least one of:

5 a record associated with a reseller and a route associated with the reseller;

 a record associated with the reseller;

10 a default reseller markup record;

81. The apparatus of claim **79** wherein said instructions for directing the processor circuit to calculate said cost per unit time value further comprises instructions for directing the processor circuit to locate at least one of:

15 an override record specifying a route cost per unit time amount associated with a route associated with the communication session;

20 a reseller record associated with a reseller of said communications session, said reseller record specifying a reseller cost per unit time associated with said reseller for the communication session;

25 a default operator markup record specifying a default cost per unit time.

82. The apparatus of claim **81** wherein said instructions include instructions for directing the processor circuit to set as said cost per unit time the sum of said reseller rate and at least one of said route

30

-90-

cost per unit time, said reseller cost per unit time and said default cost per unit time.

5 **83.** The apparatus of claim **81** wherein said instructions include instructions for directing the processor circuit to receive a communication session time representing a duration of said communication session and increment a reseller balance by the product of said reseller rate and said communication session time.

10 **84.** The apparatus of claim **81** wherein said instructions include instructions for directing the processor circuit to receive a communication session time representing a duration of said communication session and increment a system operator balance by a product of said buffer rate and said communication session time.

15

Attributing Charges to a User

85. A process for attributing charges for communications services, the process comprising:

20

determining a first chargeable time in response to a communication session time and a pre-defined billing pattern;

25

determining a user cost value in response to said first chargeable time and a free time value associated with a user of said communications services;

30

changing an account balance associated with said user in response to a user cost per unit time.

-91-

changing an account balance associated with a reseller of said communications services in response to a reseller cost per unit time and said communication session time; and

5 changing an account balance associated with an operator of said communications services in response to an operator cost per unit time and said communication session time.

10 **86.** The process of claim **85** wherein determining said first chargeable time comprises:

locating at least one of:

15 an override record specifying a route cost per unit time and billing pattern associated with a route associated with the communication session;

20 a reseller record associated with a reseller of said communications session, said reseller record specifying a reseller cost per unit time and billing pattern associated with said reseller for the communication session; and

25 a default record specifying a default cost per unit time and billing pattern; and

setting as said pre-defined billing pattern the billing pattern of the record located,

30 wherein the billing pattern of the record located comprises a first billing interval and a second billing interval.

-92-

- 5
- 87.** The process of claim **85** wherein determining said first chargeable time comprises setting said first chargeable time equal to said first billing interval when said communication session time is less than or equal to said first billing interval.
- 10
- 88.** The process of claim **86** wherein determining said first chargeable time comprises producing a remainder value representing a portion of said second billing interval remaining after dividing said second billing interval into a difference between communication session time and said first interval when said communication session time is greater than said communication session time; and
- 15
- setting said first chargeable time to a difference between said communication session time and said remainder when said remainder is greater than zero; and
- 20
- setting said first chargeable time to said communication session time when said remainder is not greater than zero.
- 25
- 89.** The process of claim **88** further comprising determining a second chargeable time in response to said first chargeable time and said free time value associated with said user of said communications services when said first chargeable time is greater than or equal to said free time value associated with said user of said communications services.
- 30
- 90.** The process of claim **89** wherein determining said second chargeable time comprises setting said second chargeable time to a difference between said first chargeable time.
- 91.** The process of claim **89** further comprising resetting said free time value associated with the user to zero when said first chargeable time

-93-

is greater than or equal to said free time value associated with said user of said communications services.

- 5 **92.** The process of claim **90** wherein changing an account balance associated with the user comprises calculating a user cost value in response to said second chargeable time and said user cost per unit time.
- 10 **93.** The process of claim **92** further comprising changing a user free cost balance in response to said user cost value.
- 15 **94.** The process of claim **85** further comprising setting said user cost to zero when said first chargeable time is less than said free time value associated with the user.
- 95.** The process of claim **85** further comprising changing a user free time balance in response to said first chargeable time.
- 20 **96.** A computer readable medium encoded with instructions for directing a processor circuit to execute the process of any one of claims **85-95**.
- 97.** An apparatus for attributing charges for communications services, the apparatus comprising:
- 25 a processor circuit;
- a computer readable medium in communication with the processor circuit and encoded with instructions for directing said processor circuit to;
- 30 determine a first chargeable time in response to a communication session time and a pre-defined billing pattern;

-94-

determine a user cost value in response to said first chargeable time and a free time value associated with a user of said communications services;

5

change an account balance associated with said user in response to a user cost per unit time.

change an account balance associated with a reseller of said communications services in response to a reseller cost per unit time and said communication session time; and

10

change an account balance associated with an operator of said communications services in response to an operator cost per unit time and said communication session time.

15

98. The apparatus of claim **97** wherein said instructions for directing the processor circuit to determine said first chargeable time comprises:

20

instructions for causing said processor circuit to communicate with a database to locate at least one of:

an override record specifying a route cost per unit time and billing pattern associated with a route associated with the communication session;

25

a reseller record associated with a reseller of said communications session, said reseller record specifying a reseller cost per unit time and billing pattern associated with said reseller for the communication session; and

30

-95-

a default record specifying a default cost per unit time and billing pattern; and

5 instructions for setting as said pre-defined billing pattern the billing pattern of the record located,

wherein the billing pattern of the record located comprises a first billing interval and a second billing interval.

10 **99.** The apparatus of claim **97** wherein said instructions causing the processor circuit to determine said first chargeable time comprises instructions for directing the processor circuit to set said first chargeable time equal to said first billing interval when said communication session time is less than or equal to said first billing interval.

15 **100.** The apparatus of claim **98** wherein said instructions for causing the processor circuit to determine said first chargeable time comprises instructions for producing a remainder value representing a portion of said second billing interval remaining after dividing said second billing interval into a difference between communication session time and said first interval when said communication session time is greater than said communication session time; and

25 instructions for causing the processor circuit to set said first chargeable time to a difference between said communication session time and said remainder when said remainder is greater than zero; and

30 instructions for causing the processor circuit to set said first chargeable time to said communication session time when said remainder is not greater than zero.

-96-

- 5 **101.** The apparatus of claim **100** wherein the computer readable medium is further encoded with instructions for causing the processor circuit to determine a second chargeable time in response to said first chargeable time and said free time value associated with said user of said communications services when said first chargeable time is greater than or equal to said free time value associated with said user of said communications services.
- 10 **102.** The apparatus of claim **101** wherein said instructions for causing the processor circuit to determine said second chargeable time comprises instructions for causing the processor circuit to set said second chargeable time to a difference between said first chargeable time.
- 15 **103.** The apparatus of claim **101** wherein the computer readable medium is further encoded with instructions for causing the processor circuit to reset said free time value associated with the user to zero when said first chargeable time is greater than or equal to said free time value associated with said user of said communications services.
- 20 **104.** The apparatus of claim **102** wherein said instructions for causing the processor circuit to change an account balance associated with the user comprises instructions for causing the processor circuit to calculate a user cost value in response to said second chargeable time and said user cost per unit time.
- 25 **105.** The apparatus of claim **104** wherein the computer readable medium is further encoded with instructions for causing the processor circuit to change a user free cost balance in response to said user cost value.
- 30 **106.** The apparatus of claim **97** wherein the computer readable medium is further encoded with instructions for causing the processor circuit to

-97-

set said user cost to zero when said first chargeable time is less than said free time value associated with the user.

- 5 **107.** The apparatus of claim 97 wherein the computer readable medium is further encoded with instructions for causing the processor circuit to change a user free time balance in response to said first chargeable time.

Patent Record Full View

Wednesday, June 3 2015

THOMSON INNOVATION

Patent/Publication: SG152752A1**Bibliography****DWPI Title**

Communication i.e. voice over internet protocol data communication, intercepting method for internet protocol network, involves communicating media relay when determination information meets intercept criteria

Assignee/Applicant

Original: DIGIFONICA, CA

DWPI Assignee/Applicant

BJORSELL J E V (BJOE-I); DIGIFONICA (DIGI-N); DIGIFONICA INT LTD (DIGI-N); SOBOLYEV M (SOBO-I)

Inventor

BJORSELL JOHAN EMIL VICTOR, CA SOBOLYEV MAKSYM, CA

Publication Date (Kind Code)

2009-06-29 (A1)

Application Number / Date

SG20093584A / 2007-11-29

Priority Number / Date / Country

US2006861431P / 2006-11-29 / US

Translation of / Language

- /English

Abstract**DWPI Abstract**

(WO2008064481A1)

Novelty

The method involves maintaining dialing profiles for respective subscribers to an internet protocol (IP) network. An intercept information is associated with the dialing profile of a subscriber whose communications are to be monitored. A media relay (17) is communicated when the determination information meets intercept criteria, where the communications involving the subscriber are conducted through the media relay to cause the media relay to send a copy of the communications to a mediation device specified by a destination information.

Detailed Description

An INDEPENDENT CLAIM is also included for an apparatus for intercepting communications in an Internet Protocol (IP) network.

Use

Method for intercepting communication i.e. voice over internet protocol data communication, in an Internet Protocol (IP) network.

Advantage

The method easily allows the dialing profile to be considered as a repository for intercept information for the subscriber and addresses the repository that whether a call is being initiated or in progress, thus effectively intercepting communication in the internet Protocol (IP) networks.

Drawing Description

The drawing shows a block diagram of a voice over internet protocol (IP) telephone call making system.

10 - Voice over internet protocol (IP) telephone call making system.

11, 21 - Supernodes.

14 - Call controller.

15, 22 - Telephones.

16 - Routing controller.

17 - Media relay.

18 - Data base.

19 - Voicemail server.

23 - Data communication media.

41 - Dialed number buffer.

Abstract

(WO2008064481A1)

Methods and apparatus for intercepting communications in an Internet Protocol (IP) network involve maintaining dialing profiles for respective subscribers to the IP network, each dialing profile including a username associated with the corresponding subscriber, and associating intercept information with the dialing profile of a subscriber whose communications are to be monitored. Intercept information will include determination information for determining whether to intercept a communication involving the subscriber, and destination information identifying a device to which intercepted communications involving the subscriber are to be sent. When the determination information meets intercept criteria communications are established with a media relay through which communications involving the subscriber will be conducted or are being conducted to cause the media relay to send a copy of the communications involving the subscriber to a mediation device specified by the destination information.

Methods and apparatus for intercepting communications in an Internet Protocol (IP) network involve maintaining dialing profiles for respective subscribers to the IP network, each dialing profile including a username associated with the corresponding subscriber, and associating intercept information with the dialing profile of a subscriber whose communications are to be monitored. Intercept information will include determination information for determining whether to intercept a communication involving the subscriber, and destination information identifying a device to which intercepted communications involving the subscriber are to be sent. When the determination information meets intercept criteria communications are established with a media relay through which communications involving the subscriber will be conducted or are being conducted to cause the media relay to send a copy of the communications involving the subscriber to a mediation device specified by the destination information.

Classes/Indexing

No Classes/Indexing exists for this Record

Legal Status**INPADOC Legal Status**

Get Family Legal Status

Family**Family**

INPADOC Family (0)

Expand DWPI Family (12); Countries (121)

Claims**Claims**

All Claims (26)

(WO2008064481A1)

Claims (English)**What is claimed is:**

1. A method for intercepting communications in an Internet Protocol (IP) network, the method comprising: maintaining dialing profiles for respective subscribers to the IP network, each said dialing profile including a username associated with the corresponding subscriber; associating intercept information with the dialing profile of a subscriber whose communications are to be monitored, said intercept information including determination information for determining whether to intercept a communication involving said subscriber, and destination information identifying a device to which intercepted communications involving said subscriber are to be sent; and when said determination information meets intercept criteria, communicating with a media relay through which said communications involving said subscriber will be conducted or are being conducted to cause said media relay to send a copy of said communications to a mediation device specified by said destination information.
2. The method of clam 1 wherein associating intercept information comprises associating said intercept information with said dialing profile when communications involving said subscriber are not in progress.
3. The method of clam 1 wherein associating intercept information comprises associating said intercept information when communications involving said subscriber are in progress.
4. The method of claim 2 or 3 wherein associating said intercept information comprises populating intercept information fields in said dialing profile of the subscriber whose communications are to be monitored.
5. The method of claim 1 further comprising producing a routing message for routing communications involving the subscriber through components of the IP network and determining whether said determination information meets said intercept criteria prior to producing said routing message and including at least some of said intercept information in said routing message when said determination information meets said intercept criteria.
6. The method of claim 5 wherein determining whether said determination information meets said intercept criteria comprises determining whether a current date and time is within a range specified by said determination information.
7. The method of claim 6 further comprising identifying a media relay through which communications involving said subscriber will be conducted in response to said routing message.
8. The method of claim 7 further comprising pre-associating at least one media relay with said dialing profile of the subscriber whose communications are to be monitored and wherein identifying said media relay comprises identifying the media relay pre-associated with said subscriber whose communications are to be monitored.

9. The method of claim 8 wherein pre-associating comprises populating media relay fields in said dialing profile with an identification of at least one media relay.

10. The method of claim 1 wherein said intercept information is associated with said dialing profile of the subscriber whose communications are to be monitored, in response to receipt of an intercept request message, wherein said intercept request message comprises said intercept information.

11. The method of claim 10 further comprising invoking an intercept request message handler to: a) find a dialing profile associated with the subscriber whose communications are to be monitored; b) perform the step of associating said intercept information with said dialing profile; c) determine whether said intercept criteria are met; and d) identify a media relay through which said communications are being conducted.

12. The method of claim 11 further comprising maintaining a active call records for communications in progress, said active call records comprising a username identifier and a media relay identifier identifying the media relay through which said communications are being conducted and wherein identifying a media relay through which said communications are being conducted comprises locating an active call record associated with communications of the subscriber whose communication are to be monitored to find the media relay associated with said communications.

13. The method of claim 12 further comprising maintaining direct inward dialing (DID) records associating PST telephone numbers with usernames of users subscribing to said IP network, and wherein finding a dialing profile associated with the subscriber whose communications are to be monitored comprises finding a username in a DID record bearing a PSTN number associated with the subscriber whose communications are to be monitored and using said username to locate a dialing profile associated with said username.

14. An apparatus for intercepting communications in an Internet Protocol (IP) network, the apparatus comprising: means for maintaining dialing profiles for respective subscribers to the IP network, each said dialing profile including a username associated with the corresponding subscriber; means for associating intercept information with the dialing profile of a subscriber whose communications are to be monitored, said intercept information including determination information for determining whether to intercept a communication involving said subscriber, and destination information identifying a device to which intercepted communications involving said subscriber are to be sent; and means for communicating with a media relay through which said communications involving said subscriber will be conducted or are being conducted to cause said media relay to send a copy of said communications to a mediation device specified by said destination information, when said determination information meets intercept criteria.

15. The apparatus of claim 14 wherein said means for associating intercept information is operably configured to associate said intercept information with said dialing profile when communications involving said subscriber are not in progress.

16. The apparatus of claim 14 wherein said means for associating intercept information is operably configured to associate said intercept information when communications involving said subscriber are in progress.

17. The apparatus of claim 15 or 16 wherein said means for associating said intercept information is operably configured to populate intercept information fields in said dialing profile of the subscriber whose communications are to be monitored.

18. The apparatus of claim 14 further comprising means for producing a routing message for routing communications involving the subscriber through components of the IP network and means for determining whether said determination information meets said intercept criteria prior to producing said routing message and wherein said means for producing said routing message is operably configured to include at least some of said intercept information in said routing message when said determination information meets said intercept criteria.

19. The apparatus of claim 18 wherein said means for determining whether said determination information meets said intercept criteria is operably configured to determine whether a current date and time is within a range specified by said determination information.

20. The apparatus of claim 19 further comprising means for identifying a media relay through which communications involving said subscriber will be conducted in response to said routing message.

21. The apparatus of claim 20 further comprising means for pre- associating at least one media relay with said dialing profile of the subscriber whose communications are to be monitored and wherein said routing means is operably configured to identify from said dialing profile the media relay pre-associated with said subscriber whose communications are to be monitored.

22. The apparatus of claim 21 wherein said means for pre-associating is operably configured to populate media relay fields in said dialing profile with an identification of at least one media relay.

23. The apparatus of claim 14 wherein means for associating said intercept information is operably configured to associate said intercept information associated with said dialing profile of the subscriber whose communications

are to be monitored, in response to receipt of an intercept request message, wherein said intercept request message comprises said intercept information.

24. The apparatus of claim 23 further comprising means for handling an intercept request message, said means for handling an intercept request message comprising: a) means for find a dialing profile associated with the subscriber whose communications are to be monitored, said means for finding a dialing profile cooperating with said means for associating said intercept information with said dialing profile to cause said intercept information to be associated with said dialing profile; b) means for determining whether said intercept criteria are met; and c) means for identifying a media relay through which said communications are being conducted.

25. The apparatus of claim 24 further comprising means for maintaining active call records for communications in progress, said active call records comprising a username identifier and a media relay identifier identifying the media relay through which said communications are being conducted and wherein said means for identifying a media relay through which said communications are being conducted is operably configured to locate an active call record associated with communications of the subscriber whose communication are to be monitored to find the media relay associated with said communications.

26. The apparatus of claim 25 further comprising means for maintaining direct inward dialing (DID) records associating PST telephone numbers with usernames of users subscribing to said IP network, and wherein said means for finding a dialing profile associated with the subscriber whose communications are to be monitored is operably configured to find a username in a DID record bearing a PSTN number associated with the subscriber whose communications are to be monitored and use said username to locate a dialing profile associated with said username.

Description

Background/ Summary

Background/Summary

-

Drawing Description

Drawing Description

-

Description

Description

(WO2008064481A1)

INTERCEPTING VOICE OVER IP COMMUNICATIONS AND OTHER DATA
COMMUNICATIONS

CROSS REFERENCE TO RELATED APPLICATIONS

This application claims the benefit of U.S. Provisional Application No.

60/861 ,431 filed November 29, 2006.

BACKGROUND OF THE INVENTION

1. Field of Invention This invention relates to data communications and methods and apparatus for intercepting data communications, particularly voice over IP data communications, in an IP network.

2. Description of Related Art The term "lawful intercept" is used to describe a procedure which allows law enforcement agencies to perform electronic surveillance of telecommunications. Lawful intercept of telecommunications, particularly phone calls, is premised on a notion that a law enforcement agency has identified a person of interest, obtained a legal authorization for the surveillance (for example, a judicial or administrative warrant), and then contacted the person's telecommunications service provider that will be

PETITIONER APPLE INC. EX 1002-593

required to provide the law enforcement agency with a real-time copy of the person's communications. This real-time copy can then be used by the law enforcement agency to monitor or record the person's communications.

Within the framework of traditional telecommunications networks, such as, for example, the Public Switched Telephone Network (PSTN) or cellular networks, lawful intercept generally presents a purely economic problem for the service providers that have to ensure that sufficient interception equipment and dedicated links to the law enforcement agencies have been deployed to satisfy lawful intercept requirements mandated by law. However, in the context of Voice over Internet Protocol (VoIP) communications, in addition to the economic problems mentioned above, lawful intercept presents significant technological challenges which often makes compliance with legally mandated lawful intercept requirements exceedingly difficult.

The problem lies in the very nature of the VoIP technology and the Internet Protocol (IP) networks (for example, the Internet) that underlie it.

Traditional telecommunications networks are "connection-oriented" or "circuit-switched". Communications over such networks occur via dedicated "circuits". Although the networks typically comprise a plurality of available parallel paths, when a circuit is established, only a single one of the available paths is picked. In situations where a circuit has failure protection, a redundant path, also determined at the time of the circuit establishment, can also be reserved. Once the circuit is established, all communications traverse from end to end. Interception of such communications is easy as the service provider can "tap" the circuit at any point in the network that is under its lawful control.

In contrast to circuit-switched networks, IP-based networks are "connectionless" by design. A connectionless IP network essentially comprises a plurality of interconnected network devices (routers) which establish a plurality of paths from any point on the network to any other point.

Information that needs to traverse an IP network is divided into small "packets", each one comprising an IP header containing source and destination addressing information, and service flags; and user payload. The specific path that each packet in a communication between parties takes across an IP network is not determined in advance such as in a circuit-switched network. The path is defined on a hop-by-hop basis (router-by-router), each router at which the packet arrives examines the source and destination addresses contained in the IP header and applies a number of service variables such as hop-count (number of routers between the current router and the destination), latency and bandwidth of available links, and administrative considerations such as inter-provider agreements, to determine the next hop to which the packet will be forwarded. Because the service variables change dynamically, for example in response to a failure of a link in the network, the available paths may change significantly and it is impossible to reliably predict the path or paths that the packets that comprise a specific communication will traverse. Furthermore, it is not even possible to predict the order in which the packets will arrive at their destination as the different paths taken may have different latency. While the plurality of available paths and out-of-order arrivals present no problems to IP-based applications that usually keep track of the packet sequence to reassemble the communication, the same factors present formidable problems for the lawful intercept of communication over IP networks, particularly lawful intercept of VoIP calls.

The problem of lawful intercept in VoIP systems is further exacerbated by the distributed technologies often utilized in such systems. While a VoIP caller typically communicates with a VoIP call controller to facilitate the connection to the VoIP callee, the actual communication between the parties typically occurs by establishing a direct IP connection between them using the User Datagram Protocol (UDP) to encapsulate audio information into IP packets.

These packets may take any available path across the IP network as described above. Even if a service provider could place an interception device at every point in the network through which a subscriber's packet could traverse, in order to provide a useful copy of the communication to a law enforcement agency, the service provider would have to reassemble all of the intercepted packets at a single device and only then pass the result to the law enforcement agency. In essence, the service provider would have to mirror the functions of the callee VoIP telephone, except the packets that comprise the communication would have to be collected from multiple points in the network. The technological challenges and economic costs associated with this proposition have thus far resulted in lack of meaningful lawful intercept capabilities in VoIP systems.

SUMMARY OF THE INVENTION

In accordance with one aspect of the invention, there is provided a method for intercepting communications in an Internet Protocol (IP) network. The method involves maintaining dialing profiles for respective subscribers to the IP network, each dialing profile including a username associated with the corresponding subscriber. The method also involves associating intercept information with the dialing profile of a subscriber whose communications are to be monitored, the intercept information including determination information for determining whether to intercept a communication involving the subscriber, and destination information identifying a device to which intercepted communications involving the subscriber are to be sent. The method further involves, when the determination information meets intercept criteria, communicating with a media relay through which the communications involving the subscriber will be conducted or are being conducted to cause

PETITIONER APPLE INC. EX. 1002-594

the media relay to send a copy of the communications to a mediation device specified by the destination information.

Associating intercept information may involve associating the intercept information with the dialing profile when communications involving the subscriber are not in progress.

Associating intercept information may involve associating the intercept information when communications involving the subscriber are in progress.

Associating the intercept information may involve populating intercept information fields in the dialing profile of the subscriber whose communications are to be monitored.

The method may involve producing a routing message for routing communications involving the subscriber through components of the IP network and determining whether the determination information meets the intercept criteria prior to producing the routing message and including at least some of the intercept information in the routing message when the determination information meets the intercept criteria.

Determining whether the determination information meets the intercept criteria may involve determining whether a current date and time is within a range specified by the determination information.

The method may involve identifying a media relay through which communications involving the subscriber will be conducted in response to the routing message.

The method may involve pre-associating at least one media relay with the dialing profile of the subscriber whose communications are to be monitored and identifying the media relay may involve identifying the media relay pre-associated with the subscriber whose communications are to be monitored.

Pre-associating may involve populating media relay fields in the dialing profile with an identification of at least one media relay.

The intercept information may be associated with the dialing profile of the subscriber whose communications are to be monitored, in response to receipt of an intercept request message, and the intercept request message may include the intercept information.

The method may involve invoking an intercept request message handler to find a dialing profile associated with the subscriber whose communications are to be monitored, and to perform the step of associating the intercept information with the dialing profile, and to determine whether the intercept criteria are met, and identify a media relay through which the communications are being conducted.

The method may involve maintaining active call records for communications in progress, and the active call records may include a username identifier and a media relay identifier identifying the media relay through which the communications are being conducted and identifying a media relay through which the communications are being conducted may involve locating an active call record associated with communications of the subscriber whose communication are to be monitored to find the media relay associated with the communications.

The method may involve maintaining direct-inward-dialing (DID) records associating PST telephone numbers with usernames of users subscribing to the IP network, and finding a dialing profile associated with the subscriber whose communications are to be monitored may involve finding a username in a DID record bearing a PSTN number associated with the subscriber whose communications are to be monitored. The username may be used to locate a dialing profile associated with the username.

In accordance with another aspect of the invention, there is provided an apparatus for intercepting communications in an Internet Protocol (IP) network. The apparatus includes provisions for maintaining dialing profiles for respective subscribers to the IP network, each dialing profile including a username associated with the corresponding subscriber. The apparatus also includes provisions for associating intercept information with the dialing profile of a subscriber whose communications are to be monitored, the intercept information including determination information for determining whether to intercept a communication involving the subscriber, and destination information identifying a device to which intercepted communications involving the subscriber are to be sent. The apparatus further includes provisions for communicating with a media relay through which the communications involving the subscriber will be conducted or are being conducted to cause the media relay to send a copy of the communications to a mediation device specified by the destination information, when the determination information meets intercept criteria.

The provisions for associating intercept information may be operably configured to associate the intercept information with the dialing profile when communications involving the subscriber are not in progress.

The provisions for associating intercept information may be operably configured to associate the intercept information when communications involving the subscriber are in progress.

The provisions for associating the intercept information may be operably configured to populate intercept information fields in the dialing profile of the subscriber whose communications are to be monitored.

The apparatus may further include provisions for producing a routing message for routing communications involving the subscriber through components of the IP network and provisions for determining whether the determination information meets the intercept criteria prior to producing the routing message and the provisions for producing the routing message may be operably configured to include at least some of the intercept information in the routing message when the determination information meets the intercept criteria.

The provisions for determining whether the determination information meets the intercept criteria may be operably configured to determine whether a current date and time is within a range specified by the determination information.

The apparatus may further include provisions for identifying a media relay through which communications involving the subscriber will be conducted in response to the routing message.

The apparatus may further include provisions for pre-associating at least one media relay with the dialing profile of the subscriber whose communications are to be monitored and the routing provisions may be operably configured to identify from the dialing profile the media relay pre-associated with the subscriber whose communications are to be monitored.

The provisions for pre-associating may be operably configured to populate media relay fields in the dialing profile with an identification of at least one media relay.

Provisions for associating the intercept information may be operably configured to associate the intercept information associated with the dialing profile of the subscriber whose communications are to be monitored, in response to receipt of an intercept request message, wherein the intercept request message comprises the intercept information.

The apparatus may further include provisions for handling an intercept request message. The provisions for handling an intercept request message may include provisions for finding a dialing profile associated with the subscriber whose communications are to be monitored. The provisions for finding a dialing profile may cooperate with the provisions for associating the intercept information with the dialing profile to cause the intercept information to be associated with the dialing profile. The provisions for handling an intercept request message may include provisions for determining whether the intercept criteria are met and provisions for identifying a media relay through which the communications are being conducted.

The apparatus may further include provisions for maintaining active call records for communications in progress, the active call records including a username identifier and a media relay identifier identifying the media relay through which the communications are being conducted and the provisions for identifying a media relay through which the communications are being conducted may be operably configured to locate an active call record associated with communications of the subscriber whose communication are to be monitored to find the media relay associated with the communications.

The apparatus may further include provisions for maintaining direct-inward- dialing (DID) records associating PST telephone numbers with usernames of users subscribing to the IP network, and the provisions for finding a dialing profile associated with the subscriber whose communications are to be monitored may be operably configured to find a username in a DID record bearing a PSTN number associated with the subscriber whose communications are to be monitored and use the username to locate a dialing profile associated with the username.

By employing a media replay, all VoIP communications traverse a point in the VoIP system that is under a provider's control and at which the communications can be copied in real-time to a mediation device that passes the intercepted communication to a law enforcement agency.

By maintaining dialing profiles for respective subscribers and associating intercept information of the type described, with the dialing profiles of subscribers whose communications are to be monitored, the dialing profile can serve as the source of determination information for determining whether or not communications involving the subscriber will be monitored and for providing destination information for specifying where the copy of the communications is to be sent. Use of the dialing profile in this manner easily facilitates the dialing profile to be considered a repository for intercept information for a given subscriber and this repository can be addressed whether a call is being initiated or in progress, thereby simplifying control algorithms because they can cooperate with a common source and format of data in the dialing profile.

Other aspects and features of the present invention will become apparent to those ordinarily skilled in the art upon review of the following description of specific embodiments of the invention in conjunction with the accompanying figures.

BRIEF DESCRIPTION OF THE DRAWINGS

In drawings which illustrate embodiments of the invention, Figure 1 is a block diagram of a system according to a first embodiment of the invention; Figure 2 is a block diagram of a caller VoIP telephone according to the first embodiment of the invention; Figure 3 is a schematic representation of a SIP Invite message transmitted between the caller telephone and a call controller (CC) shown in Figure 1, Figure 4 is a block diagram of the call

controller shown in Figure 1; Figure 5 is a flowchart of a process executed by the call controller shown in Figure 1; Figure 6 is a schematic representation of a routing controller (RC) request message produced by the call controller shown in Figure 1; Figure 7 is a block diagram of a routing controller (RC) processor circuit of the system shown in Figure 1; Figures 8A-8D are flowcharts of a RC Request message handler executed by the RC processor circuit shown in Figure 7; Figure 9 is a tabular representation of a dialing profile stored in a database accessible by the RC shown in Figure 1; Figure 10 is a tabular representation of a dialing profile for a Vancouver subscriber; Figure 11 is a tabular representation of a dialing profile for a Calgary subscriber; Figure 12 is a tabular representation of a dialing profile for a London subscriber; Figure 13 is a tabular representation of a direct-inward-dialing (DID) bank table record stored in the database shown in Figure 1; Figure 14 is a tabular representation of an exemplary DID bank table record for the London subscriber referenced in Figure 12; Figure 15 is a tabular representation of a routing message transmitted from the routing controller to the call controller shown in Figure 1; Figure 16 is a tabular representation of a routing message buffer holding a routing message for routing a call to the London callee referenced in Figure 12; Figure 16A is a tabular representation of a routing message buffer holding a message for routing a call to the London callee and to a law enforcement agency for the purpose of lawful intercept; Figure 17 is a tabular representation of a prefix to supemode table record stored in the database shown in Figure 1; Figure 18 is a tabular representation of a prefix to supernode table record that would be used for the Calgary callee referenced in Figure 11; Figure 19 is a tabular representation of a master list record stored in a master list table in the database shown in Figure 1; Figure 20 is a tabular representation of an exemplary populated master list record; Figure 21 is a tabular representation of a suppliers list record stored in the database shown in Figure 1; Figure 22 is a tabular representation of a specific supplier list record for a first supplier; Figure 23 is a tabular representation of a specific supplier list record for a second supplier; Figure 24 is a tabular representation of a specific supplier list record for a third supplier; Figure 25 is a tabular representation of a routing message, held in a routing message buffer, identifying to the routing controller a plurality of possible suppliers that may carry the call; Figure 25A is a tabular representation of a routing message held in a routing message buffer, with lawful intercept fields appended; Figure 26 is a tabular representation of a call block table record; Figure 27 is a tabular representation of a call block table record for the Calgary callee; Figure 28 is a tabular representation of a call forwarding table record; Figure 29 is a tabular representation of an exemplary call forwarding table record specific for the Calgary callee; Figure 30 is a tabular representation of a voicemail table record specifying voicemail parameters to enable the caller to leave a voicemail message for the callee; Figure 31 is a tabular representation of an exemplary voicemail table record for the Calgary callee; Figure 32 is a tabular representation of an exemplary routing message, held in a routing message buffer, indicating call forwarding numbers and a voicemail server identifier; Figure 32A is a tabular representation of an exemplary routing message, held in a routing message buffer, indicating call forwarding numbers and a voicemail server identifier with caller lawful intercept fields appended; Figure 32B is a tabular representation of an exemplary routing message, held in a routing message buffer, indicating call forwarding numbers and a voicemail server identifier with caller and callee lawful intercept fields appended; Figure 33 is a flowchart of a routing message handler process executed by the call controller.

Figure 34 is a schematic representation of messages exchanged during execution of process for establishing audio paths between telephones and a media relay; Figure 35 is a tabular representation of an active call record maintained by the call controller of Figure 1; Figure 36 is a tabular representation of an active call record maintained by the routing controller of Figure 1; Figure 37 is a tabular representation of a SIP Invite message transmitted from the call controller to the mediation device; Figure 38 is a tabular representation of a SIP OK message transmitted from the mediation device to the call controller.

Figure 39 is a tabular representation of a SIP Bye message transmitted from either of the telephones shown in Figure 1 to the call controller; Figure 40 is a tabular representation of a SIP Bye message sent to the call controller from the Calgary callee; Figure 41 is a flowchart of a process executed by the call controller for producing a RC stop message in response to receipt of a SIP Bye message; Figure 42 is a tabular representation of an exemplary RC Call Stop message; Figure 43 is a tabular representation of an exemplary RC Call Stop message for the Calgary callee; Figure 44 is a flowchart of a routing controller Law Enforcement Authority request message handler executed by the routing controller shown in Figure 1; Figure 45 is a flowchart of a call controller in-call intercept message handler executed by the call controller shown in Figure 1; Figure 46 is a flowchart of a routing controller in-call intercept shut down routine executed by the routing controller shown in Figure 1; Figure 47 is a flowchart of a call controller cease intercept message handler routing executed by the call controller shown in Figure 1.

DETAILED DESCRIPTION

Referring to Figure 1, a system for making voice over IP telephone calls is shown generally at 10. The system includes a first supemode shown generally at 11 and a second supemode shown generally at 21. The first supemode 11 is located in a geographical area, such as Vancouver B.C., for example and the second supemode 21 is located in London England, for example. Different supernodes may be located in different geographical regions throughout the world to provide telephone service to subscribers in respective regions. These supernodes may be in communication with each other through high speed / high data throughput links including optical fiber, satellite and/or cable links, for example, forming a system backbone. These supernodes may alternatively or in addition be in communication with each other through conventional Internet services. In the embodiment shown, data communication media for providing for data communications between the first and

second supernodes 11 and 21 are shown generally at 23 and may include very high speed data links, for example.

In the embodiment shown, the Vancouver supernode 11 provides telephone service to a geographical region comprising Western Canadian customers from Vancouver Island to Ontario and includes a Vancouver subscriber and a Calgary subscriber. Another supernode (not shown) may be located in Eastern Canada to provide services to subscribers in that area.

Other, smaller supernodes similar to the type shown may also be employed within the geographical area serviced by a supernode, to provide for call load sharing, for example within a region of the geographical area serviced by the supernode. However, in general, all supernodes are similar and have the properties described below in connection with the Vancouver supernode 11.

In this embodiment, the Vancouver supernode includes a call controller (CC) 14, a routing controller (RC) 16, a database 18, a media relay 17 and one or more mediation devices (MD), only one of which is shown at 31. Subscribers such as the Vancouver subscriber and the Calgary subscriber communicate with the Vancouver supernode 11 using their own Internet Service Providers (ISPs) 13 and 19 which route Internet traffic from these subscribers over the Internet. To these subscribers the Vancouver supernode 11 is accessible at a pre-determined IP address or a fully qualified domain name (FQDN) so that it can be accessed in the usual way through a subscriber's ISP. The subscriber in the city of Vancouver uses a telephone 12 that is capable of communicating with the Vancouver supernode 11 using Session Initiation Protocol (SIP) messages and the Calgary subscriber uses a similar telephone 15, to communicate with the Vancouver supernode from Calgary, AB.

It should be noted that throughout the description of the embodiments of this invention, the IP/UDP addresses of all elements such as the caller and callee telephones, call controller, media relay, and any others, will be assumed to be valid IP/UDP addresses directly accessible via the Internet or a private IP network, for example, depending on the specific implementation of the system. As such, it will be assumed, for example, that the caller and callee telephones will have IP/UDP addresses directly accessible by the call controllers and the media relays on their respective supernodes, and that will not be obscured by Network Address Translation (NAT) or similar mechanisms. In other words, the IP/UDP information contained in SIP messages (for example the SIP Invite message or the RC Request message which will be described below) will match the IP/UDP addresses of the IP packets carrying these SIP messages.

It will be appreciated that in many situations, the IP addresses assigned to various elements of the system may be in a private IP address space, and thus not directly accessible from other elements. Furthermore, it will also be appreciated that NAT is commonly used to share a "public" IP address between multiple devices, for example between home PCs and IP telephones sharing a single Internet connection. For example, a home PC may be assigned an IP address such as 192.168.0.101 and a Voice over IP telephone may be assigned an IP address of 192.168.0.103. These addresses are located in so called "non-routable" address space and cannot be accessed directly from the Internet. In order for these devices to communicate with other computers located on the Internet, these IP addresses have to be converted into a "public" IP address, for example 24.10.10.123 assigned to the subscriber by the Internet Service Provider, by a device performing NAT, typically a home router. In addition to translating the IP addresses, the NAT typically also translates UDP port numbers, for example an audio path originating at an IP telephone and using a UDP port 12378 at its private IP address may have been translated to a UDP port 23465 associated with the public IP address of the NAT device. In other words, when a packet originating from the above IP telephone arrives at an Internet-based supernode, the source IP/UDP address contained in the IP packet header will be 24.10.10.1 :23465, whereas the source IP/UDP address information contained in the SIP message inside this IP packet will be 192.168.0.103:12378. The mismatch in the IP/UDP addresses may cause a problem for SIP-based systems because, for example, a supernode will attempt to send messages to a private address of a telephone - the messages will never get there.

It will be appreciated that a number of methods are available to overcome this problem. For example, the SIP NATHelper open source software module may run on the supernode to correlate public IP/UDP address contained in the headers of the IP packets arriving from SIP devices with private IP/UDP addresses in the SIP messages contained in these packets. Therefore, the embodiments of the invention described below will function whether or not any of the elements of the system are located behind NAT devices that obscure their real IP/UDP addresses.

Referring to Figure 1, in an attempt to make a call by the Vancouver telephone 12 to the Calgary telephone 15, for example, the Vancouver telephone sends a SIP Invite message to the Vancouver supernode 11 and in response, the call controller 14 sends an RC Request message to the routing controller 16 which makes various enquiries of the database 18 to produce a routing message which is sent to the call controller 14. The call controller 14 then causes a communications link including audio paths to be established through the media relay 17 which may include the same Vancouver supernode 11, a different supernode or a communications supplier gateway, for example, to carry voice traffic to and from the call recipient or callee.

Subject to certain conditions being satisfied, as will be described below, when lawful intercept of data is to occur, data on the audio paths is copied to the mediation device 31 which may provide for real time listening of the audio data or recording of same.

Subscriber Telephone Referring to Figure 2, in this embodiment, the telephones 12, 15, 22 and 25 each includes a processor circuit shown generally at 30 comprising a microprocessor 32, program memory 34, an input/output (I/O) interface 36, parameter memory 38 and temporary memory 40. The program memory 34, I/O interface 36, parameter memory 38 and temporary memory 40 are all in communication with the microprocessor 32. The I/O interface 36 has a dial input 42 for receiving a dialed telephone number from a keypad, for example, or from a voice recognition unit or from pre-stored telephone numbers stored in the parameter memory 38, for example. For simplicity, a box labelled dialing functions 44 represents any device capable of informing the microprocessor 32 of a callee identifier, e.g., a callee telephone number.

The microprocessor 32 stores the callee identifier in a dialed number buffer 41. In the case of the Vancouver subscriber for example, the dialed number may be 2001 1050 2222, identifying the Calgary subscriber or the dialed number may be a PSTN number, for example. The I/O interface 36 also has a handset interface 46 for receiving and producing signals from and to a handset 45 that the user may place to his ear. The handset interface 46 may include a BLUETOOTH™ wireless interface, a wired interface or speakerphone, for example. The handset 45 acts as a termination point for an audio path (not shown) which will be appreciated later.

The I/O interface 36 also has a network interface 48 to an IP network which may provide a high speed Internet connection, for example, and is operable to connect the telephone to an ISP. The network interface 48 also acts as a part of the audio path, as will be appreciated later.

The parameter memory 38 has a username field 50, a password field 52, an IP address field 53 and a SIP proxy address field 54. The username field 50 is operable to hold a username, which, for the Vancouver subscriber, is 2001 1050 8667. The username is assigned upon subscription or registration into the system and, in this embodiment includes a twelve digit number having a continent code 61, a country code 63, a dealer code 70 and a unique number code 74. The continent code 61 is comprised of the first or left-most digit of the username in this embodiment. The country code 63 is comprised of the next three digits. The dealer code 70 is comprised of the next four digits and the unique number code 74 is comprised of the last four digits. The password field 52 holds a password of up to 512 characters, in this example. The IP address field 53 stores an IP address and UDP port number of the telephone 12, which, for this explanation, is 192.168.0.20:12345. The SIP proxy address field 54 stores an IP address of a SIP proxy which may be provided to the telephone 12 through the network interface 48 as part of a registration procedure.

The program memory 34 stores blocks of codes for directing the microprocessor 32 to carry out the functions of the telephone, one of which includes a firewall block 56 which provides firewall functions to the telephone, to prevent unauthorized access through the network connection to the microprocessor 32 and memories 34, 38 and 40. The program memory 34 also stores call ID codes 57 for establishing a call ID. The call ID codes 57 direct the microprocessor 32 to produce call identifiers having the format of a hexadecimal string and an IP address of the telephone stored in the IP address field 53. Thus, an exemplary call identifier for a call might be FF10@192.168.0.20.

Generally, in response to activating the handset 45 and using the dialing function 44, the microprocessor 32 produces and sends a SIP Invite message as shown in Figure 3, to the call controller 14 shown in Figure 1.

Referring to Figure 3, the SIP Invite message includes a caller identifier field 60, a callee identifier field 62, a digest parameters field 64, a call identifier field 65, a caller IP address field 67 and a caller UDP port field 69. In this embodiment, the caller identifier field 60 includes the username 2001 1050 8667, which is the username stored in the username field 50 of the parameter memory 38 in the Vancouver telephone 12 shown in Figure 2. In addition, as an example, referring back to Figure 3, the callee identifier field 62 includes the username 2001 1050 2222 which is the dialed number of the Calgary subscriber stored in the dialed number buffer 41 shown in Figure 2. The digest parameters field 64 includes digest parameters and the call identifier field 65 includes a code comprising a generated prefix code (FF10) and a suffix which is the IP address of the telephone 12 stored in the IP address field 53. The caller IP address field 67 holds the IP address assigned to the telephone, in this embodiment 192.168.0.20, and the caller UDP port field 69 includes a UDP port identifier identifying a UDP port to which audio data is to be sent for reception by the caller's telephone.

Call Controller Referring to Figure 4, a call controller circuit of the call controller 14 (Figure 1) is shown in greater detail at 100. The call controller circuit 100 includes a microprocessor 102, program memory 104 and an I/O interface 106. The call controller circuit 100 may include a plurality of microprocessors, a plurality of program memories and a plurality of I/O interfaces to be able to handle a large volume of calls. However, for simplicity, the call controller circuit 100 will be described as having only one microprocessor, program memory and I/O interface, it being understood that there may be more.

Generally, the I/O interface 106 includes an input 108 for receiving messages, such as the SIP Invite message shown in Figure 3, from the telephone shown in Figure 2. The I/O interface 106 also has an RC Request message output 110 for transmitting an RC Request message to the routing controller 16 of Figure 1, an RC message input 112 for receiving routing messages from the routing controller 16 (Figure 1), a media relay (MR) output 114 for transmitting messages to the media relay (Figure 1) to advise the media relay to establish an audio path, and a MR input 116 for receiving messages from the media relay to which a message has been sent to attempt to establish the audio path. The I/O interface 106 further includes a SIP output 118 for transmitting SIP

messages to the telephone 12 (Figure 1) to advise the telephone of the IP address of the media relay 17 (Figure 1) which will establish the audio path.

The I/O interface 106 further includes mediation device input 119 and output 121 for communicating with the mediation device 31 (Figure 1).

While certain inputs and outputs have been shown as separate, it will be appreciated that some may be associated with a single IP address and TCP or UDP port. For example, the messages sent and received from the routing controller 16 may be transmitted and received at the same single IP address and TCP or UDP port.

The program memory 104 of the call controller circuit 100 includes blocks of code for directing the microprocessor 102 to carry out various functions of the call controller 14. For example, these blocks of code include a first block 120 for causing the call controller circuit 100 to execute a SIP Invite-to-RC request process to produce an RC Request message in response to a received SIP Invite message. In addition, there is a Routing Message Handler block 122 which causes the call controller circuit 100 to engage the mediation device and/or execute a call handling routine to establish audio paths through a media relay to establish the call. The program memory 104 further includes an in-call intercept message handler 1450 for intercepting a call in progress and a cease intercept message handler 1520 for ceasing the interception of a call in progress.

Referring to Figure 5, the SIP Invite-to-RC Request process is shown in more detail at 120. On receipt of a SIP Invite message of the type shown in Figure 3, block 132 of Figure 5 directs the call controller circuit 100 of Figure 4 to authenticate the user operating the telephone from which the SIP Invite message originated. This may be done, for example, by prompting the user for a password, by sending a message back to the telephone 12 which is interpreted at the telephone as a request for password entry or the password may automatically be sent to the call controller 14 from the telephone, in response to the message. The call controller 14 may then make enquiries of databases to which it has access, to determine whether or not the user's password matches a password stored in the database. Various functions may be used to pass encryption keys or hash codes back and forth to ensure the secure transmission of passwords.

Should the authentication process fail, the call controller circuit 100 is directed to an error handling block 134 which causes messages to be displayed at the telephone 12 to indicate that there was an authentication error. If the authentication process is successful, block 131 directs the call controller circuit 100 to determine whether or not the contents of the caller identifier field 60 of the SIP Invite message is a validly formatted IP address. If it is a valid IP address, then block 133 directs the call controller circuit 100 to associate a type code with the call to indicate that the call type is a third party invite.

If at block 131 the caller identifier field 60 contents do not identify an IP address, then block 135 directs the call controller circuit 100 to associate a type code with the call to indicate the call type is a regular SIP Invite message. Then, block 136 directs the call controller circuit 100 to establish a call ID by assigning the call ID provided in the call identifier field 65 of the SIP Invite message from the telephone 12, and at block 138 the call controller circuit is directed to produce an RC Request message of the type shown in Figure 6 that includes that call ID. Referring back to Figure 5, block 139 then directs the call controller circuit 100 to send the RC Request message to the routing controller 16.

Referring to Figure 6, an RC Request message is shown generally at 150 and includes a caller identifier field 152, a callee identifier field 154, a digest field 156, a call ID field 158 and a type field 160. The caller, callee, digest, and call identifier fields 152, 154, 156 and 158 contain copies of the caller, callee, digest parameters and call ID fields 60, 62, 64 and 65 of the SIP Invite message 59 shown in Figure 3. The type field 160 contains the type code established at block 133 or 135 of Figure 5 to indicate whether the call is from a third party or system subscriber, respectively. The callee identifier field 154 may include a PSTN number or a system subscriber username as shown, for example.

Routing Controller Referring to Figure 7, the routing controller 16 is shown in greater detail and includes a routing controller processor circuit shown generally at 200. The RC processor circuit 200 includes a microprocessor 202, program memory 204, a table memory 206 and an I/O interface 208, all in communication with the processor. There may be a plurality of processor circuits (202), memories (204), etc.

The I/O interface 208 includes a database output port 210 through which a request to the database 18 (Figure 1) can be made and includes a database response port 212 for receiving a reply from the database. The I/O interface 208 further includes an RC Request message input 214 for receiving the RC Request message from the call controller 14 and includes a routing message output 216 for sending a routing message back to the call controller 14.

The program memory 204 includes blocks of codes for directing the RC processor circuit 200 to carry out various functions of the routing controller 16.

One of these blocks implements an RC Request message handler process 250 which directs the RC to produce a routing message in response to a received RC Request message of the type shown at 150 in Figure 6.

Referring back to Figure 7, the program memory 204 further includes a Law Enforcement Authority (LEA) request message handler 1400 and an in-call intercept shut down route 1500.

The RC Request message handler process 250 is shown in greater detail in Figures 8A through 8D.

RC Request Message Handler Referring to Figure 8A, the RC Request message handler process 250 begins with a first block 252 that directs the RC processor circuit 200 (Figure 7) to store the contents of the RC Request message 150 (Figure 6) in buffers.

Block 254 then directs the RC processor circuit 200 to use the contents of the caller identifier field 152 in the RC Request message shown in Figure 6, to locate and retrieve a dialing profile for the caller from the database 18.

The routing controller maintains, in the database, a dialing profile for each subscriber to the system. Referring to Figure 9, an exemplary dialing profile is shown generally at 256 and includes system fields including a username field 258, a domain field 260, a national dialing digits (NDD) field 262, an IDD (IDD) field 264, a country code field 266, a local area codes field 267, a caller minimum local length field 268, a caller maximum local length field 270 and a reseller field 273.

The exemplary dialing profile further includes lawful intercept related fields including a lawful intercept (LI) flag field 702, at least one mediation device field 704, at least one warrant ID field 706, and intercept period start and stop date/time fields 708 and 710. The LI flag field 702, the warrant ID field 706 and the LI start/stop fields 708 and 710 may be regarded as determination information fields for determining whether to intercept a communication involving the subscriber and the MD1 address field 704 may be regarded as a destination information field for identifying a device to which intercepted communications involving the subscriber are to be sent.

The system fields (258, 260, 262, 264, 266, 267, 268, 270, 273) are assigned values by a system operator or are assigned automatically according to pre-defined algorithms (not shown) when a user registers with the system to become a subscriber. The lawful intercept fields (702, 704, 706, 708, 710) are assigned values in response to communications with one or more authorized devices and may be populated at any time regardless of whether or not communications involving the subscriber are in progress.

For example, referring back to Figure 1 the mediation device 31 may be regarded as an authorized device operated by a law enforcement authority 293. A communications channel between the call controller 14 and the mediation device 31 may be established to permit the mediation device to communicate with the call controller to cause the call controller to communicate with the routing controller 16 to find a subscriber record in the database 18 which is associated with a subscriber for which a warrant for lawful intercept has been obtained. For example, once a warrant identifying a user and permitting lawful intercept of that user's communications has been received by the law enforcement authority 293, that authority can use its own computers to communicate with the mediation device 31 to cause the mediation device to communicate with the call controller 14 to cause the call controller to interact with the routing controller 16 to access a dialing profile (Figure 9) for the user specified in the warrant and load the lawful intercept fields (702, 704, 706, 708, 710) with data that sets the lawful intercept flag field 702 to "on", stores an IP address of the mediation device 31 in the MD1 address field 704, loads the warrant ID field 706 with an identifier of the warrant and loads the start and stop fields 708 and 710 with start and stop dates and times to specify a period during which lawful intercept of communications of the identified user may occur according to the warrant.

Thus, intercept information is associated with the dialing profile by the routing controller, in response to information it receives from the call controller.

A plurality of groups of lawful intercept fields of the type shown may be added, each group being added by a different authorized device, for example, if several different law enforcement agencies operating the same or different mediation devices have warrants to monitor communications of a user.

Alternatively the authorized device may include a handover interface operable to communicate with the call controller or routing controller to access the database to load the lawful intercept fields associated with a subscriber of interest.

An exemplary dialing profile for the Vancouver subscriber is shown generally at 276 in Figure 10 and indicates that the username field includes the username 2001 1050 8667 which is the same as the contents of the username field 50 in the Vancouver telephone 12 shown in Figure 2.

Referring back to Figure 10, the domain field 260 includes a domain name as shown at 282, including a supemode type identifier 284, a location code identifier 286, a system provider identifier 288 and a top level domain identifier 290, identifying a domain or supernode associated with the user identified by the contents of the username field 258.

In this embodiment, the supernode type identifier 284 includes the code "sp" identifying a supernode and the location code identifier 286 identifies the supernode as being in Vancouver (YVR). The system provider identifier 288 identifies the company supplying the service and the top level domain identifier 290 identifies the "com" domain.

The national dialing digit (NDD) field 262 in this embodiment includes the digit "1" and, in general, includes a digit specified by the International Telecommunications Union - Telecommunications Standardization Sector (ITU-T) E.164 Recommendation which assigns national dialing digits to certain countries. Herein numbering sequences compliant with this standard will be regarded as "E.164" numbers.

The International Dialing Digit (IDD) field 264 includes the code 011 and in general includes a code assigned by the ITU-T according to the country or geographical location of the user.

The country code field 266 includes the digit "1" and in general includes a number assigned by the ITU-T to represent the country in which the user is located.

The local area codes field 267 includes the numbers 604 and 778 and generally includes a list of area codes that have been assigned by the ITU-T to the geographical area in which the subscriber is located. The caller minimum and maximum local number length fields 268 and 270 hold the number 10 representing minimum and maximum local number lengths permitted in the area code(s) specified by the contents of the local area codes field 267. The reseller field 273 holds a code identifying a retailer of the telephone services, and in the embodiment shown, the retailer is "Klondike".

Initially, the lawful intercept fields shown in Figure 9 might not be included in the dialing profile and may be added as described above, by the mediation device 31, in the event a warrant is obtained to intercept the user's calls.

Alternatively, the lawful intercept fields may be included, but populated with null values until modified by a mediation device 31.

A dialing profile of the type shown at 256 in Figure 9 is produced whenever a user registers with the system or agrees to become a subscriber to the system. Thus, for example, a user wishing to subscribe to the system may contact an office maintained by a system operator and personnel in the office may ask the user certain questions about his location and service preferences, whereupon tables can be used to provide office personnel with appropriate information to be entered into the username, domain, NDD, IDD, country code, local area codes and caller minimum and maximum local length fields 258, 260, 262, 264, 266, 267, 268, 270 to establish a dialing profile for the user.

Referring to Figures 11 and 12, dialing profiles for subscribers in Calgary and London, respectively for example, are shown.

In addition to creating dialing profiles, optionally when a user registers with the system, a direct inward dialing (DID) record of the type shown at 268 in Figure 13 is added to a direct inward dialing table in the database 18 to associate the username with a host name of the supernode with which the user is associated and with an E.164 number on the PSTN network.

In this embodiment, the DID bank table records include a username field 281, a user domain field 272 and a DID field 274, for holding the username, hostname of the supernode, and an E.164 number respectively.

A DID bank table record for the London subscriber is shown generally at 291 in Figure 14.

In addition to creating dialing profiles and DID records when a user registers with the system, call blocking records of the type shown in Figure 26, call forwarding records of the type shown in Figure 28 and voicemail records of the type shown in Figure 30 may be stored in the database 18 when a new subscriber is added to the system.

Referring back to Figure 8A, after being directed at block 254 to retrieve a dialing profile for the caller, a dialing profile such as shown at 276 in Figure 10 is retrieved and the RC processor circuit 200 is directed to perform certain checks on the callee identifier provided by the contents of the callee identifier field 154 of the RC Request message shown in Figure 6. These checks are shown in greater detail in Figure 8B.

Referring to Figure 8B, the RC processor circuit 200 is directed to a first block 257 that causes it to determine whether a digit pattern of the callee identifier 154 provided in the RC Request message includes a pattern that matches the contents of the IDD field 264 in the caller dialing profile 276 shown in Figure 10. If so, then block 259 directs the RC processor circuit 200 to set a call type code identifier (not shown) to indicate that the call is a long distance call, e.g., from the Vancouver subscriber to the London subscriber, and block 261 directs the RC processor circuit 200 to produce a reformatted callee identifier by reformatting the callee identifier into a predetermined target format. In this embodiment, this is done by removing the pattern of digits matching the IDD field contents 264 of the caller dialing profile 276 to effectively shorten the number. Then, block 263 directs the RC processor circuit 200 to determine whether or not the reformatted callee identifier meets criteria establishing it as a number compliant with the E.164 Recommendation set by the ITU-T and if the length does not meet this criteria, block 265 directs the RC processor circuit 200 to send back to the call controller 14 a message indicating that the length of the call identifier is not correct. The process 250 is then ended. At the call controller 14, routines may respond to the incorrect length message by transmitting a message back to the telephone 12 to indicate that an invalid number has been dialed.

Still referring to Figure 8B, if the length of the reformatted callee identifier meets the criteria set forth at block 263, block 269 directs the RC processor circuit 200 to determine whether or not the reformatted callee identifier is associated with a direct inward dialing (DID) bank table record such as shown at 268 in Figure 13.

An exemplary DID bank table record entry for the London callee is shown generally at 291 in Figure 14. The username field 281 and user domain field 272 are as specified in the username and user domain fields 258 and 260 of the dialing profile 276 shown in Figure 12. The contents of the DID field 274 include an E.164 telephone number including a country code 283, an area code 285, an exchange code 287 and a number 289. If the user has multiple telephone numbers, then multiple records of the type shown at 291 would be included in the DID bank table in the database 18, each having the same username and user domain, but different DID field 274 contents reflecting the different telephone numbers associated with that user.

Referring back to Figure 8B, at block 269, if the RC processor circuit 200 finds that the reformatted callee identifier produced at block 261 is found in a record in the DID bank table, then the callee is a subscriber to the system and block 279 directs the RC processor circuit 200 to copy the contents of the corresponding username field 270 into a callee ID buffer (not shown). Thus, the RC processor circuit 200 locates a subscriber username associated with the reformatted callee identifier. The processor is then directed to block 275 at point B in Figure 8A.

Subscriber to Subscriber Calls Between Different Nodes Referring back to Figure 8A, block 275 then directs the RC processor circuit 200 to determine whether or not the subscriber username is associated with the same supernode as the caller. To do this, the RC processor circuit 200 determines whether or not the continent code (61) of the username stored in the callee ID buffer is the same as the continent code (61) of the username of the caller specified by the caller identifier field 152 of the RC Request message shown in Figure 6. If they are not the same, block 277 directs the RC processor circuit 200 to set a call type flag (not shown) to indicate that the call is a cross-domain call. Then, block 350 directs the RC processor circuit 200 to produce a routing message identifying the supernode in the system with which the callee is associated and to set a TTL for the call to the maximum value of 99999. The supernode in the system, with which the callee is associated, is determined by using the callee username stored in the callee ID buffer to address a supernode table having records of the type as shown at 370 in Figure 17.

Referring to Figure 17, each prefix to supernode table record 370 has a prefix field 372 and a supernode address field 374. The prefix field 372 includes the first n digits of the callee identifier. In this case $n=1$. The supernode address field 374 holds a code representing the IP address or a fully qualified domain name of the supernode associated with the code stored in the prefix field 372.

Referring to Figure 18, for example, if the prefix is 4, the supernode address associated with that prefix is sp.lhr.digifonica.com, identifying the London supernode 2 1, for example.

Referring to Figure 15, a generic routing message is shown generally at 352 and includes a supplier prefix field 354, a delimiter field 356, a callee field 358, at least one route field 360, a time-to-live (TTL) field 362 and other fields 364.

The supplier prefix field 354 holds a code for identifying supplier traffic. The delimiter field holds a symbol that delimits the supplier prefix code from the callee field 358 and in this embodiment, the symbol is a number sign (#). The route field 360 holds a domain name or an IP address of a gateway or supernode that is to carry the call and the TTL field 362 holds a value representing the number of seconds the call is permitted to be active, based on subscriber available minutes and other billing parameters, for example.

Referring to Figure 8A and Figure 16, in this example the routing message produced by the RC processor circuit 200 at block 350 is shown generally at 366 and includes only a callee field 358, a route field 360 and a TTL field 362.

The callee field 358 holds the full username of the callee and the route field 360, shown in Figure 15, contains the identification of the domain with which the callee is associated, i.e., sp.lhr.digifonica.com.

Having produced the routing message 366 as shown in Figure 16A, referring back to Figure 8A, block 351 then directs the RC processor circuit 200 to check the caller dialing profile (see Figure 9) to determine whether or not it contains lawful intercept fields (702, 704, 706, 708, 710) and if so, to determine whether or not the determination information contained therein meets intercept criteria. The intercept criteria may be that the lawful intercept flag field 702 (Figure 9) contains a flag indicating lawful intercept is enabled and whether the current date and time is within the period specified by the LI start date/time field contents 708 and the LI stop date/time field contents 710, for example. If the intercept criteria are met, block 353 directs the RC processor circuit 200 to append the contents of the lawful intercept fields 702, 704, 706, 708, 710 to the routing message produced at block 350 to produce a routing message as shown in Figure 16A. Generally, the determination of whether or not the destination information meets intercept criteria is done prior to producing the routing message so that when the intercept criteria are met, at least some of the intercept information, in this embodiment all of it, can be included in the routing message.

If at block 351 in Figure 8A, it is determined there are no lawful intercept fields associated with the caller dialing profile or that the intercept criteria are not met, the processor does not append any lawful intercept fields to the routing message produced at block 350 in Figure 8A and the routing message shown in Figure 16 is sent to the call controller 14 as shown at block 380. If the lawful intercept fields have been appended, block 380 directs the RC processor circuit 200 to send the routing message shown in Figure 16A to the call controller 14 (Figure 1).

Referring back to Figure 8B, if at block 257, the callee identifier specified by the contents of the callee field 154 of the RC Request message shown in Figure 6 does not begin with an IDD, block 381 directs the RC processor circuit 200 to determine whether or not the callee identifier begins with the same national dial digit code as assigned to the caller. To do this, the processor is directed to refer to the caller dialing profile shown in Figure 10. In the embodiment shown, the NDD code 262 is the digit 1. Thus, if the callee identifier begins with the digit 1, the RC processor circuit 200 is directed to block 382 in Figure 8B.

Block 382 directs the RC processor circuit 200 to examine the callee identifier to determine whether or not digits following the NDD code identify an area code that is the same as any of the area codes identified in the local area codes field 267 of the caller dialing profile 276 shown in Figure 10. If not, block 384 directs the RC processor circuit 200 to set a call type variable (not shown) to a code indicating the call is a national code. If the digits identify an area code that is the same as a local area code associated with the caller, block 386 directs the RC processor circuit 200 to set the call type variable to indicate that the call type is a local call, national style. After executing blocks 384 or 386, block 388 directs the RC processor circuit 200 to format the number dialed by removing the national dial digit (NDD) and prepending a caller country code identified by the country code field 266 of the caller dialing profile shown in Figure 10. The RC processor circuit 200 is then directed to block 263 to perform the processes described above beginning at block 263.

If at block 381, the callee identifier does not begin with an NDD code, block 390 directs the RC processor circuit 200 to determine whether the callee identifier begins with digits that identify the same area code as the caller.

Again, the reference for this is the caller profile shown in Figure 10 and the RC processor circuit 200 determines whether or not the first few digits in the callee identifier identify an area code identified by the local area code field 267 of the caller profile. If so, then block 392 directs the RC processor circuit 200 to set the call type to a code indicating the call is a local call and block 394 directs the RC processor circuit 200 to prepend the caller country code to the callee identifier, the caller country code being determined from the country code field 266 in the caller profile shown in Figure 10. The RC processor circuit 200 is then directed to block 263 for processing as described above beginning at block 263.

If at block 390, the callee identifier does not have the same area code as the caller, block 396 directs the RC processor circuit 200 to determine whether the callee identifier has the same number of digits as the number of digits indicated in either the caller minimum local number length field 268 or the caller maximum local number length field 270 of the caller profile shown in Figure 10. If so, then block 398 directs the RC processor circuit 200 to set the call type to local and block 400 directs the processor to prepend to the callee identifier the caller country code as indicated by the country code field 266 of the caller profile shown in Figure 10 followed by the caller area code as indicated by the local area code field 267 of the caller profile shown in Figure 10. The RC processor circuit 200 is then directed to block 263 for further processing as described above beginning at block 263.

If at block 396, the callee identifier has a length that does not match the length specified by the contents of the caller minimum local number length field 268 or the caller maximum local number length field 270, block 402 directs the RC processor circuit 200 to determine whether or not the callee identifier identifies a valid username. To do this, the RC processor circuit 200 searches through the database of dialing profiles to find a dialing profile having username field contents 258 that match the callee identifier. If no match is found, block 404 directs the RC processor circuit 200 to send an error message back to the call controller (14). If at block 402, a dialing profile having a username field 258 that matches the callee identifier is found, block 406 directs the RC processor circuit 200 to set the call type to a code indicating the call is a network call and the processor is directed to block 275 of Figure 8A, to continue processing the RC message handler process 250.

From Figure 8B, it will be appreciated that there are certain groups of blocks of codes that direct the RC processor circuit 200 to determine whether the callee identifier has certain features such as an IDD code, a NDD code, an area code and a length that meet certain criteria and to reformat the callee identifier as necessary into a predetermined target format including only a country code, area code, and a normal telephone number, for example, to cause the callee identifier to be compatible with the E.164 number plan standard, in this embodiment. This enables the RC processor circuit 200 directed by block 279 to have a consistent format of callee identifiers for use in searching through the DID bank table records of the type shown in Figure 13 to determine how to route calls for subscriber to subscriber calls on the same system.

Subscriber to Non-Subscriber Calls Not all calls will be subscriber-to-subscriber calls and this will be detected by the RC processor circuit 200 when it executes block 269 of Figure 8B, and does not find a record that is associated with the callee in the DID bank table.

When this occurs, the RC processor circuit 200 is directed to block 408 which causes it to set the callee identifier equal to the reformatted callee identifier, i.e., the number compatible with the E.164 standard. Then, block 410 directs the RC processor circuit 200 to address a master list having records of the type shown in Figure 19.

Each master list record includes a master list ID field 500, a dialing code field 502, a country code field 504, a national sign number field 506, a minimum length field 508, a maximum length field 510, a NDD field 512, an IDD field 514 and a buffer rate field 516.

The master list ID field 500 holds a unique code such as 1019, for example, identifying a route identification (route ID). The dialing code field 502 holds a predetermined number pattern which the RC processor circuit 200 uses at block 410 in Figure 8B to find the master list record having a dialing code matching the first few digits of the reformatted callee identifier. The country code field 504 holds a number representing the country code associated with the record and the national sign number field 506 holds a number representing the area code associated with the record. (It will be observed that the dialing code is a combination of the contents of the country code field 504 and the national sign number field 506.) The minimum length field 508 holds a number representing the minimum number of digits that can be associated with the record and the maximum length field 510 holds a number representing the maximum number of digits in a number with which the record may be compared. The NDD field 512 holds a number representing an access code used to make a call within the country specified by the contents of the country code field 504 and the IDD field 514 holds a number representing the international prefix needed to dial a call from the country indicated by the country code.

Thus, for example, a master list record may have a format as shown in Figure 20 with exemplary field contents as shown.

Referring back to Figure 8B, using the country code and area code portions of the reformatted callee identifier that has been formatted for compatibility with the E.164 standard, block 410 directs the RC processor circuit 200 to find a master list record such as the one shown in Figure 20 having a dialing code that matches the country code and area code of the callee identifier. Thus, in this example, the RC processor circuit 200 would find a master list record having an ID field with the number 1019. This number may be also referred to as a route ID. Thus, a route ID number is found in the master list record associated with a predetermined number pattern in the reformatted callee identifier.

After execution of block 410 in Figure 8B, the process 250 continues as shown in Figure 8D. Referring to Figure 8D, block 412 directs the RC processor circuit 200 to use the route ID number to locate at least one supplier record identifying a supplier operable to supply a communications link for this route. To do this, block 412 directs the RC processor circuit 200 to search a supplier ID table having records of the type shown in Figure 21.

Referring to Figure 21, the supplier list records include a supplier ID field 540, a route ID field 542, an optional prefix field 544, a route identifier field 546, a NDD/IDD rewrite field 548 and a rate field 550. The supplier ID field 540 holds a code identifying the name of the supplier and the route ID field 542 holds a code for associating the supplier record with a route, and hence with a master list record. The prefix field 544 holds a string used to identify the supplier traffic and the route identifier field 546 holds an IP address of a gateway operated by the supplier indicated by the supplier ID field 540. The NDD/IDD rewrite field 548 holds a code and the rate field 550 holds a code indicating the cost per second to the system operator to use the route provided by the gateway specified by the contents of the route identifier field 546. Exemplary supplier records are shown in Figures 22, 23 and 24 for the suppliers shown in Figure 1 which may include Telus, Shaw and Sprint, respectively, for example.

Referring back to Figure 8D, at block 412 the RC processor circuit 200 finds all supplier records that identify the route ID found at block 410 of Figure 8B.

Referring back to Figure 8D, block 560 directs the RC processor circuit 200 to begin to produce routing messages of the type shown in Figure 16. To do this, the RC processor circuit 200 loads a routing message buffer as shown in Figure 25 with a supplier prefix of the least costly supplier where the least costly supplier is determined from the rate fields 550 of the records associated with respective suppliers.

Referring to Figures 22-24, in the embodiment shown, the supplier "Telus" has the lowest number in the rate field 550 and therefore the prefix 4973 associated with that supplier is loaded into the routing message buffer shown in Figure 25 first. The prefix 4973 is then delimited by the number sign and the reformatted callee identifier is next loaded into the routing message buffer.

Then, the contents of the route identifier field 546 of the record associated with the supplier Telus are added to the message after an @ sign delimiter and then block 564 in Figure 8D directs the RC processor circuit 200 to get a TTL value, which in this embodiment may be 3600 seconds, for example.

Block 566 then directs the RC processor circuit 200 to load this TTL value in the routing message buffer shown in Figure 25. Accordingly, the first part of the routing message is shown generally at 570 in Figure 25.

Referring back to Figure 8D, block 568 directs the RC processor circuit 200 back to block 560 and causes it to repeat blocks 560, 562, 564 and 566 for each successive supplier until the routing message buffer is loaded with

information pertaining to each supplier. Thus, the second portion of the routing message is shown at 572 in Figure 25 and this second portion relates to the second supplier identified by the record shown in Figure 23 and referring back to Figure 25, the third portion of the routing message is shown at 574 which is associated with a third supplier as indicated by the supplier record shown in Figure 24. Consequently, referring to Figure 25, the routing message buffer holds a routing message identifying a plurality of different suppliers able to provide gateways to establish a communication link to permit the caller to contact the callee. Each of the suppliers is identified, in ascending order according to the rates contained in the rate fields 550 of the supplier list records shown in Figures 22-24, in this embodiment. Other criteria for determining the order in which suppliers are listed in the routing message may include preferred supplier priorities which may be established based on service agreements, for example. In this case additional fields may be provided in respective supplier records to hold values representing supplier priority.

After the routing message buffer has been loaded as shown in Figure 25, block 567 directs the RC processor circuit 200 to check the caller dialing profile shown in Figure 10 to determine whether or not it contains lawful intercept fields as shown in Figure 9, and if so, to determine whether or not the intercept criteria are met by checking whether the lawful intercept flag field 702 contains a flag indicating that lawful intercept is enabled and checking whether the current date and time are within the period specified by the LI start date/time field contents 708 and the LI stop date/time field contents 710.

If the intercept criteria are met, block 569 directs the RC processor circuit 200 to append the contents of the lawful intercept fields 702, 704, 706, 708, 710 to the routing message stored in the routing message buffer, as shown in Figure 25A. Again, the determination of whether or not the destination information meets intercept criteria is done prior to producing the routing message so that when the intercept criteria are met, at least some of the intercept information, in this embodiment all of it, can be included in the routing message.

If at block 567, it is determined there are no lawful intercept fields associated with the caller dialing profile shown in Figure 10 or that the intercept criteria are not met, the RC processor circuit 200 does not append any lawful intercept fields to the routing message stored in the routing message buffer shown in Figure 25.

Block 568 then directs the RC processor circuit 200 to send the contents of the routing message buffer, i.e. the routing message shown in Figure 25 or 25A, to the call controller 14 in Figure 1.

Subscriber to Subscriber Calls Within the Same Node Referring back to Figure 8A, if at block 275, the callee identifier stored in the callee ID buffer has a prefix that identifies the same supernode as that associated with the caller, block 600 directs the RC processor circuit 200 to use the callee identifier to locate and retrieve a dialing profile for the callee identified by the callee identifier. The dialing profile is of the type shown in Figure 9, and may contain data as shown in Figure 11, for example. Block 602 of Figure 8A directs the RC processor circuit 200 to get call block, call forward and voicemail tables from the database 18 based on the username identified in the callee profile retrieved by the RC processor circuit at block 600. Call block, call forward and voicemail tables have records as shown in Figures 26, 28 and 30 for example.

Referring to Figure 26, the call block records include a username field 604 and a block pattern field 606. The username field holds a username matching the username in the username field 258 of the dialing profile associated with the callee and the block pattern field 606 holds one or more E.164-compatible numbers or usernames identifying PSTN numbers or system subscribers from whom the subscriber identified by the contents of the username field 604 does not wish to receive calls.

Referring back to Figure 8A and referring to Figure 27, block 608 directs the RC processor circuit 200 to determine whether or not the caller identifier matches a block pattern stored in the block pattern field 606 of the call block record associated with the callee identified by the contents of the username field 604 in Figure 26. If the caller identifier matches a block pattern stored in the block pattern field 606, block 610 directs the RC processor circuit 200 to send a drop call or non-completion message to the call controller (14) and the process is ended. If the caller identifier does not match a block pattern associated with the callee, block 612 directs the RC processor circuit 200 to determine whether or not call forwarding is required.

Referring to Figure 28, records in the call forwarding table include a username field 614, a destination number field 616, a destination number field 616 and a sequence number field 618. The username field 614 stores a code representing a subscriber with which the record is associated. The destination number field 616 holds a username or number representing a number to which the current call should be forwarded and the sequence number field 618 holds an integer number indicating the order in which the username associated with the corresponding destination number field 616 should be attempted for call forwarding. The call forwarding table may have a plurality of records for a given user. The RC processor circuit 200 uses the contents of the sequence number field 618 to consider the records for a given subscriber in order. As will be appreciated below, this enables the call forwarding numbers to be tried in an ordered sequence.

Referring back to Figure 8A and referring to Figure 28, if at block 612 in Figure 8A, the call forwarding record for the callee identified by the callee identifier contains no contents in the destination number field 616 and accordingly no contents in the sequence number field 618, there are no call forwarding entries and the RC processor circuit 200 is directed to load the routing message buffer shown in Figure 32 with the callee username and domain, as shown at 650 in Figure 32. The processor then directs block 602 in Figure 8A to block 602-606

If there are contents in the destination number field of the call forwarding record as shown in Figure 29, block 622 shown in Figure 8A directs the RC processor circuit 200 to search the dialing profile table to find a dialing profile record of the type shown in Figure 9, for the user identified in the destination number field 616 in the call forwarding table record of Figure 29 and to store the contents of the destination number field in the routing message buffer shown in Figure 32. The RC processor circuit 200 is then directed to load the contents of the domain field 260 shown in Figure 9 associated with the username specified by the contents of the destination number field 616 of Figure 29 into the routing message buffer as shown at 652 in Figure 32. This process is repeated for each call forwarding record associated with the callee identified by the callee identifier to add to the routing message buffer all call forwarding usernames and domains associated with the callee.

Referring to Figure 8C, at block 620 the processor is directed to determine whether or not the user identified by the callee identifier has paid for voicemail service and this is done by checking to see whether or not a flag is set in a voicemail record of the type shown in Figure 30 in a voicemail table stored in the database 18 in Figure 1.

Referring to Figure 30, voicemail table records include a username field 624, a voicemail server field 626, a seconds-to-voicemail field 628 and an enable field 630. The username field 624 stores the username of the subscriber who purchased the service. The voicemail server field 626 holds a code identifying an IP address or a fully qualified domain name (FQDN) of a voicemail server associated with the subscriber identified by the username field 624. The seconds-to-voicemail field 628 holds a code identifying the time to wait before engaging voicemail and the enable field 630 holds a code representing whether or not voicemail is enabled for the user identified by the contents of the username field 624. Therefore, referring back to Figure 8C, at block 620 the processor searches for a voicemail record as shown in Figure 31 having username field 624 contents matching the callee identifier and looks at the contents of the enable field 630 to determine whether or not voicemail is enabled. If voicemail is enabled, then block 640 in Figure 8C directs the processor to store the contents of the voicemail server field 626 of Figure 31 and the contents of the seconds to voicemail field 628 of Figure 31 in the routing message buffer as shown at 654 in Figure 32. Referring back to Figure 8C, block 642 then directs the processor to get time to live (TTL) values for each route specified by the routing message according to any of a plurality of criteria such as, for example, the cost of routing and the user's account balance. These TTL values are then appended to corresponding routes already stored in the routing message buffer.

Block 644 of Figure 8C then directs the RC processor circuit 200 to store the IP address of the current supemode in the routing message buffer as shown at 656 in Figure 32. An exemplary routing message is shown in the routing message buffer shown in Figure 32.

Block 645 of Figure 8C then directs the processor to check the caller dialing profile shown in Figure 10 to determine whether or not it contains lawful intercept fields of the type shown in Figure 9 and if so, to determine whether or not the intercept criteria are met. In this embodiment, this includes determining whether the lawful intercept flag field 702 contains a flag indicating that lawful intercept is enabled and checking whether the current date and time is within the period specified by the LI start date/time field contents 708 and the LI stop date/time field contents 710. If the intercept criteria are met, block 647 directs the RC processor circuit 200 to append the contents of the lawful intercept fields 702, 704, 706, 708, 710 to the routing message shown in Figure 32A to produce a routing message with lawful intercept field contents, as shown in Figure 32A. Again, the determination of whether or not the destination information meets intercept criteria is done prior to producing the routing message so that when the intercept criteria are met, at least some of the intercept information, in this embodiment all of it, can be included in the routing message.

Referring back to Figure 8C, if at block 645, it is determined there are no lawful intercept fields associated with the caller dialing profile of Figure 10 or that the intercept criteria are not met after producing the routing message shown in Figure 32A the processor is directed to block 649 which causes the processor to check the callee dialing profile shown in Figure 11 to determine whether or not it contains lawful intercept fields of the type shown in Figure 9 and if so, to determine whether or not the intercept criteria are met by checking whether the current date and time is within the period specified by the LI start date/time field contents 708 and the LI stop date/time field contents 710 of the callee dialing profile. If the intercept criteria are met, block 651 directs the RC processor circuit 200 to append the contents of the lawful intercept fields 702, 704, 706, 708, 710 associated with the callee dialing profile to the routing message shown in Figure 32A to produce a routing message. If at block 649 of Figure 8C, it is determined there are no lawful intercept fields associated with the callee dialing profile or that the intercept criteria are not met, no lawful intercept fields associated with the callee are appended to the routing message shown in Figure 32 or 32A. Referring back to Figure 8C, block 646 then directs the RC processor circuit 200 to send the routing message to the call controller 14.

Response to Routing Message Referring back to Figure 1, the routing message, whether of the type shown in Figures 16, 16A, 25, 25A, 32, 32A or 32B, is received at the call controller 14.

Referring to Figure 33, when a routing message is received at the call controller, the routing message handler 122 is invoked at the call controller.

The routing message handler is shown in detail in Figure 33.

Referring to Figure 33, the routing message handler begins with a first block 1200 that directs the processor circuit to determine whether the routing message includes lawful intercept information. If the processor circuit

to block 1206 which causes it to invoke a call handling routine shown in Figure 34. Referring to Figure 34, as a first step in the call handling routine, a message 1100 is sent from the call controller 14 to the media relay 17, the message including the caller telephone IP address and UDP port as determined from the caller IP address field 67 and caller UDP port field 69 in the SIP Invite message shown in Figure 3.

The specific media relay 17 to which the message 1100 is sent may be selected from a pool of available media relays and such media relays may be at any geographical location. The purpose of the message 1100 is to advise the media relay that a call is desired to be set up to communicate with the IP address and UDP number of the caller telephone.

A media relay selected from media relays located at a geographical location that facilitates communication at a desired quality of service between the media relay 17 and the caller telephone 12 and callee telephone 15 may provide the best service. Alternatively, media relays may be pre-assigned or pre-associated with users by including and populating media relay fields of the dialing profiles of users, such as shown at 1150 in Figure 9, identifying one or more media relays through which calls associated with the associated user are to be directed. In this case, the identifications of possible media relays obtained from the media relay fields 1150 may be sent to the call controller in additional fields in the routing message. These media relay fields are shown at 1152 in Figures 16, 16A, 25, 25A, 32, 32A and 32B. In essence, the media relay through which communications involving the communications involving the subscriber will be conducted is identified in response to the routing message.

Referring back to Figure 34, in this case, the message 1100 may be sent in a polling fashion to all media relays identified by the media relay fields 1150, until one responds. Alternatively, the message 1100 may be sent simultaneously to all of the media relays.

In response, in the case where the media relay is known or is involved in polling as described above, the media relay 17 to which the message 1100 is sent sends a media relay status message 1102 back to the call controller 14, the message including a media relay IP address and UDP port number at which the media relay will establish a UDP connection to the callee telephone 15. Audio data to/from the callee telephone 15 will be transmitted over this connection. In the case where the message 1100 is sent to a plurality of media relays, the first one to respond with a media relay status message is the one through which the call will be carried. Media relay status messages from the remaining media relays can be ignored.

After the media relay status message 1102 is received at the call controller, the call controller 14 then sends a SIP Invite message 1104 of the type shown in Figure 3 to the callee telephone 15, including the contents of the caller and callee identifier fields (60 and 62), the call identifier field (65) and the media relay IP address and the media relay UDP port number assigned to the audio path connection with the callee telephone 15, to invite the callee telephone to establish a connection with the media relay 17.

The purpose of the SIP Invite message 1104, is to advise the callee telephone of the caller and call ID and of the IP address and UDP port number of the media relay through which the callee telephone should send and receive audio data.

The callee telephone 15 stores the media relay IP address and assigned UDP port number in the audio path IP address buffer 47 shown in Figure 2 and configures itself to create a socket between the media relay IP/UDP address and the callee telephone IP address and a UDP port number that the callee telephone 15 desires to use as an audio path to the caller telephone. Instead of being sent or received directly to or from the caller telephone, the callee telephone 15 will send and receive audio data from the media relay. To indicate this, the callee telephone 15 sends a SIP OK message 1106 back to the call controller 14, the message including the callee IP address and UDP port number from its IP address field (53 in Figure 3) at which the callee telephone 15 will establish an audio path connection with the media relay 17.

The purpose of this SIP OK message 1106 is to advise the call controller of the IP address and UDP port number through which the media relay should send and receive audio data to and from the callee telephone.

The call controller 14 then sends a message 1108 to the media relay 17 including the IP address and UDP port number that the callee telephone 15 will use for the audio path connection with the media relay. The purpose of the message 1108 is to advise the media relay of the IP address and UDP port number through which it should send and receive audio data to and from the callee telephone.

The media relay 17 then determines a UDP port through which it will carry audio data to and from the caller telephone 12 and sends a message 1110 to the call controller (14), the message including the media relay IP address and the media relay UDP port number the media relay will use to carry audio to and from the caller telephone 12. The purpose of this message 1110 is to advise the call controller 14 of the IP address and UDP port number through which it expects to transfer audio data to and from the caller telephone.

The call controller 14 then sends a SIP OK message 1112 to the caller telephone 12 to indicate that the call may now proceed. The SIP OK message includes the caller and callee usernames, the call ID and the media relay 17 IP address and the UDP port number assigned to the audio connection with the caller telephone 12. The purpose

of this SIP OK message 1112 is to advise the caller telephone 12 of the IP address and UDP port number through which it should exchange audio data with the media relay 17.

If the routing message is of the type shown in Figure 25 where there are a plurality of suppliers available, the call handling routine proceeds as described above with the exception that instead of communicating with the callee telephone directly, the call controller 14 communicates with a gateway provided by a supplier. If a SIP OK message is not received back from the first gateway, the processor is directed to send the SIP Invite message 1104 to a gateway of the next indicated supplier. For example, the call controller 14 sends the SIP Invite message 1104 to the first supplier, in this case Telus, to determine whether or not Telus is able to handle the call. If Telus does not send back a SIP OK message 1106 within a specified time or sends a message indicating that it is not able to handle the call, the call controller proceeds to send a SIP Invite message 1104 to the next supplier, in this case Shaw. The process is repeated until one of the suppliers responds with a SIP OK message 1106 indicating that it is available to carry the call and the process proceeds as shown in connection with messages 1108, 1110 and 1112. For example, the supplier "Telus" sends back a SIP OK message and thus provides a gateway to the PSTN at IP address 72.64.39.58 as provided by the routing message from the contents of the route identifier field 546 of the corresponding supplier record shown in Figure 22.

Referring back to Figure 1, if the call controller 14 receives a message of the type shown in Figure 32, i.e., a type that has one call forwarding number and/or a voicemail number, the call controller attempts to establish a call (using SIP Invite message 1104) to the callee telephone 15 and if no call is established (i.e., message 1106 is not received) within a pre-determined time, the call controller 14 attempts to establish a call with the next user identified in the call routing message, by sending a SIP invite message like message 1104 to the next user. This process is repeated until all call forwarding possibilities have been exhausted, in which case an audio path is established with the voicemail server 19 identified in the routing message. The voicemail server 19 sends the SIP OK message 1106 in response to receipt of the SIP invite message 1104 and functions as described above in connection with the callee telephone 15 to permit an outgoing audio message provided by the voicemail server to be heard by the caller and to permit the caller to record an audio message on the voicemail server.

When audio paths are established, a call timer (not shown) maintained by the call controller logs the start date and time of the call and logs the call ID and adds an active call record of the type shown in Figure 35 to an active call list, maintained by the call controller.

In this embodiment, the call controller active call record shown in Figure 35 includes a call ID field 1300, a caller IP address field 1302, a caller port field 1304, a callee IP address field 1306, a callee port field 1308, a media relay ID field 1310, a media relay caller port field 1312 and a media relay callee port field 1314. The contents of the call ID field 1300 are established at block 136 in Figure 5. The contents of the caller IP address field 1302 are established from the contents of the caller IP address field 67 of the SIP invite message shown in Figure 3. The contents of the caller port field 1304 are established from the caller UDP port field 69 of the SIP invite message shown in Figure 3.

The contents of the callee IP address field 1306 and callee port field 1308 are established from the SIP OK message 1106 shown in Figure 34.

The media relay ID field 1310 is populated with an identification of the media relay handling the call. In the example shown, the media relay is number 42.

The contents of the media relay caller port field are obtained from the message 1110 shown in Figure 34 and the contents in the media relay callee port field 1314 are obtained from the media relay status message 1102 shown in Figure 34. Each time a call is established, an active call record of the type shown in Figure 35 is added to an active call log maintained by the call controller.

The routing controller also maintains an active call log containing active call records however the active call records maintained by the routing controller are different from the active call records held by the call controller. For example, referring to Figure 36, an active call record held by the routing controller includes a call ID field 1316, a caller field 1318, a callee field 1320 and a call controller ID field 1322. Information for populating these fields may be received in a message (not shown) transmitted from the call controller to the routing controller after an active call record has been entered into the active call log of the call controller.

The message from the call controller 14 to the routing controller 16, indicating that an active call has been established may include the contents of the call ID field 1300 shown in Figure 35 and a call controller unique ID number held by the call controller. The routing controller 16 matches the call ID with the caller and callee user names contained in the original call routing message (Fig 16, 16A, 25, 25A, 32, 32A, 32B) that caused the call controller 14 to route the call, to populate the caller and callee fields 1318 and 1320 shown in Figure 36, respectively. It will be appreciated that a plurality of call controllers may be associated with a single routing controller, in which case the call controller ID allows the routing controller to uniquely identify the call controller associated with the call ID indicated by the contents of the call ID field 1316.

In the example shown, the call controller is number 61.

The active call records facilitate intercepting a call already in progress as will be described below.

Referring back to Figure 33, if at block 1200 it is determined that the routing message has lawful intercept fields, block 1202 directs the call controller circuit 100 (Figure 4) to send a SIP Invite message as shown in Figure 37 to a mediation device identified by the mediation device IP address in the routing message as obtained from the user dialing profile MD1 address field 704 as shown at 256 in Figure 9. Referring to Figure 37, the SIP Invite message includes caller and callee identifier fields 1020, 1022, a call ID field 1024, a warrant ID field 1026 and other intercept related information fields 1028, if desired. The caller, callee and call ID field contents 1020, 1022, and 1024 are obtained from the original SIP Invite message shown in Figure 6. The contents of the warrant ID field 1026 and intercept related info fields 1028 are obtained from the routing message which would be of the type shown in Figures 16A, 25A, 32A or 32B.

Referring back to Figure 33, block 1204 then directs the call controller 14 to receive a reply message, as shown in Figure 38, from the mediation device 31. The reply message is a SIP OK message that includes caller, callee, and call ID fields 1040, 1042, 1044 as described above and further includes a mediation device IP address field 1046 and a mediation device UDP caller port number field 1048 and a UDP callee port number field 1050 identifying UDP ports at the mediation device IP address to which the media relay is to send copies of audio data streams received from the caller and callee telephones respectively. Block 1206 then directs the call controller to execute the call handling routine shown in Figure 34 with the exception that the message 1100 additionally includes the contents of the mediation device IP address field 1046, the mediation device UDP caller port number field 1048 and the UDP callee port number field 1050 of the SIP OK message shown in Figure 38.

All other messages are the same as described above in connection with the call handling routine as shown in Figure 34, but in response to receiving the additional information in the message 1100, the media relay automatically configures itself to provide for copying the audio data received from both the caller telephone and the callee telephone to the mediation device IP address and the UDP caller port number and the UDP callee port number respectively.

Referring back to Figure 1, as audio data originating at the caller telephone 12 and callee telephone 15 passes through the media relay 17, this data is copied to the mediation device UDP port for the caller and the mediation device UDP port for the callee, as indicated by the SIP invite message 1100.

This enables law enforcement agencies to monitor audio communications between the caller and callee and/or to record such communications at the mediation device.

Thus, when the determination information in the dialing profile meets intercept criteria, the call controller communicates with the media relay through which communications involving the subscriber whose communications are to be monitored will be handled to cause the media relay to send a copy of such communications to a mediation device specified by the destination information included in the intercept information associated with the dialing profile associated with the subscriber whose communications are to be monitored.

Terminating the Call In the event that either the caller or the callee terminates a call, the telephone of the terminating party sends a SIP Bye message to the call controller 14. An exemplary SIP Bye message is shown at 900 in Figure 39 and includes a caller field 902, a callee field 904 and a call ID field 906. The caller field 902 holds the caller username, the callee field 904 holds a PSTN compatible number or username, and the call ID field 906 holds a unique call identifier field of the type shown in the call identifier field 65 of the SIP Invite message shown in Figure 3.

Thus, for example, referring to Figure 40, a SIP Bye message for the Calgary callee is shown generally at 908 and the caller field 902 holds a username identifying the Vancouver caller, in this case 2001 1050 8667, the callee field 904 holds a username identifying the Calgary callee, in this case 2001 1050 2222, and the call ID field 906 holds the code FA10® 192.1 68.0.20, which is the call ID for the call.

The SIP Bye message shown in Figure 40 is received at the call controller 14 and the call controller executes a process as shown generally at 910 in Figure 41. The process includes a first block 912 that directs the call controller circuit (100) to copy the caller, callee and call ID field contents from the SIP Bye message 900 shown in Figure 39 received from the terminating party to corresponding fields of an RC stop message buffer (not shown). Block 914 then directs the call controller circuit 100 to copy the call start time from the call timer and to obtain a Call Stop time from the call timer. Block 916 then directs the call controller to calculate a communication session time by determining the difference in time between the call start time and the Call Stop time. This communication session time is then stored in a corresponding field of the RC Call Stop message buffer. Block 918 then directs the call controller circuit 100 to populate the route field with the IP address of the gateway supplier, if any. An RC Call Stop message produced as described above is shown generally at 1000 in Figure 42. An RC Call Stop message specifically associated with the call made to the Calgary callee is shown generally at 1021 in Figure 43.

Referring to Figure 42, the RC call stop message 1000 includes a caller field 1002, callee field 1004, a call ID field 1006, an account start time field 1008, an account stop time field 1010, a communication session time field 1012 and a route field 1014. The caller field 1002 holds a username, the callee field 1004 holds a PSTN-compatible number or system number, the call ID field 1006 holds the unique call identifier received from the SIP Invite message shown in Figure 3, the account start time field 1008 holds the call start time, and the account stop time field 1010 holds the call end time.

the account stop time field 1010 holds the date and time the call ended, the communication session time field 1012 holds a value representing the difference between the start time and the stop time, in seconds, and the route field 1014 holds the IP address for a gateway, if a gateway is used to establish the call.

Referring to Figure 43, an exemplary RC call stop message for the Calgary callee is shown generally at 1021. In this example the caller field 1002 holds the username 2001 1050 8667 identifying the Vancouver caller and the callee field 1004 holds the username 2001 1050 2222 identifying the Calgary callee.

The contents of the call ID field 1006 are FA10® 192.1 68.0.20. The contents of the account start time field 1008 are 2006-12-30 12:12:12 and the contents of the account stop time field 1010 are 2006-12-30 12:12:14. The contents of the communication session time field 1012 are 2 to indicate 2 seconds call duration and the contents of the route field are blank but would be 72.64.39.58 if the "Telus" gateway were used, for example.

Referring back to Figure 4 1, after having produced an RC Call Stop message, block 920 directs the call controller circuit 100 to send the RC stop message contained in the RC Call Stop message buffer to the routing controller (16).

The RC (16) receives the Call Stop message and an routing controller Call Stop message process (not shown) is invoked at the routing controller to deal with charges and billing for the call.

Block 922 directs the call controller circuit 100 to send a Bye message to the party that did not terminate the call i.e. to the non-terminating party.

Block 924 then directs the call controller circuit 100 to send a SIP Bye message of the type shown in Figure 39 to the media relay 17 to cause the media relay to disconnect the audio path sockets associated with the caller telephone IP/UDP address and the callee telephone IP/UDP address. In disconnecting these communication sockets, the media relay 17 deletes associations between the caller telephone IP/UDP address media relay caller IP/UDP address and between the caller telephone IP/UDP address and media relay callee IP/UDP address.

If the media relay (17) was configured for lawful intercept, block 926 of Figure 41 then directs the call controller circuit 100 to send a SIP Bye message of the type shown in Figure 39 to the mediation device 3 1 to inform the mediation device that the call has ended and to disconnect communication sockets between the media relay caller and callee IP/UDP port addresses and the IP/UDP port address to which the audio data received at the caller and callee IP/UDP port addresses were being copied.

It will be appreciated that in the foregoing description, the components described cooperate to detect a requirement for intercept at the time a call is set up. In the following description an explanation is provided to describe how to intercept a call while the call is in progress.

Intercepting a Call in Progress Referring back to Figure 1, to intercept a call while the call is in progress, the law enforcement authority 293 may communicate with a mediation device, or may communicate with the call controller or may communicate with the routing controller or may communicate with a handover interface that communicates with any of the foregoing components to cause the routing controller to receive a law enforcement authority (LEA) intercept request message including intercept information. Such as that which would be associated with fields 702-710 in Figure 9, for example..

In response to receipt of a, LEA intercept request message, the routing controller LEA request message handler shown at 1400 in Figure 44 is invoked.

The LEA request message handler 1400 begins with a first block 1402 that directs the routing controller processor circuit to communicate with the database 18 in which dialing profile records of the type shown in Figure 9 are stored to find a dialing profile associated with the user whose calls are to be monitored.

If the username is not known, but a DID number (i.e. a PSTN number) is known, the routing controller may cause a search through the DID bank table records of the type shown in Figure 13, for example to find a username associated with a DID number. If the username is not known but a name and address is known, other records such as billing records (not shown) associating names and addresses with usernames may be searched to find a username associated with a given name and/or address of a person whose calls are to be intercepted. Regardless of the information available, to facilitate call interception any way of finding the unique dialing profile associated with the user whose calls are to be intercepted is a first step to facilitating call interception, in this embodiment.

Once the dialing profile is located, block 1404 directs the routing controller processor circuit to associate the intercept information with the dialing profile by appending and/or populating the lawful intercept fields of the dialing profile with such information as provided in the LEA intercept request message..

Block 1406 then directs the routing controller processor circuit to determine whether the intercept criteria are met by the intercept information now included in the dialing profile. This is done by determining whether the LI flag (702) is on, and the current date and time is within the LI start stop date/time ranges. If the intercept criteria are not met, the process is ended. Otherwise the processor is directed to block 1408.

Block 1408 directs the routing controller processor circuit to use the username of the dialing profile found at block 1402 to search caller and callee fields of routing controller active call records shown in Figure 36 that have contents matching the username associated with the dialing profile. If no such record is found, the user is not currently engaged in a call and the process is ended. If the user is engaged in a call, the routing controller active call record will be found. Block 1410 then directs the routing controller processor circuit to find the call controller id and call id of the associated call, from the routing controller active call record shown in Figure 36.

Block 1412 then directs the routing controller processor circuit to transmit an in-call intercept message to the call controller identified by the contents of the call controller id field 1322 of the routing controller active call record. The in-call intercept message includes the call id as determined from the routing controller active call record and the IP address of the mediation device associated with the law enforcement authority interested in intercepting the call. The IP address of the mediation device may be obtained from the law enforcement authority request message, or the dialing profile, for example.

Block 1414 then directs the routing controller processor circuit to wait a specified time to receive a call controller intercept status message back from the call controller indicating whether or not the intercept function has been activated.

Referring to Figure 45, upon receipt of an in-call intercept message at the call controller (14) the call controller executes an in-call intercept message handler shown generally at 1450. The in-call intercept message handler 1450 begins with a first block 1452 that directs the call controller processor circuit to send a SIP invite message to the mediation device associated with the IP address of the mediation device, received in the in-call intercept message.

Block 1454 then directs the call controller processor circuit to receive an IP address and callee and caller UDP port numbers from the mediation device, where this IP address and UDP port numbers are network locations at which the mediation device will expect to receive audio data streams from the media relay through which the call is carried.

Block 1456 then directs the call controller processor circuit to identify a media relay through which communications to be monitored are being conducted by using the username of the subscriber whose communications are to be monitored to locate an active call record in the call controller active call list to locate a media relay identifier such as the IP address of the media relay indicated by the contents of the media relay ID field 1310 of the call controller active call record shown in Figure 35. The call controller processor circuit is then directed to send an intercept request message to the media relay (17) that is handling the call. The intercept request message includes the mediation device IP address and caller and callee UDP port numbers to identify to the media relay (17) the mediation device IP address and UDP port number(s) at which it expects to receive a copy of the audio data stream from the caller and callee respectively.

In response, the media relay establishes internal connections between the caller and callee IP addresses and UDP ports and callee IP address and UDP port of the mediation device. Then, the media relay sends a media relay status message back to the call controller indicating whether or not internal connections have been established and that call intercept has been initiated.

As seen at block 1458, the call controller processor circuit is directed to receive the media relay status message and block 1460 directs the call controller processor circuit to send a call controller intercept status message back to the routing controller to indicate that the call intercept function has been established. The routing controller may communicate this status back to the law enforcement authority that issued the law enforcement authority request message. In the meantime, communications involving the caller or callee whose communications are to be monitored, which travel through the media relay, are copied and sent to the mediation device.

Thus, after associating intercept information with the dialing profile of the subscriber whose communications are to be monitored, when the determination information included in the intercept information meets intercept criteria, the call controller communicates with the media relay through which the communications of the subscriber whose communications are to be monitored to cause such media relay to send a copy of such communications to a mediation device specified by the destination information included in the intercept information.

When the call is ended, the call is shut down in the same way as described above.

Should the law enforcement authority desire to cease interception of the call during the call, an LEA request message requesting that the intercept function be stopped is sent to the routing controller from the law enforcement authority through any of the paths described above. This invokes the LEA request message handler such as shown in Figure 44 which causes the routing controller processor circuit to execute blocks 1402, 1404. At block 1404, the routing controller processor circuit is directed to change the contents of the lawful intercept fields to at least set the lawful intercept flag (702 in Figure 9) inactive.

Then, at block 1406, the intercept criteria are not met and the processor is directed to block 1416, which causes the routing controller processor circuit to determine whether or not an interception function is in progress. This

can be determined, for example, by maintaining evidence of the receipt of the confirmation message from the call controller, received at block 1414 of the LEA request message handler 1400.

If an intercept is not in progress, the LEA request message handler 1400 is ended.

If an intercept is in progress, block 1418 directs the routing controller processor circuit to execute an in-call intercept shut down routine as shown at 1500 in Figure 46. The in-call intercept shut down routine begins with a first block 1502 which directs the routing controller processor circuit to locate the routing controller active call record having caller or callee field contents equal to the username indicated in the dialing profile found at block 1402 of the LEA request message handler 1400 shown in Figure 44. Having found the active call record, block 1504 directs the routing controller processor circuit to find, in the routing controller active call record shown in Figure 36, the call controller id (1322) and the call id (1316) associated with the call. Block 1506 then directs the routing controller processor circuit to send a cease intercept message (not shown) to the call controller identified by the call controller id determined at block 1504. This cease intercept message includes the call id determined at block 1504 and an identification of the mediation device, the identification being obtained from the MD1 address field (704 in Figure 9) of the dialing profile for the user whose calls are currently being intercepted.

Block 1508 then directs the routing controller processor circuit to wait a specified time to receive a confirmation message from the call controller to indicate that the intercept function has been shut down.

Referring to Figure 47, upon receipt of the cease intercept message at the call controller (14), a cease intercept message handler 1520 is invoked at the call controller. The cease intercept message handler 1520 begins with a first block 1522 that directs the call controller processor circuit to send a SIP stop message to the mediation device identified in the cease intercept message received from the routing controller. In response to the SIP stop message, the mediation device stops receiving audio data and sends a confirmation message back to the call controller.

Block 1524 directs the call controller processor circuit to receive the confirmation message back from the mediation device.

Block 1526 then directs the call controller processor circuit to send a stop intercept message to the media relay 17 identified by the contents of the media relay ID field 1310 of the active call record shown in Figure 35. The stop intercept message includes the contents of the media relay caller port ID field 1312 and media relay callee port field 1314 included in the active call record and identifies to the media relay which ports to shut down. In response to the stop intercept message, the media relay 17 disconnects the connections between the media relay caller port and the mediation device port that was receiving the audio data from the caller and the connection between the media relay callee port and the mediation device port that was receiving audio data from the callee. The media relay then sends an MR stop status message to the call controller.

Block 1528 directs the call controller processor circuit to receive the MR stop status message and block 1530 directs the call controller to send a stop status message to the routing controller 16.

In an alternative embodiment, the routing controller does not maintain active call records but each call controller does. In such an embodiment, blocks 1408 and 1410 of Figure 44 are replaced with a single block 1600 that directs the routing controller processor circuit to poll each call controller to determine whether or not its active call list contains an entry having caller or callee field contents equal to the username determined from the dialing profile located at block 1402.

If any of the polled call controllers has such a record, that call controller transmits a response message back to the routing controller, the response message including a call controller ID identifying that call controller. More than one call controller may have an active call record having caller or callee field contents equal to the username determined from the user profile. Such would be the case in a conference call, for example.

The routing controller processor circuit then executes blocks 1412 and 1414 as described above or the process is ended if none of the polled call controllers contains a call record with caller and callee field contents matching the username determined from the dialing profile located at block 1402.

In effect therefore, block 1600 provides an alternate way of finding call controllers that are currently carrying a call associated with the user of interest.

In another embodiment, an interface to the routing controller and/or the call controller may be provided to enable law enforcement authorities to have direct access or a copy of the active call list maintained by the call controller and/or routing controller.

From the foregoing, it will be appreciated that indications of whether or not communications of a subscriber to the system are to be monitored are provided by law enforcement agencies directly into a subscriber dialing profile shown in Figure 9. This dialing profile is used to route a call involving the subscriber and is checked for lawful intercept requirements to determine whether or not the media relay should copy audio data associated with the call to a mediation device for lawful monitoring and/or recording purposes.

While the system has been described in connection with the monitoring of audio streams, it may similarly be used for monitoring any other data streams such as pure data and/or video or multimedia data, for example, between subscribers to the system or between a subscriber and a non-subscriber to the system.

While specific embodiments of the invention have been described and illustrated, such embodiments should be considered illustrative of the invention only and not as limiting the invention as construed in accordance with the accompanying claims.

Citations

Citation *Record level*

Citing Patents (0)

Cited Patents (0)

Cited Non-patents (0)

DPCI Citation *Patent family level*

Expand DPCI Citing Patents (17)

Expand DPCI Cited Patents (13)

Expand DPCI Cited Non-patents (1)

Expand DPCI Citation Counts

DPCI Field of Search

-

DPCI Citing Patents Country

EP; US; CN

DPCI Cited Patents Country

WO; EP; US

Other

Attorney / Agent

SPRUSON & FERGUSON (ASIA) PTE LTD

PCT Application / Publication

WO2007CA2150A / 2007-11-29

WO2008064481A1 / 2008-06-05

Copyright 2007-2015 THOMSON REUTERS

Public Search & Enquiry

Disclaimer

This search facility ("this facility") makes available information related to IP applications and registrations at Intellectual Property Office of Singapore ("IPOS"). Whilst IPOS takes reasonable care in the provision of this facility and information, it does not guarantee or in any way represent the accuracy or completeness of this facility or information, nor accept any responsibility for errors or omissions or their consequences. Nevertheless, all reasonable efforts have been made within the limits of hardware and internet bandwidth to provide as much information as possible.

Users should also note that some documents like patent specifications and abstracts have undergone automated optical character recognition (OCR) to render them text-searchable by this facility. Due to the nature of OCR, these documents may contain discrepancies when compared with the original document images.

Fast Search
 Simple Search
 Advanced Search

Search Type

Forms
 IP
 Journals
 Trade Marks Classification of Goods or Services
 Patents Abstract & Specification

Search Category

Designs
 Patents
 Trade Marks

Application No.	<input type="text"/>
Filing Date From	<input type="text"/> To <input type="text"/> (dd/mm/yyyy)
Applicant / Proprietor Name	<input type="text" value="Digifonica"/>
Agent Name	<input type="text"/>
Case No.	<input type="text"/>

Additional Information for Patent

Publication No.	<input type="text"/>
Title	<input type="text"/>
Inventor	<input type="text"/>
International Patent Classification	<input type="text"/>
Application Status	<input checked="" type="checkbox"/> All Status <input checked="" type="checkbox"/> Abandoned

PETITIONER: APPLE INC. (Extension of 1002-615)

	<input checked="" type="checkbox"/> Abandoned (Extension of Time Possible) <input checked="" type="checkbox"/> Expired <input checked="" type="checkbox"/> Lapsed <input checked="" type="checkbox"/> Lapsed (Late Renewal Possible) <input checked="" type="checkbox"/> Lapsed (Restoration Pending) <input checked="" type="checkbox"/> Lapsed (Restoration Possible) <input checked="" type="checkbox"/> Patent In Force <input checked="" type="checkbox"/> Pending (Not Published) <input checked="" type="checkbox"/> Pending (Published) <input checked="" type="checkbox"/> Refused <input checked="" type="checkbox"/> Refused (Extension of Time Pending) <input checked="" type="checkbox"/> Refused (Extension of Time Possible) <input checked="" type="checkbox"/> Revoked <input checked="" type="checkbox"/> Surrendered <input checked="" type="checkbox"/> Withdrawn
Earliest Claimed Priority Date From	<input type="text"/> To <input type="text"/> (dd/mm/yyyy)
Lodgement Date From	<input type="text"/> To <input type="text"/> (dd/mm/yyyy)
Optional Fields	<input type="checkbox"/> Inventor(s) <input type="checkbox"/> PCT Application Number <input type="checkbox"/> Earliest Claimed Priority Date <input type="checkbox"/> International Patent Classification <input type="checkbox"/> Publication Number <input type="checkbox"/> Application Type

Search Result

S/No	Application No.	App Status	Filing Date	Lodgement Date	Applicant/Proprietor Name	Title	Agent Name
1	2009050872	Abandoned	20/03/2008	14/09/2009	1) DIGIFONICA (INTERNATIONAL) LIMITED	EMERGENCY ASSISTANCE CALLING FOR VOICE OVER IP COMMUNICATIONS SYSTEMS	1) SPRUSON & FERGUSON (ASIA) PTE LTD
2	2009035841	Abandoned	29/11/2007	27/05/2009	1) DIGIFONICA (INTERNATIONAL) LIMITED	INTERCEPTING VOICE OVER IP COMMUNICATIONS AND OTHER DATA COMMUNICATIONS	1) SPRUSON & FERGUSON (ASIA) PTE LTD
3	2009029497	Abandoned	01/11/2007	29/04/2009	1) DIGIFONICA (INTERNATIONAL) LIMITED	PRODUCING ROUTING MESSAGES FOR VOICE OVER IP COMMUNICATIONS	1) SPRUSON & FERGUSON (ASIA) PTE LTD

Page 1 / 1 of 3 record(s)

[<<](#)
[<](#)
[1](#)
[>](#)
[>>](#)

Rows per page:

Details of Patent

Application No.	2009035841
Application Status	Abandoned
Filing Date	29/11/2007
SG Publication No.	152752
PCT Application No.	PCT/CA2007/002150
Entry Date	27/05/2009
Priority Claimed	29/11/2006 US 60/861,431
Title of Invention	INTERCEPTING VOICE OVER IP COMMUNICATIONS AND OTHER DATA COMMUNICAT
International Patent Classification	
PCT Publication No.	WO 2008/064481
Date of Publication of Entry into National Phase	29/06/2009

☛ Current Applicant or Proprietor Details

1) Name	DIGIFONICA (INTERNATIONAL) LIMITED
UEN / Company Code	E00056891A
Country	Canada
Address	SUITE #890, 999 WEST HASTINGS STREET, VANCOUVER, BRITISH COLUMBIA V6C 3 Canada
Sole Proprietor Or Partners' Names	

☛ Inventor Details

Name	BJORSELL, JOHAN EMIL VICTOR
Address	PO BOX 29164 RPO SOUTH GRANVILLE POST VANCOUVER, BRITISH COLUMBIA V6J PETITIONER APPLE INC. EX 1002-617

Country of Residence Canada

Name SOBOLYEV, MAKSYM

Address 506-210 ELEVENTH STREET NEW WESTMINSTER, BRITISH COLUMBIA V3M 4C9

Country of Residence Canada

☛ Agent/Correspondence Details

1) Agent Name SPRUSON & FERGUSON (ASIA) PTE LTD

UEN / Company Code 200100515C

Representative Name

Address For Service P.O. BOX 1531
ROBINSON ROAD POST OFFICE
Singapore 903031

Action Representing For all matters relating to the application, registration/grant, except those matters e:

☛ Other Entries

S/No.	Event
1	Patent application abandoned
2	Bibliographic publication of application filed
3	Request for extension of periods under sections 29(7) and 30(1)(a) filed
4	Notification of PCT national phase entry
5	ELLA CHEONG SPRUSON & FERGUSON (SINGAPORE) PTE LTD, P.O. BOX 1531, ROBINSON ROAD POST OFFICE, SINGAPORE 903031 Registered as patent agent
6	Application lodged on 27/05/2009

☛ Specification Documents

- 1 Description (with claims)
- 2 Drawing(s)

☛ Abstract Documents

- 1 Abstract

(19) World Intellectual Property Organization
International Bureau



(43) International Publication Date
5 June 2008 (05.06.2008)

PCT

(10) International Publication Number
WO 2008/064481 A1

- (51) International Patent Classification:
H04L 12/26 (2006.01) H04M 11/06 (2006.01)
H04L 12/66 (2006.01) H04M 3/22 (2006.01)
- (21) International Application Number:
PCT/CA2007/002150
- (22) International Filing Date:
29 November 2007 (29.11.2007)
- (25) Filing Language: English
- (26) Publication Language: English
- (30) Priority Data:
60/861,431 29 November 2006 (29.11.2006) US

(74) Agent: SMART & BIGGAR; Box 11560 Vancouver Center, 2200 - 650 West Georgia Street, Vancouver, British Columbia V6B 4N8 (CA).

(81) Designated States (unless otherwise indicated, for every kind of national protection available): AE, AG, AL, AM, AT, AU, AZ, BA, BB, BG, BH, BR, BW, BY, BZ, CA, CH, CN, CO, CR, CU, CZ, DE, DK, DM, DO, DZ, EC, EE, EG, ES, FI, GB, GD, GE, GH, GM, GT, HN, HR, HU, ID, IL, IN, IS, JP, KE, KG, KM, KN, KP, KR, KZ, LA, LC, LK, LR, LS, LT, LU, LY, MA, MD, ME, MG, MK, MN, MW, MX, MY, MZ, NA, NG, NI, NO, NZ, OM, PG, PH, PL, PT, RO, RS, RU, SC, SD, SE, SG, SK, SL, SM, SV, SY, TJ, TM, TN, TR, TT, TZ, UA, UG, US, UZ, VC, VN, ZA, ZM, ZW.

(71) Applicant (for all designated States except US): DIGIFONICA (INTERNATIONAL) LIMITED [CA/CA]; Suite 1401, 4710 Kingsway Avenue, Burnaby, British Columbia V5H 4M2 (CA).

(72) Inventors; and

(75) Inventors/Applicants (for US only): BJORSELL, Johan Emil Victor [SE/CA]; 273 West 5th Street, North Vancouver, British Columbia V7M 1J9 (CA). SOBOLYEV, maksym [UA/CA]; 307-265 Tenth Street, New Westminster, BC, V3M 3Y1 (CA).

(84) Designated States (unless otherwise indicated, for every kind of regional protection available): ARIPO (BW, GH, GM, KE, LS, MW, MZ, NA, SD, SL, SZ, TZ, UG, ZM, ZW), Eurasian (AM, AZ, BY, KG, KZ, MD, RU, TJ, TM), European (AT, BE, BG, CH, CY, CZ, DE, DK, EE, ES, FI, FR, GB, GR, HU, IE, IS, IT, LT, LU, LV, MC, MT, NL, PL, PT, RO, SE, SI, SK, TR), OAPI (BF, BJ, CF, CG, CI, CM, GA, GN, GQ, GW, ML, MR, NE, SN, TD, TG).

Published:

- with international search report
- with amended claims

(54) Title: INTERCEPTING VOICE OVER IP COMMUNICATIONS AND OTHER DATA COMMUNICATIONS

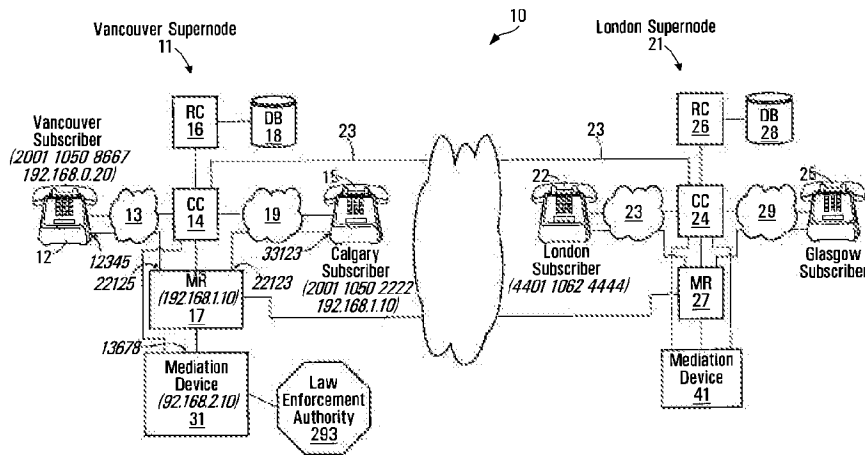

(57) Abstract: Methods and apparatus for intercepting communications in an Internet Protocol (IP) network involve maintaining dialing profiles for respective subscribers to the IP network, each dialing profile including a username associated with the corresponding subscriber, and associating intercept information with the dialing profile of a subscriber whose communications are to be monitored. Intercept information will include determination information for determining whether to intercept a communication involving the subscriber, and destination information identifying a device to which intercepted communications involving the subscriber are to be sent. When the determination information meets intercept criteria communications are established with a media relay through which communications involving the subscriber will be conducted or are being conducted to cause the media relay to send a copy of the communications involving the subscriber to a mediation device specified by the destination information.

WO 2008/064481 A1

INTERCEPTING VOICE OVER IP COMMUNICATIONS AND OTHER DATA COMMUNICATIONS

CROSS REFERENCE TO RELATED APPLICATIONS

5 This application claims the benefit of U.S. Provisional Application No. 60/861,431 filed November 29, 2006.

BACKGROUND OF THE INVENTION

1. Field of Invention

10 This invention relates to data communications and methods and apparatus for intercepting data communications, particularly voice over IP data communications, in an IP network.

2. Description of Related Art

15 The term "lawful intercept" is used to describe a procedure which allows law enforcement agencies to perform electronic surveillance of telecommunications. Lawful intercept of telecommunications, particularly phone calls, is premised on a notion that a law enforcement agency has identified a person of interest, obtained a legal authorization for the surveillance (for example, a judicial or administrative warrant), and then
20 contacted the person's telecommunications service provider that will be required to provide the law enforcement agency with a real-time copy of the person's communications. This real-time copy can then be used by the law enforcement agency to monitor or record the person's communications.

25 Within the framework of traditional telecommunications networks, such as, for example, the Public Switched Telephone Network (PSTN) or cellular networks, lawful intercept generally presents a purely economic problem for the service providers that have to ensure that sufficient interception equipment and dedicated links to the law enforcement agencies have been
30 deployed to satisfy lawful intercept requirements mandated by law. However, in the context of Voice over Internet Protocol (VoIP) communications, in addition to the economic problems mentioned above, lawful intercept presents

-2-

significant technological challenges which often makes compliance with legally mandated lawful intercept requirements exceedingly difficult.

5 The problem lies in the very nature of the VoIP technology and the Internet Protocol (IP) networks (for example, the Internet) that underlie it.

10 Traditional telecommunications networks are "connection-oriented" or "circuit-switched". Communications over such networks occur via dedicated "circuits". Although the networks typically comprise a plurality of available parallel paths, when a circuit is established, only a single one of the available paths is picked. In situations where a circuit has failure protection, a redundant path, also determined at the time of the circuit establishment, can also be reserved. Once the circuit is established, all communications traverse from end to end. Interception of such communications is easy as the service provider can "tap" the circuit at any point in the network that is under its lawful control.

20 In contrast to circuit-switched networks, IP-based networks are "connectionless" by design. A connectionless IP network essentially comprises a plurality of interconnected network devices (routers) which establish a plurality of paths from any point on the network to any other point. Information that needs to traverse an IP network is divided into small "packets", each one comprising an IP header containing source and destination addressing information, and service flags; and user payload. The specific path that each packet in a communication between parties takes across an IP network is not determined in advance such as in a circuit-switched network. The path is defined on a hop-by-hop basis (router-by-router), each router at which the packet arrives examines the source and destination addresses contained in the IP header and applies a number of service variables such as hop-count (number of routers between the current router and the destination), latency and bandwidth of available links, and administrative considerations such as inter-provider agreements, to determine

30

-3-

the next hop to which the packet will be forwarded. Because the service variables change dynamically, for example in response to a failure of a link in the network, the available paths may change significantly and it is impossible to reliably predict the path or paths that the packets that comprise a specific a
5 specific communication will traverse. Furthermore, it is not even possible to predict the order in which the packets will arrive at their destination as the different paths taken may have different latency. While the plurality of available paths and out-of-order arrivals present no problems to IP-based applications that usually keep track of the packet sequence to reassemble the
10 communication, the same factors present formidable problems for the lawful intercept of communication over IP networks, particularly lawful intercept of VoIP calls.

The problem of lawful intercept in VoIP systems is further exacerbated by the
15 distributed technologies often utilized in such systems. While a VoIP caller typically communicates with a VoIP call controller to facilitate the connection to the VoIP callee, the actual communication between the parties typically occurs by establishing a direct IP connection between them using the User Datagram Protocol (UDP) to encapsulate audio information into IP packets.
20 These packets may take any available path across the IP network as described above. Even if a service provider could place an interception device at every point in the network through which a subscriber's packet could traverse, in order to provide a useful copy of the communication to a law enforcement agency, the service provider would have to reassemble all of the
25 intercepted packets at a single device and only then pass the result to the law enforcement agency. In essence, the service provider would have to mirror the functions of the callee VoIP telephone, except the packets that comprise the communication would have to be collected from multiple points in the network. The technological challenges and economic costs associated with
30 this proposition have thus far resulted in lack of meaningful lawful intercept capabilities in VoIP systems.

-4-

SUMMARY OF THE INVENTION

In accordance with one aspect of the invention, there is provided a method for intercepting communications in an Internet Protocol (IP) network. The method involves maintaining dialing profiles for respective subscribers to the IP network, each dialing profile including a username associated with the corresponding subscriber. The method also involves associating intercept information with the dialing profile of a subscriber whose communications are to be monitored, the intercept information including determination information for determining whether to intercept a communication involving the subscriber, and destination information identifying a device to which intercepted communications involving the subscriber are to be sent. The method further involves, when the determination information meets intercept criteria, communicating with a media relay through which the communications involving the subscriber will be conducted or are being conducted to cause the media relay to send a copy of the communications to a mediation device specified by the destination information.

Associating intercept information may involve associating the intercept information with the dialing profile when communications involving the subscriber are not in progress.

Associating intercept information may involve associating the intercept information when communications involving the subscriber are in progress.

Associating the intercept information may involve populating intercept information fields in the dialing profile of the subscriber whose communications are to be monitored.

The method may involve producing a routing message for routing communications involving the subscriber through components of the IP network and determining whether the determination information meets the

-5-

intercept criteria prior to producing the routing message and including at least some of the intercept information in the routing message when the determination information meets the intercept criteria.

5 Determining whether the determination information meets the intercept criteria may involve determining whether a current date and time is within a range specified by the determination information.

10 The method may involve identifying a media relay through which communications involving the subscriber will be conducted in response to the routing message.

15 The method may involve pre-associating at least one media relay with the dialing profile of the subscriber whose communications are to be monitored and identifying the media relay may involve identifying the media relay pre-associated with the subscriber whose communications are to be monitored.

20 Pre-associating may involve populating media relay fields in the dialing profile with an identification of at least one media relay.

25 The intercept information may be associated with the dialing profile of the subscriber whose communications are to be monitored, in response to receipt of an intercept request message, and the intercept request message may include the intercept information.

30 The method may involve invoking an intercept request message handler to find a dialing profile associated with the subscriber whose communications are to be monitored, and to perform the step of associating the intercept information with the dialing profile, and to determine whether the intercept criteria are met, and identify a media relay through which the communications are being conducted.

-6-

5 The method may involve maintaining active call records for communications in progress, and the active call records may include a username identifier and a media relay identifier identifying the media relay through which the communications are being conducted and identifying a media relay through which the communications are being conducted may involve locating an active call record associated with communications of the subscriber whose communication are to be monitored to find the media relay associated with the communications.

10 The method may involve maintaining direct-inward-dialing (DID) records associating PST telephone numbers with usernames of users subscribing to the IP network, and finding a dialing profile associated with the subscriber whose communications are to be monitored may involve finding a username in a DID record bearing a PSTN number associated with the subscriber
15 whose communications are to be monitored. The username may be used to locate a dialing profile associated with the username.

In accordance with another aspect of the invention, there is provided an apparatus for intercepting communications in an Internet Protocol (IP)
20 network. The apparatus includes provisions for maintaining dialing profiles for respective subscribers to the IP network, each dialing profile including a username associated with the corresponding subscriber. The apparatus also includes provisions for associating intercept information with the dialing profile of a subscriber whose communications are to be monitored, the intercept
25 information including determination information for determining whether to intercept a communication involving the subscriber, and destination information identifying a device to which intercepted communications involving the subscriber are to be sent. The apparatus further includes provisions for communicating with a media relay through which the communications
30 involving the subscriber will be conducted or are being conducted to cause the media relay to send a copy of the communications to a mediation device

-7-

specified by the destination information, when the determination information meets intercept criteria.

5 The provisions for associating intercept information may be operably configured to associate the intercept information with the dialing profile when communications involving the subscriber are not in progress.

10 The provisions for associating intercept information may be operably configured to associate the intercept information when communications involving the subscriber are in progress.

15 The provisions for associating the intercept information may be operably configured to populate intercept information fields in the dialing profile of the subscriber whose communications are to be monitored.

20 The apparatus may further include provisions for producing a routing message for routing communications involving the subscriber through components of the IP network and provisions for determining whether the determination information meets the intercept criteria prior to producing the routing message and the provisions for producing the routing message may be operably configured to include at least some of the intercept information in the routing message when the determination information meets the intercept criteria.

25 The provisions for determining whether the determination information meets the intercept criteria may be operably configured to determine whether a current date and time is within a range specified by the determination information.

30 The apparatus may further include provisions for identifying a media relay through which communications involving the subscriber will be conducted in response to the routing message.

5 The apparatus may further include provisions for pre-associating at least one media relay with the dialing profile of the subscriber whose communications are to be monitored and the routing provisions may be operably configured to identify from the dialing profile the media relay pre-associated with the subscriber whose communications are to be monitored.

10 The provisions for pre-associating may be operably configured to populate media relay fields in the dialing profile with an identification of at least one media relay.

15 Provisions for associating the intercept information may be operably configured to associate the intercept information associated with the dialing profile of the subscriber whose communications are to be monitored, in response to receipt of an intercept request message, wherein the intercept request message comprises the intercept information.

20 The apparatus may further include provisions for handling an intercept request message. The provisions for handling an intercept request message may include provisions for finding a dialing profile associated with the subscriber whose communications are to be monitored. The provisions for finding a dialing profile may cooperate with the provisions for associating the intercept information with the dialing profile to cause the intercept information to be associated with the dialing profile. The provisions for handling an intercept request message may include provisions for determining whether the intercept criteria are met and provisions for identifying a media relay through which the communications are being conducted.

30 The apparatus may further include provisions for maintaining active call records for communications in progress, the active call records including a username identifier and a media relay identifier identifying the media relay through which the communications are being conducted and the provisions for

-9-

identifying a media relay through which the communications are being conducted may be operably configured to locate an active call record associated with communications of the subscriber whose communication are to be monitored to find the media relay associated with the communications.

5

The apparatus may further include provisions for maintaining direct-inward-dialing (DID) records associating PST telephone numbers with usernames of users subscribing to the IP network, and the provisions for finding a dialing profile associated with the subscriber whose communications are to be monitored may be operably configured to find a username in a DID record bearing a PSTN number associated with the subscriber whose communications are to be monitored and use the username to locate a dialing profile associated with the username.

15 By employing a media replay, all VoIP communications traverse a point in the VoIP system that is under a provider's control and at which the communications can be copied in real-time to a mediation device that passes the intercepted communication to a law enforcement agency.

20 By maintaining dialing profiles for respective subscribers and associating intercept information of the type described, with the dialing profiles of subscribers whose communications are to be monitored, the dialing profile can serve as the source of determination information for determining whether or not communications involving the subscriber will be monitored and for
25 providing destination information for specifying where the copy of the communications is to be sent. Use of the dialing profile in this manner easily facilitates the dialing profile to be considered a repository for intercept information for a given subscriber and this repository can be addressed whether a call is being initiated or in progress, thereby simplifying control
30 algorithms because they can cooperate with a common source and format of data in the dialing profile.

-10-

Other aspects and features of the present invention will become apparent to those ordinarily skilled in the art upon review of the following description of specific embodiments of the invention in conjunction with the accompanying figures.

5

BRIEF DESCRIPTION OF THE DRAWINGS

In drawings which illustrate embodiments of the invention,

- 10 **Figure 1** is a block diagram of a system according to a first embodiment of the invention;
- Figure 2** is a block diagram of a caller VoIP telephone according to the first embodiment of the invention;
- 15 **Figure 3** is a schematic representation of a SIP Invite message transmitted between the caller telephone and a call controller (CC) shown in **Figure 1**;
- Figure 4** is a block diagram of the call controller shown in **Figure 1**;
- 20 **Figure 5** is a flowchart of a process executed by the call controller shown in **Figure 1**;
- Figure 6** is a schematic representation of a routing controller (RC) request message produced by the call controller shown in **Figure 1**;
- 25 **Figure 7** is a block diagram of a routing controller (RC) processor circuit of the system shown in **Figure 1**;
- 30 **Figures 8A-8D** are flowcharts of a RC Request message handler executed by the RC processor circuit shown in **Figure 7**;

-11-

- Figure 9 is a tabular representation of a dialing profile stored in a database accessible by the RC shown in Figure 1;
- 5 Figure 10 is a tabular representation of a dialing profile for a Vancouver subscriber ;
- Figure 11 is a tabular representation of a dialing profile for a Calgary subscriber;
- 10 Figure 12 is a tabular representation of a dialing profile for a London subscriber;
- Figure 13 is a tabular representation of a direct-inward-dialing (DID) bank table record stored in the database shown in Figure 1;
- 15 Figure 14 is a tabular representation of an exemplary DID bank table record for the London subscriber referenced in Figure 12;
- Figure 15 is a tabular representation of a routing message transmitted from the routing controller to the call controller shown in Figure 1;
- 20 Figure 16 is a tabular representation of a routing message buffer holding a routing message for routing a call to the London callee referenced in Figure 12;
- 25 Figure 16A is a tabular representation of a routing message buffer holding a message for routing a call to the London callee and to a law enforcement agency for the purpose of lawful intercept;
- 30 Figure 17 is a tabular representation of a prefix to supernode table record stored in the database shown in Figure 1;

-12-

- Figure 18 is a tabular representation of a prefix to supernode table record that would be used for the Calgary callee referenced in Figure 11;
- 5 Figure 19 is a tabular representation of a master list record stored in a master list table in the database shown in Figure 1;
- Figure 20 is a tabular representation of an exemplary populated master list record;
- 10 Figure 21 is a tabular representation of a suppliers list record stored in the database shown in Figure 1;
- Figure 22 is a tabular representation of a specific supplier list record for a first supplier;
- 15 Figure 23 is a tabular representation of a specific supplier list record for a second supplier;
- Figure 24 is a tabular representation of a specific supplier list record for a third supplier;
- 20 Figure 25 is a tabular representation of a routing message, held in a routing message buffer, identifying to the routing controller a plurality of possible suppliers that may carry the call;
- 25 Figure 25A is a tabular representation of a routing message held in a routing message buffer, with lawful intercept fields appended;
- Figure 26 is a tabular representation of a call block table record;
- 30 Figure 27 is a tabular representation of a call block table record for the Calgary callee;

- Figure 28 is a tabular representation of a call forwarding table record;
- 5 Figure 29 is a tabular representation of an exemplary call forwarding table record specific for the Calgary callee;
- Figure 30 is a tabular representation of a voicemail table record specifying voicemail parameters to enable the caller to leave a voicemail message for the callee;
- 10 Figure 31 is a tabular representation of an exemplary voicemail table record for the Calgary callee;
- Figure 32 is a tabular representation of an exemplary routing message, held in a routing message buffer, indicating call forwarding numbers and a voicemail server identifier;
- 15 Figure 32A is a tabular representation of an exemplary routing message, held in a routing message buffer, indicating call forwarding numbers and a voicemail server identifier with caller lawful intercept fields appended;
- 20 Figure 32B is a tabular representation of an exemplary routing message, held in a routing message buffer, indicating call forwarding numbers and a voicemail server identifier with caller and callee lawful intercept fields appended;
- 25 Figure 33 is a flowchart of a routing message handler process executed by the call controller.
- 30

-14-

- Figure 34 is a schematic representation of messages exchanged during execution of process for establishing audio paths between telephones and a media relay;
- 5 Figure 35 is a tabular representation of an active call record maintained by the call controller of Figure 1;
- Figure 36 is a tabular representation of an active call record maintained by the routing controller of Figure 1;
- 10 Figure 37 is a tabular representation of a SIP Invite message transmitted from the call controller to the mediation device;
- Figure 38 is a tabular representation of a SIP OK message transmitted from the mediation device to the call controller.
- 15 Figure 39 is a tabular representation of a SIP Bye message transmitted from either of the telephones shown in Figure 1 to the call controller;
- 20 Figure 40 is a tabular representation of a SIP Bye message sent to the call controller from the Calgary callee;
- Figure 41 is a flowchart of a process executed by the call controller for producing a RC stop message in response to receipt of a SIP Bye message;
- 25 Figure 42 is a tabular representation of an exemplary RC Call Stop message;
- 30 Figure 43 is a tabular representation of an exemplary RC Call Stop message for the Calgary callee;

-15-

Figure 44 is a flowchart of a routing controller Law Enforcement Authority request message handler executed by the routing controller shown in Figure 1;

5 Figure 45 is a flowchart of a call controller in-call intercept message handler executed by the call controller shown in Figure 1;

Figure 46 is a flowchart of a routing controller in-call intercept shut down routine executed by the routing controller shown in Figure 1;

10

Figure 47 is a flowchart of a call controller cease intercept message handler routing executed by the call controller shown in Figure 1.

DETAILED DESCRIPTION

15 Referring to Figure 1, a system for making voice over IP telephone calls is shown generally at 10. The system includes a first supernode shown generally at 11 and a second supernode shown generally at 21. The first supernode 11 is located in a geographical area, such as Vancouver B.C., for example and the second supernode 21 is located in London England, for
20 example. Different supernodes may be located in different geographical regions throughout the world to provide telephone service to subscribers in respective regions. These supernodes may be in communication with each other through high speed / high data throughput links including optical fiber, satellite and/or cable links, for example, forming a system backbone. These
25 supernodes may alternatively or in addition be in communication with each other through conventional Internet services. In the embodiment shown, data communication media for providing for data communications between the first and second supernodes 11 and 21 are shown generally at 23 and may include very high speed data links, for example.

30

In the embodiment shown, the Vancouver supernode 11 provides telephone service to a geographical region comprising Western Canadian customers

-16-

from Vancouver Island to Ontario and includes a Vancouver subscriber and a Calgary subscriber. Another supernode (not shown) may be located in Eastern Canada to provide services to subscribers in that area.

5 Other, smaller supernodes similar to the type shown may also be employed within the geographical area serviced by a supernode, to provide for call load sharing, for example within a region of the geographical area serviced by the supernode. However, in general, all supernodes are similar and have the properties described below in connection with the Vancouver supernode **11**.

10

In this embodiment, the Vancouver supernode includes a call controller (CC) **14**, a routing controller (RC) **16**, a database **18**, a media relay **17** and one or more mediation devices (MD), only one of which is shown at **31**. Subscribers such as the Vancouver subscriber and the Calgary subscriber communicate with the Vancouver supernode **11** using their own Internet Service Providers (ISPs) **13** and **19** which route Internet traffic from these subscribers over the Internet. To these subscribers the Vancouver supernode **11** is accessible at a pre-determined IP address or a fully qualified domain name (FQDN) so that it can be accessed in the usual way through a subscriber's ISP. The subscriber in the city of Vancouver uses a telephone **12** that is capable of communicating with the Vancouver supernode **11** using Session Initiation Protocol (SIP) messages and the Calgary subscriber uses a similar telephone **15**, to communicate with the Vancouver supernode from Calgary, AB.

15

20

25 It should be noted that throughout the description of the embodiments of this invention, the IP/UDP addresses of all elements such as the caller and callee telephones, call controller, media relay, and any others, will be assumed to be valid IP/UDP addresses directly accessible via the Internet or a private IP network, for example, depending on the specific implementation of the system. As such, it will be assumed, for example, that the caller and callee telephones will have IP/UDP addresses directly accessible by the call controllers and the media relays on their respective supernodes, and that will

30

-17-

not be obscured by Network Address Translation (NAT) or similar mechanisms. In other words, the IP/UDP information contained in SIP messages (for example the SIP Invite message or the RC Request message which will be described below) will match the IP/UDP addresses of the IP packets carrying these SIP messages.

It will be appreciated that in many situations, the IP addresses assigned to various elements of the system may be in a private IP address space, and thus not directly accessible from other elements. Furthermore, it will also be appreciated that NAT is commonly used to share a "public" IP address between multiple devices, for example between home PCs and IP telephones sharing a single Internet connection. For example, a home PC may be assigned an IP address such as **192.168.0.101** and a Voice over IP telephone may be assigned an IP address of **192.168.0.103**. These addresses are located in so called "non-routable" address space and cannot be accessed directly from the Internet. In order for these devices to communicate with other computers located on the Internet, these IP addresses have to be converted into a "public" IP address, for example **24.10.10.123** assigned to the subscriber by the Internet Service Provider, by a device performing NAT, typically a home router. In addition to translating the IP addresses, the NAT typically also translates UDP port numbers, for example an audio path originating at an IP telephone and using a UDP port **12378** at its private IP address may have been translated to a UDP port **23465** associated with the public IP address of the NAT device. In other words, when a packet originating from the above IP telephone arrives at an Internet-based supernode, the source IP/UDP address contained in the IP packet header will be **24.10.10.1:23465**, whereas the source IP/UDP address information contained in the SIP message inside this IP packet will be **192.168.0.103:12378**. The mismatch in the IP/UDP addresses may cause a problem for SIP-based systems because, for example, a supernode will attempt to send messages to a private address of a telephone – the messages will never get there.

-18-

5 It will be appreciated that a number of methods are available to overcome this problem. For example, the SIP NATHelper open source software module may run on the supernode to correlate public IP/UDP address contained in the headers of the IP packets arriving from SIP devices with private IP/UDP addresses in the SIP messages contained in these packets. Therefore, the embodiments of the invention described below will function whether or not any of the elements of the system are located behind NAT devices that obscure their real IP/UDP addresses.

10

Referring to Figure 1, in an attempt to make a call by the Vancouver telephone 12 to the Calgary telephone 15, for example, the Vancouver telephone sends a SIP Invite message to the Vancouver supernode 11 and in response, the call controller 14 sends an RC Request message to the routing controller 16 which makes various enquiries of the database 18 to produce a routing message which is sent to the call controller 14. The call controller 14 then causes a communications link including audio paths to be established through the media relay 17 which may include the same Vancouver supernode 11, a different supernode or a communications supplier gateway, for example, to carry voice traffic to and from the call recipient or callee. Subject to certain conditions being satisfied, as will be described below, when lawful intercept of data is to occur, data on the audio paths is copied to the mediation device 31 which may provide for real time listening of the audio data or recording of same.

25

Subscriber Telephone

Referring to Figure 2, in this embodiment, the telephones 12, 15, 22 and 25 each includes a processor circuit shown generally at 30 comprising a microprocessor 32, program memory 34, an input/output (I/O) interface 36, parameter memory 38 and temporary memory 40. The program memory 34, I/O interface 36, parameter memory 38 and temporary memory 40 are all in communication with the microprocessor 32. The I/O interface 36 has a dial

30

-19-

input **42** for receiving a dialed telephone number from a keypad, for example, or from a voice recognition unit or from pre-stored telephone numbers stored in the parameter memory **38**, for example. For simplicity, a box labelled dialing functions **44** represents any device capable of informing the
5 microprocessor **32** of a callee identifier, e.g., a callee telephone number.

The microprocessor **32** stores the callee identifier in a dialed number buffer **41**. In the case of the Vancouver subscriber for example, the dialed number may be **2001 1050 2222**, identifying the Calgary subscriber or the dialed
10 number may be a PSTN number, for example. The I/O interface **36** also has a handset interface **46** for receiving and producing signals from and to a handset **45** that the user may place to his ear. The handset interface **46** may include a BLUETOOTH™ wireless interface, a wired interface or speakerphone, for example. The handset **45** acts as a termination point for an
15 audio path (not shown) which will be appreciated later.

The I/O interface **36** also has a network interface **48** to an IP network which may provide a high speed Internet connection, for example, and is operable to connect the telephone to an ISP. The network interface **48** also acts as a part
20 of the audio path, as will be appreciated later.

The parameter memory **38** has a username field **50**, a password field **52** an IP address field **53** and a SIP proxy address field **54**. The username field **50** is operable to hold a username, which, for the Vancouver subscriber, is **2001**
25 **1050 8667**. The username is assigned upon subscription or registration into the system and, in this embodiment includes a twelve digit number having a continent code **61**, a country code **63**, a dealer code **70** and a unique number code **74**. The continent code **61** is comprised of the first or left-most digit of the username in this embodiment. The country code **63** is comprised of the
30 next three digits. The dealer code **70** is comprised of the next four digits and the unique number code **74** is comprised of the last four digits. The password field **52** holds a password of up to **512** characters, in this example. The IP

-20-

address field **53** stores an IP address and UDP port number of the telephone **12**, which, for this explanation, is **192.168.0.20:12345**. The SIP proxy address field **54** stores an IP address of a SIP proxy which may be provided to the telephone **12** through the network interface **48** as part of a registration procedure.

The program memory **34** stores blocks of codes for directing the microprocessor **32** to carry out the functions of the telephone, one of which includes a firewall block **56** which provides firewall functions to the telephone, to prevent unauthorized access through the network connection to the microprocessor **32** and memories **34**, **38** and **40**. The program memory **34** also stores call ID codes **57** for establishing a call ID. The call ID codes **57** direct the microprocessor **32** to produce call identifiers having the format of a hexadecimal string and an IP address of the telephone stored in the IP address field **53**. Thus, an exemplary call identifier for a call might be **FF10@192.168.0.20**.

Generally, in response to activating the handset **45** and using the dialing function **44**, the microprocessor **32** produces and sends a SIP Invite message as shown in Figure **3**, to the call controller **14** shown in Figure **1**.

Referring to Figure **3**, the SIP Invite message includes a caller identifier field **60**, a callee identifier field **62**, a digest parameters field **64**, a call identifier field **65**, a caller IP address field **67** and a caller UDP port field **69**. In this embodiment, the caller identifier field **60** includes the username **2001 1050 8667**, which is the username stored in the username field **50** of the parameter memory **38** in the Vancouver telephone **12** shown in Figure **2**. In addition, as an example, referring back to Figure **3**, the callee identifier field **62** includes the username **2001 1050 2222** which is the dialed number of the Calgary subscriber stored in the dialed number buffer **41** shown in Figure **2**. The digest parameters field **64** includes digest parameters and the call identifier field **65** includes a code comprising a generated prefix code (**FF10**) and a

-21-

suffix which is the IP address of the telephone **12** stored in the IP address field **53**. The caller IP address field **67** holds the IP address assigned to the telephone, in this embodiment **192.168.0.20**, and the caller UDP port field **69** includes a UDP port identifier identifying a UDP port to which audio data is to be sent for reception by the caller's telephone.

Call Controller

Referring to Figure 4, a call controller circuit of the call controller **14** (Figure 1) is shown in greater detail at **100**. The call controller circuit **100** includes a microprocessor **102**, program memory **104** and an I/O interface **106**. The call controller circuit **100** may include a plurality of microprocessors, a plurality of program memories and a plurality of I/O interfaces to be able to handle a large volume of calls. However, for simplicity, the call controller circuit **100** will be described as having only one microprocessor, program memory and I/O interface, it being understood that there may be more.

Generally, the I/O interface **106** includes an input **108** for receiving messages, such as the SIP Invite message shown in Figure 3, from the telephone shown in Figure 2. The I/O interface **106** also has an RC Request message output **110** for transmitting an RC Request message to the routing controller **16** of Figure 1, an RC message input **112** for receiving routing messages from the routing controller **16** (Figure 1), a media relay (MR) output **114** for transmitting messages to the media relay (Figure 1) to advise the media relay to establish an audio path, and a MR input **116** for receiving messages from the media relay to which a message has been sent to attempt to establish the audio path. The I/O interface **106** further includes a SIP output **118** for transmitting SIP messages to the telephone **12** (Figure 1) to advise the telephone of the IP address of the media relay **17** (Figure 1) which will establish the audio path. The I/O interface **106** further includes mediation device input **119** and output **121** for communicating with the mediation device **31** (Figure 1).

5 While certain inputs and outputs have been shown as separate, it will be appreciated that some may be associated with a single IP address and TCP or UDP port. For example, the messages sent and received from the routing controller **16** may be transmitted and received at the same single IP address and TCP or UDP port.

10 The program memory **104** of the call controller circuit **100** includes blocks of code for directing the microprocessor **102** to carry out various functions of the call controller **14**. For example, these blocks of code include a first block **120** for causing the call controller circuit **100** to execute a SIP Invite-to-RC request process to produce an RC Request message in response to a received SIP Invite message. In addition, there is a Routing Message Handler block **122** which causes the call controller circuit **100** to engage the mediation device and/or execute a call handling routine to establish audio paths through a media relay to establish the call. The program memory **104** further includes
15 an in-call intercept message handler **1450** for intercepting a call in progress and a cease intercept message handler **1520** for ceasing the interception of a call in progress.

20 Referring to Figure **5**, the SIP Invite-to-RC Request process is shown in more detail at **120**. On receipt of a SIP Invite message of the type shown in Figure **3**, block **132** of Figure **5** directs the call controller circuit **100** of Figure **4** to authenticate the user operating the telephone from which the SIP Invite message originated. This may be done, for example, by prompting the user
25 for a password, by sending a message back to the telephone **12** which is interpreted at the telephone as a request for password entry or the password may automatically be sent to the call controller **14** from the telephone, in response to the message. The call controller **14** may then make enquiries of databases to which it has access, to determine whether or not the user's
30 password matches a password stored in the database. Various functions may be used to pass encryption keys or hash codes back and forth to ensure the secure transmission of passwords.

-23-

Should the authentication process fail, the call controller circuit **100** is directed to an error handling block **134** which causes messages to be displayed at the telephone **12** to indicate that there was an authentication error. If the authentication process is successful, block **131** directs the call controller circuit **100** to determine whether or not the contents of the caller identifier field **60** of the SIP Invite message is a validly formatted IP address. If it is a valid IP address, then block **133** directs the call controller circuit **100** to associate a type code with the call to indicate that the call type is a third party invite.

10

If at block **131** the caller identifier field **60** contents do not identify an IP address, then block **135** directs the call controller circuit **100** to associate a type code with the call to indicate the call type is a regular SIP Invite message. Then, block **136** directs the call controller circuit **100** to establish a call ID by assigning the call ID provided in the call identifier field **65** of the SIP Invite message from the telephone **12**, and at block **138** the call controller circuit is directed to produce an RC Request message of the type shown in Figure **6** that includes that call ID. Referring back to Figure **5**, block **139** then directs the call controller circuit **100** to send the RC Request message to the routing controller **16**.

20

Referring to Figure **6**, an RC Request message is shown generally at **150** and includes a caller identifier field **152**, a callee identifier field **154**, a digest field **156**, a call ID field **158** and a type field **160**. The caller, callee, digest, and call identifier fields **152**, **154**, **156** and **158** contain copies of the caller, callee, digest parameters and call ID fields **60**, **62**, **64** and **65** of the SIP Invite message **59** shown in Figure **3**. The type field **160** contains the type code established at block **133** or **135** of Figure **5** to indicate whether the call is from a third party or system subscriber, respectively. The callee identifier field **154** may include a PSTN number or a system subscriber username as shown, for example.

30

-24-

Routing Controller

Referring to Figure 7, the routing controller **16** is shown in greater detail and includes a routing controller processor circuit shown generally at **200**. The RC processor circuit **200** includes a microprocessor **202**, program memory **204**, a table memory **206** and an I/O interface **208**, all in communication with the processor. There may be a plurality of processor circuits (**202**), memories (**204**), etc.

The I/O interface **208** includes a database output port **210** through which a request to the database **18** (Figure 1) can be made and includes a database response port **212** for receiving a reply from the database. The I/O interface **208** further includes an RC Request message input **214** for receiving the RC Request message from the call controller **14** and includes a routing message output **216** for sending a routing message back to the call controller **14**.

The program memory **204** includes blocks of codes for directing the RC processor circuit **200** to carry out various functions of the routing controller **16**. One of these blocks implements an RC Request message handler process **250** which directs the RC to produce a routing message in response to a received RC Request message of the type shown at **150** in Figure 6. Referring back to Figure 7, the program memory **204** further includes a Law Enforcement Authority (LEA) request message handler **1400** and an in-call intercept shut down route **1500**.

The RC Request message handler process **250** is shown in greater detail in Figures **8A** through **8D**.

RC Request Message Handler

Referring to Figure **8A**, the RC Request message handler process **250** begins with a first block **252** that directs the RC processor circuit **200** (Figure 7) to store the contents of the RC Request message **150** (Figure 6) in buffers. Block **254** then directs the RC processor circuit **200** to use the contents of the

-25-

caller identifier field **152** in the RC Request message shown in Figure **6**, to locate and retrieve a dialing profile for the caller from the database **18**.

5 The routing controller maintains, in the database, a dialing profile for each subscriber to the system. Referring to Figure **9**, an exemplary dialing profile is shown generally at **256** and includes system fields including a username field **258**, a domain field **260**, a national dialing digits (NDD) field **262**, an IDD (IDD) field **264**, a country code field **266**, a local area codes field **267**, a caller minimum local length field **268**, a caller maximum local length field **270** and a reseller field **273**.

10 The exemplary dialing profile further includes lawful intercept related fields including a lawful intercept (LI) flag field **702**, at least one mediation device field **704**, at least one warrant ID field **706**, and intercept period start and stop date/time fields **708** and **710**. The LI flag field **702**, the warrant ID filed **706** and the LI start/stop fields **708** and **710** may be regarded as determination information fields for determining whether to intercept a communication involving the subscriber and the MD1 address field **704** may be regarded as a destination information field for identifying a device to which intercepted communications involving the subscriber are to be sent.

20 The system fields (**258, 260, 262, 264, 266, 267, 268, 270, 273**) are assigned values by a system operator or are assigned automatically according to pre-defined algorithms (not shown) when a user registers with the system to become a subscriber. The lawful intercept fields (**702, 704, 706, 708, 710**) are assigned values in response to communications with one or more authorized devices and may be populated at any time regardless of whether or not communications involving the subscriber are in progress.

30 For example, referring back to Figure **1** the mediation device **31** may be regarded as an authorized device operated by a law enforcement authority **293**. A communications channel between the call controller **14** and the

-26-

mediation device **31** may be established to permit the mediation device to communicate with the call controller to cause the call controller to communicate with the routing controller **16** to find a subscriber record in the database **18** which is associated with a subscriber for which a warrant for lawful intercept has been obtained. For example, once a warrant identifying a user and permitting lawful intercept of that user's communications has been received by the law enforcement authority **293**, that authority can use its own computers to communicate with the mediation device **31** to cause the mediation device to communicate with the call controller **14** to cause the call controller to interact with the routing controller **16** to access a dialing profile (Figure **9**) for the user specified in the warrant and load the lawful intercept fields (**702, 704, 706, 708, 710**) with data that sets the lawful intercept flag field **702** to "on", stores an IP address of the mediation device **31** in the MD1 address field **704**, loads the warrant ID field **706** with an identifier of the warrant and loads the start and stop fields **708** and **710** with start and stop dates and times to specify a period during which lawful intercept of communications of the identified user may occur according to the warrant. Thus, intercept information is associated with the dialing profile by the routing controller, in response to information it receives from the call controller.

A plurality of groups of lawful intercept fields of the type shown may be added, each group being added by a different authorized device, for example, if several different law enforcement agencies operating the same or different mediation devices have warrants to monitor communications of a user. Alternatively the authorized device may include a handover interface operable to communicate with the call controller or routing controller to access the database to load the lawful intercept fields associated with a subscriber of interest.

An exemplary dialing profile for the Vancouver subscriber is shown generally at **276** in Figure **10** and indicates that the username field includes the

-27-

username **2001 1050 8667** which is the same as the contents of the username field **50** in the Vancouver telephone **12** shown in Figure 2.

5 Referring back to Figure **10**, the domain field **260** includes a domain name as shown at **282**, including a supernode type identifier **284**, a location code identifier **286**, a system provider identifier **288** and a top level domain identifier **290**, identifying a domain or supernode associated with the user identified by the contents of the username field **258**.

10 In this embodiment, the supernode type identifier **284** includes the code "sp" identifying a supernode and the location code identifier **286** identifies the supernode as being in Vancouver (YVR). The system provider identifier **288** identifies the company supplying the service and the top level domain identifier **290** identifies the "com" domain.

15 The national dialing digit (NDD) field **262** in this embodiment includes the digit "1" and, in general, includes a digit specified by the International Telecommunications Union – Telecommunications Standardization Sector (ITU-T) E.164 Recommendation which assigns national dialing digits to
20 certain countries. Herein numbering sequences compliant with this standard will be regarded as "E.164" numbers.

The International Dialing Digit (IDD) field **264** includes the code **011** and in general includes a code assigned by the ITU-T according to the country or
25 geographical location of the user.

The country code field **266** includes the digit "1" and in general includes a number assigned by the ITU-T to represent the country in which the user is
30 located.

The local area codes field **267** includes the numbers **604** and **778** and generally includes a list of area codes that have been assigned by the ITU-T

-28-

to the geographical area in which the subscriber is located. The caller minimum and maximum local number length fields **268** and **270** hold the number **10** representing minimum and maximum local number lengths permitted in the area code(s) specified by the contents of the local area codes field **267**. The reseller field **273** holds a code identifying a retailer of the telephone services, and in the embodiment shown, the retailer is "Klondike".

Initially, the lawful intercept fields shown in Figure **9** might not be included in the dialing profile and may be added as described above, by the mediation device **31**, in the event a warrant is obtained to intercept the user's calls. Alternatively, the lawful intercept fields may be included, but populated with null values until modified by a mediation device **31**.

A dialing profile of the type shown at **256** in Figure **9** is produced whenever a user registers with the system or agrees to become a subscriber to the system. Thus, for example, a user wishing to subscribe to the system may contact an office maintained by a system operator and personnel in the office may ask the user certain questions about his location and service preferences, whereupon tables can be used to provide office personnel with appropriate information to be entered into the username, domain, NDD, IDD, country code, local area codes and caller minimum and maximum local length fields **258**, **260**, **262**, **264**, **266**, **267**, **268**, **270** to establish a dialing profile for the user.

Referring to Figures **11** and **12**, dialing profiles for subscribers in Calgary and London, respectively for example, are shown.

In addition to creating dialing profiles, optionally when a user registers with the system, a direct inward dialing (DID) record of the type shown at **268** in Figure **13** is added to a direct inward dialing table in the database **18** to associate the username with a host name of the supernode with which the user is associated and with an E.**164** number on the PSTN network.

-29-

In this embodiment, the DID bank table records include a username field **281**, a user domain field **272** and a DID field **274**, for holding the username, hostname of the supernode, and an E.**164** number respectively.

5

A DID bank table record for the London subscriber is shown generally at **291** in Figure **14**.

10 In addition to creating dialing profiles and DID records when a user registers with the system, call blocking records of the type shown in Figure **26**, call forwarding records of the type shown in Figure **28** and voicemail records of the type shown in Figure **30** may be stored in the database **18** when a new subscriber is added to the system.

15 Referring back to Figure **8A**, after being directed at block **254** to retrieve a dialing profile for the caller, a dialing profile such as shown at **276** in Figure **10** is retrieved and the RC processor circuit **200** is directed to perform certain checks on the callee identifier provided by the contents of the callee identifier field **154** of the RC Request message shown in Figure **6**. These checks are
20 shown in greater detail in Figure **8B**.

Referring to Figure **8B**, the RC processor circuit **200** is directed to a first block **257** that causes it to determine whether a digit pattern of the callee identifier **154** provided in the RC Request message includes a pattern that matches the
25 contents of the IDD field **264** in the caller dialing profile **276** shown in Figure **10**. If so, then block **259** directs the RC processor circuit **200** to set a call type code identifier (not shown) to indicate that the call is a long distance call, e.g., from the Vancouver subscriber to the London subscriber, and block **261** directs the RC processor circuit **200** to produce a reformatted callee identifier
30 by reformatting the callee identifier into a predetermined target format. In this embodiment, this is done by removing the pattern of digits matching the IDD field contents **264** of the caller dialing profile **276** to effectively shorten the

-30-

number. Then, block **263** directs the RC processor circuit **200** to determine whether or not the reformatted callee identifier meets criteria establishing it as a number compliant with the E.164 Recommendation set by the ITU-T and if the length does not meet this criteria, block **265** directs the RC processor circuit **200** to send back to the call controller **14** a message indicating that the length of the call identifier is not correct. The process **250** is then ended. At the call controller **14**, routines may respond to the incorrect length message by transmitting a message back to the telephone **12** to indicate that an invalid number has been dialed.

10

Still referring to Figure **8B**, if the length of the reformatted callee identifier meets the criteria set forth at block **263**, block **269** directs the RC processor circuit **200** to determine whether or not the reformatted callee identifier is associated with a direct inward dialing (DID) bank table record such as shown at **268** in Figure **13**.

15

An exemplary DID bank table record entry for the London callee is shown generally at **291** in Figure **14**. The username field **281** and user domain field **272** are as specified in the username and user domain fields **258** and **260** of the dialing profile **276** shown in Figure **12**. The contents of the DID field **274** include an E.164 telephone number including a country code **283**, an area code **285**, an exchange code **287** and a number **289**. If the user has multiple telephone numbers, then multiple records of the type shown at **291** would be included in the DID bank table in the database **18**, each having the same username and user domain, but different DID field **274** contents reflecting the different telephone numbers associated with that user.

20

25

Referring back to Figure **8B**, at block **269**, if the RC processor circuit **200** finds that the reformatted callee identifier produced at block **261** is found in a record in the DID bank table, then the callee is a subscriber to the system and block **279** directs the RC processor circuit **200** to copy the contents of the corresponding username field **270** into a callee ID buffer (not shown). Thus,

30

-31-

the RC processor circuit **200** locates a subscriber username associated with the reformatted callee identifier. The processor is then directed to block **275** at point B in Figure **8A**.

5 Subscriber to Subscriber Calls Between Different Nodes

Referring back to Figure **8A**, block **275** then directs the RC processor circuit **200** to determine whether or not the subscriber username is associated with the same supernode as the caller. To do this, the RC processor circuit **200** determines whether or not the continent code (**61**) of the username stored in the callee ID buffer is the same as the continent code (**61**) of the username of the caller specified by the caller identifier field **152** of the RC Request message shown in Figure **6**. If they are not the same, block **277** directs the RC processor circuit **200** to set a call type flag (not shown) to indicate that the call is a cross-domain call. Then, block **350** directs the RC processor circuit **200** to produce a routing message identifying the supernode in the system with which the callee is associated and to set a TTL for the call to the maximum value of **99999**. The supernode in the system, with which the callee is associated, is determined by using the callee username stored in the callee ID buffer to address a supernode table having records of the type as shown at **370** in Figure **17**.

Referring to Figure **17**, each prefix to supernode table record **370** has a prefix field **372** and a supernode address field **374**. The prefix field **372** includes the first n digits of the callee identifier. In this case n=**1**. The supernode address field **374** holds a code representing the IP address or a fully qualified domain name of the supernode associated with the code stored in the prefix field **372**. Referring to Figure **18**, for example, if the prefix is **4**, the supernode address associated with that prefix is sp.lhr.digifonica.com, identifying the London supernode **21**, for example.

30 Referring to Figure **15**, a generic routing message is shown generally at **352** and includes a supplier prefix field **354**, a delimiter field **356**, a callee field **358**,

-32-

at least one route field **360**, a time-to-live (TTL) field **362** and other fields **364**. The supplier prefix field **354** holds a code for identifying supplier traffic. The delimiter field holds a symbol that delimits the supplier prefix code from the callee field **358** and in this embodiment, the symbol is a number sign (#). The route field **360** holds a domain name or an IP address of a gateway or supernode that is to carry the call and the TTL field **362** holds a value representing the number of seconds the call is permitted to be active, based on subscriber available minutes and other billing parameters, for example.

Referring to Figure **8A** and Figure **16**, in this example the routing message produced by the RC processor circuit **200** at block **350** is shown generally at **366** and includes only a callee field **358**, a route field **360** and a TTL field **362**.

The callee field **358** holds the full username of the callee and the route field **360**, shown in Figure **15**, contains the identification of the domain with which the callee is associated, i.e., sp.lhr.digifonica.com.

Having produced the routing message **366** as shown in Figure **16A**, referring back to Figure **8A**, block **351** then directs the RC processor circuit **200** to check the caller dialing profile (see Figure **9**) to determine whether or not it contains lawful intercept fields (**702**, **704**, **706**, **708**, **710**) and if so, to determine whether or not the determination information contained therein meets intercept criteria. The intercept criteria may be that the lawful intercept flag field **702** (Figure **9**) contains a flag indicating lawful intercept is enabled and whether the current date and time is within the period specified by the LI start date/time field contents **708** and the LI stop date/time field contents **710**, for example. If the intercept criteria are met, block **353** directs the RC processor circuit **200** to append the contents of the lawful intercept fields **702**, **704**, **706**, **708**, **710** to the routing message produced at block **350** to produce a routing message as shown in Figure **16A**. Generally, the determination of whether or not the destination information meets intercept criteria is done prior to producing the routing message so that when the intercept criteria are met,

-33-

at least some of the intercept information, in this embodiment all of it, can be included in the routing message.

5 If at block **351** in Figure **8A**, it is determined there are no lawful intercept fields associated with the caller dialing profile or that the intercept criteria are not met, the processor does not append any lawful intercept fields to the routing message produced at block **350** in Figure **8A** and the routing message shown in Figure **16** is sent to the call controller **14** as shown at block **380**. If the lawful intercept fields have been appended, block **380** directs the RC processor circuit **200** to send the routing message shown in Figure **16A** to the call controller **14** (Figure **1**).
10

Referring back to Figure **8B**, if at block **257**, the callee identifier specified by the contents of the callee field **154** of the RC Request message shown in Figure **6** does not begin with an IDD, block **381** directs the RC processor circuit **200** to determine whether or not the callee identifier begins with the same national dial digit code as assigned to the caller. To do this, the processor is directed to refer to the caller dialing profile shown in Figure **10**. In the embodiment shown, the NDD code **262** is the digit **1**. Thus, if the callee identifier begins with the digit **1**, the RC processor circuit **200** is directed to block **382** in Figure **8B**.
15
20

Block **382** directs the RC processor circuit **200** to examine the callee identifier to determine whether or not digits following the NDD code identify an area code that is the same as any of the area codes identified in the local area codes field **267** of the caller dialing profile **276** shown in Figure **10**. If not, block **384** directs the RC processor circuit **200** to set a call type variable (not shown) to a code indicating the call is a national code. If the digits identify an area code that is the same as a local area code associated with the caller, block **386** directs the RC processor circuit **200** to set the call type variable to indicate that the call type is a local call, national style. After executing blocks **384** or **386**, block **388** directs the RC processor circuit **200** to format the
25
30

-34-

number dialed by removing the national dial digit (NDD) and prepending a caller country code identified by the country code field **266** of the caller dialing profile shown in Figure **10**. The RC processor circuit **200** is then directed to block **263** to perform the processes described above beginning at block **263**.

5

If at block **381**, the callee identifier does not begin with an NDD code, block **390** directs the RC processor circuit **200** to determine whether the callee identifier begins with digits that identify the same area code as the caller. Again, the reference for this is the caller profile shown in Figure **10** and the RC processor circuit **200** determines whether or not the first few digits in the callee identifier identify an area code identified by the local area code field **267** of the caller profile. If so, then block **392** directs the RC processor circuit **200** to set the call type to a code indicating the call is a local call and block **394** directs the RC processor circuit **200** to prepend the caller country code to the callee identifier, the caller country code being determined from the country code field **266** in the caller profile shown in Figure **10**. The RC processor circuit **200** is then directed to block **263** for processing as described above beginning at block **263**.

10

If at block **390**, the callee identifier does not have the same area code as the caller, block **396** directs the RC processor circuit **200** to determine whether the callee identifier has the same number of digits as the number of digits indicated in either the caller minimum local number length field **268** or the caller maximum local number length field **270** of the caller profile shown in Figure **10**. If so, then block **398** directs the RC processor circuit **200** to set the call type to local and block **400** directs the processor to prepend to the callee identifier the caller country code as indicated by the country code field **266** of the caller profile shown in Figure **10** followed by the caller area code as indicated by the local area code field **267** of the caller profile shown in Figure **10**. The RC processor circuit **200** is then directed to block **263** for further processing as described above beginning at block **263**.

20

25

30

-35-

If at block **396**, the callee identifier has a length that does not match the length specified by the contents of the caller minimum local number length field **268** or the caller maximum local number length field **270**, block **402** directs the RC processor circuit **200** to determine whether or not the callee identifier identifies a valid username. To do this, the RC processor circuit **200** searches through the database of dialing profiles to find a dialing profile having username field contents **258** that match the callee identifier. If no match is found, block **404** directs the RC processor circuit **200** to send an error message back to the call controller (**14**). If at block **402**, a dialing profile having a username field **258** that matches the callee identifier is found, block **406** directs the RC processor circuit **200** to set the call type to a code indicating the call is a network call and the processor is directed to block **275** of Figure **8A**, to continue processing the RC message handler process **250**.

From Figure **8B**, it will be appreciated that there are certain groups of blocks of codes that direct the RC processor circuit **200** to determine whether the callee identifier has certain features such as an IDD code, a NDD code, an area code and a length that meet certain criteria and to reformat the callee identifier as necessary into a predetermined target format including only a country code, area code, and a normal telephone number, for example, to cause the callee identifier to be compatible with the E.164 number plan standard, in this embodiment. This enables the RC processor circuit **200** directed by block **279** to have a consistent format of callee identifiers for use in searching through the DID bank table records of the type shown in Figure **13** to determine how to route calls for subscriber to subscriber calls on the same system.

Subscriber to Non-Subscriber Calls

Not all calls will be subscriber-to-subscriber calls and this will be detected by the RC processor circuit **200** when it executes block **269** of Figure **8B**, and does not find a record that is associated with the callee in the DID bank table. When this occurs, the RC processor circuit **200** is directed to block **408** which

-36-

causes it to set the callee identifier equal to the reformatted callee identifier, i.e., the number compatible with the E.164 standard. Then, block **410** directs the RC processor circuit **200** to address a master list having records of the type shown in Figure **19**.

5

Each master list record includes a master list ID field **500**, a dialing code field **502**, a country code field **504**, a national sign number field **506**, a minimum length field **508**, a maximum length field **510**, a NDD field **512**, an IDD field **514** and a buffer rate field **516**.

10

The master list ID field **500** holds a unique code such as **1019**, for example, identifying a route identification (route ID). The dialing code field **502** holds a predetermined number pattern which the RC processor circuit **200** uses at block **410** in Figure **8B** to find the master list record having a dialing code matching the first few digits of the reformatted callee identifier. The country code field **504** holds a number representing the country code associated with the record and the national sign number field **506** holds a number representing the area code associated with the record. (It will be observed that the dialing code is a combination of the contents of the country code field **504** and the national sign number field **506**.) The minimum length field **508** holds a number representing the minimum number of digits that can be associated with the record and the maximum length field **51** holds a number representing the maximum number of digits in a number with which the record may be compared. The NDD field **512** holds a number representing an access code used to make a call within the country specified by the contents of the country code field **504** and the IDD field **514** holds a number representing the international prefix needed to dial a call from the country indicated by the country code.

15

20

25

30

Thus, for example, a master list record may have a format as shown in Figure **20** with exemplary field contents as shown.

-37-

Referring back to Figure 8B, using the country code and area code portions of the reformatted callee identifier that has been formatted for compatibility with the E.164 standard, block 410 directs the RC processor circuit 200 to find a master list record such as the one shown in Figure 20 having a dialing code that matches the country code and area code of the callee identifier. Thus, in this example, the RC processor circuit 200 would find a master list record having an ID field with the number 1019. This number may be also referred to as a route ID. Thus, a route ID number is found in the master list record associated with a predetermined number pattern in the reformatted callee identifier.

After execution of block 410 in Figure 8B, the process 250 continues as shown in Figure 8D. Referring to Figure 8D, block 412 directs the RC processor circuit 200 to use the route ID number to locate at least one supplier record identifying a supplier operable to supply a communications link for this route. To do this, block 412 directs the RC processor circuit 200 to search a supplier ID table having records of the type shown in Figure 21.

Referring to Figure 21, the supplier list records include a supplier ID field 540, a route ID field 542, an optional prefix field 544, a route identifier field 546, a NDD/IDD rewrite field 548 and a rate field 550. The supplier ID field 540 holds a code identifying the name of the supplier and the route ID field 542 holds a code for associating the supplier record with a route, and hence with a master list record. The prefix field 544 holds a string used to identify the supplier traffic and the route identifier field 546 holds an IP address of a gateway operated by the supplier indicated by the supplier ID field 540. The NDD/IDD rewrite field 548 holds a code and the rate field 550 holds a code indicating the cost per second to the system operator to use the route provided by the gateway specified by the contents of the route identifier field 546. Exemplary supplier records are shown in Figures 22, 23 and 24 for the suppliers shown in Figure 1 which may include Telus, Shaw and Sprint, respectively, for example.

Referring back to Figure 8D, at block 412 the RC processor circuit 200 finds all supplier records that identify the route ID found at block 410 of Figure 8B.

5 Referring back to Figure 8D, block 560 directs the RC processor circuit 200 to begin to produce routing messages of the type shown in Figure 16. To do this, the RC processor circuit 200 loads a routing message buffer as shown in Figure 25 with a supplier prefix of the least costly supplier where the least
10 costly supplier is determined from the rate fields 550 of the records associated with respective suppliers.

Referring to Figures 22-24, in the embodiment shown, the supplier "Telus" has the lowest number in the rate field 550 and therefore the prefix 4973 associated with that supplier is loaded into the routing message buffer shown
15 in Figure 25 first. The prefix 4973 is then delimited by the number sign and the reformatted callee identifier is next loaded into the routing message buffer. Then, the contents of the route identifier field 546 of the record associated with the supplier Telus are added to the message after an @ sign delimiter and then block 564 in Figure 8D directs the RC processor circuit 200 to get a
20 TTL value, which in this embodiment may be 3600 seconds, for example. Block 566 then directs the RC processor circuit 200 to load this TTL value in the routing message buffer shown in Figure 25. Accordingly, the first part of the routing message is shown generally at 570 in Figure 25.

25 Referring back to Figure 8D, block 568 directs the RC processor circuit 200 back to block 560 and causes it to repeat blocks 560, 562, 564 and 566 for each successive supplier until the routing message buffer is loaded with information pertaining to each supplier. Thus, the second portion of the routing message is shown at 572 in Figure 25 and this second portion relates
30 to the second supplier identified by the record shown in Figure 23 and referring back to Figure 25, the third portion of the routing message is shown at 574 which is associated with a third supplier as indicated by the supplier

-39-

record shown in Figure 24. Consequently, referring to Figure 25, the routing message buffer holds a routing message identifying a plurality of different suppliers able to provide gateways to establish a communication link to permit the caller to contact the callee. Each of the suppliers is identified, in ascending order according to the rates contained in the rate fields 550 of the supplier list records shown in Figures 22-24, in this embodiment. Other criteria for determining the order in which suppliers are listed in the routing message may include preferred supplier priorities which may be established based on service agreements, for example. In this case additional fields may be provided in respective supplier records to hold values representing supplier priority.

After the routing message buffer has been loaded as shown in Figure 25, block 567 directs the RC processor circuit 200 to check the caller dialing profile shown in Figure 10 to determine whether or not it contains lawful intercept fields as shown in Figure 9, and if so, to determine whether or not the intercept criteria are met by checking whether the lawful intercept flag field 702 contains a flag indicating that lawful intercept is enabled and checking whether the current date and time are within the period specified by the LI start date/time field contents 708 and the LI stop date/time field contents 710. If the intercept criteria are met, block 569 directs the RC processor circuit 200 to append the contents of the lawful intercept fields 702, 704, 706, 708, 710 to the routing message stored in the routing message buffer, as shown in Figure 25A. Again, the determination of whether or not the destination information meets intercept criteria is done prior to producing the routing message so that when the intercept criteria are met, at least some of the intercept information, in this embodiment all of it, can be included in the routing message.

If at block 567, it is determined there are no lawful intercept fields associated with the caller dialing profile shown in Figure 10 or that the intercept criteria are not met, the RC processor circuit 200 does not append any lawful

-40-

intercept fields to the routing message stored in the routing message buffer shown in Figure 25.

5 Block 568 then directs the RC processor circuit 200 to send the contents of the routing message buffer, i.e. the routing message shown in Figure 25 or 25A, to the call controller 14 in Figure 1.

Subscriber to Subscriber Calls Within the Same Node

10 Referring back to Figure 8A, if at block 275, the callee identifier stored in the callee ID buffer has a prefix that identifies the same supernode as that associated with the caller, block 600 directs the RC processor circuit 200 to use the callee identifier to locate and retrieve a dialing profile for the callee identified by the callee identifier. The dialing profile is of the type shown in Figure 9, and may contain data as shown in Figure 11, for example. Block 602
15 of Figure 8A directs the RC processor circuit 200 to get call block, call forward and voicemail tables from the database 18 based on the username identified in the callee profile retrieved by the RC processor circuit at block 600. Call block, call forward and voicemail tables have records as shown in Figures 26, 28 and 30 for example.

20 Referring to Figure 26, the call block records include a username field 604 and a block pattern field 606. The username field holds a username matching the username in the username field 258 of the dialing profile associated with the callee and the block pattern field 606 holds one or more E.164-compatible
25 numbers or usernames identifying PSTN numbers or system subscribers from whom the subscriber identified by the contents of the username field 604 does not wish to receive calls.

30 Referring back to Figure 8A and referring to Figure 27, block 608 directs the RC processor circuit 200 to determine whether or not the caller identifier matches a block pattern stored in the block pattern field 606 of the call block record associated with the callee identified by the contents of the username

-41-

field **604** in Figure **26**. If the caller identifier matches a block pattern stored in the block pattern field **606**, block **610** directs the RC processor circuit **200** to send a drop call or non-completion message to the call controller (**14**) and the process is ended. If the caller identifier does not match a block pattern associated with the callee, block **612** directs the RC processor circuit **200** to determine whether or not call forwarding is required.

Referring to Figure **28**, records in the call forwarding table include a username field **614**, a destination number field **616**, a destination number field **616** and a sequence number field **618**. The username field **614** stores a code representing a subscriber with which the record is associated. The destination number field **616** holds a username or number representing a number to which the current call should be forwarded and the sequence number field **618** holds an integer number indicating the order in which the username associated with the corresponding destination number field **616** should be attempted for call forwarding. The call forwarding table may have a plurality of records for a given user. The RC processor circuit **200** uses the contents of the sequence number field **618** to consider the records for a given subscriber in order. As will be appreciated below, this enables the call forwarding numbers to be tried in a ordered sequence.

Referring back to Figure **8A** and referring to Figure **28**, if at block **612** in Figure **8A**, the call forwarding record for the callee identified by the callee identifier contains no contents in the destination number field **616** and accordingly no contents in the sequence number field **618**, there are no call forwarding entries and the RC processor circuit **200** is directed to load the routing message buffer shown in Figure **32** with the callee username and domain, as shown at **650** in Figure **32**. The processor is then directed to block **620** in Figure **8C**.

If there are contents in the destination number field of the call forwarding record as shown in Figure **29**, block **622** shown in Figure **8A** directs the RC

-42-

processor circuit **200** to search the dialing profile table to find a dialing profile record of the type shown in Figure **9**, for the user identified in the destination number field **616** in the call forwarding table record of Figure **29** and to store the contents of the destination number field in the routing message buffer shown in Figure **32**. The RC processor circuit **200** is then directed to load the contents of the domain field **260** shown in Figure **9** associated with the username specified by the contents of the destination number field **616** of Figure **29** into the routing message buffer as shown at **652** in Figure **32**. This process is repeated for each call forwarding record associated with the callee identified by the callee identifier to add to the routing message buffer all call forwarding usernames and domains associated with the callee.

Referring to Figure **8C**, at block **620** the processor is directed to determine whether or not the user identified by the callee identifier has paid for voicemail service and this is done by checking to see whether or not a flag is set in a voicemail record of the type shown in Figure **30** in a voicemail table stored in the database **18** in Figure **1**.

Referring to Figure **30**, voicemail table records include a username field **624**, a voicemail server field **626**, a seconds-to-voicemail field **628** and an enable field **630**. The username field **624** stores the username of the subscriber who purchased the service. The voicemail server field **626** holds a code identifying an IP address or a fully qualified domain name (FQDN) of a voicemail server associated with the subscriber identified by the username field **624**. The seconds-to-voicemail field **628** holds a code identifying the time to wait before engaging voicemail and the enable field **630** holds a code representing whether or not voicemail is enabled for the user identified by the contents of the username field **624**. Therefore, referring back to Figure **8C**, at block **620** the processor searches for a voicemail record as shown in Figure **31** having username field **624** contents matching the callee identifier and looks at the contents of the enabled field **630** to determine whether or not voicemail is enabled. If voicemail is enabled, then block **640** in Figure **8C** directs the

-43-

processor to store the contents of the voicemail server field **626** of Figure **31** and the contents of the seconds to voicemail field **628** of Figure **31** in the routing message buffer as shown at **654** in Figure **32**. Referring back to Figure **8C**, block **642** then directs the processor to get time to live (TTL) values for each route specified by the routing message according to any of a plurality of criteria such as, for example, the cost of routing and the user's account balance. These TTL values are then appended to corresponding routes already stored in the routing message buffer.

Block **644** of Figure **8C** then directs the RC processor circuit **200** to store the IP address of the current supernode in the routing message buffer as shown at **656** in Figure **32**. An exemplary routing message is shown in the routing message buffer shown in Figure **32**.

Block **645** of Figure **8C** then directs the processor to check the caller dialing profile shown in Figure **10** to determine whether or not it contains lawful intercept fields of the type shown in Figure **9** and if so, to determine whether or not the intercept criteria are met. In this embodiment, this includes determining whether the lawful intercept flag field **702** contains a flag indicating that lawful intercept is enabled and checking whether the current date and time is within the period specified by the LI start date/time field contents **708** and the LI stop date/time field contents **710**. If the intercept criteria are met, block **647** directs the RC processor circuit **200** to append the contents of the lawful intercept fields **702**, **704**, **706**, **708**, **710** to the routing message shown in Figure **32A** to produce a routing message with lawful intercept field contents, as shown in Figure **32A**. Again, the determination of whether or not the destination information meets intercept criteria is done prior to producing the routing message so that when the intercept criteria are met, at least some of the intercept information, in this embodiment all of it, can be included in the routing message.

-44-

Referring back to Figure 8C, if at block 645, it is determined there are no lawful intercept fields associated with the caller dialing profile of Figure 10 or that the intercept criteria are not met after producing the routing message shown in Figure 32A the processor is directed to block 649 which causes the processor to check the callee dialing profile shown in Figure 11 to determine whether or not it contains lawful intercept fields of the type shown in Figure 9 and if so, to determine whether or not the intercept criteria are met by checking whether the current date and time is within the period specified by the LI start date/time field contents 708 and the LI stop date/time field contents 710 of the callee dialing profile. If the intercept criteria are met, block 651 directs the RC processor circuit 200 to append the contents of the lawful intercept fields 702, 704, 706, 708, 710 associated with the callee dialing profile to the routing message shown in Figure 32A to produce a routing message. If at block 649 of Figure 8C, it is determined there are no lawful intercept fields associated with the callee dialing profile or that the intercept criteria are not met, no lawful intercept fields associated with the callee are appended to the routing message shown in Figure 32 or 32A. Referring back to Figure 8C, block 646 then directs the RC processor circuit 200 to send the routing message to the call controller 14.

20

Response to Routing Message

Referring back to Figure 1, the routing message, whether of the type shown in Figures 16, 16A, 25, 25A, 32, 32A or 32B, is received at the call controller 14. Referring to Figure 33, when a routing message is received at the call controller, the routing message handler 122 is invoked at the call controller. The routing message handler is shown in detail in Figure 33.

25

Referring to Figure 33, the routing message handler begins with a first block 1200 that directs the processor circuit to determine whether the routing message includes lawful intercept fields. If not, the processor is directed to block 1206 which causes it to invoke a call handling routine shown in Figure 34. Referring to Figure 34, as a first step in the call handling routine, a

30

-45-

message **1100** is sent from the call controller **14** to the media relay **17**, the message including the caller telephone IP address and UDP port as determined from the caller IP address field **67** and caller UDP port field **69** in the SIP Invite message shown in Figure **3**.

5

The specific media relay **17** to which the message **1100** is sent may be selected from a pool of available media relays and such media relays may be at any geographical location. The purpose of the message **1100** is to advise the media relay that a call is desired to be set up to communicate with the IP address and UDP number of the caller telephone.

10

A media relay selected from media relays located at a geographical location that facilitates communication at a desired quality of service between the media relay **17** and the caller telephone **12** and callee telephone **15** may provide the best service. Alternatively, media relays may be pre-assigned or pre-associated with users by including and populating media relay fields of the dialing profiles of users, such as shown at **1150** in Figure **9**, identifying one or more media relays through which calls associated with the associated user are to be directed. In this case, the identifications of possible media relays obtained from the media relay fields **1150** may be sent to the call controller in additional fields in the routing message. These media relay fields are shown at **1152** in Figures **16**, **16A**, **25**, **25A**, **32**, **32A** and **32B**. In essence, the media relay through which communications involving the communications involving the subscriber will be conducted is identified in response to the routing message.

15

20

25

Referring back to Figure **34**, in this case, the message **1100** may be sent in a polling fashion to all media relays identified by the media relay fields **1150**, until one responds. Alternatively, the message **1100** may be sent simultaneously to all of the media relays.

30

-46-

In response, in the case where the media relay is known or is involved in polling as described above, the media relay **17** to which the message **1100** is sent sends a media relay status message **1102** back to the call controller **14**, the message including a media relay IP address and UDP port number at
5 which the media relay will establish a UDP connection to the callee telephone **15**. Audio data to/from the callee telephone **15** will be transmitted over this connection. In the case where the message **1100** is sent to a plurality of media relays, the first one to respond with a media relay status message is the one through which the call will be carried. Media relay status messages
10 from the remaining media relays can be ignored.

After the media relay status message **1102** is received at the call controller, the call controller **14** then sends a SIP Invite message **1104** of the type shown in Figure **3** to the callee telephone **15**, including the contents of the caller and
15 callee identifier fields (**60** and **62**), the call identifier field (**65**) and the media relay IP address and the media relay UDP port number assigned to the audio path connection with the callee telephone **15**, to invite the callee telephone to establish a connection with the media relay **17**.

20 The purpose of the SIP Invite message **1104**, is to advise the callee telephone of the caller and call ID and of the IP address and UDP port number of the media relay through which the callee telephone should send and receive audio data.

25 The callee telephone **15** stores the media relay IP address and assigned UDP port number in the audio path IP address buffer **47** shown in Figure **2** and configures itself to create a socket between the media relay IP/UDP address and the callee telephone IP address and a UDP port number that the callee telephone **15** desires to use as an audio path to the caller telephone. Instead
30 of being sent or received directly to or from the caller telephone, the callee telephone **15** will send and receive audio data from the media relay. To indicate this, the callee telephone **15** sends a SIP OK message **1106** back to

-47-

the call controller **14**, the message including the callee IP address and UDP port number from its IP address field (**53** in Figure **3**) at which the callee telephone **15** will establish an audio path connection with the media relay **17**. The purpose of this SIP OK message **1106** is to advise the call controller of the IP address and UDP port number through which the media relay should send and receive audio data to and from the callee telephone.

The call controller **14** then sends a message **1108** to the media relay **17** including the IP address and UDP port number that the callee telephone **15** will use for the audio path connection with the media relay. The purpose of the message **1108** is to advise the media relay of the IP address and UDP port number through which it should send and receive audio data to and from the callee telephone.

The media relay **17** then determines a UDP port through which it will carry audio data to and from the caller telephone **12** and sends a message **1110** to the call controller (**14**), the message including the media relay IP address and the media relay UDP port number the media relay will use to carry audio to and from the caller telephone **12**. The purpose of this message **1110** is to advise the call controller **14** of the IP address and UDP port number through which it expects to transfer audio data to and from the caller telephone.

The call controller **14** then sends a SIP OK message **1112** to the caller telephone **12** to indicate that the call may now proceed. The SIP OK message includes the caller and callee usernames, the call ID and the media relay **17** IP address and the UDP port number assigned to the audio connection with the caller telephone **12**. The purpose of this SIP OK message **1112** is to advise the caller telephone **12** of the IP address and UDP port number through which it should exchange audio data with the media relay **17**.

If the routing message is of the type shown in Figure **25** where there are a plurality of suppliers available, the call handling routine proceeds as described

-48-

above with the exception that instead of communicating with the callee telephone directly, the call controller **14** communicates with a gateway provided by a supplier. If a SIP OK message is not received back from the first gateway, the processor is directed to send the SIP Invite message **1104** to a gateway of the next indicated supplier. For example, the call controller **14** sends the SIP Invite message **1104** to the first supplier, in this case Telus, to determine whether or not Telus is able to handle the call. If Telus does not send back a SIP OK message **1106** within a specified time or sends a message indicating that it is not able to handle the call, the call controller proceeds to send a SIP Invite message **1104** to the next supplier, in this case Shaw. The process is repeated until one of the suppliers responds with a SIP OK message **1106** indicating that it is available to carry the call and the process proceeds as shown in connection with messages **1108**, **1110** and **1112**. For example, the supplier "Telus" sends back a SIP OK message and thus provides a gateway to the PSTN at IP address **72.64.39.58** as provided by the routing message from the contents of the route identifier field **546** of the corresponding supplier record shown in Figure **22**.

Referring back to Figure **1**, if the call controller **14** receives a message of the type shown in Figure **32**, i.e., a type that has one call forwarding number and/or a voicemail number, the call controller attempts to establish a call (using SIP Invite message **1104**) to the callee telephone **15** and if no call is established (i.e., message **1106** is not received) within a pre-determined time, the call controller **14** attempts to establish a call with the next user identified in the call routing message, by sending a SIP invite message like message **1104** to the next user. This process is repeated until all call forwarding possibilities have been exhausted, in which case an audio path is established with the voicemail server **19** identified in the routing message. The voicemail server **19** sends the SIP OK message **1106** in response to receipt of the SIP invite message **1104** and functions as described above in connection with the callee telephone **15** to permit an outgoing audio message provided by the voicemail

-49-

server to be heard by the caller and to permit the caller to record an audio message on the voicemail server.

5 When audio paths are established, a call timer (not shown) maintained by the call controller logs the start date and time of the call and logs the call ID and adds an active call record of the type shown in Figure 35 to an active call list, maintained by the call controller.

10 In this embodiment, the call controller active call record shown in Figure 35 includes a call ID field 1300, a caller IP address field 1302, a caller port field 1304, a callee IP address field 1306, a callee port field 1308, a media relay ID field 1310, a media relay caller port field 1312 and a media relay callee port field 1314. The contents of the call ID field 1300 are established at block 136 in Figure 5. The contents of the caller IP address field 1302 are established from the contents of the caller IP address field 67 of the SIP invite message shown in Figure 3. The contents of the caller port field 1304 are established from the caller UDP port field 69 of the SIP invite message shown in Figure 3. The contents of the callee IP address field 1306 and callee port field 1308 are established from the SIP OK message 1106 shown in Figure 34.

20 The media relay ID field 1310 is populated with an identification of the media relay handling the call. In the example shown, the media relay is number 42. The contents of the media relay caller port field are obtained from the message 1110 shown in Figure 34 and the contents in the media relay callee port field 1314 are obtained from the media relay status message 1102 shown in Figure 34. Each time a call is established, an active call record of the type shown in Figure 35 is added to an active call log maintained by the call controller.

30 The routing controller also maintains an active call log containing active call records however the active call records maintained by the routing controller are different from the active call records held by the call controller. For

-50-

example, referring to Figure 36, an active call record held by the routing controller includes a call ID field 1316, a caller field 1318, a callee field 1320 and a call controller ID field 1322. Information for populating these fields may be received in a message (not shown) transmitted from the call controller to the routing controller after an active call record has been entered into the active call log of the call controller.

The message from the call controller 14 to the routing controller 16, indicating that an active call has been established may include the contents of the call ID field 1300 shown in Figure 35 and a call controller unique ID number held by the call controller. The routing controller 16 matches the call ID with the caller and callee user names contained in the original call routing message (Fig 16, 16A, 25, 25A, 32, 32A, 32B) that caused the call controller 14 to route the call, to populate the caller and callee fields 1318 and 1320 shown in Figure 36, respectively. It will be appreciated that a plurality of call controllers may be associated with a single routing controller, in which case the call controller ID allows the routing controller to uniquely identify the call controller associated with the call ID indicated by the contents of the call ID field 1316. In the example shown, the call controller is number 61.

The active call records facilitate intercepting a call already in progress, as will be described below.

Referring back to Figure 33, if at block 1200 it is determined that the routing message has lawful intercept fields, block 1202 directs the call controller circuit 100 (Figure 4) to send a SIP Invite message as shown in Figure 37 to a mediation device identified by the mediation device IP address in the routing message as obtained from the user dialing profile MD1 address field 704 as shown at 256 in Figure 9. Referring to Figure 37, the SIP Invite message includes caller and callee identifier fields 1020, 1022, a call ID field 1024, a warrant ID field 1026 and other intercept related information fields 1028, if desired. The caller, callee and call ID field contents 1020, 1022, and 1024 are

-51-

obtained from the original SIP Invite message shown in Figure 6. The contents of the warrant ID field **1026** and intercept related info fields **1028** are obtained from the routing message which would be of the type shown in Figures **16A**, **25A**, **32A** or **32B**.

5

Referring back to Figure **33**, block **1204** then directs the call controller **14** to receive a reply message, as shown in Figure **38**, from the mediation device **31**. The reply message is a SIP OK message that includes caller, callee, and call ID fields **1040**, **1042**, **1044** as described above and further includes a mediation device IP address field **1046** and a mediation device UDP caller port number field **1048** and a UDP callee port number field **1050** identifying UDP ports at the mediation device IP address to which the media relay is to send copies of audio data streams received from the caller and callee telephones respectively. Block **1206** then directs the call controller to execute the call handling routine shown in Figure **34** with the exception that the message **1100** additionally includes the contents of the mediation device IP address field **1046**, the mediation device UDP caller port number field **1048** and the UDP callee port number field **1050** of the SIP OK message shown in Figure **38**.

20

All other messages are the same as described above in connection with the call handling routine as shown in Figure **34**, but in response to receiving the additional information in the message **1100**, the media relay automatically configures itself to provide for copying the audio data received from both the caller telephone and the callee telephone to the mediation device IP address and the UDP caller port number and the UDP callee port number respectively.

25

Referring back to Figure **1**, as audio data originating at the caller telephone **12** and callee telephone **15** passes through the media relay **17**, this data is copied to the mediation device UDP port for the caller and the mediation device UDP port for the callee, as indicated by the SIP invite message **1100**. This enables law enforcement agencies to monitor audio communications

30

-52-

between the caller and callee and/or to record such communications at the mediation device.

5 Thus, when the determination information in the dialing profile meets intercept criteria, the call controller communicates with the media relay through which communications involving the subscriber whose communications are to be monitored will be handled to cause the media relay to send a copy of such communications to a mediation device specified by the destination information included in the intercept information associated with the dialing profile
10 associated with the subscriber whose communications are to be monitored.

Terminating the Call

In the event that either the caller or the callee terminates a call, the telephone of the terminating party sends a SIP Bye message to the call controller **14**. An
15 exemplary SIP Bye message is shown at **900** in Figure **39** and includes a caller field **902**, a callee field **904** and a call ID field **906**. The caller field **902** holds the caller username, the callee field **904** holds a PSTN compatible number or username, and the call ID field **906** holds a unique call identifier field of the type shown in the call identifier field **65** of the SIP Invite message
20 shown in Figure **3**.

Thus, for example, referring to Figure **40**, a SIP Bye message for the Calgary callee is shown generally at **908** and the caller field **902** holds a username identifying the Vancouver caller, in this case **2001 1050 8667**, the callee field
25 **904** holds a username identifying the Calgary callee, in this case **2001 1050 2222**, and the call ID field **906** holds the code **FA10@192.168.0.20**, which is the call ID for the call.

The SIP Bye message shown in Figure **40** is received at the call controller **14**
30 and the call controller executes a process as shown generally at **910** in Figure **41**. The process includes a first block **912** that directs the call controller circuit (**100**) to copy the caller, callee and call ID field contents from the SIP Bye

-53-

message **900** shown in Figure **39** received from the terminating party to corresponding fields of an RC stop message buffer (not shown). Block **914** then directs the call controller circuit **100** to copy the call start time from the call timer and to obtain a Call Stop time from the call timer. Block **916** then directs the call controller to calculate a communication session time by determining the difference in time between the call start time and the Call Stop time. This communication session time is then stored in a corresponding field of the RC Call Stop message buffer. Block **918** then directs the call controller circuit **100** to populate the route field with the IP address of the gateway supplier, if any. An RC Call Stop message produced as described above is shown generally at **1000** in Figure **42**. An RC Call Stop message specifically associated with the call made to the Calgary callee is shown generally at **1021** in Figure **43**.

Referring to Figure **42**, the RC call stop message **1000** includes a caller field **1002**, callee field **1004**, a call ID field **1006**, an account start time field **1008**, an account stop time field **1010**, a communication session time field **1012** and a route field **1014**. The caller field **1002** holds a username, the callee field **1004** holds a PSTN-compatible number or system number, the call ID field **1006** holds the unique call identifier received from the SIP Invite message shown in Figure **3**, the account start time field **1008** holds the date and start time of the call, the account stop time field **1010** holds the date and time the call ended, the communication session time field **1012** holds a value representing the difference between the start time and the stop time, in seconds, and the route field **1014** holds the IP address for a gateway, if a gateway is used to establish the call.

Referring to Figure **43**, an exemplary RC call stop message for the Calgary callee is shown generally at **1021**. In this example the caller field **1002** holds the username **2001 1050 8667** identifying the Vancouver caller and the callee field **1004** holds the username **2001 1050 2222** identifying the Calgary callee. The contents of the call ID field **1006** are **FA10@192.168.0.20**. The contents

-54-

of the account start time field **1008** are **2006-12-30 12:12:12** and the contents of the account stop time field **1010** are **2006-12-30 12:12:14**. The contents of the communication session time field **1012** are **2** to indicate **2** seconds call duration and the contents of the route field are blank but would be **72.64.39.58** if the "Telus" gateway were used, for example.

Referring back to Figure **41**, after having produced an RC Call Stop message, block **920** directs the call controller circuit **100** to send the RC stop message contained in the RC Call Stop message buffer to the routing controller (**16**).

The RC (**16**) receives the Call Stop message and an routing controller Call Stop message process (not shown) is invoked at the routing controller to deal with charges and billing for the call.

Block **922** directs the call controller circuit **100** to send a Bye message to the party that did not terminate the call i.e. to the non-terminating party.

Block **924** then directs the call controller circuit **100** to send a SIP Bye message of the type shown in Figure **39** to the media relay **17** to cause the media relay to disconnect the audio path sockets associated with the caller telephone IP/UDP address and the callee telephone IP/UDP address. In disconnecting these communication sockets, the media relay **17** deletes associations between the caller telephone IP/UDP address media relay caller IP/UDP address and between the caller telephone IP/UDP address and media relay callee IP/UDP address.

If the media relay (**17**) was configured for lawful intercept, block **926** of Figure **41** then directs the call controller circuit **100** to send a SIP Bye message of the type shown in Figure **39** to the mediation device **31** to inform the mediation device that the call has ended and to disconnect communication sockets between the media relay caller and callee IP/UDP port addresses and

-55-

the IP/UDP port address to which the audio data received at the caller and callee IP/UDP port addresses were being copied.

5 It will be appreciated that in the foregoing description, the components described cooperate to detect a requirement for intercept at the time a call is set up. In the following description an explanation is provided to describe how to intercept a call while the call is in progress.

Intercepting a Call in Progress

10 Referring back to Figure 1, to intercept a call while the call is in progress, the law enforcement authority **293** may communicate with a mediation device, or may communicate with the call controller or may communicate with the routing controller or may communicate with a handover interface that
15 communicates with any of the foregoing components to cause the routing controller to receive a law enforcement authority (LEA) intercept request message including intercept information. Such as that which would be associated with fields **702-710** in Figure 9, for example..

20 In response to receipt of a, LEA intercept request message, the routing controller LEA request message handler shown at **1400** in Figure 44 is invoked.

25 The LEA request message handler **1400** begins with a first block **1402** that directs the routing controller processor circuit to communicate with the database **18** in which dialing profile records of the type shown in Figure 9 are stored to find a dialing profile associated with the user whose calls are to be monitored.

30 If the username is not known, but a DID number (i.e. a PSTN number) is known, the routing controller may cause a search through the DID bank table records of the type shown in Figure 13, for example to find a username associated with a DID number. If the username is not known but a name and

-56-

address is known, other records such as billing records (not shown) associating names and addresses with usernames may be searched to find a username associated with a given name and/or address of a person whose calls are to be intercepted. Regardless of the information available, to facilitate call interception any way of finding the unique dialing profile associated with the user whose calls are to be intercepted is a first step to facilitating call interception, in this embodiment.

Once the dialing profile is located, block **1404** directs the routing controller processor circuit to associate the intercept information with the dialing profile by appending and/or populating the lawful intercept fields of the dialing profile with such information as provided in the LEA intercept request message..

Block **1406** then directs the routing controller processor circuit to determine whether the intercept criteria are met by the intercept information now included in the dialing profile. This is done by determining whether the LI flag (**702**) is on, and the current date and time is within the LI start stop date/time ranges. If the intercept criteria are not met, the process is ended. Otherwise the processor is directed to block **1408**.

Block **1408** directs the routing controller processor circuit to use the username of the dialing profile found at block **1402** to search caller and callee fields of routing controller active call records shown in Figure **36** that have contents matching the username associated with the dialing profile. If no such record is found, the user is not currently engaged in a call and the process is ended. If the user is engaged in a call, the routing controller active call record will be found. Block **1410** then directs the routing controller processor circuit to find the call controller id and call id of the associated call, from the routing controller active call record shown in Figure **36**.

Block **1412** then directs the routing controller processor circuit to transmit an in-call intercept message to the call controller identified by the contents of the

-57-

5 call controller id field **1322** of the routing controller active call record. The in-call intercept message includes the call id as determined from the routing controller active call record and the IP address of the mediation device associated with the law enforcement authority interested in intercepting the call. The IP address of the mediation device may be obtained from the law enforcement authority request message, or the dialing profile, for example.

10 Block **1414** then directs the routing controller processor circuit to wait a specified time to receive a call controller intercept status message back from the call controller indicating whether or not the intercept function has been activated.

15 Referring to Figure **45**, upon receipt of an in-call intercept message at the call controller (**14**) the call controller executes an in-call intercept message handler shown generally at **1450**. The in-call intercept message handler **1450** begins with a first block **1452** that directs the call controller processor circuit to send a SIP invite message to the mediation device associated with the IP address of the mediation device, received in the in-call intercept message.

20 Block **1454** then directs the call controller processor circuit to receive an IP address and callee and caller UDP port numbers from the mediation device, where this IP address and UDP port numbers are network locations at which the mediation device will expect to receive audio data streams from the media relay through which the call is carried.

25 Block **1456** then directs the call controller processor circuit to identify a media relay through which communications to be monitored are being conducted by using the username of the subscriber whose communications are to be monitored to locate an active call record in the call controller active call list to
30 locate a media relay identifier such as the IP address of the media relay indicated by the contents of the media relay ID field **1310** of the call controller active call record shown in Figure **35**. The call controller processor circuit is

-58-

then directed to send an intercept request message to the media relay (17) that is handling the call. The intercept request message includes the mediation device IP address and caller and callee UDP port numbers to identify to the media relay (17) the mediation device IP address and UDP port number(s) at which it expects to receive a copy of the audio data stream from the caller and callee respectively.

In response, the media relay establishes internal connections between the caller and callee IP addresses and UDP ports and callee IP address and UDP port of the mediation device. Then, the media relay sends a media relay status message back to the call controller indicating whether or not internal connections have been established and that call intercept has been initiated.

As seen at block 1458, the call controller processor circuit is directed to receive the media relay status message and block 1460 directs the call controller processor circuit to send a call controller intercept status message back to the routing controller to indicate that the call intercept function has been established. The routing controller may communicate this status back to the law enforcement authority that issued the law enforcement authority request message. In the meantime, communications involving the caller or callee whose communications are to be monitored, which travel through the media relay, are copied and sent to the mediation device.

Thus, after associating intercept information with the dialing profile of the subscriber whose communications are to be monitored, when the determination information included in the intercept information meets intercept criteria, the call controller communicates with the media relay through which the communications of the subscriber whose communications are to be monitored to cause such media relay to send a copy of such communications to a mediation device specified by the destination information included in the intercept information.

-59-

When the call is ended, the call is shut down in the same way as described above.

5 Should the law enforcement authority desire to cease interception of the call during the call, an LEA request message requesting that the intercept function be stopped is sent to the routing controller from the law enforcement authority through any of the paths described above. This invokes the LEA request message handler such as shown in Figure 44 which causes the routing controller processor circuit to execute blocks 1402, 1404. At block 1404, the
10 routing controller processor circuit is directed to change the contents of the lawful intercept fields to at least set the lawful intercept flag (702 in Figure 9) inactive.

15 Then, at block 1406, the intercept criteria are not met and the processor is directed to block 1416, which causes the routing controller processor circuit to determine whether or not an interception function is in progress. This can be determined, for example, by maintaining evidence of the receipt of the confirmation message from the call controller, received at block 1414 of the LEA request message handler 1400.

20 If an intercept is not in progress, the LEA request message handler 1400 is ended.

25 If an intercept is in progress, block 1418 directs the routing controller processor circuit to execute an in-call intercept shut down routine as shown at 1500 in Figure 46. The in-call intercept shut down routine begins with a first block 1502 which directs the routing controller processor circuit to locate the routing controller active call record having caller or callee field contents equal to the username indicated in the dialing profile found at block 1402 of the LEA request message handler 1400 shown in Figure 44. Having found the active
30 call record, block 1504 directs the routing controller processor circuit to find, in the routing controller active call record shown in Figure 36, the call

-60-

controller id (**1322**) and the call id (**1316**) associated with the call. Block **1506** then directs the routing controller processor circuit to send a cease intercept message (not shown) to the call controller identified by the call controller id determined at block **1504**. This cease intercept message includes the call id
5 determined at block **1504** and an identification of the mediation device, the identification being obtained from the MD1 address field (**704** in Figure **9**) of the dialing profile for the user whose calls are currently being intercepted. Block **1508** then directs the routing controller processor circuit to wait a specified time to receive a confirmation message from the call controller to
10 indicate that the intercept function has been shut down.

Referring to Figure **47**, upon receipt of the cease intercept message at the call controller (**14**), a cease intercept message handler **1520** is invoked at the call controller. The cease intercept message handler **1520** begins with a first
15 block **1522** that directs the call controller processor circuit to send a SIP stop message to the mediation device identified in the cease intercept message received from the routing controller. In response to the SIP stop message, the mediation device stops receiving audio data and sends a confirmation message back to the call controller.

20 Block **1524** directs the call controller processor circuit to receive the confirmation message back from the mediation device.

Block **1526** then directs the call controller processor circuit to send a stop
25 intercept message to the media relay **17** identified by the contents of the media relay ID field **1310** of the active call record shown in Figure **35**. The stop intercept message includes the contents of the media relay caller port ID field **1312** and media relay callee port field **1314** included in the active call record and identifies to the media relay which ports to shut down. In response
30 to the stop intercept message, the media relay **17** disconnects the connections between the media relay caller port and the mediation device port that was receiving the audio data from the caller and the connection between

-61-

the media relay callee port and the mediation device port that was receiving audio data from the callee. The media relay then sends an MR stop status message to the call controller.

5 Block **1528** directs the call controller processor circuit to receive the MR stop status message and block **1530** directs the call controller to send a stop status message to the routing controller **16**.

10 In an alternative embodiment, the routing controller does not maintain active call records but each call controller does. In such an embodiment, blocks **1408** and **1410** of Figure **44** are replaced with a single block **1600** that directs the routing controller processor circuit to poll each call controller to determine whether or not its active call list contains an entry having caller or callee field contents equal to the username determined from the dialing profile located at
15 block **1402**.

If any of the polled call controllers has such a record, that call controller transmits a response message back to the routing controller, the response message including a call controller ID identifying that call controller. More than
20 one call controller may have an active call record having caller or callee field contents equal to the username determined from the user profile. Such would be the case in a conference call, for example.

The routing controller processor circuit then executes blocks **1412** and **1414**
25 as described above or the process is ended if none of the polled call controllers contains a call record with caller and callee field contents matching the username determined from the dialing profile located at block **1402**.

30 In effect therefore, block **1600** provides an alternate way of finding call controllers that are currently carrying a call associated with the user of interest.

-62-

In another embodiment, an interface to the routing controller and/or the call controller may be provided to enable law enforcement authorities to have direct access or a copy of the active call list maintained by the call controller and/or routing controller.

5

From the foregoing, it will be appreciated that indications of whether or not communications of a subscriber to the system are to be monitored are provided by law enforcement agencies directly into a subscriber dialing profile shown in Figure 9. This dialing profile is used to route a call involving the subscriber and is checked for lawful intercept requirements to determine whether or not the media relay should copy audio data associated with the call to a mediation device for lawful monitoring and/or recording purposes.

10

While the system has been described in connection with the monitoring of audio streams, it may similarly be used for monitoring any other data streams such as pure data and/or video or multimedia data, for example, between subscribers to the system or between a subscriber and a non-subscriber to the system.

15

While specific embodiments of the invention have been described and illustrated, such embodiments should be considered illustrative of the invention only and not as limiting the invention as construed in accordance with the accompanying claims.

20

-63-

What is claimed is:

1. A method for intercepting communications in an Internet Protocol (IP) network, the method comprising:
 - 5 maintaining dialing profiles for respective subscribers to the IP network, each said dialing profile including a username associated with the corresponding subscriber;
 - 10 associating intercept information with the dialing profile of a subscriber whose communications are to be monitored, said intercept information including determination information for determining whether to intercept a communication involving said subscriber, and destination information identifying a device to
15 which intercepted communications involving said subscriber are to be sent; and
 - 20 when said determination information meets intercept criteria, communicating with a media relay through which said communications involving said subscriber will be conducted or are being conducted to cause said media relay to send a copy of said communications to a mediation device specified by said destination information.
- 25 2. The method of clam 1 wherein associating intercept information comprises associating said intercept information with said dialing profile when communications involving said subscriber are not in progress.
- 30 3. The method of clam 1 wherein associating intercept information comprises associating said intercept information when communications involving said subscriber are in progress.

-64-

- 5 4. The method of claim 2 or 3 wherein associating said intercept information comprises populating intercept information fields in said dialing profile of the subscriber whose communications are to be monitored.
- 10 5. The method of claim 1 further comprising producing a routing message for routing communications involving the subscriber through components of the IP network and determining whether said determination information meets said intercept criteria prior to producing said routing message and including at least some of said intercept information in said routing message when said determination information meets said intercept criteria.
- 15 6. The method of claim 5 wherein determining whether said determination information meets said intercept criteria comprises determining whether a current date and time is within a range specified by said determination information.
- 20 7. The method of claim 6 further comprising identifying a media relay through which communications involving said subscriber will be conducted in response to said routing message.
- 25 8. The method of claim 7 further comprising pre-associating at least one media relay with said dialing profile of the subscriber whose communications are to be monitored and wherein identifying said media relay comprises identifying the media relay pre-associated with said subscriber whose communications are to be monitored.
- 30 9. The method of claim 8 wherein pre-associating comprises populating media relay fields in said dialing profile with an identification of at least one media relay.

-65-

- 5 **10.** The method of claim **1** wherein said intercept information is associated with said dialing profile of the subscriber whose communications are to be monitored, in response to receipt of an intercept request message, wherein said intercept request message comprises said intercept information.
- 10 **11.** The method of claim **10** further comprising invoking an intercept request message handler to:
- a) find a dialing profile associated with the subscriber whose communications are to be monitored;
 - b) perform the step of associating said intercept information with said dialing profile;
 - c) determine whether said intercept criteria are met; and
 - 15 d) identify a media relay through which said communications are being conducted.
- 20 **12.** The method of claim **11** further comprising maintaining a active call records for communications in progress, said active call records comprising a username identifier and a media relay identifier identifying the media relay through which said communications are being conducted and wherein identifying a media relay through which said communications are being conducted comprises locating an active call record associated with communications of the subscriber whose communication are to be monitored to find the media relay associated with said communications.
- 25 **13.** The method of claim **12** further comprising maintaining direct inward dialing (DID) records associating PST telephone numbers with usernames of users subscribing to said IP network, and wherein finding a dialing profile associated with the subscriber whose communications are to be monitored comprises finding a username in a DID record
- 30

-66-

bearing a PSTN number associated with the subscriber whose communications are to be monitored and using said username to locate a dialing profile associated with said username.

- 5 **14.** An apparatus for intercepting communications in an Internet Protocol (IP) network, the apparatus comprising:

10 means for maintaining dialing profiles for respective subscribers to the IP network, each said dialing profile including a username associated with the corresponding subscriber;

15 means for associating intercept information with the dialing profile of a subscriber whose communications are to be monitored, said intercept information including determination information for determining whether to intercept a communication involving said subscriber, and destination information identifying a device to which intercepted communications involving said subscriber are to be sent; and

20 means for communicating with a media relay through which said communications involving said subscriber will be conducted or are being conducted to cause said media relay to send a copy of said communications to a mediation device specified by said destination information, when said determination information

25 meets intercept criteria.

- 30 **15.** The apparatus of clam **14** wherein said means for associating intercept information is operably configured to associate said intercept information with said dialing profile when communications involving said subscriber are not in progress.

-67-

- 5
16. The apparatus of claim **14** wherein said means for associating intercept information is operably configured to associate said intercept information when communications involving said subscriber are in progress.
- 10
17. The apparatus of claim **15** or **16** wherein said means for associating said intercept information is operably configured to populate intercept information fields in said dialing profile of the subscriber whose communications are to be monitored.
- 15
18. The apparatus of claim **14** further comprising means for producing a routing message for routing communications involving the subscriber through components of the IP network and means for determining whether said determination information meets said intercept criteria prior to producing said routing message and wherein said means for producing said routing message is operably configured to include at least some of said intercept information in said routing message when said determination information meets said intercept criteria.
- 20
19. The apparatus of claim **18** wherein said means for determining whether said determination information meets said intercept criteria is operably configured to determine whether a current date and time is within a range specified by said determination information.
- 25
20. The apparatus of claim **19** further comprising means for identifying a media relay through which communications involving said subscriber will be conducted in response to said routing message.
- 30
21. The apparatus of claim **20** further comprising means for pre-associating at least one media relay with said dialing profile of the subscriber whose communications are to be monitored and wherein said routing means is operably configured to identify from said dialing

-68-

profile the media relay pre-associated with said subscriber whose communications are to be monitored.

- 5 **22.** The apparatus of claim **21** wherein said means for pre-associating is operably configured to populate media relay fields in said dialing profile with an identification of at least one media relay.
- 10 **23.** The apparatus of claim **14** wherein means for associating said intercept information is operably configured to associate said intercept information associated with said dialing profile of the subscriber whose communications are to be monitored, in response to receipt of an intercept request message, wherein said intercept request message comprises said intercept information.
- 15 **24.** The apparatus of claim **23** further comprising means for handling an intercept request message, said means for handling an intercept request message comprising:
- 20 a) means for find a dialing profile associated with the subscriber whose communications are to be monitored, said means for finding a dialing profile cooperating with said means for associating said intercept information with said dialing profile to cause said intercept information to be associated with said dialing profile;
- 25 b) means for determining whether said intercept criteria are met; and
- c) means for identifying a media relay through which said communications are being conducted.
- 30 **25.** The apparatus of claim **24** further comprising means for maintaining active call records for communications in progress, said active call records comprising a username identifier and a media relay identifier identifying the media relay through which said communications are

-69-

5 being conducted and wherein said means for identifying a media relay through which said communications are being conducted is operably configured to locate an active call record associated with communications of the subscriber whose communication are to be monitored to find the media relay associated with said communications.

10 **26.** The apparatus of claim **25** further comprising means for maintaining direct inward dialing (DID) records associating PST telephone numbers with usernames of users subscribing to said IP network, and wherein said means for finding a dialing profile associated with the subscriber whose communications are to be monitored is operably configured to find a username in a DID record bearing a PSTN number associated with the subscriber whose communications are to be monitored and use said username to locate a dialing profile associated with said
15 username.

Public Search & Enquiry

Disclaimer

This search facility ("this facility") makes available information related to IP applications and registrations at Intellectual Property Office of Singapore ("IPOS"). Whilst IPOS takes reasonable care in the provision of this facility and information, it does not guarantee or in any way represent the accuracy or completeness of this facility or information, nor accept any responsibility for errors or omissions or their consequences. Nevertheless, all reasonable efforts have been made within the limits of hardware and internet bandwidth to provide as much information as possible.

Users should also note that some documents like patent specifications and abstracts have undergone automated optical character recognition (OCR) to render them text-searchable by this facility. Due to the nature of OCR, these documents may contain discrepancies when compared with the original document images.

[Fast Search](#) [Simple Search](#) [Advanced Search](#)

Search Type	
<input type="radio"/> Forms <input checked="" type="radio"/> IP <input type="radio"/> Journals <input type="radio"/> Trade Marks Classification of Goods or Services <input type="radio"/> Patents Abstract & Specification	
Search Category	
<input type="checkbox"/> Designs <input checked="" type="checkbox"/> Patents <input type="checkbox"/> Trade Marks	
Application No.	<input type="text"/>
Filing Date From	<input type="text"/> To <input type="text"/> (dd/mm/yyyy)
Applicant / Proprietor Name	<input type="text" value="Digifonica"/>
Agent Name	<input type="text"/>
Case No.	<input type="text"/>
Additional Information for Patent	
Publication No.	<input type="text"/>
Title	<input type="text"/>
Inventor	<input type="text"/>
International Patent Classification	<input type="text"/>
Application Status	<input type="checkbox"/> All Status <input type="checkbox"/> Abandoned <input type="checkbox"/> Abandoned (Extension of Time Possible) <input type="checkbox"/> Lapsed <input type="checkbox"/> Lapsed (Restoration Pending) <input type="checkbox"/> Patent In Force <input type="checkbox"/> Pending (Published) <input type="checkbox"/> Refused (Extension of Time Pending) <input type="checkbox"/> Revoked <input type="checkbox"/> Withdrawn <input type="checkbox"/> Abandoned (Extension of Time Pending) <input type="checkbox"/> Expired <input type="checkbox"/> Lapsed (Late Renewal Possible) <input type="checkbox"/> Lapsed (Restoration Possible) <input type="checkbox"/> Pending (Not Published) <input type="checkbox"/> Refused <input type="checkbox"/> Refused (Extension of Time Possible) <input type="checkbox"/> Surrendered
Earliest Claimed Priority Date From	<input type="text"/> To <input type="text"/> (dd/mm/yyyy)
Lodgement Date From	<input type="text"/> To <input type="text"/> (dd/mm/yyyy)
Optional Fields	<input type="checkbox"/> Inventor(s) <input type="checkbox"/> International Patent Classification <input type="checkbox"/> PCT Application Number <input type="checkbox"/> Publication Number <input type="checkbox"/> Earliest Claimed Priority Date <input type="checkbox"/> Application Type

PETITIONER APPLE INC.

EX. 1002-690

Search Result

S/No	Application No.	App Status	Filing Date	Lodgement Date	Applicant/Proprietor Name	Title	Agent Name	Case No.
1	2009060872	Abandoned	20/03/2008	14/09/2009	1) DIGIFONICA (INTERNATIONAL) LIMITED	EMERGENCY ASSISTANCE CALLING FOR VOICE OVER IP COMMUNICATIONS SYSTEMS	1) SPRUSON & FERGUSON (ASIA) PTE LTD	
2	2009035841	Abandoned	29/11/2007	27/05/2009	1) DIGIFONICA (INTERNATIONAL) LIMITED	INTERCEPTING VOICE OVER IP COMMUNICATIONS AND OTHER DATA COMMUNICATIONS	1) SPRUSON & FERGUSON (ASIA) PTE LTD	
3	2009029497	Abandoned	01/11/2007	29/04/2009	1) DIGIFONICA (INTERNATIONAL) LIMITED	PRODUCING ROUTING MESSAGES FOR VOICE OVER IP COMMUNICATIONS	1) SPRUSON & FERGUSON (ASIA) PTE LTD	

Page 1 / 1 of 3 record(s)

Rows per page:

Details of Patent

Print

Close

Application No.	2009060872
Application Status	Abandoned
Filing Date	26/03/2008
SG Publication No.	155474
PCT Application No.	PCT/CA2008/000545
Entry Date	14/09/2009
Priority Claimed	26/03/2007 US 60/907,224
Title of Invention	EMERGENCY ASSISTANCE CALLING FOR VOICE OVER IP COMMUNICATIONS SYSTEMS
International Patent Classification	
PCT Publication No.	WO 2008/116296
Date of Publication of Entry into National Phase	29/10/2009

Current Applicant or Proprietor Details

1) Name	DIGIFONICA (INTERNATIONAL) LIMITED
UEN / Company Code	E00056891A
Country	Canada
Address	SUITE #890 999 WEST HASTINGS STREET VANCOUVER, BRITISH COLUMBIA V6C 2W2 Canada
Sole Proprietor Or Partners' Names	

Inventor Details

Name	BJORSELL, JOHAN, EMIL, VIKTOR
Address	PG BOX 29164 RPO SOUTH GRANVILLE POST VANCOUVER, BRITISH COLUMBIA V6J 6A6
Country of Residence	Canada
Name	SOBOLYEV, MAKSYM
Address	506-210 ELEVENTH STREET NEW WESTMINSTER, BRITISH COLUMBIA V3M 4C9
Country of Residence	Canada

Agent/Correspondence Details

1) Agent Name	SPRUSON & FERGUSON (ASIA) PTE LTD
UEN / Company Code	200100515C

PETITIONER APPLE INC. EX. 1002-692

6/10/2015

Representative Name

Address For Service P.O. BOX 1531
ROBINSON ROAD POST OFFICE
Singapore 903031

Action Representing For all matters relating to the application, registration/grant, except those matters expressly excluded

☛ **Other Entries**

S/No.	Event	Event Date
1	Patent application abandoned	05/10/2012
2	Bibliographic publication of application filed	29/10/2009
3	Request for extension of periods under sections 29(7) and 30(1)(a) filed	02/10/2009
4	Notification of PCT national phase entry	29/09/2009
5	ELLA CHEONG SPRUSON & FERGUSON (SINGAPORE) PTE LTD, P.O. BOX 1531, ROBINSON ROAD POST OFFICE, SINGAPORE 903031 Registered as patent agent	23/09/2009
6	Application lodged on 14/09/2009	15/09/2009

☛ **Specification Documents**

- 1 [Drawing\(s\)](#)
- 2 [Description \(with claims\)](#)
- 3 [Drawing\(s\)](#)
- 4 [Description \(with claims\)](#)

☛ **Abstract Documents**

- 1 [Abstract](#)
- 2 [Abstract](#)

In accordance with one aspect of the invention there is provided a process for handling emergency calls from a caller in a voice over IP system. The process (12) INTERNATIONAL APPLICATION PUBLISHED UNDER THE PATENT COOPERATION TREATY (PCT)

(19) World Intellectual Property Organization
International Bureau



(43) International Publication Date: 2 October 2008 (02.10.2008)
PCT Identifier: WO 2008/116296 A1
(10) International Publication Number: WO 2008/116296 A1

- (51) International Patent Classification: H04L 12/66 (2006.01), H04Q 3/00 (2006.01), H04M 11/06 (2006.01), H04M 3/42 (2006.01)
(74) Agents: KNOX, John, W. et al.; Smart & Biggar, 2200 - 650 West Georgia Street, Box 11560, Vancouver Centre, Vancouver, British Columbia V6B 4N8 (CA).
(81) Designated States (unless otherwise indicated, for every kind of national protection available): AE, AG, AL, AM, AT, AU, AZ, BA, BB, BG, BH, BR, BW, BY, BZ, CA, CH, CN, CO, CR, CU, CZ, DE, DK, DM, DO, DZ, EC, EE, EG, ES, FI, GB, GD, GE, GH, GM, GT, HN, HR, HU, ID, IL, IN, IS, JP, KE, KG, KM, KN, KP, KR, KZ, LA, LC, LK, LR, LS, LT, LU, LY, MA, MD, ME, MG, MK, MN, MW, MX, MY, MZ, NA, NG, NI, NO, NZ, OM, PG, PH, PL, PT, RO, RU, SC, SD, SE, SG, SK, SL, SM, SV, SY, TH, TM, TN, TR, TT, TZ, UA, UG, US, UZ, VC, VN, ZA, ZM, ZW.
(21) International Application Number: PCT/CA2008/000545
(22) International Filing Date: 20 March 2008 (20.03.2008)
(25) Filing Language: English
(26) Publication Language: English
(30) Priority Data: 60790224, 26 March 2007 (26.03.2007) US

- (71) Applicant (for all designated States except US): DIGIFONICA (INTERNATIONAL) LIMITED [CA/CA]; Suite 1401, 4710 Kingsway, Burnaby, British Columbia V5H 4M2 (CA).
(72) Inventors; and
(75) Inventors/Applicants (for US only): BJORSELL, Johan, Emil, Viktor [SE/CA]; 203 - 2288 Broadway West, Vancouver, British Columbia V6K 0B3 (CA). SOBOLYEV, Maksym [RU/CA]; 307 - 265 Tenth Street, New Westminster, British Columbia V3M 3Y1 (CA).

- (84) Designated States (unless otherwise indicated, for every kind of regional protection available): ARIPO (BW, GH, GM, KE, LS, MW, MZ, NA, SD, SL, SZ, TZ, UG, ZM, ZW), Eurasian (AM, AZ, BY, KG, KZ, MD, RU, TJ, TM), European (AT, BE, BG, CH, CY, CZ, DE, DK, EE, ES, FI, FR, GB, GR, HR, HU, IE, IS, IT, LT, LU, LV, MC, MT, NL, NO, PL, PT, RO, SE, SI, SK, TR), OAPI (BF, BJ, CF, CG, CI, CM, GA, GN, GQ, GW, ML, MR, NE, SN, TD, TG).

Published: — with international search report

(54) Title: EMERGENCY ASSISTANCE CALLING FOR VOICE OVER IP COMMUNICATIONS SYSTEMS

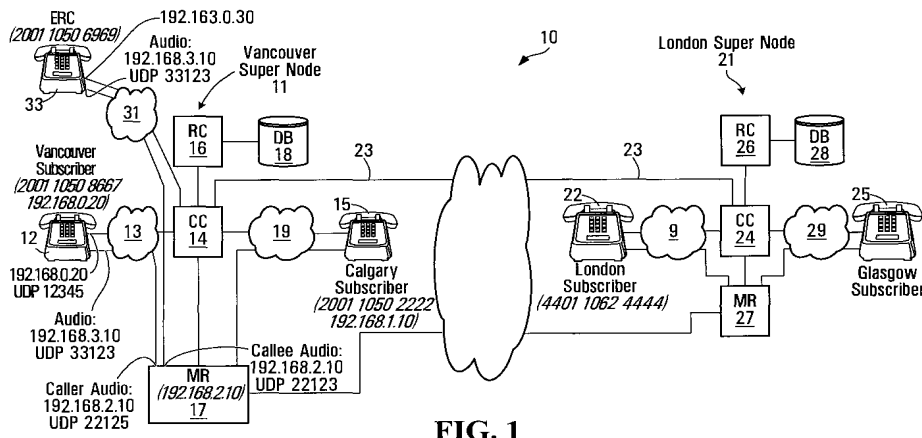

FIG. 1

(57) Abstract: In accordance with one aspect of the invention there is provided a process for handling emergency calls from a caller in a voice over IP system. The process involves receiving a routing request message including a caller identifier and a callee identifier. The process also involves setting an emergency call flag active in response to the callee identifier matching an emergency call identifier pre-associated with the caller. The process further involves producing an emergency response center identifier in response to the emergency call identifier. The process also involves determining whether the caller identifier is associated with a pre-associated direct inward dialing (DID) identifier. The process further involves producing a direct inward dialing (DID) identifier for the caller by associating a temporary DID identifier with the caller identifier when the emergency call flag is active and it is determined that the caller has no pre-associated DID. The process also involves producing a routing message including the emergency response center identifier and the temporary DID identifier for receipt by a routing controller operable to cause a route to be established between the caller and the emergency response center.



WO 2008/116296 A1

This invention relates to emergency assistance calling, voice over internet protocol communications and methods and apparatus for emergency assistance calling for voice over IP data communications. An essential feature of traditional telephone systems (PSTN) is the ability of its subscribers to dial a universal emergency number (911 in North America) to access a host of emergency services such as fire, police and ambulance. Because of the hierarchical nature of telephone networks and numbering schemes, a call coming from a specific telephone number on the PSTN network is automatically routed to a nearest Emergency Response Center (ERC) based on the area code and exchange code contained in the specific telephone number. Normally, the specific telephone number will be compliant with the E.164 standard set by the International Telecommunication Union. When the call comes into the ERC, call information presented the ERC operator includes the phone number, and where available, the address associated with this phone number. Since the late 1990s, an enhanced emergency service (E911) was mandated for PSTN and cellular carriers in North America and elsewhere. In particular, with this enhanced service the information automatically provided to the ERC includes the physical location of the person calling, even where the caller is using a cellular telephone. Moreover, a callback functionality is integrated into E911-compliant systems allowing an ERC operator to call back the person who placed the emergency call even if the original phone call was disconnected or if the calling line became busy.

EMERGENCY ASSISTANCE CALLING FOR VOICE OVER IP COMMUNICATIONS SYSTEMS

BACKGROUND OF THE INVENTION

Field of Invention

This invention relates to emergency assistance calling, voice over internet protocol communications and methods and apparatus for emergency assistance calling for voice over IP data communications.

An essential feature of traditional telephone systems (PSTN) is the ability of its subscribers to dial a universal emergency number (911 in North America) to access a host of emergency services such as fire, police and ambulance. Because of the hierarchical nature of telephone networks and numbering schemes, a call coming from a specific telephone number on the PSTN network is automatically routed to a nearest Emergency Response Center (ERC) based on the area code and exchange code contained in the specific telephone number. Normally, the specific telephone number will be compliant with the E.164 standard set by the International Telecommunication Union. When the call comes into the ERC, call information presented the ERC operator includes the phone number, and where available, the address associated with this phone number. Since the late 1990s, an enhanced emergency service (E911) was mandated for PSTN and cellular carriers in North America and elsewhere. In particular, with this enhanced service the information automatically provided to the ERC includes the physical location of the person calling, even where the caller is using a cellular telephone. Moreover, a callback functionality is integrated into E911-compliant systems allowing an ERC operator to call back the person who placed the emergency call even if the original phone call was disconnected or if the calling line became busy.

Since the late 1990s, an enhanced emergency service (E911) was mandated for PSTN and cellular carriers in North America and elsewhere. In particular, with this enhanced service the information automatically provided to the ERC includes the physical location of the person calling, even where the caller is using a cellular telephone. Moreover, a callback functionality is integrated into E911-compliant systems allowing an ERC operator to call back the person who placed the emergency call even if the original phone call was disconnected or if the calling line became busy.

Moreover, a callback functionality is integrated into E911-compliant systems allowing an ERC operator to call back the person who placed the emergency call even if the original phone call was disconnected or if the calling line became busy.

Moreover, a callback functionality is integrated into E911-compliant systems allowing an ERC operator to call back the person who placed the emergency call even if the original phone call was disconnected or if the calling line became busy.

Moreover, a callback functionality is integrated into E911-compliant systems allowing an ERC operator to call back the person who placed the emergency call even if the original phone call was disconnected or if the calling line became busy.

Moreover, a callback functionality is integrated into E911-compliant systems allowing an ERC operator to call back the person who placed the emergency call even if the original phone call was disconnected or if the calling line became busy.

Moreover, a callback functionality is integrated into E911-compliant systems allowing an ERC operator to call back the person who placed the emergency call even if the original phone call was disconnected or if the calling line became busy.

Moreover, a callback functionality is integrated into E911-compliant systems allowing an ERC operator to call back the person who placed the emergency call even if the original phone call was disconnected or if the calling line became busy.

Moreover, a callback functionality is integrated into E911-compliant systems allowing an ERC operator to call back the person who placed the emergency call even if the original phone call was disconnected or if the calling line became busy.

Moreover, a callback functionality is integrated into E911-compliant systems allowing an ERC operator to call back the person who placed the emergency call even if the original phone call was disconnected or if the calling line became busy.

Moreover, a callback functionality is integrated into E911-compliant systems allowing an ERC operator to call back the person who placed the emergency call even if the original phone call was disconnected or if the calling line became busy.

provide basic 911 services, VoIP systems present a number of problems because they do not employ hierarchical numbering schemes, and the phone numbers assigned to VoIP system subscribers, while still in the E-164 format, do not actually reflect the subscribers physical location via area code and exchange codes. As a result, a VoIP provider is not able to automatically route an emergency call to an ERC nearest to the subscriber. Because VoIP subscriber phone numbers are assigned from a bulk of phone numbers that VoIP providers purchase from wireline providers, they do not employ hierarchical numbering schemes, and the phone numbers assigned to VoIP system subscribers, while still in the E-164 format, do not actually reflect the subscribers physical location via area code and exchange codes. As a result, a VoIP provider is not able to automatically route an emergency call to an ERC nearest to the subscriber.

5

Even to provide basic 911 services, VoIP systems present a number of problems because they do not employ hierarchical numbering schemes, and the phone numbers assigned to VoIP system subscribers, while still in the E-164 format, do not actually reflect the subscribers physical location via area code and exchange codes. As a result, a VoIP provider is not able to automatically route an emergency call to an ERC nearest to the subscriber.

10

Because VoIP subscriber phone numbers are assigned from a bulk of phone numbers that VoIP providers purchase from wireline PSTN carriers, a VoIP systems are also typically not able to comply with E911 service requirements, for the same reasons they are not able to comply with regular 911 services. In accordance with one aspect of the invention, there is provided a process for handling emergency calls from a caller in a voice over IP system. The method involves receiving a routing request message including a caller identifier and a callee identifier. The method involves setting an emergency call flag active in response to the callee identifier matching an emergency call identifier.

15

In addition, because VoIP systems are not based on the Signaling System 7 (SS7) protocol, they do not natively support special short phone numbers such as 911. In particular, they do not natively support variable length phone number dialing, or dynamic translation of dialed universal phone numbers into actual destination phone numbers based on user attributes such as location or service type.

20

actual destination phone numbers based on user attributes such as location or service type.

VoIP systems are also typically not able to comply with E911 service requirements, for the same reasons they are not able to comply with regular 911 services.

25

In accordance with one aspect of the invention, there is provided a process for handling emergency calls from a caller in a voice over IP system. The method involves receiving a routing request message including a caller identifier and a callee identifier. The method also involves setting an emergency call flag active in response to the callee identifier matching an emergency call identifier pre-associated with the caller. The method further involves producing an emergency response center identifier in response to the emergency call

30

5

10

15

20

25

30

DID identifier may involve searching a database for a DID record associating a DID identifier with the caller identifier and determining that the caller identifier is not associated with a pre-associated DID identifier when a record associating a DID identifier with the caller is not found. Associating a temporary DID identifier with the caller identifier may involve associating with the caller identifier a DID identifier from a pool of pre determined DID identifiers with the caller identifier is not found. Associating a temporary DID identifier with the caller identifier may involve associating a temporary DID record with the caller, the temporary DID record having a DID identifier field populated with the DID identifier from the pool. Associating the DID identifier from the pool with the caller identifier may involve associating a temporary DID identifier from a pool of pre-determined DID identifiers. Producing the emergency response center identifier may involve obtaining an emergency response center identifier from an emergency response center field of the dialing profile associated with the caller. Obtaining may involve copying an emergency response center identifier from the dialing profile associated with the caller to a routing message buffer such that the emergency response center identifier is included in the routing message. Producing the routing message may involve causing the routing message to specify a maximum call time for the emergency call, the maximum call time exceeding a duration of an average non-emergency telephone call. In accordance with another aspect of the invention, there is provided an apparatus for handling emergency calls from a caller in a voice over IP system. The apparatus includes provisions for receiving a routing request

4
5
10
15

Producing the emergency response center identifier may involve obtaining an emergency response center identifier from an emergency response center field of the dialing profile associated with the caller.

20

Obtaining may involve copying an emergency response center identifier from the dialing profile associated with the caller to a routing message buffer such that the emergency response center identifier is included in the routing message.

25

Producing the routing message may involve causing the routing message to specify a maximum call time for the emergency call, the maximum call time exceeding a duration of an average non-emergency telephone call.

30

In accordance with another aspect of the invention, there is provided an apparatus for handling emergency calls from a caller in a voice over IP

in response to the callee identifier matching an emergency call identifier preassociated with the caller. The apparatus further includes provisions for producing an emergency response center identifier in response to the emergency call identifier. The apparatus also includes provisions for receiving a routing request message including a caller identifier and a callee identifier. The apparatus also includes provisions for determining whether the caller identifier is associated with a pre-associated direct inward dialing (DID) identifier. The apparatus further includes provisions for producing a direct inward dialing (DID) identifier for the caller including provisions for associating a direct inward dialing (DID) identifier with the caller when the caller identifier has no pre-associated direct inward dialing (DID) identifier. The apparatus further includes provisions for producing a routing message including a temporary DID identifier with the caller identifier in response to the emergency call flag being active and the caller identifier not being pre-associated with direct inward dialing (DID) identifier. The provisions for producing a direct inward dialing (DID) identifier for the caller include provisions for accessing a database of dialing profiles associated with respective subscribers to the system, each of the dialing profiles including an emergency call identifier field and an associated direct inward dialing center field and the setting provisions may comprise provisions for retrieving a dialing profile associated with the caller and for setting the emergency call flag active when the contents of the emergency call message including the emergency response center identifier and the temporary DID identifier for receipt by a routing controller operable to cause a route to be established between the caller and the emergency response center.

The apparatus may further include provisions for accessing a database of dialing profiles associated with respective subscribers to the system, each of the dialing profiles including an emergency call identifier field and an emergency call center field and the setting provisions may comprise provisions for retrieving a dialing profile associated with the caller and for setting the emergency call flag active when the contents of the emergency call identifier field of the dialing profile match the callee identifier.

The apparatus may further include database accessing provisions for accessing a database including direct inward dialing (DID) records associated

identifier field of the dialing profile match the callee identifier. The apparatus may further include database accessing provisions for accessing a database including direct inward dialing (DID) records associated with at least some subscribers to the system, each of the direct inward dialing records comprising a system username and a direct inward dialing number, and wherein the determining provisions comprise searching provisions for searching a database for a DID record associating a DID identifier with the caller. The determining provisions may be operably configured to determine that the caller identifier is associated with a pre-associated DID identifier when a record associating a DID identifier with the caller is found. The determining provisions may be operably configured to determine that the caller identifier is associated with a pre-associated DID identifier when a record associating a DID identifier with the caller is found. The apparatus may further include a DID identifier buffer and the provisions for associating a pre-assigned DID identifier with the caller identifier may comprise provisions for copying the pre-associated DID identifier from the DID record to the DID identifier buffer. The provisions for producing the routing message may include provisions for causing the contents of the DID identifier buffer to define the DID identifier in the routing message. The apparatus may further include database accessing provisions for copying the pre-associated DID identifier from the DID record to the DID identifier buffer. The provisions for producing the routing message may include provisions for causing the contents of the DID identifier buffer to define the DID identifier in the routing message.

5

10

15

20

25

30

The apparatus may further include database accessing provisions for accessing a database including direct inward dialing records associated with at least some subscribers to the system, each of the direct inward dialing records comprising a system username and a direct inward dialing number and the determining provisions may comprise searching provisions for searching a database for a DID record associating a DID identifier with the caller and wherein the determining provisions may be operably configured to determine that the caller identifier is not associated with a pre-associated DID identifier when a record associating a DID identifier with the caller is not found.

The apparatus may further include provisions for accessing a pool of pre-determined DID identifiers and the provisions for associating a temporary DID identifier with the caller identifier may comprise provisions for associating a

The apparatus may further include provisions for accessing a pool of predetermined DID identifiers and provisions for associating a temporary DID identifier with the caller identifier may comprise provisions for associating a DID identifier from the pool of pre-determined DID identifiers with the caller identifier. The provisions for associating the DID identifier from the pool of pre-determined DID identifiers with the caller identifier may include provisions for associating a temporary DID record with the caller, the temporary DID record having a DID identifier field populated with the DID identifier from the pool. The provisions for associating the DID identifier may include provisions for copying the DID identifier from the temporary DID record to a DID identifier buffer.

5 The provisions for associating a temporary DID record with the caller, the canceling the temporary DID record after a period of time. The provisions for producing the emergency response center identifier may include provisions for obtaining an emergency response center identifier from an emergency response center field of the dialing profile associated with the caller. The apparatus may include a routing message buffer and the provisions

10 for copying the DID identifier from the temporary DID record to a DID identifier buffer. The apparatus may further include provisions for canceling the temporary DID record after a period of time. The provisions for producing the emergency response center identifier may include provisions for obtaining an emergency response center identifier from an emergency response center field of the dialing profile associated with the caller to the routing message buffer such that the contents of the emergency response center field are included in the routing message.

15 The provisions for producing the emergency response center identifier may include provisions for obtaining an emergency response center identifier from an emergency response center field of the dialing profile associated with the caller. The apparatus may include a routing message buffer and the provisions for obtaining may include provisions for copying the contents of the emergency response center field of the dialing profile associated with the caller to the routing message buffer such that the contents of the emergency response center field are included in the routing message.

20 The provisions for producing the routing message may include provisions for causing the routing message to include a maximum call time for the emergency call, the maximum call time exceeding a duration of an average non-emergency telephone call. In accordance with another aspect of the invention, the apparatus may include provisions for obtaining an emergency response center identifier from an emergency response center field of the dialing profile associated with the caller.

25 The apparatus may include a routing message buffer and the provisions for obtaining may include provisions for copying the contents of the emergency response center field of the dialing profile associated with the caller to the routing message buffer such that the contents of the emergency response center field are included in the routing message.

30 The provisions for producing the routing message may include provisions for causing the routing message to include a maximum call time for the emergency call, the maximum call time exceeding a duration of an average non-emergency telephone call.

apparatus for handling emergency calls from a caller in a voice over IP system. The apparatus includes an processor circuit operably configured to receive a routing request message including a caller identifier and a callee identifier. The processor circuit is also operably configured to set an emergency call flag active in response to the callee identifier matching an emergency call identifier pre-associated with the caller. In accordance with another aspect of the invention, there is provided an apparatus for handling emergency calls from a caller in a voice over IP system. The apparatus includes an processor circuit operably configured to receive a routing request message including a caller identifier and a callee identifier. The processor circuit is also operably configured to set an emergency call flag active in response to the callee identifier matching an emergency call identifier pre-associated with the caller. The processor circuit is further operably configured to produce an emergency response center identifier in response to the emergency call identifier and to determine whether the caller identifier is associated with a pre-associated direct inward dialing (DID) identifier. The processor circuit is also operably configured to produce a routing message including the emergency response center identifier and the temporary DID identifier for receipt by a routing controller operable to cause a route to be established between the caller and the emergency response center. The processor circuit may be operably configured to retrieve a dialing profile associated with the caller and to set the emergency call flag active when the contents of an emergency call identifier field of the dialing profile match the callee identifier. The processor circuit is further operably configured to produce a routing message including the emergency response center identifier and the temporary DID identifier for receipt by a routing controller operable to cause a route to be established between the caller and the emergency response center.

5

10

15

20

25

30

The processor circuit may be operably configured to retrieve a dialing profile associated with the caller and to set the emergency call flag active when the contents of an emergency call identifier field of the dialing profile match the callee identifier.

The processor circuit may be operably configured to search a database for a DID record associating a DID identifier with the caller and to determine that the caller identifier is associated with a pre-associated DID identifier when the record associating a DID identifier with the caller is found.

The processor circuit may be operably configured to copy the pre-associated DID identifier from the DID record to a DID identifier buffer.

The processor circuit may be operably configured to copy the pre-associated DID identifier from the DID identifier buffer. The processor circuit may be operably configured to cause the contents of the DID identifier buffer to define the DID identifier in the routing message. The processor circuit may be operably configured to search a database for a DID record associating a DID identifier with the caller and to determine that the caller

identifier is associated with the pre-associated DID identifier when a record associating a DID identifier with the caller is not found. The processor circuit

may be operably configured to associate with the caller identifier a DID identifier from a pool of

5 The processor circuit may be operably configured to search a database for a DID record associating a DID identifier with the caller and to determine that the caller identifier is not associated with a pre-associated DID identifier when a record associating a DID identifier with the caller is not found from the temporary DID record to a DID buffer. The processor circuit may be operably configured to cancel

10 The processor circuit may be operably configured to associate with the caller identifier a DID identifier from a pool of pre-determined DID identifiers.

The processor circuit may be operably configured to associate a temporary

15 The processor circuit may be operably configured to copy an emergency response center identifier from an emergency response center field of the dialing profile associated with the caller to the routing message buffer such that the emergency response center identifier is included in the routing message. The processor circuit

may be operably configured to cause the routing message to include a maximum call time for the

20 The processor circuit may be operably configured to copy the DID identifier from the temporary DID record to a DID buffer.

emergency call, the maximum call time exceeding a duration of an average non-emergency

20 The processor circuit may be operably configured to cancel the temporary DID record after a period of time.

The processor circuit may be operably configured to obtain an emergency response center identifier from an emergency response center field of the dialing profile associated with the caller.

25 The apparatus may further a routing message buffer and the processor circuit may be operably configured to copy an emergency response center identifier from the dialing profile associated with the caller to the routing message buffer such that the emergency response center identifier is included in the routing message.

telephone call. In accordance with another aspect of the invention, there is provided a computer readable medium encoded with codes for directing a processor circuit to handle emergency calls from callers in a voice over IP system. The codes direct the processor circuit to receive a routing request message including a caller identifier and a callee identifier. The codes also direct the processor circuit to set an emergency call flag active in response to the callee identifier matching an emergency call identifier pre-associated with the caller. The codes further direct the processor circuit to produce an emergency response center identifier in response to the emergency call identifier.

5 In accordance with another aspect of the invention, there is provided a computer readable medium encoded with codes for directing a processor circuit to handle emergency calls from callers in a voice over IP system. The codes direct the processor circuit to receive a routing request message including a caller identifier and a callee identifier. The codes also direct the processor circuit to produce a routing message including the emergency response center identifier and the temporary DID identifier for receipt by a routing controller operable to cause a route to be established between the caller and the emergency response center. The codes further direct the processor circuit to produce an emergency response center identifier in response to the emergency call identifier. The codes also direct the processor circuit to determine whether the caller identifier is associated with a pre-associated direct inward dialing (DID) identifier. The codes further direct the processor circuit to produce a direct inward dialing (DID) identifier for the caller by associating a temporary DID identifier with the caller identifier when the emergency call flag is active and it is determined that the caller identifier has no pre-associated DID identifier. The codes also direct the processor circuit to produce a routing message including the emergency response center identifier and the temporary DID identifier for receipt by a routing controller operable to cause a route to be established between the caller and the emergency response center. The codes further direct the processor circuit to produce an emergency response center identifier in response to the emergency call identifier. The codes also direct the processor circuit to determine whether the caller identifier is associated with a pre-associated direct inward dialing (DID) identifier. The codes further direct the processor circuit to produce a direct inward dialing (DID) identifier for the caller by associating a temporary DID identifier with the caller identifier when the emergency call flag is active and it is determined that the caller identifier has no pre-associated DID identifier. The codes also direct the processor circuit to produce a routing message including the emergency response center identifier and the temporary DID identifier for receipt by a routing controller operable to cause a route to be established between the caller and the emergency response center.

BRIEF DESCRIPTION OF THE DRAWINGS

In drawings which illustrate embodiments of the invention,

Figure 1 is a block diagram of a system according to a first embodiment of the invention;

between the caller telephone and a call controller (CC) shown in Figure 1; Figure 4 is a block diagram of a call controller shown in Figure 1; Figure 5 is a flowchart of a process executed by the call controller shown in Figure 1; Figure 6 is a schematic representation of a routing controller (RC) Request message produced by the call controller shown in Figure 1; Figure 7 is a block diagram of a routing controller (RC) processor circuit of the routing controller shown in Figure 1; Figures 8A-8D are flowcharts of a RC Request message handler executed by the RC processor circuit shown in Figure 7; Figure 9 is a tabular representation of a dialling profile stored in a database accessible by the RC shown in Figure 1; Figure 10 is a tabular representation of a dialling profile for a Vancouver caller using the caller telephone shown in Figure 1; Figure 10A is a tabular representation of a dialling profile for the Emergency Response Center subscriber shown in Figure 1; Figure 11 is a tabular representation of a dialling profile for the Calgary subscriber shown in Figure 1; Figure 12 is a tabular representation of a dialling profile for the London subscriber shown in Figure 1; Figure 13 is a tabular representation of a DID bank table record stored in the database shown in Figure 1; Figure 13A is a tabular representation of an exemplary DID bank table record for the Vancouver subscriber; Figure 13B is a tabular representation of an exemplary DID bank table record for the Calgary subscriber;

WO 2008/116296 PCT/CA2008/000545
Figure 2 is a block diagram of a caller VOIP telephone according to the first embodiment of the invention;

Figure 3 is a schematic representation of a SIP invite message transmitted between the caller telephone and a call controller (CC) shown in Figure 1;

5 Figure 4 is a block diagram of the call controller shown in Figure 1;

Figure 5 is a flowchart of a process executed by the call controller shown in Figure 1;

10 Figure 6 is a schematic representation of a routing controller (RC) Request message produced by the call controller shown in Figure 1;

Figure 7 is a block diagram of a routing controller (RC) processor circuit of the routing controller shown in Figure 1;

Figure 8A-8D are flowcharts of a RC Request message handler executed by the RC processor circuit shown in Figure 7;

Figure 9 is a tabular representation of a dialling profile stored in a database accessible by the RC shown in Figure 1;

15 Figure 10 is a tabular representation of a dialling profile for a Vancouver caller using the caller telephone shown in Figure 1;

Figure 10A is a tabular representation of a dialling profile for the Emergency Response Center subscriber shown in Figure 1;

Figure 11 is a tabular representation of a dialling profile for the Calgary subscriber shown in Figure 1;

20 Figures 8A-8D are flowcharts of a RC Request message handler executed by the RC processor circuit shown in Figure 7;

Figure 9 is a tabular representation of a dialling profile stored in a database accessible by the RC shown in Figure 1;

25 Figure 10 is a tabular representation of a dialling profile for a Vancouver caller using the caller telephone shown in Figure 1;

Figure 10A is a tabular representation of a dialling profile for the Emergency Response Center subscriber shown in Figure 1;

30 Figure 11 is a tabular representation of a dialling profile for the Calgary subscriber shown in Figure 1;

Figure 14 is a tabular representation of an exemplary DID bank table record for the London subscriber;
WO 2008/116296 is a tabular representation of a routing message buffer for holding a routing message to be
RCT/CA 2008/000545

transmitted from the RC to the call controller shown in Figure 1; Figure 16 is a tabular representation of a routing message for routing a call to the Emergency Response Center; Figure 16A is a tabular representation of a routing message for routing a call to the London subscriber;

Figure 12 is a tabular representation of a dialing profile for the London subscriber shown in Figure 1; Figure 17 is a tabular representation of a prefix to supernode table record stored in the database shown in Figure 1; Figure 18 is a tabular representation of a prefix to supernode table record that would be used for the London subscriber;

5 Figure 13 is a tabular representation of a DID bank table record stored in the master list record stored in a master list table in the database shown in Figure 1; Figure 20 is a tabular representation of an exemplary populated master list record; Figure 21 is a tabular representation of a supplier list record in the exemplary DID bank table record for the Vancouver subscriber;

10 Figure 13A is a tabular representation of an exemplary DID bank table record for the Vancouver subscriber; Figure 22 is a tabular representation of a specific supplier list record for a first supplier; Figure 23 is a tabular representation of a specific supplier list record for a second supplier; Figure 24 is a tabular representation of an exemplary supplier list record for a third supplier; Figure 25 is a tabular representation of a routing message buffer for holding a routing message identifying a plurality of possible suppliers that

15 Figure 14 is a tabular representation of an exemplary DID bank table record for the London subscriber;

Figure 15 is a tabular representation of a routing message buffer for holding a routing message to be transmitted from the RC to the call controller shown in Figure 1;

20 Figure 16 is a tabular representation of a routing message for routing a call to the Emergency Response Center;

Figure 16A is a tabular representation of a routing message for routing a call to the London subscriber;

25 Figure 17 is a tabular representation of a prefix to supernode table record stored in the database shown in Figure 1;

Figure 18 is a tabular representation of a prefix to supernode table record that would be used for the London subscriber;

30 Figure 19 is a tabular representation of a routing message buffer for holding a routing message to be transmitted from the RC to the call controller shown in Figure 1;

Figure 20 is a tabular representation of an exemplary populated master list record;

Figure 21 is a tabular representation of a supplier list record in the exemplary DID bank table record for the Vancouver subscriber;

Figure 22 is a tabular representation of a specific supplier list record for a first supplier;

Figure 23 is a tabular representation of a specific supplier list record for a second supplier;

Figure 24 is a tabular representation of an exemplary supplier list record for a third supplier;

Figure 25 is a tabular representation of a routing message buffer for holding a routing message identifying a plurality of possible suppliers that

may carry the call; Figure 26 is a tabular representation of a call block table record; Figure 27 is a tabular representation of a call block table record for the Calgary subscriber; Figure 28 is a tabular representation of a call forwarding table record; Figure 29 is a tabular representation of an exemplary call forwarding table record specific to the Calgary subscriber; Figure 30 is a tabular representation of a voicemail table record specifying voicemail parameters to enable the caller to leave a voicemail message for the callee; Figure 31 is a tabular representation of an exemplary voicemail table record for the Calgary subscriber; Figure 32 is a tabular representation of an exemplary populated master list record; a routing message buffer, indicating call forwarding numbers and a voicemail server identifier; Figure 33 is a tabular representation of a SIP Bye message transmitted from any of the telephones to the call controller; Figure 34 is a tabular representation of a message sent to the call controller from the callee or caller gateway; Figure 35 is a flowchart of a process executed by the call controller for producing a RC Call Stop message in response to receipt of a SIP Bye message; Figure 36 is a tabular representation of an exemplary RC Call Stop message; Figure 37 is a tabular representation of an exemplary RC Call Stop message for the Calgary subscriber; Figure 38 is a schematic representation of messages exchanged during a

- 13
Figure 19 is a tabular representation of a master list record stored in a master list table in the database shown in Figure 1;
- 5
Figure 20 is a tabular representation of an exemplary populated master list record;
- Figure 21 is a tabular representation of a suppliers list record stored in the database shown in Figure 1;
- 10
Figure 22 is a tabular representation of a specific supplier list record for a first supplier;
- 15
Figure 23 is a tabular representation of a specific supplier list record for a second supplier;
- Figure 24 is a tabular representation of a specific supplier list record for a third supplier;
- 20
Figure 25 is a tabular representation of a routing message buffer for holding a routing message identifying a plurality of possible suppliers that may carry the call;
- Figure 26 is a tabular representation of a call block table record;
- 25
Figure 27 is a tabular representation of a call block table record for the Calgary subscriber;
- Figure 28 is a tabular representation of a call forwarding table record;
- 30
Figure 29 is a tabular representation of an exemplary call forwarding table record specific to the Calgary subscriber;

- Figure 30 is a tabular representation of a voicemail table record specifying voicemail parameters to enable the caller to leave a voicemail message for the callee;
- 5 Figure 31 is a tabular representation of an exemplary voicemail table record for the Calgary subscriber;
- Figure 32 is a tabular representation of an exemplary routing message, held in a routing message buffer, indicating call forwarding numbers and a voicemail server identifier;
- 10 Figure 33 is a tabular representation of a SIP Bye message transmitted from any of the telephones to the call controller;
- 15 Figure 34 is a tabular representation of a SIP Bye message sent to the call controller from the callee or caller gateway;
- 20 Figure 35 is a flowchart of a process executed by the call controller for producing a RC Call Stop message in response to receipt of a SIP Bye message;
- Figure 36 is a tabular representation of an exemplary RC Call Stop message;
- 25 Figure 37 is a tabular representation of an exemplary RC Call Stop message for the Calgary subscriber;
- Figure 38 is a schematic representation of messages exchanged during a process for establishing audio paths between telephones and a media relay.
- 30

example within a region of the geographical area serviced by the supernode. However, in general, all supernodes are similar and have the properties described below in connection with the Vancouver supernode 11. In this embodiment, the Vancouver supernode includes a call controller (CC) 14, a router controller (RC) 16 and a database 18 and a media relay (MR) 17. Subscribers such as the Vancouver subscriber 19, the Calgary subscriber and the Emergency Response Center subscriber communicate with the Vancouver supernode 11 using their own Internet generally at 21. The first supernode 11 is located in a geographical area, which route Internet Protocol (IP) traffic from these subscribers to the Vancouver supernode over the Internet. To these subscribers, the Vancouver supernode 11 is accessible through their ISP at a pre-determined IP address. Different supernodes may be located in different geographical regions throughout the world to provide telephone service to subscribers in respective regions. These supernodes may be in communication with each other through high speed high data throughput links including optical fiber, satellite and/or cable links, for example, forming a system backbone. These supernodes may alternatively or in addition be in communication with each other through conventional Internet services. In the embodiment shown, data communication media for providing for data communications between the first and second supernodes 11 and 21 are shown generally at 23 and may include very high speed data links, for example, IP/UDP addresses directly accessible via the Internet or a private IP network, for example, depending on the specific implementation of the system. In the embodiment shown, the Vancouver supernode 11 provides telephone service to a geographical region comprising Western Canadian customers from Vancouver Island to Ontario and includes a Vancouver subscriber, a Calgary subscriber and an emergency response center (ERC) that is also a subscriber. The second supernode 21 may be located in London, England, for example, to service London and Glasgow subscribers, 22 and 25, for example through their own service providers 9 and 29. As will be seen below however, the emergency response center need not be a subscriber.

DETAILED DESCRIPTION

Referring to Figure 1, a system for making voice over IP telephone calls including emergency calls is shown generally at 10. The system includes a first supernode shown generally at 11 and a second supernode shown generally at 21. The first supernode 11 is located in a geographical area, which route Internet Protocol (IP) traffic from these subscribers to the Vancouver supernode over the Internet. To these subscribers, the Vancouver supernode 11 is accessible through their ISP at a pre-determined IP address. Different supernodes may be located in different geographical regions throughout the world to provide telephone service to subscribers in respective regions. These supernodes may be in communication with each other through high speed high data throughput links including optical fiber, satellite and/or cable links, for example, forming a system backbone. These supernodes may alternatively or in addition be in communication with each other through conventional Internet services. In the embodiment shown, data communication media for providing for data communications between the first and second supernodes 11 and 21 are shown generally at 23 and may include very high speed data links, for example, IP/UDP addresses directly accessible via the Internet or a private IP network, for example, depending on the specific implementation of the system. In the embodiment shown, the Vancouver supernode 11 provides telephone service to a geographical region comprising Western Canadian customers from Vancouver Island to Ontario and includes a Vancouver subscriber, a Calgary subscriber and an emergency response center (ERC) that is also a subscriber. The second supernode 21 may be located in London, England, for example, to service London and Glasgow subscribers, 22 and 25, for example through their own service providers 9 and 29. As will be seen below however, the emergency response center need not be a subscriber.

The second supernode 21 may be located in London, England, for example, to service London and Glasgow subscribers, 22 and 25, for example through their own service providers 9 and 29. As will be seen below however, the emergency response center need not be a subscriber.

As will be seen below however, the emergency response center need not be a subscriber.

As will be seen below however, the emergency response center need not be a subscriber.

As will be seen below however, the emergency response center need not be a subscriber.

As will be seen below however, the emergency response center need not be a subscriber.

As will be seen below however, the emergency response center need not be a subscriber.

As will be seen below however, the emergency response center need not be a subscriber.

As will be seen below however, the emergency response center need not be a subscriber.

As will be seen below however, the emergency response center need not be a subscriber.

As will be seen below however, the emergency response center need not be a subscriber.

As will be seen below however, the emergency response center need not be a subscriber.

As will be seen below however, the emergency response center need not be a subscriber.

As will be seen below however, the emergency response center need not be a subscriber.

As will be seen below however, the emergency response center need not be a subscriber.

As will be seen below however, the emergency response center need not be a subscriber.

As will be seen below however, the emergency response center need not be a subscriber.

As will be seen below however, the emergency response center need not be a subscriber.

As will be seen below however, the emergency response center need not be a subscriber.

As will be seen below however, the emergency response center need not be a subscriber.

As will be seen below however, the emergency response center need not be a subscriber.

As will be seen below however, the emergency response center need not be a subscriber.

As will be seen below however, the emergency response center need not be a subscriber.

As will be seen below however, the emergency response center need not be a subscriber.

As will be seen below however, the emergency response center need not be a subscriber.

As will be seen below however, the emergency response center need not be a subscriber.

As will be seen below however, the emergency response center need not be a subscriber.

As will be seen below however, the emergency response center need not be a subscriber.

telephones will have IP/UDP addresses directly accessible by the call controllers and the media controllers on their respective supernodes, and those addresses will not be obscured by Network Address Translation (NAT) or similar mechanisms. In other words, the IP/UDP information contained in SIP messages (for example the SIP Invite message or the RC Request message which will be described below) will match the IP/UDP addresses of the IP packets carrying these SIP messages. In this embodiment, the Vancouver supernode includes a call controller (CC) 14, a routing controller (RC) 16, a database 18 and a media relay (MR) 17. Subscribers such as the Vancouver subscriber, the Calgary subscriber and the Emergency Response Center subscriber communicate with the Vancouver supernode 11 using their own Internet Service Providers (ISPs) 13, 19 and 31 respectively which route Internet Protocol (IP) traffic from these subscribers to the Vancouver Supernode over the Internet. To these subscribers the Vancouver supernode 11 is accessible through their ISP at a pre-determined IP address of a fully qualified domain name (FQDN). The subscriber in the city of Vancouver uses a telephone 12 that is capable of communicating with the Vancouver supernode 11 using Session Initiation Protocol (SIP) messages, and the Calgary and Emergency Response Center subscribers use similar telephones 15 and 33 respectively to communicate with the Vancouver supernode from their locations. The London supernode 21 also has a call controller 24, a routing controller 26 and a database 28 and functions in a manner similar to the Vancouver supernode 11. It should be noted that throughout the description of the embodiments of this

5

10

15

20

25

30

invention, the IP/UDP addresses of all elements such as the caller and callee telephones, call controller, media relay, and any others, will be assumed to be valid IP/UDP addresses directly accessible via the Internet or a private IP network, for example, depending on the specific implementation of the system. As such, it will be assumed, for example, that the caller and callee telephones will have IP/UDP addresses directly accessible by the call controllers and the media relays on their respective supernodes, and those addresses will not be obscured by Network Address Translation (NAT) or similar mechanisms. In other words, the IP/UDP information contained in SIP messages (for example the SIP Invite message or the RC Request message which will be described below) will match the IP/UDP addresses of the IP packets carrying these SIP messages.

be 24.10.10.123:23465, whereas the source IP/UDP address information contained in the SIP message WO 2008/016296 this IP packet will be 192.168.0.103:12378. CA 2008/000545

mismatch in the IP/UDP addresses may cause a problem for SIP-based VoIP systems because, for example, a supernode will attempt to send messages to a private address of a telephone – the messages will never get there.

It will be appreciated that in many situations, the IP addresses assigned to various elements of the system may be in a private IP address space, and thus not directly accessible from other elements. Furthermore, it will also be appreciated that NAT is commonly used to share a "public" IP address

between multiple devices, for example between home PCs and IP telephones sharing a single Internet connection. For example, a home PC may be assigned an IP address such as 192.168.0.101 and a Voice over IP telephone may be assigned an IP address of 192.168.0.103. These addresses are located in so called "non-routable" (IP) address space and cannot be accessed directly from the Internet. In order for these devices to communicate with other computers located on the Internet, these IP addresses have to be converted into a "public" IP address, for example 24.10.10.123 assigned by the Internet Service Provider to the subscriber, by a device performing NAT, which may include the same Vancouver supernode 11, a different supernode or a communications supplier gateway, for example, to carry voice traffic to and from the call recipient or callee. In an attempt to make one's life easier, a user may be dialling a short number such as 911 and the call is routed to an emergency response center (ERC) associated with the caller such as the emergency

function whether or not any of the elements of the system are located behind NAT devices that obscure their real IP/UDP addresses. Referring to Figure 1, an attempt to make a regular call by the Vancouver telephone 1022 of element 22 of Figure 1, the Vancouver telephone sends a SIP Invite message to the Vancouver supernode 11 and in response, the call controller 14 sends an PC Request message to the routing controller 16 which makes various enquiries of the database 18 to produce a routing message which is sent to the call controller. The call controller 14 then causes a communications link, including audio paths to be established through the media relay 17, typically a home router. In addition to translating the IP addresses, NAT typically also translates UDP port numbers, for example an audio path originating at a VoIP telephone and using a UDP port 12378 at its private IP address may have been translated to UDP port 23465 associated with the public IP address of the NAT device. In other words, when a packet

originating from the above VoIP telephone arrives at an Internet-based supernode, the source IP/UDP address contained in the IP packet header will be 24.10.10.123:23465, whereas the source IP/UDP address information contained in the SIP message inside this IP packet will be 192.168.0.103:12378. The mismatch in the IP/UDP addresses may cause a problem for SIP-based VoIP systems because, for example, a supernode will attempt to send messages to a private address of a telephone – the messages will never get there.

It will be appreciated that a number of methods are available to overcome this problem. For example, the SIP NATHelper open source software module may run on the supernode to correlate public IP/UDP address contained in the headers of the IP packets arriving from SIP devices with private IP/UDP addresses in the SIP messages contained in these packets. Therefore, the

response center associated with the telephone 33. However, as will be appreciated from the description WO 2008/116296 I/PCT/CA2008/000545

originating from subscribers associated with one supernode to be received by emergency response centers associated with a different supernode, if necessary. Subscriber Telephone Referring to Figure 2, in this embodiment, the telephone 12 includes a processor circuit shown generally at 30 comprising a microprocessor 32, program memory 34, an input/output (I/O) interface 36, parameter memory 38 and temporary memory 40. The program memory 34, I/O interface 36, parameter memory 38 and temporary memory 40 are all in communication with the microprocessor 32. The I/O

interface 36 has a dial input 42 for receiving a dialed telephone number from a keypad, for example, or from a voice recognition unit or from pre-stored telephone numbers stored in the parameter memory 38, for example. For simplicity, a box labelled dialling function 44 is shown, which may be implemented by informing the microprocessor 32 of a callee identifier, e.g., a callee telephone number. The processor 32 stores the callee identifier in a dialed number buffer 41. Where the callee is the London subscriber 4444, for example, identifying the London subscriber or the callee identifier may be a standard telephone number, or where the callee is the Emergency Response Center, the callee identifier may be 911, for example. The dialling function 44 may be implemented by a handset interface 46 for receiving and producing signals from and to a handset that receives user's speech to produce audio signals and produces sound in response to received audio signals. The handset interface 46 may include a BLUETOOTH wireless interface and a wired interface of a speakerphone, for example. The handset 45

Referring to Figure 1 in an attempt to make a regular call by the Vancouver telephone 12 to the London telephone 22, for example, the Vancouver telephone sends a SIP Invite message to the Vancouver supernode 11 and in response, the call controller 14 sends an RC Request message to the routing controller 16 which makes various enquiries of the database 18 to produce a routing message which is sent to the call controller. The call controller 14 then causes a communications link, including audio paths, to be established through the media relay 17 which may include the same Vancouver supernode 11, a different supernode or a communications supplier gateway, for example, to carry voice traffic to and from the call recipient or callee.

In an attempt to make an emergency call, generally the call is made by dialling a short number such as 911 and the call is routed to an emergency response center (ERC) associated with the caller such as the emergency response center associated with the telephone 33. However, as will be appreciated from the description below, this system will permit emergency calls originating from subscribers associated with one supernode to be received by emergency response centers associated with a different supernode, if necessary.

Subscriber Telephone

Referring to Figure 2, in this embodiment, the telephone 12 includes a processor circuit shown generally at 30 comprising a microprocessor 32, program memory 34, an input/output (I/O) interface 36, parameter memory 38 and temporary memory 40. The program memory 34, I/O interface 36, parameter memory 38 and temporary memory 40 are all in communication with the microprocessor 32. The I/O interface 36 has a dial input 42 for receiving a dialed telephone number from a keypad, for example, or from a

voice recognition unit or from pre-stored telephone numbers stored in the parameter memory 38, for example. For simplicity, a box labelled dialling function 44 is shown, which may be implemented by informing the microprocessor 32 of a callee identifier, e.g., a callee telephone number. The processor 32 stores the callee identifier in a dialed number buffer 41. Where the callee is the London subscriber 4444, for example, identifying the London subscriber or the callee identifier may be a standard telephone number, or where the callee is the Emergency Response Center, the callee identifier may be 911, for example. The dialling function 44 may be implemented by a handset interface 46 for receiving and producing signals from and to a handset that receives user's speech to produce audio signals and produces sound in response to received audio signals. The handset interface 46 may include a BLUETOOTH wireless interface and a wired interface of a speakerphone, for example. The handset 45

Referring to Figure 1 in an attempt to make a regular call by the Vancouver telephone 12 to the London telephone 22, for example, the Vancouver telephone sends a SIP Invite message to the Vancouver supernode 11 and in response, the call controller 14 sends an RC Request message to the routing controller 16 which makes various enquiries of the database 18 to produce a routing message which is sent to the call controller. The call controller 14 then causes a communications link, including audio paths, to be established through the media relay 17 which may include the same Vancouver supernode 11, a different supernode or a communications supplier gateway, for example, to carry voice traffic to and from the call recipient or callee.

In an attempt to make an emergency call, generally the call is made by dialling a short number such as 911 and the call is routed to an emergency response center (ERC) associated with the caller such as the emergency response center associated with the telephone 33. However, as will be appreciated from the description below, this system will permit emergency calls originating from subscribers associated with one supernode to be received by emergency response centers associated with a different supernode, if necessary.

Subscriber Telephone

Referring to Figure 2, in this embodiment, the telephone 12 includes a processor circuit shown generally at 30 comprising a microprocessor 32, program memory 34, an input/output (I/O) interface 36, parameter memory 38 and temporary memory 40. The program memory 34, I/O interface 36, parameter memory 38 and temporary memory 40 are all in communication with the microprocessor 32. The I/O interface 36 has a dial input 42 for receiving a dialed telephone number from a keypad, for example, or from a

voice recognition unit or from pre-stored telephone numbers stored in the parameter memory 38, for example. For simplicity, a box labelled dialling function 44 is shown, which may be implemented by informing the microprocessor 32 of a callee identifier, e.g., a callee telephone number. The processor 32 stores the callee identifier in a dialed number buffer 41. Where the callee is the London subscriber 4444, for example, identifying the London subscriber or the callee identifier may be a standard telephone number, or where the callee is the Emergency Response Center, the callee identifier may be 911, for example. The dialling function 44 may be implemented by a handset interface 46 for receiving and producing signals from and to a handset that receives user's speech to produce audio signals and produces sound in response to received audio signals. The handset interface 46 may include a BLUETOOTH wireless interface and a wired interface of a speakerphone, for example. The handset 45

Referring to Figure 1 in an attempt to make a regular call by the Vancouver telephone 12 to the London telephone 22, for example, the Vancouver telephone sends a SIP Invite message to the Vancouver supernode 11 and in response, the call controller 14 sends an RC Request message to the routing controller 16 which makes various enquiries of the database 18 to produce a routing message which is sent to the call controller. The call controller 14 then causes a communications link, including audio paths, to be established through the media relay 17 which may include the same Vancouver supernode 11, a different supernode or a communications supplier gateway, for example, to carry voice traffic to and from the call recipient or callee.

In an attempt to make an emergency call, generally the call is made by dialling a short number such as 911 and the call is routed to an emergency response center (ERC) associated with the caller such as the emergency response center associated with the telephone 33. However, as will be appreciated from the description below, this system will permit emergency calls originating from subscribers associated with one supernode to be received by emergency response centers associated with a different supernode, if necessary.

Subscriber Telephone

Referring to Figure 2, in this embodiment, the telephone 12 includes a processor circuit shown generally at 30 comprising a microprocessor 32, program memory 34, an input/output (I/O) interface 36, parameter memory 38 and temporary memory 40. The program memory 34, I/O interface 36, parameter memory 38 and temporary memory 40 are all in communication with the microprocessor 32. The I/O interface 36 has a dial input 42 for receiving a dialed telephone number from a keypad, for example, or from a

voice recognition unit or from pre-stored telephone numbers stored in the parameter memory 38, for example. For simplicity, a box labelled dialling function 44 is shown, which may be implemented by informing the microprocessor 32 of a callee identifier, e.g., a callee telephone number. The processor 32 stores the callee identifier in a dialed number buffer 41. Where the callee is the London subscriber 4444, for example, identifying the London subscriber or the callee identifier may be a standard telephone number, or where the callee is the Emergency Response Center, the callee identifier may be 911, for example. The dialling function 44 may be implemented by a handset interface 46 for receiving and producing signals from and to a handset that receives user's speech to produce audio signals and produces sound in response to received audio signals. The handset interface 46 may include a BLUETOOTH wireless interface and a wired interface of a speakerphone, for example. The handset 45

Referring to Figure 1 in an attempt to make a regular call by the Vancouver telephone 12 to the London telephone 22, for example, the Vancouver telephone sends a SIP Invite message to the Vancouver supernode 11 and in response, the call controller 14 sends an RC Request message to the routing controller 16 which makes various enquiries of the database 18 to produce a routing message which is sent to the call controller. The call controller 14 then causes a communications link, including audio paths, to be established through the media relay 17 which may include the same Vancouver supernode 11, a different supernode or a communications supplier gateway, for example, to carry voice traffic to and from the call recipient or callee.

In an attempt to make an emergency call, generally the call is made by dialling a short number such as 911 and the call is routed to an emergency response center (ERC) associated with the caller such as the emergency response center associated with the telephone 33. However, as will be appreciated from the description below, this system will permit emergency calls originating from subscribers associated with one supernode to be received by emergency response centers associated with a different supernode, if necessary.

acts as a termination point for an audio path (not shown) which will be appreciated later. The I/O interface 36 also has a network interface 48 to an IP network, and is operable, for example, to connect the telephone to an ISP via a high speed Internet connection. The network interface 48 also acts as a part of the audio path, as will be appreciated later. The parameter memory 38 has a username field 50, a password field 52, an IP address field 53 and a SIP proxy address field 54. The username field 50 is operable to hold a username associated with the telephone 12, which in this case is 2001 1050 8667. The username is assigned upon subscription or registration into the system and, in this embodiment includes a twelve digit number having a prefix 61, a country code 63, a dealer code 70 and a unique number code 74. The prefix 61 is comprised of the first or left-most digit of the username in this embodiment. Where the callee is the London subscriber, the callee identifier may be 4401 1062 4444, for example, identifying the London subscriber of the callee next three digits. The dealer code 70 is comprised of the next four digits and the unique number code 74 is comprised of the last four digits. The password field 52 holds a password of up to 512 characters, in this example. The IP address field 53 stores an IP address of the telephone 30, which for this explanation is 192.168.0.20. The SIP proxy address field 54 stores an IP address of a SIP proxy which may be provided to the telephone 12 through the network interface 48 as part of producing audio signals and produces sound in response to received audio signals. The parameter memory 38 also has a dialling functions 44 representing any device capable of informing the microprocessor 32 of a callee identifier, e.g., a callee telephone number. The I/O interface 36 also has a handset interface 46 for receiving and producing signals from and to a handset that receives user's speech to produce audio signals and produces sound in response to received audio signals. The handset interface 46 may include a BLUETOOTH™ wireless interface, a wired interface or speakerphone, for example. The handset 45 acts as a termination point for an audio path (not shown) which will be appreciated later.

20 The I/O interface 36 also has a network interface 48 to an IP network, and is operable, for example, to connect the telephone to an ISP via a high speed Internet connection. The network interface 48 also acts as a part of the audio path, as will be appreciated later.

25 The parameter memory 38 has a username field 50, a password field 52, an IP address field 53 and a SIP proxy address field 54. The username field 50 is operable to hold a username associated with the telephone 12, which in this case is 2001 1050 8667. The username is assigned upon subscription or registration into the system and, in this embodiment includes a twelve digit number having a prefix 61, a country code 63, a dealer code 70 and a unique number code 74. The prefix 61 is comprised of the first or left-most digit of the username in this embodiment. The prefix may act as a continent code in

30

also stores codes 57 for establishing a call ID. The call ID codes 57 direct the microprocessor 32 to produce call identifiers, that may, for example, have the format of a hexadecimal string and an IP address of the telephone stored in IP address field 53. Thus, an exemplary call identifier for a call might be FF10 @ 192.168.0.20. Generally, in response to activating the handset 45 and using the dialling function 44, the microprocessor 32 produces and sends a SIP Invite message 59 as shown in Figure 3, to the routing controller (RC) 14 shown in Figure 1. Referring to Figure 3, the SIP Invite message includes a caller identifier field 60, a callee identifier field 62, a digest parameters field 64, a call ID field 65, a caller IP address field 67 and a caller UDP port field 69. In this embodiment, the caller identifier field 60 includes the username 2001 1050 8667, which is the username stored in the username field 50 of the parameter memory 38 in the Vancouver telephone 12 shown in Figure 2. In addition, as an example, referring back to Figure 3, where the call is a normal, non-emergency call to the London subscriber the callee identifier field 62 includes the username 4401 1062 4444 which is the dialed number of the microprocessor 32 to carry out the functions of the telephone 12, one of which includes a firewall block 56 which provides firewall functions to the telephone, to prevent unauthorized access through the network interface 48 to the microprocessor 32 and memories 34, 38 and 40. The program memory 34 also stores codes 57 for establishing a call ID. The call ID codes 57 direct the microprocessor 32 to produce call identifiers, that may, for example, have the format of a hexadecimal string and an IP address of the telephone stored in IP address field 53. Thus, an exemplary call identifier for a call might be FF10 @ 192.168.0.20.

Generally, in response to activating the handset 45 and using the dialling function 44, the microprocessor 32 produces and sends a SIP Invite message 59 as shown in Figure 3, to the routing controller (RC) 14 shown in Figure 1.

Referring to Figure 3, the SIP Invite message includes a caller identifier field 60, a callee identifier field 62, a digest parameters field 64, a call ID field 65, a caller IP address field 67 and a caller UDP port field 69. In this embodiment, the caller identifier field 60 includes the username 2001 1050 8667, which is the username stored in the username field 50 of the parameter memory 38 in the Vancouver telephone 12 shown in Figure 2. In addition, as an example, referring back to Figure 3, where the call is a normal, non-emergency call to the London subscriber the callee identifier field 62 includes the username

Referring to Figure 4, a call controller circuit of the call controller 14 (Figure 1) is shown in greater detail at 100. The call controller circuit 100 includes a microprocessor 102, program memory 104, random access memory 105 and an I/O interface 106. The call controller circuit 100 include a plurality of microprocessors, a plurality of program memories and a plurality of I/O interfaces to be able to handle a large volume of calls. However, for simplicity, the call controller circuit 100 will be described as having only one microprocessor, program memory and I/O interface, it being understood that there may be more. Generally, the I/O interface 106 includes an input 108 for receiving messages, such as the SIP Invite message shown in Figure 2, from the telephone 12 stored in the dialed number buffer 41 shown in Figure 2. The digest parameters field 64 includes digest parameters and the call ID field 65 includes a code comprising a generated prefix code (FF10, for example) and a suffix which is for receiving messages, such as the SIP Invite message shown in Figure 2, from the telephone 12 stored in the IP address field 53. The IP address field 67 and UDP port field 69 define a socket for audio communications. The IP address field 67 holds the IP address assigned to the telephone, in this embodiment 192.168.0.20, and the caller UDP port field 69 includes a UDP port identifier identifying a UDP port at which the audio path will be terminated at the caller's telephone.

Call Controller

Referring to Figure 4, a call controller circuit of the call controller 14 (Figure 1) (Figure 1) which will establish the audio path. While certain inputs and outputs have been shown as separate, it will be appreciated that some may be associated with a single IP address and TCP or UDP port. For example, the messages sent and received from the RC 16 may be transmitted and received at the same single IP address and TCP or UDP port. The program memory 104 of the call controller circuit 100 includes blocks of memory to be able to handle a large volume of calls. However, for simplicity, the call controller circuit 100 will be described as having only one microprocessor, program memory and I/O interface, it being understood that there may be more.

Generally, the I/O interface 106 includes an input 108 for receiving messages, such as the SIP Invite message shown in Figure 3, from the telephone 12 shown in Figure 2. The I/O interface 106 also has an RC Request message output 110 for transmitting an RC Request message to the routing controller 16 in Figure 1, an RC message input 112 for receiving routing messages from the RC 16, a MR output 114 for transmitting messages to the media relay 17 (Figure 1) to advise the media relay to establish an audio path, and a MR input 116 for receiving messages from the media relay to which a message has been sent to attempt to establish the audio path. The I/O interface 106 further includes a SIP output 118 for transmitting SIP messages to the

code for directing the microprocessor 102 to carry out various functions of the call controller 14. For example, these blocks of code include a first block 120 for causing the call controller circuit 100 to execute a SIP Invite to RC request process to produce a RC Request message in response to a received SIP Invite message. In addition, there is a Routing Message to Media Relay message block 122 which causes the call controller circuit 100 to produce an MR Query message in response to a received routing message from the routing controller 16. Referring to Figure 5, the SIP Invite-to-RC Request process is shown in more detail at 120. On receipt of a SIP Invite message of the type shown in Figure 3, block 132 of Figure 5 directs the call controller circuit 100 of Figure 4 to authenticate the user operating the telephone from which the SIP Invite message was originated. This may be done, for example, by prompting the user for a password by sending a message back to the caller telephone 12 in Figure 1, which is interpreted at the telephone as a request for password entry or the password may automatically be sent to the call controller 14 from the telephone, in response to the message. The call controller 14 may then make enquiries of the database 18 to determine whether or not the user's password matches a password stored in the database. Various functions may be used to pass encryption keys or hash codes back and forth to ensure the secure retransmission of passwords. Authentication process to produce a RC Request message in response to a received SIP Invite message. In addition, there is a Routing Message to Media Relay message block 122 which causes the call controller circuit 100 to produce an MR Query message in response to a received routing message from the routing controller 16.

5 While certain inputs and outputs have been shown as separate, it will be appreciated that some may be associated with a single IP address and TCP or UDP port. For example, the messages sent and received from the RC 16 may be transmitted and received at the same single IP address and TCP or UDP port.

10 The program memory 104 of the call controller circuit 100 includes blocks of code for directing the microprocessor 102 to carry out various functions of the call controller 14. For example, these blocks of code include a first block 120 for causing the call controller circuit 100 to execute a SIP Invite to RC request process to produce a RC Request message in response to a received SIP Invite message. In addition, there is a Routing Message to Media Relay message block 122 which causes the call controller circuit 100 to produce an MR Query message in response to a received routing message from the routing controller 16.

20 Referring to Figure 5, the SIP Invite-to-RC Request process is shown in more detail at 120. On receipt of a SIP Invite message of the type shown in Figure 3, block 132 of Figure 5 directs the call controller circuit 100 of Figure 4 to authenticate the user operating the telephone from which the SIP Invite message originated. This may be done, for example, by prompting the user for a password by sending a message back to the caller telephone 12 in Figure 1, which is interpreted at the telephone as a request for password entry or the password may automatically be sent to the call controller 14 from the telephone, in response to the message. The call controller 14 may then make enquiries of the database 18 to determine whether or not the user's password matches a password stored in the database. Various functions may be used to pass encryption keys or hash codes back and forth to ensure the secure

identifier field 60 of the SIP Invite message shown in Figure 3 is a validly formatted IP address. If it is a transmission of passwords. Authentication may be bypassed when the call is to the ERC.

Should the authentication process fail, the call controller circuit 100 is directed to an error handling block 134 which causes messages to be displayed at the caller telephone 12, and at block 138 the call controller circuit 100 is directed to produce a routing request message of the type shown in Figure 6 that includes that call ID. Block 139 of Figure 5 then directs the call controller circuit 100 of Figure 4 to determine whether or not to send the RC Request message to the routing controller 16 of Figure 1.

5

Referring to Figure 6, a routing request message is shown generally at 150 and includes a caller identifier field 152, a callee identifier field 154, a digest field 156, a call ID field 158 and a type field 160. The caller, callee, digest, and call ID fields 152, 154, 156 and 158 contain copies of the caller, callee, digest parameters and call ID fields 60, 62, 64 and 65 of the SIP Invite message shown in Figure 3. The type field 160 contains the type code established at blocks 133 or 135 of Figure 5 to indicate whether the call is from a third party or system subscriber respectively. For a normal non-emergency call the callee identifier field 154 may include a PSIN number or a type code with the call to indicate the call type is a regular invite. Then, block 136 directs the call controller circuit 100 to establish a call ID by reading the call ID provided in the call ID field 65 of the SIP Invite message from the telephone 12, and at block 138 the call controller circuit 100 is directed to produce a routing request message of the type shown in Figure 6 that includes that call ID. Block 139 of Figure 5 then directs the call controller circuit 100 of Figure 4 to determine whether or not to send the RC Request message to the routing controller 16 of Figure 1.

10

Referring to Figure 6, a routing request message is shown generally at 150 and includes a caller identifier field 152, a callee identifier field 154, a digest field 156, a call ID field 158 and a type field 160. The caller, callee, digest, and call ID fields 152, 154, 156 and 158 contain copies of the caller, callee, digest parameters and call ID fields 60, 62, 64 and 65 of the SIP Invite message shown in Figure 3. The type field 160 contains the type code established at blocks 133 or 135 of Figure 5 to indicate whether the call is from a third party or system subscriber respectively. For a normal non-emergency call the callee identifier field 154 may include a PSIN number or a type code with the call to indicate the call type is a regular invite. Then, block 136 directs the call controller circuit 100 to establish a call ID by reading the call ID provided in the call ID field 65 of the SIP Invite message from the telephone 12, and at block 138 the call controller circuit 100 is directed to produce a routing request message of the type shown in Figure 6 that includes that call ID. Block 139 of Figure 5 then directs the call controller circuit 100 of Figure 4 to determine whether or not to send the RC Request message to the routing controller 16 of Figure 1.

15

Referring to Figure 6, a routing request message is shown generally at 150 and includes a caller identifier field 152, a callee identifier field 154, a digest field 156, a call ID field 158 and a type field 160. The caller, callee, digest, and call ID fields 152, 154, 156 and 158 contain copies of the caller, callee, digest parameters and call ID fields 60, 62, 64 and 65 of the SIP Invite message shown in Figure 3. The type field 160 contains the type code established at blocks 133 or 135 of Figure 5 to indicate whether the call is from a third party or system subscriber respectively. For a normal non-emergency call the callee identifier field 154 may include a PSIN number or a type code with the call to indicate the call type is a regular invite. Then, block 136 directs the call controller circuit 100 to establish a call ID by reading the call ID provided in the call ID field 65 of the SIP Invite message from the telephone 12, and at block 138 the call controller circuit 100 is directed to produce a routing request message of the type shown in Figure 6 that includes that call ID. Block 139 of Figure 5 then directs the call controller circuit 100 of Figure 4 to determine whether or not to send the RC Request message to the routing controller 16 of Figure 1.

20

Referring to Figure 6, a routing request message is shown generally at 150 and includes a caller identifier field 152, a callee identifier field 154, a digest field 156, a call ID field 158 and a type field 160. The caller, callee, digest, and call ID fields 152, 154, 156 and 158 contain copies of the caller, callee, digest parameters and call ID fields 60, 62, 64 and 65 of the SIP Invite message shown in Figure 3. The type field 160 contains the type code established at blocks 133 or 135 of Figure 5 to indicate whether the call is from a third party or system subscriber respectively. For a normal non-emergency call the callee identifier field 154 may include a PSIN number or a type code with the call to indicate the call type is a regular invite. Then, block 136 directs the call controller circuit 100 to establish a call ID by reading the call ID provided in the call ID field 65 of the SIP Invite message from the telephone 12, and at block 138 the call controller circuit 100 is directed to produce a routing request message of the type shown in Figure 6 that includes that call ID. Block 139 of Figure 5 then directs the call controller circuit 100 of Figure 4 to determine whether or not to send the RC Request message to the routing controller 16 of Figure 1.

25

Referring to Figure 6, a routing request message is shown generally at 150 and includes a caller identifier field 152, a callee identifier field 154, a digest field 156, a call ID field 158 and a type field 160. The caller, callee, digest, and call ID fields 152, 154, 156 and 158 contain copies of the caller, callee, digest parameters and call ID fields 60, 62, 64 and 65 of the SIP Invite message shown in Figure 3. The type field 160 contains the type code established at blocks 133 or 135 of Figure 5 to indicate whether the call is from a third party or system subscriber respectively. For a normal non-emergency call the callee identifier field 154 may include a PSIN number or a type code with the call to indicate the call type is a regular invite. Then, block 136 directs the call controller circuit 100 to establish a call ID by reading the call ID provided in the call ID field 65 of the SIP Invite message from the telephone 12, and at block 138 the call controller circuit 100 is directed to produce a routing request message of the type shown in Figure 6 that includes that call ID. Block 139 of Figure 5 then directs the call controller circuit 100 of Figure 4 to determine whether or not to send the RC Request message to the routing controller 16 of Figure 1.

30

Referring to Figure 6, a routing request message is shown generally at 150 and includes a caller identifier field 152, a callee identifier field 154, a digest field 156, a call ID field 158 and a type field 160. The caller, callee, digest, and call ID fields 152, 154, 156 and 158 contain copies of the caller, callee, digest parameters and call ID fields 60, 62, 64 and 65 of the SIP Invite message shown in Figure 3. The type field 160 contains the type code established at blocks 133 or 135 of Figure 5 to indicate whether the call is from a third party or system subscriber respectively. For a normal non-emergency call the callee identifier field 154 may include a PSIN number or a type code with the call to indicate the call type is a regular invite. Then, block 136 directs the call controller circuit 100 to establish a call ID by reading the call ID provided in the call ID field 65 of the SIP Invite message from the telephone 12, and at block 138 the call controller circuit 100 is directed to produce a routing request message of the type shown in Figure 6 that includes that call ID. Block 139 of Figure 5 then directs the call controller circuit 100 of Figure 4 to determine whether or not to send the RC Request message to the routing controller 16 of Figure 1.

Referring to Figure 7, the routing controller 16 is shown in greater detail and includes an RC processor circuit 200 including a processor 202, program memory 204, a table memory 206, a DID identifier buffer 203, a caller ID buffer 205, a callee ID buffer 209, an emergency call flag 211, a DID identifier buffer 203, and an I/O interface 208, all in communication with the processor. (As earlier indicated, there may be a plurality of processors (202), memories (204), etc.) Separate caller ID buffers 205, callee id buffers 209 and emergency call flags 211 are instantiated for each call and are associated with respective call IDs. The I/O interface 208 includes a database output port 210 through which a request to the database 18 (Figure 1) can be made and includes a database response port 212 for receiving a reply from the database. The I/O interface 208 further includes an RC Request message input 214 for receiving the routing request message and an RC Request message output 216 for sending a routing message back to the call controller 14. The RC processor circuit 200 includes blocks of codes for directing the RC processor circuit 200 to carry out various functions of the routing controller 16. One of these blocks includes an RC Request message handler process 250 which directs the RC processor circuit 200 to produce a routing message in response to a received routing request message of the type shown at 150 in Figure 6. The RC Request message handler process is shown in greater detail at 250 in Figures 8A through 8D. The I/O interface 208 includes a database output port 210 through which a request to the database 18 (Figure 1) can be made and includes a database response port 212 for receiving a reply from the database. The I/O interface 208 further includes an RC Request message input 214 for receiving the routing request message from the call controller 14. Thus, the routing controller receives a routing request message including a caller identifier and a callee identifier. The I/O interface 208 further includes a routing message output 216 for sending a routing message back to the call controller 14.

5

Routing Controller

Referring to Figure 7, the routing controller 16 is shown in greater detail and includes an RC processor circuit shown generally at 200. The RC processor circuit 200 includes a processor 202, program memory 204, a table memory 206, a DID identifier buffer 203, a caller ID buffer 205, a callee ID buffer 209, an emergency call flag 211, a DID identifier buffer 203, and an I/O interface 208, all in communication with the processor. (As earlier indicated, there may be a plurality of processors (202), memories (204), etc.) Separate caller ID buffers 205, callee id buffers 209 and emergency call flags 211 are instantiated for each call and are associated with respective call IDs. The RC Request message handler process is shown in greater detail at 250 in Figures 8A through 8D. The I/O interface 208 includes a database output port 210 through which a request to the database 18 (Figure 1) can be made and includes a database response port 212 for receiving a reply from the database. The I/O interface 208 further includes an RC Request message input 214 for receiving the routing request message from the call controller 14. Thus, the routing controller receives a routing request message including a caller identifier and a callee identifier. The I/O interface 208 further includes a routing message output 216 for sending a routing message back to the call controller 14.

10

15

20

25

30

The program memory 204 includes blocks of codes for directing the RC processor circuit 200 to carry out various functions of the routing controller 16. One of these blocks includes an RC Request message handler process 250 which directs the RC processor circuit to produce a routing message in response to a received routing request message of the type shown at 150 in Figure 6. The RC Request message handler process is shown in greater detail at 250 in Figures 8A through 8D.

the contents of the RC Request message 150 (Figure 6) in the callee ID buffer 209 and the caller buffer 205 for separately storing the contents of the callee field (154 in Figure 6) and the caller field (152 in Figure 6) respectively of the RC Request message. Block 254 then directs the RC processor circuit 200 to use the contents of the caller field (152 in Figure 6) in the RC Request message 150, to search the database 18 shown in Figure 1 and retrieve a dialling profile associated with the caller.

Referring to Figure 9, a dialling profile is shown generally at 256. Referring to Figure 8A, the routing request message handler 250 begins with a first block 252 that directs the RC processor circuit 200 (Figure 7) to store the contents of the RC Request message 150 (Figure 6) in the callee ID buffer 209 and the caller buffer 205, for separately storing the contents of the callee field (154 in Figure 6) and the caller field (152 in Figure 6) respectively of the RC Request message. Block 254 then directs the RC processor circuit 200 to use the contents of the caller field (152 in Figure 6) in the RC Request message 150 to search the database 18 shown in Figure 1 and retrieve a dialling profile associated with the caller. Referring to Figure 9, a dialling profile is shown generally at 256 and includes system fields including a username field 258, a domain field 260, a national dialling digits (NDD) field 262, an international dialling digits (IDD) field 264, a country code field 266, a local area codes field 267, a caller minimum local length field 268, a caller maximum local length field 270, a reseller field 273, a user address field 275, an emergency call identifier field 277 and an emergency response center (ERC) field 279.

An exemplary dialling profile for the Vancouver subscriber is shown generally at 276 in Figure 10 and indicates that the username field 258 includes the username 2001 1050 8667 which is the same as the contents of the username field 50 in the Vancouver telephone 12 shown in Figure 2.

Referring back to Figure 10, the domain field 260 includes a domain name as shown at 282, including a supernode type identifier 284, a location code identifier 286, a system provider identifier 288 and a top level domain identifier 290, identifying a domain or supernode associated with the user identified by the contents of the username field 258.

identifier 290 identifies the "com" domain. The NDD field 262 in this embodiment includes the digit "1" in general includes a digit specified by PCT/CA2008/000545 WO-2008/116296

International Telecommunications Union - Telecommunications Standardization Sector (ITU-T) E.164 Recommendation which assigns national dialling digits to certain countries. The IDD field 264 includes the code 011 and, in general, includes a code assigned by the ITU-T according to the country or geographical location of the subscriber. The country code field 266 includes the digit "1" and, in general, includes a number assigned by the ITU-T to identify the country in which the subscriber is located. The local area codes field 267 includes the numbers 604 and 778 and generally includes a list of area codes that have been assigned by the ITU-T to the geographical area in which the subscriber is located.

5

The caller minimum and maximum local number length fields 268 and 270 each hold the number 10 representing minimum and maximum local number lengths permitted in the area code(s) specified by the contents of the local area codes field 267. The reseller field 273 holds a code identifying a retailer of the telephone services, and in the embodiment shown, the retailer is "Klondike". The address field 275 holds an address at which the subscriber telephone is normally located. The emergency short number field 277 holds the short emergency number such as "911" that the user is expected to dial in the event of an emergency. The ERC number field 279 holds a full PSTN number associated with an emergency response center that would desirably be geographically nearest to the address specified in the address field 275. A dialling profile of the type shown at 256 in Figure 9 is provided in order to assist the user in the event that the user agrees to become a subscriber to the subscriber is located.

10

In this embodiment, the supernode type identifier 284 includes the code "sp" identifying a supernode and the location code identifier 286 identifies the supernode as being in Vancouver (vvr). The system provider identifier 288 identifies the company supplying the service and the top level domain identifier 290 identifies the "com" domain.

15

The NDD field 262 in this embodiment includes the digit "1" and in general includes a digit specified by the International Telecommunications Union - Telecommunications Standardization Sector (ITU-T) E.164 Recommendation which assigns national dialling digits to certain countries.

20

The local area codes field 267 includes the numbers 604 and 778 and generally includes a list of area codes that have been assigned by the ITU-T to the geographical area in which the subscriber is located. The caller minimum and maximum local number length fields 268 and 270 each hold the number 10 representing minimum and maximum local number lengths permitted in the area code(s) specified by the contents of the local area codes field 267. The reseller field 273 holds a code identifying a retailer of the telephone services, and in the embodiment shown, the retailer is "Klondike".

25

The address field 275 holds an address at which the subscriber telephone is normally located. The emergency short number field 277 holds the short emergency number such as "911" that the user is expected to dial in the event of an emergency. The ERC number field 279 holds a full PSTN number

30

system. An ERC may register as a user, but need not do so since, as will be appreciated below, provisions are made for making VoIP to PSTN calls which may be made via calls to an ERC only available via the PSTN. Of importance here is that the contents of the emergency short number field 277 and the contents of the ERC number field 279 are assigned when the user registers with the system and thus it may be said that these numbers are "pre-assigned" to the user before the user registers with the system.

WO 2008/115296 PCT/CA2008/000545
calls to an ERC only available via the PSTN. Of importance here is that the contents of the emergency short number field 277 and the contents of the ERC number field 279 are assigned when the user registers with the system and thus it may be said that these numbers are "pre-assigned" to the user before the user registers with the system. Personnel in the office may ask the user certain questions about his location and service preferences, whereupon tables can be used to provide office personnel with appropriate information to be entered into the username, domain, NDD, IDD, country code, local area codes and caller minimum and maximum local length fields, emergency short number field 258, 260, 262, 264, 266, 267, 268, 270, 277, 279 to establish a dialling profile for the user. Referring to Figures 10A, 11, and 12, dialling profiles for the ERC subscriber, Calgary subscriber, and the London subscriber are shown. In addition to creating dialling profiles when a user registers with the system, a direct-in-dial (DID) record of the type shown at 268 in Figure 13 may optionally be added to a direct-in-dial table in the database 18 to associate the username and a host name of the supernode, with which the user is associated, with an E.164 number on the PSTN network. If the user does not have such an E.164 number, no DID record need be created at this time. Table records include a username field 291, a user domain field 272 and DID identifier field 274, for holding the username, domain, NDD, IDD, country code, local area codes and caller minimum and maximum local length fields, emergency short number field and ERC number field 258, 260, 262, 264, 266, 267, 268, 270, 277, 279 to establish a dialling profile for the user.

5
10
15
20
25
30
A dialling profile of the type shown at 256 in Figure 9 is produced whenever a user registers with the system or agrees to become a subscriber to the system. An ERC may register as a user, but need not do so since, as will be appreciated below, provisions are made for making VoIP to PSTN calls which may include calls to an ERC only available via the PSTN. Of importance here is that the contents of the emergency short number field 277 and the contents of the ERC number field 279 are assigned when the user registers with the system and thus it may be said that these numbers are "pre-assigned" to the user before the user makes any calls.

A user wishing to subscribe to the system may contact an office maintained by a system operator. Personnel in the office may ask the user certain questions about his location and service preferences, whereupon tables can be used to provide office personnel with appropriate information to be entered into the username, domain, NDD, IDD, country code, local area codes and caller minimum and maximum local length fields, emergency short number field and ERC number field 258, 260, 262, 264, 266, 267, 268, 270, 277, 279 to establish a dialling profile for the user.

Referring to Figures 10A, 11, and 12, dialling profiles for the ERC subscriber, Calgary subscriber, and the London subscriber, respectively for example, are shown.

In addition to creating dialling profiles when a user registers with the system, a direct-in-dial (DID) record of the type shown at 268 in Figure 13 may optionally be added to a direct-in-dial table in the database 18 to associate the username and a host name of the supernode, with which the user is associated, with an E.164 number on the PSTN network. If the user does not

hostname of the supernode and E.164 number respectively. Thus a DID bank table record WO 2008/116296 associates a DID identifier with a user (RCT/CA2008/000545 caller). A DID bank table record may also include a creation time field and an expiration time field for use when the DID bank table record is a temporary record as will be explained below. DID bank table records for the Vancouver, Calgary and London subscribers are shown in Figures 13A, 13B, and 14, respectively.

In addition to creating dialling profiles and DID records when a user registers with the system, call blocking records of the type shown in Figure 26, call forwarding records of the type shown in Figure 28 and voicemail records of the type shown in Figure 30 may be added to the database 18 when a new subscriber is added to the system. Referring back to Figure 8A, after being directed at block 254 to retrieve a dialling profile associated with the caller, such as shown at 276 in Figure 10, the RC processor circuit (200) is directed to block 255 which causes it to determine whether the contents of the callee ID buffer 209 shown in Figure 7 are equal to the contents of the emergency call identifier field 277 of the dialling profile 276 for the caller, shown in Figure 10. If the contents of the callee ID buffer 209 are not equal to the contents of the emergency short number field 277, the call is deemed not to be an emergency call and the RC processor circuit 200 is directed to location A in Figure 8B to carry out further processing on the basis that the call is to be a normal, non-emergency call. If the contents of the callee ID buffer 209 match the contents of the emergency call identifier field (277) in addition to creating dialling profiles and DID records when a user registers with the system, call blocking records of the type shown in Figure 26, call forwarding records of the type shown in Figure 28 and voicemail records of the type shown in Figure 30 may be added to the database 18 when a new subscriber is added to the system.

In this embodiment, the DID bank table records include a username field 291, a user domain field 272 and DID identifier field 274, for holding the username, hostname of the supernode and E.164 number respectively. Thus a DID bank table record pre-associates a DID identifier with a user (e.g. caller) as shown at 276 in Figure 10, the RC processor circuit (200) is directed to block 255 which causes it to determine whether the contents of the callee ID buffer 209 shown in Figure 7 are equal to the contents of the emergency call identifier field 277 of the dialling profile 276 for the caller, shown in Figure 10. If the contents of the callee ID buffer 209 are not equal to the contents of the emergency short number field 277, the call is deemed not to be an emergency call and the RC processor circuit 200 is directed to location A in Figure 8B to carry out further processing on the basis that the call is to be a normal, non-emergency call. If the contents of the callee ID buffer 209 match the contents of the emergency call identifier field (277) in addition to creating dialling profiles and DID records when a user registers with the system, call blocking records of the type shown in Figure 26, call forwarding records of the type shown in Figure 28 and voicemail records of the type shown in Figure 30 may be added to the database 18 when a new subscriber is added to the system.

A DID bank table record may also include a creation time field and an expiration time field for use when the DID bank table record is a temporary record as will be explained below.

DID bank table records for the Vancouver, Calgary and London subscribers are shown in Figures 13A, 13B, and 14, respectively.

In addition to creating dialling profiles and DID records when a user registers with the system, call blocking records of the type shown in Figure 26, call forwarding records of the type shown in Figure 28 and voicemail records of the type shown in Figure 30 may be added to the database 18 when a new subscriber is added to the system.

Referring back to Figure 8A, after being directed at block 254 to retrieve a dialling profile associated with the caller, such as shown at 276 in Figure 10, the RC processor circuit (200) is directed to block 255 which causes it to determine whether the contents of the callee ID buffer 209 shown in Figure 7 are equal to the contents of the emergency call identifier field 277 of the dialling profile 276 for the caller, shown in Figure 10. If the contents of the callee ID buffer 209 are not equal to the contents of the emergency short number field 277, the call is deemed not to be an emergency call and the RC processor circuit 200 is directed to location A in Figure 8B to carry out further processing on the basis that the call is to be a normal, non-emergency call.

157 directs the RC processor circuit 200 to set active the emergency call flag 211 in Figure 7, to indicate WO 2008/116296 call is an emergency call. Then, block RCT/CA2008/000545

directs the RC processor circuit 200 to replace the contents of the callee ID buffer 209 with the contents of the ERC # field 279 of the caller dialling profile 276 (Figure 10). Thus, the RC processor circuit produces an emergency response center identifier in response to the emergency call identifier by copying the emergency call identifier field (277 in Figure 10), the call is deemed to be an emergency call and block 157 directs the RC processor circuit 200 to set a time to live (TTL) value to a high number such as 9999 to indicate that the call may have a long duration of 9999 seconds for example. In addition block 157 directs the RC processor circuit 200 to set active the emergency call flag 211 in Figure 7, to indicate that the call is an emergency call. Then, block 159 directs the RC processor circuit 200 to replace the contents of the callee ID buffer 209 with the contents of the ERC # field 279 of the caller dialling profile 276 (Figure 10). Thus, the RC processor circuit produces an emergency response center identifier in response to the emergency call identifier by copying the emergency response center identifier from the ERC field 279 of the dialling profile 276 (Figure 10) associated with the caller to the callee ID buffer 209 shown in Figure 7 so that effectively, the contents of the callee ID buffer are replaced with the Emergency Response Center number. In this embodiment, for regular and emergency call processing, beginning at location A in Figure 8B, the RC processor circuit 200 is directed to perform certain checks on the callee identifier provided by the contents of the callee identifier buffer 209 shown in Figure 7. Most of these checks are shown in greater detail in Figure 8B and are used for regular non-emergency call handling. Emergency calls in which the ERC number has been substituted for the short emergency calling number (i.e., 911) will pass all of the checks. Subjecting both emergency and non-emergency calls to these checks enables all calls, whether emergency or non-emergency, to be passed through the same process and, simplifies the introduction of emergency call handling processes into regular call processing routines depicted in Figures 8A to 8D. Alternatively, the RC processor circuit 200 may be directed directly from block 159 to block 269 in Figure 8B whenever the emergency call flag is set, as shown in broken outline in Figure 8B. Figure 8B, IDD Testing

In this embodiment, for regular and emergency call processing, beginning at location A in Figure 8B, the RC processor circuit 200 is directed to perform certain checks on the callee identifier provided by the contents of the callee identifier buffer 209 shown in Figure 7. Most of these checks are shown in greater detail in Figure 8B and are used for regular non-emergency call handling. Emergency calls in which the ERC number has been substituted for the short emergency calling number (i.e., 911) will pass all of the checks. Subjecting both emergency and non-emergency calls to these checks enables all calls, whether emergency or non-emergency, to be passed through the same process and, simplifies the introduction of emergency call handling processes into regular call processing routines depicted in Figures 8A to 8D. Alternatively, the RC processor circuit may be directed directly from block 159 to block 269 in Figure 8B whenever the emergency call flag is set, as shown in broken outline in Figure 8B.

Referring to Figure 8B, to start the first of the checks, the RC processor circuit 200 is directed to a block 257 that causes it to determine whether a digit pattern of the callee identifier provided in the callee ID buffer 209 includes a pattern that matches the contents of the IDD field 264 in the caller dialling profile 276 shown in Figure 10. If so, then block 259 directs the RC processor circuit 200 to set a call type identifier code (not shown) to indicate that the call is a long distance call, e.g., from the Vancouver subscriber to the London subscriber, and block 261 directs the RC processor circuit 200 to produce a reformatted callee identifier by reformatting the current callee identifier into a pattern of digits matching the contents of the IDD field 264 of the caller dialling profile 276 to effectively shorten the number. Then, block 263 directs the RC processor circuit 200 to determine whether the callee identifier meets criteria establishing it as an E.164 compliant number and if the length does not meet this criteria, block 265 directs the RC processor circuit 200 to send back to the call controller 14 a message indicating that the callee identifier does not meet this criteria. In this embodiment, this is done by removing the pattern of digits matching the IDD field contents 264 of the caller dialling profile 276 to effectively shorten the number. Then, block 263 directs the RC processor circuit 200 to determine whether or not the callee identifier having a pre-defined format should be available. NDD Testing Referring back to Figure 8B, if at block 257, the callee identifier specified by the contents of the callee buffer 209 Figure 7 does not begin with an IDD, block 381 directs the RC processor circuit 200 to determine whether or not the callee identifier begins with the same NDD code as assigned to the caller. To do this, the RC processor circuit is directed to refer to the caller dialling profile 276 shown in Figure 10. In the embodiment shown, the NDD code stored in

5
10
15
20
25
30

NDD Testing

Referring back to Figure 8B, if at block 257, the callee identifier specified by the contents of the callee buffer 209 Figure 7 does not begin with an IDD, block 381 directs the RC processor circuit 200 to determine whether or not the callee identifier begins with the same NDD code as assigned to the caller. To do this, the RC processor circuit is directed to refer to the caller dialling profile 276 shown in Figure 10. In the embodiment shown, the NDD code stored in

do this, the RC processor circuit is directed to refer to the caller dialling profile 276 shown in Figure 10. Embodiment shown, the NDD code stored in field 262 is the digit 1. Thus, if the callee identifier begins with the digit 1, the RC processor circuit 200 is directed to block 382 in Figure 8B. Block 382 directs the RC processor circuit 200 to examine the callee identifier to determine whether or not digits following the NDD code identify an area code that is the same as a local area code identified in the local area codes field 267 of the caller dialling profile 276 shown in Figure 10. If not, block 384 directs the RC processor circuit 200 to set a call type variable (not shown) to a code indicating that the call is a national call. If the digits identify an area code that is the same as any of the area codes identified in the local area codes field 267 of the caller dialling profile 276 shown in Figure 10. If not, block 384 directs the RC processor circuit 200 to set a call type variable to indicate that the call type is as a local call, block 384 directs the RC processor circuit 200 to set a call type variable (not shown) to a code indicating the call is a national call. If the digits identify an area code that is the same as a local area code associated with the caller, block 386 directs the RC processor circuit 200 to set the call type variable to indicate that the call type is as a local call, national style. After executing blocks 384 or 386, block 388 directs the RC processor circuit 200 to reformat the callee identifier by removing the national dial digit and prepending a caller country code identified by the country code field 266 of the caller dialling profile 276 shown in Figure 10. The RC processor circuit 200 is then directed to block 263 to perform the processes described above beginning at block 263. Again, at the conclusion of block 263 a callee identifier having a pre-defined format should be available. If the callee identifier does not begin with an NDD code, block 390 directs the RC processor circuit 200 to determine whether the callee ID buffer 209 begins with digits that identify the same area code as the caller. Again, the reference for this is the caller profile 276 shown in Figure 10 and the RC processor circuit 200 determines whether or not the first few digits in the callee identifier identify an area code identified by the local area code field 267 of the caller profile 276. If so, then block 392 directs the RC processor circuit 200 to set the call type to a code indicating the call is a local call and block 394 directs the RC processor circuit 200 to prepend the caller country code to the callee identifier, the caller country code being determined from the country code field 266 in the caller profile 276. The

Area Code Testing

If at block 381 the callee identifier does not begin with an NDD code, block 390 directs the RC processor circuit 200 to determine whether the callee identifier in the callee ID buffer 209 begins with digits that identify the same area code as the caller. Again, the reference for this is the caller profile 276 shown in Figure 10 and the RC processor circuit 200 determines whether or not the first few digits in the callee identifier identify an area code identified by the local area code field 267 of the caller profile 276. If so, then block 392 directs the RC processor circuit 200 to set the call type to a code indicating the call is a local call and block 394 directs the RC processor circuit 200 to prepend the caller country code to the callee identifier, the caller country code being determined from the country code field 266 in the caller profile 276. The

the local area code field 267 of the caller profile 276. If so, then block 392 directs the RC processor circuit 200 to set the call type to a code indicated in block 393. If the call is a local call and block 394 directs the RC processor circuit 200 to prepend the caller country code to the callee identifier 32, the caller country code being determined from the country code field 266 in the caller profile 276. The RC processor circuit 200 is then directed to block 263 for processing as described above beginning at block 263. Emergency calls are likely to follow this path since the Emergency Response Center number that supplants the short emergency number (911) will normally be formatted to include an area code, but no IDD or NDD. Again at the conclusion of block 263, a callee identifier having a pre-defined length should be available. Callee ID Length Testing

If at block 390, the callee identifier in the callee ID buffer 209 has the same number of digits as the number of digits in the caller minimum local number length field 268 or the caller maximum local number length field 270 of the caller profile 276 shown in Figure 10. If so, then block 398 directs the RC processor circuit 200 to set the call type to local and block 400 directs the processor to prepend to the callee identifier the caller country code as indicated by the country code field 266 of the caller profile 276 followed by the caller area code as indicated by the local area code field 267 of the caller profile shown in Figure 10. The RC processor circuit 200 is then directed to block 263 for further processing as described above beginning at block 263. Again at the conclusion of block 263, a callee identifier having a pre-defined length should be available. Valid Subscriber Testing

If at block 396, the callee identifier in the callee ID buffer 209 has a length that does not match the length specified by the contents of the caller minimum local number length field 268 or the caller maximum local number length field 270 of the caller profile 276, block 402 directs the RC processor circuit 200 to determine whether or not the callee identifier identifies a valid username. To do this, the RC processor circuit 200 searches through the database 18 of dialling profiles to find a dialling profile having a username field 258 that matches the callee identifier. If no match is found, block 404 directs the RC

5

10

15

20

25

30

If at block 396, the callee identifier in the callee ID buffer 209 has a length that does not match the local number length field 268 or the caller maximum local number length field 270 of the caller profile 276, block 402 directs the RC processor circuit 200 to determine whether or not the callee identifier identifies a valid username. To do this, the RC processor circuit 200 searches through the database 18 of dialing profiles having a username field 258 that matches the callee identifier. If no match is found, block 404 directs the RC processor circuit 200 to set the call type to a code indicating the call is a network call and the processor is directed back to the call controller (14). If at block 402, a dialing profile having a username field 258 that matches the callee identifier is found, block 406 directs the RC processor circuit 200 to set the call type to a code indicating the call is a network call and the processor is directed to block 275 of Figure 8A to continue executing the RC message handler process 250.

From Figure 8B, it will be appreciated that there are certain groups of blocks of codes that direct the RC processor circuit 200 to determine whether the callee identifier in the callee ID buffer 209 has certain features such as an IDD code, a NDD code, an area code and a length that meet certain criteria and to reformat the callee identifier, as necessary, into a predetermined target format including only a country code, area code, and a normal telephone number, for example, to cause the callee identifier to be compatible with the E.164 standard in this embodiment. This enables the RC processor circuit 200 to have a consistent format of callee identifiers for use at block 269 in searching through the DID bank table records of the type 268 shown in Figure 13 to determine how to route calls for subscriber to subscriber calls on the same system. Recall that the ERC may be a subscriber. Still referring to Figure 8B, if the length of the reformatted callee identifier

Still referring to Figure 8B, if the length of the reformatted callee identifier meets the length criteria set forth at block 263, block 269 directs the RC processor circuit 200 to determine whether or not the reformatted callee identifier is associated with a direct-in-dial bank (DID) record of the type shown at 268 in Figure 13.

Exemplary DID records for the Vancouver, Calgary and London subscribers are shown in Figures 13A, 13B and 14. The username field 291 and user domain field 272 are as specified in the username and user domain fields 258 and 260 of the corresponding dialing profiles shown in Figures 10, 11 and 12 respectively. Referring to Figure 13A the contents of the DID field 274 include an E.164 telephone number including a country code 293, an area code 295,

identifier is associated with a direct-in-dial bank
(DID) record of the type shown at 268 in Figure 13.
Exemplary DID records for the Vancouver, Calgary and
London subscribers are shown in Figures 13A 13B and
14. The username field 291 and user domain field 272
are as specified in the username and user domain
fields 255 and 260 of the reformatted caller ID
profiles shown in Figures 10, 11 and 12 respectively.
Referring to Figure 13A the contents of the DID field
274 include an E.164 telephone number including a
country code 293, an area code 295, an exchange code
297 and a number 299. If the user has multiple telephone
numbers, then multiple records of the type shown at 276 would be included in
the DID bank table in the database 18, each having the same username and
user domain, but different DID field 274 contents reflecting the different E.164
telephone numbers associated with that user. If the user has multiple
telephone numbers, then multiple records of the type
shown at 276 would be included in the DID bank table
in the database 18, each having the same username and
user domain, but different DID field 274 contents
reflecting the different telephone numbers
associated with that user. Referring back to Figure
8B, at block 269, if the RC processor circuit 200
determines that the current (e.g. reformatted caller identifier produced at
block 261) can be found in a record in the DID bank table, then the callee is a
subscriber to the system and block 279 directs the RC processor circuit 200 to
copy the contents of the corresponding username field 291 from the DID
bank table record into the callee ID buffer 209 shown in Figure 7. Thus, the
RC processor circuit 200 copies a subscriber username associated with the
reformatted callee identifier. If the call is being made to the Emergency
Response Center and the Emergency Response Center (ERC) is a subscriber
to the system, a DID record would be found in the DID bank table, otherwise a
DID record would be found in the DID bank table, otherwise
a DID record for the ERC would not be found. Assuming the Emergency
Response Center is a subscriber to the system, the RC processor circuit 200
is directed to block 275 at point B in Figure 8A for further processing now that

it is known that the call is essentially a subscriber to subscriber call.

Subscriber to Subscriber Calls Between Different Nodes

Referring back to Figure 8A, block 275 directs the RC processor circuit 200 to
determine whether or not the username stored in the callee ID buffer 209 (in
Figure 7) is associated with the same supernode as the caller. To do this, the
RC processor circuit 200 determines whether or not the prefix (i.e. the
leftmost digit) of the username stored in the callee ID buffer 209 is the same
as the prefix of the username of the caller specified by the caller identifier
field 152 of the RC. Request message 150 shown in Figure 6. If they are not
the same, block 277 of Figure 8A directs the RC processor circuit (200) to set
a call type flag (not shown) to indicate that the call is a cross-domain call.
Then, block 281 directs the RC processor circuit (200) to determine whether

is directed to block 275 at point B in Figure 8A for further processing now that it is known that the call is initially a subscriber to subscriber call. Referring back to Figure 8A, block 275 directs the RC processor circuit 200 to determine whether or not the username stored in the callee ID buffer 209 (in Figure 7) is associated with the same supernode as the caller. To do this, the RC processor circuit 200 determines whether or not the first digit of the leftmost digit) of the username stored in the callee ID buffer 209 is the same as the prefix of the username of the caller specified by the caller identifier field 152 of the RC. Request message 150 shown in Figure 7 has been set and if so, block 283 of Figure 8A directs the RC processor to determine whether the caller identifier is associated with a pre-associated direct inward dialing (DID) identifier. This is done by searching the DID bank table to attempt to locate a DID record having DID field (274) contents matching the contents of the caller identifier stored in the caller ID buffer (205). If such a DID record is found, the processor circuit 200 has effectively determined that the caller has a pre-associated DID identifier. If no such DID record is found, the RC processor circuit 200 has effectively determined that the caller has no pre-associated DID identifier. In this case, block 285 then directs the RC processor circuit 200 to produce a DID identifier for the caller by associating a temporary DID identifier with the caller identifier by associating with the caller identifier a DID identifier from a pool of pre-determined DID identifiers. This is done by creating and associating with the caller a temporary DID record of the type shown in Figure 13. The temporary DID record has a DID identifier field 274 populated with the DID identifier from the pool. The DID identifier from the pool may be 1 604 867 5309, for example. The pool may be provided by causing the RC processor circuit 200 to maintain a list of pre-defined DID identifiers and pointers identifying a current read point in the list and a current write point in the list. The current read pointer may be incremented each time the pool is addressed to obtain a temporary DID identifier.

A temporary DID record may be canceled after a pre-defined period of time. For example, the temporary DID identifier records are desirably as shown in Figure 13 and may further include a creation time field and an expiry time field for holding a creation time value and an expiry time value respectively. The expiry time may be 2 hours after the creation time, for example, such that the temporary DID record is deleted two hours after it is created. A separate process, not shown, may continuously or periodically scan the DID records to determine whether any DID records have expiry times that have been

caller a temporary DID record of the type shown in Figure 13. The temporary DID record has a DID field 274 populated with the DID **RCST/CA2008/000545** from the pool. The DID identifier from the pool may be 1 604 867 5309, for example. The pool may be provided by causing the RC processor circuit 200 to maintain a list of pre-defined DID identifiers and pointers identifying a current read point in the list and a current write point in the list. The current read point may be incremented in the list and the current write point may be decremented in the list. Thus, the RC processor produces a direct inward dialing identifier for the caller by associating a temporary DID identifier with the caller identifier when the emergency call flag is active and it is determined that the caller has no pre-associated DID identifier, or by associating a DID identifier pre-assigned to the caller identifier.

After a temporary DID record has been created and stored in the DID bank table in the database 18 shown in Figure 1, or if the caller already had a DID record, block 287 of Figure 8A directs the RC processor circuit to load the DID identifier buffer 203 with the contents of the field of DID temporary or pre-associated DID record. Then the RC processor circuit loads a routing message buffer with the contents of the DID identifier buffer 203 acting as the caller identifier and the contents of the callee ID buffer 209 as the callee ID identifier. This will provide for a PSTN call back number to be provided to the emergency response center.

Thus, where the caller identifier has no pre-assigned DID identifier, the RC processor produces a routing message including the emergency response center identifier and the temporary DID identifier for receipt by the routing controller to cause the routing controller to establish a route between the caller and the emergency response center.

Referring to Figure 15, a routing message buffer is shown generally at 352 and includes a supplier prefix field 354, a delimiter field 356, a callee field 358, at least one route field 360, a time-to-live (TTL) field 362 and a caller ID field 364. The supplier prefix field 354 holds a code for identifying supplier traffic. The delimiter field 356 holds a symbol that delimits the supplier prefix code from the callee field 358 and in this embodiment, the symbol is a number sign (#) as illustrated in Figure 25. Referring back to Figure 15, the callee field 358 holds a copy of the contents of the callee ID buffer 209 of Figure 7. The route field 360 holds a domain name or an IP address of a gateway or supernode

number to be provided to the emergency response
center. Thus, where the caller identifier has no
pre-assigned DID identifier, the RC processor produces
a routing message including the emergency response
center identifier and the temporary DID identifier for
that is to carry the call and the TTL field 362 holds a value representing the
number of seconds the call is permitted to be active, based on subscriber
controller to establish a route between the caller and
available minutes and other billing parameters, for example

Referring to Figure 15,
a routing message buffer is shown generally at 352 and
includes a supplier prefix field 354, a delimiter
field 356, a time-to-live field 362, a caller
ID field 364, and where the call is an emergency call, desirably, the time to live field holds a number indicating a maximum call time
for the call and where the call is an emergency call, desirably, the maximum
call time exceeds a duration of an average non-emergency telephone call.

The caller ID field 364 holds a caller identifier which in this case, is the
temporary or pre-associated DID number from the DID record associated with
the caller.

Referring to Figure 8A and Figure 16, a routing message produced by the RC
processor circuit 200 at block 287 is shown generally at 366 and includes only
subscriber available minutes and other billing
parameters, for example, desirably, the time to live
field holds a number indicating a maximum call time
for the call and where the call is an emergency call,
desirably, the maximum call time exceeds a duration of an average non-emergency telephone call. The caller ID
field 364 holds a caller identifier which in this
case, is the temporary or pre-associated DID number
from the DID record associated with the caller.

The callee field 358 holds the full username of the callee, and where the call
is an emergency call, as shown, the full username of the callee is the
username of the emergency response center. The route field 360 contains the
identification of the domain with which the emergency response center is
associated, i.e., sp.yvr.digifonica.com. The TTL field holds the value 9999 set
at block 157 in Figure 8A and the caller ID field 364 holds the DID identifier
associated with the caller. Block 380 then directs the RC processor circuit to
send the routing message shown in Figure 16 to the call controller 14 (Figure
1).

Referring to Figure 8A, if at block 281, the emergency call flag is not set, the
call is not an emergency call, and the RC processor is directed to block 350
which causes it to direct the RC processor circuit 200 to load the routing
message buffer with information identifying the supernode in the system with
which the callee is associated and to set a time to live for the call to a high
value such as 9999. The supernode, with which the callee is associated, is
determined by using the callee username stored in the callee ID buffer 209 to

If at block 559 the emergency call flag has not been set, regular non-emergency call processing ensues beginning with block 600 which directs the RC processor circuit 200 to use the callee identifier to locate and retrieve a dialling profile for the callee identified by the callee identifier stored in the

the routing message buffer has been loaded with identification of the supernode, block 380 of Figure 8A directs the RC processor circuit to send the routing message shown in Figure 16A to the call controller 14 (Figure 1). Subscriber to Subscriber Calls Within the Same Node Referring back to Figure 8A, if at block 275 the caller identifier stored in the callee ID buffer 209 (Figure 7) has a prefix that identifies the same supernode as the caller, block 602 of Figure 8A directs the RC processor circuit 200 to get call block, call forward and voicemail tables from the database 18 based on the username identified in the callee dialing profile retrieved by the RC processor circuit at block 600. Call block, call forward and voicemail tables have records as shown in Figures 26, 28 and 30 for example. Referring to Figure 26, the call block records include a username field 604 and a block pattern field 606. The username field 604 holds a username matching the username in the username field 258 of the dialing profile (Figure 9) associated with the callee, and the block pattern field 606 holds one or more E.164-compatible numbers or usernames identifying PSTN telephone numbers or system subscribers from whom the subscriber identified by the contents of the username field 604 does not wish to receive calls. Referring back to Figure 8A and referring to Figure 27, block 608 directs the RC processor circuit 200 to determine whether or not the caller identifier

5

10

15

20

25

30

Referring to Figure 28, records in the call forwarding table include a username field 614, a destination number field 616 and a sequence number field 618. The username field 614 stores a code representing a username of a subscriber with whom the call forwarding record is associated. The destination

forward and voicemail tables have records as shown in Figures 26, 28 and 30 for example. Referring to Figure WO 2008/116296 call block records include a username field 604 and a block pattern field 606. The username field 604 holds a username matching the username in the username field 258 of the dialling profile (Figure 9) associated with the callee, and the block pattern field 606 holds one or more E.164-compatible numbers or usernames identifying PSIN telephone numbers of system subscribers from whom the subscribers identified by the contents of the username field 604 does not wish to receive calls. Referring back to Figure 8A and referring to Figure 27, block 608 directs the RC processor circuit 200 to determine whether or not the caller identifier matches a block pattern stored in the field 606 of the call forwarding table. The call forwarding table may have a plurality of records for a given subscriber. The RC processor circuit 200 uses the contents of the sequence number field 618 to place the records for a given subscriber in order. As will be appreciated below, this enables the call forwarding numbers to be tried in an ordered sequence. If the caller identifier does not match a block pattern associated with the callee, block 612 directs the RC processor circuit 200 to determine whether or not forwarding is required. Referring to Figure 28, records in the call forwarding table include a username field 614, a destination number field 616 and a sequence number field 618. The username field 614 stores the number of the user to whom the call forwarding record is associated. The destination number field 616 holds a username of E.164 number representing a number to which the current call should be forwarded, and the sequence number field 618 holds an integer indicating the order in which the usemame associated with the corresponding destination number field should be

5
10
15
20
25
30

Referring back to Figure 8A and referring to Figure 28, if at block 612, the call forwarding record for the callee identified by the callee identifier contains no contents in the destination number field 616 and accordingly no contents in the sequence number field 618, then there are no call forwarding entries and the RC processor circuit 200 is directed to load the routing message buffer shown in Figure 32 with the callee username, domain and time to live as shown at 650. The RC processor circuit 200 is then directed to block 620 in Figure 8C. However, if there are contents in the call forwarding record as shown in Figure 29, block 622 shown in Figure 8A directs the RC processor circuit 200 to search the dialling profile table in the database 18 to find a dialling profile record of the type shown in Figure 9, for the callee identified in the destination number field 616 of the first call forwarding record and to store the contents in the routing message buffer. The RC processor circuit 200 is then directed to load the contents of the domain field 260 associated with the dialling profile specified by the contents of the destination number field 616 of the first call forwarding record into the routing message buffer as shown at 652 in Figure 32. This process is repeated for each call forwarding record associated with the callee identified by the callee identifier to add to the routing message buffer all call forwarding usernames and domains associated with the callee.

attempted for call forwarding. The call forwarding table may have a plurality of records for a given subscriber. The RC processor circuit 200 uses the contents of the sequence number field 618 to place the records for a given subscriber in order. As will be appreciated below, this enables the call forwarding numbers to be tried in an ordered sequence. Referring

back to Figure 8A and referring to Figure 28, if at block 612, the call forwarding record for the callee identified by the callee identifier by the callee identifier has paid for voicemail service and this is done by checking to see whether or not a flag

field 630 is set in a voicemail record of the type shown in Figure 30 in a voicemail table stored in the database 18 in Figure 1. Referring to Figure 32 with the callee username, domain and time to live as shown at 650. The RC processor circuit 200 is then directed to

block 620 in Figure 8C. However, if there are contents in the call forwarding record as shown in Figure 29,

a voicemail server field 626, a seconds-to-voicemail field 628 and an enabled circuit 200 to search the dialling profile table in the database 18 to find a dialling profile record of the type shown in Figure 9, for the callee identified

in the destination number field 616 of the first call forwarding record. The voicemail server field 626 holds a code identifying an IP address or a fully qualified domain name (FQDN) of a voicemail server associated with the subscriber identified by the username field 624. The

seconds-to-voicemail field 628 holds a code identifying the time to wait before engaging voicemail and the enable field 630 holds a code representing whether or not voicemail is enabled for the user identified by the contents of

the username field 624. Therefore, referring back to Figure 8C, at block 620 the RC processor circuit 200 finds a voicemail record as shown in Figure 31 having username field 624 contents matching the callee identifier and

examines the contents of the enable field 630 to determine whether or not voicemail is enabled. If voicemail is enabled, then block 640 in Figure 8C directs the RC processor circuit 200 to store the contents of the voicemail server field 626 of Figure 31, and the contents of the seconds to voicemail field 628 of Figure 31 in the routing message buffer as shown at 654 in Figure

32.

Referring back to Figure 8C, block 642 then directs the processor to get time to live (TTL) values for each route specified by the routing message according to any of a plurality of criteria such as, for example, the cost of routing and the user's account balance. These TTL values are then appended to corresponding routes already stored in the routing message buffer. Block 643 then directs the RC processor circuit 200 to store the TTL value determined at

5

10

15

20

25

30

table stored in the database 18 in Figure 1. Referring to Figure 30, voicemail table records include a username field 624, a voicemail server field 626, a seconds-to-voicemail field 628 and an enabled field 630. The username field 624 stores the username of the subscriber who purchased the service. The voicemail server field 626 holds a code identifying an IP address or a fully qualified domain name (FQDN) of a voicemail server associated with the subscriber identified by the username field 624. The seconds-to-voicemail field 628 holds a code identifying the time to live value is set at 60 seconds, for example.

Block 642 in the routing message buffer. In the routing message shown in Figure 32, the time to live value is set at 60 seconds, for example. Block 644 of Figure 8C then directs the RC processor circuit 200 to store the IP address or FQDN of the current supermode in the routing message buffer as shown at 656 in Figure 32. An exemplary routing message for a subscriber identified by the contents of the username field 624

5 Therefore, referring back to Figure 8C, at block 620 the RC processor circuit 200 finds a voicemail record as shown in Figure 31 having username field 624 contents matching the callee identifier and examines the contents of the enabled field 630 to determine whether or not voicemail is enabled. If voicemail is enabled, the RC processor circuit 200 stores the contents of the voicemail server field 626 of Figure 31, and the contents of the seconds-to-voicemail field 628 of Figure 31 in the routing message buffer as shown at 655 in Figure 32.

10 Subscriber to Non-Subscriber Calls
Not all calls will be subscriber-to-subscriber calls and this will be detected by the RC processor circuit 200 when it executes block 269 of Figure 8B and does not find a DID bank table record associated with the callee in the DID bank table. This may be the case, for example, where the Emergency Response Center (ERC) is not a subscriber to the system. When this occurs,

15 the RC processor circuit 200 is directed to block 408 in Figure 8B which causes it to set the contents of the callee identifier buffer 209 equal to the reformatted callee identifier, i.e. the E-164 compatible number produced prior to block 263 in Figure 8B. Block 409 then directs the RC processor circuit 200 to determine whether the emergency call flag 211 in Figure 7 has been set. If the emergency call flag is set, block 411 in Figure 8D directs the RC processor to search the DID bank table to attempt to locate a DID record having DID field (274, Figure 13) contents matching the contents of the caller identifier stored in the caller ID buffer (205 in Figure 7).

20 If no such DID record is found, the RC processor circuit 200 has effectively determined that the caller identifier is not associated with a pre-associated DID identifier. In this case, block 413 then directs the RC processor circuit 200 to associate a temporary DID identifier with the caller identifier by associating with the caller identifier a DID identifier from the pool of pre-determined DID identifiers. Again, this is done by creating and associating with the caller a temporary DID record of the type shown in Figure 13.

25

30

then directs the RC processor circuit 200 to store the TTL value determined at block 642 in the routing WO 2008/116296 buffer. In the routing message shown PCT/CA2008/00545

32, the time to live value is set at 60 seconds, for example. Block 644 of Figure 8C then directs the RC processor circuit 200 to store the IP address or FQDN of the current supemode in the routing message buffer as shown at 656 in Figure 32. An exemplary routing message for a subscriber to subscriber call on the

After a temporary DID record has been created or if the caller already has a shown in Figure 32. Subscriber to Non-Subscriber Calls DID record block 415 directs the RC processor circuit to store the DID number (274 in Figure 13) in the caller ID buffer 209 in Figure 7.

5 not find a DID bank table record associated with the callee in the DID bank table. This may be the case, for example, where the Emergency Response Center (ERC) is not a subscriber to the system. When this occurs the RC processor circuit 200 is directed to block 408 in Figure 8B. Block 410 (Figure 8B) directs the RC processor circuit 200 to

10 the callee identifier buffer 209 equal to the reformatted callee identifier, i.e., the E.164 compatible number produced prior to block 263 in Figure 8B. Block 409 then directs the RC processor circuit 200 to address a master list having records of the type shown in Figure 19.

Each master list record includes a master list ID field 500, a dialling code field 15 502, a country code field 504, a national sign number field 506, a minimum length field 508, a maximum length field 510, a NDD field 512, an 514 and a buffer rate field 516.

processor circuit 200 has a coefficient of 10 that the caller identifier is not associated with a pre-defined or identified identifier. In this case, block 413 then directs the RC processor circuit 200 to associate a temporary DID identifier with the caller identifier by the association of

20 The master list ID field 500 holds a unique code such as 1019, for example, identifying the record. The dialling code field 502 holds a predetermined number pattern that the RC processor circuit 200 uses at block 410 in Figure 8B to find the master list record having a dialling code matching the first few digits of the reformatted callee identifier. The country code field 504 holds a number representing the country code associated with the record and the 25 national sign number field 506 holds a number representing the area code associated with the record. (It will be observed that the dialling code field 502 is a combination of the contents of the country code field 504 and the national sign number field 506.) The minimum length field 508 holds a number representing the minimum number of digits that can be associated with the record and the 30 maximum length field 510 holds a number representing the maximum number of digits in a number with which the record may be compared. The NDD field 512 holds a number representing an access code used to make a call within

temporary DID record of the type shown in Figure 13. After a temporary DID record has been created or if the caller already has a DID record, block 415 directs the RC processor circuit to store the DID number (274 in Figure 13) in the caller ID buffer 209. After having loaded the caller ID buffer 209 with the number representing the international prefix needed to dial a call from the country indicated by the country code, block 416 directs the RC processor circuit

200 to initiate a process for identifying gateways to the PSTN through which the call will be established.

5 Thus, for example, a master list record may have a format as shown in Figure 20 with exemplary field contents as shown.

Each master list record includes a master list ID field 500, a dialling code field 502, a country code field

504, a minimum length field 506, a maximum length field 508, a NDD field 512, an IDD field 514 and a buffer rate field

10 516. The master list ID field 500 holds a unique code, such as 1019, for example, identifying the record. The dialling code field 502 holds a predetermined number pattern that the RC processor circuit 200 uses at

block 410 in Figure 8B to find the master list record having a dialling code matching the first few digits of the reformatted callee identifier. The country code

field 504 might find a master list record having an ID field with the number 1019. This number may be also referred to as a route ID number.

15 Thus, a route ID number is found in the master list record associated with a predetermined number pattern in the reformatted callee identifier.

After execution of block 410 in Figure 8B, the process 250 continues as shown in Figure 8D. Referring to Figure 8D, block 412 directs the RC processor circuit 200 to use the route ID number determined at block 410 to locate at least one supplier record identifying a supplier operable to supply a communications link for this route. To do this, block 412 directs the RC processor circuit 200 to search a supplier ID table having records of the type shown in Figure 21.

Referring to Figure 21, supplier list records include a supplier ID field 540, a master list ID field 542, an optional prefix field 544, a route identifier field 546, a NDD/IDD rewrite field 548 and a rate field 550. The supplier ID field 540 holds a code identifying the name of the supplier and the master list ID field 542 holds a code for associating the supplier record with the master list record. The prefix field 544 optionally holds a string used to identify the

20

25

30

35

40

45

50

55

a number with which the record may be compared. The NDD field 512 holds a number representing an access code used to make a call within the country specified by the country code 504 and IDD field 514 holds a number representing the international prefix needed to dial a call from the country indicated by the country code. Thus, for example, a master list record may have a format as shown in Figure 20 with exemplary field NDD/IDD rewrite field 548 holds a code and the rate field 550 holds a code indicating the cost per second to the system operator to use the route through the gateway operated by the supplier indicated by the supplier ID field 540. The reformatted callee identifier that has been formatted for compatibility with the ETSI standard block 410 directs the RC processor circuit 200 to find a master list record such as the one shown in Figure 20 having a dialling code that matches the country code and area code of the reformatted callee identifier held in the callee identifier buffer 209. Thus, in this example, the RC processor circuit 200 might find a master list record having an ID field with the number 1019. This number may be also referred to as a route ID number. Thus, a route ID number is found in the master list record associated with a predetermined number pattern in the reformatted callee identifier. After execution of block 410 in Figure 8B, the process 250 continues as shown in Figure 8D. Referring to Figure 8D, block 412 directs the RC processor circuit 200 to use the route identifier path to search for a supplier ID table having at least one supplier record identifying a supplier operable to supply a communications link for this route. To do this, block 412 directs the RC processor circuit 200 to search a supplier ID table having rate fields 550 of the records associated with respective suppliers. Referring to Figure 21, supplier list records include a supplier ID field 540, a

Referring to Figures 22-24, in the embodiment shown, the supplier "Telus" has the lowest number in the rate field 550 and therefore the prefix 4973 associated with that supplier is loaded into the routing message buffer shown in Figure 25 first. At block 562, the prefix 4973 is then delimited by the number sign (as defined by the contents of the delimiter field 356 in the routing message format 352 in Figure 15) and the reformatted callee identifier is next loaded into the routing message buffer after the delimiter. Then, the contents of the route identifier field 546 of the record associated with the supplier Telus are added to the message after an @ sign delimiter and then block 564 in Figure 8D directs the RC processor circuit 200 to get a TTL value (algorithm not shown), which in this embodiment may be 3600 seconds, for example. Block 566 of Figure 8D then directs the RC processor circuit 200 to append this TTL value to the contents already in the routing message buffer shown in Figure 25. Block 567 of Figure 8D then directs the processor circuit to append

master list ID field 542, an optional prefix field 544, a route identifier field 546, a NDD/IDD rewrite field 548 and a rate field 550. The supplier field 540 holds a code identifying the name of the supplier and the master list ID field 542 holds a code for associating the supplier record with the master list record. The prefix field 544 optionally holds a string used to identify the supplier traffic and the route identifier field 546 holds an IP address of a gateway operated by the supplier indicated by the field 540. The NDD/IDD rewrite field 548 holds a code and the rate field 550 holds a code indicating the cost per second to the system operator to use the route through the gateway specified by the contents of

the contents of the caller ID buffer 205 of Figure 7 to the contents already in the routing message buffer shown in Figure 25. Accordingly, the first part of the routing message is shown generally at 570 in Figure 25.

5 Referring back to Figure 8D, block 571 directs the RC processor circuit 200 records are shown in Figures 22, 23 and 24 for Telus, Shaw and Sprint, respectively, for example. Referring back to Figure 8D, at block 412 the RC processor circuit 200 finds all supplier records that contain information pertaining to each supplier. Thus, the second portion of the routing message is shown at 572 in Figure 25 and this second portion relates to the second supplier identified by the record shown in Figure 23 and referring back to Figure 25, the third portion of the routing message is shown at 574 which is associated with a third supplier as indicated by the supplier record shown in Figure 24. Consequently, referring to Figure 25, the routing message buffer holds a routing message identifying a plurality of different suppliers able to provide gateways to establish a communication link to permit the caller to contact the callee. Each of the suppliers is identified, in succession according to rate contained in the rate field 550 of the supplier list record shown in Figure 21, in this embodiment. Other criteria for determining the order in which suppliers are listed in the routing message may include preferred supplier priorities which may be established based on service agreements, for example.

Response to Routing Message

25 Referring back to Figure 1, the routing message of the type shown in Figures 16, 16A, 25 or 32, is received at the call controller 14. It will be recalled that the call controller 14 already has the original SIP invite message shown in Figure 3. Referring to Figure 4, the program memory 104 of the call controller 14 includes a routing-to-media relay routine depicted generally at 122.

30 Referring to Figure 38, the routing to media relay routine 122 directs the processor to participate in a process for establishing audio paths. Assume the call is directed to the ERC.

in Figure 8D directs the RC processor circuit 200 to get a TTL value (algorithm not shown), which in this embodiment may be 3600 seconds, for example. Block 566 of Figure 8D then directs the RC processor circuit 200 to append this TTL value to the contents already in the routing message buffer shown in Figure 25. Block 567 of Figure 8D then directs the RC processor circuit 200 to append the contents of the caller ID buffer 205 of Figure 25 to the contents already in the routing message buffer shown in Figure 25. Accordingly, the first part of the routing message is shown generally at 570 in Figure 8D. The routing data field 571 of the routing message 59 shown in broken outline, block 571 directs the RC processor circuit 200 back to block 560 and causes it to repeat blocks 560, 562, 564, 566 and 567 for each successive supplier until the routing message buffer is loaded with information pertaining to the suppliers identified in the routing message 59.

As a first step in the process for establishing audio paths, a message 1100 is sent from the call controller 14 to the media relay 17, the message including the call ID, the caller telephone IP address and UDP port as determined from the caller IP address field 67 and caller UDP port field 69 in the SIP Invite message 59 shown in broken outline.

In response, the media relay (MR) 17 sends a confirmation message 1102 back to the call controller 14, the message including a media relay IP address (192.168.2.10) and UDP port number (22123) defining a callee socket that the media relay will use to establish an audio path to the ERC telephone or a PSTN gateway to the ERC, where the Emergency Response Center is only available through the PSTN.

The call controller 14 then sends a SIP Invite message 1104 of type shown in Figure 3 to the callee telephone 15 (or PSTN gateway), to advise the callee that telephone of the socket the media relay expects to use for audio communication with the caller telephone. The SIP invite message includes the caller and callee identifiers (60 and 62), the call ID (65) and the media relay

17 IP address (192.168.2.10) and the media relay UDP port number (22123) assigned to the callee socket as received from the confirmation message 1102.

The caller identifier may be that which was associated with the caller at blocks 413 in Figure 8D or block 285 in Figure 8A, for example, or may be the DID associated with the caller as determined from a DID record already associated with the caller. Such caller identifier, as obtained from the routing message, may be used as calling line identification (CLID) information and may be caused to appear on a display of the callee telephone, which is particularly advantageous where the callee telephone is one at an ERC. Such CLID information provides an ERC operator with callback information, enabling the operator to call back the caller who made the emergency call.

Since the temporarily assigned DID records persist for some time after the emergency call has taken place, the ERC operator can call back the person

5

10

15

20

25

30

The media relay 17 then sends a message 1110 including the call ID and the IP address (192.168.2.10) and UDP port number (22125) identifying the caller socket that the media relay assigned to the caller telephone 12, back to the call controller 14 to indicate that the caller and callee sockets have been established and that the call can proceed.

The call controller 14 then sends a SIP OK message 1112 to the caller telephone 12 to indicate that the call may now proceed. The SIP OK message includes the caller and callee usernames, the call ID and the IP address

DID associated with the caller as determined from a DID record already associated with the caller. Such caller identifier, as obtained from the routing message, may be used as calling line identification (CLID) information and may be caused to appear on a display of the callee telephone, which is particularly advantageous where the callee telephone is one at an ERC. Such CLID information provides an ERC operator with callback information, enabling the operator to call back the caller who made the emergency call. Since the temporarily assigned DID records persist for some time after the emergency call has taken place the ERC operator can call back the person who made the emergency call or may communicate with a different media relay (for example 27) adapted to establish the above-mentioned links between separate media relays associated with respective supermodes, where the IP network links are provided by the communications medium 23.

Alternatively, referring back to Figure 1, if the routing message is of a type that identifies a domain associated with another supermode in the system, the call controller 14 may communicate with a different media relay (for example 27) adapted to establish the above-mentioned links between separate media relays associated with respective supermodes, where the IP network links are provided by the communications medium 23.

In the case of an emergency call, the routing message is unlikely to identify a callee telephone 15 (or PSTN gateway) then sends a SIP OK message 1106 back to the call controller 14, the message including the CALL ID, the callee IP address (192.168.3.10) and UDP port number (33123) to advise the caller telephone 15 that the call is established. In the case of a regular, non-emergency call, if the routing message is of the type shown in Figure 25 where there are a plurality of suppliers available, the process proceeds as described above with the exception that instead of communicating with the callee telephone directly, the call controller 14 communicates with a gateway provided by a supplier. If a SIP OK message is not received back from the first gateway, the processor is directed to send the

SIP Invite message 1104 to a gateway of the next indicated supplier. For example, the call controller 14 sends the SIP Invite message 1104 to the first supplier, in this case Telus, to determine whether or not Telus is able to handle the call. If Telus does not send back an OK message 1106 or sends a message indicating that it is not able to handle the call, the call controller proceeds to send a SIP Invite message 1104 to the next supplier, in this case Shaw. The process is repeated until one of the suppliers responds with a SIP OK message 1106 indicating that it is available to carry the call and the process proceeds as shown in connection with messages 1108, 1110 and 1112.

Referring to Figure 2, in response to receiving the SIP OK message 1112 at the network interface 48, the microprocessor 32 of the caller telephone 12

UDP port number 22125 and creates an internal bridge for relaying audio traffic between the caller socket (192.168.2.10: 22125) and the callee socket (192.168.2.10: 22123). The media relay 17 then sends a message 1110 including the call ID and the IP address (192.168.2.10) and UDP port number (22125) identifying the caller socket that the media relay assigned to the caller telephone 12, back to the call controller 14 to indicate that the caller and callee sockets have been established and that the call can proceed. The call controller 14 then sends a SIP OK message 1112 to the caller telephone 12. The microprocessor 32 is now ready to transfer audio signals and from the handset and the media relay 17 using the sockets created above.

Alternatively, referring back to Figure 1, if the routing message is of a type that identifies a domain associated with another supernode in the system, the call controller 14 receives a message of the type shown in Figure 32, i.e., a media relay (for example 27) adapted to establish the above-mentioned links between separate media relays associated with respective supernodes, where the IP network links are provided by the communications medium 28. In the case of a regular, non-emergency call, if the routing message is unlikely to identify a domain other than that of the caller, the call controller 14 attempts to establish a call with the next user identified in the routing message. This process is repeated until all call forwarding possibilities have been exhausted after respective times to live in which case an audio path is established with the voicemail server 19 identified in the routing message. The voicemail server 19 sends message 1106 in response to receipt of message 1104 and functions as described above in connection with the callee telephone 15 to permit an outgoing audio message provided by the voicemail server to be heard by the caller and to permit the caller to record an audio message on the voicemail server.

When audio paths are established, a call timer (not shown) maintained by the call controller logs the start date and time of the call and logs the call ID and an identification of the route (i.e., audio path IP address) for later use in billing, for example.

Terminating the Call

In the event that either the caller or the callee (or callee via the PSTN) terminates a call, the telephone of the terminating party (or gateway associated with the terminating party) sends a SIP Bye message to the call controller 14. An exemplary SIP Bye message is shown at 900 in Figure 33

SIP Invite message 1104 to a gateway of the next indicated supplier. For example, the call controller WO12008/116296 the SIP Invite message 1104 to the PCH/CA2008/000545 supplier, in this case Telus, to determine whether or not Telus is able to handle the call. If Telus does not send back an OK message 1106 or sends a message indicating that it is not able to handle the call, the

51 and includes a caller field 902, a callee field 904 and a call ID field 906. The caller field 902 holds the caller username, the callee field 904 holds a PSTN compatible number or username, and the call ID field 906 holds a unique call identifier field of the type shown in the caller ID field 65 of the SIP Invite

5 messages shown in Figure 3. In response to message 1112 at the network interface 48, the microprocessor 32 of the caller telephone 12 stores the media relay IP address

(192.168.2.10) and UDP port number (22125) identifying the caller socket at the media relay in an audio path Vancouver subscriber to the Calgary subscriber for example, referring to

10 Figure 34, a SIP Bye message is produced as shown generally at 908 and using the sockets created above. Referring back to Figure 1, if the call is a regular, non-emergency case 2001 1050 8667, the callee field 904 holds a username identifying the

10 Calgary callee, in this case 2001 1050 2222, and the callee ID field 906 holds the code FA10 @ 192.168.0.20 which is the call ID for the call.

15 The SIP Bye message shown in Figure 34 is received at the call controller 14 associated TTL (3600 seconds), the call controller 14 attempts to establish a call with the next party

15 identified in the call routing message. This process is repeated until all call forwarding possibilities have been exhausted after respective times to live, in which case an audio path is established with the

20 message 900 shown in Figure 33 received from the terminating party to corresponding fields of an RC Call Stop message buffer (not shown). Block

914 then directs the call controller circuit 100 to copy the call start time from the call timer and to obtain a Call Stop time from the call timer. Block 916 then directs the call controller to calculate a communication session time by determining the difference in time between the call start time and the call stop

25 time. This communication session time is then stored in a corresponding field of the RC Call Stop message buffer. Block 918 then directs the call controller

circuit 100 to copy the route identifier from the call log. An RC Call Stop message produced as described above is shown generally at 1000 in Figure

30 36. An RC Call Stop message specifically associated with the call made to the Calgary callee is shown generally at 1020 in Figure 37.

message. The voicemail server 19 sends message 1106 in response to receipt of message 1104 and functions as described above in connection with the callee **PCT/CA2008/000545**

52-
Referring to Figure 36, the RC Call Stop message includes a caller field **1002**, callee field **1004**, a call ID field **1006**, an accounting start time field **1008**, an accounting stop time field **1010**, a communication session time field **1012** and a route field **1014**. The caller field **1002** holds a username, the callee field **1004** holds a PSTN-compatible number or system number, the call ID field **1006** holds the unique call identifier received from the SIP Invite message shown in Figure 3, the accounting start time field **1008** holds the date and start time of the call, the accounting stop time field **1010** holds the date and time the call ended, the communication session time field **1012** holds a value representing the difference between the start time and the stop time, in seconds, and the route field **1014** holds the IP address for the communications link that was established.

10
15
Referring to Figure 37, an exemplary RC stop call message for the Calgary caller is shown generally at **1020**. In this example the caller field **1002** holds the username **2001 1050 8667** identifying the Vancouver caller and the callee field **1004** holds the username **2001 1050 2222** identifying the Calgary callee. The contents of the call ID field **1006** are **FA10 @ 192.168.0.20**. The contents of the accounting start time field **1008** are **2006-12-30 12:12:12** and

20
the contents of the accounting stop time field are **2006-12-30 12:12:14**. The contents of the communication session time field **1012** are **2** to indicate **2** seconds call duration and the contents of the route field are **72.64.39.58**.

25
Referring back to Figure 35, after having produced an RC Call Stop message, block **920** directs the call controller circuit **100** to send the RC stop message contained in the RC Call Stop message buffer to the routing controller **16**.

30
The routing controller **16** receives the Call Stop message and an RC Call Stop message process is invoked at the RC to deal with charges and billing for the call.

Block **922** directs the call controller circuit **100** to send a Bye message back to the party that did not terminate the call.

and the call controller executes a process as shown generally at 910 in Figure 35. The process includes a block 912 that directs the call controller circuit 100 to copy the caller, callee and call ID field contents from the SIP Bye message 900 shown in Figure 33 received from the terminating party to corresponding fields of an RC Call Stop message buffer (not shown). Block 914 then directs the call controller circuit 100 to copy the call start time from the call timer and to obtain a Call Stop time from the call timer. Block 916 then directs the call controller circuit 100 to copy a communication session time by determining the difference in time between the call start time and the call stop time. This communication session time is then stored in a corresponding field of the RC Call Stop message buffer. Block 918 then directs the call controller circuit 100 to copy the route identifier from the call log. An RC Call Stop message produced as described above is shown generally at 1000 in Figure 36. An RC Call Stop message specifically associated with the call made to the Calgary callee is shown generally at 1020 in Figure 37. Referring to Figure 36, the RC Call Stop message includes a caller field 1002, callee field 1004, a call ID field 1006, an account start time field 1008, an account stop time field 1010, a communication session time 1012 and a route field 1014. The caller field 1002 holds a username, the callee field 1004 holds a PSTN-compatible number or system number, the call ID field 1006 holds the unique call identifier received from the SIP Invite message shown in Figure 3, the account start time field 1008 holds the date and start time of the call, the account stop time field 1010 holds the date and time the call ended, the account session time field 1012 holds a value representing the difference between the start time and the stop time, in seconds, and the route field 1014 holds the IP address for the communications link that was established. Referring to Figure 37, an exemplary RC stop call message for the Calgary

5

10

Block 924 then directs the call controller circuit 100 to send a "Bye" message of the type shown in Figure 33 to the media relay 17 to cause the media relay to delete the caller and callee sockets it established for the call and to delete the bridge between the sockets.

While specific embodiments of the invention have been described and illustrated, such embodiments should be considered illustrative of the invention only and not as limiting the invention as construed in accordance with the accompanying claims.

callee is shown generally at 1020. In this example the caller field 1002 holds the username 2001 1050 8667 referring the Vancouver caller and the call ID field 1004 holds the username 2001 1050 2222 identifying the Calgary callee. The contents of the call ID field 1006 are FA10 (S) 192.168.0.20. The contents of the accounting start time field 1008 are 2006-12-30 12:12:12 and the contents of the accounting stop time field 1010 are 2006-12-30 12:12:14. The contents of the communication session time field 1012 are 2 to indicate 2 seconds call duration and the contents of the route field 1014 are 72-64-29-58. Referring back to Figure 35, after having produced an RC Call Stop message, block 920 directs the call controller circuit 100 to send the RC stop message contained in the RC Call Stop message buffer to the routing controller 16. The routing controller 16 receives the Call Stop message and an RC Call Stop message process is invoked at the RC to deal with charges and billing for the call. Block 932 directs the call controller circuit 100 to send a Bye message back to the party that did not terminate the call. Block 934 directs the call controller circuit 100 to send a "Bye" message of the type shown in Figure 33 to the media relay 17 to cause the media relay to delete the caller and callee sockets it established for the call and to delete the bridge between the caller and callee. The details of the invention have been described and illustrated, such embodiments should be considered illustrative of the invention only and not as limiting the invention as construed in accordance with the accompanying claims.

What is claimed is:

1. A process for handling emergency calls from a caller in a voice over IP system, the method comprising:

5

receiving a routing request message including a caller identifier and a callee identifier; receiving the Call Stop message and an RC Call Stop message process is invoked at the RC to deal with charges and billing for the call.

10

Block 932 directs the call controller circuit 100 to send a Bye message back to the party that did not terminate the call. Block 934 directs the call controller circuit 100 to send a "Bye" message of the type shown in Figure 33 to the media relay 17 to cause the media relay to delete the caller and callee sockets it established for the call and to delete the bridge between the caller and callee.

15

producing an emergency response center identifier in response to said emergency call identifier; determining whether said caller identifier is associated with a pre-associated direct inward dialing (DID) identifier; receiving a routing request message including a caller identifier

20

producing a direct inward dialing (DID) identifier for said caller by associating a temporary DID identifier with said caller identifier when said emergency call flag is active and it is determined that said caller has no pre-associated DID identifier;

25

producing a routing message including said emergency response center identifier and said temporary DID identifier for receipt by a routing controller operable to cause a route to be established between the caller and said emergency response center.

30

2. The process of claim 1 wherein setting said emergency call flag active comprises retrieving a dialing profile associated with the caller and setting said emergency call flag active when the contents of an

and a callee identifier; setting an emergency call flag active in response to said callee identifier with the caller; producing an emergency response center identifier in response to said emergency call identifier; determining whether said caller identifier is associated with a pre-associated direct inward dialing (DID) identifier; producing a direct inward dialing emergency call identifier field of said dialing profile match said callee identifier by associating a temporary DID identifier with said caller identifier when said emergency call flag is active and it is determined that said caller has no pre-associated DID identifier; producing a routing message including said emergency response center identifier and said temporary DID identifier for receipt by a routing controller operable to cause a route to be taken to a DID record associating a DID identifier with emergency response center 2. The process of claim 1 wherein setting said emergency call flag active comprises retrieving a dialing profile associated with the caller and setting said emergency call flag active when the caller's emergency call identifier field of said dialing profile match said callee identifier. 3. The process of claim 2 wherein determining whether said caller identifier is associated with a pre-associated DID identifier comprises searching a database for a DID record associating a DID identifier with said caller and determining that said caller identifier is associated with a pre-associated DID identifier when said record associating a DID identifier with said caller is found. 4. The process of claim 3 wherein associating a pre-assigned DID pre-associated DID identifier comprises searching a database for a DID record associating a DID identifier with said caller and determining that said caller identifier is associated with a pre-associated DID identifier when said record associating a DID

5

10

15

20

25

30

- 5. The process of claim 4 wherein producing said routing message comprises causing the contents of said DID identifier buffer to define said DID identifier in said routing message.
- 6. The process of claim 2 wherein determining whether said caller identifier is associated with a pre-associated DID identifier comprises searching a database for a DID record associating a DID identifier with said caller and determining that said caller identifier is not associated with a pre-associated DID identifier when a record associating a DID identifier with said caller is not found.
- 7. The process of claim 6 wherein associating a temporary DID identifier with said caller identifier comprises associating with said caller identifier a DID identifier from a pool of pre-determined DID identifiers.
- 8. The process of claim 7 wherein associating said DID identifier from said pool comprises associating a temporary DID record with said

identifier with said caller is found. 4. The process of claim 3 wherein associating a pre-assigned DID caller with said caller identifier comprises copying said preassociated DID identifier from said DID record to a DID identifier buffer. 5. The process of claim 4 wherein producing said routing message comprises causing the contents of said DID identifier buffer to define said DID identifier in said routing message. 6. The process of claim 2 wherein determining whether said caller identifier is associated with a pre-associated DID identifier comprises searching a database for a DID record associating a DID identifier with said caller and determining that said caller identifier is not associated with a pre-associated DID identifier when a record associating a DID identifier with said caller is not found. 7. The process of claim 6 wherein associating a DID identifier with said caller identifier comprises associating with said caller identifier a DID identifier from a pool of pre-determined DID identifiers. 8. The process of claim 7 wherein associating said DID identifier from said pool comprises causing the contents of said DID identifier buffer to define said DID identifier in said routing message with said caller, said temporary DID record having a DID identifier field populated with said DID identifier from said pool. 9. The process of claim 8 wherein associating said DID identifier from said pool comprises copying said DID identifier from said temporary DID record to a DID identifier buffer. 10. The process of claim 9 wherein producing said routing message comprises causing the contents of said DID identifier buffer to define said DID identifier in said routing message. 11. The process of claim 8 further comprising canceling said temporary DID record after a pre-defined period of time. 12. The process of claim 2 wherein producing said emergency response center identifier comprises obtaining an emergency response center identifier from an emergency response center field of said dialing profile associated with said caller.

5

10

15

20

25

30

13. The process of claim 12 wherein obtaining comprises copying an emergency response center identifier from said dialing profile associated with said caller to a routing message buffer such that the emergency response center identifier is included in the routing message.

14. The process of claim 1 wherein producing said routing message comprises causing said routing message to specify a maximum call time for said emergency call, said maximum call time exceeding a duration of an average non-emergency telephone call.

15. An apparatus for handling emergency calls from a caller in a voice over IP system, the apparatus comprising:

DID record after a pre-defined period of time. 12. The process of claim 2 wherein producing said emergency response center identifier comprises obtaining said emergency response center identifier from an emergency response center field of said dialing profile associated with said caller. 13. The process of claim 12 wherein obtaining comprises copying an emergency response center identifier from said dialing profile associated with said caller to a routing message buffer such that the emergency response center identifier is included in the routing message. 14. The process of claim 13 comprising said routing message comprises causing said routing message to specify a maximum call time for said emergency call, said maximum call time exceeding a duration of an average non-emergency telephone call. 15. An apparatus for handling emergency calls from a caller in a network over IP system, the apparatus comprising: means for receiving a routing request message including a caller identifier and a callee identifier; setting means for setting an emergency call flag active in response to said callee identifier matching an emergency call identifier pre-associated with the caller; means for producing an emergency response center identifier in response to said emergency call identifier; means for determining whether said caller identifier is associated with a pre-associated direct inward dialing (DID) identifier; and means for producing a direct inward dialing (DID) identifier for

5

10

15

means for producing a direct inward dialing (DID) identifier for said caller including:

20

means for associating a temporary DID identifier with said caller identifier in response to said emergency call flag being active and said caller not being pre-associated with a direct inward dialing identifier; and

25

means for producing a routing message including said emergency response center identifier and said temporary DID identifier or said pre-assigned DID identifier for receipt by a routing controller operable to cause a route to be established between the caller and said emergency response center.

30

16. The apparatus of claim 15 further comprising means for accessing a database of dialing profiles associated with respective subscribers to

5

10

15

said caller including: means for associating a temporary DID identifier with said caller identifier in response to said emergency call flag being active and said caller not being pre-associated with a direct inward dialing identifier; and means for producing a routing message including said emergency response center identifier and said temporary DID identifier or said pre-assigned DID identifier for receipt by a routing controller operable to cause a route to be established between the caller and said emergency response center. 16. The apparatus of claim 15 further comprising means for accessing a database including dialing profiles associated with respective subscribers to said system, each of said dialing profiles including an emergency call identifier field and an emergency call center field and wherein said setting means comprises means for retrieving a dialing profile associated with the caller and for setting said emergency call flag active when the contents of said emergency call identifier field of said dialing profile match said caller identifier.

17. The apparatus of claim 16 further comprising means for accessing a database including direct inward dialing (DID) records associated with at least some subscribers to said system, each of said direct inward dialing records comprising a system username and a direct inward dialing number, and wherein said determining means comprises searching for a DID record in a database for a DID record associating a DID identifier with said caller and wherein said determining means is operably configured to determine that said caller identifier is associated with a pre-associated DID identifier when said

record associating a DID identifier with said caller is found.

18. The apparatus of claim 17 further comprising a DID identifier buffer and wherein said means for associating a pre-assigned DID identifier with said caller identifier comprises means for copying said pre-associated DID identifier from said DID record to said DID identifier buffer.

19. The apparatus of claim 18 wherein said means for producing said routing message comprises means for causing the contents of said DID identifier buffer to define said DID identifier in said routing message.

20. The apparatus of claim 16 further comprising database accessing means for accessing a database including direct inward dialing records associated with at least some subscribers to said system, each of said direct inward dialing records comprising a system username and a

means for associating a pre-assigned DID identifier with said caller identifier comprises means for copying said pre-associated DID identifier from said DID record to said DID identifier buffer. 19. The

5 apparatus of claim 18 wherein said means for producing said routing message comprises means for causing the contents of said DID identifier buffer to define said DID identifier in said routing message. 20. The apparatus of claim 18 further comprising a database associating a DID identifier with said caller and wherein said accessing means for accessing a database including direct inward dialing records associated with at least some subscribers to said system, each of said subscribers is not associated with a pre-associated DID identifier when a 5 inward dialing records comprising a system username and address associated with said caller is not found. determining means comprises searching means for searching a database for a DID record associating a

10 21. The apparatus of claim 18 further comprising means for accessing a determining means is operably configured to determine that said pool of pre-determined DID identifiers and wherein said means for pre-associated DID identifier when a record associating a DID identifier with said caller is not found. 22. The apparatus of claim 18 further comprising means for associating a DID identifier from said pool of pre-determined DID identifiers with said caller identifier

15 22. The apparatus of claim 20 wherein said means for associating said DID identifier with said caller identifier. 22. The apparatus of claim 20 wherein said means for associating a temporary DID record with said caller, said temporary DID record having a DID identifier field populated with said DID identifier from said pool. DID

20 23. The apparatus of claim 22 wherein said means for associating comprises means for copying said DID identifier from said temporary DID record to a DID identifier buffer.

25 24. The apparatus of claim 22 wherein said means for producing said routing message comprises means for causing the contents of said DID identifier buffer to define said DID identifier in said routing message.

30 25. The apparatus of claim 22 further comprising means for canceling said temporary DID record after a period of time.

26. The apparatus of claim 16 wherein said means for producing said emergency response center identifier comprises means for obtaining

identifier field populated with said DID identifier
 from said pool. 23. The apparatus of claim 22 wherein
 said means for associating comprises means for copying
 said DID identifier from said temporary DID record to
 a DID identifier buffer. 24. The apparatus of claim 22
 wherein said means for producing said routing message
 comprises means for causing the contents of said DID
 identifier buffer to define said DID identifier in
 said routing message. 25. The apparatus of claim 22
 further comprising means for canceling said temporary
 DID record after a period of time. 26. The apparatus
 of claim 16 wherein said means for producing said
 emergency response center identifier comprises means
 for obtaining an emergency response center identifier
 from an emergency response center field of said
 dialing profile associated with said caller. 27. The
 apparatus of claim 26 further comprising means for copying the
 contents of said emergency response center field of said dialing profile
 associated with said caller to the routing message buffer such that said
 contents of said emergency response center field are included in said
 routing message. 28. The apparatus of claim 27 wherein said means
 comprises means for causing said routing message to
 include a maximum call time for said emergency call,
 said maximum call time exceeding a duration of an
 average non-emergency telephone call. 29. An apparatus
 for handling emergency calls from a caller in a voice over
 IP system, the apparatus comprising a processor
 circuit operably

29. An apparatus for handling emergency calls from a caller in a voice over
 IP system, the apparatus comprising a processor circuit operably
 configured to:

receive a routing request message including a caller identifier
 and a callee identifier;

set an emergency call flag active in response to said callee
 identifier matching an emergency call identifier pre-associated
 with the caller;

produce an emergency response center identifier in response to
 said emergency call identifier;

determine whether said caller identifier is associated with a pre-
 associated direct inward dialing (DID) identifier;

configured to: receive a routing request message including a caller identifier and a callee identifier; emergency call flag active in response to said caller identifier matching an emergency call identifier pre-associated with the caller; produce an emergency response center identifier in response to said emergency call identifier; determine whether said caller identifier is associated with a preassociated direct inward dialing (DID) identifier; produce a direct inward dialing (DID) identifier for said caller by associating a temporary DID identifier with said caller identifier; when said emergency call flag is active and it is determined that said caller has no pre-associated DID identifier; and produce a routing message including said emergency response center identifier and said temporary DID identifier for receipt by a routing controller operable to cause a route to be established between the caller and said emergency response center. 30. The apparatus of claim 29 wherein said processor circuit is operably configured to retrieve a dialing profile associated with the caller and set said emergency call flag active when the contents of an emergency call identifier field of said dialing profile match said callee identifier. 31. The apparatus of claim 30 wherein said processor circuit is operably configured to search a database for a DID record associating a DID identifier with said caller and determine that said caller identifier is associated with a pre-associated DID identifier when said record associating a DID identifier with said caller is found.

5

10

15

31. The apparatus of claim 30 wherein said processor circuit is operably configured to search a database for a DID record associating a DID identifier with said caller and determine that said caller identifier is associated with a pre-associated DID identifier when said record associating a DID identifier with said caller is found.

20

32. The apparatus of claim 31 wherein said processor circuit is operably configured to copy said pre-associated DID identifier from said DID record to a DID identifier buffer.

25

33. The apparatus of claim 32 wherein said processor circuit is operably configured to cause the contents of said DID identifier buffer to define said DID identifier in said routing message.

30

34. The apparatus of claim 30 wherein said processor circuit is operably configured to search a database for a DID record associating a DID

32. The apparatus of claim 31 wherein said processor circuit is operably configured to copy said a DID identifier buffer. 33. The apparatus of claim 32 wherein said processor circuit is operably configured to cause the contents of said DID identifier buffer to define said DID identifier in said routing message.

34. The apparatus of claim 30 wherein said processor circuit is operably configured to search a database for a DID record associating a DID identifier with said caller and determine that said caller identifier is not associated with a pre-associated DID identifier when a record associating a DID identifier with said caller is not found.

5 35. The apparatus of claim 32 wherein said processor circuit is operably configured to associate with said caller identifier a DID identifier from a pool of pre-determined DID identifiers.

36. The apparatus of claim 35 wherein said processor circuit is operably configured to associate a temporary DID record with the caller, said temporary DID record having a DID identifier field populated with said DID identifier from said pool.

10 37. The apparatus of claim 36 wherein said processor circuit is operably configured to cancel said temporary DID record after a period of time.

38. The apparatus of claim 35 wherein said processor circuit is operably configured to cause the contents of said DID identifier buffer to define said DID identifier in said routing message. 39. The apparatus of claim 36 wherein said processor circuit is operably configured to copy said DID identifier from said temporary DID record to a DID buffer.

20 38. The apparatus of claim 35 wherein said processor circuit is operably configured to cause the contents of said DID identifier buffer to define said DID identifier in said routing message.

39. The apparatus of claim 36 wherein said processor circuit is operably configured to cancel said temporary DID record after a period of time.

25 40. The apparatus of claim 30 wherein said processor circuit is operably configured to obtain an emergency response center identifier from an emergency response center field of said dialing profile associated with said caller.

30 41. The apparatus of claim 40 further comprising a routing message buffer and wherein said processor circuit is operably configured to copy an emergency response center identifier from said dialing profile

configured to obtain an emergency response center identifier from an emergency response center field of dialing profile associated with said caller. The apparatus of claim 40 further comprising a routing message buffer and wherein said processor circuit is operably configured to copy an emergency response center identifier from said dialing profile associated with said caller to said routing message buffer such that said emergency response center identifier is included in said routing message. The apparatus of claim 29 wherein said processor circuit is operably configured to cause said routing message to include a maximum call time for said emergency call, said maximum call time exceeding a duration of an average non-emergency telephone call.

42. The apparatus of claim 29 wherein said processor circuit is operably configured to cause said routing message to include a maximum call time for said emergency call, said maximum call time exceeding a duration of an average non-emergency telephone call.

43. A computer readable medium encoded with codes for directing a processor circuit to handle emergency calls from callers in a voice over IP system, said codes directing said processor circuit to: receive a routing request message including a caller identifier; set an emergency call flag active in response to said caller identifier matching an emergency call identifier pre-associated with the caller; produce an emergency response center identifier in response to said caller identifier; determine whether said caller identifier is associated with a pre-associated direct inward dialing (DID) identifier; produce a direct inward dialing (DID) identifier for said caller by associating a temporary DID identifier with said caller identifier and a callee identifier;

5
10
15

set an emergency call flag active in response to said callee identifier matching an emergency call identifier pre-associated with the caller;

20

produce an emergency response center identifier in response to said emergency call identifier;

25

determine whether said caller identifier is associated with a pre-associated direct inward dialing (DID) identifier;

30

produce a direct inward dialing (DID) identifier for said caller by associating a temporary DID identifier with said caller identifier when said emergency call flag is active and it is determined that said caller has no pre-associated DID identifier; and

when said emergency call flag is active and it is determined that said caller has no pre-associated DID WO 2008/116296; and produce a routing message including said emergency response center identifier and said temporary DID identifier for receipt by a routing controller operable to cause a route to be established between the caller and said emergency response center. PCT/CA 2008/000545

produce a routing message including said emergency response center identifier and said temporary DID identifier for receipt by a routing controller operable to cause a route to be established between the caller and said emergency response center.

Electronic Patent Application Fee Transmittal

Application Number:	13966096
Filing Date:	13-Aug-2013
Title of Invention:	PRODUCING ROUTING MESSAGES FOR VOICE OVER IP COMMUNICATIONS
First Named Inventor/Applicant Name:	CLAY PERREAULT
Filer:	John M Carson/Norman Green
Attorney Docket Number:	DIGIF.001C1

Filed as Small Entity

Filing Fees for Utility under 35 USC 111(a)

Description	Fee Code	Quantity	Amount	Sub-Total in USD(\$)
Basic Filing:				
Pages:				
Claims:				
Miscellaneous-Filing:				
Petition:				
Patent-Appeals-and-Interference:				
Post-Allowance-and-Post-Issuance:				
Extension-of-Time:				

Description	Fee Code	Quantity	Amount	Sub-Total in USD(\$)
Miscellaneous:				
Submission- Information Disclosure Stmt	2806	1	90	90
Total in USD (\$)				90

Electronic Acknowledgement Receipt

EFS ID:	22610217
Application Number:	13966096
International Application Number:	
Confirmation Number:	8712
Title of Invention:	PRODUCING ROUTING MESSAGES FOR VOICE OVER IP COMMUNICATIONS
First Named Inventor/Applicant Name:	CLAY PERREAULT
Customer Number:	20995
Filer:	John M Carson/Norman Green
Filer Authorized By:	John M Carson
Attorney Docket Number:	DIGIF.001C1
Receipt Date:	11-JUN-2015
Filing Date:	13-AUG-2013
Time Stamp:	20:54:14
Application Type:	Utility under 35 USC 111(a)

Payment information:

Submitted with Payment	yes
Payment Type	Credit Card
Payment was successfully received in RAM	\$90
RAM confirmation Number	19831
Deposit Account	111410
Authorized User	KNOBBE MARTENS OLSON AND BEAR

The Director of the USPTO is hereby authorized to charge indicated fees and credit any overpayment as follows:

Charge any Additional Fees required under 37 C.F.R. Section 1.16 (National application filing, search, and examination fees)

Charge any Additional Fees required under 37 C.F.R. Section 1.17 (Patent application and examination processing fees)

PETITIONER APPLE INC. PEX: 1902761

--	--	--	--	--	--

File Listing:

Document Number	Document Description	File Name	File Size(Bytes)/ Message Digest	Multi Part /.zip	Pages (if appl.)
1		2015_06_11_IDS_DIGIF_001C1.pdf	141201 6a18350b76d298a1a18d7e09b996421454007542	yes	4

Multipart Description/PDF files in .zip description					
Document Description		Start	End		
Transmittal Letter		1	2		
Information Disclosure Statement (IDS) Form (SB08)		3	4		

Warnings:

Information:

2	Foreign Reference	Ref1_IN_24_2009.pdf	1103891 40d8a0992d759c4f2569bd987a6c9cce499c518d	no	17
---	-------------------	---------------------	---	----	----

Warnings:

Information:

3	Foreign Reference	Ref2_IN_29_2009.pdf	1939525 f8775ab91d9328df3641585646d89fc6de8b61e0	no	31
---	-------------------	---------------------	---	----	----

Warnings:

Information:

4	Foreign Reference	Ref3_SG151991_Full_Trans.pdf	12232700 c960041e75c6f056d1b7b9624dbae052d2e5f9580	no	138
---	-------------------	------------------------------	---	----	-----

Warnings:

Information:

5	Foreign Reference	Ref4_SG152752_Full_Trans.pdf	9304036 c29ff052a03261eb8661b97b03063bf2b140e243	no	101
---	-------------------	------------------------------	---	----	-----

Warnings:

Information:

6	Foreign Reference	Ref5_SG155474_Abst.pdf	851694 cb9b542eb3ba64ab703aab6535b2d0010c9c9969	no	69
---	-------------------	------------------------	--	----	----

Warnings:

Information:

7	Non Patent Literature	Ref6_CN_First_OA_CN2007800 49791_5_03_24_2011.pdf	1133474 b480ace607a90e9d8ea8ea1d3a70734c80a78d65	no	11
Warnings:					
Information:					
8	Non Patent Literature	Ref7_CN_First_OA_CN2007800 49136_X_06_23_2011.pdf	922066 c2267b042a38fd97a4e37a3f894bf2f1decff2f	no	8
Warnings:					
Information:					
9	Non Patent Literature	Ref8_IN_Exam_Report_7_5_20 12_W-00200901414.pdf	196694 f6cbabf78c1eb03e2e05d38c05fbb7b20d802ff0	no	2
Warnings:					
Information:					
10	Non Patent Literature	Ref9_IN_Exam_Report_2_8_20 13_W-00200901165.pdf	100609 ada54ac139d65a31dd44d0e6662fc2aef61a63574	no	2
Warnings:					
Information:					
11	Non Patent Literature	Ref10_MX_OA_MXa200900481 1.pdf	417661 7edb8842a712a3dc31bdce6fa353415291c84eca	no	4
Warnings:					
Information:					
12	Non Patent Literature	Ref11_MX_NOA_MXa20090057 51.pdf	332934 67c89c7f57e87920f63c8ce00f6409b9e50dfbc2	no	4
Warnings:					
Information:					
13	Fee Worksheet (SB06)	fee-info.pdf	30465 e823c2bcf3698687700ecc8d2584c7b1030e8a27	no	2
Warnings:					
Information:					
Total Files Size (in bytes):			28706950		

This Acknowledgement Receipt evidences receipt on the noted date by the USPTO of the indicated documents, characterized by the applicant, and including page counts, where applicable. It serves as evidence of receipt similar to a Post Card, as described in MPEP 503.

New Applications Under 35 U.S.C. 111

If a new application is being filed and the application includes the necessary components for a filing date (see 37 CFR 1.53(b)-(d) and MPEP 506), a Filing Receipt (37 CFR 1.54) will be issued in due course and the date shown on this Acknowledgement Receipt will establish the filing date of the application.

National Stage of an International Application under 35 U.S.C. 371

If a timely submission to enter the national stage of an international application is compliant with the conditions of 35 U.S.C. 371 and other applicable requirements a Form PCT/DO/EO/903 indicating acceptance of the application as a national stage submission under 35 U.S.C. 371 will be issued in addition to the Filing Receipt, in due course.

New International Application Filed with the USPTO as a Receiving Office

If a new international application is being filed and the international application includes the necessary components for an international filing date (see PCT Article 11 and MPEP 1810), a Notification of the International Application Number and of the International Filing Date (Form PCT/RO/105) will be issued in due course, subject to prescriptions concerning national security, and the date shown on this Acknowledgement Receipt will establish the international filing date of the application.

INFORMATION DISCLOSURE STATEMENT

Inventor	:	Clay Perreault, et al.
App. No.	:	13/966,096
Filed	:	August 13, 2013
For	:	PRODUCING ROUTING MESSAGES FOR VOICE OVER IP COMMUNICATIONS
Examiner	:	Sing, Simon P.
Art Unit	:	2653
Conf. No.	:	8712

Commissioner for Patents
P.O. Box 1450
Alexandria, VA 22313-1450

References and Listing

Pursuant to 37 CFR 1.56, an Information Disclosure Statement listing references is provided herewith. Copies of any listed foreign and non-patent literature references are being submitted.

No Disclaimers

To the extent that anything in the Information Disclosure Statement or the listed references could be construed as a disclaimer of any subject matter supported by the present application, Applicant hereby rescinds and retracts such disclaimer.

Timing of Disclosure

This Information Disclosure Statement is being filed after receipt of a First Office Action, but before the mailing date of a Final Action and before the mailing date of a Notice of Allowance. This Statement is accompanied by the fees set forth in 37 CFR 1.17(p). The

Application No.: 13/966,096
Filing Date: August 13, 2013

Commissioner is hereby authorized to charge any additional fees which may be required or to credit any overpayment to Account No. 11-1410.

Respectfully submitted,

KNOBBE, MARTENS, OLSON & BEAR, LLP

Dated: 6/11/15

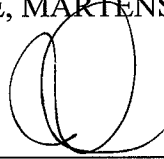
By:  _____

John M. Carson
Registration No. 34,303
Attorney of Record
Customer No. 20995
(858) 707-4000

IDS
20878651
061015



UNITED STATES PATENT AND TRADEMARK OFFICE

UNITED STATES DEPARTMENT OF COMMERCE
United States Patent and Trademark Office
Address: COMMISSIONER FOR PATENTS
P.O. Box 1450
Alexandria, Virginia 22313-1450
www.uspto.gov

Table with 5 columns: APPLICATION NO., FILING DATE, FIRST NAMED INVENTOR, ATTORNEY DOCKET NO., CONFIRMATION NO.
13/966,096 08/13/2013 CLAY PERREAULT DIGIF.001C1 8712

20995 7590 06/02/2015
KNOBBE MARTENS OLSON & BEAR LLP
2040 MAIN STREET
FOURTEENTH FLOOR
IRVINE, CA 92614

EXAMINER

SING, SIMON P

ART UNIT PAPER NUMBER

2653

NOTIFICATION DATE DELIVERY MODE

06/02/2015

ELECTRONIC

Please find below and/or attached an Office communication concerning this application or proceeding.

The time period for reply, if any, is set in the attached communication.

Notice of the Office communication was sent electronically on above-indicated "Notification Date" to the following e-mail address(es):

jayna.cartee@knobbe.com
efiling@knobbe.com

Applicant-Initiated Interview Summary	Application No. 13/966,096	Applicant(s) PERREAULT ET AL.	
	Examiner SIMON SING	Art Unit 2653	

All participants (applicant, applicant's representative, PTO personnel):

- (1) SIMON SING. (3) _____.
- (2) Mr. John Carson. (4) _____.

Date of Interview: 28 May 2015.

Type: Telephonic Video Conference
 Personal [copy given to: applicant applicant's representative]

Exhibit shown or demonstration conducted: Yes No.
If Yes, brief description: _____.

Issues Discussed 101 112 102 103 Others
(For each of the checked box(es) above, please describe below the issue and detailed description of the discussion)

Claim(s) discussed: 1.

Identification of prior art discussed: US 6,798,767 (Alexander et al).

Substance of Interview

(For each issue discussed, provide a detailed description and indicate if agreement was reached. Some topics may include: identification or clarification of a reference or a portion thereof, claim interpretation, proposed amendments, arguments of any applied references etc...)

Applicant argues that Alexander teaches routing a call by looking up a table, based on a callee's number, to determining a callee's IP address. Alexander fails to teach claimed limitations of determining if a calling attribute meets (matches) a portion of a callee's identifier, and producing a routing message accordingly. Examiner agrees with the applicant. A new search will be conducted to find applicable prior arts, and patentability will be determined based on the new search.

Applicant recordation instructions: The formal written reply to the last Office action must include the substance of the interview. (See MPEP section 713.04). If a reply to the last Office action has already been filed, applicant is given a non-extendable period of the longer of one month or thirty days from this interview date, or the mailing date of this interview summary form, whichever is later, to file a statement of the substance of the interview

Examiner recordation instructions: Examiners must summarize the substance of any interview of record. A complete and proper recordation of the substance of an interview should include the items listed in MPEP 713.04 for complete and proper recordation including the identification of the general thrust of each argument or issue discussed, a general indication of any other pertinent matters discussed regarding patentability and the general results or outcome of the interview, to include an indication as to whether or not agreement was reached on the issues raised.

Attachment

/SIMON SING/
Primary Examiner, Art Unit 2653

Summary of Record of Interview Requirements

Manual of Patent Examining Procedure (MPEP), Section 713.04, Substance of Interview Must be Made of Record

A complete written statement as to the substance of any face-to-face, video conference, or telephone interview with regard to an application must be made of record in the application whether or not an agreement with the examiner was reached at the interview.

Title 37 Code of Federal Regulations (CFR) § 1.133 Interviews

Paragraph (b)

In every instance where reconsideration is requested in view of an interview with an examiner, a complete written statement of the reasons presented at the interview as warranting favorable action must be filed by the applicant. An interview does not remove the necessity for reply to Office action as specified in §§ 1.111, 1.135. (35 U.S.C. 132)

37 CFR §1.2 Business to be transacted in writing.

All business with the Patent or Trademark Office should be transacted in writing. The personal attendance of applicants or their attorneys or agents at the Patent and Trademark Office is unnecessary. The action of the Patent and Trademark Office will be based exclusively on the written record in the Office. No attention will be paid to any alleged oral promise, stipulation, or understanding in relation to which there is disagreement or doubt.

The action of the Patent and Trademark Office cannot be based exclusively on the written record in the Office if that record is itself incomplete through the failure to record the substance of interviews.

It is the responsibility of the applicant or the attorney or agent to make the substance of an interview of record in the application file, unless the examiner indicates he or she will do so. It is the examiner's responsibility to see that such a record is made and to correct material inaccuracies which bear directly on the question of patentability.

Examiners must complete an Interview Summary Form for each interview held where a matter of substance has been discussed during the interview by checking the appropriate boxes and filling in the blanks. Discussions regarding only procedural matters, directed solely to restriction requirements for which interview recordation is otherwise provided for in Section 812.01 of the Manual of Patent Examining Procedure, or pointing out typographical errors or unreadable script in Office actions or the like, are excluded from the interview recordation procedures below. Where the substance of an interview is completely recorded in an Examiners Amendment, no separate Interview Summary Record is required.

The Interview Summary Form shall be given an appropriate Paper No., placed in the right hand portion of the file, and listed on the "Contents" section of the file wrapper. In a personal interview, a duplicate of the Form is given to the applicant (or attorney or agent) at the conclusion of the interview. In the case of a telephone or video-conference interview, the copy is mailed to the applicant's correspondence address either with or prior to the next official communication. If additional correspondence from the examiner is not likely before an allowance or if other circumstances dictate, the Form should be mailed promptly after the interview rather than with the next official communication.

The Form provides for recordation of the following information:

- Application Number (Series Code and Serial Number)
- Name of applicant
- Name of examiner
- Date of interview
- Type of interview (telephonic, video-conference, or personal)
- Name of participant(s) (applicant, attorney or agent, examiner, other PTO personnel, etc.)
- An indication whether or not an exhibit was shown or a demonstration conducted
- An identification of the specific prior art discussed
- An indication whether an agreement was reached and if so, a description of the general nature of the agreement (may be by attachment of a copy of amendments or claims agreed as being allowable). Note: Agreement as to allowability is tentative and does not restrict further action by the examiner to the contrary.
- The signature of the examiner who conducted the interview (if Form is not an attachment to a signed Office action)

It is desirable that the examiner orally remind the applicant of his or her obligation to record the substance of the interview of each case. It should be noted, however, that the Interview Summary Form will not normally be considered a complete and proper recordation of the interview unless it includes, or is supplemented by the applicant or the examiner to include, all of the applicable items required below concerning the substance of the interview.

A complete and proper recordation of the substance of any interview should include at least the following applicable items:

- 1) A brief description of the nature of any exhibit shown or any demonstration conducted,
- 2) an identification of the claims discussed,
- 3) an identification of the specific prior art discussed,
- 4) an identification of the principal proposed amendments of a substantive nature discussed, unless these are already described on the Interview Summary Form completed by the Examiner,
- 5) a brief identification of the general thrust of the principal arguments presented to the examiner,
(The identification of arguments need not be lengthy or elaborate. A verbatim or highly detailed description of the arguments is not required. The identification of the arguments is sufficient if the general nature or thrust of the principal arguments made to the examiner can be understood in the context of the application file. Of course, the applicant may desire to emphasize and fully describe those arguments which he or she feels were or might be persuasive to the examiner.)
- 6) a general indication of any other pertinent matters discussed, and
- 7) if appropriate, the general results or outcome of the interview unless already described in the Interview Summary Form completed by the examiner.

Examiners are expected to carefully review the applicant's record of the substance of an interview. If the record is not complete and accurate, the examiner will give the applicant an extendable one month time period to correct the record.

Examiner to Check for Accuracy

If the claims are allowable for other reasons of record, the examiner should send a letter setting forth the examiner's version of the statement attributed to him or her. If the record is complete and accurate, the examiner should place the indication, "Interview Record OK" on the paper recording the substance of the interview along with the date and the examiner's initials.

IN THE UNITED STATES PATENT AND TRADEMARK OFFICE

Inventor	:	Clay Perreault, et al.
App. No.	:	13/966,096
Filed	:	August 13, 2013
For	:	PRODUCING ROUTING MESSAGES FOR VOICE OVER IP COMMUNICATIONS
Examiner	:	Simon P. Sing
Art Unit	:	2653
Conf. No.	:	8712

REPLY TO NON-FINAL OFFICE ACTION**Mail Stop Amendment**

Commissioner for Patents

P.O. Box 1450

Alexandria, VA 22313-1450

Dear Sir:

In reply to the non-final Office Action dated April 9, 2015, Applicant presents the following amendments and remarks.

Listing of the Claims begin on page 2 of this paper.

Remarks begin on page 22 of this paper.

LISTING OF THE CLAIMS

1. (Original) A process for producing a routing message for routing communications between a caller and a callee in a communication system, the process comprising:

using a caller identifier associated with the caller to locate a caller dialing profile comprising a plurality of calling attributes associated with the caller;

when at least one of said calling attributes and at least a portion of a callee identifier associated with the callee meet private network classification criteria, producing a private network routing message for receipt by a call controller, said private network routing message identifying an address, on the private network, associated with the callee; and

when at least one of said calling attributes and at least a portion of said callee identifier meet a public network classification criterion, producing a public network routing message for receipt by the call controller, said public network routing message identifying a gateway to the public network.

2. (Original) The process of claim 1, wherein said private network classification criteria include:

a) said callee identifier does not begin with the same digit pattern as an international dialing digit (IDD) attribute of said callee identifier; and

b) said callee identifier does not begin with the same digit pattern as a national dialing digit (NDD) attribute of said callee identifier; and

c) said callee identifier does not begin with the same area code as an area code of said caller; and

d) said callee identifier does not have a length that is within a range of caller local number lengths; and

e) said callee identifier is a valid username.

Application No.: 13/966,096
Filing Date: August 13, 2013

3. (Original) The process of claim 2, further comprising identifying the call as a cross-domain call on the private network when said callee identifier identifies a callee that is not associated with the same network node as said caller.

4. (Original) The process of claim 2, further comprising:
locating a callee dialing profile for the callee when said callee identifier identifies a callee that is associated with the same network node as said caller; and
retrieving call handling information associated with the callee, where said call handling information is available, said call handling information including at least one of call blocking information, call forwarding information, and voicemail information.

5. (Original) The process of claim 4, further comprising, where said call handling information including said call blocking information is available, blocking the call when said call blocking information identifies the caller as a caller from whom calls are to be blocked from being established with the callee.

6. (Original) The process of claim 4, further comprising, where said call handling information including said call forwarding information is available, causing said call forwarding information to be included in said private network routing message.

7. (Original) The process of claim 4, further comprising, where said call handling information including said voicemail information is available, causing said voicemail information to be included in said private network routing message.

8. (Original) The process of claim 1, further comprising associating at least one direct inward dial (DID) record with at least one subscriber to said communication system, each of said at least one direct inward dial records comprising a field storing a direct inward dial number associated with said at least one subscriber.

9. (Original) The process of claim 8, wherein said public network classification criteria include:

Application No.: 13/966,096
Filing Date: August 13, 2013

a) said callee identifier begins with the same digit pattern as an international dialing digit (IDD) attribute of said callee identifier; and

b) a reformatted callee identifier produced by removing the IDD attribute from said callee identifier has no DID bank table record.

10. (Original) The process of claim 8, wherein said public network classification criteria include:

a) said callee identifier begins with the same digit pattern as a national dialing digit (NDD) attribute of said callee identifier; and

b) a reformatted callee identifier produced by removing the NDD attribute from said callee identifier and including a caller country code has no DID bank table record.

11. (Original) The process of claim 8, wherein said public network classification criteria include:

a) said callee identifier begins with the same area code as an area code of said caller; and

b) a reformatted callee identifier produced by reformatting the callee identifier to include a caller country code has no DID bank table record.

12. (Original) The process of claim 8, wherein said public network classification criteria include:

a) said callee identifier has a length that is within a range of caller local number lengths; and

b) a reformatted callee identifier produced by reformatting the callee identifier to include a caller country code and area code has no DID bank table record.

13. (Original) The process of claim 1, wherein said plurality of calling attributes includes at least one of an international dialing digits identifier, a national dialing digits identifier, a country code identifier, a local area codes identifier, a caller minimum local length

Application No.: 13/966,096
Filing Date: August 13, 2013

identifier, a caller maximum local length identifier, a reseller identifier, and a maximum number of concurrent calls identifier.

14. (Original) The process of claim 8, wherein said DID record comprises a user name field, a user domain field and a DID number field.

15. (Original) The process of claim 1, further comprising maintaining a list of public network route suppliers and when said public network classification criterion is met identifying at least one of said public network route suppliers that satisfies public network routing selection criteria.

16. (Original) The process of claim 15, wherein said producing said public network routing message comprises producing a public network routing message identifying said at least one public network route supplier that satisfies said public network routing selection criteria.

17. (Original) The process of claim 16, wherein producing said public network routing message comprises causing said public network routing message to include a gateway supplier identifier identifying a gateway supplier able to establish a communications link in a route through which communications between the caller and callee are to be conducted.

18. (Original) The process of claim 17, further comprising causing said public network routing message to include a time value and a timeout value.

19. (Original) The process of claim 17, wherein causing said public network routing message to include said gateway supplier identifier comprises causing said public network routing message to include a plurality of gateway supplier identifiers identifying a plurality of gateway suppliers able to supply respective communication links through which communications between the caller and callee can be conducted.

Application No.: 13/966,096
Filing Date: August 13, 2013

20. (Original) The process of claim 19, further comprising causing said public network routing message to include priority information identifying a priority in which gateway suppliers associated with said gateway identifiers are to be considered for selection of a communication link through which communications between the caller and callee can be conducted.

21. (Original) The process of claim 19, wherein causing said public network routing message to include priority information includes arranging said gateway supplier identifiers in said public network routing message in order of rate, where rate is determined from rate fields of respective said gateway supplier records.

22. (Original) The process of claim 21, wherein arranging said gateway supplier identifiers in order of rate comprises arranging said gateway supplier identifiers in order of increasing rate.

23. (Original) The process of claim 17, further comprising arranging said gateway supplier identifiers in an order based on at least one provision in a service agreement.

24. (Original) The process of claim 1, further comprising causing the private network routing message or the public network routing message to be communicated to a call controller to effect routing of the call.

25. (Original) A non-transitory computer readable medium encoded with codes for directing a processor to execute the method of claim 1.

26. (Original) A call routing controller apparatus for producing a routing message for routing communications between a caller and a callee in a communication system, the apparatus comprising:

at least one processor operably configured to:

use a caller identifier associated with the caller to locate a caller dialing profile comprising a plurality of calling attributes associated with the caller;

when at least one of said calling attributes and at least a portion of a callee identifier associated with the callee meet private network classification criteria, produce a private network routing message for receipt by a call controller, said private network routing message identifying an address, on the private network, associated with the callee; and

when at least one of said calling attributes and at least a portion of said callee identifier meet a public network classification criterion, produce a public network routing message for receipt by the call controller, said public network routing message identifying a gateway to the public network.

27. (Original) The apparatus of claim 26, wherein said private network classification criteria include:

- a) said callee identifier does not begin with the same digit pattern as an international dialing digit (IDD) attribute of said callee identifier; and
- b) said callee identifier does not begin with the same digit pattern as a national dialing digit (NDD) attribute of said callee identifier; and
- c) said callee identifier does not begin with the same area code as an area code of said caller; and
- d) said callee identifier does not have a length that is within a range of caller local number lengths; and
- e) said callee identifier is a valid username.

28. (Original) The apparatus of claim 27, wherein said at least one processor is further operably configured to identify the call as a cross-domain call on the private network when said callee identifier identifies a callee that is not associated with the same network node as said caller.

29. (Original) The apparatus of claim 27, wherein said at least one processor is further configured to:

Application No.: 13/966,096
Filing Date: August 13, 2013

access the database of caller dialing profiles to locate a callee dialing profile for the callee when said callee identifier identifies a callee that is associated with the same network node as said caller; and

retrieve call handling information associated with the callee, where said call handling information is available, said call handling information including at least one of call blocking information, call forwarding information, and voicemail information.

30. (Original) The apparatus of claim **29**, wherein said at least one processor is further operably configured to determine whether said call handling information including said call blocking information is available and to block the call when said call blocking information identifies the caller as a caller from whom calls are to be blocked.

31. (Original) The apparatus of claim **29**, wherein said at least one processor is further operably configured to determine whether said call handling information including said call forwarding information is available and to cause said call forwarding information to be included in said private network routing message.

32. (Original) The apparatus of claim **29**, wherein said at least one processor is further operably configured to determine whether said call handling information including said voicemail information is available and to cause said voicemail information to be included in said private network routing message.

33. (Original) The apparatus of claim **26**, wherein said at least one processor is further operably configured to access a database of direct inward dial records each associating at least one direct inward dial number with at least one subscriber to said communication system.

34. (Original) The apparatus of claim **33**, wherein said public network classification criteria include:

a) said callee identifier begins with the same digit pattern as an international dialing digit (IDD) attribute of said callee identifier; and

Application No.: 13/966,096
Filing Date: August 13, 2013

b) a reformatted callee identifier produced by removing the IDD attribute from said callee identifier has no DID record.

35. (Original) The apparatus of claim 33, wherein said public network classification criteria include:

a) said callee identifier begins with the same digit pattern as a national dialing digit (NDD) attribute of said callee identifier; and

b) a reformatted callee identifier produced by removing the NDD attribute from said callee identifier and including a caller country code has no DID record.

36. (Original) The apparatus of claim 33, wherein said public network classification criteria include:

a) said callee identifier begins with the same area code as an area code of said caller; and

b) a reformatted callee identifier produced by reformatting the callee identifier to include a caller country code has no DID record.

37. (Original) The apparatus of claim 33, wherein said public network classification criteria include:

a) said callee identifier has a length that is within a range of caller local number lengths; and

b) a reformatted callee identifier produced by reformatting the callee identifier to include a caller country code and area code has no DID record.

38. (Original) The apparatus of claim 26, wherein said plurality of calling attributes includes at least one of an international dialing digits identifier, a national dialing digits identifier, a country code identifier, a local area codes identifier, a caller minimum local length identifier, a caller maximum local length identifier, a reseller identifier, and a maximum number of concurrent calls identifier.

Application No.: 13/966,096
Filing Date: August 13, 2013

39. (Original) The apparatus of claim **33**, wherein said DID record comprises a user name field, a user domain field and a DID number field.

40. (Original) The apparatus of claim **26**, wherein said at least one processor is further operably configured to access a list of public network route suppliers when said public network classification criterion is met and to identify at least one of said public network route suppliers that satisfies public network routing selection criteria.

41. (Original) The apparatus of claim **40**, wherein said at least one processor is further operably configured to produce a public network routing message identifying said at least one public network route supplier that satisfies said public network routing selection criteria.

42. (Original) The apparatus of claim **41**, wherein said at least one processor is operably configured to cause said public network routing message to include a gateway supplier identifier identifying a gateway supplier able to establish a communications link in a route through which communications between the caller and callee can be conducted.

43. (Original) The apparatus of claim **42**, wherein said at least one processor is operably configured to cause said public network routing message to include a time value and a timeout value.

44. (Original) The apparatus of claim **42**, wherein said at least one processor is operably configured to cause said public network routing message to include a plurality of gateway supplier identifiers identifying a plurality of gateway suppliers able to supply respective communication links through which communications between the caller and callee can be conducted.

45. (Original) The apparatus of claim **44**, wherein said at least one processor is operably configured to cause said public network routing message to include priority information identifying a priority in which gateway suppliers associated with said gateway identifiers are to

Application No.: 13/966,096
Filing Date: August 13, 2013

be considered for selection of a communication link through which communications between the caller and callee can be conducted.

46. (Original) The apparatus of claim 44, wherein said at least one processor is operably configured to arrange said gateway supplier identifiers in said public network routing message in order of rate, where rate is determined from rate fields of respective said gateway supplier records.

47. (Original) The apparatus of claim 46, wherein said at least one processor is operably configured to arrange said gateway supplier identifiers in order of increasing rate.

48. (Original) The apparatus of claim 42, wherein said at least one processor is operably configured to arrange said gateway supplier identifiers in an order based on at least one provision in a service agreement.

49. (Original) The apparatus of claim 26, wherein said at least one processor is further operably configured to cause the private network routing message or the public network routing message to be communicated to a call controller to effect routing of the call.

50. (Original) A call routing controller apparatus for producing a routing message for routing communications between a caller and a callee in a communication system, the apparatus comprising:

means for using a caller identifier associated with the caller to locate a caller dialing profile comprising a plurality of calling attributes associated with the caller; and

means for, when at least one of said calling attributes and at least a portion of a callee identifier associated with the callee meet private network classification criteria, producing a private network routing message for receipt by a call controller, said private network routing message identifying an address, on the private network, associated with the callee; and

means for, when at least one of said calling attributes and at least a portion of said callee identifier meet a public network classification criterion, producing a public

network routing message for receipt by the call controller, said public network routing message identifying a gateway to the public network.

51. (Original) The apparatus of claim 50, wherein said private network classification criteria include:

a) said callee identifier does not begin with the same digit pattern as an international dialing digit (IDD) attribute of said callee identifier; and

b) said callee identifier does not begin with the same digit pattern as a national dialing digit (NDD) attribute of said callee identifier; and

c) said callee identifier does not begin with the same area code as an area code of said caller; and

said callee identifier does not have a length that is within a range of caller local number lengths; and

said callee identifier is a valid username.

52. (Original) The apparatus of claim 51, further comprising means for identifying the call as a cross-domain call on the private network when said callee identifier identifies a callee that is not associated with the same network node as said caller.

53. (Original) The apparatus of claim 51, further comprising:

means for accessing the database of caller dialing profiles to locate a callee dialing profile for the callee when said callee identifier identifies a callee that is associated with the same network node as said caller; and

means for retrieving call handling information associated with the callee, where said call handling information is available, said call handling information including at least one of call blocking information, call forwarding information, and voicemail information.

54. (Original) The apparatus of claim 53, further comprising, where said call handling information including said call blocking information is available, means for blocking the call being established with the callee when said call blocking information identifies the caller as a caller from whom calls are to be blocked.

Application No.: 13/966,096
Filing Date: August 13, 2013

55. (Original) The apparatus of claim 53, further comprising, means for causing said call forwarding information to be included in said private network routing message, where said call handling information including said call forwarding information is available.

56. (Original) The apparatus of claim 53, further comprising, where said call handling information including said voicemail information is available, means for causing said voicemail information to be included in said private network routing message.

57. (Original) The apparatus of claim 50, further comprising means for accessing a database of direct inward dial records each associating at least one direct inward dial number with at least one subscriber to said communication system.

58. (Original) The apparatus of claim 57, wherein said public network classification criteria include:

- a) said callee identifier begins with the same digit pattern as an international dialing digit (IDD) attribute of said callee identifier; and
- b) a reformatted callee identifier produced by removing the IDD attribute from said callee identifier has no DID record.

59. (Original) The apparatus of claim 57, wherein said public network classification criteria include:

- a) said callee identifier begins with the same digit pattern as a national dialing digit (NDD) attribute of said callee identifier; and
- b) a reformatted callee identifier produced by removing the NDD attribute from said callee identifier and including a caller country code has no DID record.

60. (Original) The apparatus of claim 57, wherein said public network classification criteria include:

- a) said callee identifier begins with the same area code as an area code of said caller; and

Application No.: 13/966,096
Filing Date: August 13, 2013

b) a reformatted callee identifier produced by reformatting the callee identifier to include a caller country code has no DID record.

61. (Original) The apparatus of claim 57, wherein said public network classification criteria include:

a) said callee identifier has a length that is within a range of caller local number lengths; and

b) a reformatted callee identifier produced by reformatting the callee identifier to include a caller country code and area code has no DID record.

62. (Original) The apparatus of claim 50, wherein said plurality of calling attributes includes at least one of an international dialing digits identifier, a national dialing digits identifier, a country code identifier, a local area codes identifier, a caller minimum local length identifier, a caller maximum local length identifier, a reseller identifier, and a maximum number of concurrent calls identifier.

63. (Original) The apparatus of claim 57, wherein said DID record comprises a user name field, a user domain field and a DID number field.

64. (Original) The apparatus of claim 50, further comprising means for accessing a list of public network route suppliers when said public network classification criterion is met and means for identifying at least one of said public network route suppliers that satisfies public network routing selection criteria.

65. (Original) The apparatus of claim 64, wherein said means for producing said public network routing message comprises means for producing a public network routing message identifying said at least one public network route supplier that satisfies said public network routing selection criteria.

66. (Original) The apparatus of claim 65, wherein said means for producing said public network routing message comprises means for causing said public network routing

Application No.: 13/966,096
Filing Date: August 13, 2013

message to include a gateway supplier identifier identifying a gateway supplier able to establish a communications link in a route through which communications between the caller and callee can be conducted.

67. (Original) The apparatus of claim **66**, further comprising means for causing said public network routing message to include a time value and a timeout value.

68. (Original) The apparatus of claim **66**, wherein said means for causing said public network routing message to include said gateway supplier identifier comprises means for causing said public network routing message to include a plurality of gateway supplier identifiers identifying a plurality of gateway suppliers able to supply respective communication links through which communications between the caller and callee can be conducted.

69. (Original) The apparatus of claim **68**, further comprising means for causing said public network routing message to include priority information identifying a priority in which gateway suppliers associated with said gateway identifiers are to be considered for selection of a communication link through which communications between the caller and callee can be conducted.

70. (Original) The apparatus of claim **68**, wherein said means for causing said public network routing message to include priority information includes means for arranging said gateway supplier identifiers in said public network routing message in order of rate, where rate is determined from rate fields of respective said gateway supplier records.

71. (Original) The apparatus of claim **70**, wherein said means for arranging said gateway supplier identifiers in order of rate comprises means for arranging said gateway supplier identifiers in order of increasing rate.

72. (Original) The apparatus of claim **66**, further comprising means for arranging said gateway supplier identifiers in an order based on at least one provision in a service agreement.

73. (Original) The apparatus of claim 50, further comprising means for causing the private network routing message or the public network routing message to be communicated to a call controller to effect routing of the call.

74. (Canceled).

75. (Canceled).

76. (Canceled).

77. (Canceled).

78. (Canceled).

79. (Previously Presented) A method of routing communications in a packet switched network in which a first participant identifier is associated with a first participant and a second participant identifier is associated with a second participant in a communication, the method comprising:

after the first participant has accessed the packet switched network to initiate the communication, using the first participant identifier to locate a first participant profile comprising a plurality of attributes associated with the first participant;

when at least one of the first participant attributes and at least a portion of the second participant identifier meet a first network classification criterion, producing a first network routing message for receipt by a controller, the first network routing message identifying an address in a first portion of the packet switched network, the address being associated with the second participant, the first portion being controlled by an entity; and

when at least one of the first participant attributes and at least a portion of the second participant identifier meet a second network classification criterion, producing a second network routing message for receipt by the controller, the second network routing

Application No.: 13/966,096
Filing Date: August 13, 2013

message identifying an address in a second portion of the packet switched network, the second portion not controlled by the entity.

80. (Previously Presented) The method of Claim 79, wherein the packet switched network comprises the Internet.

81. (Previously Presented) The method of Claim 79, wherein the first participant identifier comprises a first participant telephone number or username.

82. (Previously Presented) The method of Claim 79, wherein the second participant identifier comprises a second participant telephone number or username.

83. (Previously Presented) The method of Claim 79, wherein the communication comprises a voice-over-IP communication.

84. (Previously Presented) The method of Claim 79, wherein the packet switched network is accessed via an Internet service provider.

85. (Previously Presented) The method of Claim 79, wherein the first participant profile further comprises a username and a domain associated with first participant.

86. (Previously Presented) The method of Claim 79, wherein the attributes comprise at least one of an international dialing digit (IDD), a national dialing digit (NDD), an area code, a country code and a number length range.

87. (Previously Presented) The method of Claim 79, wherein the first classification criterion is satisfied when the first participant identifier does not begin with the same international dialing digit (IDD) digit pattern as the second participant identifier.

88. (Previously Presented) The method of Claim 79, wherein the first classification criterion is satisfied when an address associated with the first participant and the address

associated with the second participant are both in the first portion of the packet switched network.

89. (Previously Presented) The method of Claim 79, wherein the address in the first portion is accessible through the first participant's Internet service provider.

90. (Previously Presented) The method of Claim 79, wherein the first portion comprises one or more supernodes.

91. (Previously Presented) The method of Claim 79, further comprising storing in a database a direct inward dial (DID) record associated with at least one of the first participant and the second participant.

92. (Previously Presented) The method of Claim 91, wherein the stored DID record for the second participant comprises a username, a user domain and a record number.

93. (Previously Presented) The method of Claim 79, wherein the entity is an entity supplying communication services for the first portion.

94. (Previously Presented) The method of Claim 79, wherein the second network classification criterion is satisfied when access to the second participant requires routing through a portion of the packet switched network operated by a communication service supplier.

95. (Previously Presented) The method of Claim 91, wherein the second network classification criterion is satisfied when the second participant identifier is not associated with a stored DID record in the database.

96. (Previously Presented) The method of Claim 91, wherein the second network classification criterion is satisfied when:

the second participant identifier begins with the same international dialing digit (IDD) digit pattern as the first participant identifier; and

the second participant identifier, without considering the IDD digit pattern, has no stored DID record in the database.

Application No.: 13/966,096
Filing Date: August 13, 2013

97. (Previously Presented) The method of Claim 79, wherein the address in the second portion of the packet switched network comprises an address accessed by a communication service supplier.

98. (Previously Presented) The method of Claim 79, wherein producing the second network routing message identifying the address in the second portion comprises searching a database of route records associating route identifiers with dialing codes, in an attempt to find a route record having a dialing code with a number pattern matching at least a portion of second participant identifier.

99. (Previously Presented) A system for routing communications in a packet switched network in which a first participant in a communication has an associated first participant identifier and a second participant in the communication has an associated second participant identifier, the system comprising:

a controller comprising:

a processor operably configured to access a memory,

wherein the processor is configured to:

after the first participant has accessed the packet switched network to initiate the communication, locate a first participant profile in the memory using the first participant identifier, the first participant profile comprising a plurality of attributes associated with the first participant;

produce a first network routing message when at least one of the first participant attributes and at least a portion of the second participant identifier meet a first network classification criterion, the first network routing message identifying an address in a first portion of the packet switched network, the address being associated with the second participant, the first portion being controlled by an entity; and

produce a second network routing message when at least one of the first participant attributes and at least a portion of the second participant identifier meet a second network classification criterion, the second network routing message

identifying an address in a second portion of the packet switched network, the second portion not controlled by the entity.

100. (Previously Presented) The system of Claim 99, wherein the communication comprises a voice-over-IP communication.

101. (Previously Presented) The system of Claim 99, wherein the packet switched network is accessed via an Internet service provider.

102. (Previously Presented) The system of Claim 99, wherein the first classification criterion is satisfied when the first participant identifier does not begin with the same international dialing digit (IDD) digit pattern as the second participant identifier.

103. (Previously Presented) The system of Claim 99, wherein the second network classification criterion is satisfied when access to the second participant requires routing through a portion of the packet switched network operated by a communication service supplier.

104. (Previously Presented) A non-transitory computer readable medium comprising instructions that when executed cause a processor to perform a method of routing communications in a packet switched network in which a first participant identifier is associated with a first participant and a second participant identifier is associated with a second participant in a communication, the method comprising:

after the first participant has accessed the packet switched network to initiate the communication, using the first participant identifier to locate a first participant profile comprising a plurality of attributes associated with the first participant;

when at least one of the first participant attributes and at least a portion of the second participant identifier meet a first network classification criterion, producing a first network routing message for receipt by a controller, the first network routing message identifying an address in a first portion of the packet switched network, the address being associated with the second participant, the first portion being controlled by an entity; and

Application No.: 13/966,096
Filing Date: August 13, 2013

when at least one of the first participant attributes and at least a portion of the second participant identifier meet a second network classification criterion, producing a second network routing message for receipt by the controller, the second network routing message identifying an address in a second portion of the packet switched network, the second portion not controlled by the entity.

Application No.: 13/966,096
Filing Date: August 13, 2013

REMARKS

In the Office Action, the Examiner rejected Claims 1-73 and 79-104. Applicant respectfully requests reconsideration of the rejections in light of the amendments and the following remarks. Claims 1-73 and 79-104 are pending.

Discussion of Double Patenting Rejection

The Examiner has provisionally rejected Claims 1-73 and 79-104 on the ground of non-statutory double patenting as being unpatentable over Claims 1-111 of U.S. Patent No. 8,542,815. *Office Action*, p. 3. If appropriate, Applicant will further address the rejection when the claims are otherwise in condition for allowance.

Discussion of Claim Rejections Under 35 U.S.C. § 103(a)

The Examiner has rejected Claims 1, 13, 15-17, 19-26, 38, 40-42, 44-50, 62, 64-66, 68-73, and 79-104 as being unpatentable over Alexander et al. (U.S. Patent No. 6,798,767). Applicant respectfully submits that all pending claims are patentable over the prior art of record as discussed below.

Standard of *Prima facie* Obviousness

The Patent and Trademark Office has the burden under section 103 to establish a *prima facie* case of obviousness. The rationale to support a conclusion that the claim would have been obvious is that **all the claimed elements** were known in the prior art and one skilled in the art could have combined the elements as claimed by known methods with no change in their respective functions, and the combination yielded nothing more than predictable results to one of ordinary skill in the art. It can be important to identify **a reason that would have prompted a person of ordinary skill in the relevant field to combine the elements** in the way the claimed new invention does. If any of these findings cannot be made, then this rationale cannot be used to support a conclusion that the claim would have been obvious to one of ordinary skill in the art. M.P.E.P. § 2143; *see also KSR v. Teleflex*, 82 U.S.P.Q.2d 1385 (2007); *In re Royka*, 180 U.S.P.Q. 580 (1974).

Application No.: 13/966,096
Filing Date: August 13, 2013

Additionally, MPEP § 2143 states that “[t]he key to supporting any rejection under 35 U.S.C. 103 is the **clear articulation** of the reason(s) why the claimed invention would have been obvious. *Id.* The Supreme Court in *KSR* noted that the analysis supporting a rejection under 35 U.S.C. 103 should be **made explicit**” (emphasis added). See *KSR v. Teleflex*, 550 US 398 (2007).

Discussion of Patentability of Pending Claims

Applicant’s independent Claim 1 recites:

using a caller identifier associated with the caller to locate a caller dialing profile comprising a plurality of calling attributes associated with the caller;

Alexander generally relates to a “system and method for generating multiple line appearances in a communication network.” *Alexander*, col. 1, ll. 7-10. The Examiner states that a call manager of Alexander “obviously stores attributes of IP phone 22, including user's or caller's name, telephone number and IP address, etc.” *Office Action*, p. 4. The Examiner also references that figures 1-3 and column 5, line 52 - column 7, line 45 disclose the above feature. The Examiner appears to suggest that the call manager 26 illustrated in FIG. 2 of Alexander uses a caller identifier “to locate a caller dialing profile comprising a plurality of calling attributes associated with the caller” as recited in Claim 1. Applicant respectfully submits that neither the call manager 26 nor any other part of the Alexander system uses a caller identifier to locate a caller dialing profile comprising a plurality of calling attributes.

For example, Alexander discloses that when a call is initiated, and “once call manager 26a receives the call initiation request, call manager 26a sends a signal to the target IP telephony device offering the call to the telephony device.” *Alexander*, col. 6, ll. 28-31. Nowhere does Alexander disclose that the call initiation request comprises a caller identifier much less is used to locate a caller dialing profile comprising a plurality of calling attributes. Indeed, FIG. 5A of Alexander discloses that the call manager receives a call initiation request and “determines the telephone number of the target telephony device from the call initiation request and determines an associated IP address 124 of the target telephony device using mapping tables 120a and 120b.” *Id.* at col. 10, ll. 37-42. Alexander is completely silent as to performing any functions

Application No.: 13/966,096
Filing Date: August 13, 2013

related to the caller or caller dialing profile and only locates a callee telephone number. Therefore the telephone number of the target telephony device that is located by Alexander is not a dialing profile associated with the caller as in Applicant's claimed invention. Alexander makes no mention of locating any information associated with the caller and provides no suggestion or motivation to do so. Furthermore, while the entries in the database tables of Alexander include callee phone number, device/group name and IP address, none of these entries can be regarded by one skilled in the art as a "calling attribute associated with the caller." *See id.* at FIGs. 1-4B, col. 8, l. 47-col. 9, l. 15. Therefore, it is respectfully submitted that Alexander fails to disclose *using a caller identifier associated with the caller to locate a caller dialing profile comprising a plurality of calling attributes associated with the caller*, as claimed by Applicant.

Additionally, the Examiner provides no explicit citation (e.g., pinpoint cite) to Alexander as disclosing "using a caller identifier associated with the caller to locate a caller dialing profile." *See Office Action*, p. 4. Instead, the Examiner makes a conclusory statement that the call manager of Alexander "obviously stores attributes of IP phone 22, including user's or caller's name, telephone number and IP address, etc." *Office Action*, p. 4. The Examiner is reminded that "whenever, on examination, any claim for a patent is rejected, or any objection ... made, notification of the reasons for rejection and/or objection together with such information and references as may be useful in judging the propriety of continuing the prosecution (35 U.S.C. 132) should be given." *M.P.E.P.* § 707. Additionally, MPEP § 2143, citing *KSR*, states that "[t]he key to supporting any rejection under 35 U.S.C. 103 is the **clear articulation** of the reason(s) why the claimed invention would have been obvious. The Supreme Court in *KSR* noted that the analysis supporting a rejection under 35 U.S.C. 103 should be **made explicit**" (emphasis added, see also *KSR*, 550 US at 408-410).

Applicant respectfully submits that the Examiner's conclusory statement, without citing to specific portion(s) of Alexander, amounts to depriving Applicant of the opportunity to respond completely and with particularity as to why the claims are patentable. Thus, if the Examiner wishes to sustain the rejection of Claim 1 based on the Alexander, the Examiner is respectfully requested to "clearly articulate any rejection early in the prosecution process so the applicant has the opportunity to provide evidence of patentability and otherwise respond completely at the earliest opportunity." *See M.P.E.P.* § 706. More particularly, the Examiner is respectfully

Application No.: 13/966,096
Filing Date: August 13, 2013

requested to provide the Applicant with specific citations to passages of Alexander and to explain where and how Alexander teaches that the call manager “obviously stores attributes of IP phone 22, including user's or caller's name, telephone number and IP address, etc.” See *Office Action*, p. 4.

Instead of making an explicit citation to the reference, it appears that the Examiner is making an inherency argument that the call manager of Alexander “obviously stores attributes of IP phone 22, including user's or caller's name, telephone number and IP address, etc.” *Id.* at p. 4. “The inherent teaching of a prior art reference, a question of fact, arises both in the context of anticipation and obviousness.” *In re Napier*, 55 F.3d 610, 613 (Fed. Cir. 1995). However, the Examiner must provide rationale or evidence tending to show inherency. See MPEP 2112.IV. The fact that a certain result or characteristic may occur or be present in the prior art is not sufficient to establish the inherency of that result or characteristic. *In re Rijckaert*, 9 F.3d 1531, 1534 (Fed. Cir. 1993) (reversed rejection because inherency was based on what would result due to optimization of conditions, not what was necessarily present in the prior art). “To establish inherency, the extrinsic evidence ‘must make clear that the missing descriptive matter is necessarily present in the thing described in the reference, and that it would be so recognized by persons of ordinary skill.’” *In re Robertson*, 169 F.3d 743, 745 (Fed. Cir. 1999). “In relying upon the theory of inherency, the examiner must provide a basis in fact and/or technical reasoning to reasonably support the determination that the allegedly inherent characteristic necessarily flows from the teachings of the applied prior art.” *Ex parte Levy*, 17 USPQ2d 1461, 1464 (Bd. Pat. App. & Inter. 1990). Additionally, “[o]bviousness cannot be predicated on what is not known at the time an invention is made, even if the inherency of a certain feature is later established.” M.P.E.P. § 2141.02 at ¶ V (citing *In re Rijckaert*, 9 F.2d 1531). Therefore, when used in an obviousness rejection, any reliance on what is inherent must be supported by what was known at the time of the invention.

Applicant respectfully submits that the Examiner has made no finding or referred to any evidence that a person of ordinary skill in the art (POSITA) would have recognized that the call manager of Alexander inherently “stores attributes of IP phone 22” at the time of the invention. The Examiner has not shown that the call manager necessarily stores such attributes and instead makes the conclusory statement that the call manager “obviously stores attributes of IP phone 22,

Application No.: 13/966,096
Filing Date: August 13, 2013

including user's or caller's name, telephone number and IP address, etc.” Indeed, Alexander’s disclosure with respect to routing implies that storing attributes of the caller is not necessary because the call manager “sends a signal to the target IP telephony device offering the call to the telephony device” based on the call manager locating the callee IP address or gateway and not based on any calling attribute associated with the caller. *See Alexander*, FIG. 5A, col. 6, ll. 28-55. For the sake of argument, even if the call manager did store “attributes of IP phone 22,” Alexander does not disclose that the call manager uses “a caller identifier associated with the caller to locate a caller dialing profile comprising” the attributes, as recited in Claim 1. Therefore, Applicant respectfully submits that the Examiner has not met the burden of presenting a *prima facie* ground to support an obviousness rejection based on his apparent inherency assertion.

Claim 1 also recites:

when at least one of said calling attributes and at least a portion of a callee identifier associated with the callee meet private network classification criteria, producing a private network routing message for receipt by a call controller, said private network routing message identifying an address, on the private network, associated with the callee;

The Examiner takes the position that “when phone 22 calls phone 23, both are identified, by either phone number or IP address, as IP phones within the same LAN 20a” corresponds to Claim 1’s feature of “when at least one of said calling attributes and at least a portion of a callee identifier associated with the callee meet private network classification criteria.” *See Office Action*, p. 4. Here, the Examiner does not reference a specific passage of Alexander that discloses this feature. Again, Applicant notes that “whenever, on examination, any claim for a patent is rejected, or any objection ... made, notification of the reasons for rejection and/or objection together with such information and references as may be useful in judging the propriety of continuing the prosecution (35 U.S.C. 132) should be given.” *M.P.E.P.* § 707. As discussed above, when attempting to route a call, Alexander locates a database table entry associated with the callee, not the caller and neither describes nor suggests anything like a calling attribute of the

Application No.: 13/966,096
Filing Date: August 13, 2013

type recited in Applicant's claims. For the sake of argument, even if it could be shown that a field of any of the entries in Alexander's database table (120) could be interpreted to be a calling attribute, such attribute would be associated with the callee and not the caller. Moreover, there is no disclosure in Alexander of determining "when at least one of said calling attributes and at least a portion of a callee identifier associated with the callee meet private network classification criteria" and producing the private network routing message when such criteria is met. Instead, Alexander only describes a call manager that performs a table lookup to determine the IP address of the target telephony device and "directs the call to the target telephony device by signaling the target telephony device." *Alexander*, col. 10, ll. 37-45, FIG. 5A. The call manager in Alexander does not make a determination of whether "at least one of said calling attributes and ... meet private network classification criteria."

Additionally, the Examiner correctly observed that "Alexander does not explicitly discloses [sic] a routing message." *Office Action*, p. 4. However, the Examiner suggests that the call manager "obviously producing a private network routing message for receipt by a call controller (a call router in LAN 20a; figure 5A, steps 204-208)." *Id.* Applicant respectfully submits that none of the passages cited by the Examiner, or any other disclosure in Alexander, discloses or suggests the production of a private network routing message. Applicant respectfully submits that routing provides the path selection in a network, based on different criteria. Routing does not transfer useful payload (e.g., voice, video, data), as forwarding does, but routing tells how/which way to forward packets with payload. Applicant directs the Examiner to column 6, lines 28-31 of Alexander which states, in reference to whether the originating telephony device is an IP telephony device or a non-IP telephony device: "In either case, once call manager 26a receives the call initiation request, call manager 26a sends a signal to the target IP telephony device offering the call to the telephony device." Furthermore, column 10, lines 37-45 describe steps 204-208 of FIG. 5A and disclose that "Call manager 26 directs the call to the target telephony device by signaling the target telephony device to indicate the presence of the incoming call at step 206." *See also*, Alexander at FIG. 5A. There is nothing to suggest that this signal or signaling is a routing message in the sense one skilled in the art would understand this term, and it seems quite clear that the call manager sends a signal directly to the target IP telephony device to try to set up the call. When describing calls between devices in different

Application No.: 13/966,096
Filing Date: August 13, 2013

LANs, Alexander discloses that “a router (or other similar device) directs the [data] packets to the IP address of the target IP telephony device 25.” *See Alexander*, col. 6, ll. 1-17. However, as clearly stated in Alexander, the router only forwards data packets, **not routing messages**, to the address of the target IP telephony device. Contrast this with the Applicant’s Claim 1 which recites that the private network routing message is produced and provides path selection (i.e., “an address, on the private network, associated with the callee”) based on certain criteria (i.e., private network classification criteria).

Indeed, in the Private Branch Exchange (PBX) system of Alexander, once an IP address is known to an IP telephony device, it may directly initiate a connection on its own to another LAN/WAN connected IP telephony device without the need for routing messages to direct the call to the other IP telephony device. Contrast this with Applicant’s Claim 1 which recites that the private network routing message is for receipt by a call controller. Simply put, a person of ordinary skill in the art (POSITA) would recognize that the target IP telephony device of Alexander is not a call controller. The Examiner takes the position that the call manager is “obviously producing a private network routing message for receipt by a call controller (a call router in LAN 20a; figure 5A, steps 204-208).” Applicant respectfully submits it is unclear whether the Examiner is stating a call router in LAN 20a is a call controller or whether the Examiner meant to say a “call manager” in LAN 20a is a call controller. If the Examiner believes that there exists a call router in LAN 20a that is the call controller, then Applicant respectfully refers the Examiner again to column 6, lines 1-17, which contain the only mention of a “router” in Alexander. As discussed above, this router only receives and forwards **data packets** and not a **private network routing message** as recited in Claim 1. Thus, the router does not correlate to the call controller recited in Claim 1.

If the Examiner meant to write “call manager” instead of “call router,” Applicant respectfully submits call manager 26a in LAN 20a is not a call controller because that would mean that the call manager both produces and receives a private network routing message. There is no disclosure in Alexander that the call manager sends a private network routing message to itself. Therefore, Alexander’s “call manager” does not and cannot correlate to the call controller recited in Claim 1.

Application No.: 13/966,096
Filing Date: August 13, 2013

Thus, while Alexander may disclose that the call manager “controls call processing, routing, telephone features and options, device configuration and other telephony functions and parameters” and that the call manager may route calls in the sense that it decides which device to send a call signal to, however, as discussed above, there is nothing in Alexander that discloses or suggests producing a routing message at all, let alone producing a private network routing message and sending it to a call controller “when at least one of said calling attributes and at least a portion of a callee identifier associated with the callee meet private network classification criteria.”

Similarly, since Alexander does not disclose a private network routing message, *a fortiori*, Alexander also does not disclose that a private network routing message identifies “an address, on the private network, associated with the callee.” Therefore, it is respectfully submitted that Alexander fails to recite *when at least one of said calling attributes and at least a portion of a callee identifier associated with the callee meet private network classification criteria, producing a private network routing message for receipt by a call controller, said private network routing message identifying an address, on the private network, associated with the callee*, as recited in Claim 1.

Since the Examiner correctly observed that “Alexander does not explicitly discloses [sic] a routing message,” the Examiner appears to be making another inherency argument that the call manager of Alexander is “obviously producing a private network routing message for receipt by a call controller (a call router in LAN 20a; figure 5A, steps 204-208).” *Office Action*, p. 4. Applicant respectfully submits that the Examiner has made no finding or referred to any evidence that a POSITA would have recognized at the time of the invention that the call manager of Alexander inherently produces “a private network routing message for receipt by a call controller.” The Examiner has not shown that the call manager necessarily produces the private network routing message, while conceding that “Alexander does not explicitly discloses a routing message.” *See id.* For the sake of argument, even if the call manager did produce a “private network routing message” as suggested by Examiner, Alexander does not disclose a private network routing message being produced for receipt by a call controller. The Examiner merely makes a conclusory statement and implies that there must be an unidentified “call router in LAN 20a” that would receive the private network routing message, as recited in Claim 1. Additionally,

Application No.: 13/966,096
Filing Date: August 13, 2013

and again for the sake of argument, even if the call manager did produce a “private network routing message” as suggested by Examiner, Alexander does not disclose a private network routing message being produced “when at least one of said calling attributes and at least a portion of a callee identifier associated with the callee meet private network classification criteria” as recited in Claim 1. Therefore, Applicant respectfully submits that the Examiner has not met the burden of presenting a *prima facie* ground to support an obviousness rejection based on his apparent inherency assertion.

As discussed above, the Examiner concedes that “Alexander does not explicitly disclose [sic] a routing message” and instead relies on Moss et al. US 5,917,899, column 4, lines 59-61, and Buckley US 2007/0217354, paragraph [0020] as disclosing a routing message. *Office Action*, p. 4. The cited portion of Moss discloses a switching control point (SCP) that “sends an analyzed route message containing a routing instruction.” Moss, col. 4, ll. 59-63. However, there is no disclosure in Moss that this analyzed route message is produced “when at least one of said calling attributes and at least a portion of a callee identifier associated with the callee meet private network classification criteria” or that the analyzed route message is “for receipt by a call controller” as recited by Claim 1.

The cited portion of Buckley discloses that a voice call continuity (VCC) application server (AS) node “is operable to effectuate generation of appropriate routing messages when a call is originated by a UE device.” Buckley, [0020]. There is no disclosure in Buckley that these routing messages are produced “when at least one of said calling attributes and at least a portion of a callee identifier associated with the callee meet private network classification criteria” or that the routing messages are “for receipt by a call controller.” On the contrary, Buckley only mentions that routing messages are generated “when a call is originated by a UE device.”

Accordingly, neither Moss nor Buckley cure the deficiencies of Alexander discussed above with respect to producing a private network routing message for receipt by a call controller much less “when at least one of said calling attributes and at least a portion of a callee identifier associated with the callee meet private network classification criteria.”

Lastly, the Examiner’s statement that “it was well known in the art that a network control node produced a routing message to route a call through a network, see Moss et al. US 5,917,899, column 4, lines 59-61, also Buckley US 2007/0217354, paragraph [0020]”, has not

Application No.: 13/966,096
Filing Date: August 13, 2013

met the burden of presenting a *prima facie* ground to support an obviousness rejection based on such a limited assertion as to what the secondary references may disclose.

As discussed above, “it can be important to identify **a reason that would have prompted a person of ordinary skill in the relevant field to combine the elements** in the way the claimed new invention does” (emphasis added). *KSR*, 550 U.S. at 403. “Although the Supreme Court in *KSR* cautioned against an overly rigid application of [teaching, suggestion, or motivation] TSM, it also recognized that TSM was one of a number of valid rationales that could be used to determine obviousness.” M.P.E.P. § 2141; *see also KSR*, 550 U.S. at 418. Obviousness can be established by combining or modifying the teachings of the prior art to produce the claimed invention where there is some teaching, suggestion, or motivation to do so. *In re Kahn*, 441 F.3d 977, 986, 78 USPQ2d 1329, 1335 (Fed. Cir. 2006). However, a statement that modifications of the prior art to meet the claimed invention would have been “‘well within the ordinary skill of the art at the time the claimed invention was made’” because the references relied upon teach that all aspects of the claimed invention were individually known in the art is not sufficient to establish a *prima facie* case of obviousness without some objective reason to combine the teachings of the references. See M.P.E.P. § 2143.01 (citing *Ex parte Levengood*, 28 USPQ2d 1300 (Bd. Pat. App. & Inter. 1993). “[R]ejections on obviousness cannot be sustained by mere conclusory statements; instead, there must be some articulated reasoning with some rational underpinning to support the legal conclusion of obviousness.” *KSR*, 550 U.S. at 418, (quoting *In re Kahn*, 441 F.3d 977, 988, 78 USPQ2d 1329, 1336 (Fed. Cir. 2006)).

Here, the Examiner has not met the *KSR* burden of providing an articulated reason for combining the cited prior art references. Instead, the Examiner merely states that it was known that routing messages can be used to route calls through a network and has not provided any rationale how a POSITA would have combined the routing of Alexander, which does not contain a routing message, let alone a private network routing message produced “when at least one of said calling attributes and at least a portion of a callee identifier associated with the callee meet private network classification criteria”, with a generic routing message of Moss and/or Buckley to arrive at Applicant’s claimed invention. Therefore, Applicant respectfully submits that the Examiner has not met the burden of presenting a *prima facie* ground to support an obviousness rejection, and thus, it is improper and must be withdrawn.

Application No.: 13/966,096
Filing Date: August 13, 2013

Claim 1 further recites:

when at least one of said calling attributes and at least a portion of said callee identifier meet a public network classification criterion, producing a public network routing message for receipt by the call controller, said public network routing message identifying a gateway to the public network;

As similarly discussed above with respect to private network classification criteria, Applicant respectfully submits that there is no disclosure by Alexander to determine when at least one of said calling attributes and at least a portion of a callee identifier associated with the callee meet public network classification criteria. To the contrary, the call manager in Alexander simply looks up the callee number in the mapping table (120) to find the associated IP address and causes the call signal to be routed there. *See Alexander*, col. 10, ll. 37-41. Alexander fails to disclose or suggest any criteria that are used in conjunction with the comparison involving calling attributes of the caller, a portion of the callee identifier, and public network classification criterion, as recited in Claim 1 to classify a call. Rather, in Alexander, it appears that calls are merely routed to the gateway associated with the callee, when the callee is on a public network, where the gateway is identified by an entry associated with the callee in the database table (120). The Examiner has not presented any suggestion or motivation for a POSITA to modify Alexander to classify a call as a public network call “when at least one of said calling attributes and at least a portion of said callee identifier meet a public network classification criterion.”

Therefore, it is respectfully submitted that Alexander fails to disclose or suggest *when at least one of said calling attributes and at least a portion of said callee identifier meet a public network classification criterion, producing a public network routing message for receipt by the call controller, said public network routing message identifying a gateway to the public network*, as recited in Claim 1.

Applicant further wishes to draw the Examiner’s attention to the fact that Claim 1 recites two separate and distinct routing messages, a private network routing message and a public network routing message. As the Examiner concedes, “Alexander does not explicitly disclose [sic] a routing message,” let alone two different and distinct routing messages performing

Application No.: 13/966,096
Filing Date: August 13, 2013

different functions. *Office Action*, p. 4. For the sake of argument, even if the Examiner's conclusory statement that the call manager of Alexander is "obviously producing" routing messages, there is no mention of different types of routing messages that are produced when different classification criteria are met. Accordingly, Applicant further respectfully submits that Alexander fails to disclose all the features recited in Claim 1.

Additionally, Applicant's arguments above with respect to the Examiner's apparent position of inherency that the call manager "obviously" produces a private network routing message and with respect to the combination with Moss and/or Buckley also apply to producing the public network routing message. Thus, Applicant respectfully submits that the Examiner has not met the Office's burden of presenting a *prima facie* ground to support an obviousness rejection based on his apparent inherency assertion and his asserted combination, and thus, the rejection is improper and must be withdrawn.

Applicant has made the observation that the Examiner addressed independent Claims 1, 26 and 50 together in the Office Action. *Office Action*, p. 4. Thus, Applicant respectfully submits that independent Claims 26 and 50 recite at least similar patentable features to those specified in Claim 1 and are also patentable over Alexander for similar reasons as discussed above with respect to Claim 1.

Applicant has made the observation that the Examiner addressed independent Claims 79, 99, and 104 together in the Office Action. *Office Action*, p. 6. In rejecting Claims 79, 99, and 104, the Examiner stated that "Alexander teaches a packet switching network LAN 20 (column 4, line 63 - column 5, line 5; column 6, lines 1-8), and the rest limitations as in claim 1." *Id.* For the sake of argument, even if Alexander indicates the existence of a packet switching network, as discussed above, Alexander does not disclose the limitations of Claim 1. Accordingly, Claims 79, 99, and 104 are similarly patentable over Alexander because they recite at least similar patentable limitations to those specified in Claim 1. Applicant respectfully requests withdrawal of the rejections for independent Claims 1, 26, 50, 79, 99 and 104.

The Examiner has rejected Claims 2-7, 27-32 and 51-56 under pre-AIA 35 U.S.C. 103(a) as being unpatentable over Alexander in view of Stucker (U.S. Patent No. 7,010,727). *Office Action* at p. 8. Applicant respectfully submits that Stucker fails to cure the deficiencies of Alexander identified above. Furthermore, Claims 2-7, 27-32 and 51-56 depend directly or

Application No.: 13/966,096
Filing Date: August 13, 2013

indirectly on one of independent Claims 1, 26 or 50 and are patentable over the combination of Alexander and Stucker at least by virtue of their dependency.

The Examiner rejected Claims 8-12, 14, 33-37, 39, 57-61 and 63 under 35 U.S.C. § 103(a) as being unpatentable over Alexander in view of Tada et al. (U.S. Patent No. 6,597,783). *Office Action* at p. 10. Applicant respectfully submits that Tada fails to cure the deficiencies of Alexander identified above. Furthermore, Claims 8-12, 14, 33-37, 39, 57-61 and 63 depend directly or indirectly on one of independent Claims 1, 26 or 50 and are patentable over the combination of Alexander and Tada at least by virtue of their dependency.

The Examiner rejected Claims 18, 43, and 67 under 35 U.S.C. § 103(a) as allegedly being unpatentable over Alexander in view of Han (U.S. Patent No. 6,873,599). *Office Action* at p. 11. Applicant respectfully submits that Han fails to cure the deficiencies of Alexander identified above. Furthermore, Claims 18, 43, and 67 depend directly or indirectly on one of independent Claims 1, 26 or 50 and are patentable over the combination of Alexander and Han at least by virtue of their dependency.

Discussion of Dependent Claims

Although Applicant has not addressed all the issues of the dependent claims, Applicant respectfully submits that Applicant does not necessarily agree with the characterization and assessments of the dependent claims made by the Examiner, and Applicant believes that each claim is patentable on its own merits. The dependent claims are dependent either directly or indirectly on the above-discussed independent claims. Applicant respectfully submits that pursuant to 35 U.S.C. § 112, ¶ 4, the dependent claims incorporate by reference all the features of the claim to which they refer and include their own patentable features, and are therefore in condition for allowance. Therefore, Applicant respectfully requests the withdrawal of all claim rejections and prompt allowance of the claims.

Official Notice

Applicant wishes to place on the record that official notice unsupported by documentary evidence should only be taken by the examiner where the facts asserted to be well-known, or to be common knowledge in the art are capable of **instant and unquestionable demonstration** as

Application No.: 13/966,096
Filing Date: August 13, 2013

being well-known. As noted by the court in *In re Ahlert*, 424 F.2d 1088, 1091, 165 USPQ 418, 420 (CCPA 1970), the notice of **facts** beyond the record which may be taken by the examiner **must be “capable of such instant and unquestionable demonstration as to defy dispute”** (citing *In re Knapp Monarch Co.*, 296 F.2d 230, 132 USPQ 6 (CCPA 1961)). MPEP § 2144.03 (emphasis added).

Regarding Claims 84 and 101, the Examiner took “official notice that it was well known and obvious for computer 44 and IP phone 44 to access Internet 40 via an Internet service provider.” *Office Action*, p. 6. Applicant respectfully submits that the Official Notice is improper and respectfully requests that, if the rejection is to be maintained, the factual assertions made by the Examiner be supported by adequate evidence per MPEP § 2144.03(C).

Regarding Claim 85, the Examiner took “official notice that it was well known and obvious that an IP phone is associated with a user name and domain name.” *Office Action*, p. 7. Applicant respectfully submits that the Official Notice is improper and respectfully requests that, if the rejection is to be maintained, the factual assertions made by the Examiner be supported by adequate evidence per MPEP § 2144.03(C).

Regarding Claims 4-7, 29-32 and 53-56, the Examiner took “official notice that it was well known and obvious that a telephone subscriber was able to set up a call profile for managing his incoming calls.” *Office Action*, p. 9. Applicant respectfully submits that the Official Notice is improper and respectfully requests that, if the rejection is to be maintained, the factual assertions made by the Examiner be supported by adequate evidence per MPEP § 2144.03(C).

Regarding Claims 9, 34 and 58, the Examiner took “official notice that it would be obvious that an international call (which would be terminated outside LAN 20a) initiated by IP phone 22 would be routed through a public network (i.e. Internet or 40 of PSTN 60, see figure 1).” *Office Action*, p. 10. Applicant respectfully submits that the Official Notice is improper and respectfully requests that, if the rejection is to be maintained, the factual assertions made by the Examiner be supported by adequate evidence per MPEP § 2144.03(C).

Regarding Claims 10, 35 and 59, the Examiner took “official notice that it would be obvious to route a call initiated by IP phone 22 with national digit (which would be terminated outside LAN 20a) would be routed through PSTN 60.” *Office Action*, p. 10. Applicant respectfully submits that the Official Notice is improper and respectfully requests that, if the

Application No.: 13/966,096
Filing Date: August 13, 2013

rejection is to be maintained, the factual assertions made by the Examiner be supported by adequate evidence per MPEP § 2144.03(C).

Regarding Claims 11, 36 and 60, the Examiner took “official notice that it would be obvious to route a call initiated by IP phone 22 with area code national digit (which would be terminated outside LAN 20a) would be routed through PSTN 60.” *Office Action*, p. 11. Applicant respectfully submits that the Official Notice is improper and respectfully requests that, if the rejection is to be maintained, the factual assertions made by the Examiner be supported by adequate evidence per MPEP § 2144.03(C).

Regarding Claims 12, 37 and 61, the Examiner took “official notice that it would be obvious that a callee's identification has a length within the range of a national dialing plan, e.g. a North America Dialing Plan, or NANP.” *Office Action*, p. 11. Applicant respectfully submits that the Official Notice is improper and respectfully requests that, if the rejection is to be maintained, the factual assertions made by the Examiner be supported by adequate evidence per MPEP § 2144.03(C).

Co-Pending Applications of Assignee

Applicant wishes to draw the Examiner's attention to the following co-pending applications assigned to Applicant's assignee.

Docket No.	Serial No.	Title	Filed
DIGIF.001C2 (formally known as SMARB19.001C2)	14/029671	Determining a Time to Permit a Communications Session to be Conducted	09/17/13
DIGIF.001C4 (formally known as SMARB19.001C4)	14/325181	Allocating Charges for Communications Services	07/07/14
DIGIF.002C1 (formally known as SMARB19.002C1)	13/863306	Intercepting Voice Over IP Communications and Other Data Communications	04/15/13
DIGIF.003C1 (formally known as SMARB19.003C1)	13/968217	Emergency Assistance Calling for Voice Over IP Communications Systems	08/15/13
DIGIF.004C1 (formally known as SMARB19.004C1)	14/035806	Mobile Gateway	09/24/13

Application No.: 13/966,096
Filing Date: August 13, 2013

DIGIF.005C1 (formally known as SMARB19.005C1)	14/092831	Uninterrupted Transmission of Internet Protocol Transmissions During Endpoint Changes	11/27/13
---	-----------	---	----------

Conclusion

Although the present communication may include alterations to the application or claims, or characterizations of claim scope or referenced art, Applicant is not conceding in this application that previously pending claims are not patentable over the cited references. Rather, any alterations or characterizations are being made to facilitate expeditious prosecution of this application. Applicant reserves the right to pursue at a later date any previously pending or other broader or narrower claims that capture any subject matter supported by the present disclosure, including subject matter found to be specifically disclaimed herein or by any prior prosecution. Accordingly, reviewers of this or any parent, child or related prosecution history shall not reasonably infer that Applicant has made any disclaimers or disavowals of any subject matter supported by the present application.

Applicant has endeavored to address all of the Examiner's concerns as expressed in the outstanding Office Action. In light of the above remarks, reconsideration and withdrawal of the outstanding rejections is respectfully requested. If the Examiner has any questions which may be answered by telephone, the Examiner is invited to call the undersigned directly.

Any remarks in support of patentability of one claim should not be imputed to any other claim in this or a related application, even if similar terminology is used. Any remarks referring to only a portion of a claim should not be understood to base patentability on solely that portion; rather, patentability must rest on each claim taken as a whole.

Application No.: 13/966,096
Filing Date: August 13, 2013

Please charge any additional fees, including any fees for additional extension of time, or credit overpayment to Deposit Account No. 11-1410.

Respectfully submitted,

KNOBBE, MARTENS, OLSON & BEAR, LLP

Dated: _____

5/14/15

By: _____

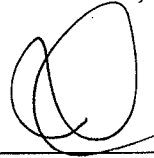

John M. Carson
Registration No. 34,303
Attorney of Record
Customer No. 20995
(858) 707-4000

20441102
041415

INFORMATION DISCLOSURE STATEMENT

Inventor	:	Clay Perreault, et al.
App. No.	:	13/966,096
Filed	:	August 13, 2013
For	:	PRODUCING ROUTING MESSAGES FOR VOICE OVER IP COMMUNICATIONS
Examiner	:	Sing, Simon P.
Art Unit	:	2653
Conf. No.	:	8712

Mail Stop Amendment
Commissioner for Patents
P.O. Box 1450
Alexandria, VA 22313-1450

References and Listing

Pursuant to 37 CFR 1.56, an Information Disclosure Statement listing references is provided herewith. Copies of any listed foreign and non-patent literature references are being submitted.

No Disclaimers

To the extent that anything in the Information Disclosure Statement or the listed references could be construed as a disclaimer of any subject matter supported by the present application, Applicant hereby rescinds and retracts such disclaimer.

Timing of Disclosure

This Information Disclosure Statement is being filed after receipt of a First Office Action, but before the mailing date of a Final Action and before the mailing date of a Notice of Allowance. This Statement is accompanied by the fees set forth in 37 CFR.1.17(p). The

Application No.: 13/966,096
Filing Date: August 13, 2013

Commissioner is hereby authorized to charge any additional fees which may be required or to credit any overpayment to Account No. 11-1410.

Respectfully submitted,
KNOBBE, MARTENS, OLSON & BEAR, LLP

Dated: 5/14/15

By: 
John M. Carson
Registration No. 34,303
Attorney of Record
Customer No. 20995
(858) 707-4000

IDS
20683524
051415

INFORMATION DISCLOSURE STATEMENT BY APPLICANT	Application No.	13/966,096
	Filing Date	August 13, 2013
	First Named Inventor	Perreault, Clay
	Art Unit	2653
<i>(Multiple sheets used when necessary)</i>	Examiner	Sing, Simon P.
SHEET 1 OF 5	Attorney Docket No.	DIGIF.001C1

U.S. PATENT DOCUMENTS					
Examiner Initials	Cite No.	Document Number <i>Number - Kind Code (if known)</i> Example: 1,234,567 B1	Publication Date MM-DD-YYYY	Name	Pages, Columns, Lines Where Relevant Passages or Relevant Figures Appear
	1	7,958,233 B2	06-07-2011	Gutierrez, Alvaro Fernández	
	2	8,078,164 B2	12-13-2011	Ganesan, Vasudevan	
	3	8,127,005 B2	02-28-2012	Gutierrez, Alvaro Fernández	
	4	8,166,547 B2	04-24-2012	Bevan et al.	
	5	8,190,739 B2	05-29-2012	Gutierrez, Alvaro Fernández	
	6	8,223,927 B2	07-17-2012	Di Serio et al.	
	7	8,300,632 B2	10-30-2012	Davis et al.	
	8	8,315,521 B2	11-20-2012	Leiden et al.	
	9	8,396,445 B2	03-12-2013	Crawford et al.	
	10	8,526,306 B2	09-03-2013	Jungck et al.	
	11	8,542,815 B2	09-24-2013	Perreault et al.	
	12	8,599,747 B1	12-03-2013	Saleem et al.	
	13	8,599,837 B2	12-03-2013	Kyle, Andre B.	
	14	8,634,838 B2	01-21-2014	Hellwig et al.	
	15	8,774,378 B2	07-08-2014	Björzell et al.	
	16	8,819,566 B2	08-26-2014	Mehin et al.	
	17	8,848,887 B2	09-30-2014	Willman et al.	
	18	8,862,701 B2	10-14-2014	Havriluk, George	
	19	8,885,609 B2	11-11-2014	Nix, John A.	
	20	8,903,051 B2	12-02-2014	Li et al.	
	21	8,903,360 B2	12-02-2014	Celi, Jr. et al.	
	22	8,909,556 B2	12-09-2014	Huxham, Horatio Nelson	
	23	8,938,209 B2	01-20-2015	Crawford et al.	
	24	8,938,534 B2	01-20-2015	Le et al.	
	25	8,948,061 B2	02-03-2015	Sridhar, Sriram	
	26	8,972,612 B2	03-03-2015	Le et al.	
	27	8,982,719 B2	03-17-2015	Seetharaman et al.	
	28	8,995,428 B2	03-31-2015	Haster, Lars-Olof	

Examiner Signature	Date Considered
*Examiner: Initial if reference considered, whether or not citation is in conformance with MPEP 609. Draw line through citation if not in conformance and not considered. Include copy of this form with next communication to applicant.	

INFORMATION DISCLOSURE STATEMENT BY APPLICANT	Application No.	13/966,096	
	Filing Date	August 13, 2013	
	First Named Inventor	Perreault, Clay	
	Art Unit	2653	
<i>(Multiple sheets used when necessary)</i>		Examiner	Sing, Simon P.
SHEET 2 OF 5		Attorney Docket No.	DIGIF.001C1

U.S. PATENT DOCUMENTS					
Examiner Initials	Cite No.	Document Number <i>Number - Kind Code (if known)</i> Example: 1,234,567 B1	Publication Date MM-DD-YYYY	Name	Pages, Columns, Lines Where Relevant Passages or Relevant Figures Appear
	29	9,003,306 B2	04-07-2015	Mehin et al.	
	30	2007/0053382 A1	03-08-2007	Bevan et al.	
	31	2009/0213839 A1	08-27-2009	Davis et al.	
	32	2010/0083364 A1	04-01-2010	Gutierrez, Alvaro Fernández	
	33	2010/0114896 A1	05-06-2010	Clark et al.	
	34	2010/0115018 A1	05-06-2010	Yoon et al.	
	35	2010/0142382 A1	06-10-2010	Jungck et al.	
	36	2010/0220852 A1	09-02-2010	Willman et al.	
	37	2010/0233991 A1	09-16-2010	Crawford et al.	
	38	2010/0278534 A1	11-04-2010	Leiden et al.	
	39	2010/0316195 A1	12-16-2010	Di Serio et al.	
	40	2011/0072095 A1	03-24-2011	Havriluk, George	
	41	2011/0167164 A1	07-07-2011	Gutierrez, Alvaro Fernández	
	42	2011/0208859 A1	08-25-2011	Gutierrez, Alvaro Fernández	
	43	2011/0235543 A1	09-29-2011	Seetharaman et al.	
	44	2011/0273526 A1	11-10-2011	Mehin et al.	
	45	2011/0276903 A1	11-10-2011	Mehin et al.	
	46	2011/0276904 A1	11-10-2011	Mehin et al.	
	47	2011/0292929 A1	12-01-2011	Haster, Lars-Olof	
	48	2012/0089717 A1	04-12-2012	Chen, Yanheng	
	49	2012/0096145 A1	04-19-2012	Le et al.	
	50	2012/0155333 A1	06-21-2012	Yoon et al.	
	51	2012/0195236 A1	08-02-2012	Knight, Eric	
	52	2012/0259975 A1	10-11-2012	Le et al.	
	53	2012/0270554 A1	10-25-2012	Hellwig et al.	
	54	2013/0039226 A1	02-14-2013	Sridhar, Sriram	
	55	2013/0097308 A1	04-18-2013	Le et al.	
	56	2013/0128879 A1	05-23-2013	Kyle, Andre B.	
	57	2013/0148549 A1	06-13-2013	Crawford et al.	

Examiner Signature	Date Considered
<p>*Examiner: Initial if reference considered, whether or not citation is in conformance with MPEP 609. Draw line through citation if not in conformance and not considered. Include copy of this form with next communication to applicant.</p>	

INFORMATION DISCLOSURE STATEMENT BY APPLICANT	Application No.	13/966,096	
	Filing Date	August 13, 2013	
	First Named Inventor	Perreault, Clay	
	Art Unit	2653	
<i>(Multiple sheets used when necessary)</i>		Examiner	Sing, Simon P.
SHEET 3 OF 5		Attorney Docket No.	DIGIF.001C1

U.S. PATENT DOCUMENTS					
Examiner Initials	Cite No.	Document Number Number - Kind Code (if known) Example: 1,234,567 B1	Publication Date MM-DD-YYYY	Name	Pages, Columns, Lines Where Relevant Passages or Relevant Figures Appear
	58	2013/0173534 A1	07-04-2013	Nelakonda et al.	
	59	2013/0229950 A1	09-05-2013	Björzell et al.	
	60	2013/0287006 A1	10-31-2013	Nix, John A.	
	61	2013/0310002 A1	11-21-2013	Celi, Jr. et al.	
	62	2013/0318166 A1	11-28-2013	Jungck et al.	
	63	2013/0329864 A1	12-12-2013	Björzell et al.	
	64	2014/0010119 A1	01-09-2014	Björzell et al.	
	65	2014/0016764 A1	01-16-2014	Björzell et al.	
	66	2014/0024367 A1	01-23-2014	Björzell et al.	
	67	2014/0153477 A1	06-05-2014	Huttunen et al.	
	68	2014/0215642 A1	07-31-2014	Huxham, Horatio Nelson	
	69	2014/0307858 A1	10-16-2014	Li et al.	
	70	2014/0321333 A1	10-30-2014	Björzell et al.	

FOREIGN PATENT DOCUMENTS						
Examiner Initials	Cite No.	Foreign Patent Document Country Code-Number-Kind Code Example: JP 1234567 A1	Publication Date MM-DD-YYYY	Name	Pages, Columns, Lines Where Relevant Passages or Relevant Figures Appear	T ¹
	71	BR PI 0718312-7 A2	11-26-2013	Digifonica International Ltd	<i>Corresponds to International Publication No. WO 2008-052340 A1 previously disclosed</i>	Abstract
	72	BR PI 0719682-2 A2	01-14-2014	Digifonica International Ltd	<i>Corresponds to International Publication No. WO 2008/064481 A1 previously disclosed</i>	Abstract
	73	CA 2,668,025 A1	05-08-2008	Digifonica International Ltd	<i>Corresponds to International Publication No. WO 2008-052340 A1 previously disclosed</i>	Abstract
	74	CA 2,670,510 A1	06-05-2008	Digifonica International Ltd	<i>Corresponds to International Publication No. WO 2008-064481 A1; previously disclosed</i>	Abstract

Examiner Signature	Date Considered
<p>*Examiner: Initial if reference considered, whether or not citation is in conformance with MPEP 609. Draw line through citation if not in conformance and not considered. Include copy of this form with next communication to applicant.</p>	

T¹ - Place a check mark in this area when an English language translation is available. **PETITIONER: APPLE INC. EX. 1002-812**

INFORMATION DISCLOSURE STATEMENT BY APPLICANT	Application No.	13/966,096
	Filing Date	August 13, 2013
	First Named Inventor	Perreault, Clay
	Art Unit	2653
<i>(Multiple sheets used when necessary)</i>	Examiner	Sing, Simon P.
SHEET 4 OF 5	Attorney Docket No.	DIGIF.001C1

FOREIGN PATENT DOCUMENTS						
Examiner Initials	Cite No.	Foreign Patent Document Country Code-Number-Kind Code Example: JP 1234567 A1	Publication Date MM-DD-YYYY	Name	Pages, Columns, Lines Where Relevant Passages or Relevant Figures Appear	T ¹
	75	CA 2,681,984 A1	10-02-2008	Digifonica International Ltd	<i>Corresponds to International Publication No. WO 2008/116296 A1; previously disclosed</i>	Abstract
	76	CA 2,732,148 A1	02-04-2010	Digifonica International Ltd	<i>Corresponds to International Publication No. WO 2010/012090 A2; previously disclosed</i>	Abstract
	77	CA 2,812,174 A1	03-24-2011	Digifonica International Ltd	<i>Corresponds to International Publication No. WO 2011/032256 A1; previously disclosed</i>	Abstract
	78	CN 101584150 A	11-18-2009	Digifonica International Ltd	<i>Corresponds to International Publication No. WO 2008/064481 A1 previously disclosed</i>	Abstract
	79	CN 101584166 A	11-18-2009	Digifonica International Ltd	<i>Corresponds to International Publication No. WO 2008-052340 A1 previously disclosed</i>	Abstract
	80	CN 101605342 A	12-16-2009	ZTE Corp [CN]		Abstract
	81	CN 102457494 A	05-16-2012	China Mobile Comm Corp Sichuan Co Ltd		Abstract
	82	CN 102572123 A	07-11-2012	Chengdu 30RTOM Mobile Comm Co Ltd		Abstract
	83	CN 101605342 B	12-19-2012	ZTE Corp [CN]	<i>Corresponds to Chinese Publication No. CN 101605342 A shown above</i>	
	84	CN 102457494 B	10-01-2014	China Mobile Comm Corp Sichuan Co Ltd	<i>Corresponds to Chinese Publication No. CN 102457494 A shown above</i>	
	85	EP 2 084 868 A0	08-05-2009	Digifonica International Ltd	<i>Corresponds to International Publication No. WO 2008-052340 A1 previously disclosed</i>	Abstract
	86	EP 2 227 048 A1	09-08-2010	France Telecom [FR]		Abstract

Examiner Signature	Date Considered
--------------------	-----------------

***Examiner:** Initial if reference considered, whether or not citation is in conformance with MPEP 609. Draw line through citation if not in conformance and not considered. Include copy of this form with next communication to applicant.

INFORMATION DISCLOSURE STATEMENT BY APPLICANT	Application No.	13/966,096	
	Filing Date	August 13, 2013	
	First Named Inventor	Perreault, Clay	
	Art Unit	2653	
<i>(Multiple sheets used when necessary)</i>		Examiner	Sing, Simon P.
SHEET 5 OF 5		Attorney Docket No.	DIGIF.001C1

FOREIGN PATENT DOCUMENTS						
Examiner Initials	Cite No.	Foreign Patent Document Country Code-Number-Kind Code Example: JP 1234567 A1	Publication Date MM-DD-YYYY	Name	Pages, Columns, Lines Where Relevant Passages or Relevant Figures Appear	T ¹
	87	EP 2 311 292 A0	04-20-2011	Digifonica International Ltd	<i>Corresponds to International Publication No. WO 2010/012090 A2 previously disclosed</i>	Abstract
	88	EP 2 478 678 A0	07-25-2012	Digifonica International Ltd	<i>Corresponds to International Publication No. WO 2011/032256 A1 previously disclosed</i>	Abstract
	89	KR 10-2009-0086428 (A)	08-12-2009	Digifonica International Ltd	<i>Korean Publication Unavailable Corresponds to International Publication No. WO 2008-052340 A1 previously disclosed</i>	Abstract
	90	KR 10-2009-0095621 (A)	09-09-2009	Digifonica International Ltd	<i>Corresponds to International Publication No. WO 2008-064481 A1 previously disclosed</i>	Abstract
	91	MX 2009005751 A	08-26-2009	Digifonica International Ltd	<i>Corresponds to International Publication No. WO 2008-064481 A1 previously disclosed</i>	Abstract
	92	MX 2009004811 A	08-28-2009	Digifonica International Ltd	<i>Corresponds to International Publication No. WO 2008-052340 A1 previously disclosed</i>	Abstract
	93	WO 2013/013189 A2	01-24-2013	VISA Int Service ASS [US]		

NON PATENT LITERATURE DOCUMENTS			
Examiner Initials	Cite No.	Include name of the author (in CAPITAL LETTERS), title of the article (when appropriate), title of the item (book, magazine, journal, serial, symposium, catalog, etc.), date, page(s), volume-issue number(s), publisher, city and/or country where published.	T ¹

20682667
051415

Examiner Signature	Date Considered
*Examiner: Initial if reference considered, whether or not citation is in conformance with MPEP 609. Draw line through citation if not in conformance and not considered. Include copy of this form with next communication to applicant.	

T¹ - Place a check mark in this area when an English language PUBLISHED BY PATENT AND TRADE MARK OFFICE OF CANADA. EX. 1002-814

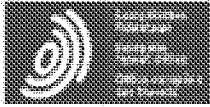

Espacenet

Bibliographic data: BRPI0718312 (A2) — 2013-11-26

PRODUCING ROUTING MESSAGES FOR VOICE OVER IP COMMUNICATIONS

Inventor(s): PERREAULT CLAY; NICHOLSON STEVE; THOMSON ROD;
BJORSELL JOHAN EMIL VICTOR; ARAFA FUAD ± (CLAY
PERREAULT, ; STEVE NICHOLSON, ; ROD THOMSON, ; JOHAN
EMIL VICTOR BJORSELL, ; FUAD ARAFA)

Applicant(s): DIGIFONICA INTERNATIONAL LTD [CA] ± (DIGIFONICA
(INTERNATIONAL) LIMITED)

Classification: - international: H04L12/14; H04L12/66; H04M11/06; H04M15/00;
H04Q3/64
- cooperative: H04L12/14; H04L12/1439; H04L12/1496;
H04L12/66; H04L9/3226; H04M15/51; H04M15/56;
H04M7/0075; H04Q3/66; H04Q3/70;
H04Q2213/13091; H04Q2213/13141;
H04Q2213/13196; H04Q2213/1322;
H04Q2213/13384

Application number: BR2007PI18312 20071101

Priority number(s): US20060856212P 20061102 ; WO2007CA01956 20071101

Also published as: WO2008052340 (A1) WO2008052340 (A8) US2014321333 (A1)
US2014010119 (A1) US2014016764 (A1) US2014016764 (A1)
US8774378 (B2) US8774378 (B2) US2013329722 (A1)
US2010150328 (A1) US2010150328 (A1) US8542815 (B2)
US8542815 (B2) KR20090086428 (A) EP2084868 (A1)
EP2084868 (A4) CN101584166 (A) CA2668025 (A1) less

Abstract not available for BRPI0718312 (A2)

Abstract of corresponding document: WO2008052340 (A1)

A process and apparatus to facilitate communication between callers and callees in a system comprising a plurality of nodes with which callers and callees are associated is disclosed. In response to initiation of a call by a calling subscriber, a caller identifier and a callee identifier are received. Call classification criteria associated with the caller identifier are used to classify the call as a public network call or a private network call. A routing message identifying an address, on the private network, associated with the

PETITIONER APPLE INC. EX. 1002-815

callee is produced when the call is classified as a private network call and a routing message identifying a gateway to the public network is produced when the call is classified as a public network call.

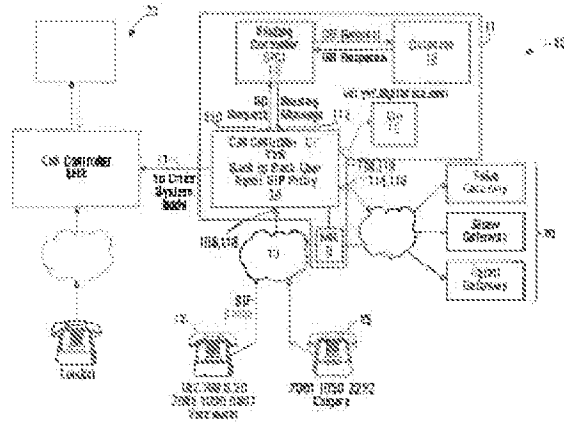



República Federativa do Brasil
Ministério do Desenvolvimento, Indústria
e do Comércio Exterior
Instituto Nacional da Propriedade Industrial

(21) PI 0718312-7 A2



(22) Data de Depósito: 01/11/2007
(43) Data da Publicação: 26/11/2013
(RPI 2238)

(51) *Int.Cl.*:
H04L 12/66
H04L 12/14
H04M 11/06
H04M 15/00
H04Q 3/64

(54) **Título:** PRODUÇÃO DE MENSAGENS DE DIRECIONAMENTO PARA COMUNICAÇÕES DE VOZ ATRAVÉS DE IP

(57) **Resumo:**

(30) **Prioridade Unionista:** 02/11/2006 US 60/856,212

(73) **Titular(es):** Digifonica (International) Limited

(72) **Inventor(es):** Clay Perreault, Fuad Arafa, Johan Emil Victor Bjorsell, Rod Thomson, Steve Nicholson

(74) **Procurador(es):** Dannemann, Siemsen, Bigler & Ipanema Moreira

(86) **Pedido Internacional:** PCT CA2007001956 de 01/11/2007

(87) **Publicação Internacional:** WO 2008/052340de 08/05/2008

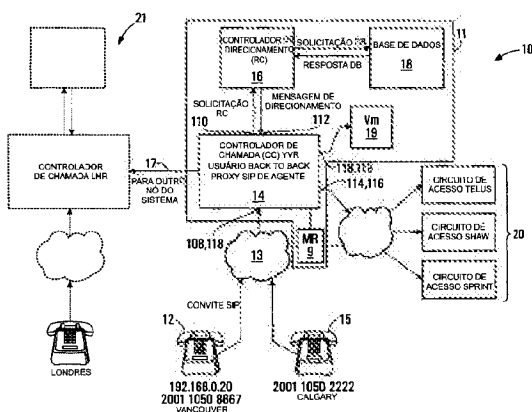

Relatório Descritivo da Patente de Invenção para **"PRODUÇÃO DE MENSAGENS DE DIRECIONAMENTO PARA COMUNICAÇÕES DE VOZ ATRAVÉS DE IP"**.

Antecedentes da Invenção

5 Campo da Invenção

A presente invenção refere-se a comunicações de voz através de IP e métodos e aparelho para o direcionamento e cobrança.

Descrição da Técnica Relacionada

10 Os telefones de protocolo de Internet (IP) são tipicamente computadores pessoais (PC) com base em telefones conectados dentro de uma rede IP, tal como a Internet pública ou uma rede privada de uma grande organização. Esses telefones IP têm instalados um software de "voz através de IP" (VoIP) que permite que os mesmos realizem e recebam chamadas de voz e enviem e recebam informação em formatos de dados e vídeo.

15 Os comutadores de telefonia IP instalados dentro da rede IP permitem que as chamadas de voz sejam realizadas dentro ou entre redes IP, e entre uma rede IP e uma rede de circuito comutador (SCN), tal como a rede de telefonia permutada pública (PSTN). Se o comutador IP suportar o protocolo de Sistema de Sinalização 7 (SS7), o telefone IP também pode
20 acessar as bases de dados PSTN.

A rede PSTN inclui tipicamente nós de rede complexos que contêm toda a informação sobre uma área de serviço de chamada local incluindo a autenticação de usuário e o direcionamento de chamada. A rede PSTN agrega tipicamente toda a informação e o tráfego em um único local ou nó,
25 processa os mesmos localmente e então passa os mesmos para outros nós de rede, como necessário, pela manutenção de tabelas de rota no nó. Os nós PSTN são redundantes em termos de desenho e, dessa forma, fornecem um serviço confiável, mas se um nó falhar devido a um terremoto ou outro desastre natural, outages de serviço significativos se não completos
30 podem ocorrer, sem qualquer outro nó ser capaz de assumir a carga.

Os sistemas VoIP existentes não permitem uma grande disponibilidade e resiliência na distribuição de Voz através de IP com base no serviço

de protocolo do Protocolo de Iniciação de Sessão (SIP) através de uma área geograficamente dispersa tal como uma cidade, região ou continente. Mais resiliência se origina do fornecimento dos serviços de telefonia com base em IP para um local ou um pequeno número de localizações tal como um único
5 escritório ou rede de escritórios ramificados.

Sumário da Invenção

De acordo com um aspecto da invenção, é fornecido um processo para operar um controlador de direcionamento de chamada para facilitar a comunicação entre os chamadores e os chamados de um sistema compreendendo uma pluralidade de nós com os quais os chamadores e os chamados estão associados. O processo envolve, em resposta à iniciação de
10 uma chamada por um assinante chamador, o recebimento de um identificador do chamador e um identificador de chamada. O processo também envolve a utilização de critérios de classificação de chamada associados com o identificador do chamador para classificar a chamada como uma chamada
15 de rede pública ou uma chamada de rede privada. O processo envolve adicionalmente a produção de uma mensagem de direcionamento identificando um endereço, na rede privada, associado com o chamado quando a chamada é classificada com uma chamada de rede privada. O processo também
20 envolve a produção de uma mensagem de direcionamento identificando um circuito de acesso à rede pública quando a chamada é classificada como uma chamada de rede pública.

O processo pode envolver o recebimento de uma solicitação para o estabelecimento de uma chamada a partir de um controlador de chamada em comunicação com um chamador identificado pelo identificador de
25 chamada.

A utilização dos critérios de classificação de chamada pode envolver a busca em uma base de dados para localizar um registro identificando os atributos da chamada associados com um chamador identificado pelo
30 identificador do chamador.

A localização de um registro pode envolver a localização de um perfil de discagem de chamada compreendendo um nome de usuário asso-

ciado com o chamador, um domínio associado com o chamador, e pelo menos um atributo de chamada.

A utilização de todos os critérios de classificação pode envolver a comparação dos atributos de chamada associados com o perfil de discagem do chamador com aspectos do identificador de chamada.

A comparação pode envolver a determinação de se o identificador de chamada inclui uma parte que combina com um IDD associado com o perfil de discagem do chamador.

A comparação pode envolver a determinação de se o identificador de chamada inclui uma parte que combina com um NDD associado com o perfil de discagem do chamador.

A comparação pode envolver a determinação de se o identificador de chamada inclui uma parte que combina com um código de área associado com o perfil de discagem do chamador.

A comparação pode envolver a determinação de se o identificador de chamada possui um comprimento dentro de uma faixa especificada no perfil de discagem do chamador.

O processo pode envolver a formatação do identificador de chamada em um formato de dígito predefinido para produzir um identificador de chamada reformatado.

A formatação pode envolver a remoção de um dígito de discagem internacional do identificador de chamada, quando o identificador de chamada começa com um dígito que combina com um dígito de discagem internacional especificado pelo perfil de discagem do chamador associado com o chamador.

A formatação pode envolver a remoção de um dígito de discagem nacional do identificador de chamada e a anexação de um código de país do chamador ao identificador de chamada quando o identificador de chamada começa com um dígito de discagem nacional.

A formatação pode envolver a anexação de um código de país de chamador ao identificador de chamada quando o identificador de chamada começa com os dígitos que identificam um código de área especificado

pelo perfil de discagem do chamador.

A formatação pode envolver a anexação de um código de país do chamador e um código de área ao identificador de chamada quando o identificador de chamada possui um comprimento que combina com um formato de número de discagem do chamador especificado pelo perfil de discagem do chamador e apenas um código de área é especificado como sendo associado com o chamador no perfil de discagem do chamador.

O processo pode envolver a classificação da chamada como uma chamada de rede privada quando o identificador de chamada reformatado identifica um assinante para a rede privada.

O processo pode envolver a determinação de se o identificador de chamada está em conformidade com um formato de nome de usuário predefinido e se for esse o caso, classificar a chamada como uma chamada de rede privada.

O processo pode envolver fazer com que a base de dados de registros seja buscada para localizar um registro de tabela de banco de discagem direta (DID) associando um número telefônico público ao identificador de chamada reformatado e se o registro de tabela de banco DID for encontrado, classificar a chamada como uma chamada de rede privada e se um registro de tabela de banco DID não for encontrado, classifica a chamada como uma chamada de rede pública.

A produção da mensagem de direcionamento identificando um nó na rede privada pode envolver a configuração de um identificador de chamada em resposta a um nome de usuário associado com o registro de tabela de banco DID.

A produção da mensagem de direcionamento pode envolver a determinação de se um nó associado com o identificador de chamada reformatado é igual a um nó associado com o identificador do chamador.

A determinação de se um nó associado com o identificador de chamada reformatado é igual a um nó associado com o identificador do chamador pode envolver a determinação de se um prefixo do identificador de chamada reformatado combina com um prefixo correspondente de um

nome de usuário associado com o perfil de discagem do chamador.

Quando o nó associado com o chamado não é igual ao nó associado com a chamada, o processo envolve a produção de uma mensagem de direcionamento incluindo o identificador do chamador, o identificador de chamada reformatado e uma identificação de um nó de rede privada associados com o chamado e comunicando a mensagem de direcionamento para um controlador de chamada.

Quando o nó associado com o chamador é igual ao nó associado com o chamado, o processo envolve a determinação de se realiza pelo menos um dentre o seguinte: envio de chamada para outra parte, bloqueio de chamada e direcionamento do chamador para um servidor de correio de voz associado com o chamado.

A produção da mensagem de direcionamento pode envolver a produção de uma mensagem de direcionamento possuindo uma identificação de pelo menos um dentre o identificador de chamada, uma identificação de uma parte para quem a chamada deve ser enviada e uma identificação de um servidor de correio de voz associado com o chamado.

O processo pode envolver a comunicação da mensagem de direcionamento para um controlador de chamada.

A produção de uma mensagem de direcionamento identificando um circuito de acesso à rede pública pode envolver a busca de uma base de dados de registros de rota associando os identificadores de rota com os códigos de discagem para encontrar um registro de rota possuindo um código de discagem possuindo um padrão de número que combina pelo menos uma parte do identificador de chamada reformatado.

O processo pode envolver a busca de uma base de dados dos registros de fornecedor associando os identificadores de fornecedor com os identificadores de rota para localizar pelo menos um registro de fornecedor associado com o identificador de rota associado com o registro de rota possuindo um código de discagem possuindo um padrão de número que combina com pelo menos uma parte do identificador de chamada reformatado.

O processo pode envolver o carregamento de um armazenador

de mensagem de direcionamento com o identificador de chamada reformado e uma identificação das rotas específicas associadas com os respectivos registros de fornecedor associados com o registro de rota e o carregamento do armazenador de mensagem de direcionamento com um valor de tempo e um valor de expiração de tempo.

O processo pode envolver a comunicação de uma mensagem de direcionamento envolvendo o conteúdo do armazenador de mensagem de direcionamento para um controlador de chamada.

O processo pode envolver fazer com que um perfil de discagem inclua um valor de chamada máximo simultânea e um valor de contagem de chamada simultânea e fazendo com que o valor de contagem de chamada simultânea seja incrementado quando o usuário associado com o perfil de discagem iniciar uma chamada e fazendo com que o valor de contagem de chamada simultânea seja reduzido quando uma chamada com o usuário associado com o perfil de discagem é encerrada.

De acordo com outro aspecto da invenção, é fornecido um aparelho de direcionamento de chamada para facilitar as comunicações entre os chamadores e os chamados em um sistema compreendendo uma pluralidade de nós com os quais os chamadores e os chamados estão associados. O aparelho inclui o recebimento de um identificador do chamador e um identificador de chamada, em resposta à iniciação de uma chamada por um assinante chamador. O aparelho também inclui classificação da chamada como uma chamada de rede privada ou uma chamada de rede pública de acordo com os critérios de classificação de chamada associados com o identificador do chamador. O aparelho inclui adicionalmente a produção de uma mensagem de direcionamento identificando um endereço, na rede privada, associado com o chamado quando a chamada é classificada como uma chamada de rede privada. O aparelho também inclui a produção de uma mensagem de direcionamento identificando um circuito de acesso à rede pública quando a chamada é classificada como uma chamada de rede pública.

O recebimento pode ser configurado de forma operacional para receber uma solicitação para o estabelecimento de uma chamada, de um

controlador de chamada em comunicação com um chamador identificado pelo identificador de chamada.

O aparelho pode incluir adicionalmente a busca de uma base de dados incluindo registros associando os atributos da chamada com assinantes da rede privada para localizar um registro identificando os atributos de chamada associados com um chamador identificado pelo identificador do chamador.

Os registros podem incluir perfis de discagem, cada um incluindo um nome de usuário associado com o assinante, uma identificação de um domínio associado com o assinante, e uma identificação de pelo menos um atributo de chamada associado com o assinante.

A classificação de chamada pode ser configurada de forma operacional para comparar os atributos da chamada associados com o perfil de discagem do chamador com os aspectos do identificador de chamada.

Os atributos de chamada podem incluir um dígito de discagem internacional e a classificação de chamada pode ser configurada de forma operacional para determinar se o identificador de chamada inclui uma parte que combina com um IDD associado com o perfil de discagem do chamador.

Os atributos de chamada podem incluir um dígito de discagem nacional e a classificação de chamada pode ser configurada de forma operacional para determinar se o identificador de chamada inclui uma parte que combina com um NDD associado com o perfil de discagem do chamador.

Os atributos de chamada podem incluir um código de área e a classificação de chamada pode ser configurada de forma operacional para determinar se o identificador de chamada inclui uma parte que combina com um código de área associado com o perfil de discagem do chamador.

O atributo de chamada pode incluir uma faixa de comprimento de número e a classificação da chamada pode ser configurada de forma operacional para determinar se o identificador de chamada tem um comprimento contido em uma faixa de comprimento de número especificada no perfil de discagem do chamador.

O aparelho pode incluir adicionalmente a formatação do identifi-

gador de chamada em um formato de dígitos predefinido para produzir um identificador de chamada reformatado.

As provisões de formatação podem ser configuradas de forma operacional para remover um dígito de discagem internacional do identificador de chamada, quando o identificador de chamada começa com um dígito
5 que combina com um dígito de discagem internacional especificado pelo perfil de discagem do chamador associado com o chamador.

As provisões de formatação podem ser configuradas operacionalmente para remover um dígito de discagem nacional do identificador de chamada e anexar um código de país do chamador ao identificador de chamada quando o identificador de chamada começar com um dígito de discagem nacional.
10

As provisões de formatação podem ser configuradas de forma operacional para anexar um código de país do chamador ao identificador de chamada quando o identificador de chamada começar com dígitos que identificam um código de área especificado pelo perfil de discagem do chamador.
15

A provisões de formatação podem ser configuradas de forma operacional para anexar um código de país do chamador e um código de área ao identificador de chamada quando o identificador de chamada possui um comprimento que combina com um formato do número de discagem do chamador especificado pelo perfil de discagem do chamador e apenas um código de área é especificado como sendo associado ao chamador no perfil de discagem do chamador.
20

A classificação pode ser configurada de forma operacional para classificar a chamada como uma chamada de rede privada quando o identificador de chamada reformatado identificar um assinante para a rede privada.
25

A classificação pode ser configurada de forma operacional para classificar a chamada como uma chamada de rede privada quando o identificador de chamada está em conformidade com o formato de nome de usuário predefinido.
30

O aparelho pode adicionalmente incluir a busca de uma base de dados dos registros para localizar um registro de tabela de banco DID asso-

ciando um número de telefone público ao identificador de chamada reformatado e a classificação pode ser configurada de forma operacional para classificar a chamada como uma chamada de rede privada quando o registro de tabela de banco DID é encontrado e para classificar a chamada como uma chamada de rede pública quando o registro de tabela de banco DID não é encontrado.

A produção de mensagem de direcionamento de rede privada pode ser configurada de forma operacional para produzir uma mensagem de direcionamento possuindo um identificador de chamada configurado de acordo com um nome de usuário associado com o registro de tabela de banco DID.

A produção de mensagem de direcionamento de rede privada pode ser configurada de forma operacional para determinar se um nó associado com o identificador de chamada reformatado é igual a um nó associado com o identificador do chamador.

O direcionamento de rede privada pode incluir a determinação de se um prefixo do identificador de chamada reformatado combina com um prefixo correspondente de um nome de usuário associado com o perfil de discagem do chamador.

A produção de mensagem de direcionamento de rede privada pode ser configurada de forma operacional para produzir uma mensagem de direcionamento incluindo o identificador do chamador, o identificador de chamada reformatado e uma identificação de um nó de rede privada associado com o chamado e para comunicar a mensagem de direcionamento para um controlador de chamadas.

A produção de mensagem de direcionamento de rede privada pode ser configurada de forma operacional para realizar pelo menos um dentre os seguintes: envio da chamada para outra parte, bloqueio da chamada e direcionamento do chamador para um servidor de correio de voz associado com o chamado, quando o nó associado com o chamador é igual ao nó associado com o chamado.

A produção da mensagem de direcionamento de rede privada pode ser configurada de forma operacional para produzir uma mensagem de

direcionamento possuindo uma identificação de pelo menos um dentre o i-
dentificador de chamada, uma identificação de uma parte para quem a cha-
mada deve ser enviada e uma identificação de um servidor de correio de voz
associado com o chamado.

5 O aparelho inclui adicionalmente a comunicação da mensagem
de direcionamento para um controlador de chamada.

A produção de uma mensagem de direcionamento de rede pú-
blica identificando um circuito de acesso à rede pública pode incluir a busca
de uma base de dados de registros de rota associando os identificadores de
10 rota com códigos de discagem para encontrar um registro de rota possuindo
um código de discagem possuindo um padrão de número que combina pelo
menos uma parte do identificador de chamada reformatado.

O aparelho inclui adicionalmente a busca de uma base de dados
dos registros do fornecedor associando os identificadores de fornecedor com
15 os identificadores de rota para localizar pelo menos um registro de fornece-
dor associado com o identificador de rota associado com o registro de rota
posuindo um código de discagem possuindo um padrão de número combi-
nando pelo menos uma parte do identificador de chamada reformatado.

O aparelho inclui adicionalmente um armazenador de mensa-
20 gem de direcionamento e o carregamento do armazenador de mensagem de
direcionamento com o identificador de chamada reformatado e uma identifi-
cação das rotas específicas associadas com os registros de fornecedor res-
pectivos associados com o registro de rota e o carregamento do armazena-
dor de mensagem de direcionamento com um valor de tempo e um valor de
25 expiração de tempo.

O aparelho inclui adicionalmente a comunicação de uma men-
sagem de direcionamento incluindo o conteúdo do armazenador de mensa-
gem de direcionamento para um controlador de chamada.

O aparelho inclui adicionalmente o fornecimento de comunica-
30 ção de uma mensagem de direcionamento incluindo o conteúdo do armaze-
nador de mensagem de direcionamento para um controlador de chamada.

O aparelho inclui adicionalmente meios para fazer com que o

dito perfil de discagem inclua um valor de chamada simultânea máximo e um valor de contagem de chamada simultânea e para fazer com que o dito valor de contagem de chamada simultânea seja incremento quando o usuário associado com o dito perfil de discagem inicia uma chamada e para fazer com
5 que o dito valor de contagem de chamada simultânea seja reduzido quando uma chamada com o dito usuário associado com o dito perfil de discagem é encerrado.

De acordo com outro aspecto da invenção, é fornecida uma estrutura de dados para ser acessada por um aparelho para a produção de
10 uma mensagem de direcionamento para uso por um controlador de direcionamento de chamada em um sistema de comunicações. A estrutura de dados inclui os registros de perfil de discagem compreendendo campos para a associação com assinantes respectivos para o sistema, um nome de usuário de assinante, registros de discagem direta compreendendo campos para a
15 associação com os nomes de usuário de assinante respectivos, um domínio de usuário e um número de discagem direta, prefixo para os registros de nó compreendendo campos para a associação com pelo menos uma parte dos nomes de usuários de assinante respectivos, um endereço de nó de um nó no sistema, onde um nome de assinante pode ser utilizado para encontrar
20 um domínio de usuário, pelo menos uma parte de um nome de assinante pode ser utilizado para encontrar um nó com o qual o assinante identificado pelo nome de assinante está associado, e um domínio de usuário e um nome de assinante podem ser localizados em resposta a um número de discagem direta.

De acordo com outro aspecto da invenção, é fornecida uma estrutura de dados para ser acessada por um aparelho para a produção de uma mensagem de direcionamento para uso por um controlador de direcionamento de chamada em um sistema de comunicações. A estrutura de dados inclui registros de lista principal compreendendo campos para a associ-
25 ação de um código de discagem com os identificadores de lista principal respectivos e registros de lista de fornecedor conectados aos registros de lista principal pelos identificadores de lista principal, os ditos registros de lista
30

de fornecedor compreendendo campos para associação com um fornecedor de serviços de comunicações, um ID de fornecedor, um ID de lista principal, um identificador de rota e um código de taxa de cobrança, onde os fornecedores de serviços de comunicações são associados com os códigos de discagem, de forma que os códigos de discagem possam ser utilizados para localizar os fornecedores capazes de fornecer um link de comunicações com um código de discagem determinado.

De acordo com outro aspecto da invenção, é fornecido um método de determinação de um tempo para permitir que uma sessão de comunicação seja conduzida. O método envolve o cálculo de um custo por tempo unitário, o cálculo de um primeiro valor de tempo como uma soma de um tempo livre atribuído a um participante na sessão de comunicação e o quociente de um saldo de fundos mantido pelo participante para o custo por valor de tempo unitário e produzindo um segundo valor de tempo em resposta ao primeiro valor de tempo e um padrão de cobrança associado com o participante, o padrão de cobrança incluindo primeiro e segundo intervalos de cobrança e o segundo valor de tempo sendo o tempo para permitir que uma sessão de comunicação seja conduzida.

O cálculo do primeiro valor de tempo pode envolver a recuperação de um registro associado com o participante e a obtenção a partir do registro de pelo menos um dente o tempo livre e o saldo de fundos.

A produção do segundo valor de tempo pode envolver a produção de um valor restante representando uma parte do segundo intervalo de cobrança restando depois da divisão do segundo intervalo de cobrança em uma diferença entre o primeiro valor de tempo e o primeiro intervalo de cobrança.

A produção do segundo valor de tempo pode envolver a configuração de uma diferença entre o primeiro valor de tempo e o restante como o segundo valor de tempo.

O método pode envolver adicionalmente a configuração do segundo valor de tempo para zero quando o restante é superior a zero e o primeiro valor de tempo é inferior ao tempo livre associado com o participante.

O cálculo do custo por tempo unitário pode envolver a localização de um registro em uma base de dados, o registro compreendendo um indicador de tipo de marcação, um valor de marcação e um padrão de cobrança e a configuração de uma taxa de revendedor igual à soma do valor de marcação e da taxa de armazenamento.

A localização do registro em uma base de dados pode envolver a localização de pelo menos um dentre um registro associado com um revendedor e uma rota associada com o revendedor, um registro associado com o revendedor e um registro de marcação de revendedor padrão.

O cálculo do custo por valor de tempo unitário pode envolver a localização de pelo menos um dentre um registro de eliminação especificando um custo de rota por quantidade de tempo unitário associado com uma rota associada com a sessão de comunicação, um registro de revendedor associado com um revendedor da sessão de comunicações, o registro de revendedor especificando um custo de revendedor por tempo unitário associado com o revendedor para a sessão de comunicação, um registro de marcação de operador padrão especificando um custo padrão por tempo unitário.

O método pode envolver adicionalmente a configuração como custo por tempo unitário da soma da taxa de revendedor e pelo menos um dentre o custo de rota por tempo unitário, o custo de revendedor por tempo unitário e o custo padrão por tempo unitário.

O método pode envolver adicionalmente o recebimento de um tempo de sessão de comunicação representando uma duração da sessão de comunicação e incrementando um saldo de revendedor pelo produto da taxa de revendedor e o tempo de sessão de comunicação.

O método pode envolver adicionalmente o recebimento de um tempo de sessão de comunicação representando uma duração da sessão de comunicação e incrementando um saldo de operador de sistema por um produto da taxa de armazenador e o tempo de sessão de comunicação.

De acordo com outro aspecto da invenção, é fornecido um aparelho para determinar um tempo para permitir que uma sessão de comunica-

ção seja conduzida. O aparelho inclui um circuito processador, um meio legível por computador, acoplado ao circuito processador e codificado com instruções para direcionar o circuito processador para calcular um custo por tempo unitário para a sessão de comunicação, calcular um primeiro valor de tempo como uma soma de um tempo livre atribuído a um participante na sessão de comunicação e o quociente de um saldo de fundos mantido pelo participante para o custo por valor de tempo unitário e produzindo um segundo valor de tempo em resposta ao primeiro valor de tempo e um padrão de cobrança associado com o participante, o padrão de cobrança incluindo primeiro e segundo intervalos de cobrança, e o segundo valor de tempo sendo o tempo para permitir que uma sessão de comunicação seja conduzida.

As instruções podem incluir instruções para direcionar o circuito processador para recuperar um registro associado com o participante e obter a partir do registro pelo menos um dentre o tempo livre e o saldo de fundos.

As instruções podem incluir instruções para o direcionamento do circuito processador para produzir o segundo valor de tempo pela produção de um valor restante representando uma parte do segundo intervalo de cobrança restando após a divisão do segundo intervalo de cobrança em uma diferença entre o primeiro valor de tempo e o primeiro intervalo de cobrança.

As instruções podem incluir instruções para direcionar o circuito processador para produzir o segundo valor de tempo e compreende a configuração de uma diferença entre o primeiro valor de tempo e o restante como o segundo valor de tempo.

As instruções podem incluir instruções para o direcionamento do circuito processador para configurar o segundo valor de tempo para zero quando o restante é maior do que zero e o primeiro valor de tempo é inferior ao tempo livre associado com o participante.

As instruções para o direcionamento do circuito processador para calcular o custo por tempo unitário podem incluir instruções para o direcionamento do circuito processador para localizar um registro em uma base de dados, o registro compreendendo um indicador tipo marcação, um valor de marcação e um padrão de cobrança e configurando uma taxa de reven-

dedor igual à soma do valor de marcação e a taxa de buffer.

As instruções para o direcionamento do circuito processador para localizar o registro em uma base de dados podem incluir instruções para direcionar o circuito processador para localizar pelo menos um dentre um
5 registro associado com um revendedor e uma rota associada com o revendedor, um registro associado com o revendedor, e um registro de marcação de revendedor padrão. As instruções para o direcionamento do circuito processador para calcular o custo por unidade de tempo podem incluir adicionalmente instruções para direcionamento do circuito processador para localizar pelo menos um dentre um registro de eliminação especificando um custo
10 de rota por quantidade de tempo unitário com uma rota associada com a sessão de comunicação, um registro de revendedor associado com um revendedor da sessão de comunicações, o registro de revendedor especificando um custo de revendedor por tempo unitário associado com o revendedor para a sessão de comunicação, um registro de marcação de operador
15 padrão especificando um custo padrão por tempo unitário.

As instruções podem incluir instruções para o direcionamento do circuito processador para configurar como custo por tempo unitário a soma da taxa de revendedor e pelo menos um custo de rota por tempo unitário, o
20 custo de revendedor por tempo unitário e o custo padrão por tempo unitário.

As instruções podem incluir instruções para o direcionamento do circuito processador para receber um tempo de sessão de comunicação representando uma duração da sessão de comunicação e incrementar um saldo de revendedor pelo produto da taxa do revendedor e do tempo de sessão
25 de comunicação.

As instruções podem incluir instruções para o direcionamento do circuito processador para receber um tempo de sessão de comunicação representando uma duração da sessão de comunicação e incrementar um saldo de operador de sistema por um produto da taxa de armazenador e o tempo de sessão de comunicação.
30

De acordo com outro aspecto da invenção, é fornecido um processo para a atribuição de cobranças pelos serviços de comunicações. O

processo envolve a determinação de um primeiro tempo passível de cobrança em resposta a um tempo de sessão de comunicação e um padrão de cobrança predefinido, determinado um valor de custo de usuário em resposta ao primeiro tempo passível de cobrança e um valor de tempo livre associado com um usuário dos serviços de comunicações, alterando um saldo de conta associado com o usuário em resposta a um custo de usuário por tempo unitário. O processo pode envolver adicionalmente a alteração de um saldo de conta associado com um revendedor dos serviços de comunicações em resposta a um custo de revendedor por tempo unitário e o tempo de sessão de comunicação e alteração de um saldo de conta associado com um operador dos serviços de comunicações em resposta a um custo de operador por tempo unitário e o tempo de sessão de comunicação.

A determinação do primeiro tempo passível de cobrança pode envolver a localização de pelo menos um dentre um registro de eliminação especificando um custo de rota por tempo unitário e o padrão de cobrança associado com uma rota associada com a sessão de comunicação, um registro de revendedor associado com um revendedor da sessão de comunicações, o registro de revendedor especificando um custo de revendedor por tempo unitário e o padrão de cobrança associado com o revendedor para sessão de comunicação e um registro padrão especificando um custo padrão por tempo unitário e o padrão de cobrança e configurando como o padrão de cobrança predefinido o padrão de cobrança do registro localizado. O padrão de cobrança do registro localizado pode envolver um primeiro intervalo de cobrança e um segundo intervalo de cobrança.

A determinação do primeiro tempo passível de cobrança pode envolver a configuração do primeiro tempo passível de cobrança igual ao primeiro intervalo de cobrança quando o tempo da sessão de comunicação é inferior a ou igual ao primeiro intervalo de cobrança.

A determinação do primeiro tempo passível de cobrança pode envolver a produção de um valor restante representando uma parte do segundo intervalo de cobrança restando após a divisão do segundo intervalo de cobrança em uma diferença entre o tempo de sessão de comunicação e

o primeiro intervalo quando o tempo de sessão de comunicação é superior ao tempo de sessão de comunicação e a configuração do primeiro tempo passível de cobrança para uma diferença entre o tempo de sessão de comunicação e o restante quando o restante é superior a zero e a configuração do primeiro tempo passível de cobrança para o tempo de sessão de comunicação quando o restante não é superior a zero.

O processo pode envolver adicionalmente a determinação de um segundo tempo passível de cobrança em resposta ao primeiro tempo passível de cobrança e o valor de tempo livre associado com o usuário dos serviços de comunicações quando o primeiro tempo passível de cobrança é superior a ou igual ao valor de tempo livre associado com o usuário dos serviços de comunicações.

A determinação do segundo tempo passível de cobrança pode envolver a configuração do segundo tempo passível de cobrança para uma diferença entre o primeiro tempo passível de cobrança.

O processo pode envolver adicionalmente a reconfiguração do valor de tempo livre associado com o usuário para zero quando o primeiro tempo passível de cobrança é superior a ou igual ao valor de tempo livre associado com o usuário dos serviços de comunicações.

A alteração de um saldo de conta associado com o usuário pode envolver o cálculo de um valor de custo de usuário em resposta ao segundo tempo passível de cobrança e o custo de usuário por tempo unitário.

O processo pode envolver adicionalmente a alteração de um saldo de custo livre de usuário em resposta ao valor de custo de usuário.

O processo pode envolver adicionalmente a configuração do custo de usuário para zero quando o primeiro tempo passível de cobrança é inferior ao valor de tempo livre associado com o usuário.

O processo pode envolver adicionalmente a alteração de um saldo de tempo livre de usuário em resposta ao primeiro tempo passível de cobrança.

De acordo com outro aspecto da invenção, é fornecido um aparelho, para atribuir mudanças para os serviços de comunicações. O aparelho

inclui um circuito processador, um meio legível por computador em comunicação com o circuito processador e codificado com instruções para o direcionamento do circuito processador para determinar um primeiro tempo passível de cobrança em resposta a um tempo de sessão de comunicação e um padrão de cobrança predefinido, determinar um valor de custo de usuário em resposta ao primeiro tempo passível de cobrança e um valor de tempo livre associado com um usuário dos serviços de comunicações, alterar um saldo de conta associado com o usuário em resposta a um custo de usuário por tempo unitário.

10 As instruções podem incluir adicionalmente instruções para a alteração de um saldo de conta associado com um revendedor dos serviços de comunicações em resposta a um custo de revendedor por tempo unitário e o tempo de sessão de comunicação e alteração de um saldo de conta associado com um operador dos serviços de comunicações em resposta a um custo de operador por tempo unitário e o tempo de sessão de comunicação.

15 As instruções para o direcionamento do circuito processador para determinar o primeiro tempo passível de cobrança podem incluir adicionalmente instruções para fazer com que o circuito processador se comunique com uma base de dados para localizar pelo menos um dentre um registro de eliminação especificando um custo de rota por tempo unitário e o padrão de cobrança associado com uma rota associada com a sessão de comunicação, um registro de revendedor associado com um revendedor da sessão de comunicações, o registro de revendedor especificando um custo de revendedor por tempo unitário e o padrão de cobrança associado com o revendedor para a sessão de comunicação e um registro padrão especificando um custo padrão por tempo unitário e padrão de cobrança e instruções para a configuração como o padrão de cobrança predefinido o padrão de cobrança do registro localizado. O padrão de cobrança do registro localizado pode incluir um primeiro intervalo de cobrança e um segundo intervalo de cobrança.

30 As instruções para fazer com que o circuito processador determine o primeiro tempo passível de cobrança pode incluir instruções para di-

recionar o circuito processador para configurar o primeiro tempo passível de cobrança igual ao primeiro intervalo de cobrança quando o tempo da sessão de comunicação é inferior a ou igual ao primeiro intervalo de cobrança.

As instruções para fazer com que o circuito processador determine o primeiro tempo passível de cobrança podem incluir instruções para produzir um valor restante representando uma parte do segundo intervalo de cobrança restando depois da divisão do segundo intervalo de cobrança em uma diferença entre o tempo de sessão de comunicação e o primeiro intervalo quando o tempo de sessão de comunicação é superior ao tempo de sessão de comunicação e as instruções para fazer com que o circuito processador configure o primeiro tempo passível de cobrança para uma diferença ente o tempo de sessão de comunicação e o restante quando o restante é superior a zero e instruções para fazer com que o circuito processador configure o primeiro tempo passível de cobrança para o tempo de sessão de comunicação quando o restante não é superior a zero.

As instruções podem incluir adicionalmente instruções para fazer com que o circuito processador determine um segundo tempo passível de cobrança em resposta ao primeiro tempo passível de cobrança e o valor de tempo livre associado com o usuário dos serviços de comunicações quando o primeiro tempo passível de cobrança é superior a ou igual ao valor de tempo livre associado com o usuário dos serviços de comunicações.

As instruções para fazer com que o circuito processador determine o segundo tempo passível de cobrança podem incluir fazer com que o circuito processador configure o segundo tempo passível de cobrança para uma diferença ente o primeiro tempo passível de cobrança.

As instruções podem incluir adicionalmente instruções para fazer com que o circuito processador reconfigure o valor de tempo livre associado com o usuário para zero quando o primeiro tempo passível de cobrança é superior a ou igual ao primeiro valor de tempo livre associado com o usuário dos serviços de comunicações.

As instruções para fazer com que o circuito processador altere um saldo de conta associado com o usuário podem incluir instruções para

fazer com que o circuito processador calcule um valor de custo de usuário em resposta ao segundo tempo passível de cobrança e o custo de usuário por tempo unitário.

5 As instruções podem incluir adicionalmente instruções para fazer com que o circuito processador altere um saldo de custo livre de usuário em resposta ao valor de custo de usuário.

10 As instruções podem adicionalmente incluir instruções para fazer com que o circuito processador configure o custo do usuário para zero quando o primeiro tempo passível de cobrança é inferior ao valor de tempo livre associado com o usuário.

As instruções podem incluir adicionalmente instruções para fazer com que o circuito processador altere um saldo de tempo livre de usuário em resposta ao primeiro tempo passível de cobrança.

15 De acordo com outro aspecto da invenção, é fornecido um meio legível por computador codificado com códigos para direcionar um circuito processador para executar um ou mais dos métodos descritos acima e/ou variações dos mesmos.

20 Outros aspectos e características da presente invenção se tornarão aparentes aos versados na técnica mediante revisão da descrição a seguir das modalidades específicas da invenção em conjunto com as figuras em anexo.

Breve Descrição dos Desenhos

Nos desenhos que ilustram as modalidades da invenção,

25 A figura 1 é um diagrama em bloco de um sistema de acordo com uma primeira modalidade da invenção.

A figura 2 é um diagrama em bloco de um telefone chamador de acordo com a primeira modalidade da invenção.

30 A figura 3 é uma representação esquemática de uma mensagem de convite SIP transmitida ente o telefone do chamado e um controlador ilustrado na figura 1.

A figura 4 é um diagrama em bloco de um controlador de chamada ilustrado na figura 1.

A figura 5 é um fluxograma de um processo executado pelo controlador de chamada ilustrado na figura 1.

5 A figura 6 é uma representação esquemática de uma mensagem de solicitação de direcionamento, cobrança e classificação (RC) produzida pelo controlador de chamada ilustrado na figura 1.

A figura 7 é um diagrama em bloco de um circuito processador de um elemento de direcionamento, cobrança e classificação do sistema ilustrado na figura 1.

10 As figuras de 8A a 8D são fluxogramas do manuseador de mensagem de solicitação RC executadas pelo circuito processador RC ilustrado na figura 7.

A figura 9 é uma representação tabular de um perfil de discagem armazenado em uma base de dados acessível pelo RC ilustrado na figura 1.

15 A figura 10 é uma representação tabular de um perfil de discagem para um chamador utilizando o telefone de chamador ilustrado na figura 1.

A figura 11 é uma representação tabular do perfil do chamado para um chamado localizado em Calgary.

A figura 12 é uma representação tabular de um perfil de chamado para um chamado localizado em Londres.

20 A figura 13 é uma representação tabular de um registro de tabela de banco DID armazenado na base de dados ilustrada na figura 1.

A figura 14 é uma representação tabular de um registro de tabela de banco DID para o chamado de Calgary referido na figura 11.

25 A figura 15 é uma representação tabular de uma mensagem de direcionamento transmitida a partir do RC para o controlador de chamada ilustrado na figura 1.

30 A figura 16 é uma representação esquemática de um armazenador de mensagem de direcionamento mantendo uma mensagem de direcionamento para direcionar uma chamada para o chamado de Calgary referido na figura 11.

A figura 17 é uma representação tabular de um prefixo para o registro de tabela de supernó armazenado na base de dados ilustrada na

figura 1.

A figura 18 é uma representação tabular de um prefixo do registro de tabela de supernó que seria utilizado para o chamado de Calgary referido na figura 11.

5 A figura 19 é uma representação tabular de um registro de lista principal armazenado em uma tabela de lista principal na base de dados ilustrada na figura 1.

A figura 20 é uma representação tabular de um registro de lista principal preenchido.

10 A figura 21 é uma representação tabular de um registro de lista de fornecedores armazenado na base de dados ilustrada na figura 1.

A figura 22 é uma representação tabular de um registro de lista de fornecedor especifica para um primeiro fornecedor.

15 A figura 23 é uma representação tabular de um registro de lista de fornecedor especifica para um segundo fornecedor.

A figura 24 é uma representação tabular de um registro de lista de fornecedor especifica para um terceiro fornecedor.

20 A figura 25 é uma representação esquemática de uma mensagem de direcionamento, mantida em um armazenador de mensagem de direcionamento, identificando para o controlador uma pluralidade de possíveis fornecedores que podem portar a chamada

A figura 26 é uma representação tabular de um registro de tabela de bloqueio de chamada.

25 A figura 27 é uma representação tabular de um registro de tabela de bloqueio de chamada para o chamado de Calgary;

A figura 28 é uma representação tabular de um registro de tabela de envio de chamada.

A figura 29 é uma representação tabular de um registro de tabela de envio de chamada específico para o chamado de Calgary.

30 A figura 30 é uma representação tabular de um registro de tabela de correio de voz especificando os parâmetros de correio de voz para permitir que o chamador deixe uma mensagem de correio de voz para o

chamado.

A figura 31 é uma representação tabular de um registro de tabela de correio de voz específico para o chamado de Calgary.

5 A figura 32 é uma representação esquemática de uma mensagem de direcionamento ilustrativa, mantida em um armazenador de mensagem de direcionamento, indicando os números de envio de chamada e um identificador de servidor de correio de voz.

10 As figuras 33A e 33B são partes respectivas de um fluxograma de um processo executado pelo processador RC para determinar um tempo para o valor de duração ao vivo.

A figura 34 é uma representação tabular de um registro de tabela de feixe de assinante.

A figura 35 é uma representação tabular de um registro de feixe de assinante para o chamador de Vancouver.

15 A figura 36 é uma representação tabular de um registro de tabela de eliminação de feixe.

A figura 37 é uma representação tabular de um registro de eliminação de feixe para um ID de lista principal localizado.

20 A figura 38 é uma representação tabular de um registro de tabela de conta de assinante.

A figura 39 é uma representação tabular de um registro de conta de assinante para o chamador de Vancouver.

25 A figura 40 é um fluxograma é um processo para a produção de um segundo valor de tempo executado pelo circuito processador RC ilustrado na figura 7.

A figura 41 é um fluxograma para calcular um custo de chamada por tempo unitário.

A figura 42 é uma representação tabular de um registro de tabela de taxas especiais para operador de sistema.

30 A figura 43 é uma representação tabular de um registro de tabela de taxas especiais para operador de sistema para um revendedor chamado Klondike.

A figura 44 é uma representação tabular de um registro de tabela de marcação de operador de sistema.

A figura 45 é uma representação tabular de um registro de tabela de marcação de operador de sistema para o revendedor Klondike.

5 A figura 46 é uma representação tabular de um registro de tabela de marcação de operador de sistema padrão.

A figura 47 é uma representação tabular de um registro de tabela de destinos especiais para revendedor.

10 A figura 48 é uma representação tabular de um registro de tabela de destinos especiais de revendedor para o revendedor Klondike.

A figura 49 é uma representação tabular de um registro de tabela de marcação global de revendedor.

A figura 50 é uma representação tabular de um registro de tabela de marcação global de revendedor para o revendedor Klondike.

15 A figura 51 é uma representação tabular de uma mensagem de adeus SIP transmitida a partir de um dos telefones ilustrados na figura 1 para o controlador de chamada.

A figura 52 é uma representação tabular de uma mensagem de adeus SIP enviada para o controlador a partir do chamado de Calgary.

20 A figura 53 é um fluxograma de um processo executado pelo controlador da chamada para produzir uma mensagem de interrupção RC em resposta ao recebimento de uma mensagem de adeus SIP.

A figura 54 é uma representação tabular de uma mensagem de interrupção de chamada RC.

25 A figura 55 é uma representação tabular de uma mensagem de interrupção de chamada RC para o chamado de Calgary.

As figuras 56A e 56B são partes respectivas de um fluxograma de uma mensagem de interrupção de chamada RC manuseando a rotina executada pelo RC ilustrado na figura 1.

30 A figura 57 é uma representação tabular de um registro de tabela de contas de revendedor.

A figura 58 é uma representação tabular de um registro de tabe-

la de contas de revendedor para o revendedor Klondike.

A figura 59 é uma representação tabular de um registro de tabela de contas de operador de sistema.

5 A figura 60 é uma representação tabular de um registro de contas de operador de sistema para o operador de sistema descrito aqui.

Descrição Detalhada

Com referência à figura 1, um sistema para a realização de chamadas de telefone/videofone de voz através de IP é ilustrado de forma geral por 10. O sistema inclui um primeiro supernó ilustrado geralmente por 11 e um segundo supernó ilustrado geralmente por 21. O primeiro supernó 10 11 é localizado na área geográfica, tal como Vancouver, B.C., Canadá, por exemplo, e o segundo supernó 21 está localizado em Londres, Inglaterra, por exemplo. Diferentes supernós podem estar localizados em diferentes regiões geográficas por todo o mundo para fornecer serviço de telefo- 15 ne/videofone para assinantes nas respectivas regiões. Esses supernós podem estar em comunicação um com o outro por meio de links de alta velocidade/altos dados incluindo fibra ótica, satélite e/ou links de cabo, formando uma estrutura para o sistema. Esses supernós podem estar alternativamente ou adicionalmente em comunicação um com o outro através de serviços de 20 Internet convencionais.

Na modalidade ilustrada, o supernó de Vancouver 11 fornece serviço de telefone/videofone para clientes Canadenses do oeste a partir da Ilha de Vancouver para Ontário. Outro nó (não ilustrado) pode ser localizado no Canadá lado Leste para fornecer serviços de assinantes nessa área.

25 Outros nós do tipo ilustrado podem ser empregados também dentro da área geográfica servida por um supernó, para fornecer o compartilhamento de carga de chamada, por exemplo, dentro de uma região da área geográfica servida pelo supernó. No entanto, em geral, todos os nós são similares e possuem as propriedades descritas abaixo com relação ao su- 30 perνό de Vancouver 11.

Nessa modalidade, o supernó Vancouver inclui um controlador de chamada (C) 14, um controlador de direcionamento (RC) 16, uma base

de dados 18 e um servidor de correio de voz 19 e um relé de mídia 9. Cada um dos mesmos pode ser implementado como módulos separados em um sistema de computador comum ou por computadores separados, por exemplo. O servidor de correio de voz 19 não precisa ser incluído no nó e pode ser fornecido por um provedor de serviço de saída.

Os assinantes tal como um assinante em Vancouver e um assinante em Calgary se comunicam com o supernó de Vancouver utilizando seus próprios provedores de serviço de Internet que direcionam o tráfego de Internet de rota desses assinantes através do Internet ilustrados geralmente por 13 na figura 1. Para essas assinantes o supernó de Vancouver é acessível em um endereço de protocolo de Internet (IP) predeterminado ou um nome de domínio totalmente qualificados que possa ser acessado da forma normal através de um provedor de serviço de Internet de assinante. O assinante em Vancouver utiliza um telefone 12 que é capaz de se comunicar com o supernó de Vancouver 11 utilizando as mensagens de Protocolo de Iniciação de Sessão (SIP) e o assinante de Calgary utiliza um telefone similar 15, em Calgary AB.

Deve-se notar que por toda a descrição das modalidades dessa invenção, os endereços IP/UDP de todos os elementos tal como os telefones do chamador e da parte chamada, o controlador de chamada, o relé de mídia e quaisquer outros, serão considerados endereços IP/UDP válidos diretamente acessíveis através da Internet ou uma rede IP privada, por exemplo, dependendo da implementação específica do sistema. Como tal, será considerado, por exemplo, que os telefones do chamador e do chamado terão endereços IP/UDP diretamente acessíveis pelos controladores de chamada e os relés de mídia em seus respectivos supernós, e esses endereços não serão obscurecidos pela Tradução de Endereço de Rede (NAT) ou mecanismos similares. Em outras palavras, a informação IP/UDP contida nas mensagens SIP (por exemplo, a mensagem de Convite SIP ou a mensagem de Solicitação RC que serão descritas abaixo) que combinará os endereços IP/UDP dos pacotes IP portando essas mensagens SIP.

Será apreciado que em muitas situações, os endereços IP de-

signados para os vários elementos do sistema podem estar em um espaço de endereço IP privado, e, dessa forma, não diretamente acessíveis a partir de outros elementos. Adicionalmente, será apreciado também que NAT é comumente utilizada para compartilhar um endereço IP "público" entre os múltiplos dispositivos, por exemplo, entre PCs domésticos e telefones IP compartilhando uma conexão de Internet única. Por exemplo, um PC doméstico pode receber um endereço IP tal como 192.168.0.101 e um telefone VoIP pode receber um endereço IP igual a 192.168.0.103. Esses endereços são localizados em um espaço de endereço chamado de "não-direcionável" (IP) e não podem ser acessados diretamente a partir da Internet. A fim de que esses dispositivos se comuniquem com outros computadores localizados na Internet, esses endereços IP precisam ser convertidos em um endereço IP "público", por exemplo, 24.10.10.123 designado pelo Provedor de Serviço de Internet para o assinante, por um dispositivo realizando NAT, tipicamente um roteador doméstico. Em adição à tradução dos endereços IP, NAT tipicamente também traduz números de porta UDP, por exemplo, um percurso de áudio originando em um telefone VoIP e utilizando uma porta UDP 12378 em seu endereço IP privado, pode ter sido traduzido para uma porta UDP 23465 associada com o endereço IP público do dispositivo NAT. Em outras palavras, quando um pacote originário do telefone VoIP acima chega a um supernó com base em Internet, o endereço IP/UDP fonte contido no cabeçalho de pacote IP será 24.10.10.1:23465, ao passo que a informação de endereço IP/UDP fonte contida na mensagem SIP dentro desse pacote IP será 192.168.0.103:12378. A falta de combinação nos endereços IP/UDP pode causar um problema para os sistemas VoIP com base em SIP visto que, por exemplo, um supernó tentará enviar as mensagens para um endereço privado de um telefone, mas as mensagens nunca chegarão lá.

Com referência à figura 1, em uma tentativa de se realizar uma chamada pelo telefone/videofone de Vancouver 12 para o telefone/videofone de Calgary 15, o telefone/videofone de Vancouver envia uma mensagem de convite SIP para o supernó de Vancouver 11 e em resposta, o controlador de chamada 14 envia uma mensagem de solicitação RC para o RC 16 que

realiza várias pesquisas na base de dados 18 para produzir uma mensagem de direcionamento que é enviada de volta para o controlador de chamada 14. O controlador de chamada 14 então se comunica com o relé de mídia 9 para fazer com que um link de comunicações incluindo um percurso de áudio e um videofone (se uma chamada de vídeopercurso) seja estabelecido
5 através do relé de mídia para o mesmo nó, um nó diferente ou para um circuito de acesso de fornecedor de comunicações como ilustrado geralmente em 20 para transportar áudio, e onde aplicável, tráfego de vídeo para o recipiente da chamada ou chamado.

10 Geralmente, o RC 16 executa um processo para facilitar a comunicação entre os chamadores e os chamados. O processo envolve, em resposta à iniciação de uma chamada por um assinante chamador, o recebimento de um identificador de chamada do assinante chamador, utilizando os critérios de classificação de chamada associados com o assinante chamador para classificar a chamada como uma chamada de rede pública ou
15 uma chamada de rede privada e produzindo uma mensagem de direcionamento que identifica um endereço na rede privada, associada com o chamado quando a chamada é classificada como uma chamada de rede privada e produzindo uma mensagem de direcionamento identificando um circuito de acesso para a rede pública quando a chamada for classificada como uma
20 chamada de rede pública.

Telefone de Assinante

Em maiores detalhes, com referência à figura 2, nessa modalidade, o telefone/videofone 12 inclui um circuito processador ilustrado geralmente por 30 compreendendo um microprocessador 32, uma memória de
25 programa 34, uma porta de entrada/saída (I/O) 36, uma memória de parâmetro 38 e uma memória temporária 40. A memória de programa 34, porta I/O 36, memória de parâmetro 38 e memória temporária 40 estão todas em comunicação com o microprocessador 32. A porta I/O 36 possui uma entrada
30 discada 42 para receber um número de telefone/videofone discado a partir de um teclado, por exemplo, ou de uma unidade de reconhecimento de voz ou de números de telefone/videofone pré-armazenados armazenados na

memória de parâmetro 38, por exemplo. Por motivos de simplicidade, na figura 2 uma caixa rotulada funções de discagem 44 representa qualquer dispositivo capaz de informar ao microprocessador 32 sobre um identificador de chamada, por exemplo, um número de telefone/videofone do chamado.

5 O processador 32 armazena o identificador de chamada em um armazenador de número discado 45. Nesse caso, considera-se o número discado como sendo 2001 1050 2222 e que esse é um número associado com o assinante de Calgary. A porta I/O 36 também possui uma interface de aparelho 46 para receber e produzir sinais de e para um aparelho que o usuário pode colocar em sua orelha. Essa interface 46 pode incluir uma interface sem fio BLUETOOTH™, uma interface com fio ou um fone de ouvido, por exemplo. O aparelho age como um ponto final para um percurso de áudio (não ilustrado) que será apreciado posteriormente. A porta I/O 36 também possui uma conexão de Internet 48 que é preferivelmente uma conexão de Internet de alta velocidade e é operável para conectar o telefone/videofone a um provedor de serviço de Internet. A conexão de Internet 48 também age como uma parte do percurso de voz, como será apreciado posteriormente. Será apreciado que onde o dispositivo de assinante é um videofone, um percurso de vídeo separado é estabelecido da mesma forma que um percurso de áudio é estabelecido. Por motivos de simplicidade, a descrição a seguir se refere a uma chamada telefônica, mas deve se compreender que uma chamada de videofone é manuseada de forma similar, com o controlador de chamada fazendo com que o relé de mídia facilite um percurso de áudio e um percurso de vídeo ao invés de apenas um percurso de áudio.

25 A memória de parâmetro 38 possui um campo de nome de usuário 50, um campo de senha 52, um campo de endereço IP 53 e um campo de endereço Proxy SIP 54, por exemplo. O campo de nome de usuário 50 opera para manter um nome de usuário, que, nesse caso, é 2001 1050 8667. O nome de usuário é designado mediante assinatura ou registro no sistema e, nessa modalidade, inclui um número de doze dígitos possuindo um código de continente 61, um código de país 63, um código de fornecedor 70 e um código de número singular 74. O código de continente 61 é constitu-

ido do primeiro dígito ou dígito mais para a esquerda do nome de usuário nessa modalidade. O código de país 63 é constituído dos próximos três dígitos. O código de fornecedor 70 é constituído dos próximos quatro dígitos e o código de número singular 74 é constituído dos últimos quatro dígitos. O campo de senha 52 mantém uma senha de até 512 caracteres, nesse exemplo. O campo de endereço IP 53 armazena um endereço IP do telefone, que para essa explicação é 192.168.0.20. O campo de endereço proxy SIP 54 mantém um protocolo IP compatível com o endereço proxy que pode ser fornecido para o telefone através da conexão de Internet 48 como parte de um procedimento de registro.

A memória do programa 34 armazena os blocos de códigos para o direcionamento do processador 32 para a realização das funções do telefone, uma das quais inclui um bloco de firewall 56 que fornece funções de firewall para o telefone, para impedir o acesso por pessoas não autorizadas ao microprocessador 32 e memórias 34, 38 e 40 através da conexão de Internet 48. A memória do programa 34 também armazena códigos 57 para o estabelecimento de um ID de chamada. Os códigos de ID de chamada 57 direcionam o processador 32 para produzir um identificador de chamada possuindo um formato compreendendo uma sequência hexadecimal em um endereço IP, o endereço IP sendo o endereço IP do telefone. Dessa forma, um identificador de chamada ilustrativo pode ser FF10@192.168.0.20.

Geralmente, em resposta ao ato de apanhar a interface do aparelho 46 e ativar uma função de discagem 44, o microprocessador 32 produz e envia uma mensagem de convite SIP como ilustrado na figura 3, para o controlador de direcionamento 16 ilustrado na figura 1. Essa mensagem de convite SIP serve essencialmente para iniciar uma chamada por um assinante chamador.

Com referência à figura 3, a mensagem de convite SIP inclui um campo de ID de chamador 60, um campo de identificador de chamada 62, um campo de parâmetros de compilador 64, um campo de ID de chamada 65, um campo de endereço IP 67 e um campo de porta UDP de chamador 69. Nessa modalidade, o campo de ID de chamador 60 inclui o nome de u-

usuário 2001 1050 8667 que é o nome do usuário de Vancouver armazenado no campo de nome de usuário 50 da memória de parâmetro 38 no telefone 12 ilustrado na figura 2. Adicionalmente, com referência novamente à figura 3, o campo de identificador de chamada 62 inclui um identificador de chamada que nessa modalidade é o nome do usuário 2001 1050 2222 que é o número discado do assinante de Calgary armazenado no armazenador de número discado 45 ilustrado na figura 2. O campo de parâmetros de compilador 64 inclui parâmetros de compilador e o campo ID de chamada 65 inclui um código compreendendo um código de prefixo gerado (FF10) e um sufixo que é o endereço de Protocolo de Internet (IP) do telefone 12 armazenado no campo de endereço IP 53 do telefone. O campo de endereço IP 67 mantém o endereço IP designado ao telefone, nessa modalidade, 192.168.0.20, e o campo de porta UDP do chamador 69 inclui um identificador de porta UDP identificando uma porta UDP na qual o percurso de áudio será encerrado no telefone do chamador.

Controlador de chamada

Com referência à figura 4, um circuito controlador de chamada do controlador de chamada 14 (figura 1) é ilustrado em maiores detalhes em 100. O circuito controlador de chamada 100 inclui um microprocessador 102, uma memória de programa 104 e uma porta I/O 106. O circuito 100 pode incluir uma pluralidade de microprocessadores, uma pluralidade de memórias de programa e uma pluralidade de portas I/O para ser capaz de manejar um grande volume de chamadas. No entanto, por motivos de simplicidade, o circuito controlador de chamada 100 será descrito como possuindo apenas um microprocessador 102, uma memória de programa 104 e uma porta I/O 106, sendo compreendido que podem existir mais.

Geralmente, a porta I/O 106 inclui uma entrada 108 para receber mensagens tal como a mensagem de convite SIP ilustrada na figura 3, do telefone ilustrado na figura 2. A porta I/O 106 também possui uma saída de mensagem de solicita;ao RC 110 para transmitir uma mensagem de solicita;ao RC para o RC 16 na figura 1, uma entrada de mensagem RC 112 para receber as mensagens de direcionamento do RC 16, uma saída de circuito

de acesso 114 para transmitir mensagens para um dos circuitos de acesso
20 ilustrados na figura 1 para aconselhar o circuito de acesso a estabelecer
um percurso de áudio, por exemplo, e uma entrada de circuito de acesso
116 para receber mensagens do circuito de acesso. A porta I/O 106 inclui
5 adicionalmente uma saída SIP 118 para transmitir mensagens para o telefo-
ne 12 para aconselhar o telefone dos endereços IP dos circuitos de acesso
que estabelecerão o percurso de áudio. A porta I/O 106 inclui adicionalmente
uma entrada e uma saída de servidor de correio de voz 117, 119 respecti-
vamente para comunicar com o servidor de correio e voz 19 ilustrado na fi-
10 gura 1.

Enquanto determinadas entradas e saídas foram ilustradas co-
mo separadas, será apreciado que algumas podem ser um endereço IP úni-
co e uma porta IP. Por exemplo, as mensagens enviadas para o RC 16 e
recebidas do RC 16 podem ser transmitidas e recebidas na mesma porta IP
15 única.

A memória de programa 104 inclui blocos de código para o dire-
cionamento do microprocessador 102 para realização de várias funções do
controlador de chamada 14. Por exemplo, esses blocos de código incluem
um primeiro bloco 120 para fazer com que o circuito controlador de chamada
20 100 execute um converte SIP para o processo de solicitação RC para produ-
zir uma mensagem de solicitação RC em resposta a uma mensagem de
convite SIP recebida. Adicionalmente, existe uma mensagem de direciona-
mento para o bloco de mensagem de circuito de acesso 122 que faz com
que o circuito controlador de chamada 100 produza uma mensagem de pes-
25 quisa de circuito de acesso em resposta a uma mensagem de direcionamen-
to recebida do RC 16.

Com referência à figura 5, o convite SIP para o processo de soli-
citação RC é ilustrado em maiores detalhes em 120. Mediante o recebimento
de uma mensagem de convite SIP do tipo ilustrado na figura 3, o bloco 122
30 da figura 5 direciona o circuito controlador de chamada 100 da figura 4 para
autenticar o usuário. Isso pode ser feito, por exemplo, solicitando uma senha
do usuário, enviando uma mensagem de volta para o telefone 12 que é in-

terpretada no telefone como uma solicitação de registro de senha ou a senha pode ser enviada automaticamente para o controlador de chamada 14 a partir do telefone, em resposta à mensagem. O controlador de chamada 14 pode então realizar pesquisas nas bases de dados às quais tem acesso, para determinar se ou não a senha do usuário combina com uma senha armazenada na base de dados. Várias funções podem ser utilizadas para se passar pelas chaves de criptografia ou códigos de hash para trás e para frente para garantir que a transmissão das senhas seja segura.

No caso de o processo de autenticação falhar, o circuito controlador de chamada 100 é direcionado para uma rotina de manuseio de erro 124 que faz com que as mensagens sejam exibidas no telefone 12 para indicar que houve um problema de autenticação. Se o procedimento de autenticação for bem sucedido, o bloco 121 direciona o circuito controlador de chamada 100 para determinar se ou não o conteúdo do campo de ID de chamador 60 da mensagem de convite SIP recebida a partir do telefone é um endereço IP. Se for um endereço IP, então o bloco 123 direciona o circuito controlador de chamada 100 para configurar o conteúdo de um campo de tipo variável mantido pelo microprocessador 102 para um código representando que o tipo de chamada é um convite de terceira parte. Se no bloco 121 o conteúdo do campo de ID de chamador não identificar um endereço IP, então o bloco 125 direciona o microprocessador para configurar o conteúdo do campo de tipo para um código indicando que a chamada está sendo realizada por um assinante de sistema. Então, o bloco 126 direciona o circuito controlador de chamada para ler o identificador de chamada 65 fornecido na mensagem de convite SIP a partir do telefone 12, e no bloco 128 o processador é direcionado para produzir uma mensagem de solicitação RC que inclui esse ID de chamada. O bloco 129 então direciona o circuito controlador de chamada 100 para enviar a solicitação RC para o RC 16.

Com referência à figura 6, uma mensagem é solicitada; ao RC é ilustrada geralmente por 150 e inclui um campo de chamador 152, um campo de chamado 154, um campo de compilador 156, um campo ID de chamada 158 e um campo de tipo 160. Os campos de ID de chamador, chama-

da, de compilador e ID de chamada 152, 154, 156 e 158 contêm cópias dos campos chamador, chamado, de compilador, parâmetros e ID de chamada 60, 62, 64 e 65 da mensagem de convite SIP ilustrada na figura 3. O campo de tipo 160 contém o código de tipo estabelecido nos blocos 123 e 125 da figura 5 para indicar se a chamada é de uma terceira parte ou de um assinante de sistema, respectivamente. O campo de identificador do chamador pode incluir um número PSTN ou um nome de usuário de assinante de sistema como ilustrado, por exemplo.

Controlador de Direcionamento (RC)

10 Com referência à figura 7, o RC 16 é ilustrado em maiores detalhes e inclui um circuito processador RC ilustrado geralmente por 200. O circuito processador RC 200 inclui um processador 202, uma memória de programa 204, uma memória de tabela 206, uma memória de armazenador 207 e uma porta I/O 208, todos em comunicação com o processador 202. (Como
15 indicado anteriormente, pode haver uma pluralidade de circuitos processadores (202), memórias (204), etc.).

A memória de armazenador 207 inclui um armazenador de ID de chamador 209 e um armazenador de ID de chamado 211.

A porta I/O 208 inclui uma porta de solicitação de base de dados
20 210 através da qual uma solicitação à base de dados (18 ilustrado na figura 1) pode ser realizada e inclui uma porta de resposta de base de dados 212 para receber uma resposta da base de dados 18. A porta I/O 208 inclui adicionalmente uma entrada de mensagem de solicitação RC 214 para o recebimento da mensagem de solicitação RC do controlador de chamada (14
25 ilustrado na figura 1) e inclui uma saída de mensagem de direcionamento 216 para enviar uma mensagem de direcionamento de volta para o controlador de chamada 14. A porta I/O 208 age, dessa forma, para receber o identificador do chamador e um identificador de chamada contidos na mensagem de solicitação RC do controlador de chamada, a mensagem de solicitação
30 de RC sendo recebida em resposta à iniciação de uma chamada por um assinante chamador.

A memória de programa 204 inclui blocos de códigos para dire-

cionar o processador 202 para realizar as várias funções do RC (16). Um desses blocos inclui um manuseador de mensagem de solicitação RC 250 que direciona o RC para produzir uma mensagem de direcionamento em resposta a uma mensagem de solicitação RC recebida. O processo de manuseio de mensagem de solicitação RC é ilustrado em maiores detalhes em 250 nas figuras 8A a 8D.

Manuseador de Mensagem de Solicitação RC

Com referência à figura 8A, o manuseador de mensagem de solicitação RC começa com um primeiro bloco 252 que direciona o circuito processador RC (200) para armazenar o conteúdo da mensagem de solicitação RC (150) nos armazenadores na memória de armazenamento 207 da figura 7, um dos quais inclui o armazenador de ID de chamador 209 da figura 7 para o armazenamento separadamente do conteúdo do campo de chamado 154 da mensagem de solicitação de RC. O bloco 254 então direciona o circuito processador RC para utilizar o conteúdo do campo de chamador 152 na mensagem de solicitação RC ilustrada na figura 6, para localizar e recuperar a partir da base de dados 18 um registro associando os atributos de chamada com o assinante chamador. O registro localizado pode ser referido como um perfil de discagem para o chamador. O perfil de discagem recuperado pode então ser armazenado na memória de armazenamento 207, por exemplo.

Com referência à figura 9, uma estrutura de dados ilustrativa para um perfil de discagem é ilustrada geralmente em 253 e inclui um campo de nome de usuário 258, um campo de domínio 260, e atributos de chamada compreendendo um campo de dígitos de discagem nacionais (NDD) 262, um campo de dígitos de discagem internacional (IDD) 264, um campo de código de país 266, um campo de códigos de área local 267, um campo de comprimento local mínimo de chamador 268, um campo de comprimento local máximo de chamador 270, um campo de revendedor 273, um campo de número máximo de chamadas simultâneas 275 e um campo de número atual de chamadas simultâneas 277. Efetivamente, perfil de discagem é um registro identificado os atributos de chamada do chamador identificado pelo identifi-

gador do chamador. Mais geralmente, os perfis de discagem representam atributos de chamada dos respectivos assinantes.

Um perfil de chamador ilustrativo para o assinante de Vancouver é ilustrado geralmente em 276 na figura 10 e indica que o campo de nome de usuário 258 inclui o nome do usuário (2001 1050 8667) que foi designado para o assinante e é armazenado no campo de nome de usuário 50 no telefone como ilustrado na figura 2

Com referência novamente à figura 10, o campo de domínio 260 inclui um nome de domínio como ilustrado em 282, incluindo um identificador de tipo de nó 284, um identificador de código de localização 286, um identificador de provedor de sistema 288 e uma parte de domínio 290. O campo de domínio 260 identifica de forma efetiva um domínio ou nó associado com o usuário identificado pelo conteúdo do campo de nome de usuário 258.

Nessa modalidade, o identificador de tipo de nó 284 inclui o código "sp" identificando um supernó e o identificador de localização 286 identifica o supernó como estando em Vancouver (YVR). O identificador de provedor de sistema 288 identifica a companhia que supre o serviço e a parte de domínio 290 identifica o domínio "com".

O campo de dígito discado nacional 262 nessa modalidade inclui o dígito "1" e, em geral, inclui um número especificado pela Recomendação do Setor E de Padronização de Telecomunicações (ITU-T) da União de Telecomunicações Internacional (ITU) 164 que designa os dígitos de discagem nacional para os países.

O campo de dígito de discagem internacional 264 inclui um código designado também de acordo com ITU-T de acordo com o país ou localização do usuário.

O campo de código de país 266 também inclui o dígito "1" e, em geral, inclui um número designado de acordo com o ITU-T para representar o país no qual o usuário está localizado.

O campo de códigos de área local 267 inclui uma lista de códigos de área que foram designados pelo ITU-T para a área geográfica na qual o assinante está localizado. Os campos de comprimento de número

local máximo e mínimo do chamador 268 e 270 mantêm os números que representam os comprimentos de número local mínimo e máximo permitidos nos códigos de área especificados pelo conteúdo do campo de códigos de área local 267. O campo de revendedor 273 é opcional e mantêm um código identificando um varejista dos serviços, nessa modalidade "Klondike". O número máximo do campo de chamadas simultâneas 275 mantêm um código identificando o número máximo de chamadas simultâneas que o usuário pode realizar simultaneamente. Isso permite que mais de uma chamada ocorra simultaneamente enquanto todas as chamadas para o usuário são cobradas na mesma conta. O número atual do campo de chamadas simultâneas 277 é inicialmente igual a 0 e é aumentado cada vez que uma chamada simultânea associada com o usuário é iniciada e é reduzido quando uma chamada simultânea é encerrada.

Os códigos de área associados com o usuário são os códigos associados com o identificador de código de localização 286 do conteúdo do campo de domínio 260.

Um perfil de discagem do tipo ilustrado na figura 9 é produzido toda vez que um usuário registra com o sistema ou concorda em se tornar um assinante do sistema. Dessa forma, por exemplo, um usuário que deseja assinar o sistema pode entrar em contato com um escritório mantido por um operador de sistema e com o pessoal do escritório para perguntar ao usuários determinadas perguntas sobre sua localização e preferências de serviço, onde as tabelas podem ser utilizadas para fornecer ao pessoal do escritório informações adequadas a serem registradas nos campos de nome de usuário 258, domínio 260, NDD 262, IDD 264, código de país 266, códigos de área local 267, comprimento local mínimo e máximo do chamador 268 e 270, campo de revendedor 273 e campos de chamada simultânea 275 e 277 para estabelecer um perfil de discagem para o usuário.

Com referência às figuras 11 e 12, os perfis de discagem do chamado para usuários em Calgary e Londres, respectivamente, por exemplo, são ilustrados.

Em adição à criação de perfis de discagem quando um usuário

se registra com o sistema, um registro DID do tipo ilustrado em 278 na figura 13 é adicionado a uma tabela de banco de discagem direta na base de dados (18 na figura 1) para associar o nome de usuário e um nome de hospedeiro do supernó com o qual o usuário está associado, com um número E.164 associado com o usuário na rede PSTN.

Um registro de tabela DID ilustrativo para o chamado de Calgary é ilustrado geralmente por 300 na figura 14. O campo de nome de usuário 281 e o campo de domínio de usuário 272 são análogos aos campos de nome de usuário e domínio 258 e 260 do perfil de discagem do chamador ilustrado na figura 10. O conteúdo do campo DID 274 inclui um número de telefone público E.164 incluindo um código de país 283, um código de área 285, um código de permuta 287 e um número 289. Se o usuário possuir múltiplos números de telefone, então os múltiplos registros do tipo ilustrado em 300 serão incluídos na tabela de banco DID, cada um possuindo o mesmo número de usuário e domínio de usuário, mas diferentes conteúdos de campo DID 274 refletindo os diferentes números telefônicos associados com esse usuário.

Em adição à criação de perfis de discagem, como ilustrado na figura 9, e registros DID, como ilustrado na figura 13, quando um usuário registra com o sistema, os registros de bloqueio de chamada do tipo ilustrado na figura 26, os registros de envio de chamada do tipo ilustrado na figura 28 e os registros de correio de voz do tipo ilustrado na figura 30 podem ser adicionados à base de dados 18 quando um novo assinante é adicionado ao sistema.

Com referência novamente à figura 8A, depois da recuperação de um perfil de discagem para o chamador, tal como ilustrado por 276 na figura 10, o circuito processador RC 200 é direcionado ao bloco 256 que direciona o circuito processador (200) para determinar se o conteúdo do campo de chamada simultânea 277 é inferior ao conteúdo do campo de chamada simultânea máxima 275 do perfil de discagem para o chamador e, se for esse o caso, o bloco 271 direciona o circuito processador para incrementar o conteúdo do campo de chamada simultânea 277. Se o conteúdo do campo

de chamada simultânea 277 for igual a ou superior ao conteúdo do campo de chamada simultânea máxima 275, o bloco 259 direciona o circuito processador 200 para enviar uma mensagem de erro de volta para o controlador de chamada (14) para fazer com que o controlador de chamada notifique o chamador de que o número máximo de chamadas simultâneas foi alcançado e nenhuma chamada adicional pode existir simultaneamente, incluindo a chamada atualmente solicitada.

Assumindo-se que o bloco 256 permita que a chamada prossiga, o circuito processador RC 200 é direcionado para realizar determinadas verificações no identificador de chamada fornecido pelo conteúdo do campo do chamado 154 na figura 6, da mensagem de solicitação RC 150. Essas verificações são ilustradas em maiores detalhes na figura 8B.

Com referência à figura 8B, o processador (202 na figura 7) é direcionado para um primeiro bloco 257 que faz com que o mesmo determine se um padrão de dígito do identificador de chamada (154) fornecido na mensagem de solicitação RC (150) inclui um padrão que combina o conteúdo do campo de dígitos de discagem internacional (IDD) 264 no perfil do chamador ilustrado na figura 10. Se for esse o caso, então o bloco 259 direciona o processador (202) para configurar uma variável do identificador de código de tipo de chamada mantida pelo processador para indicar que a chamada é uma chamada internacional e o bloco 261 direciona o processador para produzir um identificador de chamada reformatado pela reformatação do identificador de chamada em um formato de dígito predefinido. Nessa modalidade, isso é feito pela remoção do padrão de dígitos combinando o conteúdo de campo IDD 264 do perfil de discagem do chamador para encurtar de forma efetiva o identificador de chamada. Então, o bloco 263 direciona o processador 202 para determinar se ou não o identificador de chamada tem um comprimento que corresponde aos critérios estabelecendo o mesmo como um número em conformidade com o Padrão E.164 configurado por ITU. Se o comprimento não corresponder a esse critério, o bloco 265 direciona o processador 202 para enviar de volta para o controlador de chamada (14) uma mensagem indicando que o comprimento não está correto. O pro-

cesso é então encerrado. No controlador de chamada 14, as rotinas (não ilustradas) armazenadas na memória do programa 104 podem direcionar o processador (102 da figura 4) para responder à mensagem de comprimento incorreto pela transmissão de uma mensagem de volta para o telefone (12
5 ilustrado na figura 1) para indicar que um número inválido foi discado.

Ainda com referência à figura 8B, se o comprimento do identificador de chamada emendado corresponder aos critérios apresentados no bloco 263, o bloco 269 direciona o processador (202 da figura 7) para realizar uma solicitação de base de dados para determinar se ou não o identificador de chamada emendado foi encontrado em um registro na tabela de
10 bando DID. Com referência novamente à figura 8B, no bloco 269, se o processador 202 receber uma resposta da base de dados indicando que o identificador de chamada reformatado produzido no bloco 261 foi encontrado em um registro na tabela de banco DID, então o chamado é um assinante do
15 sistema e a chamada é classificada como uma chamada de rede privada pelo direcionamento do processador para o bloco 279 que direciona o processador para copiar o conteúdo do campo de nome de usuário correspondente (281 na figura 14) a partir do registro de tabela de banco DID do chamado (300 na figura 14) para o armazenador de ID de chamado (211 na fi-
20 gura 7). Dessa forma, o processador 202 localiza um nome de usuário de assinante associado com o identificador de chamada reformatado. O processador 202 é então direcionado para o ponto B na figura 8A.

Chamadas de Assinante para Assinante Entre Nós Diferentes

Com referência à figura 8A, o bloco 280 direciona o processador
25 (202 da figura 7) para executar um processo para determinar se ou não o nó associado com o identificador de chamada reformatado é o mesmo nó que o associado com o identificador do chamador. Para se fazer isso, o processador 202 determina se ou não um prefixo (por exemplo, código de continente 61) do nome do chamado mantido no armazenador de ID de chamado (211
30 na figura 7) é igual ao prefixo correspondente do nome do chamador mantido no campo de nome de usuário 258 do perfil de discagem do chamador ilustrado na figura 10. Se os prefixos correspondentes não forem iguais, o

bloco 302 na figura 8A direciona o processador (202 na figura 7) para configurar um indicador de tipo de chamada na memória do armazenador (207 na figura 7) para indicar que a chamada é uma chamada de domínio cruzado. Então, o bloco 350 da figura 8A direciona o processador (202 na figura 7) para produzir uma mensagem de direcionamento identificando um endereço na rede privada com o qual a parte chamada identificada pelo conteúdo do armazenador de ID de chamada é associada e para configurar um tempo para a chamada de no máximo 99999, por exemplo.

Dessa forma, a mensagem de direcionamento inclui um identificador do chamador, um identificador de chamada configurado de acordo com um nome de usuário associado ao registro de tabela de banco DID e inclui um identificador de um nó na rede privada com a qual a parte chamada está associada.

O nó no sistema com o qual o chamado está associado é determinado pela utilização do identificador de chamada para endereçar uma tabela de supernós possuindo registros do tipo como ilustrado por 370 na figura 17. Cada registro 370 possui um campo de prefixo 372 e um campo de endereço de supernó 374. O campo de prefixo 372 inclui os primeiros n dígitos do identificador de chamada. Nessa modalidade $n = 2$. O campo de endereço de supernó 374 mantém um código representando o endereço IP ou um nome de domínio totalmente qualificado do nó associado com o código armazenado no campo de prefixo de identificador de chamada 372. Com referência à figura 18, por exemplo, se o prefixo for 20, o endereço de supernó associado com esse prefixo é sp.yvr.digifonica.com.

Com referência à figura 15, uma mensagem de direcionamento genérica é ilustrada geralmente por 352 e inclui um campo de prefixo de fornecedor opcional 354, e o campo delimitador opcional 356, um campo de nome de usuário do chamado 358, pelo menos um campo de direcionamento 360, um campo para tempo ao vivo 362 e outros campos 364. O campo de prefixo de fornecedor opcional 354 mantém um código para identificar o tráfego de fornecedor. O campo delimitador opcional 356 mantém um símbolo que delimita o código de prefixo de fornecedor a partir do campo de nome

de usuário de chamado 358. Nessa modalidade, o símbolo é um sinal de número (#). O campo de direcionamento 360 mantém um nome de domínio ou endereço IP de um circuito de acesso ou nó que deve realizar a chamada, e o campo de tempo ao vivo 362 mantém um valor representando o número de segundos durante os quais a chamada pode estar ativa, com base nos minutos disponíveis para o assinante e outros parâmetros de cobrança.

Com referência à figura 8A e à figura 16, um exemplo de uma mensagem de direcionamento produzida pelo processador no bloco 350 para um chamador associado com um nó diferente do chamador é ilustrado geralmente por 366 e inclui apenas um campo de chamado 359, um campo de rota 361 e um campo de tempo ao vivo 362.

Com referência à figura 8A, tendo produzido uma mensagem de direcionamento como ilustrado na figura 16, o bloco 381 direciona o processador (202 da figura 7) para enviar a mensagem de direcionamento ilustrada na figura 16 para o controlador de chamada 14 ilustrado na figura 1.

Com referência novamente à figura 8B, se no bloco 257, o identificador de chamada armazenado no armazenador de ID de parte chamada (211 da figura 7) não começar com um dígito de discagem internacional, o bloco 380 direciona o processador (202) para determinar se ou não o identificador de chamada começa com o mesmo código de dígito de discagem nacional que o designado para o chamador. Para se fazer isso, o processador (202) é direcionado para se referir ao perfil de discagem de chamador recuperado como ilustrado na figura 10. Na figura 10, o código de dígito de discagem nacional 262 é o número 1. Dessa forma, se o identificador de chamada começar com o número 1, então o processador (202) é direcionado para o bloco 382 na figura 8B.

O bloco 382 direciona o processador (202 da figura 7) para examinar o identificador de chamado para determinar se ou não os dígitos seguindo o dígito NDD identificam um código de área que é igual a qualquer um dos códigos de área identificados no campo de códigos de área local 267 do perfil de discagem do chamador 276 ilustrado na figura 10. Se não, o bloco 384 da figura 8B direciona o processador 202 para configurar o indicador

de tipo de chamada para indicar que a chamada é uma chamada nacional. Se os dígitos seguindo o dígito NDD identificarem um código de área que é igual ao código de área local associado com o chamador como indicado pelo perfil de discagem do chamador, o bloco 386 direciona o processador 202 para configurar o indicador de tipo de chamada para indicar uma chamada local, estio nacional. Depois da execução dos blocos 384 e 386, o bloco 388 direciona o processador 202 para formatar o identificador de chamada em um formato de dígito predefinido para produzir um identificador de chamada reformatado pela remoção do dígito discado nacional e anexando um código de país de chamador identificado pelo campo de código de país 266 do perfil de discagem do chamador ilustrado na figura 10. O processador (202) é então direcionado para o bloco 263 da figura 8B para realizar outro processamento como já descrito acima.

Se no bloco 380, o identificador de chamada não começar com um dígito discado nacional, o bloco 390 direciona o processador (202) para determinar se o identificador de chamada começa com os dígitos que identificam o mesmo código de área que o chamador. Novamente, a referência para isso é o perfil de discagem do chamador recuperado ilustrado na figura 10. O processador (202) determina se ou não os primeiros poucos dígitos do identificador de chamada identificam um código de área correspondente ao campo de código de área local 267 do perfil de discagem do chamador recuperado. Se for assim, então o bloco 392 direciona o processador 202 para configurar o indicador de tipo de chamada para indicar que a chamada é uma chamada local e o bloco 394 direciona o processador (202) para formatar o identificador de chamada em um formato de dígito predefinido para produzir um identificador de chamada reformatado pela anexação do código de país de chamador ao identificador de chamada, o código de país de chamador sendo determinado a partir do campo de código de país 266 do perfil de discagem do chamador recuperado ilustrado na figura 10. O processador (202) é então direcionado para o bloco 263 para processamento adicional como descrito acima.

Com referência novamente à figura 8B, no bloco 390, o identifi-

cador de chamada não começa com o mesmo código de área que o chamador, o bloco 396 direciona o processador (202 da figura 7) para determinar se o número de dígitos no identificador de chamada, isso é, o comprimento do identificador de chamada, está dentro da faixa de dígitos indicada pelo campo de comprimento de número local mínimo do chamador 268 e o campo de comprimento de número local máximo de chamador 270 do perfil de discagem do chamador recuperado ilustrado na figura 10. Se for esse o caso, então o bloco 398 direciona o processador (202) para configurar o indicador de tipo de chamada para indicar uma chamada local e bloco 400 direciona o processador (202) para formatar o identificador de chamada em um formato de dígito predefinido para produzir um identificador de chamada reformatado pela anexação ao identificador de chamada o código de país do chamador (como indicado pelo campo de código de país 266 do perfil de discagem do chamador recuperado ilustrado na figura 10) seguido pelo código de área do chamador (como indicado pelo campo de código de área local 267 do perfil de chamador ilustrado na figura 10). O processador (202) é então direcionado para o bloco 263 da figura 8B para processamento adicional como descrito acima.

Com referência novamente à figura 8B, se no bloco 396, o identificador de chamada tiver um comprimento que não se encontra dentro da faixa especificada pelo campo de comprimento de número local mínimo do chamador (268 na figura 10) e o campo de comprimento de número local máximo do chamador (270 na figura 10), o bloco 402 direciona o processador 202 da figura 7 para determinar se ou não o identificador de chamada identifica um nome de usuário válido. Para se fazer isso, o processador 202 busca através da base de dados (18 da figura 10) dos perfis de discagem para encontrar um perfil de discagem possuindo o conteúdo do campo de nome de usuário (258 na figura 10) que combine com o identificador de chamada. Se nenhuma coincidência for encontrada, o bloco 404 direciona o processador (202) para enviar uma mensagem de erro de volta para o controlador de chamada (14). Se no bloco 402, um perfil de discagem possuindo um campo de nome de usuário 258 que combina com o identificador de

chamada for encontrado, o bloco 406 direciona o processador 202 para configurar o indicador de tipo de chamada para indicar que a chamada é uma chamada de rede privada e então o processador é direcionado para o bloco 280 da figura 8A. Dessa forma, a chamada é classificada como uma chamada de rede privada quando o identificador de chamada identifica um assinante para a rede privada.

A partir da figura 8B, será apreciado que existem determinados grupos de blocos de códigos que direcionam o processador 202 na figura 7 para determinar se o identificador de chamada contém determinadas características tal como um dígito de discagem internacional, um dígito de discagem nacional, um código de área e um comprimento que correspondem a determinados critérios, e fazem com que o processador 202 reformate o identificador de chamada armazenado no armazenador de ID de chamado 211, como necessário em um formato alvo predeterminado incluindo apenas um código de país, um código de área, e um número de telefone normal, por exemplo, para fazer com que o identificador de chamada seja compatível com o padrão de plano de número E.164 nessa modalidade. Isso permite que o bloco 269 na figura 8B tenha um formato consistente de identificadores e chamado para uso na busca através dos registros de tabela de banco DID do tipo ilustrado na figura 13 para determinar como direcionar as chamadas para chamadas de assinante para assinante no mesmo sistema. Efetivamente, portanto, os blocos 257, 380, 390, 396 e 402 estabelecem os critérios de classificação de chamada para classificar a chamada como uma chamada de rede pública ou uma chamada de rede privada. O bloco 269 classifica a chamada, dependendo de se ou não o identificador de chamada formatado possui um registro de tabela de banco DID e isso depende de como os critérios de classificação de chamada são correspondidos e o bloco 402 direciona o processador 202 da figura 7 para classificar a chamada como uma chamada de rede privada quando o identificador de chamada está em conformidade com um formato predefinido, isso é, é um nome de usuário válido e identifica um assinante para a rede privada, depois que o identificador de chamada foi submetido aos critérios de classificação dos blocos 257,

380, 390 e 396.

Chamadas de Assinante para Não Assinante

Nem todas as chamadas serão chamadas de assinante para assinante e isso será detectado pelo processador 202 da figura 7 quando
5 executar o bloco 269 na figura 8B, e não encontrar um registro de tabela de banco DID que seja associado com a parte chamada, na tabela de banco DID. Quando isso ocorre, a chamada é classificada como uma chamada de rede pública pelo direcionamento do processador 202 para o bloco 408 da figura 8B que faz com que a mesma seja configurada para o conteúdo do
10 armazenador de ID da parte chamada 211 da figura 7 igual ao identificador de chamada recém formatado, isso é, um número compatível com o padrão E.164. Então, o bloco 410 da figura 8B direciona o processador (202) para buscar uma base de dados de rota ou registros de lista principal associando os identificadores de rota com os códigos de discagem ilustrados na figura
15 19 para localizar um direcionador possuindo um código de discagem possuindo um padrão de número que combina pelo menos uma parte do identificador de chamada reformatado.

Com referência à figura 19, uma estrutura de dados para uma lista principal ou registro de lista de rota é ilustrada. Cada registro de lista
20 principal inclui um campo de ID de lista principal 500, um campo de código de discagem 502, um campo de código de país 504, um campo de número de sinal nacional 506, um campo de comprimento mínimo 508, um campo de comprimento máximo 510, um campo de dígito discado nacional 512, um campo de dígito discado internacional 514 e um campo de taxa de armaze-
25 nador 516.

O campo de ID de lista principal 500 mantém um código singular tal como 1019, por exemplo, identificando o registro. O campo de código de discagem 502 mantém um padrão de número predeterminado que o proces-
30 sador 202 da figura 7 utiliza no bloco 410 na figura 8B para encontrar o registro de lista principal possuindo um código de discagem coincidindo com os primeiros poucos dígitos do identificador de chamada emendado armazenado no armazenador de ID de parte de chamada 211. O campo de código

de país 504 mantém um número representando o código de país associado com o registro e o campo de número de sinal nacional 506 mantém um número representando o código de área associado com o registro. (Será observado que o código de discagem é uma combinação do conteúdo do campo de código de país 504 e campo de número de sinal nacional 506). O campo de comprimento mínimo 508 mantém um número representando o comprimento mínimo de dígitos associados com o registro e o campo de comprimento máximo 51 mantém um número representando o número máximo de dígitos em um número com o qual o registro pode ser comparado. O campo de dígito discado nacional (NDD) 512 mantém um número representando um código de acesso utilizado para realizar uma chamada dentro do país especificado pelo código de país, e o campo de dígito discado internacional (IDD) 514 mantém um número representando o prefixo internacional necessário para realizar uma chamada do país indicado pelo código de país.

Dessa forma, por exemplo, um registro de lista principal pode ter um formato como ilustrado na figura 20 com o conteúdo de campo ilustrativo como ilustrado.

Com referência novamente à figura 8B, utilizando as partes de código de país e código de área do identificador de chamada reformatado armazenado no armazenador de ID de chamado 211, o bloco 410 direciona o processador 202 da figura 7 para encontrar um registro de lista principal tal como o ilustrado na figura 20 possuindo um código de discagem que combina o código de país (1) e o código de área (604) do identificador de chamada. Dessa forma, nesse exemplo, o processador (202) encontra um registro de lista principal possuindo um campo de ID contendo o número 1019. Esse número pode ser referido como um ID de rota. Dessa forma, um número de ID de rota é encontrado no registro de lista principal associado com um padrão de número predeterminado no identificador de chamada reformatado.

Depois da execução do bloco 410 na figura 8B, o processo continua como ilustrado na figura 8D. Com referência à figura 8D, o bloco 412 direciona o processador 202 da figura 7 a utilizar o número de ID de rota para buscar uma base de dados dos registros de fornecedor associando os

identificadores de fornecedor com os identificadores de rota para localizar pelo menos um registro de fornecedor associado com o identificador de rota para identificar pelo menos um fornecedor que opera para suprir um link de comunicações para a rota.

5 Com referência à figura 21, uma estrutura de dados para um registro de lista de fornecedor é ilustrada. Os registros de lista de fornecedor incluem um campo de ID de fornecedor 540, um campo de ID de lista principal 542, um campo de prefixo opcional 544, um campo de identificador de rota específica 546, um campo de reescrita de NDD/IDD 548, um campo de taxa 550, e um campo de expiração de tempo 551. O campo de ID de fornecedor 540 mantém um código identificando o nome do fornecedor e o campo de ID de lista principal 542 mantém um código para associar o registro do fornecedor com um registro de lista principal. O campo de prefixo 544 mantém uma sequência utilizada para identificar o tráfego de fornecedor e o campo de identificador de rota específica 546 mantém um endereço IP de um circuito de acesso operado pelo fornecedor indicado pelo campo de ID de fornecedor 540. O campo de reescrita de NDD/IDD 548 mantém um código representando um valor reescrito do NDD/IDD associado com essa rota para esse fornecedor, e o campo de taxa 550 mantém um código indicando o custo por segundo para o operador do sistema utilizar a rota fornecida pelo circuito de acesso especificado pelo conteúdo do campo de identificador de rota 546. O campo de expiração de tempo 551 mantém um código indicando um tempo pelo qual o controlador de chamada deve esperar por uma resposta do circuito de acesso associado antes de desistir e tentar o próximo circuito de acesso. Esse valor de tempo pode ser representado em segundos, por exemplo. Os registros de fornecedor ilustrativos são ilustrados nas figuras 22, 23 e 24 para os fornecedores ilustrativos ilustrados em 20, na figura 1, isso é, Telus, Shaw e Sprint.

30 Com referência novamente à figura 8D, no bloco 412, o processador 202 encontra todos os registros de fornecedor que identificam o ID de lista principal encontrado no bloco 410 da figura 8B.

 Com referência novamente à figura 8D, o bloco 560 direciona o

processador 202 da figura 7 para começar a produzir uma mensagem de direcionamento do tipo ilustrado na figura 15. Para se fazer isso, o processador 202 carrega um armazenador de mensagem de direcionamento como ilustrado na figura 25 com um prefixo de fornecedor do fornecedor menos caro onde o fornecedor menos caro é determinado a partir dos campos de taxas 550 da figura 21 dos registros associados com os respectivos fornecedores.

Com referência às figuras 22 a 24, na modalidade ilustrada, o fornecedor "Telus" possui o número mais baixo no campo de taxa 550 e, portanto, o prefixo 4973 associado com esse fornecedor é carregado no armazenador de mensagem de direcionamento ilustrado na figura 25 primeiro.

O bloco 562 na figura 8D direciona o processador para delimitar o prefixo 4973 pelo sinal de número (#) e para carregar a seguir o identificador de chamada reformatado no armazenador de mensagem de direcionamento ilustrado na figura 25. No bloco 563 da figura 8D, o conteúdo do campo de identificador de rota 546 da figura 21 do registro associado com o fornecedor "Telus" é adicionado pelo processador 202 da figura 7 ao armazenador de mensagem de direcionamento ilustrada na figura 25 depois de um delimitador de sinal @, e então o bloco 564 na figura 8D direciona o processador para obter um valor de tempo ao vivo, que em uma modalidade pode ser de 3600 segundos, por exemplo. O bloco 566 então direciona o processador 202 para carregar esse valor de tempo ao vivo e o valor de expiração de tempo (551) na figura 21 no armazenador de mensagem de direcionamento da figura 25. De acordo, uma primeira parte da mensagem de direcionamento para o circuito de acesso Telus é ilustrada geralmente por 570 na figura 25.

Com referência novamente à figura 8D, o bloco 571 direciona o processador 202 de volta para o bloco 560 e faz com que o mesmo repita os blocos 560, 562, 563, 564 e 566 para cada fornecedor sucessivo até que o armazenador de mensagem de direcionamento seja carregado com informação pertencente a cada fornecedor identificado pelo processador no bloco 412. Dessa forma, uma segunda parte da mensagem de direcionamento

como ilustrado em 572 na figura 25 se refere ao segundo fornecedor identificado pelo registro ilustrado na figura 23. Com referência novamente à figura 25, uma terceira parte da mensagem de direcionamento como ilustrado em 574 e associada com um terceiro fornecedor como indicado pelo registro de
5 fornecedor ilustrado na figura 24.

Consequentemente, com referência à figura 25, o armazenador de mensagem de direcionamento mantém uma mensagem de direcionamento identificando uma pluralidade de fornecedores diferentes capazes de fornecer circuitos de acesso para a rede de telefonia pública (isso é, rotas específicas) para estabelecer pelo menos parte de um link de comunicação
10 através do qual o chamador pode entrar em contato com a parte chamada. Nessa modalidade, cada um dos fornecedores é identificado, em sucessão, de acordo com a taxa. Outros critérios para a determinação da ordem na qual os fornecedores são listados na mensagem de direcionamento podem
15 incluir prioridades preferidas do fornecedor, que podem ser estabelecidas com base nos acordos de serviço, por exemplo.

Com referência novamente à figura 8D, o bloco 568 direciona o processador 202 da figura 7 para enviar a mensagem de direcionamento ilustrada na figura 25 para o controlador de chamada 14 na figura 1.

20 Chamadas de Assinante para Assinante Dentro do Mesmo Nó

Com referência novamente à figura 8A, se no bloco 280, o identificador de chamada recebido na mensagem de solicitação ao RC possui um prefixo que identifique o mesmo nó como o associado com o chamador, o bloco 600 direciona o processador 202 para utilizar o identificador de chamada no armazenador de ID de chamado 211 para localizar e recuperar um
25 perfil de discagem para o chamado. O perfil de discagem pode ser do tipo ilustrado na figura 11 ou 12, por exemplo. O bloco 602 da figura 8A então direciona o processador 202 da figura 7 para obter os registros de bloqueio de chamada, envio de chamada e correio de voz a partir da base de dados
30 18 da figura 1 com base no nome de usuário identificado no perfil de discagem do chamado recuperado pelo processador no bloco 600. Os registros de bloqueio de chamada, envio de chamada e correio de voz podem ser co-

mo ilustrado nas figuras 26, 27, 28 e 30 por exemplo.

Com referência à figura 26, os registros de bloqueio de chamada incluem um campo de nome de usuário 604 e um campo de padrão de bloco 606. O campo de nome de usuário mantém um nome de usuário correspondente ao nome de usuário no campo de nome de usuário (258 na figura 10) do perfil da parte chamada e o campo de padrão de bloco 606 mantém um ou mais números compatíveis com E.164 ou nomes de usuário identificando números PSTN ou assinantes de sistema dos quais o assinante identificado no campo de nome de usuário 604 não deseja receber chamadas.

Com referência à figura 8A e à figura 27, o bloco 608 direciona o processador 202 da figura 7 para determinar se ou não o identificador do chamador recebido na mensagem de solicitação RC combina com um padrão de bloco armazenado no campo de padrão de bloco 606 do registro de bloqueio de chamada associado com o chamado identificado pelo conteúdo do campo de nome de usuário 604 na figura 26. Se o identificador do chamador combinar um padrão de bloqueio, o bloco 610 direciona o processador para enviar uma mensagem de chamada interrompida ou mensagem de não conexão para o controlador de chamada (14) e o processo é encerrado. Se o identificador do chamador não combinar com um padrão de bloqueio associado com o chamado, o bloco 609 direciona o processador para armazenar o nome de usuário e o domínio da parte chamada, como determinado a partir do perfil de discagem da parte chamada, e um valor de tempo ao vivo no armazenador de mensagem de direcionamento como ilustrado em 650 na figura 32. Com referência novamente à figura 8A, o bloco 612 então direciona o processador 202 para determinar se ou não o envio de chamada é necessário.

Com referência à figura 28, os registros de envio de chamada incluem um campo de nome de usuário 614, um campo de número de destino 616, e um campo de número de sequência 618. O campo de nome de usuário 614 armazena um código representando um usuário com o qual o registro está associado. O campo de número de destino 616 mantém um nome de usuário representando um número para o qual a chamada atual

deve ser enviado, e o campo de número de sequência 618 mantém um número inteiro indicando a ordem na qual o nome de usuário associado com o campo de número de destino correspondente 616 deve ser tentado para o envio de chamada. A tabela de envio de chamada pode ter uma pluralidade

5 de registros para um usuário determinado. O processador 202 da figura 7 utiliza o conteúdo do campo de número de sequência 618 para colocar os registros para um determinado usuário em ordem. Como será apreciado abaixo, isso permite que os números de envio de chamada sejam tentados em uma sequência ordenada.

10 Com referência à figura 8A e à figura 29, se no bloco 612, o registro de envio de chamada para o chamado identificado pelo identificador de chamada não contiver qualquer conteúdo no campo de número de destino 616 e, de acordo, nenhum conteúdo no campo de número de sequência 618, não existem registros de envio de chamada para esse chamado, e o

15 processador 202 é direcionado para o bloco 620 na figura 8C. Se houver registros na tabela de envio de chamada 27, o bloco 622 na figura 8A direciona o processador 202 para buscar a tabela de perfil de discagem para encontrar um registro de perfil de discagem como ilustrado na figura 9, para o usuário identificado pelo campo de número de destino 616 do registro de

20 avanço de chamada ilustrado na figura 28. O processador 202 da figura 7 é adicionalmente direcionado para armazenar o nome de usuário e domínio para esse usuário e um valor de tempo ao vivo no armazenador de mensagem de direcionamento como ilustrado em 652 na figura 32, para produzir uma mensagem de direcionamento como ilustrado. Esse processo é repeti-

25 do para cada registro de envio de chamada associado com o chamado identificado pelo armazenador de ID de chamado 211 na figura 7 para adicionar ao armazenador de mensagem de direcionamento todos os nomes de usuário e domínios de envio de chamada associados com a parte chamada.

30 Com referência novamente à figura 8A, se no bloco 612 não houver registros de envio de chamada, então no bloco 620 na figura 8C o processador 202 é direcionado para determinar se ou não o usuário identificado pelo identificador de chamada pagou pelo serviço de correio de voz.

Isso é feito pela verificação para se ver se ou não um indicador é configurado em um registro de correio de voz do tipo ilustrado na figura 30 em uma tabela de correio de voz armazenado na base de dados 18 ilustrada na figura 1.

5 Com referência à figura 30, os registros de correio de voz nessa modalidade podem incluir um campo de nome de usuário 624, um campo de servidor de correio de voz 626, uns segundos para o campo de correio de voz 628 e um campo de ativação 630. O campo de nome de usuário 624 armazena o nome de usuário da parte chamada. O campo de servidor de
10 correio de voz 626 mantém um código identificando um nome de domínio de um servidor de correio de voz associado com o usuário identificado pelo campo de nome de usuário 624. O campo de segundos para correio de voz 628 mantém um código identificando o tempo de espera antes do acesso ao correio de voz, e o campo de ativação 630 mantém um código representando se ou não o correio de voz está ativado para o usuário. Com referência
15 novamente à figura 8C, no bloco 620, se o processador 202 da figura 7 encontrar um registro de correio de voz como ilustrado na figura 30 possuindo o conteúdo do campo de nome de usuário 624 combinando com o identificador de chamada, o processador é direcionado para examinar o conteúdo do campo de ativação 630 para determinar se ou não o correio de voz está
20 ativado. Se o correio de voz estiver ativado, então o bloco 640 na figura 8C direciona o processador 202 para a figura 7 para armazenar o conteúdo do campo de servidor de correio de voz 626 e o conteúdo do campo de segundos para correio de voz 628 no armazenador de mensagem de direcionamento, como ilustrado por 654 na figura 32. O bloco 642 então direciona o
25 processador 202 para obter os valores de tempo ao vivo para cada percurso especificado pela mensagem de direcionamento de acordo com o custo de direcionamento e do saldo do usuário. Esses valores de tempo ao vivo são então anexados aos percursos correspondentes já armazenados no arma-
30 zenador de mensagem de direcionamento.

Com referência novamente à figura 8C, o bloco 644 então direciona o processador 202 da figura 7 para armazenar o endereço IP do nó

atual no armazenador de mensagem de direcionamento como ilustrado por 656 na figura 32. O bloco 646 então direciona o processador 202 para enviar a mensagem de direcionamento ilustrada na figura 32 para o controlador de chamada 14 na figura 1. Dessa forma, na modalidade descrita o controlador de direcionamento produzirá uma mensagem de direcionamento que causará pelo menos um dos seguintes: envio da chamada para outra parte, bloqueio da chamada e direcionamento do chamador para um servidor de correio de voz.

Com referência novamente à figura 1, a mensagem de direcionamento caso o dito tipo ilustrado nas figuras 16, 25 ou 32 seja recebido no controlador de chamada 14 e o controlador de chamada interpretar o recebimento da mensagem de direcionamento como uma solicitação para o estabelecimento de uma chamada.

Com referência à figura 4, a memória de programa 104 do controlador de chamada 14 inclui um direcionamento para a rotina de circuito de acesso apresentada geralmente em 122.

Onde uma mensagem de direcionamento do tipo ilustrado na figura 32 é recebida pelo controlador de chamada 14, o direcionamento para a rotina de circuito de acesso 122 ilustrado na figura 4 pode direcionar o processador 102 para fazer com que uma mensagem seja enviada de volta através da Internet 13 ilustrado na figura 1 para o telefone da parte chamada 15, conhecendo o endereço IP do telefone da parte chamada 15 a partir do nome do usuário.

Alternativamente, se a mensagem de direcionamento for do tipo ilustrado na figura 16, que identifica um domínio associado com outro nó no sistema, o controlador de chamada pode enviar uma mensagem de convite SIP ao longo da estrutura de alta velocidade 17 conectada ao outro nó. O outro nó funciona como explicado acima, em resposta ao recebimento de uma mensagem de convite SIP.

Se a mensagem de direcionamento for do tipo ilustrado na figura 25 onde existe uma pluralidade de fornecedores de circuito de acesso disponíveis, o controlador de chamada envia uma mensagem de convite SIP

para o primeiro fornecedor, nesse caso Telus, utilizando uma linha dedicada ou uma conexão de Internet para determinar se ou não Telus é capaz de manusear a chamada. Se o circuito de acesso Telus retornar uma mensagem indicando que não é capaz de manusear a chamada, o controlador de chamada 14 então prossegue para enviar uma mensagem de convite SIP para o próximo fornecedor, nesse caso, Shaw. O processo é repetido até que um dos fornecedores responda indicando que está disponível para realizar a chamada. Uma vez que o fornecedor responde indicando que é capaz de realizar a chamada, o fornecedor envia de volta para o controlador de chamada 14 um endereço IP para um circuito de acesso fornecido pelo fornecedor através do qual a chamada ou percurso de áudio da chamada pode ser realizado. Esse endereço IP é enviado em uma mensagem do controlador de chamada 14 para o relé de mídia 9 que responde a uma mensagem indicando um endereço IP para o qual o telefone do chamador deve enviar seu áudio/vídeo, tráfego e um endereço IP ao qual o circuito de acesso deve enviar seu áudio/vídeo para a chamada. O controlador de chamada transporta o endereço IP no qual o relé de mídia espera receber áudio/vídeo do telefone do chamador, para o telefone do chamador 12 em uma mensagem. O telefone do chamador responde ao controlador de chamada com um endereço IP no qual gostaria de receber o áudio/vídeo e o controlador de chamada transporta esse endereço IP para o relé de mídia. A chamada pode então ser conduzida entre o chamador e a parte chamada através do relé de mídia e do circuito de acesso.

Com referência novamente à figura 1, se o controlador de chamada 14 receber uma mensagem de direcionamento do tipo ilustrado na figura 32, e que possui pelo menos um número de envio de chamada e/ou um número de correio de voz, o controlador de chamada tenta estabelecer uma chamada para o telefone da parte chamada 15 buscando a partir do telefone do chamado por uma mensagem indicando um endereço IP ao qual o relé de mídia deve enviar áudio/vídeo. Se nenhuma mensagem for recebida do telefone da parte chamada, nenhuma chamada é estabelecida. Se nenhuma chamada for estabelecida dentro de um tempo predeterminado, o

controlador de chamada 14 tenta estabelecer uma chamada com o próximo usuário identificado na mensagem de direcionamento de chamada da mesma forma. Esse processo é repetido até que todas as possibilidades de envio de chamada tenha sido exauridas, caso no qual o controlador de chamada se comunica com o servidor de correio de voz 19 identificado na mensagem de direcionamento para obter um endereço IP ao qual o relé de mídia deve enviar áudio/vídeo e o restante do processo mencionado acima para o estabelecimento de endereços IP no relé de mídia 9 e o telefone do chamador é realizado para estabelecer percursos de áudio/vídeo para permitir que o chamador deixe uma mensagem de correio de voz com o servidor de correio de voz.

Quando um percurso de áudio/vídeo através do relé de mídia é estabelecido, um temporizador de chamada mantido pelo controlador de chamada 14 arquiva a data e hora inicial da chamada e arquiva o ID de chamada e uma identificação da rota (isso é, endereço IP do percurso de áudio/vídeo) para uso posterior na cobrança.

Time to Live

Com referência às figuras 33A e 33B, um processo de determinação de um valor de time to Live para qualquer um dos blocos 642 na figura 8C, 350 na figura 8A ou 564 na figura 8D acima é descrito. O processo é executado pelo processador 202 ilustrado na figura 7. Geralmente, o processo envolve o cálculo de um custo por tempo unitário, calculando um primeiro valor de tempo como uma soma de um tempo livre atribuído a um participante na sessão de comunicação e o quociente de um saldo de fundos mantido pelo participante para o custo por valor de tempo unitário e produzindo um segundo valor de tempo em resposta ao primeiro valor de tempo e um padrão de cobrança associado com o participante, o padrão de cobrança incluindo primeiro e segundo intervalos de cobrança e o segundo valor de tempo sendo o tempo para permitir que uma sessão de comunicação seja conduzida.

Com referência à figura 33A, nessa modalidade, o processo começa com um primeiro bloco 700 que direciona o processador RC para determinar se ou não o tipo de chamada determinado no bloco 302 na figura

8A indica que a chamada é uma chamada de domínio cruzado ou rede. Se a chamada for uma chamada de domínio cruzado ou rede, o bloco 702 da figura 33A direciona o processador RC para configurar o tempo ao vivo igual a 99999 e o processo é encerrado. Dessa forma, o tipo de chamada de domínio cruzado ou rede possui um longo tempo ao vivo. Se no bloco 700 o tipo de chamada for determinado como não sendo um tipo de domínio cruzado ou rede, o bloco 704 direciona o processador RC para obter um registro de tabela de feixe de assinante a partir da base de dados 18 na figura 1 e armazenar o mesmo localmente no armazenador de registro de feixe de assinante em RC 14.

Com referência à figura 34, um registro de tabela de feixe de assinante é geralmente ilustrado em 706. O registro inclui um campo de nome de usuário 708 e um campo de serviços 710. O campo de nome de usuário 708 mantém um código identificando o nome do usuário assinante e o campo de serviços 710 mantém os códigos identificando as características do serviço designados para o assinante, tal como chamada local livre, bloqueio de chamada e correio de voz, por exemplo.

A figura 35 ilustra um registro de feixe de assinante ilustrativo para o chamador de Vancouver. Nesse registro o campo do nome do usuário 708 é carregado com o nome do usuário 2001 1050 8667 e o campo de serviços 710 é carregado com códigos 10, 14 e 16 correspondentes à chamada local livre, bloqueio de chamada e correio de voz, respectivamente. Dessa forma, o usuário 2001 1050 8667 possui as características de chamada local livre, bloqueio de chamada e correio de voz.

Com referência novamente à figura 33A, depois de ter carregado um registro de feixe de assinante no armazenador de registro de feixe de assinante, o bloco 712 direciona o processador RC para buscar a base de dados (18) para determinar se ou não existe um registro de tabela de eliminação de feixe para o valor de ID de lista principal que foi determinado no bloco 410 na figura 8B. Um registro de tabela de eliminação de feixe ilustrativo é ilustrado em 714 na figura 36. O registro de tabela de feixe inclui um campo de ID de lista principal 716, um campo de tipo de eliminação 718, um

campo de valor de eliminação 720, um campo de primeiro intervalo 722 e um campo de segundo intervalo 724. O campo de ID de lista principal 716 mantém um código de ID de lista principal. O campo de tipo de eliminação 718 mantém um código de tipo de eliminação indicando uma quantidade fixa, percentual para indicar a quantidade pela qual uma taxa será aumentada. O campo de valor de eliminação 720 mantém um número real representando o valor do tipo de eliminação. O campo de primeiro intervalo 722 mantém um valor indicando o número mínimo de segundos para um primeiro nível de carga e o campo de segundo intervalo 724 mantém um número representando um segundo nível de carga.

Com referência à figura 37, um registro de eliminação de feixe para o código de ID de lista principal localizado é ilustrado geralmente em 726 e inclui um campo de ID de lista principal 716 mantendo o código 1019 que foi o código localizado no bloco 410 da figura 8B. O campo de tipo de eliminação 718 inclui um código indicando que o tipo de eliminação é um valor percentual e o campo de valor de eliminação 720 mantém o valor 10.0 indicando que a eliminação será de 10,0% do valor cobrado. O campo de primeiro intervalo 722 mantém um valor representando 30 segundos e o campo de segundo intervalo 724 mantém um valor representando 6 segundos. O valor de 30 segundos no campo de primeiro intervalo 722 indica que as cobranças para direcionamento serão realizadas em uma primeira taxa por 30 segundos e, depois disso, as cobranças serão realizadas em uma taxa diferentes em incrementos de 6 segundos, como indicado pelo conteúdo do campo de segundo intervalo 724.

Com referência novamente à figura 33A, se no bloco 712 o processador encontrar um registro de eliminação de feixe do tipo ilustrado na figura 37, o bloco 728 direciona o processador para armazenar o registro de eliminação de feixe na memória local. Na modalidade ilustrada, o registro de eliminação de feixe ilustrado na figura 37 é armazenado no armazenador de registro de eliminação de feixe em RC como ilustrado na figura 7. Ainda com referência à figura 33A, o bloco 730 então direciona o processador RC para determinar se ou não o registro de tabela de feixe de assinante 706 na figura

35 possui um campo de serviços incluindo um código identificando que o usuário tem direito a chamadas locais livres e também direciona o processador para determinar se ou não o tipo de chamada não é uma célula de domínio cruzado, isso é, é um estilo local ou local/nacional. Se ambas essas condições forem satisfeitas, o bloco 732 direciona o processador para configurar o tempo ao vivo igual a 99999, fornecendo ao usuário um período longo de tempo para a chamada. O processo é então encerrado. Se as condições associadas com o bloco 730 não forem satisfeitas, o bloco 734 da figura 33B direciona o processador RC para recuperar um registro de conta de assinante associado a um participante na chamada. Isso é feito pela cópia e armazenamento no armazenador de registro de conta de assinante de um registro de conta de assinante para o chamador.

Com referência à figura 38, um registro de tabela de conta de assinante ilustrativo é ilustrado geralmente em 736. O registro inclui um campo de nome de usuário 738, um campo de saldo de fundos 740 e um campo de tempo livre 742. O campo de nome de usuário 738 mantém um nome de usuário de assinante, o campo de saldo de fundos 740 mantém um número real representando um valor em dólares de crédito disponível para o assinante e o campo de tempo livre 742 mantém um número inteiro representando o número de segundos livres aos quais o usuário tem direito.

Um registro de conta de assinante ilustrativo para o chamador de Vancouver é ilustrado geralmente por 744 na figura 39, onde o campo de nome de usuário 738 mantém o nome do usuário 2001 1050 8667, o campo de saldo de fundos 740 mantém o valor de \$ 10.00, e o campo de tempo livre 742 mantém o valor de 100. campo de saldo de fundos mantendo o valor de \$ 10.00 indica que o usuário tem \$ 10.00 de créditos e o campo de tempo livre possuindo o valor de 100 indica que o usuário possui um saldo de 100 segundos livres de tempo de chamada.

Com referência novamente à figura 33B, depois de copiar e armazenar o registro de conta de assinante ilustrado na figura 39 a partir da base de dados para o armazenador de registro de conta de assinante RC, o bloco 746 direciona o processador para determinar se ou não o campo de

saldo de fundos de registro de conta de assinante 740 ou o campo de tempo livre 742 é maior que zero. Se não forem maiores que zero, o bloco 748 direciona o processador para determinar o tempo ao vivo igual a zero e o processo é encerrado. O RC então envia uma mensagem de volta para o controlador de chamada para fazer com que o controlador de chamada rejeite a chamada para o chamador. Se as condições associadas com o bloco 746 forem satisfeitas, o bloco 750 direciona o processador para calcular o custo da chamada por tempo unitário. Um procedimento para o cálculo do custo de chamada por tempo unitário é descrito abaixo com relação à figura 41.

10 Assumindo-se que o procedimento para o cálculo de custo por segundo retorne um número representando o custo da chamada por segundo, o bloco 752 direciona o processador 202 na figura 7 para determinar se ou não o custo por segundo é igual a zero. Se for esse o caso, o bloco 754 direciona o processador para configurar o tempo ao vivo para 99999 para
15 fornecer ao chamador um tempo longo de chamada e o processo é encerrado.

 Se no bloco 752 o custo de chamada por segundo não for igual a zero, o bloco 756 direciona o processador 202 na figura 7 para calcular um primeiro valor de tempo ao vivo como uma soma de um tempo livre atribuído ao participante na sessão de comunicação e o quociente do saldo de fundos mantido pelo participante para o valor de custo por tempo unitário. Para se
20 fazer isso, o processador 202 da figura 7 é direcionado a configurar um primeiro valor de tempo ou tempo temporário para o valor ao vivo igual à soma do tempo livre fornecido no campo de tempo livre 742 do registro de conta de assinante ilustrado na figura 39 e o quociente do conteúdo do campo de
25 saldo de fundos 740 no registro de conta do assinante para a chamada ilustrado na figura 39 e o custo por segundo determinado no bloco 750 da figura 33B. Dessa forma, por exemplo, se no bloco 750 o custo por segundo for determinado como sendo de três centavos por segundo e o campo de saldo de fundos mantiver o valor de \$ 10.00, o quociente do saldo de fundos e o
30 custo por segundo será de 333 segundos e isso é adicionado ao conteúdo do campo de tempo livre 742, que é igual a 100, resultando em um tempo ao vivo de 433 segundos.

O bloco 758 então direciona o processador RC para produzir um segundo valor de tempo em resposta ao primeiro valor de tempo e o padrão de cobrança associado com o participante como estabelecido pelo registro de eliminação de feixe ilustrado na figura 37. Esse processo é ilustrado em maiores detalhes em 760 na figura 40 e geralmente envolve a produção de um valor restante representando uma parte do segundo intervalo de cobrança restando após a divisão do segundo intervalo de cobrança em uma diferença entre o primeiro valor de tempo e o primeiro intervalo de cobrança.

Com referência à figura 40, o processo para a produção do segundo valor de tempo começa com um primeiro bloco 762 que direciona o processador 202 na figura 7 para configurar um valor restante igual à diferença entre o valor de tempo ao vivo calculado no bloco 756 na figura 33b e o conteúdo do campo de primeiro intervalo 722 do registro ilustrado na figura 37, multiplicado pelo módulo do conteúdo do campo de segundo intervalo 724, da figura 37. Dessa forma, no exemplo fornecido, a diferença entre o campo de tempo ao vivo e o campo de primeiro intervalo é de 433 menos 30, que é igual a 403 e, portanto, o restante produzido pelo mod de 403 dividido por 6 é 0,17. O bloco 764 então direciona o processador para determinar se ou não esse valor restante é superior a zero e, se for, o bloco 766 direciona o processador para subtrair o restante do primeiro valor de tempo e configurar a diferença como o segundo valor de tempo. Para fazer isso o processador é direcionado para configurar o valor de tempo ao vivo igual ao tempo ao vivo atual de 403 menos o restante de 1, isso é, 402 segundos. O processador então é retornado para o bloco 758 da figura 33B.

Com referência novamente à figura 40, se no bloco 764 o restante não for superior a zero, o bloco 768 direciona o processador 202 da figura 7 para determinar se ou não o tempo ao vivo é inferior ao conteúdo do campo de primeiro intervalo 722 no registro ilustrado na figura 37. Se for, então o bloco 770, da figura 40, direciona o processador para configurar o tempo ao vivo igual a zero. Dessa forma, o segundo valor de tempo é configurado para zero quando o restante é superior a zero e o primeiro valor de tempo é inferior ao tempo livre associado com o participante na chamada. Se no bloco 768

as condições desse bloco não forem satisfeitas, o processador retorna o primeiro tempo de valor ao vivo como o segundo tempo de valor ao vivo.

Dessa forma, com referência à figura 33B, depois de ter produzido um segundo tempo de valor ao vivo, o bloco 772 direciona o processador para configurar o tempo do valor ao vivo para uso nos blocos 342, 350
5 ou 564.

Custo por Segundo

Com referência à figura 33B, no bloco 750, foi explicado que um custo de chamada por tempo unitário é calculado. A seguir é explicado que o
10 custo de chamada por valor de tempo unitário é calculado.

Com referência à figura 41, um processo para o cálculo de um custo por tempo unitário é ilustrado geralmente em 780. O processo é executado pelo processador 202 na figura 7 e envolve geralmente a localização de um registro em uma base de dados, o registro compreendendo um indicador de tipo de marcação, um valor de marcação e um padrão de cobrança
15 e configuração de uma taxa de revenda igual à soma do valor de marcação e a taxa de armazenador, localizando pelo menos um dentre um registro de eliminação especificando um custo de rota por quantidade de tempo unitário associada com uma rota associada com a sessão de comunicação, um registro de revendedor associado com um revendedor da sessão de comunicações, o registro de revendedor especificando um custo de revendedor por
20 tempo unitário associado com o revendedor para a sessão de comunicação e um registro de marcação de operador padrão especificando um custo padrão por tempo unitário e configuração como o custo por tempo unitário a soma da taxa de revendedor e pelo menos um dentre o custo de rota por
25 tempo unitário, o custo de revendedor por tempo unitário e o custo padrão por tempo unitário.

O processo começa com um primeiro conjunto de blocos 782, 802 e 820 que direcionam o processador 202 na figura 7 para localizar pelo
30 menos um registro associado com um revendedor e uma rota associada com o revendedor, um registro associado com o revendedor, e um registro de marcação de revendedor padrão. O bloco 782, em particular, direciona o

processador para endereçar a base de dados 18 para buscar um registro associado com um revendedor e uma rota com o revendedor buscando por um registro de taxa especial com base no ID de lista principal estabelecido no bloco 410 na figura 8C.

5 Com referência à figura 42, um registro de tabela de taxa especial de operador de sistema é ilustrado geralmente em 784. O registro inclui um campo de revendedor 786, um campo de ID de lista principal 788, um campo de tipo de marcação 790, um campo de valor de marcação 792, um campo de primeiro intervalo 794, e um campo de segundo intervalo 796. O
10 campo de revendedor 786 mantém um código de ID de revendedor e um campo ID de lista principal 788 mantém um código de ID de lista principal. O campo de tipo de marcação 790 mantém um tipo de marcação tal como o percentual fixo ou centavos e o campo de valor de marcação 792 mantém um número real representando o valor correspondente ao tipo de marcação.
15 O primeiro campo de intervalo 794 mantém um número representando um primeiro nível de cobrança e o campo de segundo intervalo 796 mantém um número representando um segundo nível de cobrança.

Uma tabela de taxa especial de operador de sistema ilustrativa para um revendedor conhecido como "Klondike" é ilustrada em 798 na figura
20 43. Nesse registro, o campo de revendedor 786 mantém um código indicando o ID de varejista é Klondike, o campo de ID de lista principal 788 mantém o código 1019 para associar o registro com o código ID de lista principal 1019. O campo de tipo de marcação 790 mantém um código indicando que o tipo de marcação é centavos e o campo de valor de marcação 792 mantém
25 um valor de marcação indicando 1/10 de um centavo. O campo de primeiro intervalo 794 mantém o valor 30 e o campo de segundo intervalo 796 mantém o valor de 6, esses dois campos indicando que o operador permite 30 segundos grátis e então a cobrança é realizada em incrementos de 6 segundos depois disso.

30 Com referência novamente à figura 41, se no bloco 782 um registro tal como o ilustrado na figura 43 for localizado na tabela de taxas especiais de operador de sistema, o processador é direcionado para o bloco

800 na figura 41. Se tal registro não for encontrado na tabela de taxas especiais de operador de sistema, o bloco 802 direciona o processador para endereçar a base de dados 18 para buscar em uma tabela de marcação de operador de sistema por um registro de marcação associado com o revendedor.

5 Com referência à figura 44, um registro de tabela de marcação de operador de sistema ilustrativo é ilustrado geralmente em 804. O registro inclui um campo de revendedor 806, um campo de tipo de marcação 808, um campo de valor de marcação 810, um campo de primeiro intervalo 812 e um campo de segundo intervalo 814. O tipo de marcação de revendedor,
10 valor de marcação, campos de primeiro intervalo e segundo intervalos são como descritos com relação aos campos pelos mesmos nomes na tabela de taxas especiais de operador de sistema ilustrada na figura 42.

A figura 45 fornece um registro de tabela de marcação de operador de sistema ilustrativo para o revendedor conhecido como Klondike, e,
15 portanto, o campo de revendedor 806 mantém o valor "Klondike", o campo de tipo de marcação 808 mantém os centavos de valor, o campo de valor de marcação mantém o valor 0,01, o campo de primeiro intervalo 812 mantém o valor 30 e o campo de segundo intervalo 814 mantém o valor 6. Isso indica que as cobranças "Klondike" de revendedor pelo centavo a uma taxa de um
20 centavo por minuto. Os primeiros 30 segundos da chamada são grátis e a cobrança é realizada na taxa de um centavo por minuto em incrementos de 6 segundos.

A figura 46 fornece um registro de tabela de marcação de operador de sistema ilustrativo para os casos nos quais nenhum registro de ta-
25 bela de marcação de operador de sistema específico existe para um revendedor particular, isso é, um registro de marcação de revendedor padrão. Esse registro é similar ao registro ilustrado na figura 45 e o campo de revendedor 806 mantém o valor "todos", o campo de tipo de marcação 808 é carregado com um código indicando marcação é baseado em um percentual, o
30 campo de valor de marcação 810 mantém o percentual pelo qual o custo é marcado, e os campos de primeiro e segundo intervalos 812 e 814 identificam os primeiro e segundo níveis de cobrança.

Com referência novamente à figura 41, se no bloco 802 um registro de marcação específico para o revendedor identificado no bloco 782 não for localizado, o bloco 820 direciona o processador para obter o registro de marcação ilustrado na figura 46, possuindo o código "todos" no campo de revendedor 806. O processador é então direcionado para o bloco 800.

Com referência novamente à figura 41, no bloco 800, o processador 202 da figura 7 é direcionado para configurar uma taxa de revendedor igual à soma do valor de marcação do registro localizado pelos blocos 782, 802 ou 820 e a taxa de armazenador especificada pelo conteúdo do campo de taxa de armazenador 516 do registro de lista principal ilustrado na figura 20. Para se fazer isso, o processador RC configura uma variável intitulada "custo de revendedor por segundo" para um valor igual à soma do conteúdo do campo de valor de marcação (792, 810) do registro associado, mais o conteúdo do campo de taxa de armazenador (516) do registro de lista principal associado com o ID de lista principal. Então, o bloco 822 direciona o processador para configurar um custo de operador de sistema por segunda variável igual ao conteúdo do campo de taxa de armazenador (516) a partir do registro de lista principal. O bloco 824 então direciona o processador para determinar se o indicador de tipo de chamada indica que a chamada é um estilo local ou local/nacional e se o chamador possui chamada local grátis. Se ambas essas condições forem satisfeitas, então o bloco 826 configura o custo de usuário por segundo variável igual a zero e configura duas variáveis de incremento igual a um, para uso no processamento posterior. O custo por segundo pode, dessa forma, ser calculado e o processo ilustrado na figura 41 é encerrado.

Se no bloco 824 as condições desse bloco não forem correspondidas, o processador 202 da figura 7 é direcionado para localizar pelo menos um dentre um registro de tabela de eliminação de feixe especificando um custo de rota por tempo unitário associado com uma rota associada com a sessão de comunicação, um registro de tabela de destinos especial de revendedor associado com um revendedor da sessão de comunicações, o registro de revendedor especificando um custo de revendedor por tempo

unitário associado com o revendedor para a sessão de comunicação e um registro de marcação global de revendedor padrão especificando um custo padrão por tempo unitário.

Para fazer isso, o bloco 828 direciona o processador 202 da figura 7 para determinar se ou não o registro de eliminação de feixe 726 da figura 37 localizado no bloco 712 na figura 33A possui um ID de lista principal igual ao ID de lista principal armazenado que foi determinado no bloco 410 na figura 8B. Se não, o bloco 830 direciona o processador para encontrar um registro de tabela de destinos especial de revendedor em uma tabela de destinos especial de revendedor na base de dados (18), possuindo um código de ID de lista principal igual ao código ID de lista principal do ID de lista principal que foi determinado no bloco 410 na figura 8B. Um registro de tabela de destinos especial de revendedor ilustrativo é ilustrado na figura 47 em 832. O registro de tabela de destinos especial de revendedor inclui um campo de revendedor 834, um campo de ID de lista principal 836, um campo de tipo de marcação 838, um campo de valor de marcação 840, um campo de primeiro intervalo 842 e um campo de segundo intervalo 844. Esse registro tem o mesmo formato que o registro de tabela de taxas especiais de operador de sistema ilustrado na figura 42, mas é armazenado em uma tabela diferente para permitir que tipos de marcação diferentes e valores e intervalos de tempo diferentes sejam configurado de acordo com as preferências do revendedor. Dessa forma, por exemplo, um registro de tabela de destinos especial de revendedor ilustrativo para o revendedor "Klondike" é ilustrado em 846 na figura 48. O campo de revendedor 834 mantém um valor indicando o revendedor como o revendedor "Klondike" e o campo ID de lista principal mantém o código 1019. O campo de tipo de marcação 838 mantém um código indicando que o tipo de marcação é percentual e o campo de valor de marcação 840 mantém um número representando o valor de marcação como 5%. Os campos de primeiro e segundo intervalos identificam diferentes níveis de cobrança utilizados como descrito anteriormente.

Com referência novamente à figura 41, o registro ilustrado na figura 48 pode ser localizado no bloco 830, por exemplo. Se no bloco 830 tal

registro não for encontrado, então o bloco 832 direciona o processador para obter um registro de marcação global de operador padrão com base no ID do revendedor.

Com referência à figura 49, um registro de tabela de marcação global de revendedor padrão é ilustrado geralmente em 848. Esse registro inclui um campo de revendedor 850, um campo de tipo de marcação 852, um campo de valor de marcação 854, um campo de primeiro intervalo 856 e um campo de segundo intervalo 858. O campo de revendedor 850 mantém um código identificando o revendedor. O campo de tipo de marcação 852, o campo de valor de marcação 854 e os campos de primeiro e segundo intervalos 856 e 858 são do mesmo tipo que descrito com relação aos campos de mesmo nome na figura 47, por exemplo. O conteúdo dos campos desse registro 860 pode ser configurado de acordo com as preferências do operador do sistema, por exemplo.

Com referência à figura 50, um registro de tabela de marcação global de revendedor ilustrativo é ilustrado geralmente por 860. Nesse registro, o campo de revendedor 850 mantém um código indicando o revendedor como "Klondike", o campo de tipo de marcação 852 mantém um código indicando que o tipo de marcação é percentual, o campo de valor de marcação 854 mantém um valor representando 10% como o valor de marcação, o campo de primeiro intervalo 856 mantém o valor 30 e o campo de segundo intervalo 858 mantém os valores 30 e 6 respectivamente para indicar que os primeiros 30 segundos são grátis e a cobrança deve ser feita em incrementos de 6 segundos depois disso.

Com referência novamente à figura 41, no caso de o processador seguir para o bloco 832, o registro de tabela de marcação global de revendedor como ilustrado na figura 50 é recuperado a partir da base de dados e armazenado localmente no RC. Como observado na figura 41, deve-se apreciar que se as condições forem correspondidas nos blocos 828 e 830, ou se o processador executar o bloco 832, o processador é então direcionado para o bloco 862 o que faz com que o mesmo configure um valor de eliminação igual ao conteúdo do campo de valor de marcação do registro

localizado, para configurar a primeira variável de incremento igual ao conteúdo do campo de primeiro intervalo do registro localizado e para configurar a segunda variável de incremento igual ao conteúdo do campo de segundo intervalo do registro localizado. (As variáveis de incremento foram alternativamente configuradas para valores específicos no bloco 826 da figura 41).

Será apreciado que o registro localizado pode ser um registro de eliminação de feixe do tipo ilustrado na figura 37 ou o registro localizado pode ser um registro de destino especial de revendedor do tipo ilustrado na figura 48 ou o registro pode ser um registro de tabela de marcação global de revendedor do tipo ilustrado na figura 50. Depois que a eliminação e que as primeira e segunda variáveis de incremento foram configurados no bloco 862, o processador 202 na figura 7 é direcionado para configurar como custo por tempo unitário a soma da taxa do revendedor e pelo menos um dentre o custo de rota por tempo unitário, o custo de revendedor por tempo unitário e o custo padrão por tempo unitário, dependendo de qual registro foi localizado. Para fazer isso, o bloco 864 direciona o processador para configurar o custo por tempo unitário igual à soma de custo de revendedor determinado no bloco 800 na figura 41, mais o conteúdo da variável de eliminação calculado no bloco 862 na figura 41. O custo por tempo unitário foi, dessa forma, calculado e é esse custo por tempo unitário que é utilizado no bloco 752 da figura 33B, por exemplo.

Encerramento de Chamada

No caso de o chamador ou o chamado encerrar uma chamada, o telefone da parte que encerrou a chamada envia uma mensagem de adeus SIP para o controlador 14. Uma mensagem de adeus SIP ilustrativa é ilustrada em 900 na figura 51 e inclui um campo de chamador 902, um campo de chamado 904, e um campo de ID de chamada 906. O campo de chamador 902 mantém um nome de usuário de doze dígitos, o campo de chamado 904 mantém um número compatível com PSTN ou nome de usuário, e o campo de ID de chamada 906 mantém um campo de identificador de chamada singular do tipo ilustrado no campo de ID de chamada 65 da mensagem de convite SIP ilustrada na figura 3.

Dessa forma, por exemplo, com referência à figura 52, uma mensagem de adeus SIP para a parte chamada de Calgary é ilustrada geralmente em 908 e o campo chamador 902 mantém um nome de usuário identificando a parte chamada, nesse caso 2001 1050 8667, o campo da parte chamada 904 mantém um nome de usuário identificando o chamado de Calgary, nesse caso 2001 1050 2222, e o campo de ID de chamada 906 mantém o código FA10 @ 192.168.0.20, que é o ID de chamada para a chamada.

A mensagem de adeus SIP ilustrada na figura 52 é recebida no controlador de chamada 14 e o controlador de chamada executa um processo como ilustrado geralmente em 910 na figura 53. O processo inclui um primeiro bloco 912 que direciona o processador de controlador de chamada 202 da figura 7 para copiar os conteúdos de campo de ID de chamador, parte chamada e chamada da mensagem de adeus SIP recebida da parte que encerrou a chamada para os campos correspondentes de um armazenador de mensagem de interrupção RC (não ilustrado). O bloco 914 então direciona o processador para copiar o tempo de início da chamada a partir do temporizador de chamada e para obter um tempo de interrupção de chamada a partir do temporizador de chamada. O bloco 916 então direciona o controlador de chamada para calcular um tempo de sessão de comunicação pela determinação da diferença no tempo entre o tempo de início de chamada e o tempo de interrupção de chamada. Esse tempo de sessão é então armazenado em um campo correspondente do armazenador de mensagem de interrupção de chamada RC. O bloco 917 então direciona o processador para reduzir o conteúdo do campo de chamada simultânea atual 277 do perfil de discagem para o chamador como ilustrado na figura 10, para indicar que existe menos uma chamada simultânea em andamento. Uma copia do perfil de discagem emendado para o chamador é então armazenada na base de dados 18 da figura 1. O bloco 918 então direciona o processador para copiar a rota a partir do arquivo de chamada. Uma mensagem de interrupção de chamada RC produzida como descrito acima é ilustrada geralmente em 1000 na figura 54. Uma mensagem de interrupção de chamada RC especifi-

camente associada com a chamada realizada para o chamado de Calgary é ilustrada geralmente por 1020 na figura 55.

Com referência à figura 54, a mensagem de chamada de interrupção RC inclui um campo de chamador 1002, um campo de chamado
5 1004, um campo de ID de chamada 1006, um campo de tempo de início de conta 1008, um campo de tempo de interrupção de conta 1010, um tempo de sessão de comunicação 1012 e um campo de rota 1014. O campo de chamador 1002 mantém um nome de usuário, o campo de chamado 1004 mantém um número compatível com PSTN ou número de sistema, o campo
10 de ID de chamada 1006 mantém o identificador de chamada singular recebido a partir da mensagem de convite SIP ilustrada na figura 3, o campo de tempo de início de conta 1010 mantém a data e hora do encerramento da chamada, o campo de tempo de sessão de comunicação 1012 mantém um valor representando a diferença entre o tempo de início e o tempo de final,
15 em segundos, e o campo de rota 1014 mantém o endereço IP para o link de comunicações que foi estabelecido.

Com referência à figura 55, uma mensagem de chamada de interrupção RC para o chamado de Calgary é ilustrada em 1020. Nesse exemplo, o campo de chamador 1002 mantém o nome de usuário 2001 1050
20 8667 identificando o chamador com base em Vancouver e o campo chamado 1004 mantém o nome de usuário 2001 1050 2222 identificando o chamado de Calgary. O conteúdo do campo de ID de chamada 1006 é FA10 @ 192.168.0.20. O conteúdo do campo de tempo de início de conta 1008 é 2006-12-30 12:12:12 e o conteúdo do campo de tempo de interrupção de
25 conta é 2006-12-30 12:12:14. O conteúdo do campo de tempo de sessão de comunicação 1012 é igual a 2 para indicar a duração de chamada de 2 segundos e o conteúdo do campo de rota é 72.64.39.58.

Com referência novamente à figura 53, depois de ter produzido uma mensagem de interrupção de chamada RC, o bloco 920 direciona o
30 processador 202 da figura 7 para enviar a mensagem de interrupção RC compilada no armazenador de mensagem de interrupção de chamada RC para o RC 16 da figura 1. O bloco 922 direciona o controlador de chamada

14 para enviar uma mensagem de "adeus" de volta para a parte que não encerrou a chamada.

O RC 16 da figura 1 recebe a mensagem de interrupção de chamada e um processo de mensagem de interrupção de chamada RC é
5 invocado no RC, o processo sendo ilustrado em 950 nas figuras 56A, 56B e 56C. Com referência à figura 56a, o processo de mensagem de interrupção RC 950 começa com um primeiro bloco 952 que direciona o processador 202 na figura 7 a determinar se ou não o tempo de sessão de comunicação é inferior a ou igual ao primeiro valor de incremento determinado pela rotina
10 de cálculo de custo ilustrada na figura 41, especificamente os blocos 826 e 862. Se essa condição for correspondida, então o bloco 954 da figura 56A direciona o processador RC para configurar uma variável de tempo passível de cobrança igual ao primeiro valor de incremento determinado no bloco 826 ou 862 da figura 41. Se no bloco 952 da figura 56a a condição não for correspondida, o bloco 956 direciona o processador RC para configurar uma
15 variável restante igual à diferença entre o tempo de sessão de comunicação e o primeiro valor de incremento mod o segundo valor de incremento produzido no bloco 826 ou 862 da figura 41. Então, o processador é direcionado para o bloco 958 da figura 56a que direciona o mesmo para determinar se
20 ou não o restante é superior a zero. Se for, o bloco 960 direciona o processador RC para determinar a variável de tempo passível de cobrança igual à diferença entre o tempo de sessão de comunicação e o valor restante. Se no bloco 958 o restante não for superior a zero, o bloco 962 direciona o processado RC para determinar a variável de tempo passível de cobrança igual ao
25 conteúdo do tempo de sessão de comunicação a partir da mensagem de interrupção RC. O processador é então direcionado para o bloco 964. Adicionalmente, depois da execução do bloco 954 ou do bloco 960, o processador é direcionado para o bloco 964.

O bloco 964 direciona o processador 202 da figura 7 para de-
30 terminar se ou não a variável de tempo passível de cobrança é maior que ou igual ao saldo de tempo grátis como determinado a partir do campo de tempo grátis 742 do registro de conta de assinante ilustrado na figura 39. Se

essa condição for satisfeita, o bloco 966 da figura 56A direciona o processador para determinar o campo de tempo grátis 742 no registro ilustrado na figura 39, para zero. Se a variável de tempo passível de cobrança não for superior a ou igual ao saldo de tempo livre, o bloco 968 direciona o processador RC para configurar uma variável de custo de usuário para zero e o bloco 970 então reduz o campo de tempo livre 742 do registro de conta do assinante para o chamador pela quantidade de tempo passível de cobrança determinada pelo bloco 954, 960 ou 962.

Se no bloco 964 o processador 202 da figura 7 for direcionado para o bloco 966 que faz com que o campo de tempo livre (742 na figura 39) seja configurado para zero, com referência à figura 56b, o bloco 972 direciona o processador para determinar uma variável de tempo passível de cobrança restante igual à diferença entre o tempo passível de cobrança e o conteúdo do campo de tempo livre (742 na figura 39). O bloco 974 então direciona o processador para determinar a variável de custo de usuário igual ao produto do tempo passível de cobrança restante e o custo por segundo calculado no bloco 750 na figura 33b. O bloco 976 então direciona o processador para reduzir o campo de saldo de fundos (740) do registro de conta de assinante ilustrado na figura 39 pelo conteúdo da variável de custo de usuário calculado no bloco 974.

Depois de completar o bloco 976 ou depois de completar o bloco 970 na figura 56A, o bloco 978 da figura 56b direciona o processador 202 da figura 7 para calcular uma variável de custo de revendedor como o produto da taxa de revendedor como indicado no campo de valor de marcação 810 do registro de tabela de marcação de operador de sistema ilustrado na figura 45 e o tempo de sessão de comunicação determinado no bloco 916 na figura 53. Então, o bloco 980 da figura 56B direciona o processador para adicionar o custo do revendedor para o campo de saldo de revendedor 986 de um registro de conta de revendedor do tipo ilustrado na figura 57 em 982.

O registro de conta de revendedor inclui um campo de ID de revendedor 984 e o campo de saldo de revendedor mencionado acima 986. O campo de ID de revendedor 984 mantém um código de ID de revendedor, e

o campo de saldo de revendedor 986 mantém um saldo acumulado de cobranças.

Com referência à figura 58, um registro de contas de revendedor específico para o revendedor "Klondike" é ilustrado geralmente em 988.

5 Nesse registro o campo de ID de revendedor 984 mantém um código representando o revendedor "Klondike" e o campo de saldo de revendedor 986 mantém um saldo de \$ 100,02. Dessa forma, o conteúdo do campo de saldo de revendedor 986 na figura 58 é incrementado pelo custo de revendedor calculado no bloco 978 da figura 56B.

10 Ainda com referência à figura 56B, após a adição do custo do revendedor ao campo de saldo de revendedor como indicado no bloco 980, o bloco 990 direciona o processador 202 da figura 7 para calcular um custo de operador de sistema como o produto do custo de operador de sistema por segundo, como determinado no bloco 822, na figura 41, e o tempo de
15 sessão de comunicação como determinado no bloco 916 na figura 53. O bloco 992 então direciona o processado para adicionar o valor do custo de operador de sistema calculado no bloco 990 a um registro de tabela de conta de operador de sistema do tipo ilustrado em 994 na figura 59. Esse registro inclui um campo de saldo de operador de sistema 996 mantendo um saldo
20 de cobranças acumuladas. Com referência à figura 60 na modalidade descrita, o campo de saldo de operador de sistema 996 pode manter o valor de \$ 1.000,02 por exemplo, e a esse valor o custo do operador de sistema calculado no bloco 990 é adicionado quando o processador executa o bloco 992 da figura 56B.

25 Por fim, o saldo de revendedor final 986 da figura 58 mantém um número representando uma quantia devida ao revendedor pelo operador do sistema e o saldo do operador de sistema 996 da figura 59 mantém um número representando uma quantia de lucro para o operador de sistema.

30 Enquanto as modalidades específicas da invenção foram descritas e ilustradas, tais modalidades devem ser consideradas ilustrativas da invenção apenas e não como limitadoras da invenção como consideradas de acordo com as reivindicações em anexo.

REIVINDICAÇÕES

1. Processo para operar um controlador de direcionamento de chamada para facilitar a comunicação entre os chamadores e as parte chamadas em um sistema compreendendo uma pluralidade de nós com os
5 quais os chamadores e as partes chamadas são associados, o processo compreendendo:

em resposta à iniciação de uma chamada por um assinante chamador, o recebimento de um identificador do chamador e um identificador de chamadas;

10 a utilização dos critérios de classificação de chamada associados com o identificador do chamador para classificar a chamada como uma chamada de rede pública ou uma chamada de rede privada;

a produção de uma mensagem de direcionamento identificando um endereço, na rede privada, associado com o chamado quando a chamada é classificada como uma chamada de rede privada; e
15

a produção de uma mensagem de direcionamento identificando um circuito de acesso à rede pública quando a chamada é classificada como uma chamada de rede pública.

2. Processo, de acordo com a reivindicação 1, compreendendo
20 adicionalmente o recebimento de uma solicitação para estabelecer uma chamada, de um controlador de chamada em comunicação com um chamador identificado pelo dito identificador de chamada.

3. Processo, de acordo com a reivindicação 1, em que a utilização dos ditos critérios de classificação de chamada compreende a busca de
25 uma base de dados para localizar um registro identificando os atributos da chamada associados com um chamador identificado pelo dito identificador do chamador.

4. Processo, de acordo com a reivindicação 3, em que a localização de um registro compreende a localização de um perfil de discagem de
30 chamador compreendendo um nome de usuário associado ao dito chamador, um domínio associado ao chamador, e pelo menos um atributo de chamada.

5. Processo, de acordo com a reivindicação 4, em que a utilização dos critérios de classificação compreende a comparação dos atributos de chamada associados com o perfil de discagem do chamador com os aspectos do identificador de chamada.

5 6. Processo, de acordo com a reivindicação 4, em que a comparação compreende a determinação de se o dito identificador de chamada inclui uma parte que combina com um IDD associado com o perfil de discagem do chamador.

10 7. Processo, de acordo com a reivindicação 4, em que a comparação compreende a determinação de se o identificador de chamada inclui uma parte que combina com um NDD associado com o perfil de discagem.

15 8. Processo, de acordo com a reivindicação 4, em que a comparação compreende a determinação se o identificador de chamada inclui uma parte que combina um código de área associado com o perfil de discagem do chamador.

9. Processo, de acordo com a reivindicação 4, em que a comparação compreende a determinação e o identificador de chamada possui um comprimento dentro de uma faixa especificada no perfil de discagem do chamador.

20 10. Processo, de acordo com a reivindicação 4, adicionalmente compreendendo a formatação do identificador de chamada em um formato de dígitos predefinido para produzir um identificador de chamada reformata-

25 11. Processo, de acordo com a reivindicação 10, em que a formatação compreende a remoção de um dígito de discagem internacional a partir do identificador de chamada, quando o dito identificador de chamada começa com um dígito combinando um dígito de discagem internacional especificado pelo perfil de discagem do chamador associado com o chamador.

30 12. Processo, de acordo com a reivindicação 10, em que a formatação compreende a remoção de um dígito de discagem nacional a partir do identificador de chamada e pendendo previamente um código de área de país ao dito identificador de chamada quando o identificador de chamada

começa com um dígito de discagem nacional.

13. Processo, de acordo com a reivindicação 10, em que a formatação compreende pender previamente um código de país do chamador ao identificador de chamada quando o identificador de chamada começa
5 com dígitos identificando um código de área especificado pelo dito perfil de discagem do chamador.

14. Processo, de acordo com a reivindicação 10, em que a formatação compreende pender previamente um código de país do chamador e código de área ao identificador de chamada quando o identificador de chamada possui um comprimento que combina com um formato de número de
10 discagem do chamador especificado pelo perfil de discagem do chamador e apenas um código de área é especificado como sendo associado com o chamador no perfil de discagem do chamador.

15. Processo, de acordo com a reivindicação 10, adicionalmente compreendendo a classificação da chamada como uma chamada de rede privada quando o identificador de chamada reformatado identifica um assinante para a rede privada.

16. Processo, de acordo com a reivindicação 10, adicionalmente compreendendo determinar se o identificador de chamada está em conformidade com um formato de nome de usuário predefinido e se for esse o caso classificar a chamada como uma chamada de rede privada.
20

17. Processo, de acordo com a reivindicação 10, adicionalmente compreendendo a busca da base de dados por registros para localizar um registro de tabela de bando de discagem direta (DID) associando um número
25 de telefone público com o identificador de chamada reformatado e se o registro de tabela de bando DID é encontrado classificando a chamada como uma chamada de rede privada e se um registro de tabela de banco DID não é encontrado classificando a chamada como uma chamada de rede pública.

18. Processo, de acordo com a reivindicação 17, em que a produção da dita mensagem de direcionamento identificando um nó na rede
30 privada compreende a configuração de um identificador de chamada em resposta a um nome de usuário associado com o registro de tabela de ban-

do DID.

19. Processo, de acordo com a reivindicação 18, em que a produção da mensagem de direcionamento compreende determinar se um nó associado com o identificador de chamada reformatado é igual a um nó associado com o identificador do chamador.

20. Processo, de acordo com a reivindicação 19, em que determina se um nó associado com o identificador de chamada reformatado é igual a um nó associado com o identificador do chamador compreende a determinação de se um prefixo do identificador de chamada reformatado combina com um prefixo correspondente de um nome de usuário associado com o perfil de discagem do chamador.

21. Processo, de acordo com a reivindicação 20, em que quando o nó associado com o chamador não é o mesmo que o nó associado com o chamado, a produção de uma mensagem de direcionamento incluindo o identificador do chamador, o identificador de chamada reformatado e uma identificação de um nó de rede privada associado com o chamado e comunicação da mensagem de direcionamento a um controlador de chamada.

22. Processo, de acordo com a reivindicação 19, em que quando o nó associado com o chamador é igual ao nó associado com o chamado, determinar se realiza pelo menos um dentre os seguintes: envio da chamada para outra parte, bloqueio de chamada e direcionamento do chamador para um servidor de correio de voz associado com o chamador.

23. Processo, de acordo com a reivindicação 22, em que a produção da mensagem de direcionamento compreende a produção de uma mensagem de direcionamento possuindo uma identificação de se pelo menos um dentre o identificador de chamada, uma identificação de uma parte para a qual a chamada deve ser enviada e uma identificação de um servidor de correio de voz associado com o chamado.

24. Processo, de acordo com a reivindicação 23, adicionalmente compreendendo a comunicação da mensagem de direcionamento para um controlador de chamadas.

25. Processo, de acordo com a reivindicação 10, em que a pro-

dução de uma mensagem de direcionamento identificando um circuito de acesso para a rede pública compreende a busca de uma base de dados dos registros de direcionamento associando os identificadores de direcionamento com os códigos de discagem para encontrar um registro de direcionamento possuindo um código de discagem possuindo um padrão de número combinando pelo menos uma parte do identificador de parte chamada reformatado.

26. Processo, de acordo com a reivindicação 25, adicionalmente compreendendo a busca de uma base de dados dos registros do fornecedor associando os identificadores do fornecedor com os ditos fornecedores de direcionamento para localizar pelo menos um registro de fornecedor associado com o identificador de direcionamento associado com o registro de direcionamento possuindo um código de discagem possuindo um padrão de número combinando pelo menos uma parte do identificador de chamada reformatado.

27. Processo, de acordo com a reivindicação 26, adicionalmente compreendendo o carregamento de um armazenador de mensagem de direcionamento com o identificador de chamada reformatado e uma identificação das rotas específicas associadas com os respectivos registros de fornecedor associados com o registro de direcionamento e o carregamento do armazenador de mensagem de direcionamento com um valor de tempo e um valor de expiração de tempo.

28. Processo, de acordo com a reivindicação 27, adicionalmente compreendendo a comunicação de uma mensagem de direcionamento compreendendo o conteúdo do armazenador de mensagem de direcionamento para um controlador de chamada.

29. Processo, de acordo com a reivindicação 4, compreendendo adicionalmente fazer com que o perfil de discagem inclua um valor de chamada simultânea máximo e um valor de contagem de chamada simultânea e fazendo com que o valor de contagem de chamada simultânea seja incrementado quando o usuário associado com o perfil de discagem inicia uma chamada e fazendo com que o valor de contagem de chamada simultânea

seja reduzido quando uma chamada com o usuário associado com o perfil de discagem é encerrada.

30. Meio legível por computador, codificado com códigos para direcionar um processador para executar o método como definido em qualquer uma das reivindicações de 1 a 29.

31. Aparelho para o direcionamento de chamada para facilitar as comunicações entre os chamadores e os chamados em um sistema compreendendo uma pluralidade de nós com os quais os chamadores e as partes chamadas são associadas, o aparelho compreendendo:

meios de recebimento para receber um identificador do chamador e um identificador de chamada, em resposta à iniciação de uma chamada por um assinante de chamada;

meios de classificação para classificar a chamada como uma chamada de rede privada ou uma chamada de rede pública de acordo com os critérios de classificação de chamada associados com o identificador do chamador;

meios para produzir uma mensagem de direcionamento identificando um endereço, na rede privada, associado com o chamado quando a chamada é classificada como uma chamada de rede privada; e

meios para produzir uma mensagem de direcionamento identificando um circuito de acesso para a rede pública se a chamada for classificada como uma chamada de rede pública.

32. Aparelho, de acordo com a reivindicação 31, em que os meios de recebimento são configurados de forma operacional para receber uma solicitação para estabelecer uma chamada, a partir de um controlador de chamada em comunicação com um chamador identificado pelo identificador de chamada.

33. Aparelho, de acordo com a reivindicação 31, compreendendo adicionalmente meios de busca para buscar uma base de dados compreendendo registros associando os atributos de chamada com assinantes para a dita rede privada para localizar um registro identificando os atributos da chamada associados com um chamador identificado pelo identificador do

chamador.

34. Aparelho, de acordo com a reivindicação 33, em que os registros incluem a discagem de perfis, cada um compreendendo um nome de usuário associado com o assinante, uma identificação de um domínio associado com o assinante, e uma identificação de pelo menos um atributo de chamada associada com o assinante.

35. Aparelho, de acordo com a reivindicação 34, em que o meio de classificação de chamada é configurado de forma operacional para comparar os atributos de chamada associados com o perfil de discagem do chamador com aspectos do identificador de chamadas.

36. Aparelho, de acordo com a reivindicação 35, em que os atributos de chamada incluem um dígito de discagem internacional e em que os meios de classificação de chamada são configurados de forma operacional para determinar se o identificador de chamada inclui uma parte que combina um IDD associado com o perfil de discagem de chamador.

37. Aparelho, de acordo com a reivindicação 34, em que os atributos de chamada incluem um dígito de discagem nacional e onde os meios de classificação de chamada são configurados de forma operacional para determinar se o identificador de chamadas inclui uma parte que combina com um NDD associado com o perfil de discagem do chamador.

38. Aparelho, de acordo com a reivindicação 34, em que os atributos de chamada incluem um código de área e no qual os meios de classificação de chamada são configurados de forma operacional para determinar se o identificador de parte chamada inclui uma parte que combina um código de área associado com o perfil de discagem do chamador.

39. Aparelho, de acordo com a reivindicação 34, em que o atributo de chamada inclui uma faixa de comprimento de número e onde o meio de classificação de chamada é configurado de forma operacional para determinar se o identificador de chamada possui um comprimento dentro de uma faixa especificada no perfil de discagem do chamador.

40. Aparelho, de acordo com a reivindicação 34, adicionalmente compreendendo meios de formatação para formatar o identificador de cha-

mada em um formato de dígito predefinido para produzir um identificador de chamada reformatado.

41. Aparelho, de acordo com a reivindicação 40, em que o meio de formatação é configurado de forma operacional para remover um dígito de discagem internacional do identificador de chamada, quando o identificador de chamada começa com um dígito que combina com um dígito de discagem internacional especificado pelo perfil de discagem do chamador associado com o chamador.

42. Aparelho, de acordo com a reivindicação 40, em que os meios de formatação são configurados de forma operacional para remover um dígito de discagem nacional do identificador de chamada e anexar um código de país do chamador ao identificador de chamada quando o identificador de chamada começar com um dígito de discagem nacional.

43. Aparelho, de acordo com a reivindicação 40, em que os meios de formatação são configurados operacionalmente para anexar previamente um código de país do chamador ao identificador de chamada quando o identificador de chamada começa com dígitos identificando um código de área especificado pelo perfil de discagem do chamador.

44. Aparelho, de acordo com a reivindicação 40, em que os meios de formatação são configurados operacionalmente para anexar previamente um código de país de chamador e código de área ao identificador de chamada quando o identificador de chamada possui um comprimento que combina um formato de número de discagem de chamador especificado pelo perfil de discagem do chamador e apenas um código de área é especificado como sendo associado com o chamador no perfil de discagem do chamador.

45. Aparelho, de acordo com a reivindicação 40, em que os meios de classificação são configurados de forma operacional para classificar a dita chamada como uma chamada de rede privada quando o identificador de chamada reformatado identifica um assinante para a rede privada.

46. Aparelho, de acordo com a reivindicação 40, em que os meios de classificação são configurados de forma operacional para classificar a chamada como uma chamada de rede privada quando o identificador de

chamada se conforma a um formato de nome de usuário predefinido.

47. Aparelho, de acordo com a reivindicação 40, adicionalmente compreendendo meios de busca para buscar uma base de dados de registros para localizar um registro de tabela de banco de discagem direta (DID) associando um número de telefone público com o identificador de chamada reformatado e onde os meios de classificação são configurados de forma operacional para classificar a chamada como uma chamada de rede privada quando o registro de tabela de banco DID é encontrado e para classificar a chamada como uma chamada de rede pública quando um registro de tabela de banco DID não é encontrado.

48. Aparelho, de acordo com a reivindicação 47, em que os meios de produção da mensagem de direcionamento de rede privada são configurados de forma operacional para produzir uma mensagem de direcionamento possuindo um identificador de chamada configurado de acordo com um nome de usuário associado ao registro de tabela de banco DID.

49. Aparelho, de acordo com a reivindicação 48, em que o dispositivo de produção de mensagem de direcionamento de rede privada é configurado de forma operacional para determinar se um nó associado com o identificador de chamada reformatado é o mesmo que o nó associado com o identificador do chamador.

50. Aparelho, de acordo com a reivindicação 49, em que o dispositivo de direcionamento de rede privada inclui meios para determinar se um prefixo do identificador de chamada reformatado combina com um prefixo correspondente de um nome de usuário associado com o perfil de discagem do chamador.

51. Aparelho, de acordo com a reivindicação 50, em que os dispositivos de produção de mensagem de direcionamento de rede privada são configurados de forma operacional para produzir uma mensagem de direcionamento incluindo o identificador do chamador, o identificador de chamada reformatado, e uma identificação de um nó de rede privada associados com o chamado e comunicando a dita mensagem de direcionamento para um controlador de chamada.

52. Aparelho, de acordo com a reivindicação 49, em que os dispositivos de produção de mensagem de direcionamento de rede privada são configurados de forma operacional para realizar pelo menos um dos seguintes: envio da chamada para outra parte, bloqueio da chamada e direcionamento do chamador para um servidor de correio de voz associado com o chamado, quando o nó associado com o chamador for igual ao nó associado com o chamado.

53. Aparelho, de acordo com a reivindicação 52, em que os meios de produção da mensagem de direcionamento de rede privada são configurados de forma operacional para produzir uma mensagem de direcionamento possuindo uma identificação de pelo menos um dentre o identificador de chamada, uma identificação de uma parte para quem a chamada deve ser enviada e uma identificação de um servidor de correio de voz associado com o chamado.

54. Aparelho, de acordo com a reivindicação 53, adicionalmente compreendendo meios para comunicação da mensagem de direcionamento para um controlador de chamada.

55. Aparelho, de acordo com a reivindicação 40, em que os meios de produção de uma mensagem de direcionamento de rede pública identificando um circuito de acesso à rede pública compreendem meios para buscar uma base de dados dos registro de direcionamento associando os identificadores de rota com os códigos de discagem para encontrar um registro de direcionamento possuindo um código de discagem possuindo um padrão de número combinando com pelo menos uma parte do identificador de chamada reformatado.

56. Aparelho, de acordo com a reivindicação 55, adicionalmente compreendendo meios para buscar uma base de dados dos registros do fornecedor associando identificadores de fornecedor com os identificadores de direcionamento para localizar pelo menos um registro de fornecedor associado com o identificador de direcionamento associado com o registro de direcionamento possuindo um código possuindo um padrão de número que coincide pelo menos com uma parte do identificador de chamada reformatado.

57. Aparelho, de acordo com a reivindicação 56, adicionalmente compreendendo um armazenador de mensagem de direcionamento e meios para carregar o armazenador de mensagem de direcionamento com o identificador de chamada reformatado e uma identificação das rotas específicas associadas com as rotas respectivas dos registros de fornecedor associados com o registro de rota e o carregamento do armazenador de mensagem de direcionamento com um valor de tempo e um valor de expiração de tempo.

58. Aparelho, de acordo com a reivindicação 57, adicionalmente compreendendo meios para comunicação de uma mensagem de direcionamento compreendendo o conteúdo do armazenador de mensagem de direcionamento para um controlador de chamada.

59. Aparelho, de acordo com a reivindicação 34, adicionalmente compreendendo meios para fazer com que o perfil de discagem inclua um valor máximo de chamadas simultâneas e um valor de contagem de chamadas simultâneas e para fazer com que o valor de contagem de chamadas simultâneas seja incrementado quando o usuário associado com o perfil de discagem inicia uma chamada e para fazer com que o valor de contagem de chamadas simultâneas seja reduzido quando uma chamada com o usuário associado com o perfil de discagem é encerrada.

60. Estrutura de dados para acesso por um aparelho para a produção de uma mensagem de direcionamento para uso por um controlador de direcionamento de chamada em um sistema de comunicações, a estrutura de dados compreendendo:

os registros de perfil de discagem compreendendo campos para a associação de um nome de usuário de assinante com assinantes respectivos com o sistema;

os registros de discagem direta compreendendo campos para a associação de um domínio de usuário e um número de discagem direta com os nomes de usuário de assinante respectivos;

o prefixo para os registros de nó compreendendo campos para a associação de um endereço de nó de um nó no dito sistema com pelo menos uma parte dos nomes de usuário de assinante respectivos:

em que o nome de usuário de assinante pode ser utilizado para encontrar o domínio de usuário, pelo menos uma parte do nome de usuário de assinante pode ser utilizada para encontrar o nó com o qual um assinante identificado pelo nome de usuário de assinante é associado, e o dito domínio de usuário e o dito nome de usuário de assinante podendo ser localizados em resposta ao dito número de discagem direta.

61. Estrutura de dados para acesso por um aparelho para a produção de uma mensagem de direcionamento par auso por um controlador de direcionamento de chamada em um sistema de comunicações, a estrutura de dados compreendendo:

registros de lista principal compreendendo campos para a associação de um código de discagem com os identificadores de lista principal respectivos; e

registros de lista de fornecedor conectados aos registros de lista principal pelos ditos identificadores de lista principal, os registros de lista de fornecedor compreendendo campos para a associação com um fornecedor de serviços de comunicações:

um ID de fornecedor;
um ID de lista principal;
um identificador de rota; e
um código de taxa de cobrança;

em que pelo menos um fornecedor de serviço de comunicações é associado com o código de discagem, de forma que o código de discagem possa ser utilizado para localizar os fornecedores capazes de fornecer um link de comunicações associado com um determinado código de discagem.

62. Método para determinar um tempo para permitir que uma sessão de comunicação seja conduzida, o método compreendendo as etapas de:

calcular um custo por tempo unitário;
calcular um primeiro valor de tempo como uma soma de um tempo livre atribuído a um participante na sessão de comunicação e o quociente de um saldo de fundos mantido pelo participante ao custo por valor de

tempo unitário; e

produzir um segundo valor de tempo em resposta ao dito primeiro valor de tempo e um padrão de cobrança associado com o participante, o padrão de cobrança incluindo primeiro e segundo intervalos de cobrança e o dito segundo valor de tempo sendo o tempo para permitir que uma sessão de comunicação seja conduzida.

63. Método, de acordo com a reivindicação 62, em que a etapa de calcular o primeiro valor de tempo compreende recuperar um registro associado com o participante e obtendo a partir do registro pelo menos um dentre o tempo grátis e o saldo de fundos.

64. Método, de acordo com a reivindicação 62, em que a produção do dito segundo valor de tempo compreende a produção de um valor restante representando uma parte do dito segundo intervalo de cobrança restante após a divisão do dito segundo intervalo de cobrança em uma diferença entre o dito primeiro valor de tempo e o dito primeiro intervalo de cobrança.

65. Método, de acordo com a reivindicação 64, em que a produção do dito segundo valor de tempo compreende a configuração de uma diferença entre o dito primeiro valor de tempo e o dito restante do dito segundo valor de tempo.

66. Método, de acordo com a reivindicação 62, adicionalmente compreendendo a configuração do dito segundo valor de tempo para zero quando o dito restante é superior a zero e o dito primeiro valor de tempo é inferior ao dito tempo livre associado com o dito participante.

67. Método, de acordo com a reivindicação 62, em que o cálculo do dito custo por tempo unitário compreende:

a localização de um registro em uma base de dados, o registro compreendendo um indicador de tipo de marcação, um valor de marcação e um padrão de cobrança; e

a configuração de uma taxa de revenda igual à soma do valor de marcação e a dita taxa de armazenamento.

68. Método, de acordo com a reivindicação 67, em que a locali-

zação do registro em uma base de dados compreende a localização de pelo menos um dentre:

um registro associado com um revendedor e uma rota associada com o revendedor;

- 5 um registro associado com o revendedor; e
um registro de marcação de revendedor padrão.

69. Método, de acordo com a reivindicação 67, em que o cálculo do dito custo por valor de tempo unitário compreende adicionalmente a localização de pelo menos um dentre:

- 10 um registro de eliminação especificando um custo de rota por quantidade de tempo unitário associado com uma rota associada com a sessão de comunicação;

um registro de revendedor associado com um revendedor da dita sessão de comunicações, o registro de revendedor especificando um
15 custo de revendedor por tempo unitário associado com o dito revendedor para a sessão de comunicação;

um registro de marcação de operador padrão especificando um custo padrão por tempo unitário.

70. Método, de acordo com a reivindicação 69, adicionalmente
20 compreendendo a configuração do dito custo por tempo unitário como a soma da dita taxa de revendedor e pelo menos um dentre o dito custo de rota por tempo unitário, o dito custo de revendedor por tempo unitário e o dito custo padrão por tempo unitário.

71. Método, de acordo com a reivindicação 69, adicionalmente
25 compreendendo o recebimento de um tempo de sessão de comunicação representando uma duração da dita sessão de comunicação e incrementando um extrato de revendedor pelo produto da dita taxa de revendedor e o dito tempo de sessão de comunicação.

72. Método, de acordo com a reivindicação 69, adicionalmente
30 compreendendo o recebimento de um tempo de sessão de comunicação representando uma duração da dita sessão de comunicação e incrementando um extrato do operador de sistema por um produto da dita taxa de arma-

zenamento e o dito tempo de sessão de comunicação.

73. Meio legível por computador, codificado com instruções para o direcionamento de um circuito processador para executar o método como definido em qualquer uma das reivindicações de 62 a 72.

5 74. Aparelho para determinar um tempo para permitir que uma sessão de comunicação seja conduzida, o aparelho compreendendo:

um circuito processador;

um meio legível por computador acoplado ao circuito processador e codificado com instruções para o direcionamento do circuito processador para:

10 calcular um custo por tempo unitário para a sessão de comunicação;

calcular um primeiro valor de tempo como uma soma de um tempo livre atribuído a um participante na sessão de comunicação e o quociente de um extrato de fundos mantido pelo dito participante para o valor de custo por tempo unitário; e

15 produzir um segundo valor de tempo em resposta ao dito primeiro valor de tempo e um padrão de cobrança associado com o dito participante, o dito padrão de cobrança incluindo primeiro e segundo intervalos de cobrança e o dito segundo valor de tempo sendo o dito tempo para permitir que

20 uma sessão de comunicação seja conduzida.

75. Aparelho, de acordo com a reivindicação 74, em que as ditas instruções incluem instruções para o direcionamento do circuito processador para recuperar um registro associado com o dito participante e obter a partir

25 do registro pelo menos um dentre o dito tempo livre e o dito extrato de fundos.

76. Aparelho, de acordo com a reivindicação 74, em que as ditas instruções incluem instruções para o direcionamento do circuito processador para produzir o dito segundo valor de tempo pela produção de um valor restante que representa uma parte do dito segundo intervalo de cobrança

30 restante após a divisão do dito segundo intervalo de cobrança em uma diferença entre o dito primeiro valor e o dito primeiro intervalo de cobrança.

77. Aparelho, de acordo com a reivindicação 76, em que as ditas instruções incluem instruções para o direcionamento do circuito processador para produzir o dito segundo valor de tempo e compreendem a configuração de uma diferença entre o dito primeiro valor de tempo e o dito restante como o dito segundo valor de tempo.

78. Aparelho, de acordo com a reivindicação 74, em que as ditas instruções incluem instruções para o direcionamento do circuito processador para configurar o dito segundo valor de tempo para zero quando o dito restante é maior que zero e o dito primeiro valor de tempo é inferior ao dito tempo livre associado com o dito participante.

79. Aparelho, de acordo com a reivindicação 74, em que as ditas instruções para o direcionamento do dito circuito de processador para cálculo do dito custo por tempo unitário compreende instruções para o direcionamento do circuito processador para:

localizar um registro em uma base de dados, o registro compreendendo um indicador do tipo de marcação, um valor de marcação e um padrão de cobrança; e

configurar uma taxa de revendedor igual à soma do valor de marcação e a dita taxa de armazenamento.

80. Aparelho, de acordo com a reivindicação 79, em que as ditas instruções para o direcionamento do circuito processador para localizar o registro em uma base de dados compreende a instrução para direcionar o circuito processador para localizar pelo menos um dentre:

um registro associado com um revendedor e uma rota associada com o revendedor;

um registro associado com o revendedor;

um registro de marcação de revendedor padrão.

81. Aparelho, de acordo com a reivindicação 79, em que as ditas instruções para o direcionamento do circuito processador para calcular o dito custo por valor de tempo unitário compreendem adicionalmente instruções para direcionar o circuito processador para localizar pelo menos um dentre:

um registro de eliminação especificando um custo de rota por

quantidade de tempo unitário associado com uma rota associada com a sessão de comunicação;

um registro de revendedor associado com um revendedor da dita sessão de comunicações, o registro de revendedor especificando um custo de revendedor por tempo unitário associado com o dito revendedor para a sessão de comunicação;

um registro de marcação de operador padrão especificando um custo padrão por tempo unitário.

82. Aparelho, de acordo com a reivindicação 81, em que as ditas instruções incluem instruções para o direcionamento do circuito processador para configurar como o dito custo por tempo unitário a soma da dita taxa de revendedor e pelo menos um dentre o dito custo de rota por tempo unitário, o dito custo de revendedor por tempo unitário e o dito custo padrão por tempo unitário.

83. Aparelho, de acordo com a reivindicação 81, em que as ditas instruções incluem instruções para direcionar o circuito processador para receber um tempo de sessão de comunicação representando uma duração da dita sessão de comunicação e incrementar um extrato de revendedor pelo produto da dita taxa de revendedor e o dito tempo de sessão de comunicação.

84. Aparelho, de acordo com a reivindicação 81, em que as ditas instruções incluem instruções para direcionar o circuito processador para receber um tempo de sessão de comunicação representando uma duração da dita sessão de comunicação e incrementar um extrato de operador de sistema por um produto da dita taxa de armazenamento e o dito tempo de sessão de comunicação.

85. Processo para atribuir cobrança por serviços de comunicações, o processo compreendendo:

a determinação de um primeiro tempo passível de cobrança em resposta a um tempo de sessão de comunicação e um padrão de cobrança predefinido;

a determinação de um primeiro valor de custo em resposta ao

dito primeiro tempo passível de cobrança e um valor de tempo livre associado a um usuário dos ditos serviços de comunicações;

a cobrança de um extrato de conta associado com o usuário em resposta a um custo de usuário por tempo unitário;

5 a cobrança de um extrato de conta associado a um revendedor dos ditos serviços de comunicações em resposta a um custo de revendedor por tempo unitário e o dito tempo de sessão de comunicação; e

a cobrança de um extrato de conta associado com um operador dos ditos serviços de comunicações em resposta a um custo de operador por tempo unitário e o dito tempo de sessão de comunicação.

86. Processo, de acordo com a reivindicação 85, em que a determinação do dito primeiro tempo passível de cobrança compreende:

da localização de pelo menos um dentre:

um registro de eliminação especificando um custo de rota por tempo unitário e o padrão de cobrança associado com uma rota associada com a sessão de comunicação;

um registro de revendedor associado com um revendedor da dita sessão de comunicações, o registro de revendedor especificando um custo de revendedor por tempo unitário e o padrão de cobrança associado com o dito revendedor para a sessão de comunicação; e

um registro padrão especificando um custo padrão por tempo unitário e um padrão de cobrança; e

a configuração como o dito padrão de cobrança predefinido do padrão de cobrança do registro localizado;

25 onde o padrão de cobrança do registro localizado compreende um primeiro intervalo de cobrança e um segundo intervalo de cobrança.

87. Processo, de acordo com a reivindicação 85, em que a determinação do dito primeiro tempo passível de cobrança compreende a configuração do dito primeiro tempo passível de cobrança igual ao dito primeiro intervalo de cobrança quando o dito tempo de sessão de comunicação é inferior a ou igual ao dito primeiro intervalo de cobrança.

88. Processo, de acordo com a reivindicação 86, em que a de-

terminação do dito primeiro tempo passível de cobrança compreende a produção de um valor restante representando uma parte do dito segundo intervalo de cobrança restando após a divisão do dito segundo intervalo de cobrança em uma diferença entre o tempo de sessão de comunicação e o dito primeiro intervalo quando o dito tempo de sessão de comunicação é maior do que o dito tempo de sessão de comunicação; e

a configuração do dito primeiro tempo passível de cobrança em uma diferença entre o dito tempo de sessão de comunicação e o dito restante quando o dito restante é superior a zero; e

a configuração do dito primeiro tempo passível de cobrança para o dito tempo de sessão de comunicação quando o dito restante não é superior a zero.

89. Processo, de acordo com a reivindicação 88, adicionalmente compreendendo a determinação de um segundo tempo passível de cobrança em resposta ao dito primeiro tempo passível de cobrança e o valor de tempo livre associado com o usuário dos ditos serviços de comunicações quando o dito primeiro tempo passível de cobrança é superior a ou igual ao valor de tempo livre associado com o usuário dos ditos serviços de comunicações.

90. Processo, de acordo com a reivindicação 89, em que a determinação do dito segundo tempo passível de cobrança compreende a configuração do dito segundo tempo passível de cobrança para uma diferença entre o dito primeiro tempo passível de cobrança.

91. Processo, de acordo com a reivindicação 89, adicionalmente compreendendo a reconfiguração do valor de tempo livre associado com o usuário para zero quando o dito primeiro tempo passível de cobrança é superior a ou igual ao valor de tempo livre associado com o usuário dos ditos serviços de comunicações.

92. Processo, de acordo com a reivindicação 90, em que a cobrança de um extrato de conta associado ao usuário compreende o cálculo de um valor de custo de usuário em resposta ao dito segundo tempo passível de cobrança e o dito custo de usuário por tempo unitário.

93. Processo, de acordo com a reivindicação 92, adicionalmente compreendendo a alteração de um extrato de custo livre de usuário em resposta ao valor de custo de usuário.

5 94. Processo, de acordo com a reivindicação 85, adicionalmente compreendendo a configuração do dito custo de usuário para zero quando o dito primeiro tempo passível de cobrança é inferior ao valor de tempo livre associado com o usuário.

10 95. Processo, de acordo com a reivindicação 85, adicionalmente compreendendo a alteração de um extrato de tempo livre de usuário em resposta ao dito primeiro tempo passível de cobrança.

96. Meio legível por computador, codificado com instruções para o direcionamento de um circuito de processo para executar o processo, como definido em qualquer uma das reivindicações de 85 a 95.

15 97. Aparelho para atribuir cobranças para os serviços de comunicações, o aparelho compreendendo:

um circuito processador;

um meio legível por computador em comunicação com o circuito processador e codificado com instruções para o direcionamento do dito circuito processador para:

20 determinar um primeiro tempo passível de cobrança em resposta a um tempo de sessão de comunicação e um padrão de cobrança predefinido;

25 determinar um valor de custo de usuário em resposta ao dito primeiro tempo passível de cobrança e um valor de tempo livre associado com um usuário dos ditos serviços de comunicações;

mudar um extrato de conta associado com o usuário em resposta a um custo de usuário por tempo unitário;

30 mudar um extrato de conta associado com um revendedor dos ditos serviços de comunicações em resposta a um custo de revendedor por tempo unitário e o dito tempo de sessão de comunicação; e

mudar um extrato de contato associado com um operador dos ditos serviços de comunicações em resposta a um custo de operador por

tempo unitário e o dito tempo de sessão de comunicação.

98. Aparelho, de acordo com a reivindicação 97, em que as ditas instruções para o direcionamento do circuito processador para determinação do dito primeiro tempo passível de cobrança compreende:

5 instruções para fazer com que o dito circuito processador se comunique com uma base de dados para localizar pelo menos um dentre:

um registro de eliminação especificando um custo de rota por tempo unitário e o padrão de cobrança associado com uma rota associada com a sessão de comunicação;

10 um registro de revendedor associado com um revendedor da dita sessão de comunicações, o registro de revendedor especificando um custo de revendedor por tempo unitário e o padrão de cobrança associado com o dito revendedor para a sessão de comunicação; e

15 um registro padrão especificando um custo padrão por tempo unitário e padrão de cobrança; e

instruções para configurar como o dito padrão de cobrança predefinido do padrão de cobrança do registro localizado;

onde o padrão de cobrança do registro localizado compreende um primeiro intervalo de cobrança e um segundo intervalo de cobrança.

20 99. Aparelho, de acordo com a reivindicação 97, em que as ditas instruções fazendo com que o circuito processador determine o dito primeiro tempo passível de cobrança compreendendo instruções para o direcionamento do circuito processador para configurar o dito primeiro tempo passível de cobrança igual ao dito primeiro intervalo de cobrança quando o dito tempo de sessão de comunicação é inferior a ou igual ao dito primeiro intervalo de cobrança.

25 100. Aparelho, de acordo com a reivindicação 98, em que as ditas instruções para fazer com que o circuito processador determine o dito primeiro tempo passível de cobrança compreende instruções para a produção de um valor restante representando uma parte do dito segundo intervalo de cobrança restando após a divisão do dito segundo intervalo de cobrança em uma diferença entre o tempo de sessão de comunicação e o dito primei-

30

ro intervalo quando o dito tempo de sessão de comunicação é superior ao dito tempo de sessão de comunicação; e

instruções para fazer com que o circuito processador configure o dito primeiro tempo passível de cobrança para uma diferença entre o dito
5 tempo de sessão de comunicação e o dito restante quando o dito restante é superior a zero; e

instruções para fazer com que o circuito processador configure o dito primeiro tempo passível de cobrança para o dito tempo de sessão de comunicação quando o dito restante não é superior a zero.

10 101. Aparelho, de acordo com a reivindicação 100, em que o meio legível por computador é adicionalmente codificado com instruções para fazer com que o circuito processador determine um segundo tempo passível de cobrança em resposta ao dito primeiro tempo passível de cobrança e o valor de tempo livre associado com o usuário dos ditos serviços
15 de comunicações quando o dito primeiro tempo passível de cobrança é superior a ou igual ao valor de tempo livre associado com o usuário dos ditos serviços de comunicações.

102. Aparelho, de acordo com a reivindicação 101, em que as ditas instruções para fazer com que o circuito processador determine o dito
20 segundo tempo passível de cobrança compreendendo instruções para fazer com que o circuito processador configure o dito segundo tempo passível de cobrança para uma diferença entre o dito primeiro tempo passível de cobrança.

103. Aparelho, de acordo com a reivindicação 101, em que o
25 meio legível por computador é codificado adicionalmente com instruções para fazer com que o circuito processador reconfigure o valor de tempo livre associado com o usuário para zero quando o dito primeiro tempo passível de cobrança é superior a ou igual ao valor de tempo livre associado com o usuário dos ditos serviços de comunicações.

30 104. Aparelho, de acordo com a reivindicação 102, em que as ditas instruções para fazer com que o circuito processador mude um extrato de conta associado com o usuário compreendem instruções para fazer com

que o circuito processador calcule um valor de custo de usuário em resposta ao dito segundo tempo passível de cobrança e o dito custo de usuário por tempo unitário.

105. Aparelho, de acordo com a reivindicação 104, em que o meio legível por computador é adicionalmente codificado com instruções para fazer com que o circuito processador mude um extrato de custo livre de usuário em resposta ao valor de custo do usuário.

106. Aparelho, de acordo com a reivindicação 97, em que o meio legível por computador é adicionalmente codificado com instruções para fazer com que o circuito processador configure o dito custo de usuário para zero quando o dito primeiro tempo passível de cobrança é inferior ao valor de tempo livre associado com o usuário.

107. Aparelho, de acordo com a reivindicação 97, em que o meio legível por computador é adicionalmente codificado com instruções para fazer com que o circuito processador mude um extrato de tempo livre de usuário em resposta ao dito primeiro tempo passível de cobrança.

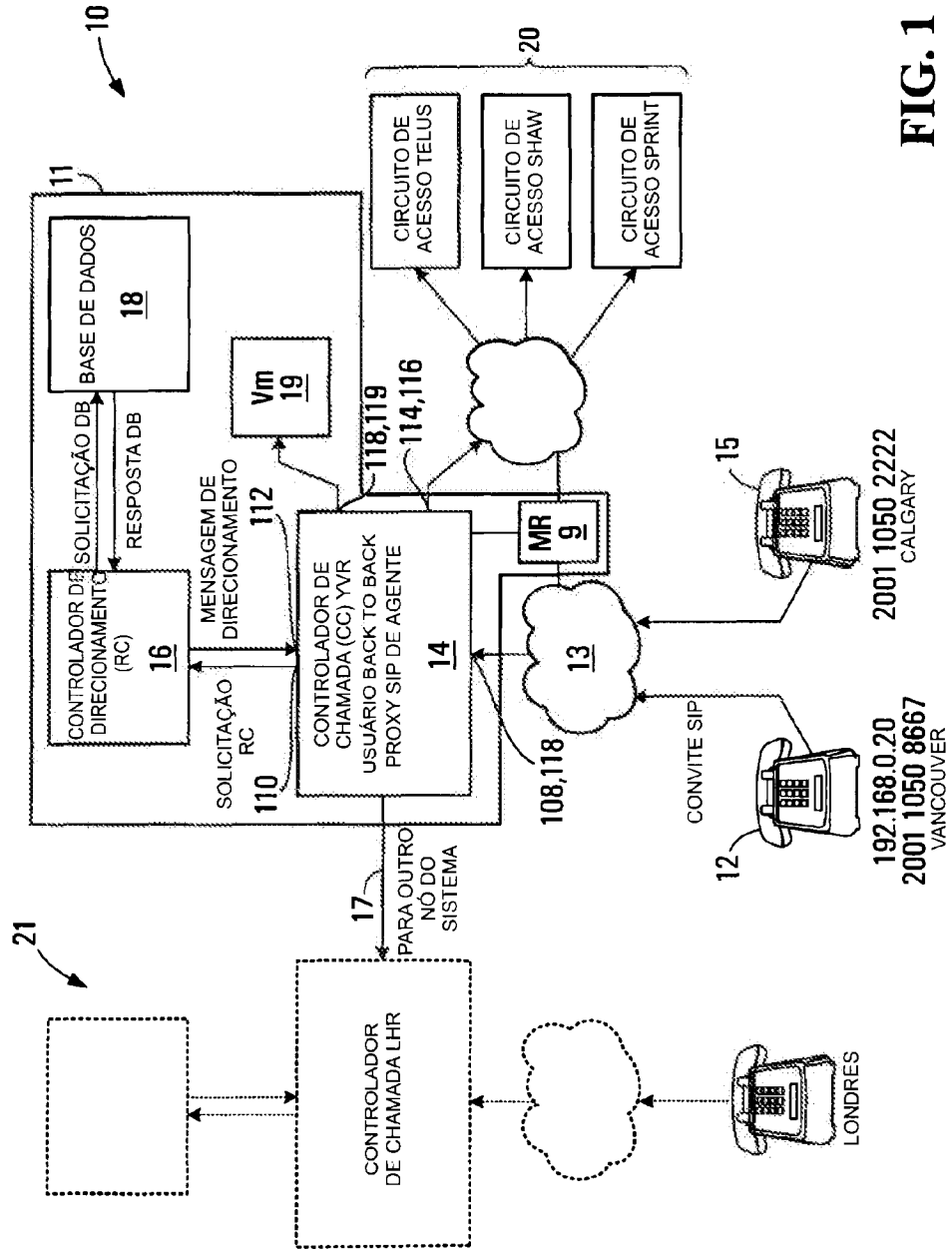

FIG. 1

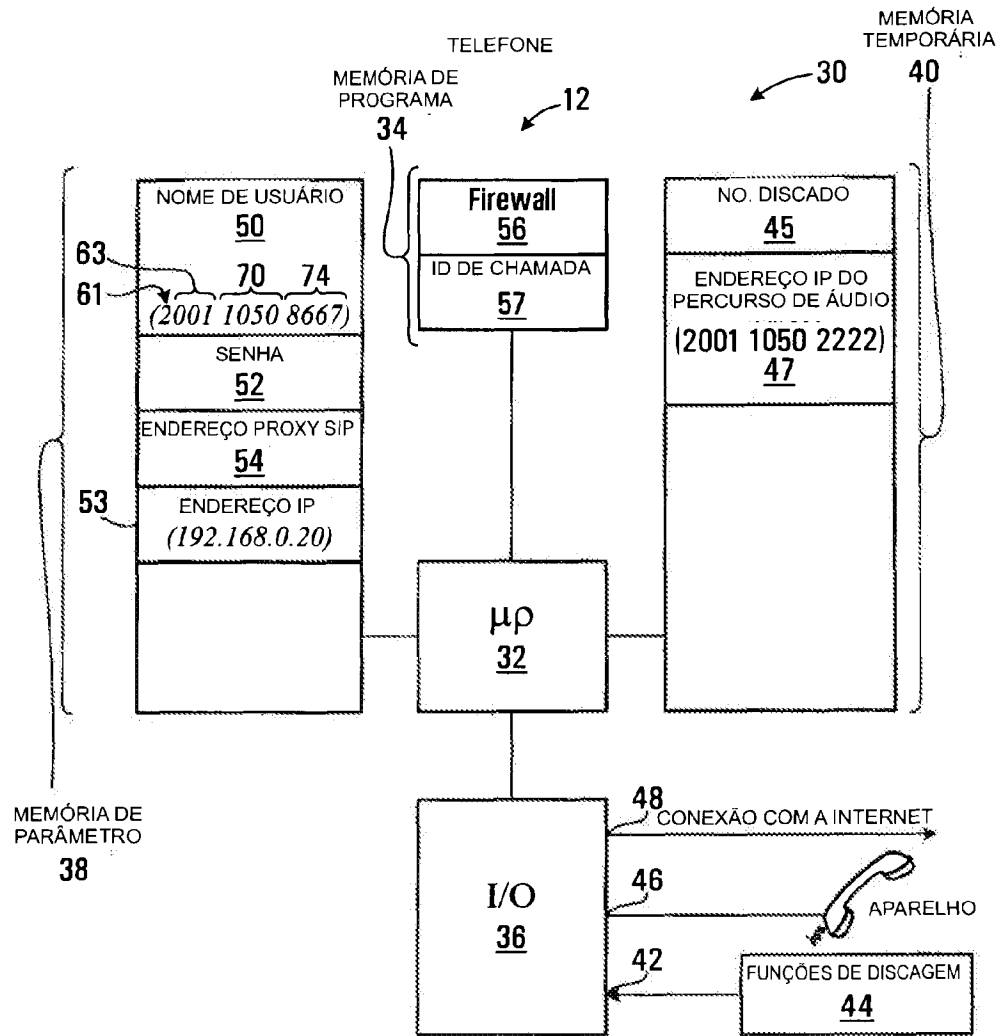

FIG. 2

MENSAGEM DE CONVITE SIP

60 — CHAMADOR 2001 1050 8667
62 — CHAMADO 2001 1050 2222
64 — PARÂMETROS DIGEST XXXXXX
65 — ID DE CHAMADA FF10@ 192.168.0.20
67 — ENDEREÇO IP 192.168.0.20
69 — PORTA UDP DE CHAMADOR 1

FIG. 3

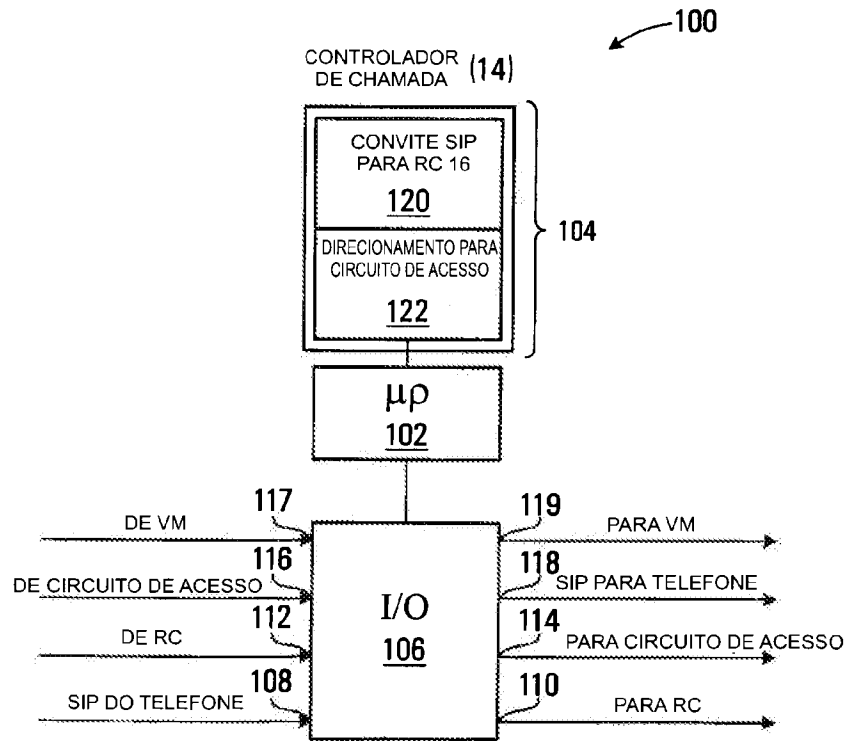

FIG. 4

PROCESSO DE CONTROLADOR DE CHAMADA

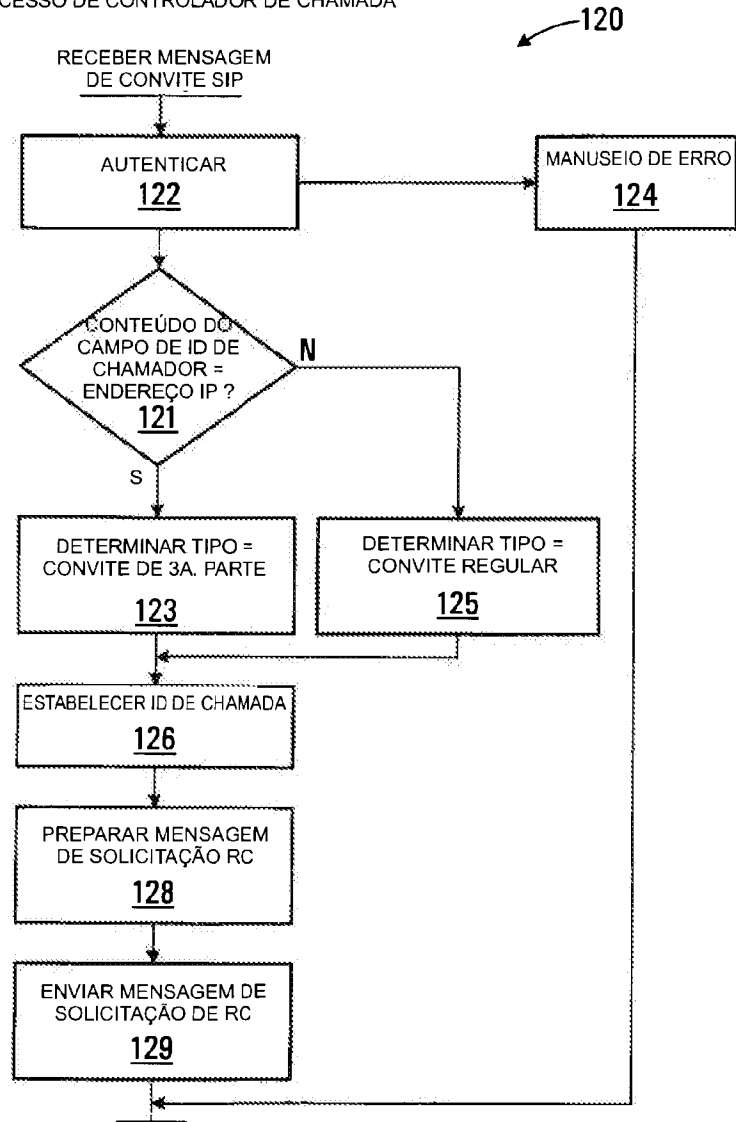

FIG. 5

MENSAGEM DE SOLICITAÇÃO RC ↖ 150

152 ~ CHAMADOR 2001 1050 8667

154 ~ CHAMADO 2001 1050 2222

156 ~ DIGEST XXXXXXXX

158 ~ ID DE CHAMADA FF10@ 192.168.0.20

160 ~ TIPO ASSINANTE

FIG. 6

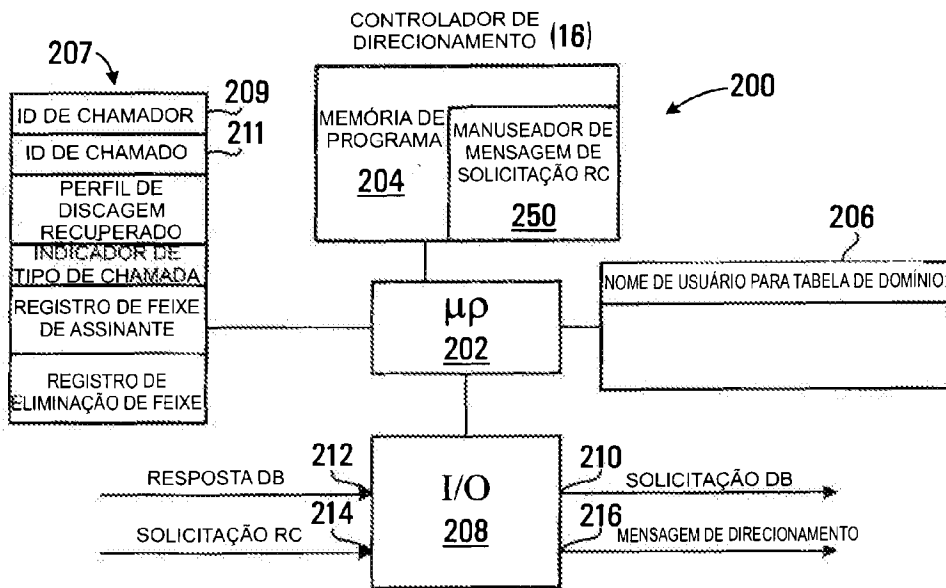

FIG. 7

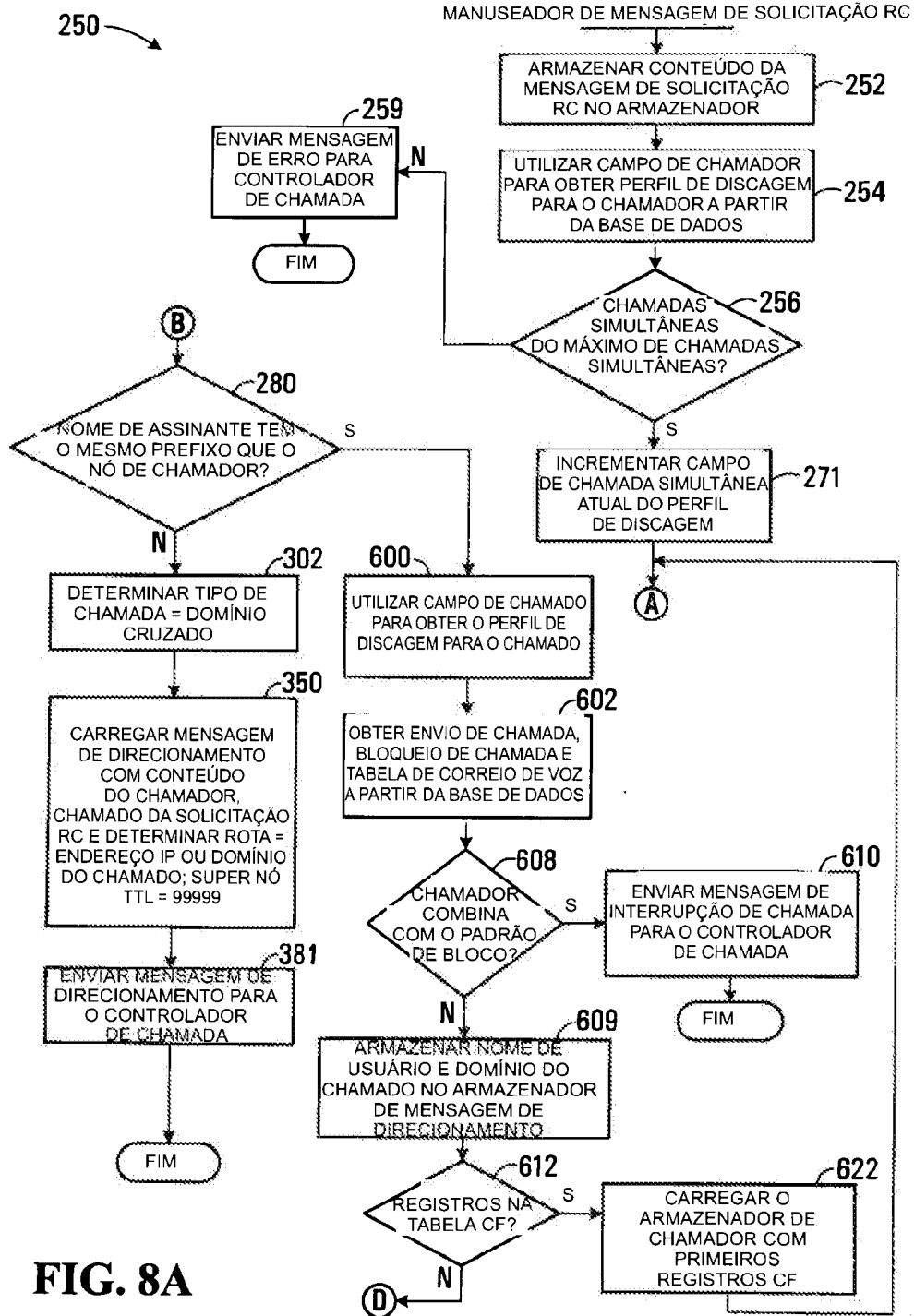
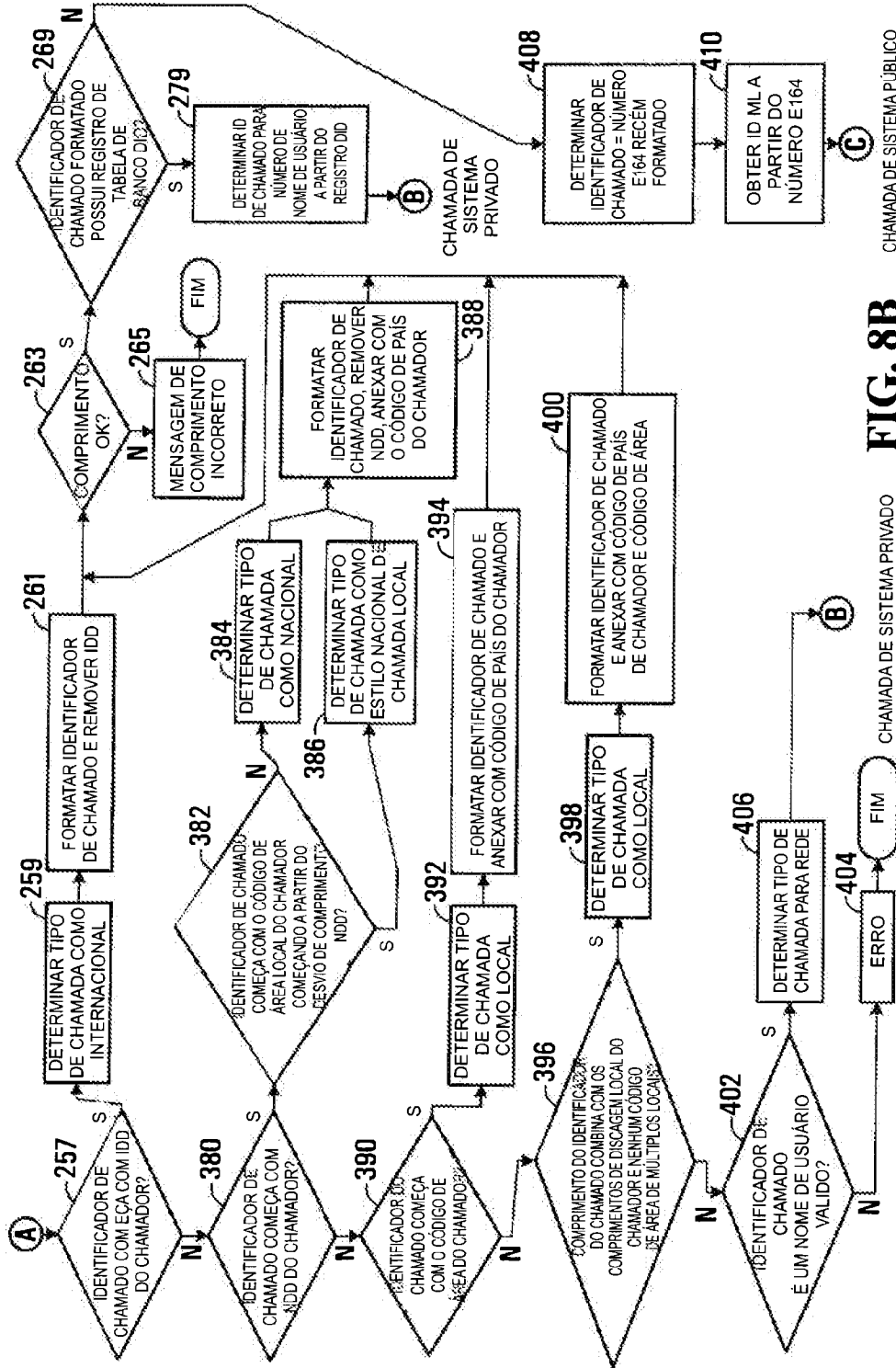

FIG. 8A



CHAMADA DE SISTEMA PÚBLICO

CHAMADA DE SISTEMA PRIVADO

FIG. 8B

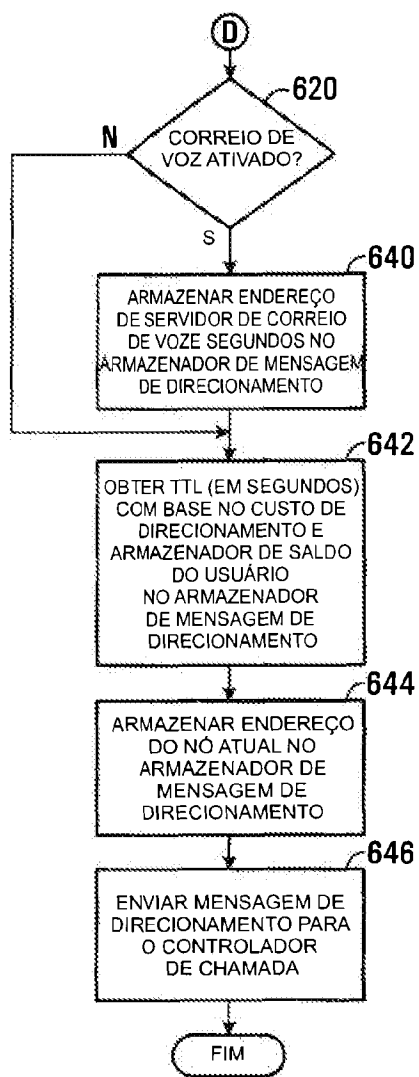

FIG. 8C

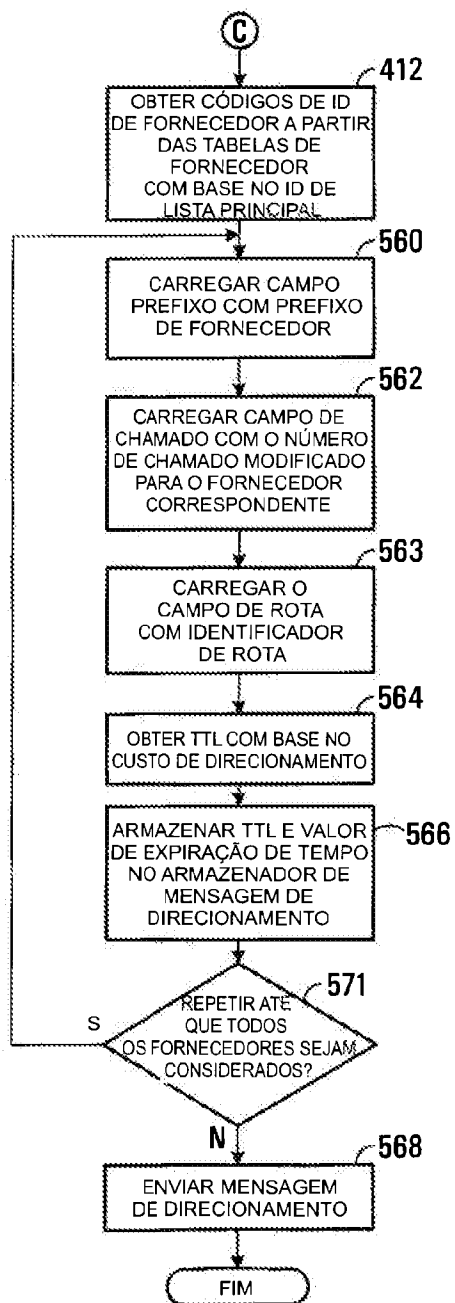

FIG. 8D

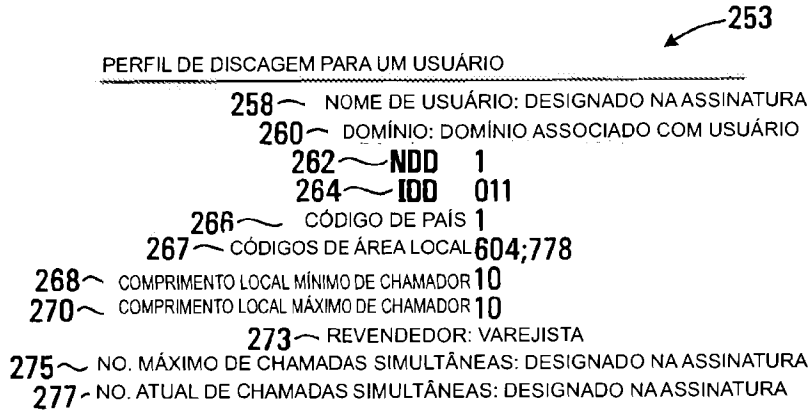

FIG. 9

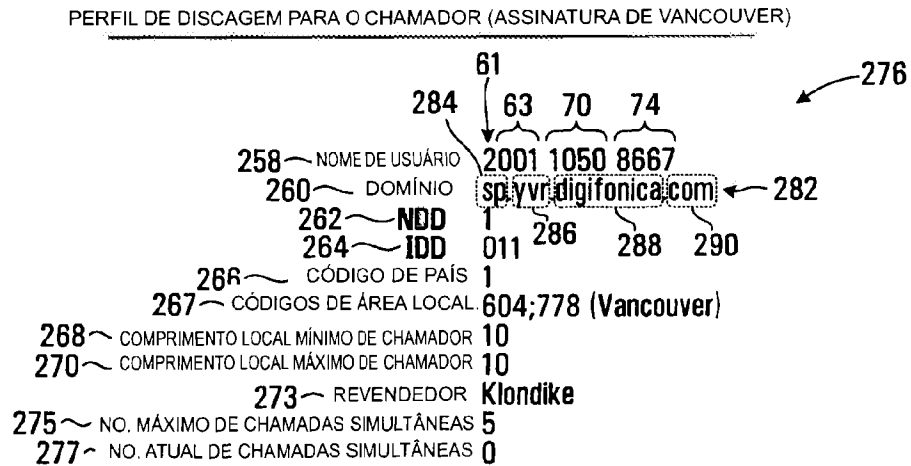

FIG. 10

 PERFIL DO CHAMADO PARA ASSINANTE DE CALGARY

NOME DE USUÁRIO	2001 1050 2222
DOMÍNIO	sp.yvr.digifonica.com
NDD	1
IDD	011
CÓDIGO DE PAÍS	1
CÓDIGOS DE ÁREA LOCAL	403 (Calgary)
COMPRIMENTO LOCAL MÍNIMO DE CHAMADOR	7
COMPRIMENTO LOCAL MÁXIMO DE CHAMADOR	10
REVENDEDOR	Deerfoot
NO. MÁXIMO DE CHAMADAS SIMULTÂNEAS	5
NO. ATUAL DE CHAMADAS SIMULTÂNEAS	0

FIG. 11

 PERFIL DO CHAMADO PARA ASSINANTE DE LONDRES

NOME DE USUÁRIO	4401 1062 4444
DOMÍNIO	sp.lhr.digifonica.com
CÓDIGO DE PAÍS	0
NDD	00
IDD	44
CÓDIGOS DE ÁREA LOCAL: LONDRES	20 (London)
COMPRIMENTO LOCAL MÍNIMO DO CHAMADOR	10
COMPRIMENTO LOCAL MÁXIMO DO CHAMADOR	11
REVENDEDOR	Marble Arch
NO. MÁXIMO DE CHAMADAS SIMULTÂNEAS	5
NO. ATUAL DE CHAMADAS SIMULTÂNEAS	0

FIG. 12

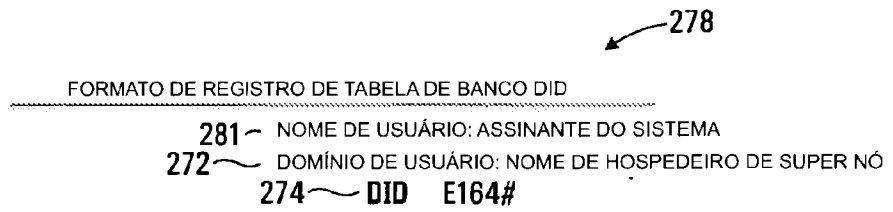

FIG. 13

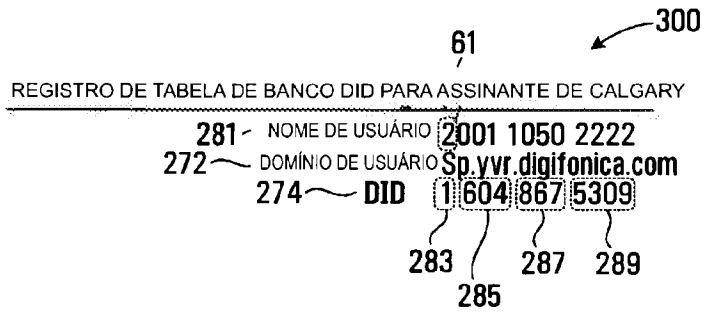

FIG. 14

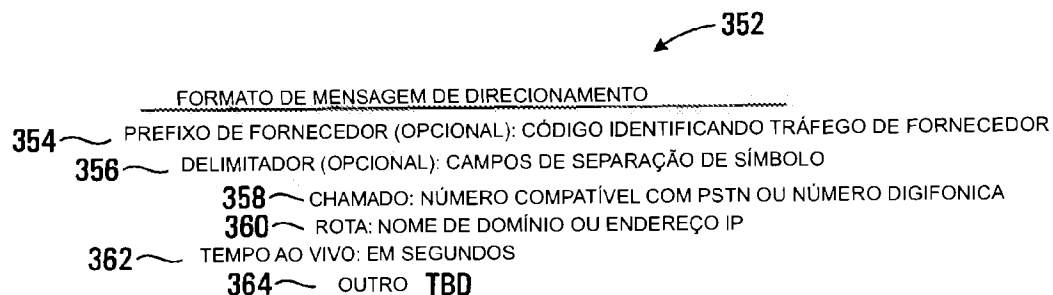

FIG. 15

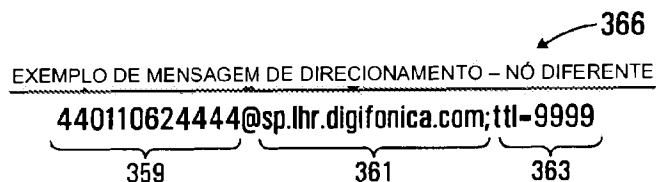

FIG. 16

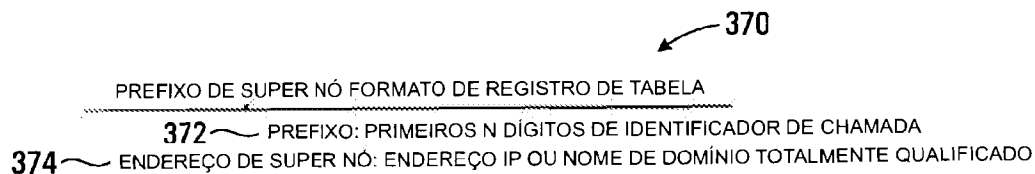

FIG. 17



FIG. 18

FORMATO DE REGISTRO DE LISTA PRINCIPAL

- 500 ~ ML_ID: ALFANUMÉRICO
- 502 ~ CÓDIGO DE DISCAGEM: SEQUÊNCIA NUMÉRICA
- 504 ~ CÓDIGO DE PAÍS: O CÓDIGO DE PAÍS É O PREFIXO NACIONAL A SER UTILIZADO QUANDO DISCAGEM TO DE UM PAÍS EM PARTICULAR
-
- 506 ~ NO. DE ASSINATURA NAT (CÓDIGO DE ÁREA): SEQUÊNCIA NUMÉRICA
- 508 ~ COMPRIMENTO MÍNIMO: NUMÉRICO
- 510 ~ COMPRIMENTO MÁXIMO: NUMÉRICO
- 512 ~ O PREFIXO NDD É O CÓDIGO DE ACESSO UTILIZADO PARA REALIZAR UMA CHAMADA DENTRO DESSE PAÍS A PARTIR DE UMA CIDADE PARA OUTRA (QUANDO CHAMANDO OUTRA CIDADE NAS MESMAS PROXIMIDADES, ISSO PODE NÃO SER NECESSÁRIO).
-
- 514 ~ **IDD** O PREFIXO IDD É O PREFIXO INTERNACIONAL NECESSÁRIO PARA DISCAR UMA CHAMADA A PARTIR DO PAÍS LISTADO PARA OUTRO PAÍS
-
- 516 ~ TAXA DE ARMAZENADOR: TAXA DE MUDANÇA SEGURA ACIMA DA TAXA MAIS ALTA COBRADA PELO FORNECEDOR

FIG. 19

EXEMPLO: REGISTRO DE LISTA PRINCIPAL COM CAMPOS PREENCHIDOS

ml_id	1019
CÓDIGO DE DISCAGEM	1604
CÓDIGO DE PAIS	1
NO. DE ASSINATURA NAT (CÓDIGO DE ÁREA)	604
COMPRIMENTO MÍNIMO	7
COMPRIMENTO MÁXIMO	7
NDD	1
IDD	011
TAXA DE ARMAZENADOR	\$0.009/min

FIG. 20

 FORMATO DE REGISTRO DE LISTA DE FORNECEDORES

540 ~ Sup_id CÓDIGO DE NOME
 542 ~ MI_id CÓDIGO NUMÉRICO
 544 ~ PREFIXO (OPCIONAL): SEQUÊNCIA IDENTIFICANDO O NO. DE TRÁFEGO DO FORNECEDOR
 546 ~ ROTA ESPECÍFICA: ENDEREÇO IP
 548 ~ REESCREVER NDD/IDD
 550 ~ TAXA: CUSTO POR SEGUNDO PARA DIGIFONICA PARA USO DESSA ROTA
 551 ~ TEMPO DE EXPIRAÇÃO: TEMPO MÁXIMO PARA ESPERAR POR UMA RESPOSTA QUANDO DA SOLICITAÇÃO DESSE CIRCUITO DE ACESSO

FIG. 21

 REGISTRO DE FORNECEDOR TELUS

Sup_id 2010 (Telus)
 MI_id 1019
 PREFIXO (OPCIONAL) 4973#
 ROTA ESPECÍFICA 72.64.39.58
 REESCRITA NDD/IDD 011
 TAXA \$0.02/min
 EXPIRAÇÃO DE TEMPO 20

FIG. 22

 REGISTRO DE FORNECEDOR SHAW

Sup_id 2011 (Shaw)
 MI_id 1019
 PREFIXO (OPCIONAL) 4974#
 ROTA ESPECÍFICA 73.65.40.59
 REESCRITA NDD/IDD 011
 TAXA \$0.025/min
 EXPIRAÇÃO DE TEMPO 30

FIG. 23

 REGISTRO DE FORNECEDOR SPRINT

Sup_id 2012 (Sprint)
 MI_id 1019
 PREFIXO (OPCIONAL) 4975#
 ROTA ESPECÍFICA 74.66.41.60
 REESCRITA NDD/IDD 011
 TAXA \$0.03/min
 EXPIRAÇÃO DE TEMPO 40

FIG. 24

ARMAZENADOR DE MENSAGEM DE DIRECIONAMENTO PARA A CHAMADA DE CIRCUITO DE ACESSO

4973#0116048675309@72.64.39.58;tll=3600;to=20 ~ 570
4974#0116048675309@73.65.40.59;tll=3600;to=30 ~ 572
4975#0116048675309@74.66.41.60;tll=3600;to=40 ~ 574

FIG. 25

FORMATO DE REGISTRO DE TABELA DE BLOQUEIO DE CHAMADA

604 ~ NOME DE USUÁRIO **Diaifonica #**
606 ~ PADRÃO DE BLOQUEIO: COMPATIVEL COM PSTN OU NO. DIGIFONICA

FIG. 26

REGISTRO DE TABELA DE BLOQUEIO DE CHAMADA PARA CHAMADO CALGARY

604 ~ NOME DE USUÁRIO DO CHAMADO 2001 1050 2222
606 ~ PADRÃO DE BLOQUEIO 2001 1050 8664

FIG. 27

FORMATO DE REGISTRO DE TABELA DE ENVIO DE CHAMADA PARA CHAMADO

614 ~ NOME DE USUÁRIO DO CHAMADO **Digifonica #**
616 ~ NÚMERO DE DESTINO **Diaifonica #**
618 ~ NÚMERO DE SEQUÊNCIA: INTEIRO INDICANDO ORDEM PARA TENTATIVAS

FIG. 28

REGISTRO DE TABELA DE ENVIO DE CHAMADA PARA O CHAMADO DE CALGARY

614 ~ NOME DE USUÁRIO DO CHAMADO 2001 1050 2222
616 ~ NÚMERO DE DESTINO 2001 1055 2223
618 ~ NÚMERO DE SEQUÊNCIA 1

FIG. 29

FORMATO DE REGISTRO DE TABELA DE CORREIO DE VOZ

624 ~ NOME DE USUÁRIO DO CHAMADO **Digifonica #**
626 ~ SERVIDOR VM: NOME DE DOMÍNIO
628 ~ SEGUNDOS PARA CORREIO DE VOZ: TEMPO DE ESPERA ANTES DA ATIVAÇÃO DO CORREIO DE VOZ
630 ~ ATIVADO: SIM/NÃO

FIG. 30

REGISTRO DE TABELA DE CORREIO DE VOZ PARA O CHAMADO DE CALGARY

NOME DE USUÁRIO DO CHAMADO **2001 1050 2222**
SERVIDOR VM **vm.yvr.digifonica.com**
SEGUNDOS PARA CORREIO DE VOZ **20**
ATIVADO **1**

FIG. 31

ARMAZENADOR DE MENSAGEM DE DIRECIONAMENTO – MESMO NÓ

650 ~ **200110502222@sp.yvr.digifonica.com;tli=3600**
652 ~ **200110552223@sp.yvr.digifonica.com;tli=3600**
654 ~ **vm.yvr.digifonica.com;20;tli=60**
656 ~ **sp.yvr.digifonica.com**

FIG. 32

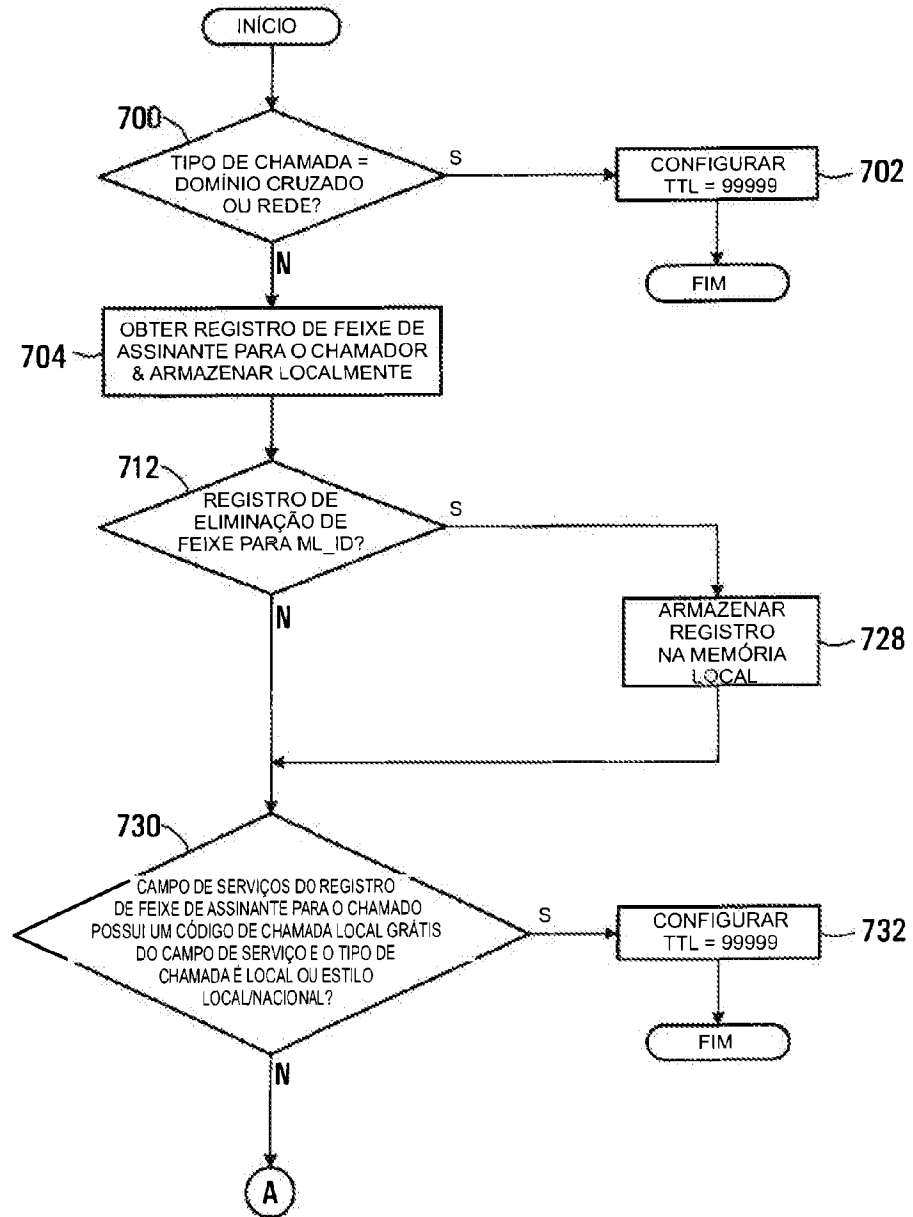

FIG. 33A

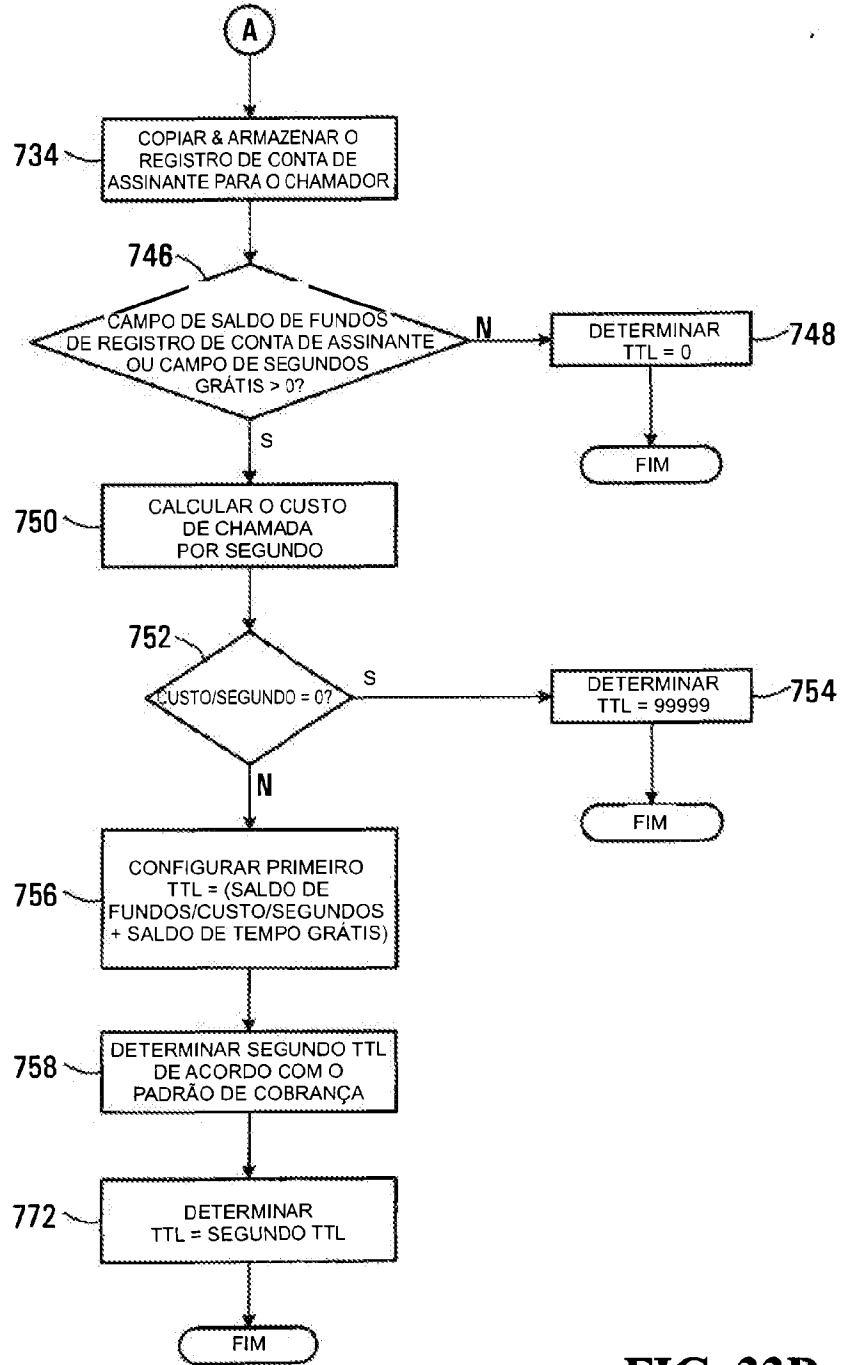

FIG. 33B

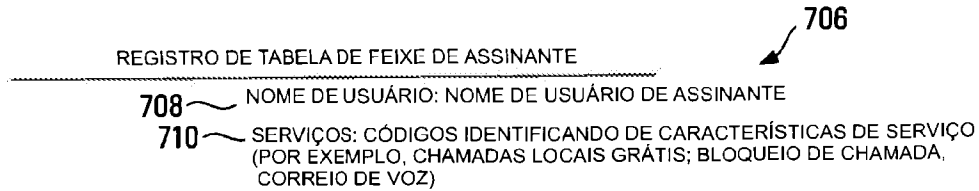

FIG. 34

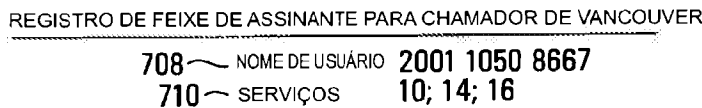

FIG. 35

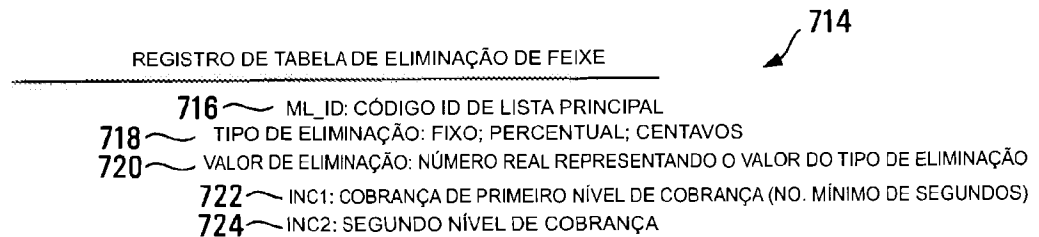

FIG. 36

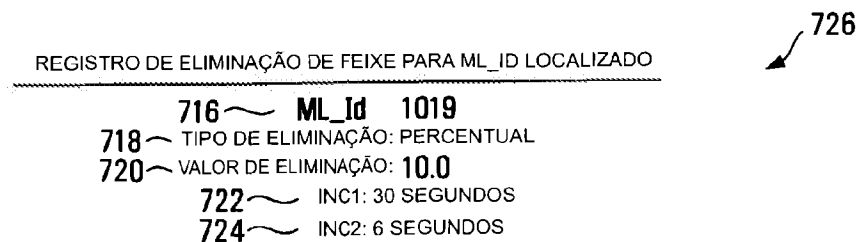

FIG. 37

REGISTRO DE TABELA DE CONTA DE ASSINANTE 736

738- NOME DE USUÁRIO: NOME DE USUÁRIO DE ASSINANTE

740- SALDO DE FUNDOS: NÚMERO REAL REPRESENTANDO \$ VALOR DE CRÉDITO

742- SALDO DE TEMPO GRÁTIS: INTEIRO REPRESENTANDO NO. DE SEGUNDOS GRÁTIS

FIG. 38

REGISTRO DE CONTA DE ASSINANTE PARA CHAMADOR DE VANCOUVER 744

738- NOME DE USUÁRIO 2001 1050 8667

740- SALDO DE FUNDOS \$10.00

742- SALDO DE TEMPO GRÁTIS 100

FIG. 39

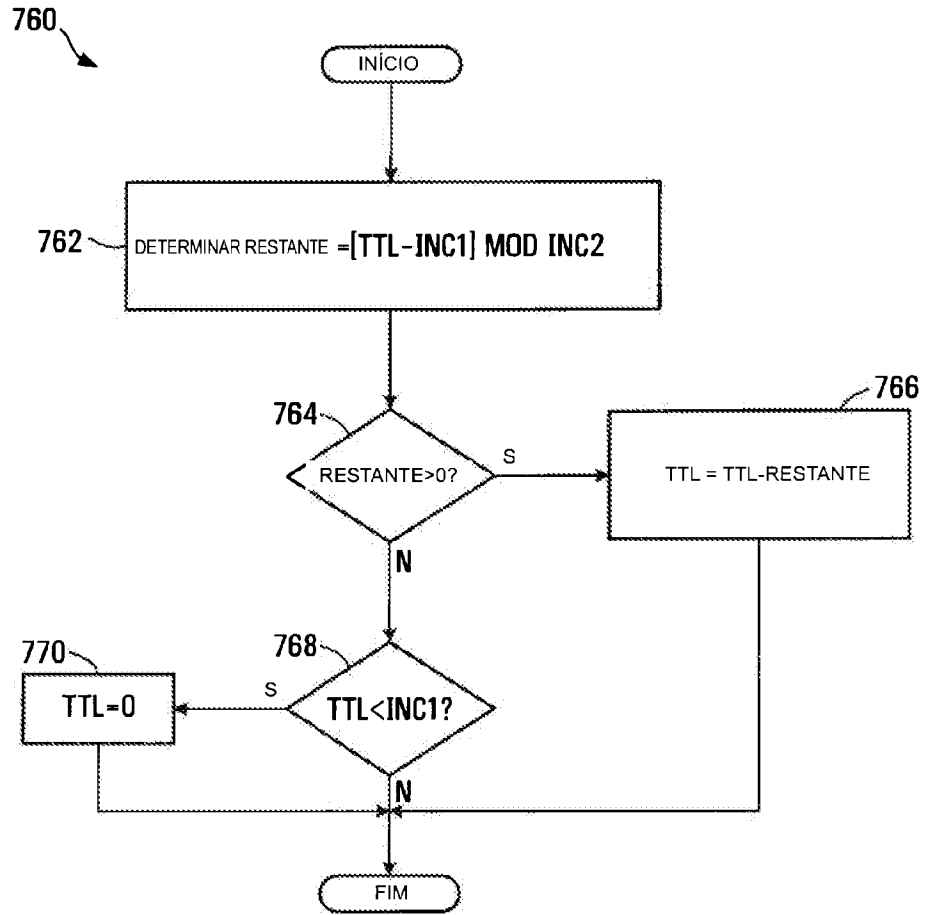

FIG. 40

780

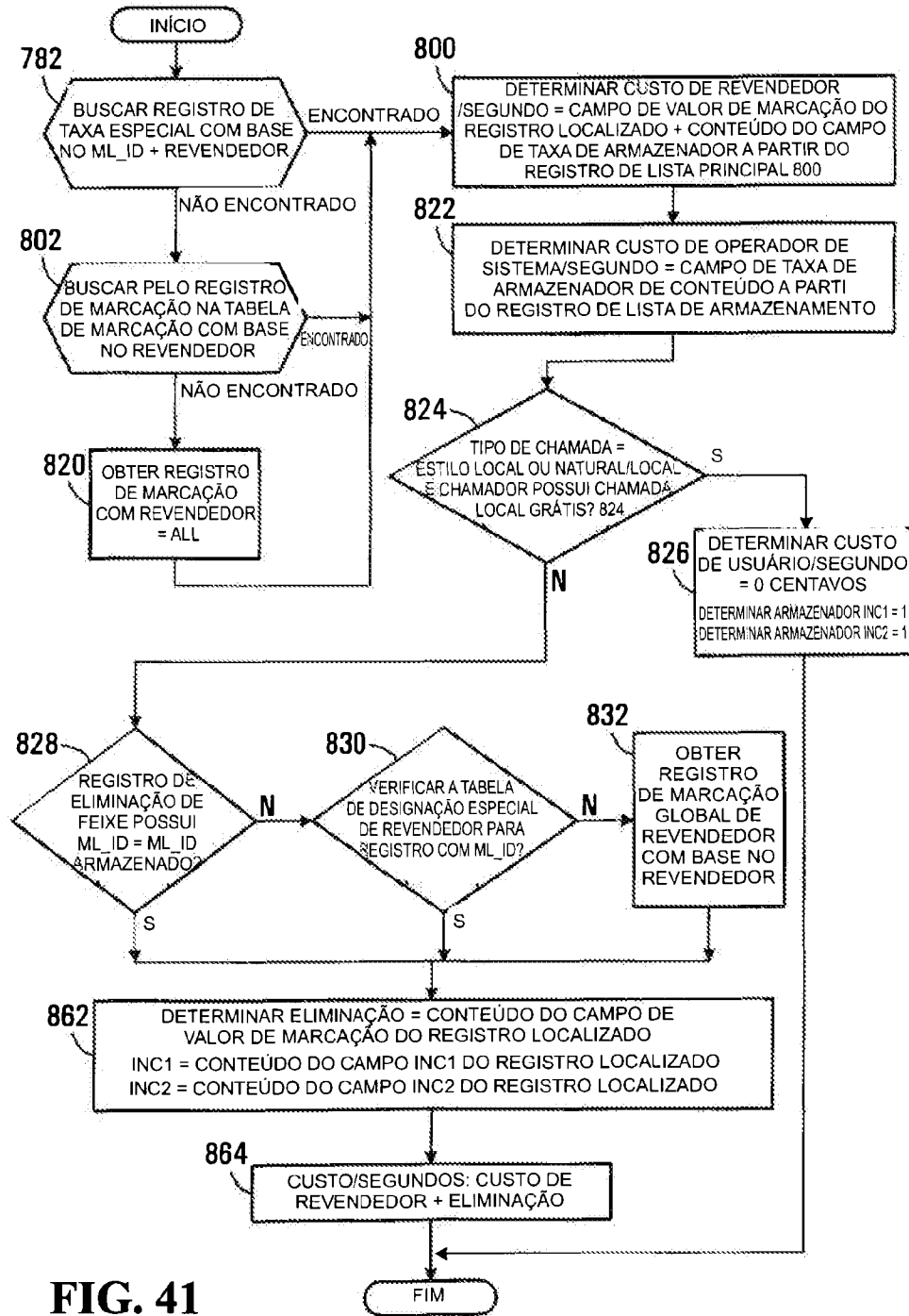

FIG. 41

784

REGISTRO DE TABELA DE TAXAS ESPECIAIS DE OPERADOR DE SISTEMA

786 ~ REVENDEDOR: ID DE REVENDEDOR
788 ~ **ML_Id** ID DE LISTA PRINCIPAL
790 ~ TABELA DE MARCAÇÃO: FIXA; PERCENTUAL; CENTAVOS
792 ~ VALOR DE MARCAÇÃO: NÚMERO REAL REPRESENTANDO O VALOR DO TIPO DE MARCAÇÃO
794 ~ INC1: COBRANÇA DO PRIMEIRO NÍVEL DE COBRANÇA (NO. MÍNIMO DE SEGUNDOS)
796 ~ INC2: SEGUNDO NÍVEL DE COBRANÇA

FIG. 42

798

REGISTRO DE TABELA DE TAXAS ESPECIAIS DE OPERADOR DE SISTEMA PARA KLONDIKE

786 ~ REVENDEDOR **Klondike**
788 ~ **ML_Id** **1019**
790 ~ TABELA DE MARCAÇÃO: CENTAVOS
792 ~ VALOR DE MARCAÇÃO **\$0.001**
794 ~ **Inc1** **30**
796 ~ **Inc2** **6**

FIG. 43

REGISTRO DE TABELA DE MARCAÇÃO DE OPERADOR DE SISTEMA

804 ↙

- 806 ~ REVENDEDOR: CÓDIGO DE ID DE REVENDEDOR
- 808 ~ TABELA DE MARCAÇÃO: FIXA, PERCENTUAL; CENTAVOS
- 810 ~ VALOR DE MARCAÇÃO: NÚMERO REAL REPRESENTANDO O VALOR DO TIPO DE MARCAÇÃO
 - 812 ~ INC1: COBRANÇA DO PRIMEIRO NÍVEL DE COBRANÇA (NO. MÍNIMO DE SEGUNDOS)
 - 814 ~ INC2: SEGUNDO NÍVEL DE COBRANÇA

FIG. 44

REGISTRO DE TABELA DE MARCAÇÃO DO OPERADOR DO SISTEMA PARA O REVENDEDOR KLONDIKE

- 806 ~ REVENDEDOR **Klondike**
- 808 ~ TABELA DE MARCAÇÃO: CENTAVOS
- 810 ~ VALOR DE MARCAÇÃO **\$0.01**
 - 812 ~ **Inc1 30**
 - 814 ~ **Inc2 6**

FIG. 45

REGISTRO DE TABELA DE MARCAÇÃO DE OPERADOR DE SISTEMA

- 806 ~ REVENDEDOR: TODOS
- 808 ~ TABELA DE MARCAÇÃO: PERCENTUAL
- 810 ~ VALOR DE MARCAÇÃO: **1.0**
 - 812 ~ **Inc1 30**
 - 814 ~ **Inc2 6**

FIG. 46

REGISTRO DE TABELA DE DESTINOS ESPECIAIS DO REVENDEDOR

834 ~ REVENDEDOR: CÓDIGO ID DE REVENDEDOR
 836 ~ ML_ID: CÓDIGO ID DE LISTA PRINCIPAL
 838 ~ TABELA DE MARCAÇÃO: FIXA; PERCENTUAL; CENTAVOS
 840 ~ VALOR DE MARCAÇÃO: NÚMERO REAL REPRESENTANDO O VALOR DO TIPO DE MARCAÇÃO
 842 ~ INC1: COBRAR PRIMEIRO NÍVEL DE COBRANÇA (NO. MÍNIMO DE SEGUNDOS)
 844 ~ INC2: SEGUNDO NÍVEL DE COBRANÇA

832

FIG. 47

REGISTRO DE TABELA DE DESTINOS ESPECIAIS DE REVENDEDOR PARA REVENDEDOR KLONDIKE

834 ~ REVENDEDOR **Klondike**
 836 ~ ML_id **1019**
 838 ~ TABELA DE MARCAÇÃO: PERCENTUAL
 840 ~ VALOR DE MARCAÇÃO: **5%**
 842 ~ Inc1 **30**
 844 ~ Inc2 **6**

846

FIG. 48

REGISTRO DE TABELA DE MARCAÇÃO GLOBAL DE REVENDEDOR

850 ~ REVENDEDOR: CÓDIGO ID DE REVENDEDOR
 852 ~ TABELA DE MARCAÇÃO: FIXA, PERCENTUAL; CENTAVOS
 854 ~ VALOR DE MARCAÇÃO: NÚMERO REAL REPRESENTANDO O VALOR DO TIPO DE MARCAÇÃO
 856 ~ INC1: COBRAR PRIMEIRO NÍVEL DE COBRANÇA (NO. MÍNIMO DE SEGUNDOS)
 858 ~ INC2: SEGUNDO NÍVEL DE COBRANÇA

848

FIG. 49

REGISTRO DE TABELA DE MARCAÇÃO GLOBAL DE REVENDEDOR PARA O REVENDEDOR KLONDIKE

850 ~ REVENDEDOR **Klondike**
 852 ~ TABELA DE MARCAÇÃO: PERCENTUAL
 854 ~ VALOR DE MARCAÇÃO **10%**
 856 ~ Inc1 **30**
 858 ~ Inc2 **6**

860

FIG. 50

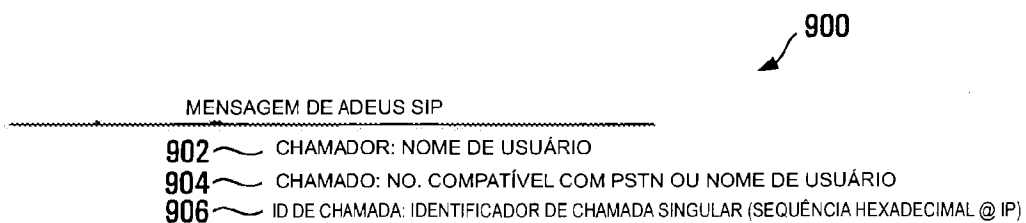

FIG. 51

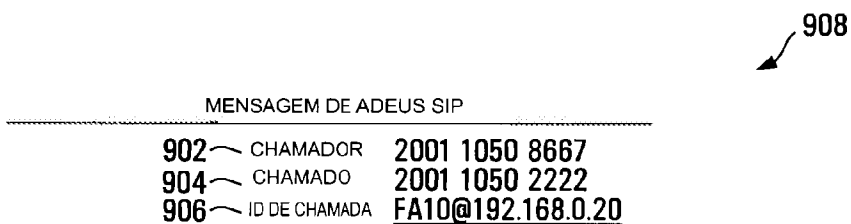

FIG. 52

910

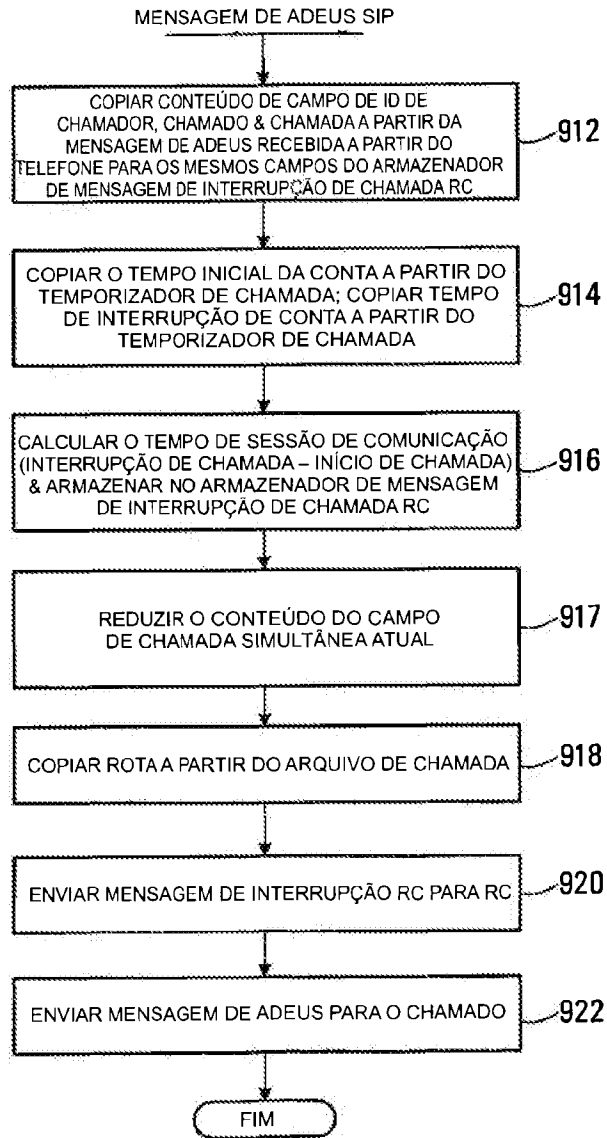

FIG. 53

1000 ↙

MENSAGEM DE INTERRUÇÃO DE CHAMADA RC

1002 — CHAMADOR: NOME DE USUÁRIO
 1004 — CHAMADO: NO. COMPATÍVEL COM PSTN OU NOME DE USUÁRIO
 1006 — ID DE CHAMADA: IDENTIFICADOR DE CHAMADA SINGULAR (SEQUÊNCIA HEXADECIMAL @ IP)
 1008 — TEMPO DE INÍCIO DE CONTA: TEMPO INICIAL DA CHAMADA
 1010 — TEMPO DE INTERRUÇÃO DE CONTA: TEMPO DE CHAMADA ENCERRADA
 1012 — TEMPO DE SESSÃO DE CONTA: TEMPO INICIAL – TEMPO FINAL (EM SEGUNDOS)
 1014 — ROTA: ENDEREÇO IP PARA O LINK DE COMUNICAÇÕES QUE FOI ESTABELECIDO

FIG. 54

1020 ↙

MENSAGEM DE INTERRUÇÃO DE CHAMADA RC PARA O CHAMADO DE CALGARY

1002	— CHAMADOR	2001 1050 8667
1004	— CHAMADO	2001 1050 2222
1006	— ID DE CHAMADA	FA10@192.168.0.20
1008	— TEMPO DE INÍCIO DE CONTA	2006-12-30 12:12:12
1010	— TEMPO DE FINAL DE CONTA	2006-12-30 12:12:14
1012	— TEMPO DE SESSÃO DE CONTA	2
1014	— ROTA	72.64.39.58

FIG. 55

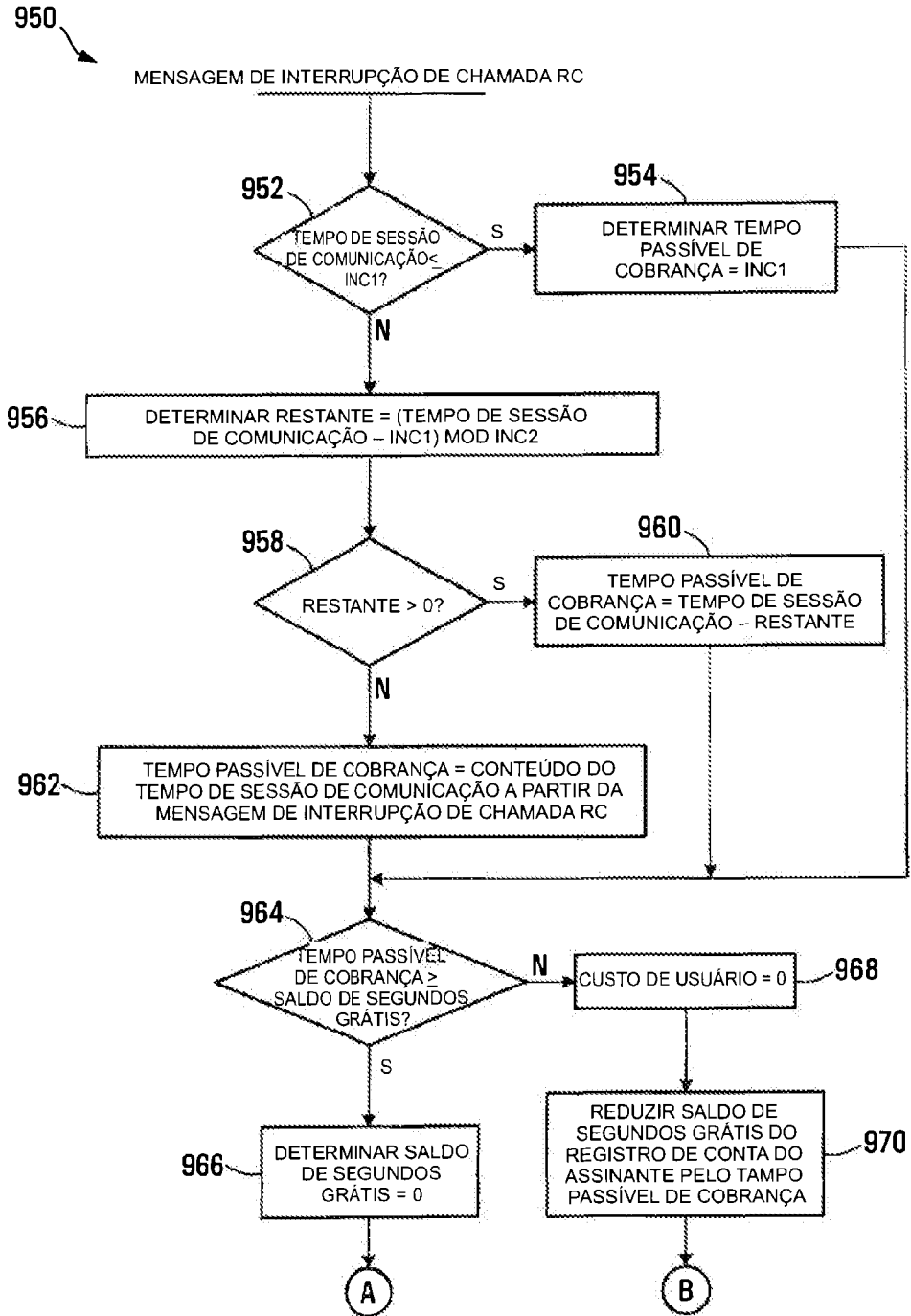

FIG. 56A

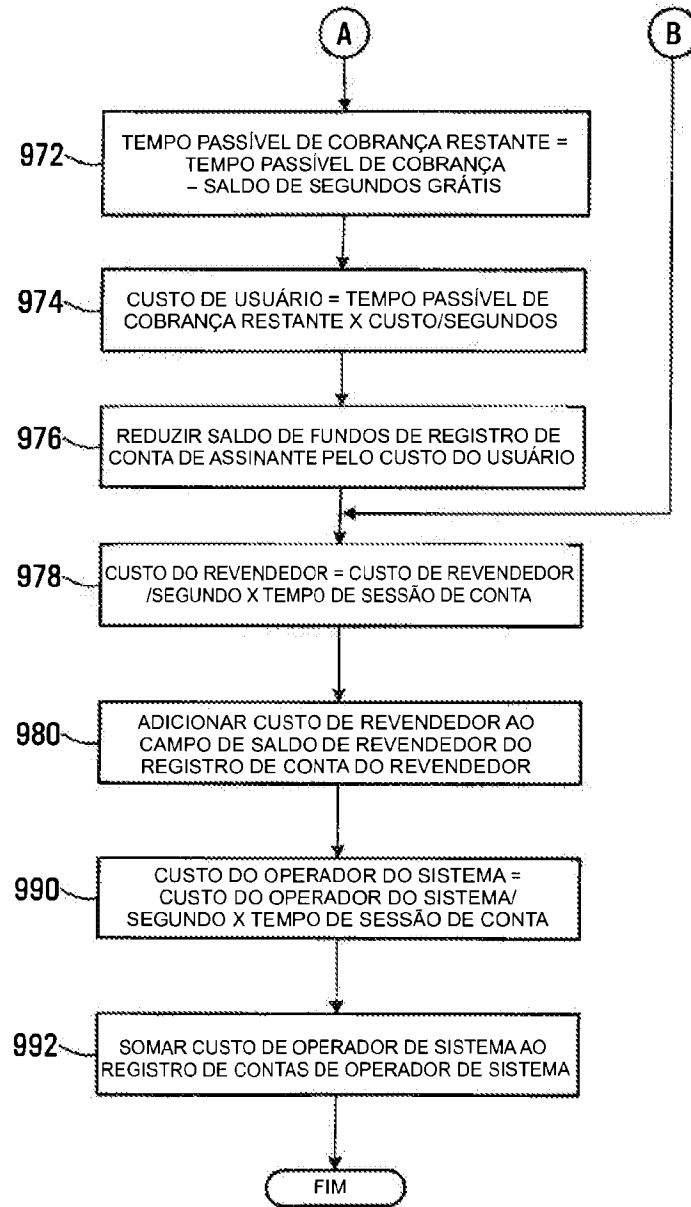

FIG. 56B

982 ↙

REGISTRO DE TABELA DE CONTAS DE REVENDEDOR

984 ~ ID DE REVENDEDOR: CÓDIGO DE ID DE REVENDEDOR
986 ~ SALDO DE REVENDEDOR: SALDO ACUMULADO DE COBRANÇAS

FIG. 57

988 ↙

REGISTRO DE TABELA DE CONTAS DE REVENDEDOR PARA KLONDIKE

984 ~ ID DE REVENDEDOR: **Klondike**
986 ~ SALDO DE REVENDEDOR: **\$100.02**

FIG. 58

994 ↙

REGISTRO DE CONTAS DE OPERADOR DE SISTEMA

996 ~ SALDO DE OPERADOR DE SISTEMA: SALDO ACUMULADO DE COBRANÇAS

FIG. 59

REGISTRO DE CONTAS DE OPERADOR DE SISTEMA PARA ESSE OPERADOR DE SISTEMA

996 ~ SALDO DE OPERADOR DE SISTEMA **\$1000.02**

FIG. 60

RESUMO

Patente de Invenção: **"PRODUÇÃO DE MENSAGENS DE DIRECIONAMENTO PARA COMUNICAÇÕES DE VOZ ATRAVÉS DE IP"**.

A presente invenção refere-se a um processo e aparelho para
5 facilitar a comunicação entre os chamadores e os chamados em um sistema,
que compreende uma pluralidade de nós com os quais os chamadores e os
chamados são associados. Em resposta à iniciação de uma chamada por
parte de um assinante chamador, um identificador do chamador e um identi-
ficador de chamada são recebidos. Os critérios de classificação de chamada
10 associados com o identificador do chamador são utilizados para classificar a
chamada como uma chamada de rede pública ou uma chamada de rede
privada. Uma mensagem de direcionamento identificando um endereço, na
rede privada, associado ao chamado é produzida quando a chamada é clas-
sificada como chamada de rede privada e uma mensagem de direcionamen-
15 to identificando um circuito de acesso à rede pública é produzida quando a
chamada é classificada como uma chamada de rede pública.

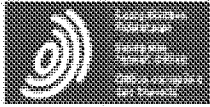

Espacenet

Bibliographic data: BRPI0719682 (A2) — 2014-01-14

INTERCEPTING VOICE OVER IP COMMUNICATIONS AND OTHER DATA COMMUNICATIONS

Inventor(s): BJORSELL JOHAN EMIL VICTOR; SOBOLYEV MAKSYM + (JOHAN EMIL VICTOR BJORSELL, ; MAKSYM SOBOLYEV)

Applicant(s): DIGIFONICA INTERNATIONAL LTD [CA] ± (DIGIFONICA (INTERNATIONAL) LIMITED)

Classification: - **international:** H04L12/26; H04L12/66; H04M11/06; H04M3/22
- **cooperative:** H04L63/00; H04L63/30; H04M3/2281; H04M7/0078; H04M2203/15; H04M2203/2022

Application number: BR2007PI19682 20071129

Priority number(s): US20060861431P 20061129 ; WO2007CA02150 20071129

Also published as: WO2008064481 (A1) US2013229950 (A1) US2010150138 (A1)
US2010150138 (A1) US8422507 (B2) US8422507 (B2)
MX2009005751 (A) KR20090095621 (A) EP2090024 (A1)
EP2090024 (A4) CN101584150 (A) CA2670510 (A1) less

Abstract not available for BRPI0719682 (A2)

Abstract of corresponding document: WO2008064481 (A1)

Methods and apparatus for intercepting communications in an Internet Protocol (IP) network involve maintaining dialing profiles for respective subscribers to the IP network, each dialing profile including a username associated with the corresponding subscriber, and associating intercept information with the dialing profile of a subscriber whose communications are to be monitored. Intercept

information will include determination information for determining whether to intercept a communication involving the subscriber, and destination information identifying a device to which intercepted communications involving the subscriber are to be sent. When the determination information meets intercept criteria communications are established with a media relay through which communications involving the subscriber

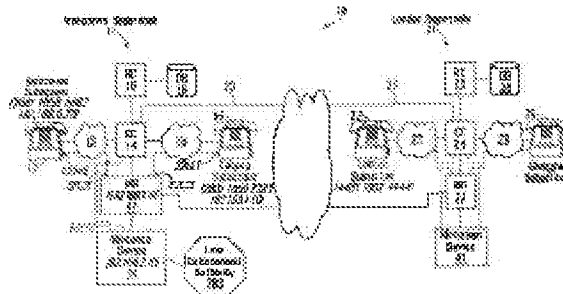

PETITIONER APPLE INC. EX. 1002-947

will be conducted or are being conducted to cause the media relay to send a copy of the communications involving the subscriber to a mediation device specified by the destination information.



República Federativa do Brasil
Ministério do Desenvolvimento, Indústria
e do Comércio Exterior
Instituto Nacional da Propriedade Industrial

(21) PI 0719682-2 A2



(22) Data de Depósito: 29/11/2007
(43) Data da Publicação: 14/01/2014
(RPI 2245)

(51) Int.Cl.:
H04L 12/26
H04L 12/66
H04M 11/06
H04M 3/22

(54) Título: INTERCEPTANDO COMUNICAÇÕES DE VOZ VIA IP E OUTRAS COMUNICAÇÕES DE DADOS

(57) Resumo:

(30) Prioridade Unionista: 29/11/2006 US 60/861,431

(73) Titular(es): Digifonica (International) Limited

(72) Inventor(es): Johan Emil Victor Bjorsell, Maksym Sobolyev

(74) Procurador(es): Dannemann, Siemsen, Bigler & Ipanema Moreira

(86) Pedido Internacional: PCT CA2007002150 de 29/11/2007

(87) Publicação Internacional: WO 2008/064481de 05/06/2008

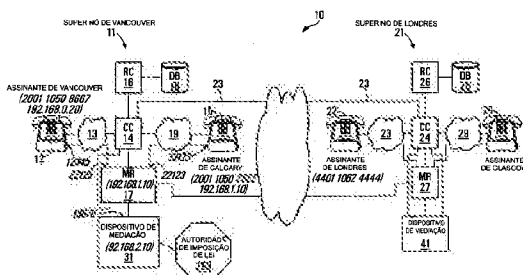

Relatório Descritivo da Patente de Invenção para "INTERCEPTANDO COMUNICAÇÕES DE VOZ VIA IP E OUTRAS COMUNICAÇÕES DE DADOS".

ANTECEDENTES DA INVENÇÃO

5 1. Campo da Invenção

A presente invenção refere-se a comunicações de dados e a métodos e aparelhos para interceptar comunicações de dados, particularmente comunicações de dados de voz via IP, em uma rede IP.

2. Descrição da Técnica Relacionada

10 O termo "interceptação legítima" é utilizado para descrever um procedimento que permite que as agências de imposição de lei executem vigilância eletrônica das telecomunicações. A interceptação legítima de telecomunicações, particularmente, de chamadas de telefone, baseada na premissa de uma noção de que a agência de imposição de lei identificou uma
15 pessoa de interesse, obteve uma autorização legal para a vigilância (por exemplo, um mandato judicial ou administrativo), e então, entrou em contato com o provedor de serviço de telecomunicações da pessoa, o qual será obrigado a proporcionar para a agência de imposição de lei uma cópia em tempo real das comunicações da pessoa. Esta cópia em tempo real pode
20 então ser utilizada pela agência de imposição de lei para monitorar e gravar as comunicações da pessoa. Dentro da estrutura de redes de telecomunicações tradicionais, tal como, por exemplo, a Rede Comutada de Telefonia Pública (PSTN), ou as redes de celular, a interceptação legítima geralmente apresenta um problema puramente econômico para os provedores de serviços, que têm que garantir que equipamento de interceptação suficiente e
25 ligações dedicadas com as agências de imposição de lei tenham sido dispostos para satisfazer as exigências de interceptação legítima obrigadas pela lei. Entretanto, no contexto das comunicações de Voz através do Protocolo Internet (VoIP), em adição aos problemas econômicos mencionados

acima, a interceptação legítima apresenta significativos desafios tecnológicos que frequentemente tornam compatibilidade com as exigências de interceptação legítima obrigadas por lei excessivamente difíceis.

O problema se situa na natureza da tecnologia VoIP e das redes com Protocolo Internet (IP) (por exemplo, a Internet) que são subjacentes à mesma.

As redes de telecomunicações tradicionais são "orientadas por conexão" ou "comutadas por circuito". As comunicações através de tais redes ocorrem via "circuitos" dedicados. Apesar das redes tipicamente compreenderem vários trajetos paralelos disponíveis, quando um circuito é estabelecido, somente um dos trajetos disponíveis é captado. Em situações onde um circuito possui proteção contra falha, um trajeto redundante, também determinado na hora do estabelecimento do circuito, também pode ser reservado. Uma vez que o circuito é estabelecido, todas as comunicações percorrem de ponta a ponta. A interceptação de tais comunicações é fácil à medida que o provedor de serviço possa "grampear" o circuito em qualquer ponto na rede que esteja sob seu controle legítimo.

Em contraste com as redes comutadas por circuito, as redes baseadas em IP são "sem conexões" por projeto. Uma rede IP sem conexões essencialmente compreende vários dispositivos de rede (roteadores) interconectados que estabelecem vários trajetos a partir de qualquer ponto na rede para qualquer outro ponto. A informação que precisa percorrer uma rede IP é dividida em pequenos "pacotes", cada um compreendendo um cabeçalho IP contendo informação de endereçamento de fonte e de destino, e indicadores de serviço; e uma carga útil do usuário. O trajeto específico que cada pacote em uma comunicação entre partes percorre através de uma rede IP não é determinado antecipadamente, tal como em uma rede comutada por circuito. O trajeto é definido em uma base de nó por nó (roteador por roteador), e em cada roteador que o pacote chega, ele examina os endereços de fonte e de destino contidos no cabeçalho IP e aplica uma série de variáveis de serviço, tal como contagem de nó (número de roteadores entre o roteador corrente e o destino), latência e largura de banda de ligações dis-

poníveis, e considerações administrativas, tal como acordos interprovedores, para determinar o próximo nó para o qual o pacote será enviado. Devido às variáveis do serviço se alterarem de forma dinâmica, por exemplo, em resposta a uma falha de uma ligação na rede, os caminhos disponíveis podem alterar de forma significativa e é impossível prever de forma confiável o caminho ou os caminhos que os pacotes que compreendem uma comunicação específica irão percorrer. Adicionalmente, não é mesmo possível prever a ordem na qual os pacotes irão chegar a seu destino, à medida que os diferentes trajetos escolhidos podem ter diferentes latências. Enquanto os vários trajetos disponíveis e as chegadas fora de ordem não apresentam problemas para as aplicações baseadas em IP que normalmente mantêm um rastro da sequência do pacote para novamente montar a comunicação, os mesmos fatores apresentam problemas formidáveis para a interceptação legítima de comunicação via redes IP, particularmente, a interceptação legítima de chamadas VoIP.

O problema da interceptação legítima nos sistemas VoIP é adicionalmente exacerbado pelas tecnologias distribuídas frequentemente utilizadas em tais sistemas. Enquanto um chamador VoIP tipicamente se comunica com um controlador de chamada VoIP para facilitar a conexão com o receptor VoIP, a comunicação real entre as partes tipicamente ocorre pelo estabelecimento de uma conexão IP direta entre as mesmas, utilizando o Protocolo de Datagrama do Usuário (UDP), para encapsular a informação de áudio em pacotes IP. Estes pacotes podem percorrer qualquer trajeto disponível através da rede IP como descrito acima. Mesmo se um provedor de serviço pudesse colocar um dispositivo de interceptação em cada ponto na rede através do qual um pacote do assinante poderia percorrer, de modo a proporcionar uma cópia útil da comunicação para a agência de imposição de lei, o provedor de serviço teria que remontar todos os pacotes interceptados em um único dispositivo e somente então passar o resultado para a agência de imposição de lei. Em essência, o provedor de serviço teria que espelhar as funções do telefone VoIP do receptor, exceto os pacotes que compreendem a comunicação que teriam que ser coletados a partir de vários pontos

na rede. Os desafios tecnológicos e os custos econômicos associados com esta proposição desse modo tem resultado na carência de capacidades significativas de interceptação legítima nos sistemas VoIP.

SUMÁRIO DA INVENÇÃO

5 De acordo com um aspecto da invenção, é proporcionado um método para interceptar comunicações em uma rede de Protocolo Internet (IP). O método envolve manter perfis de discagem para os respectivos assinantes da rede IP, cada perfil de discagem incluindo um nome de usuário associado com o assinante correspondente. O método também envolve associar informação de interceptação com o perfil de discagem de um assinante cujas comunicações são para serem monitoradas, a informação de interceptação incluindo informação de determinação para determinar se intercepta uma comunicação envolvendo o assinante, e informação de destino, identificando um dispositivo para o qual as comunicações interceptadas envolvendo o assinante são para serem enviadas. O método adicionalmente envolve, quando a informação de determinação atende aos critérios de interceptação, se comunicar com uma retransmissão de mídia através da qual as comunicações envolvendo o assinante serão conduzidas ou estão sendo conduzidas para fazer com que o retransmissor de mídia envie uma cópia das comunicações para um dispositivo de mediação especificado pela informação de destino.

Associar a informação de interceptação pode envolver associar a informação de interceptação com o perfil de discagem quando as comunicações envolvendo o assinante não estão em progresso.

25 Associar a informação de interceptação pode envolver associar a informação de interceptação quando comunicações envolvendo o assinante estão em progresso.

Associar a informação de interceptação pode envolver popular campos da informação de interceptação no perfil de discagem do assinante cujas comunicações são para serem monitoradas.

30 O método pode envolver produzir uma mensagem de roteamento para rotear comunicações envolvendo o assinante através dos componen-

tes da rede IP e determinar se a informação de determinação atende aos critérios de interceptação antes de produzir a mensagem de roteamento e incluindo pelo menos alguma parte da informação de interceptação na mensagem de roteamento quando a informação de determinação satisfaz os critérios de interceptação.

Determinar se a informação de determinação satisfaz os critérios de interceptação pode envolver determinar se a data e a hora correntes estão dentro de uma faixa especificada pela informação de determinação.

O método pode envolver identificar uma retransmissão de mídia através da qual as comunicações envolvendo o assinante serão conduzidas em resposta à mensagem de roteamento.

O método pode envolver associar anteriormente pelo menos uma retransmissão de mídia com o perfil de discagem do assinante cujas comunicações são para serem monitoradas e identificar a retransmissão de mídia pode envolver identificar a retransmissão de mídia associada anteriormente com o assinante cujas comunicações são para serem monitoradas.

Associar anteriormente pode envolver preencher campos da retransmissão de mídia no perfil de discagem com uma identificação da pelo menos uma retransmissão de mídia.

A informação de interceptação pode ser associada com o perfil de discagem do assinante cujas comunicações são para serem monitoradas, em resposta à recepção de uma mensagem de requisição de interceptação, e a mensagem de requisição de interceptação pode incluir a informação de interceptação.

O método pode envolver chamar um manipulador de mensagem de requisição de interceptação para encontrar um perfil de discagem associado com o assinante cujas comunicações são para serem monitoradas, e executar a etapa de associar a informação de interceptação com o perfil de discagem, e determinar se os critérios de interceptação são satisfeitos, e identificar uma retransmissão de mídia através da qual as comunicações estão sendo conduzidas.

O método pode envolver manter registros de chamada ativa para

comunicações em andamento, e os registros de chamada ativa podem incluir um identificador do nome do usuário e um identificador da retransmissão de mídia identificando a retransmissão de mídia através da qual as comunicações estão sendo conduzidas e identificar uma retransmissão de mídia através da qual as comunicações estão sendo conduzidas, pode envolver localizar um registro de chamada ativa associado com comunicações do assinante cujas comunicações são para serem monitoradas para encontrar a retransmissão de mídia associada com as comunicações.

O método pode envolver manter registros de discagem direta interna (DID) associando números de telefone PST com os nomes de usuários que assinam a rede IP, e encontrar um perfil de discagem associado com o assinante cujas comunicações são para serem monitoradas, pode envolver encontrar um nome de usuário e um registro de ID carregando o número PSTN associado com o assinante cujas comunicações são para serem monitoradas. O nome do usuário pode ser utilizado para localizar um perfil de discagem associado com o nome do usuário.

De acordo com outro aspecto da invenção, é proporcionado um aparelho para interceptar comunicações em uma rede de Protocolo Internet (IP). O aparelho inclui provisões para manter perfis de discagem para os respectivos assinantes da rede IP, cada perfil de discagem incluindo um nome de usuário associado com o assinante correspondente. O aparelho também inclui provisões para associar a informação de interceptação com o perfil de discagem de um assinante cujas comunicações são para serem monitoradas, a informação de interceptação incluindo informação de determinação para determinar se é para ser feita a interceptação de uma comunicação envolvendo o assinante, e informação de destino identificando um dispositivo para o qual as comunicações interceptadas envolvendo o assinante são para serem enviadas. O aparelho adicionalmente inclui provisões para a comunicação com uma retransmissão de mídia através da qual as comunicações envolvendo o assinante serão conduzidas ou estão sendo conduzidas, para fazer com que a retransmissão de mídia envie uma cópia das comunicações para um dispositivo de mediação especificado pela informação de destino,

quando a informação de determinação atende aos critérios de interceptação.

As provisões para associar a informação de interceptação podem ser de forma operacional configuradas para associar a informação de interceptação com o perfil de discagem quando as comunicações envolvendo o assinante não estão em andamento.

As provisões para associar a informação de interceptação podem ser de forma operacional configuradas para associar a informação de interceptação quando as comunicações envolvendo o assinante estão em andamento.

As provisões para associar a informação de interceptação podem ser de forma operacional configuradas para preencher campos da informação de interceptação no perfil de discagem do assinante cujas comunicações são para serem monitoradas.

O aparelho adicionalmente pode incluir provisões para produzir uma mensagem de roteamento para rotear comunicações envolvendo o assinante através dos componentes da rede IP e provisões para determinar se a informação de determinação atende aos critérios de interceptação antes de produzir a mensagem de roteamento e as provisões para produzir a mensagem de roteamento podem ser configuradas de forma operacional para incluir pelo menos alguma parte da informação de interceptação na mensagem de roteamento, quando a informação de determinação atende aos critérios de interceptação.

As provisões para determinar se a informação de determinação atende aos critérios de interceptação podem ser configuradas de forma operacional para determinar se uma data e hora corrente estão dentro de uma faixa especificada pela informação de determinação.

O aparelho adicionalmente pode incluir provisões para identificar uma retransmissão de mídia através da qual as comunicações envolvendo o assinante serão conduzidas em resposta à mensagem de roteamento.

O aparelho adicionalmente pode incluir provisões para associar anteriormente pelo menos uma retransmissão de mídia com o perfil de discagem do assinante cujas comunicações são para serem monitoradas e as

provisões de roteamento podem ser configuradas de forma operacional para identificar a partir do perfil de discagem a retransmissão de mídia associada anteriormente com o assinante cujas comunicações são para serem monitoradas.

5 As provisões para associar anteriormente podem ser configuradas de forma operacional para preencher campos da retransmissão de mídia no perfil de discagem com uma identificação da pelo menos uma retransmissão de mídia.

10 As provisões para associar a informação de interceptação podem ser configuradas de forma operacional para associar a informação de interceptação associada com o perfil de discagem do assinante cujas comunicações são para serem monitoradas, e resposta à recepção de uma mensagem de requisição de interceptação, onde a mensagem de requisição de interceptação compreende a informação de interceptação.

15 O aparelho adicionalmente pode incluir provisões para manipular uma mensagem de requisição de interceptação. As provisões para manipular uma mensagem de requisição de interceptação podem incluir provisões para encontrar um perfil de discagem associado com o assinante cujas comunicações são para serem monitoradas. As provisões para encontrar um
20 perfil de discagem podem cooperar com as provisões para associar a informação de interceptação com o perfil de discagem para fazer com que a informação de interceptação seja associada com o perfil de discagem. As provisões para manipular uma mensagem de requisição de interceptação podem incluir provisões para determinar se os critérios de interceptação são
25 satisfeitos e provisões para identificar uma retransmissão de mídia através da qual as comunicações estão sendo conduzidas.

30 O aparelho adicionalmente pode incluir provisões para manter registros de chamada ativa para comunicações em andamento, os registros de chamada ativa incluindo um identificador de nome de usuário e um identificador de retransmissão de mídia identificando a retransmissão de mídia através da qual as comunicações estão sendo conduzidas e as provisões para identificar uma retransmissão de mídia através da qual as comunica-

ções estão sendo conduzidas podem ser configuradas de forma operável para localizar um registro de chamada ativa associado com as comunicações do assinante cujas comunicações são para serem monitoradas para encontrar a retransmissão de mídia associada com as comunicações.

5 O aparelho pode adicionalmente incluir provisões para manter registros de discagem direta interna (DID) associando números de telefone PST com os nomes de usuário de usuários assinando a rede IP, e as provisões para encontrar um perfil de discagem associado com o assinante cujas comunicações são para serem monitoradas podem ser de forma operacional
10 configuradas para encontrar um nome de usuário em um registro DID carregando um número PSTN associado com o assinante cujas comunicações são para serem monitoradas e utilizar o nome do usuário para localizar um perfil de discagem associado com o nome do usuário.

Por empregar uma media replay, todas as comunicações VoIP
15 percorrem um ponto no sistema VoIP que está sobre controle de um provedor e no qual as comunicações podem ser copiadas em tempo real para um dispositivo de mediação que passa a comunicação interceptada para uma agência de imposição de lei.

Por manter perfis de discagem para os respectivos assinantes e
20 associar a informação de interceptação do tipo descrito, com os perfis de discagem de assinantes cujas comunicações são para serem monitoradas, o perfil de discagem pode servir como uma fonte de informação de determinação para determinar se as comunicações envolvendo o assinante serão ou não monitoradas e para proporcionar informação de destino para especificar
25 para onde a cópia das comunicações é para ser enviada. O uso do perfil de discagem desta maneira facilmente facilita que um dado assinante e este repositório possam ser endereçados se uma chamada estiver sendo iniciada ou estiver em andamento, desse modo simplificando os algoritmos de controle, porque eles podem cooperar com uma fonte comum e com o formato
30 de dados no perfil de discagem.

Outros aspectos e características da presente invenção irão se tornar aparentes para os versados na técnica quando da inspeção da descri-

ção seguinte de concretizações específicas da invenção em conjunto com as figuras acompanhantes.

BREVE DESCRIÇÃO DOS DESENHOS

Nos desenhos, os quais ilustram concretizações da invenção:

5 A Figura 1 é um diagrama de blocos de um sistema de acordo com uma primeira concretização da invenção;

A Figura 2 é um diagrama de blocos de um telefone VoIP do chamador de acordo com uma primeira concretização da invenção;

10 A Figura 3 é uma representação esquemática de uma mensagem de convite SIP transmitida entre o telefone do chamador e um controlador de chamada (CC) apresentado na Figura 1;

A Figura 4 é um diagrama de blocos do controlador de chamada apresentado na Figura 1;

15 A Figura 5 é um fluxograma de um processo executado pelo controlador de chamada apresentado na Figura 1;

A Figura 6 é uma representação esquemática de uma mensagem de requisição do controlador de roteamento (RC) produzida pelo controlador de chamada apresentado na Figura 1;

20 A Figura 7 é um diagrama de blocos de um circuito do processador do controlador de roteamento (RC) do sistema apresentado na Figura 1;

As Figuras 8A até 8D são fluxogramas de um manipulador de mensagem de Requisição RC executados pelo circuito do processador RC apresentado na Figura 7;

25 A Figura 9 é uma representação tabular de um perfil de descarga armazenado em uma base de dados acessível pelo RC apresentado na Figura 1;

A Figura 10 é uma representação tabular de um perfil de descarga para um assinante de Vancouver;

30 A Figura 11 é uma representação tabular de um perfil de descarga para um assinante de Calgary;

A Figura 12 é uma representação tabular de um perfil de diálogo para um assinante de Londres;

A Figura 13 é uma representação tabular de um registro de tabela de banco de discagem direta interna (DID) armazenado na base de dados apresentada na Figura 1;

5 A Figura 14 é uma representação tabular de um registro de tabela de banco de ID ilustrativo para o assinante de Londres, referenciado na Figura 12;

A Figura 15 é uma representação tabular de uma mensagem de roteamento transmitida a partir do controlador de roteamento para o controlador de chamada apresentado na Figura 1;

10 A Figura 16 é uma representação tabular de uma memória temporária de mensagem de roteamento mantendo uma mensagem de roteamento para rotear uma chamada para o receptor de Londres referenciado na Figura 12;

15 A Figura 16A é uma representação tabular de uma memória temporária de mensagem de roteamento mantendo uma mensagem para rotear uma chamada para o receptor de Londres e para uma agência de imposição de lei para o propósito de interceptação legítima;

20 A Figura 17 é uma representação tabular de um prefixo para o registro de tabela de supernó armazenado na base de dados apresentada na Figura 1;

A Figura 18 é uma representação tabular de um prefixo para o registro de tabela de supernó que seria utilizado para o receptor de Calgary, referenciado na Figura 11;

25 A Figura 19 é uma representação tabular de um registro de lista mestre armazenada em uma tabela de lista mestre na base de dados apresentada na Figura 1;

A Figura 20 é uma representação tabular de um registro de lista mestre preenchido ilustrativo;

30 A Figura 21 é uma representação tabular de um registro de lista de fornecedores armazenado na base de dados apresentada na Figura 1;

A Figura 22 é uma representação tabular de um registro específico da lista de fornecedores para um primeiro fornecedor;

A Figura 23 é uma representação tabular de um registro específico da lista de fornecedores para um segundo fornecedor;

A Figura 24 é uma representação tabular de um registro específico da lista de fornecedores para um terceiro fornecedor;

5 A Figura 25 é uma representação tabular de uma mensagem de roteamento, mantida em uma memória temporária de mensagem de roteamento, identificando para o controlador de roteamento vários fornecedores possíveis que podem transportar a chamada;

10 A Figura 25A é uma representação tabular de uma mensagem de roteamento mantida em uma memória temporária de mensagem de roteamento, com campos de interceptação legítima anexos;

A Figura 26 é uma representação tabular de um registro da tabela de bloco de chamada;

15 A Figura 27 é uma representação tabular de um registro de tabela de bloco de chamada para o receptor de Calgary;

A Figura 28 é uma representação tabular de um registro de tabela de envio de chamada;

A Figura 29 é uma representação tabular de um registro ilustrativo da tabela de envio de chamada específico para o receptor de Calgary;

20 A Figura 30 é uma representação tabular de um registro da tabela de correio de voz especificando parâmetros de correio de voz para permitir ao chamador deixar uma mensagem de correio de voz para o receptor;

A Figura 31 é uma representação tabular de um registro ilustrativo da tabela de correio de voz para o receptor de Calgary;

25 A Figura 32 é uma representação tabular de uma mensagem de roteamento ilustrativa, mantida em uma memória temporária de mensagem de roteamento, indicando números de envio de chamada e um identificador de servidor de correio de voz;

30 A Figura 32A é uma representação tabular de uma mensagem de roteamento ilustrativa, mantida em uma memória de mensagem de roteamento, indicando números de envio de chamada e um identificador de servidor de correio de voz com campos de interceptação legítima do chamador

anexos;

5 A Figura 32B é uma representação tabular de uma mensagem de roteamento ilustrativa, mantida em uma memória de mensagem de roteamento, indicando números de envio de chamada e um identificador de servidor de correio de voz com campos de interceptação legítima do chamador e do receptor, anexos;

A Figura 33 é um fluxograma de um processo do manipulador de mensagem de roteamento executado pelo controlador de chamada;

10 A Figura 34 é uma representação esquemática de mensagens trocadas durante a execução do processo para estabelecer caminhos de áudio entre telefones e uma retransmissão de mídia;

A Figura 35 é uma representação tabular de um registro de chamada ativa mantido pelo controlador de chamada da Figura 1;

15 A Figura 36 é uma representação tabular de um registro de chamada ativa mantido pelo controlador de roteamento da Figura 1;

A Figura 37 é uma representação tabular de uma mensagem de Convite SIP transmitida a partir do controlador de chamada para o dispositivo de mediação;

20 A Figura 38 é uma representação tabular de uma mensagem SIP OK transmitida a partir do dispositivo de mediação para o controlador de chamada;

A Figura 39 é uma representação tabular de uma mensagem SIP Bye transmitida a partir de qualquer um dos telefones apresentados na Figura 1 para o controlador de chamada;

25 A Figura 40 é uma representação tabular de uma mensagem SIP Bye enviada para o controlador de chamada a partir do receptor de Calgary;

30 A Figura 41 é um fluxograma de um processo executado pelo controlador de chamada para produzir uma mensagem de término RC em resposta à recepção de uma mensagem SIP Bye;

A Figura 42 é uma representação tabular de uma mensagem ilustrativa de Término de Chamada RC;

A Figura 43 é uma representação tabular de uma mensagem ilustrativa de Término de Chamada RC para o receptor de Calgary;

A Figura 44 é um fluxograma de um manipulador de mensagem de requisição da Autoridade de Imposição de Lei do controlador de roteamento executado pelo controlador de roteamento apresentado na Figura 1;

A Figura 45 é um fluxograma de um manipulador de mensagem de interceptação dentro da chamada do controlador de chamada executado pelo controlador de chamada apresentado na Figura 1;

A Figura 46 é um fluxograma de uma rotina de término de interceptação dentro da chamada do controlador de roteamento executada pelo controlador de roteamento apresentado na Figura 1;

A Figura 47 é um fluxograma de um roteamento de término do manipulador de mensagem de interceptação do controlador de chamada, executado pelo controlador de chamada apresentado na Figura 1.

15 DESCRIÇÃO DETALHADA

Referindo-se à Figura 1, um sistema para fazer chamadas de telefone de voz via IP é geralmente apresentado como 10. O sistema inclui um primeiro supernó geralmente apresentado como 11 e um segundo supernó geralmente apresentado como 21. O primeiro supernó 11 está localizado em uma área geográfica, tal como Vancouver BC, por exemplo, e o segundo supernó 21 é localizado em Londres, Inglaterra, por exemplo. Diferentes supernós podem estar localizados em diferentes regiões geográficas em todo o mundo para proporcionar serviços de telefone para assinantes nas respectivas regiões. Estes supernós podem estar em comunicação uns com os outros através de ligações de alta velocidade / altas taxas de transmissão efetiva de dados, incluindo fibra ótica, satélite, e / ou ligações por cabo, por exemplo, formando uma estrutura principal de sistema. Estes supernós podem alternativamente ou em adição estar em comunicação uns com os outros através de serviços de Internet convencionais. Na concretização apresentada, a mídia de comunicação de dados para proporcionar as comunicações de dados entre os primeiro e segundo supernós 11 e 21, é apresentada geralmente por 23 e pode incluir ligações de dados de altíssima

velocidade, por exemplo.

Na concretização apresentada, o supernó de Vancouver 11 proporciona serviço de telefone para uma rede geográfica compreendendo os clientes canadenses ocidentais a partir da ilha de Vancouver até Ontário, e inclui um assinante de Vancouver e um assinante de Calgary. Outro supernó (não-apresentado) pode estar localizado no Canadá Oriental, para proporcionar serviços para assinantes nesta área.

Outros supernós menores similares ao tipo apresentado também podem ser empregados dentro da área geográfica servida por um supernó, para proporcionar compartilhamento de carga de chamada, por exemplo, dentro de uma região da área geográfica servida pelo supernó. Entretanto, em geral, todos os supernós são similares e possuem as propriedades descritas abaixo em conexão com o supernó de Vancouver 11.

Nesta concretização, o supernó de Vancouver inclui um controlador de chamada (CC) 14, um controlador de roteamento (RC) 16, uma base de dados 18 uma retransmissão de mídia 17 e um ou mais dispositivos de mediação (MD), somente um dos quais é apresentado em 31. Os assinantes, tal como o assinante de Vancouver e o assinante de Calgary se comunicam com o supernó de Vancouver 11 utilizando seus próprios Provedores de Serviço Internet (ISPs) 13 e 19, que roteiam o tráfego de Internet a partir destes assinantes através da Internet. Para estes assinantes, o supernó de Vancouver 11 é acessível em um endereço IP predeterminado ou em um nome de domínio totalmente qualificado (FQDN), de modo que ele pode ser acessado do modo usual através do ISP de um assinante. O assinante na cidade de Vancouver utiliza um telefone 12 que é capaz de se comunicar com o supernó de Vancouver 1 utilizando mensagens do Protocolo de Início de Sessão (SIP) e o assinante de Calgary utiliza um telefone similar 15, para se comunicar com o supernó de Vancouver a partir de Calgary, AB.

Deve ser observado que através da descrição das concretizações desta invenção, os endereços IP / UDP de todos os elementos, tal como os telefones do chamador e do receptor, o controlador de chamada, a retransmissão de mídia, e quaisquer outros, serão assumidos como sendo

endereços IP / UDP válidos, diretamente acessíveis via a Internet ou uma rede IP privada, por exemplo, dependendo da implementação específica do sistema. Como tal, será assumido, por exemplo, que os telefones do chamador e do receptor irão possuir endereços IP / UDP diretamente acessíveis
5 pelos controladores de chamada e pelas retransmissões de mídia em seus respectivos supernós, e isto não será obscurecido pela Translação de Endereço de Rede (NAT) ou mecanismos similares. Em outras palavras, a informação IP / UDP contida nas mensagens SIP (por exemplo, a mensagem de convite SIP ou a mensagem de requisição RC que serão descritas abaixo)
10 irá corresponder aos endereços IP / UDP dos pacotes IP transportando estas mensagens SIP.

Será apreciado que em várias situações, os endereços IP designados para os vários elementos do sistema podem estar em um espaço de endereço IP privado, e assim, não diretamente acessíveis a partir de outros
15 elementos. Adicionalmente, também será apreciado que a NAT é normalmente utilizada para compartilhar um endereço IP "público" entre múltiplos dispositivos, por exemplo, entre PCs domésticos e telefones IP compartilhando uma única conexão Internet. Por exemplo, pode ser designado para um PC doméstico um endereço IP tal como 192.168.0.101 e para um telefone de voz via IP pode ser designado um endereço IP de 192.168.0.103. Estes endereços estão localizados no assim chamado espaço de endereço
20 "não roteável" e não podem ser acessados diretamente a partir da Internet. De modo que estes dispositivos se comuniquem com outros computadores localizados na Internet, estes endereços IP têm que ser convertidos para um endereço IP "público", por exemplo, 24.10.10.123, designado para o assinante pelo Provedor de Serviço Internet, por um dispositivo executando a NAT, tipicamente um roteador doméstico. Em adição a traduzir os endereços
25 IP, a NAT tipicamente também traduz os números de porta UDP, por exemplo, um caminho de áudio se originando em um telefone IP e utilizando uma porta UDP 12378 em seu endereço IP privado pode ser traduzido para uma porta UDP 23465 associada com o endereço IP público do dispositivo NAT.
30 Em outras palavras, quando um pacote se originando a partir do telefone IP

acima chega em um supernó baseado na Internet, o endereço IP / UDP da fonte contido no cabeçalho do pacote IP será 24.10.10.1:23465, ao passo que a informação de endereço IP / UDP da fonte contida na mensagem SIP dentro deste pacote IP será 192.168.0.103:12378. A não correspondência
5 entre os endereços IP / UDP pode causar um problema para sistemas baseados em SIP porque, por exemplo, um supernó irá tentar enviar mensagens para um endereço privado de um telefone – as mensagens nunca chegarão lá.

Será apreciado que vários métodos estão disponíveis para superar este problema. Por exemplo, um módulo de software de fonte aberta SIP
10 NATHelper pode funcionar no supernó para correlacionar o endereço IP / UDP público contido nos cabeçalhos dos pacotes IP chegando a partir de dispositivos SIP com endereços IP / UDP privados nas mensagens SIP contidas nestes pacotes. Portanto, as concretizações da invenção descritas abaixo irão funcionar, estando ou não os elementos dos sistemas localizados
15 por trás de dispositivos NAT que obscurecem seus endereços IP / UDP reais.

Referindo-se à Figura 1, em uma tentativa de fazer uma chamada pelo telefone de Vancouver 12 para o telefone de Calgary 15, por exemplo, o telefone de Vancouver envia uma mensagem de convite SIP para o
20 supernó de Vancouver 11 e em resposta, o controlador de chamada 14 envia uma mensagem de Requisição RC para o controlador de roteamento 16, o qual faz várias consultas junto à base de dados 18 para produzir uma mensagem de roteamento que é enviada para o controlador de chamada 14.
25 O controlador de chamada 14 então causa que uma ligação de comunicações incluindo caminhos de áudio seja estabelecida através da retransmissão de mídia 17, a qual pode incluir o mesmo supernó de Vancouver 11, um supernó diferente ou um dispositivo de interconexão de rede fornecedor de comunicações, por exemplo, para transportar o tráfego de voz para e a partir
30 do receptor ou receptor da chamada. Sujeito a certas condições serem satisfeitas, como será descrito abaixo, quando a interceptação legítima de dados é para ocorrer, os dados nos caminhos de áudio são copiados para o

dispositivo de mediação 31, o qual pode proporcionar escuta em tempo real dos dados de áudio ou gravação dos mesmos.

Telefone do Assinante

Referindo-se à Figura 2, nesta concretização, cada um dos telefones 12, 15, 22 e 25 inclui um circuito processador apresentado geralmente como 30, compreendendo um microprocessador 32, memória de programa 34, uma interface de entrada / saída (E / S) 36, memória de parâmetro 38 e memória temporária 40. A memória de programa 34, a interface de E / S 36, a memória de parâmetro 38 e a memória temporária 40 estão todas em comunicação com o microprocessador 32. A interface de E / S 36 possui uma entrada de discagem 42 para receber um número de telefone discado a partir de um teclado, por exemplo, ou a partir de uma unidade de reconhecimento de voz ou a partir de números de telefone pré-armazenados, armazenados na memória de parâmetro 38, por exemplo. Por simplicidade, uma caixa rotulada funções de discagem 44 representa qualquer dispositivo capaz de informar para o microprocessador 32 um identificador do receptor, por exemplo, um número de telefone do receptor.

O microprocessador 32 armazena o identificador do receptor em uma memória temporária de número discado 41. No caso do assinante de Vancouver, por exemplo, o número discado pode ser 2001 1050 2222, identificando o assinante de Calgary ou o número discado pode ser um número PSTN por exemplo. A interface de E / S 36 também possui uma interface de aparelho de telefone 46 para receber e produzir sinais a partir e para um aparelho de telefone 45 que um usuário pode colocar no seu ouvido. A interface do aparelho de telefone 46 pode incluir uma interface sem uso de fios BLUETOOTH®, uma interface com o uso de fios ou viva voz, por exemplo. O aparelho de telefone 45 atua como um ponto de terminação para um caminho de áudio (não-apresentado), o qual será apreciado posteriormente.

A interface de E / S 36 também possui uma interface de rede 48 com uma rede IP que pode proporcionar conexão Internet de alta velocidade, por exemplo, e é operável para conectar o telefone com um ISP. A interface de rede 48 também atua como uma parte do caminho de áudio, como

será apreciado posteriormente.

A memória de parâmetro 38 possui um campo de nome do usuário 50, um campo de senha 52, um campo de endereço IP 53 e um campo de endereço de Proxy SIP 54. O campo de nome do usuário 50 é operável para manter um nome do usuário, o qual, para o assinante de Vancouver, é 2001 1050 8667. O nome do usuário é designado quando da assinatura ou registro no sistema e, nesta concretização, inclui um número com doze dígitos, possuindo um código de continente 61, um código de país 63 e um código de concessionária 70 e um código de número único 74. O código de continente 61 é compreendido do primeiro dígito ou dígito mais à esquerda do nome do usuário nesta concretização. O código do país 63 é compreendido dos próximos três dígitos. O código da concessionária 70 é compreendido dos próximos quatro dígitos e o código de número único 74 é compreendido dos últimos quatro dígitos. O campo de senha 52 mantém uma senha com até 512 números caracteres, neste exemplo. O campo de endereço IP 53 armazena um endereço IP e o número de porta UDP do telefone 12, o qual, para esta explicação, é 192.168.0.20:12345. O campo de endereço de Proxy SIP 54 armazena um endereço IP de um Proxy SIP que pode ser proporcionado para o telefone 12 através da interface de rede 48 como parte de um procedimento de registro.

A memória de programa 34 armazena blocos de códigos para direcionar o microprocessador 38 para realizar as funções do telefone, um dos quais inclui um bloco de proteção 56 que proporciona funções de proteção para o telefone, para impedir acesso não autorizado através da conexão de rede ao microprocessador 32 e às memórias 34, 38 e 40. A memória de programa 34 também armazena códigos ID de chamada 57 para estabelecer um ID de chamada. Os códigos de ID de chamada 57 direcionam o microprocessador 32 para produzir identificadores de chamada possuindo o formato de uma cadeia hexadecimal e um endereço IP do telefone armazenado no campo de endereço IP 53. Assim, um identificador de chamada ilustrativo para uma chamada pode ser FF10@192.168.0.20.

Geralmente, em resposta a ativar o aparelho de telefone 45 e

utilizar a função de discagem 44, o microprocessador 32 produz e envia uma mensagem de convite SIP como apresentado na Figura 3, para o controlador de chamada 14 apresentado na Figura 1.

Referindo-se à Figura 3, a mensagem de convite SIP inclui um
5 campo de identificador do chamador 60, um campo de identificador do receptor 62, um campo de parâmetros de resumo 64, um campo de identificador de chamada 65, um campo de endereço IP do chamador 67 e um campo de porta UDP do chamador 69. Nesta concretização, o campo de identificador do chamador 60 inclui o nome do usuário 2001 1050 8667, o qual é o
10 nome do usuário armazenado no campo de nome do usuário 50 da memória de parâmetro 38 no telefone de Vancouver 12 apresentado na Figura 2. Em adição, como um exemplo, se referindo de volta à Figura 3, o campo de identificador do receptor 62 inclui o nome do usuário 2001 1050 2222 que é o número discado do assinante de Calgary armazenado na memória temporária de número discado 41 apresentada na Figura 2. O campo de parâmetros de resumo 64 inclui os parâmetros de resumo e o campo de identificador de chamada 65 inclui um código compreendendo um código de prefixo gerado (FF10) e um sufixo que é o endereço IP do telefone 12 armazenado no campo de endereço IP 53. O campo de endereço IP do chamador 67 mantém o
20 endereço IP designado para o telefone, nesta concretização, 192.168.0.20, e o campo de porta UDP do chamador 69 inclui um identificador de porta UDP identificando uma porta UDP para a qual os dados de áudio são para serem enviados para a recepção pelo telefone do chamador.

Controlador de Chamada

Referindo-se à Figura 4, um circuito do controlador de chamada
25 do controlador de chamada 14 (Figura 1) é apresentado em maiores detalhes em 100. O circuito do controlador de chamada 100 inclui um microprocessador 102, a memória de programa 104, e uma interface de E / S 106. O circuito do controlador de chamada 100 pode incluir vários microprocessadores, várias memórias de programa e várias interfaces de E / S para estar
30 apto a manipular um grande volume de chamadas. Entretanto, por simplicidade, o circuito do controlador de chamada 100 será descrito como possuindo

do somente um microprocessador, a memória de programa e a interface de E / S, sendo entendido que podem existir mais.

5 Geralmente, a interface de E / S 106 inclui uma entrada 108 para receber mensagens, tal como a mensagem de convite SIP apresentada na Figura 3, a partir do telefone apresentado na Figura 2. A interface de E / S 106 também possui uma saída de mensagem de Requisição RC 110 para transmitir uma mensagem de Requisição RC para o controlador de roteamento 16 da Figura 1, uma entrada de mensagem RC 112 para receber mensagens de roteamento a partir do controlador de roteamento 16 (Figura 10 1), uma saída de retransmissão de mídia (MR) 114 para transmitir mensagens para a retransmissão de mídia (Figura 1) para avisar a retransmissão de mídia para estabelecer um caminho de áudio, e uma entrada MR 116 para receber mensagens a partir da retransmissão de mídia para a qual uma mensagem foi enviada para tentar estabelecer o caminho de áudio. A interface de E / S 106 adicionalmente inclui uma saída SIP 118 para transmitir mensagens SIP para o telefone 12 (Figura 1) para avisar ao telefone sobre o endereço IP da retransmissão de mídia 17 (Figura 1) que irá estabelecer o caminho de áudio. A interface de E / S 106 adicionalmente inclui a entrada do dispositivo de mediação 119 e a saída 121 para a comunicação com o 20 dispositivo de mediação 31 (Figura 1).

Enquanto certas entradas e saídas foram apresentadas como separadas, será apreciado que algumas podem ser associadas com um único endereço IP e porta TCP ou UDP. Por exemplo, as mensagens enviadas e recebidas a partir do controlador de roteamento 16 podem ser transmitidas e recebidas no mesmo endereço IP único e porta TCP ou UDP. 25

A memória de programa 104 do circuito do controlador de chamada 100 inclui blocos de código para direcionar o microprocessador 102 para realizar várias funções do controlador de chamada 14. Por exemplo, estes blocos de código incluem um primeiro bloco 120 para causar que o 30 circuito controlador de chamada 100 execute um processo SIP de requisição de convite para RC para produzir uma mensagem de Requisição RC em resposta a uma mensagem de Convite SIP recebida. Em adição, existe um

bloco Manipulador de Mensagem de Roteamento 122 que causa que o circuito controlador de chamada 100 empregue o dispositivo de mediação e / ou execute uma rotina de manipulação de chamada para estabelecer caminhos de áudio através de uma retransmissão de mídia para estabelecer a chamada. A memória de programa 104 adicionalmente inclui um manipulador de mensagem de interceptação dentro da chamada 1450 para interceptar uma chamada em andamento e um manipulador de término de mensagem de interceptação 1520 para paralisar a interceptação de uma chamada em andamento.

10 Referindo-se à Figura 5, o processo SIP de Requisição de Convite para RC é apresentado em maiores detalhes em 120. Ao receber uma mensagem de convite SIP do tipo apresentado na Figura 3, o bloco 132 da Figura 5 direciona o circuito do controlador de chamada da Figura 4 para autenticar o usuário operando o telefone a partir do qual a mensagem de
15 Convite SIP se originou. Isto pode ser feito, por exemplo, por solicitar ao usuário uma senha, por enviar uma mensagem de volta para o telefone 12 que é interpretada no telefone como uma requisição por uma entrada de senha ou a senha pode ser automaticamente enviada para o controlador de chamada 14 a partir do telefone, em resposta à mensagem. O controlador de
20 chamada 14 pode então fazer consultas em bases de dados junto as quais ele tem acesso, para determinar se a senha do usuário corresponde ou não a uma senha armazenada na base de dados. Várias funções podem ser utilizadas para passar chaves de criptografia ou códigos de hash ida e volta, para garantir a transmissão segura de senhas.

25 Caso o processo de autenticação falhe, o circuito do controlador de chamada 100 é direcionado para um bloco de manipulação de erro 134 que causa que mensagens sejam exibidas no telefone 12 para indicar que existiu um erro de autenticação. Se o processo de autenticação tiver sucesso, o bloco 131 direciona o circuito do controlador de chamada 100 para de-
30 terminar se o conteúdo do campo de identificador de chamador 60 da mensagem de Convite SIP é ou não um endereço IP formatado de forma válida. Se ele for um endereço IP válido, então o bloco 133 direciona o circuito do

controlador de chamada 100 para associar um código de tipo com a chamada, para indicar que o tipo da chamada é um convite de terceira parte.

Se no bloco 131, o conteúdo do campo de identificador do chamador 60 não identificar um endereço IP, então, o bloco 135 direciona o circuito do controlador de chamada 100 para associar um código de tipo com a chamada, para indicar que o tipo da chamada é uma mensagem de convite SIP habitual. Então, o bloco 136 direciona o circuito do controlador de chamada 100 para estabelecer um ID de chamada por designar o ID de chamada proporcionado no campo de identificador de chamada 65 da mensagem de Convite SIP a partir do telefone 12, e no bloco 138, o circuito do controlador de chamada é direcionado para produzir uma mensagem de requisição RC do tipo apresentado na Figura 6, que inclui este ID de chamada. Referindo-se novamente à Figura 5, o bloco 139 então direciona o circuito do controlador de chamada 100 para enviar a mensagem de Requisição RC para o controlador de roteamento 16.

Referindo-se à Figura 6, uma mensagem de Requisição RC é apresentada geralmente por 150 e inclui um campo de identificação de chamador 152, um campo de identificador de receptor 154, um campo de resumo 156, um campo de ID da chamada 158 e um campo de tipo 160. Os campos de identificador de chamador, receptor, de resumo e de chamada 152, 154, 156 e 158 contêm cópias dos campos de chamador, receptor, de parâmetros de resumo e de ID de chamada 60, 62, 64 e 65, da mensagem de Convite SIP 59 apresentada na Figura 3. O campo de tipo 160 contém o código de tipo estabelecido no bloco 133 ou no bloco 135 da Figura 5 para indicar se a chamada é a partir de uma terceira parte ou do assinante do sistema, respectivamente. O campo de identificador do receptor 154 pode incluir um número PSTN ou um nome do usuário do assinante do sistema, como apresentado, por exemplo.

Controlador de Roteamento

Referindo-se à Figura 7, o controlador de roteamento 16 é apresentado em maiores detalhes e inclui um circuito do processador do controlador de roteamento geralmente apresentado por 200. O circuito do proces-

sador RC 200 inclui um microprocessador 202, uma memória de programa 204, uma memória de tabela 206 e uma interface de E / S 208, todos em comunicação com o processador. Podem existir vários circuitos do processador (202), memórias (204), etc.

5 A interface de E / S 208 inclui uma porta de saída de base de dados 210 através da qual uma requisição para a base de dados 18 (Figura 1) pode ser feita e inclui uma porta de resposta da base de dados 212 para receber uma resposta a partir da base de dados. A interface de E / S 208 adicionalmente inclui uma entrada de mensagem de Requisição RC 214 para a recepção da mensagem de Requisição RC, a partir do controlador de chamada 14 e inclui uma saída de mensagem de roteamento 216 para enviar uma mensagem de roteamento de volta para o controlador de chamada 14.

15 A memória de programa 204 inclui blocos de códigos para direccionar o circuito do processador RC 200 para realizar várias funções do controlador de roteamento 16. Um destes blocos implementa um processo manipulador de mensagem de Requisição RC 250 que direcciona o RC para produzir uma mensagem de roteamento em resposta a uma mensagem de Requisição RC recebida, do tipo apresentado em 150 na Figura 6. Referindo-se de novo à Figura 7, a memória de programa 204 adicionalmente inclui um manipulador de mensagem de requisição de Autoridade de Imposição de Lei (LEA) 1400 e uma rotina de término de interceptação dentro da chamada 1500.

25 O processo manipulador de mensagem de Requisição RC 250 é apresentado em maiores detalhes nas Figuras 8A até 8D.

Manipulador de Mensagem de Requisição RC

30 Referindo-se à Figura 8A, o processo manipulador de mensagem de Requisição RC 250 começa com um primeiro bloco 252 que direcciona o circuito do processador RC 200 (Figura 7) para armazenar o conteúdo da mensagem de Requisição RC 150 (Figura 6) em memórias temporárias. Então, o bloco 254 direcciona o circuito do processador RC 200 para utilizar o conteúdo do campo de identificador do chamador 152 na mensagem de Re-

quisição RC apresentada na Figura 6, para localizar e recuperar um perfil de discagem para o chamador a partir da base de dados 18.

O controlador de roteamento mantém, na base de dados, um perfil de discagem para cada assinante do sistema. Referindo-se à Figura 9, um perfil de discagem ilustrativo é geralmente apresentado por 256 e inclui campos do sistema incluindo um campo de nome do usuário 258, um campo de domínio 260, um campo de dígitos de discagem nacional (NDD) 262, um campo de IDD (IDD) 264, um campo de código de país 266, um campo de códigos de área local 267, um campo de comprimento local mínimo do chamador 268, um campo de comprimento local máximo do chamador 270 e um campo de revendedor 273.

O perfil de discagem ilustrativo adicionalmente inclui campos relacionados com a interceptação legítima incluindo um campo indicador de interceptação legítima (LI) 702, pelo menos um campo de dispositivo de mediação 704, pelo menos um campo de ID de mandato 706, e os campos de data / hora de início e de parada do período de interceptação 708 e 710. O campo de indicador LI 702, o campo de ID de mandato 706 e os campos de início / parada de LI 708 e 710 podem ser considerados como campos de informação de determinação, para determinar se intercepta uma comunicação envolvendo o assinante e o campo de endereço MD1 704 pode ser considerado como um campo de informação de destino para identificar um dispositivo para o qual as comunicações interceptadas envolvendo o assinante são para serem enviadas.

Para os campos do sistema (258, 260, 262, 264, 266, 267, 268, 270, 273) são designados valores por um operador do sistema ou são designados automaticamente de acordo com algoritmos predefinidos (não-apresentados) quando um usuário se registra com o sistema para se tornar um assinante. Para os campos de interceptação legítima (702, 704, 706, 708, 710) são designados valores em resposta às comunicações com um ou mais dispositivos autorizados e podem ser preenchidos a qualquer tempo, independente de se as comunicações envolvendo o assinante estão ou não em andamento.

Por exemplo, referindo-se de volta à Figura 1, o dispositivo de mediação 31 pode ser considerado como um dispositivo autorizado operado por uma autoridade de imposição de lei 293. Um canal de comunicações entre o controlador de chamada 14 e o dispositivo de mediação 31 pode ser estabelecido para permitir que o dispositivo de mediação se comunique com o controlador de chamada, para causar que o controlador de chamada se comunique com o controlador de roteamento 16, para encontrar um registro do assinante na base de dados 18 que esteja associado com um assinante para o qual um mandato para a interceptação legítima foi obtido. Por exemplo, uma vez que um mandato identificando um usuário e permitindo a interceptação legítima das comunicações do usuário tenha sido recebido pela autoridade de imposição de lei 293, esta autoridade pode utilizar seus próprios computadores para se comunicar com o dispositivo de mediação 31 para causar que o dispositivo de mediação se comunique com o controlador de chamada 14 para causar que o controlador de chamada interaja com o controlador de roteamento 16 para acessar um perfil de discagem (Figura 9) para o usuário especificado no mandato e carregar os campos de interceptação legítima (702, 704, 706, 708, 710) com dados que estabelecem o campo de indicador de interceptação legítima 702 para "ativo", estabelecer um endereço IP do dispositivo de mediação 31 no campo de endereço MD1 704, carregar o campo de ID de mandato 706 com um identificador do mandato e carregar os campos de início e parada 708 e 710 com datas e horas de início e de parada para especificar um período durante o qual a interceptação legítima das comunicações do usuário identificado pode ocorrer de acordo com um mandato. Assim, a informação de interceptação é associada com o perfil de discagem pelo controlador de roteamento, em resposta à informação que ele recebe a partir do controlador de chamada.

Vários grupos de campos de interceptação legítima do tipo apresentado podem ser adicionados, cada grupo sendo adicionado por um dispositivo autorizado diferente, por exemplo, se várias agências de posição de lei diferentes operando os mesmos ou dispositivos de mediação diferentes possuírem mandatos para monitorar as comunicações de um usuário. Alter-

nativamente, o dispositivo autorizado pode incluir uma interface de transferência suave operável para se comunicar com o controlador de chamada ou com o controlador de roteamento para acessar a base de dados para carregar os campos de interceptação legítima associados com um assinante de interesse.

Um perfil de discagem ilustrativo para o assinante de Vancouver é geralmente apresentado por 276 na Figura 10 e indica que o campo de nome do usuário inclui o nome do usuário 2001 1050 8667, o qual é o mesmo que o conteúdo do campo de nome do usuário 50 no telefone de Vancouver 12 apresentado na Figura 2.

Referindo-se de volta à Figura 10, o campo de domínio 260 inclui um nome de domínio como apresentado por 282, incluindo um identificador de tipo de supernó 284, um identificador de código de localização 286, um identificador de provedor do sistema 288 e um identificador de domínio de nível superior 290, identificando um domínio ou supernó associado com o usuário identificado pelo conteúdo do campo de nome do usuário 258.

Nesta concretização, o identificador de tipo de supernó 284 inclui o código "sp" identificando um supernó e o identificador de código de localização 286 identifica o supernó como sendo em Vancouver (YVR). O identificador de provedor do sistema 288 identifica a companhia fornecendo o serviço e o identificador de domínio de nível superior 290 identifica o domínio "com".

O campo de dígito de discagem nacional (NDD) 262 nesta concretização inclui o dígito "1" e, em geral, inclui um dígito especificado pela International Telecommunications Union – Telecommunications Standardization Sector (ITU-T) E.164 Recommendation que designa dígitos de discagem nacional para certos países. Aqui, as sequências de numeração de acordo com este padrão podem ser consideradas como números "E.164".

O campo de Dígito de Discagem Internacional (IDD) 264 inclui o código 011 e em geral inclui um código designado pela ITU-T, de acordo com o país ou com a localização geográfica do usuário.

O campo de código de país 266 inclui o dígito "1" e em geral in-

clui um número designado pela ITU-T para representar o país no qual o usuário está localizado.

O campo de códigos de área local 267 inclui os números 604 e 778, e geralmente inclui uma lista de códigos de área que foram designados pela ITU-T para a área geográfica na qual o assinante está localizado.

Os campos de comprimento mínimo e máximo de número local do chamador 268 e 270 mantêm o número 10 representando os comprimentos mínimo e máximo do número local permitido no código (códigos) de área especificado pelo conteúdo do campo de códigos de área local 267. O campo de revendedor 273 mantêm um código identificando um varejista dos serviços de telefone, e na concretização apresentada, o varejista é "Klondike".

Inicialmente, os campos de interceptação legítima apresentados na Figura 9 podem não estar incluídos no perfil de discagem e podem ser adicionados como descrito acima, pelo dispositivo de mediação 31, no caso de um mandato ser obtido para interceptar as chamadas do usuário. Alternativamente, os campos de interceptação legítima podem ser incluídos, mas preenchidos com valores nulos até que modificados por um dispositivo de mediação 31.

Um perfil de discagem do tipo apresentado em 256 na Figura 9 é produzido sempre que um usuário se registra no sistema ou concorda em se tornar um assinante do sistema. Assim, por exemplo, um usuário desejando assinar o sistema pode entrar em contato com um escritório mantido por um operador do sistema e o pessoal no escritório pode perguntar ao usuário certas questões acerca de sua localização e de preferências de serviço, em consequência do que tabelas podem ser utilizadas para proporcionar ao pessoal do escritório informações apropriadas a serem informadas para os campos de nome do usuário, domínio, NDD, IDD, código de país, códigos de área local e de comprimento mínimo e máximo de código local do chamador 258, 260, 262, 264, 266, 267, 268, 270, para estabelecer um perfil de discagem para o usuário.

Referindo-se às Figuras 11 e 12, os perfis de discagem para assinantes em Calgary e Londres, respectivamente, por exemplo, são apresen-

tados.

Em adição a criar os perfis de discagem, opcionalmente quando um usuário se registra no sistema, um registro de discagem direta interna (DID) do tipo apresentado em 268, na Figura 13, é adicionado para uma ta-
5 bela de discagem direta interna na base de dados 18, para associar o nome do usuário com um nome do hospedeiro do supernó com o qual o usuário está associado e com um número E.164 na rede PSTN.

Nesta concretização, os registros da tabela do banco DID incluem um campo de nome do usuário 281, um campo de domínio do usuário
10 272, e um campo DID 274, para manter o nome do usuário, o nome do hospedeiro do supernó, e um número E.164, respectivamente.

Um registro da tabela do banco DID para o assinante de Londres é geralmente apresentado por 291, na Figura 14.

Em adição a criar os perfis de discagem e os registros DID
15 quando um usuário se registra no sistema, registros de bloqueio de chamada do tipo apresentado na Figura 26, registros de envio de chamada do tipo apresentado na Figura 28 e registros de correio de voz do tipo apresentado na Figura 30, podem ser armazenados na base de dados 18, quando o novo assinante é adicionado para o sistema.

20 Referindo-se de volta a Figura 8A, após ser direcionado no bloco 254 para recuperar um perfil de discagem para o chamador, um perfil de discagem, tal como apresentado em 276 na Figura 10, é recuperado e o circuito do processador RC 200 é direcionado para executar certas verificações em relação ao identificador do receptor proporcionado pelo conteúdo do campo
25 de identificador do receptor 154 da mensagem de Requisição RC apresentada na Figura 6. Estas verificações são apresentadas em maiores detalhes na Figura 8B.

Referindo-se à Figura 8B, o circuito do processador RC 200 é direcionado para um primeiro bloco 257 que causa que o mesmo determine
30 se um padrão de dígito do identificador do receptor 154 proporcionado na mensagem de Requisição RC inclui um padrão que corresponda ao conteúdo do campo IDD 264 no perfil de discagem do chamador 276 apresentado

na Figura 10. Se corresponder, então, o bloco 259 direciona o circuito do processador RC 200 para estabelecer um identificador de código de tipo de chamada (não-apresentado) para indicar que a chamada é uma chamada de longa distância, por exemplo, a partir do assinante de Vancouver para o assinante de Londres, e o bloco 261 direciona o circuito do processador RC 200 para produzir um identificador de receptor reformatado por reformatar o identificador do receptor para um formato alvo predeterminado. Nesta concretização, isto é feito pela remoção do padrão de dígitos correspondendo ao conteúdo do campo IDD 264 do perfil de discagem do chamador 276 para efetivamente encurtar o número. Então, o bloco 263 direciona o circuito do processador RC 200 para determinar se o identificador de receptor reformatado atende ou não aos critérios estabelecendo o mesmo como um número de acordo com a Recomendação E.164 estabelecida pela ITU-T e se o comprimento não atender a estes critérios, o bloco 265 direciona o circuito do processador RC 200 para enviar de volta para o controlador de chamada 14 uma mensagem indicando que o comprimento do identificador de chamada não está correto. Então, o processo 250 é terminado. No controlador de chamada 14, rotinas podem responder à mensagem de comprimento incorreto por transmitir uma mensagem de volta para o telefone 12 para indicar que o número inválido foi discado.

Ainda se referindo à Figura 8B, se o comprimento do identificador de receptor reformatado atender aos critérios expostos no bloco 263, o bloco 269 direciona o circuito do processador RC 200 para determinar se o identificador do receptor reformatado está ou não associado com um registro da tabela de banco de discagem direta interna (DID), tal como apresentado em 268 na Figura 13.

Uma entrada de registro de tabela de banco DID ilustrativa para o receptor de Londres é apresentada geralmente por 291 na Figura 14. O campo de nome do usuário 281 e o campo de domínio do usuário 272 são como especificados nos campos de nome do usuário e de domínio do usuário 258 e 260 do perfil de discagem 276 apresentado na Figura 12. O conteúdo do campo DID 274 inclui um número de telefone E.164 incluindo um có-

digo de país 283, um código de área 285, um código de central telefônica 287 e um número 289. Se o usuário possuir vários números de telefone, então vários registros do tipo apresentado em 291 seriam incluídos na tabela de banco DID na base de dados 18, cada um possuindo o mesmo nome do usuário e domínio do usuário, mas o conteúdo do campo DID 274 diferente, refletindo os números de telefones diferentes associados com este usuário.

Referindo-se de volta à Figura 8B, no bloco 269, se o circuito do processador RC 200 descobrir que o identificador do receptor reformatado produzido no bloco 261 é encontrado em um registro na tabela de banco DID, então, o receptor é um assinante do sistema e o bloco 279 direciona o circuito processador RC 200 para copiar o conteúdo do campo de nome de usuário correspondente 270 para uma memória temporária de ID de receptor (não-apresentada). Assim, o circuito do processador RC 200 localiza um nome do usuário do assinante associado com o identificador do receptor reformatado. O processador é então direcionado para o bloco 275 no ponto B na Figura 8A.

Chamadas de Assinante para Assinante Entre Nós Diferentes

Referindo-se de novo à Figura 8A, o bloco 275 então direciona o circuito do processador RC 200 para determinar se o nome do usuário do assinante está ou não associado com o mesmo supernó que o do chamador. Para fazer isto, o circuito do processador RC 200 determina se o código de continente (61) do nome de usuário armazenado na memória temporária de ID de receptor é ou não o mesmo que o código de continente (61) do nome do usuário do chamador especificado pelo campo de identificador do chamador 152 da mensagem de Requisição RC apresentada na Figura 6. Se eles não forem os mesmos, o bloco 277 direciona o circuito do processador RC 200 para estabelecer um indicador de tipo de chamada (não-apresentado) para indicar que a chamada é uma chamada de domínio entre domínios. Então, o bloco 350 direciona o circuito do processador RC 200 para produzir uma mensagem de roteamento identificando o supernó no sistema com o qual o receptor está associado e para estabelecer um TTL para a chamada com o valor máximo de 99999. O supernó no sistema, com o

qual o receptor está associado, é determinado pela utilização do nome de usuário de receptor armazenado na memória temporária de ID de receptor para endereçar uma tabela do supernó possuindo registros do tipo como apresentado em 270 na Figura 17.

5 Referindo-se à Figura 17, cada prefixo para o registro da tabela de supernó 370 possui um campo de prefixo 372 e um campo de endereço de supernó 374. O campo de prefixo 372 inclui os primeiros n dígitos do identificador de receptor. Neste caso, n = 1. O campo de endereço de supernó 374 mantém um código representando o endereço IP ou um nome de domínio totalmente qualificado do supernó associado com o código armazenado no campo de prefixo 372. Referindo-se à Figura 18, por exemplo, se o
10 prefixo for 4, o endereço de supernó associado com este prefixo é sp.lhr.digifonica.com, identificando o supernó de Londres 21, por exemplo.

 Referindo-se à Figura 15, uma mensagem de roteamento genérica é apresentada geralmente por 352 e inclui um campo de prefixo de fornecedor 354, um campo de delimitador 356, um campo de receptor 358, pelo menos um campo de rota 360, um campo de tempo de vida (TTL) 362 e outros campos 364. O campo de prefixo de fornecedor 354 mantém um código para identificar o tráfego do fornecedor. O campo de delimitador mantém um
15 símbolo que delimita o código de prefixo de fornecedor a partir do campo de receptor 358 e nesta concretização, o símbolo é um sinal de número (#). O campo de rota 360 mantém um nome de domínio ou um endereço IP de um dispositivo de conexão de rede ou do supernó que é para transportar a chamada e o campo TTL 362 mantém um valor representando o número de segundos durante os quais a chamada é permitida de estar ativa, baseado nos
20 minutos disponíveis do assinante e em outros parâmetros de faturamento, por exemplo.

 Referindo-se à Figura 8A e à Figura 16, neste exemplo, a mensagem de roteamento produzida pelo circuito do processador RC 200 no
25 bloco 350, é geralmente apresentada por 366 e inclui somente um campo de receptor 358, um campo de rota 360 e um campo TTL 362.

 O campo de receptor 358 mantém o nome do usuário completo

do receptor e o campo de rota 360, apresentado na Figura 15, contém a identificação do domínio com o qual o receptor está associado, isto é, sp.lhr.digifonica.com.

5 Tendo produzido a mensagem de roteamento 366 como apresentado na Figura 16A, referindo-se de volta à Figura 8A, então, o bloco 351 direciona o circuito do processador RC 200 para verificar o perfil de discagem do chamador (veja a Figura 9) para determinar se o mesmo contém ou não campos de interceptação legítima (702, 704, 706, 708, 710) e se conti-
10 ver, para determinar se a informação de determinação contida nos mesmos atende ou não aos critérios de interceptação. Os critérios de interceptação podem ser que o campo de indicador de interceptação legítima 702 (Figura 9) contenha um indicador indicando que a interceptação legítima está habilitada, e se a data e a hora atuais estão dentro do período especificado pelo conteúdo do campo de data / hora inicial de LI 708 e pelo conteúdo do campo de data / hora de parada de LI 710, por exemplo. Se os critérios de interceptação forem atendidos, o bloco 353 direciona o circuito do processador RC 200 para anexar os conteúdos dos campos de interceptação legítima 702, 704, 706, 708, 710, para a mensagem de roteamento produzida no blo-
15 co 350 para produzir uma mensagem de roteamento como apresentada na Figura 16A. Geralmente, a determinação de se a informação de destino atende ou não aos critérios de interceptação é feita antes da produção da mensagem de roteamento de modo que quando os critérios de interceptação são atendidos, pelo menos alguma parte da informação de interceptação, nesta concretização, toda ela, possa ser incluída na mensagem de rotea-
20 mento.
25

Se, no bloco 351, na Figura 8A, for determinado que não existem campos de interceptação legítima associados com o perfil de discagem no chamador ou que os critérios de interceptação não são atendidos, o processador não anexa quaisquer campos de interceptação legítima para a
30 mensagem de roteamento produzida no bloco 350 na Figura 8A, e a mensagem de roteamento apresentada na Figura 16 é enviada para o controlador de chamada 14, como apresentado no bloco 380. Se os campos de intercep-

tação legítima tiverem sido anexados, o bloco 380 direciona o circuito do processador RC 200 para enviar a mensagem de roteamento apresentada na Figura 16A para o controlador de chamada 14 (Figura 1).

Referindo-se de novo à Figura 8B, se no bloco 257, o identificador do receptor especificado pelo conteúdo do campo de receptor 154 da mensagem de Requisição RC apresentada na Figura 6 não começar com um IDD, o bloco 381 direciona o circuito do processador RC 200 para determinar se o identificador de receptor começa ou não com o mesmo código de dígito de discagem nacional que designado para o chamador. Para fazer isto, o processador é direcionado para se referir ao perfil de discagem do chamador apresentado na Figura 10. Na concretização apresentada, o código de NDD 262 é o dígito 1. Assim, se o identificador do receptor começar com o dígito 1, o circuito do processador RC 200 é direcionado para o bloco 382 na Figura 8B.

O bloco 382 direciona o circuito do processador RC 200 para examinar o identificador do receptor para determinar se os dígitos seguindo ao código de NDD identificam ou não um código de área que é o mesmo que qualquer um dos códigos de área identificados no campo de códigos de área local 267 do perfil de discagem do chamador 276 apresentado na Figura 10. Se não, o bloco 384 direciona o circuito do processador RC 200 para estabelecer uma variável de tipo de chamada (não-apresentada) para um código indicando que a chamada é um código nacional. Se os dígitos identificam um código de área que é o mesmo que um código de área local associado com o chamador, o bloco 386 direciona o circuito do processador RC 200 para estabelecer a variável de tipo de chamada para indicar que o tipo de chamada é uma chamada local, estilo nacional. Após executar os blocos 384 ou 386, o bloco 388 direciona o circuito do processador RC 200 para formatar o número discado por remover o dígito de discagem nacional (NDD) e acrescentando no começo um código de país do chamador identificado pelo campo de código de país 266 do perfil de discagem do chamador apresentado na Figura 10. O circuito do processador RC 200 é então direcionado para o bloco 263 para executar os processos descritos acima começando no bloco

263.

Se no bloco 381, o identificador do receptor não começar com o código NDD, o bloco 390 direciona o circuito do processador RC 200 para determinar se o identificador do receptor começa com os dígitos que identificam o mesmo código de área que o do chamador. Novamente, a referência para isto é o perfil do chamador apresentado na Figura 10, e o circuito do processador RC 200 determina se os primeiros poucos dígitos no identificador do receptor identificam ou não um código de área identificado pelo campo de código de área local 267 do perfil do chamador. Se identificarem, então, o bloco 392 direciona o circuito do processador RC 200 para estabelecer o tipo de chamada para um código indicando que a chamada é uma chamada local e o bloco 394 direciona o circuito do processador RC 200 para acrescentar no começo o código de país do chamador para o identificador do receptor, o código de país do chamador sendo determinado a partir do campo de código de país 266 no perfil do chamador apresentado na Figura 10. O circuito do processador RC 200 é então direcionado para o bloco 263 para processar como descrito acima, começando no bloco 263.

Se no bloco 390, o identificador do receptor não possuir o mesmo código de área que o chamador, o bloco 396 direciona o circuito do processador RC 200 para determinar se o identificador do receptor possui o mesmo número de dígitos que o número de dígitos indicado no campo de comprimento mínimo de número local do chamador 268 ou no campo de comprimento máximo de número local do chamador 270 do perfil do chamador apresentado na Figura 10. Se possuir, então, o bloco 398 direciona o circuito do processador RC 200 para estabelecer o tipo de chamada para local e o bloco 400 direciona o processador para colocar no início do identificador do receptor o código de país do chamador, como indicado pelo campo de código de país 266 do perfil do chamador apresentado na Figura 10 seguido pelo código de área do chamador, como indicado pelo campo de código de área local 267 do perfil do chamador apresentado na Figura 10. O circuito do processador RC 200 é então direcionado para o bloco 263 para processamento adicional, como descrito acima, começando no bloco 263.

Se no bloco 396, o identificador do receptor possuir um comprimento que não corresponde ao comprimento especificado pelos conteúdos do campo de comprimento mínimo de número local do chamador 268 ou pelo campo de comprimento máximo de número local do chamador 270, o bloco 402 direciona o circuito do processador RC para determinar se o identificador do receptor identifica ou não um nome de usuário válido. Para fazer isto, o circuito do processador RC 200 pesquisa através de uma base de dados de perfis de discagem, para encontrar um perfil de discagem possuindo o conteúdo do campo de nome de usuário 258 que corresponda ao identificador de receptor. Se nenhuma correspondência for encontrada, o bloco 404 direciona o circuito do processador RC 200 para enviar uma mensagem de erro de volta para o controlador de chamada (14). Se no bloco 402, um perfil de discagem possuindo um campo de nome de usuário 258 que corresponda ao identificador de receptor for encontrado, o bloco 406 direciona o circuito do processador RC 200 para estabelecer o tipo de chamada para um código indicando que a chamada é uma chamada de rede e o processador é direcionado para o bloco 275 da Figura 8A, para continuar o processamento do processo manipulador de mensagem RC 250.

A partir da Figura 8B, será apreciado que existem certos grupos de blocos de códigos que direcionam o circuito do processador RC 200 para determinar se o identificador do receptor possui certos aspectos, tal como um código de IDD, um código de NDD, um código de área e um comprimento que atenda a certos critérios, e para reformatar o identificador do receptor à medida que necessário para um formato alvo predeterminado, incluindo somente um código de país, o código de área, e um número de telefone normal, por exemplo, para causar que o identificador do receptor seja compatível com o padrão do plano de números E.164, nesta concretização. Isto permite que o circuito do processador RC 200 direcionado pelo bloco 279 possua um formato consistente de identificadores de receptor para uso em pesquisar através dos registros da tabela de banco DID do tipo apresentado na Figura 13 para determinar como rotear as chamadas para o assinante para as chamadas de assinante no mesmo sistema.

Chamadas de Assinante para Não Assinante

Nem todas as chamadas serão chamadas de assinante para assinante, e isto será detectado pelo circuito do processador RC 200 quando ele executa o bloco 269 da Figura 8B, e não encontra um registro que esteja associado com o receptor na tabela de banco DID. Quando isto ocorre, o
5 circuito do processador RC 200 é direcionado para o bloco 408, o qual causa que o mesmo estabeleça o identificador do receptor igual ao identificador do receptor reformatado, isto é, o número compatível com o padrão E.164. Então, o bloco 410 direciona o circuito do processador RC 200 para endereçar
10 uma lista mestra possuindo registros do tipo apresentado na Figura 19.

Cada registro da lista mestra inclui um campo de ID da lista mestra 500, um campo de código de discagem 502, um campo de código de país 504, um campo de número de sinal nacional 506, um campo de comprimento mínimo 508, um campo de comprimento máximo 510, um campo NDD
15 512, um campo IDD 514 e um campo de taxa de memória temporária 516.

O campo de ID de lista mestra 500 mantém um código único, tal como 1019, por exemplo, identificando uma identificação de rota (ID de rota). O campo de código de discagem 502 mantém um padrão de número predefinido que o circuito do processador RC 200 utiliza no bloco 410 na
20 Figura 8B para encontrar o registro da lista mestra possuindo um código de discagem correspondendo aos primeiros poucos dígitos do identificador de receptor reformatado. O campo de código de país 504 mantém um número representando o código de país associado com o registro e o campo de número de sinal nacional 506 mantém um número representando o código de
25 área associado com o registro (será observado que o código de discagem é uma combinação dos conteúdos do campo de código de país 504 e do campo de número de sinal nacional 506). O campo de comprimento mínimo 508 mantém um número representando o número mínimo de dígitos que pode ser associado com o registro e o campo de comprimento máximo 51 mantém
30 um número representando o número máximo de dígitos em um número com o qual o registro pode ser comparado. O campo NDD 512 mantém um número representando um código de acesso utilizado para fazer uma chamada

dentro do país especificado pelo conteúdo do campo de código de país 504 e o campo de IDD 514 mantém um número representando o prefixo internacional necessário para fazer uma chamada a partir do país indicado pelo código de país.

5 Assim, por exemplo, um registro da lista mestra pode possuir um formato como o apresentado na Figura 20, com os conteúdos de campo ilustrativos como apresentado.

Referindo-se de novo à Figura 8B, utilizar as partes do código de país e do código de área do identificador de receptor reformatado que foi
10 formatado para compatibilidade com o padrão E.164, o bloco 410 direciona o circuito do processador RC 200 para encontrar um registro da lista mestra, tal como o registro apresentado na Figura 20 possuindo um código de discagem que corresponda ao código de país e ao código de área do identificador do receptor. Assim, neste exemplo, o circuito do processador RC 200 encon-
15 traria um registro da lista mestra possuindo um campo de ID com um número 1019. Este número também pode ser referido como um ID de rota. Assim, um número de ID de rota é encontrado no registro da lista mestra associado com um padrão de número predeterminado no identificador do receptor reformatado.

20 Após a execução do bloco 410 na Figura 8B, o processo 250 continua como apresentado na Figura 8D. Referindo-se à Figura 8D, o bloco 412 direciona o circuito do processador RC 200 para utilizar o número de ID de rota para localizar pelo menos um registro de fornecedor identificando um fornecedor operável para fornecer uma ligação de comunicações para esta
25 rota. Para fazer isto, o bloco 412 direciona o circuito do processador RC 200 para pesquisar uma tabela de IDs de fornecedor possuindo registros do tipo apresentado na Figura 21.

Referindo-se à Figura 21, os registros da lista de fornecedores inclui um campo de ID de fornecedor 540, um campo de ID de rota 542, um
30 campo de prefixo opcional 544, um campo de identificador de rota 546, um campo de regulação de NDD / IDD 548 e um campo de taxa 550. O campo de ID de fornecedor 540 mantém um código identificando o nome do forne-

cedor e o campo de ID de rota 542 mantém um código para associar o registro do fornecedor com uma rota, e por consequência, com um registro da lista mestra. O campo de prefixo 544 mantém uma cadeia utilizada para identificar o tráfego do fornecedor, e o campo de identificador de rota 546 mantém um endereço IP de um dispositivo de interconexão de rede operado pelo fornecedor indicado pelo campo de ID de fornecedor 540. O campo de regulação de NDD / IDD 548 mantém um código e o campo de taxa 550 mantém um código indicando o custo por segundo para o operador do sistema utilizar a rota proporcionada pelo dispositivo de interconexão de rede especificado pelo conteúdo do campo de identificador de rota 546. Registros de fornecedor ilustrativos são apresentados nas Figuras 22, 23 e 24, para os fornecedores apresentados na Figura 1 que podem incluir Telus, Shaw e Sprint, respectivamente, por exemplo.

Referindo-se de volta à Figura 8D, no bloco 412, o circuito do processador RC 200 encontra todos os registros de fornecedor que identificam o ID de rota encontrado no bloco 410 da Figura 8B.

Referindo-se de novo à Figura 8D, o bloco 560 direciona o circuito do processador RC 200 para começar a produzir mensagens de roteamento do tipo apresentado na Figura 16. Para fazer isto, o circuito do processador RC 200 carrega uma memória temporária de mensagem de roteamento, como apresentado na Figura 25, com um prefixo de fornecedor do fornecedor menos oneroso onde o fornecedor menos oneroso é determinado a partir dos campos de taxa 550 dos registros associados com os respectivos fornecedores.

Referindo-se às Figuras 22 até 24, na concretização apresentada, o fornecedor "Telus" possui o número mais baixo no campo de taxa 550 e portanto, o prefixo 4973 associado com este fornecedor é carregado na memória temporária de mensagem de roteamento apresentada primeiro na Figura 25. O prefixo 4973 é então delimitado pelo sinal de número e o identificador de receptor reformatado é a seguir carregado na memória temporária de mensagem de roteamento. Então, o conteúdo do campo de identificador de rota 546 do registro associado com o fornecedor Telus é adicionado para

a mensagem após um delimitador com o sinal @ e então, o bloco 564 na Figura 8D, direciona um circuito do processador RC 200 para obter um valor TTL, o qual, nesta concretização, pode ser 3600 segundos, por exemplo. Então, o bloco 566 direciona o circuito do processador RC 200 para carregar este valor TTL na memória temporária de mensagem de roteamento apresentada na Figura 25. Por consequência, a primeira parte da mensagem de roteamento é apresentada geralmente por 570 na Figura 25.

Referindo-se volta à Figura 8D, o bloco 568 direciona o circuito do processador RC 200 de volta para o bloco 560, e causa que o mesmo repita os blocos 560, 562, 564, e 566, para cada fornecedor sucessivo, até que a memória temporária de mensagem de roteamento esteja carregada com a informação pertencendo a cada fornecedor. Assim, a segunda parte da mensagem de roteamento é apresentada por 572 na Figura 25 e esta segunda parte se relaciona com o segundo fornecedor identificado pelo registro apresentado na Figura 23, e referindo-se de novo à Figura 25, a terceira parte da mensagem de roteamento é apresentada em 574 que está associada com um terceiro fornecedor como indicado pelo registro de fornecedor apresentado na Figura 24. Por consequência, referindo-se à Figura 25, a memória temporária de mensagem de roteamento mantém uma mensagem de roteamento identificando vários fornecedores diferentes aptos a proporcionar dispositivos de interconexão de rede para estabelecer uma ligação de comunicação para permitir que o chamador entre em contato com o receptor. Cada um dos fornecedores é identificado, em ordem ascendente, de acordo com as taxas contidas nos campos de taxa 550 dos registros da lista de fornecedores apresentados nas Figuras 22 até 24, nesta concretização. Outros critérios para determinar a ordem na qual os fornecedores são listados na mensagem de roteamento podem incluir prioridades de fornecedor preferidas, que podem ser estabelecidas baseado nos acordos de serviço, por exemplo. Neste caso, campos adicionais podem ser proporcionados nos respectivos registros de fornecedor para manter valores representando prioridades de fornecedor.

Após a memória temporária de mensagem de roteamento ter

sido carregada como apresentado na Figura 25, o bloco 567 direciona o circuito do processador RC 200 para verificar o perfil de discagem do chamador apresentado na Figura 10 para determinar se ele contém ou não campos de interceptação legítima, como apresentados na Figura 9, e se contém, para determinar se os critérios de interceptação são ou não satisfeitos pela verificação de se o campo de indicador de interceptação legítima 702 contém um indicador indicando que a interceptação legítima está habilitada e verificando se a data e a hora correntes estão dentro do período especificado pelos conteúdos do campo de data / hora de início de LI 708 e pelo conteúdo do campo de data / hora de parada de LI 710. Se os critérios de interceptação forem satisfeitos, o bloco 569 direciona o circuito do processador RC 200 para anexar os conteúdos dos campos de interceptação legítima 702, 704, 706, 708, e 710, para a mensagem de roteamento armazenada na memória temporária de mensagem de roteamento, como apresentado na Figura 25A. Novamente, a determinação de se a informação de destino atende ou não aos critérios de interceptação é feita antes da produção da mensagem de roteamento, de modo que quando os critérios de interceptação são satisfeitos, pelo menos alguma parte da informação de interceptação, nesta concretização, toda ela, pode ser incluída na mensagem de roteamento.

Se, no bloco 567, for determinado que não existem campos de interceptação legítima associados com o perfil de discagem do chamador apresentado na Figura 10 ou que os critérios de interceptação não foram satisfeitos, o circuito do processador RC não anexa quaisquer campos de interceptação legítima para a mensagem de roteamento armazenada na memória temporária de mensagem de roteamento apresentada na Figura 25.

Então, o bloco 568 direciona o circuito do processador RC 200 para enviar o conteúdo da memória temporária de mensagem de roteamento, isto é, a mensagem de roteamento apresentada na Figura 25 ou 25A, para o controlador de chamada 14 na Figura 1.

Chamadas de Assinante para Assinante dentro do Mesmo Nó

Referindo-se de novo à Figura 8A, se no bloco 275, o identifica-

5 dor do receptor armazenado na memória temporária de ID de receptor pos-
suir um prefixo que identifica o mesmo supernó que o do associado com o
chamador, o bloco 600 direciona o circuito do processador RC 200 para utili-
zar o identificador do receptor e recuperar um perfil de discagem para o re-
ceptor identificado pelo identificador do receptor. O perfil de discagem é do
10 tipo apresentado na Figura 9, e pode conter dados como apresentados na
Figura 11, por exemplo. O bloco 602 da Figura 8A direciona o circuito do
processador RC 200 para obter as tabelas de bloco de chamada, de envio
de chamada e de correio de voz a partir da base de dados 18 baseado no
15 nome do usuário identificado no perfil do receptor recuperado pelo circuito
do processador RC no bloco 600. As tabelas de bloco de chamada, de envio
de chamada e de correio de voz possuem registros como apresentados nas
Figuras 26, 28 e 30, por exemplo.

15 Referindo-se à Figura 26, os registros de bloco de chamada in-
cluem um campo de nome de usuário 604 e um campo de padrão de bloco
606. O campo de nome de usuário mantém um nome de usuário correspon-
dendo ao nome de usuário no campo de nome de usuário 258 no perfil de
discagem associado com o receptor e o campo de padrão de bloco 606
20 mantém um ou mais número ou nomes de usuário compatíveis com a E.164
identificando números PSTN ou assinantes do sistema a partir dos quais o
assinante identificado pelo conteúdo do campo de nome de usuário 604 não
desejada receber chamadas.

25 Referindo-se de novo à Figura 8A e referindo-se à Figura 27, o
bloco 608 direciona o circuito do processador RC 200 para determinar se o
identificador do chamador corresponde ou não a um padrão de bloco arma-
zenado no campo de padrão de bloco 606 do registro de bloco de chamada
associado com o receptor identificado pelo conteúdo do campo de nome de
usuário 604 na Figura 26. Se o identificador do chamador corresponder a um
30 padrão de bloco armazenado no campo de padrão de bloco 606, o bloco 610
direciona o circuito do processador RC 200 para enviar uma mensagem de
queda de chamada ou de não conclusão para o controlador de chamada
(14) e o processo é terminado. Se o identificador do chamador não corres-

ponder a um padrão de bloco associado com o receptor, o bloco 612 direciona o circuito do processador RC 200 para determinar se o envio de chamada é ou não requerido.

Referindo-se à Figura 28, os registros na tabela de envio de chamada incluem um campo de nome de usuário 614, um campo de número de destino 616, um campo de número de destino 616 e um campo de número de sequência 618. O campo de nome de usuário 614 armazena um código representando um assinante com o qual o registro está associado. O campo de número de destino 616 mantém um nome de usuário ou número representando um número para o qual a chamada corrente deve ser enviada e o campo de número de sequência 618 mantém um número inteiro indicado a ordem na qual o nome do usuário associado com o campo de número de destino correspondente 616 deve ser tentado para envio de chamada. A tabela de envio de chamada pode possuir vários registros para um dado usuário. O circuito do processador RC 200 utiliza o conteúdo do campo de número de sequência 618 para considerar os registros para um dado assinante em ordem. Como será apreciado abaixo, isto permite que os números de envio de chamada sejam tentados em uma sequência ordenada.

Referindo-se de volta à Figura 8A e referindo-se à Figura 28, se no bloco 612 na Figura 8A, o registro de envio de chamada para o receptor identificado pelo identificador de receptor não tiver conteúdo no campo de número de destino 616 e por consequência, não tiver conteúdo no campo de número de sequência 618, não existem entradas de envio de chamada e o circuito do processador RC 200 é direcionado para carregar a memória temporária de mensagem de roteamento apresentada na Figura 32 com o nome de usuário do receptor e com o domínio, como apresentado em 650 na Figura 32. O processador então é direcionado para o bloco 620 na Figura 8C.

Se existir conteúdo no campo de número de destino do registro de envio de chamada como apresentado na Figura 29, o bloco 622 apresentado na Figura 8A direciona o circuito do processador RC 200 para pesquisar a tabela de perfis de discagem para encontrar u, registro de perfil de discagem do tipo apresentado na Figura 9, para o usuário identificado no cam-

po de número de destino 616 no registro da tabela de envio de chamada da Figura 29 e para armazenar o conteúdo do campo de número de destino na memória temporária de mensagem de roteamento apresentada na Figura 32. O circuito do processador RC 200 é então direcionado para carregar o conteúdo do campo de domínio 260 apresentado na Figura 9 associado com o nome de usuário especificado pelo conteúdo do campo de número de destino 616 da Figura 29 na memória temporária de mensagem de roteamento como apresentada em 652 na Figura 32. Este processo é repetido para cada registro de envio de chamada associado com o receptor identificado pelo identificador de receptor para adicionar para a memória temporária de mensagem de roteamento todos os nomes de usuário e domínios de envio de chamada associados com o receptor.

Referindo-se à Figura 8C, no bloco 620, o processador é direcionado para determinar se o usuário identificado pelo identificador de receptor pagou ou não pelo serviço de correio de voz e isto é feito por verificar se um indicador está ou não estabelecido em um registro de correio de voz do tipo apresentado na Figura 30 em uma tabela de correio de voz armazenada na base de dados 18 na Figura 1.

Referindo-se à Figura 30, os registros da tabela de correio de voz incluem um campo de nome de usuário 624, um campo de servidor de correio de voz 626, um campo de segundos para o correio de voz 628 e um campo habilitável 630. O campo de nome de usuário 624 armazena o nome de usuário do assinante que comprou o serviço. O campo de servidor de correio de voz 626 mantém um código identificando um endereço IP ou um nome de domínio totalmente qualificado (FQDN) de um servidor de correio de voz associado com o assinante identificado pelo campo de nome de usuário 624. O campo de segundos para o correio de voz 628 mantém um código identificando o tempo para aguardar antes de ativar o correio de voz e o campo habilitável 630 mantém um código representando se o correio de voz está ou não habilitado para o usuário identificado pelo conteúdo do campo de nome de usuário 624. Portanto, referindo-se de novo à Figura 8C, no bloco 620, o processador de pesquisa por um registro de correio de voz como

apresentado na Figura 31 possuindo o conteúdo do campo de nome de usuário 624 correspondendo ao identificador de receptor e procura o conteúdo do campo habilitado 630 para determinar se o correio de voz está ou não habilitado. Se o correio de voz estiver habilitado, então, o bloco 640 na Figura 8C direciona o processador para armazenar o conteúdo do campo de servidor de correio de voz 626 da Figura 31 e o conteúdo do campo de segundos para o correio de voz 628 da Figura 31 na memória temporária de mensagem de roteamento como apresentada em 654 na Figura 32. Referindo-se de novo à Figura 8C, o bloco 642 então direciona o processador para obter os valores de tempo de vida (TTL) para cada rota especificada pela mensagem de roteamento de acordo com qualquer um dentre vários critérios, tal como, por exemplo, o custo de roteamento e o saldo da conta do usuário. Estes valores TTL são então anexados para as rotas correspondentes já armazenadas na memória temporária de mensagem de roteamento.

O bloco 644 da Figura 8C então direciona o circuito do processador RC 200 para armazenar o endereço IP do supernó corrente na memória temporária de mensagem de roteamento como apresentado em 656 na Figura 32. Uma mensagem de roteamento ilustrativa é apresentada na memória temporária de mensagem de roteamento apresentada na Figura 32.

O bloco 645 da Figura 8C então direciona o processador para verificar o perfil de discagem do chamador apresentado na Figura 10 para determinar se ele contém ou não campo de interceptação legítima do tipo apresentado na Figura 9, e se tiver, para determinar se os critérios de interceptação são ou não atendidos. Nesta concretização, isto inclui determinar se o campo de indicador de interceptação legítima 702 contém um indicador indicando que a interceptação legítima está habilitada e verificar se a data e a hora corrente estão dentro do período especificado pelo conteúdo do campo de data / hora de início de LI 708 e pelo conteúdo do campo de data / hora de término de LI 710. Se os critérios de interceptação forem atendidos, o bloco 647 direciona o circuito do processador RC 200 para anexar os conteúdos dos campos de interceptação legítima 702, 704, 706, 708, 710 para a mensagem de roteamento apresentada na Figura 32A para produzir uma

mensagem de roteamento com conteúdos de campo de interceptação legítima, como apresentado na Figura 32A. Novamente, a determinação de que se a informação de destino satisfaz ou não os critérios de interceptação é feita antes de produzir a mensagem de roteamento, de modo que quando os

5 critérios de interceptação são satisfeitos, pelo menos alguma parte da informação de interceptação, nesta concretização, toda ela, pode ser incluída na mensagem de roteamento.

Referindo-se de novo à Figura 8C, se no bloco 645 for determinado que não existem campos de interceptação legítima associados com o

10 perfil de discagem do chamador da Figura 10 ou que os critérios de interceptação não são atendidos após a produção da mensagem de roteamento apresentada na Figura 32A, o processador é direcionado para o bloco 649 que causa que o processador verifique o perfil de discagem do receptor apresentado na Figura 11 para determinar se seu conteúdo contém ou não

15 campos de interceptação legítima do tipo apresentado na Figura 9 e se tiver, para determinar se os critérios de interceptação são ou não satisfeitos por verificar se a data e a hora corrente estão dentro do período especificado pelo conteúdo do campo de data / hora de início de LI 708 e pelo conteúdo do campo de data / hora de término de LI 710 do perfil de discagem do receptor. Se os critérios de interceptação forem atendidos, o bloco 651 direciona o circuito do processador RC 200 para anexar os conteúdos dos campos de interceptação legítima 702, 704, 706, 708, 710 associados com o perfil de discagem do receptor para a mensagem de roteamento apresentada na Figura 32A para produzir uma mensagem de roteamento. Se, no bloco

20 649 da Figura 8C, for determinado que não existem campos de interceptação legítima associados com o perfil de discagem do receptor ou que os critérios de interceptação não foram atendidos, nenhum campo de interceptação legítima associado com o receptor é anexado para a mensagem de roteamento apresentada na Figura 32 ou 32A. Referindo-se de novo à Figura

25 8C, o bloco 646 então direciona o circuito do processador RC 200 para enviar a mensagem de roteamento para o controlador de chamada 14.

Resposta para a Mensagem de Roteamento

Referindo-se de volta à Figura 1, a mensagem de roteamento, seja do tipo apresentado nas Figuras 16, 16A, 25, 25A, 32, 32A ou 32B, é recebida no controlador de chamada 14. Referindo-se à Figura 33, quando uma mensagem de roteamento é recebida no controlador de chamada, o manipulador de mensagem de roteamento 122 é ativado no controlador de chamada. O manipulador de mensagem de roteamento é apresentado em detalhes na Figura 33.

Referindo-se à Figura 33, o manipulador de mensagem de roteamento começa com um primeiro bloco 1200 que direciona o circuito do processador para determinar se a mensagem de roteamento inclui ou não campos de interceptação legítima. Se não, o processador é direcionado para o bloco 1206 que causa que o mesmo ative a rotina de manipulação de chamada apresentada na Figura 34. Referindo-se à Figura 34, como uma primeira etapa na rotina de manipulação de chamada, uma mensagem 1100 é enviada a partir do controlador de chamada 14 para a retransmissão de mídia 17, a mensagem incluindo o endereço IP do telefone do chamador e a porta UDP como determinados a partir do campo de endereço IP do chamador 67 e do campo de porta UDP do chamador 69 na mensagem de Convite SIP apresentada na Figura 3.

A retransmissão de mídia 17 específica para a qual a mensagem 1100 é enviada pode ser selecionada a partir de um grupo de retransmissões de mídia disponíveis e tais retransmissões de mídia podem estar em qualquer localização geográfica. O propósito da mensagem 1100 é avisar à retransmissão de mídia que é desejado que uma chamada seja configurada para se comunicar com o endereço IP e com o número UDP do telefone do receptor;

Uma retransmissão de mídia selecionada dentre as retransmissões de mídia localizadas em uma localização geográfica que facilita a comunicação em uma qualidade de serviço desejada entre a retransmissão de mídia 17 e o telefone do chamador 12 e o telefone do receptor 15 pode proporcionar melhor serviço. Alternativamente, retransmissões de mídia podem ser pré-designadas ou pré-associadas com usuários pela inclusão e preen-

chimento dos campos de retransmissão de mídia dos perfis de discagem de usuário, tal como apresentado em 1150 na Figura 9, identificando uma ou mais retransmissões de mídia através das quais as chamadas associadas com o usuário associado são para serem direcionadas. Neste caso, as identificações de retransmissões de mídia possíveis obtidas a partir dos campos de retransmissão de mídia 1150 podem ser envidas para o controlador de chamada em campos adicionais na mensagem de roteamento. Estes campos de retransmissão de mídia são apresentados em 1152 nas Figuras 16, 16A, 25, 25A, 32, 32A e 32B. Em essência, a retransmissão de mídia através da qual as comunicações envolvendo as comunicações envolvendo o assinante serão conduzidas é identificada em resposta à mensagem de roteamento.

Referindo-se de volta à Figura 34, neste caso, a mensagem 1100 pode ser enviada em um modo de sondagem para todas as retransmissões de mídia identificadas pelos campos de retransmissão de mídia 1150, até que uma resposta. Alternativamente, a mensagem 1100 pode ser enviada simultaneamente para todas as retransmissões de mídia.

Em resposta, no caso onde a retransmissão de mídia é conhecida ou está envolvida na sondagem como descrito acima, a retransmissão de mídia 17 para a qual a mensagem 1100 é enviada envia uma mensagem de condição da retransmissão de mídia 1102 de volta para o controlador de chamada 14, a mensagem incluindo um endereço IP da retransmissão de mídia e o número de porta UDP na qual a retransmissão de mídia irá estabelecer uma conexão UDP com o telefone do receptor 15. Os dados de áudio para / a partir do telefone 15 serão transmitidos através desta conexão. No caso onde a mensagem 1100 é enviada para várias retransmissões de mídia, a primeira a responder com a mensagem de condição de retransmissão de mídia é a retransmissão de mídia através da qual a chamada será transportada. As mensagens de condição da retransmissão de mídia a partir de retransmissões de mídia restantes podem ser ignoradas.

Após a mensagem de condição da retransmissão de mídia 1102 ser recebida no controlador de chamada, o controlador de chamada 14 envia

um mensagem de Convite SIP 1104 do tipo apresentado na Figura 3 para o telefone do receptor 15, incluindo os conteúdos dos campos de identificador de chamador e de receptor (60 e 62), do campo de identificador de chamada (65), do endereço IP da retransmissão de mídia e do número de porta UDP da retransmissão de mídia designados para a conexão de caminho de áudio com o telefone do receptor 15, para convidar o telefone do receptor para estabelecer uma conexão com a retransmissão de mídia 17.

O propósito da mensagem de Convite SIP 1104 é avisar ao telefone do receptor sobre o chamador e sobre o ID da chamada e sobre o endereço IP e o número de porta UDP da retransmissão de mídia através da qual o telefone do receptor deve enviar e receber dados de áudio.

O telefone do receptor 15 armazena o endereço IP da retransmissão de mídia e o número de porta UDP designado na memória temporária de endereço IP de caminho de áudio 47 apresentada na Figura 2e configura-se para criar um soquete entre o endereço IP / UDP da retransmissão de mídia e o endereço IP do telefone do receptor e um número de porta UDP que o telefone do receptor 15 deseja utilizar como um caminho de áudio para o telefone do chamador. Ao invés de enviado ou recebido diretamente para ou a partir do telefone do chamador, o telefone do receptor 15 irá enviar e receber dados de áudio a partir da retransmissão de mídia. Para indicar isto, o telefone do chamador 15 envia uma mensagem SIP OK 1106 de volta para o controlador de chamada 14, a mensagem incluindo o endereço IP do receptor e o número de porta UDP a partir de seu campo de endereço IP (53 na Figura 3) no qual o telefone do receptor 15 irá estabelecer uma conexão de caminho de áudio com a retransmissões de mídia 17. O propósito desta mensagem SIP OK 1106 é avisar ao controlador de chamada sobre o endereço IP e sobre o número de porta UDP através dos quais a retransmissão de mídia deve enviar e receber dados de áudio para e a partir do telefone do receptor.

O controlador de chamada 14 então envia uma mensagem 1108 para a retransmissão de mídia 17 incluindo o endereço IP e o número de porta UDP que o telefone do receptor 15 irá utilizar para a conexão de cami-

nho de áudio com a retransmissão de mídia. O propósito da mensagem 1108 é avisar à retransmissão de mídia sobre o endereço IP e o número de porta UDP através dos quais ela deve enviar e receber dados de áudio para e a partir do telefone do receptor.

5 A retransmissão de mídia 17 então determina uma porta UDP através da qual ela irá transportar os dados de áudio para e a partir do telefone do receptor 12 e envia uma mensagem 1110 para o controlador de chamada (14), a mensagem incluindo o endereço IP da retransmissão de mídia e o número de porta UDP da retransmissão de mídia que a retrans-
10 missão de mídia irá utilizar para transportar áudio para e a partir do telefone do receptor 12. O propósito desta mensagem 1110 é avisar ao controlador de chamada 14 sobre o endereço IP e número de porta UDP através dos quais é esperado transferir os dados de áudio para e a partir do telefone do receptor.

15 O controlador de chamada 14 então envia uma mensagem SIP OK 1112 para o telefone do chamador 12 para indicar que a chamada pode agora continuar. A mensagem SIP OK inclui os nomes de usuário do chamador e do receptor, o ID de chamada e o endereço IP e o número de porta UDP da retransmissão de mídia 17 designados para a conexão de áudio
20 com o telefone do chamador 12. O propósito desta mensagem SIP OK 1112 é avisar ao telefone do chamador 12 sobre o endereço IP e o número de porta UDP através dos quais ele deve trocar dados de áudio com a retransmissão de mídia 17.

25 Se a mensagem de roteamento for do tipo apresentado na Figura 25, onde existem vários fornecedores disponíveis, a rotina de manipulação de chamada continua como descrito acima, com a exceção de que ao invés de se comunicar com o telefone do receptor diretamente, o controlador de chamada 14 se comunica com um dispositivo de interconexão de rede proporcionado por um fornecedor. Se uma mensagem SIP OK não for rece-
30 bida de volta a partir do primeiro dispositivo de interconexão de rede, o processador é direcionado para enviar a mensagem de Convite SIP 1104 para um dispositivo de interconexão de rede do próximo fornecedor indicado. Por

exemplo, o controlador de chamada 14 envia a mensagem de Convite SIP 1104 para o primeiro fornecedor, neste caso, Telus, para determinar se o Telus está ou não apto a manipular a chamada. Se Telus não enviar de volta uma mensagem SIP OK 1106 dentro de um tempo especificado ou enviar uma mensagem indicando que ele não está apto a manipular a chamada, o controlador de chamada continua a enviar uma mensagem de Convite SIP 1104 para o próximo fornecedor, neste caso Shaw. O processo é repetido até que um dos fornecedores responda com uma mensagem SIP OK 1106 indicando que ele está disponível para transportar a chamada e o processo continua como apresentado em conexão com as mensagens 1108, 1110 e 1112. Por exemplo, o fornecedor "Telus" envia de volta uma mensagem SIP OK e assim proporciona um dispositivo de interconexão de rede para o PSTN no endereço IP 72.64.39.58 como proporcionado pela mensagem de roteamento a partir do conteúdo do campo de identificador de rota 546 do registro de fornecedor correspondente apresentado na Figura 22.

Referindo-se de volta à Figura 1, se o controlador de chamada 14 receber uma mensagem do tipo apresentada na Figura 32, isto é, um tipo que possui um número de envio de chamada e / ou um número de correio de voz, o controlador de chamada tenta estabelecer uma chamada (utilizando a mensagem de Convite SIP 1104) com o telefone do receptor 15 e se nenhuma chamada for estabelecida (isto é, a mensagem 1106 não é recebida) dentro de um tempo predeterminado, o controlador de chamada 14 tenta estabelecer uma chamada com o próximo usuário identificado na mensagem de roteamento de chamada, por enviar uma mensagem de Convite SIP igual a mensagem 1104 para o próximo usuário. Este processo é repetido até que todas as possibilidades de envio de chamada tenham sido esgotadas, caso em que um caminho de áudio é estabelecido com o servidor de correio de voz 19 identificado na mensagem de roteamento. O servidor de correio de voz 19 envia a mensagem SIP OK 1106 em resposta a recepção da mensagem de Convite SIP 1104 e funciona como descrito acima em conexão com o telefone do receptor 15 para permitir uma mensagem de áudio emitida pelo servidor de correio de voz possa ser ouvida pelo chamador para permitir que

o chamador grave uma mensagem de áudio no servidor do correio de voz.

Quando os caminhos de áudio são estabelecidos, um temporizador de chamada (não-apresentado) mantido pelo controlador de chamada registra a data e a hora inicial da chamada e registra o ID da chamada e adiciona um registro de chamada ativa do tipo apresentado na Figura 35 para uma lista de chamadas ativas, mantida pelo controlador de chamada.

Nesta concretização, o registro de chamada ativa do controlador de chamada apresentada na Figura 35 inclui um campo de ID de chamada 1300, um campo de endereço IP do chamador 1302, um campo de porta do chamador 1304, um campo de endereço IP do receptor 1306, um campo de porta do receptor 1312 e um campo de porta do receptor da retransmissão de mídia 1314. O conteúdo do campo de ID da chamada 1300 é estabelecido no bloco 136 na Figura 5. O conteúdo do campo de endereço IP do chamador 1302 é estabelecido a partir dos conteúdos do campo de endereço IP do chamador 67 da mensagem de convite SIP apresentada na Figura 3. O conteúdo do campo de porta do chamador 1304 é estabelecido a partir do campo de porta UDP do chamador 69 da mensagem de convite SIP apresentada na Figura 3. O conteúdo do campo de endereço IP do receptor 1306 e do campo de porta do receptor 1308 são estabelecidos a partir da mensagem SIP OK 1106 apresentada na Figura 34.

O campo de ID de retransmissão de mídia 1310 é preenchido com uma identificação da retransmissão de mídia manipulando a chamada. No exemplo apresentado, a retransmissão de mídia é o número 42. O conteúdo do campo de porta do receptor da retransmissão de mídia é obtido a partir da mensagem 1110 apresentada na Figura 34 e o conteúdo do campo de porta do receptor da retransmissão de mídia 1314 é obtido a partir da mensagem de condição da retransmissão de mídia 1102 apresentada na Figura 34. Cada vez que uma chamada é estabelecida, um registro de chamada ativa do tipo apresentado na Figura 35 é adicionado para um registro de ocorrência de chamada ativa mantido pelo controlador de chamada.

O controlador de roteamento também mantém um registro de ocorrência de chamada ativa contendo registros de chamada ativa, entretan-

to, os registros de chamada ativa mantidos pelo controlador de roteamento são diferentes dos registros de chamada ativa mantidos pelo controlador de chamada. Por exemplo, referindo-se à Figura 36, um registro de chamada ativa mantido pelo controlador de roteamento inclui um campo de ID de chamada 1316, um campo de chamador 1318, um campo de receptor 1320 e um campo de ID de controlador de chamada 1322. A informação para preencher estes campos pode ser recebida em uma mensagem (não-apresentada) transmitida a partir do controlador de chamada para o controlador de roteamento após um registro de chamada ativa ter sido informado para o registro de ocorrência de chamada ativa do controlador de chamada.

A mensagem a partir do controlador de chamada 14 para o controlador de roteamento 16, indicando que uma chamada ativa foi estabelecida, pode incluir o conteúdo do campo de ID de chamada 1300 apresentado na Figura 35 e um número de ID único do controlador de chamada mantido pelo controlador de chamada. O controlador de roteamento 16 corresponde o ID da chamada com os nomes de usuário do chamador e do receptor contidos na mensagem de roteamento de chamada original (Figura 16, 16A, 25, 25A, 32, 32A, 32B) que causou que o controlador de chamada direcionasse a chamada, para preencher os campos de chamador e de receptor 1318 e 1320 apresentados na Figura 36, respectivamente. Será apreciado que vários controladores de chamada podem ser associados com um único controlador de roteamento, caso em que o ID do controlador de chamada permite que o controlador de roteamento de forma única identifique o controlador de chamada associado com o ID da chamada indicado pelo conteúdo do campo de ID de chamada 1316. No exemplo apresentado, o controlador de chamada é o número 61.

Os registros de chamada ativa facilitam a interceptação de uma chamada já em andamento, como será descrito abaixo.

Referindo-se de volta à Figura 33, se no bloco 1200 for determinado que a mensagem de roteamento possui campos de interceptação legítima, o bloco 1202 direciona o circuito do controlador de chamada 100 (Figura 4) para enviar uma mensagem de Convite SIP como apresentada na Figu-

ra 37 para um dispositivo de mediação identificado pelo endereço IP de dispositivo de mediação na mensagem de roteamento como obtido a partir do campo de endereço MD1 704 do perfil de discagem do usuário como apresentado em 256 na Figura 9. Referindo-se à Figura 37, a mensagem de

5 Convite SIP inclui os campos de identificador de chamador e de receptor 1020, 1022, um campo de ID de chamada 1024, um campo de ID de mandato 1026 e outros campos de informação relacionada com interceptação 1028, se desejado. Os conteúdos dos campos de ID do chamador, do receptor e da chamada 1020, 1022 e 1024 são obtidos a partir da mensagem de

10 Convite SIP original apresentada na Figura 6. Os conteúdos dos campos de ID do mandato 1026 e de campos de informação relacionada com a interceptação 1028 são obtidos a partir da mensagem de roteamento que seria do tipo apresentado nas Figuras 16A, 25A, 32A ou 32B.

Referindo-se de novo à Figura 33, o bloco 1204 então direciona

15 o controlador de chamada 14 para receber uma mensagem de resposta, como apresentada na Figura 38, a partir do dispositivo de mediação 31. A mensagem de resposta é uma mensagem SIP OK que inclui os campos de ID do chamador, do receptor e da chamada 1040, 1042, 1044 como descritos acima e adicionalmente inclui um campo de endereço IP do dispositivo

20 de mediação 1046 e um campo de número de porta UDP do chamador do dispositivo de mediação 1048 e um campo de número de porta UDP do receptor 1050 identificando as portas UDP no endereço IP do dispositivo de mediação para as quais a retransmissão de mídia é para enviar cópias de fluxos de dados de áudio recebidos a partir dos telefones do chamador e do

25 receptor, respectivamente. O bloco 1206 então direciona o controlador de chamada para executar a rotina de manipulação de chamada apresentada na Figura 34 com a exceção de que a mensagem 1100 adicionalmente inclui os conteúdos do campo de endereço IP do dispositivo de mediação 1046, do campo de número de porta UDP do chamador do dispositivo de mediação

30 1048 e do campo de número de porta UDP do receptor 1050 da mensagem SIP OK apresentada na Figura 38.

Todas as outras mensagens são as mesmas que descritas aci-

ma em conexão com a rotina de manipulação de chamada como apresentada na Figura 34, mas em resposta a receber a informação adicional na mensagem 1100, a retransmissão de mídia automaticamente configura-se para proporcionar a cópia dos dados de áudio recebidos a partir tanto do telefone do chamador como do telefone do receptor para o endereço IP do dispositivo de mediação e para o número de porta UDP do chamador e para o número de porta UDP do receptor, respectivamente.

Referindo-se de volta à Figura 1, à medida que os dados de áudio originários do telefone do chamador 12 e do telefone do receptor 15 passam através da retransmissão de mídia 17, estes dados são copiados para a porta UDP do dispositivo de mediação para o chamador e para a porta UDP do dispositivo de mediação para o receptor, como indicado pela mensagem de convite SIP 1100. Isto permite que as agências de imposição de lei monitorem as comunicações de áudio entre o chamador e o receptor e / ou gravem tais comunicações no dispositivo de mediação.

Assim, quando a informação de determinação no perfil de discagem atende aos critérios de interceptação, o controlador de chamada comunica-se com a retransmissão de mídia através da qual as comunicações envolvendo o assinante cujas comunicações são para serem monitoradas serão manipuladas para causar que a retransmissão de mídia envie um cópia de tais comunicações para um dispositivo de mediação especificado pela informação de destino incluída na informação de interceptação associada com o perfil de discagem associado com o assinante cujas comunicações são para serem monitoradas.

25 Terminando a Chamada

No caso em que o chamador ou o receptor termina uma chamada, o telefone da parte que termina envia uma mensagem SIP Bye para o controlador de chamada 14. Uma mensagem SIP Bye ilustrativa é apresentada em 900 na Figura 39 e inclui um campo de chamador 902, um campo de receptor 904 e um campo de ID da chamada 906. O campo de chamador 902 mantém o nome de usuário do chamador, o campo de receptor 904 mantém um número ou nome de usuário compatível com a PSTN, e o cam-

po de ID da chamada 906 mantém um campo de identificador único de chamada do tipo apresentado no campo de identificador de chamada 65 da mensagem de Convite SIP apresentada na Figura 3.

Assim, por exemplo, referindo-se à Figura 40, uma mensagem SIP Bye para o receptor de Calgary é apresentada geralmente por 908 e o campo de chamador 902 mantém um nome de usuário identificando o chamador de Vancouver, neste caso, 2001 1050 8667, o campo de receptor 904 mantém um nome de usuário identificando o receptor de Calgary, neste caso 2001 1050 222, e o campo de ID da chamada 906 mantém o código FA10@192.168.0.20, que é o ID da chamada para a chamada.

A mensagem SIP Bye apresentada na Figura 40 é recebida no controlador de chamada 14 e o controlador de chamada executa um processo como apresentado geralmente por 910 na Figura 41. O processo inclui um primeiro bloco 912 que direciona o circuito do controlador de chamada (100) para copiar os conteúdos dos campos de chamador, de receptor e de ID da chamada a partir da mensagem SIP Bye 900 apresentada na Figura 39 recebida a partir da parte que termina para os campos correspondentes de uma memória temporária de mensagem de término RC (não-apresentada). O bloco 914 então direciona o circuito do controlador de chamada 100 para copiar a hora inicial da chamada a partir do temporizador de chamada e para obter um tempo de Término da Chamada a partir do temporizador de chamada. O bloco 916 então direciona o controlador de chamada para calcular um tempo da sessão de comunicação por determinar a diferença no tempo entre a hora inicial da chamada e a hora de Parada da Chamada. Este tempo de sessão de comunicação é então armazenado em um campo correspondente da memória temporária de mensagem de Término de Chamada RC. Então, o bloco 918 direciona o circuito do controlador de chamada 100 para preencher o campo de rota com o endereço IP dão fornecedor do dispositivo de interconexão de rede, se houver. Uma mensagem de Término de Chamada RC produzida como descrito acima é apresentada geralmente por 1000 na Figura 42. Uma mensagem de Término de Chamada RC especificamente associada com a chamada feita para o recep-

tor de Calgary é apresentada geralmente por 1021 na Figura 43.

Referindo-se à Figura 42, a mensagem de término de chamada RC 1000 inclui um campo de chamador 1002, um campo de receptor 1004, um campo de ID da chamada 1006, um campo de registro de hora inicial 1008, um campo de registro de hora de término 1010, um campo de tempo de sessão de comunicação 1012 e um campo de rota 1014. O campo de chamador 1002 mantém um nome de usuário, o campo de receptor 1004 mantém um número compatível com a PSTN ou o número do sistema, o campo de ID da chamada 1006 mantém um identificador único de chamada recebido a partir da mensagem de convite SIP apresentada na Figura 3, o campo de registro de hora inicial 1008 mantém a data e a hora inicial da chamada, o campo de registro de hora de término 1010 mantém a data e a hora que a chamada terminou, o campo de tempo de sessão de comunicação 1012 mantém um valor representando a diferença entre a hora inicial e a hora da término, em segundos, e o campo de rota 1014 mantém o endereço IP para um dispositivo de interconexão de rede, se um dispositivo de interconexão de rede for utilizado para estabelecer a chamada.

Referindo-se à Figura 43, uma mensagem ilustrativa de término de chamada RC para o receptor de Calgary é apresentada geralmente por 1021. Neste exemplo, o campo de chamador 1002 mantém o nome de usuário 2001 1050 8867 identificando o chamador de Vancouver e o campo de receptor 1004 mantém o nome de usuário 2001 1050 222 identificando o receptor de Calgary. O conteúdo do campo de ID da chamada 1006 é FA10@192.168.0.20. O conteúdo do campo de registro de hora inicial 1008 é 2006-12-30 12:12:12 e o conteúdo do campo de registro de hora de término 1010 é 2006-12-30 12:12:14. O conteúdo do campo de tempo de sessão de comunicação 1012 é 2 para indicar a duração de 2 segundos da chamada e o conteúdo do campo rota está em branco mas poderia ser 72.64.39.58 se o dispositivo de interconexão de rede "Telus" fosse utilizado, por exemplo.

Referindo-se de volta à Figura 41, após ter produzido uma mensagem de Término de Chamada RC, o bloco 920 direciona o circuito do con-

trolador de chamada 100 para enviar a mensagem de término RC contida na memória temporária de mensagem de Término de Chamada RC para o controlador de roteamento (16).

5 O RC (16) recebe a mensagem de Término de Chamada e um processo de mensagem de Término de Chamada do controlador de roteamento (não-apresentado) é ativado no controlador de roteamento para lidar com as tarifas e faturamento para a chamada.

10 O bloco 922 direciona o circuito do controlador de chamada 100 para enviar uma mensagem Bye para a parte que não terminou a chamada, isto é, para a parte que não está terminando.

15 O bloco 924 então direciona o circuito do controlador de chamada 100 para enviar uma mensagem SIP Bye do tipo apresentada na Figura 39 para a retransmissão de mídia 17 para causar que a retransmissão de mídia desconecte os soquetes de caminho de áudio associados com o endereço IP / UDP do telefone do chamador e com o endereço IP / UDP do telefone do receptor. Ao desconectar estes soquetes de comunicação, a retransmissão de mídia 17 apaga as associações entre o endereço IP / UDP do telefone do chamador e o endereço IP / UDP do chamador da retransmissão de mídia e entre o endereço IP / UDP do telefone do chamador e o endereço IP / UDP do receptor da retransmissão de mídia.

20 Se a retransmissão de mídia (17) foi configurada para interceptação legítima, o bloco 926 da Figura 1 então direciona o circuito do controlador de chamada 100 para enviar uma mensagem SIP Bye do tipo apresentada na Figura 39 para o dispositivo de mediação 31 para informar para o dispositivo de mediação que a chamada terminou e para desconectar os soquetes de comunicação entre os endereços de porta IP / UDP do chamador e do receptor da retransmissão de mídia e o endereço de porta IP / UDP para o qual os dados de áudio recebidos nos endereços de porá IP / UDP do chamador e do receptor estavam sendo copiados.

30 Será apreciado que na descrição anterior, os componentes descritos cooperam para detectar um requerimento de interceptação na hora que uma chamada é configurada. Na descrição seguinte, é proporcionada

uma explicação para descrever como interceptar uma chamada enquanto a chamada está em andamento.

Interceptando uma Chamada em Andamento

Referindo-se de volta à Figura 1, para interceptar uma chamada enquanto a chamada está em andamento, a autoridade de imposição de lei 5 293 ode ser comunicar com um dispositivo de mediação, ou pode ser comunicar com o controlador de chamada ou pode comunicar-se com o controlador de roteamento ou pode comunicar-se com uma interface de transferência que comunica-se com qualquer um dos componentes anteriores para 10 causar que o controlador de roteamento receba uma mensagem de requisição da interceptação da autoridade de imposição de lei (LEA) incluindo a informação de interceptação, tal como esta que estaria associada com os campos 702 até 710 na Figura 9, por exemplo.

Em resposta à recepção de uma mensagem de requisição de 15 interceptação LEA, o manipulador de mensagem de requisição LEA do controlador de roteamento em 1400 na Figura 44 é ativado.

O manipulador de mensagem de requisição LEA 1400 começa com um primeiro bloco 1402 que direciona o circuito do processador do controlador de roteamento para se comunicar com a base de dados 18 na qual 20 os registros de perfil de discagem do tipo apresentado na Figura 9 são armazenados para encontrar um perfil de discagem associado com o usuário cujas chamadas são para serem monitoradas.

Se o nome de usuário não for conhecido, mas um número DID (isto é, um número PSTN) for conhecido, o controlador de roteamento pode 25 causar uma pesquisa através dos registros da tabela de banco DID do tipo apresentado na Figura 13, por exemplo, para encontrar um nome de usuário associado com um número DID, se o nome de usuário não for conhecido, mas um nome e endereço forem conhecidos, outros registros, tal como registros de faturamento (não-apresentados) associando nomes e endereços com nomes de usuário, podem ser pesquisados para encontrar um nome de 30 usuário associado com um dado nome e / ou endereço de uma pessoa cujas chamadas são para serem interceptadas. Independente da informação dis-

ponível, para facilitar a interceptação de chamada, qualquer modo de encontrar o perfil de discagem único associado com o usuário cujas chamadas são para serem interceptadas é uma primeira etapa para facilitar a interceptação de chamada, nesta concretização.

5 Uma vez que o perfil de discagem seja encontrado, o bloco 1404 direciona o circuito do processador do controlador de chamada para associar a informação de interceptação com o perfil de discagem por anexar e / ou preencher os campos de interceptação legítima do perfil de discagem com tais informações como proporcionadas pela mensagem de requisição de interceptação LEA.
10

 O bloco 1406 então direciona o circuito do processador do controlador de chamada para determinar se os critérios de interceptação são atendidos pela informação de interceptação agora incluída no perfil de discagem. Isto é feito pela determinação de se o indicador LI (702) está ativado, e se a data e a hora corrente estão dentro das faixas de data / hora de início / fim da LI. Se os critérios de interceptação não forem satisfeitos, o processo é terminado. Caso contrário, o processador é direcionado para o bloco 1408.
15

 O bloco 1408 direciona o circuito do processador do controlador de roteamento para utilizar o nome de usuário do perfil de discagem encontrado no bloco 1402 para pesquisar os campos de chamador e de receptor dos registros de chamada ativa do controlador de roteamento apresentados na Figura 36 que possuem conteúdos correspondendo ao nome de usuário associado com o perfil de discagem. Se nenhum registro for encontrado, o usuário não está atualmente envolvido em uma chamada e o processo é terminado. Se o usuário estiver envolvido em uma chamada, o registro de chamada ativa do controlador de roteamento será encontrado. O bloco 1410 então direciona o circuito do processador do controlador de roteamento para encontrar o ID do controlador de chamada e o ID da chamada da chamada associada, a partir do registro de chamada ativa do controlador de roteamento apresentado na Figura 36.
20
25
30

 O bloco 1412 então direciona o circuito do processador do controlador de roteamento para transmitir uma mensagem de interceptação dentro

da chamada para o controlador de chamada identificado pelo conteúdo do campo de ID de controlador de chamada 1422 do registro de chamada ativa do controlador de roteamento. A mensagem de interceptação dentro da chamada inclui o ID da chamada como determinado a partir do registro de chamada ativa do controlador de roteamento e o endereço IP do dispositivo de mediação associado com a autoridade de imposição de lei interessada em interceptar a chamada. O endereço IP do dispositivo de mediação pode ser obtido a partir da mensagem de requisição da autoridade de imposição de lei, ou do perfil de discagem, por exemplo.

10 O bloco 1414 então direciona o circuito do processador do controlador de roteamento para aguardar por um tempo especificado para receber a mensagem de condição de interceptação do controlador de chamada de volta a partir do controlador de chamada indicando se a função de interceptação foi ou não ativada.

15 Referindo-se à Figura 45, ao receber a mensagem de interceptação dentro da chamada no controlador de chamada (14), o controlador de chamada executa um manipulador de mensagem de interceptação dentro da chamada apresentado geralmente por 1450. O manipulador de mensagem de interceptação dentro da chamada 1450 começa com um primeiro bloco 20 1452 que direciona o circuito do processador do controlador de chamada para enviar uma mensagem de Convite SIP para o dispositivo de mediação associado com o endereço IP do dispositivo de mediação, recebido na mensagem de interceptação dentro da chamada.

O bloco 1454 então direciona o circuito do processador do controlador de chamada para receber um endereço IP e os números de porta UDP do receptor e do chamador a partir do dispositivo de mediação, onde este endereço IP e os números de porta UDP são localizações na rede nas quais o dispositivo de mediação irá esperar receber fluxos de dados de áudio a partir da retransmissão de mídia através da qual a chamada é transportada.

30 O bloco 1456 então direciona o circuito do processador do controlador de chamada para identificar uma retransmissão de mídia através da

qual as comunicações a serem monitoradas estão sendo conduzidas por utilizar o nome de usuário do assinante cujas comunicações são para serem monitoradas para localizar um registro de chamada ativa na lista de chamadas ativas do controlador de chamada para localizar um identificador de retransmissão de mídia, tal como o endereço IP da retransmissão de mídia, indicado pelo conteúdo do campo de ID de retransmissão de mídia 1310 do registro de chamada ativa do controlador de chamada, apresentado na Figura 35. O circuito do processador do controlador de chamada é então direcionado para enviar uma mensagem de requisição de interceptação para a retransmissão de mídia (17) que está manipulando a chamada. A mensagem de requisição de interceptação inclui o endereço IP do dispositivo de mediação e os números de porta UDP do chamador e do receptor para identificar para a retransmissão de mídia (17) o endereço IP do dispositivo de mediação e o número (números) de porta UDP nos quais ele espera receber uma cópia do fluxo de dados de áudio a partir do chamador e do receptor, respectivamente.

Em resposta, a retransmissão de mídia estabelece conexões internas entre os endereços IP do chamador e do receptor e as portas UDP e o endereço IP e a porta IP do dispositivo de mediação. Então, a retransmissão de mídia envia uma mensagem de condição da retransmissão de mídia de volta para o controlador de chamada indicando se as conexões internas foram ou não estabelecidas e que a interceptação de chamada foi iniciada.

Como visto no bloco 1458, o circuito do processador do controlador de chamada é direcionado para receber a mensagem de condição da retransmissão de mídia e o bloco 1460 direciona o circuito do processador do controlador de chamada para enviar uma mensagem de condição de interceptação do controlador de chamada de volta para o controlador de roteamento para indicar que a função de interceptação de chamada foi estabelecida. O controlador de roteamento pode comunicar sua condição de volta para a autoridade de imposição de lei que emitiu a mensagem de requisição de autoridade de imposição de lei. Neste meio tempo, as comunicações en-

volvendo o chamador ou o receptor cujas comunicações são para serem monitoradas, as quais percorrem através da retransmissão de mídia, são copiadas e enviadas para o dispositivo de mediação.

Assim, após associar a informação de interceptação com o perfil
5 de discagem do assinante cujas comunicações são para serem monitoradas, quando a informação de determinação incluída na informação de interceptação atende aos critérios de interceptação, o controlador de chamada comunica-se com a retransmissão de mídia através da qual as comunicações do assinante cujas comunicações são para serem monitoradas para causar que
10 tal retransmissão de mídia envie uma cópia de tais comunicações para um dispositivo de mediação especificado pela informação de destino incluída na informação de interceptação.

Quando a chamada é terminada, a chamada é encerrada do mesmo modo que descrito acima.

15 Caso a autoridade de imposição de lei deseje cessar a interceptação da chamada durante a chamada, um mensagem de requisição LEA requisitando que a função de interceptação seja paralisada é enviada para o controlador de roteamento a partir da autoridade de imposição de lei através de qualquer um dos caminhos descritos acima. Isto ativa o manipulador de
20 mensagem de requisição LEA tal como apresentado na Figura 44 que causa que o circuito do processador do controlador de roteamento execute os blocos 1402, 1404. No bloco 1404, o circuito do processador do controlador de roteamento é direcionado para alterar o conteúdo dos campos de interceptação legítima para pelo menos estabelecer o indicador de interceptação legítima (702 na Figura 9) para inativo.
25

Então, no bloco 1406, os critérios de interceptação não são atendidos e o processador é direcionado para o bloco 1416, o qual causa que o circuito do processador do controlador de roteamento determine se uma função de interceptação está ou não em andamento. Isto pode ser determinado, por exemplo, por manter a evidência da recepção da mensagem de
30 confirmação a partir do controlador de chamada, recebida no bloco 1414 do manipulador de mensagem de requisição LEA 1400.

Se uma interceptação não estiver em andamento, o manipulador de mensagem de requisição LEA 1400 é terminado.

Se uma interceptação estiver em andamento, o bloco 1418 direciona o circuito do processador do controlador de roteamento para executar
5 uma rotina de encerramento de interceptação dentro da chamada como apresentada por 1500 na Figura 46. A rotina de encerramento da interceptação dentro da chamada começa com um primeiro bloco 1502 que direciona o circuito do processador do controlador de roteamento para localizar o registro de chamada ativa do controlador de roteamento possuindo os conteúdos de campo de chamador e de receptor iguais ao nome de usuário indicado no perfil de discagem encontrado no bloco 1402 do manipulador de mensagem de requisição LEA 1400 apresentado na Figura 44. Tendo encontrado o registro de chamada ativa, o bloco 1504 direciona o circuito do processador do controlador de roteamento para encontrar, no registro de chamada
10 ativa do controlador de roteamento apresentado na Figura 36, o ID do controlador de chamada (1322) e o ID de chamada (1316) associados com a chamada. O bloco 1506 então direciona o circuito do processador do controlador de roteamento para enviar uma mensagem de encerramento de interceptação (não-apresentada) para o controlador de chamada identificado pelo ID de controlador de chamada determinado no bloco 1504. Esta mensagem
15 de encerramento de interceptação inclui o ID de chamada determinado no bloco 1504 e uma identificação do dispositivo de mediação, a identificação sendo obtida a partir do campo de endereço MD1 (704 na Figura 9) do perfil de discagem para o usuário cujas chamadas estão atualmente sendo interceptadas. O bloco 1508 então direciona o circuito do processador do controlador de roteamento para aguardar por um tempo especificado para receber uma mensagem de confirmação a partir do controlador de chamada para
20 indicar que a função de interceptação foi encerrada.

Referindo-se à Figura 47, ao receber a mensagem de encerramento de interceptação no controlador de chamada (14), o manipulador de mensagem de encerramento de interceptação 1520 é ativado no controlador de chamada. O manipulador de mensagem de encerramento de intercepta-
25

ção 1520 começa com um primeiro bloco 1522 que direciona o circuito do processador do controlador de chamada para enviar uma mensagem de término SIP para o dispositivo de mediação identificado na mensagem de encerramento de interceptação recebida a partir do controlador de roteamento. Em resposta à mensagem de término SIP, o dispositivo de mediação para de receber dados de áudio e envia uma mensagem de confirmação de volta para o controlador de chamada.

O bloco 1524 direciona o circuito do processador do controlador de chamada para receber a mensagem de confirmação de volta a partir do dispositivo de mediação.

O bloco 1526 então direciona o circuito do processador do controlador de chamada para enviar uma mensagem de término de interceptação para a retransmissão de mídia 17 identificada pelo conteúdo do campo de ID de retransmissão de mídia 1310 do registro de chamada ativa apresentado na Figura 35. A mensagem de término de interceptação inclui os conteúdos do campo de ID de porta do chamador da retransmissão de mídia 1312 e do campo de porta do receptor da retransmissão de mídia 1314 incluídos no registro de chamada ativa e identifica para a retransmissão de mídia quais portas encerrar. Em resposta à mensagem de término de interceptação, a retransmissão de mídia 17 desconecta as conexões entre a porta do chamador da retransmissão de mídia e a porta do dispositivo de mediação que estava recebendo os dados de áudio a partir do chamador e a conexão entre a porta do receptor da retransmissão de mídia e a porta do dispositivo de mediação que estava recebendo os dados de áudio a partir do receptor. Então, a retransmissão de mídia envia uma mensagem de condição de término MR para o controlador de chamada.

O bloco 1528 direciona o circuito do processador do controlador de chamada para receber a mensagem de condição de término MR e o bloco 1530 direciona o controlador de chamada para enviar uma mensagem de condição de término para o controlador de roteamento 16.

Em uma concretização alternativa, o controlador de roteamento não mantém registros de chamada ativa, mas cada controlador de chamada

mantém. Em tal concretização, os blocos 1408 e 1410 da Figura 44 são substituídos por um único bloco 1600 que direciona o circuito do processador do controlador de roteamento para sondar cada controlador de chamada para determinar se sua lista de chamadas ativas contém uma entrada possuindo os conteúdos do campo de chamador e de receptor iguais ao nome de usuário determinado a partir do perfil de discagem localizado no bloco 1402.

Se qualquer um dos controladores de chamada sondados possuir tal registro, este controlador de chamada transmite uma mensagem de resposta de volta para o controlador de roteamento, a mensagem de resposta incluindo um ID do controlador de chamada identificando este controlador de chamada. Mais do que um controlador de chamada pode ter um registro de chamada ativa possuindo conteúdos de campo de chamador ou de receptor iguais ao nome de usuário determinado a partir do perfil do usuário. Este seria o caso em uma chamada de conferência, por exemplo.

O circuito do processador do controlador de roteamento então executa os blocos 1412 e 1414 como descrito acima ou o processo é terminado se nenhum dos controladores de chamada sondados contiver um registro de chamada com os conteúdos de campo de chamador e de receptor correspondendo ao nome de usuário determinado a partir do perfil de discagem localizado no bloco 1402.

Portanto, na prática, o bloco 1600 proporciona um meio alternativo para encontrar controladores de chamada que estão atualmente transportando uma chamada associada com o usuário de interesse.

Em outra concretização, uma interface com o controlador de roteamento e / ou com o controlador de chamada pode ser proporcionada para permitir que as autoridades de imposição de lei possuam acesso direto ou uma cópia da lista de chamadas ativas mantida pelo controlador de chamada e / ou pelo controlador de roteamento.

A partir do precedente, será apreciado que indicações de que se as comunicações de um assinante com o sistema são ou não para serem monitoradas, são proporcionadas pelas agências de imposição de lei diretamente para um perfil de discagem do assinante apresentado na Figura 9.

Este perfil de discagem é utilizado para direcionar uma chamada envolvendo o assinante e é verificado em relação aos requerimentos de interceptação legítima para determinar se a retransmissão de mídia deve ou não copiar os dados de áudio associados com a chamada para um dispositivo de mediação para propósitos de monitoramento e / ou gravação legítimos.

5 Enquanto o sistema foi descrito em conexão com o monitoramento de fluxos de áudio, ele pode de forma similar ser utilizado para monitoramento de quaisquer outros fluxos de dados, tal como dados puros e / ou dados de vídeo ou de multimídia, por exemplo, entre assinantes do sistema ou entre um assinante e um não assinante do sistema.

10 Enquanto concretizações específicas da invenção foram descritas e ilustradas, tais concretizações devem ser consideradas somente ilustrativas da invenção e não limitando a invenção como construída de acordo com as reivindicações acompanhantes.

REIVINDICAÇÕES

1. Método para interceptar comunicações em um sistema de rede de Protocolo Internet (IP) no qual as comunicações entre um assinante do dito sistema e outra parte ocorrem através de uma retransmissão de mídia para a qual o dito assinante e a dita outra parte endereçam suas comunicações destinadas um para o outro e que retransmite as ditas comunicações entre o dito assinante e a dita outra parte, o método compreendendo:
- 5 determinar se a informação de determinação associada com um perfil de discagem de assinante associado com o dito assinante atende os
- 10 critérios de interceptação;
- quando a dita informação de determinação atende aos ditos critérios de interceptação, causar que a mesma retransmissão de mídia através da qual as comunicações entre o dito assinante e a dita outra parte são retransmitidas produza uma cópia das ditas comunicações entre o dito assinante e a dita outra parte, enquanto a dita mesma retransmissão de mídia retransmite as comunicações entre o dito assinante e a dita outra parte; e
- 15 causar que a mesma dita retransmissão de mídia envie a dita cópia para um dispositivo de mediação identificado pela informação de destino associada com o dito perfil de discagem de assinante.
- 20 2. Método, de acordo com a reivindicação 1, adicionalmente compreendendo associar a dita informação de de terminação e a dita informação de destino com o dito perfil de discagem quando comunicações envolvendo o dito assinante não estão em andamento.
3. Método, de acordo com a reivindicação 1, adicionalmente
- 25 compreendendo associar a dita informação de determinação e a dita informação de destino com o dito perfil de discagem de assinante quando comunicações envolvendo o dito assinante estão em andamento.
4. Método, de acordo com a reivindicação 2 ou 3, onde associar a dita informação de determinação e a dita informação de destino compreende preencher campos da informação de interceptação no dito perfil de discagem de um assinante cujas comunicações são para serem monitoradas.
- 30 5. Método, de acordo com a reivindicação 1, adicionalmente

compreendendo produzir uma mensagem de roteamento para rotear comunicações envolvendo o assinante através dos componentes da rede IP e determinar se a dita informação de determinação atende aos ditos critérios de interceptação antes de produzir a dita mensagem de roteamento e incluindo
5 pelo menos alguma parte da dita informação de determinação e da dita informação de destino na dita mensagem de roteamento quando a dita informação de determinação atende aos ditos critérios de interceptação.

6. Método, de acordo com a reivindicação 5, onde determinar se a dita informação de determinação atende aos ditos critérios de interceptação compreende determinar se uma data e hora correntes estão dentro de
10 uma faixa especificada pela dita informação de determinação.

7. Método, de acordo com a reivindicação 6, onde produzir uma mensagem de roteamento compreende identificar uma retransmissão de mídia através da qual as comunicações envolvendo o dito assinante serão
15 conduzidas e incluindo uma identificação da dita retransmissão de mídia na dita mensagem de roteamento de modo que a dita retransmissão de mídia atue como a dita mesma retransmissão de mídia através da qual as comunicações entre o dito assinante e a dita outra parte são retransmitidas.

8. Método, de acordo com a reivindicação 7, adicionalmente compreendendo associar anteriormente pelo menos uma retransmissão de mídia com o dito perfil de discagem associado com o assinante cujas comunicações são para serem monitoradas e onde identificar a dita retransmissão de mídia compreende identificar a retransmissão de mídia associada anteriormente com o dito assinante cujas comunicações são para serem monito-
20 radas.
25

9. Método, de acordo com a reivindicação 8, onde associar anteriormente compreende preencher campos da retransmissão de mídia no dito perfil de discagem com uma identificação da dita pelo menos uma retransmissão de mídia.

30 10. Método, de acordo com a reivindicação 3, onde associar a dita informação de determinação e a dita informação de destino compreende associar a dita informação de determinação e a dita informação de destino

com o dito perfil de discagem do assinante cujas comunicações são para serem monitoradas, em resposta a recepção de uma mensagem de requisição de interceptação, onde a dita mensagem de recepção de interceptação compreende a dita informação de determinação e a dita informação de destino.

11. Método, de acordo com a reivindicação 10, adicionalmente compreendendo ativar um manipulador de mensagem de requisição de interceptação para:

a) encontrar um perfil de discagem associado com o assinante cujas comunicações são para serem monitoradas;

b) executar a etapa de associar a dita informação de determinação e a dita informação de destino com o dito perfil de discagem;

c) determinar se os ditos critérios de interceptação são satisfeitos; e

d) identificar uma retransmissão de mídia através da qual as dita comunicações estão sendo conduzidas de modo que a ditas retransmissão de mídia possa ser levada a enviar a dita cópia para o dito dispositivo de mediação.

12. Método, de acordo com a reivindicação 11, onde o dito perfil de discagem inclui um identificador de nome de usuário e adicionalmente compreendendo manter registros de chamada ativa para comunicações em andamento, os ditos registros de chamada ativa compreendendo um identificador de nome de usuário e um identificador de retransmissão de mídia identificando a retransmissão de mídia através da qual as ditas comunicações estão sendo conduzidas e onde identificar uma retransmissão de mídia compreende localizar um registro de chamada ativa associado com comunicações do assinante cujas comunicações são para serem monitoradas para identificar a retransmissão de mídia associada com as ditas comunicações.

13. Método, de acordo com a reivindicação 12, adicionalmente compreendendo manter registros de discagem direta interna (DID) associando números de telefone PST com os nomes de usuários assinando a dita rede IP, e onde encontrar um perfil de discagem associado com o assinante

5 cujas comunicações são para serem monitoradas compreende encontrar um nome de usuário em um registro DID carregando um número PSTN associado com o assinante cujas comunicações são para serem monitoradas e utilizando o dito nome de usuário para localizar um perfil de discagem associado com o dito nome de usuário.

14. Aparelho para interceptar comunicações em uma rede de Protocolo Internet (IP), o aparelho compreendendo:

10 dispositivo para acessar perfis de discagem associados com os respectivos assinantes da rede IP, pelo menos um dos ditos perfis de discagem sendo associado com um assinante cujas comunicações são para serem monitoradas, o perfil de discagem do assinante cujas comunicações são para serem monitoradas incluindo informação de interceptação incluindo informação de determinação para determinar se intercepta uma comunicação envolvendo o dito assinante, e informação de destino identificando um dispositivo de mediação para o qual as comunicações interceptadas envolvendo o dito assinante são para serem enviadas;

15 dispositivo para determinar se a dita informação de determinação atende aos critérios de interceptação;

20 dispositivo para causar que a mesma retransmissão de mídia através da qual as comunicações entre o dito assinante e a dita outra parte são retransmitidas produza uma cópia das ditas comunicações entre o dito assinante e a dita outra parte, enquanto a dita retransmissão de mídia retransmite as comunicações entre o dito assinante e a dita outra parte;

25 dispositivo para se comunicar com a mesma retransmissão de mídia para causar que a dita retransmissão de mídia envia a dita cópia das ditas comunicações para um dispositivo de mediação especificado pela dita informação de destino, quando a dita informação de determinação atende aos ditos critérios de interceptação.

30 15. Aparelho, de acordo com a reivindicação 14, adicionalmente compreendendo o dispositivo para associar a dita informação de interceptação com o dito perfil de discagem quando as comunicações envolvendo o dito assinante não estão em andamento.

16. Aparelho, de acordo com a reivindicação 14, adicionalmente compreendendo o dispositivo para associar a dita informação de interceptação com o dito perfil de discagem quando as comunicações envolvendo o dito assinante estão em andamento.

5 17. Aparelho, de acordo com a reivindicação 15 ou 16, onde o dito dispositivo para associar a dita informação de interceptação é de forma operacional configurado para preencher campos da informação de interceptação no dito perfil de discagem do assinante cujas comunicações são para serem monitoradas.

10 18. Aparelho, de acordo com a reivindicação 14, adicionalmente compreendendo o dispositivo para produzir uma mensagem de roteamento para rotear comunicações envolvendo o assinante através dos componentes da rede IP e dispositivo para determinar se a dita informação de determinação atende aos ditos critérios de interceptação antes de produzir a dita mensagem de roteamento e onde o dito dispositivo para produzir a dita mensagem de roteamento é configurado de forma operacional para incluir pelo menos alguma parte da dita informação de interceptação na dita mensagem de roteamento, quando a dita informação de determinação atende aos ditos critérios de interceptação.

15 19. Aparelho, de acordo com a reivindicação 18, onde o dito dispositivo para determinar se a dita informação de determinação atende aos ditos critérios de interceptação é configurado de forma operacional para determinar se uma data e hora correntes estão dentro de uma faixa especificada pela dita informação de determinação.

20 20. Aparelho, de acordo com a reivindicação 19, onde o dito dispositivo para produzir a dita mensagem de roteamento é configurado de forma operacional para identificar uma retransmissão de mídia através da qual as comunicações envolvendo o dito assinante serão conduzidas e para incluir uma identificação da dita retransmissão de mídia na dita mensagem de roteamento de modo que a dita retransmissão de mídia atue como a dita mesma retransmissão de mídia através da qual as comunicações entre o
30 dito assinante e a dita outra parte são retransmitidas.

21. Aparelho, de acordo com a reivindicação 20, adicionalmente compreendendo o dispositivo para associar anteriormente pelo menos uma retransmissão de mídia com o dito perfil de discagem do assinante cujas comunicações são para serem monitoradas e onde o dito dispositivo de roteamento é configurado de forma operacional para identificar a partir do dito perfil de discagem a retransmissão de mídia associada anteriormente com o dito assinante cujas comunicações são para serem monitoradas.

22. Aparelho, de acordo com a reivindicação 21, onde o dito dispositivo para associar anteriormente é configurado de forma operacional para preencher campos da retransmissão de mídia no dito perfil de discagem com uma identificação da dita pelo menos uma retransmissão de mídia.

23. Aparelho, de acordo com a reivindicação 16, onde o dito dispositivo para associar a dita informação de interceptação é configurado de forma operacional para associar a dita informação de interceptação associada com o dito perfil de discagem do assinante cujas comunicações são para serem monitoradas, em resposta à recepção de uma mensagem de requisição de interceptação, onde a dita mensagem de requisição de interceptação compreende a dita informação de interceptação.

24. Aparelho, de acordo com a reivindicação 23, adicionalmente compreendendo o dispositivo para manipular uma mensagem de requisição de interceptação, o dito dispositivo para manipular a dita mensagem de requisição de interceptação compreendendo:

a) dispositivo para encontrar um perfil de discagem associado com o assinante cujas comunicações são para serem monitoradas, o dito dispositivo para encontrar um perfil de discagem cooperando com o dito dispositivo para associar a dita informação de interceptação com o dito perfil de discagem para fazer com que a dita informação de interceptação seja associada com o dito perfil de discagem;

b) dispositivo para determinar se os ditos critérios de interceptação são atendidos; e

c) dispositivo para identificar uma retransmissão de mídia através da qual as ditas comunicações estão sendo conduzidas de modo que a

dita retransmissão de mídia possa ser levada a enviar a dita cópia para o dito dispositivo de mediação.

25. Aparelho, de acordo com a reivindicação 24, onde o dito perfil de discagem inclui um identificador de nome de usuário e adicionalmente
5 compreendendo o dispositivo para manter registros de chamada ativa para comunicações em andamento, os ditos registros de chamada ativa compreendendo um identificador de nome de usuário e um identificador de retransmissão de mídia identificando uma retransmissão de mídia através da qual
10 as ditas comunicações estão sendo conduzidas e onde o dito dispositivo para identificar a retransmissão de mídia é de forma operável configurado para localizar um registro de chamada ativa associado com as comunicações do assinante cujas comunicações são para serem monitoradas para identificar a retransmissão de mídia associada com as ditas comunicações.

26. Aparelho, de acordo com a reivindicação 25, adicionalmente
15 compreendendo o dispositivo para manter registros de discagem direta interna (DID) associando números de telefone PST com os nomes de usuário de usuários assinando a dita rede IP, e onde o dito dispositivo para encontrar um perfil de discagem associado com o assinante cujas comunicações são para serem monitoradas é de forma operacional configurado para en-
20 contrar um nome de usuário em um registro DID carregando um número PSTN associado com o assinante cujas comunicações são para serem monitoradas e utilizar o dito nome do usuário para localizar um perfil de discagem associado com o dito nome de usuário.

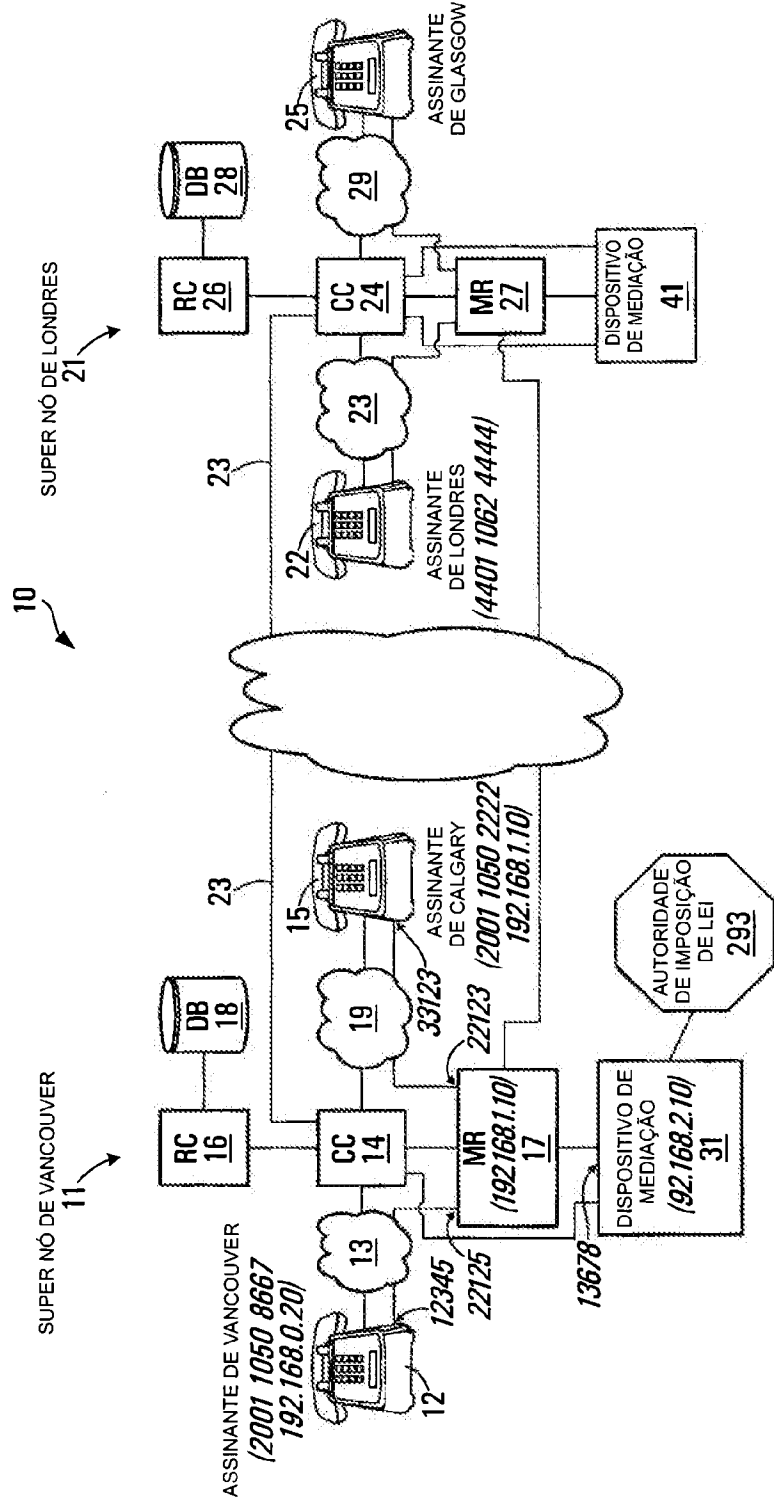

FIG. 1

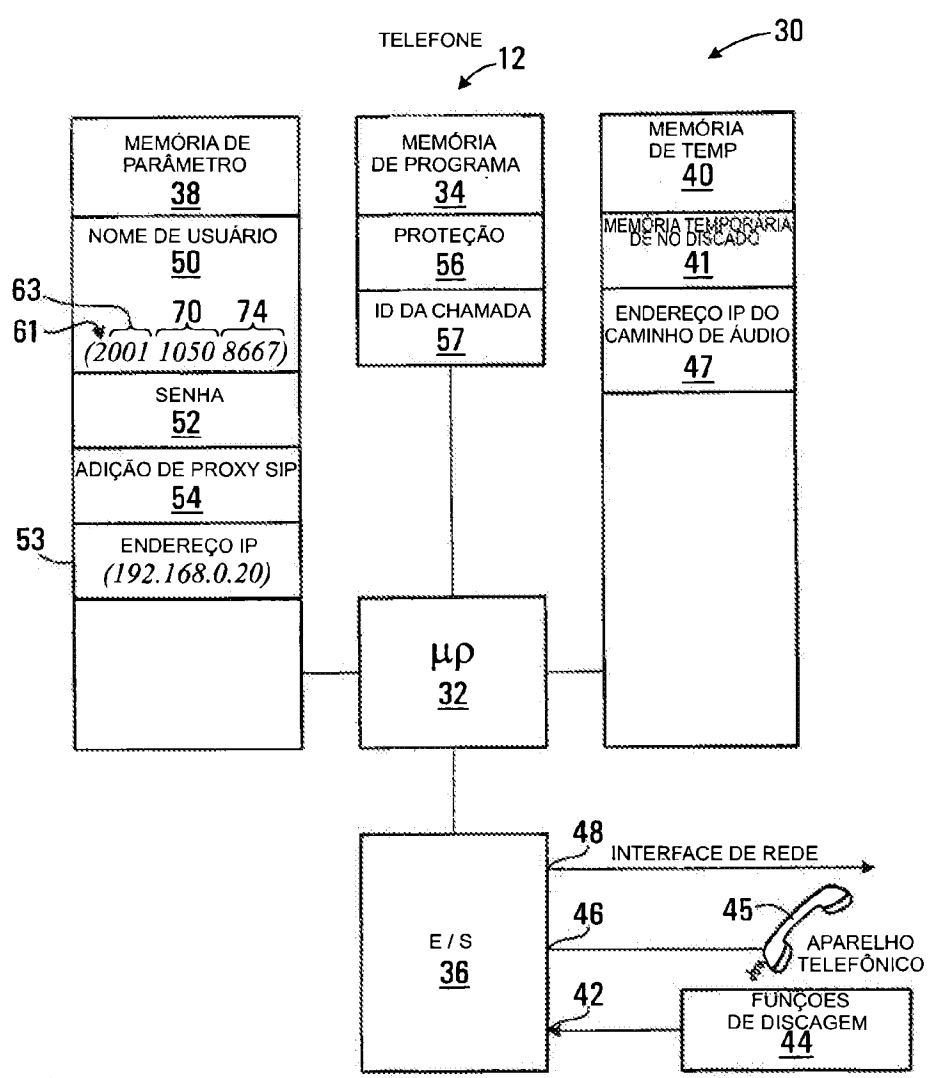

FIG. 2

MENSAGEM DE CONVITE SIP

60 — CHAMADOR 2001 1050 8667

62 — RECEPTOR 2001 1050 2222

64 — PARÂMETROS DE RESUMO XXXXXX

65 — ID DA CHAMADA FF10@ 192.168.0.20

67 — ENDEREÇO IP DO CHAMADOR 192.168.0.20

69 — PORTA UDP DO CHAMADOR 12345

FIG. 3

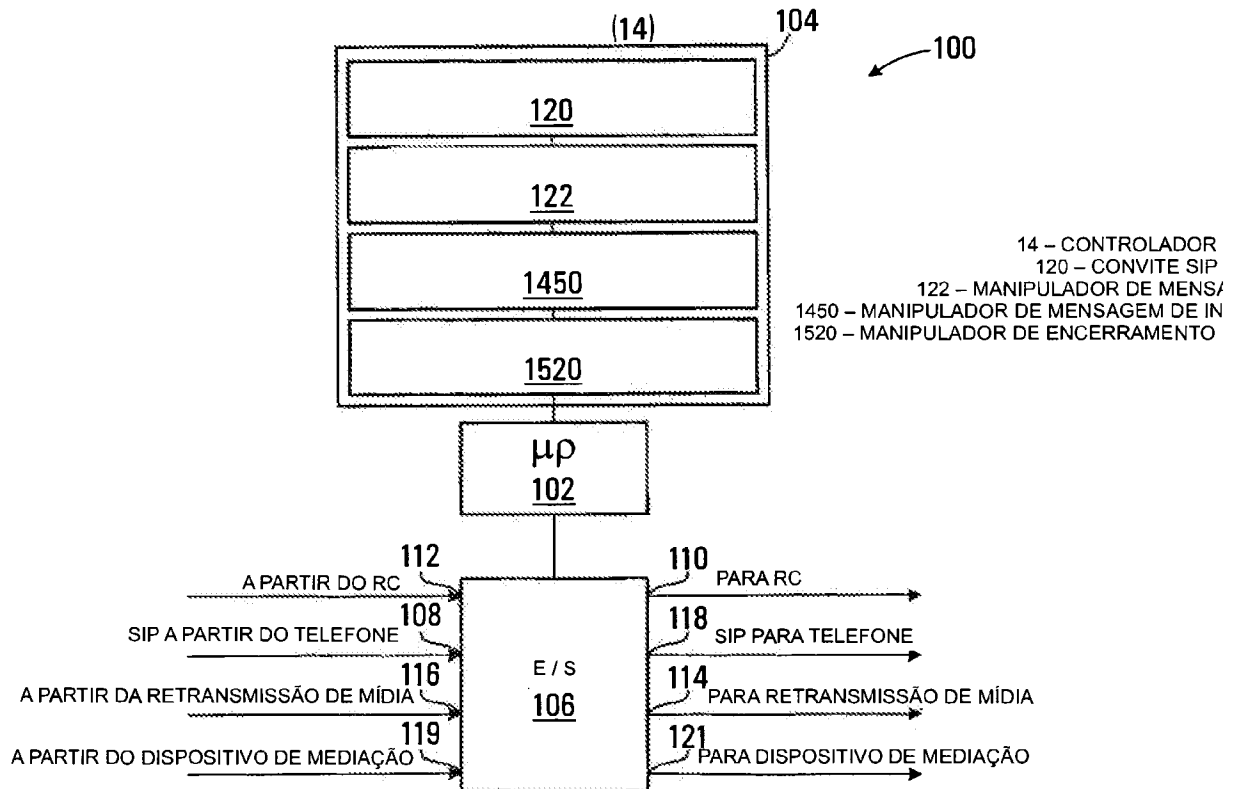

FIG. 4

CONTROLADOR DE CHAMADA

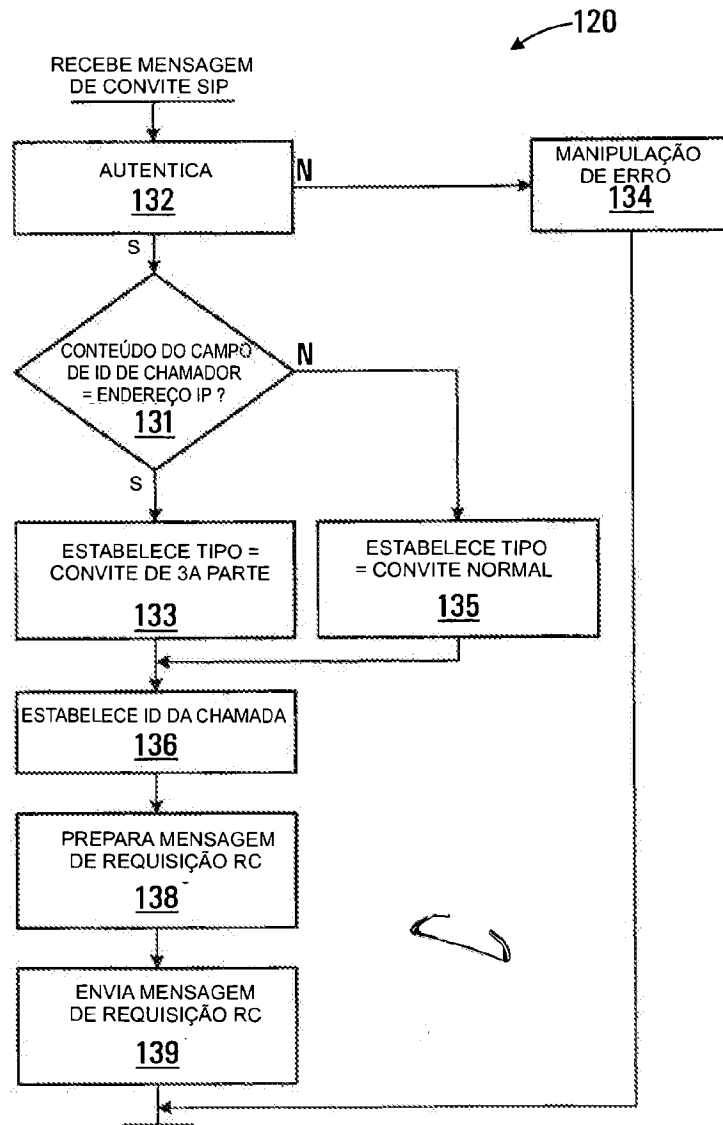

FIG. 5

MENSAGEM DE REQUISIÇÃO RC 150

152 CHAMADOR 2001 1050 8667

154 RECEPTOR 2001 1050 2222

156 RESUMO XXXXXXX

158 ID DA CHAMADA FF10@ 192.168.0.20

160 TIPO ASSINANTE

FIG. 6

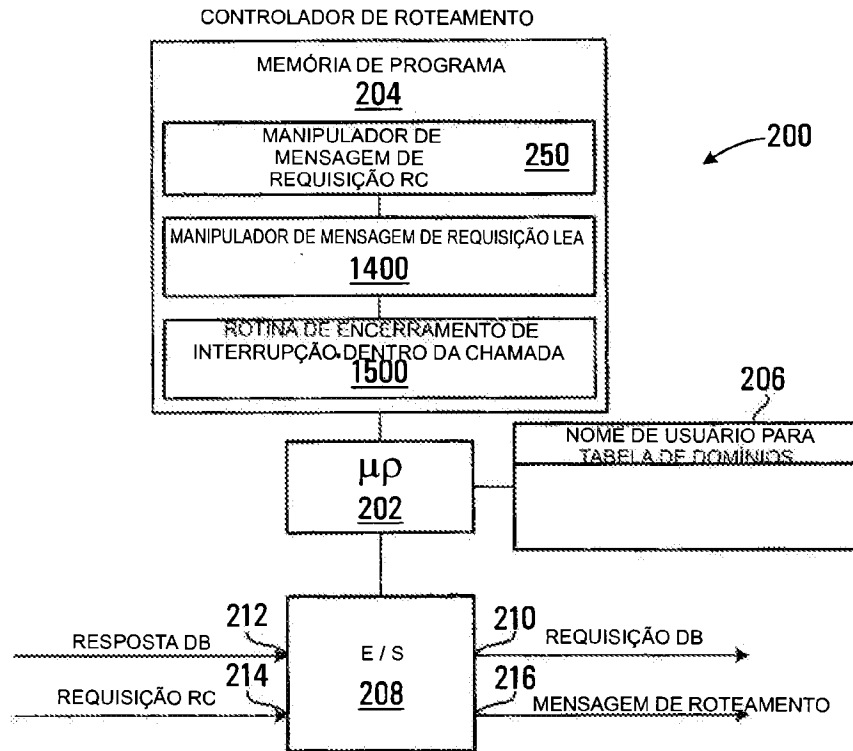

FIG. 7

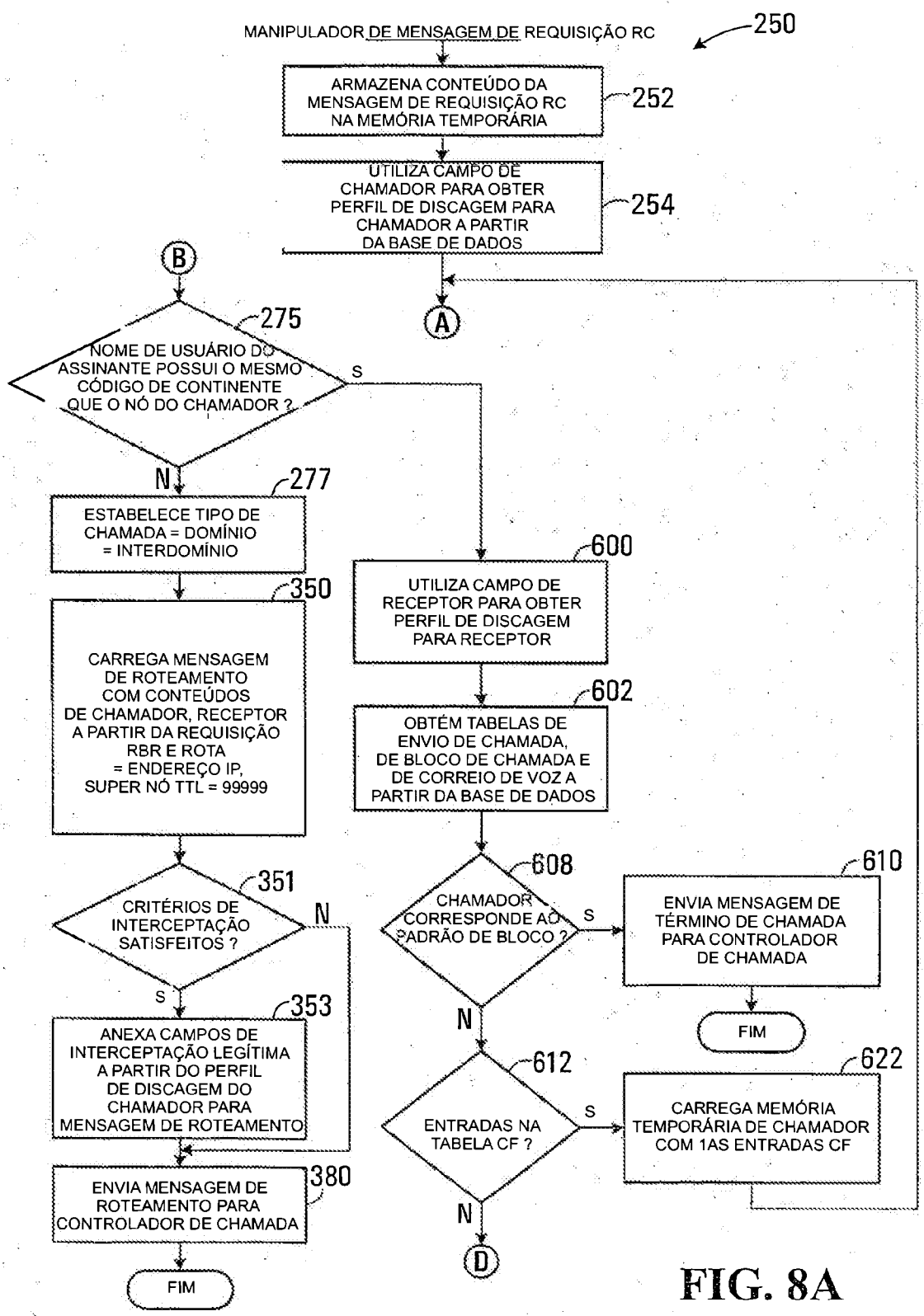

FIG. 8A

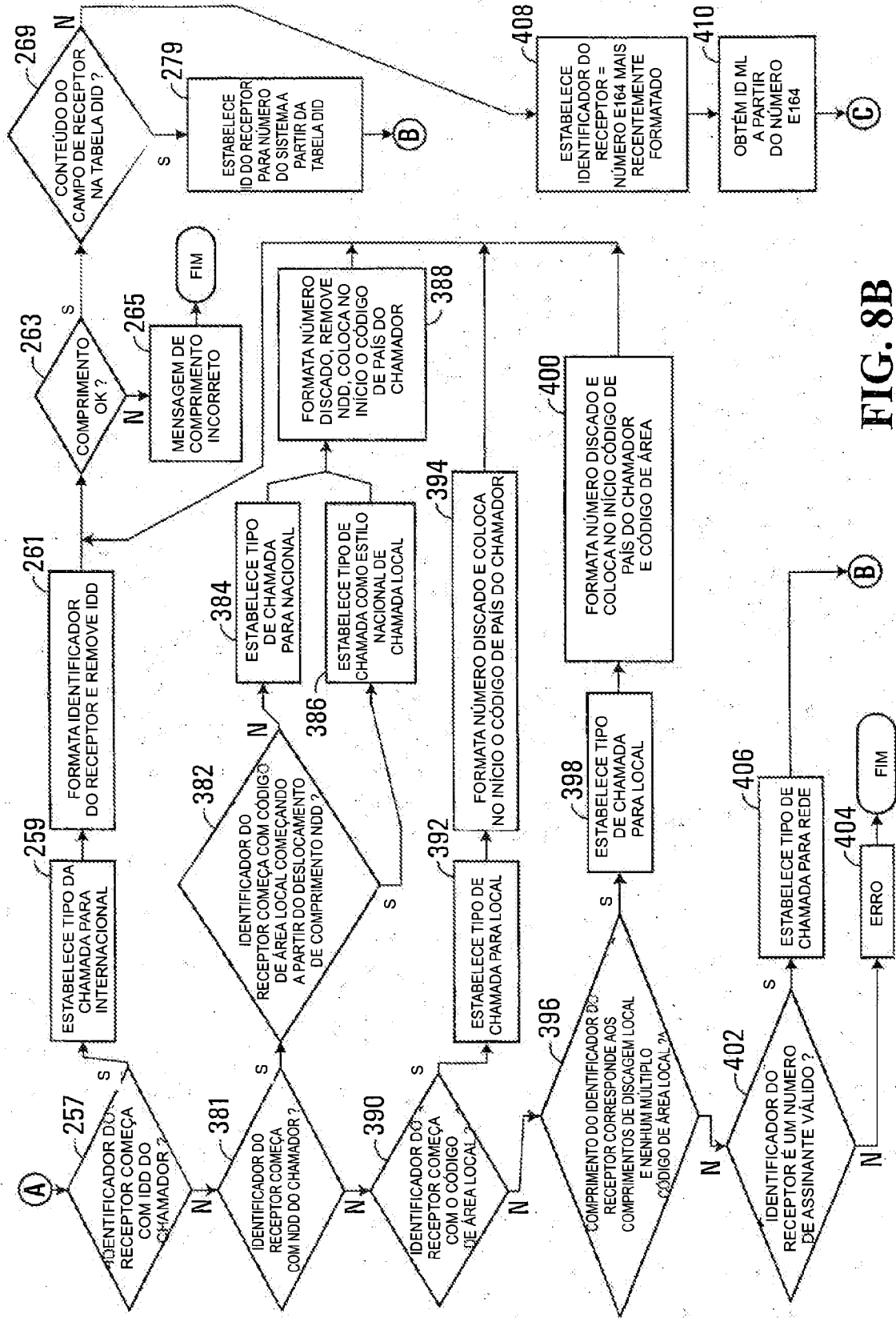

FIG. 8B

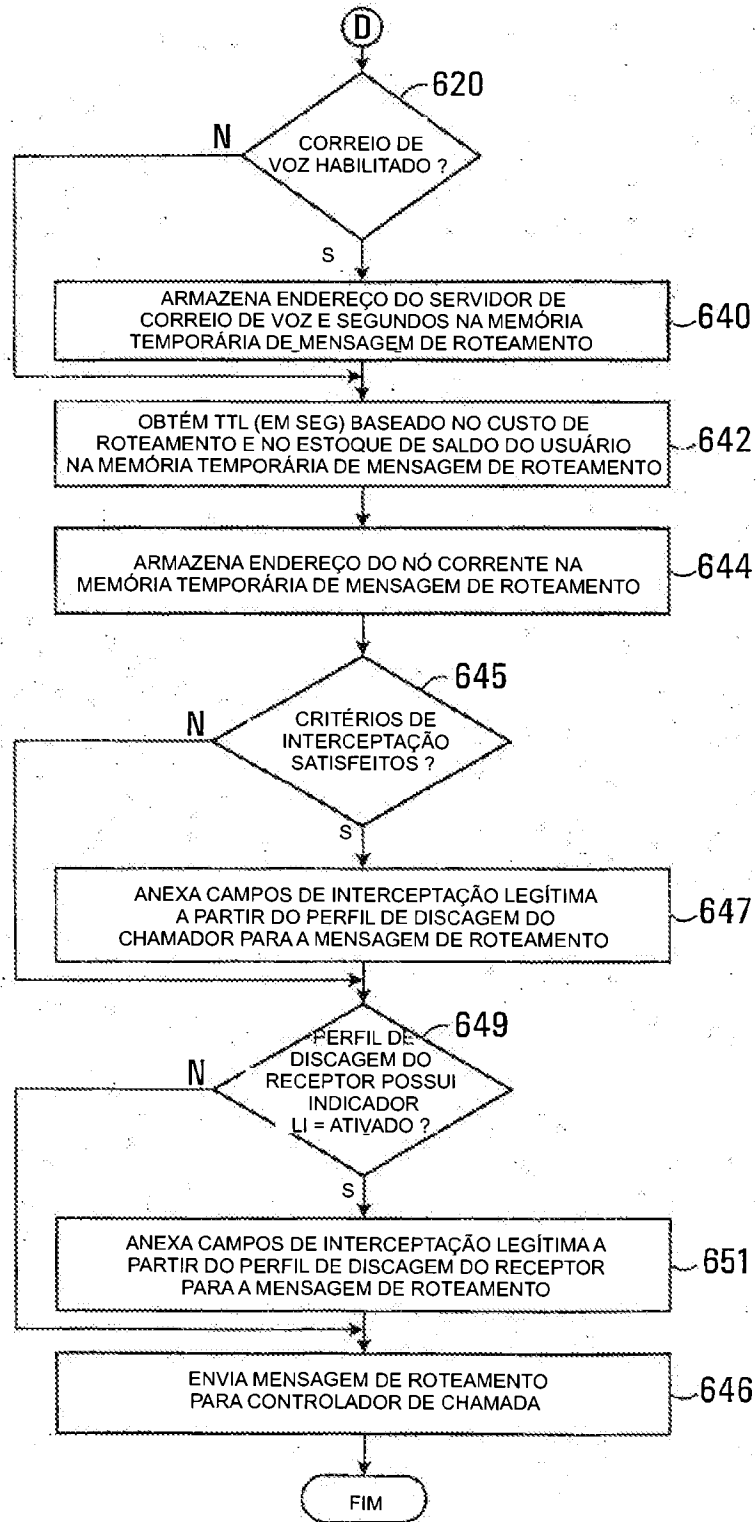

FIG. 8C

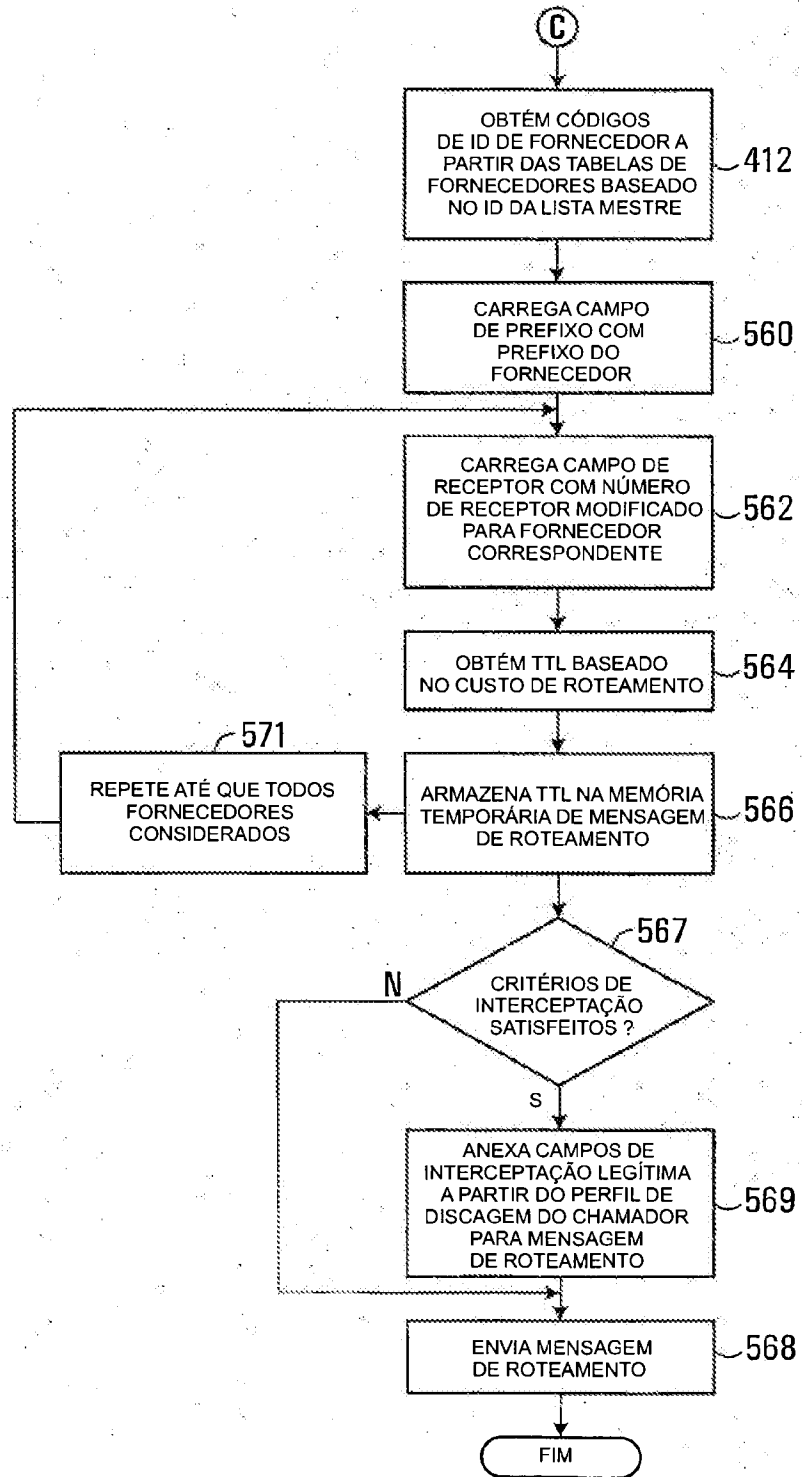

FIG. 8D

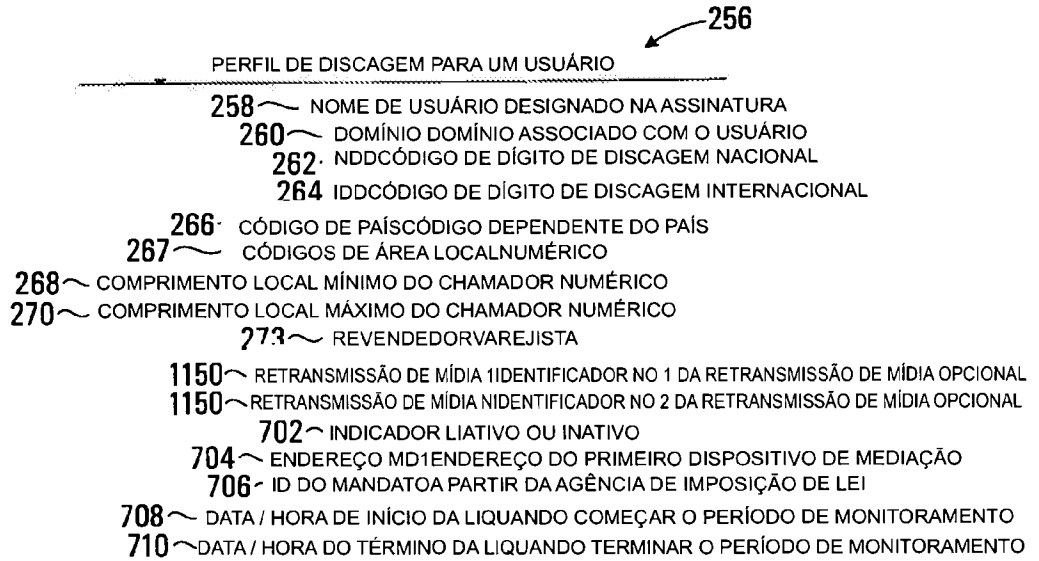

FIG. 9

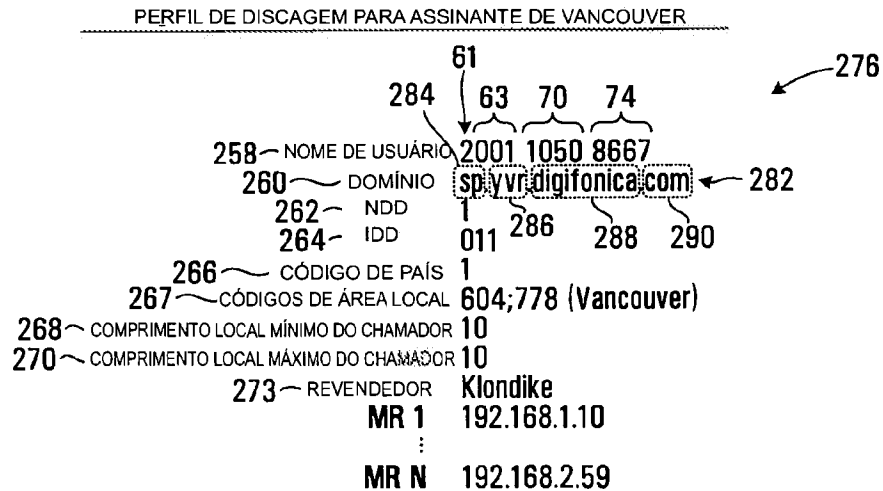

FIG. 10

11/29

PERFIL DE DISCAGEM PARA O ASSINANTE DE CALGARY

NOME DE USUÁRIO	2001 1050 2222
DOMÍNIO	sp.yvr.digifonica.com
NDD	1
IDD	011
CÓDIGO DE PAÍS	1
CÓDIGOS DE ÁREA LOCAL	403 (Calgary)
COMPRIMENTO LOCAL MÍNIMO DO CHAMADOR	7
COMPRIMENTO LOCAL MÁXIMO DO CHAMADOR	10
REVENDEDOR	ABC
MR1	192.168.3.60
⋮	
MRn	192.168.4.69

FIG. 11

PERFIL DE DISCAGEM PARA ASSINANTE DE LONDRES

NOME DE USUÁRIO	4401 1062 4444
DOMÍNIO	sp.lhr.digifonica.com
NDD	0
IDD	00
CÓDIGO DE PAÍS	44
CÓDIGOS DE ÁREA LOCAL	20 (London)
COMPRIMENTO LOCAL MÍNIMO DO CHAMADOR	10
COMPRIMENTO LOCAL MÁXIMO DO CHAMADOR	11
REVENDEDOR	DEF
MR1	192.168.5.70
⋮	
MRn	192.168.6.79

FIG. 12

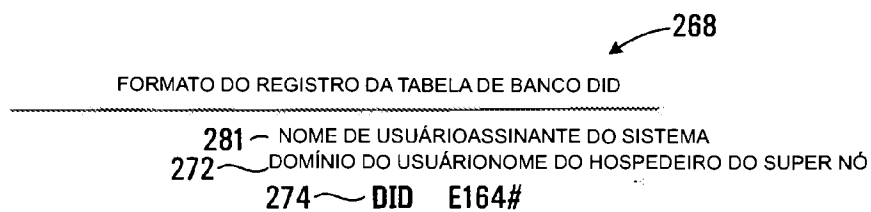

FIG. 13

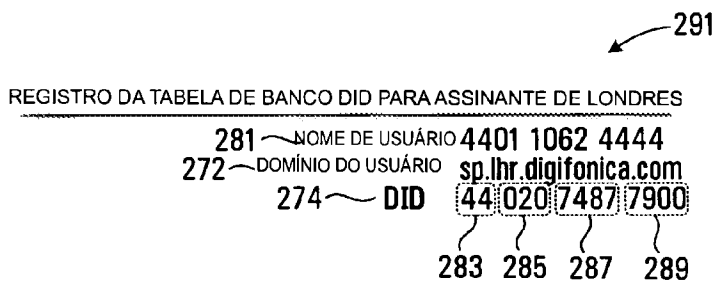

FIG. 14

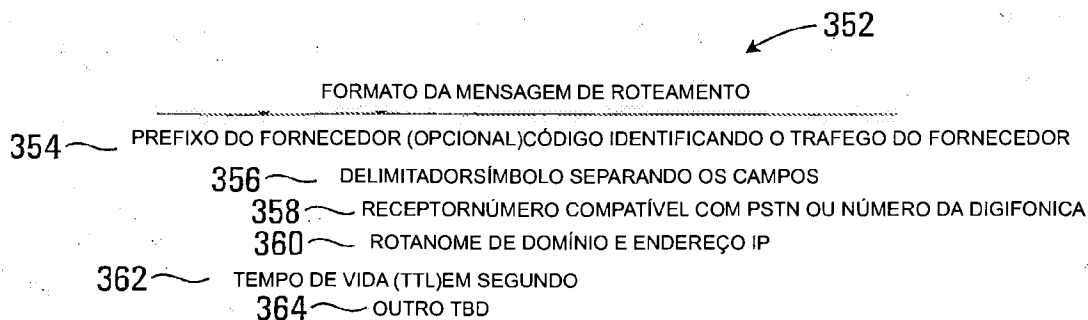

FIG. 15

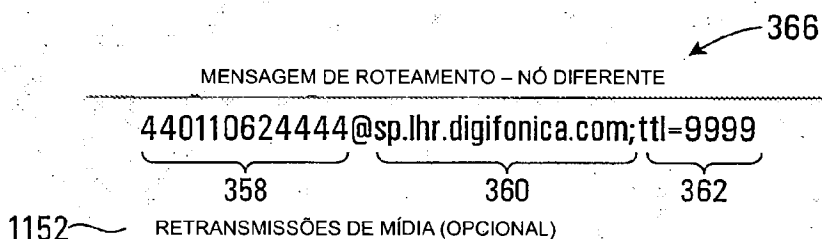

FIG. 16

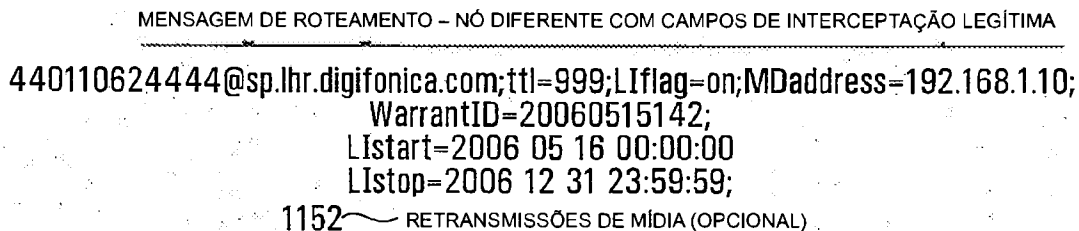

FIG. 16A

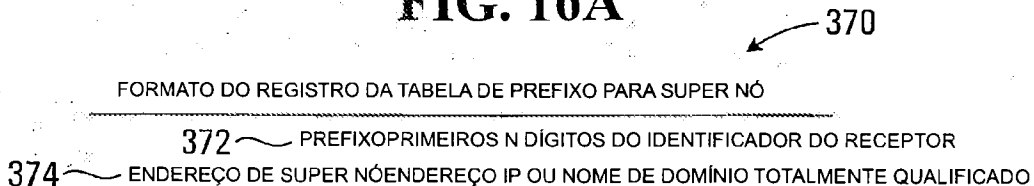

FIG. 17

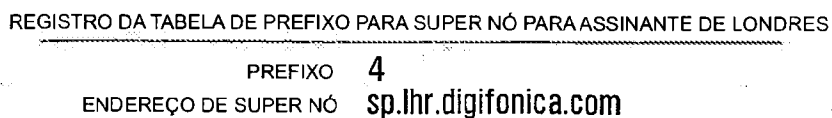

FIG. 18

FORMATO DO REGISTRO DA LISTA MESTRE

500	~	ID ml	1019
502	~	CÓDIGO DE DISCAGEM	1604
504	~	CÓDIGO DE PAÍS	CÓDIGO DE PAÍS É O PREFIXO NACIONAL A SER UTILIZADO QUANDO DISCANDO PARA UM PAÍS PARTICULAR A PARTIR DE OUTRO PAÍS
506	~	No DE SINAL NAC (CÓDIGO DE ÁREA)	NUMÉRICO
508	~	COMPRIMENTO MIN	NUMÉRICO
510	~	COMPRIMENTO MAX	NUMÉRICO
512	~	NDDO PREFIXO NDD	É O CÓDIGO DE ACESSO UTILIZADO PARA FAZER UMA CHAMADA DENTRO DESTE PAÍS A PARTIR DE UMA CIDADE PARA OUTRA (QUANDO CHAMANDO OUTRA CIDADE NA MESMA VIZINHANÇA, ESTE PODE NÃO SER NECESSÁRIO).
514	~	IDDO PREFIXO IDD	É O PREFIXO INTERNACIONAL NECESSÁRIO PARA FAZER UMA CHAMADA A PARTIR DO PAÍS LISTADO PARA OUTRO PAÍS
516	~	TAXA DE MEMÓRIA TEMPORÁRIA	TAXA DE CARGA SEGURA ACIMA DA MAIS ALTA TAXA CARREGADA PELOS FORNECEDORES

FIG. 19

EXEMPLO: REGISTRO DA LISTA MESTRA COM CAMPOS PREENCHIDOS

ID DA ROTA	1019	1019
CÓDIGO DE DISCAGEM	1604	1604
CÓDIGO DE PAÍS	1	1
No DE SINAL NAC (CÓDIGO DE ÁREA)	604	604
COMPRIMENTO MÍNIMO	7	7
COMPRIMENTO MÁXIMO	7	7
NDD	1	1
IDD	011	011
TAXA DE MEMÓRIA TEMPORÁRIA	\$0.009/min	\$0.009/min

FIG. 20

 FORMATO DO REGISTRO DA LISTA DE FORNECEDORES

540	~	ID DO FORNECEDOR	CÓDIGO DE NOME
542	~	ID DA ROTA	CÓDIGO NUMÉRICO
544	~	PREFIXO (OPCIONAL)	CADEIA IDENTIFICANDO Nº DE TRÁFEGO DO FORNECEDOR
546	~	ROTA	ENDEREÇO IP
548	~	REGRAVA	NDD / IDD
550	~	TAXA	CUSTO POR SEGUNDO PARA DIGIFONICA PARA UTILIZAR ESTA ROTA

FIG. 21

 REGISTRO DO FORNECEDOR TELUS

		ID DO FORNECEDOR	2010 (Telus)
		ID DA ROTA	1019
		PREFIXO (OPCIONAL)	4973#
546	~	ROTA	72.64.39.58
		REGRAVA	NDD / IDD
550	~	TAXA	\$0.02/min

FIG. 22

 REGISTRO DO FORNECEDOR SHAW

		ID DO FORNECEDOR	2011 (Shaw)
		ID DA ROTA	1019
		PREFIXO (OPCIONAL)	4974#
		ROTA	73.65.40.59
		REGRAVA	NDD / IDD
550	~	TAXA	\$0.025/min

FIG. 23

 REGISTRO DO FORNECEDOR SPRINT

		ID DO FORNECEDOR	2012 (Sprint)
		ID DA ROTA	1019
		PREFIXO (OPCIONAL)	4975#
		ROTA	74.66.41.60
		REGRAVA	NDD / IDD
550	~	TAXA	\$0.03/min

FIG. 24

MEMÓRIA TEMPORÁRIA DE MENSAGEM DE ROTEAMENTO
PARA CHAMADA DO DISPOSITIVO DE INTERCONEXÃO DE REDE

4973#0116048675309@72.64.39.58;tli=3600 ~ 570
4974#0116048675309@73.65.40.59;tli=3600 ~ 572
4975#0116048675309@74.66.41.60;tli=3600 ~ 574
RETRANSMISSÕES DE MÍDIA (OPCIONAL) ~ 1152

FIG. 25

MEMÓRIA TEMPORÁRIA DE MENSAGEM DE ROTEAMENTO PARA CHAMADA DO
DISPOSITIVO DE INTERCONEXÃO DE REDE COM CAMPOS DE INTERCEPTAÇÃO LEGÍTIMA

4973#0116048675309@72.64.39.58;tli=3600
4974#0116048675309@73.65.40.59;tli=3600
4975#0116048675309@74.66.41.60;tli=3600
Liflag=on;MAddress=192.168.1.10;WarrantID=20060515142;
Lstart=2006051600:00:00;Lstop=2006123123:59:59
RETRANSMISSÕES DE MÍDIA (OPCIONAL) ~ 1152

FIG. 25A

FORMATO DO REGISTRO DE BLOCO DE CHAMADA

604 ~ NOME DE USUÁRIO Digifonica #
606 ~ PADRÃO DE BLOCOCOMPATÍVEL COM PSTN OU Nº DA DIGIFONICA

FIG. 26

REGISTRO DE BLOCO DE CHAMADA PARA RECEPTOR DE CALGARY

604 ~ NOME DE USUÁRIO DO RECEPTOR 2001 1050 2222
606 ~ PADRÃO DE BLOCO 2001 1050 8664

FIG. 27

FORMATO DE REGISTRO DE ENVIO DE CHAMADA PARA RECEPTOR

614 ~ NOME DE USUÁRIO DO RECEPTOR Nº DA DIGIFONICA
616 ~ NÚMERO DE DESTINO Nº DA DIGIFONICA
618 ~ NÚMERO DE SEQUÊNCIA Nº INTEIRO INDICANDO ORDEM PARA TENTAREM ISTO

FIG. 28

REGISTRO DA TABELA DE ENVIO DE CHAMADA
PARA RECEPTOR DE CALGARY

614 ~ NOME DE USUÁRIO DO RECEPTOR 2001 1050 2222
616 ~ NÚMERO DE DESTINO 2001 1055 2223
618 ~ NÚMERO DE SEQUÊNCIA 1

FIG. 29

FORMATO DO REGISTRO DA TABELA DE CORREIO DE VOZ

624 ~ NOME DE USUÁRIO DO RECEPTOR DA DIGIFONICA
626 ~ SERVIDOR VM NOME DE DOMÍNIO
628 ~ SEGUNDOS PARA CORREIO DE VOZ TEMPO PARA AGUARDAR ANTES DE EMPREENDER O CORREIO DE VOZ
630 ~ HABILITADO SIM / NÃO

FIG. 30

REGISTRO DA TABELA DE CORREIO DE VOZ PARA RECEPTOR DE CALGARY

624 ~ NOME DE USUÁRIO DO RECEPTOR 2001 1050 2222
626 ~ SERVIDOR VM vm.yvr.digifonica.com
628 ~ SEGUNDOS PARA O CORREIO DE VOZ 20
630 ~ HABILITADO 1

FIG. 31

MEMÓRIA TEMPORÁRIA DE MENSAGEM DE ROTEAMENTO
PARA A MENSAGEM DE ROTEAMENTO CF / VM

650 ~ 200110502222@sp.yvr.digifonica.com;tll=3600
652 ~ 200110552223@sp.yvr.digifonica.com;tll=3600
654 ~ vm.yvr.digifonica.com;20;tll=60
656 ~ sp.yvr.digifonica.com
1152 ~ RETRANSMISSÕES DE MÍDIA (OPCIONAL)

FIG. 32

MEMÓRIA TEMPORÁRIA DE MENSAGEM DE ROTEAMENTO PARA A MENSAGEM DE ROTEAMENTO
CF / VM COM CAMPOS DE INTERRUPÇÃO LEGÍTIMA DO CHAMADOR

200110502222@sp.yvr.digifonica.com;tll=3600
200110552223@sp.yvr.digifonica.com;tll=3600
vm.yvr.digifonica.com;20;tll=60
sp.yvr.digifonica.com
LIflag=on;MDaddress=192.168.1.10;WarrantID=20060615142;
LIstart=2006061500:00:00;LIstop=2006123123:59:59
RETRANSMISSÕES DE MÍDIA (OPCIONAL) ~ 1152

FIG. 32A

MEMÓRIA TEMPORÁRIA DE MENSAGEM DE ROTEAMENTO PARA A MENSAGEM DE ROTEAMENTO
CF / VM COM CAMPOS DE INTERRUPÇÃO LEGÍTIMA DO CHAMADOR E DO RECEPTOR

200110502222@sp.yvr.digifonica.com;tll=3600
200110552223@sp.yvr.digifonica.com;tll=3600
vm.yvr.digifonica.com;20;tll=60
sp.yvr.digifonica.com
LI1flag=on;MDaddress=192.168.1.10;WarrantID=20060515142;
LI1start=2006051600:00:00;LI1stop=2006123123:59:59
LI2flag=0;MD2address=192.168.1.20;WarrantID=20060615142;
LI2start=2006061500:00:00;LI2stop=2006123123:59:59
RETRANSMISSÕES DE MÍDIA (OPCIONAL) ~ 1152

FIG. 32B

MANIPULADOR DE MENSAGEM DE ROTEAMENTO
EXECUTADO PELO CONTROLADOR DE CHAMADA

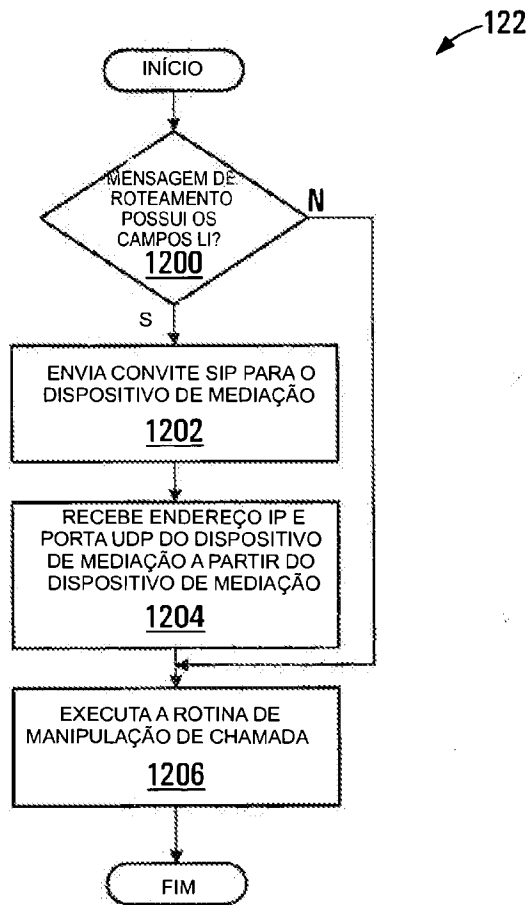

FIG. 33

123

ROTINA DE MANIPULAÇÃO DE CHAMADA

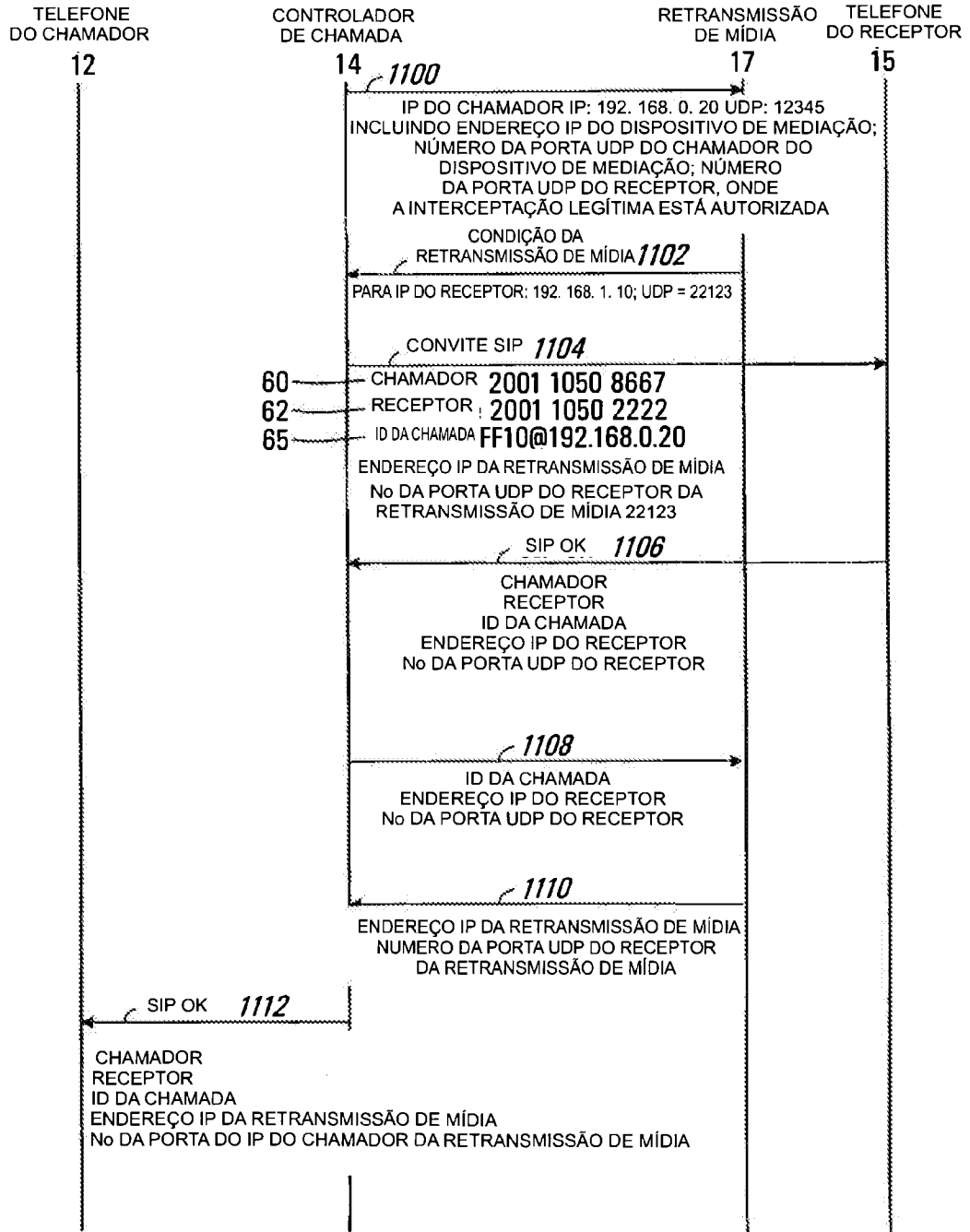

FIG. 34

REGISTRO DE CHAMADA ATIVA DO CONTROLADOR DE CHAMADA

1300 — ID DA CHAMADA FF10@192.168.0.20
1302 — ENDEREÇO IP DO CHAMADOR 192.168.0.20
1304 — PORTA DO CHAMADOR 12345
1306 — ENDEREÇO IP DO RECEPTOR 192.168.3.10
1308 — PORTA DO RECEPTOR 33123
1310 — ID DA RETRANSMISSÃO DE MÍDIA 42
1312 — PORTA DO CHAMADOR DA RETRANSMISSÃO DE MÍDIA 22125
1314 — PORTA DO RECEPTOR DA RETRANSMISSÃO DE MÍDIA 22123

FIG. 35

REGISTRO DE CHAMADA ATIVA DO CONTROLADOR DE ROTEAMENTO

1316 — ID DA CHAMADA FF10@192.168.0.20
1318 — CHAMADOR 2001 1050 8667
1320 — RECEPTOR 2001 1050 2222
1322 — ID DO CONTROLADOR DE CHAMADA 61

FIG. 36

MENSAGEM A PARTIR DO CONTROLADOR DE CHAMADA PARA O DISPOSITIVO DE MEDIAÇÃO - CONVITE SIP

1020 CHAMADOR 2001 1050 8667
1022 RECEPTOR 2001 1050 2222
1024 ID DA CHAMADA FF10@192.168.0.20
1026 ID DO MANDATO 12345678
1028 INFORMAÇÃO RELACIONADA COM INTERCEPTAÇÃO XXXXXXXX

FIG. 37

MENSAGEM DE RESPOSTA A PARTIR DO DISPOSITIVO DE MEDIAÇÃO - SIP OK

1040 CHAMADOR 2001 1050 8667
1042 RECEPTOR 2001 1050 2222
1044 ID DA CHAMADA FF10@192.168.0.20
1046 ENDEREÇO IP DO DISPOSITIVO DE MEDIAÇÃO 192.138.2.10
1048 No DA PORTA UDP DO CHAMADOR DO DISPOSITIVO DE MEDIAÇÃO 13678
1050 No DA PORTA UDP DO RECEPTOR DO DISPOSITIVO DE MEDIAÇÃO 13679

FIG. 38

900

MENSAGEM SIP BYE

- 902 ~ CHAMADOR NOME DE USUÁRIO
- 904 ~ RECEPTOR No COMPATÍVEL COM PSTN OU NOME DE USUÁRIO
- 906 ~ ID DA CHAMADA IDENTIFICADOR ÚNICO DA CHAMADA (CADEIA @IP HEXADECIMAL)

FIG. 39

908

MENSAGEM SIP BYE

- 902 ~ CHAMADOR 2001 1050 8667
- 904 ~ RECEPTOR 2001 1050 2222
- 906 ~ ID DA CHAMADA FA10@192.168.0.20

FIG. 40

910

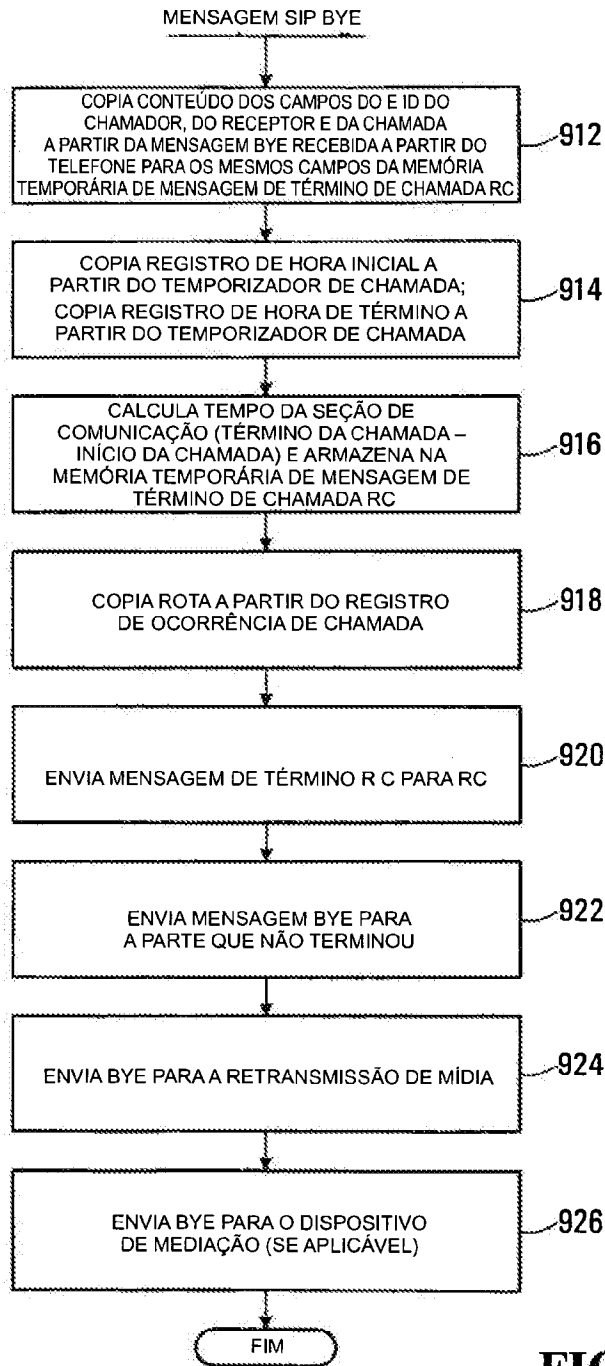

FIG. 41

MENSAGEM DE TÉRMINO DE CHAMADA RC

1000

- 1002 — CHAMADOR NOME DE USUÁRIO
- 1004 — RECEPTOR NÚMERO COMPATÍVEL COM PSTN OU NOME DE USUÁRIO
- 1006 — ID DA CHAMADA IDENTIFICADOR ÚNICO DA CHAMADA (CADEIA @IP HEXADECIMAL)
- 1008 — REGISTRO DE HORA INICIAL HORA INICIAL DA CHAMADA
- 1010 — REGISTRO DE HORA DE TÉRMINO HORA EM QUE A CHAMADA TERMINOU
- 1012 — REGISTRO DE TEMPO DE SESSÃO HORA INICIAL – HORA DE TÉRMINO (EM SEGUNDOS)
- 1014 — ROTA ENDEREÇO IP PARA DISPOSITIVO DE INTERCONEXÃO DE REDE, ONDE UM DISPOSITIVO DE INTERCONEXÃO DE REDE É UTILIZADO

FIG. 42

MENSAGEM DE TÉRMINO DE CHAMADA RC PARA O RECEPTOR DE CALGARY

1021

- 1002 — CHAMADOR 2001 1050 8667
- 1004 — RECEPTOR 2001 1050 2222
- 1006 — ID DA CHAMADA FA10@192.168.0.20
- 1008 — REGISTRO DE HORA INICIAL 2006-12-30 12:12:12
- 1010 — REGISTRO DE HORA DE TÉRMINO 2006-12-30 12:12:14
- 1012 — REGISTRO DE TEMPO DA SESSÃO 2
- 1014 — ROTA(72. 64. 39. 58 SE O DISPOSITIVO DE INTERCONEXÃO DE REDE TELUS FOR UTILIZADO)

FIG. 43

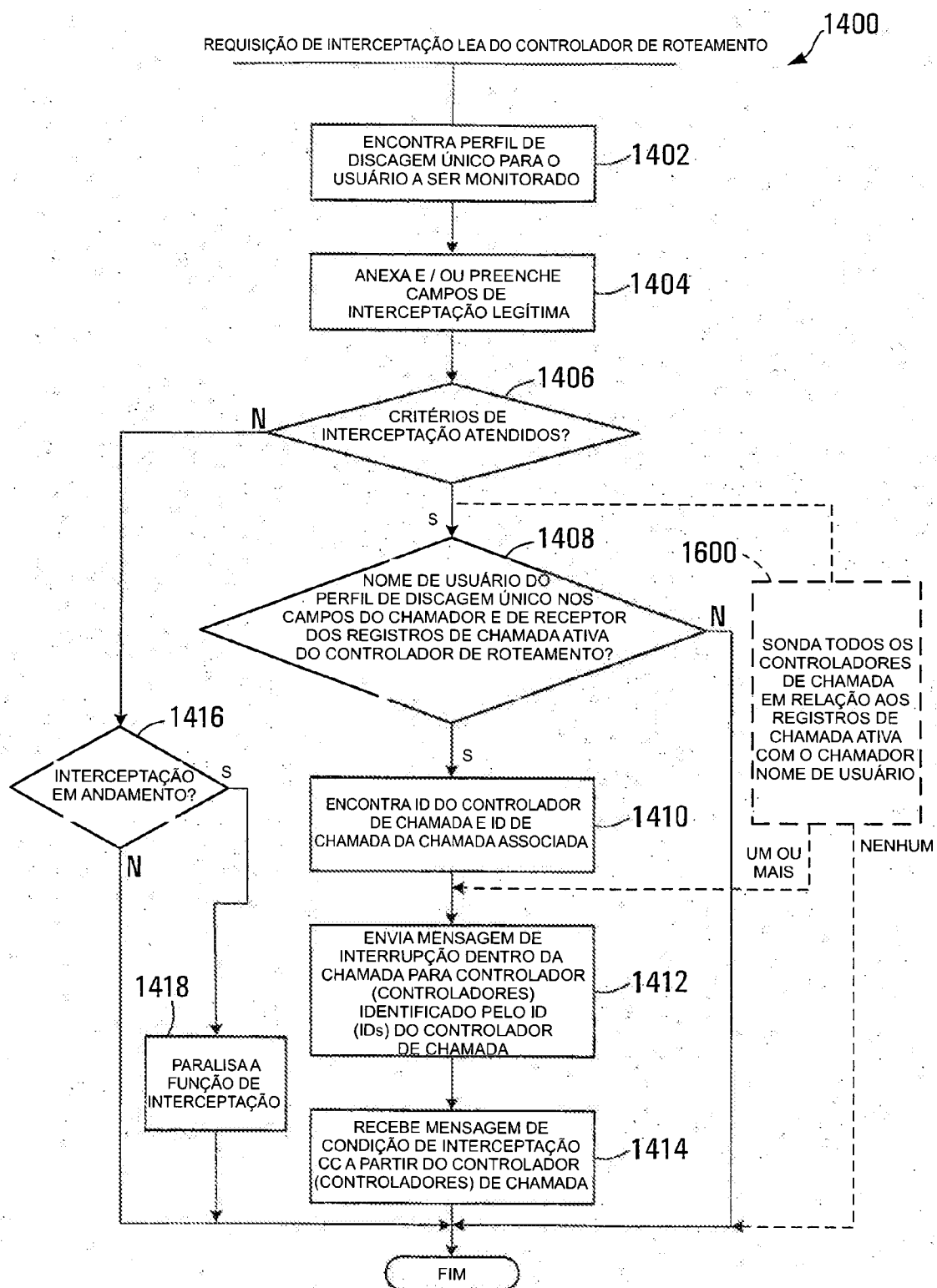

FIG. 44

MENSAGEM DE INTERCEPTAÇÃO DENTRO DA CHAMADA DO CONTROLADOR DE CHAMADA

1450

ENVA O CONVITE SIP PARA O DISPOSITIVO DE MEDIAÇÃO 1452

RECEBE ENDEREÇO IP E PORTA UDP DO DISPOSITIVO DE MEDIAÇÃO A PARTIR DO DISPOSITIVO DE MEDIAÇÃO 1454

ENVA MENSAGEM DE REQUISIÇÃO DE INTERCEPTAÇÃO PARA RETRANSMISSÃO DE MÍDIA 1456

RECEBE A MENSAGEM DE CONDIÇÃO DE INTERCEPTAÇÃO MR A PARTIR DA RETRANSMISSÃO DE MÍDIA 1458

ENVA MENSAGEM DE CONDIÇÃO DE INTERCEPTAÇÃO CC PARA O CONTROLADOR DE ROTEAMENTO 1460

FIM

FIG. 45

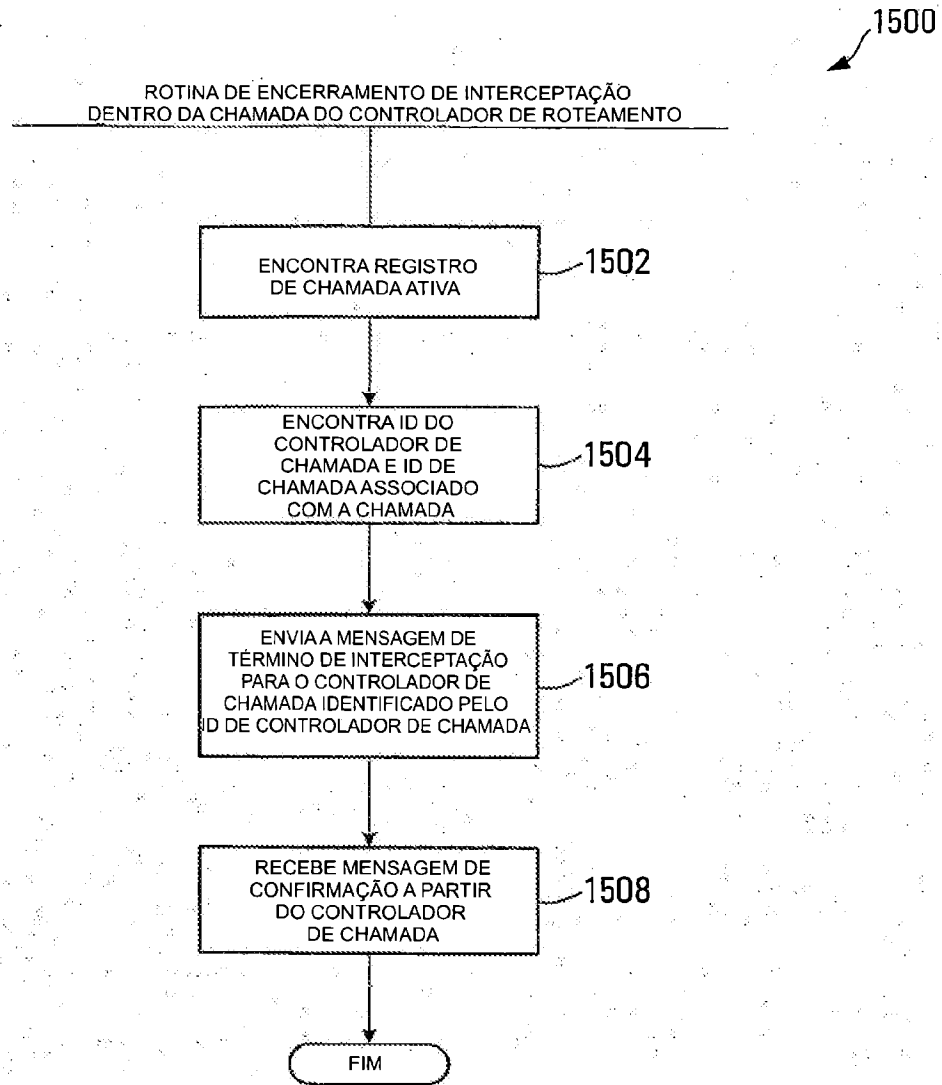

FIG. 46

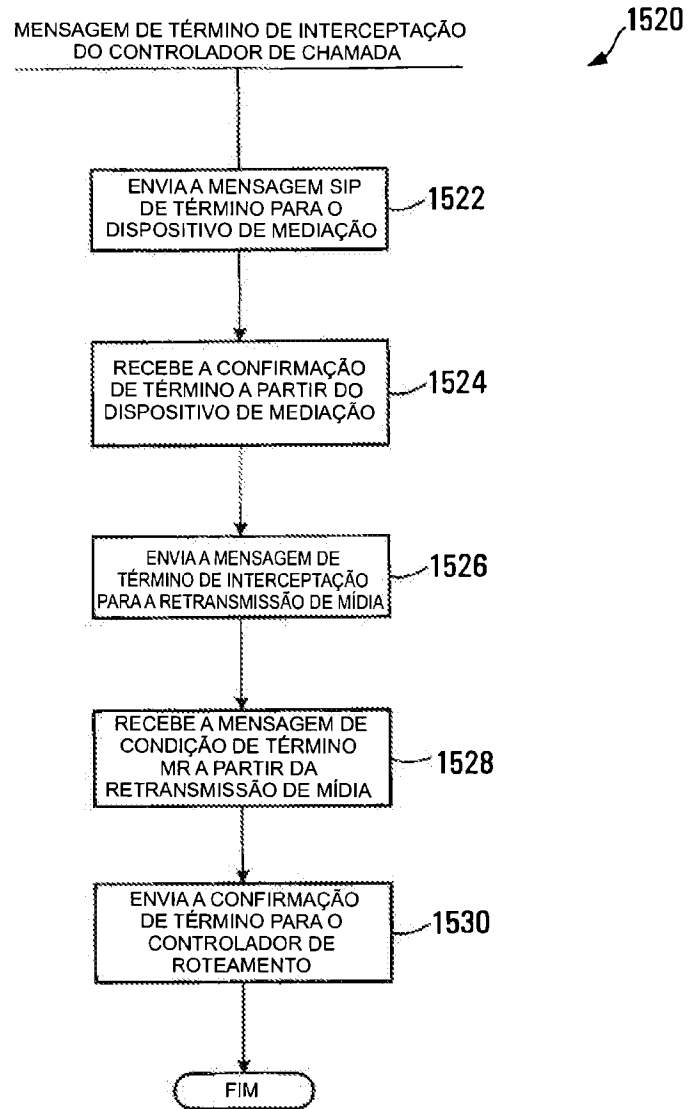
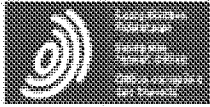

FIG. 47

RESUMO

Patente de Invenção: **"INTERCEPTANDO COMUNICAÇÕES DE VOZ VIA IP E OUTRAS COMUNICAÇÕES DE DADOS"**.

A presente invenção refere-se a métodos e aparelho para interceptar comunicações em uma rede de Protocolo de Internet (IP) que envolvem manter perfis de discagem para os respectivos assinantes da rede IP, cada perfil de discagem incluindo um nome de usuário associado com o assinante correspondente, e associar informação de interceptação com o perfil de discagem de um assinante cujas comunicações são para serem monitoradas. A informação de interceptação irá incluir informação de determinação para determinar se intercepta uma comunicação envolvendo o assinante, e informação de destino identificando um dispositivo para o qual as comunicações interceptadas envolvendo o assinante são para serem enviadas. Quando a informação de determinação atende aos critérios de interceptação, as comunicações são estabelecidas com uma retransmissão de mídia através da qual as comunicações envolvendo o assinante serão conduzidas ou estão sendo conduzidas para fazer com que a retransmissão de mídia envie uma cópia das comunicações envolvendo o assinante para um dispositivo de mediação especificado pela informação de destino.



Espacenet

Bibliographic data: CA2668025 (A1) — 2008-05-08

PRODUCING ROUTING MESSAGES FOR VOICE OVER IP COMMUNICATIONS

Inventor(s): ARAFA FUAD [CA]; BJORSELL JOHAN EMIL VICTOR [CA]; THOMSON ROD [CA]; PERREAULT CLAY [PA]; NICHOLSON STEVE [NZ] ± (ARAFA, FUAD, ; BJORSELL, JOHAN EMIL VICTOR, ; THOMSON, ROD, ; PERREAULT, CLAY, ; NICHOLSON, STEVE)

Applicant(s): DIGIFONICA INTERNATIONAL LTD [CA] ± (DIGIFONICA (INTERNATIONAL) LIMITED)

Classification: - international: H04L12/14; H04L12/66; H04M11/06; H04M15/00; H04Q3/64
 - cooperative: H04L12/14; H04L12/1439; H04L12/1496; H04L12/66; H04L9/3226; H04M15/51; H04M15/56; H04M7/0075; H04Q3/66; H04Q3/70; H04Q2213/13091; H04Q2213/13141; H04Q2213/13196; H04Q2213/1322; H04Q2213/13384

Application number: CA20072668025 20071101

Priority number(s): US20060856212P 20061102 ; WO2007CA01956 20071101

Also published as: WO2008052340 (A1) WO2008052340 (A8) US2014321333 (A1) US2014010119 (A1) US2014016764 (A1) US2014016764 (A1) US8774378 (B2) US8774378 (B2) US2013329722 (A1) US2010150328 (A1) US2010150328 (A1) US8542815 (B2) US8542815 (B2) KR20090086428 (A) EP2084868 (A1) EP2084868 (A4) CN101584166 (A) BRPI0718312 (A2) less

Abstract of CA2668025 (A1)

A process and apparatus to facilitate communication between callers and callees in a system comprising a plurality of nodes with which callers and callees are associated is disclosed. In response to initiation of a call by a calling subscriber, a caller identifier and a callee identifier are received. Call classification criteria associated with the caller identifier are used to classify the call as a public network call or a private network call. A routing message identifying an address, on the private network, associated with the

PETITIONER APPLE INC. EX. 1002-1054



(86) Date de dépôt PCT/PCT Filing Date: 2007/11/01
 (87) Date publication PCT/PCT Publication Date: 2008/05/08
 (85) Entrée phase nationale/National Entry: 2009/04/30
 (86) N° demande PCT/PCT Application No.: CA 2007/001956
 (87) N° publication PCT/PCT Publication No.: 2008/052340
 (30) Priorité/Priority: 2006/11/02 (US60/856,212)

(51) Cl.Int./Int.Cl. *H04L 12/66* (2006.01),
H04L 12/14 (2006.01), *H04M 11/06* (2006.01),
H04M 15/00 (2006.01), *H04Q 3/64* (2006.01)
 (71) Demandeur/Applicant:
 DIGIFONICA (INTERNATIONAL) LIMITED, CA
 (72) Inventeurs/Inventors:
 PERREAU, CLAY, PA;
 NICHOLSON, STEVE, NZ;
 BJORSELL, JOHAN EMIL VICTOR, CA;
 ARAFA, FUAD, CA;
 THOMSON, ROD, CA
 (74) Agent: SMART & BIGGAR

(54) Titre : PRODUCTION DE MESSAGES DE ROUTAGE POUR DES COMMUNICATIONS PAR VOIX SUR IP
 (54) Title: PRODUCING ROUTING MESSAGES FOR VOICE OVER IP COMMUNICATIONS

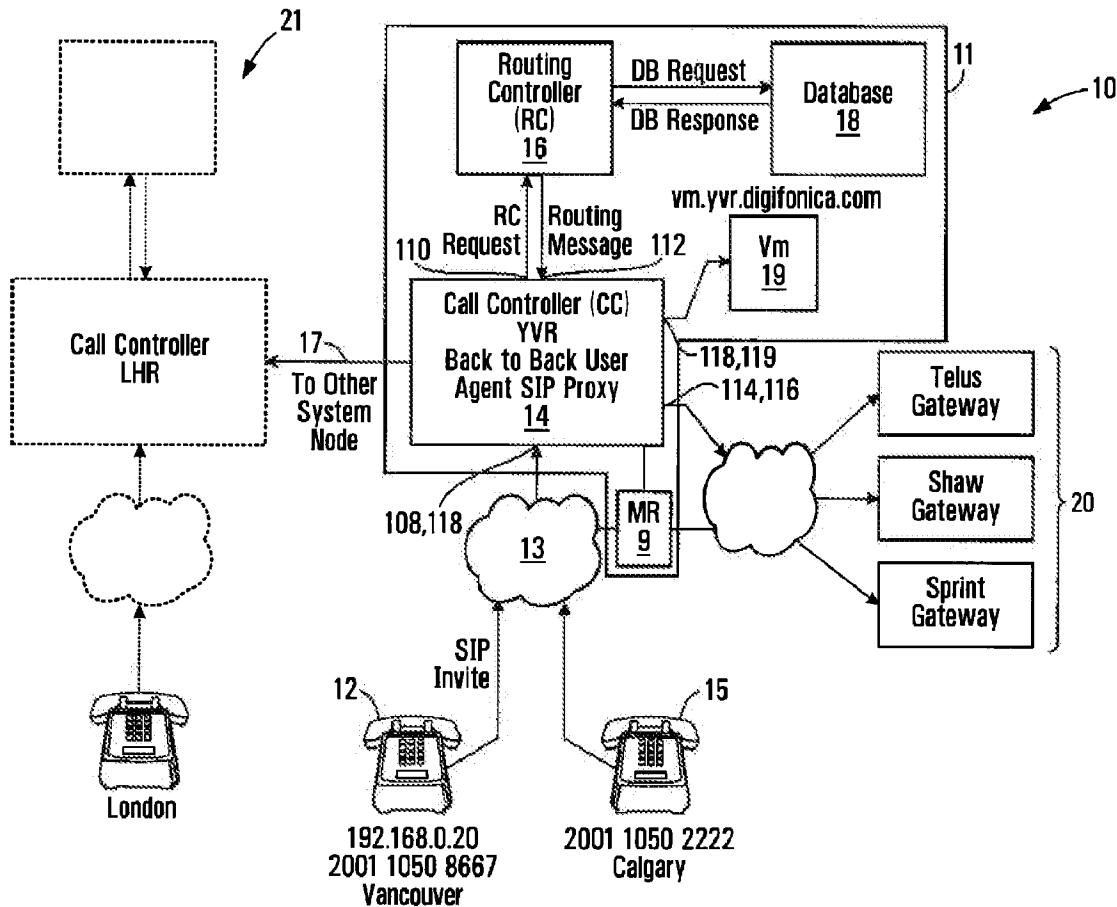

(57) Abrégé/Abstract:

A process and apparatus to facilitate communication between callers and callees in a system comprising a plurality of nodes with which callers and callees are associated is disclosed. In response to initiation of a call by a calling subscriber, a caller identifier and a



(57) **Abrégé(suite)/Abstract(continued):**

callee identifier are received. Call classification criteria associated with the caller identifier are used to classify the call as a public network call or a private network call. A routing message identifying an address, on the private network, associated with the callee is produced when the call is classified as a private network call and a routing message identifying a gateway to the public network is produced when the call is classified as a public network call.

(12) INTERNATIONAL APPLICATION PUBLISHED UNDER THE PATENT COOPERATION TREATY (PCT)

(19) World Intellectual Property Organization
International Bureau



(43) International Publication Date
8 May 2008 (08.05.2008)

PCT

(10) International Publication Number
WO 2008/052340 A1

- (51) **International Patent Classification:**
H04L 12/66 (2006.01) *H04M 15/00* (2006.01)
H04L 12/14 (2006.01) *H04Q 3/64* (2006.01)
H04M 11/06 (2006.01)
- (21) **International Application Number:**
PCT/CA2007/001956
- (22) **International Filing Date:**
1 November 2007 (01.11.2007)
- (25) **Filing Language:** English
- (26) **Publication Language:** English
- (30) **Priority Data:**
60/856,212 2 November 2006 (02.11.2006) US
- (71) **Applicant (for all designated States except US): DIGIFONICA (INTERNATIONAL) LIMITED [CA/CA];** Suite 1401, 4710 Kingsway Avenue, Burnaby, British Columbia V5H 4M2 (CA).

- Columbia V7H 2N9 (CA). **BJORSELL, Johan Emil Victor** [SE/CA]; 273 West 5th Street, North Vancouver, British Columbia V7M 1J9 (CA). **ARAFU, Fuad** [CA/CA]; 305 - 3199 Willow Street, Vancouver, British Columbia V5Z 4L5 (CA).
- (74) **Agents: KNOX, John, W.** et al.; SMART & BIGGAR, Box 11560, Vancouver Centre, 650 West Georgia Street, Suite 2200, Vancouver, British Columbia V6B 4N8 (CA).
- (81) **Designated States (unless otherwise indicated, for every kind of national protection available):** AE, AG, AL, AM, AT, AU, AZ, BA, BB, BG, BH, BR, BW, BY, BZ, CA, CH, CN, CO, CR, CU, CZ, DE, DK, DM, DO, DZ, EC, EE, EG, ES, FI, GB, GD, GE, GH, GM, GT, HN, HR, HU, ID, IL, IN, IS, JP, KE, KG, KM, KN, KP, KR, KZ, LA, LC, LK, LR, LS, LT, LU, LY, MA, MD, ME, MG, MK, MN, MW, MX, MY, MZ, NA, NG, NI, NO, NZ, OM, PG, PH, PL, PT, RO, RS, RU, SC, SD, SE, SG, SK, SL, SM, SV, SY, TJ, TM, TN, TR, TT, TZ, UA, UG, US, UZ, VC, VN, ZA, ZM, ZW.
- (84) **Designated States (unless otherwise indicated, for every kind of regional protection available):** ARIPO (BW, GI, GM, KE, LS, MW, MZ, NA, SD, SL, SZ, TZ, UG, ZM, ZW), Eurasian (AM, AZ, BY, KG, KZ, MD, RU, TJ, TM), European (AT, BE, BG, CH, CY, CZ, DE, DK, EE, ES, FI, FR, GB, GR, HU, IE, IS, IT, LT, LU, LV, MC, MT, NL, PL,

- (72) **Inventors; and**
- (75) **Inventors/Applicants (for US only): PERREAULT, Clay** [CA/GB]; Suite #5 Keats Avenue, London, E161TW (GB). **NICHOLSON, Steve** [CA/CA]; Suite #5 Keats Avenue, London, E161TW (CA). **THOMSON, Rod** [CA/CA]; 3320 Garabaldi Drive, North Vancouver, British Columbia V7H 2N9 (CA).

[Continued on next page]

(54) Title: PRODUCING ROUTING MESSAGES FOR VOICE OVER IP COMMUNICATIONS

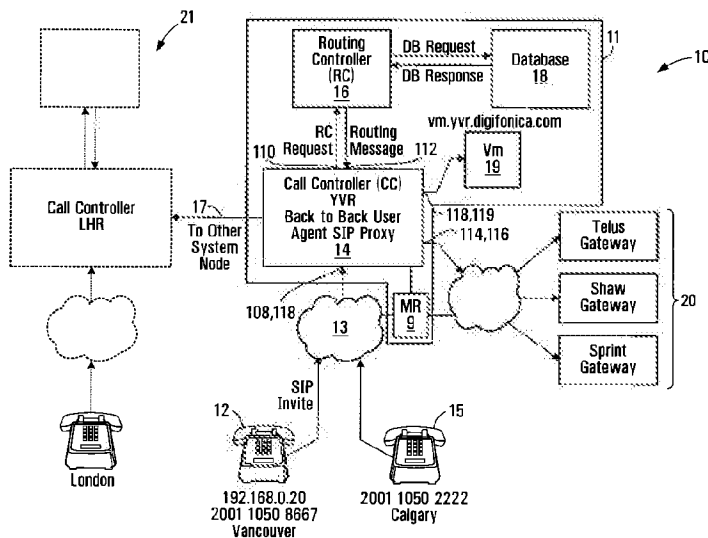

(57) **Abstract:** A process and apparatus to facilitate communication between callers and callees in a system comprising a plurality of nodes with which callers and callees are associated is disclosed. In response to initiation of a call by a calling subscriber, a caller identifier and a callee identifier are received. Call classification criteria associated with the caller identifier are used to classify the call as a public network call or a private network call. A routing message identifying an address, on the private network, associated with the callee is produced when the call is classified as a private network call and a routing message identifying a gateway to the public network is produced when the call is classified as a public network call.

WO 2008/052340 A1

WO 2008/052340 A1



PT, RO, SE, SI, SK, TR), OAPI (BF, BJ, CF, CG, CI, CM,
GA, GN, GQ, GW, ML, MR, NE, SN, TD, TG).

Published:

- with *international search report*
- with *amended claims*

-1-

PRODUCING ROUTING MESSAGES FOR VOICE OVER IP COMMUNICATIONS

BACKGROUND OF THE INVENTION

5 1. Field of Invention

This invention relates to voice over IP communications and methods and apparatus for routing and billing.

2. Description of Related Art

10 Internet protocol (IP) telephones are typically personal computer (PC) based telephones connected within an IP network, such as the public Internet or a private network of a large organization. These IP telephones have installed "voice-over-IP" (VoIP) software enabling them to make and receive voice calls and send and receive information in data and video formats.

15 IP telephony switches installed within the IP network enable voice calls to be made within or between IP networks, and between an IP network and a switched circuit network (SCN), such as the public switched telephone network (PSTN). If the IP switch supports the Signaling System 7 (SS7)
20 protocol, the IP telephone can also access PSTN databases.

The PSTN network typically includes complex network nodes that contain all information about a local calling service area including user authentication and call routing. The PSTN network typically aggregates all information and
25 traffic into a single location or node, processes it locally and then passes it on to other network nodes, as necessary, by maintaining route tables at the node. PSTN nodes are redundant by design and thus provide reliable service, but if a node should fail due to an earthquake or other natural disaster, significant, if not complete service outages can occur, with no other nodes
30 being able to take up the load.

-2-

Existing VoIP systems do not allow for high availability and resiliency in delivering Voice Over IP based Session Initiation Protocol (SIP) Protocol service over a geographically dispersed area such as a city, region or continent. Most resiliency originates from the provision of IP based telephone services to one location or a small number of locations such as a single office or network of branch offices.

SUMMARY OF THE INVENTION

In accordance with one aspect of the invention, there is provided a process for operating a call routing controller to facilitate communication between callers and callees in a system comprising a plurality of nodes with which callers and callees are associated. The process involves, in response to initiation of a call by a calling subscriber, receiving a caller identifier and a callee identifier. The process also involves using call classification criteria associated with the caller identifier to classify the call as a public network call or a private network call. The process further involves producing a routing message identifying an address, on the private network, associated with the callee when the call is classified as a private network call. The process also involves producing a routing message identifying a gateway to the public network when the call is classified as a public network call.

The process may involve receiving a request to establish a call, from a call controller in communication with a caller identified by the callee identifier.

Using the call classification criteria may involve searching a database to locate a record identifying calling attributes associated with a caller identified by the caller identifier.

Locating a record may involve locating a caller dialing profile comprising a username associated with the caller, a domain associated with the caller, and at least one calling attribute.

-3-

Using the call classification criteria may involve comparing calling attributes associated with the caller dialing profile with aspects of the callee identifier.

5 Comparing may involve determining whether the callee identifier includes a portion that matches an IDD associated with the caller dialing profile.

Comparing may involve determining whether the callee identifier includes a portion that matches an NDD associated with the caller dialing profile.

10 Comparing may involve determining whether the callee identifier includes a portion that matches an area code associated with the caller dialing profile.

Comparing may involve determining whether the callee identifier has a length within a range specified in the caller dialing profile.

15 The process may involve formatting the callee identifier into a pre-defined digit format to produce a re-formatted callee identifier.

20 Formatting may involve removing an international dialing digit from the callee identifier, when the callee identifier begins with a digit matching an international dialing digit specified by the caller dialing profile associated with the caller.

25 Formatting may involve removing a national dialing digit from the callee identifier and prepending a caller country code to the callee identifier when the callee identifier begins with a national dialing digit.

30 Formatting may involve prepending a caller country code to the callee identifier when the callee identifier begins with digits identifying an area code specified by the caller dialing profile.

-4-

5 Formatting may involve prepending a caller country code and an area code to the callee identifier when the callee identifier has a length that matches a caller dialing number format specified by the caller dialing profile and only one area code is specified as being associated with the caller in the caller dialing profile.

The process may involve classifying the call as a private network call when the re-formatted callee identifier identifies a subscriber to the private network.

10 The process may involve determining whether the callee identifier complies with a pre-defined username format and if so, classifying the call as a private network call.

15 The process may involve causing a database of records to be searched to locate a direct in dial (DID) bank table record associating a public telephone number with the reformatted callee identifier and if the DID bank table record is found, classifying the call as a private network call and if a DID bank table record is not found, classifying the call as a public network call.

20 Producing the routing message identifying a node on the private network may involve setting a callee identifier in response to a username associated with the DID bank table record.

25 Producing the routing message may involve determining whether a node associated with the reformatted callee identifier is the same as a node associated the caller identifier.

30 Determining whether a node associated with the reformatted callee identifier is the same as a node associated the caller identifier may involve determining whether a prefix of the re-formatted callee identifier matches a corresponding prefix of a username associated with the caller dialing profile.

-5-

5 When the node associated with the caller is not the same as the node associated with the callee, the process involves producing a routing message including the caller identifier, the reformatted callee identifier and an identification of a private network node associated with the callee and communicating the routing message to a call controller.

10 When the node associated with the caller is the same as the node associated with the callee, the process involves determining whether to perform at least one of the following: forward the call to another party, block the call and direct the caller to a voicemail server associated with the callee.

15 Producing the routing message may involve producing a routing message having an identification of at least one of the callee identifier, an identification of a party to whom the call should be forwarded and an identification of a voicemail server associated with the callee.

The process may involve communicating the routing message to a call controller.

20 Producing a routing message identifying a gateway to the public network may involve searching a database of route records associating route identifiers with dialing codes to find a route record having a dialing code having a number pattern matching at least a portion of the reformatted callee identifier.

25 The process may involve searching a database of supplier records associating supplier identifiers with the route identifiers to locate at least one supplier record associated with the route identifier associated with the route record having a dialing code having a number pattern matching at least a portion of the reformatted callee identifier.

30 The process may involve loading a routing message buffer with the reformatted callee identifier and an identification of specific routes associated

-6-

respective ones of the supplier records associated with the route record and loading the routing message buffer with a time value and a timeout value.

5 The process may involve communicating a routing message involving the contents of the routing message buffer to a call controller.

10 The process may involve causing the dialing profile to include a maximum concurrent call value and a concurrent call count value and causing the concurrent call count value to be incremented when the user associated with the dialing profile initiates a call and causing the concurrent call count value to be decremented when a call with the user associated with the dialing profile is ended.

15 In accordance with another aspect of the invention, there is provided a call routing apparatus for facilitating communications between callers and callees in a system comprising a plurality of nodes with which callers and callees are associated. The apparatus includes receiving provisions for receiving a caller identifier and a callee identifier, in response to initiation of a call by a calling subscriber. The apparatus also includes classifying provisions for classifying
20 the call as a private network call or a public network call according to call classification criteria associated with the caller identifier. The apparatus further includes provisions for producing a routing message identifying an address, on the private network, associated with the callee when the call is classified as a private network call. The apparatus also includes provisions for
25 producing a routing message identifying a gateway to the public network when the call is classified as a public network call.

30 The receiving provisions may be operably configured to receive a request to establish a call, from a call controller in communication with a caller identified by the callee identifier.

-7-

The apparatus may further include searching provisions for searching a database including records associating calling attributes with subscribers to the private network to locate a record identifying calling attributes associated with a caller identified by the caller identifier.

5

The records may include dialing profiles each including a username associated with the subscriber, an identification of a domain associated with the subscriber, and an identification of at least one calling attribute associated with the subscriber.

10

The call classification provisions may be operably configured to compare calling attributes associated with the caller dialing profile with aspects of the callee identifier.

15

The calling attributes may include an international dialing digit and call classification provisions may be operably configured to determine whether the callee identifier includes a portion that matches an IDD associated with the caller dialing profile.

20

The calling attributes may include a national dialing digit and the call classification provisions may be operably configured to determine whether the callee identifier includes a portion that matches an NDD associated with the caller dialing profile.

25

The calling attributes may include an area code and the call classification provisions may be operably configured to determine whether the callee identifier includes a portion that matches an area code associated with the caller dialing profile.

30

The calling attribute may include a number length range and the call classification provisions may be operably configured to determine whether the

-8-

callee identifier has a length within a number length range specified in the caller dialing profile.

5 The apparatus may further include formatting provisions for formatting the callee identifier into a pre-defined digit format to produce a re-formatted callee identifier.

10 The formatting provisions may be operably configured to remove an international dialing digit from the callee identifier, when the callee identifier begins with a digit matching an international dialing digit specified by the caller dialing profile associated with the caller.

15 The formatting provisions may be operably configured to remove a national dialing digit from the callee identifier and prepend a caller country code to the callee identifier when the callee identifier begins with a national dialing digit.

20 The formatting provisions may be operably configured to prepend a caller country code to the callee identifier when the callee identifier begins with digits identifying an area code specified by the caller dialing profile.

25 The formatting provisions may be operably configured to prepend a caller country code and area code to the callee identifier when the callee identifier has a length that matches a caller dialing number format specified by the caller dialing profile and only one area code is specified as being associated with the caller in the caller dialing profile.

30 The classifying provisions may be operably configured to classify the call as a private network call when the re-formatted callee identifier identifies a subscriber to the private network.

-9-

The classifying provisions may be operably configured to classify the call as a private network call when the callee identifier complies with a pre-defined username format.

5 The apparatus may further include searching provisions for searching a database of records to locate a direct in dial (DID) bank table record associating a public telephone number with the reformatted callee identifier and the classifying provisions may be operably configured to classify the call as a private network call when the DID bank table record is found and to
10 classify the call as a public network call when a DID bank table record is not found

The private network routing message producing provisions may be operably configured to produce a routing message having a callee identifier set
15 according to a username associated with the DID bank table record.

The private network routing message producing provisions may be operably configured to determine whether a node associated with the reformatted callee identifier is the same as a node associated the caller identifier.
20

The private network routing provisions may include provisions for determining whether a prefix of the re-formatted callee identifier matches a corresponding prefix of a username associated with the caller dialing profile.

25 The private network routing message producing provisions may be operably configured to produce a routing message including the caller identifier, the reformatted callee identifier and an identification of a private network node associated with the callee and to communicate the routing message to a call controller.

30 The private network routing message producing provisions may be operably configured to perform at least one of the following forward the call to another

-10-

party, block the call and direct the caller to a voicemail server associated with the callee, when the node associated with the caller is the same as the node associated with the callee.

5 The provisions for producing the private network routing message may be operably configured to produce a routing message having an identification of at least one of the callee identifier, an identification of a party to whom the call should be forwarded and an identification of a voicemail server associated with the callee.

10

The apparatus further includes provisions for communicating the routing message to a call controller.

15 The provisions for producing a public network routing message identifying a gateway to the public network may include provisions for searching a database of route records associating route identifiers with dialing codes to find a route record having a dialing code having a number pattern matching at least a portion of the reformatted callee identifier.

20 The apparatus further includes provisions for searching a database of supplier records associating supplier identifiers with the route identifiers to locate at least one supplier record associated with the route identifier associated with the route record having a dialing code having a number pattern matching at least a portion of the reformatted callee identifier.

25

The apparatus further includes a routing message buffer and provisions for loading the routing message buffer with the reformatted callee identifier and an identification of specific routes associated respective ones of the supplier records associated with the route record and loading the routing message buffer with a time value and a timeout value.

30

-11-

The apparatus further includes provisions for communicating a routing message including the contents of the routing message buffer to a call controller.

5 The apparatus further includes means for causing said dialing profile to include a maximum concurrent call value and a concurrent call count value and for causing said concurrent call count value to be incremented when the user associated with said dialing profile initiates a call and for causing said concurrent call count value to be decremented when a call with said user
10 associated with said dialing profile is ended.

In accordance with another aspect of the invention, there is provided a data structure for access by an apparatus for producing a routing message for use by a call routing controller in a communications system. The data structure
15 includes dialing profile records comprising fields for associating with respective subscribers to the system, a subscriber user name, direct-in-dial records comprising fields for associating with respective subscriber usernames, a user domain and a direct-in-dial number, prefix to node records comprising fields for associating with at least a portion of the respective
20 subscriber usernames, a node address of a node in the system, whereby a subscriber name can be used to find a user domain, at least a portion of the a subscriber name can be used to find a node with which the subscriber identified by the subscriber name is associated, and a user domain and subscriber name can be located in response to a direct-in-dial number.

25 In accordance with another aspect of the invention, there is provided a data structure for access by an apparatus for producing a routing message for use by a call routing controller in a communications system. The data structure includes master list records comprising fields for associating a dialing code with respective master list identifiers and supplier list records linked to master
30 list records by the master list identifiers, said supplier list records comprising fields for associating with a communications services supplier, a supplier id, a

-12-

master list id, a route identifier and a billing rate code, whereby communications services suppliers are associated with dialing codes, such that dialing codes can be used to locate suppliers capable of providing a communications link associated with a given dialing code.

5

In accordance with another aspect of the invention, there is provided a method for determining a time to permit a communication session to be conducted. The method involves calculating a cost per unit time, calculating a first time value as a sum of a free time attributed to a participant in the communication session and the quotient of a funds balance held by the participant to the cost per unit time value and producing a second time value in response to the first time value and a billing pattern associated with the participant, the billing pattern including first and second billing intervals and the second time value being the time to permit a communication session to be conducted.

10

15

Calculating the first time value may involve retrieving a record associated with the participant and obtaining from the record at least one of the free time and the funds balance.

20

Producing the second time value may involve producing a remainder value representing a portion of the second billing interval remaining after dividing the second billing interval into a difference between the first time value and the first billing interval.

25

Producing the second time value may involve setting a difference between the first time value and the remainder as the second time value.

30

The method may further involve setting the second time value to zero when the remainder is greater than zero and the first time value is less than the free time associated with the participant.

-13-

Calculating the cost per unit time may involve locating a record in a database, the record comprising a markup type indicator, a markup value and a billing pattern and setting a reseller rate equal to the sum of the markup value and the buffer rate.

5

Locating the record in a database may involve locating at least one of a record associated with a reseller and a route associated with the reseller, a record associated with the reseller and a default reseller markup record.

10

Calculating the cost per unit time value further may involve locating at least one of an override record specifying a route cost per unit time amount associated with a route associated with the communication session, a reseller record associated with a reseller of the communications session, the reseller record specifying a reseller cost per unit time associated with the reseller for the communication session, a default operator markup record specifying a default cost per unit time.

15

The method may further involve setting as the cost per unit time the sum of the reseller rate and at least one of the route cost per unit time, the reseller cost per unit time and the default cost per unit time.

20

The method may further involve receiving a communication session time representing a duration of the communication session and incrementing a reseller balance by the product of the reseller rate and the communication session time.

25

The method may further involve receiving a communication session time representing a duration of the communication session and incrementing a system operator balance by a product of the buffer rate and the communication session time.

30

-14-

In accordance with another aspect of the invention, there is provided an apparatus for determining a time to permit a communication session to be conducted. The apparatus includes a processor circuit, a computer readable medium coupled to the processor circuit and encoded with instructions for directing the processor circuit to calculate a cost per unit time for the communication session, calculate a first time value as a sum of a free time attributed to a participant in the communication session and the quotient of a funds balance held by the participant to the cost per unit time value and produce a second time value in response to the first time value and a billing pattern associated with the participant, the billing pattern including first and second billing intervals and the second time value being the time to permit a communication session to be conducted.

The instructions may include instructions for directing the processor circuit to retrieve a record associated with the participant and obtain from the record at least one of the free time and the funds balance.

The instructions may include instructions for directing the processor circuit to produce the second time value by producing a remainder value representing a portion of the second billing interval remaining after dividing the second billing interval into a difference between the first time value and the first billing interval.

The instructions may include instructions for directing the processor circuit to produce the second time value comprises setting a difference between the first time value and the remainder as the second time value.

The instructions may include instructions for directing the processor circuit to set the second time value to zero when the remainder is greater than zero and the first time value is less than the free time associated with the participant.

-15-

5 The instructions for directing the processor circuit to calculate the cost per unit time may include instructions for directing the processor circuit to locate a record in a database, the record comprising a markup type indicator, a markup value and a billing pattern and set a reseller rate equal to the sum of the markup value and the buffer rate.

10 The instructions for directing the processor circuit to locate the record in a database may include instructions for directing the processor circuit to locate at least one of a record associated with a reseller and a route associated with the reseller, a record associated with the reseller, and a default reseller markup record. The instructions for directing the processor circuit to calculate the cost per unit time value may further include instructions for directing the processor circuit to locate at least one of an override record specifying a route cost per unit time amount associated with a route associated with the communication session, a reseller record associated with a reseller of the communications session, the reseller record specifying a reseller cost per unit time associated with the reseller for the communication session, a default operator markup record specifying a default cost per unit time.

20 The instructions may include instructions for directing the processor circuit to set as the cost per unit time the sum of the reseller rate and at least one of the route cost per unit time, the reseller cost per unit time and the default cost per unit time.

25 The instructions may include instructions for directing the processor circuit to receive a communication session time representing a duration of the communication session and increment a reseller balance by the product of the reseller rate and the communication session time.

30 The instructions may include instructions for directing the processor circuit to receive a communication session time representing a duration of the

-16-

communication session and increment a system operator balance by a product of the buffer rate and the communication session time.

5 In accordance with another aspect of the invention, there is provided a process for attributing charges for communications services. The process involves determining a first chargeable time in response to a communication session time and a pre-defined billing pattern, determining a user cost value in response to the first chargeable time and a free time value associated with a user of the communications services, changing an account balance associated with the user in response to a user cost per unit time. The process may further involve changing an account balance associated with a reseller of the communications services in response to a reseller cost per unit time and the communication session time and changing an account balance associated with an operator of the communications services in response to an operator cost per unit time and the communication session time.

10

15

Determining the first chargeable time may involve locating at least one of an override record specifying a route cost per unit time and billing pattern associated with a route associated with the communication session, a reseller record associated with a reseller of the communications session, the reseller record specifying a reseller cost per unit time and billing pattern associated with the reseller for the communication session and a default record specifying a default cost per unit time and billing pattern and setting as the pre-defined billing pattern the billing pattern of the record located. The billing pattern of the record located may involve a first billing interval and a second billing interval.

20

25

Determining the first chargeable time may involve setting the first chargeable time equal to the first billing interval when the communication session time is less than or equal to the first billing interval.

30

-17-

5 Determining the first chargeable time may involve producing a remainder value representing a portion of the second billing interval remaining after dividing the second billing interval into a difference between communication session time and the first interval when the communication session time is greater than the communication session time and setting the first chargeable time to a difference between the communication session time and the remainder when the remainder is greater than zero and setting the first chargeable time to the communication session time when the remainder is not greater than zero.

10

The process may further involve determining a second chargeable time in response to the first chargeable time and the free time value associated with the user of the communications services when the first chargeable time is greater than or equal to the free time value associated with the user of the communications services.

15

Determining the second chargeable time may involve setting the second chargeable time to a difference between the first chargeable time.

20 The process may further involve resetting the free time value associated with the user to zero when the first chargeable time is greater than or equal to the free time value associated with the user of the communications services.

25

Changing an account balance associated with the user may involve calculating a user cost value in response to the second chargeable time and the user cost per unit time.

30

The process may further involve changing a user free cost balance in response to the user cost value.

The process may further involve setting the user cost to zero when the first chargeable time is less than the free time value associated with the user.

-18-

The process may further involve changing a user free time balance in response to the first chargeable time.

5 In accordance with another aspect of the invention, there is provided an apparatus for attributing charges for communications services. The apparatus includes a processor circuit, a computer readable medium in communication with the processor circuit and encoded with instructions for directing the processor circuit to determine a first chargeable time in response to a
10 communication session time and a pre-defined billing pattern, determine a user cost value in response to the first chargeable time and a free time value associated with a user of the communications services, change an account balance associated with the user in response to a user cost per unit time.

15 The instructions may further include instructions for changing an account balance associated with a reseller of the communications services in response to a reseller cost per unit time and the communication session time and changing an account balance associated with an operator of the communications services in response to an operator cost per unit time and
20 the communication session time.

The instructions for directing the processor circuit to determine the first chargeable time may further include instructions for causing the processor circuit to communicate with a database to locate at least one of an override
25 record specifying a route cost per unit time and billing pattern associated with a route associated with the communication session, a reseller record associated with a reseller of the communications session, the reseller record specifying a reseller cost per unit time and billing pattern associated with the reseller for the communication session and a default record specifying a
30 default cost per unit time and billing pattern and instructions for setting as the pre-defined billing pattern the billing pattern of the record located. The billing

-19-

pattern of the record located may include a first billing interval and a second billing interval.

5 The instructions for causing the processor circuit to determine the first chargeable time may include instructions for directing the processor circuit to set the first chargeable time equal to the first billing interval when the communication session time is less than or equal to the first billing interval.

10 The instructions for causing the processor circuit to determine the first chargeable time may include instructions for producing a remainder value representing a portion of the second billing interval remaining after dividing the second billing interval into a difference between communication session time and the first interval when the communication session time is greater than the communication session time and instructions for causing the
15 processor circuit to set the first chargeable time to a difference between the communication session time and the remainder when the remainder is greater than zero and instructions for causing the processor circuit to set the first chargeable time to the communication session time when the remainder is not greater than zero.

20 The instructions may further include instructions for causing the processor circuit to determine a second chargeable time in response to the first chargeable time and the free time value associated with the user of the communications services when the first chargeable time is greater than or
25 equal to the free time value associated with the user of the communications services.

30 The instructions for causing the processor circuit to determine the second chargeable time may include instructions for causing the processor circuit to set the second chargeable time to a difference between the first chargeable time.

-20-

The instructions may further include instructions for causing the processor circuit to reset the free time value associated with the user to zero when the first chargeable time is greater than or equal to the free time value associated with the user of the communications services.

5

The instructions for causing the processor circuit to change an account balance associated with the user may include instructions for causing the processor circuit to calculate a user cost value in response to the second chargeable time and the user cost per unit time.

10

The instructions may further include instructions for causing the processor circuit to change a user free cost balance in response to the user cost value.

15

The instructions may further include instructions for causing the processor circuit to set the user cost to zero when the first chargeable time is less than the free time value associated with the user.

20

The instructions may further include instructions for causing the processor circuit to change a user free time balance in response to the first chargeable time.

25

In accordance with another aspect of the invention, there is provided a computer readable medium encoded with codes for directing a processor circuit to execute one or more of the methods described above and/or variants thereof.

30

Other aspects and features of the present invention will become apparent to those ordinarily skilled in the art upon review of the following description of specific embodiments of the invention in conjunction with the accompanying figures.

-21-

BRIEF DESCRIPTION OF THE DRAWINGS

In drawings which illustrate embodiments of the invention,

- 5 **Figure 1** is a block diagram of a system according to a first embodiment of the invention;
- Figure 2** is a block diagram of a caller telephone according to the first embodiment of the invention;
- 10 **Figure 3** is a schematic representation of a SIP invite message transmitted between the caller telephone and a controller shown in **Figure 1**;
- Figure 4** is a block diagram of a call controller shown in **Figure 1**;
- 15 **Figure 5** is a flowchart of a process executed by the call controller shown in **Figure 1**;
- Figure 6** is a schematic representation of a routing, billing and rating (RC) request message produced by the call controller shown in **Figure 1**;
- 20 **Figure 7** is a block diagram of a processor circuit of a routing, billing, rating element of the system shown in **Figure 1**;
- 25 **Figures 8A-8D** is a flowchart of a RC request message handler executed by the RC processor circuit shown in **Figure 7**;
- Figure 9** is a tabular representation of a dialing profile stored in a database accessible by the RC shown in **Figure 1**;
- 30 **Figure 10** is a tabular representation of a dialing profile for a caller using the caller telephone shown in **Figure 1**;

-22-

- Figure 11 is a tabular representation of a callee profile for a callee located in Calgary;
- 5 Figure 12 is a tabular representation of a callee profile for a callee located in London;
- Figure 13 is a tabular representation of a Direct-in-Dial (DID) bank table record stored in the database shown in Figure 1;
- 10 Figure 14 is a tabular representation of an exemplary DID bank table record for the Calgary callee referenced in Figure 11;
- Figure 15 is a tabular representation of a routing message transmitted from the RC to the call controller shown in Figure 1;
- 15 Figure 16 is a schematic representation of a routing message buffer holding a routing message for routing a call to the Calgary callee referenced in Figure 11;
- 20 Figure 17 is a tabular representation of a prefix to supernode table record stored in the database shown in Figure 1;
- Figure 18 is a tabular representation of a prefix to supernode table record that would be used for the Calgary callee referenced in Figure 11;
- 25 Figure 19 is a tabular representation of a master list record stored in a master list table in the database shown in Figure 1;
- 30 Figure 20 is a tabular representation of a populated master list record;

-23-

- Figure 21 is a tabular representation of a suppliers list record stored in the database shown in Figure 1;
- 5 Figure 22 is a tabular representation of a specific supplier list record for a first supplier;
- Figure 23 is a tabular representation of a specific supplier list record for a second supplier;
- 10 Figure 24 is a tabular representation of a specific supplier list record for a third supplier;
- Figure 25 is a schematic representation of a routing message, held in a routing message buffer, identifying to the controller a plurality of possible suppliers that may carry the call;
- 15 Figure 26 is a tabular representation of a call block table record;
- Figure 27 is a tabular representation of a call block table record for the Calgary callee;
- 20 Figure 28 is a tabular representation of a call forwarding table record;
- Figure 29 is a tabular representation of a call forwarding table record specific for the Calgary callee;
- 25 Figure 30 is a tabular representation of a voicemail table record specifying voicemail parameters to enable the caller to leave a voicemail message for the callee;
- 30 Figure 31 is a tabular representation of a voicemail table record specific to the Calgary callee;

-24-

- 5
Figure 32 is a schematic representation of an exemplary routing message, held in a routing message buffer, indicating call forwarding numbers and a voicemail server identifier;
- Figures 33A and 33B are respective portions of a flowchart of a process executed by the RC processor for determining a time to live value;
- 10
Figure 34 is a tabular representation of a subscriber bundle table record;
- Figure 35 is a tabular representation of a subscriber bundle record for the Vancouver caller;
- 15
Figure 36 is a tabular representation of a bundle override table record;
- Figure 37 is a tabular representation of bundle override record for a located master list ID;
- 20
Figure 38 is a tabular representation of a subscriber account table record;
- Figure 39 is a tabular representation of a subscriber account record for the Vancouver caller;
- 25
Figure 40 is a flowchart of a process for producing a second time value executed by the RC processor circuit shown in Figure 7;
- Figure 41 is a flowchart for calculating a call cost per unit time;
- 30
Figure 42 is a tabular representation of a system operator special rates table record;

-25-

- Figure 43 is a tabular representation of a system operator special rates table record for a reseller named Klondike;
- 5 Figure 44 is a tabular representation of a system operator mark-up table record;
- Figure 45 is a tabular representation of a system operator mark-up table record for the reseller Klondike;
- 10 Figure 46 is a tabular representation of a default system operator mark-up table record;
- Figure 47 is a tabular representation of a reseller special destinations table record;
- 15 Figure 48 is a tabular representation of a reseller special destinations table record for the reseller Klondike;
- Figure 49 is a tabular representation of a reseller global mark-up table record;
- 20 Figure 50 is a tabular representation of a reseller global mark-up table record for the reseller Klondike;
- Figure 51 is a tabular representation of a SIP bye message transmitted from either of the telephones shown in Figure 1 to the call controller;
- 25 Figure 52 is a tabular representation of a SIP bye message sent to the controller from the Calgary callee;
- 30

-26-

- Figure 53 is a flowchart of a process executed by the call controller for producing a RC stop message in response to receipt of a SIP bye message;
- 5 Figure 54 is a tabular representation of an exemplary RC call stop message;
- Figure 55 is a tabular representation of an RC call stop message for the Calgary callee;
- 10 Figures 56A and 56B are respective portions of a flowchart of a RC call stop message handling routine executed by the RC shown in Figure 1;
- Figure 57 is a tabular representation of a reseller accounts table record;
- 15 Figure 58 is a tabular representation of a reseller accounts table record for the reseller Klondike;
- Figure 59 is a tabular representation of a system operator accounts table record; and
- 20 Figure 60 is a tabular representation of a system operator accounts record for the system operator described herein.

25 **DETAILED DESCRIPTION**

Referring to Figure 1, a system for making voice over IP telephone/videophone calls is shown generally at 10. The system includes a first super node shown generally at 11 and a second super node shown generally at 21. The first super node 11 is located in geographical area, such as Vancouver, B.C., Canada for example and the second super node 21 is located in London, England, for example. Different super nodes may be located in different geographical regions throughout the world to provide

30

-27-

5 telephone/videophone service to subscribers in respective regions. These super nodes may be in communication with each other by high speed/ high data throughput links including optical fiber, satellite and/or cable links, forming a backbone to the system. These super nodes may alternatively or, in addition, be in communication with each other through conventional internet services.

10 In the embodiment shown, the Vancouver supernode **11** provides telephone/videophone service to western Canadian customers from Vancouver Island to Ontario. Another node (not shown) may be located in Eastern Canada to provide services to subscribers in that area.

15 Other nodes of the type shown may also be employed within the geographical area serviced by a supernode, to provide for call load sharing, for example within a region of the geographical area serviced by the supernode. However, in general, all nodes are similar and have the properties described below in connection with the Vancouver supernode **11**.

20 In this embodiment, the Vancouver supernode includes a call controller (C) **14**, a routing controller (RC) **16**, a database **18** and a voicemail server **19** and a media relay **9**. Each of these may be implemented as separate modules on a common computer system or by separate computers, for example. The voicemail server **19** need not be included in the node and can be provided by an outside service provider.

25
30 Subscribers such as a subscriber in Vancouver and a subscriber in Calgary communicate with the Vancouver supernode using their own internet service providers which route internet traffic from these subscribers over the internet shown generally at **13** in Figure 1. To these subscribers the Vancouver supernode is accessible at a pre-determined internet protocol (IP) address or a fully qualified domain name that can be accessed in the usual way through a subscriber's internet service provider. The subscriber in Vancouver uses a

-28-

telephone **12** that is capable of communicating with the Vancouver supernode **11** using Session Initiation Protocol (SIP) messages and the Calgary subscriber uses a similar telephone **15**, in Calgary AB.

5 It should be noted that throughout the description of the embodiments of this invention, the IP/UDP addresses of all elements such as the caller and callee telephones, call controller, media relay, and any others, will be assumed to be valid IP/UDP addresses directly accessible via the Internet or a private IP network, for example, depending on the specific implementation of the system. As such, it will be assumed, for example, that the caller and callee
10 telephones will have IP/UDP addresses directly accessible by the call controllers and the media relays on their respective supernodes, and those addresses will not be obscured by Network Address Translation (NAT) or similar mechanisms. In other words, the IP/UDP information contained in SIP
15 messages (for example the SIP Invite message or the RC Request message which will be described below) will match the IP/UDP addresses of the IP packets carrying these SIP messages.

20 It will be appreciated that in many situations, the IP addresses assigned to various elements of the system may be in a private IP address space, and thus not directly accessible from other elements. Furthermore, it will also be appreciated that NAT is commonly used to share a "public" IP address between multiple devices, for example between home PCs and IP telephones sharing a single Internet connection. For example, a home PC may be
25 assigned an IP address such as **192.168.0.101** and a Voice over IP telephone may be assigned an IP address of **192.168.0.103**. These addresses are located in so called "non-routable" (IP) address space and cannot be accessed directly from the Internet. In order for these devices to communicate with other computers located on the Internet, these IP addresses have to be
30 converted into a "public" IP address, for example **24.10.10.123** assigned by the Internet Service Provider to the subscriber, by a device performing NAT, typically a home router. In addition to translating the IP addresses, NAT

-29-

typically also translates UDP port numbers, for example an audio path originating at a VoIP telephone and using a UDP port **12378** at its private IP address, may have be translated to a UDP port **23465** associated with the public IP address of the NAT device. In other words, when a packet
5 originating from the above VoIP telephone arrives at an Internet-based supernode, the source IP/UDP address contained in the IP packet header will be **24.10.10.1:23465**, whereas the source IP/UDP address information contained in the SIP message inside this IP packet will be **192.168.0.103:12378**. The mismatch in the IP/UDP addresses may cause a
10 problem for SIP-based VoIP systems because, for example, a supernode will attempt to send messages to a private address of a telephone but the messages will never get there.

Referring to Figure 1, in an attempt to make a call by the Vancouver
15 telephone/videophone **12** to the Calgary telephone/videophone **15**, the Vancouver telephone/videophone sends a SIP invite message to the Vancouver supernode **11** and in response, the call controller **14** sends an RC request message to the RC **16** which makes various enquiries of the database **18** to produce a routing message which is sent back to the call
20 controller **14**. The call controller **14** then communicates with the media relay **9** to cause a communications link including an audio path and a videophone (if a videopath call) to be established through the media relay to the same node, a different node or to a communications supplier gateway as shown generally
25 at **20** to carry audio, and where applicable, video traffic to the call recipient or callee.

Generally, the RC **16** executes a process to facilitate communication between callers and callees. The process involves, in response to initiation of a call by a calling subscriber, receiving a callee identifier from the calling subscriber,
30 using call classification criteria associated with the calling subscriber to classify the call as a public network call or a private network call and producing a routing message identifying an address on the private network,

-30-

associated with the callee when the call is classified as a private network call and producing a routing message identifying a gateway to the public network when the call is classified as a public network call.

5 Subscriber Telephone

In greater detail, referring to Figure 2, in this embodiment, the telephone/videophone 12 includes a processor circuit shown generally at 30 comprising a microprocessor 32, program memory 34, an input/output (I/O) port 36, parameter memory 38 and temporary memory 40. The program
10 memory 34, I/O port 36, parameter memory 38 and temporary memory 40 are all in communication with the microprocessor 32. The I/O port 36 has a dial input 42 for receiving a dialled telephone/videophone number from a keypad, for example, or from a voice recognition unit or from pre-stored telephone/videophone numbers stored in the parameter memory 38, for
15 example. For simplicity, in Figure 2 a box labelled dialing functions 44 represents any device capable of informing the microprocessor 32 of a callee identifier, e.g., a callee telephone/videophone number.

The processor 32 stores the callee identifier in a dialled number buffer 45. In
20 this case, assume the dialled number is 2001 1050 2222 and that it is a number associated with the Calgary subscriber. The I/O port 36 also has a handset interface 46 for receiving and producing signals from and to a handset that the user may place to his ear. This interface 46 may include a BLUETOOTH™ wireless interface, a wired interface or speaker phone, for
25 example. The handset acts as a termination point for an audio path (not shown) which will be appreciated later. The I/O port 36 also has an internet connection 48 which is preferably a high speed internet connection and is operable to connect the telephone/videophone to an internet service provider. The internet connection 48 also acts as a part of the voice path, as will be
30 appreciated later. It will be appreciated that where the subscriber device is a videophone, a separate video path is established in the same way an audio path is established. For simplicity, the following description refers to a

-31-

telephone call, but it is to be understood that a videophone call is handled similarly, with the call controller causing the media relay to facilitate both an audio path and a video path instead of only an audio path.

5 The parameter memory **38** has a username field **50**, a password field **52** an IP address field **53** and a SIP proxy address field **54**, for example. The user name field **50** is operable to hold a user name, which in this case is **2001 1050 8667**. The user name is assigned upon subscription or registration into the system and, in this embodiment, includes a twelve digit number having a
10 continent code **61**, a country code **63**, a dealer code **70** and a unique number code **74**. The continent code **61** is comprised of the first or left-most digit of the user name in this embodiment. The country code **63** is comprised of the next three digits. The dealer code **70** is comprised of the next four digits and the unique number code **74** is comprised of the last four digits. The password
15 field **52** holds a password of up to **512** characters, in this example. The IP address field **53** stores an IP address of the telephone, which for this explanation is **192.168.0.20**. The SIP proxy address field **54** holds an IP protocol compatible proxy address which may be provided to the telephone through the internet connection **48** as part of a registration procedure.

20 The program memory **34** stores blocks of codes for directing the processor **32** to carry out the functions of the telephone, one of which includes a firewall block **56** which provides firewall functions to the telephone, to prevent access by unauthorized persons to the microprocessor **32** and memories **34**, **38** and
25 **40** through the internet connection **48**. The program memory **34** also stores codes **57** for establishing a call ID. The call ID codes **57** direct the processor **32** to produce a call identifier having a format comprising a hexadecimal string at an IP address, the IP address being the IP address of the telephone. Thus, an exemplary call identifier might be **FF10@192.168.0.20**.

30 Generally, in response to picking up the handset interface **46** and activating a dialing function **44**, the microprocessor **32** produces and sends a SIP invite

-32-

message as shown in Figure 3, to the routing controller 16 shown in Figure 1. This SIP invite message is essentially to initiate a call by a calling subscriber.

5 Referring to Figure 3, the SIP invite message includes a caller ID field 60, a callee identifier field 62, a digest parameters field 64, a call ID field 65 an IP address field 67 and a caller UDP port field 69. In this embodiment, the caller ID field 60 includes the user name 2001 1050 8667 that is the Vancouver user name stored in the user name field 50 of the parameter memory 38 in the telephone 12 shown in Figure 2. In addition, referring back to Figure 3, the
10 callee identifier field 62 includes a callee identifier which in this embodiment is the user name 2001 1050 2222 that is the dialled number of the Calgary subscriber stored in the dialled number buffer 45 shown in Figure 2. The digest parameters field 64 includes digest parameters and the call ID field 65 includes a code comprising a generated prefix code (FF10) and a suffix which
15 is the Internet Protocol (IP) address of the telephone 12 stored in the IP address field 53 of the telephone. The IP address field 67 holds the IP address assigned to the telephone, in this embodiment 192.168.0.20, and the caller UDP port field 69 includes a UDP port identifier identifying a UDP port at which the audio path will be terminated at the caller's telephone.

20

Call Controller

Referring to Figure 4, a call controller circuit of the call controller 14 (Figure 1) is shown in greater detail at 100. The call controller circuit 100 includes a microprocessor 102, program memory 104 and an I/O port 106. The circuit
25 100 may include a plurality of microprocessors, a plurality of program memories and a plurality of I/O ports to be able to handle a large volume of calls. However, for simplicity, the call controller circuit 100 will be described as having only one microprocessor 102, program memory 104 and I/O port 106, it being understood that there may be more.

30

Generally, the I/O port 106 includes an input 108 for receiving messages such as the SIP invite message shown in Figure 3, from the telephone shown in

-33-

Figure 2. The I/O port 106 also has an RC request message output 110 for transmitting an RC request message to the RC 16 of Figure 1, an RC message input 112 for receiving routing messages from the RC 16, a gateway output 114 for transmitting messages to one of the gateways 20 shown in Figure 1 to advise the gateway to establish an audio path, for example, and a gateway input 116 for receiving messages from the gateway. The I/O port 106 further includes a SIP output 118 for transmitting messages to the telephone 12 to advise the telephone of the IP addresses of the gateways which will establish the audio path. The I/O port 106 further includes a voicemail server input and output 117, 119 respectively for communicating with the voicemail server 19 shown in Figure 1.

While certain inputs and outputs have been shown as separate, it will be appreciated that some may be a single IP address and IP port. For example, the messages sent to the RC 16 and received from the RC 16 may be transmitted and received on the same single IP port.

The program memory 104 includes blocks of code for directing the microprocessor 102 to carry out various functions of the call controller 14. For example, these blocks of code include a first block 120 for causing the call controller circuit 100 to execute a SIP invite to RC request process to produce an RC request message in response to a received SIP invite message. In addition, there is a routing message to gateway message block 122 which causes the call controller circuit 100 to produce a gateway query message in response to a received routing message from the RC 16.

Referring to Figure 5, the SIP invite to RC request process is shown in more detail at 120. On receipt of a SIP invite message of the type shown in Figure 3, block 122 of Figure 5 directs the call controller circuit 100 of Figure 4 to authenticate the user. This may be done, for example, by prompting the user for a password, by sending a message back to the telephone 12 which is interpreted at the telephone as a request for a password entry or the

-34-

password may automatically be sent to the call controller **14** from the telephone, in response to the message. The call controller **14** may then make enquiries of databases to which it has access, to determine whether or not the user's password matches a password stored in the database. Various
5 functions may be used to pass encryption keys or hash codes back and forth to ensure that the transmittal of passwords is secure.

Should the authentication process fail, the call controller circuit **100** is directed to an error handling routine **124** which causes messages to be displayed at
10 the telephone **12** to indicate there was an authentication problem. If the authentication procedure is passed, block **121** directs the call controller circuit **100** to determine whether or not the contents of the caller ID field **60** of the SIP invite message received from the telephone is an IP address. If it is an IP address, then block **123** directs the call controller circuit **100** to set the
15 contents of a type field variable maintained by the microprocessor **102** to a code representing that the call type is a third party invite. If at block **121** the caller ID field contents do not identify an IP address, then block **125** directs the microprocessor to set the contents of the type field to a code indicating that the call is being made by a system subscriber. Then, block **126** directs
20 the call controller circuit to read the call identifier **65** provided in the SIP invite message from the telephone **12**, and at block **128** the processor is directed to produce an RC request message that includes that call ID. Block **129** then directs the call controller circuit **100** to send the RC request to the RC **16**.

Referring to Figure **6**, an RC request message is shown generally at **150** and includes a caller field **152**, a callee field **154**, a digest field **156**, a call ID field **158** and a type field **160**. The caller, callee, digest call ID fields **152**, **154**, **156** and **158** contain copies of the caller, callee, digest parameters and call ID
25 fields **60**, **62**, **64** and **65** of the SIP invite message shown in Figure **3**. The type field **160** contains the type code established at blocks **123** or **125** of
30 Figure **5** to indicate whether the call is from a third party or system subscriber,

-35-

respectively. The caller identifier field may include a PSTN number or a system subscriber username as shown, for example.

Routing Controller (RC)

5 Referring to Figure 7, the RC 16 is shown in greater detail and includes an RC processor circuit shown generally at 200. The RC processor circuit 200 includes a processor 202, program memory 204, a table memory 206, buffer memory 207, and an I/O port 208, all in communication with the processor 202. (As earlier indicated, there may be a plurality of processor circuits (202),
10 memories (204), etc.)

The buffer memory 207 includes a caller id buffer 209 and a callee id buffer 211.

15 The I/O port 208 includes a database request port 210 through which a request to the database (18 shown in Figure 1) can be made and includes a database response port 212 for receiving a reply from the database 18. The I/O port 208 further includes an RC request message input 214 for receiving the RC request message from the call controller (14 shown in Figure 1) and
20 includes a routing message output 216 for sending a routing message back to the call controller 14. The I/O port 208 thus acts to receive caller identifier and a callee identifier contained in the RC request message from the call controller, the RC request message being received in response to initiation of a call by a calling subscriber.

25 The program memory 204 includes blocks of codes for directing the processor 202 to carry out various functions of the RC (16). One of these blocks includes an RC request message handler 250 which directs the RC to produce a routing message in response to a received RC request message.
30 The RC request message handler process is shown in greater detail at 250 in Figures 8A through 8D.

-36-

RC Request Message Handler

Referring to Figure 8A, the RC request message handler begins with a first block 252 that directs the RC processor circuit (200) to store the contents of the RC request message (150) in buffers in the buffer memory 207 of Figure 7, one of which includes the caller ID buffer 209 of Figure 7 for separately storing the contents of the callee field 154 of the RC request message. Block 254 then directs the RC processor circuit to use the contents of the caller field 152 in the RC request message shown in Figure 6, to locate and retrieve from the database 18 a record associating calling attributes with the calling subscriber. The located record may be referred to as a dialing profile for the caller. The retrieved dialing profile may then be stored in the buffer memory 207, for example.

Referring to Figure 9, an exemplary data structure for a dialing profile is shown generally at 253 and includes a user name field 258, a domain field 260, and calling attributes comprising a national dialing digits (NDD) field 262, an international dialing digits (IDD) field 264, a country code field 266, a local area codes field 267, a caller minimum local length field 268, a caller maximum local length field 270, a reseller field 273, a maximum number of concurrent calls field 275 and a current number of concurrent calls field 277. Effectively the dialing profile is a record identifying calling attributes of the caller identified by the caller identifier. More generally, dialing profiles represent calling attributes of respective subscribers.

An exemplary caller profile for the Vancouver subscriber is shown generally at 276 in Figure 10 and indicates that the user name field 258 includes the user name (2001 1050 8667) that has been assigned to the subscriber and is stored in the user name field 50 in the telephone as shown in Figure 2.

Referring back to Figure 10, the domain field 260 includes a domain name as shown at 282, including a node type identifier 284, a location code identifier 286, a system provider identifier 288 and a domain portion 290. The domain

-37-

field **260** effectively identifies a domain or node associated with the user identified by the contents of the user name field **258**.

5 In this embodiment, the node type identifier **284** includes the code "sp" identifying a supernode and the location identifier **286** identifies the supernode as being in Vancouver (YVR). The system provider identifier **288** identifies the company supplying the service and the domain portion **290** identifies the "com" domain.

10 The national dialled digit field **262** in this embodiment includes the digit "1" and, in general, includes a number specified by the International Telecommunications Union (ITU) Telecommunications Standardization Sector (ITU-T) E. **164** Recommendation which assigns national dialing digits to countries.

15 The international dialing digit field **264** includes a code also assigned according to the ITU-T according to the country or location of the user.

20 The country code field **266** also includes the digit "1" and, in general, includes a number assigned according to the ITU-T to represent the country in which the user is located.

25 The local area codes field **267** includes a list of area codes that have been assigned by the ITU-T to the geographical area in which the subscriber is located. The caller minimum and maximum local number length fields **268** and **270** hold numbers representing minimum and maximum local number lengths permitted in the area code(s) specified by the contents of the local area codes field **267**. The reseller field **273** is optional and holds a code identifying a retailer of the services, in this embodiment "Klondike". The maximum number of concurrent calls field **275** holds a code identifying the maximum number of
30 concurrent calls that the user is entitled to cause to concurrently exist. This permits more than one call to occur concurrently while all calls for the user are

-38-

billed to the same account. The current number of concurrent calls field **277** is initially **0** and is incremented each time a concurrent call associated with the user is initiated and is decremented when a concurrent call is terminated.

5 The area codes associated with the user are the area codes associated with the location code identifier **286** of the contents of the domain field **260**.

A dialing profile of the type shown in Figure **9** is produced whenever a user registers with the system or agrees to become a subscriber to the system.
10 Thus, for example, a user wishing to subscribe to the system may contact an office maintained by a system operator and personnel in the office may ask the user certain questions about his location and service preferences, whereupon tables can be used to provide office personnel with appropriate information to be entered into the user name **258**, domain **260**, NDD **262**, IDD
15 **264**, country code **266**, local area codes **267**, caller minimum and maximum local length fields **268** and **270** reseller field **273** and concurrent call fields **275** and **277** to establish a dialing profile for the user.

Referring to Figures **11** and **12**, callee dialing profiles for users in Calgary and
20 London, respectively for example, are shown.

In addition to creating dialing profiles when a user registers with the system, a direct-in-dial (DID) record of the type shown at **278** in Figure **13** is added to a direct-in-dial bank table in the database (**18** in Figure **1**) to associate the
25 username and a host name of the supernode with which the user is associated, with an E.164 number associated with the user on the PSTN network.

An exemplary DID table record entry for the Calgary callee is shown generally
30 at **300** in Figure **14**. The user name field **281** and user domain field **272** are analogous to the user name and user domain fields **258** and **260** of the caller dialing profile shown in Figure **10**. The contents of the DID field **274** include a

-39-

E.164 public telephone number including a country code **283**, an area code **285**, an exchange code **287** and a number **289**. If the user has multiple telephone numbers, then multiple records of the type shown at **300** would be included in the DID bank table, each having the same user name and user domain, but different DID field **274** contents reflecting the different telephone numbers associated with that user.

In addition to creating dialing profiles as shown in Figure **9** and DID records as shown in Figure **13** when a user registers with the system, call blocking records of the type shown in Figure **26**, call forwarding records of the type shown in Figure **28** and voicemail records of the type shown in Figure **30** may be added to the database **18** when a new subscriber is added to the system.

Referring back to Figure **8A**, after retrieving a dialing profile for the caller, such as shown at **276** in Figure **10**, the RC processor circuit **200** is directed to block **256** which directs the processor circuit (**200**) to determine whether the contents of the concurrent call field **277** are less than the contents of the maximum concurrent call field **275** of the dialing profile for the caller and, if so, block **271** directs the processor circuit to increment the contents of the concurrent call field **277**. If the contents of concurrent call field **277** are equal to or greater than the contents of the maximum concurrent call field **275**, block **259** directs the processor circuit **200** to send an error message back to the call controller (**14**) to cause the call controller to notify the caller that the maximum number of concurrent calls has been reached and no further calls can exist concurrently, including the presently requested call.

Assuming block **256** allows the call to proceed, the RC processor circuit **200** is directed to perform certain checks on the callee identifier provided by the contents of the callee field **154** in Figure **6**, of the RC request message **150**. These checks are shown in greater detail in Figure **8B**.

-40-

Referring to Figure 8B, the processor (202 in Figure 7) is directed to a first block 257 that causes it to determine whether a digit pattern of the callee identifier (154) provided in the RC request message (150) includes a pattern that matches the contents of the international dialing digits (IDD) field 264 in the caller profile shown in Figure 10. If so, then block 259 directs the processor (202) to set a call type code identifier variable maintained by the processor to indicate that the call is an international call and block 261 directs the processor to produce a reformatted callee identifier by reformatting the callee identifier into a predefined digit format. In this embodiment, this is done by removing the pattern of digits matching the IDD field contents 264 of the caller dialing profile to effectively shorten the callee identifier. Then, block 263 directs the processor 202 to determine whether or not the callee identifier has a length which meets criteria establishing it as a number compliant with the E.164 Standard set by the ITU. If the length does not meet this criteria, block 265 directs the processor 202 to send back to the call controller (14) a message indicating the length is not correct. The process is then ended. At the call controller 14, routines (not shown) stored in the program memory 104 may direct the processor (102 of Figure 4) to respond to the incorrect length message by transmitting a message back to the telephone (12 shown in Figure 1) to indicate that an invalid number has been dialled.

Still referring to Figure 8B, if the length of the amended callee identifier meets the criteria set forth at block 263, block 269 directs the processor (202 of Figure 7) to make a database request to determine whether or not the amended callee identifier is found in a record in the direct-in-dial bank (DID) table. Referring back to Figure 8B, at block 269, if the processor 202 receives a response from the database indicating that the reformatted callee identifier produced at block 261 is found in a record in the DID bank table, then the callee is a subscriber to the system and the call is classified as a private network call by directing the processor to block 279 which directs the processor to copy the contents of the corresponding user name field (281 in Figure 14) from the callee DID bank table record (300 in Figure 14) into the

-41-

callee ID buffer (211 in Figure 7). Thus, the processor 202 locates a subscriber user name associated with the reformatted callee identifier. The processor 202 is then directed to point B in Figure 8A.

5 Subscriber to Subscriber Calls Between Different Nodes

Referring to Figure 8A, block 280 directs the processor (202 of Figure 7) to execute a process to determine whether or not the node associated with the reformatted callee identifier is the same node that is associated with the caller identifier. To do this, the processor 202 determines whether or not a prefix (e.g., continent code 61) of the callee name held in the callee ID buffer (211 in Figure 7), is the same as the corresponding prefix of the caller name held in the username field 258 of the caller dialing profile shown in Figure 10. If the corresponding prefixes are not the same, block 302 in Figure 8A directs the processor (202 in Figure 7) to set a call type flag in the buffer memory (207 in Figure 7) to indicate the call is a cross-domain call. Then, block 350 of Figure 8A directs the processor (202 of Figure 7) to produce a routing message identifying an address on the private network with which the callee identified by the contents of the callee ID buffer is associated and to set a time to live for the call at a maximum value of 99999, for example.

20 Thus the routing message includes a caller identifier, a call identifier set according to a username associated with the located DID bank table record and includes an identifier of a node on the private network with which the callee is associated.

25 The node in the system with which the callee is associated is determined by using the callee identifier to address a supernode table having records of the type as shown at 370 in Figure 17. Each record 370 has a prefix field 372 and a supernode address field 374. The prefix field 372 includes the first n digits of the callee identifier. In this embodiment n=2. The supernode address field 374 holds a code representing the IP address or a fully qualified domain name of the node associated with the code stored in the callee identifier prefix field

30

-42-

372. Referring to Figure 18, for example, if the prefix is **20**, the supernode address associated with that prefix is sp.yvr.digifonica.com.

5 Referring to Figure 15, a generic routing message is shown generally at **352** and includes an optional supplier prefix field **354**, and optional delimiter field **356**, a callee user name field **358**, at least one route field **360**, a time to live field **362** and other fields **364**. The optional supplier prefix field **354** holds a code for identifying supplier traffic. The optional delimiter field **356** holds a symbol that delimits the supplier prefix code from the callee user name field **358**. In this embodiment, the symbol is a number sign (#). The route field **360** holds a domain name or IP address of a gateway or node that is to carry the call, and the time to live field **362** holds a value representing the number of seconds the call is permitted to be active, based on subscriber available minutes and other billing parameters.

15 Referring to Figure 8A and Figure 16, an example of a routing message produced by the processor at block **350** for a caller associated with a different node than the caller is shown generally at **366** and includes only a callee field **359**, a route field **361** and a time to live field **362**.

20 Referring to Figure 8A, having produced a routing message as shown in Figure 16, block **381** directs the processor (**202** of Figure 7) to send the routing message shown in Figure 16 to the call controller **14** shown in Figure 1.

25 Referring back to Figure 8B, if at block **257**, the callee identifier stored in the callee id buffer (**211** in Figure 7) does not begin with an international dialing digit, block **380** directs the processor (**202**) to determine whether or not the callee identifier begins with the same national dial digit code as assigned to the caller. To do this, the processor (**202**) is directed to refer to the retrieved caller dialing profile as shown in Figure 10. In Figure 10, the national dialing

30

-43-

digit code **262** is the number **1**. Thus, if the callee identifier begins with the number **1**, then the processor (**202**) is directed to block **382** in Figure **8B**.

5 Block **382** directs the processor (**202** of Figure **7**) to examine the callee identifier to determine whether or not the digits following the NDD digit identify an area code that is the same as any of the area codes identified in the local area codes field **267** of the caller dialing profile **276** shown in Figure **10**. If not, block **384** of Figure **8B** directs the processor **202** to set the call type flag to indicate that the call is a national call. If the digits following the NDD digit
10 identify an area code that is the same as a local area code associated with the caller as indicated by the caller dialing profile, block **386** directs the processor **202** to set the call type flag to indicate a local call, national style. After executing blocks **384** or **386**, block **388** directs the processor **202** to format the callee identifier into a pre-defined digit format to produce a re-
15 formatted callee identifier by removing the national dialled digit and prepending a caller country code identified by the country code field **266** of the caller dialing profile shown in Figure **10**. The processor (**202**) is then directed to block **263** of Figure **8B** to perform other processing as already described above.

20 If at block **380**, the callee identifier does not begin with a national dialled digit, block **390** directs the processor (**202**) to determine whether the callee identifier begins with digits that identify the same area code as the caller. Again, the reference for this is the retrieved caller dialing profile shown in
25 Figure **10**. The processor (**202**) determines whether or not the first few digits of the callee identifier identify an area code corresponding to the local area code field **267** of the retrieved caller dialing profile. If so, then block **392** directs the processor **202** to set the call type flag to indicate that the call is a local call and block **394** directs the processor (**202**) to format the callee
30 identifier into a pre-defined digit format to produce a reformatted callee identifier by prepending the caller country code to the callee identifier, the caller country code being determined from the country code field **266** of the

-44-

retrieved caller dialing profile shown in Figure 10. The processor (202) is then directed to block 263 for further processing as described above.

5 Referring back to Figure 8B, at block 390, the callee identifier does not start with the same area code as the caller, block 396 directs the processor (202 of Figure 7) to determine whether the number of digits in the callee identifier, i.e. the length of the callee identifier, is within the range of digits indicated by the caller minimum local number length field 268 and the caller maximum local number length field 270 of the retrieved caller dialing profile shown in Figure 10. If so, then block 398 directs the processor (202) to set the call type flag to indicate a local call and block 400 directs the processor (202) to format the callee identifier into a pre-defined digit format to produce a reformatted callee identifier by prepending to the callee identifier the caller country code (as indicated by the country code field 266 of the retrieved caller dialing profile shown in Figure 10) followed by the caller area code (as indicated by the local area code field 267 of the caller profile shown in Figure 10). The processor (202) is then directed to block 263 of Figure 8B for further processing as described above.

20 Referring back to Figure 8B, if at block 396, the callee identifier has a length that does not fall within the range specified by the caller minimum local number length field (268 in Figure 10) and the caller maximum local number length field (270 in Figure 10), block 402 directs the processor 202 of Figure 7 to determine whether or not the callee identifier identifies a valid user name. To do this, the processor 202 searches through the database (18 of Figure 10) of dialing profiles to find a dialing profile having user name field contents (258 in Figure 10) that match the callee identifier. If no match is found, block 404 directs the processor (202) to send an error message back to the call controller (14). If at block 402, a dialing profile having a user name field 258 that matches the callee identifier is found, block 406 directs the processor 202 to set the call type flag to indicate that the call is a private network call and then the processor is directed to block 280 of Figure 8A. Thus, the call is

-45-

classified as a private network call when the callee identifier identifies a subscriber to the private network.

5 From Figure 8B, it will be appreciated that there are certain groups of blocks of codes that direct the processor 202 in Figure 7 to determine whether the callee identifier has certain features such as an international dialing digit, a national dialing digit, an area code and a length that meet certain criteria, and cause the processor 202 to reformat the callee identifier stored in the callee id buffer 211, as necessary into a predetermined target format including only a country code, area code, and a normal telephone number, for example, to cause the callee identifier to be compatible with the E.164 number plan standard in this embodiment. This enables block 269 in Figure 8B to have a consistent format of callee identifiers for use in searching through the DID bank table records of the type shown in Figure 13 to determine how to route calls for subscriber to subscriber calls on the same system. Effectively, therefore blocks 257, 380, 390, 396 and 402 establish call classification criteria for classifying the call as a public network call or a private network call. Block 269 classifies the call, depending on whether or not the formatted callee identifier has a DID bank table record and this depends on how the call classification criteria are met and block 402 directs the processor 202 of Figure 7 to classify the call as a private network call when the callee identifier complies with a pre-defined format, i.e. is a valid user name and identifies a subscriber to the private network, after the callee identifier has been subjected to the classification criteria of blocks 257, 380, 390 and 396.

25

Subscriber to Non-Subscriber Calls

30 Not all calls will be subscriber to subscriber calls and this will be detected by the processor 202 of Figure 7 when it executes block 269 in Figure 8B, and does not find a DID bank table record that is associated with the callee, in the DID bank table. When this occurs, the call is classified as a public network

-46-

call by directing the processor **202** to block **408** of Figure **8B** which causes it to set the contents of the callee id buffer **211** of Figure **7** equal to the newly formatted callee identifier, i.e., a number compatible with the E.164 standard. Then, block **410** of Figure **8B** directs the processor (**202**) to search a
5 database of route or master list records associating route identifiers with dialing codes shown in Figure **19** to locate a router having a dialing code having a number pattern matching at least a portion of the reformatted callee identifier.

10 Referring to Figure **19**, a data structure for a master list or route list record is shown. Each master list record includes a master list ID field **500**, a dialing code field **502**, a country code field **504**, a national sign number field **506**, a minimum length field **508**, a maximum length field **510**, a national dialled digit field **512**, an international dialled digit field **514** and a buffer rate field **516**.

15 The master list ID field **500** holds a unique code such as **1019**, for example, identifying the record. The dialing code field **502** holds a predetermined number pattern that the processor **202** of Figure **7** uses at block **410** in Figure **8B** to find the master list record having a dialing code matching the first few
20 digits of the amended callee identifier stored in the callee id buffer **211**. The country code field **504** holds a number representing the country code associated with the record and the national sign number field **506** holds a number representing the area code associated with the record. (It will be observed that the dialing code is a combination of the contents of the country
25 code field **504** and the national sign number field **506**.) The minimum length field **508** holds a number representing the minimum length of digits associated with the record and the maximum length field **51** holds a number representing the maximum number of digits in a number with which the record may be compared. The national dialled digit (NDD) field **512** holds a number
30 representing an access code used to make a call within the country specified by the country code, and the international dialled digit (IDD) field **514** holds a

-47-

number representing the international prefix needed to dial a call from the country indicated by the country code.

5 Thus, for example, a master list record may have a format as shown in Figure 20 with exemplary field contents as shown.

10 Referring back to Figure 8B, using the country code and area code portions of the reformatted callee identifier stored in the callee id buffer 211, block 410 directs the processor 202 of Figure 7 to find a master list record such as the one shown in Figure 20 having a dialing code that matches the country code (1) and area code (604) of the callee identifier. Thus, in this example, the processor (202) would find a master list record having an ID field containing the number 1019. This number may be referred to as a route ID. Thus, a route ID number is found in the master list record associated with a predetermined
15 number pattern in the reformatted callee identifier.

20 After executing block 410 in Figure 8B, the process continues as shown in Figure 8D. Referring to Figure 8D, block 412 directs the processor 202 of Figure 7 to use the route ID number to search a database of supplier records associating supplier identifiers with route identifiers to locate at least one supplier record associated with the route identifier to identify at least one supplier operable to supply a communications link for the route.

25 Referring to Figure 21, a data structure for a supplier list record is shown. Supplier list records include a supplier ID field 540, a master list ID field 542, an optional prefix field 544, a specific route identifier field 546, a NDD/IDD rewrite field 548, a rate field 550, and a timeout field 551. The supplier ID field 540 holds a code identifying the name of the supplier and the master list ID field 542 holds a code for associating the supplier record with a master list
30 record. The prefix field 544 holds a string used to identify the supplier traffic and the specific route identifier field 546 holds an IP address of a gateway operated by the supplier indicated by the supplier ID field 540. The NDD/IDD

-48-

rewrite field **548** holds a code representing a rewritten value of the NDD/IDD associated with this route for this supplier, and the rate field **550** holds a code indicating the cost per second to the system operator to use the route provided by the gateway specified by the contents of the route identifier field **546**. The timeout field **551** holds a code indicating a time that the call controller should wait for a response from the associated gateway before giving up and trying the next gateway. This time value may be in seconds, for example. Exemplary supplier records are shown in Figures **22**, **23** and **24** for the exemplary suppliers shown at **20** in Figure 1, namely Telus, Shaw and Sprint.

Referring back to Figure **8D**, at block **412** the processor **202** finds all supplier records that identify the master list ID found at block **410** of Figure **8B**.

Referring back to Figure **8D**, block **560** directs the processor **202** of Figure 7 to begin to produce a routing message of the type shown in Figure **15**. To do this, the processor **202** loads a routing message buffer as shown in Figure **25** with a supplier prefix of the least costly supplier where the least costly supplier is determined from the rate fields **550** of Figure **21** of the records associated with respective suppliers.

Referring to Figures **22-24**, in the embodiment shown, the supplier "Telus" has the lowest number in the rate field **550** and therefore the prefix **4973** associated with that supplier is loaded into the routing message buffer shown in Figure **25** first.

Block **562** in Figure **8D** directs the processor to delimit the prefix **4973** by the number sign (#) and to next load the reformatted callee identifier into the routing message buffer shown in Figure **25**. At block **563** of Figure **8D**, the contents of the route identifier field **546** of Figure **21** of the record associated with the supplier "Telus" are added by the processor **202** of Figure 7 to the routing message buffer shown in Figure **25** after an @ sign delimiter, and then

-49-

block **564** in Figure **8D** directs the processor to get a time to live value, which in one embodiment may be **3600** seconds, for example. Block **566** then directs the processor **202** to load this time to live value and the timeout value (**551**) in Figure **21** in the routing message buffer of Figure **25**. Accordingly, a first part of the routing message for the Telus gateway is shown generally at **570** in Figure **25**.

Referring back to Figure **8D**, block **571** directs the processor **202** back to block **560** and causes it to repeat blocks **560**, **562**, **563**, **564** and **566** for each successive supplier until the routing message buffer is loaded with information pertaining to each supplier identified by the processor at block **412**. Thus, a second portion of the routing message as shown at **572** in Figure **25** relates to the second supplier identified by the record shown in Figure **23**. Referring back to Figure **25**, a third portion of the routing message as shown at **574** and is associated with a third supplier as indicated by the supplier record shown in Figure **24**.

Consequently, referring to Figure **25**, the routing message buffer holds a routing message identifying a plurality of different suppliers able to provide gateways to the public telephone network (i.e. specific routes) to establish at least part of a communication link through which the caller may contact the callee. In this embodiment, each of the suppliers is identified, in succession, according to rate. Other criteria for determining the order in which suppliers are listed in the routing message may include preferred supplier priorities which may be established based on service agreements, for example.

Referring back to Figure **8D**, block **568** directs the processor **202** of Figure **7** to send the routing message shown in Figure **25** to the call controller **14** in Figure **1**.

30

Subscriber to Subscriber Calls Within the Same Node

-50-

Referring back to Figure 8A, if at block 280, the callee identifier received in the RC request message has a prefix that identifies the same node as that associated with the caller, block 600 directs the processor 202 to use the callee identifier in the callee id buffer 211 to locate and retrieve a dialing profile for the callee. The dialing profile may be of the type shown in Figure 11 or 12, for example. Block 602 of Figure 8A then directs the processor 202 of Figure 7 to get call block, call forward and voicemail records from the database 18 of Figure 1 based on the user name identified in the callee dialing profile retrieved by the processor at block 600. Call block, call forward and voicemail records may be as shown in Figures 26, 27, 28 and 30 for example.

Referring to Figure 26, the call block records include a user name field 604 and a block pattern field 606. The user name field holds a user name corresponding to the user name in the user name field (258 in Figure 10) of the callee profile and the block pattern field 606 holds one or more E.164-compatible numbers or user names identifying PSTN numbers or system subscribers from whom the subscriber identified in the user name field 604 does not wish to receive calls.

Referring to Figure 8A and Figure 27, block 608 directs the processor 202 of Figure 7 to determine whether or not the caller identifier received in the RC request message matches a block pattern stored in the block pattern field 606 of the call block record associated with the callee identified by the contents of the user name field 604 in Figure 26. If the caller identifier matches a block pattern, block 610 directs the processor to send a drop call or non-completion message to the call controller (14) and the process is ended. If the caller identifier does not match a block pattern associated with the callee, block 609 directs the processor to store the username and domain of the callee, as determined from the callee dialing profile, and a time to live value in the routing message buffer as shown at 650 in Figure 32. Referring back to

-51-

Figure 8A, block 612 then directs the processor 202 to determine whether or not call forwarding is required.

5 Referring to Figure 28, the call forwarding records include a user name field 614, a destination number field 616, and a sequence number field 618. The user name field 614 stores a code representing a user with which the record is associated. The destination number field 616 holds a user name representing a number to which the current call should be forwarded, and the sequence number field 618 holds an integer number indicating the order in
10 which the user name associated with the corresponding destination number field 616 should be attempted for call forwarding. The call forwarding table may have a plurality of records for a given user. The processor 202 of Figure 7 uses the contents of the sequence number field 618 to place the records for a given user in order. As will be appreciated below, this enables the call
15 forwarding numbers to be tried in an ordered sequence.

Referring to Figure 8A and Figure 29, if at block 612, the call forwarding record for the callee identified by the callee identifier contains no contents in the destination number field 616 and accordingly no contents in the sequence
20 number field 618, there are no call forwarding entries for this callee, and the processor 202 is directed to block 620 in Figure 8C. If there are entries in the call forwarding table 27, block 622 in Figure 8A directs the processor 202 to search the dialing profile table to find a dialing profile record as shown in Figure 9, for the user identified by the destination number field 616 of the call
25 forward record shown in Figure 28. The processor 202 of Figure 7 is further directed to store the username and domain for that user and a time to live value in the routing message buffer as shown at 652 in Figure 32, to produce a routing message as illustrated. This process is repeated for each call forwarding record associated with the callee identified by the callee id buffer
30 211 in Figure 7 to add to the routing message buffer all call forwarding usernames and domains associated with the callee.

-52-

Referring back to Figure 8A, if at block 612 there are no call forwarding records, then at block 620 in Figure 8C the processor 202 is directed to determine whether or not the user identified by the callee identifier has paid for voicemail service. This is done by checking to see whether or not a flag is set in a voicemail record of the type shown in Figure 30 in a voicemail table stored in the database 18 shown in Figure 1.

Referring to Figure 30, voicemail records in this embodiment may include a user name field 624, a voicemail server field 626, a seconds to voicemail field 628 and an enable field 630. The user name field 624 stores the user name of the callee. The voicemail server field 626 holds a code identifying a domain name of a voicemail server associated with the user identified by the user name field 624. The seconds to voicemail field 628 holds a code identifying the time to wait before engaging voicemail, and the enable field 630 holds a code representing whether or not voicemail is enabled for the user. Referring back to Figure 8C, at block 620 if the processor 202 of Figure 7 finds a voicemail record as shown in Figure 30 having user name field 624 contents matching the callee identifier, the processor is directed to examine the contents of the enabled field 630 to determine whether or not voicemail is enabled. If voicemail is enabled, then block 640 in Figure 8C directs the processor 202 to Figure 7 to store the contents of the voicemail server field 626 and the contents of the seconds to voicemail field 628 in the routing message buffer, as shown at 654 in Figure 32. Block 642 then directs the processor 202 to get time to live values for each path specified by the routing message according to the cost of routing and the user's balance. These time to live values are then appended to corresponding paths already stored in the routing message buffer.

Referring back to Figure 8C, block 644 then directs the processor 202 of Figure 7 to store the IP address of the current node in the routing message buffer as shown at 656 in Figure 32. Block 646 then directs the processor 202 to send the routing message shown in Figure 32 to the call controller 14 in

-53-

Figure 1. Thus in the embodiment described the routing controller will produce a routing message that will cause at least one of the following: forward the call to another party, block the call and direct the caller to a voicemail server.

5 Referring back to Figure 1, the routing message whether of the type shown in Figures 16, 25 or 32, is received at the call controller 14 and the call controller interprets the receipt of the routing message as a request to establish a call.

10 Referring to Figure 4, the program memory 104 of the call controller 14 includes a routing to gateway routine depicted generally at 122.

15 Where a routing message of the type shown in Figure 32 is received by the call controller 14, the routing to gateway routine 122 shown in Figure 4 may direct the processor 102 cause a message to be sent back through the internet 13 shown in Figure 1 to the callee telephone 15, knowing the IP address of the callee telephone 15 from the user name.

20 Alternatively, if the routing message is of the type shown in Figure 16, which identifies a domain associated with another node in the system, the call controller may send a SIP invite message along the high speed backbone 17 connected to the other node. The other node functions as explained above, in response to receipt of a SIP invite message.

25 If the routing message is of the type shown in Figure 25 where there are a plurality of gateway suppliers available, the call controller sends a SIP invite message to the first supplier, in this case Telus, using a dedicated line or an internet connection to determine whether or not Telus is able to handle the call. If the Telus gateway returns a message indicating it is not able to handle the call, the call controller 14 then proceeds to send a SIP invite message to
30 the next supplier, in this case Shaw. The process is repeated until one of the suppliers responds indicating that it is available to carry the call. Once a supplier responds indicating that it is able to carry the call, the supplier sends

-54-

back to the call controller **14** an IP address for a gateway provided by the supplier through which the call or audio path of the call will be carried. This IP address is sent in a message from the call controller **14** to the media relay **9** which responds with a message indicating an IP address to which the caller
5 telephone should send its audio/video, traffic and an IP address to which the gateway should send its audio/video for the call. The call controller conveys the IP address at which the media relay expects to receive audio/video from the caller telephone, to the caller telephone **12** in a message. The caller telephone replies to the call controller with an IP address at which it would like
10 to receive audio/video and the call controller conveys that IP address to the media relay. The call may then be conducted between the caller and callee through the media relay and gateway.

Referring back to Figure **1**, if the call controller **14** receives a routing message
15 of the type shown in Figure **32**, and which has at least one call forwarding number and/or a voicemail number, the call controller attempts to establish a call to the callee telephone **15** by seeking from the callee telephone a message indicating an IP address to which the media relay should send audio/video. If no such message is received from the callee telephone, no call
20 is established. If no call is established within a pre-determined time, the call controller **14** attempts to establish a call with the next user identified in the call routing message in the same manner. This process is repeated until all call forwarding possibilities have been exhausted, in which case the call controller communicates with the voicemail server **19** identified in the routing message
25 to obtain an IP address to which the media relay should send audio/video and the remainder of the process mentioned above for establishing IP addresses at the media relay **9** and the caller telephone is carried out to establish audio/video paths to allowing the caller to leave a voicemail message with the voicemail server.

30

When an audio/video path through the media relay is established, a call timer maintained by the call controller **14** logs the start date and time of the call and

-55-

logs the call ID and an identification of the route (i.e., audio/video path IP address) for later use in billing.

Time to Live

5 Referring to Figures **33A** and **33B**, a process for determining a time to live value for any of blocks **642** in Figure **8C**, **350** in Figure **8A** or **564** in Figure **8D** above is described. The process is executed by the processor **202** shown in Figure **7**. Generally, the process involves calculating a cost per unit time, calculating a first time value as a sum of a free time attributed to a participant
10 in the communication session and the quotient of a funds balance held by the participant to the cost per unit time value and producing a second time value in response to the first time value and a billing pattern associated with the participant, the billing pattern including first and second billing intervals and the second time value being the time to permit a communication session to be
15 conducted.

Referring to Figure **33A**, in this embodiment, the process begins with a first block **700** that directs the RC processor to determine whether or not the call type set at block **302** in Figure **8A** indicates the call is a network or cross-domain call. If the call is a network or cross-domain call, block **702** of Figure **33A** directs the RC processor to set the time to live equal to **99999** and the process is ended. Thus, the network or cross-domain call type has a long time to live. If at block **700** the call type is determined not to be a network or cross-domain type, block **704** directs the RC processor to get a subscriber bundle table record from the database **18** in Figure **1** and store it locally in the subscriber bundle record buffer at the RC **14**.
20
25

Referring to Figure **34**, a subscriber bundle table record is shown generally at **706**. The record includes a user name field **708** and a services field **710**. The user name field **708** holds a code identifying the subscriber user name and the services field **710** holds codes identifying service features assigned to the subscriber, such as free local calling, call blocking and voicemail, for example.
30

-56-

Figure 35 shows an exemplary subscriber bundle record for the Vancouver caller. In this record the user name field 708 is loaded with the user name 2001 1050 8667 and the services field 710 is loaded with codes 10, 14 and 16 corresponding to free local calling, call blocking and voicemail, respectively. Thus, user 2001 1050 8667 has free local calling, call blocking and voicemail features.

Referring back to Figure 33A, after having loaded a subscriber bundle record into the subscriber bundle record buffer, block 712 directs the RC processor to search the database (18) determine whether or not there is a bundle override table record for the master list ID value that was determined at block 410 in Figure 8B. An exemplary bundle override table record is shown at 714 in Figure 36. The bundle table record includes a master list ID field 716, an override type field 718, an override value field 720 a first interval field 722 and a second interval field 724. The master list ID field 716 holds a master list ID code. The override type field 718 holds an override type code indicating a fixed, percent or cent amount to indicate the amount by which a fee will be increased. The override value field 720 holds a real number representing the value of the override type. The first interval field 722 holds a value indicating the minimum number of seconds for a first level of charging and the second interval field 724 holds a number representing a second level of charging.

Referring to Figure 37, a bundle override record for the located master list ID code is shown generally at 726 and includes a master list ID field 716 holding the code 1019 which was the code located in block 410 of Figure 8B. The override type field 718 includes a code indicating the override type is a percentage value and the override value field 720 holds the value 10.0 indicating that the override will be 10.0% of the charged value. The first interval field 722 holds a value representing 30 seconds and the second interval field 724 holds a value representing 6 seconds. The 30 second value in the first interval field 722 indicates that charges for the route will be made at

-57-

a first rate for **30** seconds and thereafter the charges will be made at a different rate in increments of **6** seconds, as indicated by the contents of the second interval field **724**.

5 Referring back to Figure **33A**, if at block **712** the processor finds a bundle
override record of the type shown in Figure **37**, block **728** directs the
processor to store the bundle override record in local memory. In the
embodiment shown, the bundle override record shown in Figure **37** is stored
10 in the bundle override record buffer at the RC as shown in Figure **7**. Still
referring to Figure **33A**, block **730** then directs the RC processor to determine
whether or not the subscriber bundle table record **706** in Figure **35** has a
services field including a code identifying that the user is entitled to free local
calling and also directs the processor to determine whether or not the call type
15 is not a cross domain cell, i.e. it is a local or local/national style. If both of
these conditions are satisfied, block **732** directs the processor to set the time
to live equal to **99999**, giving the user a long period of time for the call. The
process is then ended. If the conditions associated with block **730** are not
satisfied, block **734** of Figure **33B** directs the RC processor to retrieve a
20 subscriber account record associated with a participant in the call. This is
done by copying and storing in the subscriber account record buffer a
subscriber account record for the caller.

Referring to Figure **38**, an exemplary subscriber account table record is
shown generally at **736**. The record includes a user name field **738**, a funds
25 balance field **740** and a free time field **742**. The user name field **738** holds a
subscriber user name, the funds balance field **740** holds a real number
representing the dollar value of credit available to the subscriber and the free
time field **742** holds an integer representing the number of free seconds that
the user is entitled to.

30 An exemplary subscriber account record for the Vancouver caller is shown
generally at **744** in Figure **39**, wherein the user name field **738** holds the user

-58-

name **2001 1050 8667**, the funds balance field **740** holds the value **\$10.00**, and the free time field **742** holds the value **100**. The funds balance field holding the value of **\$10.00** indicates the user has **\$10.00** worth of credit and the free time field having the value of **100** indicates that the user has a
5 balance of **100** free seconds of call time.

Referring back to Figure **33B**, after copying and storing the subscriber account record shown in Figure **39** from the database to the subscriber account record buffer RC, block **746** directs the processor to determine
10 whether or not the subscriber account record funds balance field **740** or free time field **742** are greater than zero. If they are not greater than zero, block **748** directs the processor to set the time to live equal to zero and the process is ended. The RC then sends a message back to the call controller to cause the call controller to deny the call to the caller. If the conditions associated
15 with block **746** are satisfied, block **750** directs the processor to calculate the call cost per unit time. A procedure for calculating the call cost per unit time is described below in connection with Figure **41**.

Assuming the procedure for calculating the cost per second returns a number
20 representing the call cost per second, block **752** directs the processor **202** in Figure **7** to determine whether or not the cost per second is equal to zero. If so, block **754** directs the processor to set the time to live to **99999** to give the caller a very long length of call and the process is ended.

If at block **752** the call cost per second is not equal to zero, block **756** directs
25 the processor **202** in Figure **7** to calculate a first time to live value as a sum of a free time attributed to the participant in the communication session and the quotient of the funds balance held by the participant to the cost per unit time value. To do this, the processor **202** of Figure **7** is directed to set a first time
30 value or temporary time to live value equal to the sum of the free time provided in the free time field **742** of the subscriber account record shown in Figure **39** and the quotient of the contents of the funds balance field **740** in the

-59-

subscriber account record for the call shown in Figure 39 and the cost per second determined at block 750 of Figure 33B. Thus, for example, if at block 750 the cost per second is determined to be three cents per second and the funds balance field holds the value \$10.00, the quotient of the funds balance and cost per second is 333 seconds and this is added to the contents of the free time field 742, which is 100, resulting in a time to live of 433 seconds.

Block 758 then directs the RC processor to produce a second time value in response to the first time value and the billing pattern associated with the participant as established by the bundle override record shown in Figure 37. This process is shown in greater detail at 760 in Figure 40 and generally involves producing a remainder value representing a portion of the second billing interval remaining after dividing the second billing interval into a difference between the first time value and the first billing interval.

Referring to Figure 40, the process for producing the second time value begins with a first block 762 that directs the processor 202 in Figure 7 to set a remainder value equal to the difference between the time to live value calculated at block 756 in Figure 33B and the contents of the first interval field 722 of the record shown in Figure 37, multiplied by the modulus of the contents of the second interval field 724 of Figure 37. Thus, in the example given, the difference between the time to live field and the first interval field is 433 minus 30, which is 403 and therefore the remainder produced by the mod of 403 divided by 6 is 0.17. Block 764 then directs the processor to determine whether or not this remainder value is greater than zero and, if so, block 766 directs the processor to subtract the remainder from the first time value and set the difference as the second time value. To do this the processor is directed to set the time to live value equal to the current time to live of 403 minus the remainder of 1, i.e., 402 seconds. The processor is then returned back to block 758 of Figure 33B.

-60-

Referring back to Figure 40, if at block 764 the remainder is not greater than zero, block 768 directs the processor 202 of Figure 7 to determine whether or not the time to live is less than the contents of the first interval field 722 in the record shown in Figure 37. If so, then block 770 of Figure 40 directs the processor to set the time to live equal to zero. Thus, the second time value is set to zero when the remainder is greater than zero and the first time value is less than the free time associated with the participant in the call. If at block 768 the conditions of that block are not satisfied, the processor returns the first time to live value as the second time to live value.

Thus, referring to Figure 33B, after having produced a second time to live value, block 772 directs the processor to set the time to live value for use in blocks 342, 350 or 564.

Cost per Second

Referring back to Figure 33B, at block 750 it was explained that a call cost per unit time is calculated. The following explains how that call cost per unit time value is calculated.

Referring to Figure 41, a process for calculating a cost per unit time is shown generally at 780. The process is executed by the processor 202 in Figure 7 and generally involves locating a record in a database, the record comprising a markup type indicator, a markup value and a billing pattern and setting a reseller rate equal to the sum of the markup value and the buffer rate, locating at least one of an override record specifying a route cost per unit time amount associated with a route associated with the communication session, a reseller record associated with a reseller of the communications session, the reseller record specifying a reseller cost per unit time associated with the reseller for the communication session and a default operator markup record specifying a default cost per unit time and setting as the cost per unit time the sum of the reseller rate and at least one of the route cost per unit time, the reseller cost per unit time and the default cost per unit time.

-61-

The process begins with a first set of blocks **782**, **802** and **820** which direct the processor **202** in Figure **7** to locate at least one of a record associated with a reseller and a route associated with the reseller, a record associated with the reseller, and a default reseller mark-up record. Block **782**, in particular, directs the processor to address the database **18** to look for a record associated with a reseller and a route with the reseller by looking for a special rate record based on the master list ID established at block **410** in Figure **8C**.

Referring to Figure **42**, a system operator special rate table record is shown generally at **784**. The record includes a reseller field **786**, a master list ID field **788**, a mark-up type field **790**, a mark-up value field **792**, a first interval field **794** and a second interval field **796**. The reseller field **786** holds a reseller ID code and the master list ID field **788** holds a master list ID code. The mark-up type field **790** holds a mark-up type such as fixed percent or cents and the mark-up value field **792** holds a real number representing the value corresponding to the mark-up type. The first interval field **794** holds a number representing a first level of charging and the second interval field **796** holds a number representing a second level of charging.

An exemplary system operator special rate table for a reseller known as "Klondike" is shown at **798** in Figure **43**. In this record, the reseller field **786** holds a code indicating the retailer ID is Klondike, the master list ID field **788** holds the code **1019** to associate the record with the master list ID code **1019**. The mark-up type field **790** holds a code indicating the mark-up type is cents and the mark-up value field **792** holds a mark-up value indicating **1/10** of one cent. The first interval field **794** holds the value **30** and the second interval field **796** holds the value **6**, these two fields indicating that the operator allows **30** seconds for free and then billing is done in increments of **6** seconds after that.

-62-

Referring back to Figure 41, if at block 782 a record such as the one shown in Figure 43 is located in the system operator special rates table, the processor is directed to block 800 in Figure 41. If such a record is not found in the system operator special rates table, block 802 directs the processor to address the database 18 to look in a system operator mark-up table for a mark-up record associated with the reseller.

Referring to Figure 44, an exemplary system operator mark-up table record is shown generally at 804. The record includes a reseller field 806, a mark-up type field 808, a mark-up value field 810, a first interval field 812 and a second interval field 814. The reseller mark-up type, mark-up value, first interval and second interval fields are as described in connection with the fields by the same names in the system operator special rates table shown in Figure 42.

Figure 45 provides an exemplary system operator mark-up table record for the reseller known as Klondike and therefore the reseller field 806 holds the value "Klondike", the mark-up type field 808 holds the value cents, the mark-up value field holds the value 0.01, the first interval field 812 holds the value 30 and the second interval field 814 holds the value 6. This indicates that the reseller "Klondike" charges by the cent at a rate of one cent per minute. The first 30 seconds of the call are free and billing is charged at the rate of one cent per minute in increments of 6 seconds.

Figure 46 provides an exemplary system operator mark-up table record for cases where no specific system operator mark-up table record exists for a particular reseller, i.e., a default reseller mark-up record. This record is similar to the record shown in Figure 45 and the reseller field 806 holds the value "all", the mark-up type field 808 is loaded with a code indicating mark-up is based on a percentage, the mark-up value field 810 holds the percentage by which the cost is marked up, and the first and second interval fields 812 and 814 identify first and second billing levels.

-63-

Referring back to Figure 41, if at block 802 a specific mark-up record for the reseller identified at block 782 is not located, block 820 directs the processor to get the mark-up record shown in Figure 46, having the "all" code in the reseller field 806. The processor is then directed to block 800.

5

Referring back to Figure 41, at block 800, the processor 202 of Figure 7 is directed to set a reseller rate equal to the sum of the mark-up value of the record located by blocks 782, 802 or 820 and the buffer rate specified by the contents of the buffer rate field 516 of the master list record shown in Figure 20. To do this, the RC processor sets a variable entitled "reseller cost per second" to a value equal to the sum of the contents of the mark-up value field (792, 810) of the associated record, plus the contents of the buffer rate field (516) from the master list record associated with the master list ID. Then, block 822 directs the processor to set a system operator cost per second variable equal to the contents of the buffer rate field (516) from the master list record. Block 824 then directs the processor to determine whether the call type flag indicates the call is local or national/local style and whether the caller has free local calling. If both these conditions are met, then block 826 sets the user cost per second variable equal to zero and sets two increment variables equal to one, for use in later processing. The cost per second has thus be calculated and the process shown in Figure 41 is ended.

10

15

25

30

If at block 824 the conditions of that block are not met, the processor 202 of Figure 7 is directed to locate at least one of a bundle override table record specifying a route cost per unit time associated with a route associated with the communication session, a reseller special destinations table record associated with a reseller of the communications session, the reseller record specifying a reseller cost per unit time associated with the reseller for the communication session and a default reseller global markup record specifying a default cost per unit time.

-64-

To do this block **828** directs the processor **202** of Figure **7** to determine whether or not the bundle override record **726** in Figure **37** located at block **712** in Figure **33A** has a master list ID equal to the stored master list ID that was determined at block **410** in Figure **8B**. If not, block **830** directs the processor to find a reseller special destinations table record in a reseller special destinations table in the database (**18**), having a master list ID code equal to the master list ID code of the master list ID that was determined at block **410** in Figure **8B**. An exemplary reseller special destinations table record is shown in Figure **47** at **832**. The reseller special destinations table record includes a reseller field **834**, a master list ID field **836**, a mark-up type field **838**, a mark-up value field **840**, a first interval field **842** and a second interval field **844**. This record has the same format as the system operator special rates table record shown in Figure **42**, but is stored in a different table to allow for different mark-up types and values and time intervals to be set according to resellers' preferences. Thus, for example, an exemplary reseller special destinations table record for the reseller "Klondike" is shown at **846** in Figure **48**. The reseller field **834** holds a value indicating the reseller as the reseller "Klondike" and the master list ID field holds the code **1019**. The mark-up type field **838** holds a code indicating the mark-up type is percent and the mark-up value field **840** holds a number representing the mark-up value as **5%**. The first and second interval fields identify different billing levels used as described earlier.

Referring back to Figure **41**, the record shown in Figure **48** may be located at block **830**, for example. If at block **830** such a record is not found, then block **832** directs the processor to get a default operator global mark-up record based on the reseller ID.

Referring to Figure **49**, an exemplary default reseller global mark-up table record is shown generally at **848**. This record includes a reseller field **850**, a mark-up type field **852**, a mark-up value field **854**, a first interval field **856** and a second interval field **858**. The reseller field **850** holds a code identifying the

-65-

reseller. The mark-up type field **852**, the mark-up value field **854** and the first and second interval fields **856** and **858** are of the same type as described in connection with fields of the same name in Figure **47**, for example. The contents of the fields of this record **860** may be set according to system operator preferences, for example.

Referring to Figure **50**, an exemplary reseller global mark-up table record is shown generally at **860**. In this record, the reseller field **850** holds a code indicating the reseller is "Klondike", the mark-up type field **852** holds a code indicating the mark-up type is percent, the mark-up value field **854** holds a value representing **10%** as the mark-up value, the first interval field **856** holds the value **30** and the second interval field **858** holds the values **30** and **6** respectively to indicate the first **30** seconds are free and billing is to be done in **6** second increments after that.

Referring back to Figure **41**, should the processor get to block **832**, the reseller global mark-up table record as shown in Figure **50** is retrieved from the database and stored locally at the RC. As seen in Figure **41**, it will be appreciated that if the conditions are met in blocks **828** or **830**, or if the processor executes block **832**, the processor is then directed to block **862** which causes it to set an override value equal to the contents of the mark-up value field of the located record, to set the first increment variable equal to the contents of the first interval field of the located record and to set the second increment variable equal to the contents of the second interval field of the located record. (The increment variables were alternatively set to specific values at block **826** in Figure **41**.)

It will be appreciated that the located record could be a bundle override record of the type shown in Figure **37** or the located record could be a reseller special destination record of the type shown in Figure **48** or the record could be a reseller global mark-up table record of the type shown in Figure **50**. After the override and first and second increment variables have been set at block

-66-

5 **862**, the processor **202** if Figure **7** is directed to set as the cost per unit time the sum of the reseller rate and at least one of the route cost per unit time, the reseller cost per unit time and the default cost per unit time, depending on which record was located. To do this, block **864** directs the processor to set the cost per unit time equal to the sum of the reseller cost set at block **800** in Figure **41**, plus the contents of the override variable calculated in block **862** in Figure **41**. The cost per unit time has thus been calculated and it is this cost per unit time that is used in block **752** of Figure **33B**, for example.

10 Terminating the Call

15 In the event that either the caller or the callee terminates a call, the telephone of the terminating party sends a SIP bye message to the controller **14**. An exemplary SIP bye message is shown at **900** in Figure **51** and includes a caller field **902**, a callee field **904** and a call ID field **906**. The caller field **902** holds a twelve digit user name, the callee field **904** holds a PSTN compatible number or user name, and the call ID field **906** holds a unique call identifier field of the type shown in the call ID field **65** of the SIP invite message shown in Figure **3**.

20 Thus, for example, referring to Figure **52**, a SIP bye message for the Calgary callee is shown generally at **908** and the caller field **902** holds a user name identifying the caller, in this case **2001 1050 8667**, the callee field **904** holds a user name identifying the Calgary callee, in this case **2001 1050 2222**, and the call ID field **906** holds the code **FA10 @ 192.168.0.20**, which is the call ID for the call.

25 The SIP bye message shown in Figure **52** is received at the call controller **14** and the call controller executes a process as shown generally at **910** in Figure **53**. The process includes a first block **912** that directs the call controller processor **202** of Figure **7** to copy the caller, callee and call ID field contents from the SIP bye message received from the terminating party to corresponding fields of an RC stop message buffer (not shown). Block **914**

-67-

then directs the processor to copy the call start time from the call timer and to obtain a call stop time from the call timer. Block **916** then directs the call controller to calculate a communication session time by determining the difference in time between the call start time and the call stop time. This session time is then stored in a corresponding field of the RC call stop message buffer. Block **917** then directs the processor to decrement the contents of the current concurrent call field **277** of the dialing profile for the caller as shown in Figure **10**, to indicate that there is one less concurrent call in progress. A copy of the amended dialing profile for the caller is then stored in the database **18** of Figure **1**. Block **918** then directs the processor to copy the route from the call log. An RC call stop message produced as described above is shown generally at **1000** in Figure **54**. An RC call stop message specifically associated with the call made to the Calgary callee is shown generally at **1020** in Figure **55**.

Referring to Figure **54**, the RC stop call message includes a caller field **1002**, callee field **1004**, a call ID field **1006**, an account start time field **1008**, an account stop time field **1010**, a communication session time **1012** and a route field **1014**. The caller field **1002** holds a username, the callee field **1004** holds a PSTN-compatible number or system number, the call ID field **1006** hold the unique call identifier received from the SIP invite message shown in Figure **3**, the account start time field **1008** holds the date and start time of the call, the account stop time field **1010** holds the date and time the call ended, the communication session time field **1012** holds a value representing the difference between the start time and the stop time, in seconds, and the route field **1014** holds the IP address for the communications link that was established.

Referring to Figure **55**, an exemplary RC stop call message for the Calgary callee is shown generally at **1020**. In this example the caller field **1002** holds the user name **2001 1050 8667** identifying the Vancouver-based caller and the callee field **1004** holds the user name **2001 1050 2222** identifying the

-68-

Calgary callee. The contents of the call ID field **1006** are **FA10 @ 192.168.0.20**. The contents of the account start time field **1008** are **2006-12-30 12:12:12** and the contents of the account stop time field are **2006-12-30 12:12:14**. The contents of the communication session time field **1012** are **2** to indicate **2** seconds call duration and the contents of the route field are **72.64.39.58**.

Referring back to Figure **53**, after having produced an RC call stop message, block **920** directs the processor **202** in Figure **7** to send the RC stop message compiled in the RC call stop message buffer to the RC **16** of Figure **1**. Block **922** directs the call controller **14** to send a "bye" message back to the party that did not terminate the call.

The RC **16** of Figure **1** receives the call stop message and an RC call stop message process is invoked at the RC, the process being shown at **950** in Figures **56A**, **56B** and **56C**. Referring to Figure **56A**, the RC stop message process **950** begins with a first block **952** that directs the processor **202** in Figure **7** to determine whether or not the communication session time is less than or equal to the first increment value set by the cost calculation routine shown in Figure **41**, specifically blocks **826** or **862** thereof. If this condition is met, then block **954** of Figure **56A** directs the RC processor to set a chargeable time variable equal to the first increment value set at block **826** or **862** of Figure **41**. If at block **952** of Figure **56A** the condition is not met, block **956** directs the RC processor to set a remainder variable equal to the difference between the communication session time and the first increment value mod the second increment value produced at block **826** or **862** of Figure **41**. Then, the processor is directed to block **958** of Figure **56A** which directs it to determine whether or not the remainder is greater than zero. If so, block **960** directs the RC processor to set the chargeable time variable equal to the difference between the communication session time and the remainder value. If at block **958** the remainder is not greater than zero, block **962** directs the RC processor to set the chargeable time variable equal to the contents of the

-69-

communication session time from the RC stop message. The processor is then directed to block **964**. In addition, after executing block **954** or block **960**, the processor is directed to block **964**.

5 Block **964** directs the processor **202** of Figure **7** to determine whether or not the chargeable time variable is greater than or equal to the free time balance as determined from the free time field **742** of the subscriber account record shown in Figure **39**. If this condition is satisfied, block **966** of Figure **56A** directs the processor to set the free time field **742** in the record shown in
10 Figure **39**, to zero. If the chargeable time variable is not greater than or equal to the free time balance, block **968** directs the RC processor to set a user cost variable to zero and Block **970** then decrements the free time field **742** of the subscriber account record for the caller by the chargeable time amount determined by block **954**, **960** or **962**.

15 If at Block **964** the processor **202** of Figure **7** was directed to Block **966** which causes the free time field (**742** of Figure **39**) to be set to zero, referring to Figure **56B**, Block **972** directs the processor to set a remaining chargeable time variable equal to the difference between the chargeable time and the
20 contents of the free time field (**742** of Figure **39**). Block **974** then directs the processor to set the user cost variable equal to the product of the remaining chargeable time and the cost per second calculated at Block **750** in Figure **33B**. Block **976** then directs the processor to decrement the funds balance field (**740**) of the subscriber account record shown in Figure **39** by the
25 contents of the user cost variable calculated at Block **974**.

After completing Block **976** or after completing Block **970** in Figure **56A**, block **978** of Figure **56B** directs the processor **202** of Figure **7** to calculate a reseller cost variable as the product of the reseller rate as indicated in the
30 mark-up value field **810** of the system operator mark-up table record shown in Figure **45** and the communication session time determined at Block **916** in Figure **53**. Then, Block **980** of Figure **56B** directs the processor to add the

-70-

reseller cost to the reseller balance field **986** of a reseller account record of the type shown in Figure **57** at **982**.

5 The reseller account record includes a reseller ID field **984** and the aforementioned reseller balance field **986**. The reseller ID field **984** holds a reseller ID code, and the reseller balance field **986** holds an accumulated balance of charges.

10 Referring to Figure **58**, a specific reseller accounts record for the reseller "Klondike" is shown generally at **988**. In this record the reseller ID field **984** holds a code representing the reseller "Klondike" and the reseller balance field **986** holds a balance of **\$100.02**. Thus, the contents of the reseller balance field **986** in Figure **58** are incremented by the reseller cost calculated at block **978** of Figure **56B**.

15 Still referring to Figure **56B**, after adding the reseller cost to the reseller balance field as indicated by Block **980**, Block **990** directs the processor to **202** of Figure **7** calculate a system operator cost as the product of the system operator cost per second, as set at block **822** in Figure **41**, and the communication session time as determined at Block **916** in Figure **53**. Block **992** then directs the processor to add the system operator cost value calculated at Block **990** to a system operator accounts table record of the type shown at **994** in Figure **59**. This record includes a system operator balance field **996** holding an accumulated charges balance. Referring to Figure **60** in

20 the embodiment described, the system operator balance field **996** may hold the value **\$1,000.02** for example, and to this value the system operator cost calculated at Block **990** is added when the processor executes Block **992** of Figure **56B**.

30 Ultimately, the final reseller balance **986** in Figure **58** holds a number representing an amount owed to the reseller by the system operator and the

-71-

system operator balance **996** of Figure **59** holds a number representing an amount of profit for the system operator.

5 While specific embodiments of the invention have been described and illustrated, such embodiments should be considered illustrative of the invention only and not as limiting the invention as construed in accordance with the accompanying claims.

-72-

What is claimed is:

1. A process for operating a call routing controller to facilitate communication between callers and callees in a system comprising a plurality of nodes with which callers and callees are associated, the process comprising:
 - 5 in response to initiation of a call by a calling subscriber, receiving a caller identifier and a callee identifier;
 - 10 using call classification criteria associated with the caller identifier to classify the call as a public network call or a private network call;
 - 15 producing a routing message identifying an address, on the private network, associated with the callee when the call is classified as a private network call; and
 - 20 producing a routing message identifying a gateway to the public network when the call is classified as a public network call.
2. The process of claim 1 further comprising receiving a request to establish a call, from a call controller in communication with a caller identified by said callee identifier.
- 25 3. The process of claim 1 wherein using said call classification criteria comprises searching a database to locate a record identifying calling attributes associated with a caller identified by said caller identifier.
- 30 4. The process of claim 3 wherein locating a record comprises locating a caller dialing profile comprising a username associated with said caller, a domain associated with said caller, and at least one calling attribute.

-73-

- 5
- 6
- 10
- 15
- 20
- 25
- 30
5. The process of claim 4 wherein using said call classification criteria comprises comparing calling attributes associated with said caller dialing profile with aspects of said callee identifier.
 6. The process of claim 4 wherein comparing comprises determining whether said callee identifier includes a portion that matches an IDD associated with said caller dialing profile.
 7. The process of claim 4 wherein comparing comprises determining whether said callee identifier includes a portion that matches an NDD associated with said caller dialing profile.
 8. The process of claim 4 wherein comparing comprises determining whether said callee identifier includes a portion that matches an area code associated with said caller dialing profile.
 9. The process of claim 4 wherein comparing comprises determining whether said callee identifier has a length within a range specified in said caller dialing profile.
 10. The process of claim 4 further comprising formatting said callee identifier into a pre-defined digit format to produce a re-formatted callee identifier.
 11. The process of claim 10 wherein formatting comprises removing an international dialing digit from said callee identifier, when said callee identifier begins with a digit matching an international dialing digit specified by said caller dialing profile associated with said caller.
 12. The process of claim 10 wherein formatting comprises removing a national dialing digit from said callee identifier and prepending a caller

-74-

country code to said callee identifier when said callee identifier begins with a national dialing digit.

- 5
- 13.** The process of claim **10** wherein formatting comprises prepending a caller country code to said callee identifier when said callee identifier begins with digits identifying an area code specified by said caller dialing profile.
- 10
- 14.** The process of claim **10** wherein formatting comprises prepending a caller country code and area code to said callee identifier when said callee identifier has a length that matches a caller dialing number format specified by said caller dialing profile and only one area code is specified as being associated with said caller in said caller dialing profile.
- 15
- 15.** The process of claim **10** further comprising classifying said call as a private network call when said re-formatted callee identifier identifies a subscriber to the private network.
- 20
- 16.** The process of claim **10** further comprising determining whether said callee identifier complies with a pre-defined username format and if so classifying the call as a private network call.
- 25
- 17.** The process of claim **10** further comprising causing a database of records to be searched to locate a direct in dial (DID) bank table record associating a public telephone number with said reformatted callee identifier and if said DID bank table record is found classifying the call as a private network call and if a DID bank table record is not found classifying the call as a public network call.
- 30
- 18.** The process of claim **17** wherein producing said routing message identifying a node on the private network comprises setting a callee

-75-

identifier in response to a username associated with said DID bank table record.

- 5
- 19.** The process of claim **18** wherein producing said routing message comprises determining whether a node associated with the reformatted callee identifier is the same as a node associated the caller identifier.
- 10
- 20.** The process of claim **19** wherein determining whether a node associated with the reformatted callee identifier is the same as a node associated the caller identifier comprises determining whether a prefix of said re-formatted callee identifier matches a corresponding prefix of a username associated with said caller dialing profile.
- 15
- 21.** The process of claim **20** wherein when said node associated with said caller is not the same as the node associated with the callee, producing a routing message including said caller identifier, said reformatted callee identifier and an identification of a private network node associated with said callee and communicating said routing message to a call controller.
- 20
- 22.** The process of claim **19** wherein when said node associated with said caller is the same as the node associated with said callee, determining whether to perform at least one of the following: forward said call to another party, block the call and direct the caller to a voicemail server associated with the callee.
- 25
- 23.** The process of claim **22** wherein producing said routing message comprises producing a routing message having an identification of at least one of the callee identifier, an identification of a party to whom the call should be forwarded and an identification of a voicemail server associated with the callee.
- 30

-76-

24. The process of claim 23 further comprising communicating said routing message to a call controller.
- 5 25. The process of claim 10 wherein producing a routing message identifying a gateway to the public network comprises searching a database of route records associating route identifiers with dialing codes to find a route record having a dialing code having a number pattern matching at least a portion of said reformatted callee identifier.
- 10 26. The process of claim 25 further comprising searching a database of supplier records associating supplier identifiers with said route identifiers to locate at least one supplier record associated with said route identifier associated with said route record having a dialing code having a number pattern matching at least a portion of said reformatted
- 15 callee identifier.
27. The process of claim 26 further comprising loading a routing message buffer with the reformatted callee identifier and an identification of specific routes associated respective ones of the supplier records associated with said route record and loading said routing message
- 20 buffer with a time value and a timeout value.
28. The process of claim 27 further comprising communicating a routing message comprising the contents of said routing message buffer to a
- 25 call controller.
29. The process of claim 4 further comprising causing said dialing profile to include a maximum concurrent call value and a concurrent call count value and causing said concurrent call count value to be incremented
- 30 when the user associated with said dialing profile initiates a call and causing said concurrent call count value to be decremented when a call with said user associated with said dialing profile is ended.

-77-

30. A computer readable medium encoded with codes for directing a processor to execute the method of any one of claims **1-29**.

5 **31.** A call routing apparatus for facilitating communications between callers and callees in a system comprising a plurality of nodes with which callers and callees are associated, the apparatus comprising:

10 receiving means for receiving a caller identifier and a callee identifier, in response to initiation of a call by a calling subscriber;

15 classifying means for classifying the call as a private network call or a public network call according to call classification criteria associated with the caller identifier;

20 means for producing a routing message identifying an address, on the private network, associated with the callee when the call is classified as a private network call; and

means for producing a routing message identifying a gateway to the public network if the call is classified as a public network call.

25 **32.** The apparatus of claim **31** wherein said receiving means is operably configured to receive a request to establish a call, from a call controller in communication with a caller identified by said callee identifier.

30 **33.** The apparatus of claim **31** further comprising searching means for searching a database comprising records associating calling attributes with subscribers to said private network to locate a record identifying calling attributes associated with a caller identified by said caller identifier.

-78-

- 5 **34.** The apparatus of claim **33** wherein said records include dialing profiles each comprising a username associated with said subscriber, an identification of a domain associated with said subscriber, and an identification of at least one calling attribute associated with said subscriber.
- 10 **35.** The apparatus of claim **34** wherein said call classification means is operably configured to compare calling attributes associated with said caller dialing profile with aspects of said callee identifier.
- 15 **36.** The apparatus of claim **35** wherein said calling attributes include an international dialing digit and wherein said call classification means is operably configured to determine whether said callee identifier includes a portion that matches an IDD associated with said caller dialing profile.
- 20 **37.** The apparatus of claim **34** wherein said calling attributes include an national dialing digit and wherein said call classification means is operably configured to determine whether said callee identifier includes a portion that matches an NDD associated with said caller dialing profile.
- 25 **38.** The apparatus of claim **34** wherein said calling attributes include an area code and wherein said call classification means is operably configured to determine whether said callee identifier includes a portion that matches an area code associated with said caller dialing profile.
- 30 **39.** The apparatus of claim **34** wherein said calling attribute include a number length range and wherein said call classification means is operably configured to determine whether said callee identifier has a length within a range specified in said caller dialing profile.

-79-

- 5
40. The apparatus of claim **34** further comprising formatting means for formatting said callee identifier into a pre-defined digit format to produce a re-formatted callee identifier.
- 10
41. The apparatus of claim **40** wherein said formatting means is operably configured to remove an international dialing digit from said callee identifier, when said callee identifier begins with a digit matching an international dialing digit specified by said caller dialing profile associated with said caller.
- 15
42. The apparatus of claim **40** wherein said formatting means is operably configured to remove a national dialing digit from said callee identifier and prepend a caller country code to said callee identifier when said callee identifier begins with a national dialing digit.
- 20
43. The apparatus of claim **40** wherein said formatting means is operably configured to prepend a caller country code to said callee identifier when said callee identifier begins with digits identifying an area code specified by said caller dialing profile.
- 25
44. The apparatus of claim **40** wherein said formatting means is operably configured to prepend a caller country code and area code to said callee identifier when said callee identifier has a length that matches a caller dialing number format specified by said caller dialing profile and only one area code is specified as being associated with said caller in said caller dialing profile.
- 30
45. The apparatus of claim **40** wherein said classifying means is operably configured to classifying said call as a private network call when said re-formatted callee identifier identifies a subscriber to the private network.

-80-

- 5
- 10
- 15
- 20
- 25
- 30
46. The apparatus of claim **40** wherein said classifying means is operably configured to classify the call as a private network call when said callee identifier complies with a pre-defined username format.
 47. The apparatus of claim **40** further comprising searching means for searching a database of records to locate a direct in dial (DID) bank table record associating a public telephone number with said reformatted callee identifier and wherein said classifying means is operably configured to classify the call as a private network call when said DID bank table record is found and to classify the call as a public network call when a DID bank table record is not found
 48. The apparatus of claim **47** wherein said private network routing message producing means is operably configured to produce a routing message having a callee identifier set according to a username associated with said DID bank table record.
 49. The apparatus of claim **48** wherein said private network routing message producing means is operably configured to determine whether a node associated with the reformatted callee identifier is the same as a node associated the caller identifier.
 50. The apparatus of claim **49** wherein said private network routing means includes means for determining whether a prefix of said re-formatted callee identifier matches a corresponding prefix of a username associated with said caller dialing profile.
 51. The apparatus of claim **50** wherein said private network routing message producing means is operably configured to produce a routing message including said caller identifier, said reformatted callee identifier and an identification of a private network node associated with

-81-

said callee and communicating said routing message to a call controller.

- 5
- 52.** The apparatus of claim **49** wherein said private network routing message producing means is operably configured to perform at least one of the following: forward said call to another party, block the call and direct the caller to a voicemail server associated with the callee, when said node associated with said caller is the same as the node associated with said callee.
- 10
- 53.** The apparatus of claim **52** wherein said means for producing said private network routing message is operably configured to produce a routing message having an identification of at least one of the callee identifier, an identification of a party to whom the call should be forwarded and an identification of a voicemail server associated with the callee.
- 15
- 54.** The apparatus of claim **53** further comprising means for communicating said routing message to a call controller.
- 20
- 55.** The apparatus of claim **40** wherein said means for producing a public network routing message identifying a gateway to the public network comprises means for searching a database of route records associating route identifiers with dialing codes to find a route record having a dialing code having a number pattern matching at least a portion of said reformatted callee identifier.
- 25
- 56.** The apparatus of claim **55** further comprising means for searching a database of supplier records associating supplier identifiers with said route identifiers to locate at least one supplier record associated with said route identifier associated with said route record having a dialing
- 30

AMENDED CLAIMS**received by the International Bureau on 18 April 2008 (18.04.08)**

code having a number pattern matching at least a portion of said reformatted callee identifier.

- 5 **57.** The apparatus of claim **56** further comprising a routing message buffer and means for loading said routing message buffer with the reformatted callee identifier and an identification of specific routes associated respective ones of the supplier records associated with said route record and loading said routing message buffer with a time value and a timeout value.
- 10 **58.** The apparatus of claim **57** further comprising means for communicating a routing message comprising the contents of said routing message buffer to a call controller.
- 15 **59.** The apparatus of claim **34** further comprising means for causing said dialing profile to include a maximum concurrent call value and a concurrent call count value and for causing said concurrent call count value to be incremented when the user associated with said dialing profile initiates a call and for causing said concurrent call count value to be decremented when a call with said user associated with said dialing profile is ended.
- 20

Data Structure

- 25 **60.** A data structure for access by an apparatus for producing a routing message for use by a call routing controller in a communications system, the data structure comprising:
- 30 dialing profile records comprising fields for associating a subscriber username with respective subscribers to the system;

direct-in-dial records comprising fields for associating a user domain and a direct-in-dial number with respective subscriber usernames;

5 prefix to node records comprising fields for associating a node address of a node in said system with at least a portion of said respective subscriber usernames:

10 whereby said subscriber username can be used to find said user domain, at least a portion of said subscriber username can be used to find said node with which a subscriber identified by said subscriber user name is associated, and said user domain and said subscriber username can be located in response to said direct-in-dial number.

15

61. A data structure for access by an apparatus for producing a routing message for use by a call routing controller in a communications system, the data structure comprising:

20 master list records comprising fields for associating a dialing code with respective master list identifiers; and

25 supplier list records linked to said master list records by said master list identifiers, said supplier list records comprising fields for associating with a communications services supplier:

a supplier id;

a master list id;

30

a route identifier; and

a billing rate code,

5 whereby at least one communications service supplier is associated with said dialing code, such that said dialing code can be used to locate suppliers capable of providing a communications link associated with a given dialing code.

10 **62.** A method of determining a time to permit a communication session to be conducted, the method comprising:

calculating a cost per unit time;

15 calculating a first time value as a sum of a free time attributed to a participant in the communication session and the quotient of a funds balance held by said participant to said cost per unit time value; and

20 producing a second time value in response to said first time value and a billing pattern associated with said participant, said billing pattern including first and second billing intervals and said second time value being said time to permit a communication session to be conducted.

25 **63.** The method of claim **62** wherein calculating said first time value comprises retrieving a record associated with said participant and obtaining from said record at least one of said free time and said funds balance.

-85-

5 **64.** The method of claim **62** wherein producing said second time value comprises producing a remainder value representing a portion of said second billing interval remaining after dividing said second billing interval into a difference between said first time value and said first billing interval.

10 **65.** The method of claim **64** wherein producing said second time value comprises setting a difference between said first time value and said remainder as said second time value.

15 **66.** The method of claim **62** further comprising setting said second time value to zero when said remainder is greater than zero and said first time value is less than said free time associated with said participant.

20 **67.** The method of claim **62** wherein calculating said cost per unit time comprises:

 locating a record in a database, said record comprising a markup type indicator, a markup value and a billing pattern;

20

 and

 setting a reseller rate equal to the sum of said markup value and said buffer rate.

25

68. The method of claim **67** wherein locating said record in a database comprises locating at least one of:

30

 a record associated with a reseller and a route associated with the reseller;

 a record associated with the reseller; and

-86-

a default reseller markup record.

5 **69.** The method of claim **67** wherein calculating said cost per unit time value further comprises locating at least one of:

10 an override record specifying a route cost per unit time amount associated with a route associated with the communication session;

15 a reseller record associated with a reseller of said communications session, said reseller record specifying a reseller cost per unit time associated with said reseller for the communication session;

 a default operator markup record specifying a default cost per unit time.

20 **70.** The method of claim **69** further comprising setting as said cost per unit time the sum of said reseller rate and at least one of said route cost per unit time, said reseller cost per unit time and said default cost per unit time.

25 **71.** The method of claim **69** further comprising receiving a communication session time representing a duration of said communication session and incrementing a reseller balance by the product of said reseller rate and said communication session time.

30 **72.** The method of claim **69** further comprising receiving a communication session time representing a duration of said communication session and incrementing a system operator balance by a product of said buffer rate and said communication session time.

-87-

73. A computer readable medium encoded with instructions for directing a processor circuit to execute the method of any one of claims **62-72**.

5 **74.** An apparatus for determining a time to permit a communication session to be conducted, the apparatus comprising:

a processor circuit;

10 a computer readable medium coupled to the processor circuit and encoded with instructions for directing the processor circuit to:

calculate a cost per unit time for the communication session;

15

calculate a first time value as a sum of a free time attributed to a participant in the communication session and the quotient of a funds balance held by said participant to said cost per unit time value; and

20

produce a second time value in response to said first time value and a billing pattern associated with said participant, said billing pattern including first and second billing intervals and said second time value being said time to permit a communication session to be conducted.

25

75. The apparatus of claim **74** wherein said instructions include instructions for directing the processor circuit to retrieve a record associated with said participant and obtain from said record at least one of said free time and said funds balance.

30

-88-

- 5 **76.** The apparatus of claim **74** wherein said instructions include instructions for directing the processor circuit to produce said second time value by producing a remainder value representing a portion of said second billing interval remaining after dividing said second billing interval into a difference between said first time value and said first billing interval.
- 10 **77.** The apparatus of claim **76** wherein said instructions include instructions for directing the processor circuit to produce said second time value comprises setting a difference between said first time value and said remainder as said second time value.
- 15 **78.** The apparatus of claim **74** wherein said instructions include instructions for directing the processor circuit to set said second time value to zero when said remainder is greater than zero and said first time value is less than said free time associated with said participant.
- 20 **79.** The apparatus of claim **74** wherein said instructions for directing said processor circuit to calculate said cost per unit time comprises instructions for directing the processor circuit to:
- 25 locate a record in a database, said record comprising a markup type indicator, a markup value and a billing pattern;
- and
- set a reseller rate equal to the sum of said markup value and said buffer rate.
- 30

-89-

80. The apparatus of claim **79** wherein said instructions for directing the processor circuit to locate said record in a database comprises instruction for directing the processor circuit to locate at least one of:

5 a record associated with a reseller and a route associated with the reseller;

 a record associated with the reseller;

10 a default reseller markup record;

81. The apparatus of claim **79** wherein said instructions for directing the processor circuit to calculate said cost per unit time value further comprises instructions for directing the processor circuit to locate at least one of:

15 an override record specifying a route cost per unit time amount associated with a route associated with the communication session;

20 a reseller record associated with a reseller of said communications session, said reseller record specifying a reseller cost per unit time associated with said reseller for the communication session;

25 a default operator markup record specifying a default cost per unit time.

82. The apparatus of claim **81** wherein said instructions include instructions for directing the processor circuit to set as said cost per unit time the sum of said reseller rate and at least one of said route

30

-90-

cost per unit time, said reseller cost per unit time and said default cost per unit time.

5 **83.** The apparatus of claim **81** wherein said instructions include instructions for directing the processor circuit to receive a communication session time representing a duration of said communication session and increment a reseller balance by the product of said reseller rate and said communication session time.

10 **84.** The apparatus of claim **81** wherein said instructions include instructions for directing the processor circuit to receive a communication session time representing a duration of said communication session and increment a system operator balance by a product of said buffer rate and said communication session time.

15

Attributing Charges to a User

20 **85.** A process for attributing charges for communications services, the process comprising:

25

determining a first chargeable time in response to a communication session time and a pre-defined billing pattern;

30

determining a user cost value in response to said first chargeable time and a free time value associated with a user of said communications services;

35

changing an account balance associated with said user in response to a user cost per unit time.

-91-

changing an account balance associated with a reseller of said communications services in response to a reseller cost per unit time and said communication session time; and

5 changing an account balance associated with an operator of said communications services in response to an operator cost per unit time and said communication session time.

10 **86.** The process of claim **85** wherein determining said first chargeable time comprises:

locating at least one of:

15 an override record specifying a route cost per unit time and billing pattern associated with a route associated with the communication session;

20 a reseller record associated with a reseller of said communications session, said reseller record specifying a reseller cost per unit time and billing pattern associated with said reseller for the communication session; and

25 a default record specifying a default cost per unit time and billing pattern; and

setting as said pre-defined billing pattern the billing pattern of the record located,

30 wherein the billing pattern of the record located comprises a first billing interval and a second billing interval.

-92-

- 5
- 87.** The process of claim **85** wherein determining said first chargeable time comprises setting said first chargeable time equal to said first billing interval when said communication session time is less than or equal to said first billing interval.
- 10
- 88.** The process of claim **86** wherein determining said first chargeable time comprises producing a remainder value representing a portion of said second billing interval remaining after dividing said second billing interval into a difference between communication session time and said first interval when said communication session time is greater than said communication session time; and
- 15
- setting said first chargeable time to a difference between said communication session time and said remainder when said remainder is greater than zero; and
- 20
- setting said first chargeable time to said communication session time when said remainder is not greater than zero.
- 25
- 89.** The process of claim **88** further comprising determining a second chargeable time in response to said first chargeable time and said free time value associated with said user of said communications services when said first chargeable time is greater than or equal to said free time value associated with said user of said communications services.
- 30
- 90.** The process of claim **89** wherein determining said second chargeable time comprises setting said second chargeable time to a difference between said first chargeable time.
- 91.** The process of claim **89** further comprising resetting said free time value associated with the user to zero when said first chargeable time

-93-

is greater than or equal to said free time value associated with said user of said communications services.

- 5 **92.** The process of claim **90** wherein changing an account balance associated with the user comprises calculating a user cost value in response to said second chargeable time and said user cost per unit time.
- 10 **93.** The process of claim **92** further comprising changing a user free cost balance in response to said user cost value.
- 15 **94.** The process of claim **85** further comprising setting said user cost to zero when said first chargeable time is less than said free time value associated with the user.
- 95.** The process of claim **85** further comprising changing a user free time balance in response to said first chargeable time.
- 20 **96.** A computer readable medium encoded with instructions for directing a processor circuit to execute the process of any one of claims **85-95**.
- 97.** An apparatus for attributing charges for communications services, the apparatus comprising:
- 25 a processor circuit;
- a computer readable medium in communication with the processor circuit and encoded with instructions for directing said processor circuit to;
- 30 determine a first chargeable time in response to a communication session time and a pre-defined billing pattern;

-94-

determine a user cost value in response to said first chargeable time and a free time value associated with a user of said communications services;

5

change an account balance associated with said user in response to a user cost per unit time.

10

change an account balance associated with a reseller of said communications services in response to a reseller cost per unit time and said communication session time; and

15

change an account balance associated with an operator of said communications services in response to an operator cost per unit time and said communication session time.

98. The apparatus of claim **97** wherein said instructions for directing the processor circuit to determine said first chargeable time comprises:

20

instructions for causing said processor circuit to communicate with a database to locate at least one of:

25

an override record specifying a route cost per unit time and billing pattern associated with a route associated with the communication session;

30

a reseller record associated with a reseller of said communications session, said reseller record specifying a reseller cost per unit time and billing pattern associated with said reseller for the communication session; and

-95-

a default record specifying a default cost per unit time and billing pattern; and

5 instructions for setting as said pre-defined billing pattern the billing pattern of the record located,

wherein the billing pattern of the record located comprises a first billing interval and a second billing interval.

10 **99.** The apparatus of claim **97** wherein said instructions causing the processor circuit to determine said first chargeable time comprises instructions for directing the processor circuit to set said first chargeable time equal to said first billing interval when said communication session time is less than or equal to said first billing interval.

15 **100.** The apparatus of claim **98** wherein said instructions for causing the processor circuit to determine said first chargeable time comprises instructions for producing a remainder value representing a portion of said second billing interval remaining after dividing said second billing interval into a difference between communication session time and said first interval when said communication session time is greater than said communication session time; and

25 instructions for causing the processor circuit to set said first chargeable time to a difference between said communication session time and said remainder when said remainder is greater than zero; and

30 instructions for causing the processor circuit to set said first chargeable time to said communication session time when said remainder is not greater than zero.

-96-

- 5 **101.** The apparatus of claim **100** wherein the computer readable medium is further encoded with instructions for causing the processor circuit to determine a second chargeable time in response to said first chargeable time and said free time value associated with said user of said communications services when said first chargeable time is greater than or equal to said free time value associated with said user of said communications services.
- 10 **102.** The apparatus of claim **101** wherein said instructions for causing the processor circuit to determine said second chargeable time comprises instructions for causing the processor circuit to set said second chargeable time to a difference between said first chargeable time.
- 15 **103.** The apparatus of claim **101** wherein the computer readable medium is further encoded with instructions for causing the processor circuit to reset said free time value associated with the user to zero when said first chargeable time is greater than or equal to said free time value associated with said user of said communications services.
- 20 **104.** The apparatus of claim **102** wherein said instructions for causing the processor circuit to change an account balance associated with the user comprises instructions for causing the processor circuit to calculate a user cost value in response to said second chargeable time and said user cost per unit time.
- 25 **105.** The apparatus of claim **104** wherein the computer readable medium is further encoded with instructions for causing the processor circuit to change a user free cost balance in response to said user cost value.
- 30 **106.** The apparatus of claim **97** wherein the computer readable medium is further encoded with instructions for causing the processor circuit to

-97-

set said user cost to zero when said first chargeable time is less than said free time value associated with the user.

- 5 **107.** The apparatus of claim **97** wherein the computer readable medium is further encoded with instructions for causing the processor circuit to change a user free time balance in response to said first chargeable time.

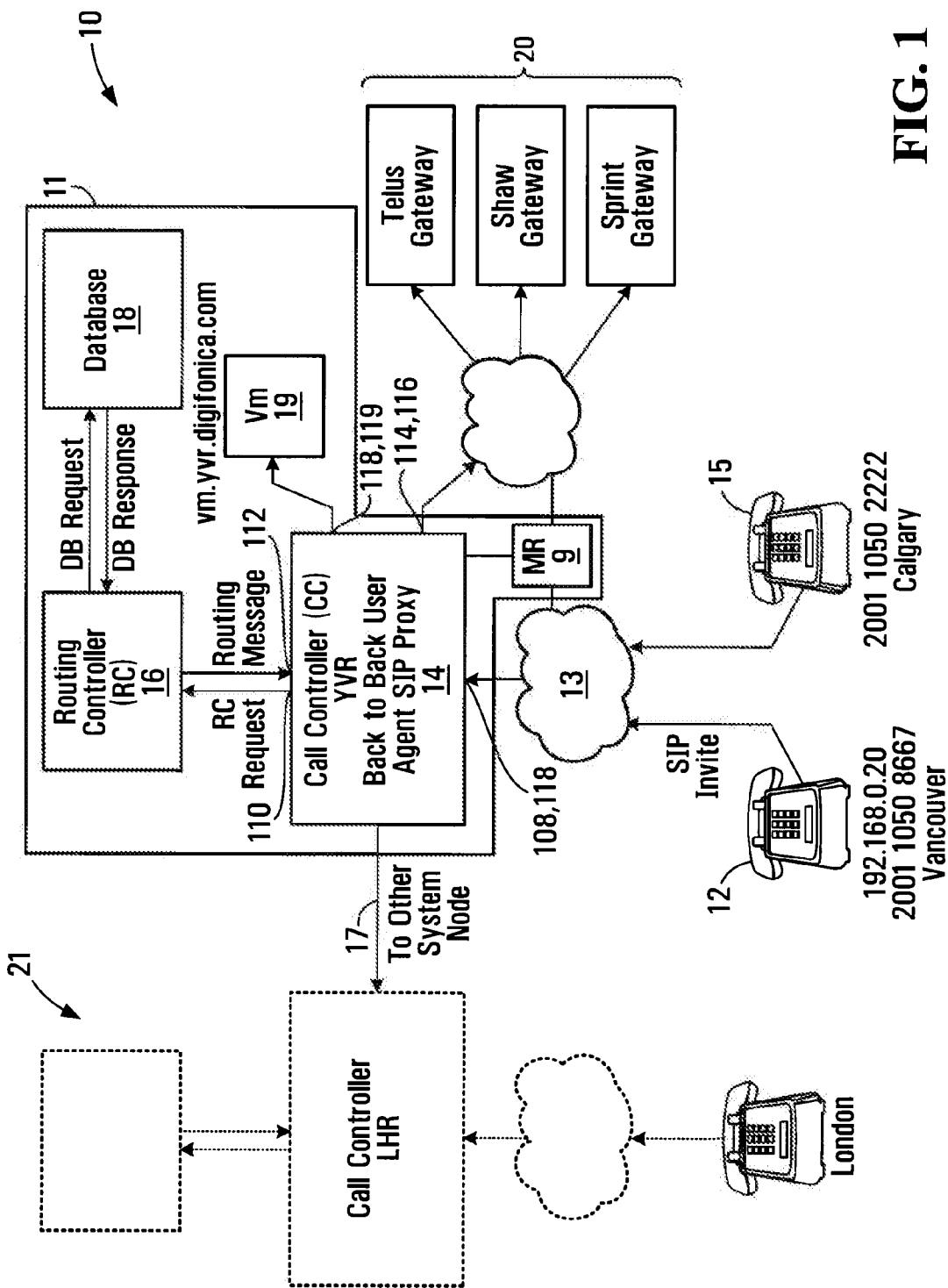

FIG. 1

2/32

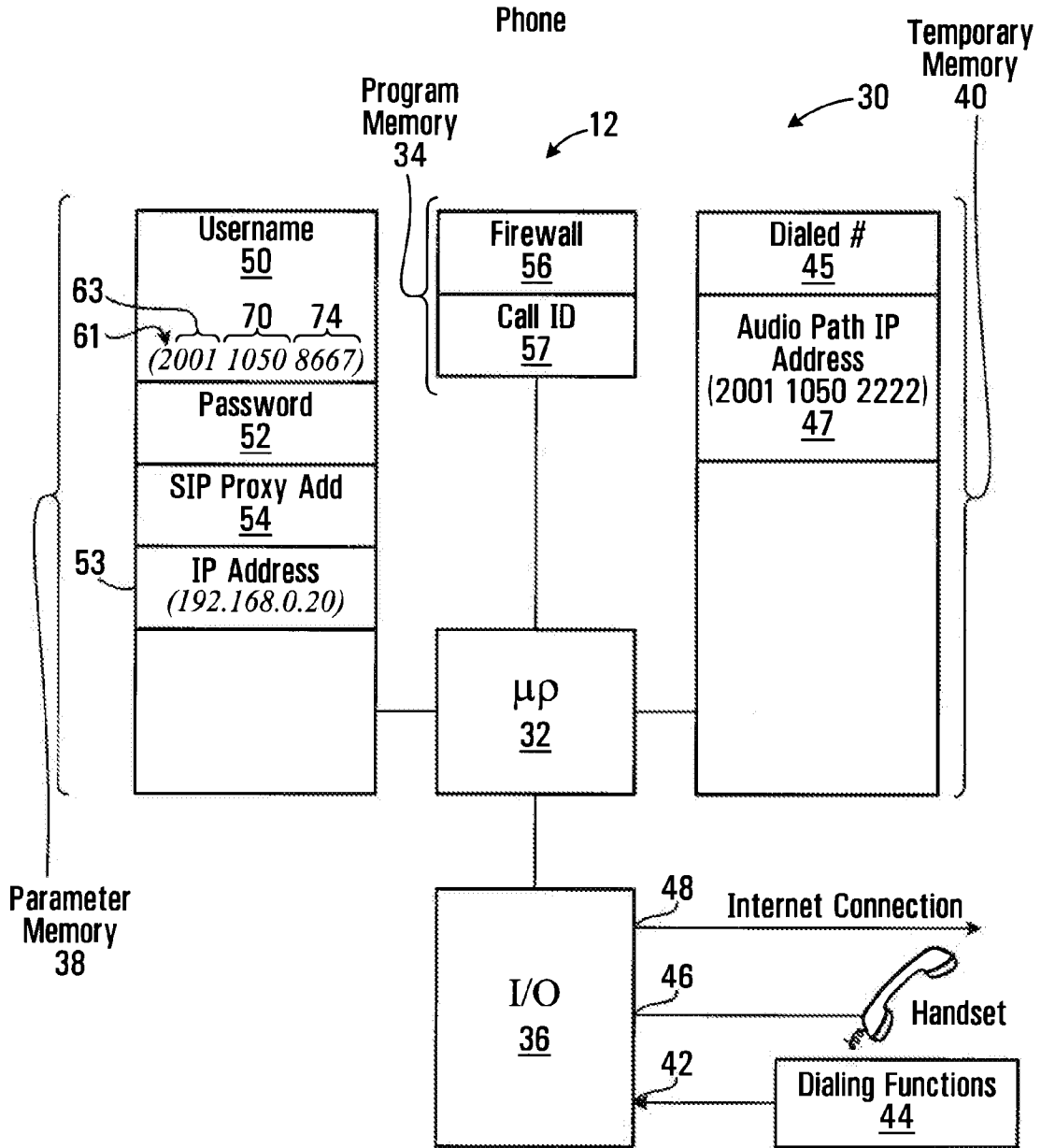

FIG. 2

3/32

SIP Invite Message

60 ~ Caller 2001 1050 8667
 62 ~ Callee 2001 1050 2222
 64 ~ Digest Parameters XXXXXX
 65 ~ Call ID FF10@ 192.168.0.20
 67 ~ IP Address 192.168.0.20
 69 ~ Caller UDP Port 1

FIG. 3

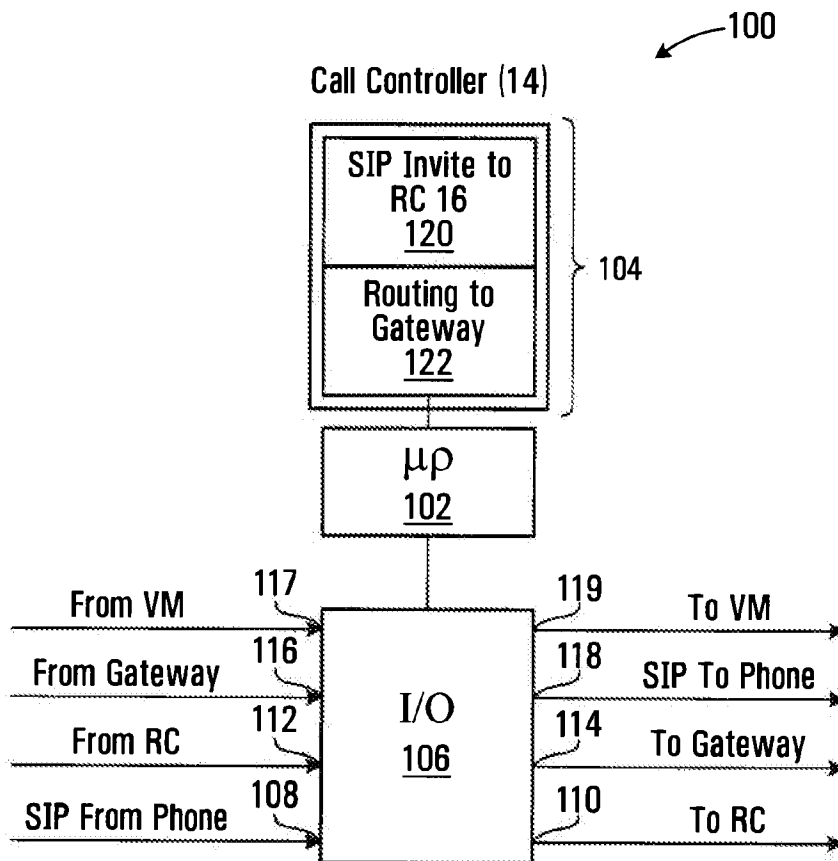

FIG. 4

4/32

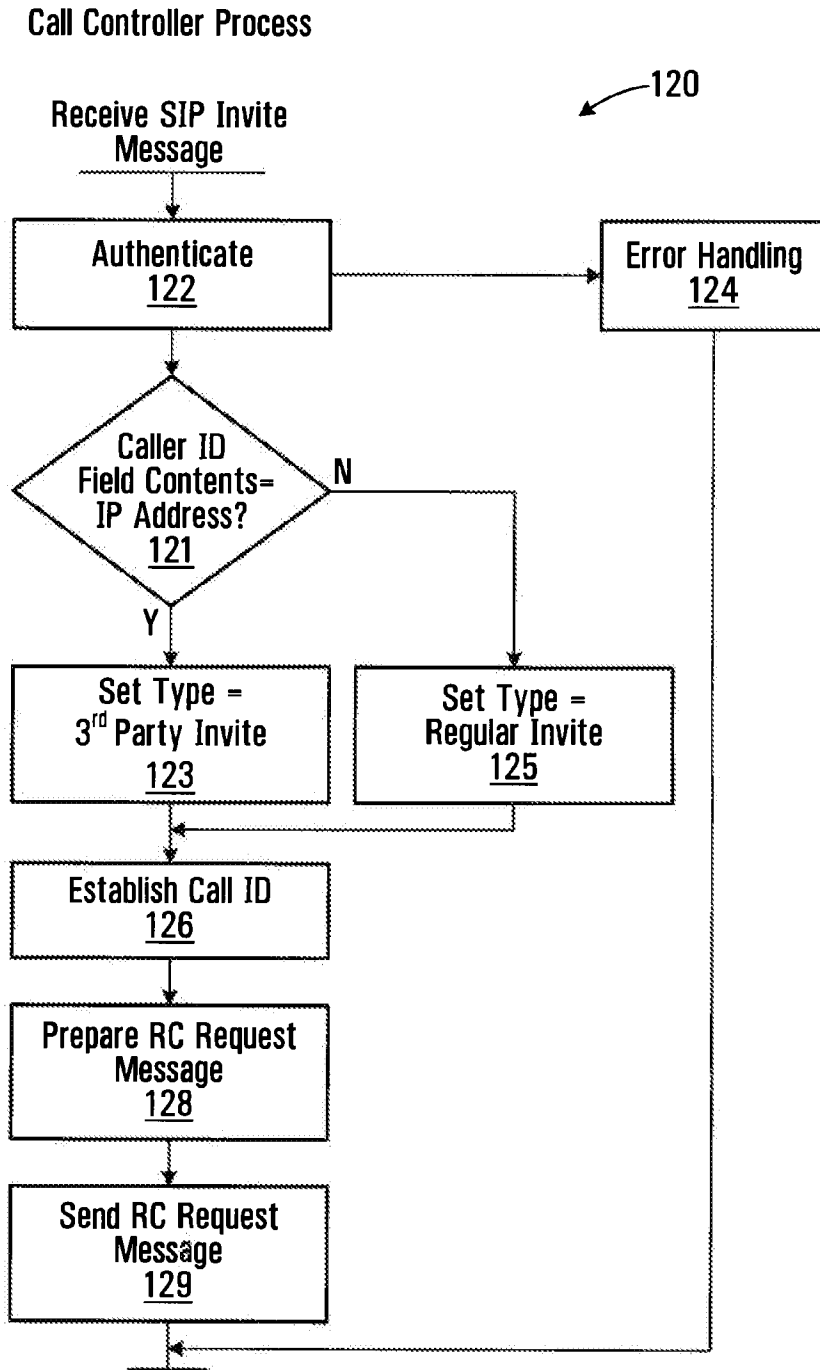

FIG. 5

5/32

150 ↙

RC Request Message

152 ~ Caller 2001 1050 8667
 154 ~ Callee 2001 1050 2222
 156 ~ Digest XXXXXXX
 158 ~ Call ID FF10@ 192.168.0.20
 160 ~ Type Subscriber

FIG. 6

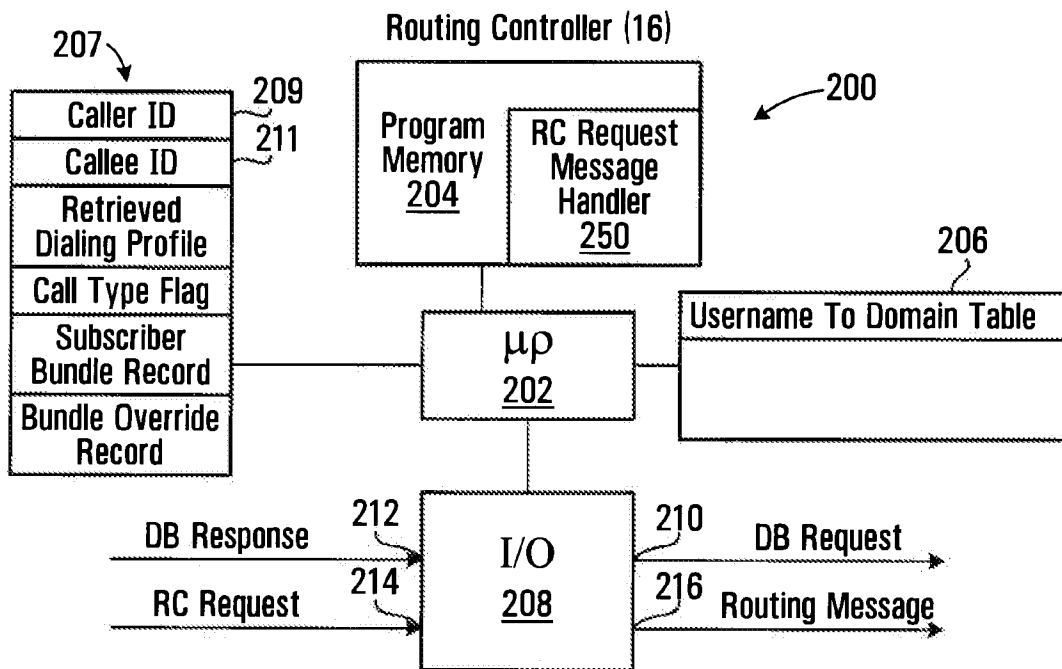

FIG. 7

6/32

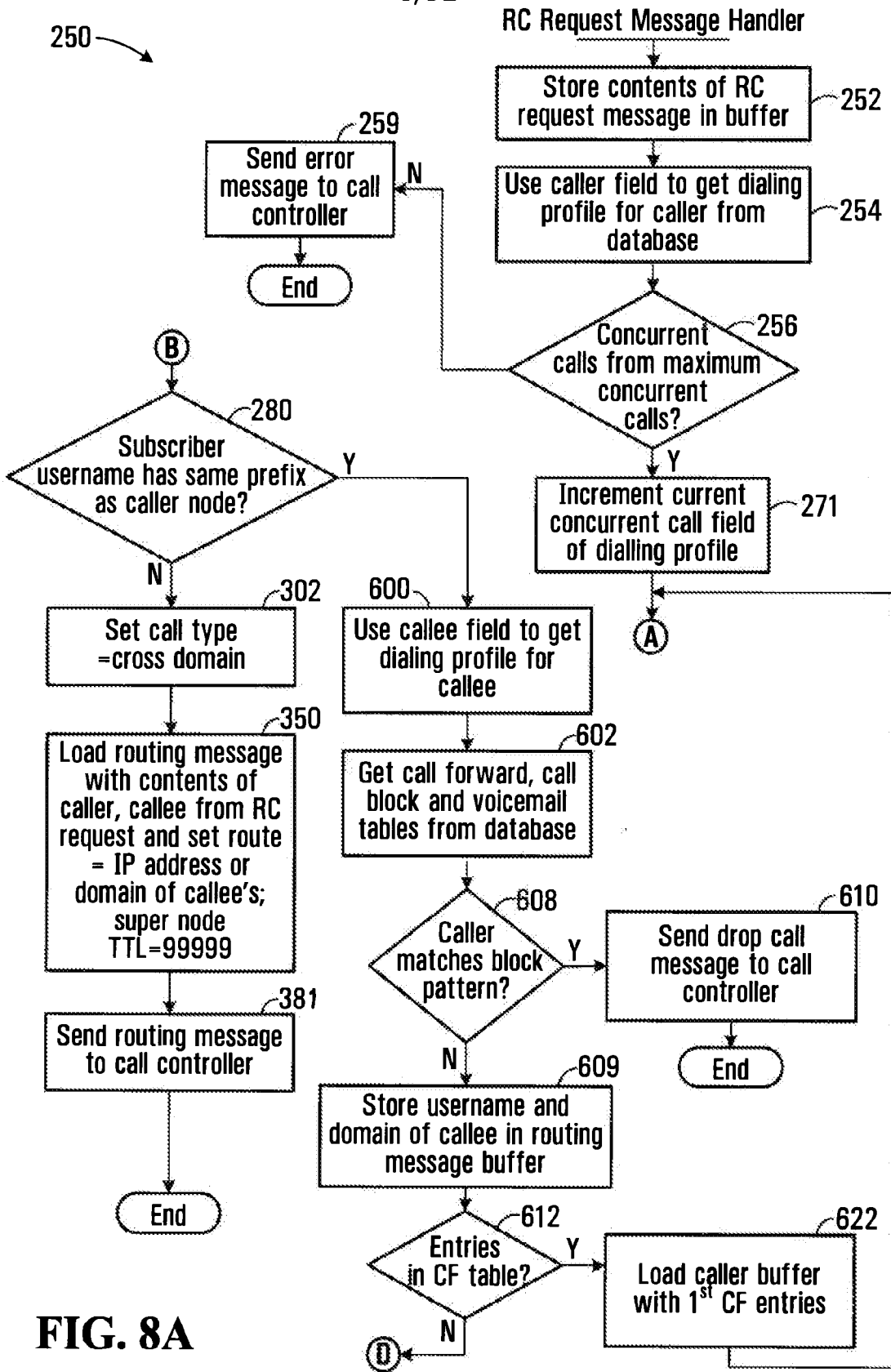

FIG. 8A

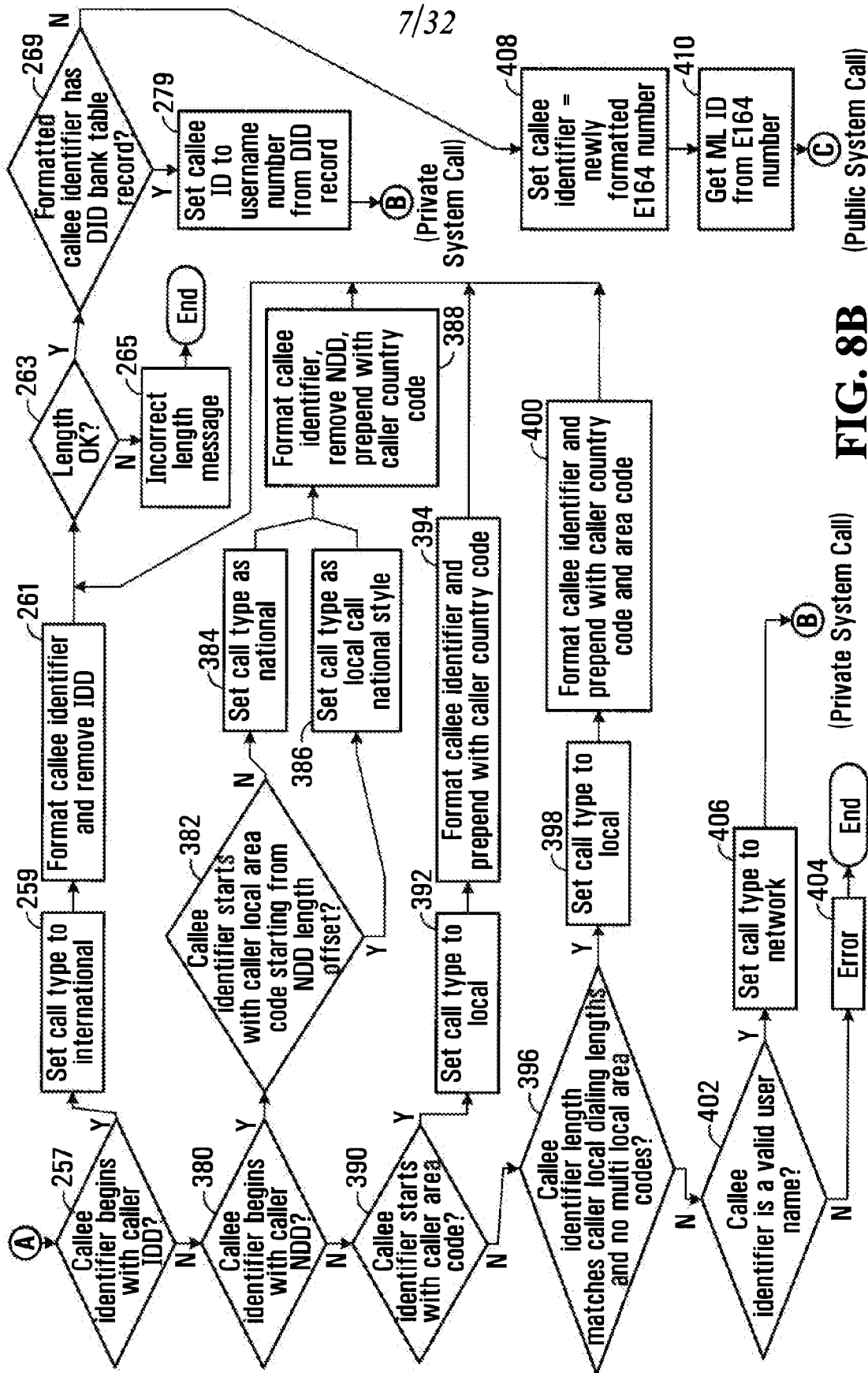

FIG. 8B (Public System Call)

(Private System Call)

8/32

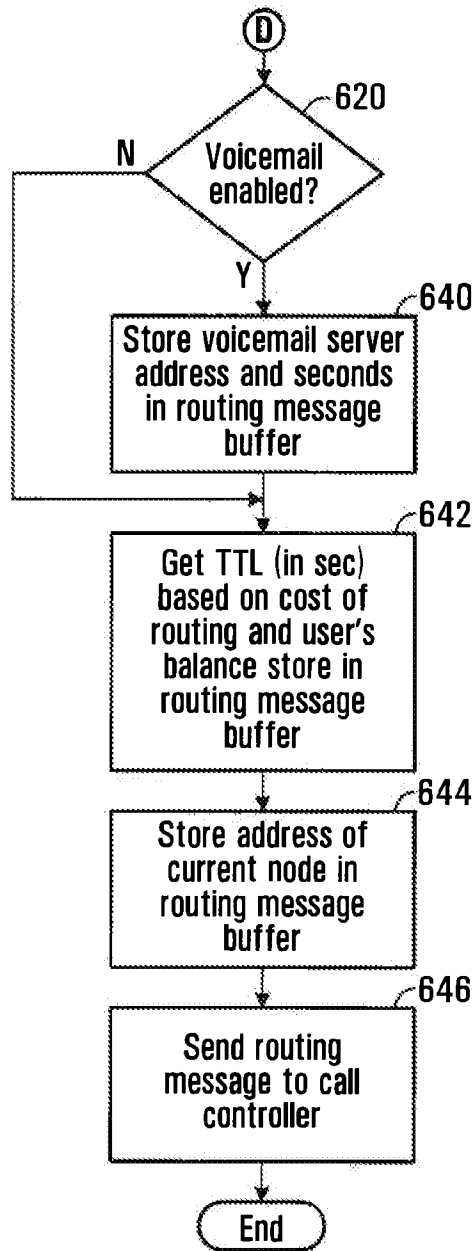

FIG. 8C

9/32

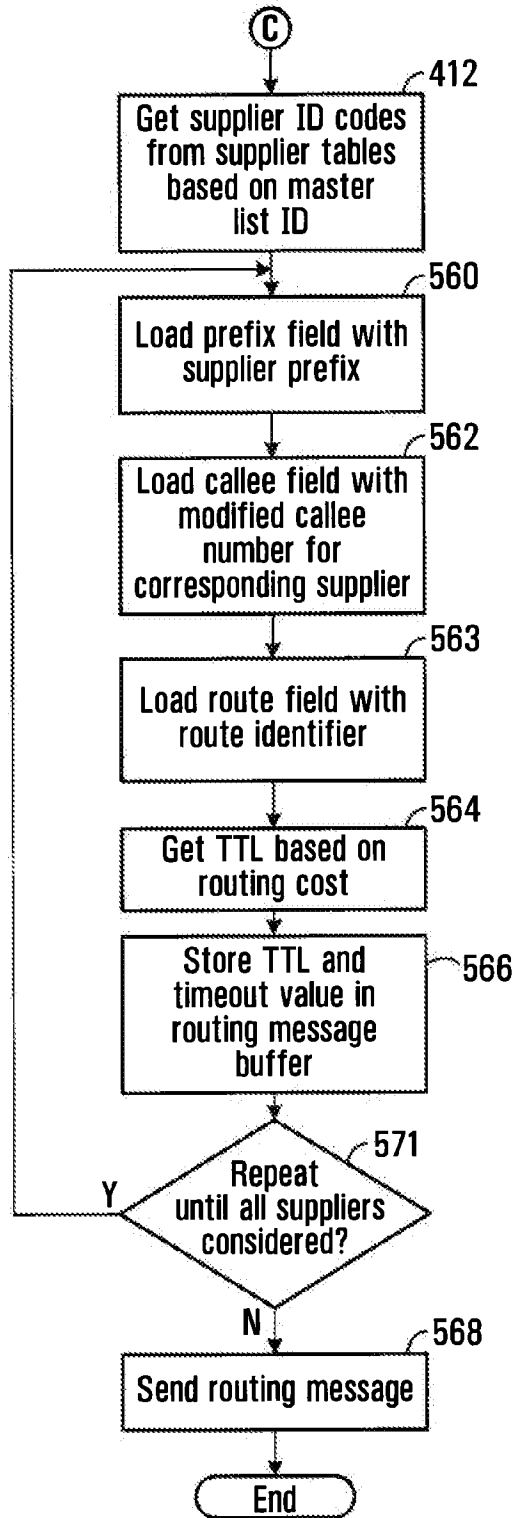

FIG. 8D

10/32

253

Dialing Profile for a User

258 ~ Username	Assigned on Subscription
260 ~ Domain	Domain Associated with User
262 ~ NDD	1
264 ~ IDD	011
266 ~ Country Code	1
267 ~ Local Area Codes	604;778
268 ~ Caller Minimum Local Length	10
270 ~ Caller Maximum Local Length	10
273 ~ Reseller	Retailer
275 ~ Maximum # of concurrent calls	Assigned on Subscription
277 ~ Current # of concurrent calls	Assigned on Subscription

FIG. 9

Dialing Profile for Caller (Vancouver Subscriber)

258 ~ Username	2001 1050 8667
260 ~ Domain	sp.yvr.digifonica.com
262 ~ NDD	1
264 ~ IDD	011
266 ~ Country Code	1
267 ~ Local Area Codes	604;778 (Vancouver)
268 ~ Caller Minimum Local Length	10
270 ~ Caller Maximum Local Length	10
273 ~ Reseller	Klondike
275 ~ Maximum # of concurrent calls	5
277 ~ Current # of concurrent calls	0

FIG. 10

11/32

Callee Profile for Calgary Subscriber

Username	2001 1050 2222
Domain	sp.yvr.digifonica.com
NDD	1
IDD	011
Country Code	1
Local Area Codes	403 (Calgary)
Caller Minimum Local Length	7
Caller Maximum Local Length	10
Reseller	Deerfoot
Maximum # of concurrent calls	5
Current # of concurrent calls	0

FIG. 11**Callee Profile for London Subscriber**

Username	4401 1062 4444
Domain	sp.lhr.digifonica.com
NDD	0
IDD	00
Country Code	44
Local Area Codes	20 (London)
Caller Minimum Local Length	10
Caller Maximum Local Length	11
Reseller	Marble Arch
Maximum # of concurrent calls	5
Current # of concurrent calls	0

FIG. 12

12/32

278

DID Bank Table Record Format

281 ~	Username	System subscriber
272 ~	User Domain	Host name of supernode
274 ~	DID	E164#

FIG. 13

300

DID Bank Table Record for Calgary Subscriber

281 ~	Username	2001 1050 2222
272 ~	User Domain	Sp.yvr.digifonica.com
274 ~	DID	1 604 867 5309

61

283 287 289

285

FIG. 14

13/32

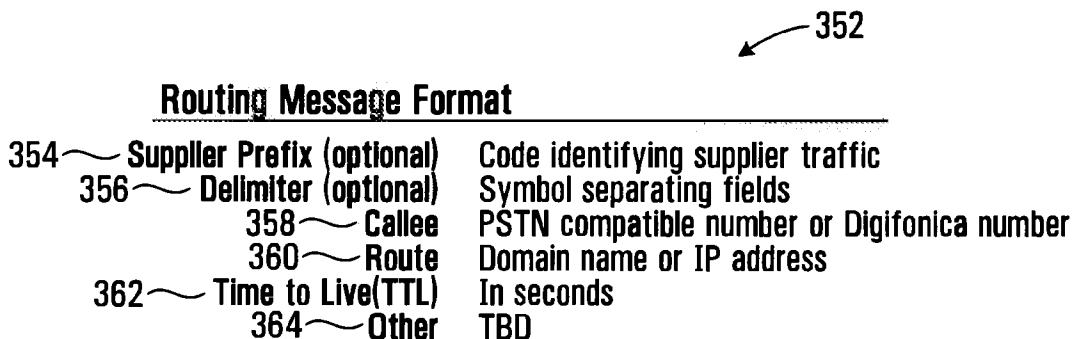

FIG. 15



FIG. 16

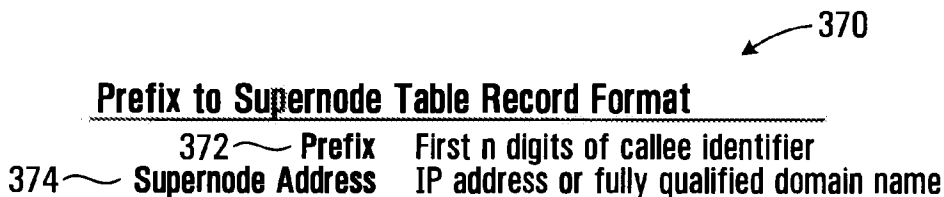

FIG. 17



FIG. 18

14/32

Master List Record Format

500 ~	ml_id	Alphanumeric
502 ~	Dialing code	Number Sequence
504 ~	Country code	The country code is the national prefix to be used when dialing TO a particular country FROM another country.
506 ~	Nat Sign #(Area Code)	Number Sequence
508 ~	Min Length	Numeric
510 ~	Max Length	Numeric
512 ~	NDD	The NDD prefix is the access code used to make a call WITHIN that country from one city to another (when calling another city in the same vicinity, this may not be necessary).
514 ~	IDD	The IDD prefix is the international prefix needed to dial a call FROM the country listed TO another country.
516 ~	Buffer rate	Safe change rate above the highest rate charged by suppliers

FIG. 19**Example: Master List Record with Populated Fields**

ml_id	1019
Dialing code	1604
Country code	1
Nat Sign #(Area Code)	604
Min Length	7
Max Length	7
NDD	1
IDD	011
Buffer rate	\$0.009/min

FIG. 20

15/32

Suppliers List Record Format

540 ~	Sup_id	Name code
542 ~	MI_id	Numeric code
544 ~	Prefix (optional)	String identifying supplier's traffic #
546 ~	Specific Route	IP address
548 ~	NDD/IDD rewrite	
550 ~	Rate	Cost per second to Digifonica to use this route
551 ~	Timeout	Maximum time to wait for a response when requesting this gateway

FIG. 21**Telus Supplier Record**

Sup_id	2010 (Telus)
MI_id	1019
Prefix (optional)	4973#
Specific Route	72.64.39.58
NDD/IDD rewrite	011
Rate	\$0.02/min
Timeout	20

FIG. 22**Shaw Supplier Record**

Sup_id	2011 (Shaw)
MI_id	1019
Prefix (optional)	4974#
Specific Route	73.65.40.59
NDD/IDD rewrite	011
Rate	\$0.025/min
Timeout	30

FIG. 23**Sprint Supplier Record**

Sup_id	2012 (Sprint)
MI_id	1019
Prefix (optional)	4975#
Specific Route	74.66.41.60
NDD/IDD rewrite	011
Rate	\$0.03/min
Timeout	40

FIG. 24

16/32

Routing Message Buffer for Gateway Call

4973#0116048675309@72.64.39.58;ttl=3600;to=20 ~ 570
 4974#0116048675309@73.65.40.59;ttl=3600;to=30 ~ 572
 4975#0116048675309@74.66.41.60;ttl=3600;to=40 ~ 574

FIG. 25**Call Block Table Record Format**

604 ~ Username Digifonica #
 606 ~ Block Pattern PSTN compatible or Digifonica #

FIG. 26**Call Block Table Record for Calgary Callee**

604 ~ Username of Callee 2001 1050 2222
 606 ~ Block Pattern 2001 1050 8664

FIG. 27**Call Forwarding Table Record Format for Callee**

614 ~ Username of Callee Digifonica #
 616 ~ Destination Number Digifonica #
 618 ~ Sequence Number Integer indicating order to try this

FIG. 28**Call Forwarding Table Record for Calgary Callee**

614 ~ Username of Callee 2001 1050 2222
 616 ~ Destination Number 2001 1055 2223
 618 ~ Sequence Number 1

FIG. 29

17/32

Voicemail Table Record Format

624	~	Username of Callee	Digifonica #
626	~	Vm Server	domain name
628	~	Seconds to Voicemail	time to wait before engaging voicemail
630	~	Enabled	yes/no

FIG. 30**Voicemail Table Record for Calgary Callee**

Username of Callee	2001 1050 2222
Vm Server	vm.yvr.digifonica.com
Seconds to Voicemail	20
Enabled	1

FIG. 31**Routing Message Buffer - Same Node**

650	~	200110502222@sp.yvr.digifonica.com;ttl=3600
652	~	200110552223@sp.yvr.digifonica.com;ttl=3600
654	~	vm.yvr.digifonica.com;20;ttl=60
656	~	sp.yvr.digifonica.com

FIG. 32

18/32

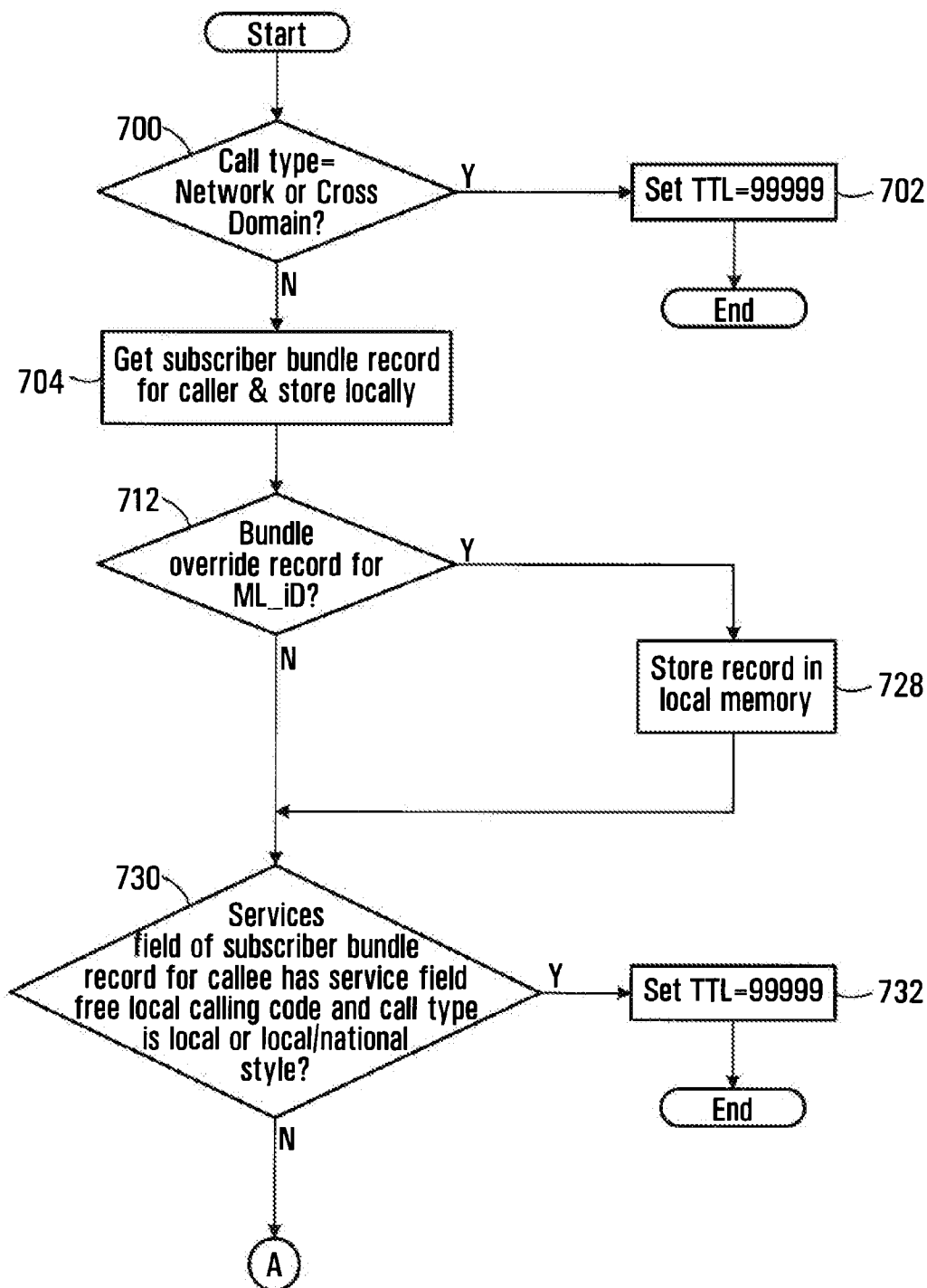

FIG. 33A

19/32

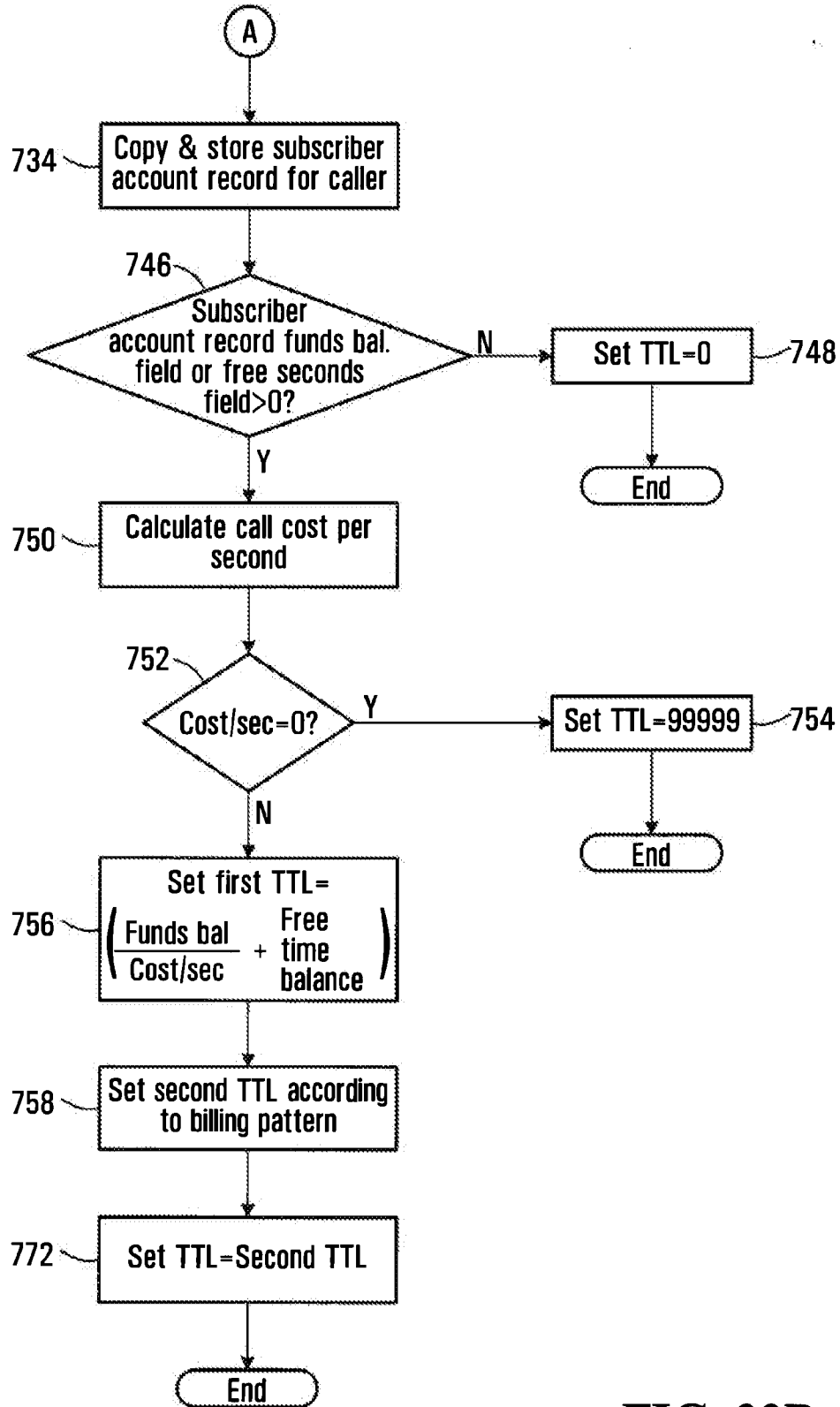

FIG. 33B

20/32

Subscriber Bundle Table Record

708 ~ Username Subscriber username
 710 ~ Services Codes identifying service features
 (e.g. Free local calling; call blocking, voicemail)

706

FIG. 34**Subscriber Bundle Record for Vancouver Caller**

708 ~ Username 2001 1050 8667
 710 ~ Services 10; 14; 16

FIG. 35**Bundle Override Table Record**

716 ~ ML_Id Master list ID code
 718 ~ Override type Fixed; percent; cents
 720 ~ Override value real number representing value of override type
 722 ~ Inc1 first level of charging (minimum # of seconds) charge
 724 ~ Inc2 second level of charging

714

FIG. 36**Bundle Override Record for Located ML_id**

716 ~ ML_Id 1019
 718 ~ Override type percent
 720 ~ Override value 10.0
 722 ~ Inc1 30 seconds
 724 ~ Inc2 6 seconds

726

FIG. 37

21/32

		736
<u>Subscriber Account Table Record</u>		
738 ~	Username	Subscriber username
740 ~	Funds balance	real number representing \$ value of credit
742 ~	Free time balance	integer representing # of free seconds

FIG. 38

		744
<u>Subscriber Account Record for Vancouver Caller</u>		
738 ~	Username	2001 1050 8667
740 ~	Funds balance	\$10.00
742 ~	Free time balance	100

FIG. 39

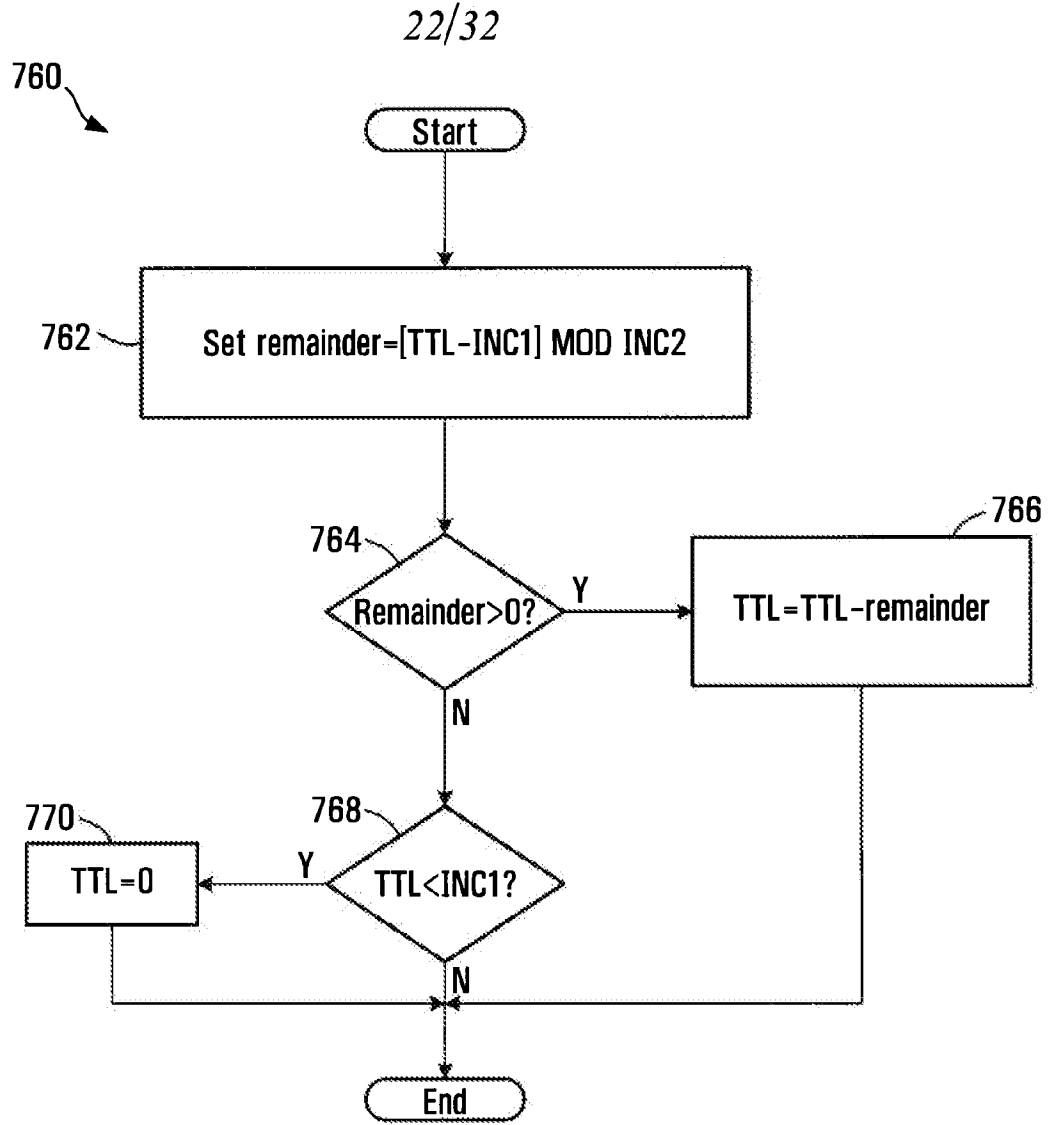

FIG. 40

23/32

780

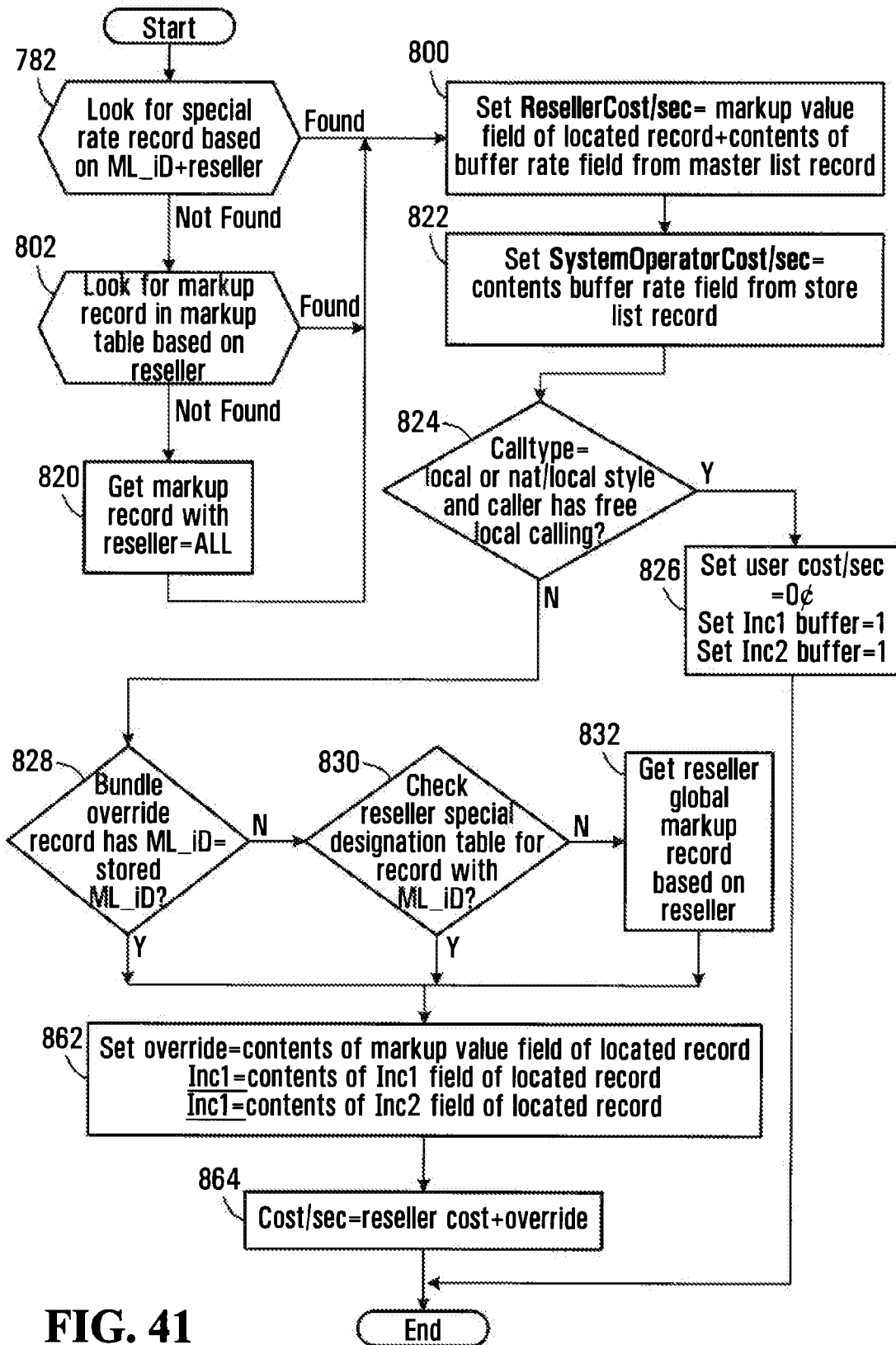

FIG. 41

24/32

784

System Operator Special Rates Table Record

786	Reseller	retailer id
788	ML_Id	master list id
790	Markup Table	fixed; percent; cents
792	Markup Value	real number representing value of markup type
794	Inc1	first level of charging (minimum # of seconds) charge
796	Inc2	second level of charging

FIG. 42

798

System Operator Special Rates Table Record for Klondike

786	Reseller	Klondike
788	ML_Id	1019
790	Markup Table	cents
792	Markup Value	\$0.001
794	Inc1	30
796	Inc2	6

FIG. 43

25/32

System Operator Markup Table Record

804 ↙

806	Reseller	reseller id code
808	Markup Table	fixed; percent; cents
810	Markup Value	real number representing value of markup type
812	Inc1	first level of charging (minimum # of seconds) charge
814	Inc2	second level of charging

FIG. 44

System Operator Markup Table Record for the Reseller Klondike

806	Reseller	Klondike
808	Markup Table	cents
810	Markup Value	\$0.01
812	Inc1	30
814	Inc2	6

FIG. 45

System Operator Markup Table Record

806	Reseller	all
808	Markup Table	percent
810	Markup Value	1.0
812	Inc1	30
814	Inc2	6

FIG. 46

26/32

Reseller Special Destinations Table Record

832

834	Reseller	reseller id code
836	ML_id	Master List ID code
838	Markup Table	fixed; percent; cents
840	Markup Value	real number representing value of markup type
842	Inc1	first level of charging (minimum # of seconds) charge
844	Inc2	second level of charging

FIG. 47

Reseller Special Destinations Table Record for the Reseller Klondike

846

834	Reseller	Klondike
836	ML_id	1019
838	Markup Table	percent
840	Markup Value	5%
842	Inc1	30
844	Inc2	6

FIG. 48

Reseller Global Markup Table Record

848

850	Reseller	reseller id code
852	Markup Table	fixed; percent; cents
854	Markup Value	real number representing value of markup type
856	Inc1	first level of charging (minimum # of seconds) charge
858	Inc2	second level of charging

FIG. 49

Reseller Global Markup Table Record for the Reseller Klondike

860

850	Reseller	Klondike
852	Markup Table	percent
854	Markup Value	10%
856	Inc1	30
858	Inc2	6

FIG. 50

27/32

900

SIP Bye Message

902 ~	Caller	Username
904 ~	Callee	PSTN compatible # or Username
906 ~	Call ID	unique call identifier (hexadecimal string@IP)

FIG. 51

908

SIP Bye Message

902 ~	Caller	2001 1050 8667
904 ~	Callee	2001 1050 2222
906 ~	Call ID	<u>FA10@192.168.0.20</u>

FIG. 52

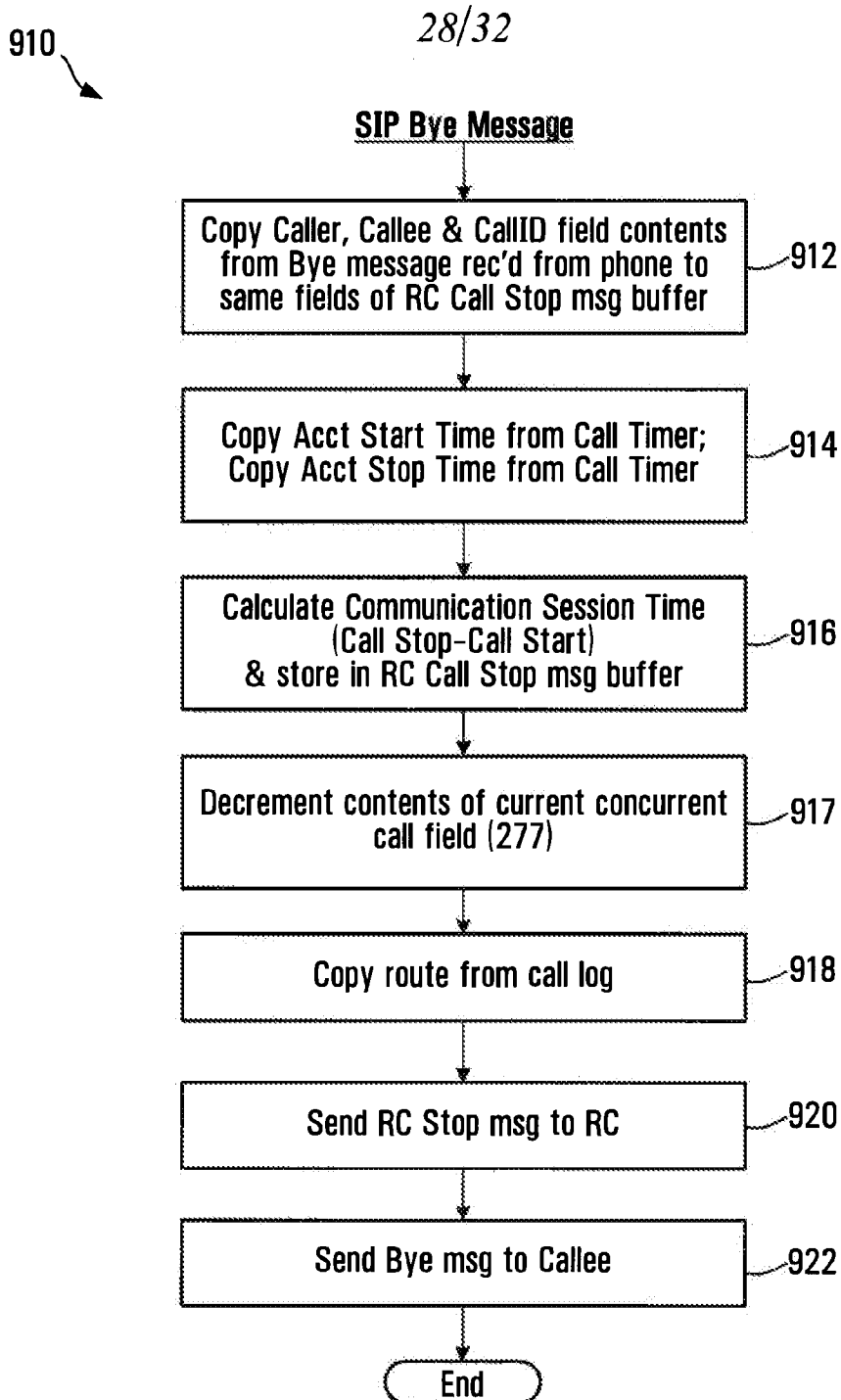

FIG. 53

29/32

1000

RC Call Stop Message

1002	Caller	Username
1004	Callee	PSTN compatible # or Username
1006	Call ID	unique call identifier (hexadecimal string@IP)
1008	Acct Start Time	start time of call
1010	Acct Stop Time	time the call ended
1012	Acct Session Time	start time-stop time (in seconds)
1014	Route	IP address for the communications link that was established

FIG. 54

1020

RC Call Stop Message for Calgary Callee

1002	Caller	2001 1050 8667
1004	Callee	2001 1050 2222
1006	Call ID	FA10@192.168.0.20
1008	Acct Start Time	2006-12-30 12:12:12
1010	Acct Stop Time	2006-12-30 12:12:14
1012	Acct Session Time	2
1014	Route	72.64.39.58

FIG. 55

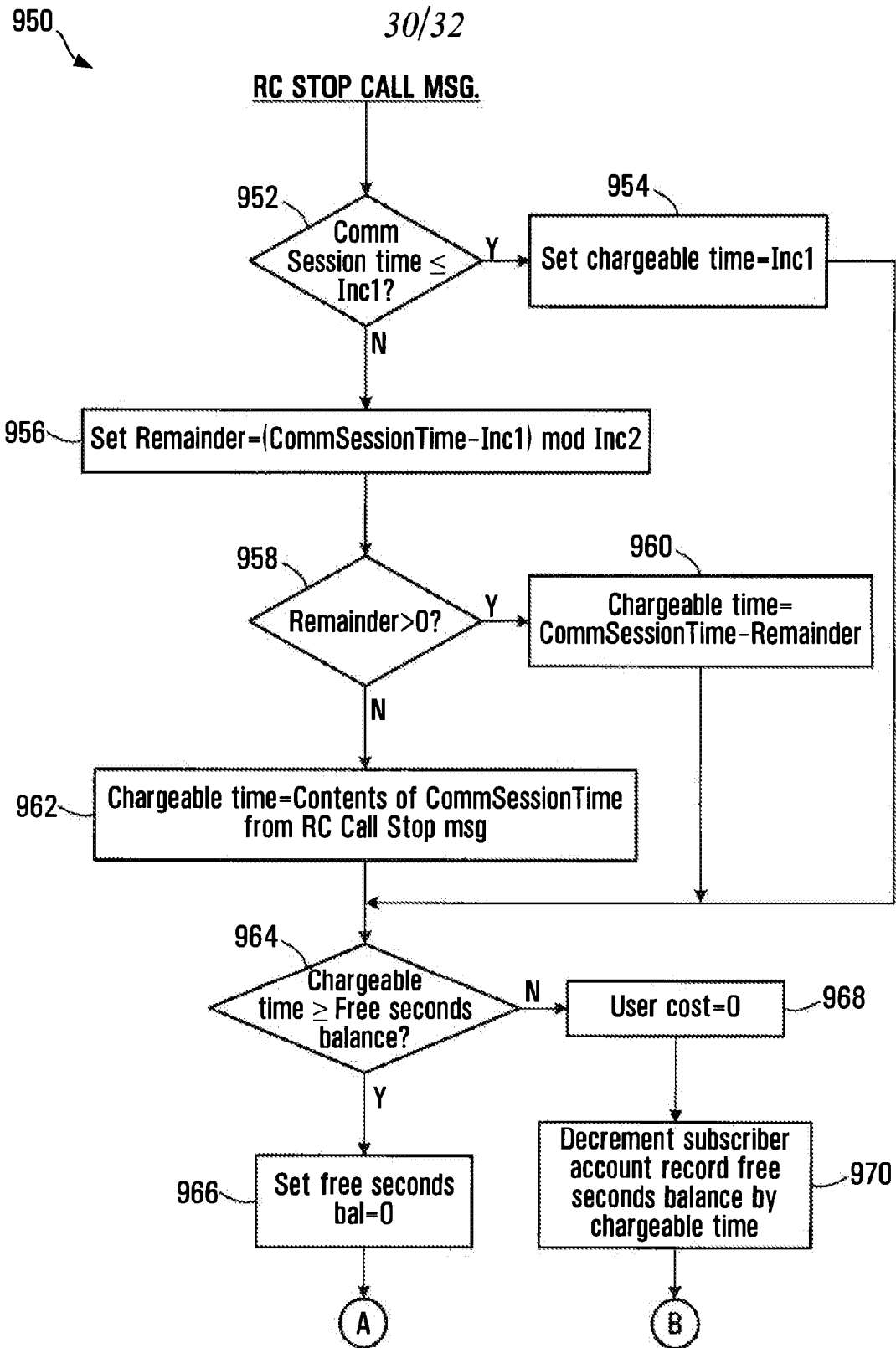

FIG. 56A

31/32

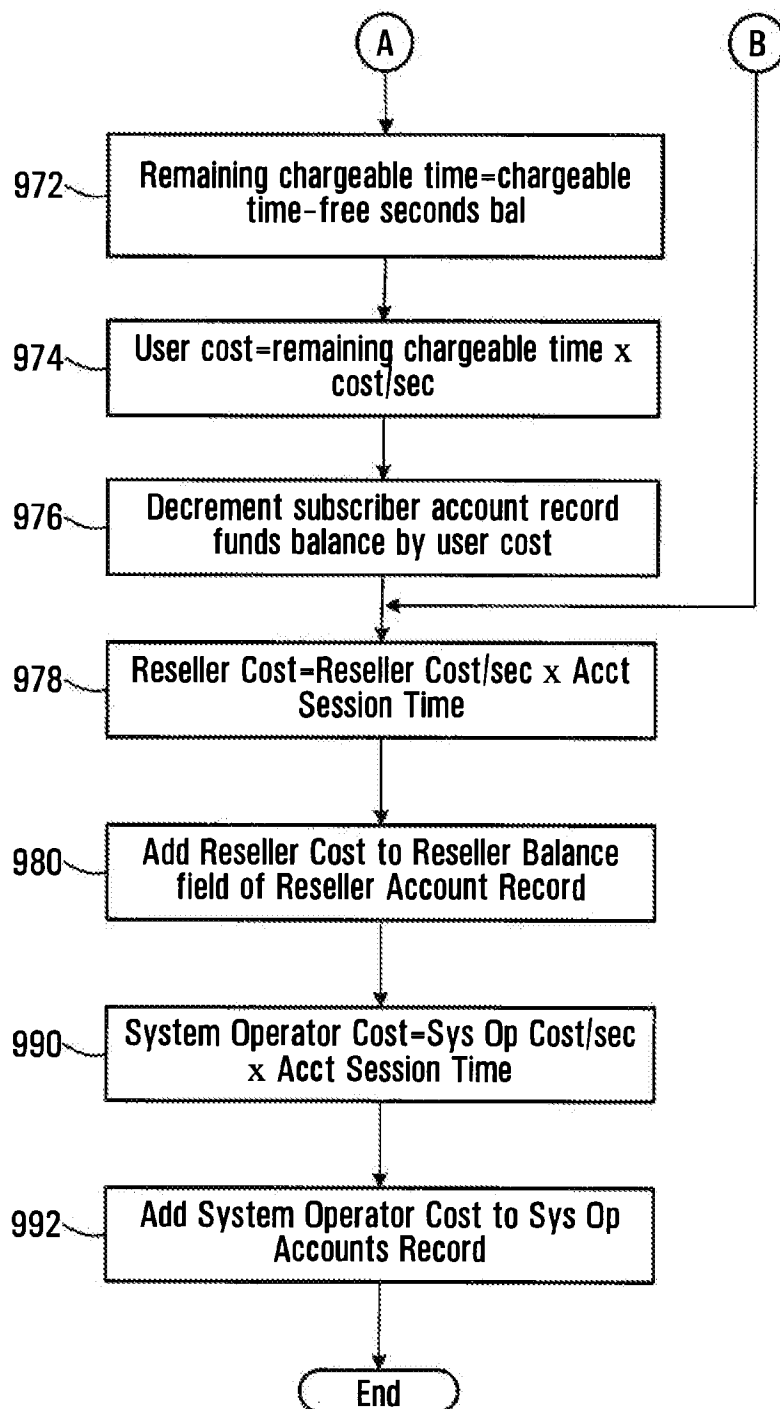

FIG. 56B

32/32

Reseller Accounts Table Record

984 ~ Reseller ID reseller id code
 986 ~ Reseller balance accumulated balance of charges

982

FIG. 57

Reseller Accounts Table Record for Klondike

984 ~ Reseller ID Klondike
 986 ~ Reseller balance \$100.02

988

FIG. 58

System Operator Accounts Table Record

996 ~ System Operator balance accumulated balance of charges

994

FIG. 59

System Operator Accounts Record for this System Operator

996 ~ System Operator balance \$1000.02

FIG. 60

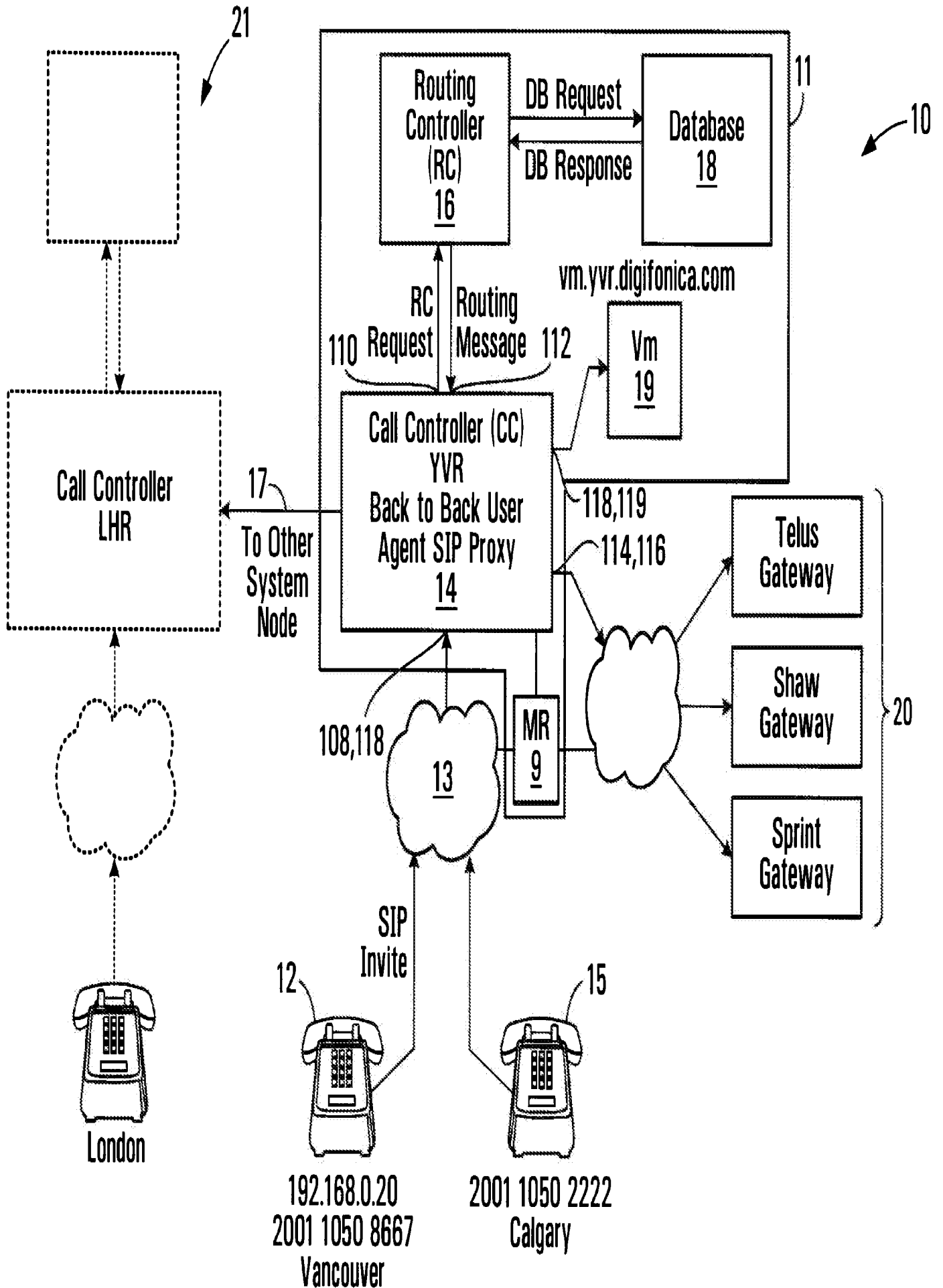

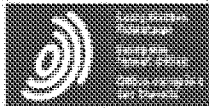

Espacenet

Bibliographic data: CA2670510 (A1) — 2008-06-05

INTERCEPTING VOICE OVER IP COMMUNICATIONS AND OTHER DATA COMMUNICATIONS

Inventor(s): SOBOLYEV MAKSYM [CA]; BJORSELL JOHAN EMIL VICTOR [CA] ± (SOBOLYEV, MAKSYM, ; BJORSELL, JOHAN EMIL VICTOR)

Applicant(s): DIGIFONICA INTERNATIONAL LTD [CA] ± (DIGIFONICA (INTERNATIONAL) LIMITED)

Classification: - **international:** H04L12/26; H04L12/66; H04M11/06; H04M3/22
- **cooperative:** H04L63/00; H04L63/30; H04M3/2281; H04M7/0078; H04M2203/15; H04M2203/2022

Application number: CA20072670510 20071129

Priority number(s): US20060861431P 20061129 ; WO2007CA02150 20071129

Also published as: WO2008064481 (A1) US2013229950 (A1) US2010150138 (A1)
US2010150138 (A1) US8422507 (B2) US8422507 (B2)
MX2009005751 (A) KR20090095621 (A) EP2090024 (A1)
EP2090024 (A4) CN101584150 (A) BRPI0719682 (A2) less

Abstract of CA2670510 (A1)

Methods and apparatus for intercepting communications in an Internet Protocol (IP) network involve maintaining dialing profiles for respective subscribers to the IP network, each dialing profile including a username associated with the corresponding subscriber, and associating intercept information with the dialing profile of a subscriber whose communications are to be monitored.

Intercept information will include determination information for determining whether to intercept a communication involving the subscriber, and destination information identifying a device to which intercepted communications involving the subscriber are to be sent. When the determination information meets intercept criteria communications are

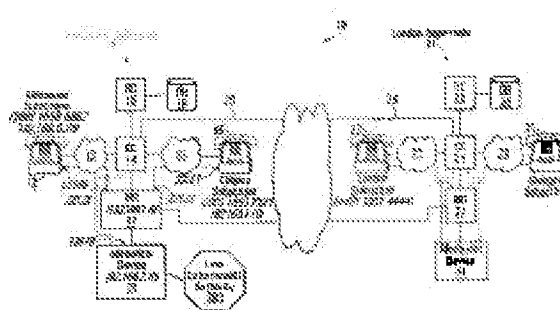

PETITIONER APPLE INC. EX. 1002-1190

established with a media relay through which communications involving the subscriber will be conducted or are being conducted to cause the media relay to send a copy of the communications involving the subscriber to a mediation device specified by the destination information.



(86) Date de dépôt PCT/PCT Filing Date: 2007/11/29
 (87) Date publication PCT/PCT Publication Date: 2008/06/05
 (85) Entrée phase nationale/National Entry: 2009/05/25
 (86) N° demande PCT/PCT Application No.: CA 2007/002150
 (87) N° publication PCT/PCT Publication No.: 2008/064481
 (30) Priorité/Priority: 2006/11/29 (US60/861,431)

(51) Cl.Int./Int.Cl. *H04L 12/26* (2006.01),
H04L 12/66 (2006.01), *H04M 11/06* (2006.01),
H04M 3/22 (2006.01)
 (71) Demandeur/Applicant:
 DIGIFONICA (INTERNATIONAL) LIMITED, CA
 (72) Inventeurs/Inventors:
 BJORSELL, JOHAN EMIL VICTOR, CA;
 SOBOLYEV, MAKSYM, CA
 (74) Agent: SMART & BIGGAR

(54) Titre : INTERCEPTION DE COMMUNICATIONS VOIP ET AUTRES TRANSMISSIONS DE DONNEES
 (54) Title: INTERCEPTING VOICE OVER IP COMMUNICATIONS AND OTHER DATA COMMUNICATIONS

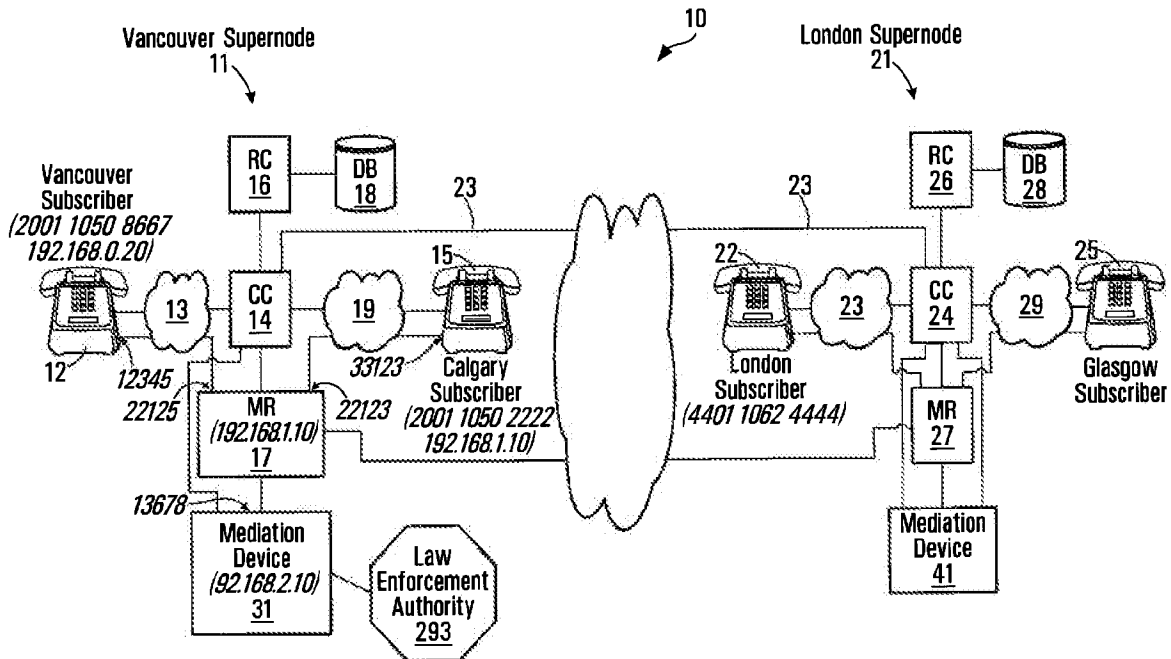

(57) Abrégé/Abstract:

Methods and apparatus for intercepting communications in an Internet Protocol (IP) network involve maintaining dialing profiles for respective subscribers to the IP network, each dialing profile including a username associated with the corresponding subscriber, and associating intercept information with the dialing profile of a subscriber whose communications are to be monitored. Intercept information will include determination information for determining whether to intercept a communication involving the subscriber, and destination information identifying a device to which intercepted communications involving the subscriber are to be sent. When the determination information meets intercept criteria communications are established with a media relay through which communications involving the subscriber will be conducted or are being conducted to cause the media relay to send a copy of the communications involving the subscriber to a mediation device specified by the destination information.



(12) INTERNATIONAL APPLICATION PUBLISHED UNDER THE PATENT COOPERATION TREATY (PCT)

(19) World Intellectual Property Organization
International Bureau



(43) International Publication Date
5 June 2008 (05.06.2008)

PCT

(10) International Publication Number
WO 2008/064481 A1

- (51) International Patent Classification:
H04L 12/26 (2006.01) H04M 11/06 (2006.01)
H04L 12/66 (2006.01) H04M 3/22 (2006.01)
- (74) Agent: SMART & BIGGAR; Box 11560 Vancouver Center, 2200 - 650 West Georgia Street, Vancouver, British Columbia V6B 4N8 (CA).
- (21) International Application Number: PCT/CA2007/002150
- (22) International Filing Date: 29 November 2007 (29.11.2007)
- (25) Filing Language: English
- (26) Publication Language: English
- (30) Priority Data: 60/861,431 29 November 2006 (29.11.2006) US
- (71) Applicant (for all designated States except US): DIGIFONICA (INTERNATIONAL) LIMITED [CA/CA]; Suite 1401, 4710 Kingsway Avenue, Burnaby, British Columbia V5H 4M2 (CA).
- (72) Inventors; and
- (75) Inventors/Applicants (for US only): BJORSELL, Johan Emil Victor [SE/CA]; 273 West 5th Street, North Vancouver, British Columbia V7M 1J9 (CA). SOBOLYEV, maksym [UA/CA]; 307-265 Tenth Street, New Westminster, BC, V3M 3Y1 (CA).
- (81) Designated States (unless otherwise indicated, for every kind of national protection available): AE, AG, AL, AM, AT, AU, AZ, BA, BB, BG, BH, BR, BW, BY, BZ, CA, CH, CN, CO, CR, CU, CZ, DE, DK, DM, DO, DZ, EC, EE, EG, ES, FI, GB, GD, GE, GH, GM, GT, HN, HR, HU, ID, IL, IN, IS, JP, KE, KG, KM, KN, KP, KR, KZ, LA, LC, LK, LR, LS, LT, LU, LY, MA, MD, ME, MG, MK, MN, MW, MX, MY, MZ, NA, NG, NI, NO, NZ, OM, PG, PH, PL, PT, RO, RS, RU, SC, SD, SE, SG, SK, SL, SM, SV, SY, TJ, TM, TN, TR, TT, TZ, UA, UG, US, UZ, VC, VN, ZA, ZM, ZW.
- (84) Designated States (unless otherwise indicated, for every kind of regional protection available): ARIPO (BW, GH, GM, KE, LS, MW, MZ, NA, SD, SL, SZ, TZ, UG, ZM, ZW), Eurasian (AM, AZ, BY, KG, KZ, MD, RU, TJ, TM), European (AT, BE, BG, CH, CY, CZ, DE, DK, EE, ES, FI, FR, GB, GR, HU, IE, IS, IT, LT, LU, LV, MC, MT, NL, PL, PT, RO, SE, SI, SK, TR), OAPI (BF, BJ, CF, CG, CI, CM, GA, GN, GQ, GW, ML, MR, NE, SN, TD, TG).
- Published:
— with international search report
— with amended claims

(54) Title: INTERCEPTING VOICE OVER IP COMMUNICATIONS AND OTHER DATA COMMUNICATIONS

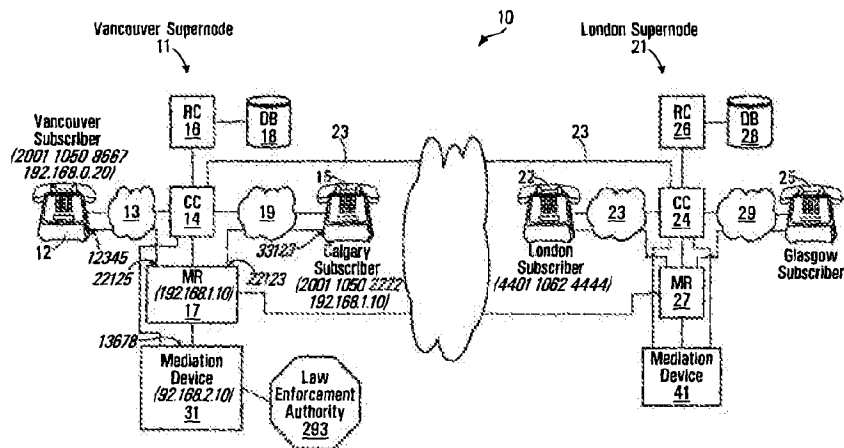

(57) Abstract: Methods and apparatus for intercepting communications in an Internet Protocol (IP) network involve maintaining dialing profiles for respective subscribers to the IP network, each dialing profile including a username associated with the corresponding subscriber, and associating intercept information with the dialing profile of a subscriber whose communications are to be monitored. Intercept information will include determination information for determining whether to intercept a communication involving the subscriber, and destination information identifying a device to which intercepted communications involving the subscriber are to be sent. When the determination information meets intercept criteria communications are established with a media relay through which communications involving the subscriber will be conducted or are being conducted to cause the media relay to send a copy of the communications involving the subscriber to a mediation device specified by the destination information.

WO 2008/064481 A1

-1-

INTERCEPTING VOICE OVER IP COMMUNICATIONS AND OTHER DATA COMMUNICATIONS

BACKGROUND OF THE INVENTION

5 1. Field of Invention

This invention relates to data communications and methods and apparatus for intercepting data communications, particularly voice over IP data communications, in an IP network.

10 2. Description of Related Art

The term "lawful intercept" is used to describe a procedure which allows law enforcement agencies to perform electronic surveillance of telecommunications. Lawful intercept of telecommunications, particularly phone calls, is premised on a notion that a law enforcement agency has identified a person of interest, obtained a legal authorization for the surveillance (for example, a judicial or administrative warrant), and then contacted the person's telecommunications service provider that will be required to provide the law enforcement agency with a real-time copy of the person's communications. This real-time copy can then be used by the law enforcement agency to monitor or record the person's communications. Within the framework of traditional telecommunications networks, such as, for example, the Public Switched Telephone Network (PSTN) or cellular networks, lawful intercept generally presents a purely economic problem for the service providers that have to ensure that sufficient interception equipment and dedicated links to the law enforcement agencies have been deployed to satisfy lawful intercept requirements mandated by law. However, in the context of Voice over Internet Protocol (VoIP) communications, in addition to the economic problems mentioned above, lawful intercept presents

-2-

significant technological challenges which often makes compliance with legally mandated lawful intercept requirements exceedingly difficult.

5 The problem lies in the very nature of the VoIP technology and the Internet Protocol (IP) networks (for example, the Internet) that underlie it.

10 Traditional telecommunications networks are “connection-oriented” or “circuit-switched”. Communications over such networks occur via dedicated “circuits”. Although the networks typically comprise a plurality of available parallel paths, when a circuit is established, only a single one of the available paths is picked. In situations where a circuit has failure protection, a redundant path, also determined at the time of the circuit establishment, can also be reserved. Once the circuit is established, all communications traverse from end to end. Interception of such communications is easy as the service provider can “tap” the circuit at any point in the network that is under its lawful control.

15 In contrast to circuit-switched networks, IP-based networks are “connectionless” by design. A connectionless IP network essentially comprises a plurality of interconnected network devices (routers) which establish a plurality of paths from any point on the network to any other point. Information that needs to traverse an IP network is divided into small “packets”, each one comprising an IP header containing source and destination addressing information, and service flags; and user payload. The specific path that each packet in a communication between parties takes across an IP network is not determined in advance such as in a circuit-switched network. The path is defined on a hop-by-hop basis (router-by-router), each router at which the packet arrives examines the source and destination addresses contained in the IP header and applies a number of service variables such as hop-count (number of routers between the current router and the destination), latency and bandwidth of available links, and administrative considerations such as inter-provider agreements, to determine

20
25
30

-3-

the next hop to which the packet will be forwarded. Because the service variables change dynamically, for example in response to a failure of a link in the network, the available paths may change significantly and it is impossible to reliably predict the path or paths that the packets that comprise a specific a
5 specific communication will traverse. Furthermore, it is not even possible to predict the order in which the packets will arrive at their destination as the different paths taken may have different latency. While the plurality of available paths and out-of-order arrivals present no problems to IP-based applications that usually keep track of the packet sequence to reassemble the
10 communication, the same factors present formidable problems for the lawful intercept of communication over IP networks, particularly lawful intercept of VoIP calls.

The problem of lawful intercept in VoIP systems is further exacerbated by the
15 distributed technologies often utilized in such systems. While a VoIP caller typically communicates with a VoIP call controller to facilitate the connection to the VoIP callee, the actual communication between the parties typically occurs by establishing a direct IP connection between them using the User Datagram Protocol (UDP) to encapsulate audio information into IP packets.
20 These packets may take any available path across the IP network as described above. Even if a service provider could place an interception device at every point in the network through which a subscriber's packet could traverse, in order to provide a useful copy of the communication to a law enforcement agency, the service provider would have to reassemble all of the
25 intercepted packets at a single device and only then pass the result to the law enforcement agency. In essence, the service provider would have to mirror the functions of the callee VoIP telephone, except the packets that comprise the communication would have to be collected from multiple points in the network. The technological challenges and economic costs associated with
30 this proposition have thus far resulted in lack of meaningful lawful intercept capabilities in VoIP systems.

-4-

SUMMARY OF THE INVENTION

In accordance with one aspect of the invention, there is provided a method for intercepting communications in an Internet Protocol (IP) network. The method involves maintaining dialing profiles for respective subscribers to the IP network, each dialing profile including a username associated with the corresponding subscriber. The method also involves associating intercept information with the dialing profile of a subscriber whose communications are to be monitored, the intercept information including determination information for determining whether to intercept a communication involving the subscriber, and destination information identifying a device to which intercepted communications involving the subscriber are to be sent. The method further involves, when the determination information meets intercept criteria, communicating with a media relay through which the communications involving the subscriber will be conducted or are being conducted to cause the media relay to send a copy of the communications to a mediation device specified by the destination information.

Associating intercept information may involve associating the intercept information with the dialing profile when communications involving the subscriber are not in progress.

Associating intercept information may involve associating the intercept information when communications involving the subscriber are in progress.

Associating the intercept information may involve populating intercept information fields in the dialing profile of the subscriber whose communications are to be monitored.

The method may involve producing a routing message for routing communications involving the subscriber through components of the IP network and determining whether the determination information meets the

-5-

intercept criteria prior to producing the routing message and including at least some of the intercept information in the routing message when the determination information meets the intercept criteria.

- 5 Determining whether the determination information meets the intercept criteria may involve determining whether a current date and time is within a range specified by the determination information.

10 The method may involve identifying a media relay through which communications involving the subscriber will be conducted in response to the routing message.

15 The method may involve pre-associating at least one media relay with the dialing profile of the subscriber whose communications are to be monitored and identifying the media relay may involve identifying the media relay pre-associated with the subscriber whose communications are to be monitored.

20 Pre-associating may involve populating media relay fields in the dialing profile with an identification of at least one media relay.

The intercept information may be associated with the dialing profile of the subscriber whose communications are to be monitored, in response to receipt of an intercept request message, and the intercept request message may include the intercept information.

25 The method may involve invoking an intercept request message handler to find a dialing profile associated with the subscriber whose communications are to be monitored, and to perform the step of associating the intercept information with the dialing profile, and to determine whether the intercept
30 criteria are met, and identify a media relay through which the communications are being conducted.

-6-

5 The method may involve maintaining active call records for communications in progress, and the active call records may include a username identifier and a media relay identifier identifying the media relay through which the communications are being conducted and identifying a media relay through which the communications are being conducted may involve locating an active call record associated with communications of the subscriber whose communication are to be monitored to find the media relay associated with the communications.

10 The method may involve maintaining direct-inward-dialing (DID) records associating PST telephone numbers with usernames of users subscribing to the IP network, and finding a dialing profile associated with the subscriber whose communications are to be monitored may involve finding a username in a DID record bearing a PSTN number associated with the subscriber
15 whose communications are to be monitored. The username may be used to locate a dialing profile associated with the username.

In accordance with another aspect of the invention, there is provided an apparatus for intercepting communications in an Internet Protocol (IP)
20 network. The apparatus includes provisions for maintaining dialing profiles for respective subscribers to the IP network, each dialing profile including a username associated with the corresponding subscriber. The apparatus also includes provisions for associating intercept information with the dialing profile of a subscriber whose communications are to be monitored, the intercept
25 information including determination information for determining whether to intercept a communication involving the subscriber, and destination information identifying a device to which intercepted communications involving the subscriber are to be sent. The apparatus further includes provisions for communicating with a media relay through which the communications
30 involving the subscriber will be conducted or are being conducted to cause the media relay to send a copy of the communications to a mediation device

-7-

specified by the destination information, when the determination information meets intercept criteria.

5 The provisions for associating intercept information may be operably configured to associate the intercept information with the dialing profile when communications involving the subscriber are not in progress.

10 The provisions for associating intercept information may be operably configured to associate the intercept information when communications involving the subscriber are in progress.

15 The provisions for associating the intercept information may be operably configured to populate intercept information fields in the dialing profile of the subscriber whose communications are to be monitored.

20 The apparatus may further include provisions for producing a routing message for routing communications involving the subscriber through components of the IP network and provisions for determining whether the determination information meets the intercept criteria prior to producing the routing message and the provisions for producing the routing message may be operably configured to include at least some of the intercept information in the routing message when the determination information meets the intercept criteria.

25 The provisions for determining whether the determination information meets the intercept criteria may be operably configured to determine whether a current date and time is within a range specified by the determination information.

30 The apparatus may further include provisions for identifying a media relay through which communications involving the subscriber will be conducted in response to the routing message.

-8-

5 The apparatus may further include provisions for pre-associating at least one media relay with the dialing profile of the subscriber whose communications are to be monitored and the routing provisions may be operably configured to identify from the dialing profile the media relay pre-associated with the subscriber whose communications are to be monitored.

10 The provisions for pre-associating may be operably configured to populate media relay fields in the dialing profile with an identification of at least one media relay.

15 Provisions for associating the intercept information may be operably configured to associate the intercept information associated with the dialing profile of the subscriber whose communications are to be monitored, in response to receipt of an intercept request message, wherein the intercept request message comprises the intercept information.

20 The apparatus may further include provisions for handling an intercept request message. The provisions for handling an intercept request message may include provisions for finding a dialing profile associated with the subscriber whose communications are to be monitored. The provisions for finding a dialing profile may cooperate with the provisions for associating the intercept information with the dialing profile to cause the intercept information to be associated with the dialing profile. The provisions for handling an intercept request message may include provisions for determining whether the intercept criteria are met and provisions for identifying a media relay through which the communications are being conducted.

30 The apparatus may further include provisions for maintaining active call records for communications in progress, the active call records including a username identifier and a media relay identifier identifying the media relay through which the communications are being conducted and the provisions for

-9-

identifying a media relay through which the communications are being conducted may be operably configured to locate an active call record associated with communications of the subscriber whose communication are to be monitored to find the media relay associated with the communications.

5

The apparatus may further include provisions for maintaining direct-inward-dialing (DID) records associating PST telephone numbers with usernames of users subscribing to the IP network, and the provisions for finding a dialing profile associated with the subscriber whose communications are to be monitored may be operably configured to find a username in a DID record bearing a PSTN number associated with the subscriber whose communications are to be monitored and use the username to locate a dialing profile associated with the username.

10

15

By employing a media replay, all VoIP communications traverse a point in the VoIP system that is under a provider's control and at which the communications can be copied in real-time to a mediation device that passes the intercepted communication to a law enforcement agency.

20

By maintaining dialing profiles for respective subscribers and associating intercept information of the type described, with the dialing profiles of subscribers whose communications are to be monitored, the dialing profile can serve as the source of determination information for determining whether or not communications involving the subscriber will be monitored and for providing destination information for specifying where the copy of the communications is to be sent. Use of the dialing profile in this manner easily facilitates the dialing profile to be considered a repository for intercept information for a given subscriber and this repository can be addressed whether a call is being initiated or in progress, thereby simplifying control algorithms because they can cooperate with a common source and format of data in the dialing profile.

25

30

-10-

Other aspects and features of the present invention will become apparent to those ordinarily skilled in the art upon review of the following description of specific embodiments of the invention in conjunction with the accompanying figures.

5

BRIEF DESCRIPTION OF THE DRAWINGS

In drawings which illustrate embodiments of the invention,

- 10 **Figure 1** is a block diagram of a system according to a first embodiment of the invention;
- Figure 2** is a block diagram of a caller VoIP telephone according to the first embodiment of the invention;
- 15 **Figure 3** is a schematic representation of a SIP Invite message transmitted between the caller telephone and a call controller (CC) shown in Figure 1;
- Figure 4** is a block diagram of the call controller shown in Figure 1;
- 20 **Figure 5** is a flowchart of a process executed by the call controller shown in Figure 1;
- Figure 6** is a schematic representation of a routing controller (RC) request message produced by the call controller shown in Figure 1;
- 25 **Figure 7** is a block diagram of a routing controller (RC) processor circuit of the system shown in Figure 1;
- 30 **Figures 8A-8D** are flowcharts of a RC Request message handler executed by the RC processor circuit shown in Figure 7;

-11-

- Figure 9 is a tabular representation of a dialing profile stored in a database accessible by the RC shown in Figure 1;
- 5 Figure 10 is a tabular representation of a dialing profile for a Vancouver subscriber ;
- Figure 11 is a tabular representation of a dialing profile for a Calgary subscriber;
- 10 Figure 12 is a tabular representation of a dialing profile for a London subscriber;
- Figure 13 is a tabular representation of a direct-inward-dialing (DID) bank table record stored in the database shown in Figure 1;
- 15 Figure 14 is a tabular representation of an exemplary DID bank table record for the London subscriber referenced in Figure 12;
- Figure 15 is a tabular representation of a routing message transmitted from the routing controller to the call controller shown in Figure 1;
- 20 Figure 16 is a tabular representation of a routing message buffer holding a routing message for routing a call to the London callee referenced in Figure 12;
- 25 Figure 16A is a tabular representation of a routing message buffer holding a message for routing a call to the London callee and to a law enforcement agency for the purpose of lawful intercept;
- 30 Figure 17 is a tabular representation of a prefix to supernode table record stored in the database shown in Figure 1;

-12-

- Figure 18 is a tabular representation of a prefix to supernode table record that would be used for the Calgary callee referenced in Figure 11;
- 5 Figure 19 is a tabular representation of a master list record stored in a master list table in the database shown in Figure 1;
- Figure 20 is a tabular representation of an exemplary populated master list record;
- 10 Figure 21 is a tabular representation of a suppliers list record stored in the database shown in Figure 1;
- Figure 22 is a tabular representation of a specific supplier list record for a first supplier;
- 15 Figure 23 is a tabular representation of a specific supplier list record for a second supplier;
- Figure 24 is a tabular representation of a specific supplier list record for a third supplier;
- 20 Figure 25 is a tabular representation of a routing message, held in a routing message buffer, identifying to the routing controller a plurality of possible suppliers that may carry the call;
- 25 Figure 25A is a tabular representation of a routing message held in a routing message buffer, with lawful intercept fields appended;
- Figure 26 is a tabular representation of a call block table record;
- 30 Figure 27 is a tabular representation of a call block table record for the Calgary callee;

-13-

- Figure 28 is a tabular representation of a call forwarding table record;
- 5 Figure 29 is a tabular representation of an exemplary call forwarding table record specific for the Calgary callee;
- Figure 30 is a tabular representation of a voicemail table record specifying voicemail parameters to enable the caller to leave a voicemail message for the callee;
- 10 Figure 31 is a tabular representation of an exemplary voicemail table record for the Calgary callee;
- Figure 32 is a tabular representation of an exemplary routing message, held in a routing message buffer, indicating call forwarding numbers and a voicemail server identifier;
- 15 Figure 32A is a tabular representation of an exemplary routing message, held in a routing message buffer, indicating call forwarding numbers and a voicemail server identifier with caller lawful intercept fields appended;
- 20 Figure 32B is a tabular representation of an exemplary routing message, held in a routing message buffer, indicating call forwarding numbers and a voicemail server identifier with caller and callee lawful intercept fields appended;
- 25 Figure 33 is a flowchart of a routing message handler process executed by the call controller.
- 30

-14-

- Figure 34 is a schematic representation of messages exchanged during execution of process for establishing audio paths between telephones and a media relay;
- 5 Figure 35 is a tabular representation of an active call record maintained by the call controller of Figure 1;
- Figure 36 is a tabular representation of an active call record maintained by the routing controller of Figure 1;
- 10 Figure 37 is a tabular representation of a SIP Invite message transmitted from the call controller to the mediation device;
- Figure 38 is a tabular representation of a SIP OK message transmitted from the mediation device to the call controller.
- 15 Figure 39 is a tabular representation of a SIP Bye message transmitted from either of the telephones shown in Figure 1 to the call controller;
- 20 Figure 40 is a tabular representation of a SIP Bye message sent to the call controller from the Calgary callee;
- Figure 41 is a flowchart of a process executed by the call controller for producing a RC stop message in response to receipt of a SIP Bye message;
- 25 Figure 42 is a tabular representation of an exemplary RC Call Stop message;
- 30 Figure 43 is a tabular representation of an exemplary RC Call Stop message for the Calgary callee;

-15-

Figure 44 is a flowchart of a routing controller Law Enforcement Authority request message handler executed by the routing controller shown in Figure 1;

5 Figure 45 is a flowchart of a call controller in-call intercept message handler executed by the call controller shown in Figure 1;

Figure 46 is a flowchart of a routing controller in-call intercept shut down routine executed by the routing controller shown in Figure 1;

10

Figure 47 is a flowchart of a call controller cease intercept message handler routing executed by the call controller shown in Figure 1.

DETAILED DESCRIPTION

15 Referring to Figure 1, a system for making voice over IP telephone calls is shown generally at 10. The system includes a first supernode shown generally at 11 and a second supernode shown generally at 21. The first supernode 11 is located in a geographical area, such as Vancouver B.C., for example and the second supernode 21 is located in London England, for example. Different supernodes may be located in different geographical regions throughout the world to provide telephone service to subscribers in respective regions. These supernodes may be in communication with each other through high speed / high data throughput links including optical fiber, satellite and/or cable links, for example, forming a system backbone. These
20 supernodes may alternatively or in addition be in communication with each other through conventional Internet services. In the embodiment shown, data communication media for providing for data communications between the first and second supernodes 11 and 21 are shown generally at 23 and may include very high speed data links, for example.

30

In the embodiment shown, the Vancouver supernode 11 provides telephone service to a geographical region comprising Western Canadian customers

-16-

from Vancouver Island to Ontario and includes a Vancouver subscriber and a Calgary subscriber. Another supernode (not shown) may be located in Eastern Canada to provide services to subscribers in that area.

5 Other, smaller supernodes similar to the type shown may also be employed within the geographical area serviced by a supernode, to provide for call load sharing, for example within a region of the geographical area serviced by the supernode. However, in general, all supernodes are similar and have the properties described below in connection with the Vancouver supernode 11.

10

In this embodiment, the Vancouver supernode includes a call controller (CC) 14, a routing controller (RC) 16, a database 18, a media relay 17 and one or more mediation devices (MD), only one of which is shown at 31. Subscribers such as the Vancouver subscriber and the Calgary subscriber communicate with the Vancouver supernode 11 using their own Internet Service Providers (ISPs) 13 and 19 which route Internet traffic from these subscribers over the Internet. To these subscribers the Vancouver supernode 11 is accessible at a pre-determined IP address or a fully qualified domain name (FQDN) so that it can be accessed in the usual way through a subscriber's ISP. The subscriber in the city of Vancouver uses a telephone 12 that is capable of communicating with the Vancouver supernode 11 using Session Initiation Protocol (SIP) messages and the Calgary subscriber uses a similar telephone 15, to communicate with the Vancouver supernode from Calgary, AB.

15

25 It should be noted that throughout the description of the embodiments of this invention, the IP/UDP addresses of all elements such as the caller and callee telephones, call controller, media relay, and any others, will be assumed to be valid IP/UDP addresses directly accessible via the Internet or a private IP network, for example, depending on the specific implementation of the system. As such, it will be assumed, for example, that the caller and callee telephones will have IP/UDP addresses directly accessible by the call controllers and the media relays on their respective supernodes, and that will

30

-17-

not be obscured by Network Address Translation (NAT) or similar mechanisms. In other words, the IP/UDP information contained in SIP messages (for example the SIP Invite message or the RC Request message which will be described below) will match the IP/UDP addresses of the IP packets carrying these SIP messages.

It will be appreciated that in many situations, the IP addresses assigned to various elements of the system may be in a private IP address space, and thus not directly accessible from other elements. Furthermore, it will also be appreciated that NAT is commonly used to share a "public" IP address between multiple devices, for example between home PCs and IP telephones sharing a single Internet connection. For example, a home PC may be assigned an IP address such as **192.168.0.101** and a Voice over IP telephone may be assigned an IP address of **192.168.0.103**. These addresses are located in so called "non-routable" address space and cannot be accessed directly from the Internet. In order for these devices to communicate with other computers located on the Internet, these IP addresses have to be converted into a "public" IP address, for example **24.10.10.123** assigned to the subscriber by the Internet Service Provider, by a device performing NAT, typically a home router. In addition to translating the IP addresses, the NAT typically also translates UDP port numbers, for example an audio path originating at an IP telephone and using a UDP port **12378** at its private IP address may have been translated to a UDP port **23465** associated with the public IP address of the NAT device. In other words, when a packet originating from the above IP telephone arrives at an Internet-based supernode, the source IP/UDP address contained in the IP packet header will be **24.10.10.1:23465**, whereas the source IP/UDP address information contained in the SIP message inside this IP packet will be **192.168.0.103:12378**. The mismatch in the IP/UDP addresses may cause a problem for SIP-based systems because, for example, a supernode will attempt to send messages to a private address of a telephone – the messages will never get there.

-18-

It will be appreciated that a number of methods are available to overcome this problem. For example, the SIP NATHelper open source software module may run on the supernode to correlate public IP/UDP address contained in the headers of the IP packets arriving from SIP devices with private IP/UDP addresses in the SIP messages contained in these packets. Therefore, the embodiments of the invention described below will function whether or not any of the elements of the system are located behind NAT devices that obscure their real IP/UDP addresses.

Referring to Figure 1, in an attempt to make a call by the Vancouver telephone 12 to the Calgary telephone 15, for example, the Vancouver telephone sends a SIP Invite message to the Vancouver supernode 11 and in response, the call controller 14 sends an RC Request message to the routing controller 16 which makes various enquiries of the database 18 to produce a routing message which is sent to the call controller 14. The call controller 14 then causes a communications link including audio paths to be established through the media relay 17 which may include the same Vancouver supernode 11, a different supernode or a communications supplier gateway, for example, to carry voice traffic to and from the call recipient or callee. Subject to certain conditions being satisfied, as will be described below, when lawful intercept of data is to occur, data on the audio paths is copied to the mediation device 31 which may provide for real time listening of the audio data or recording of same.

Subscriber Telephone

Referring to Figure 2, in this embodiment, the telephones 12, 15, 22 and 25 each includes a processor circuit shown generally at 30 comprising a microprocessor 32, program memory 34, an input/output (I/O) interface 36, parameter memory 38 and temporary memory 40. The program memory 34, I/O interface 36, parameter memory 38 and temporary memory 40 are all in communication with the microprocessor 32. The I/O interface 36 has a dial

-19-

input **42** for receiving a dialed telephone number from a keypad, for example, or from a voice recognition unit or from pre-stored telephone numbers stored in the parameter memory **38**, for example. For simplicity, a box labelled dialing functions **44** represents any device capable of informing the
5 microprocessor **32** of a callee identifier, e.g., a callee telephone number.

The microprocessor **32** stores the callee identifier in a dialed number buffer **41**. In the case of the Vancouver subscriber for example, the dialed number may be **2001 1050 2222**, identifying the Calgary subscriber or the dialed
10 number may be a PSTN number, for example. The I/O interface **36** also has a handset interface **46** for receiving and producing signals from and to a handset **45** that the user may place to his ear. The handset interface **46** may include a BLUETOOTH™ wireless interface, a wired interface or speakerphone, for example. The handset **45** acts as a termination point for an
15 audio path (not shown) which will be appreciated later.

The I/O interface **36** also has a network interface **48** to an IP network which may provide a high speed Internet connection, for example, and is operable to connect the telephone to an ISP. The network interface **48** also acts as a part
20 of the audio path, as will be appreciated later.

The parameter memory **38** has a username field **50**, a password field **52** an IP address field **53** and a SIP proxy address field **54**. The username field **50** is operable to hold a username, which, for the Vancouver subscriber, is **2001**
25 **1050 8667**. The username is assigned upon subscription or registration into the system and, in this embodiment includes a twelve digit number having a continent code **61**, a country code **63**, a dealer code **70** and a unique number code **74**. The continent code **61** is comprised of the first or left-most digit of the username in this embodiment. The country code **63** is comprised of the
30 next three digits. The dealer code **70** is comprised of the next four digits and the unique number code **74** is comprised of the last four digits. The password field **52** holds a password of up to **512** characters, in this example. The IP

-20-

address field **53** stores an IP address and UDP port number of the telephone **12**, which, for this explanation, is **192.168.0.20:12345**. The SIP proxy address field **54** stores an IP address of a SIP proxy which may be provided to the telephone **12** through the network interface **48** as part of a registration procedure.

The program memory **34** stores blocks of codes for directing the microprocessor **32** to carry out the functions of the telephone, one of which includes a firewall block **56** which provides firewall functions to the telephone, to prevent unauthorized access through the network connection to the microprocessor **32** and memories **34**, **38** and **40**. The program memory **34** also stores call ID codes **57** for establishing a call ID. The call ID codes **57** direct the microprocessor **32** to produce call identifiers having the format of a hexadecimal string and an IP address of the telephone stored in the IP address field **53**. Thus, an exemplary call identifier for a call might be **FF10@192.168.0.20**.

Generally, in response to activating the handset **45** and using the dialing function **44**, the microprocessor **32** produces and sends a SIP Invite message as shown in Figure **3**, to the call controller **14** shown in Figure **1**.

Referring to Figure **3**, the SIP Invite message includes a caller identifier field **60**, a callee identifier field **62**, a digest parameters field **64**, a call identifier field **65**, a caller IP address field **67** and a caller UDP port field **69**. In this embodiment, the caller identifier field **60** includes the username **2001 1050 8667**, which is the username stored in the username field **50** of the parameter memory **38** in the Vancouver telephone **12** shown in Figure **2**. In addition, as an example, referring back to Figure **3**, the callee identifier field **62** includes the username **2001 1050 2222** which is the dialed number of the Calgary subscriber stored in the dialed number buffer **41** shown in Figure **2**. The digest parameters field **64** includes digest parameters and the call identifier field **65** includes a code comprising a generated prefix code (**FF10**) and a

-21-

suffix which is the IP address of the telephone **12** stored in the IP address field **53**. The caller IP address field **67** holds the IP address assigned to the telephone, in this embodiment **192.168.0.20**, and the caller UDP port field **69** includes a UDP port identifier identifying a UDP port to which audio data is to be sent for reception by the caller's telephone.

Call Controller

Referring to Figure 4, a call controller circuit of the call controller **14** (Figure 1) is shown in greater detail at **100**. The call controller circuit **100** includes a microprocessor **102**, program memory **104** and an I/O interface **106**. The call controller circuit **100** may include a plurality of microprocessors, a plurality of program memories and a plurality of I/O interfaces to be able to handle a large volume of calls. However, for simplicity, the call controller circuit **100** will be described as having only one microprocessor, program memory and I/O interface, it being understood that there may be more.

Generally, the I/O interface **106** includes an input **108** for receiving messages, such as the SIP Invite message shown in Figure 3, from the telephone shown in Figure 2. The I/O interface **106** also has an RC Request message output **110** for transmitting an RC Request message to the routing controller **16** of Figure 1, an RC message input **112** for receiving routing messages from the routing controller **16** (Figure 1), a media relay (MR) output **114** for transmitting messages to the media relay (Figure 1) to advise the media relay to establish an audio path, and a MR input **116** for receiving messages from the media relay to which a message has been sent to attempt to establish the audio path. The I/O interface **106** further includes a SIP output **118** for transmitting SIP messages to the telephone **12** (Figure 1) to advise the telephone of the IP address of the media relay **17** (Figure 1) which will establish the audio path. The I/O interface **106** further includes mediation device input **119** and output **121** for communicating with the mediation device **31** (Figure 1).

5 While certain inputs and outputs have been shown as separate, it will be appreciated that some may be associated with a single IP address and TCP or UDP port. For example, the messages sent and received from the routing controller **16** may be transmitted and received at the same single IP address and TCP or UDP port.

10 The program memory **104** of the call controller circuit **100** includes blocks of code for directing the microprocessor **102** to carry out various functions of the call controller **14**. For example, these blocks of code include a first block **120** for causing the call controller circuit **100** to execute a SIP Invite-to-RC request process to produce an RC Request message in response to a received SIP Invite message. In addition, there is a Routing Message Handler block **122** which causes the call controller circuit **100** to engage the mediation device and/or execute a call handling routine to establish audio paths through a media relay to establish the call. The program memory **104** further includes
15 an in-call intercept message handler **1450** for intercepting a call in progress and a cease intercept message handler **1520** for ceasing the interception of a call in progress.

20 Referring to Figure **5**, the SIP Invite-to-RC Request process is shown in more detail at **120**. On receipt of a SIP Invite message of the type shown in Figure **3**, block **132** of Figure **5** directs the call controller circuit **100** of Figure **4** to authenticate the user operating the telephone from which the SIP Invite message originated. This may be done, for example, by prompting the user
25 for a password, by sending a message back to the telephone **12** which is interpreted at the telephone as a request for password entry or the password may automatically be sent to the call controller **14** from the telephone, in response to the message. The call controller **14** may then make enquiries of databases to which it has access, to determine whether or not the user's
30 password matches a password stored in the database. Various functions may be used to pass encryption keys or hash codes back and forth to ensure the secure transmission of passwords.

-23-

Should the authentication process fail, the call controller circuit **100** is directed to an error handling block **134** which causes messages to be displayed at the telephone **12** to indicate that there was an authentication error. If the authentication process is successful, block **131** directs the call controller circuit **100** to determine whether or not the contents of the caller identifier field **60** of the SIP Invite message is a validly formatted IP address. If it is a valid IP address, then block **133** directs the call controller circuit **100** to associate a type code with the call to indicate that the call type is a third party invite.

If at block **131** the caller identifier field **60** contents do not identify an IP address, then block **135** directs the call controller circuit **100** to associate a type code with the call to indicate the call type is a regular SIP Invite message. Then, block **136** directs the call controller circuit **100** to establish a call ID by assigning the call ID provided in the call identifier field **65** of the SIP Invite message from the telephone **12**, and at block **138** the call controller circuit is directed to produce an RC Request message of the type shown in Figure **6** that includes that call ID. Referring back to Figure **5**, block **139** then directs the call controller circuit **100** to send the RC Request message to the routing controller **16**.

Referring to Figure **6**, an RC Request message is shown generally at **150** and includes a caller identifier field **152**, a callee identifier field **154**, a digest field **156**, a call ID field **158** and a type field **160**. The caller, callee, digest, and call identifier fields **152**, **154**, **156** and **158** contain copies of the caller, callee, digest parameters and call ID fields **60**, **62**, **64** and **65** of the SIP Invite message **59** shown in Figure **3**. The type field **160** contains the type code established at block **133** or **135** of Figure **5** to indicate whether the call is from a third party or system subscriber, respectively. The callee identifier field **154** may include a PSTN number or a system subscriber username as shown, for example.

-24-

Routing Controller

Referring to Figure 7, the routing controller **16** is shown in greater detail and includes a routing controller processor circuit shown generally at **200**. The RC processor circuit **200** includes a microprocessor **202**, program memory **204**, a
5 table memory **206** and an I/O interface **208**, all in communication with the processor. There may be a plurality of processor circuits (**202**), memories (**204**), etc.

The I/O interface **208** includes a database output port **210** through which a
10 request to the database **18** (Figure 1) can be made and includes a database response port **212** for receiving a reply from the database. The I/O interface **208** further includes an RC Request message input **214** for receiving the RC Request message from the call controller **14** and includes a routing message output **216** for sending a routing message back to the call controller **14**.

15 The program memory **204** includes blocks of codes for directing the RC processor circuit **200** to carry out various functions of the routing controller **16**. One of these blocks implements an RC Request message handler process **250** which directs the RC to produce a routing message in response to a
20 received RC Request message of the type shown at **150** in Figure 6. Referring back to Figure 7, the program memory **204** further includes a Law Enforcement Authority (LEA) request message handler **1400** and an in-call intercept shut down routine **1500**.

25 The RC Request message handler process **250** is shown in greater detail in Figures 8A through 8D.

RC Request Message Handler

Referring to Figure 8A, the RC Request message handler process **250** begins
30 with a first block **252** that directs the RC processor circuit **200** (Figure 7) to store the contents of the RC Request message **150** (Figure 6) in buffers. Block **254** then directs the RC processor circuit **200** to use the contents of the

-25-

caller identifier field **152** in the RC Request message shown in Figure **6**, to locate and retrieve a dialing profile for the caller from the database **18**.

5 The routing controller maintains, in the database, a dialing profile for each subscriber to the system. Referring to Figure **9**, an exemplary dialing profile is shown generally at **256** and includes system fields including a username field **258**, a domain field **260**, a national dialing digits (NDD) field **262**, an IDD (IDD) field **264**, a country code field **266**, a local area codes field **267**, a caller minimum local length field **268**, a caller maximum local length field **270** and a reseller field **273**.

10 The exemplary dialing profile further includes lawful intercept related fields including a lawful intercept (LI) flag field **702**, at least one mediation device field **704**, at least one warrant ID field **706**, and intercept period start and stop date/time fields **708** and **710**. The LI flag field **702**, the warrant ID field **706** and the LI start/stop fields **708** and **710** may be regarded as determination information fields for determining whether to intercept a communication involving the subscriber and the MD1 address field **704** may be regarded as a destination information field for identifying a device to which intercepted communications involving the subscriber are to be sent.

15 The system fields (**258, 260, 262, 264, 266, 267, 268, 270, 273**) are assigned values by a system operator or are assigned automatically according to pre-defined algorithms (not shown) when a user registers with the system to become a subscriber. The lawful intercept fields (**702, 704, 706, 708, 710**) are assigned values in response to communications with one or more authorized devices and may be populated at any time regardless of whether or not communications involving the subscriber are in progress.

20 For example, referring back to Figure **1** the mediation device **31** may be regarded as an authorized device operated by a law enforcement authority **293**. A communications channel between the call controller **14** and the

-26-

mediation device **31** may be established to permit the mediation device to communicate with the call controller to cause the call controller to communicate with the routing controller **16** to find a subscriber record in the database **18** which is associated with a subscriber for which a warrant for lawful intercept has been obtained. For example, once a warrant identifying a user and permitting lawful intercept of that user's communications has been received by the law enforcement authority **293**, that authority can use its own computers to communicate with the mediation device **31** to cause the mediation device to communicate with the call controller **14** to cause the call controller to interact with the routing controller **16** to access a dialing profile (Figure **9**) for the user specified in the warrant and load the lawful intercept fields (**702, 704, 706, 708, 710**) with data that sets the lawful intercept flag field **702** to "on", stores an IP address of the mediation device **31** in the MD1 address field **704**, loads the warrant ID field **706** with an identifier of the warrant and loads the start and stop fields **708** and **710** with start and stop dates and times to specify a period during which lawful intercept of communications of the identified user may occur according to the warrant. Thus, intercept information is associated with the dialing profile by the routing controller, in response to information it receives from the call controller.

A plurality of groups of lawful intercept fields of the type shown may be added, each group being added by a different authorized device, for example, if several different law enforcement agencies operating the same or different mediation devices have warrants to monitor communications of a user. Alternatively the authorized device may include a handover interface operable to communicate with the call controller or routing controller to access the database to load the lawful intercept fields associated with a subscriber of interest.

An exemplary dialing profile for the Vancouver subscriber is shown generally at **276** in Figure **10** and indicates that the username field includes the

-27-

username **2001 1050 8667** which is the same as the contents of the username field **50** in the Vancouver telephone **12** shown in Figure **2**.

5 Referring back to Figure **10**, the domain field **260** includes a domain name as shown at **282**, including a supernode type identifier **284**, a location code identifier **286**, a system provider identifier **288** and a top level domain identifier **290**, identifying a domain or supernode associated with the user identified by the contents of the username field **258**.

10 In this embodiment, the supernode type identifier **284** includes the code "sp" identifying a supernode and the location code identifier **286** identifies the supernode as being in Vancouver (YVR). The system provider identifier **288** identifies the company supplying the service and the top level domain identifier **290** identifies the "com" domain.

15 The national dialing digit (NDD) field **262** in this embodiment includes the digit "1" and, in general, includes a digit specified by the International Telecommunications Union – Telecommunications Standardization Sector (ITU-T) E.164 Recommendation which assigns national dialing digits to
20 certain countries. Herein numbering sequences compliant with this standard will be regarded as "E.164" numbers.

The International Dialing Digit (IDD) field **264** includes the code **011** and in general includes a code assigned by the ITU-T according to the country or
25 geographical location of the user.

The country code field **266** includes the digit "1" and in general includes a number assigned by the ITU-T to represent the country in which the user is
30 located.

The local area codes field **267** includes the numbers **604** and **778** and generally includes a list of area codes that have been assigned by the ITU-T

-28-

to the geographical area in which the subscriber is located. The caller minimum and maximum local number length fields **268** and **270** hold the number **10** representing minimum and maximum local number lengths permitted in the area code(s) specified by the contents of the local area codes field **267**. The reseller field **273** holds a code identifying a retailer of the telephone services, and in the embodiment shown, the retailer is "Klondike".

Initially, the lawful intercept fields shown in Figure **9** might not be included in the dialing profile and may be added as described above, by the mediation device **31**, in the event a warrant is obtained to intercept the user's calls. Alternatively, the lawful intercept fields may be included, but populated with null values until modified by a mediation device **31**.

A dialing profile of the type shown at **256** in Figure **9** is produced whenever a user registers with the system or agrees to become a subscriber to the system. Thus, for example, a user wishing to subscribe to the system may contact an office maintained by a system operator and personnel in the office may ask the user certain questions about his location and service preferences, whereupon tables can be used to provide office personnel with appropriate information to be entered into the username, domain, NDD, IDD, country code, local area codes and caller minimum and maximum local length fields **258**, **260**, **262**, **264**, **266**, **267**, **268**, **270** to establish a dialing profile for the user.

Referring to Figures **11** and **12**, dialing profiles for subscribers in Calgary and London, respectively for example, are shown.

In addition to creating dialing profiles, optionally when a user registers with the system, a direct inward dialing (DID) record of the type shown at **268** in Figure **13** is added to a direct inward dialing table in the database **18** to associate the username with a host name of the supernode with which the user is associated and with an E.**164** number on the PSTN network.

-29-

In this embodiment, the DID bank table records include a username field **281**, a user domain field **272** and a DID field **274**, for holding the username, hostname of the supernode, and an E.**164** number respectively.

5

A DID bank table record for the London subscriber is shown generally at **291** in Figure **14**.

10 In addition to creating dialing profiles and DID records when a user registers with the system, call blocking records of the type shown in Figure **26**, call forwarding records of the type shown in Figure **28** and voicemail records of the type shown in Figure **30** may be stored in the database **18** when a new subscriber is added to the system.

15 Referring back to Figure **8A**, after being directed at block **254** to retrieve a dialing profile for the caller, a dialing profile such as shown at **276** in Figure **10** is retrieved and the RC processor circuit **200** is directed to perform certain checks on the callee identifier provided by the contents of the callee identifier field **154** of the RC Request message shown in Figure **6**. These checks are
20 shown in greater detail in Figure **8B**.

Referring to Figure **8B**, the RC processor circuit **200** is directed to a first block **257** that causes it to determine whether a digit pattern of the callee identifier **154** provided in the RC Request message includes a pattern that matches the
25 contents of the IDD field **264** in the caller dialing profile **276** shown in Figure **10**. If so, then block **259** directs the RC processor circuit **200** to set a call type code identifier (not shown) to indicate that the call is a long distance call, e.g., from the Vancouver subscriber to the London subscriber, and block **261** directs the RC processor circuit **200** to produce a reformatted callee identifier
30 by reformatting the callee identifier into a predetermined target format. In this embodiment, this is done by removing the pattern of digits matching the IDD field contents **264** of the caller dialing profile **276** to effectively shorten the

-30-

number. Then, block **263** directs the RC processor circuit **200** to determine whether or not the reformatted callee identifier meets criteria establishing it as a number compliant with the E.164 Recommendation set by the ITU-T and if the length does not meet this criteria, block **265** directs the RC processor circuit **200** to send back to the call controller **14** a message indicating that the length of the call identifier is not correct. The process **250** is then ended. At the call controller **14**, routines may respond to the incorrect length message by transmitting a message back to the telephone **12** to indicate that an invalid number has been dialed.

Still referring to Figure **8B**, if the length of the reformatted callee identifier meets the criteria set forth at block **263**, block **269** directs the RC processor circuit **200** to determine whether or not the reformatted callee identifier is associated with a direct inward dialing (DID) bank table record such as shown at **268** in Figure **13**.

An exemplary DID bank table record entry for the London callee is shown generally at **291** in Figure **14**. The username field **281** and user domain field **272** are as specified in the username and user domain fields **258** and **260** of the dialing profile **276** shown in Figure **12**. The contents of the DID field **274** include an E.164 telephone number including a country code **283**, an area code **285**, an exchange code **287** and a number **289**. If the user has multiple telephone numbers, then multiple records of the type shown at **291** would be included in the DID bank table in the database **18**, each having the same username and user domain, but different DID field **274** contents reflecting the different telephone numbers associated with that user.

Referring back to Figure **8B**, at block **269**, if the RC processor circuit **200** finds that the reformatted callee identifier produced at block **261** is found in a record in the DID bank table, then the callee is a subscriber to the system and block **279** directs the RC processor circuit **200** to copy the contents of the corresponding username field **270** into a callee ID buffer (not shown). Thus,

-31-

the RC processor circuit **200** locates a subscriber username associated with the reformatted callee identifier. The processor is then directed to block **275** at point B in Figure **8A**.

5 Subscriber to Subscriber Calls Between Different Nodes

Referring back to Figure **8A**, block **275** then directs the RC processor circuit **200** to determine whether or not the subscriber username is associated with the same supernode as the caller. To do this, the RC processor circuit **200** determines whether or not the continent code (**61**) of the username stored in
10 the callee ID buffer is the same as the continent code (**61**) of the username of the caller specified by the caller identifier field **152** of the RC Request message shown in Figure **6**. If they are not the same, block **277** directs the RC processor circuit **200** to set a call type flag (not shown) to indicate that the call is a cross-domain call. Then, block **350** directs the RC processor circuit
15 **200** to produce a routing message identifying the supernode in the system with which the callee is associated and to set a TTL for the call to the maximum value of **99999**. The supernode in the system, with which the callee is associated, is determined by using the callee username stored in the callee ID buffer to address a supernode table having records of the type as shown at
20 **370** in Figure **17**.

Referring to Figure **17**, each prefix to supernode table record **370** has a prefix field **372** and a supernode address field **374**. The prefix field **372** includes the first n digits of the callee identifier. In this case n=1. The supernode address
25 field **374** holds a code representing the IP address or a fully qualified domain name of the supernode associated with the code stored in the prefix field **372**. Referring to Figure **18**, for example, if the prefix is **4**, the supernode address associated with that prefix is sp.lhr.digifonica.com, identifying the London supernode **21**, for example.

30

Referring to Figure **15**, a generic routing message is shown generally at **352** and includes a supplier prefix field **354**, a delimiter field **356**, a callee field **358**,

-32-

at least one route field **360**, a time-to-live (TTL) field **362** and other fields **364**. The supplier prefix field **354** holds a code for identifying supplier traffic. The delimiter field holds a symbol that delimits the supplier prefix code from the callee field **358** and in this embodiment, the symbol is a number sign (#). The route field **360** holds a domain name or an IP address of a gateway or supernode that is to carry the call and the TTL field **362** holds a value representing the number of seconds the call is permitted to be active, based on subscriber available minutes and other billing parameters, for example.

Referring to Figure **8A** and Figure **16**, in this example the routing message produced by the RC processor circuit **200** at block **350** is shown generally at **366** and includes only a callee field **358**, a route field **360** and a TTL field **362**.

The callee field **358** holds the full username of the callee and the route field **360**, shown in Figure **15**, contains the identification of the domain with which the callee is associated, i.e., sp.lhr.digifonica.com.

Having produced the routing message **366** as shown in Figure **16A**, referring back to Figure **8A**, block **351** then directs the RC processor circuit **200** to check the caller dialing profile (see Figure **9**) to determine whether or not it contains lawful intercept fields (**702**, **704**, **706**, **708**, **710**) and if so, to determine whether or not the determination information contained therein meets intercept criteria. The intercept criteria may be that the lawful intercept flag field **702** (Figure **9**) contains a flag indicating lawful intercept is enabled and whether the current date and time is within the period specified by the LI start date/time field contents **708** and the LI stop date/time field contents **710**, for example. If the intercept criteria are met, block **353** directs the RC processor circuit **200** to append the contents of the lawful intercept fields **702**, **704**, **706**, **708**, **710** to the routing message produced at block **350** to produce a routing message as shown in Figure **16A**. Generally, the determination of whether or not the destination information meets intercept criteria is done prior to producing the routing message so that when the intercept criteria are met,

-33-

at least some of the intercept information, in this embodiment all of it, can be included in the routing message.

5 If at block **351** in Figure **8A**, it is determined there are no lawful intercept fields associated with the caller dialing profile or that the intercept criteria are not met, the processor does not append any lawful intercept fields to the routing message produced at block **350** in Figure **8A** and the routing message shown in Figure **16** is sent to the call controller **14** as shown at block **380**. If the lawful intercept fields have been appended, block **380** directs the RC processor circuit **200** to send the routing message shown in Figure **16A** to the call controller **14** (Figure **1**).
10

Referring back to Figure **8B**, if at block **257**, the callee identifier specified by the contents of the callee field **154** of the RC Request message shown in Figure **6** does not begin with an IDD, block **381** directs the RC processor circuit **200** to determine whether or not the callee identifier begins with the same national dial digit code as assigned to the caller. To do this, the processor is directed to refer to the caller dialing profile shown in Figure **10**. In the embodiment shown, the NDD code **262** is the digit **1**. Thus, if the callee identifier begins with the digit **1**, the RC processor circuit **200** is directed to block **382** in Figure **8B**.
15
20

Block **382** directs the RC processor circuit **200** to examine the callee identifier to determine whether or not digits following the NDD code identify an area code that is the same as any of the area codes identified in the local area codes field **267** of the caller dialing profile **276** shown in Figure **10**. If not, block **384** directs the RC processor circuit **200** to set a call type variable (not shown) to a code indicating the call is a national code. If the digits identify an area code that is the same as a local area code associated with the caller, block **386** directs the RC processor circuit **200** to set the call type variable to indicate that the call type is a local call, national style. After executing blocks **384** or **386**, block **388** directs the RC processor circuit **200** to format the
25
30

-34-

number dialed by removing the national dial digit (NDD) and prepending a caller country code identified by the country code field **266** of the caller dialing profile shown in Figure **10**. The RC processor circuit **200** is then directed to block **263** to perform the processes described above beginning at block **263**.

5

If at block **381**, the callee identifier does not begin with an NDD code, block **390** directs the RC processor circuit **200** to determine whether the callee identifier begins with digits that identify the same area code as the caller. Again, the reference for this is the caller profile shown in Figure **10** and the RC processor circuit **200** determines whether or not the first few digits in the callee identifier identify an area code identified by the local area code field **267** of the caller profile. If so, then block **392** directs the RC processor circuit **200** to set the call type to a code indicating the call is a local call and block **394** directs the RC processor circuit **200** to prepend the caller country code to the callee identifier, the caller country code being determined from the country code field **266** in the caller profile shown in Figure **10**. The RC processor circuit **200** is then directed to block **263** for processing as described above beginning at block **263**.

10

If at block **390**, the callee identifier does not have the same area code as the caller, block **396** directs the RC processor circuit **200** to determine whether the callee identifier has the same number of digits as the number of digits indicated in either the caller minimum local number length field **268** or the caller maximum local number length field **270** of the caller profile shown in Figure **10**. If so, then block **398** directs the RC processor circuit **200** to set the call type to local and block **400** directs the processor to prepend to the callee identifier the caller country code as indicated by the country code field **266** of the caller profile shown in Figure **10** followed by the caller area code as indicated by the local area code field **267** of the caller profile shown in Figure **10**. The RC processor circuit **200** is then directed to block **263** for further processing as described above beginning at block **263**.

25

30

-35-

If at block **396**, the callee identifier has a length that does not match the length specified by the contents of the caller minimum local number length field **268** or the caller maximum local number length field **270**, block **402** directs the RC processor circuit **200** to determine whether or not the callee identifier identifies a valid username. To do this, the RC processor circuit **200** searches through the database of dialing profiles to find a dialing profile having username field contents **258** that match the callee identifier. If no match is found, block **404** directs the RC processor circuit **200** to send an error message back to the call controller (**14**). If at block **402**, a dialing profile having a username field **258** that matches the callee identifier is found, block **406** directs the RC processor circuit **200** to set the call type to a code indicating the call is a network call and the processor is directed to block **275** of Figure **8A**, to continue processing the RC message handler process **250**.

From Figure **8B**, it will be appreciated that there are certain groups of blocks of codes that direct the RC processor circuit **200** to determine whether the callee identifier has certain features such as an IDD code, a NDD code, an area code and a length that meet certain criteria and to reformat the callee identifier as necessary into a predetermined target format including only a country code, area code, and a normal telephone number, for example, to cause the callee identifier to be compatible with the E.164 number plan standard, in this embodiment. This enables the RC processor circuit **200** directed by block **279** to have a consistent format of callee identifiers for use in searching through the DID bank table records of the type shown in Figure **13** to determine how to route calls for subscriber to subscriber calls on the same system.

Subscriber to Non-Subscriber Calls

Not all calls will be subscriber-to-subscriber calls and this will be detected by the RC processor circuit **200** when it executes block **269** of Figure **8B**, and does not find a record that is associated with the callee in the DID bank table. When this occurs, the RC processor circuit **200** is directed to block **408** which

-36-

causes it to set the callee identifier equal to the reformatted callee identifier, i.e., the number compatible with the E.164 standard. Then, block 410 directs the RC processor circuit 200 to address a master list having records of the type shown in Figure 19.

5

Each master list record includes a master list ID field 500, a dialing code field 502, a country code field 504, a national sign number field 506, a minimum length field 508, a maximum length field 510, a NDD field 512, an IDD field 514 and a buffer rate field 516.

10

The master list ID field 500 holds a unique code such as 1019, for example, identifying a route identification (route ID). The dialing code field 502 holds a predetermined number pattern which the RC processor circuit 200 uses at block 410 in Figure 8B to find the master list record having a dialing code matching the first few digits of the reformatted callee identifier. The country code field 504 holds a number representing the country code associated with the record and the national sign number field 506 holds a number representing the area code associated with the record. (It will be observed that the dialing code is a combination of the contents of the country code field 504 and the national sign number field 506.) The minimum length field 508 holds a number representing the minimum number of digits that can be associated with the record and the maximum length field 51 holds a number representing the maximum number of digits in a number with which the record may be compared. The NDD field 512 holds a number representing an access code used to make a call within the country specified by the contents of the country code field 504 and the IDD field 514 holds a number representing the international prefix needed to dial a call from the country indicated by the country code.

15

20

25

30

Thus, for example, a master list record may have a format as shown in Figure 20 with exemplary field contents as shown.

-37-

Referring back to Figure 8B, using the country code and area code portions of the reformatted callee identifier that has been formatted for compatibility with the E.164 standard, block 410 directs the RC processor circuit 200 to find a master list record such as the one shown in Figure 20 having a dialing code that matches the country code and area code of the callee identifier. Thus, in this example, the RC processor circuit 200 would find a master list record having an ID field with the number 1019. This number may be also referred to as a route ID. Thus, a route ID number is found in the master list record associated with a predetermined number pattern in the reformatted callee identifier.

After execution of block 410 in Figure 8B, the process 250 continues as shown in Figure 8D. Referring to Figure 8D, block 412 directs the RC processor circuit 200 to use the route ID number to locate at least one supplier record identifying a supplier operable to supply a communications link for this route. To do this, block 412 directs the RC processor circuit 200 to search a supplier ID table having records of the type shown in Figure 21.

Referring to Figure 21, the supplier list records include a supplier ID field 540, a route ID field 542, an optional prefix field 544, a route identifier field 546, a NDD/IDD rewrite field 548 and a rate field 550. The supplier ID field 540 holds a code identifying the name of the supplier and the route ID field 542 holds a code for associating the supplier record with a route, and hence with a master list record. The prefix field 544 holds a string used to identify the supplier traffic and the route identifier field 546 holds an IP address of a gateway operated by the supplier indicated by the supplier ID field 540. The NDD/IDD rewrite field 548 holds a code and the rate field 550 holds a code indicating the cost per second to the system operator to use the route provided by the gateway specified by the contents of the route identifier field 546. Exemplary supplier records are shown in Figures 22, 23 and 24 for the suppliers shown in Figure 1 which may include Telus, Shaw and Sprint, respectively, for example.

-38-

Referring back to Figure 8D, at block 412 the RC processor circuit 200 finds all supplier records that identify the route ID found at block 410 of Figure 8B.

5 Referring back to Figure 8D, block 560 directs the RC processor circuit 200 to begin to produce routing messages of the type shown in Figure 16. To do this, the RC processor circuit 200 loads a routing message buffer as shown in Figure 25 with a supplier prefix of the least costly supplier where the least
10 with respective suppliers.

Referring to Figures 22-24, in the embodiment shown, the supplier "Telus" has the lowest number in the rate field 550 and therefore the prefix 4973 associated with that supplier is loaded into the routing message buffer shown
15 in Figure 25 first. The prefix 4973 is then delimited by the number sign and the reformatted callee identifier is next loaded into the routing message buffer. Then, the contents of the route identifier field 546 of the record associated with the supplier Telus are added to the message after an @ sign delimiter and then block 564 in Figure 8D directs the RC processor circuit 200 to get a
20 TTL value, which in this embodiment may be 3600 seconds, for example. Block 566 then directs the RC processor circuit 200 to load this TTL value in the routing message buffer shown in Figure 25. Accordingly, the first part of the routing message is shown generally at 570 in Figure 25.

25 Referring back to Figure 8D, block 568 directs the RC processor circuit 200 back to block 560 and causes it to repeat blocks 560, 562, 564 and 566 for each successive supplier until the routing message buffer is loaded with information pertaining to each supplier. Thus, the second portion of the routing message is shown at 572 in Figure 25 and this second portion relates
30 to the second supplier identified by the record shown in Figure 23 and referring back to Figure 25, the third portion of the routing message is shown at 574 which is associated with a third supplier as indicated by the supplier

-39-

record shown in Figure **24**. Consequently, referring to Figure **25**, the routing message buffer holds a routing message identifying a plurality of different suppliers able to provide gateways to establish a communication link to permit the caller to contact the callee. Each of the suppliers is identified, in ascending order according to the rates contained in the rate fields **550** of the supplier list records shown in Figures **22-24**, in this embodiment. Other criteria for determining the order in which suppliers are listed in the routing message may include preferred supplier priorities which may be established based on service agreements, for example. In this case additional fields may be provided in respective supplier records to hold values representing supplier priority.

After the routing message buffer has been loaded as shown in Figure **25**, block **567** directs the RC processor circuit **200** to check the caller dialing profile shown in Figure **10** to determine whether or not it contains lawful intercept fields as shown in Figure **9**, and if so, to determine whether or not the intercept criteria are met by checking whether the lawful intercept flag field **702** contains a flag indicating that lawful intercept is enabled and checking whether the current date and time are within the period specified by the LI start date/time field contents **708** and the LI stop date/time field contents **710**. If the intercept criteria are met, block **569** directs the RC processor circuit **200** to append the contents of the lawful intercept fields **702**, **704**, **706**, **708**, **710** to the routing message stored in the routing message buffer, as shown in Figure **25A**. Again, the determination of whether or not the destination information meets intercept criteria is done prior to producing the routing message so that when the intercept criteria are met, at least some of the intercept information, in this embodiment all of it, can be included in the routing message.

If at block **567**, it is determined there are no lawful intercept fields associated with the caller dialing profile shown in Figure **10** or that the intercept criteria are not met, the RC processor circuit **200** does not append any lawful

-40-

intercept fields to the routing message stored in the routing message buffer shown in Figure 25.

5 Block 568 then directs the RC processor circuit 200 to send the contents of the routing message buffer, i.e. the routing message shown in Figure 25 or 25A, to the call controller 14 in Figure 1.

Subscriber to Subscriber Calls Within the Same Node

10 Referring back to Figure 8A, if at block 275, the callee identifier stored in the callee ID buffer has a prefix that identifies the same supernode as that associated with the caller, block 600 directs the RC processor circuit 200 to use the callee identifier to locate and retrieve a dialing profile for the callee identified by the callee identifier. The dialing profile is of the type shown in Figure 9, and may contain data as shown in Figure 11, for example. Block 602

15 of Figure 8A directs the RC processor circuit 200 to get call block, call forward and voicemail tables from the database 18 based on the username identified in the callee profile retrieved by the RC processor circuit at block 600. Call block, call forward and voicemail tables have records as shown in Figures 26, 28 and 30 for example.

20 Referring to Figure 26, the call block records include a username field 604 and a block pattern field 606. The username field holds a username matching the username in the username field 258 of the dialing profile associated with the callee and the block pattern field 606 holds one or more E.164-compatible

25 numbers or usernames identifying PSTN numbers or system subscribers from whom the subscriber identified by the contents of the username field 604 does not wish to receive calls.

30 Referring back to Figure 8A and referring to Figure 27, block 608 directs the RC processor circuit 200 to determine whether or not the caller identifier matches a block pattern stored in the block pattern field 606 of the call block record associated with the callee identified by the contents of the username

-41-

field **604** in Figure **26**. If the caller identifier matches a block pattern stored in the block pattern field **606**, block **610** directs the RC processor circuit **200** to send a drop call or non-completion message to the call controller (**14**) and the process is ended. If the caller identifier does not match a block pattern associated with the callee, block **612** directs the RC processor circuit **200** to determine whether or not call forwarding is required.

Referring to Figure **28**, records in the call forwarding table include a username field **614**, a destination number field **616**, a destination number field **616** and a sequence number field **618**. The username field **614** stores a code representing a subscriber with which the record is associated. The destination number field **616** holds a username or number representing a number to which the current call should be forwarded and the sequence number field **618** holds an integer number indicating the order in which the username associated with the corresponding destination number field **616** should be attempted for call forwarding. The call forwarding table may have a plurality of records for a given user. The RC processor circuit **200** uses the contents of the sequence number field **618** to consider the records for a given subscriber in order. As will be appreciated below, this enables the call forwarding numbers to be tried in a ordered sequence.

Referring back to Figure **8A** and referring to Figure **28**, if at block **612** in Figure **8A**, the call forwarding record for the callee identified by the callee identifier contains no contents in the destination number field **616** and accordingly no contents in the sequence number field **618**, there are no call forwarding entries and the RC processor circuit **200** is directed to load the routing message buffer shown in Figure **32** with the callee username and domain, as shown at **650** in Figure **32**. The processor is then directed to block **620** in Figure **8C**.

If there are contents in the destination number field of the call forwarding record as shown in Figure **29**, block **622** shown in Figure **8A** directs the RC

-42-

processor circuit **200** to search the dialing profile table to find a dialing profile record of the type shown in Figure **9**, for the user identified in the destination number field **616** in the call forwarding table record of Figure **29** and to store the contents of the destination number field in the routing message buffer shown in Figure **32**. The RC processor circuit **200** is then directed to load the contents of the domain field **260** shown in Figure **9** associated with the username specified by the contents of the destination number field **616** of Figure **29** into the routing message buffer as shown at **652** in Figure **32**. This process is repeated for each call forwarding record associated with the callee identified by the callee identifier to add to the routing message buffer all call forwarding usernames and domains associated with the callee.

Referring to Figure **8C**, at block **620** the processor is directed to determine whether or not the user identified by the callee identifier has paid for voicemail service and this is done by checking to see whether or not a flag is set in a voicemail record of the type shown in Figure **30** in a voicemail table stored in the database **18** in Figure **1**.

Referring to Figure **30**, voicemail table records include a username field **624**, a voicemail server field **626**, a seconds-to-voicemail field **628** and an enable field **630**. The username field **624** stores the username of the subscriber who purchased the service. The voicemail server field **626** holds a code identifying an IP address or a fully qualified domain name (FQDN) of a voicemail server associated with the subscriber identified by the username field **624**. The seconds-to-voicemail field **628** holds a code identifying the time to wait before engaging voicemail and the enable field **630** holds a code representing whether or not voicemail is enabled for the user identified by the contents of the username field **624**. Therefore, referring back to Figure **8C**, at block **620** the processor searches for a voicemail record as shown in Figure **31** having username field **624** contents matching the callee identifier and looks at the contents of the enabled field **630** to determine whether or not voicemail is enabled. If voicemail is enabled, then block **640** in Figure **8C** directs the

-43-

processor to store the contents of the voicemail server field **626** of Figure **31** and the contents of the seconds to voicemail field **628** of Figure **31** in the routing message buffer as shown at **654** in Figure **32**. Referring back to Figure **8C**, block **642** then directs the processor to get time to live (TTL) values for each route specified by the routing message according to any of a plurality of criteria such as, for example, the cost of routing and the user's account balance. These TTL values are then appended to corresponding routes already stored in the routing message buffer.

5

Block **644** of Figure **8C** then directs the RC processor circuit **200** to store the IP address of the current supernode in the routing message buffer as shown at **656** in Figure **32**. An exemplary routing message is shown in the routing message buffer shown in Figure **32**.

10

Block **645** of Figure **8C** then directs the processor to check the caller dialing profile shown in Figure **10** to determine whether or not it contains lawful intercept fields of the type shown in Figure **9** and if so, to determine whether or not the intercept criteria are met. In this embodiment, this includes determining whether the lawful intercept flag field **702** contains a flag indicating that lawful intercept is enabled and checking whether the current date and time is within the period specified by the LI start date/time field contents **708** and the LI stop date/time field contents **710**. If the intercept criteria are met, block **647** directs the RC processor circuit **200** to append the contents of the lawful intercept fields **702**, **704**, **706**, **708**, **710** to the routing message shown in Figure **32A** to produce a routing message with lawful intercept field contents, as shown in Figure **32A**. Again, the determination of whether or not the destination information meets intercept criteria is done prior to producing the routing message so that when the intercept criteria are met, at least some of the intercept information, in this embodiment all of it, can be included in the routing message.

15

20

25

30

-44-

Referring back to Figure 8C, if at block 645, it is determined there are no lawful intercept fields associated with the caller dialing profile of Figure 10 or that the intercept criteria are not met after producing the routing message shown in Figure 32A the processor is directed to block 649 which causes the processor to check the callee dialing profile shown in Figure 11 to determine whether or not it contains lawful intercept fields of the type shown in Figure 9 and if so, to determine whether or not the intercept criteria are met by checking whether the current date and time is within the period specified by the LI start date/time field contents 708 and the LI stop date/time field contents 710 of the callee dialing profile. If the intercept criteria are met, block 651 directs the RC processor circuit 200 to append the contents of the lawful intercept fields 702, 704, 706, 708, 710 associated with the callee dialing profile to the routing message shown in Figure 32A to produce a routing message. If at block 649 of Figure 8C, it is determined there are no lawful intercept fields associated with the callee dialing profile or that the intercept criteria are not met, no lawful intercept fields associated with the callee are appended to the routing message shown in Figure 32 or 32A. Referring back to Figure 8C, block 646 then directs the RC processor circuit 200 to send the routing message to the call controller 14.

20

Response to Routing Message

Referring back to Figure 1, the routing message, whether of the type shown in Figures 16, 16A, 25, 25A, 32, 32A or 32B, is received at the call controller 14. Referring to Figure 33, when a routing message is received at the call controller, the routing message handler 122 is invoked at the call controller. The routing message handler is shown in detail in Figure 33.

25

Referring to Figure 33, the routing message handler begins with a first block 1200 that directs the processor circuit to determine whether the routing message includes lawful intercept fields. If not, the processor is directed to block 1206 which causes it to invoke a call handling routine shown in Figure 34. Referring to Figure 34, as a first step in the call handling routine, a

30

-45-

message **1100** is sent from the call controller **14** to the media relay **17**, the message including the caller telephone IP address and UDP port as determined from the caller IP address field **67** and caller UDP port field **69** in the SIP Invite message shown in Figure **3**.

5

The specific media relay **17** to which the message **1100** is sent may be selected from a pool of available media relays and such media relays may be at any geographical location. The purpose of the message **1100** is to advise the media relay that a call is desired to be set up to communicate with the IP address and UDP number of the caller telephone.

10

A media relay selected from media relays located at a geographical location that facilitates communication at a desired quality of service between the media relay **17** and the caller telephone **12** and callee telephone **15** may provide the best service. Alternatively, media relays may be pre-assigned or pre-associated with users by including and populating media relay fields of the dialing profiles of users, such as shown at **1150** in Figure **9**, identifying one or more media relays through which calls associated with the associated user are to be directed. In this case, the identifications of possible media relays obtained from the media relay fields **1150** may be sent to the call controller in additional fields in the routing message. These media relay fields are shown at **1152** in Figures **16**, **16A**, **25**, **25A**, **32**, **32A** and **32B**. In essence, the media relay through which communications involving the communications involving the subscriber will be conducted is identified in response to the routing message.

15

20

25

Referring back to Figure **34**, in this case, the message **1100** may be sent in a polling fashion to all media relays identified by the media relay fields **1150**, until one responds. Alternatively, the message **1100** may be sent simultaneously to all of the media relays.

30

-46-

In response, in the case where the media relay is known or is involved in polling as described above, the media relay **17** to which the message **1100** is sent sends a media relay status message **1102** back to the call controller **14**, the message including a media relay IP address and UDP port number at which the media relay will establish a UDP connection to the callee telephone **15**. Audio data to/from the callee telephone **15** will be transmitted over this connection. In the case where the message **1100** is sent to a plurality of media relays, the first one to respond with a media relay status message is the one through which the call will be carried. Media relay status messages from the remaining media relays can be ignored.

After the media relay status message **1102** is received at the call controller, the call controller **14** then sends a SIP Invite message **1104** of the type shown in Figure **3** to the callee telephone **15**, including the contents of the caller and callee identifier fields (**60** and **62**), the call identifier field (**65**) and the media relay IP address and the media relay UDP port number assigned to the audio path connection with the callee telephone **15**, to invite the callee telephone to establish a connection with the media relay **17**.

The purpose of the SIP Invite message **1104**, is to advise the callee telephone of the caller and call ID and of the IP address and UDP port number of the media relay through which the callee telephone should send and receive audio data.

The callee telephone **15** stores the media relay IP address and assigned UDP port number in the audio path IP address buffer **47** shown in Figure **2** and configures itself to create a socket between the media relay IP/UDP address and the callee telephone IP address and a UDP port number that the callee telephone **15** desires to use as an audio path to the caller telephone. Instead of being sent or received directly to or from the caller telephone, the callee telephone **15** will send and receive audio data from the media relay. To indicate this, the callee telephone **15** sends a SIP OK message **1106** back to

-47-

the call controller **14**, the message including the callee IP address and UDP port number from its IP address field (**53** in Figure **3**) at which the callee telephone **15** will establish an audio path connection with the media relay **17**. The purpose of this SIP OK message **1106** is to advise the call controller of the IP address and UDP port number through which the media relay should send and receive audio data to and from the callee telephone.

The call controller **14** then sends a message **1108** to the media relay **17** including the IP address and UDP port number that the callee telephone **15** will use for the audio path connection with the media relay. The purpose of the message **1108** is to advise the media relay of the IP address and UDP port number through which it should send and receive audio data to and from the callee telephone.

The media relay **17** then determines a UDP port through which it will carry audio data to and from the caller telephone **12** and sends a message **1110** to the call controller (**14**), the message including the media relay IP address and the media relay UDP port number the media relay will use to carry audio to and from the caller telephone **12**. The purpose of this message **1110** is to advise the call controller **14** of the IP address and UDP port number through which it expects to transfer audio data to and from the caller telephone.

The call controller **14** then sends a SIP OK message **1112** to the caller telephone **12** to indicate that the call may now proceed. The SIP OK message includes the caller and callee usernames, the call ID and the media relay **17** IP address and the UDP port number assigned to the audio connection with the caller telephone **12**. The purpose of this SIP OK message **1112** is to advise the caller telephone **12** of the IP address and UDP port number through which it should exchange audio data with the media relay **17**.

If the routing message is of the type shown in Figure **25** where there are a plurality of suppliers available, the call handling routine proceeds as described

-48-

above with the exception that instead of communicating with the callee telephone directly, the call controller **14** communicates with a gateway provided by a supplier. If a SIP OK message is not received back from the first gateway, the processor is directed to send the SIP Invite message **1104** to a gateway of the next indicated supplier. For example, the call controller **14** sends the SIP Invite message **1104** to the first supplier, in this case Telus, to determine whether or not Telus is able to handle the call. If Telus does not send back a SIP OK message **1106** within a specified time or sends a message indicating that it is not able to handle the call, the call controller proceeds to send a SIP Invite message **1104** to the next supplier, in this case Shaw. The process is repeated until one of the suppliers responds with a SIP OK message **1106** indicating that it is available to carry the call and the process proceeds as shown in connection with messages **1108**, **1110** and **1112**. For example, the supplier "Telus" sends back a SIP OK message and thus provides a gateway to the PSTN at IP address **72.64.39.58** as provided by the routing message from the contents of the route identifier field **546** of the corresponding supplier record shown in Figure **22**.

Referring back to Figure **1**, if the call controller **14** receives a message of the type shown in Figure **32**, i.e., a type that has one call forwarding number and/or a voicemail number, the call controller attempts to establish a call (using SIP Invite message **1104**) to the callee telephone **15** and if no call is established (i.e., message **1106** is not received) within a pre-determined time, the call controller **14** attempts to establish a call with the next user identified in the call routing message, by sending a SIP invite message like message **1104** to the next user. This process is repeated until all call forwarding possibilities have been exhausted, in which case an audio path is established with the voicemail server **19** identified in the routing message. The voicemail server **19** sends the SIP OK message **1106** in response to receipt of the SIP invite message **1104** and functions as described above in connection with the callee telephone **15** to permit an outgoing audio message provided by the voicemail

-49-

server to be heard by the caller and to permit the caller to record an audio message on the voicemail server.

5 When audio paths are established, a call timer (not shown) maintained by the call controller logs the start date and time of the call and logs the call ID and adds an active call record of the type shown in Figure 35 to an active call list, maintained by the call controller.

10 In this embodiment, the call controller active call record shown in Figure 35 includes a call ID field 1300, a caller IP address field 1302, a caller port field 1304, a callee IP address field 1306, a callee port field 1308, a media relay ID field 1310, a media relay caller port field 1312 and a media relay callee port field 1314. The contents of the call ID field 1300 are established at block 136 in Figure 5. The contents of the caller IP address field 1302 are established
15 from the contents of the caller IP address field 67 of the SIP invite message shown in Figure 3. The contents of the caller port field 1304 are established from the caller UDP port field 69 of the SIP invite message shown in Figure 3. The contents of the callee IP address field 1306 and callee port field 1308 are established from the SIP OK message 1106 shown in Figure 34.

20 The media relay ID field 1310 is populated with an identification of the media relay handling the call. In the example shown, the media relay is number 42. The contents of the media relay caller port field are obtained from the message 1110 shown in Figure 34 and the contents in the media relay callee
25 port field 1314 are obtained from the media relay status message 1102 shown in Figure 34. Each time a call is established, an active call record of the type shown in Figure 35 is added to an active call log maintained by the call controller.

30 The routing controller also maintains an active call log containing active call records however the active call records maintained by the routing controller are different from the active call records held by the call controller. For

-50-

example, referring to Figure **36**, an active call record held by the routing controller includes a call ID field **1316**, a caller field **1318**, a callee field **1320** and a call controller ID field **1322**. Information for populating these fields may be received in a message (not shown) transmitted from the call controller to the routing controller after an active call record has been entered into the active call log of the call controller.

The message from the call controller **14** to the routing controller **16**, indicating that an active call has been established may include the contents of the call ID field **1300** shown in Figure **35** and a call controller unique ID number held by the call controller. The routing controller **16** matches the call ID with the caller and callee user names contained in the original call routing message (Fig **16**, **16A**, **25**, **25A**, **32**, **32A**, **32B**) that caused the call controller **14** to route the call, to populate the caller and callee fields **1318** and **1320** shown in Figure **36**, respectively. It will be appreciated that a plurality of call controllers may be associated with a single routing controller, in which case the call controller ID allows the routing controller to uniquely identify the call controller associated with the call ID indicated by the contents of the call ID field **1316**. In the example shown, the call controller is number **61**.

The active call records facilitate intercepting a call already in progress, as will be described below.

Referring back to Figure **33**, if at block **1200** it is determined that the routing message has lawful intercept fields, block **1202** directs the call controller circuit **100** (Figure **4**) to send a SIP Invite message as shown in Figure **37** to a mediation device identified by the mediation device IP address in the routing message as obtained from the user dialing profile MD1 address field **704** as shown at **256** in Figure **9**. Referring to Figure **37**, the SIP Invite message includes caller and callee identifier fields **1020**, **1022**, a call ID field **1024**, a warrant ID field **1026** and other intercept related information fields **1028**, if desired. The caller, callee and call ID field contents **1020**, **1022**, and **1024** are

-51-

obtained from the original SIP Invite message shown in Figure 6. The contents of the warrant ID field **1026** and intercept related info fields **1028** are obtained from the routing message which would be of the type shown in Figures **16A**, **25A**, **32A** or **32B**.

5

Referring back to Figure **33**, block **1204** then directs the call controller **14** to receive a reply message, as shown in Figure **38**, from the mediation device **31**. The reply message is a SIP OK message that includes caller, callee, and call ID fields **1040**, **1042**, **1044** as described above and further includes a mediation device IP address field **1046** and a mediation device UDP caller port number field **1048** and a UDP callee port number field **1050** identifying UDP ports at the mediation device IP address to which the media relay is to send copies of audio data streams received from the caller and callee telephones respectively. Block **1206** then directs the call controller to execute the call handling routine shown in Figure **34** with the exception that the message **1100** additionally includes the contents of the mediation device IP address field **1046**, the mediation device UDP caller port number field **1048** and the UDP callee port number field **1050** of the SIP OK message shown in Figure **38**.

20

All other messages are the same as described above in connection with the call handling routine as shown in Figure **34**, but in response to receiving the additional information in the message **1100**, the media relay automatically configures itself to provide for copying the audio data received from both the caller telephone and the callee telephone to the mediation device IP address and the UDP caller port number and the UDP callee port number respectively.

25

Referring back to Figure **1**, as audio data originating at the caller telephone **12** and callee telephone **15** passes through the media relay **17**, this data is copied to the mediation device UDP port for the caller and the mediation device UDP port for the callee, as indicated by the SIP invite message **1100**. This enables law enforcement agencies to monitor audio communications

30

-52-

between the caller and callee and/or to record such communications at the mediation device.

Thus, when the determination information in the dialing profile meets intercept
5 criteria, the call controller communicates with the media relay through which
communications involving the subscriber whose communications are to be
monitored will be handled to cause the media relay to send a copy of such
communications to a mediation device specified by the destination information
included in the intercept information associated with the dialing profile
10 associated with the subscriber whose communications are to be monitored.

Terminating the Call

In the event that either the caller or the callee terminates a call, the telephone
of the terminating party sends a SIP Bye message to the call controller **14**. An
15 exemplary SIP Bye message is shown at **900** in Figure **39** and includes a
caller field **902**, a callee field **904** and a call ID field **906**. The caller field **902**
holds the caller username, the callee field **904** holds a PSTN compatible
number or username, and the call ID field **906** holds a unique call identifier
field of the type shown in the call identifier field **65** of the SIP Invite message
20 shown in Figure **3**.

Thus, for example, referring to Figure **40**, a SIP Bye message for the Calgary
callee is shown generally at **908** and the caller field **902** holds a username
identifying the Vancouver caller, in this case **2001 1050 8667**, the callee field
25 **904** holds a username identifying the Calgary callee, in this case **2001 1050**
2222, and the call ID field **906** holds the code **FA10@192.168.0.20**, which is
the call ID for the call.

The SIP Bye message shown in Figure **40** is received at the call controller **14**
30 and the call controller executes a process as shown generally at **910** in Figure
41. The process includes a first block **912** that directs the call controller circuit
(**100**) to copy the caller, callee and call ID field contents from the SIP Bye

-53-

message **900** shown in Figure **39** received from the terminating party to corresponding fields of an RC stop message buffer (not shown). Block **914** then directs the call controller circuit **100** to copy the call start time from the call timer and to obtain a Call Stop time from the call timer. Block **916** then
5 directs the call controller to calculate a communication session time by determining the difference in time between the call start time and the Call Stop time. This communication session time is then stored in a corresponding field of the RC Call Stop message buffer. Block **918** then directs the call controller circuit **100** to populate the route field with the IP address of the gateway supplier, if any. An RC Call Stop message produced as described
10 above is shown generally at **1000** in Figure **42**. An RC Call Stop message specifically associated with the call made to the Calgary callee is shown generally at **1021** in Figure **43**.

15 Referring to Figure **42**, the RC call stop message **1000** includes a caller field **1002**, callee field **1004**, a call ID field **1006**, an account start time field **1008**, an account stop time field **1010**, a communication session time field **1012** and a route field **1014**. The caller field **1002** holds a username, the callee field **1004** holds a PSTN-compatible number or system number, the call ID field
20 **1006** holds the unique call identifier received from the SIP Invite message shown in Figure **3**, the account start time field **1008** holds the date and start time of the call, the account stop time field **1010** holds the date and time the call ended, the communication session time field **1012** holds a value representing the difference between the start time and the stop time, in
25 seconds, and the route field **1014** holds the IP address for a gateway, if a gateway is used to establish the call.

Referring to Figure **43**, an exemplary RC call stop message for the Calgary callee is shown generally at **1021**. In this example the caller field **1002** holds
30 the username **2001 1050 8667** identifying the Vancouver caller and the callee field **1004** holds the username **2001 1050 2222** identifying the Calgary callee. The contents of the call ID field **1006** are **FA10@192.168.0.20**. The contents

-54-

of the account start time field **1008** are **2006-12-30 12:12:12** and the contents of the account stop time field **1010** are **2006-12-30 12:12:14**. The contents of the communication session time field **1012** are **2** to indicate **2** seconds call duration and the contents of the route field are blank but would be
5 **72.64.39.58** if the "Telus" gateway were used, for example.

Referring back to Figure **41**, after having produced an RC Call Stop message, block **920** directs the call controller circuit **100** to send the RC stop message contained in the RC Call Stop message buffer to the routing controller (**16**).
10

The RC (**16**) receives the Call Stop message and an routing controller Call Stop message process (not shown) is invoked at the routing controller to deal with charges and billing for the call.

Block **922** directs the call controller circuit **100** to send a Bye message to the party that did not terminate the call i.e. to the non-terminating party.
15

Block **924** then directs the call controller circuit **100** to send a SIP Bye message of the type shown in Figure **39** to the media relay **17** to cause the media relay to disconnect the audio path sockets associated with the caller telephone IP/UDP address and the callee telephone IP/UDP address. In disconnecting these communication sockets, the media relay **17** deletes associations between the caller telephone IP/UDP address media relay caller IP/UDP address and between the caller telephone IP/UDP address and media relay callee IP/UDP address.
20
25

If the media relay (**17**) was configured for lawful intercept, block **926** of Figure **41** then directs the call controller circuit **100** to send a SIP Bye message of the type shown in Figure **39** to the mediation device **31** to inform the mediation device that the call has ended and to disconnect communication sockets between the media relay caller and callee IP/UDP port addresses and
30

-55-

the IP/UDP port address to which the audio data received at the caller and
callee IP/UDP port addresses were being copied.

5 It will be appreciated that in the foregoing description, the components
described cooperate to detect a requirement for intercept at the time a call is
set up. In the following description an explanation is provided to describe how
to intercept a call while the call is in progress.

Intercepting a Call in Progress

10 Referring back to Figure 1, to intercept a call while the call is in progress, the
law enforcement authority **293** may communicate with a mediation device, or
may communicate with the call controller or may communicate with the
routing controller or may communicate with a handover interface that
communicates with any of the foregoing components to cause the routing
15 controller to receive a law enforcement authority (LEA) intercept request
message including intercept information, such as that which would be
associated with fields **702-710** in Figure 9, for example.

20 In response to receipt of a LEA intercept request message, the routing
controller LEA request message handler shown at **1400** in Figure 44 is
invoked.

25 The LEA request message handler **1400** begins with a first block **1402** that
directs the routing controller processor circuit to communicate with the
database **18** in which dialing profile records of the type shown in Figure 9 are
stored to find a dialing profile associated with the user whose calls are to be
monitored.

30 If the username is not known, but a DID number (i.e. a PSTN number) is
known, the routing controller may cause a search through the DID bank table
records of the type shown in Figure 13, for example to find a username
associated with a DID number. If the username is not known but a name and

-56-

address is known, other records such as billing records (not shown) associating names and addresses with usernames may be searched to find a username associated with a given name and/or address of a person whose calls are to be intercepted. Regardless of the information available, to
5 facilitate call interception any way of finding the unique dialing profile associated with the user whose calls are to be intercepted is a first step to facilitating call interception, in this embodiment.

Once the dialing profile is located, block **1404** directs the routing controller processor circuit to associate the intercept information with the dialing profile
10 by appending and/or populating the lawful intercept fields of the dialing profile with such information as provided in the LEA intercept request message..

Block **1406** then directs the routing controller processor circuit to determine
15 whether the intercept criteria are met by the intercept information now included in the dialing profile. This is done by determining whether the LI flag (**702**) is on, and the current date and time is within the LI start stop date/time ranges. If the intercept criteria are not met, the process is ended. Otherwise the processor is directed to block **1408**.

20 Block **1408** directs the routing controller processor circuit to use the username of the dialing profile found at block **1402** to search caller and callee fields of routing controller active call records shown in Figure **36** that have contents matching the username associated with the dialing profile. If no such record is
25 found, the user is not currently engaged in a call and the process is ended. If the user is engaged in a call, the routing controller active call record will be found. Block **1410** then directs the routing controller processor circuit to find the call controller id and call id of the associated call, from the routing controller active call record shown in Figure **36**.

30 Block **1412** then directs the routing controller processor circuit to transmit an in-call intercept message to the call controller identified by the contents of the

-57-

call controller id field **1322** of the routing controller active call record. The in-call intercept message includes the call id as determined from the routing controller active call record and the IP address of the mediation device associated with the law enforcement authority interested in intercepting the call. The IP address of the mediation device may be obtained from the law enforcement authority request message, or the dialing profile, for example.

Block **1414** then directs the routing controller processor circuit to wait a specified time to receive a call controller intercept status message back from the call controller indicating whether or not the intercept function has been activated.

Referring to Figure **45**, upon receipt of an in-call intercept message at the call controller (**14**) the call controller executes an in-call intercept message handler shown generally at **1450**. The in-call intercept message handler **1450** begins with a first block **1452** that directs the call controller processor circuit to send a SIP invite message to the mediation device associated with the IP address of the mediation device, received in the in-call intercept message.

Block **1454** then directs the call controller processor circuit to receive an IP address and callee and caller UDP port numbers from the mediation device, where this IP address and UDP port numbers are network locations at which the mediation device will expect to receive audio data streams from the media relay through which the call is carried.

Block **1456** then directs the call controller processor circuit to identify a media relay through which communications to be monitored are being conducted by using the username of the subscriber whose communications are to be monitored to locate an active call record in the call controller active call list to locate a media relay identifier such as the IP address of the media relay indicated by the contents of the media relay ID field **1310** of the call controller active call record shown in Figure **35**. The call controller processor circuit is

-58-

then directed to send an intercept request message to the media relay (17) that is handling the call. The intercept request message includes the mediation device IP address and caller and callee UDP port numbers to identify to the media relay (17) the mediation device IP address and UDP port number(s) at which it expects to receive a copy of the audio data stream from the caller and callee respectively.

In response, the media relay establishes internal connections between the caller and callee IP addresses and UDP ports and callee IP address and UDP port of the mediation device. Then, the media relay sends a media relay status message back to the call controller indicating whether or not internal connections have been established and that call intercept has been initiated.

As seen at block 1458, the call controller processor circuit is directed to receive the media relay status message and block 1460 directs the call controller processor circuit to send a call controller intercept status message back to the routing controller to indicate that the call intercept function has been established. The routing controller may communicate this status back to the law enforcement authority that issued the law enforcement authority request message. In the meantime, communications involving the caller or callee whose communications are to be monitored, which travel through the media relay, are copied and sent to the mediation device.

Thus, after associating intercept information with the dialing profile of the subscriber whose communications are to be monitored, when the determination information included in the intercept information meets intercept criteria, the call controller communicates with the media relay through which the communications of the subscriber whose communications are to be monitored to cause such media relay to send a copy of such communications to a mediation device specified by the destination information included in the intercept information.

-59-

When the call is ended, the call is shut down in the same way as described above.

5 Should the law enforcement authority desire to cease interception of the call during the call, an LEA request message requesting that the intercept function be stopped is sent to the routing controller from the law enforcement authority through any of the paths described above. This invokes the LEA request message handler such as shown in Figure 44 which causes the routing controller processor circuit to execute blocks 1402, 1404. At block 1404, the
10 routing controller processor circuit is directed to change the contents of the lawful intercept fields to at least set the lawful intercept flag (702 in Figure 9) inactive.

15 Then, at block 1406, the intercept criteria are not met and the processor is directed to block 1416, which causes the routing controller processor circuit to determine whether or not an interception function is in progress. This can be determined, for example, by maintaining evidence of the receipt of the confirmation message from the call controller, received at block 1414 of the LEA request message handler 1400.

20 If an intercept is not in progress, the LEA request message handler 1400 is ended.

25 If an intercept is in progress, block 1418 directs the routing controller processor circuit to execute an in-call intercept shut down routine as shown at 1500 in Figure 46. The in-call intercept shut down routine begins with a first block 1502 which directs the routing controller processor circuit to locate the routing controller active call record having caller or callee field contents equal to the username indicated in the dialing profile found at block 1402 of the LEA request message handler 1400 shown in Figure 44. Having found the active
30 call record, block 1504 directs the routing controller processor circuit to find, in the routing controller active call record shown in Figure 36, the call

-60-

controller id (**1322**) and the call id (**1316**) associated with the call. Block **1506** then directs the routing controller processor circuit to send a cease intercept message (not shown) to the call controller identified by the call controller id determined at block **1504**. This cease intercept message includes the call id
5 determined at block **1504** and an identification of the mediation device, the identification being obtained from the MD1 address field (**704** in Figure **9**) of the dialing profile for the user whose calls are currently being intercepted. Block **1508** then directs the routing controller processor circuit to wait a specified time to receive a confirmation message from the call controller to
10 indicate that the intercept function has been shut down.

Referring to Figure **47**, upon receipt of the cease intercept message at the call controller (**14**), a cease intercept message handler **1520** is invoked at the call controller. The cease intercept message handler **1520** begins with a first
15 block **1522** that directs the call controller processor circuit to send a SIP stop message to the mediation device identified in the cease intercept message received from the routing controller. In response to the SIP stop message, the mediation device stops receiving audio data and sends a confirmation message back to the call controller.

20 Block **1524** directs the call controller processor circuit to receive the confirmation message back from the mediation device.

Block **1526** then directs the call controller processor circuit to send a stop
25 intercept message to the media relay **17** identified by the contents of the media relay ID field **1310** of the active call record shown in Figure **35**. The stop intercept message includes the contents of the media relay caller port ID field **1312** and media relay callee port field **1314** included in the active call record and identifies to the media relay which ports to shut down. In response
30 to the stop intercept message, the media relay **17** disconnects the connections between the media relay caller port and the mediation device port that was receiving the audio data from the caller and the connection between

-61-

the media relay callee port and the mediation device port that was receiving audio data from the callee. The media relay then sends an MR stop status message to the call controller.

5 Block **1528** directs the call controller processor circuit to receive the MR stop status message and block **1530** directs the call controller to send a stop status message to the routing controller **16**.

10 In an alternative embodiment, the routing controller does not maintain active call records but each call controller does. In such an embodiment, blocks **1408** and **1410** of Figure **44** are replaced with a single block **1600** that directs the routing controller processor circuit to poll each call controller to determine whether or not its active call list contains an entry having caller or callee field contents equal to the username determined from the dialing profile located at
15 block **1402**.

If any of the polled call controllers has such a record, that call controller transmits a response message back to the routing controller, the response message including a call controller ID identifying that call controller. More than
20 one call controller may have an active call record having caller or callee field contents equal to the username determined from the user profile. Such would be the case in a conference call, for example.

The routing controller processor circuit then executes blocks **1412** and **1414**
25 as described above or the process is ended if none of the polled call controllers contains a call record with caller and callee field contents matching the username determined from the dialing profile located at block **1402**.

In effect therefore, block **1600** provides an alternate way of finding call
30 controllers that are currently carrying a call associated with the user of interest.

-62-

In another embodiment, an interface to the routing controller and/or the call controller may be provided to enable law enforcement authorities to have direct access or a copy of the active call list maintained by the call controller and/or routing controller.

5

From the foregoing, it will be appreciated that indications of whether or not communications of a subscriber to the system are to be monitored are provided by law enforcement agencies directly into a subscriber dialing profile shown in Figure 9. This dialing profile is used to route a call involving the subscriber and is checked for lawful intercept requirements to determine whether or not the media relay should copy audio data associated with the call to a mediation device for lawful monitoring and/or recording purposes.

10

While the system has been described in connection with the monitoring of audio streams, it may similarly be used for monitoring any other data streams such as pure data and/or video or multimedia data, for example, between subscribers to the system or between a subscriber and a non-subscriber to the system.

15

While specific embodiments of the invention have been described and illustrated, such embodiments should be considered illustrative of the invention only and not as limiting the invention as construed in accordance with the accompanying claims.

20

-63-

What is claimed is:

- 5
1. A method for intercepting communications in an Internet Protocol (IP) network system in which communications between a subscriber of said system and another party occur through a media relay to which said subscriber and said another party address their communications destined for each other and which relays said communications between said subscriber and said another party, the method comprising:
- 10
- determining whether determination information associated with a subscriber dialing profile associated with said subscriber meets intercept criteria;
- 15
- when said determination information meets said intercept criteria, causing the same media relay through which communications between said subscriber and said another party are relayed to produce a copy of said communications between said subscriber and said another party, while said same media
- 20
- relay relays communications between said subscriber and said another party; and
- causing said same media relay to send said copy to a mediation device identified by destination information associated with said
- 25
- subscriber dialing profile.
- 30
2. The method of claim 1 further comprising associating said determination information and said destination information with said dialing profile when communications involving said subscriber are not in progress.

-64-

3. The method of claim 1 further comprising associating said determination information and said destination information with said subscriber dialing profile when communications involving said subscriber are in progress.
- 5
4. The method of claim 2 or 3 wherein associating said determination information and said destination information comprises populating intercept information fields in said dialing profile of a subscriber whose communications are to be monitored.
- 10
5. The method of claim 1 further comprising producing a routing message for routing communications involving the subscriber through components of the IP network and determining whether said determination information meets said intercept criteria prior to producing said routing message and including at least some of said determination information and said destination information in said routing message when said determination information meets said intercept criteria.
- 15
6. The method of claim 5 wherein determining whether said determination information meets said intercept criteria comprises determining whether a current date and time is within a range specified by said determination information.
- 20
7. The method of claim 6 wherein producing a routing message comprises identifying a media relay through which communications involving said subscriber will be conducted and including an identification of said media relay in said routing message such that said media relay acts as said same media relay through which communications between said subscriber and said another party are relayed.
- 25
- 30

-65-

- 5
8. The method of claim 7 further comprising pre-associating at least one media relay with said dialing profile associated with the subscriber whose communications are to be monitored and wherein identifying said media relay comprises identifying the media relay pre-associated with said subscriber whose communications are to be monitored.
- 10
9. The method of claim 8 wherein pre-associating comprises populating media relay fields in said dialing profile with an identification of said at least one media relay.
- 15
10. The method of claim 3 wherein associating said determination information and said destination information comprises associating said determination information and said destination information with said dialing profile of the subscriber whose communications are to be monitored, in response to receipt of an intercept request message, wherein said intercept request message comprises said determination information and said destination information.
- 20
11. The method of claim 10 further comprising invoking an intercept request message handler to:
- 25
- a) find a dialing profile associated with the subscriber whose communications are to be monitored;
 - b) perform the step of associating said determination information and said destination information with said dialing profile;
 - c) determine whether said intercept criteria are met; and
 - d) identify a media relay through which said communications are being conducted such that said media relay can be caused to send said copy to said mediation device.
- 30

-66-

- 5
12. The method of claim 11 wherein said dialing profile includes a username identifier and further comprising maintaining active call records for communications in progress, said active call records comprising a username identifier and a media relay identifier identifying the media relay through which said communications are being conducted and wherein identifying the media relay comprises locating an active call record associated with communications of the subscriber whose communication are to be monitored to identify the media relay associated with said communications.
- 10
13. The method of claim 12 further comprising maintaining direct-in-dial (DID) records associating PST telephone numbers with usernames of users subscribing to said IP network, and wherein finding a dialing profile associated with the subscriber whose communications are to be monitored comprises finding a username in a DID record bearing a PSTN number associated with the subscriber whose communications are to be monitored and using said username to locate a dialing profile associated with said username.
- 15
- 20
14. An apparatus for intercepting communications in an Internet Protocol (IP) network, the apparatus comprising:
- 25
- means for accessing dialing profiles associated with respective subscribers of the IP network, at least one of said dialing profiles being associated with a subscriber whose communications are to be monitored, the dialing profile of the subscriber whose communications are to be monitored including intercept information including determination information for determining whether to intercept a communication involving said subscriber, and destination information identifying a mediation device to which intercepted communications involving said subscriber are to be sent;
- 30

-67-

means for determining whether said determination information meets intercept criteria;

5 means for causing the same media relay through which communications between said subscriber and said another party are relayed to produce a copy of said communications between said subscriber and said another party, while said media relay relays communications between said subscriber and said
10 another party;

means for communicating with said same media relay to cause said same media relay to send said copy of said communications to a mediation device specified by said
15 destination information, when said determination information meets said intercept criteria.

15. The apparatus of claim **14** further comprising means for associating said intercept information with said dialing profile when
20 communications involving said subscriber are not in progress.

16. The apparatus of claim **14** further comprising means for associating said intercept information with said dialing profile when
25 communications involving said subscriber are in progress.

17. The apparatus of claim **15** or **16** wherein said means for associating said intercept information is operably configured to populate intercept information fields in said dialing profile of the subscriber whose
30 communications are to be monitored.

18. The apparatus of claim **14** further comprising means for producing a routing message for routing communications involving the subscriber through components of the IP network and means for determining

-68-

5 whether said determination information meets said intercept criteria prior to producing said routing message and wherein said means for producing said routing message is operably configured to include at least some of said intercept information in said routing message when said determination information meets said intercept criteria.

10 19. The apparatus of claim 18 wherein said means for determining whether said determination information meets said intercept criteria is operably configured to determine whether a current date and time is within a range specified by said determination information.

15 20. The apparatus of claim 19 wherein said means for producing said routing message is operably configured to identify a media relay through which communications involving said subscriber will be conducted and to include an identification of said media relay in said routing message such that said media relay acts as said same media relay through which communications between said subscriber and said another party are relayed.

20 21. The apparatus of claim 20 further comprising means for pre-associating at least one media relay with said dialing profile of the subscriber whose communications are to be monitored and wherein said routing means is operably configured to identify from said dialing profile the media relay pre-associated with said subscriber whose communications are to be monitored.

25

22. The apparatus of claim 21 wherein said means for pre-associating is operably configured to populate media relay fields in said dialing profile with an identification of at said least one media relay.

30

23. The apparatus of claim 16 wherein said means for associating said intercept information is operably configured to associate said intercept information associated with said dialing profile of the subscriber whose

-69-

communications are to be monitored, in response to receipt of an intercept request message, wherein said intercept request message comprises said intercept information.

5 **24.** The apparatus of claim **23** further comprising means for handling an intercept request message, said means for handling said intercept request message comprising:

10 a) means for finding a dialing profile associated with the subscriber whose communications are to be monitored, said means for finding a dialing profile cooperating with said means for associating said intercept information with said dialing profile to cause said intercept information to be associated with said dialing profile;

15 b) means for determining whether said intercept criteria are met; and

20 c) means for identifying a media relay through which said communications are being conducted such that said media relay can be caused to send said copy to said mediation device.

25 **25.** The apparatus of claim **24** wherein said dialing profile includes a username identifier and further comprising means for maintaining active call records for communications in progress, said active call records comprising a username identifier and a media relay identifier identifying a media relay through which said communications are being conducted and wherein said means for identifying the media relay is operably configured to locate an active call record associated with communications of the subscriber whose communications are to be monitored to identify the media relay associated with said
30 communications.

-70-

- 5 **26.** The apparatus of claim **25** further comprising means for maintaining direct-in-dial (DID) records associating PST telephone numbers with usernames of users subscribing to said IP network, and wherein said means for finding a dialing profile associated with the subscriber whose communications are to be monitored is operably configured to find a username in a DID record bearing a PSTN number associated with the subscriber whose communications are to be monitored and use said username to locate a dialing profile associated with said username.

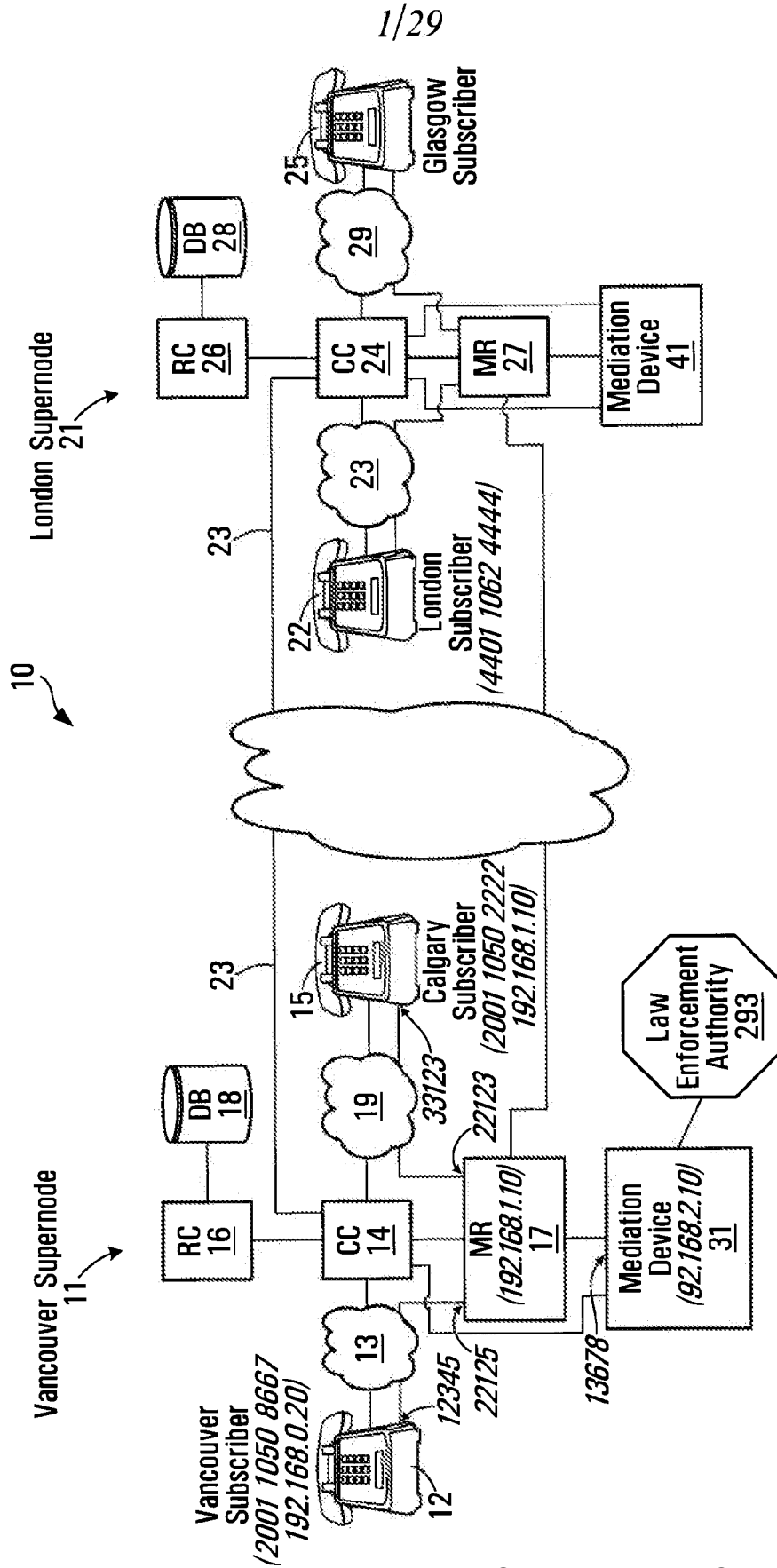

FIG. 1

2/29

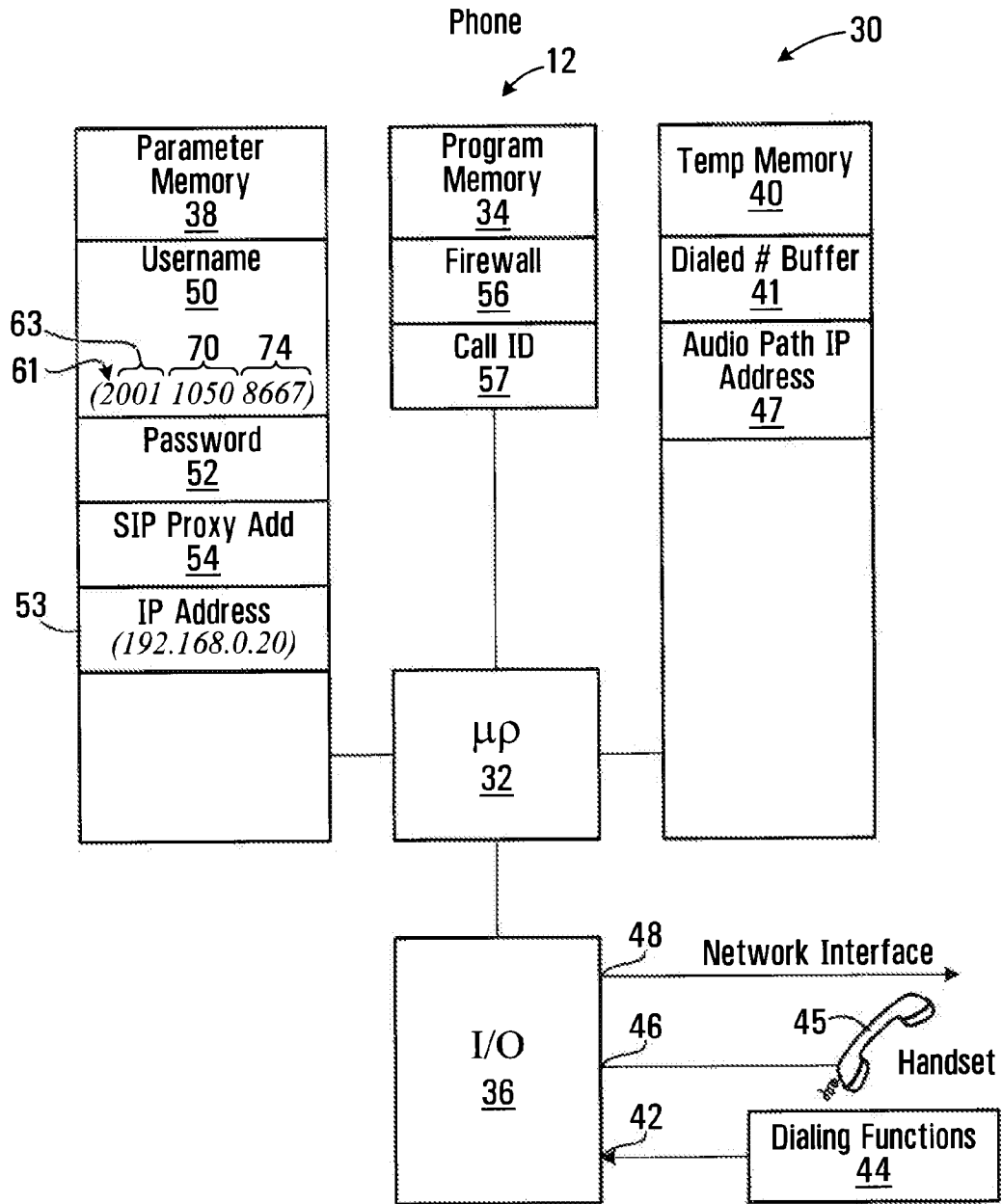

FIG. 2

3/29

SIP Invite Message

60 ~ Caller 2001 1050 8667
 62 ~ Callee 2001 1050 2222
 64 ~ Digest Parameters XXXXXXX
 65 ~ Call ID FF10@ 192.168.0.20
 67 ~ Caller IP Address 192.168.0.20
 69 ~ Caller UDP port 12345

FIG. 3

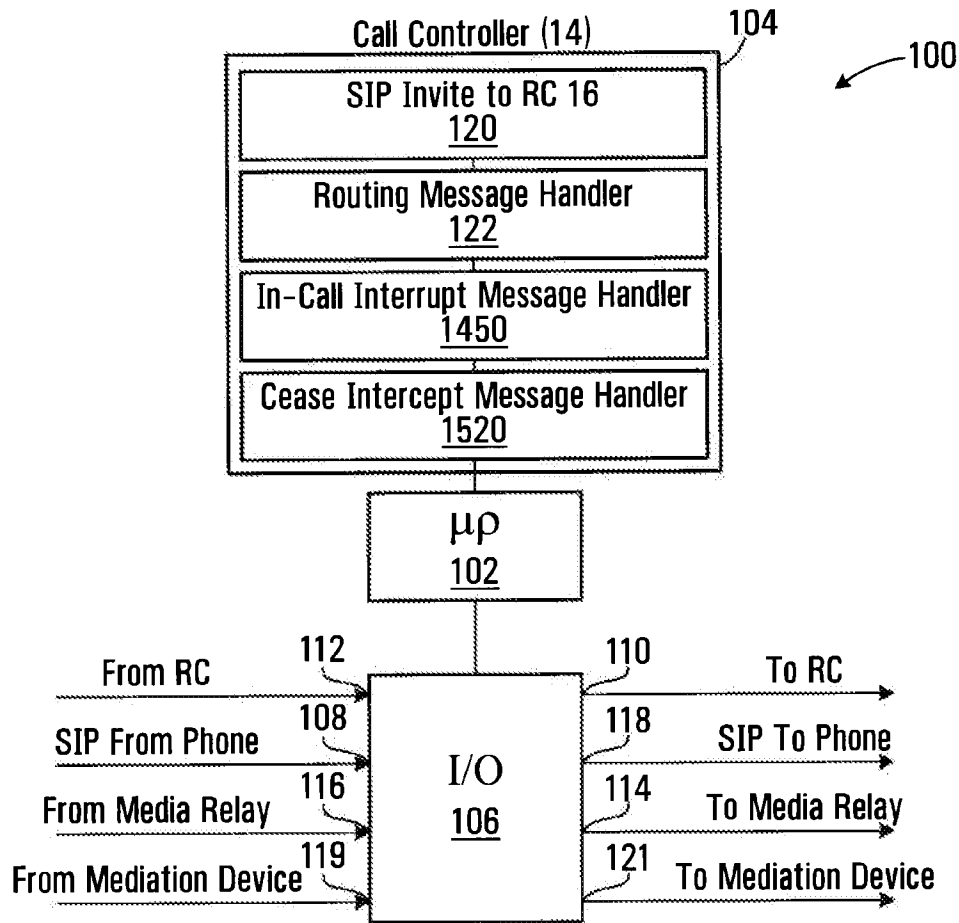

FIG. 4

4/29

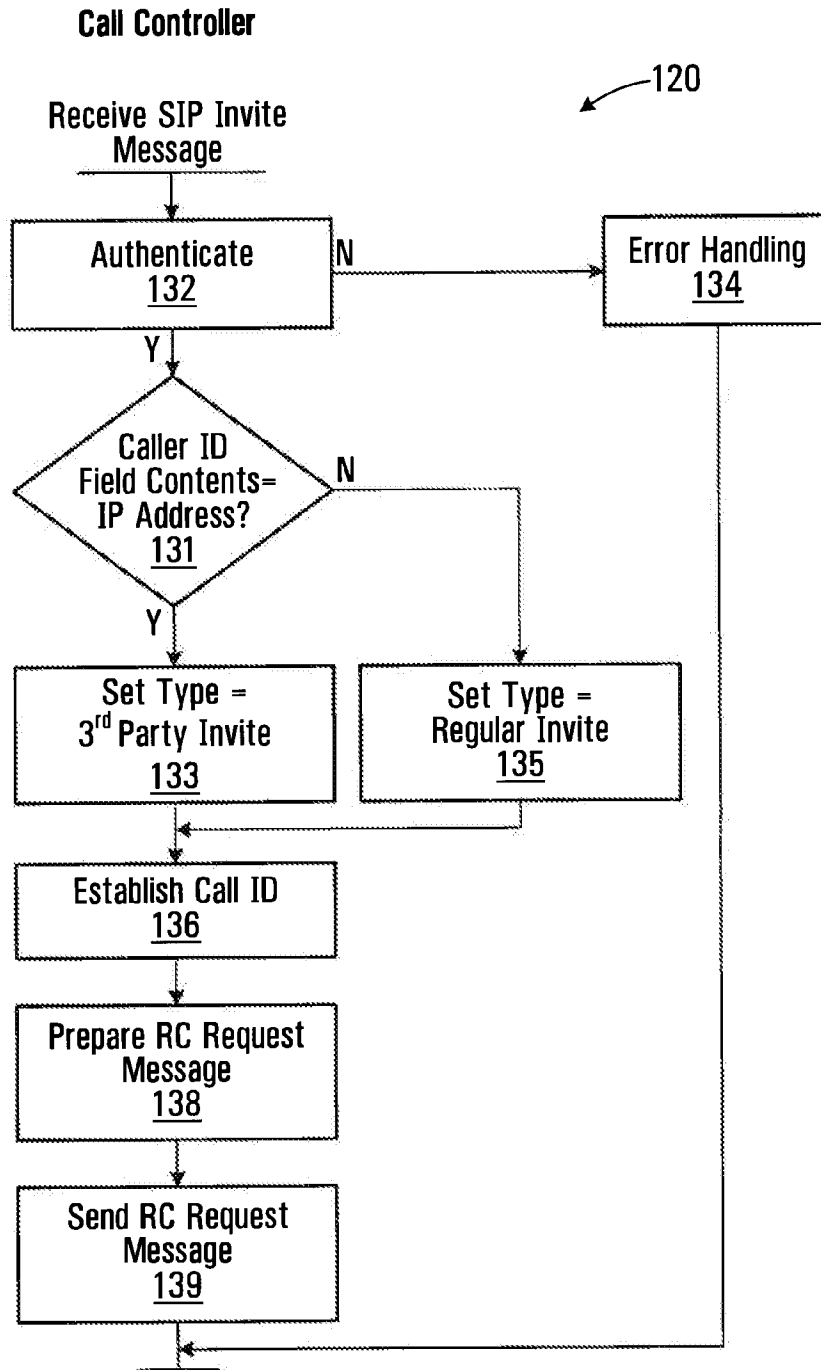

FIG. 5

5/29

150 ↙

RC Request Message

152 ~ Caller 2001 1050 8667
 154 ~ Callee 2001 1050 2222
 156 ~ Digest XXXXXXX
 158 ~ Call ID FF10@ 192.168.0.20
 160 ~ Type Subscriber

FIG. 6

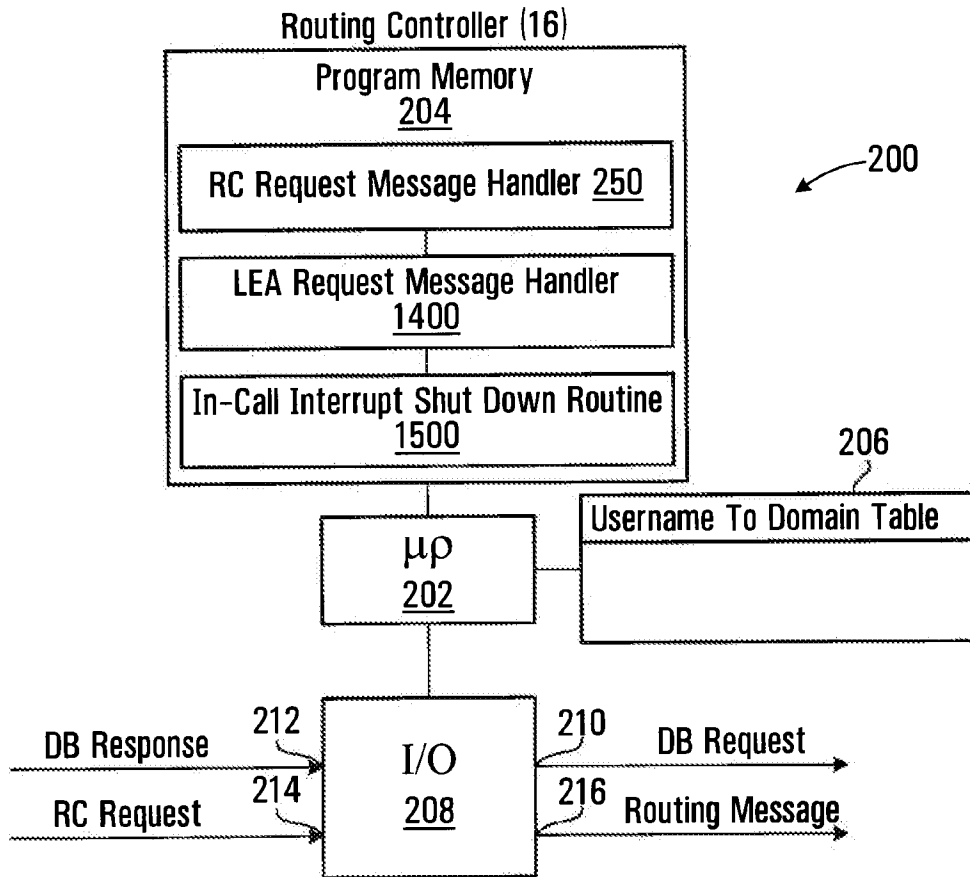

FIG. 7

6/29

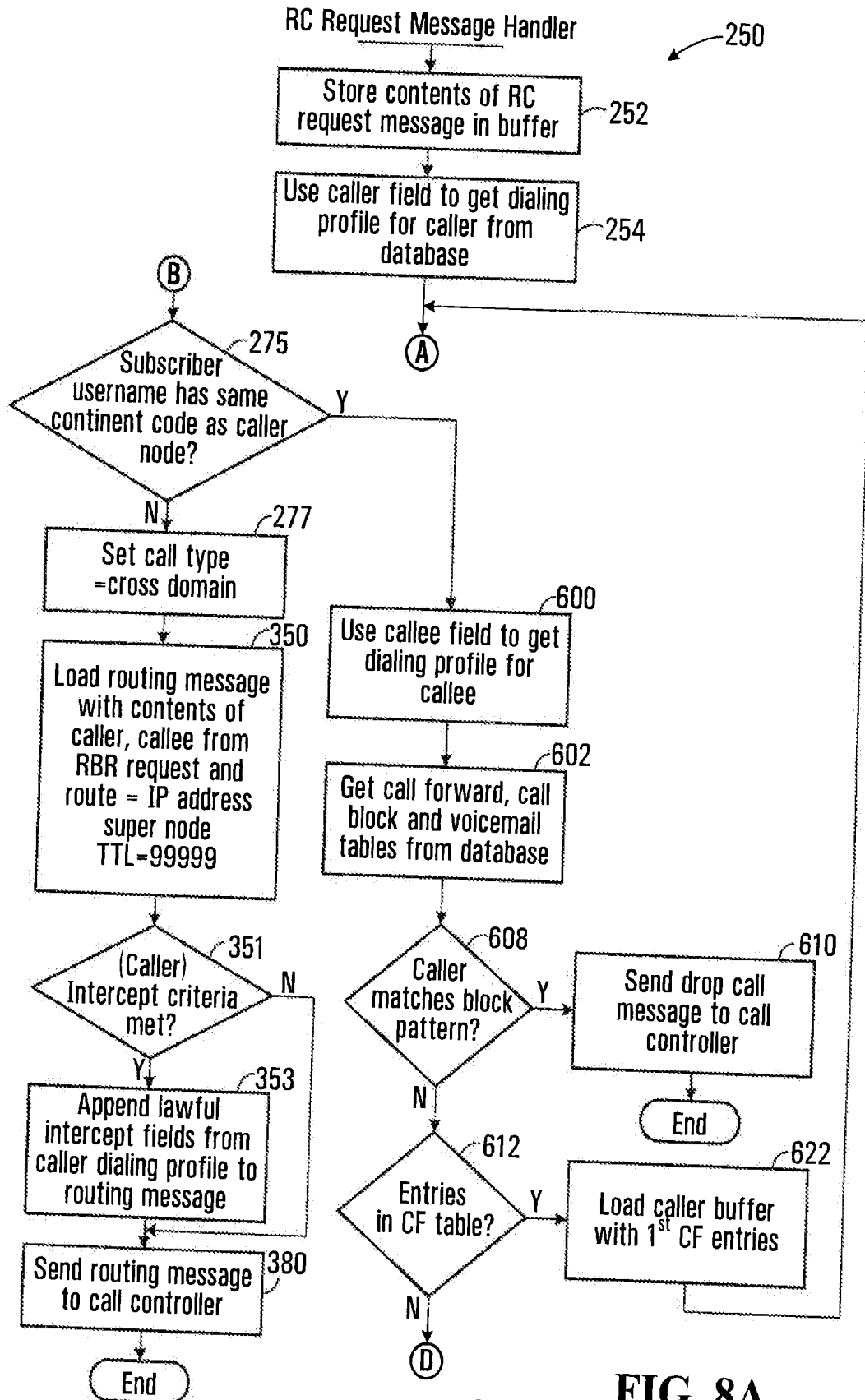

FIG. 8A

7/29

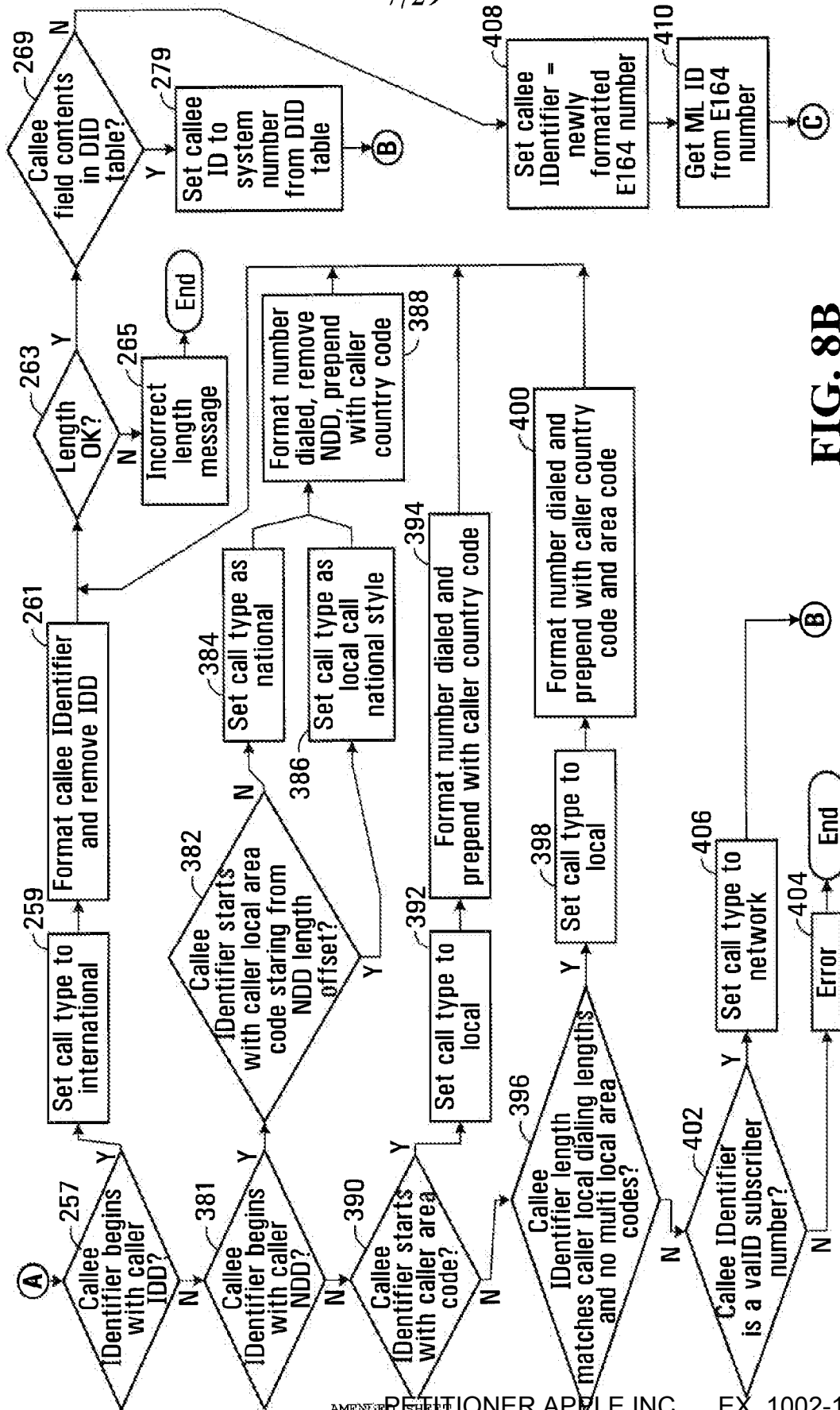
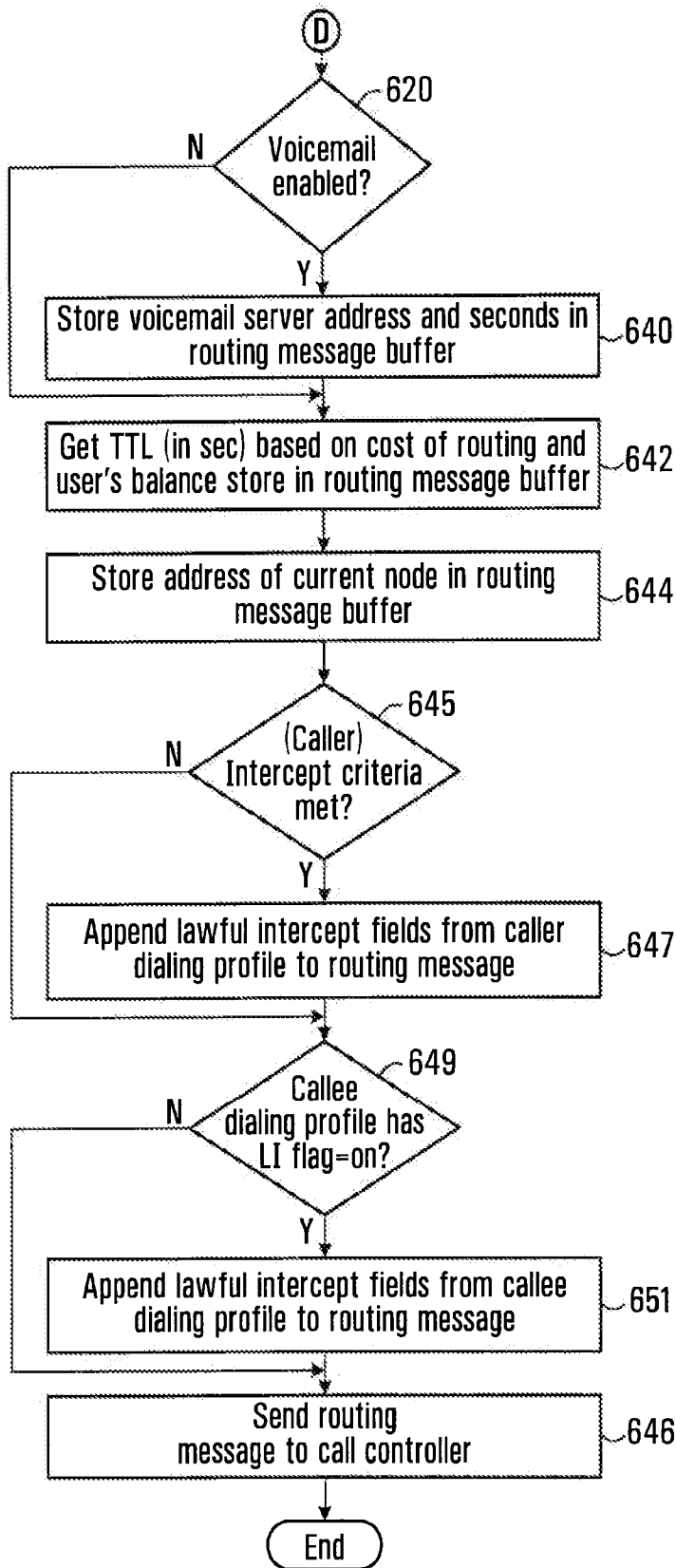

FIG. 8B

8/29



9/29

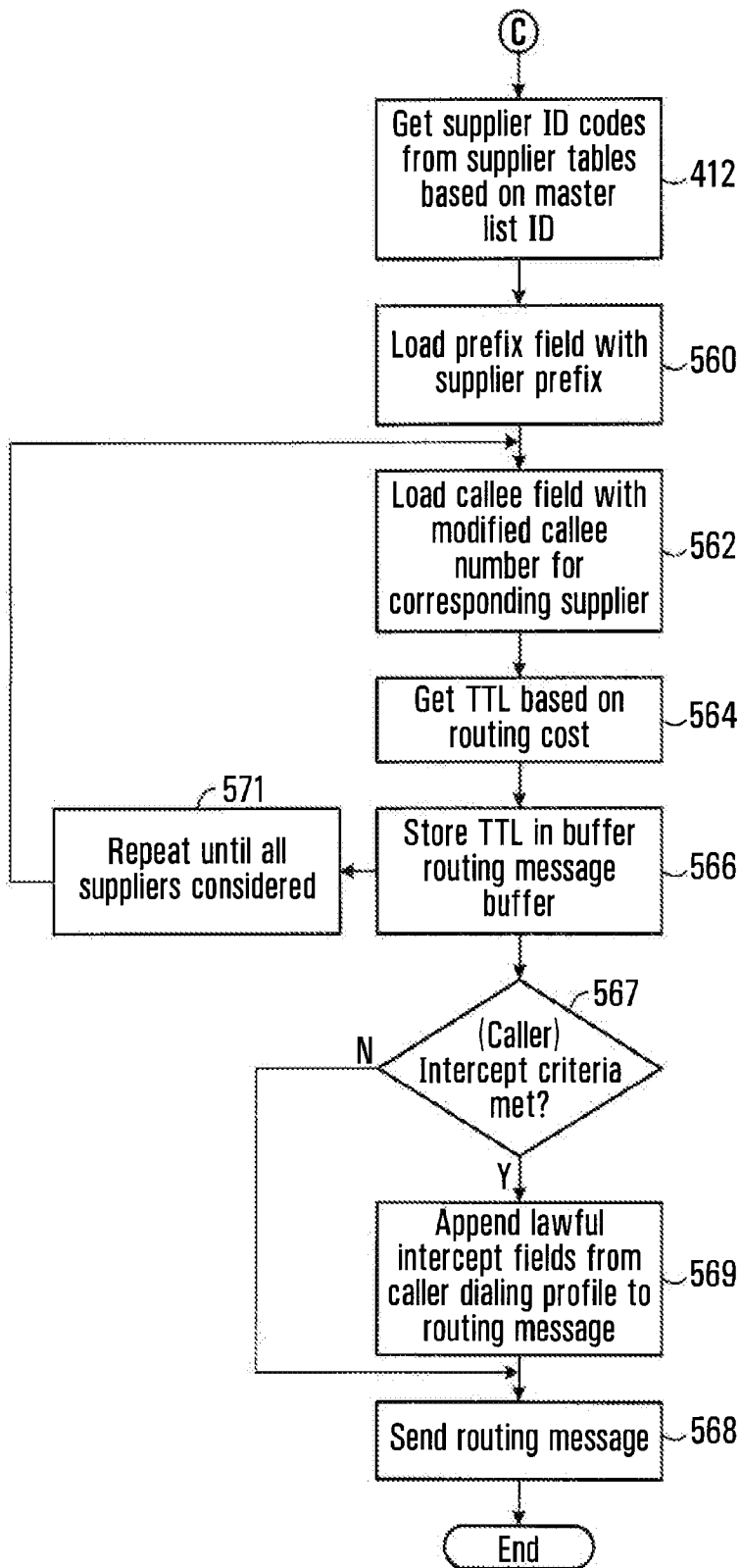

FIG. 8D

10/29

↖ 256

Dialing Profile for a User

258 ~ Username	Assigned on Subscription
260 ~ Domain	Domain Associated with User
262 ~ NDD	National Dialing Digit Code
264 ~ IDD	International Dialing Digit Code
266 ~ Country Code	Country Dependant Code
267 ~ Local Area Codes	Numeric
268 ~ Caller Minimum Local Length	Numeric
270 ~ Caller Maximum Local Length	Numeric
273 ~ Reseller	Retailer
1150 ~ Media Relay 1	Optional Media relay IDentifier #1
1150 ~ Media Relay n	Optional Media relay IDentifier #2
702 ~ LI flag	on or off
704 ~ MD1 Address	Address of First Mediation Device
706 ~ Warrant ID	From Law Enforcement Agency
708 ~ LI-Start Date/Time	When to Begin Monitoring Period
710 ~ LI-Stop Date/Time	When to End Monitoring Period

FIG. 9

↖ 276

Dialing Profile for Vancouver Subscriber

258 ~ Username	284	61	63	70	74	
260 ~ Domain	2001	1050	8667			
262 ~ NDD	sp.yvr	digifonica	com			← 282
264 ~ IDD	011	286	288	290		
266 ~ Country Code	1					
267 ~ Local Area Codes	604;778 (Vancouver)					
268 ~ Caller Minimum Local Length	10					
270 ~ Caller Maximum Local Length	10					
273 ~ Reseller	Klondike					
MR 1	192.168.1.10					
⋮						
MR N	192.168.2.59					

FIG. 10

11/29

Dialing Profile for Calgary Subscriber

Username	2001 1050 2222
Domain	sp.yvr.digifonica.com
NDD	1
IDD	011
Country Code	1
Local Area Codes	403 (Calgary)
Caller Minimum Local Length	7
Caller Maximum Local Length	10
Reseller	ABC
MR1	192.168.3.60
:	
MRn	192.168.4.69

FIG. 11**Dialing Profile for London Subscriber**

Username	4401 1062 4444
Domain	sp.lhr.digifonica.com
NDD	0
IDD	00
Country Code	44
Local Area Codes	20 (London)
Caller Minimum Local Length	10
Caller Maximum Local Length	11
Reseller	DEF
MR1	192.168.5.70
:	
MRn	192.168.6.79

FIG. 12

12/29

268

DID Bank Table Record Format

281 ~	Username	System subscriber
272 ~	User Domain	Host name of supernode
274 ~	DID	E164#

FIG. 13

291

DID Bank Table Record for London Subscriber

281 ~	Username	4401 1062 4444				
272 ~	User Domain	sp.lhr.digifonica.com				
274 ~	DID	44 020 7487 7900				
		<table border="0"> <tr> <td>283</td> <td>285</td> <td>287</td> <td>289</td> </tr> </table>	283	285	287	289
283	285	287	289			

FIG. 14

13/29

352

Routing Message Format

354 ~	Supplier Prefix (optional)	Code identifying supplier traffic
356 ~	Delimiter	Symbol separating fields
358 ~	Callee	PSTN compatible number or Digifonica number
360 ~	Route	Domain name and IP address
362 ~	Time to Live(TTL)	In seconds
364 ~	Other	TBD

FIG. 15

366

Routing Message - Different Node

440110624444@sp.lhr.digifonica.com;tli=9999

358 360 362

1152 ~ Media Relays (optional)

FIG. 16**Routing Message - Different Node with lawful intercept fields**

440110624444@sp.lhr.digifonica.com;tli=999;LIflag=on;MAddress=192.168.1.10;
WarrantID=20060515142;
Lstart=2006 05 16 00:00:00
Lstop=2006 12 31 23:59:59;
1152 ~ Media Relays (optional)

FIG. 16A

370

Prefix to Supernode Table Record Format

372 ~	Prefix	First n digits of callee identifier
374 ~	Supernode Address	IP address or fully qualified domain name

FIG. 17**Prefix to Supernode Table Record for London Subscriber**

Prefix	4
Supernode Address	sp.lhr.digifonica.com

FIG. 18

15/29

Suppliers List Record Format

540	~ Sup_ID	Name code
542	~ Route_ID	Numeric code
544	~ Prefix (optional)	String identifying supplier's traffic #
546	~ Route	IP address
548	~ NDD/IDD rewrite	
550	~ Rate	Cost per second to Digifonica to use this route

FIG. 21**Telus Supplier Record**

	Sup_ID	2010 (Telus)
	Route_ID	1019
	Prefix (optional)	4973#
546	~ Route	72.64.39.58
	NDD/IDD rewrite	011
550	~ Rate	\$0.02/min

FIG. 22**Shaw Supplier Record**

	Sup_ID	2011 (Shaw)
	Route_ID	1019
	Prefix (optional)	4974#
	Route	73.65.40.59
	NDD/IDD rewrite	011
550	~ Rate	\$0.025/min

FIG. 23**Sprint Supplier Record**

	Sup_ID	2012 (Sprint)
	Route_ID	1019
	Prefix (optional)	4975#
	Route	74.66.41.60
	NDD/IDD rewrite	011
550	~ Rate	\$0.03/min

FIG. 24

16/29

Routing Message Buffer for Gateway Call

4973#0116048675309@72.64.39.58;ttl=3600 ~ 570
 4974#0116048675309@73.65.40.59;ttl=3600 ~ 572
 4975#0116048675309@74.66.41.60;ttl=3600 ~ 574
 Media Relays (optional) ~ 1152

FIG. 25**Routing Message Buffer for Gateway Call with Lawful Intercept Fields**

4973#0116048675309@72.64.39.58;ttl=3600
 4974#0116048675309@73.65.40.59;ttl=3600
 4975#0116048675309@74.66.41.60;ttl=3600
 LIflag=on;MAddress=192.168.1.10;WarrantID=20060515142;
 LIstart=2006051600:00:00;LIstop=2006123123:59:59
 Media Relays (optional) ~ 1152

FIG. 25A**Call Block Record Format**

604 ~ Username Digifonica #
 606 ~ Block Pattern PSTN compatible or Digifonica #

FIG. 26**Call Block Record for Calgary Callee**

604 ~ Username of Callee 2001 1050 2222
 606 ~ Block Pattern 2001 1050 8664

FIG. 27**Call Forwarding Record Format for Callee**

614 ~ Username of Callee Digifonica #
 616 ~ Destination Number Digifonica #
 618 ~ Sequence Number Integer indicating order to try this

FIG. 28

17/29

Call Forwarding Table Record for Calgary Callee

614	Username of Callee	2001 1050 2222
616	Destination Number	2001 1055 2223
618	Sequence Number	1

FIG. 29**Voicemail Table Record Format**

624	Username of Callee	Digifonica #
626	Vm Server	domain name
628	Seconds to Voicemail	time to wait before engaging voicemail
630	Enabled	yes/no

FIG. 30**Voicemail Table Record for Calgary Callee**

624	Username of Callee	2001 1050 2222
626	Vm Server	vm.yvr.digifonica.com
628	Seconds to Voicemail	20
630	Enabled	1

FIG. 31

18/29

Routing Message Buffer for CF/VM Routing Message

650 ~ 200110502222@sp.yvr.digifonica.com;tll=3600
 652 ~ 200110552223@sp.yvr.digifonica.com;tll=3600
 654 ~ vm.yvr.digifonica.com;20;tll=60
 656 ~ sp.yvr.digifonica.com
 1152 ~ Media Relays (optional)

FIG. 32**Routing Message Buffer for CF/VM Routing Message with Caller Lawful Intercept Fields**

200110502222@sp.yvr.digifonica.com;tll=3600
 200110552223@sp.yvr.digifonica.com;tll=3600
 vm.yvr.digifonica.com;20;tll=60
 sp.yvr.digifonica.com
 LIflag=on;MDaddress=192.168.1.10;WarrantID=20060615142;
 LIstart=2006061500:00:00;LIstop=2006123123:59:59
 Media Relays (optional) ~ 1152

FIG. 32A**Routing Message Buffer for CF/VM Routing Message with Caller and Callee Lawful Intercept Fields**

200110502222@sp.yvr.digifonica.com;tll=3600
 200110552223@sp.yvr.digifonica.com;tll=3600
 vm.yvr.digifonica.com;20;tll=60
 sp.yvr.digifonica.com
 LI1flag=on;MDaddress=192.168.1.10;WarrantID=20060515142;
 LI1start=2006051600:00:00;LI1stop=2006123123:59:59
 LI2flag=0;MD2address=192.168.1.20;WarrantID=20060615142;
 LI2start=2006061500:00:00;LI2stop=2006123123:59:59
 Media Relays (optional) ~ 1152

FIG. 32B

19/29

Routing Message Handler
Executed by Call Controller

122

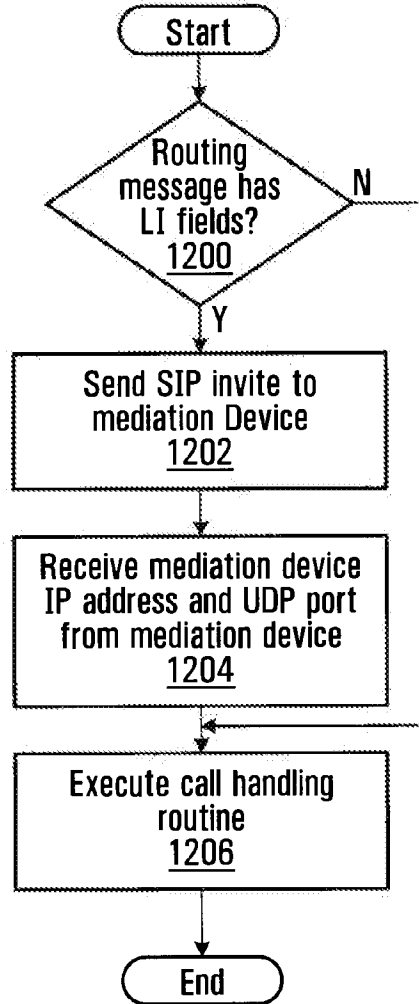

FIG. 33

20/29

123

Call Handling Routine

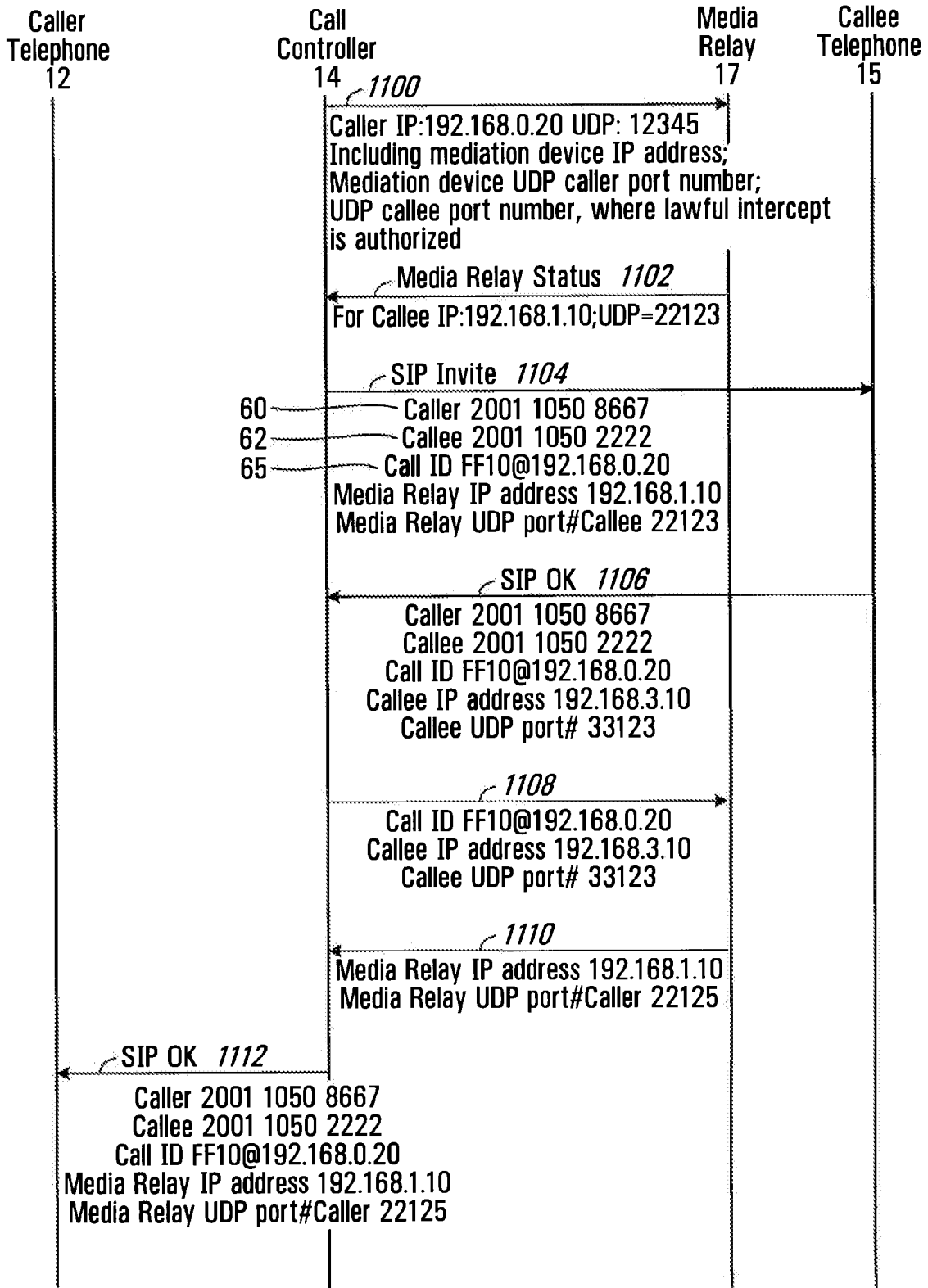

FIG. 34

21/29

Call Controller Active Call Record

1300	Call ID	FF10@192.168.0.20
1302	Caller IP Address	192.168.0.20
1304	Caller Port	12345
1306	Callee IP Address	192.168.3.10
1308	Callee Port	33123
1310	Media Relay ID	42
1312	Media Relay Caller Port	22125
1314	Media Relay Callee Port	22123

FIG. 35**Routing Controller Active Call Record**

1316	Call ID	FF10@192.168.0.20
1318	Caller	2001 1050 8667
1320	Callee	2001 1050 2222
1322	Call Controller ID	61

FIG. 36

22/29

Message from Call Controller to Mediation Device - SIP Invite

1020	~	Caller	2001 1050 8667
1022	~	Callee	2001 1050 2222
1024	~	Call ID	FF10@192.168.0.20
1026	~	Warrant ID	12345678
1028	~	Intercept Related Info	XXXXXXXX

FIG. 37**Reply Message from Mediation Device - SIP Ok**

1040	~	Caller	2001 1050 8667
1042	~	Callee	2001 1050 2222
1044	~	Call ID	FF10@192.168.0.20
1046	~	Mediation Device IP Address	192.138.2.10
1048	~	Mediation Device UDP Port # Caller	13678
1050	~	Mediation Device UDP Port # Callee	13679

FIG. 38

23/29

900
↙

SIP Bye Message

902 ~	Caller	Username
904 ~	Callee	PSTN compatible # or Username
906 ~	Call ID	unique call identifier (hexadecimal string@IP)

FIG. 39

908
↙

SIP Bye Message

902 ~	Caller	2001 1050 8667
904 ~	Callee	2001 1050 2222
906 ~	Call ID	FA10@192.168.0.20

FIG. 40

24/29

910 ↘

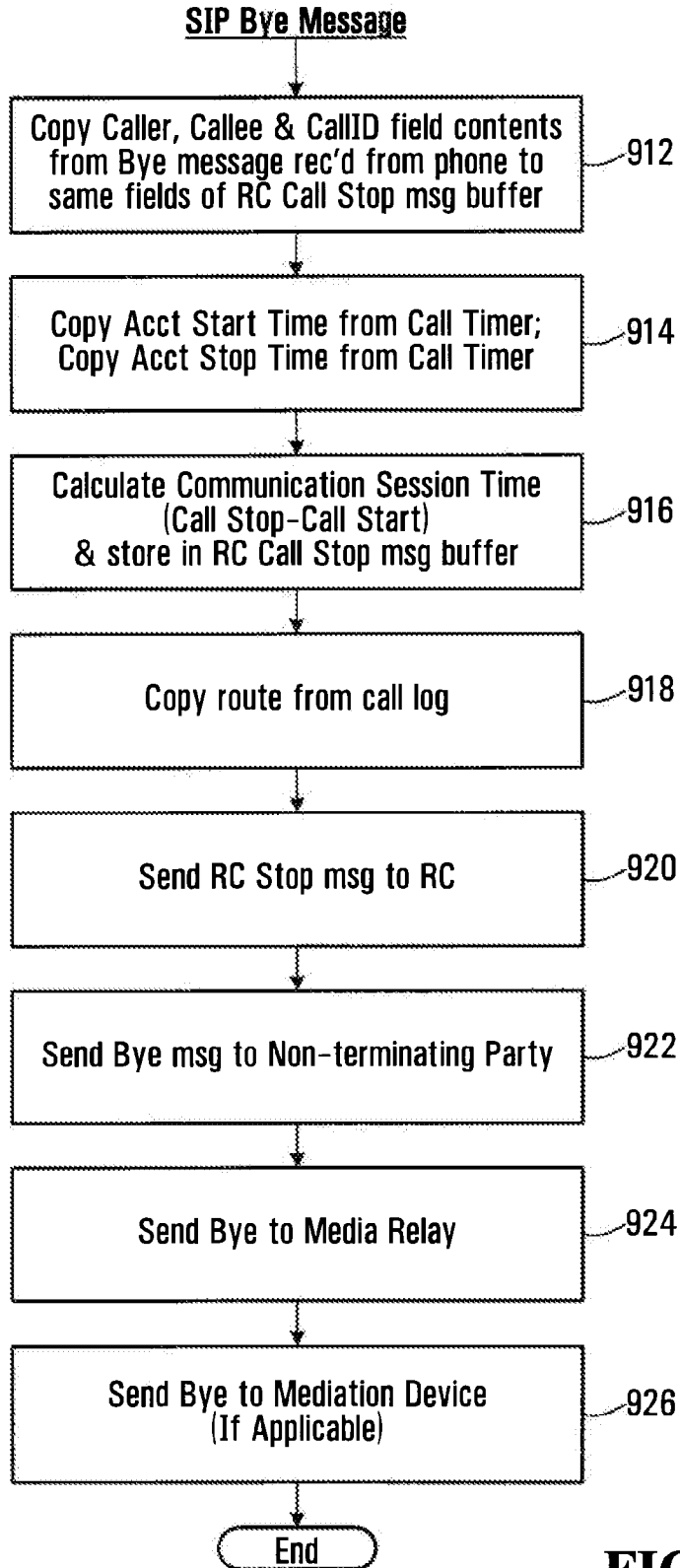

FIG. 41

25/29

1000
↙

RC Call Stop Message

1002	Caller	Username
1004	Callee	PSTN compatible # or Username
1006	Call ID	unique call identifier (hexadecimal string@IP)
1008	Acct Start Time	start time of call
1010	Acct Stop Time	time the call ended
1012	Acct Session Time	start time-stop time (in seconds)
1014	Route	IP address for gateway, where a gateway is used

FIG. 42

1021
↙

RC Call Stop Message for Calgary Callee

1002	Caller	2001 1050 8667
1004	Callee	2001 1050 2222
1006	Call ID	FA10@192.168.0.20
1008	Acct Start Time	2006-12-30 12:12:12
1010	Acct Stop Time	2006-12-30 12:12:14
1012	Acct Session Time	2
1014	Route	(72.64.39.58 if Telus gateway is used)

FIG. 43

26/29

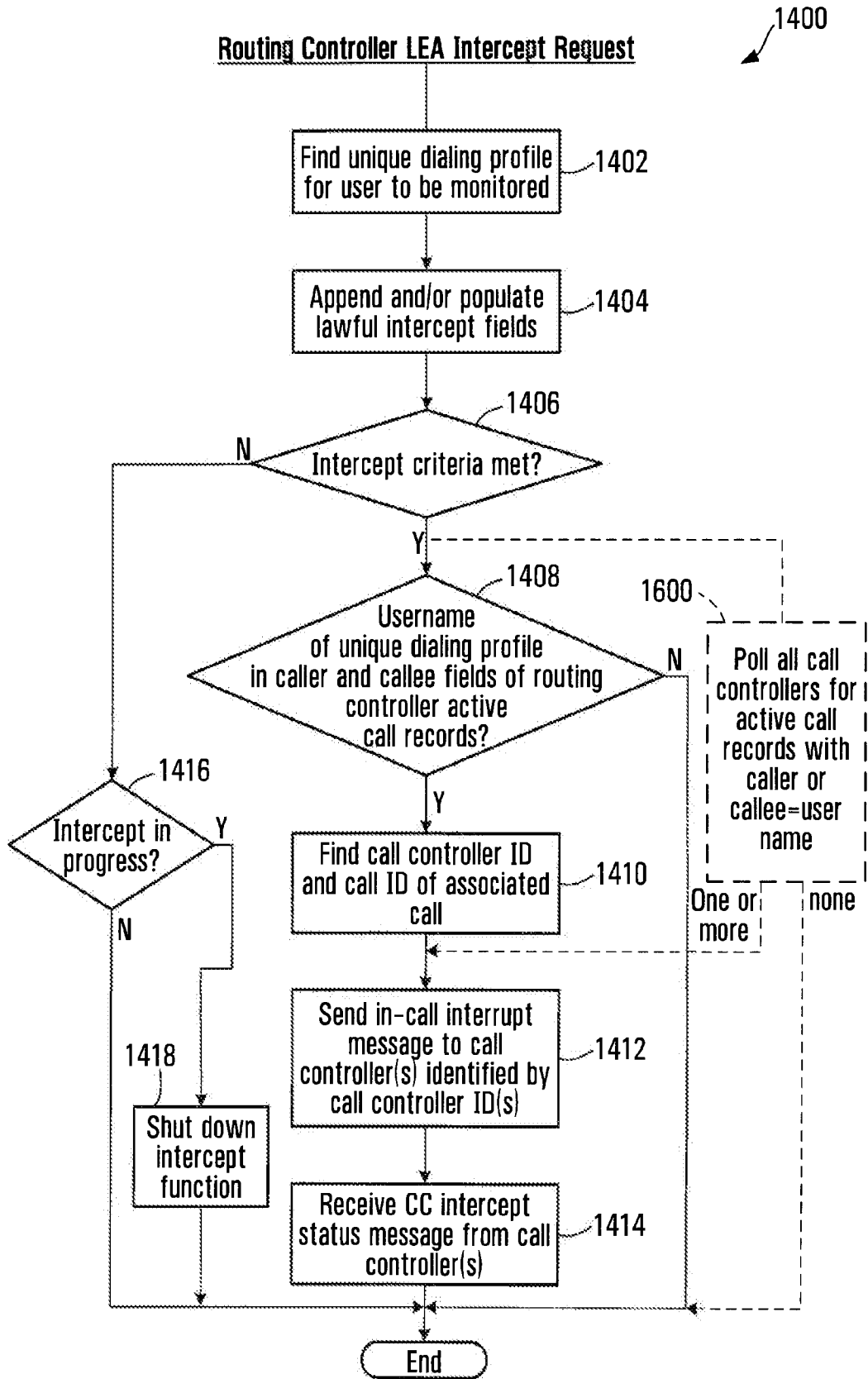

27/29

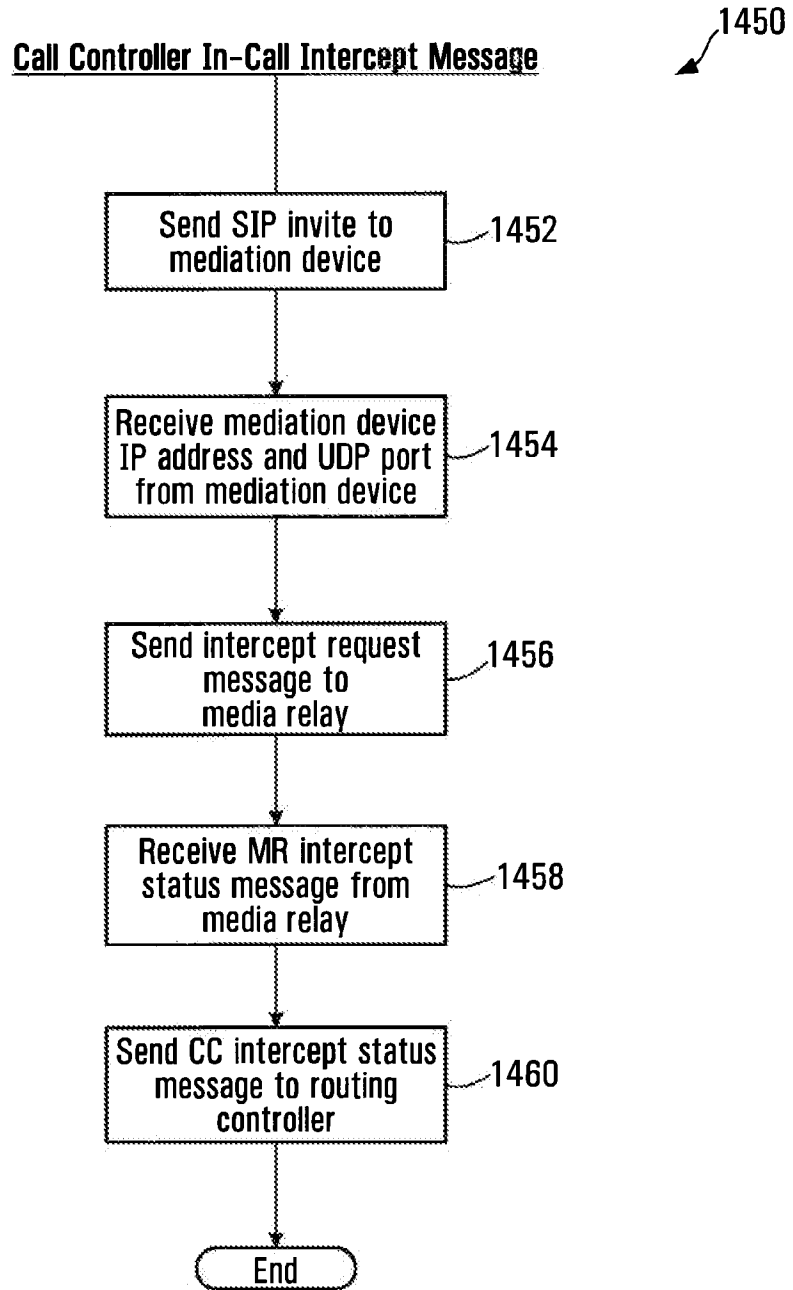

FIG. 45

28/29

1500

Routing Controller In-Call Intercept Shut Down Routine

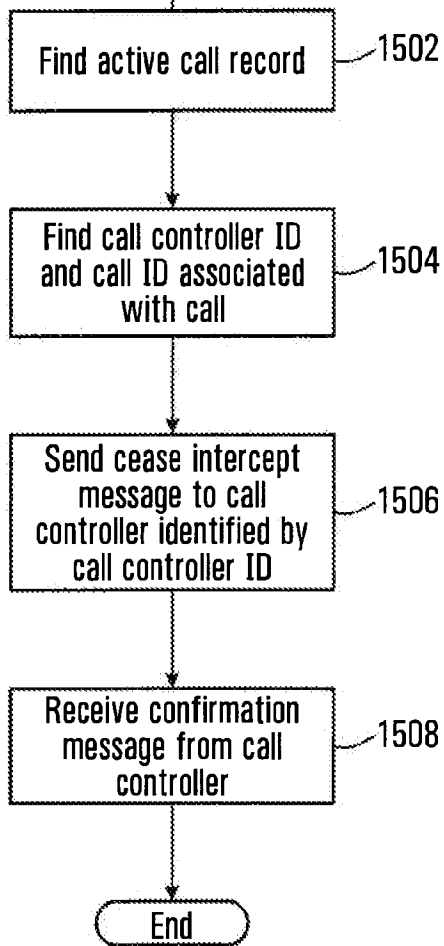

FIG. 46

29/29

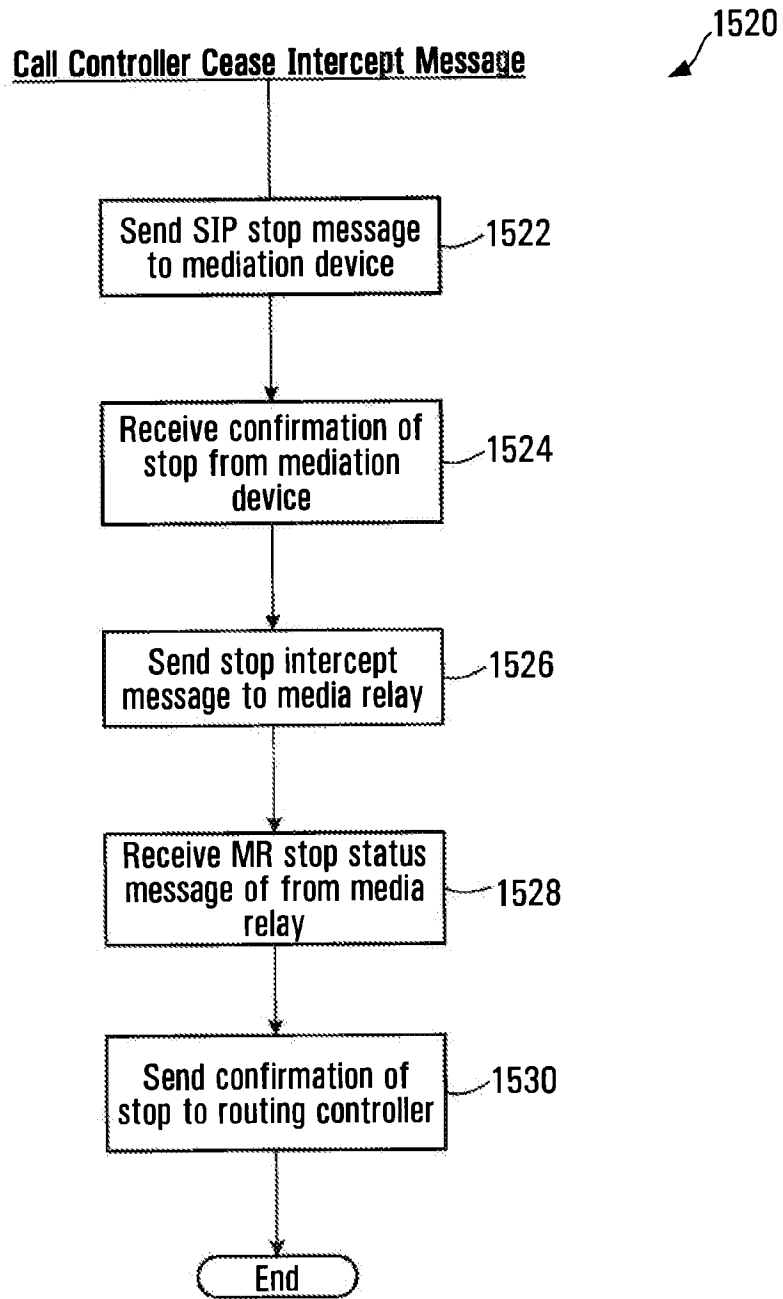
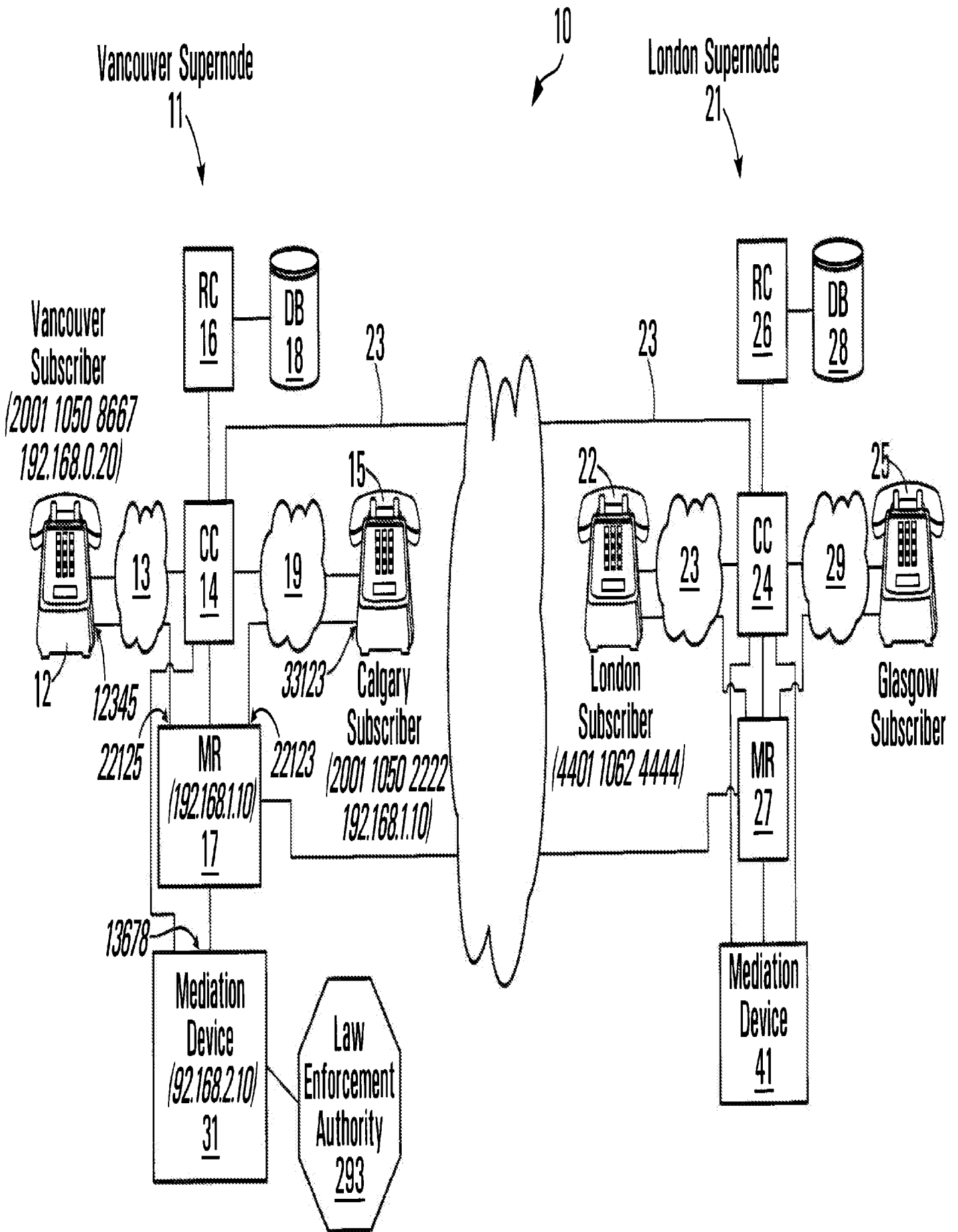
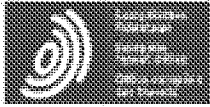

FIG. 47





Espacenet

Bibliographic data: CA2681984 (A1) — 2008-10-02

EMERGENCY ASSISTANCE CALLING FOR VOICE OVER IP COMMUNICATIONS SYSTEMS

Inventor(s): SOBOLYEV MAKSYM [CA]; BJORSELL JOHAN EMIL VIKTOR [CA] ± (SOBOLYEV, MAKSYM, ; BJORSELL, JOHAN EMIL VIKTOR)

Applicant(s): DIGIFONICA INTERNATIONAL LTD [CA] ± (DIGIFONICA (INTERNATIONAL) LIMITED)

Classification: - international: H04L12/66; H04M11/06; H04M3/42; H04Q3/00; H04Q3/64
- cooperative: H04L65/1069; H04L65/40; H04M3/5116; H04M7/006; H04M2242/04

Application number: CA20082681984 20080320

Priority number (s): US20070907224P 20070326 ; WO2008CA00545 20080320

Also published as: WO2008116296 (A1) US2013329864 (A1) US2010172345 (A1) US2010172345 (A1) US8537805 (B2) US8537805 (B2) less

Abstract of CA2681984 (A1)

In accordance with one aspect of the invention there is provided a process for handling emergency calls from a caller in a voice over IP system. The process involves receiving a routing request message including a caller identifier and a callee identifier. The process also involves setting an emergency call flag active in response to the callee identifier

matching an emergency call identifier pre-associated with the caller. The process further involves producing an emergency response center identifier in response to the emergency call identifier. The process also involves determining whether the caller identifier is associated with a pre-associated direct inward dialing (DID) identifier. The process further involves producing a direct inward dialing (DID) identifier for the caller

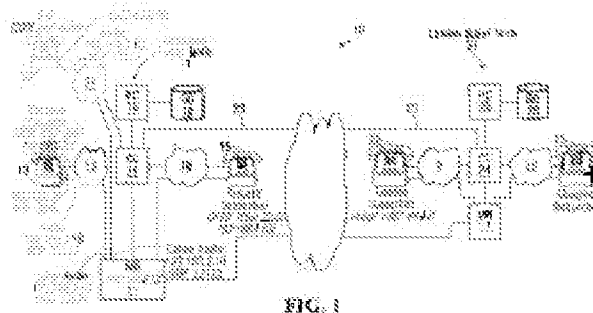

by associating a temporary DID identifier with the caller identifier when the emergency call flag is active and it is determined that the caller has no pre-associated DID. The process also involves producing a routing message including the emergency response center identifier and the temporary DID identifier for receipt by a routing controller operable to cause a route to be established between the caller and the emergency response center.



(86) Date de dépôt PCT/PCT Filing Date: 2008/03/20
 (87) Date publication PCT/PCT Publication Date: 2008/10/02
 (85) Entrée phase nationale/National Entry: 2009/09/24
 (86) N° demande PCT/PCT Application No.: CA 2008/000545
 (87) N° publication PCT/PCT Publication No.: 2008/116296
 (30) Priorité/Priority: 2007/03/26 (US60/907,224)

(51) Cl.Int./Int.Cl. *H04L 12/66* (2006.01),
H04M 11/06 (2006.01), *H04M 3/42* (2006.01),
H04Q 3/00 (2006.01), *H04Q 3/64* (2006.01)
 (71) Demandeur/Applicant:
 DIGIFONICA (INTERNATIONAL) LIMITED, CA
 (72) Inventeurs/Inventors:
 BJORSELL, JOHAN EMIL VIKTOR, CA;
 SOBOLYEV, MAKSYM, CA
 (74) Agent: SMART & BIGGAR

(54) Titre : APPEL D'ASSISTANCE D'URGENCE POUR DES SYSTEMES DE COMMUNICATION DE VOIX SUR IP
 (54) Title: EMERGENCY ASSISTANCE CALLING FOR VOICE OVER IP COMMUNICATIONS SYSTEMS

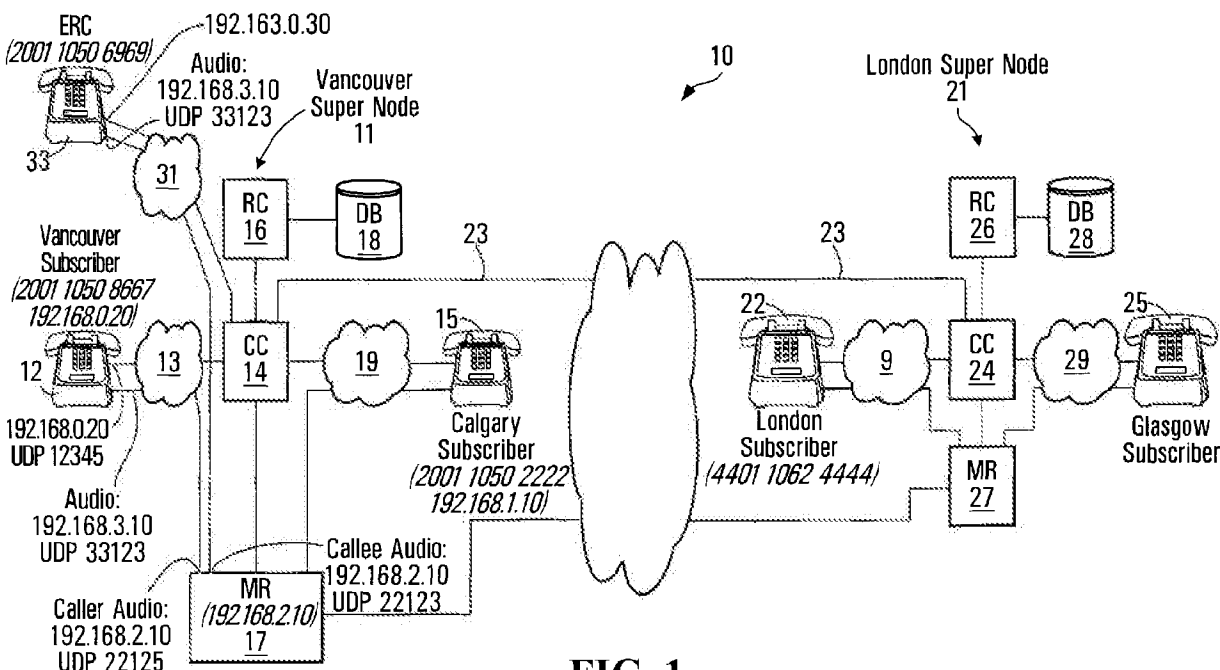

FIG. 1

(57) Abrégé/Abstract:

In accordance with one aspect of the invention there is provided a process for handling emergency calls from a caller in a voice over IP system. The process involves receiving a routing request message including a caller identifier and a callee identifier. The process also involves setting an emergency call flag active in response to the callee identifier matching an emergency call identifier pre-associated with the caller. The process further involves producing an emergency response center identifier in response to the emergency call identifier. The process also involves determining whether the caller identifier is associated with a pre-associated direct inward dialing (DID) identifier. The process further involves producing a direct inward dialing (DID) identifier for the caller by associating a temporary DID identifier with the caller identifier when the emergency call flag is active and it is determined that the caller has no pre-associated DID. The process also involves producing a routing message including the emergency response center identifier and the temporary DID identifier for receipt by a routing controller operable to cause a route to be established between the caller and the emergency response center.



(12) INTERNATIONAL APPLICATION PUBLISHED UNDER THE PATENT COOPERATION TREATY (PCT)

(19) World Intellectual Property Organization
International Bureau



(43) International Publication Date
2 October 2008 (02.10.2008)

PCT

(10) International Publication Number
WO 2008/116296 A1

(51) International Patent Classification:
H04L 12/66 (2006.01) H04Q 3/00 (2006.01)
H04M 11/06 (2006.01) H04Q 3/64 (2006.01)
H04M 3/42 (2006.01)

(74) Agents: KNOX, John, W. et al.; Smart & Biggar, 2200
- 650 West Georgia Street Box 11560, Vancouver Centre,
Vancouver, British Columbia V6B 4N8 (CA).

(21) International Application Number:
PCT/CA2008/000545

(22) International Filing Date: 20 March 2008 (20.03.2008)

(25) Filing Language: English

(26) Publication Language: English

(30) Priority Data:
60/907.224 26 March 2007 (26.03.2007) US

(81) Designated States (unless otherwise indicated, for every kind of national protection available): AE, AG, AL, AM, AO, AT, AU, AZ, BA, BB, BG, BH, BR, BW, BY, BZ, CA, CH, CN, CO, CR, CU, CZ, DE, DK, DM, DO, DZ, EC, EE, EG, ES, FI, GB, GD, GE, GH, GM, GT, HN, HR, HU, ID, IL, IN, IS, JP, KE, KG, KM, KN, KP, KR, KZ, LA, LC, LK, LR, LS, LT, LU, LY, MA, MD, ME, MG, MK, MN, MW, MX, MY, MZ, NA, NG, NI, NO, NZ, OM, PG, PH, PL, PT, RO, RS, RU, SC, SD, SE, SG, SK, SL, SM, SV, SY, TJ, TM, TN, TR, TT, TZ, UA, UG, US, UZ, VC, VN, ZA, ZM, ZW.

(71) Applicant (for all designated States except US): DIGI-FONICA (INTERNATIONAL) LIMITED [CA/CA]; Suite 1401, 4710 Kingsway, Burnaby, British Columbia V5H 4M2 (CA).

(84) Designated States (unless otherwise indicated, for every kind of regional protection available): ARIPO (BW, GH, GM, KE, LS, MW, MZ, NA, SD, SI, SZ, TZ, UG, ZM, ZW), Eurasian (AM, AZ, BY, KG, KZ, MD, RU, TJ, TM), European (AT, BE, BG, CH, CY, CZ, DE, DK, EE, ES, FI, FR, GB, GR, HR, HU, IE, IS, IT, LT, LU, LV, MC, MT, NL, NO, PL, PT, RO, SE, SI, SK, TR), OAPI (BF, BJ, CF, CG, CI, CM, GA, GN, GQ, GW, ML, MR, NE, SN, TD, TG).

(72) Inventors; and

(75) Inventors/Applicants (for US only): BJORSELL, Johan, Emil, Viktor [SE/CA]; 203 - 2288 Broadway West, Vancouver, British Columbia V6K 0B3 (CA). SOBOLYEV, Maksym [RU/CA]; 307 - 265 Tenth Street, New Westminster, British Columbia V3M 3Y1 (CA).

Published:
— with international search report

(54) Title: EMERGENCY ASSISTANCE CALLING FOR VOICE OVER IP COMMUNICATIONS SYSTEMS

WO 2008/116296 A1

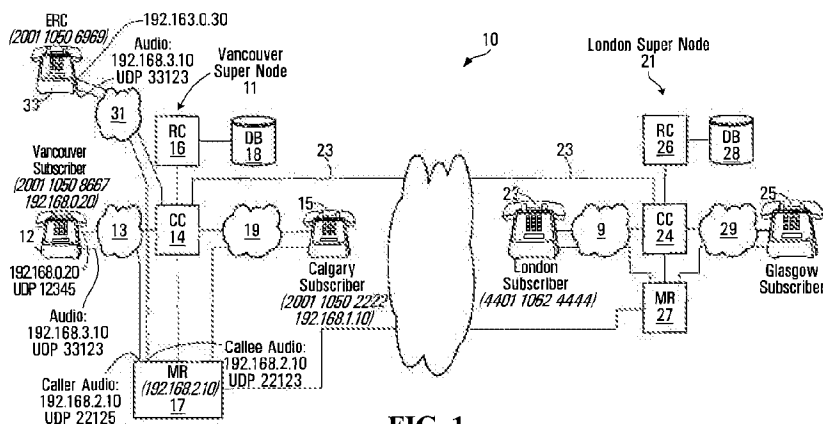

FIG. 1

(57) Abstract: In accordance with one aspect of the invention there is provided a process for handling emergency calls from a caller in a voice over IP system. The process involves receiving a routing request message including a caller identifier and a callee identifier. The process also involves setting an emergency call flag active in response to the callee identifier matching an emergency call identifier pre-associated with the caller. The process further involves producing an emergency response center identifier in response to the emergency call identifier. The process also involves determining whether the caller identifier is associated with a pre-associated direct inward dialing (DID) identifier. The process further involves producing a direct inward dialing (DID) identifier for the caller by associating a temporary DID identifier with the caller identifier when the emergency call flag is active and it is determined that the caller has no pre-associated DID. The process also involves producing a routing message including the emergency response center identifier and the temporary DID identifier for receipt by a routing controller operable to cause a route to be established between the caller and the emergency response center.

-1-

EMERGENCY ASSISTANCE CALLING FOR VOICE OVER IP COMMUNICATIONS SYSTEMS

BACKGROUND OF THE INVENTION

5 Field of Invention

This invention relates to emergency assistance calling, voice over internet protocol communications and methods and apparatus for emergency assistance calling for voice over IP data communications.

10 An essential feature of traditional telephone systems (PSTN) is the ability of its subscribers to dial a universal emergency number (911 in North America) to access a host of emergency services such as fire, police and ambulance. Because of the hierarchical nature of telephone networks and numbering schemes, a call coming from a specific telephone number on the PSTN
15 network is automatically routed to a nearest Emergency Response Center (ERC) based on the area code and exchange code contained in the specific telephone number. Normally, the specific telephone number will be compliant with the E.164 standard set by the International Telecommunication Union. When the call comes into the ERC, call information presented the ERC
20 operator includes the phone number, and where available, the address associated with this phone number.

Since the late **1990s**, an enhanced emergency service (**E911**) was mandated for PSTN and cellular carriers in North America and elsewhere. In particular,
25 with this enhanced service the information automatically provided to the ERC includes the physical location of the person calling, even where the caller is using a cellular telephone. Moreover, a callback functionality is integrated into **E911**-compliant systems allowing an ERC operator to call back the person who placed the emergency call even if the original phone call was
30 disconnected or if the calling line became busy.

-2-

In the realm of VoIP networks, implementation of **911** and **E911** services often presents significant problems.

5 Even to provide basic **911** services, VoIP systems present a number of problems because they do not employ hierarchical numbering schemes, and the phone numbers assigned to VoIP system subscribers, while still in the E.164 format, do not actually reflect the subscribers physical location via area code and exchange codes. As a result, a VoIP provider is not able to automatically route an emergency call to an ERC nearest to the subscriber.

10 Because VoIP subscriber phone numbers are assigned from a bulk of phone numbers that VoIP providers purchase from wireline PSTN carriers, a VoIP **911** emergency services call coming into the ERC is not associated with a subscriber address that can be accessed by the ERC operator.

15 In addition, because VoIP systems are not based on the Signaling System 7 (SS7) protocol, they do not natively support special short phone numbers such as **911**. In particular, they do not natively support variable length phone number dialing, or dynamic translation of dialed universal phone numbers into actual destination phone numbers based on user attributes such as location

20 or service type.

VoIP systems are also typically not able to comply with **E911** service requirements, for the same reasons they are not able to comply with regular **911** services.

25 In accordance with one aspect of the invention, there is provided a process for handling emergency calls from a caller in a voice over IP system. The method involves receiving a routing request message including a caller identifier and a callee identifier. The method also involves setting an emergency call flag active in response to the callee identifier matching an emergency call identifier

30 pre-associated with the caller. The method further involves producing an emergency response center identifier in response to the emergency call

-3-

5 identifier. The method also involves determining whether the caller identifier is associated with a pre-associated direct inward dialing (DID) identifier. The method further involves producing a direct inward dialing (DID) identifier for the caller by associating a temporary DID identifier with the caller identifier when the emergency call flag is active and it is determined that the caller has no pre-associated DID identifier. The method also involves producing a routing message including the emergency response center identifier and the temporary DID identifier for receipt by a routing controller operable to cause a route to be established between the caller and the emergency response center.

10

Setting the emergency call flag active may involve retrieving a dialing profile associated with the caller and setting the emergency call flag active when the contents of an emergency call identifier field of the dialing profile match the callee identifier.

15

Determining whether the caller identifier is associated with a pre-associated DID identifier may involve searching a database for a DID record associating a DID identifier with the caller and determining that the caller identifier is associated with a pre-associated DID identifier when the record associating a DID identifier with the caller is found.

20

Associating a pre-assigned DID identifier with the caller identifier may involve copying the pre-associated DID identifier from the DID record to a DID identifier buffer.

25

Producing the routing message may involve causing the contents of the DID identifier buffer to define the DID identifier in the routing message.

30 Determining whether the caller identifier is associated with a pre-associated DID identifier may involve searching a database for a DID record associating a DID identifier with the caller and determining that the caller identifier is not

-4-

associated with a pre-associated DID identifier when a record associating a DID identifier with the caller is not found.

5 Associating a temporary DID identifier with the caller identifier may involve associating with the caller identifier a DID identifier from a pool of pre-determined DID identifiers.

10 Associating the DID identifier from the pool may involve associating a temporary DID record with the caller, the temporary DID record having a DID identifier field populated with the DID identifier from the pool.

Associating the DID identifier from the pool may involve copying the DID identifier from the temporary DID record to a DID identifier buffer.

15 The method may involve canceling the temporary DID record after a pre-defined period of time.

20 Producing the emergency response center identifier may involve obtaining an emergency response center identifier from an emergency response center field of the dialing profile associated with the caller.

25 Obtaining may involve copying an emergency response center identifier from the dialing profile associated with the caller to a routing message buffer such that the emergency response center identifier is included in the routing message.

30 Producing the routing message may involve causing the routing message to specify a maximum call time for the emergency call, the maximum call time exceeding a duration of an average non-emergency telephone call.

In accordance with another aspect of the invention, there is provided an apparatus for handling emergency calls from a caller in a voice over IP

-5-

system. The apparatus includes provisions for receiving a routing request message including a caller identifier and a callee identifier. The apparatus also includes setting provisions for setting an emergency call flag active in response to the callee identifier matching an emergency call identifier pre-associated with the caller. The apparatus further includes provisions for producing an emergency response center identifier in response to the emergency call identifier. The apparatus also includes provisions for determining whether the caller identifier is associated with a pre-associated direct inward dialing (DID) identifier. The apparatus further includes provisions for producing a direct inward dialing (DID) identifier for the caller including provisions for associating a temporary DID identifier with the caller identifier in response to the emergency call flag being active and the caller identifier not being pre-associated with direct inward dialing identifier. The provisions for producing a direct inward dialing (DID) identifier for the caller further include provisions for associating a pre-assigned DID identifier with the caller identifier when the caller identifier has no pre-associated direct inward dialing identifier. The apparatus also includes provisions for producing a routing message including the emergency response center identifier and the temporary DID identifier for receipt by a routing controller operable to cause a route to be established between the caller and the emergency response center.

The apparatus may further include provisions for accessing a database of dialing profiles associated with respective subscribers to the system, each of the dialing profiles including an emergency call identifier field and an emergency call center field and the setting provisions may comprise provisions for retrieving a dialing profile associated with the caller and for setting the emergency call flag active when the contents of the emergency call identifier field of the dialing profile match the callee identifier.

The apparatus may further include database accessing provisions for accessing a database including direct inward dialing (DID) records associated

-6-

with at least some subscribers to the system, each of the direct inward dialing records comprising a system username and a direct inward dialing number, and wherein the determining provisions comprise searching provisions for searching a database for a DID record associating a DID identifier with the caller. The determining provisions may be operably configured to determine that the caller identifier is associated with a pre-associated DID identifier when a record associating a DID identifier with the caller is found.

The apparatus may further include a DID identifier buffer and the provisions for associating a pre-assigned DID identifier with the caller identifier may comprise provisions for copying the pre-associated DID identifier from the DID record to the DID identifier buffer.

The provisions for producing the routing message may include provisions for causing the contents of the DID identifier buffer to define the DID identifier in the routing message.

The apparatus may further include database accessing provisions for accessing a database including direct inward dialing records associated with at least some subscribers to the system, each of the direct inward dialing records comprising a system username and a direct inward dialing number and the determining provisions may comprise searching provisions for searching a database for a DID record associating a DID identifier with the caller and wherein the determining provisions may be operably configured to determine that the caller identifier is not associated with a pre-associated DID identifier when a record associating a DID identifier with the caller is not found.

The apparatus may further include provisions for accessing a pool of pre-determined DID identifiers and the provisions for associating a temporary DID identifier with the caller identifier may comprise provisions for associating a

-7-

DID identifier from the pool of pre-determined DID identifiers with the caller identifier.

5 The provisions for associating the DID identifier from the pool may include provisions for associating a temporary DID record with the caller, the temporary DID record having a DID identifier field populated with the DID identifier from the pool.

10 The provisions for associating the DID identifier may include provisions for copying the DID identifier from the temporary DID record to a DID identifier buffer.

15 The apparatus may further include provisions for canceling the temporary DID record after a period of time.

20 The provisions for producing the emergency response center identifier may include provisions for obtaining an emergency response center identifier from an emergency response center field of the dialing profile associated with the caller.

25 The apparatus may include a routing message buffer and the provisions for obtaining may include provisions for copying the contents of the emergency response center field of the dialing profile associated with the caller to the routing message buffer such that the contents of the emergency response center field are included in the routing message.

30 The provisions for producing the routing message may include provisions for causing the routing message to include a maximum call time for the emergency call, the maximum call time exceeding a duration of an average non-emergency telephone call.

-8-

In accordance with another aspect of the invention, there is provided an apparatus for handling emergency calls from a caller in a voice over IP system. The apparatus includes an processor circuit operably configured to receive a routing request message including a caller identifier and a callee identifier. The processor circuit is also operably configured to set an emergency call flag active in response to the callee identifier matching an emergency call identifier pre-associated with the caller. The processor circuit is further operably configured to produce an emergency response center identifier in response to the emergency call identifier and to determine whether the caller identifier is associated with a pre-associated direct inward dialing (DID) identifier. The processor circuit is also operably configured to produce a direct inward dialing (DID) identifier for the caller by associating a temporary DID identifier with the caller identifier when the emergency call flag is active and it is determined that the caller identifier has no pre-associated DID identifier. The processor circuit is further operably configured to produce a routing message including the emergency response center identifier and the temporary DID identifier for receipt by a routing controller operable to cause a route to be established between the caller and the emergency response center.

The processor circuit may be operably configured to retrieve a dialing profile associated with the caller and to set the emergency call flag active when the contents of an emergency call identifier field of the dialing profile match the callee identifier.

The processor circuit may be operably configured to search a database for a DID record associating a DID identifier with the caller and to determine that the caller identifier is associated with a pre-associated DID identifier when the record associating a DID identifier with the caller is found.

The processor circuit may be operably configured to copy the pre-associated DID identifier from the DID record to a DID identifier buffer.

-9-

The processor circuit may be operably configured to cause the contents of the DID identifier buffer to define the DID identifier in the routing message.

5 The processor circuit may be operably configured to search a database for a DID record associating a DID identifier with the caller and to determine that the caller identifier is not associated with a pre-associated DID identifier when a record associating a DID identifier with the caller is not found.

10 The processor circuit may be operably configured to associate with the caller identifier a DID identifier from a pool of pre-determined DID identifiers.

The processor circuit may be operably configured to associate a temporary DID record with the caller, the temporary DID record having a DID identifier field populated with the DID identifier from the pool.

15

The processor circuit may be operably configured to copy the DID identifier from the temporary DID record to a DID buffer.

20 The processor circuit may be operably configured to cancel the temporary DID record after a period of time.

The processor circuit may be operably configured to obtain an emergency response center identifier from an emergency response center field of the dialing profile associated with the caller.

25

The apparatus may further a routing message buffer and the processor circuit may be operably configured to copy an emergency response center identifier from the dialing profile associated with the caller to the routing message buffer such that the emergency response center identifier is included in the routing message.

30

-10-

The processor circuit may be operably configured to cause the routing message to include a maximum call time for the emergency call, the maximum call time exceeding a duration of an average non-emergency telephone call.

5

In accordance with another aspect of the invention, there is provided a computer readable medium encoded with codes for directing a processor circuit to handle emergency calls from callers in a voice over IP system. The codes direct the processor circuit to receive a routing request message including a caller identifier and a callee identifier. The codes also direct the processor circuit to set an emergency call flag active in response to the callee identifier matching an emergency call identifier pre-associated with the caller. The codes further direct the processor circuit to produce an emergency response center identifier in response to the emergency call identifier. The codes also direct the processor circuit to determine whether the caller identifier is associated with a pre-associated direct inward dialing (DID) identifier. The codes further direct the processor circuit to produce a direct inward dialing (DID) identifier for the caller by associating a temporary DID identifier with the caller identifier when the emergency call flag is active and it is determined that the caller identifier has no pre-associated DID identifier. The codes also direct the processor circuit to produce a routing message including the emergency response center identifier and the temporary DID identifier for receipt by a routing controller operable to cause a route to be established between the caller and the emergency response center.

25

BRIEF DESCRIPTION OF THE DRAWINGS

In drawings which illustrate embodiments of the invention,

Figure 1 is a block diagram of a system according to a first embodiment of the invention;

30

-11-

- Figure 2 is a block diagram of a caller VoIP telephone according to the first embodiment of the invention;
- 5 Figure 3 is a schematic representation of a SIP Invite message transmitted between the caller telephone and a call controller (CC) shown in Figure 1;
- Figure 4 is a block diagram of the call controller shown in Figure 1;
- 10 Figure 5 is a flowchart of a process executed by the call controller shown in Figure 1;
- Figure 6 is a schematic representation of a routing controller (RC) Request message produced by the call controller shown in Figure 1;
- 15 Figure 7 is a block diagram of a routing controller (RC) processor circuit of the routing controller shown in Figure 1;
- Figures 8A-8D are flowcharts of a RC Request message handler executed by the RC processor circuit shown in Figure 7;
- 20 Figure 9 is a tabular representation of a dialling profile stored in a database accessible by the RC shown in Figure 1;
- 25 Figure 10 is a tabular representation of a dialling profile for a Vancouver caller using the caller telephone shown in Figure 1;
- Figure 10A is a tabular representation of a dialling profile for the Emergency Response Center subscriber shown in Figure 1;
- 30 Figure 11 is a tabular representation of a dialling profile for the Calgary subscriber shown in Figure 1;

-12-

- Figure 12 is a tabular representation of a dialing profile for the London subscriber shown in Figure 1;
- 5 Figure 13 is a tabular representation of a DID bank table record stored in the database shown in Figure 1;
- Figure 13A is a tabular representation of an exemplary DID bank table record for the Vancouver subscriber;
- 10 Figure 13B is a tabular representation of an exemplary DID bank table record for the Calgary subscriber;
- Figure 14 is a tabular representation of an exemplary DID bank table record for the London subscriber;
- 15 Figure 15 is a tabular representation of a routing message buffer for holding a routing message to be transmitted from the RC to the call controller shown in Figure 1;
- 20 Figure 16 is a tabular representation of a routing message for routing a call to the Emergency Response Center;
- Figure 16A is a tabular representation of a routing message for routing a call to the London subscriber;
- 25 Figure 17 is a tabular representation of a prefix to supernode table record stored in the database shown in Figure 1;
- 30 Figure 18 is a tabular representation of a prefix to supernode table record that would be used for the London subscriber;

-13-

- Figure 19 is a tabular representation of a master list record stored in a master list table in the database shown in Figure 1;
- 5 Figure 20 is a tabular representation of an exemplary populated master list record;
- Figure 21 is a tabular representation of a suppliers list record stored in the database shown in Figure 1;
- 10 Figure 22 is a tabular representation of a specific supplier list record for a first supplier;
- Figure 23 is a tabular representation of a specific supplier list record for a second supplier;
- 15 Figure 24 is a tabular representation of a specific supplier list record for a third supplier;
- Figure 25 is a tabular representation of a routing message buffer for holding a routing message identifying a plurality of possible suppliers that may carry the call;
- 20 Figure 26 is a tabular representation of a call block table record;
- 25 Figure 27 is a tabular representation of a call block table record for the Calgary subscriber;
- Figure 28 is a tabular representation of a call forwarding table record;
- 30 Figure 29 is a tabular representation of an exemplary call forwarding table record specific to the Calgary subscriber;

-14-

- Figure 30 is a tabular representation of a voicemail table record specifying voicemail parameters to enable the caller to leave a voicemail message for the callee;
- 5 Figure 31 is a tabular representation of an exemplary voicemail table record for the Calgary subscriber;
- Figure 32 is a tabular representation of an exemplary routing message, held in a routing message buffer, indicating call forwarding numbers and a voicemail server identifier;
- 10 Figure 33 is a tabular representation of a SIP Bye message transmitted from any of the telephones to the call controller;
- 15 Figure 34 is a tabular representation of a SIP Bye message sent to the call controller from the callee or caller gateway;
- Figure 35 is a flowchart of a process executed by the call controller for producing a RC Call Stop message in response to receipt of a SIP Bye message;
- 20 Figure 36 is a tabular representation of an exemplary RC Call Stop message;
- 25 Figure 37 is a tabular representation of an exemplary RC Call Stop message for the Calgary subscriber;
- Figure 38 is a schematic representation of messages exchanged during a process for establishing audio paths between telephones and a media relay.
- 30

-15-

DETAILED DESCRIPTION

Referring to Figure 1, a system for making voice over IP telephone calls including emergency calls is shown generally at **10**. The system includes a first supernode shown generally at **11** and a second supernode shown generally at **21**. The first supernode **11** is located in a geographical area, such as Vancouver B.C., for example and the second supernode **21** is located in London, England, for example. Different supernodes may be located in different geographical regions throughout the world to provide telephone service to subscribers in respective regions. These supernodes may be in communication with each other through high speed / high data throughput links including optical fiber, satellite and/or cable links, for example, forming a system backbone. These supernodes may alternatively or in addition be in communication with each other through conventional Internet services. In the embodiment shown, data communication media for providing for data communications between the first and second supernodes **11** and **21** are shown generally at **23** and may include very high speed data links, for example.

In the embodiment shown, the Vancouver supernode **11** provides telephone service to a geographical region comprising Western Canadian customers from Vancouver Island to Ontario and includes a Vancouver subscriber, a Calgary subscriber and an emergency response center (ERC) that is also a subscriber. The second supernode **21** may be located in London, England, for example, to service London and Glasgow subscribers, **22** and **25**, for example through their own service providers **9** and **29**. As will be seen below however, the emergency response center need not be a subscriber.

Other supernodes similar to the type shown may also be employed within the geographical area serviced by a supernode, to provide for call load sharing, for example within a region of the geographical area serviced by the supernode. However, in general, all supernodes are similar and have the properties described below in connection with the Vancouver supernode **11**.

-16-

In this embodiment, the Vancouver supernode includes a call controller (CC) **14**, a routing controller (RC) **16**, a database **18** and a media relay (MR) **17**.
Subscribers such as the Vancouver subscriber, the Calgary subscriber and
5 the Emergency Response Center subscriber communicate with the Vancouver supernode **11** using their own Internet Service Providers (ISPs) **13**, **19** and **31** respectively which route Internet Protocol (IP) traffic from these subscribers to the Vancouver Supernode over the Internet. To these subscribers the Vancouver supernode **11** is accessible through their ISP at a
10 pre-determined IP address or a fully qualified domain name (FQDN). The subscriber in the city of Vancouver uses a telephone **12** that is capable of communicating with the Vancouver supernode **11** using Session Initiation Protocol (SIP) messages, and the Calgary and Emergency Response Center subscribers use similar telephones **15** and **33** respectively, to communicate
15 with the Vancouver supernode from their locations. The London supernode **21** also has a call controller **24**, a routing controller **26** and a database **28** and functions in a manner similar to the Vancouver supernode **11**.

It should be noted that throughout the description of the embodiments of this
20 invention, the IP/UDP addresses of all elements such as the caller and callee telephones, call controller, media relay, and any others, will be assumed to be valid IP/UDP addresses directly accessible via the Internet or a private IP network, for example, depending on the specific implementation of the system. As such, it will be assumed, for example, that the caller and callee
25 telephones will have IP/UDP addresses directly accessible by the call controllers and the media relays on their respective supernodes, and those addresses will not be obscured by Network Address Translation (NAT) or similar mechanisms. In other words, the IP/UDP information contained in SIP messages (for example the SIP Invite message or the RC Request message
30 which will be described below) will match the IP/UDP addresses of the IP packets carrying these SIP messages.

-17-

It will be appreciated that in many situations, the IP addresses assigned to various elements of the system may be in a private IP address space, and thus not directly accessible from other elements. Furthermore, it will also be appreciated that NAT is commonly used to share a “public” IP address between multiple devices, for example between home PCs and IP telephones sharing a single Internet connection. For example, a home PC may be assigned an IP address such as **192.168.0.101** and a Voice over IP telephone may be assigned an IP address of **192.168.0.103**. These addresses are located in so called “non-routable” (IP) address space and cannot be accessed directly from the Internet. In order for these devices to communicate with other computers located on the Internet, these IP addresses have to be converted into a “public” IP address, for example **24.10.10.123** assigned by the Internet Service Provider to the subscriber, by a device performing NAT, typically a home router. In addition to translating the IP addresses, NAT typically also translates UDP port numbers, for example an audio path originating at a VoIP telephone and using a UDP port **12378** at its private IP address, may have been translated to UDP port **23465** associated with the public IP address of the NAT device. In other words, when a packet originating from the above VoIP telephone arrives at an Internet-based supernode, the source IP/UDP address contained in the IP packet header will be **24.10.10.123:23465**, whereas the source IP/UDP address information contained in the SIP message inside this IP packet will be **192.168.0.103:12378**. The mismatch in the IP/UDP addresses may cause a problem for SIP-based VoIP systems because, for example, a supernode will attempt to send messages to a private address of a telephone – the messages will never get there.

It will be appreciated that a number of methods are available to overcome this problem. For example, the SIP NATHelper open source software module may run on the supernode to correlate public IP/UDP address contained in the headers of the IP packets arriving from SIP devices with private IP/UDP addresses in the SIP messages contained in these packets. Therefore, the

-18-

embodiments of the invention described below will function whether or not any of the elements of the system are located behind NAT devices that obscure their real IP/UDP addresses.

5 Referring to Figure 1, in an attempt to make a regular call by the Vancouver telephone 12 to the London telephone 22, for example, the Vancouver telephone sends a SIP Invite message to the Vancouver supernode 11 and in response, the call controller 14 sends an RC Request message to the routing controller 16 which makes various enquiries of the database 18 to produce a routing message which is sent to the call controller. The call controller 14 then causes a communications link, including audio paths, to be established through the media relay 17 which may include the same Vancouver supernode 11, a different supernode or a communications supplier gateway, for example, to carry voice traffic to and from the call recipient or callee.

15 In an attempt to make an emergency call, generally the call is made by dialling a short number such as 911 and the call is routed to an emergency response center (ERC) associated with the caller such as the emergency response center associated with the telephone 33. However, as will be appreciated from the description below, this system will permit emergency calls originating from subscribers associated with one supernode to be received by emergency response centers associated with a different supernode, if necessary.

25 Subscriber Telephone

Referring to Figure 2, in this embodiment, the telephone 12 includes a processor circuit shown generally at 30 comprising a microprocessor 32, program memory 34, an input/output (I/O) interface 36, parameter memory 38 and temporary memory 40. The program memory 34, I/O interface 36, parameter memory 38 and temporary memory 40 are all in communication with the microprocessor 32. The I/O interface 36 has a dial input 42 for receiving a dialed telephone number from a keypad, for example, or from a

-19-

voice recognition unit or from pre-stored telephone numbers stored in the parameter memory **38**, for example. For simplicity, a box labelled dialling functions **44** represents any device capable of informing the microprocessor **32** of a callee identifier, e.g., a callee telephone number.

5

The processor **32** stores the callee identifier in a dialed number buffer **41**. Where the callee is the London subscriber, the callee identifier may be **4401 1062 4444**, for example, identifying the London subscriber or the callee identifier may be a standard telephone number, or where the callee is the Emergency Response Center, the callee identifier may be **911**, for example.

10

The I/O interface **36** also has a handset interface **46** for receiving and producing signals from and to a handset that receives user's speech to produce audio signals and produces sound in response to received audio signals. The handset interface **46** may include a BLUETOOTH™ wireless interface, a wired interface or speakerphone, for example. The handset **45** acts as a termination point for an audio path (not shown) which will be appreciated later.

15

The I/O interface **36** also has a network interface **48** to an IP network, and is operable, for example, to connect the telephone to an ISP via a high speed Internet connection. The network interface **48** also acts as a part of the audio path, as will be appreciated later.

20

The parameter memory **38** has a username field **50**, a password field **52**, an IP address field **53** and a SIP proxy address field **54**. The username field **50** is operable to hold a username associated with the telephone **12**, which in this case is **2001 1050 8667**. The username is assigned upon subscription or registration into the system and, in this embodiment includes a twelve digit number having a prefix **61**, a country code **63**, a dealer code **70** and a unique number code **74**. The prefix **61** is comprised of the first or left-most digit of the username in this embodiment. The prefix may act as a continent code in

25

30

-20-

5 some embodiments, for example. The country code **63** is comprised of the next three digits. The dealer code **70** is comprised of the next four digits and the unique number code **74** is comprised of the last four digits. The password field **52** holds a password of up to **512** characters, in this example. The IP address field **53** stores an IP address of the telephone **30**, which for this explanation is **192.168.0.20**. The SIP proxy address field **54** stores an IP address of a SIP proxy which may be provided to the telephone **12** through the network interface **48** as part of a registration procedure, for example.

10 The program memory **34** stores blocks of codes for directing the microprocessor **32** to carry out the functions of the telephone **12**, one of which includes a firewall block **56** which provides firewall functions to the telephone, to prevent unauthorized access through the network interface **48** to the microprocessor **32** and memories **34**, **38** and **40**. The program memory **34**
15 also stores codes **57** for establishing a call ID. The call ID codes **57** direct the microprocessor **32** to produce call identifiers, that may, for example have the format of a hexadecimal string and an IP address of the telephone stored in IP address field **53**. Thus, an exemplary call identifier for a call might be **FF10 @ 192.168.0.20**.

20 Generally, in response to activating the handset **45** and using the dialling function **44**, the microprocessor **32** produces and sends a SIP Invite message **59** as shown in Figure 3, to the routing controller (RC) **14** shown in Figure 1.

25 Referring to Figure 3, the SIP Invite message includes a caller identifier field **60**, a callee identifier field **62**, a digest parameters field **64**, a call ID field **65**, a caller IP address field **67** and a caller UDP port field **69**. In this embodiment, the caller identifier field **60** includes the username **2001 1050 8667**, which is the username stored in the username field **50** of the parameter memory **38**
30 in the Vancouver telephone **12** shown in Figure 2. In addition, as an example, referring back to Figure 3, where the call is a normal, non-emergency call to the London subscriber the callee identifier field **62** includes the username

-21-

5 **4401 1062 4444** which is the dialed number of the London subscriber stored in the dialed number buffer **41** shown in Figure **2**. The digest parameters field **64** includes digest parameters and the call ID field **65** includes a code comprising a generated prefix code (**FF10**, for example) and a suffix which is the IP address of the telephone **12** stored in the IP address field **53**. The IP address field **67** and UDP port field **69** define a socket for audio communications. The IP address field **67** holds the IP address assigned to the telephone, in this embodiment **192.168.0.20**, and the caller UDP port field **69** includes a UDP port identifier identifying a UDP port at which the audio path will be terminated at the caller's telephone.

10

Call Controller

Referring to Figure **4**, a call controller circuit of the call controller **14** (Figure **1**) is shown in greater detail at **100**. The call controller circuit **100** includes a microprocessor **102**, program memory **104**, random access memory **105** and an I/O interface **106**. The call controller circuit **100** may include a plurality of microprocessors, a plurality of program memories and a plurality of I/O interfaces to be able to handle a large volume of calls. However, for simplicity, the call controller circuit **100** will be described as having only one microprocessor, program memory and I/O interface, it being understood that there may be more.

15

20

Generally, the I/O interface **106** includes an input **108** for receiving messages, such as the SIP Invite message shown in Figure **3**, from the telephone **12** shown in Figure **2**. The I/O interface **106** also has an RC Request message output **110** for transmitting an RC Request message to the routing controller **16** in Figure **1**, an RC message input **112** for receiving routing messages from the RC **16**, a MR output **114** for transmitting messages to the media relay **17** (Figure **1**) to advise the media relay to establish an audio path, and a MR input **116** for receiving messages from the media relay to which a message has been sent to attempt to establish the audio path. The I/O interface **106** further includes a SIP output **118** for transmitting SIP messages to the

25

30

-22-

telephone **12** (Figure **2**) to advise the telephone of the IP address of the media relay **17** (Figure **1**) which will establish the audio path.

5 While certain inputs and outputs have been shown as separate, it will be appreciated that some may be associated with a single IP address and TCP or UDP port. For example, the messages sent and received from the RC **16** may be transmitted and received at the same single IP address and TCP or UDP port.

10 The program memory **104** of the call controller circuit **100** includes blocks of code for directing the microprocessor **102** to carry out various functions of the call controller **14**. For example, these blocks of code include a first block **120** for causing the call controller circuit **100** to execute a SIP Invite to RC request process to produce a RC Request message in response to a received SIP
15 Invite message. In addition, there is a Routing Message to Media Relay message block **122** which causes the call controller circuit **100** to produce an MR Query message in response to a received routing message from the routing controller **16**.

20 Referring to Figure **5**, the SIP Invite-to-RC Request process is shown in more detail at **120**. On receipt of a SIP Invite message of the type shown in Figure **3**, block **132** of Figure **5** directs the call controller circuit **100** of Figure **4** to authenticate the user operating the telephone from which the SIP Invite message originated. This may be done, for example, by prompting the user
25 for a password by sending a message back to the caller telephone **12** in Figure **1**, which is interpreted at the telephone as a request for password entry or the password may automatically be sent to the call controller **14** from the telephone, in response to the message. The call controller **14** may then make enquiries of the database **18** to determine whether or not the user's password
30 matches a password stored in the database. Various functions may be used to pass encryption keys or hash codes back and forth to ensure the secure

-23-

transmission of passwords. Authentication may be bypassed when the call is to the ERC.

5 Should the authentication process fail, the call controller circuit **100** is directed to an error handling block **134** which causes messages to be displayed at the caller telephone **12** to indicate that there was an authentication error. If the authentication process is successful, block **131** directs the call controller circuit **100** of Figure **4** to determine whether or not the contents of the caller identifier field **60** of the SIP Invite message shown in Figure **3** is a validly
10 formatted IP address. If it is a valid IP address, then block **133** of Figure **5** directs the call controller circuit **100** of Figure **4** to associate a type code with the call to indicate that the call type is a third party invite.

15 If at block **131** the caller identifier field **60** contents do not identify an IP address (for example, they may identify a PSTN number or Emergency Calling short number such as **911**), then block **135** directs the call controller circuit **100** to associate a type code with the call to indicate the call type is a regular invite. Then, block **136** directs the call controller circuit **100** to establish a call ID by reading the call ID provided in the call ID field **65** of the
20 SIP Invite message from the telephone **12**, and at block **138** the call controller circuit is directed to produce a routing request message of the type shown in Figure **6** that includes that call ID. Block **139** of Figure **5** then directs the call controller circuit **100** of Figure **4** to send the RC Request message to the routing controller **16** of Figure **1**.

25 Referring to Figure **6**, a routing request message is shown generally at **150** and includes a caller identifier field **152**, a callee identifier field **154**, a digest field **156**, a call ID field **158** and a type field **160**. The caller, callee, digest, and call ID fields **152**, **154**, **156** and **158** contain copies of the caller, callee, digest
30 parameters and call ID fields **60**, **62**, **64** and **65** of the SIP Invite message shown in Figure **3**. The type field **160** contains the type code established at blocks **133** or **135** of Figure **5** to indicate whether the call is from a third party

-24-

or system subscriber, respectively. For a normal non-emergency call the callee identifier field **154** may include a PSTN number or a system subscriber username as shown, for example. For an emergency call, the callee identifier field **154** includes the Emergency short number **911**, in this embodiment.

5

Routing Controller

Referring to Figure 7, the routing controller **16** is shown in greater detail and includes an RC processor circuit shown generally at **200**. The RC processor circuit **200** includes a processor **202**, program memory **204**, a table memory **206**, a DID identifier buffer **203**, a caller ID buffer **205**, a callee ID buffer **209**, an emergency call flag **211**, a DID identifier buffer **203**, a and an I/O interface **208**, all in communication with the processor. (As earlier indicated, there may be a plurality of processors (**202**), memories (**204**), etc.) Separate caller ID buffers **205**, callee id buffers **209** and emergency call flags **211** are instantiated for each call and are associated with respective call IDs.

10

15

The I/O interface **208** includes a database output port **210** through which a request to the database **18** (Figure 1) can be made and includes a database response port **212** for receiving a reply from the database. The I/O interface **208** further includes an RC Request message input **214** for receiving the routing request message from the call controller **14**. Thus, the routing controller receives a routing request message including a caller identifier and a callee identifier. The I/O interface **208** further includes a routing message output **216** for sending a routing message back to the call controller **14**.

20

25

The program memory **204** includes blocks of codes for directing the RC processor circuit **200** to carry out various functions of the routing controller **16**. One of these blocks includes an RC Request message handler process **250** which directs the RC processor circuit to produce a routing message in response to a received routing request message of the type shown at **150** in Figure 6. The RC Request message handler process is shown in greater detail at **250** in Figures **8A** through **8D**.

30

-25-

RC Request Message Handler

Referring to Figure 8A, the routing request message handler **250** begins with a first block **252** that directs the RC processor circuit **200** (Figure 7) to store the contents of the RC Request message **150** (Figure 6) in the callee ID buffer **209** and the caller buffer **205** buffers for separately storing the contents of the callee field (**154** in Figure 6) and the caller field (**152** in Figure 6) respectively of the RC Request message. Block **254** then directs the RC processor circuit **200** to use the contents of the caller field (**152** in Figure 6) in the RC Request message **150**, to search the database **18** shown in Figure 1 and retrieve a dialling profile associated with the caller.

Referring to Figure 9, a dialling profile is shown generally at **256** and includes system fields including a username field **258**, a domain field **260**, a national dialling digits (NDD) field **262**, an International dialing digits (IDD) field **264**, a country code field **266**, a local area codes field **267**, a caller minimum local length field **268**, a caller maximum local length field **270**, a reseller field **273**, a user address field **275**, an emergency call identifier field **277** and an emergency response center (ERC) field **279**.

An exemplary dialling profile for the Vancouver subscriber is shown generally at **276** in Figure 10 and indicates that the username field **258** includes the username **2001 1050 8667** which is the same as the contents of the username field **50** in the Vancouver telephone **12** shown in Figure 2.

Referring back to Figure 10, the domain field **260** includes a domain name as shown at **282**, including a supernode type identifier **284**, a location code identifier **286**, a system provider identifier **288** and a top level domain identifier **290**, identifying a domain or supernode associated with the user identified by the contents of the username field **258**.

-26-

5 In this embodiment, the supernode type identifier **284** includes the code "sp" identifying a supernode and the location code identifier **286** identifies the supernode as being in Vancouver (yvr). The system provider identifier **288** identifies the company supplying the service and the top level domain identifier **290** identifies the "com" domain.

10 The NDD field **262** in this embodiment includes the digit "1" and in general includes a digit specified by the International Telecommunications Union – Telecommunications Standardization Sector (ITU-T) E.164 Recommendation which assigns national dialling digits to certain countries.

15 The IDD field **264** includes the code **011** and, in general, includes a code assigned by the ITU-T according to the country or geographical location of the subscriber.

The country code field **266** includes the digit "1" and, in general, includes a number assigned by the ITU-T to represent the country in which the subscriber is located.

20 The local area codes field **267** includes the numbers **604** and **778** and generally includes a list of area codes that have been assigned by the ITU-T to the geographical area in which the subscriber is located. The caller minimum and maximum local number length fields **268** and **270** each hold the number **10** representing minimum and maximum local number lengths permitted in the area code(s) specified by the contents of the local area codes field **267**. The reseller field **273** holds a code identifying a retailer of the telephone services, and in the embodiment shown, the retailer is "Klondike".

30 The address field **275** holds an address at which the subscriber telephone is normally located. The emergency short number field **277** holds the short emergency number such as "911" that the user is expected to dial in the event of an emergency. The ERC number field **279** holds a full PSTN number

-27-

associated with an emergency response center that would desirably be geographically nearest to the address specified in the address field **275**.

5 A dialling profile of the type shown at **256** in Figure **9** is produced whenever a user registers with the system or agrees to become a subscriber to the system. An ERC may register as a user, but need not do so since, as will be appreciated below, provisions are made for making VoIP to PSTN calls which may include calls to an ERC only available via the PSTN. Of importance here is that the contents of the emergency short number field **277** and the contents
10 of the ERC number field **279** are assigned when the user registers with the system and thus it may be said that these numbers are "pre-assigned" to the user before the user makes any calls.

15 A user wishing to subscribe to the system may contact an office maintained by a system operator. Personnel in the office may ask the user certain questions about his location and service preferences, whereupon tables can be used to provide office personnel with appropriate information to be entered into the username, domain, NDD, IDD, country code, local area codes and caller minimum and maximum local length fields, emergency short number
20 field and ERC number field **258, 260, 262, 264, 266, 267, 268, 270, 277, 279** to establish a dialling profile for the user.

25 Referring to Figures **10A, 11, and 12**, dialling profiles for the ERC subscriber, Calgary subscriber, and the London subscriber, respectively for example, are shown.

30 In addition to creating dialling profiles when a user registers with the system, a direct-in-dial (DID) record of the type shown at **268** in Figure **13** may optionally be added to a direct-in-dial table in the database **18** to associate the username and a host name of the supernode, with which the user is associated, with an E.**164** number on the PSTN network. If the user does not

-28-

have such an E.164 number, no DID record need be created at this time for that user.

5 In this embodiment, the DID bank table records include a username field **291**, a user domain field **272** and DID identifier field **274**, for holding the username, hostname of the supernode and E.164 number respectively. Thus a DID bank table record pre-associates a DID identifier with a user (e.g. caller).

10 A DID bank table record may also include a creation time field and an expiration time field for use when the DID bank table record is a temporary record as will be explained below.

DID bank table records for the Vancouver, Calgary and London subscribers are shown in Figures **13A**, **13B**, and **14**, respectively

15 In addition to creating dialling profiles and DID records when a user registers with the system, call blocking records of the type shown in Figure **26**, call forwarding records of the type shown in Figure **28** and voicemail records of the type shown in Figure **30** may be added to the database **18** when a new subscriber is added to the system.

20 Referring back to Figure **8A**, after being directed at block **254** to retrieve a dialling profile associated with the caller, such as shown at **276** in Figure **10**, the RC processor circuit (**200**) is directed to block **255** which causes it to determine whether the contents of the callee ID buffer **209** shown in Figure **7** are equal to the contents of the emergency call identifier field **277** of the dialling profile **276** for the caller, shown in Figure **10**. If the contents of the callee ID buffer **209** are not equal to the contents of the emergency short number field **277**, the call is deemed not to be an emergency call and the RC processor circuit **200** is directed to location A in Figure **8B** to carry out further processing on the basis that the call is to be a normal, non-emergency call.

-29-

If the contents of the callee ID buffer **209** match the contents of the emergency call identifier field (**277** in Figure **10**), the call is deemed to be an emergency call and block **157** directs the RC processor circuit **200** to set a time to live (TTL) value to a high number such as **9999** to indicate that the call may have a long duration of **9999** seconds, for example. In addition block **157** directs the RC processor circuit **200** to set active the emergency call flag **211** in Figure **7**, to indicate that the call is an emergency call. Then, block **159** directs the RC processor circuit **200** to replace the contents of the callee ID buffer **209** with the contents of the ERC # field **279** of the caller dialling profile **276** (Figure **10**). Thus, the RC processor circuit produces an emergency response center identifier in response to the emergency call identifier by copying the emergency response center identifier from the ERC field **279** of the dialing profile **276** (Figure **10**) associated with the caller to the callee ID buffer **209** shown in Figure **7** so that effectively, the contents of the callee ID buffer are replaced with the Emergency Response Center number. The RC processor circuit **200** is then directed to location A in Figure **8B**.

In this embodiment, for regular and emergency call processing, beginning at location A in Figure **8B**, the RC processor circuit **200** is directed to perform certain checks on the callee identifier provided by the contents of the callee identifier buffer **209** shown in Figure **7**. Most of these checks are shown in greater detail in Figure **8B** and are used for regular non-emergency call handling. Emergency calls in which the ERC number has been substituted for the short emergency calling number (i.e., **911**) will pass all of the checks. Subjecting both emergency and non-emergency calls to these checks enables all calls, whether emergency or non-emergency, to be passed through the same process and, simplifies the introduction of emergency call handling processes into regular call processing routines depicted in Figures **8A** to **8D**. Alternatively, the RC processor circuit may be directed directly from block **159** to block **269** in Figure **8B** whenever the emergency call flag is set, as shown in broken outline in Figure **8B**.

-30-

Figure 8B

IDD Testing

Referring to Figure 8B, to start the first of the checks, the RC processor circuit 200 is directed to a first block 257 that causes it to determine whether a digit pattern of the callee identifier provided in the callee ID buffer 209 includes a pattern that matches the contents of the IDD field 264 in the caller dialling profile 276 shown in Figure 10. If so, then block 259 directs the RC processor circuit 200 to set a call type identifier code (not shown) to indicate that the call is a long distance call, e.g., from the Vancouver subscriber to the London subscriber, and block 261 directs the RC processor circuit 200 to produce a reformatted callee identifier by reformatting the current callee identifier into a predetermined target format. In this embodiment, this is done by removing the pattern of digits matching the IDD field contents 264 of the caller dialling profile 276 to effectively shorten the number. Then, block 263 directs the RC processor circuit 200 to determine whether or not the reformatted callee identifier meets criteria establishing it as an E.164 compliant number and if the length does not meet this criteria, block 265 directs the RC processor circuit 200 to send back to the call controller 14 a message indicating that the length of the call identifier is not correct. The process 250 is then ended. At the call controller 14, routines may respond to the incorrect length message by transmitting a message back to the telephone 12 to indicate that an invalid number has been dialed, for example. Thus at the conclusion of block 263 a callee identifier having a pre-defined format should be available.

25 NDD Testing

Referring back to Figure 8B, if at block 257, the callee identifier specified by the contents of the callee buffer 209 Figure 7 does not begin with an IDD, block 381 directs the RC processor circuit 200 to determine whether or not the callee identifier begins with the same NDD code as assigned to the caller. To do this, the RC processor circuit is directed to refer to the caller dialling profile 276 shown in Figure 10. In the embodiment shown, the NDD code stored in

-31-

an NDD field **262** is the digit **1**. Thus, if the callee identifier begins with the digit **1**, the RC processor circuit **200** is directed to block **382** in Figure **8B**.

5 Block **382** directs the RC processor circuit **200** to examine the callee identifier to determine whether or not digits following the NDD code identify an area code that is the same as any of the area codes identified in the local area codes field **267** of the caller dialling profile **276** shown in Figure **10**. If not, block **384** directs the RC processor circuit **200** to set a call type variable (not shown) to a code indicating the call is a national call. If the digits identify an
10 area code that is the same as a local area code associated with the caller, block **386** directs the RC processor circuit **200** to set the call type variable to indicate that the call type is as a local call, national style. After executing blocks **384** or **386**, block **388** directs the RC processor circuit **200** to reformat the callee identifier by removing the national dial digit and prepending a caller
15 country code identified by the country code field **266** of the caller dialling profile **276** shown in Figure **10**. The RC processor circuit **200** is then directed to block **263** to perform the processes described above beginning at block **263**. Again, at the conclusion of block **263** a callee identifier having a pre-defined format should be available.

20

Area Code Testing

If at block **381** the callee identifier does not begin with an NDD code, block **390** directs the RC processor circuit **200** to determine whether the callee identifier in the callee ID buffer **209** begins with digits that identify the same
25 area code as the caller. Again, the reference for this is the caller profile **276** shown in Figure **10** and the RC processor circuit **200** determines whether or not the first few digits in the callee identifier identify an area code identified by the local area code field **267** of the caller profile **276**. If so, then block **392** directs the RC processor circuit **200** to set the call type to a code indicating the call is a local call and block **394** directs the RC processor circuit **200** to
30 prepend the caller country code to the callee identifier, the caller country code being determined from the country code field **266** in the caller profile **276**. The

-32-

RC processor circuit **200** is then directed to block **263** for processing as described above beginning at block **263**. Emergency calls are likely to follow this path since the Emergency Response Center number that supplants the short emergency number (**911**) will normally be formatted to include an area code, but no IDD or NDD. Again at the conclusion of block **263** a callee identifier having a pre-defined length should be available.

Callee ID Length Testing

If at block **390**, the callee identifier does not have the same area code as the caller, as may be the case with non-emergency calls, block **396** directs the RC processor circuit **200** to determine whether the callee identifier in the callee ID buffer **209** has the same number of digits as the number of digits indicated in either the caller minimum local number length field **268** or the caller maximum local number length field **270** of the caller profile **276** shown in Figure **10**. If so, then block **398** directs the RC processor circuit **200** to set the call type to local and block **400** directs the processor to prepend to the callee identifier the caller country code as indicated by the country code field **266** of the caller profile **276** followed by the caller area code as indicated by the local area code field **267** of the caller profile shown in Figure **10**. The RC processor circuit **200** is then directed to block **263** for further processing as described above beginning at block **263**. Again at the conclusion of block **263** a callee identifier having a pre-defined length should be available.

Valid Subscriber Testing

If at block **396**, the callee identifier in the callee ID buffer **209** has a length that does not match the length specified by the contents of the caller minimum local number length field **268** or the caller maximum local number length field **270** of the caller profile **276**, block **402** directs the RC processor circuit **200** to determine whether or not the callee identifier identifies a valid username. To do this, the RC processor circuit **200** searches through the database **18** of dialling profiles to find a dialling profile having a username field **258** that matches the callee identifier. If no match is found, block **404** directs the RC

-33-

processor circuit **200** to send an error message back to the call controller (**14**).
If at block **402**, a dialling profile having a username field **258** that matches the
callee identifier is found, block **406** directs the RC processor circuit **200** to set
the call type to a code indicating the call is a network call and the processor is
5 directed to block **275** of Figure **8A**, to continue executing the RC message
handler process **250**.

From Figure **8B**, it will be appreciated that there are certain groups of blocks
of codes that direct the RC processor circuit **200** to determine whether the
10 callee identifier in the callee ID buffer **209** has certain features such as an IDD
code, a NDD code, an area code and a length that meet certain criteria and to
reformat the callee identifier, as necessary, into a predetermined target format
including only a country code, area code, and a normal telephone number, for
example, to cause the callee identifier to be compatible with the E.164
15 standard, in this embodiment. This enables the RC processor circuit **200** to
have a consistent format of callee identifiers for use at block **269** in searching
through the DID bank table records of the type **268** shown in Figure **13**
to determine how to route calls for subscriber to subscriber calls on the same
system. Recall that the ERC may be a subscriber.

20 Still referring to Figure **8B**, if the length of the reformatted callee identifier
meets the length criteria set forth at block **263**, block **269** directs the RC
processor circuit **200** to determine whether or not the reformatted callee
identifier is associated with a direct-in-dial bank (DID) record of the type
25 shown at **268** in Figure **13**.

Exemplary DID records for the Vancouver, Calgary and London subscribers
are shown in Figures **13A**, **13B** and **14**. The username field **291** and user
domain field **272** are as specified in the username and user domain fields **258**
30 and **260** of the corresponding dialling profiles shown in Figures **10**, **11** and **12**
respectively. Referring to Figure **13A** the contents of the DID field **274** include
an E.164 telephone number including a country code **293**, an area code **295**,

-34-

an exchange code **297** and a number **299**. If the user has multiple telephone numbers, then multiple records of the type shown at **276** would be included in the DID bank table in the database **18**, each having the same username and user domain, but different DID field **274** contents reflecting the different E.164
5 telephone numbers associated with that user.

Referring back to Figure **8B**, at block **269**, if the RC processor circuit **200** determines that the current, (e.g.reformatted callee identifier produced at block **261**) can be found in a record in the DID bank table, then the callee is a
10 subscriber to the system and block **279** directs the RC processor circuit **200** to copy the contents of the corresponding username field **291** from the DID bank table record into the callee ID buffer **209** shown in Figure **7**. Thus, the RC processor circuit **200** locates a subscriber username associated with the reformatted callee identifier. If the call is being made to the Emergency
15 Response Center and the Emergency Response Center (ERC) is a subscriber to the system, a DID record would be found in the DID bank table, otherwise a DID record for the ERC would not be found. Assuming the Emergency Response Center is a subscriber to the system, the RC processor circuit **200** is directed to block **275** at point **B** in Figure **8A** for further processing now that
20 it is known that the call is essentially a subscriber to subscriber call.

Subscriber to Subscriber Calls Between Different Nodes

Referring back to Figure **8A**, block **275** directs the RC processor circuit **200** to determine whether or not the username stored in the callee ID buffer **209** (in
25 Figure **7**) is associated with the same supernode as the caller. To do this, the RC processor circuit **200** determines whether or not the prefix (i.e. the leftmost digit) of the username stored in the callee ID buffer **209** is the same as the prefix of the username of the caller specified by the caller identifier field **152** of the RC. Request message **150** shown in Figure **6**. If they are not
30 the same, block **277** of Figure **8A** directs the RC processor circuit (**200**) to set a call type flag (not shown) to indicate that the call is a cross-domain call. Then, block **281** directs the RC processor circuit (**200**) to determine whether

-35-

the emergency call flag **211** shown in Figure **7** has been set and if so, block **283** of Figure **8A** directs the RC processor to determine whether the caller identifier is associated with a pre-associated direct inward dialing (DID) identifier. This is done by searching the DID bank table to attempt to locate a
5 DID record having DID field (**274**) contents matching the contents of the caller identifier stored in the caller ID buffer (**205**). If such a DID record is found, the processor circuit **200** has effectively determined that the caller has a pre-associated DID identifier.

10 If no such DID record is found, the RC processor circuit **200** has effectively determined that the caller has no pre-associated DID identifier. In this case, block **285** then directs the RC processor circuit **200** to produce a DID identifier for the caller by associating a temporary DID identifier with the caller identifier by associating with the caller identifier a DID identifier from a pool of pre-
15 determined DID identifiers. This is done by creating and associating with the caller a temporary DID record of the type shown in Figure **13**. The temporary DID record has a DID identifier field **274** populated with the DID identifier from the pool. The DID identifier from the pool may be **1 604 867 5309**, for example. The pool may be provided by causing the RC processor circuit **200**
20 to maintain a list of pre-defined DID identifiers and pointers identifying a current read point in the list and a current write point in the list. The current read pointer may be incremented each time the pool is addressed to obtain a temporary DID identifier.

25 A temporary DID record may be canceled after a pre-defined period of time. For example, the temporary DID identifier records are desirably as shown in Figure **13** and may further include a creation time field and an expiry time field for holding a creation time value and an expiry time value respectively. The expiry time may be **2** hours after the creation time, for example, such that
30 the temporary DID record is deleted two hours after it is created. A separate process, not shown, may continuously or periodically scan the DID records to determine whether any DID records have expiry times that have been

-36-

5 exceeded and if so, cause such temporary DID records to be cancelled or deleted. Thus, the RC processor produces a direct inward dialing identifier for the caller by associating a temporary DID identifier with the caller identifier when the emergency call flag is active and it is determined that the caller has no pre-associated DID identifier, or by associating a DID identifier pre-assigned to the caller identifier.

10 After a temporary DID record has been created and stored in the DID bank table in the database **18** shown in Figure **1**, or if the caller already had a DID record, block **287** of Figure **8A** directs the RC processor circuit to load the DID identifier buffer **203** with the contents of the field of DID temporary or pre-associated DID record. Then the RC processor circuit loads a routing message buffer with the contents of the DID identifier buffer **203** acting as the caller identifier and the contents of the callee ID buffer **209** as the callee identifier. This will provide for a PSTN call back number to be provided to the emergency response center.

15 Thus, where the caller identifier has no pre-assigned DID identifier, the RC processor produces a routing message including the emergency response center identifier and the temporary DID identifier for receipt by the routing controller to cause the routing controller to establish a route between the caller and the emergency response center.

20 Referring to Figure **15**, a routing message buffer is shown generally at **352** and includes a supplier prefix field **354**, a delimiter field **356**, a callee field **358**, at least one route field **360**, a time-to-live (TTL) field **362** and a caller ID field **364**. The supplier prefix field **354** holds a code for identifying supplier traffic. The delimiter field **356** holds a symbol that delimits the supplier prefix code from the callee field **358** and in this embodiment, the symbol is a number sign (#) as illustrated in Figure **25**. Referring back to Figure **15**, the callee field **358** holds a copy of the contents of the callee ID buffer **209** of Figure **7**. The route field **360** holds a domain name or an IP address of a gateway or supernode

-37-

that is to carry the call and the TTL field **362** holds a value representing the number of seconds the call is permitted to be active, based on subscriber available minutes and other billing parameters, for example.

5 Desirably, the time to live field holds a number indicating a maximum call time for the call and where the call is an emergency call, desirably the maximum call time exceeds a duration of an average non-emergency telephone call. The caller ID field **364** holds a caller identifier which in this case, is the temporary or pre-associated DID number from the DID record associated with
10 the caller.

Referring to Figure **8A** and Figure **16**, a routing message produced by the RC processor circuit **200** at block **287** is shown generally at **366** and includes only the callee field **358**, route field **360**, TTL field **362** and caller ID field **364**.

15 The callee field **358** holds the full username of the callee, and where the call is an emergency call as shown, the full username of the callee is the username of the emergency response center. The route field **360** contains the identification of the domain with which the emergency response center is associated, i.e., sp.yvr.digifonica.com. The TTL field holds the value **9999** set
20 at block **157** in Figure **8A** and the caller ID field **364** holds the DID identifier associated with the caller. Block **380** then directs the RC processor circuit to send the routing message shown in Figure **16** to the call controller **14** (Figure **1**).

25 Referring to Figure **8A**, if at block **281**, the emergency call flag is not set, the call is not an emergency call, and the RC processor is directed to block **350** which causes it to direct the RC processor circuit **200** to load the routing message buffer with information identifying the supernode in the system with
30 which the callee is associated and to set a time to live for the call to a high value such as **9999**. The supernode, with which the callee is associated, is determined by using the callee username stored in the callee ID buffer **209** to

-38-

address a supernode table having records of the type as shown at **370** in Figure **17**.

5 Referring to Figure **17**, each prefix to a supernode table record **370** has a prefix field **372** and a supernode address field **374**. The prefix field **372** includes the first n digits of the callee identifier. In this case n=1. The supernode address field **374** holds a code representing the IP address or a fully qualified domain name (FQDN) of the supernode associated with the code stored in the prefix field **372**. Referring to Figure **18**, for example, if the
10 prefix is **4**, the supernode address associated with that prefix is sp.lhr.digifonica.com, identifying the London supernode (**21** in Figure **1**), for example. After the routing message buffer has been loaded with identification of the supernode, block **380** of Figure **8A** directs the RC processor circuit to send the routing message shown in Figure **16A** to the call controller **14**
15 (Figure **1**).

Subscriber to Subscriber Calls Within the Same Node

Referring back to Figure **8A**, if at block **275**, the callee identifier stored in the callee ID buffer **209** (Figure **7**) has a prefix that identifies the same supernode
20 as that associated with the caller, block **559** directs the RC processor circuit **200** to determine whether or not the emergency call flag **211** of Figure **7** has been set. If at block **559**, the RC processor circuit **200** determines that the emergency call flag **211** is set, the RC processor circuit **200** is directed to resume processing at block **283** to scan the DID bank table to determine
25 whether the caller has a DID record and to assign a temporary DID number if necessary, as described above and then to send a routing message of the type shown in Figure **16** to the call controller.

If at block **559** the emergency call flag has not been set, regular non-emergency call processing ensues beginning with block **600** which directs the
30 RC processor circuit **200** to use the callee identifier to locate and retrieve a dialling profile for the callee identified by the callee identifier stored in the

-39-

5 callee ID buffer **209**. The dialling profile is of the type shown in Figure **9**, and may contain data as shown in Figure **11**, for example. In this case the same-node subscriber is the Calgary subscriber. Block **602** of Figure **8A** directs the RC processor circuit **200** to get call block, call forward and voicemail tables from the database **18** based on the username identified in the callee dialling profile retrieved by the RC processor circuit at block **600**. Call block, call forward and voicemail tables have records as shown in Figures **26**, **28** and **30** for example.

10 Referring to Figure **26**, the call block records include a username field **604** and a block pattern field **606**. The username field **604** holds a username matching the username in the username field **258** of the dialling profile (Figure **9**) associated with the callee, and the block pattern field **606** holds one or more E.164-compatible numbers or usernames identifying PSTN telephone
15 numbers or system subscribers from whom the subscriber identified by the contents of the username field **604** does not wish to receive calls.

Referring back to Figure **8A** and referring to Figure **27**, block **608** directs the RC processor circuit **200** to determine whether or not the caller identifier
20 matches a block pattern stored in the block pattern field **606** of the call block record associated with the callee identified by the contents of the username field **604** in Figure **26**. If the caller identifier matches a block pattern stored in the field **606**, block **610** directs the RC processor circuit **200** to send a drop call or non-completion message to the call controller **14** and the process **250**
25 is ended. If the caller identifier does not match a block pattern associated with the callee, block **612** directs the RC processor circuit **200** to determine whether or not call forwarding is required.

Referring to Figure **28**, records in the call forwarding table include a username
30 field **614**, a destination number field **616** and a sequence number field **618**. The username field **614** stores a code representing a username of a subscriber with whom the call forwarding record is associated. The destination

-40-

number field **616** holds a username or E.**164** number representing a number to which the current call should be forwarded, and the sequence number field **618** holds an integer number indicating the order in which the username associated with the corresponding destination number field should be attempted for call forwarding. The call forwarding table may have a plurality of records for a given subscriber. The RC processor circuit **200** uses the contents of the sequence number field **618** to place the records for a given subscriber in order. As will be appreciated below, this enables the call forwarding numbers to be tried in an ordered sequence.

Referring back to Figure **8A** and referring to Figure **28**, if at block **612**, the call forwarding record for the callee identified by the callee identifier contains no contents in the destination number field **616** and accordingly no contents in the sequence number field **618**, then there are no call forwarding entries and the RC processor circuit **200** is directed to load the routing message buffer shown in Figure **32** with the callee username, domain and time to live as shown at **650**. The RC processor circuit **200** is then directed to block **620** in Figure **8C**. However, if there are contents in the call forwarding record as shown in Figure **29**, block **622** shown in Figure **8A** directs the RC processor circuit **200** to search the dialling profile table in the database **18** to find a dialling profile record of the type shown in Figure **9**, for the callee identified in the destination number field **616** of the first call forwarding record and to store the contents in the routing message buffer. The RC processor circuit **200** is then directed to load the contents of the domain field **260** associated with the dialing profile specified by the contents of the destination number field **616** of the first call forwarding record into the routing message buffer as shown at **652** in Figure **32**. This process is repeated for each call forwarding record associated with the callee identified by the callee identifier to add to the routing message buffer all call forwarding usernames and domains associated with the callee.

-41-

Referring to Figure 8C, at block 620 the RC processor circuit 200 is directed to determine whether or not the user identified by the callee identifier has paid for voicemail service and this is done by checking to see whether or not a flag 630 is set in a voicemail record of the type shown in Figure 30 in a voicemail table stored in the database 18 in Figure 1.

Referring to Figure 30, voicemail table records include a username field 624, a voicemail server field 626, a seconds-to-voicemail field 628 and an enabled field 630. The username field 624 stores the username of the subscriber who purchased the service. The voicemail server field 626 holds a code identifying an IP address or a fully qualified domain name (FQDN) of a voicemail server associated with the subscriber identified by the username field 624. The seconds-to-voicemail field 628 holds a code identifying the time to wait before engaging voicemail and the enable field 630 holds a code representing whether or not voicemail is enabled for the user identified by the contents of the username field 624. Therefore, referring back to Figure 8C, at block 620 the RC processor circuit 200 finds a voicemail record as shown in Figure 31 having username field 624 contents matching the callee identifier and examines the contents of the enabled field 630 to determine whether or not voicemail is enabled. If voicemail is enabled, then block 640 in Figure 8C directs the RC processor circuit 200 to store the contents of the voicemail server field 626 of Figure 31, and the contents of the seconds to voicemail field 628 of Figure 31 in the routing message buffer as shown at 654 in Figure 32.

Referring back to Figure 8C, block 642 then directs the processor to get time to live (TTL) values for each route specified by the routing message according to any of a plurality of criteria such as, for example, the cost of routing and the user's account balance. These TTL values are then appended to corresponding routes already stored in the routing message buffer. Block 643 then directs the RC processor circuit 200 to store the TTL value determined at

-42-

block **642** in the routing message buffer. In the routing message shown in Figure **32**, the time to live value is set at **60** seconds, for example.

5 Block **644** of Figure **8C** then directs the RC processor circuit **200** to store the IP address or FQDN of the current supernode in the routing message buffer as shown at **656** in Figure **32**. An exemplary routing message for a subscriber to subscriber call on the same node is thus shown in the routing message buffer shown in Figure **32**.

10 Subscriber to Non-Subscriber Calls

Not all calls will be subscriber-to-subscriber calls and this will be detected by the RC processor circuit **200** when it executes block **269** of Figure **8B** and does not find a DID bank table record associated with the callee in the DID bank table. This may be the case, for example, where the Emergency Response Center (ERC) is not a subscriber to the system. When this occurs, the RC processor circuit **200** is directed to block **408** in Figure **8B** which causes it to set the contents of the callee identifier buffer **209** equal to the reformatted callee identifier, i.e., the E.164 compatible number produced prior to block **263** in Figure **8B**. Block **409** then directs the RC processor circuit **200** to determine whether the emergency call flag **211** in Figure **7** has been set. If the emergency call flag is set, block **411** in Figure **8D** directs the RC processor to search the DID bank table to attempt to locate a DID record having DID field (**274**, Figure **13**) contents matching the contents of the caller identifier stored in the caller ID buffer (**205** in Figure **7**).

25 If no such DID record is found, the RC processor circuit **200** has effectively determined that the caller identifier is not associated with a pre-associated DID identifier. In this case, block **413** then directs the RC processor circuit **200** to associate a temporary DID identifier with the caller identifier by associating with the caller identifier a DID identifier from the pool of pre-determined DID identifiers. Again, this is done by creating and associating with the caller a temporary DID record of the type shown in Figure **13**.

30

-43-

After a temporary DID record has been created or if the caller already has a DID record, block **415** directs the RC processor circuit to store the DID number (**274** in Figure **13**) in the caller ID buffer **209** in Figure **7**.

5

After having loaded the caller ID buffer **209** with the temporary or pre-associated DID number, or after having determined that the emergency call flag is not set, block **410** (Figure **8B**) directs the RC processor circuit **200** to initiate a process for identifying gateways to the PSTN through which the call will be established. This process begins with block **410** which directs the RC processor circuit **200** to address a master list having records of the type shown in Figure **19**.

10

Each master list record includes a master list ID field **500**, a dialling code field **502**, a country code field **504**, a national sign number field **506**, a minimum length field **508**, a maximum length field **510**, a NDD field **512**, an IDD field **514** and a buffer rate field **516**.

15

The master list ID field **500** holds a unique code such as **1019**, for example, identifying the record. The dialling code field **502** holds a predetermined number pattern that the RC processor circuit **200** uses at block **410** in Figure **8B** to find the master list record having a dialling code matching the first few digits of the reformatted callee identifier. The country code field **504** holds a number representing the country code associated with the record and the national sign number field **506** holds a number representing the area code associated with the record. (It will be observed that the dialling code **502** is a combination of the contents of the country code field **504** and the national sign number field **506**.) The minimum length field **508** holds a number representing the minimum number of digits that can be associated with the record and the maximum length field **510** holds a number representing the maximum number of digits in a number with which the record may be compared. The NDD field **512** holds a number representing an access code used to make a call within

25

30

-44-

the country specified by the country code **504** and IDD field **514** holds a number representing the international prefix needed to dial a call from the country indicated by the country code.

5 Thus, for example, a master list record may have a format as shown in Figure **20** with exemplary field contents as shown.

Referring back to Figure **8B**, using the country code and area code portions of the reformatted callee identifier that has been formatted for compatibility with the E.**164** standard, block **410** directs the RC processor circuit **200** to find a master list record such as the one shown in Figure **20** having a dialling code that matches the country code and area code of the reformatted callee identifier held in the callee identifier buffer **209**. Thus, in this example, the RC processor circuit **200** might find a master list record having an ID field with the number **1019**. This number may be also referred to as a route ID number. Thus, a route ID number is found in the master list record associated with a predetermined number pattern in the reformatted callee identifier.

After execution of block **410** in Figure **8B**, the process **250** continues as shown in Figure **8D**. Referring to Figure **8D**, block **412** directs the RC processor circuit **200** to use the route ID number determined at block **410** to locate at least one supplier record identifying a supplier operable to supply a communications link for this route. To do this, block **412** directs the RC processor circuit **200** to search a supplier ID table having records of the type shown in Figure **21**.

Referring to Figure **21**, supplier list records include a supplier ID field **540**, a master list ID field **542**, an optional prefix field **544**, a route identifier field **546**, a NDD/IDD rewrite field **548** and a rate field **550**. The supplier ID field **540** holds a code identifying the name of the supplier and the master list ID field **542** holds a code for associating the supplier record with the master list record. The prefix field **544** optionally holds a string used to identify the

-45-

supplier traffic and the route identifier field **546** holds an IP address of a gateway operated by the supplier indicated by the supplier ID field **540**. The NDD/IDD rewrite field **548** holds a code and the rate field **550** holds a code indicating the cost per second to the system operator to use the route through
5 the gateway specified by the contents of the route identifier field **546**. Exemplary supplier records are shown in Figures **22**, **23** and **24** for Telus, Shaw and Sprint, respectively, for example.

Referring back to Figure **8D**, at block **412** the RC processor circuit **200** finds
10 all supplier records that contain the master list ID found at block **410** of Figure **8B**.

Block **560** of Figure **8D** directs the RC processor circuit **200** to begin to produce routing messages. To do this, the RC processor circuit **200** loads a routing message buffer as shown in Figure **25** with a supplier prefix of the
15 least costly supplier where the least costly supplier is determined from the rate fields **550** of the records associated with respective suppliers.

Referring to Figures **22-24**, in the embodiment shown, the supplier "Telus"
20 has the lowest number in the rate field **550** and therefore the prefix **4973** associated with that supplier is loaded into the routing message buffer shown in Figure **25** first. At block **562**, the prefix **4973** is then delimited by the number sign (as defined by the contents of the delimiter field **356** in the routing message format **352** in Figure **15**) and the reformatted callee identifier is next
25 loaded into the routing message buffer after the delimiter . Then, the contents of the route identifier field **546** of the record associated with the supplier Telus are added to the message after an @ sign delimiter and then block **564** in Figure **8D** directs the RC processor circuit **200** to get a TTL value (algorithm not shown), which in this embodiment may be **3600** seconds, for example.
30 Block **566** of Figure **8D** then directs the RC processor circuit **200** to append this TTL value to the contents already in the routing message buffer shown in Figure **25**. Block **567** of Figure **8D** then directs the processor circuit to append

-46-

the contents of the caller ID buffer **205** of Figure **7** to the contents already in the routing message buffer shown in Figure **25**. Accordingly, the first part of the routing message is shown generally at **570** in Figure **25**.

5 Referring back to Figure **8D**, block **571** directs the RC processor circuit **200** back to block **560** and causes it to repeat blocks **560**, **562**, **564**, **566** and **567** for each successive supplier until the routing message buffer is loaded with information pertaining to each supplier. Thus, the second portion of the routing message is shown at **572** in Figure **25** and this second portion relates
10 to the second supplier identified by the record shown in Figure **23** and referring back to Figure **25**, the third portion of the routing message is shown at **574** which is associated with a third supplier as indicated by the supplier record shown in Figure **24**. Consequently, referring to Figure **25**, the routing message buffer holds a routing message identifying a plurality of different
15 suppliers able to provide gateways to establish a communication link to permit the caller to contact the callee. Each of the suppliers is identified, in succession, according to rate contained in the rate field **550** of the supplier list record shown in Figure **21**, in this embodiment. Other criteria for determining the order in which suppliers are listed in the routing message may include
20 preferred supplier priorities which may be established based on service agreements, for example.

Response to Routing Message

Referring back to Figure **1**, the routing message of the type shown in Figures
25 **16**, **16A**, **25** or **32**, is received at the call controller **14**. It will be recalled that the call controller **14** already has the original SIP invite message shown in Figure **3**. Referring to Figure **4**, the program memory **104** of the call controller **14** includes a routing-to-media relay routine depicted generally at **122**.

30 Referring to Figure **38**, the routing to media relay routine **122** directs the processor to participate in a process for establishing audio paths. Assume the call is directed to the ERC.

-47-

As a first step in the process for establishing audio paths, a message **1100** is sent from the call controller **14** to the media relay **17**, the message including the call ID, the caller telephone IP address and UDP port as determined from the caller IP address field **67** and caller UDP port field **69** in the SIP Invite message **59** shown in broken outline.

In response, the media relay (MR) **17** sends a confirmation message **1102** back to the call controller **14**, the message including a media relay IP address (**192.168.2.10**) and UDP port number (**22123**) defining a callee socket that the media relay will use to establish an audio path to the ERC telephone or a PSTN gateway to the ERC, where the Emergency Response Center is only available through the PSTN

The call controller **14** then sends a SIP Invite message **1104** of type shown in Figure **3** to the callee telephone **15** (or PSTN gateway), to advise the callee that telephone of the socket the media relay expects to use for audio communication with the caller telephone. The SIP invite message includes the caller and callee identifiers (**60** and **62**), the call ID (**65**) and the media relay **17** IP address (**192.168.2.10**) and the media relay UDP port number (**22123**) assigned to the callee socket as received from the confirmation message **1102**. The caller identifier may be that which was associated with the caller at blocks **413** in Figure **8D** or block **285** in Figure **8A**, for example, or may be the DID associated with the caller as determined from a DID record already associated with the caller. Such caller identifier, as obtained from the routing message, may be used as calling line identification (CLID) information and may be caused to appear on a display of the callee telephone, which is particularly advantageous where the callee telephone is one at an ERC. Such CLID information provides an ERC operator with callback information, enabling the operator to call back the caller who made the emergency call. Since the temporarily assigned DID records persist for some time after the emergency call has taken place, the ERC operator can call back the person

-48-

who made the emergency call during a period of time after the emergency call is terminated. In this embodiment, assume the callee telephone identifies its socket as IP address **192.168.3.10** and UDP port **33123**.

5 The callee (ERC) telephone **33** of Figure **1** (or PSTN gateway) stores the media relay **17** IP address (**192.168.2.10**) and assigned UDP port number (**22123**) and configures itself to create a socket for an audio path between the media relay. Referring to Figures **1** and **38** the callee telephone **15** (or PSTN gateway) then sends a SIP OK message **1106** back to the call controller **14**,
10 the message including the CALL ID, the callee IP address (**192.168.3.10**) and UDP port number (**33123**) to advise the call controller of the socket at which it expects to use for audio communications with the media relay **17**.

The call controller **14** then sends a message **1108** to the media relay **17**
15 including the IP address (**192.168.3.10**) and UDP port number (**33123**) identifying the socket at that the callee telephone **15** (or PSTN gateway) that is to be used for audio communications with the media relay. The media relay **17** then creates a caller socket identified by IP address **192.168.2.10** and UDP port number **22125** and creates an internal bridge for relaying audio
20 traffic between the caller socket (**192.168.2.10: 22125**) and the callee socket (**192.168.2.10: 22123**).

The media relay **17** then sends a message **1110** including the call ID and the IP address (**192.168.2.10**) and UDP port number (**22125**) identifying the caller
25 socket that the media relay assigned to the caller telephone **12**, back to the call controller **14** to indicate that the caller and callee sockets have been established and that the call can proceed.

The call controller **14** then sends a SIP OK message **1112** to the caller
30 telephone **12** to indicate that the call may now proceed. The SIP OK message includes the caller and callee usernames, the call ID and the IP address

-49-

(**192.168.2.10**) and UDP port number (**22125**) identifying the caller socket at the media relay **17**.

Alternatively, referring back to Figure **1**, if the routing message is of a type that identifies a domain associated with another supernode in the system, the call controller **14** may communicate with a different media relay (for example **27**) adapted to establish the above-mentioned links between separate media relays associated with respective supernodes, where the IP network links are provided by the communications medium **23**.

In the case of an emergency call, the routing message is unlikely to identify a domain other than that of the caller.

In the case of a regular, non-emergency call, if the routing message is of the type shown in Figure **25** where there are a plurality of suppliers available, the process proceeds as described above with the exception that instead of communicating with the callee telephone directly, the call controller **14** communicates with a gateway provided by a supplier. If a SIP OK message is not received back from the first gateway, the processor is directed to send the SIP Invite message **1104** to a gateway of the next indicated supplier. For example, the call controller **14** sends the SIP Invite message **1104** to the first supplier, in this case Telus, to determine whether or not Telus is able to handle the call. If Telus does not send back an OK message **1106** or sends a message indicating that it is not able to handle the call, the call controller proceeds to send a SIP Invite message **1104** to the next supplier, in this case Shaw. The process is repeated until one of the suppliers responds with a SIP OK message **1106** indicating that it is available to carry the call and the process proceeds as shown in connection with messages **1108**, **1110** and **1112**.

Referring to Figure **2**, in response to receiving the SIP OK message **1112** at the network interface **48**, the microprocessor **32** of the caller telephone **12**

-50-

stores the media relay IP address (192.168.2.10) and UDP port number (22125) identifying the caller socket at the media relay in an audio path IP address buffer 47 in the temporary memory 40. The microprocessor 32 is now ready to transfer audio signals and from the handset and the media relay 17 using the sockets created above.

Referring back to Figure 1, if the call is a regular, non-emergency call, and the call controller 14 receives a message of the type shown in Figure 32, i.e., a type which has one call forwarding number and/or a voicemail number, the call controller attempts to establish a call (using message 1104 in Figure 38) to the callee telephone 15 and if no call is established (i.e., message 1106 in Figure 38 is not received) within the associated TTL (3600 seconds), the call controller 14 attempts to establish a call with the next user identified in the call routing message. This process is repeated until all call forwarding possibilities have been exhausted after respective times to live, in which case an audio path is established with the voicemail server 19 identified in the routing message. The voicemail server 19 sends message 1106 in response to receipt of message 1104 and functions as described above in connection with the callee telephone 15 to permit an outgoing audio message provided by the voicemail server to be heard by the caller and to permit the caller to record an audio message on the voicemail server.

When audio paths are established, a call timer (not shown) maintained by the call controller logs the start date and time of the call and logs the call ID and an identification of the route (i.e., audio path IP address) for later use in billing, for example.

Terminating the Call

In the event that either the caller or the callee (or callee via the PSTN) terminates a call, the telephone of the terminating party (or gateway associated with the terminating party) sends a SIP Bye message to the call controller 14. An exemplary SIP Bye message is shown at 900 in Figure 33

-51-

and includes a caller field **902**, a callee field **904** and a call ID field **906**. The caller field **902** holds the caller username, the callee field **904** holds a PSTN compatible number or username, and the call ID field **906** holds a unique call identifier field of the type shown in the caller ID field **65** of the SIP Invite message shown in Figure **3**.

Thus, when terminating a regular non-emergency call, such as initiated by the Vancouver subscriber to the Calgary subscriber for example, referring to Figure **34**, a SIP Bye message is produced as shown generally at **908** and the caller field **902** holds a username identifying the Vancouver caller, in this case **2001 1050 8667**, the callee field **904** holds a username identifying the Calgary callee, in this case **2001 1050 2222**, and the callee ID field **906** holds the code **FA10 @ 192.168.0.20**, which is the call ID for the call.

The SIP Bye message shown in Figure **34** is received at the call controller **14** and the call controller executes a process as shown generally at **910** in Figure **35**. The process includes a first block **912** that directs the call controller circuit **100** to copy the caller, callee and call ID field contents from the SIP Bye message **900** shown in Figure **33** received from the terminating party to corresponding fields of an RC Call Stop message buffer (not shown). Block **914** then directs the call controller circuit **100** to copy the call start time from the call timer and to obtain a Call Stop time from the call timer. Block **916** then directs the call controller to calculate a communication session time by determining the difference in time between the call start time and the call stop time. This communication session time is then stored in a corresponding field of the RC Call Stop message buffer. Block **918** then directs the call controller circuit **100** to copy the route identifier from the call log. An RC Call Stop message produced as described above is shown generally at **1000** in Figure **36**. An RC Call Stop message specifically associated with the call made to the Calgary callee is shown generally at **1020** in Figure **37**.

-52-

Referring to Figure 36, the RC Call Stop message includes a caller field **1002**, callee field **1004**, a call ID field **1006**, an account start time field **1008**, an account stop time field **1010**, a communication session time **1012** and a route field **1014**. The caller field **1002** holds a username, the callee field **1004** holds a PSTN-compatible number or system number, the call ID field **1006** holds the unique call identifier received from the SIP Invite message shown in Figure 3, the account start time field **1008** holds the date and start time of the call, the account stop time field **1010** holds the date and time the call ended, the account session time field **1012** holds a value representing the difference between the start time and the stop time, in seconds, and the route field **1014** holds the IP address for the communications link that was established.

Referring to Figure 37, an exemplary RC stop call message for the Calgary callee is shown generally at **1020**. In this example the caller field **1002** holds the username **2001 1050 8667** identifying the Vancouver caller and the callee field **1004** holds the username **2001 1050 2222** identifying the Calgary callee. The contents of the call ID field **1006** are **FA10 @ 192.168.0.20**. The contents of the accounting start time field **1008** are **2006-12-30 12:12:12** and the contents of the accounting stop time field are **2006-12-30 12:12:14**. The contents of the communication session time field **1012** are **2** to indicate **2** seconds call duration and the contents of the route field are **72.64.39.58**.

Referring back to Figure 35, after having produced an RC Call Stop message, block **920** directs the call controller circuit **100** to send the RC stop message contained in the RC Call Stop message buffer to the routing controller **16**.

The routing controller **16** receives the Call Stop message and an RC Call Stop message process is invoked at the RC to deal with charges and billing for the call.

Block **922** directs the call controller circuit **100** to send a Bye message back to the party that did not terminate the call.

-53-

Block **924** then directs the call controller circuit **100** to send a "Bye" message of the type shown in Figure **33** to the media relay **17** to cause the media relay to delete the caller and callee sockets it established for the call and to delete the bridge between the sockets.

5

While specific embodiments of the invention have been described and illustrated, such embodiments should be considered illustrative of the invention only and not as limiting the invention as construed in accordance with the accompanying claims.

10

-54-

What is claimed is:

1. A process for handling emergency calls from a caller in a voice over IP system, the method comprising:

5 receiving a routing request message including a caller identifier and a callee identifier;

setting an emergency call flag active in response to said callee identifier matching an emergency call identifier pre-associated with the caller;

10

producing an emergency response center identifier in response to said emergency call identifier;

15 determining whether said caller identifier is associated with a pre-associated direct inward dialing (DID) identifier;

producing a direct inward dialing (DID) identifier for said caller by associating a temporary DID identifier with said caller identifier when said emergency call flag is active and it is determined that said caller has no pre-associated DID identifier;

20

producing a routing message including said emergency response center identifier and said temporary DID identifier for receipt by a routing controller operable to cause a route to be established between the caller and said emergency response center.

25

2. The process of claim 1 wherein setting said emergency call flag active comprises retrieving a dialing profile associated with the caller and setting said emergency call flag active when the contents of an

30

-55-

emergency call identifier field of said dialing profile match said callee identifier.

- 5
3. The process of claim 2 wherein determining whether said caller identifier is associated with a pre-associated DID identifier comprises searching a database for a DID record associating a DID identifier with said caller and determining that said caller identifier is associated with a pre-associated DID identifier when said record associating a DID identifier with said caller is found.
- 10
4. The process of claim 3 wherein associating a pre-assigned DID identifier with said caller identifier comprises copying said pre-associated DID identifier from said DID record to a DID identifier buffer.
- 15
5. The process of claim 4 wherein producing said routing message comprises causing the contents of said DID identifier buffer to define said DID identifier in said routing message.
- 20
6. The process of claim 2 wherein determining whether said caller identifier is associated with a pre-associated DID identifier comprises searching a database for a DID record associating a DID identifier with said caller and determining that said caller identifier is not associated with a pre-associated DID identifier when a record associating a DID identifier with said caller is not found.
- 25
7. The process of claim 6 wherein associating a temporary DID identifier with said caller identifier comprises associating with said caller identifier a DID identifier from a pool of pre-determined DID identifiers.
- 30
8. The process of claim 7 wherein associating said DID identifier from said pool comprises associating a temporary DID record with said

-56-

caller, said temporary DID record having a DID identifier field populated with said DID identifier from said pool.

- 5 **9.** The process of claim **8** wherein associating said DID identifier from said pool comprises copying said DID identifier from said temporary DID record to a DID identifier buffer.
- 10 **10.** The process of claim **9** wherein producing said routing message comprises causing the contents of said DID identifier buffer to define said DID identifier in said routing message.
- 11.** The process of claim **8** further comprising canceling said temporary DID record after a pre-defined period of time.
- 15 **12.** The process of claim **2** wherein producing said emergency response center identifier comprises obtaining an emergency response center identifier from an emergency response center field of said dialing profile associated with said caller.
- 20 **13.** The process of claim **12** wherein obtaining comprises copying an emergency response center identifier from said dialing profile associated with said caller to a routing message buffer such that the emergency response center identifier is included in the routing message.
- 25 **14.** The process of claim **1** wherein producing said routing message comprises causing said routing message to specify a maximum call time for said emergency call, said maximum call time exceeding a duration of an average non-emergency telephone call.
- 30 **15.** An apparatus for handling emergency calls from a caller in a voice over IP system, the apparatus comprising:

-57-

means for receiving a routing request message including a caller identifier and a callee identifier;

5 setting means for setting an emergency call flag active in response to said callee identifier matching an emergency call identifier pre-associated with the caller;

10 means for producing an emergency response center identifier in response to said emergency call identifier;

15 means for determining whether said caller identifier is associated with a pre-associated direct inward dialing (DID) identifier; and

 means for producing a direct inward dialing (DID) identifier for said caller including:

20 means for associating a temporary DID identifier with said caller identifier in response to said emergency call flag being active and said caller not being pre-associated with a direct inward dialing identifier; and

25 means for producing a routing message including said emergency response center identifier and said temporary DID identifier or said pre-assigned DID identifier for receipt by a routing controller operable to cause a route to be established between the caller and said emergency response center.

30

16. The apparatus of claim 15 further comprising means for accessing a database of dialing profiles associated with respective subscribers to

-58-

5 said system, each of said dialing profiles including an emergency call identifier field and an emergency call center field and wherein said setting means comprises means for retrieving a dialing profile associated with the caller and for setting said emergency call flag active when the contents of said emergency call identifier field of said dialing profile match said callee identifier.

10 17. The apparatus of claim 16 further comprising database accessing means for accessing a database including direct inward dialing (DID) records associated with at least some subscribers to said system, each of said direct inward dialing records comprising a system username and a direct inward dialing number, and wherein said determining means comprises searching means for a database for a DID record associating a DID identifier with said caller and wherein said determining means is operably configured to determine that said caller identifier is associated with a pre-associated DID identifier when said record associating a DID identifier with said caller is found.

20 18. The apparatus of claim 17 further comprising a DID identifier buffer and wherein said means for associating a pre-assigned DID identifier with said caller identifier comprises means for copying said pre-associated DID identifier from said DID record to said DID identifier buffer.

25 19. The apparatus of claim 18 wherein said means for producing said routing message comprises means for causing the contents of said DID identifier buffer to define said DID identifier in said routing message.

30 20. The apparatus of claim 16 further comprising database accessing means for accessing a database including direct inward dialing records associated with at least some subscribers to said system, each of said direct inward dialing records comprising a system username and a

-59-

5 direct inward dialing number and wherein said determining means comprises searching means for searching a database for a DID record associating a DID identifier with said caller and wherein said determining means is operably configured to determine that said caller identifier is not associated with a pre-associated DID identifier when a record associating a DID identifier with said caller is not found.

10 **21.** The apparatus of claim **18** further comprising means for accessing a pool of pre-determined DID identifiers and wherein said means for associating a temporary DID identifier with said caller identifier comprises means for associating a DID identifier from said pool of pre-determined DID identifiers with said caller identifier.

15 **22.** The apparatus of claim **20** wherein said means for associating said DID identifier from said pool comprises means for associating a temporary DID record with said caller, said temporary DID record having a DID identifier field populated with said DID identifier from said pool.

20 **23.** The apparatus of claim **22** wherein said means for associating comprises means for copying said DID identifier from said temporary DID record to a DID identifier buffer.

25 **24.** The apparatus of claim **22** wherein said means for producing said routing message comprises means for causing the contents of said DID identifier buffer to define said DID identifier in said routing message.

30 **25.** The apparatus of claim **22** further comprising means for canceling said temporary DID record after a period of time.

26. The apparatus of claim **16** wherein said means for producing said emergency response center identifier comprises means for obtaining

-60-

an emergency response center identifier from an emergency response center field of said dialing profile associated with said caller.

5 **27.** The apparatus of claim **26** further comprising a routing message buffer and wherein said means for obtaining comprises means for copying the contents of said emergency response center field of said dialing profile associated with said caller to the routing message bufer such that said contents of said emergency response center field are included in said routing message.

10

28. The apparatus of claim **27** wherein said means for producing said routing message comprises means for causing said routing message to include a maximum call time for said emergency call, said maximum call time exceeding a duration of an average non-emergency telephone call.

15

29. An apparatus for handling emergency calls from a caller in a voice over IP system, the apparatus comprising a processor circuit operably configured to:

20

receive a routing request message including a caller identifier and a callee identifier;

25

set an emergency call flag active in response to said callee identifier matching an emergency call identifier pre-associated with the caller;

30

produce an emergency response center identifier in response to said emergency call identifier;

determine whether said caller identifier is associated with a pre-associated direct inward dialing (DID) identifier;

-61-

5 produce a direct inward dialing (DID) identifier for said caller by associating a temporary DID identifier with said caller identifier when said emergency call flag is active and it is determined that said caller has no pre-associated DID identifier; and

10 produce a routing message including said emergency response center identifier and said temporary DID identifier for receipt by a routing controller operable to cause a route to be established between the caller and said emergency response center.

15 **30.** The apparatus of claim **29** wherein said processor circuit is operably configured to retrieve a dialing profile associated with the caller and set said emergency call flag active when the contents of an emergency call identifier field of said dialing profile match said callee identifier.

20 **31.** The apparatus of claim **30** wherein said processor circuit is operably configured to search a database for a DID record associating a DID identifier with said caller and determine that said caller identifier is associated with a pre-associated DID identifier when said record associating a DID identifier with said caller is found.

25 **32.** The apparatus of claim **31** wherein said processor circuit is operably configured to copy said pre-associated DID identifier from said DID record to a DID identifier buffer.

30 **33.** The apparatus of claim **32** wherein said processor circuit is operably configured to cause the contents of said DID identifier buffer to define said DID identifier in said routing message.

34. The apparatus of claim **30** wherein said processor circuit is operably configured to search a database for a DID record associating a DID

-62-

identifier with said caller and determine that said caller identifier is not associated with a pre-associated DID identifier when a record associating a DID identifier with said caller is not found.

- 5 **35.** The apparatus of claim **32** wherein said processor circuit is operably configured to associate with said caller identifier a DID identifier from a pool of pre-determined DID identifiers.
- 10 **36.** The apparatus of claim **35** wherein said processor circuit is operably configured to associate a temporary DID record with the caller, said temporary DID record having a DID identifier field populated with said DID identifier from said pool.
- 15 **37.** The apparatus of claim **36** wherein said processor circuit is operably configured to copy said DID identifier from said temporary DID record to a DID buffer.
- 20 **38.** The apparatus of claim **35** wherein said processor circuit is operably configured to cause the contents of said DID identifier buffer to define said DID identifier in said routing message.
- 39.** The apparatus of claim ~~**36**~~ wherein said processor circuit is operably configured to cancel said temporary DID record after a period of time.
- 25 **40.** The apparatus of claim **30** wherein said processor circuit is operably configured to obtain an emergency response center identifier from an emergency response center field of said dialing profile associated with said caller.
- 30 **41.** The apparatus of claim **40** further comprising a routing message buffer and wherein said processor circuit is operably configured to copy an emergency response center identifier from said dialing profile

-63-

associated with said caller to said routing message buffer such that said emergency response center identifier is included in said routing message.

- 5 **42.** The apparatus of claim **29** wherein said processor circuit is operably configured to cause said routing message to include a maximum call time for said emergency call, said maximum call time exceeding a duration of an average non-emergency telephone call.
- 10 **43.** A computer readable medium encoded with codes for directing a processor circuit to handle emergency calls from callers in a voice over IP system, said codes directing said processor circuit to:
- 15 receive a routing request message including a caller identifier and a callee identifier;
- set an emergency call flag active in response to said callee identifier matching an emergency call identifier pre-associated with the caller;
- 20 produce an emergency response center identifier in response to said emergency call identifier;
- determine whether said caller identifier is associated with a pre-associated direct inward dialing (DID) identifier;
- 25 produce a direct inward dialing (DID) identifier for said caller by associating a temporary DID identifier with said caller identifier when said emergency call flag is active and it is determined that
- 30 said caller has no pre-associated DID identifier; and

-64-

produce a routing message including said emergency response center identifier and said temporary DID identifier for receipt by a routing controller operable to cause a route to be established between the caller and said emergency response center.

5

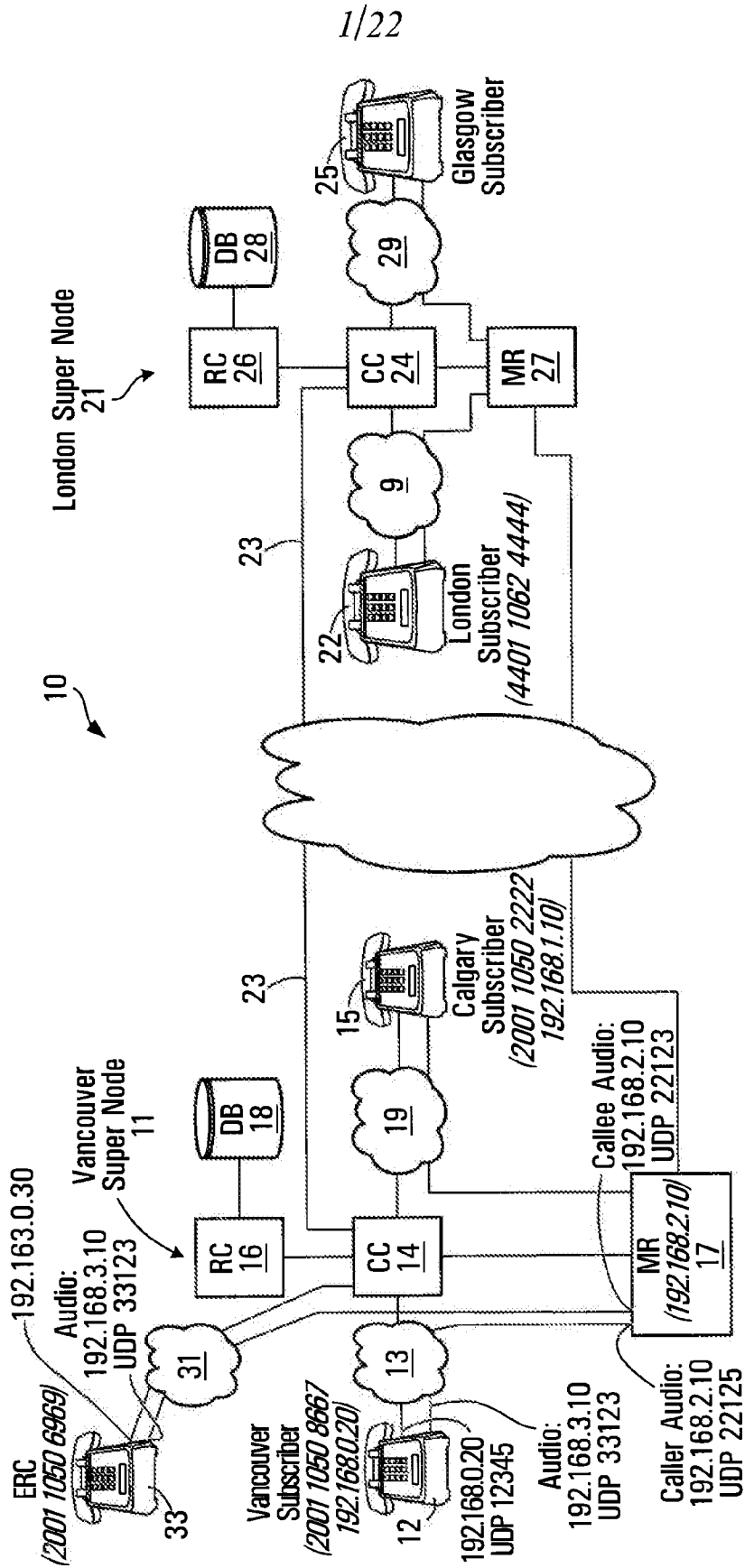

FIG. 1

2/22

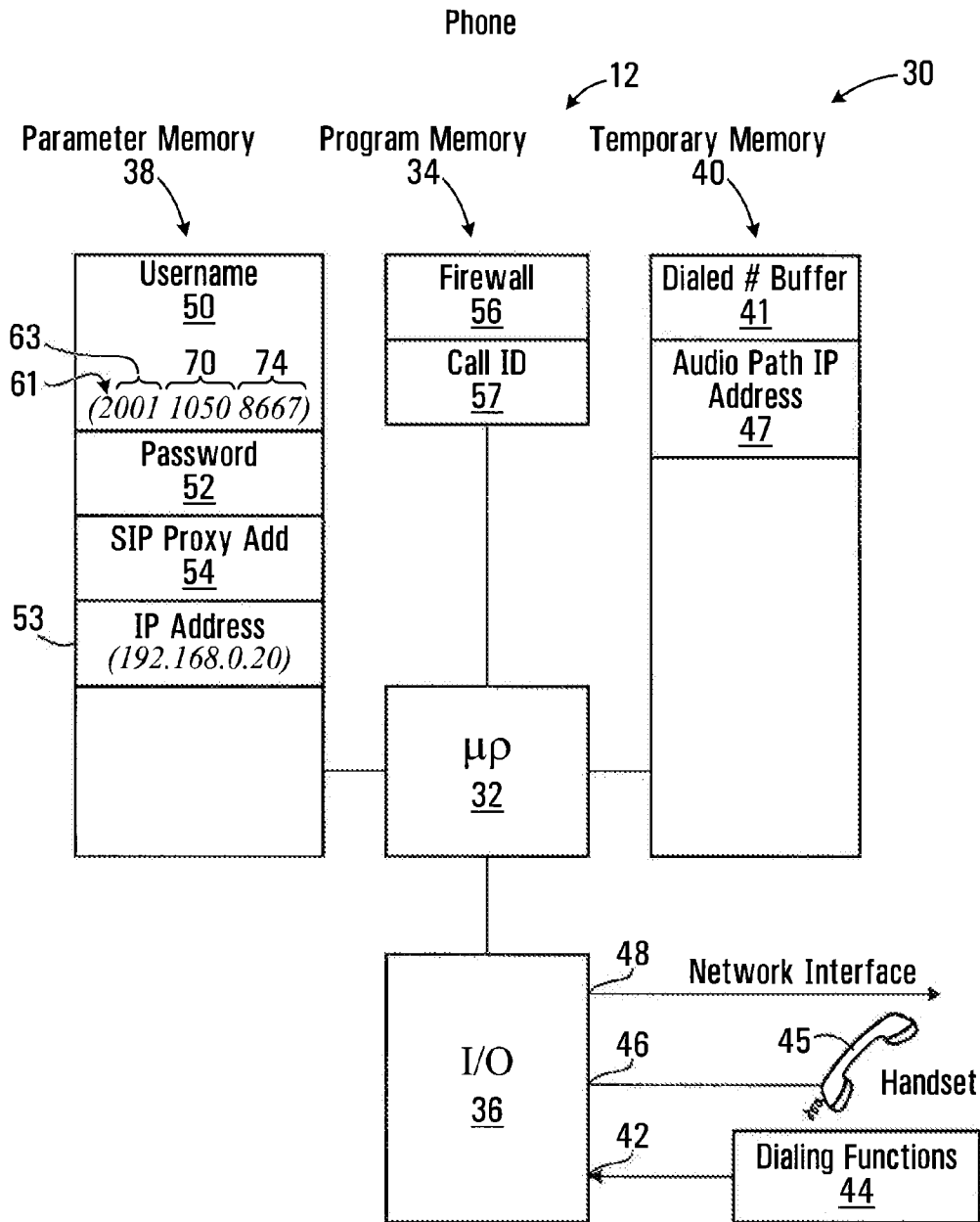

FIG. 2

3/22

59 ←

SIP Invite Message

60 ~ Caller 2001 1050 8667

62 ~ Callee 4401 1062 4444

64 ~ Digest Parameters XXXXXXX

65 ~ Call ID FF10@ 192.168.0.20

67 ~ Caller IP Address 192.168.0.20

69 ~ Caller UDP port 12345

FIG. 3

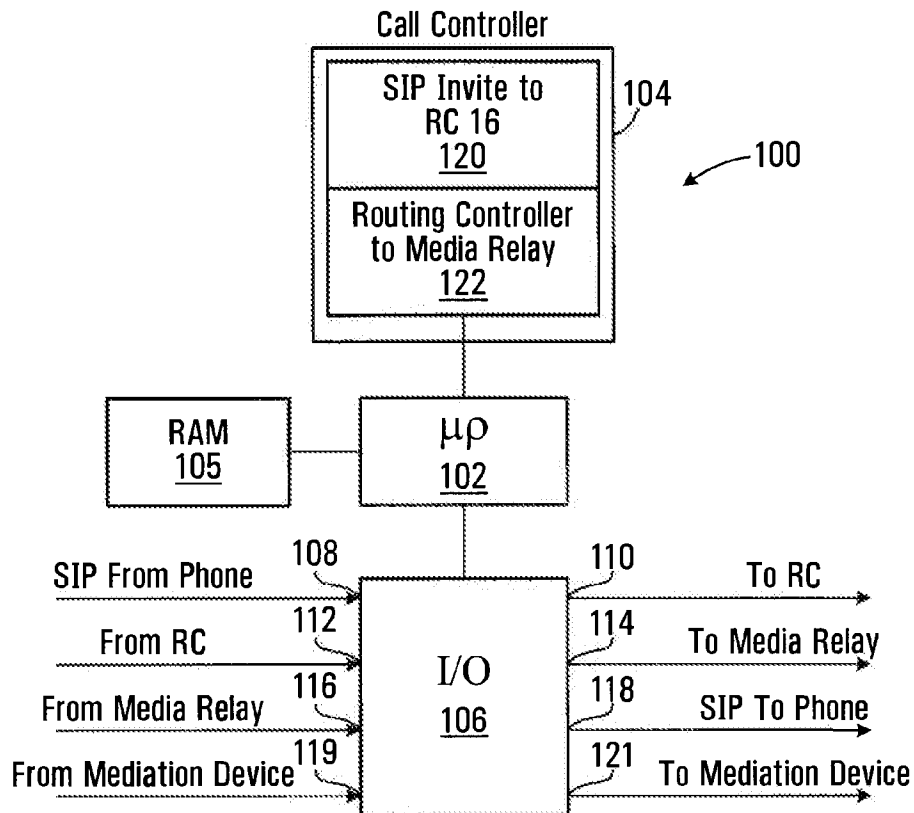

FIG. 4

4/22

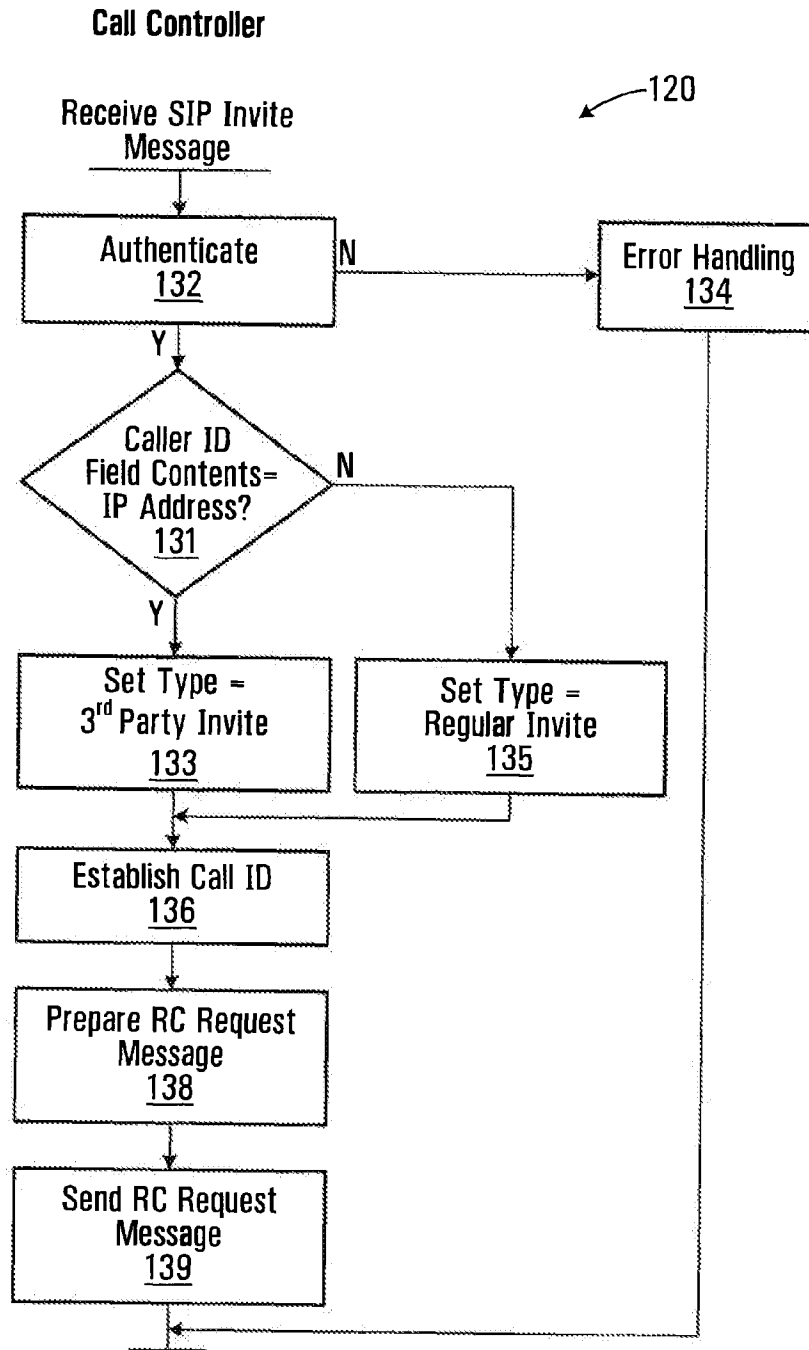

FIG. 5

5/22

150 ↙

RC Request Message

152 ~ Caller 2001 1050 8667
 154 ~ Callee 4401 1062 4444 (911)
 156 ~ Digest XXXXXXX
 158 ~ Call ID FF10@ 192.168.0.20
 160 ~ Type Subscriber

FIG. 6

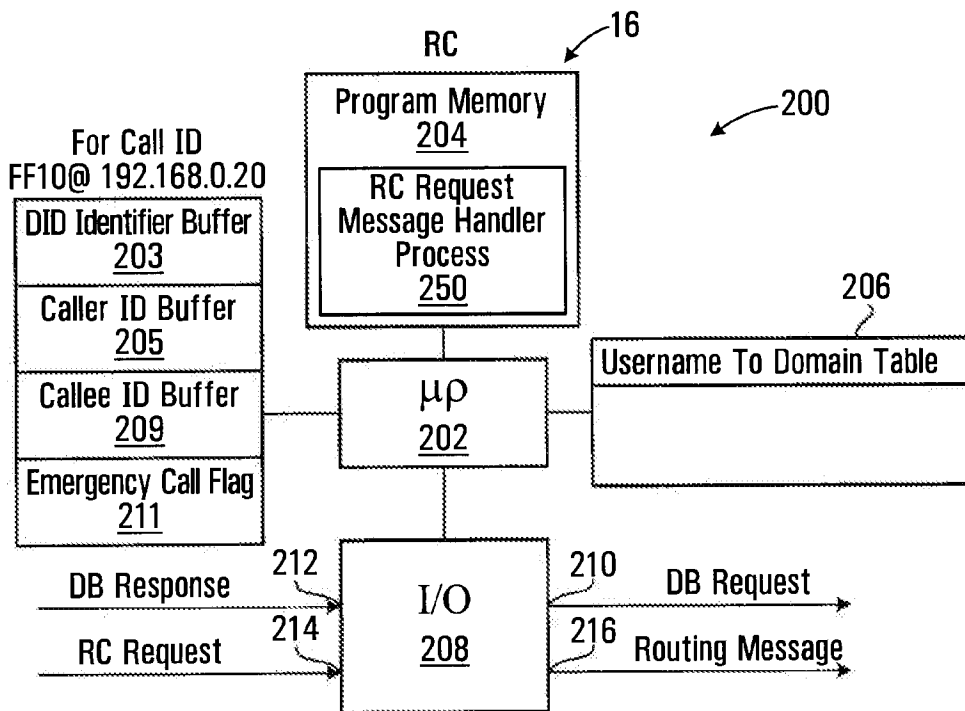

FIG. 7

6/22

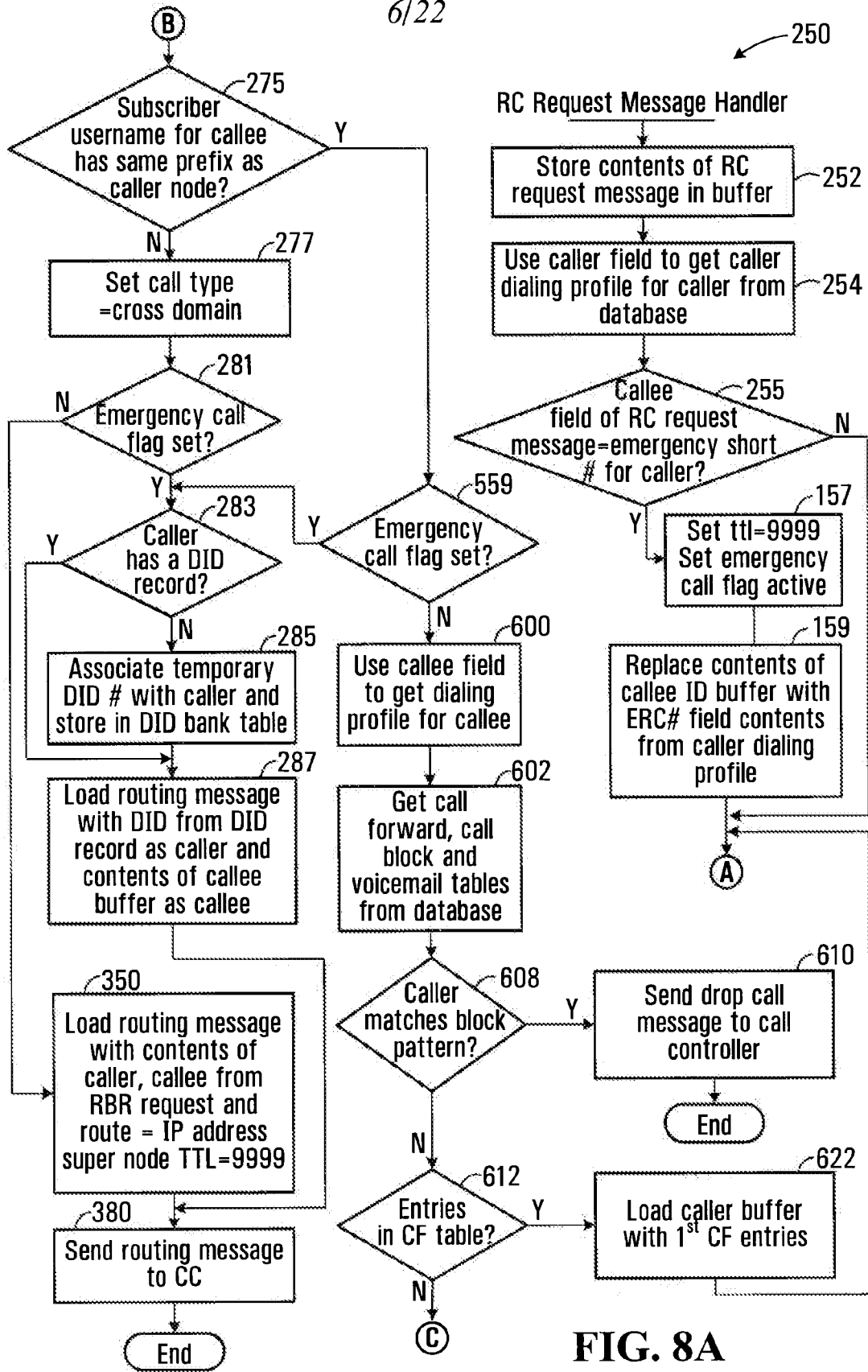

FIG. 8A

+

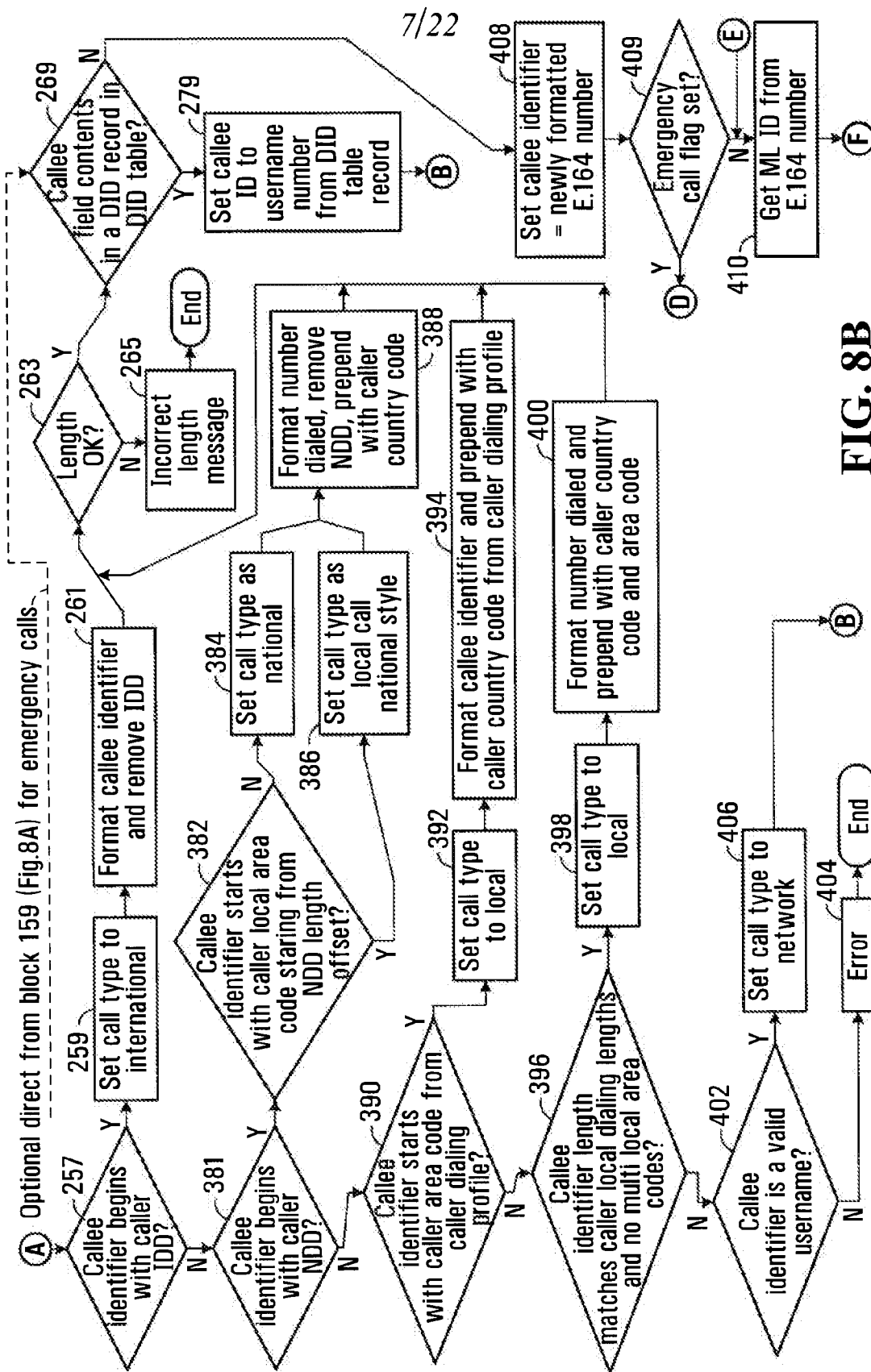

FIG. 8B

+

8/22

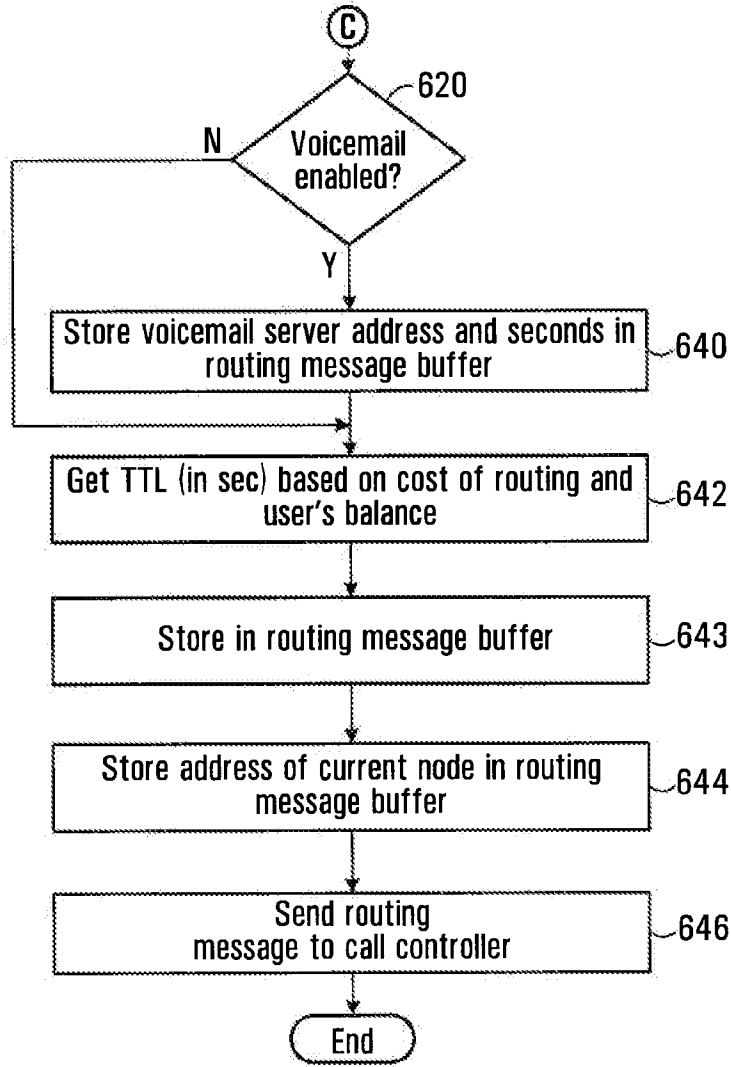

FIG. 8C

9/22

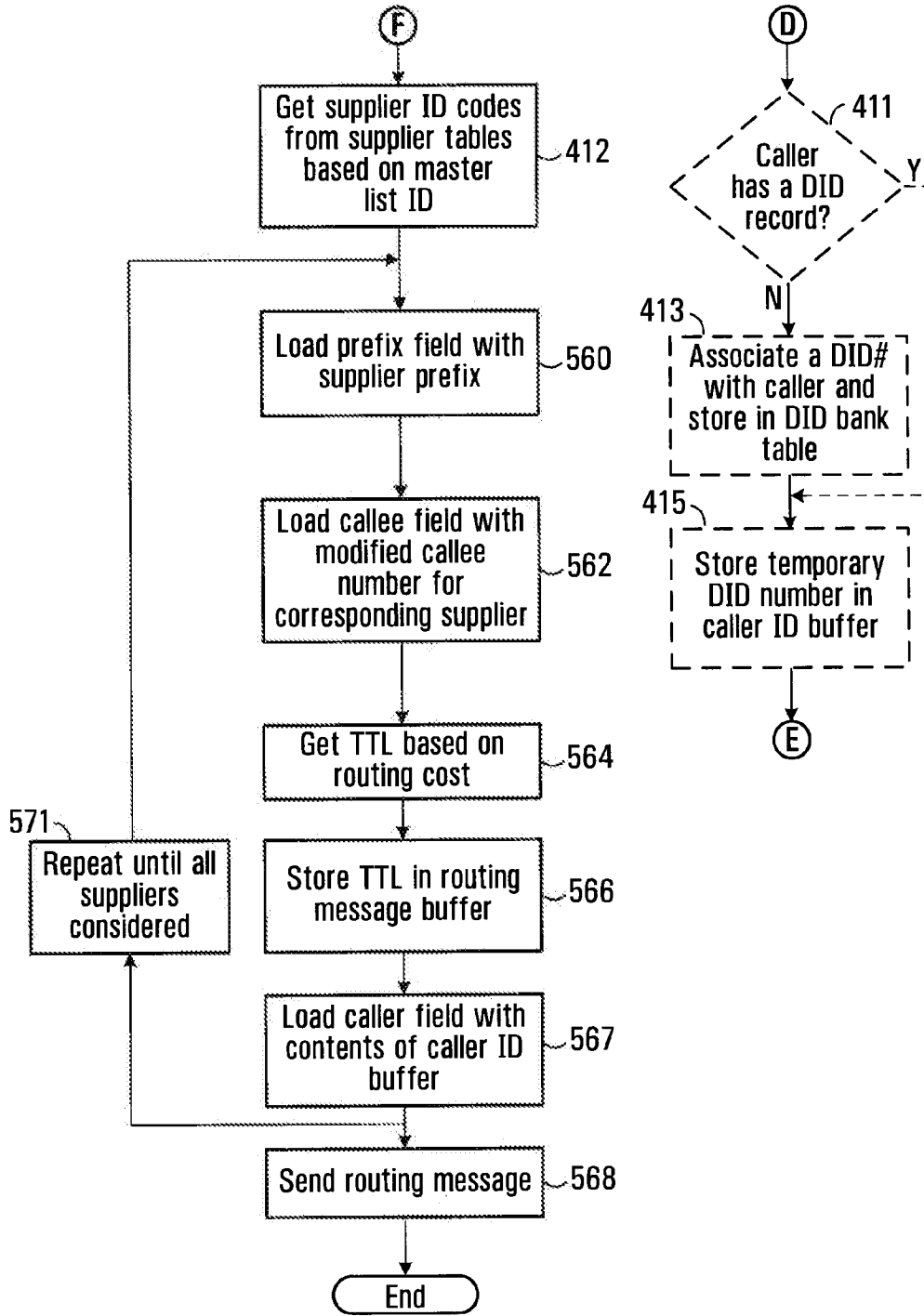

FIG. 8D

10/22

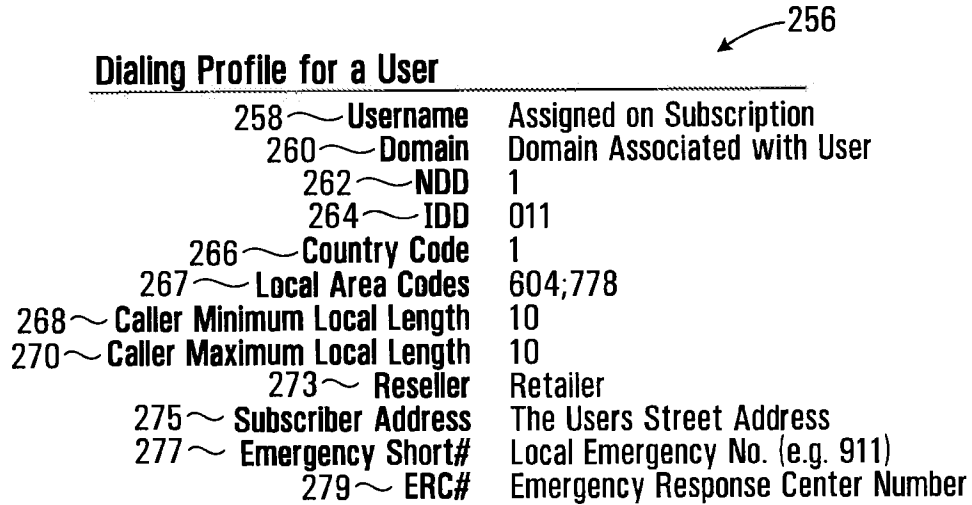

FIG. 9

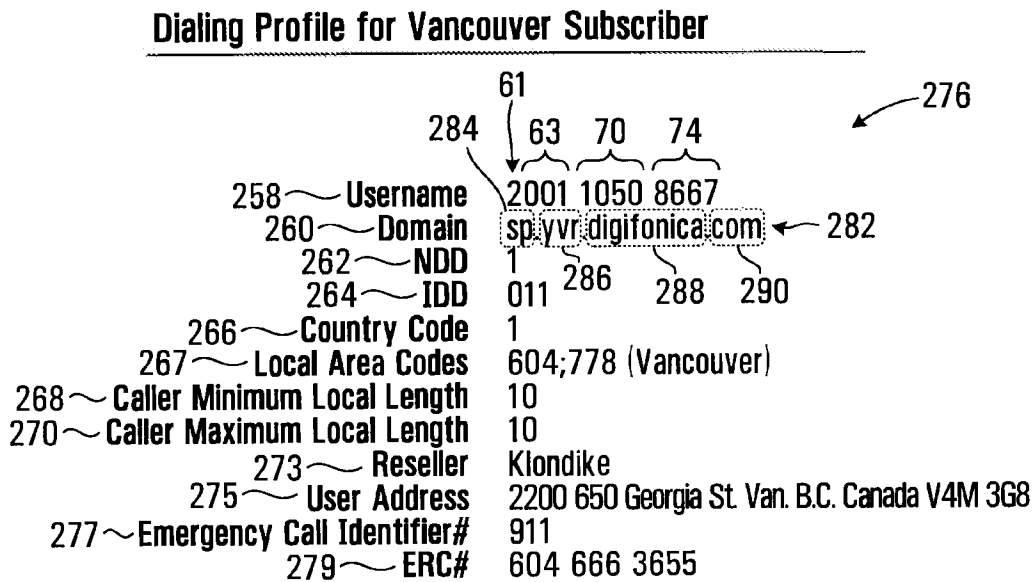

FIG. 10

*11/22***Dialing Profile for ERC Subscriber**

Username	2001 1050 6969
Domain	sp.yvr.digifonica.com
NDD	1
IDD	011
Country Code	1
Local Area Codes	604
Caller Minimum Local Length	7
Caller Maximum Local Length	10
Reseller	Klondike
User Address	#Epson downs, Tripson Falls B.C. Canada VON 2N3
Emergency Call Identifier#	911
ERC#	604 666 3655

FIG. 10A

12/22

Dialing Profile for Calgary Subscriber

Username	2001 1050 2222
Domain	sp.yvr.digifonica.com
NDD	1
IDD	011
Country Code	1
Local Area Codes	403
Caller Minimum Local Length	7
Caller Maximum Local Length	10
User Address	1210 Deerfoot Trail SE, Calgary Alberta Canada H0H 0H0
Emergency Short#	911
ERC#	403 123 4567

FIG. 11**Dialing Profile for London Subscriber**

Username	4401 1062 4444
Domain	sp.lhr.digifonica.com
NDD	0
IDD	00
Country Code	44
Local Area Codes	20 (London)
Caller Minimum Local Length	10
Caller Maximum Local Length	11
User Address	21 Basil Rd. Faulty Towers, London NW1 4NS
Emergency Short#	911
ERC#	7487-7973

FIG. 12

13/22

268

DID Bank Table Record Format

291 ~ Username	System subscriber	
272 ~ User Domain	Host name of supernode	
274 ~ DID	E164#	
For temporary DID records only {	Creation Time	Current time when record is created
	Expiration Time	Time at which record is to be deleted

FIG. 13

276

DID Bank Table Record for Vancouver Subscriber

291 ~ Username	2001 1050 8667				
272 ~ User Domain	sp.yvr.digifonica.com				
274 ~ DID	1 604 321 3353				
	<table border="0"> <tr> <td>293</td> <td>295</td> <td>297</td> <td>299</td> </tr> </table>	293	295	297	299
293	295	297	299		

FIG. 13A

276

DID Bank Table Record for Calgary Subscriber

291 ~ Username	2001 1050 2222				
272 ~ User Domain	sp.yvr.digifonica.com				
274 ~ DID	1 403 516 0744				
	<table border="0"> <tr> <td>293</td> <td>295</td> <td>297</td> <td>299</td> </tr> </table>	293	295	297	299
293	295	297	299		

FIG. 13B

276

DID Bank Table Record for London Subscriber

291 ~ Username	4401 1062 4444				
272 ~ User Domain	sp.lhr.digifonica.com				
274 ~ DID	44 020 7487 7900				
	<table border="0"> <tr> <td>293</td> <td>295</td> <td>297</td> <td>299</td> </tr> </table>	293	295	297	299
293	295	297	299		

FIG. 14

14/22

352

Routing Message Buffer

- 354 ~ Supplier Prefix (optional) Code identifying supplier traffic
- 356 ~ Delimiter Symbol separating fields
- 358 ~ Callee PSTN compatible number or Digifonica number
- 360 ~ Route Domain name and IP address
- 362 ~ Time to Live(TTL) In seconds
- 364 ~ Caller ID DID number or username (contents of callee ID buffer)

FIG. 15

Routing Message for Emergency Call

200110506969@sp.yvr.digifonica.com;tll=9999;CLI=16043213353

358
360
362
364

366

FIG. 16

Routing Message Different Node

44011062444@sph.lhr.digifonica.com;tll=9999;CLI=200110508667

358
360
362
364

366

FIG. 16A

Prefix to Supernode Table Record Format

- 372 ~ Prefix First n digits of callee identifier
- 374 ~ Supernode Address IP address or fully qualified domain name

370

FIG. 17

Prefix to Supernode Table Record for London Subscriber

Prefix 4

Supernode Address sp.lhr.digifonica.com

FIG. 18

15/22

Master List Record Format

500 ~	ml_id	1019
502 ~	Dialing code	1604
504 ~	Country code	The country code is the national prefix to be used when dialing TO a particular country FROM another country.
506 ~	Nat Sign #(Area Code)	604
508 ~	Min Length	7
510 ~	Max Length	7
512 ~	NDD	The NDD prefix is the access code used to make a call WITHIN that country from on city to another (when calling another city in the same vicinity, this may not be necessary).
514 ~	IDD	The IDD prefix is the international prefix needed to dial a call FROM the country listed TO another country.
516 ~	Buffer rate	Safe charge rate above the highest rate charged by suppliers

FIG. 19**Example: Master List Record with Populated Fields**

ml_id	1019
Dialing code	1604
Country code	1
Nat Sign #(Area Code)	604
Min Length	7
Max Length	7
NDD	1
IDD	011
Buffer rate	\$0.009/min

FIG. 20

16/22

Suppliers List Record Format

540	~ Sup_id	Name code
542	~ MI_id	Numeric code
544	~ Prefix (optional)	String identifying supplier's traffic #
546	~ Route	IP address
548	~ NDD/IDD rewrite	
550	~ Rate	Cost per second to Digifonica to use this route

FIG. 21**(Telus) Supplier Record**

Sup_id	2010 (Telus)
MI_id	1019
Prefix (optional)	4973#
Route	72.64.39.58
NDD/IDD rewrite	011
Rate	\$0.02/min

FIG. 22**(Shaw) Supplier Record**

Sup_id	2011 (Shaw)
MI_id	1019
Prefix (optional)	4974#
Route	73.65.40.59
NDD/IDD rewrite	011
Rate	\$0.025/min

FIG. 23**(Sprint) Supplier Record**

Sup_id	2012 (Sprint)
MI_id	1019
Prefix (optional)	4975#
Route	74.66.41.60
NDD/IDD rewrite	011
Rate	\$0.03/min

FIG. 24

17/22

356

Routing Message Buffer for Gateway Call

570 ~ 4973#0116046663655@72.64.39.58;tli=3600;16046827780
 572 ~ 4974#0116046663655@73.65.40.59;tli=3600;16046827780
 574 ~ 4975#0116046663655@74.66.41.60;tli=3600;16046827780

FIG. 25Call Block Table Record Format

604 ~ Username Digifonica #
 606 ~ Block Pattern PSTN compatible or Digifonica #

FIG. 26Call Block Table Record for Calgary Subscriber

604 ~ Username of Callee 2001 1050 2222
 606 ~ Block Pattern 2001 1050 8664

FIG. 27Call Forwarding Table Record Format for Callee

614 ~ Username of Callee Digifonica #
 616 ~ Destination Number Digifonica #
 618 ~ Sequence Number Integer indicating order to try this

FIG. 28

18/22

Call Forwarding Table Record for Calgary Subscriber

614	Username of Callee	2001 1050 2222
616	Destination Number	2001 1055 2223
618	Sequence Number	1

FIG. 29**Voicemail Table Record Format**

624	Username of Callee	Digifonica #
626	Vm Server	domain name
628	Seconds to Voicemail	time to wait before engaging voicemail
630	Enabled	yes/no

FIG. 30**Voicemail Table Record for Calgary Subscriber**

624	Username of Callee	2001 1050 2222
626	Vm Server	vm.yvr.digifonica.com
628	Seconds to Voicemail	20
630	Enabled	1

FIG. 31**Routing Message Buffer for CF/VM Routing Message**

650	200110502222@sp.yvr.digifonica.com;tll=3600
652	200110552223@sp.yvr.digifonica.com;tll=3600
654	vm.yvr.digifonica.com;20;tll=60
656	sp.yvr.digifonica.com

FIG. 32

19/22

900
↙

Bye Message

902 ~	Caller	Username
904 ~	Callee	PSTN compatible # or Username
906 ~	Call ID	unique call identifier (hexadecimal string@IP)

FIG. 33

908
↙

Bye Message

902 ~	Caller	2001 1050 8667
904 ~	Callee	2001 1050 2222
906 ~	Call ID	<u>FA10@192.168.0.20</u>

FIG. 34

20/22

910 ↘

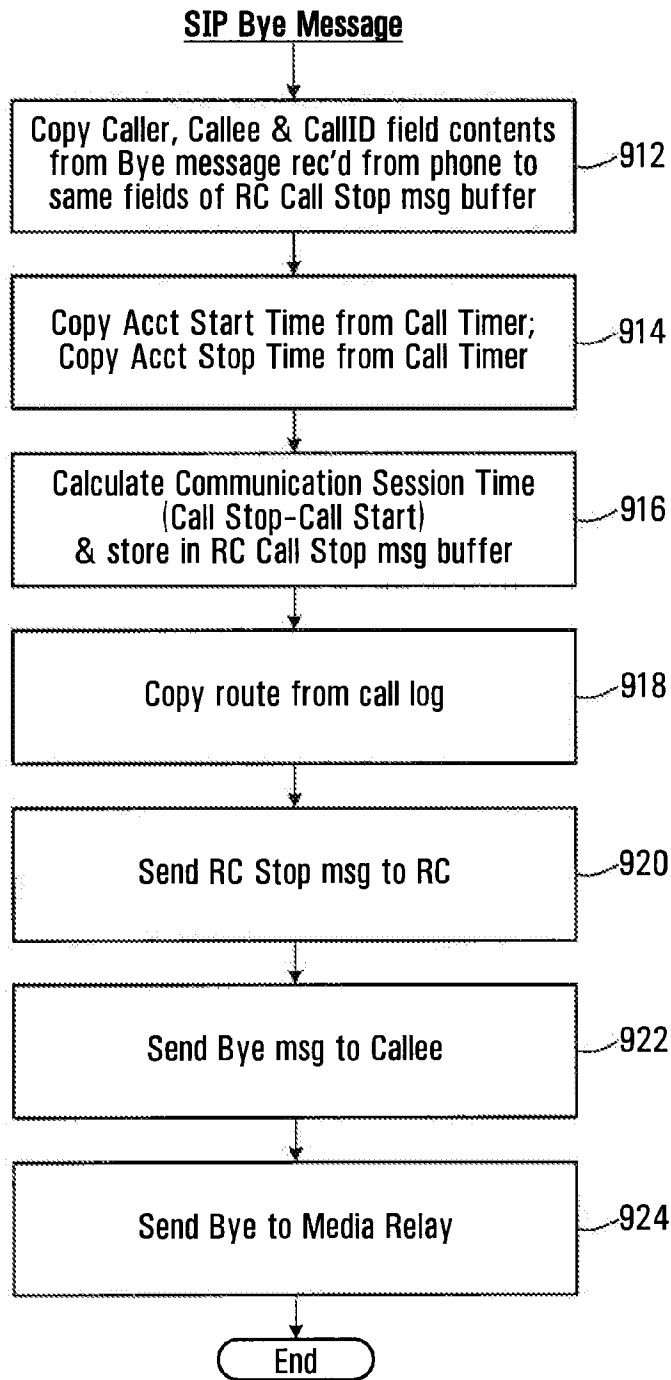

FIG. 35

21/22

1000

RC Call Stop Message

1002	Caller	Username
1004	Callee	PSTN compatible # or Username
1006	Call ID	unique call identifier (hexadecimal string@IP)
1008	Acct Start Time	start time of call
1010	Acct Stop Time	time the call ended
1012	Acct Session Time	start time-stop time (in seconds)
1014	Route	IP address for the communications link that was established

FIG. 36

1020

RC Call Stop Message for Calgary Subscriber

1002	Caller	2001 1050 8667
1004	Callee	2001 1050 2222
1006	Call ID	FA10@192.168.0.20
1008	Acct Start Time	2006-12-30 12:12:12
1010	Acct Stop Time	2006-12-30 12:12:14
1012	Acct Session Time	2
1014	Route	72.64.39.58

FIG. 37

22/22

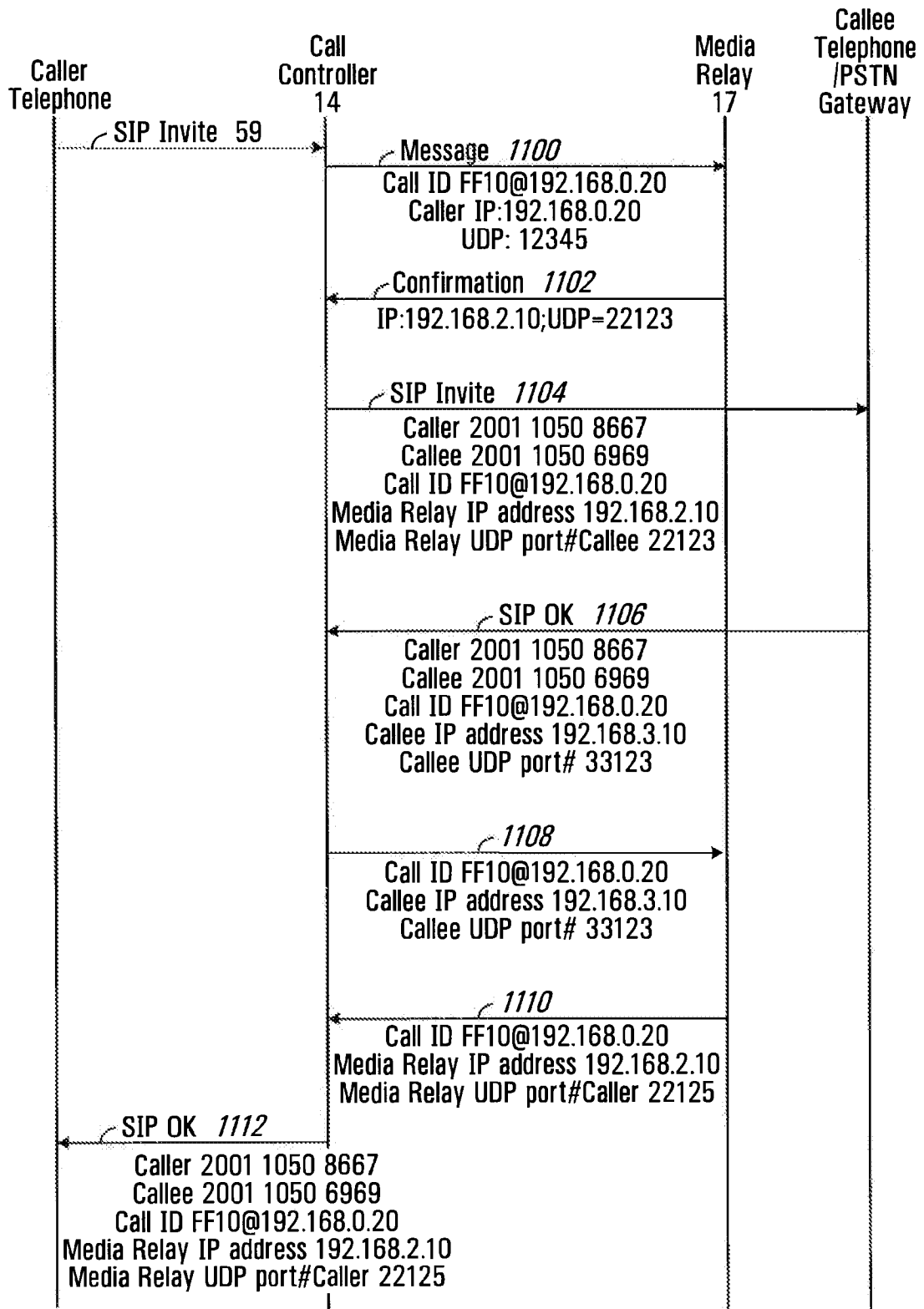

FIG. 38

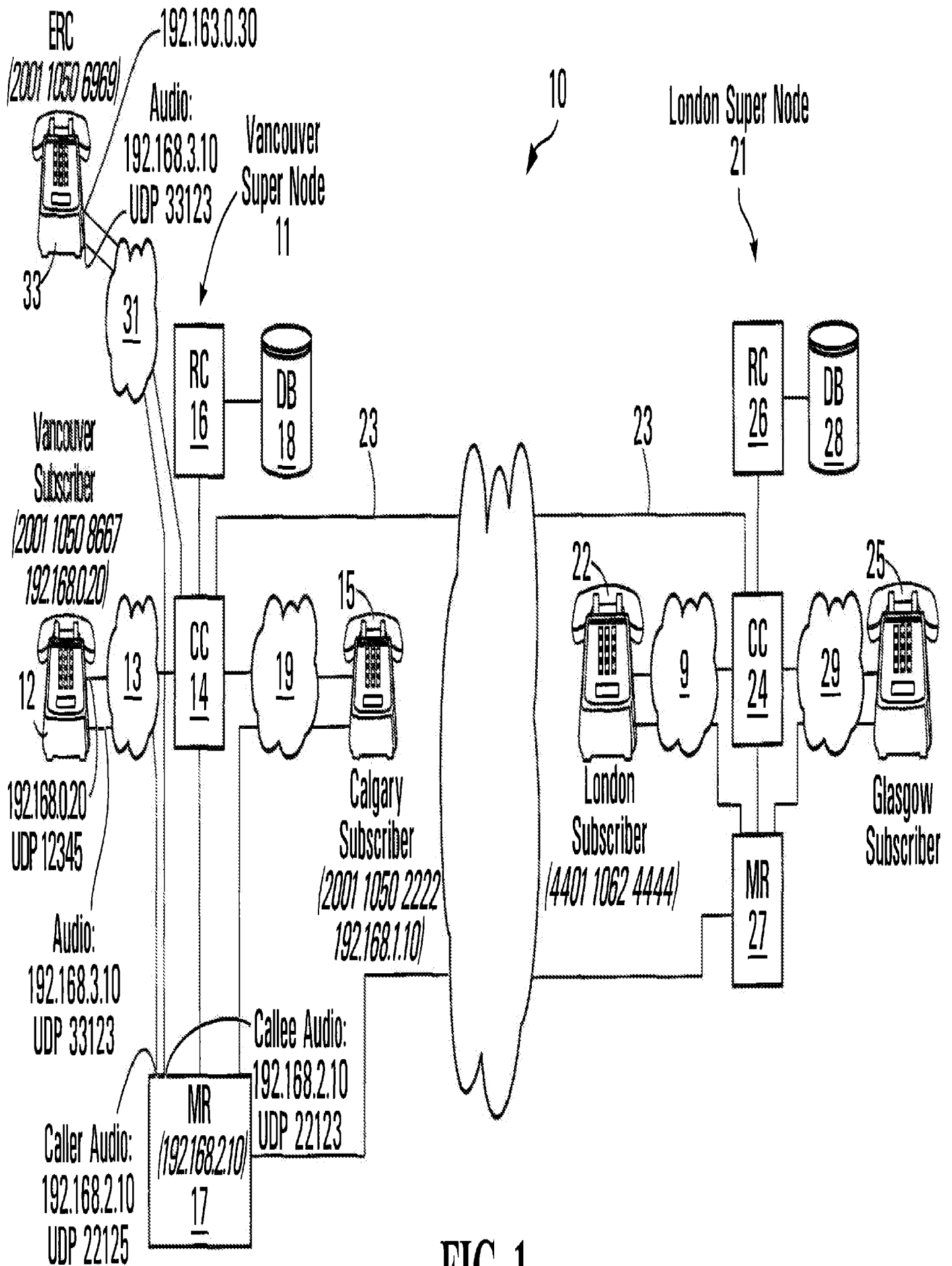

FIG. 1



Espacenet

Bibliographic data: CA2732148 (A1) — 2010-02-04

MOBILE GATEWAY

Inventor(s): BJORSELL JOHAN EMIL VIKTOR [CA]; HUTTUNEN PENTTI KALEVI [CA]; SOBOLYEV MAKSYM [CA] ± (BJORSELL, JOHAN EMIL VIKTOR, ; HUTTUNEN, PENTTI KALEVI, ; SOBOLYEV, MAKSYM)

Applicant(s): DIGIFONICA INTERNATIONAL LTD [CA] ± (DIGIFONICA (INTERNATIONAL) LIMITED)

Classification: - **international:** H04W76/02; H04W88/06; H04W88/16
- **cooperative:** H04W76/021; H04W8/02; H04W76/025

Application number: CA20092732148 20090728

Priority number (s): US20080129898P 20080728 ; WO2009CA01062 20090728

Also published as: WO2010012090 (A2) WO2010012090 (A3) US2014024367 (A1)
US2011122827 (A1) US2011122827 (A1) US8630234 (B2)
US8630234 (B2) EP2311292 (A2) EP2311292 (A4) less

Abstract of CA2732148 (A1)

A method of initiating a call to a callee using a mobile telephone involves: receiving, from a user of the mobile telephone, a callee identifier associated with the callee; transmitting an access code request message to an access server, said access code request message including said callee identifier; receiving an access code reply message from the access server in response to said access code request message, said access code reply message including an access code different from said callee identifier and associated with said callee identifier; and initiating a call with the mobile telephone using said access code to identify the callee.

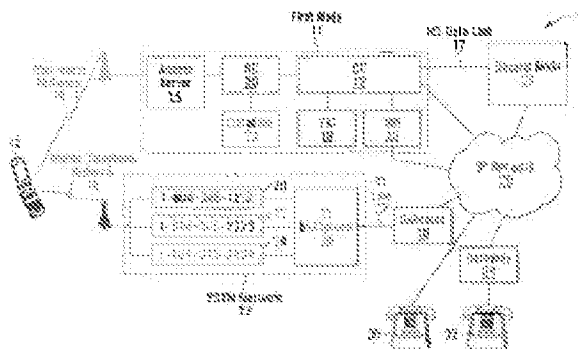

FIG. 1



(86) Date de dépôt PCT/PCT Filing Date: 2009/07/28
 (87) Date publication PCT/PCT Publication Date: 2010/02/04
 (85) Entrée phase nationale/National Entry: 2011/01/26
 (86) N° demande PCT/PCT Application No.: CA 2009/001062
 (87) N° publication PCT/PCT Publication No.: 2010/012090
 (30) Priorité/Priority: 2008/07/28 (US61/129,898)

(51) Cl.Int./Int.Cl. *H04W 76/02* (2009.01),
H04W 88/06 (2009.01), *H04W 88/16* (2009.01)
 (71) Demandeur/Applicant:
DIGIFONICA (INTERNATIONAL) LIMITED, CA
 (72) Inventeurs/Inventors:
BJORSELL, JOHAN EMIL VIKTOR, CA;
HUTTUNEN, PENTTI KALEVI, CA;
SOBOLYEV, MAKSYM, CA
 (74) Agent: SMART & BIGGAR

(54) Titre : PASSERELLE MOBILE
 (54) Title: MOBILE GATEWAY

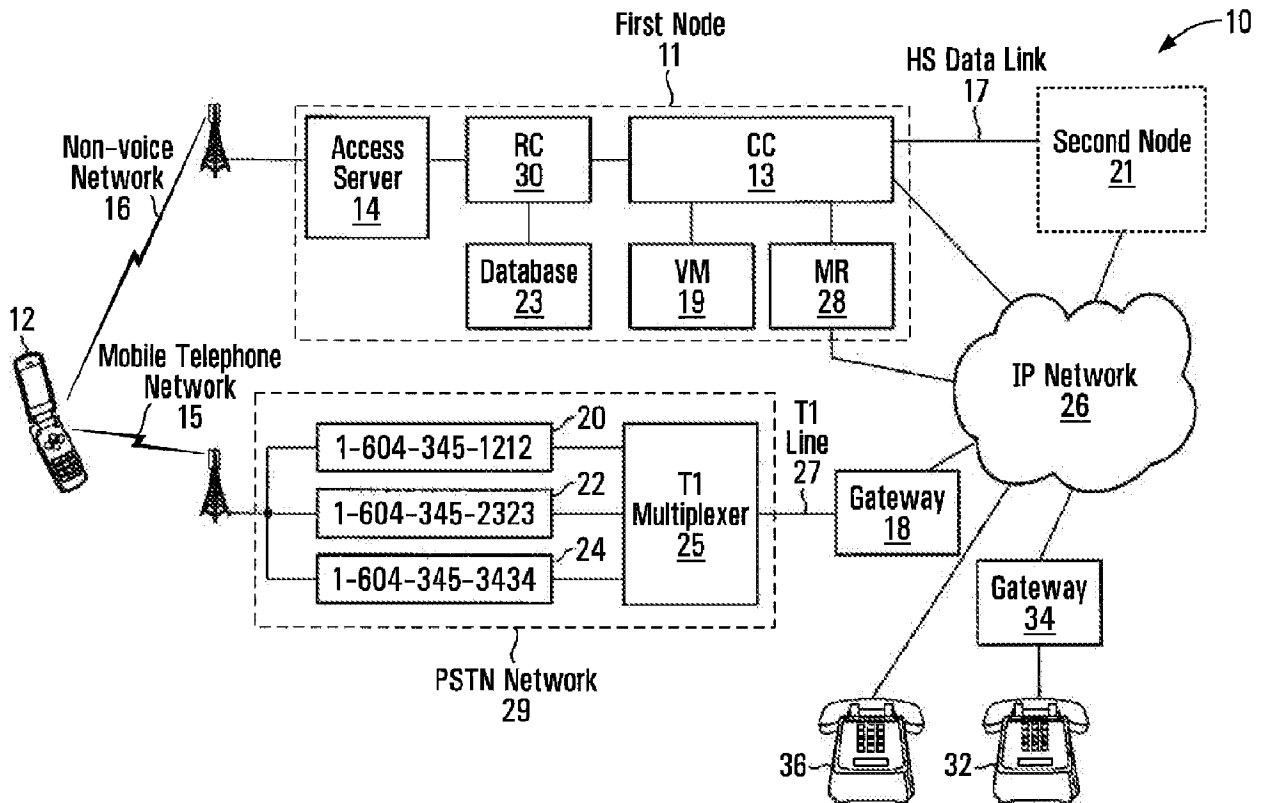

FIG. 1

(57) Abrégé/Abstract:

A method of initiating a call to a callee using a mobile telephone involves: receiving, from a user of the mobile telephone, a callee identifier associated with the callee; transmitting an access code request message to an access server, said access code request



(57) **Abrégé(suite)/Abstract(continued):**

message including said callee identifier; receiving an access code reply message from the access server in response to said access code request message, said access code reply message including an access code different from said callee identifier and associated with said callee identifier; and initiating a call with the mobile telephone using said access code to identify the callee.

(12) INTERNATIONAL APPLICATION PUBLISHED UNDER THE PATENT COOPERATION TREATY (PCT)

(19) World Intellectual Property Organization
International Bureau



(43) International Publication Date
4 February 2010 (04.02.2010)

PCT

(10) International Publication Number
WO 2010/012090 A3

- (51) **International Patent Classification:**
H04W 76/02 (2009.01) H04W 88/16 (2009.01)
H04W 88/06 (2009.01)
- (21) **International Application Number:**
PCT/CA2009/001062
- (22) **International Filing Date:**
28 July 2009 (28.07.2009)
- (25) **Filing Language:** English
- (26) **Publication Language:** English
- (30) **Priority Data:**
61/129,898 28 July 2008 (28.07.2008) US
- (71) **Applicant (for all designated States except US): DIGI-FONICA (INTERNATIONAL) LIMITED [CA/CA];** Suite #890, 999 West Hastings Street, Vancouver, British Columbia V6C 2W2 (CA).
- (72) **Inventors; and**
- (75) **Inventors/Applicants (for US only): BJORSELL, Johan, Emil, Viktor [SE/CA];** PO Box 29164, RPO South Granville Post, Vancouver, British Columbia V6J 0A6 (CA). **SOBOLYEV, Maksym [UA/CA];** 506-210 Eleventh Street, New Westminster, British Columbia V3M 4C9 (CA). **HUTTUNEN, Pentti, Kalevi [CA/CA];** 76-3180 East 58th Avenue, Vancouver, British Columbia V5S 3S8 (CA).
- (74) **Agent: KNOX, John, W.; SMART & BIGGAR,** 2200-650 West Georgia Street, Vancouver, British Columbia V6B 4N8 (CA).
- (81) **Designated States (unless otherwise indicated, for every kind of national protection available):** AE, AG, AL, AM, AO, AT, AU, AZ, BA, BB, BG, BH, BR, BW, BY, BZ, CA, CH, CL, CN, CO, CR, CU, CZ, DE, DK, DM, DO, DZ, EC, EE, EG, ES, FI, GB, GD, GE, GH, GM, GT, HN, HR, HU, ID, IL, IN, IS, JP, KE, KG, KM, KN, KP, KR, KZ, LA, LC, LK, LR, LS, LT, LU, LY, MA, MD, ME, MG, MK, MN, MW, MX, MY, MZ, NA, NG, NI, NO, NZ, OM, PE, PG, PH, PL, PT, RO, RS, RU, SC, SD, SE, SG, SK, SL, SM, ST, SV, SY, TJ, TM, TN, TR, TT, TZ, UA, UG, US, UZ, VC, VN, ZA, ZM, ZW.
- (84) **Designated States (unless otherwise indicated, for every kind of regional protection available):** ARIPO (BW, GH, GM, KE, LS, MW, MZ, NA, SD, SL, SZ, TZ, UG, ZM, ZW), Eurasian (AM, AZ, BY, KG, KZ, MD, RU, TJ, TM), European (AT, BE, BG, CH, CY, CZ, DE, DK, EE, ES, FI, FR, GB, GR, HR, HU, IE, IS, IT, LT, LU, LV, MC, MK, MT, NL, NO, PL, PT, RO, SE, SI, SK, SM, TR), OAPI (BF, BJ, CF, CG, CI, CM, GA, GN, GQ, GW, ML, MR, NE, SN, TD, TG).

Declarations under Rule 4.17:

- as to the identity of the inventor (Rule 4.17(i))
- as to applicant's entitlement to apply for and be granted a patent (Rule 4.17(ii))
- of inventorship (Rule 4.17(iv))

[Continued on next page]

(54) Title: MOBILE GATEWAY

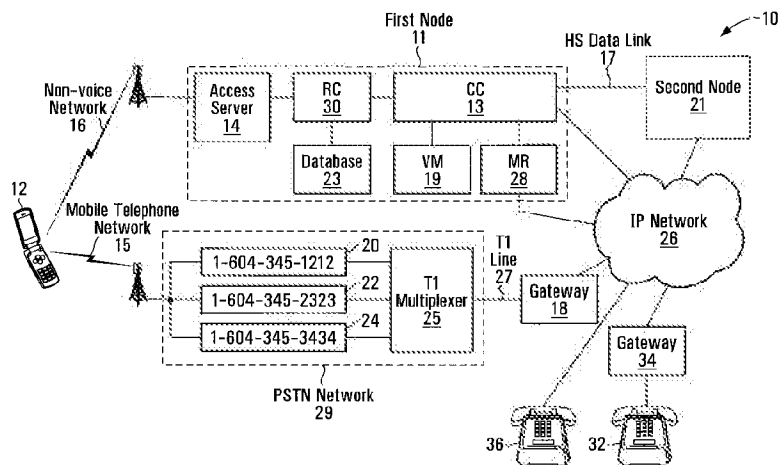

FIG. 1

(57) **Abstract:** A method of initiating a call to a callee using a mobile telephone involves: receiving, from a user of the mobile telephone, a callee identifier associated with the callee; transmitting an access code request message to an access server, said access code request message including said callee identifier; receiving an access code reply message from the access server in response to said access code request message, said access code reply message including an access code different from said callee identifier and associated with said callee identifier; and initiating a call with the mobile telephone using said access code to identify the callee.

WO 2010/012090 A3

WO 2010/012090 A3



Published:

(88) Date of publication of the international search report:
6 May 2010

- *with international search report (Art. 21(3))*
- *before the expiration of the time limit for amending the claims and to be republished in the event of receipt of amendments (Rule 48.2(h))*

MOBILE GATEWAY

BACKGROUND OF THE INVENTION

1. Field of Invention

5 This invention relates generally to telecommunication, and more particularly to methods, systems, apparatuses, and computer readable media for initiating or enabling a call with a mobile telephone to a callee.

2. Description of Related Art

10 Mobile telephone service providers often charge significant fees for long distance telephone calls, particularly when the mobile telephone is roaming in another mobile telephone service provider's network.

One known technique for avoiding the long distance charges of mobile
15 telephone service providers is to use a "calling card". A "calling card" may permit the user of the mobile telephone to place a call to a local telephone number or to a less-expensive telephone number (such as a toll-free number, for example) instead of placing the call directly to the callee. The user may thus avoid the long distance charges of the mobile telephone service provider,
20 which may be higher than the charges for using the "calling card". However, this technique can be cumbersome and undesirable, because it may require the user of the mobile telephone to follow a number of complicated or cumbersome steps in order to initiate a call to the callee, for example.

25 SUMMARY OF THE INVENTION

In accordance with one aspect of the invention there is provided a method of initiating a call to a callee using a mobile telephone. The method involves receiving, from a user of the mobile telephone, a callee identifier associated with the callee; transmitting an access code request message to an access
30 server, the access code request message including the callee identifier; receiving an access code reply message from the access server in response to the access code request message, the access code reply message including an access code different from the callee identifier and associated

with the callee identifier; and initiating a call with the mobile telephone using the access code to identify the callee.

5 Transmitting may involve transmitting the access code request message to the access server on a non-voice network.

Transmitting may involve transmitting a location identifier of a location associated with the mobile telephone to the access server.

10 Transmitting the location identifier may involve transmitting an IP address of the mobile telephone in a wireless IP network.

15 Transmitting the location identifier may involve transmitting an identifier of a wireless voice signal station in wireless communication with the mobile telephone.

Transmitting the location identifier may involve transmitting a user-configured identifier of a location associated with the mobile telephone.

20 Receiving the access code reply message may involve receiving the access code reply message from the access server on a non-voice network.

25 Receiving the access code reply message may involve receiving, in the access code reply message, an access code temporarily associated with the callee identifier.

30 Receiving the access code reply message may involve receiving, in the access code reply message, a telephone number identifying a channel operably configured to cooperate with an IP network to cause a call involving the mobile telephone and the callee to be routed through the IP network.

Initiating the call may involve engaging a routing controller to route the call on the IP network to the callee.

5 The method may further involve: receiving from the mobile telephone the access code request message; communicating with a routing controller to obtain from the routing controller the access code wherein the access code identifies a channel and is useable by the mobile telephone to cause the routing controller to establish a call to the callee using the channel; and transmitting the access code reply message to the mobile telephone.

10 In accordance with another aspect of the invention, there is provided a mobile telephone. The mobile telephone includes: provisions for receiving, from a user of the mobile telephone, a callee identifier associated with the callee; transmitting provisions for transmitting an access code request message to an access server, the access code request message including the callee identifier; provisions for receiving an access code reply message from the
15 access server in response to the access code request message, the access code reply message including an access code different from the callee identifier and associated with the callee identifier; and provisions for initiating a call using the access code to identify the callee.

20 The transmitting provisions may include a non-voice network interface for transmitting the access code request message to the access server on a non-voice network.

25 The access code request message may further include a location identifier of a location associated with the mobile telephone.

The location identifier may include an IP address of the mobile telephone in a wireless IP network.

30 The location identifier may include an identifier of a wireless voice signal station in wireless communication with the mobile telephone.

The location identifier may include a user-configured identifier of a location associated with the mobile telephone.

5 The provisions for receiving an access code reply message may include a non-voice network interface for receiving the access code reply message on a non-voice network.

The access code may include a telephone number.

10 The means for initiating may involve a mobile telephone network interface.

In accordance with another aspect of the invention, there is provided a system for initiating a call to a callee. The system includes the mobile telephone, a routing controller, and an access server. The access server includes:
15 provisions for receiving from the mobile telephone the access code request message; provisions for communicating with the routing controller to obtain from the routing controller the access code wherein the access code identifies a channel and is useable by the mobile telephone to cause the routing controller to establish a call to the callee using the channel; and provisions for
20 transmitting the access code reply message including the access code to the mobile telephone.

In accordance with another aspect of the invention, there is provided a mobile telephone. The mobile telephone includes a processor circuit, a network
25 interface in communication with the processor circuit, and a computer readable medium in communication with the processor circuit and encoded with codes for directing the processor circuit to: receive, from a user of the mobile telephone, a callee identifier associated with the callee; cause an access code request message to be transmitted to an access server, the
30 access code request message including the callee identifier; receive an access code reply message from the access server in response to the access code request message, the access code reply message including an access

code different from the callee identifier and associated with the callee identifier; and initiate a call using the access code to identify the callee.

5 The network interface may include a non-voice network interface, and the codes for directing the processor circuit to cause the access code request message to be transmitted may include codes for directing the processor circuit to cause the access code request message to be transmitted to the access server using the non-voice network interface on a non-voice network.

10 The access code request message may further include a location identifier of a location associated with the mobile telephone.

The location identifier may include an IP address of the mobile telephone in a wireless IP network.

15

The location identifier may include an identifier of a wireless voice signal station in wireless communication with the mobile telephone.

20 The location identifier may include a user-configured identifier of a location associated with the mobile telephone.

25 The network interface may include a non-voice network interface, and the codes for directing the processor circuit to receive an access code reply message may include codes for directing the processor circuit to cause the access code reply message to be received from the access server using the non-voice network interface on a non-voice network.

30 The access code may include a telephone number identifying a channel operably configured to cooperate with an IP network to cause a call involving the mobile telephone and the callee to be routed through the IP network.

The network interface may include a mobile telephone network interface, and the codes for directing the processor circuit to initiate may include codes for

directing the processor circuit to cause a call to be initiated using the mobile telephone network interface on a mobile telephone network.

5 In accordance with another aspect of the invention, there is provided a system for initiating a call to a callee. The system includes: the mobile telephone; a routing controller; and an access server comprising a processor circuit and a computer readable medium in communication with the processor circuit. The computer readable medium is encoded with codes for directing the processor circuit to: receive from the mobile telephone the access code request
10 message; communicate with the routing controller to obtain from the routing controller the access code wherein the access code identifies a channel and is useable by the mobile telephone to cause the routing controller to establish a call to the callee using the channel; and transmit the access code reply message to the mobile telephone.

15 In accordance with another aspect of the invention, there is provided a computer readable medium encoded with codes for directing a processor circuit to: receive, from a user of a mobile telephone, a callee identifier associated with a callee; transmit an access code request message to an
20 access server, the access code request message including the callee identifier; receive an access code reply message from the access server in response to the access code request message, the access code reply message including an access code different from the callee identifier and associated with the callee identifier; and initiate a call using the access code
25 to identify the callee.

In accordance with another aspect of the invention, there is provided a method for enabling a mobile telephone to initiate a call to a callee through a channel. The method involves: receiving from the mobile telephone an
30 access code request message including a callee identifier associated with the callee; communicating with a routing controller to obtain from the routing controller an access code identifying the channel, the access code being different from the callee identifier and useable by the mobile telephone to

initiate a call to the callee using the channel; and transmitting an access code reply message including the access code to the mobile telephone.

5 Receiving may involve receiving the access code request message on a non-voice network.

The method may further involve causing the routing controller to produce the access code.

10 Producing may involve selecting the access code from a pool of access codes, where each access code in the pool of access codes identifies a respective telephone number.

15 The method may further involve determining a local calling area associated with the mobile telephone.

Determining may involve accessing a dialing profile associated with the caller, the dialing profile including a location field having contents identifying at least a default location of the caller.

20 Determining may involve receiving an IP address of the mobile telephone in a wireless IP network.

25 Determining may involve receiving an identifier of a wireless voice signal station in wireless communication with the mobile telephone.

Determining may involve receiving a user-configured identifier of a location associated with the mobile telephone.

30 Selecting may involve selecting an access code in the local calling area associated with the mobile telephone.

Each access code in the pool of access codes may further identify a respective channel operably configured to cooperate with an IP network to cause a call involving the mobile telephone and the callee to be routed through the IP network.

5

The method may further involve causing the routing controller to establish communication through the IP network in response to a call received on the channel.

10

Producing may further involve storing a caller identifier associated with the mobile telephone in association with the access code.

Causing the routing controller to establish communication may involve causing the routing controller to establish communication only if the caller identifier associated with the access code identifies the mobile telephone.

15

Producing may further involve storing the callee identifier in association with the access code.

20

Producing may further involve searching the pool of access codes for an access code associated with the callee identifier to identify the channel usable by the mobile telephone to initiate a call to the callee.

25

Producing may further involve storing, in association with the access code, a timestamp for use in determining when the usability of the access code to initiate a call to the callee will expire.

30

Causing the routing controller to establish communication may involve causing the routing controller to establish communication only if the usability of the access code to initiate a call to the callee has not expired.

Transmitting may involve transmitting the access code reply message on a non-voice network.

In accordance with another aspect of the invention, there is provided a system for enabling a mobile telephone to initiate a call to a callee through a channel. The system includes: provisions for receiving from the mobile telephone an access code request message including a callee identifier associated with the callee; provisions for communicating with the routing controller to obtain from the routing controller an access code identifying the channel, the access code being different from the callee identifier and useable by the mobile telephone to initiate a call to the callee using the channel; and provisions for transmitting an access code reply message including the access code to the mobile telephone.

The provisions for receiving may include a non-voice network interface for receiving the access code request message on a non-voice network.

The system may further include provisions for producing the access code.

The provisions for producing may include a processor circuit operably configured to select the access code from a pool of access codes, where each access code in the pool of access codes identifies a respective telephone number.

The processor circuit may be operably configured to determine a local calling area associated with the mobile telephone.

The processor circuit may be operably configured to determine a local calling area associated with the mobile telephone using a dialing profile associated with the caller, the dialing profile including a location field having contents identifying at least a default location of the caller.

The processor circuit may be operably configured to determine a local calling area associated with the mobile telephone using an IP address of the mobile telephone in a wireless IP network.

The processor circuit may be operably configured to determine a local calling area associated with the mobile telephone using an identifier of a wireless voice signal station in wireless communication with the mobile telephone.

5

The processor circuit may be operably configured to determine a local calling area associated with the mobile telephone using a user-configured identifier of a location associated with the mobile telephone.

10

The processor circuit may be operably configured to select an access code in the local calling area associated with the mobile telephone.

Each access code in the pool of access codes may further identify a respective channel operably configured to cooperate with an IP network to cause a call involving the mobile telephone and the callee to be routed through the IP network.

15

The processor circuit may be operably configured to establish communication through the IP network in response to a call received on the channel.

20

The processor circuit may be operably configured to store a caller identifier associated with the mobile telephone in association with the access code.

The processor circuit may be operably configured to cause the routing controller to establish communication only if the caller identifier associated with the access code identifies the mobile telephone.

25

The processor circuit may be operably configured to store the callee identifier in association with the access code.

30

The processor circuit may be operably configured to search the pool of access codes for an access code associated with the callee identifier to

identify the channel usable by the mobile telephone to initiate a call to the callee.

5 The processor circuit may be operably configured to store, in association with the access code, a timestamp for use in determining when the usability of the access code to initiate a call to the callee will expire.

10 The processor circuit may operably configured to establish communication only if the usability of the access code to initiate a call to the callee has not expired.

The provisions for transmitting may include a non-voice network interface for transmitting the access code reply message on a non-voice network.

15 In accordance with another aspect of the invention, there is provided a system for enabling a mobile telephone to initiate a call to a callee through a channel. The system includes a processor circuit, a network interface in communication with the processor circuit, and a computer readable medium in communication with the processor circuit and encoded with codes for directing the processor
20 circuit to: receive from the mobile telephone an access code request message including a callee identifier associated with the callee; communicate with the routing controller to obtain from the routing controller an access code identifying the channel, the access code being different from the callee identifier and useable by the mobile telephone to initiate a call to the callee
25 using the channel; and cause an access code reply message including the access code to be transmitted to the mobile telephone.

30 The network interface may include a non-voice network interface, and the codes for directing the processor circuit to receive may include codes for directing the processor circuit to cause the access code request message to be received using the non-voice network interface on a non-voice network.

The computer readable medium may be further encoded with codes for directing the processor circuit to cause the access code to be produced.

5 The codes for directing the processor circuit to cause the access code to be produced may cause the access code to be selected from a pool of access codes, where each access code in the pool of access codes identifies a respective telephone number.

10 The computer readable medium may be further encoded with codes for directing the processor circuit to cause to be determined a local calling area associated with the mobile telephone.

15 The codes for directing the processor circuit to cause to be determined may cause a dialing profile associated with the caller to be accessed, the dialing profile including a location field having contents identifying at least a default location of the caller.

20 The codes for directing the processor circuit to cause to be determined may cause to be received an IP address of the mobile telephone in a wireless IP network.

25 The codes for directing the processor circuit to cause to be determined may cause to be received an identifier of a wireless voice signal station in wireless communication with the mobile telephone.

The codes for directing the processor circuit to cause to be determined may cause to be received a user-configured identifier of a location associated with the mobile telephone.

30 The codes for directing the processor circuit to cause the access code to be produced may further cause to be selected an access code in the local calling area associated with the mobile telephone.

Each access code in the pool of access codes may further identify a respective channel operably configured to cooperate with an IP network to cause a call involving the mobile telephone and the callee to be routed through the IP network.

5

The computer readable medium may be further encoded with codes for directing the processor circuit to cause communication through the IP network to be established in response to a call received on the channel.

10

The codes for directing the processor circuit to cause the access code to be produced may cause a caller identifier associated with the mobile telephone to be stored in association with the access code.

15

The codes for directing the processor circuit to cause communication to be established may cause communication to be established only if the caller identifier associated with the access code identifies the mobile telephone.

20

The codes for directing the processor circuit to cause the access code to be produced may cause the callee identifier to be stored in association with the access code.

25

The codes for directing the processor circuit to cause the access code to be produced may cause the pool of access codes to be searched for an access code associated with the callee identifier to identify the channel usable by the mobile telephone to initiate a call to the callee.

30

The codes for directing the processor circuit to cause the access code to be produced may cause a timestamp for use in determining when the usability of the access code to initiate a call to the callee will expire, to be stored in association with the access code.

The codes for directing the processor circuit to cause communication to be established may cause communication to be established only if the usability of the access code to initiate a call to the callee has not expired.

5 The network interface may include a non-voice network interface, and the codes for directing the processor circuit to transmit include codes for directing the processor circuit to cause the access code reply message to be transmitted using the non-voice network interface on a non-voice network.

10 In accordance with another aspect of the invention, there is provided a computer readable medium encoded with codes for directing a processor circuit to: receive from the mobile telephone an access code request message including a callee identifier associated with the callee; communicate with the routing controller to obtain from the routing controller an access code
15 identifying the channel, the access code being different from the callee identifier and useable by the mobile telephone to initiate a call to the callee using the channel; and cause an access code reply message including the access code to be transmitted to the mobile telephone.

20 Other aspects and features of the present invention will become apparent to those ordinarily skilled in the art upon review of the following description of specific embodiments of the invention in conjunction with the accompanying figures.

25 **BRIEF DESCRIPTION OF THE DRAWINGS**

In drawings which illustrate embodiments of the invention,

Figure 1 is a block diagram of a system for enabling a mobile telephone to initiate a call through a channel to a callee in accordance with a first embodiment in the invention;

30 Figure 2 is a block diagram of mobile telephone shown in Figure 1;

Figure 3 is a flow chart of a process executed by the mobile telephone shown in Figure 1;

- Figure 4 is a schematic representation of an access code request message transmitted between the mobile telephone and an access server shown in Figure 1;
- Figure 5 is a schematic representation of an access code reply message transmitted between the mobile telephone and the access server shown in Figure 1;
- Figure 6 is a block diagram of the access server shown in Figure 1;
- Figure 7 is a flow chart of a process executed by the access server shown in Figure 1;
- Figure 8 is a block diagram of a routing controller shown in Figure 1;
- Figure 9 is a tabular representation of a dialing profile stored in a database accessible by the routing controller illustrated in Figure 1;
- Figure 10 is a tabular representation of an access code association table stored in memory accessible by the routing controller shown in Figure 1;
- Figure 11 is a schematic representation of a DID bank table record stored in a database shown in Figure 1;
- Figure 12 is a flow chart of a process executed by the routing controller illustrated in Figure 1;
- Figure 13 is a block diagram of a gateway shown in Figure 1;
- Figure 14 is a tabular representation of an SIP invite message transmitted between the gateway and a call controller illustrated in Figure 1;
- Figure 15 is a block diagram of the call controller illustrated in Figure 1;
- Figure 16 is a flow chart of a process executed by the call controller illustrated in Figure 1;
- Figure 17 is a tabular representation of an RC request message transmitted between the call controller and the routing controller illustrated in Figure 1;
- Figures 18A–18C are a flow chart of a process executed by the routing controller illustrated in Figure 1; and
- Figure 19 is a tabular representation of a gateway node association table stored in the database illustrated in Figure 1.

DETAILED DESCRIPTION

Referring to Figure 1, a system for enabling a mobile telephone to initiate a call to a callee is shown generally at **10**. The system **10** includes a first node **11**, a second node **21**, and a mobile telephone **12**.

The first and second nodes **11** and **21** in the illustrated embodiment may support "voice-over-IP" (VoIP) calls between telephones and/or videophones using the internet protocol (IP), as described in PCT Publication No. WO **2008/052340**, which is hereby incorporated by reference in its entirety herein. In the embodiment shown, the first node **11** is located in a geographical area, such as Vancouver, British Columbia, Canada, for example, and the second node **21** is located in London, England, for example. Different nodes may be located in different geographical regions throughout the world to provide telephone/videophone service to subscribers in respective regions. These nodes may be in communication with each other by high speed/high data throughput links including optical fiber, satellite, and/or cable links illustrated generally at **17**, forming a backbone to the system. These nodes may alternatively, or in addition, be in communication with each other through conventional internet services.

In the embodiment shown, the first node **11** provides telephone/videophone service to western Canadian customers from Vancouver Island to Ontario. Another node (not shown) may be located in Eastern Canada to provide services to subscribers in that area, for example.

Other nodes of the type shown may also be employed within the geographical area serviced by a node to provide for call load sharing, for example, within a region of the geographical area serviced by the node. However, in general, all nodes may be similar and have the properties described in connection with the first node **11**.

In this embodiment, the first node **11** includes a call controller (CC) **13**, an access server **14**, a routing controller (RC) **30**, a database **23**, a voicemail server **19**, and a media relay **28**. Each of these may be implemented as separate modules on a common computer system or by separate computers, for example. The voicemail server **19** need not be included in the node and can be provided by a third party service provider. Although the access server **14** is illustrated as being part of the first node **11**, access servers in alternative embodiments may be separate from the node and may be in communication with one or more nodes, for example.

The mobile telephone **12** is configured to place calls over a mobile telephone network, illustrated generally at **15**, in a manner well-known in the art. Furthermore, the mobile telephone **12** and the access server **14** are configured to communicate with each other, preferably on a non-voice network illustrated generally at **16**, such as a "WiFi" wireless IP network or a General Packet Radio Service (GPRS) network, for example. However, in alternative embodiments, the mobile telephone **12** and the access server **14** may communicate with each other over other networks, such as a mobile telephone network using Short Message Service (SMS) messages, for example.

The system **10** further includes a gateway **18** in communication with at least one, and preferably a plurality of, channels, which are illustrated schematically at **20**, **22**, and **24**, to which the mobile telephone **12** may initiate a call over the mobile telephone network **15**. The channels **20**, **22**, and **24** maybe telephone lines in a Public Switched Telephone Network (PSTN) **29**. The channels **20**, **22**, and **24** maybe associated with PSTN telephone numbers in a local calling area associated with the mobile telephone **12**, and thus these channels preferably depend on a geographical location of the mobile telephone. The expression "local calling area" herein refers generally to a set of telephone numbers, typically defined by a geographical region, to which telephone calls may be placed by callers within the local calling area at either no additional charge or at a lower additional charge than would be required for calls to

5 numbers that are outside of the local calling area. However, it will be appreciated that in other embodiments, the gateway **18** may be in communication with any number of channels, which need not be PSTN telephone lines. Also, in the illustrated embodiment, the channels **20**, **22**, and **24** are associated with telephone numbers for Vancouver, British Columbia, Canada and the surrounding area, although it will be appreciated that these channels may include PSTN telephone lines associated with other areas, for example, which may not necessarily be in a local calling area associated with the mobile telephone **12**.

10 In the illustrated embodiment, each of the channels **20**, **22**, and **24** is configured by a PSTN service provider (which, in Canada, may be Bell Canada or Telus, for example) to direct calls that are received on the channels to the gateway **18**. In the illustrated embodiment, the PSTN service provider has configured the channels **20**, **22**, and **24** to communicate with a T1 multiplexer **25**, which multiplexes the channels **20**, **22**, and **24** in a manner known in the art onto one or more T1 lines **27** that are in communication with the gateway **18**. The gateway **18** is in communication with an IP network shown generally at **26**. The channels **20**, **22**, and **24** are thus configured to cooperate with the IP network **26** (via the gateway **18** in the illustrated embodiment) to cause a call involving the mobile telephone **12** and the callee to be routed through the IP network in response to a call received at one of the channels.

25 Also, in the illustrated embodiment, the access server **14** is in communication with the routing controller **30** of the first node **11**, and the routing controller **30** is configurable to associate a callee identifier with one of the channels **20**, **22**, and **24**, as described below. A callee identifier associated with one of the channels **20**, **22**, and **24** may be a telephone number of a PSTN telephone **32** that is in communication with the IP network **26** through a gateway **34**, or it may be a telephone number of a VoIP telephone **36** that is directly in communication with the IP network **26**, for example. Other routing controllers **30** of other nodes, such as the second node **21**, for example, may also

associate callee identifiers with other channels that are in communication with other gateways (not shown).

Mobile Telephone

5 Referring to Figure 2, in this embodiment, the mobile telephone (12) includes a processor circuit shown generally at 50. The processor circuit 50 includes a microprocessor 52, a program memory 54, an input/output (I/O) port 56, parameter memory 58, and temporary memory 60. The program memory 54,
10 I/O port 56, parameter memory 58, and temporary memory 60 are all in communication with the microprocessor 52. The processor circuit 50 may alternatively include a plurality of processors, a plurality of program memories, a plurality of temporary memories, and/or a plurality of I/O ports, or these components may alternatively be combined into a single device. However, for simplicity, the components of the processor circuit 50 are illustrated as shown
15 in the example of Figure 2.

In the illustrated embodiment, the I/O port 56 includes a dialing input 62 for receiving a callee identifier from a key pad, for example, or from a voice recognition unit, or from pre-stored callee identifiers stored in the parameter
20 memory 58, for example. For illustration purposes only, a myriad of possible dialing functions for providing a callee identifier are represented by the block entitled dialing function 64. A callee identifier may be a telephone number of a callee, for example.

25 The I/O port 56 also includes a handset interface 66 for receiving and producing signals to and from a handset 68 that may be placed close to the user's ear and mouth, for producing and receiving audible signals for and from the user. It will be appreciated that alternatively, the handset 68 may include a camera and video screen, for example, and that video or other types of
30 signals may be transmitted additionally or alternatively to audible signals.

The I/O port 56 also includes a non-voice network interface 70 for transmitting information to, and receiving information from, the non-voice network 16

illustrated in Figure 1, for example, and preferably interfaces with a high-speed internet connection.

5 The I/O port 56 in the illustrated embodiment further includes a mobile telephone network interface 72 for transmitting signals to and receiving signals from a mobile telephone service provider over a network such as a Global System for Mobile communications (GSM) or a Code Division Multiple Access (CDMA) network, such as the mobile telephone network 15 illustrated in Figure 1, for example. Again, for simplicity, a mobile telephone network
10 interface is illustrated, although it will be appreciated that video signals or other signals may be handled similarly when the mobile telephone (12) is facilitating communication of one or more of these types of signals. It will also be appreciated that alternatively, the non-voice network interface 70 and mobile telephone network interface 72 need not be distinct, but may be a
15 single interface for communication over a single network, for example, or may be configured to communicate over a plurality of different networks, for example.

In the illustrated embodiment, the parameter memory 58 includes a username
20 field 74 and a password field 76, although it will be appreciated that the username and password may not be necessary, or may be input by the user as required, for example. The parameter memory 58 in the illustrated embodiment also includes a caller identifier field 78 for storing a caller
25 identifier, which may be a telephone number associated with the mobile telephone (12) for identifying a "channel" such as a telephone line assigned to the mobile telephone that may be used to call back to the mobile telephone, for example. Generally, the contents of the username field 74, the password field 76, and the caller identifier field 78 are set once when the user first
30 subscribes to the system.

The usernames referred to herein, such as the username in the username field 74, preferably include a twelve digit number such as 2001 1050 8667, for example, wherein the left-most digit is a continent code (such as "2" to

indicate North America, for example), followed by a three-digit country code (such as "001" to indicate Canada and the United States, for example), a four-digit dealer code (such as "1050", for example), and a unique four-digit number code (such as "8667", for example), as discussed more generally in
5 PCT Publication No. **2008/052340**. Therefore, a prefix of a username referred to herein preferably indicates a geographical region associated with the user, or with the access code, and more preferably indicates a node associated with the user or access code.

10 The program memory **54** stores blocks of codes for directing the microprocessor **52** to carry out the functions of the mobile telephone (**12**), which are illustrated by example below.

Referring to Figures **2** and **3**, a flow chart representing functions performed by
15 blocks of code that direct the microprocessor **52** to initiate a call with the mobile telephone **12** to a callee is shown generally at **100**. The blocks shown in Figure **3** generally represent codes that may be stored in the program memory **54** for example, for directing the microprocessor **52** to perform various functions relating to initiating a call with the mobile telephone (**12**) to a
20 callee. The actual code to implement each block may be written in any suitable programming language, such as Java, C, and/or C++, for example.

The process **100** begins at **102**, in response to an interrupt produced at or for the microprocessor **52** by the dialing function **64**. Upon initiation of the
25 process **100**, block **104** directs the microprocessor **52** to obtain a callee identifier from the dialing function **64** at the dialing input **62** of the I/O port **56** in the illustrated embodiment. The callee identifier is associated with a desired callee, and may be a telephone number of the callee, for example. The microprocessor **52** thus receives, from a user of the mobile telephone (**12**), a
30 callee identifier associated with a callee.

Block **106** directs the microprocessor **52** to transmit, using the non-voice network interface **70** in the illustrated embodiment, an access code request

message, the access code request message including the callee identifier obtained at block **104**, to the access server **14** (illustrated in Figure **1**). In general, preferably block **106** directs the microprocessor **52** to cause an access code request message to be transmitted to the access server **14** over
5 a non-voice network, such as an internet, using WiFi or GPRS technology for example. However, it will be appreciated that block **106** may direct the microprocessor **52** to transmit an access code request message to the access server **14** using any suitable technique, which may alternatively include a voice network, for example.

10 Referring to Figure **4**, an exemplary access code request message is shown generally at **110**. The access code request message **110** includes a username field **112**, a password field **114**, a callee identifier field **116**, and a caller identifier field **118**. In the illustrated embodiment, values for the username, password, and caller identifier fields **112**, **114**, and **118** are
15 retrieved from the username, password, and caller identifier fields **74**, **76**, and **78** respectively in the parameter memory **58** of the processor circuit **50** (illustrated in Figure **2**), and a value for the callee identifier field **116** is obtained from the dialing function **64** in block **104**, and may be stored in the temporary memory (**60**), for example. It will be appreciated that the username field **112**, password field **114**, and caller identifier field **118** are not essential, although these fields are preferable in order to identify the user of the mobile
20 telephone for billing purposes, for example.

25 Referring to Figures **1** and **4**, it will be appreciated that in order to minimize charges from the mobile telephone service provider of the mobile telephone **12**, the channels **20**, **22**, **24** will preferably be local or relatively inexpensive telephone lines associated with a geographical location, more particularly a pre-defined local calling area, associated with the mobile telephone **12**.
30 Therefore, the exemplary access code request message **110** further includes a location identifier field **119**. The location identifier stored in the location identifier field **119** preferably identifies a location of the mobile telephone **12**

for use in determining a local calling area associated with the mobile telephone **12**.

5 For example, the location identifier in the location identifier field **119** may include an IP address of the mobile telephone **12** in a wireless IP network, such as the non-voice network **16** to which the non-voice network interface **70** shown in Figure **2** is connected, because this IP address may be an indicator of a geographical location of the mobile telephone **12**. The location identifier may also or alternatively include an identifier of a wireless voice signal station
10 in wireless communication with the mobile telephone. In the illustrated embodiment, the wireless voice signal station is part of the mobile telephone network **15** that is in communication with the mobile telephone **12** through the mobile telephone network interface **72** illustrated in Figure **2**. In still other embodiments, the location identifier may include a user-configured identifier of
15 a geographical location or local calling area where the mobile telephone **12** is or may be situated. The location identifier may thus be pre-determined and stored in the parameter memory **58** shown in Figure **2** or may be acquired from non-voice network or wireless voice signal station or from user input, for example. Therefore, in summary, the location identifier in the location
20 identifier field **119** may include one or more of an IP address of the mobile telephone **12** in a wireless IP network, an identifier of a wireless voice signal station in wireless communication with the mobile telephone, and a user-configured identifier.

25 As described below, the location identifier in the location identifier field **119** may be used to determine a local calling area associated with the mobile telephone **12**, within which local calling area channels (illustrated as **20**, **22**, and **24** in Figure **1**) are available to the mobile telephone **12** for the lowest cost to the user. However, it will be appreciated that the location identifier may
30 only approximately identify a local calling area, and may not necessarily identify the lowest cost channel (illustrated as **20**, **22**, and **24** in Figure **1**) for the mobile telephone **12**. It will also be appreciated that in other embodiments, the location identifier field **119** may be omitted.

Referring back to Figure 3, the process 100 continues at block 130, which directs the microprocessor (52) to receive an access code reply message from the access server (14) in response to the access code request message that was transmitted at block 106.

Referring to Figure 5, an exemplary access code reply message is shown generally at 140. The access code reply message 140 includes an access code field 142 and a timeout field 144. In the illustrated embodiment, the access code field 142 stores an access code which is a telephone number associated with a telephone line associated with one of the channels 20, 22, or 24 in Figure 1. It will be appreciated that the access code is different from the callee identifier in the callee identifier field 116 shown in Figure 4, in that the access code identifies a channel, other than that provided by the callee identifier provided by the dialing function 64 in Figure 2, that the mobile telephone (12) can use to initiate a call to the callee. It will be appreciated that use of the access code facilitates avoidance of long distance or roaming charges that a mobile telephone service provider would charge for a call placed directly using the callee identifier using conventional calling processes, for example.

Still referring to Figure 5, the timeout field 144 in the illustrated embodiment stores a value that indicates a period of time, for example a number of minutes, during which the access code in the access code field 142 is associated with the callee identifier in the callee identifier field 116 of the exemplary access code request message 110 illustrated in Figure 4, such that the access code is only temporarily associated with the callee identifier. In one embodiment, the value stored in the timeout field 144 indicates 10 minutes, for example. It will be appreciated that in other embodiments, the timeout field 144 may not be necessary, but preferably it is included.

In the illustrated embodiment, the program codes in block 130 direct the microprocessor 52 to receive the access code reply message over a non-

voice network, such as a WiFi or GPRS network (illustrated at **16** in Figure **1**) via the non-voice network interface **70** shown in Figure **2**. However, it will be appreciated that the access code reply message may be received on any suitable network, even a voice network, for example.

5

Referring back to Figures **2** and **3**, block **149** directs the microprocessor **52** to initiate a call with the mobile telephone (**12**) on the mobile telephone network **15** (illustrated in Figure **1**) using the access code received in the access code field **142** of the access code reply message **140** (shown in Figure **5**) to identify the callee. In the illustrated embodiment, the codes in block **149** direct the microprocessor **52** to initiate a call to the channel (**20**, **22**, or **24**) identified by the access code, using the mobile telephone network interface **72** of the I/O port **56** of the mobile telephone (**12**), to engage the mobile telephone network (**15**).

10

15

Referring to Figure **1**, in the embodiment shown, the access code in the access code field (**142**) is a telephone number identifying a channel **20**, **22**, or **24** that is in communication with the gateway **18** to the IP network **26**. Through the gateway **18**, the channel **20**, **22**, or **24** is thus operably configured to cooperate with the IP network **26** to cause a call from the mobile telephone **12** to the callee to be routed through the IP network. Routing the call through the IP network may involve engaging the routing controller **30** to route the call on the IP network **26** to the callee, as described below. However, it will be appreciated that in other embodiments, the access code need not be a telephone number, but may be any code identifying a channel through which the mobile telephone **12** can initiate a call. Alternatively, if the mobile telephone is capable of voice over IP communications, the access code may be used to identify an IP address in the IP network to which the call is routed. In this embodiment, the IP address may act as the access code.

The process **100** shown in Figure **3** is then ended.

20

25

30

Access Server

Referring to Figure 6, the access server (14) includes a processor circuit shown generally at 150. The processor circuit 150 includes a microprocessor 152, program memory 154, an I/O port 156, parameter memory 158, and temporary memory 160. The program memory 154, I/O port 156, parameter memory 158, and temporary memory 160 are all in communication with the microprocessor 152. The processor circuit 150 may alternatively include a plurality of microprocessors or I/O ports, for example, and the components of the illustrated processor circuit 150 may also alternatively be combined into a single device.

The program memory 154 stores blocks of codes for directing the microprocessor 152 to carry out the functions of the access server 14. The I/O port 156 includes a non-voice network interface 162 for communicating with the non-voice network 16 illustrated in Figure 1. The I/O port 156 also includes a routing controller interface 164 for interfacing with the routing controller 30 illustrated in Figure 1.

Referring to Figures 6 and 7, a flow chart of blocks of code for directing the microprocessor 152 of the access server (14) to provide an access code to the mobile telephone (12) is shown generally at 190. The blocks 190 in Figure 7 generally represent codes that may be stored in the program memory 154 for directing the microprocessor 152 to perform various functions to provide the access to the mobile telephone (12) to enable the mobile telephone to place a call through a channel (20, 22, or 24).

The process 190 begins at 192, in response to an interrupt created by or for the microprocessor 152 when it receives an access code request message 110 (as illustrated in Figure 4) from the mobile telephone (12). In the illustrated embodiment, the access code request message (110) is received via the non-voice network interface 162 through a non-voice network (16) such as a WiFi or GPRS network, for example. However, it will be appreciated that other embodiments may use different techniques for receiving the access code request message (110) from the mobile telephone (12).

The process **190** continues at block **196**, which directs the microprocessor **152** to communicate with the routing controller **30** to obtain from the routing controller an access code identifying a channel (illustrated as **20**, **22**, or **24** in Figure **1**) in communication with the gateway (**18**), wherein the access code is different from the callee identifier in the callee identifier field **116** (shown in Figure **4**) and is usable by the mobile telephone (**12**) to initiate a call to the callee using the channel, as further described below. Therefore, block **196** preferably causes an access code to be produced by retransmitting the access code request message **110** illustrated in Figure **4** that was received at **192** from the mobile telephone (**12**), to the routing controller **30** through the routing controller interface **164** of the I/O port **156**.

The process **190** continues at block **198**, which directs the microprocessor **152** to transmit an access code reply message (**140**), including the access code obtained by block **196**, to the mobile telephone (**12**). An exemplary access code reply message is shown in Figure **5**. In the illustrated embodiment, an access code reply message (**140**) is produced by the routing controller **30** in a manner described below in response to the access code request message (**110**) that was transmitted to the routing controller at block **196**, and the access code reply message (**140**) is received from the routing controller through the routing controller interface **164** of the I/O port **156**. Block **198** then causes the access code reply message that was received from the routing controller to be retransmitted to the mobile telephone (**12**). In the illustrated embodiment, the codes in block **198** direct the microprocessor **152** to transmit the access code reply message (**140**) using the non-voice network interface **162** to the non-voice network **16**, which may be a WiFi or GPRS network, for example. However, it will be appreciated that other embodiments may employ other types of networks for communicating the access code reply message (**140**) to the mobile telephone (**12**). The process **190** is then ended.

In summary, referring to Figure **1**, the access server **14** generally acts as an interface to the routing controller **30** for relaying access code request

5 messages and access code reply messages between the mobile telephone 12 and the routing controller. Therefore, it will be appreciated that in alternative embodiments, the access server 14 and the routing controller 30 need not be separate, but may, for example, be combined in a single component.

Routing Controller (RC)

10 Referring to Figure 1, generally, the routing controller 30 executes a process to facilitate communication between callers and callees. The function of a routing controller generally in a VoIP system is described in PCT Publication No. WO 2008/052340.

15 Referring to Figure 8, the routing controller (30) includes a processor circuit shown generally at 230. The processor circuit 230 includes a microprocessor (or more generally a processor) 232, program memory 234, an I/O port 236, table memory 238, temporary memory 240, and a clock 244. The program memory 234, I/O port 236, table memory 238, temporary memory 240, and clock 244 are all in communication with the processor 232. The processor circuit 230 may include a plurality of microprocessors, for example, and the
20 aforementioned components of the processor circuit 230 may be combined, for example. The program memory 234 includes blocks of code for directing the processor 232 to carry out the functions of the routing controller (30), and the I/O port 236 includes an access server interface 242 for communicating with the access server 14.

25 In the illustrated embodiment as described above, the access server (14) transmits (at block 196 illustrated in Figure 7) an access code request message (110) to the routing controller (30) in order to obtain from the routing controller (30) an access code. When an access code request message (110)
30 is received at the access server interface 242, the processor 232 preferably stores certain values from the access code request message in stores in the temporary memory 240 for ease of retrieval. In particular, the temporary memory 240 includes a callee identifier store 246 for storing the callee

identifier from the callee identifier field **116** in the access code request message **110** illustrated in Figure 4, a caller identifier store **248** for storing the caller identifier that was stored in the caller identifier field **118** of the access code request message **110** illustrated in Figure 4, a caller username store **249**
5 for storing the caller username that was stored in the caller username field **112** of the access code request message **110** illustrated in Figure 4, and an access code store **250** for storing an access code that is selected when the routing controller (**30**) receives an access code request message (**110**). The temporary memory **240** also includes a local calling area identifier store **245**
10 for storing an identifier of a local calling area associated with the mobile telephone (**12**). The clock **244** generally maintains and stores a representation of a current date and time.

The I/O port **236** further includes a database request port **256** through which a
15 request to the database (**23** in Figure 1) can be made, and also includes a database response port **258** for receiving a reply from the database (**23**). The I/O port **236** further includes a routing controller (RC) request message input **260** for receiving an RC request message (illustrated in Figure 17) from the call controller (**13** in Figure 1) and includes a routing message output **262** for
20 sending a routing message back to the call controller **13**. The I/O port **236** thus acts to receive a caller identifier and a callee identifier contained in an RC request message from the call controller, the RC request message being received in response to initiation of a call by a subscriber of the system, as described below.

25 The program memory **234** includes blocks of codes for directing the processor **232** to carry out various functions of the routing controller (**30**). One of these blocks includes an RC request message handler **380** which directs the routing controller (**30**) to produce a routing message in response to a received RC request message, an example of which is illustrated in Figure 17. The RC request message handler process is shown in greater detail at **380** in Figures **18A** through **18C**. Another of these blocks in the program memory **234**
30 includes an access code generator, which is described at **270** in Figure 12,

and which directs the routing controller (30) to produce an access code as directed by the program codes in block 196 shown in Figure 7. Yet another of these blocks in the program memory 234 includes a local calling area identifier generator, which directs the routing controller (30) to produce a local calling area identifier using the location identifier from the location identifier field 119 of the access code request message 110 illustrated in Figure 4.

10 Local Calling Area Identifier Generator

Referring to Figure 1, it will be appreciated that preferably, a call made by the mobile telephone 12 using the access code obtained from the access server 14 will be a local call for the mobile telephone 12, based on a geographical location of the mobile telephone. Therefore, blocks in the program memory 15 234 include a local calling area identifier generator, which directs the routing controller 30 to produce a local calling area identifier.

For example, the local calling area identifier generator may direct the microprocessor 152 to access a dialing profile associated with the caller. The dialing profile may be identified using the username in the username field 112 20 in the access code request message 110 illustrated in Figure 4, and to store in the local calling area identifier field 245 a default location of the caller retrieved from the dialing profile associated with the caller.

25 Referring to Figure 9, an exemplary dialing profile is illustrated generally at 200 and includes a username field 202, a domain field 204, and calling attributes comprising a national dialing digits (NDD) field 206, an international dialing digits (IDD) field 208, a country code field 210, a local area codes field 212, a caller minimum local number length field 214, a caller maximum local number length field 216, a reseller field 218, a maximum number of concurrent calls field 220, a current number of concurrent calls field 222, and a default local calling area identifier field 224. Therefore, in some 30 embodiments, the local calling area identifier generator directs the

microprocessor **152** to determine a local calling area associated with the mobile telephone (**12**) by retrieving the default local calling area identifier from the default local calling area identifier field **224** of the dialing profile **200**.

5 Effectively, the dialing profile **200** is a record identifying calling attributes of the caller identified by the username in the username field **202**. More generally, dialing profiles **200** represent calling attributes of respective users, and are discussed in more detail in PCT publication No. WO **2008/052340**. As described in PCT publication No. WO **2008/052340**, a dialing profile of the
10 type shown in Figure **9**, and also other records such as direct-in-dial (DID) records, call blocking records, call forwarding records, and voicemail records, may be created whenever a user registers with the system or agrees to become a subscriber to the system.

15 Alternatively, the local calling area identifier generator may generate a local calling area identifier to be stored in the local calling area identifier store **245** using the location identifier from the location identifier field **119** of the access code request message **110** illustrated in Figure **4**. As described above, the location identifier field (**119**) may store one or more of an IP address of the
20 mobile telephone (**12**) in a wireless IP network, an identifier of a wireless voice signal station in wireless communication with the mobile telephone, and a user-configured identifier. One or more of these values may be used to identify a local calling area that is or is likely to be associated with the mobile telephone (**12**) in order to generate a local calling area identifier to be stored
25 in the local calling area identifier store **245**.

For example, it has been found that services available from web sites such as <http://www.ip2location.com/> and http://www.serviceobjects.com/products/dots_ipgeo.asp, for example, can produce a name of a location, and also
30 latitude and longitude values, associated with an IP address. Using this information derived from an IP address, or other information from the location identifier field (**119**), a local calling area may be identified by hierarchical jurisdictional designations (such as country, province, and city in Canada or

country, state, and city in the United States) and encoded as codes identifying the local calling area. These codes may then be stored in the local calling area identifier store **245**.

5 Access Code Association Table

In the illustrated embodiment, the table memory **238** (shown in Figure **8**) includes an access code association table **170**, an example of which is illustrated in Figure **10**, for associating access codes with callee identifiers, caller identifiers, caller usernames, timeouts, and timestamps. Although the routing controller (**30**) is illustrated in this embodiment as a separate component from the access server (**14**), it will be appreciated that in other embodiments, the routing controller (**30**) may be part of or integrated with the access server (**14**), and in these other embodiments, the access code association table **170** may be part of or integrated with the access server.

15 Referring to Figures **1** and **10**, the access code association table **170** generally includes a plurality of records, each having an access code field **173** storing an access code. The access codes in the access code association table **170** may thus form a pool of access codes, where each access code may identify a respective telephone number. In the illustrated embodiment, the access codes in the access code fields **173** of records of the access code association table **170** identify respective channels (illustrated by example only as **20**, **22**, and **24**) that are operably configured to cooperate with the IP network **26** via the gateway **18** to cause a call involving the mobile telephone **12** to be routed through the IP network.

20 Referring to Figure **10**, the exemplary access code association table **170** includes records **172**, **174**, **176**, **178**, and **180**, each having respective fields for storing a local calling area identifier **171**, an access code **173**, a channel identifier **175**, a callee identifier **177**, a caller identifier **179**, a caller username **183**, a timeout **181**, and a timestamp **182**. Generally, a record in the access code association table **170** will be created for each access code that identifies a channel (such as the channels **20**, **22**, and **24** illustrated in Figure **1**) that is

configured or configurable to establish communication through a gateway (such as the gateway **18** illustrated in Figure **1**) to an IP network (**26** in Figure **1**) in response to a call received at the channel. When a record is created in respect of a channel, the local calling area identifier field **171** is preferably
5 initialized with an identifier of a local calling area associated with the channel, the access code field **173** is preferably initialized with an access code associated with the channel, and the channel identifier field **175** is preferably initialized with an identifier of the channel. The remaining fields (for storing a callee identifier **177**, a caller identifier **179**, a caller username **183**, a timeout
10 **181**, and a timestamp **182**) are preferably initialized with default "null" values when a record is created. The fields for storing a local calling area identifier **171**, an access code **173**, a channel identifier **175** preferably remain generally constant during ordinary operation of the access code association table **170**, although the values stored in the fields for storing a callee identifier **177**, a
15 caller identifier **179**, a caller username **183**, a timeout **181**, and a timestamp **182** may vary as described below. It will be appreciated that in some embodiments, one or more of the fields for storing a local calling area identifier **171**, a channel identifier **175**, a caller identifier **179**, a caller username **183**, a timeout **181**, and a timestamp **182** may not be required and
20 be omitted.

As noted above, the local calling area identifier field **171** is preferably initialized with an identifier of a local calling area associated with the channel. The local calling area identifier field **171** preferably stores codes that are
25 encoded in the same manner as the codes in the local calling area identifier store **245**, as described above, so that an access code in the local calling area identified by the codes in the local calling area identifier store **245** may be identified by searching the access code association table **170** for an access code associated with a local calling area identifier in the associated
30 local calling area identifier field **171** that matches the local calling area identifier in the local calling area identifier store **245**. It has been found that information available from web sites such as http://en.wikipedia.org/wiki/List_of_NANP_area_codes, and services available from web sites such as

<http://www.serviceobjects.com/demos/PhoneExchangeDemo.asp>, for example, may be used to determine a local calling area identifier associated with a given access code where, for example, the access code is a PSTN telephone number.

5

In the exemplary access code association table **170**, the access codes in the access code fields **173** are telephone numbers for PSTN lines, three of which are in the **604** area code in Vancouver, British Columbia, Canada, and two of which are in the **416** area code in Toronto, Ontario, Canada. It will be appreciated that the access code association table **170** is an example only, and other access code association tables may include any number of access codes, which need not be PSTN telephone numbers, and which need not be limited to particular geographical areas.

10

15

In the exemplary access code association table **170**, the access code field **173** in the record **174** stores an access code **1-604-345-2323**, which may be a local telephone number for Vancouver, British Columbia, Canada, and the callee identifier field **177** of the record **174** stores a callee identifier **1-403-789-1234**, which may be a telephone number for a callee in Calgary, Alberta, Canada for example, thereby associating the callee identifier **1-403-789-1234** with the access code **1-604-345-2323**. Furthermore, the caller identifier field **179** of the record **174** stores a caller identifier **1-416-444-1441** and the caller username field **183** stores a caller username **2001 1050 8667**, thereby associating the caller identifier **1-416-444-1441** and caller username **2001 1050 8667** with the aforementioned access code and callee identifier. The caller identifier **1-416-444-1441** may be associated with a mobile telephone normally geographically located in Toronto, Ontario, Canada, but which may be in Vancouver and is therefore using a Vancouver-based access code to place a call to a Calgary-based number, for example. In the example record **174**, the timestamp field **182** indicates that the callee identifier **1-403-789-1234**, the caller identifier **1-416-444-1441**, and the caller username **2001 1050 8667** were associated with the access code **1-604-345-2323** on June 15,

20

25

30

2008 at **10:31** am, and the timeout field **181** indicates that this association is to expire **10** minutes after the time indicated in the timestamp field.

5 Likewise, the exemplary record **178** indicates that the callee identifier **1-604-321-1234**, the caller identifier **1-416-444-1234**, and the caller username **2001 1050 4141** were associated with the access code **1-416-234-4646** on June **15, 2008** at **2:21** pm, and the timeout field **181** of the record **178** indicates that this association is to expire within **10** minutes of the time in the timestamp field **182**.

10 It will also be appreciated that the access code association table **170** may, in other embodiments, be substituted with other data structures or storage media. For example, in alternative embodiments, as described below, a DID record of the type shown at **370** in Figure **11** may associate an access code with a callee identifier and with other information such as a caller identifier, a timeout value, and a timestamp value, additionally or alternatively to the access code association table **170**.

DID Bank Table Records

20 As described in PCT Publication No. **2008/052340**, a DID bank table record may be created and stored in a DID bank table in the database (**23** in Figure **1**) when a user registers with the system, to associate the username of the user and a host name of the node with which the user is associated, with a number on the PSTN network formatted in compliance with the **E.164** standard set by the International Telecommunication Union (ITU). However, as explained below, DID records may, in some embodiments, also associate usernames and host names with respective access codes, and may also associate access codes with respective callee identifiers and with other information such as caller identifiers, timeout values, and timestamp values.

30 Referring to Figure **11**, an exemplary DID bank table record is shown generally at **370**, and includes a username field **371**, a user domain field **372**, and a DID field **373**. The username field **371** may store a username of a user

of the system, in which case the user domain field **372** stores a host name of the node with which the user is associated, and the DID field **373** stores an E.164 number on the PSTN network associated with the user. Exemplary host names stored in the user domain field **372** include sp.yvr.digifonica.com for
5 Vancouver, British Columbia, Canada and sp.lhr.digifonica.com for London England, for example, as described in PCT Publication No. **2008/052340**. If the user has multiple telephone numbers, then multiple records of the type shown at **370** would be included in the DID bank table, each having the same username and user domain, but different DID field **373** contents reflecting the
10 different telephone numbers associated with that user.

However, DID fields **373** of DID bank table records **370** may also store access codes, in which case the username field **371** may store a username associated with the access code. In these DID bank table records **370**, the
15 user domain field **372** stores a host name of the node with which the access code is associated. Therefore, DID bank table records **370** may, in some embodiments, associate usernames and host names with respective access codes.

The exemplary DID bank table record **370** further includes a callee identifier field **374**, a caller identifier field **375**, a timeout field **376**, a timestamp field **377**, a local calling area identifier field **378**, a channel identifier field **379**, and a caller username field **381**, which may be used in an analogous manner to the callee identifier field **177**, the caller identifier field **179**, the timeout field
20 **181**, the timestamp field **182**, the local calling area identifier field **171**, the channel identifier field **175**, and the caller username field **183** respectively of the access code association table **170** illustrated in Figure **10**. The DID bank table records **370** may thus associate access codes with respective local calling area identifiers, callee identifiers, caller identifiers, caller usernames,
25 timeouts, and timestamps, although the caller identifier field **375**, timeout field **376**, timestamp field **377**, local calling area identifier field **378**, channel identifier field **379**, and caller username field **381** may not be necessary, and
30 one or more of these fields may be omitted in some embodiments.

Furthermore, it will be appreciated that the callee identifier field **374**, caller identifier field **375**, timeout field **376**, and timestamp field **377** of the DID bank table record **370** may be omitted for DID table records that are not in respect of access codes, but rather are in respect of telephone numbers of users of the system, for example, as described in PCT Publication No. **2008/052340**.
5 The callee identifier field **374**, caller identifier field **375**, timeout field **376**, and timestamp field **377** of the DID bank table record **370** may also be omitted in embodiments where the access code association table **170** includes records with these types of fields.

10 For simplicity, the following description is directed to embodiments wherein an access code association table **170** associates access codes with respective callee identifiers, caller identifiers, timeout values, and timestamp values. However, it will be appreciated that the processes described herein for records in the access code association table **170** may additionally or
15 alternatively be applied to DID bank table records **370** in an analogous manner.

Access Code Generator

20 Referring back to Figures **1**, **4**, and **8** in the illustrated embodiment as described above, the access server **14** transmits (at block **196** illustrated in Figure **7**) an access code request message **110** to the routing controller **30** in order to obtain from the routing controller **30** an access code. When an access code request message **110** is received at the access server interface
25 **242**, the processor **232** preferably authenticates the user by making various enquiries of databases to which it has access, to determine whether or not the password in the password field **114** of the access code request message **110** matches a password stored in the database in association with the username in the username field **112**. Various functions may be used to pass encryption
30 keys or hash codes back and forth to ensure that the transmittal of passwords is secure. If the user is successfully authenticated, the processor **232** then preferably produces an access code.

Referring to Figures **8** and **12**, a process for producing an access code is shown generally at **270**. Essentially the process **270** determines whether the access code in a given record (referred to below as the “currently addressed record”) in the access code association table shown at **170** in Figure **10** is
5 within the local calling area identified by the local calling area identifier store **245**, and whether the access code is currently available for association with a callee identifier. In order to produce an access code in response to receiving an access code request message (**110**) from the access server (**14**), the processor **232** of the routing controller (**30**) preferably searches the pool of
10 access codes in the access code association table (**170**) to identify an access code identifying a channel usable by the mobile telephone (**12**) to initiate a call to the callee, using the process **270** until an available access code in the local calling area identified by the local calling area identifier store **245** is identified. The access code generator thus preferably selects an access code
15 from the pool of access codes in the access code association table (**170**), and preferably selects an access code in a local calling area associated with the mobile telephone (**12**).

Starting with the first record in the access code association table, the process
20 **270** begins at block **272**, which directs the processor **232** of the routing controller (**30**) to determine whether the access code in the currently addressed record of the access code association table **170** is associated with the same local calling area as the mobile telephone (**12**) as identified by the contents of the local calling area identifier store **245**. If at block **272** the
25 access code of the currently addressed record is not associated with the same local calling area as the mobile telephone (**12**), the process **270** ends, the next record in the access code association table **170** is addressed, and the process is repeated for the next record in the access code association table.

30 However, if at block **272** the access code of the currently addressed record is associated with the same local calling area as the mobile telephone (**12**), or if the access code request message **110** (illustrated in Figure **4**) did not include

a local calling area identifier, then the process **270** continues at block **274**, which directs the processor **232** to determine whether the access code of the currently addressed record is associated with a callee identifier. To do this, the processor **232** determines whether the callee identifier field (**177**) of the currently addressed record stores a “null” value that was assigned to it on initialization, or whether the callee identifier field instead stores a callee identifier. In other words the processor checks to see whether the currently addressed record has already been in use.

If at block **274** the callee identifier field (**177**) of the currently addressed record in the access code association table (**170**) does store a callee identifier and not the “null” value that was assigned to the callee identifier field on initialization (for example, records **174** and **178** in Figure **10**), then the access code of that record is associated with a callee identifier, and the process **270** continues at block **278**, which directs the processor **232** to determine whether the association of the callee identifier with the access code has expired. In the illustrated embodiment, the codes at block **278** direct the processor **232** to determine whether the sum of the contents of the timestamp field (**182**) and of the timeout field (**181**) in the currently addressed record of the access code association table **170** (shown in Figure **10**) is less than the current time represented by the clock **244**. If at block **278** the sum of the timeout and timestamp fields in the currently addressed record of the access code association table **170** is less than the time represented by the clock **244**, then the association of the callee identifier with the access code is not expired and the process **270** ends, the next record in the access code association table (**170**) is addressed, and the process **270** is repeated for the next record in the access code association table.

However, if at block **278** the sum of the contents of the timeout and timestamp fields (**181** and **182**) in the currently addressed record of the access code association table (**170**) is not less than the time represented by the clock **244**, then the association of the callee identifier with the access code has expired, and the process **270** continues at block **276** which directs the processor **232**

to store the contents of the access code field **173** of the currently addressed record in the access code store **250** of the temporary memory **240** of the routing controller **30**.

5 Referring to Figures **8**, **10**, and **12**, if at block **274** the callee identifier field in the currently addressed record does not store a callee identifier but stores instead the “null” value that was assigned to the callee identifier field on initialization (for example, records **172**, **176**, and **180**), then the access code of that record is not associated with a callee identifier, and the process **270**
10 continues at block **276**, which directs the processor **232** to store the access code from the access code field **173** of the currently addressed record, in the access code store **250** in the temporary memory **240**.

After the selected access code is stored in the access code store **250** at block
15 **276**, the process **270** continues at block **280**, which directs the processor **232** to store the callee identifier from the callee identifier store **246** in the callee identifier field **177** of the currently addressed record, thereby creating an association of the callee identifier with the selected access code.

20 The process **270** then continues at block **282**, which directs the processor **232** to store the caller identifier from the caller identifier store **248** (which identifies the mobile telephone **12** shown in Figure **1**) in the caller identifier field **179** of the currently addressed record of the access code association table **170**, thereby also storing the caller identifier in association with the selected access
25 code.

The process **270** then continues at block **283**, which directs the processor **232** to store the caller username from the caller username store **249** in the caller username field **183** of the currently addressed record of the access code
30 association table **170**, thereby also storing the caller username in association with the selected access code.

The process **270** then continues at block **284**, which directs the processor **232** to store timeout and timestamp values in the timeout and timestamp fields **181** and **182** of the currently addressed record of the access code association table **170**, thus further storing, in association with the selected access code, a
5 timestamp for use in determining when the usability of the access code to initiate a call to the callee will expire. A default value, such as **10** minutes, for example may be stored in the timeout field **181** of the currently addressed record. Also, the current time indicated by the clock **244** is preferably stored in the timestamp field **182** of the currently addressed record.

10 In alternative embodiments, the access code association table (**170**) might not include fields for a caller identifier, caller username, a timeout, or a timestamp. In these embodiments, one or more of blocks **282**, **283**, and **284** described above are not necessary, and one or more of the caller identifier store **248**
15 and the caller username store **249** may be omitted.

In summary, the access code generator in the illustrated embodiment responds to receiving an access code request message **110** illustrated in
20 Figure **4** from the access server (**14**) by first authenticating the user, and then by searching through a pool of access codes, using the process **270** shown in Figure **12**, to identify an access code that is associated with the local calling area identified by the local calling area identifier store (**245**) and that is not previously and validly associated with another callee identifier. It will be appreciated that in alternative embodiments, different data structures and
25 algorithms may be preferable for identifying an access code that meets the aforementioned criteria. For example, in accordance with conventional database design that is well-known in the art, the records illustrated in the access code association table **170** illustrated in Figure **10** may alternatively be organized in a binary tree according to the value in the local calling area
30 identifier field **171**, or in separate tables for respective local calling area identifiers, for example, in order to enable a more efficient search of the access code association table for an access code that satisfies the aforementioned criteria. Therefore, the access code association table (**170**)

and the process **270** illustrated in Figure **12** are examples only, and one of ordinary skill in the art will readily appreciate numerous alternative data structures and algorithms.

5 Gateway

Referring to Figure **13**, in this embodiment, the gateway (**18**) includes a processor circuit shown generally at **300**, which includes a microprocessor **302**. The processor circuit **300** also includes a program memory **304**, a memory **305**, and an I/O port **306**, all of which are in communication with the
10 microprocessor **302**. The processor circuit **300** may include multiple processors etc., and the aforementioned components of the processor circuit **300** may alternatively be combined.

The I/O port **306** includes a channel interface **308**, which, in the illustrated
15 embodiment, is in communication with the channels **20**, **22**, and **24** that were also illustrated in Figure **1**. Where, as in the illustrated embodiment, the channels **20**, **22**, and **24** are PSTN telephone lines in the PSTN network **29**, the channel interface **308** may, for example, be a T1 port for communication with one or more T1 lines (illustrated at **27** in Figure **1**) of a PSTN service
20 provider, in a manner well-known in the art. The I/O port in the illustrated embodiment also includes an internet interface **309** for interfacing with the IP network **26** illustrated in Figure **1**. The program memory **304** stores blocks of codes for directing the microprocessor **302** to carry out the functions of the gateway (**18**). It has been found that the AS**5350** Universal Gateway available
25 from Cisco Systems, Inc. of San Jose, California may, for example, be suitable as the gateway (**18**).

Referring back to Figure **1**, and also still to Figure **13**, when a call is received
30 on one of the channels **20**, **22**, or **24**, the microprocessor **302** causes the I/O port **306** to use the internet interface **309** to send a Session Initiation Protocol (SIP) Invite message to a pre-determined node with which the gateway **18** is associated, which in the illustrated embodiment is the first node **11**. Generally, the gateway **18** will be associated with a node that is geographically closest to

the gateway, in order to minimize transmission times over the IP network **26**. In response to the SIP Invite message, the call controller **13** sends an RC request message to the routing controller **30** which makes various enquiries of the database **23** to produce a routing message that is sent back to the call controller **13**. The call controller **13** then communicates with the media relay **28** to cause a communications link including an audio path (and a videopath if a videophone call) to be established through the media relay to the same node, a different node, or to a communications supplier gateway as shown generally at **34** to carry audio, and where applicable, video traffic to the call recipient or callee.

Referring to Figure **14**, an exemplary SIP Invite message is shown generally at **310** and includes a caller identifier field **312**, a callee identifier field **314**, a digest parameter field **315**, a call identifier field **316**, an IP address field **317**, and a gateway UDP port field **318**. Examples of values for the fields in the SIP Invite message **310** are shown for illustration purposes only in Figure **14**. The caller identifier in the caller identifier field **312** is preferably in the form of the telephone number of the caller followed by the "@" symbol, which in turn is followed by the IP address of the gateway (**18**) in the IP network (**26**). The caller identifier may be determined by retrieving calling line identification (CLID) information from the signal provided by the PSTN network (**29**) to the gateway (**18**) for example. Where the caller identification information is not available to the gateway (**18**), the caller identifier in the caller identifier field **312** preferably includes a pre-assigned number (such as **11111**, for example) indicating that the caller identification information was not available, followed by the "@" symbol and then by the IP address of the gateway (**18**).

The callee identifier in the callee identifier field **314** is the access code identifying the channel (**20**, **22**, or **24** in the example of Figure **1**) on which the call was placed, and which was received from the access server (**14**). In the illustrated example, the access code is the PSTN telephone number **1-604-345-1212** corresponding to the channel **20** illustrated in Figure **1**, and to the

access code stored in the access code field **173** of the record **172** in the exemplary access code association table **170** illustrated in Figure **10**.

5 The digest parameter in the digest parameter field **315** is generated by the gateway (**18**) and may uniquely identify the SIP session that is initiated with the SIP Invite message **310**.

10 The call identifier in the call identifier field **316** is, in the illustrated embodiment, a four-digit hexadecimal number generated by the gateway (**18**) to identify the call, followed by the "@" symbol, which in turn is followed by the IP address of the gateway.

15 The IP address in the IP address field **317** is the IP address of the gateway (**18**) in the IP network (**26**), and the gateway UDP port number in the gateway UDP port field **318** includes a UDP port identifier identifying a UDP port at which the audio/video path will be terminated at the gateway (**18**).

20 It should be noted that throughout the description of the embodiments of this invention, the IP/UDP addresses of all elements such as the gateway (**18**) will be assumed to be valid IP/UDP addresses directly accessible via the Internet or a private IP network, for example, depending on the specific implementation of the system. As such, it will be assumed, for example, that the gateway (**18**) will have an IP/UDP address directly accessible by the call
25 controllers and the media relays on their respective nodes, and those addresses will not be obscured by Network Address Translation (NAT) or similar mechanisms. In other words, the IP/UDP information contained in SIP messages (for example the SIP Invite message or the RC Request message which will be described below) will match the IP/UDP addresses of the IP
30 packets carrying these SIP messages.

It will be appreciated that in many situations, the IP addresses assigned to various elements of the system may be in a private IP address space, and thus not directly accessible from other elements. Furthermore, it will also be

appreciated that NAT is commonly used to share a "public" IP address between multiple devices, for example between home PCs and IP telephones sharing a single Internet connection. For example, the gateway (18) may be assigned an IP address such as **192.168.0.5**. This address is located in so called "non-routable" (IP) address space and cannot be accessed directly from the Internet. In order for this device to communicate with other computers located on the Internet, the IP address has to be converted into a "public" IP address, for example **24.14.102.5** assigned by the Internet Service Provider, by a device performing NAT, typically a router. In addition to translating the IP address, NAT typically also translates UDP port numbers, for example an audio path originating at the gateway (18) and using a UDP port **12378** at its private IP address, may have be translated to a UDP port **23465** associated with the public IP address of the NAT device. In other words, when a packet originating from the gateway (18) arrives at an Internet-based node, the source IP/UDP address contained in the IP packet header will be **24.14.102.5:23465**, whereas the source IP/UDP address information contained in the SIP message inside this IP packet will be **192.168.0.5:12378**. The mismatch in the IP/UDP addresses may cause a problem for SIP-based VoIP systems because, for example, a node will attempt to send messages to a private address but the messages will never get there.

Call Controller

Referring to Figure 15, the call controller (13) includes a processor circuit shown generally at **320**. The processor circuit **320** includes a microprocessor **322**, program memory **324**, and an I/O port **326**. The program memory **324** and the I/O port **326** are in communication with the microprocessor **322**. The processor circuit **320** may include a plurality of microprocessors, a plurality of program memories, and a plurality of I/O ports to be able to handle a large volume of calls. However, for simplicity, the processor circuit **320** will be described as having only one microprocessor **322**, program memory **324**, and I/O port **326**, it being understood that there may be more.

Generally, the I/O port **326** includes an input **328** for receiving messages such as the SIP Invite message from the gateway (**18**) or from a VoIP telephone (**36** in Figure 1, for example). The I/O port **326** also has an RC request message output **330** for transmitting an RC request message to the routing controller **30** of Figure 1, an RC message input **332** for receiving routing messages from the routing controller **30**, a gateway output **334** for transmitting messages to the gateway **18** and/or **34** shown in Figure 1 to advise the gateway **18** and/or **34** to establish an audio path, for example, and a gateway input **336** for receiving messages from the gateway **18** and/or **34**.
The I/O port **326** further includes a SIP output **338** for transmitting messages to the gateway (**18** and/or **34**) or VoIP telephone (**36**, for example) to advise the gateway **18** and/or **34** or IP telephone of the IP addresses of the gateways which will establish the audio/video path. The I/O port **326** further includes a voicemail server input and output **340** and **342** respectively for communicating with the voicemail server **19** shown in Figure 1.

While certain inputs and outputs have been shown as separate, it will be appreciated that some may be a single IP address and IP port. For example, the messages sent to the routing controller (**30**) and received from the routing controller (**30**) may be transmitted and received on the same single IP port.

The program memory **324** includes blocks of code for directing the microprocessor **322** to carry out various functions of the call controller (**13**). For example, these blocks of code include a first block **344** for causing the processor circuit **320** to execute a SIP Invite to RC Request process to produce an RC Request Message in response to a received SIP Invite message. In addition, there is a Routing Message to Gateway message block **346** which causes the processor circuit **320** of the call controller to produce a gateway query message in response to a received routing message from the routing controller (**30**).

Referring to Figures **15** and **16**, the SIP Invite to RC Request process is shown in more detail at **344**. On receipt of a SIP Invite message of the type

shown in Figure 14, block 350 directs the processor circuit 320 to produce an RC Request Message. Block 352 then directs the processor circuit 320 to cause the RC Request Message to be sent to the routing controller 30 illustrated in Figure 1.

5

Referring to Figure 17, an exemplary RC request message is shown generally at 360 and includes a caller identifier field 362, a callee identifier field 364, a digest parameters field 366, and a call identifier field 368. These fields may be populated with the contents of the caller identifier field 312, callee identifier field 314, digest parameter field 315, and call identifier field 316 respectively of the SIP Invite message 310 illustrated in Figure 14. In other embodiments, the RC request message may further include a type field (not shown) containing a type code to indicate whether the call is from a third party or from a system subscriber. Other variations of an RC request message are explained in PCT Publication No. WO 2008/052340. A type field (not shown) in the RC request message 360 may be advantageous in embodiments where SIP Invite messages may also be received from an IP telephone that is using VoIP software to make a voice call. However, in the embodiments that are illustrated herein, SIP Invite messages originate from the gateway (18), and therefore a type designation is not necessary and may be omitted from the RC request message 360. In embodiments where a SIP Invite message may be received from an IP telephone, the SIP invite to RC request process shown in Figure 16 may require additional steps, as illustrated in Figure 5 of PCT Publication No. WO 2008/052340.

10

15

20

25

RC Request Message Handler

As illustrated in Figure 8, the program memory 234 includes an RC request message handler 380 which directs the routing controller (30) to produce a routing message in response to a received RC request message (360). Referring to Figure 18A, the RC request message handler 380 begins with a first block 382 that directs the RC processor circuit (230) to separately store the contents of the callee identifier field 364 and caller identifier field 362 of

30

the RC request message (360) in the callee identifier store 246 and the caller identifier store 248 respectively of Figure 8.

5 Block 384 then directs the RC processor circuit (230) to use the contents of the caller username store 249 to locate and retrieve from the database (23) a dialing profile 200 associated with the caller, as described above and illustrated in Figure 9, for example. The retrieved dialing profile may then be stored in the temporary memory 240, for example.

10 The RC request message handler 380 continues at block 386, which directs the processor circuit (230) of the routing controller to determine whether the contents of the current number of concurrent calls field 222 of the dialing profile 200 shown in Figure 9 are less than the contents of the maximum number of concurrent calls field 220 of the dialing profile for the caller and, if so, block 388 directs the processor circuit to increment the contents of the current number of concurrent calls field 222 and the processor circuit (230) is directed to point A in Figure 18B. If the contents of the current number of concurrent calls field 222 are equal to or greater than the contents of the maximum number of concurrent calls field 220, then block 390 directs the processor circuit (230) to send an error message back to the call controller (13) to cause the call controller to notify the caller that the maximum number of concurrent calls has been reached and no further calls can exist concurrently, including the presently requested call.

20 Assuming that block 386 allows the call to proceed, the RC processor circuit (230) is directed to perform certain checks on the callee identifier in the callee identifier field 246 in Figure 8. These checks are shown in greater detail in Figure 18B.

30 Referring to Figure 18B, the RC processor circuit (230) is directed to a first block 392 that causes it to determine whether a digit pattern of the callee identifier includes a pattern that matches the contents of the international dialing digits (IDD) field 208 in the dialing profile 200 (shown in Figure 9)

associated with the caller. If so, then block **394** directs the RC processor circuit (**230**) to set a call type code identifier variable maintained by the processor to indicate that the call is an international call, and block **396** directs the processor to produce a reformatted callee identifier by reformatting the callee identifier into a predefined digit format. In this embodiment, this is done by removing the pattern of digits matching the IDD field contents (**208**) of the caller dialing profile **200** to effectively shorten the callee identifier. Then, block **398** directs the RC processor circuit (**230**) to determine whether or not the callee identifier has a length which meets criteria establishing it as a number compliant with the E.164 Standard set by the ITU. If the length does not meet these criteria, then block **400** directs RC processor circuit (**230**) to send back to the call controller (**13**) a message indicating the length is not correct. The process **380** is then ended. At the call controller **13**, routines (not shown) stored in the program memory **324** may direct the processor circuit (**320** of Figure **15**) to respond to the incorrect length message by transmitting a message back to the mobile telephone (**12** shown in Figure **1**) to indicate that an invalid number has been dialled.

If the length of the amended callee identifier meets the criteria set forth at block **398**, then block **402** directs the RC processor circuit (**230**) to make a database request to the database (**23**) to determine whether or not the amended callee identifier is found in the DID field (**373**) of a record such as shown in Figure **11** in the DID bank table. If at block **402** the RC processor circuit (**230**) receives a response from the database (**23**) indicating that the reformatted callee identifier produced at block **396** is found in the DID field (**373**) of a record in the DID bank table, then the callee is a subscriber to the system and the call is classified as a private network call by directing the processor to block **404**, which directs the RC processor circuit (**230**) to copy the contents of the corresponding username field (**371** in Figure **11**) from the callee DID bank table record (**370** in Figure **11**) into the callee identifier store (**246** in Figure **8**). Thus, the RC processor circuit (**230**) locates a subscriber username associated with the reformatted callee identifier. The processor (**232**) is then directed to point B in Figure **18A**.

Calls to Subscribers in Different Nodes

Referring back to Figure 1, as noted above, the gateway **18** is preferably associated with a pre-determined node, which in the illustrated embodiment is the first node **11**. Referring back to Figure **18A**, block **406** directs the processor (**232** of Figure **8**) to execute a process to determine whether or not the node associated with the reformatted callee identifier in the callee identifier store (**246** in Figure **8**, which, at block **404**, was set to be a username of the callee) is the same node that is associated with the gateway **18** illustrated in Figure **1**.

To do this, the processor (**232**) may, for example, identify a node associated with the gateway (**18**) by using an IP address associated with the gateway to determine a node identifier of the gateway. An IP address associated with the gateway (**18**) may, for example, be obtained from either the caller identifier field **362** or the call identifier field **368** of the RC request message **360** illustrated in Figure **17**, as each of these fields includes a portion following an "@" symbol that indicates an IP address of the gateway. In order to determine a node identifier associated with the gateway (**18**) using the IP address associated with gateway (**18**), the processor **232** (illustrated in Figure **8**) may access a gateway node association table stored in the database **23** (illustrated in Figure **1**).

Referring to Figure **19**, an exemplary gateway node association table is shown generally at **480**. The exemplary gateway node association table **480** includes first and second records **482** and **484**, each having a respective gateway IP address field **486** and a respective node identifier field **488**. It will be appreciated that the exemplary gateway node association table **480** is an example for illustration purposes only. The values in the gateway IP address fields **486** are preferably initialized when a gateway (such as the gateway **18** illustrated in Figure **1**) is installed as part of the system (**10**), and are preferably updated as the IP addresses of the respective gateways may change from time to time. The values in the node identifier fields **488** are also

preferably initialized when a gateway (such as the gateway **18** illustrated in Figure **1**) is installed as part of the system (**10**).

As indicated above, the reformatted callee identifier in the callee identifier store (**246** in Figure **8**) was set at block **404** in Figure **18B** to be a username of the callee from the username field **371** (illustrated in Figure **11**), and in this embodiment, a prefix of the username of the callee preferably indicates a node associated with the callee. In the illustrated embodiment, the left-most digit in the username of the callee is a continent code, which is a sufficient prefix to identify a node associated with the callee. However, it will be appreciated that in other embodiments, other prefixes or other information may identify the associated node. Preferably, the values in the node identifier fields **488** correspond to the prefixes of the usernames in the username fields **371** (illustrated in Figure **11**), so that the node associated with the callee is the same node that is associated with the gateway **18** illustrated in Figure **1** if the prefix of the username of the callee matches the node identifier associated with the gateway (**18**). Therefore, in the illustrated embodiment, if the reformatted callee identifier in the callee identifier store (**246** in Figure **8**) is **2001 1050 8667**, for example, then in the example of Figure **19**, the node associated with the callee is the same node as the node identified by the continent code “**2**” that is associated with the gateway associated with the IP address **20.14.102.5** in the record **482**, but is not the same node as the node identified by the continent code “**5**” that is associated with the gateway associated with the IP address **104.12.131.12** in the record **484**.

Referring back to Figure **18A**, if at block **406** the prefix of the username of the callee does not match the node identifier associated with the gateway (**18**), then the call is a “cross-domain” call, and block **408** in Figure **18A** directs the processor (**232** in Figure **8**) to set a call type flag in the temporary memory (**240** in Figure **8**) to indicate the call is a cross-domain call. Then, block **410** of Figure **18A** directs the processor (**232** of Figure **8**) to produce a routing message identifying an address on the private network with which the callee identified by the contents of the callee ID buffer is associated and to set a time

to live for the call at a maximum value of **99999**, for example. Routing messages and time to live values, and also a method of determining the node in the system with which the callee is associated, are further described in PCT Publication No. WO **2008/052340**. Once a routing message is produced at block **410**, block **412** directs the processor (**232** in Figure **8**) to cause the routing message to be sent to the call controller **13** shown in Figure **1**, and the process ends.

Referring back to Figure **18B**, if at block **392**, the callee identifier stored in the callee identifier store (**246** in Figure **8**) does not begin with an international dialing digit, then block **414** directs the processor (**232**) to determine whether or not the callee identifier begins with the same national dial digit code as assigned to the caller. To do this, the processor (**232**) is directed to refer to the retrieved caller dialing profile as shown in Figure **9**. In Figure **9**, the national dialing digit code **206** is the number **1**. Thus, if the callee identifier begins with the number **1**, then the processor (**232**) is directed to block **416** in Figure **18B**.

Block **416** directs the processor (**232** of Figure **8**) to examine the callee identifier to determine whether or not the digits following the NDD digit identify an area code that is the same as any of the area codes identified in the local area codes field **212** of the caller dialing profile **200** shown in Figure **9**. If not, block **418** of Figure **18B** directs the processor (**232**) to set the call type flag to indicate that the call is a national call. If the digits following the NDD digit identify an area code that is the same as a local area code associated with the caller as indicated by the caller dialing profile, block **420** directs the processor (**232**) to set the call type flag to indicate a local call, national style. After executing block **418** or **420**, block **422** directs the processor (**232**) to format the callee identifier into a pre-defined digit format to produce a reformatted callee identifier by removing the national dialled digit and prepending a caller country code identified by the country code field **210** of the caller dialing profile shown in Figure **9**. The processor (**232**) is then

directed to block **398** of Figure **18B** to perform other processing as already described above.

5 If at block **414**, the callee identifier does not begin with a national dialled digit, block **424** directs the processor (**232**) to determine whether the callee identifier begins with digits that identify the same area code as the caller. Again, the reference for this is the retrieved caller dialing profile shown in Figure **9**. The processor (**232**) determines whether or not the first few digits of the callee identifier identify an area code corresponding to the contents of any
10 area code identifier stored in the local area code field **212** of the retrieved caller dialing profile **200** (illustrated in Figure **9**). If so, then block **426** directs the processor (**232**) to set the call type flag to indicate that the call is a local call. It should be noted that the call will not necessarily be a local call in every case where the first few digits of the callee identifier identify an area code
15 corresponding to the contents of an area code identifier stored in the local area code field **212** (illustrated in Figure **9**), and other determinations of when a call is to be considered local may be appropriate. However, it has been found that the determination described above for block **424** is satisfactory for some purposes. Next, block **428** directs the processor (**232**) to format the
20 callee identifier into a pre-defined digit format to produce a reformatted callee identifier by prepending the caller country code to the callee identifier, the caller country code being determined from the country code field **210** of the retrieved caller dialing profile **200** shown in Figure **9**. The processor (**232**) is then directed to block **398** for further processing as described above.

25 If at block **424**, the callee identifier does not start with the same area code as the caller, block **430** directs the processor (**232** of Figure **8**) to determine whether the number of digits in the callee identifier, *i.e.* the length of the callee identifier, is within the range of digits indicated by the caller minimum local
30 number length field **214** and the caller maximum local number length field **216** of the retrieved caller dialing profile **200** shown in Figure **9**, and whether there is more than one area code identifier stored in the local area code field **212** of the retrieved caller dialing profile. If the number of digits in the callee identifier

is within the aforementioned range and there is only one area code identifier stored in the local area code field (212), then block 432 directs the processor (232) to set the call type flag to indicate a local call and block 434 directs the processor (232) to format the callee identifier into a pre-defined digit format to produce a reformatted callee identifier by prepending to the callee identifier the caller country code (as indicated by the country code field 210 of the retrieved caller dialing profile 200 shown in Figure 9) followed by the caller area code as indicated by the local area code stored in the local area code field 212 of the caller dialing profile 200 shown in Figure 9. The processor (232) is then directed to block 398 of Figure 18B for further processing as described above.

If at block 430, the callee identifier has a length that does not fall within the range specified by the caller minimum local number length field (214 in Figure 9) and the caller maximum local number length field (216 in Figure 9), or if there is more than one area code identifier stored in the local area code field 212 of the retrieved caller dialing profile 200 illustrated in Figure 9, then block 436 directs the processor (232) to send an error message back to the call controller (13), and the process ends.

In alternative embodiments, such as those illustrated in PCT Publication No. WO 2008/052340, an additional block (402 in Figure 8B of PCT Publication No. WO 2008/052340) may determine whether the callee identifier is a valid username. However, in the embodiment disclosed herein, the callee identifier is assumed to be a telephone number of the callee, and not a username.

From Figure 18B, it will be appreciated that there are certain groups of blocks of codes that direct the processor 232 in Figure 8 to determine whether the callee identifier has certain features such as an international dialing digit, a national dialing digit, an area code and a length that meet certain criteria, and cause the processor 232 to reformat the callee identifier stored in the callee identifier store 246 in Figure 8, as necessary into a predetermined target format including only a country code, area code, and a normal telephone number, for example, to cause the callee identifier to be compatible with the

E.164 number plan standard in this embodiment. This enables block 402 in Figure 18B to have a consistent format of callee identifiers for use in searching through the DID bank table records 370 of the type shown in Figure 11 to determine how to route calls to subscribers on the same system. Effectively, therefore blocks 392, 414, 424, and 430 establish call classification criteria for classifying the call as a public network call or a private network call. Block 402 classifies the call, depending on whether or not the formatted callee identifier has a DID bank table record, and this depends on how the call classification criteria are met.

Calls to Non-Subscribers

Not all calls will be to subscribers, and this will be detected by the processor 232 of Figure 8 when it executes block 402 in Figure 18B, and does not find a DID bank table record (370 illustrated in Figure 11) that is associated with the callee, in the DID bank table. When this occurs, the call is classified as a public network call, by directing the processor (232) to point C in Figure 18C.

Referring to Figure 18C, block 438 directs the processor (232) to determine whether the formatted callee identifier in the callee identifier store 246 in Figure 8 corresponds to an access code in the access code field 173 of a record in the access code association table 170 illustrated in Figure 10 that is associated with a callee identifier. Because the callee identifier in the callee identifier store 246 in Figure 8 has been formatted as described above with reference to Figure 18B, block 438 may involve determining whether an access code in the access code field 173 of a record of the access code association table 170 (illustrated in Figure 10) matches the formatted callee identifier in the callee identifier store 246 in Figure 8, and also whether a callee identifier (as opposed to the "null" value assigned on initialization) is stored in the callee identifier field 177 in association with the access code. As noted above, for simplicity, this description is directed to embodiments wherein an access code association table 170 associates access codes with respective callee identifiers, caller identifiers, timeout values, and timestamp values, although it will be appreciated that the processes described herein for

records in the access code association table **170** may additionally or alternatively be applied to DID bank table records **370** in an analogous manner.

5 If at block **438** the formatted callee identifier in the callee identifier store **246** in Figure **8** is the same as an access code in the access code field (**173**) of a record of the access code association table **170** illustrated in Figure **10** that is associated with a callee identifier, then block **440** directs the processor (**232**) to determine whether the caller identifier in the caller identifier store **248**
10 (illustrated in Figure **8**) is the same as the caller identifier in the caller identifier field (**179**) of the record of the access code association table (**170**), and thus whether the caller identifier in the caller identifier field (**179**) of the record of the access code association table (**170**) identifies the mobile telephone identified by the caller identifier in the caller identifier store **248**. If not, then
15 block **442** directs the processor (**232**) to send an error message to the call controller (**13**), and the process ends.

But if at block **440** the caller identifier in the caller identifier store **248** (illustrated in Figure **8**) corresponds to the caller identifier in the caller identifier field (**179**) of the record of the access code association table (**170**),
20 then the routing controller (**30**) will produce a routing message that will cause the call controller to establish communication through the IP network (**26**) to the callee in response to a call received at a channel (**20**, **22**, or **24**). Preferably, block **444** includes codes that direct the processor (**232**) to determine whether the association of the access code with the callee identifier
25 has expired, and thus whether the usability of the access code to initiate a call to the callee has expired, in the manner described above for block **278** in Figure **12**. If at block **444** the association of the access code with the callee identifier has expired, then block **442** directs the processor (**232**) to send an error message to the call controller (**13**), and the process ends. Thus the
30 routing controller produces a routing message that causes the call controller to establish the call only when the association of the access code with the callee identifier has not expired.

It will be appreciated that in alternative embodiments, one or more of the caller identifier, timeout, and timestamp fields **179**, **181**, and **182** may be omitted from the access code association table **170** illustrated in Figure **10**, and in these embodiments, one or more of the blocks **440**, **442**, and **444** may also be omitted.

If at block **444** the association of the access code with the callee identifier has not expired, or if one or both of blocks **440** and **444** is omitted, then block **446** directs the processor (**232**) to store the callee identifier from the callee identifier field **177** of the record of the access code association table (**170**) in the callee identifier store **246** illustrated in Figure **8**. The processor (**232**) is then directed to point A in Figure **18B** to repeat the steps illustrated in Figure **18B** using the callee identifier retrieved from the callee identifier field (**177**) in the record of the access code association table (**170**).

However, if at block **438** the formatted callee identifier in the callee identifier store **246** in Figure **8** does not correspond to an access code in a record of the access code association table **170** illustrated in Figure **10** that is associated with a callee identifier, then block **448** of Figure **18B** causes the processor (**232**) to set the contents of the callee identifier store **246** of Figure **8** to be the newly formatted callee identifier, i.e., a number compatible with the E.164 standard. Then, block **450** of Figure **18B** directs the processor (**232**) to generate a routing message identifying a gateway to the public network usable by the call controller (**13**) to establish a "public system" call. In one embodiment, block **450** includes codes that, for example, direct the processor (**232**) to search a database of route or master list records and to search a database of supplier records to identify at least one supplier operable to supply a communications link for the call, and to load a routing message buffer with supplier information, time to live values, and timeout values. An example of an implementation of these steps is described with reference to blocks **410**, **412**, **560**, **562**, **563**, **564**, **566**, and **571** in Figures **8B** and **8D** in PCT Publication No. WO **2008/052340**. Next, block **452** directs the processor

232 of Figure 10 to send the routing message to the call controller 13 in Figure 1, and the process ends.

Calls to Subscribers Within the Same Node

5 Referring back to Figure 18A, if at block 406, the prefix of the username of the callee matches the node identifier associated with the gateway (18), then the call is on one domain, and block 454 directs the processor (232) to use the callee identifier in the callee identifier store 246 illustrated in Figure 8 (which, at block 404, was set to be a username of the callee) to locate and retrieve a
10 dialing profile for the callee. The dialing profile may be of the type shown in Figure 9, for example. Block 456 of Figure 18A then directs the processor 232 of Figure 8 to get call block, call forward, and voicemail records from the database 23 of Figure 1, based on the username identified in the callee dialing profile retrieved by the processor at block 454. Exemplary call block,
15 call forward, and voicemail records are described in PCT Publication No. WO 2008/052340.

Then block 458 directs the processor 232 of Figure 8 to determine whether or not the caller identifier received in the RC request message matches a block
20 pattern stored in the call block record associated with the callee and retrieved at block 454. If the caller identifier matches a block pattern, then block 460 directs the processor to send a drop call or non-completion message to the call controller (13) and the process is ended. If the caller identifier does not match a block pattern associated with the callee, then block 462 directs the
25 processor (232) to determine whether or not call forwarding is required, as described in PCT Publication No. WO 2008/052340.

If at block 462, the call forwarding record for the callee indicates that no call forwarding is required, then the processor (232) is directed to block 464,
30 which directs the processor (232) to generate a routing message identifying an address on the private network, associated with the callee for a "private system" call. In one embodiment, block 464 includes codes that, for example, direct the processor (232) to store, in a routing message buffer, a username

and domain of the callee, time to live values, and an IP address of the current node, to determine whether or not the user identified by the callee identifier has paid for voicemail service and if so, to store voicemail information in the routing message buffer. An example of an implementation of these steps is described with reference to blocks **609**, **620**, **640**, **642**, and **644** in Figures **8A** and **8C** in PCT Publication No. WO **2008/052340**, which is incorporated herein by reference. Next, block **466** directs the processor **232** of Figure **8** to cause the routing message to be sent to the call controller **13** in Figure **1**, and the process ends.

But if at block **462**, the call forwarding record for the callee indicates that call forwarding is required, then block **468** directs the processor (**232**) to search a dialing profile table to find a dialing profile record as shown in Figure **9**, for the user identified by the destination number field of the call forward record, as illustrated in PCT Publication No. WO **2008/052340**. The processor (**232**) is further directed to store the username and domain for that user and a time to live value in a routing message buffer, an example of which is described in PCT Publication No. WO **2008/052340**. This process is repeated for each call forwarding record associated with the callee identified by the callee identifier store **246** in Figure **8** to add to the routing message buffer all call forwarding usernames and domains associated with the callee.

Referring to Figures **1**, **18A**, and **18C**, the routing message sent at one of blocks **412**, **452**, and **466** is received at the call controller **13** and the call controller interprets the receipt of the routing message as a request to establish a call. Referring to Figure **15**, the program memory **324** of the call controller **13** includes a routing to gateway routine depicted generally at **346**.

Where a routing message received at the call controller **13** is of the type produced at block **464** shown in Figure **18A**, indicating that the callee is a system subscriber on the same node as the gateway (**18**) (such as a user of the VoIP telephone **36** illustrated in Figure **1**), the routing to gateway routine **346** may direct the microprocessor **322** to cause a message to be sent back

through the IP network **26** shown in Figure **1** to the VoIP telephone (**36**), using the IP address of the VoIP telephone (**36**) that is available from the callee username.

5 Alternatively, if the routing message received at the call controller **13** is of the type produced at block **410** shown in Figure **18A**, identifying a domain associated with another node in the system, the call controller **13** may send a SIP invite message along the high speed/high data throughput link **17** in communication with the other node. The other node may function as
10 explained above and in PCT Publication No. WO **2008/052340**, in response to receipt of a SIP invite message.

If the routing message received at the call controller **13** is of the type produced at block **450** shown in Figure **18C**, indicating that the callee is not a
15 subscriber to the system (such as a user of the PSTN telephone **32** that is in communication with the IP network **26** through the gateway **34** as illustrated in Figure **1**), the call controller sends one or more SIP invite messages to the suppliers identified in the routing message to identify the IP address of a supplier that is able to carry the call, such as the IP address of the gateway **34**
20 illustrated in the example of Figure **1**. A process for identifying the IP address of a supplier that is able to carry the call is given in PCT Publication No. WO **2008/052340**, which is incorporated herein by reference. In some cases, the gateway of the supplier that is able to carry the call will be the gateway **18** illustrated in Figure **1**, that is, the same gateway through which the caller telephone (**12**) initiated the call. For simplicity, the following description
25 assumes that the gateways **18** and **34** are distinct gateways. It will be understood that in some cases, they may be the same gateway, but in these cases, the following steps may still be applied.

30 Referring to Figure **1**, the IP address of the gateway **34** is sent in a message from the call controller **13** to the media relay **28**, which responds with a message indicating an IP address to which the gateway **18** should send its audio/video traffic, and an IP address to which the gateway **34** should send its

audio/video for the call. The call controller conveys the IP address at which the media relay **28** expects to receive audio/video from the gateways **18** and **34**, to the gateways **18** and **34** in one or more messages. The gateway **18** replies to the call controller **13** with an IP address at which it would like to receive audio/video, and the call controller conveys that IP address to the media relay **28**. The call may then be conducted between the caller and callee through the media relay **28** and the gateways **18** and **34**.

If the call controller **13** receives a routing message of the type produced at block **464** shown in Figure **18A**, indicating that the callee is a system subscriber on the same node as the gateway (**18**) (such as a user of the VoIP telephone **36** illustrated in Figure **1**), and which has at least one call forwarding number and/or a voicemail number, the call controller attempts to establish a call to the callee VoIP telephone **36** by seeking from the callee telephone a message indicating an IP address to which the media relay **28** should send audio/video. If no such message is received from the callee telephone, no call is established. If no call is established within a pre-determined time, the call controller **13** attempts to establish a call with the next user identified in the call routing message in the same manner. This process is repeated until all call forwarding possibilities have been exhausted, in which case the call controller communicates with the voicemail server **19** identified in the routing message to obtain an IP address to which the media relay **28** should send audio/video and the remainder of the process mentioned above for establishing IP addresses at the media relay and the caller telephone is carried out to establish audio/video paths to allowing the caller to leave a voicemail message with the voicemail server.

When an audio/video path through the media relay **28** is established, a call timer maintained by the call controller **13** preferably logs the start date and time of the call and logs the call ID and an identification of the route (i.e., audio/video path IP address) for later use in billing.

Terminating the Call

Referring back to Figure 1, in the event that the caller terminates a call, the gateway 18 sends a SIP bye message to the call controller 13. Similarly, in the event that the callee terminates the call, the gateway 34 or the VoIP telephone 36 of the callee sends a SIP bye message to the call controller 13.

5 Exemplary SIP bye messages are described in PCT Publication No. WO 2008/052340. The SIP bye message is received at the call controller 13, and the call controller executes a process that involves decrementing the contents of the current number of concurrent calls field 222 dialing profile 200 of the caller as illustrated in Figure 9, generating an RC call stop message (not

10 shown), sending the RC call stop message to the routing controller 30, and sending a "bye" message to the party that did not terminate the call. An exemplary RC call stop message, and an example of how these steps may be implemented, are described in PCT Publication No. WO 2008/052340, which is incorporated herein by reference.

15

When the routing controller 30 receives the RC call stop message from the call controller 13, the routing controller executes an RC call stop message process that involves making various updates to subscriber, reseller, and supplier account records (not shown) following the call. Examples of

20 subscriber, reseller, and supplier account records, and of updates to subscriber, reseller, and supplier account records, are described in PCT Publication No. WO 2008/052340, which is incorporated herein by reference.

25 While specific embodiments of the invention have been described and illustrated, such embodiments should be considered illustrative of the invention only and not as limiting the invention.

What is claimed is:

1. A method of initiating a call to a callee using a mobile telephone, the method comprising:

5 receiving, from a user of the mobile telephone, a callee identifier associated with the callee;

transmitting an access code request message to an access server, said access code request message including said callee
10 identifier;

receiving an access code reply message from the access server in response to said access code request message, said access code reply message including an access code different from
15 said callee identifier and associated with said callee identifier; and

initiating a call with the mobile telephone using said access code to identify the callee.

20

2. The method of claim 1 wherein transmitting comprises transmitting said access code request message to said access server on a non-voice network.

25 3. The method of claim 1 wherein transmitting comprises transmitting a location identifier of a location associated with the mobile telephone to said access server.

30 4. The method of claim 3 wherein transmitting said location identifier comprises transmitting an IP address of the mobile telephone in a wireless IP network.

5. The method of claim 3 wherein transmitting said location identifier comprises transmitting an identifier of a wireless voice signal station in wireless communication with the mobile telephone.
- 5 6. The method of claim 3 wherein transmitting said location identifier comprises transmitting a user-configured identifier of a location associated with the mobile telephone.
- 10 7. The method of claim 1 wherein receiving said access code reply message comprises receiving said access code reply message from said access server on a non-voice network.
- 15 8. The method of claim 1 wherein receiving said access code reply message comprises receiving, in said access code reply message, said access code temporarily associated with said callee identifier.
- 20 9. The method of claim 1 wherein receiving said access code reply message comprises receiving, in said access code reply message, a telephone number identifying a channel operably configured to cooperate with an IP network to cause a call involving the mobile telephone and the callee to be routed through the IP network.
- 25 10. The method of claim 9 wherein initiating said call comprises engaging a routing controller to route said call on said IP network to the callee.
- 30 11. The method of any one of claims 1 to 10 further comprising:
- receiving from the mobile telephone said access code request message;
- communicating with a routing controller to obtain from the routing controller said access code wherein said access code identifies a channel and is useable by the mobile telephone to

cause the routing controller to establish a call to the callee using the channel; and

5 transmitting said access code reply message to the mobile telephone.

12. A mobile telephone apparatus comprising:

10 means for receiving, from a user of the mobile telephone, a callee identifier associated with the callee;

transmitting means for transmitting an access code request message to an access server, said access code request message including said callee identifier;

15 means for receiving an access code reply message from the access server in response to said access code request message, said access code reply message including an access code different from said callee identifier and associated with said callee identifier; and

20 means for initiating a call using said access code to identify the callee.

25 **13.** The mobile telephone apparatus of claim **12** wherein said transmitting means comprises a non-voice network interface for transmitting said access code request message to said access server on a non-voice network.

30 **14.** The mobile telephone apparatus of claim **12** wherein said access code request message further includes a location identifier of a location associated with the mobile telephone.

15. The mobile telephone apparatus of claim **14** wherein said location identifier comprises an IP address of the mobile telephone in a wireless IP network.
- 5 16. The mobile telephone apparatus of claim **14** wherein said location identifier comprises an identifier of a wireless voice signal station in wireless communication with the mobile telephone.
- 10 17. The mobile telephone apparatus of claim **14** wherein said location identifier comprises a user-configured identifier of a location associated with the mobile telephone.
- 15 18. The mobile telephone apparatus of claim **12** wherein said means for receiving an access code reply message comprises a non-voice network interface for receiving said access code reply message on a non-voice network.
- 20 19. The mobile telephone apparatus of claim **12** wherein said access code includes a telephone number.
- 25 20. The mobile telephone apparatus of claim **12** wherein said means for initiating comprises a mobile telephone network interface.
- 30 21. A system for initiating a call to a callee, the system comprising:
the mobile telephone apparatus of any one of claims **12 – 20**,
and further comprising;
a routing controller; and
an access server comprising:

means for receiving from the mobile telephone said access code request message;

5

means for communicating with said routing controller to obtain from said routing controller said access code wherein said access code identifies a channel and is useable by the mobile telephone to cause the routing controller to establish a call to the callee using the channel; and

10

means for transmitting said access code reply message including said access code to the mobile telephone.

22. A mobile telephone apparatus comprising:

15

a processor circuit;

a network interface in communication with said processor circuit; and

20

a computer readable medium in communication with said processor circuit and encoded with codes for directing said processor circuit to:

25

receive, from a user of the mobile telephone, a callee identifier associated with the callee;

30

cause an access code request message to be transmitted to an access server, said access code request message including said callee identifier;

receive an access code reply message from the access server in response to said access code request message,

said access code reply message including an access code different from said callee identifier and associated with said callee identifier; and

5 initiate a call using said access code to identify the callee.

10 **23.** The mobile telephone apparatus of claim **22** wherein said network interface comprises a non-voice network interface, and wherein said codes for directing said processor circuit to cause said access code request message to be transmitted include codes for directing said processor circuit to cause said access code request message to be transmitted to said access server using said non-voice network interface on a non-voice network.

15 **24.** The mobile telephone apparatus of claim **22** wherein said access code request message further includes a location identifier of a location associated with the mobile telephone.

20 **25.** The mobile telephone apparatus of claim **24** wherein said location identifier comprises an IP address of the mobile telephone in a wireless IP network.

25 **26.** The mobile telephone apparatus of claim **24** wherein said location identifier comprises an identifier of a wireless voice signal station in wireless communication with the mobile telephone.

30 **27.** The mobile telephone apparatus of claim **24** wherein said location identifier comprises a user-configured identifier of a location associated with the mobile telephone.

28. The mobile telephone apparatus of claim **22** wherein said network interface comprises a non-voice network interface, and wherein said codes for directing said processor circuit to receive an access code

reply message include codes for directing said processor circuit to cause said access code reply message to be received from said access server using said non-voice network interface on a non-voice network.

5

29. The mobile telephone apparatus of claim **22** wherein said access code includes a telephone number identifying a channel operably configured to cooperate with an IP network to cause a call involving the mobile telephone and the callee to be routed through the IP network.

10

30. The mobile telephone apparatus of claim **22** wherein said network interface comprises a mobile telephone network interface, and wherein said codes for directing said processor circuit to initiate include codes for directing said processor circuit to cause a call to be initiated using said mobile telephone network interface on a mobile telephone network.

15

31. A system for initiating a call to a callee, the system comprising:

20

the mobile telephone of any one of claims **22 – 30**, and further comprising;

a routing controller; and

25

an access server comprising a processor circuit and a computer readable medium in communication with the processor circuit, the computer readable medium encoded with codes for directing said processor circuit to:

30

receive from the mobile telephone said access code request message;

communicate with said routing controller to obtain from said routing controller said access code wherein said access code identifies a channel and is useable by the mobile telephone to cause the routing controller to establish a call to the callee using the channel; and

5

transmit said access code reply message to the mobile telephone.

10 **32.** A computer readable medium encoded with codes for directing a processor circuit to initiate a call to a callee using a mobile telephone, said codes being operable to direct the processor circuit to:

15

receive, from a user of a mobile telephone, a callee identifier associated with a callee;

transmit an access code request message to an access server, said access code request message including said callee identifier;

20

receive an access code reply message from the access server in response to said access code request message, said access code reply message including an access code different from said callee identifier and associated with said callee identifier; and

25

initiate a call using said access code to identify the callee.

30 **33.** A method for enabling a mobile telephone to initiate a call to a callee through a channel, the method comprising:

receiving from the mobile telephone an access code request message including a callee identifier associated with the callee;

5 communicating with a routing controller to obtain from the routing controller an access code identifying the channel, said access code being different from the callee identifier and useable by the mobile telephone to initiate a call to the callee using the channel; and

10 transmitting an access code reply message including said access code to the mobile telephone.

- 15
- 20
- 25
- 30
- 34.** The method of claim **33** wherein receiving comprises receiving said access code request message on a non-voice network.
- 35.** The method of claim **33** further comprising causing the routing controller to produce said access code.
- 36.** The method of claim **35** wherein producing comprises selecting said access code from a pool of access codes, where each access code in said pool of access codes identifies a respective telephone number.
- 37.** The method of claim **36** further comprising determining a local calling area associated with the mobile telephone.
- 38.** The method of claim **37** wherein determining comprises accessing a dialing profile associated with the caller, said dialing profile including a location field having contents identifying at least a default location of the caller.
- 39.** The method of claim **37** wherein determining comprises receiving an IP address of the mobile telephone in a wireless IP network.

40. The method of claim 37 wherein determining comprises receiving an identifier of a wireless voice signal station in wireless communication with the mobile telephone.
- 5 41. The method of claim 37 wherein determining comprises receiving a user-configured identifier of a location associated with the mobile telephone.
- 10 42. The method of claim 37 wherein selecting comprises selecting an access code in said local calling area associated with the mobile telephone.
- 15 43. The method of claim 36 wherein each access code in said pool of access codes further identifies a respective channel operably configured to cooperate with an IP network to cause a call involving the mobile telephone and the callee to be routed through the IP network.
- 20 44. The method of claim 43 further comprising causing said routing controller to establish communication through said IP network in response to a call received on said channel.
- 25 45. The method of claim 44 wherein producing further comprises storing a caller identifier associated with the mobile telephone in association with said access code.
- 30 46. The method of claim 45 wherein causing said routing controller to establish communication comprises causing said routing controller to establish communication only if said caller identifier associated with said access code identifies the mobile telephone.
47. The method of claim 36 wherein producing further comprises storing said callee identifier in association with said access code.

5
48. The method of claim 47 wherein producing further comprises searching said pool of access codes for an access code associated with said callee identifier to identify the channel usable by the mobile telephone to initiate a call to the callee.

10
49. The method of claim 35 wherein producing further comprises storing, in association with said access code, a timestamp for use in determining when the usability of said access code to initiate a call to the callee will expire.

15
50. The method of claim 49 wherein causing said routing controller to establish communication comprises causing said routing controller to establish communication only if the usability of said access code to initiate a call to the callee has not expired.

20
51. The method of claim 33 wherein transmitting comprises transmitting said access code reply message on a non-voice network.

25
52. A system for enabling a mobile telephone to initiate a call to a callee through a channel, the system comprising:

means for receiving from the mobile telephone an access code request message including a callee identifier associated with the callee;

25
means for communicating with said routing controller to obtain from said routing controller an access code identifying the channel, said access code being different from the callee identifier and useable by the mobile telephone to initiate a call to the callee using the channel; and

30
means for transmitting an access code reply message including said access code to the mobile telephone.

53. The system of claim 52 wherein said means for receiving comprises a non-voice network interface for receiving said access code request message on a non-voice network.
- 5
54. The system of claim 52 further comprising means for producing said access code.
55. The system of claim 54 wherein said means for producing comprises a processor circuit operably configured to select said access code from a pool of access codes, where each access code in said pool of access codes identifies a respective telephone number.
- 10
56. The system of claim 55 wherein said processor circuit is operably configured to determine a local calling area associated with the mobile telephone.
- 15
57. The system of claim 56 wherein said processor circuit is operably configured to determine a local calling area associated with the mobile telephone using a dialing profile associated with the caller, said dialing profile including a location field having contents identifying at least a default location of the caller.
- 20
58. The system of claim 56 wherein said processor circuit is operably configured to determine a local calling area associated with the mobile telephone using an IP address of the mobile telephone in a wireless IP network.
- 25
59. The system of claim 56 wherein said processor circuit is operably configured to determine a local calling area associated with the mobile telephone using an identifier of a wireless voice signal station in wireless communication with the mobile telephone.
- 30

- 5
60. The system of claim **56** wherein said processor circuit is operably configured to determine a local calling area associated with the mobile telephone using a user-configured identifier of a location associated with the mobile telephone.
- 10
61. The system of claim **56** wherein said processor circuit is operably configured to select an access code in said local calling area associated with the mobile telephone.
- 15
62. The system of claim **55** wherein each access code in said pool of access codes further identifies a respective channel operably configured to cooperate with an IP network to cause a call involving the mobile telephone and the callee to be routed through the IP network.
- 20
63. The system of claim **62** wherein said processor circuit is operably configured to establish communication through said IP network in response to a call received on said channel.
- 25
64. The system of claim **63** wherein said processor circuit is operably configured to store a caller identifier associated with the mobile telephone in association with said access code.
- 30
65. The system of claim **64** wherein said processor circuit is operably configured to cause said routing controller to establish communication only if said caller identifier associated with said access code identifies the mobile telephone.
66. The system of claim **55** wherein said processor circuit is operably configured to store said callee identifier in association with said access code.
67. The system of claim **66** wherein said processor circuit is operably configured to search said pool of access codes for an access code

associated with said callee identifier to identify the channel usable by the mobile telephone to initiate a call to the callee.

- 5 **68.** The system of claim **54** wherein said processor circuit is operably configured to store, in association with said access code, a timestamp for use in determining when the usability of said access code to initiate a call to the callee will expire.
- 10 **69.** The system of claim **68** wherein said processor circuit is operably configured to establish communication only if the usability of said access code to initiate a call to the callee has not expired.
- 15 **70.** The system of claim **52** wherein said means for transmitting comprises a non-voice network interface for transmitting said access code reply message on a non-voice network.
- 71.** A system for enabling a mobile telephone to initiate a call to a callee through a channel, the system comprising:
- 20 a processor circuit;
- a network interface in communication with said processor circuit;
- and
- 25 a computer readable medium in communication with said processor circuit and encoded with codes for directing said processor circuit to:
- 30 receive from the mobile telephone an access code request message including a callee identifier associated with the callee;

communicate with said routing controller to obtain from said routing controller an access code identifying the channel, said access code being different from the callee identifier and useable by the mobile telephone to initiate a call to the callee using the channel; and

5

cause an access code reply message including said access code to be transmitted to the mobile telephone.

10 **72.** The system of claim **71** wherein said network interface comprises a non-voice network interface, and wherein said codes for directing said processor circuit to receive include codes for directing said processor circuit to cause said access code request message to be received using said non-voice network interface on a non-voice network.

15

73. The system of claim **71** wherein said computer readable medium is further encoded with codes for directing said processor circuit to cause said access code to be produced.

20 **74.** The system of claim **73** wherein said codes for directing said processor circuit to cause said access code to be produced cause said access code to be selected from a pool of access codes, where each access code in said pool of access codes identifies a respective telephone number.

25

75. The system of claim **74** wherein said computer readable medium is further encoded with codes for directing said processor circuit to cause to be determined a local calling area associated with the mobile telephone.

30

76. The system of claim **75** wherein said codes for directing said processor circuit to cause to be determined cause a dialing profile associated with

the caller to be accessed, said dialing profile including a location field having contents identifying at least a default location of the caller.

- 5
77. The system of claim 75 wherein said codes for directing said processor circuit to cause to be determined cause to be received an IP address of the mobile telephone in a wireless IP network.
- 10
78. The system of claim 75 wherein said codes for directing said processor circuit to cause to be determined cause to be received an identifier of a wireless voice signal station in wireless communication with the mobile telephone.
- 15
79. The system of claim 75 wherein said codes for directing said processor circuit to cause to be determined cause to be received a user-configured identifier of a location associated with the mobile telephone.
- 20
80. The system of claim 75 wherein said codes for directing said processor circuit to cause said access code to be produced further cause to be selected an access code in said local calling area associated with the mobile telephone.
- 25
81. The system of claim 74 wherein each access code in said pool of access codes further identifies a respective channel operably configured to cooperate with an IP network to cause a call involving the mobile telephone and the callee to be routed through the IP network.
- 30
82. The system of claim 81 wherein said computer readable medium is further encoded with codes for directing said processor circuit to cause communication through said IP network to be established in response to a call received on said channel.
83. The system of claim 82 wherein said codes for directing said processor circuit to cause said access code to be produced cause a caller

identifier associated with the mobile telephone to be stored in association with said access code.

- 5 **84.** The system of claim **83** wherein said codes for directing said processor circuit to cause communication to be established cause communication to be established only if said caller identifier associated with said access code identifies the mobile telephone.
- 10 **85.** The system of claim **74** wherein said codes for directing said processor circuit to cause said access code to be produced cause said callee identifier to be stored in association with said access code.
- 15 **86.** The system of claim **85** wherein said codes for directing said processor circuit to cause said access code to be produced cause said pool of access codes to be searched for an access code associated with said callee identifier to identify the channel usable by the mobile telephone to initiate a call to the callee.
- 20 **87.** The system of claim **73** wherein said codes for directing said processor circuit to cause said access code to be produced cause a timestamp for use in determining when the usability of said access code to initiate a call to the callee will expire, to be stored in association with said access code.
- 25 **88.** The system of claim **87** wherein said codes for directing said processor circuit to cause communication to be established cause communication to be established only if the usability of said access code to initiate a call to the callee has not expired.
- 30 **89.** The system of claim **71** wherein said network interface comprises a non-voice network interface, and wherein codes for directing said processor circuit to transmit include codes for directing said processor

circuit to cause said access code reply message to be transmitted using said non-voice network interface on a non-voice network.

5 **90.** A computer readable medium encoded with codes for directing a processor circuit to enable a mobile telephone to initiate a call to a callee through a channel, the codes being operable to direct the processor circuit:

10 receive from the mobile telephone an access code request message including a callee identifier associated with the callee;

15 communicate with said routing controller to obtain from said routing controller an access code identifying the channel, said access code being different from the callee identifier and useable by the mobile telephone to initiate a call to the callee using the channel; and

 cause an access code reply message including said access code to be transmitted to the mobile telephone.

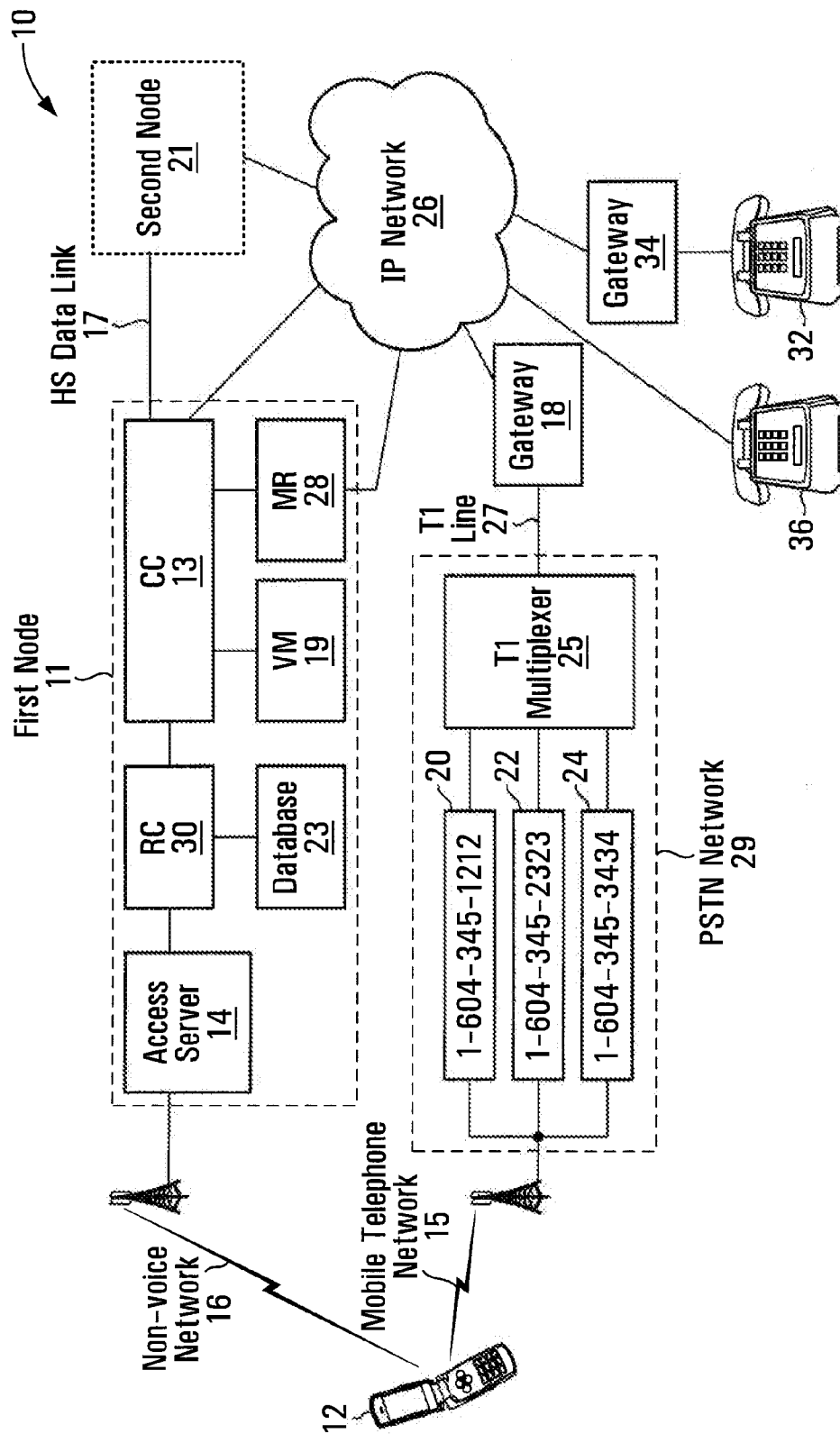

FIG. 1

2/17

Mobile Telephone (12)

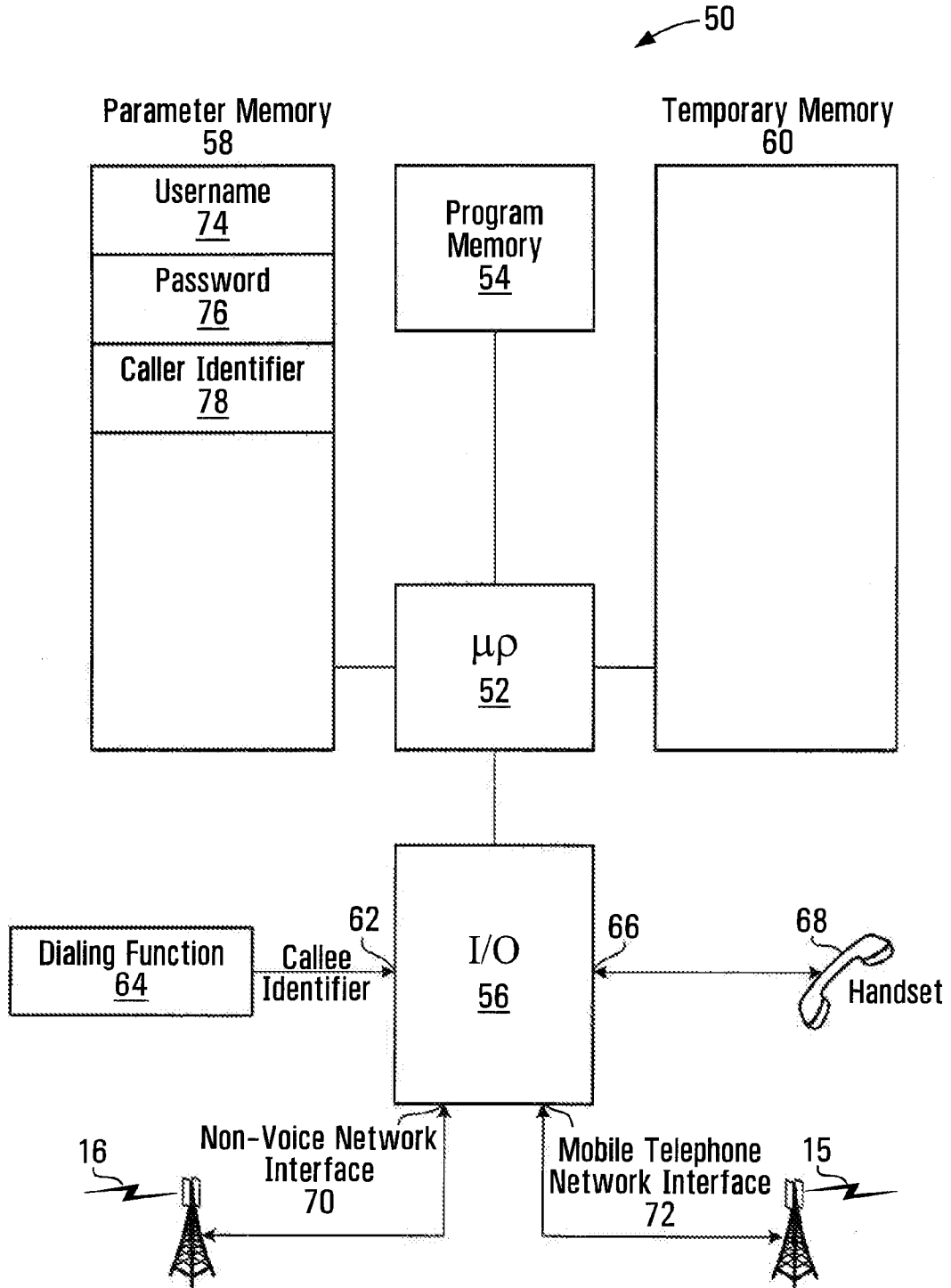

FIG. 2

3/17

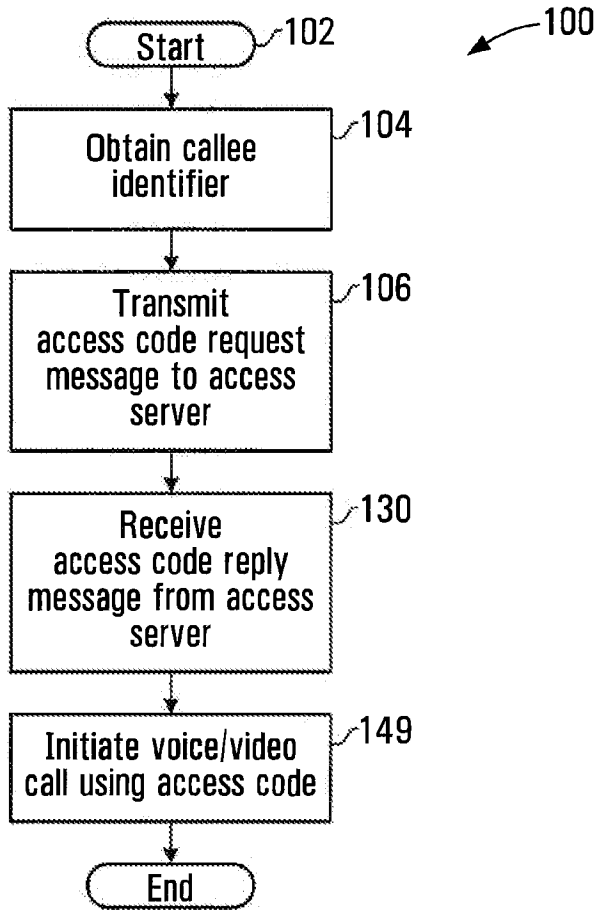

FIG. 3

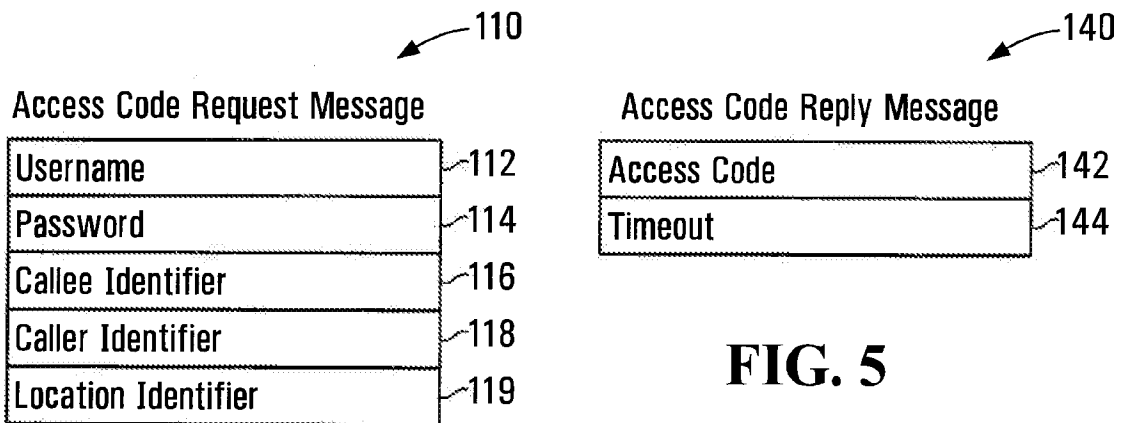

FIG. 4

FIG. 5

4/17

Access Server (14)

150

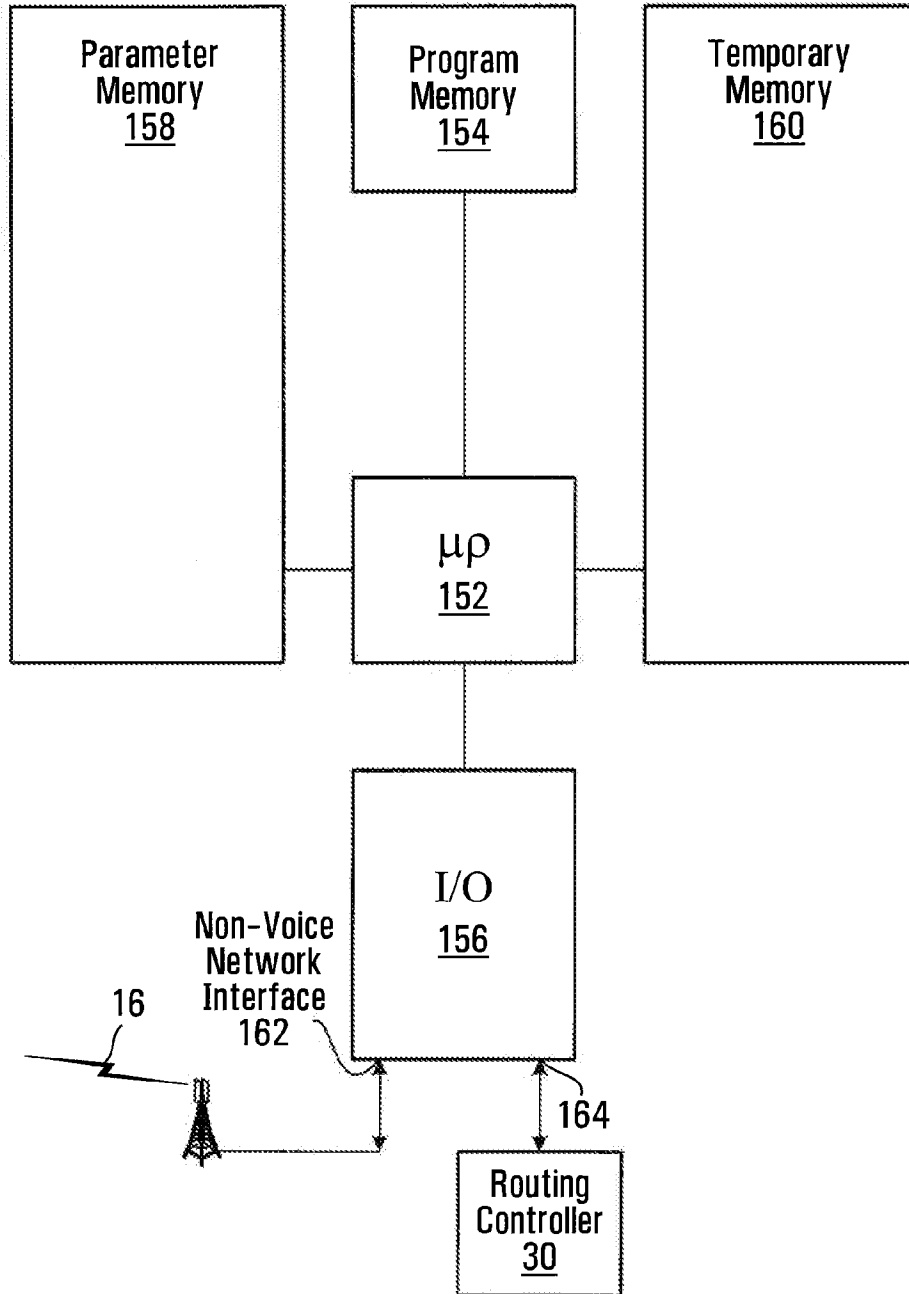

FIG. 6

5/17

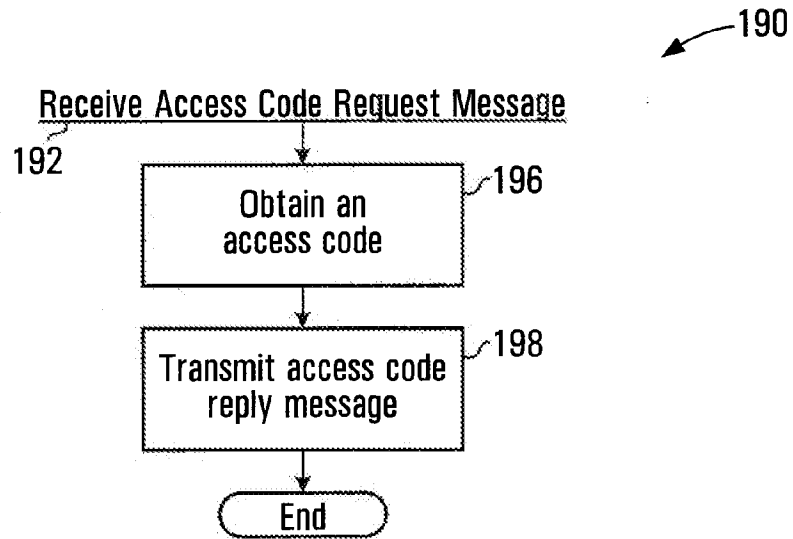

FIG. 7

6/17

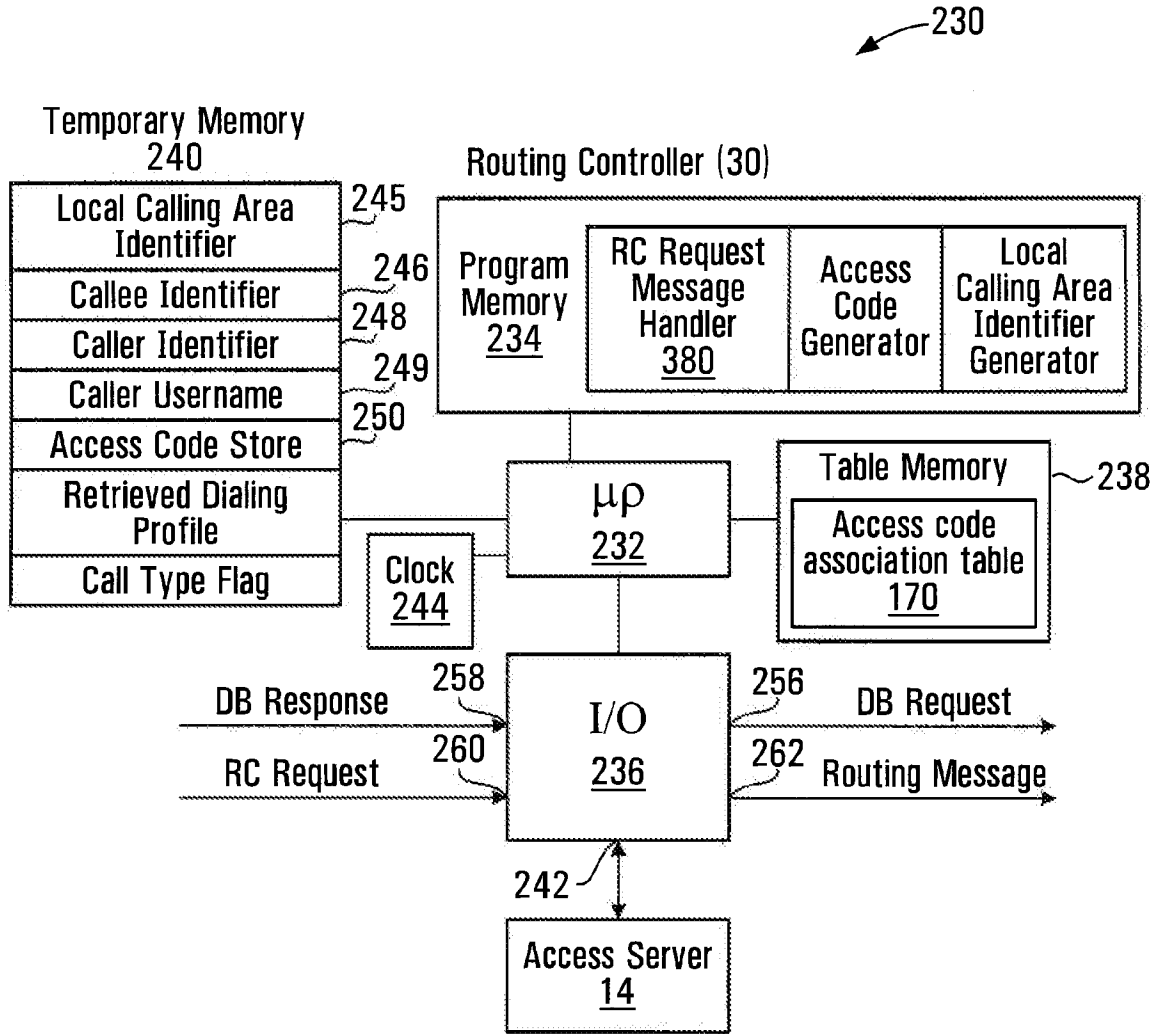

FIG. 8

7/17

↖ 200

Dialing Profile for a User

202 ~ Username	Assigned on Subscription
204 ~ Domain	Domain Associated with User
206 ~ NDD	1
208 ~ IDD	011
210 ~ Country Code	1
212 ~ Local Area Codes	604;778
214 ~ Caller Minimum Local # Length	10
216 ~ Caller Maximum Local # Length	10
218 ~ Reseller	Retailer
220 ~ Maximum # of concurrent calls	Assigned on Subscription
222 ~ Current # of concurrent calls	Assigned on Subscription
224 ~ Default Local Calling Area Identifier	Assigned on Subscription

FIG. 9

170

171	173	175	177	179	183
Local Calling Area Identifier	Access Code	Channel Identifier	Callee Identifier	Caller Identifier	Caller Username
XXXX	1-604-345-1212	20			
174	1-604-345-2323	22	1-403-789-1234	1-416-444-1441	2001 1050 8667
176	1-604-345-3434	24			
178	1-416-234-4646	XX	1-604-321-1234	1-416-444-1234	2001 1050 4141
180	1-416-234-6868	XY			

181	182
Timeout	Timestamp
10	06-15-2008 10:31
10	06-15-2008 14:21

FIG. 10

9/17

370

DID Bank Table Record

Username	371
User Domain	372
DID	373
Callee Identifier	374
Caller Identifier	375
Timeout	376
Timestamp	377
Local Calling Area Identifier	378
Channel Identifier	379
Caller Username	381

FIG. 11

10/17

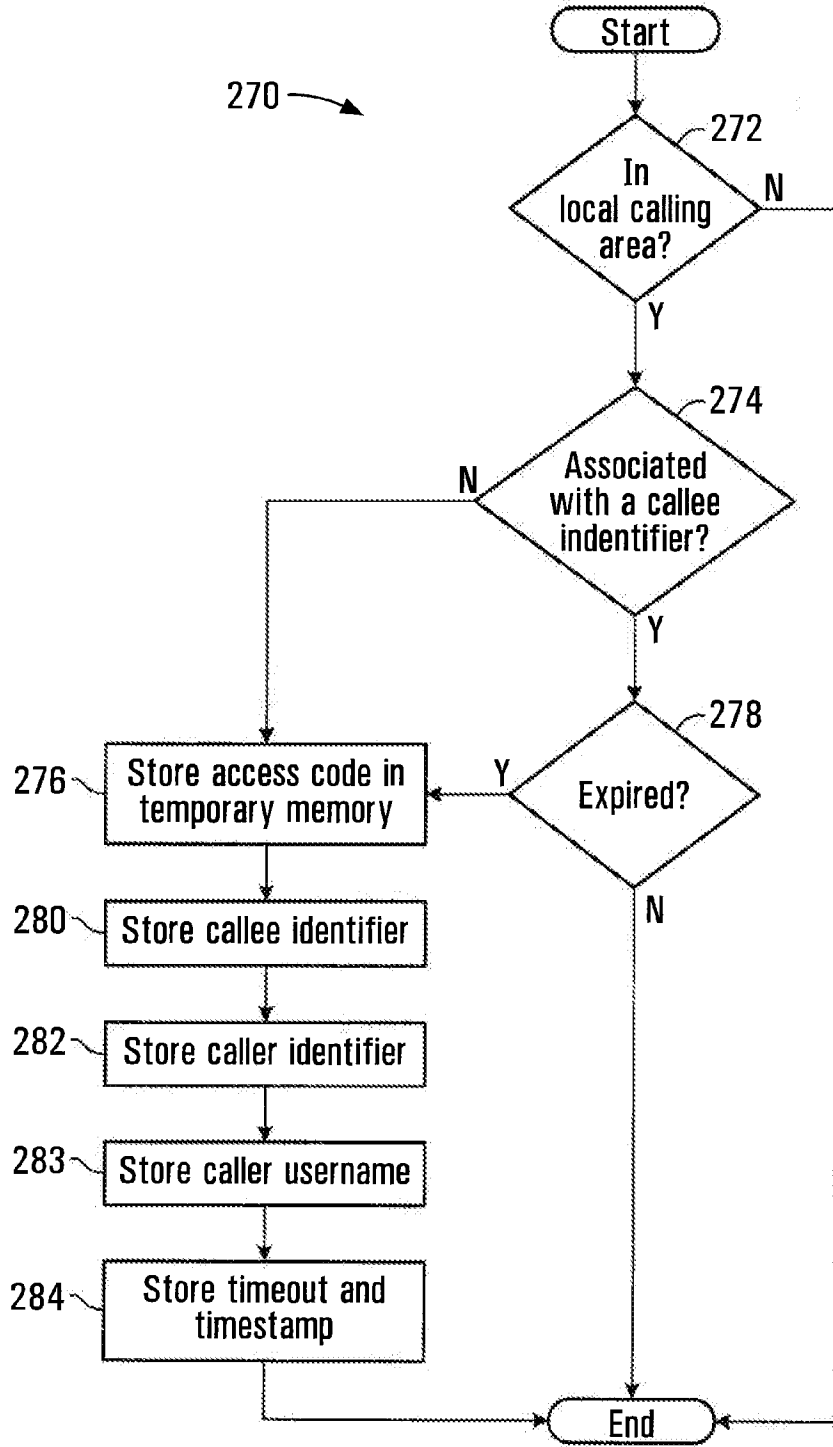

FIG. 12

11/17

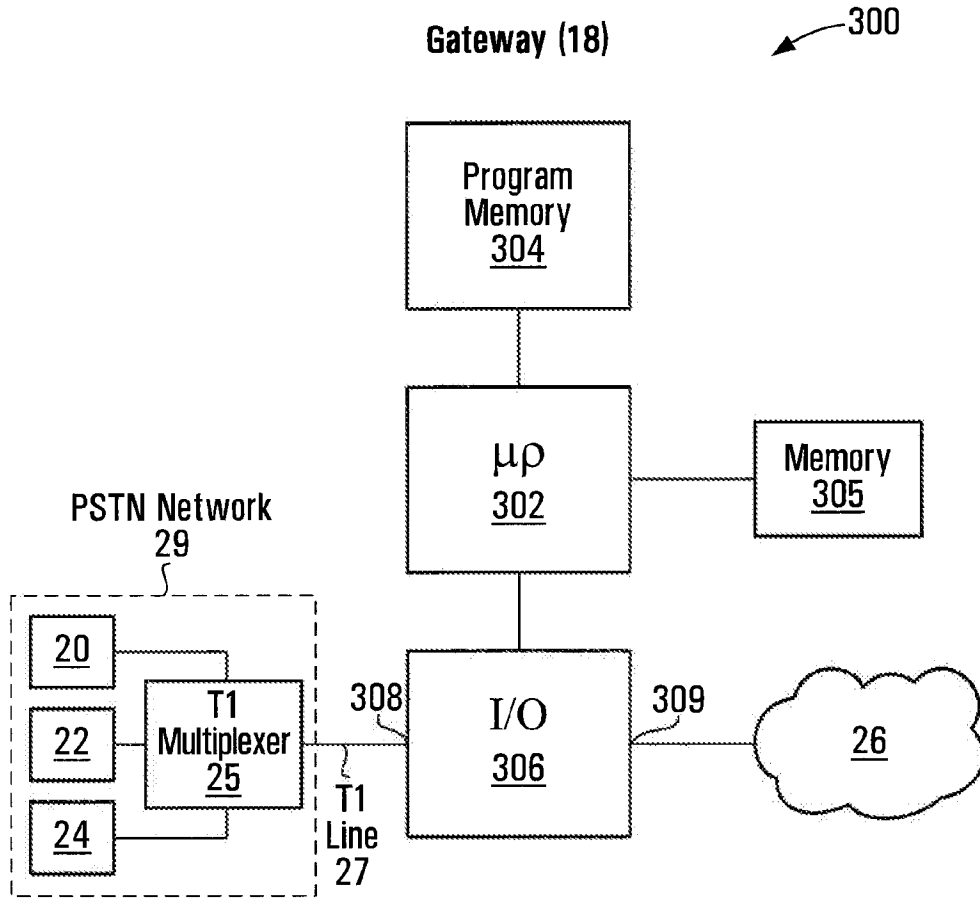

FIG. 13

310

SIP Invite Message

312	Caller Identifier	1-604-678-1234@20.14.102.5
314	Callee Identifier	1-604-345-1212
315	Digest Parameter	XXXXXXX
316	Call Identifier	FF10@20.14.102.5
317	IP Address	20.14.102.5
318	Gateway UDP Port	12378

FIG. 14

12/17

Call Controller (13)

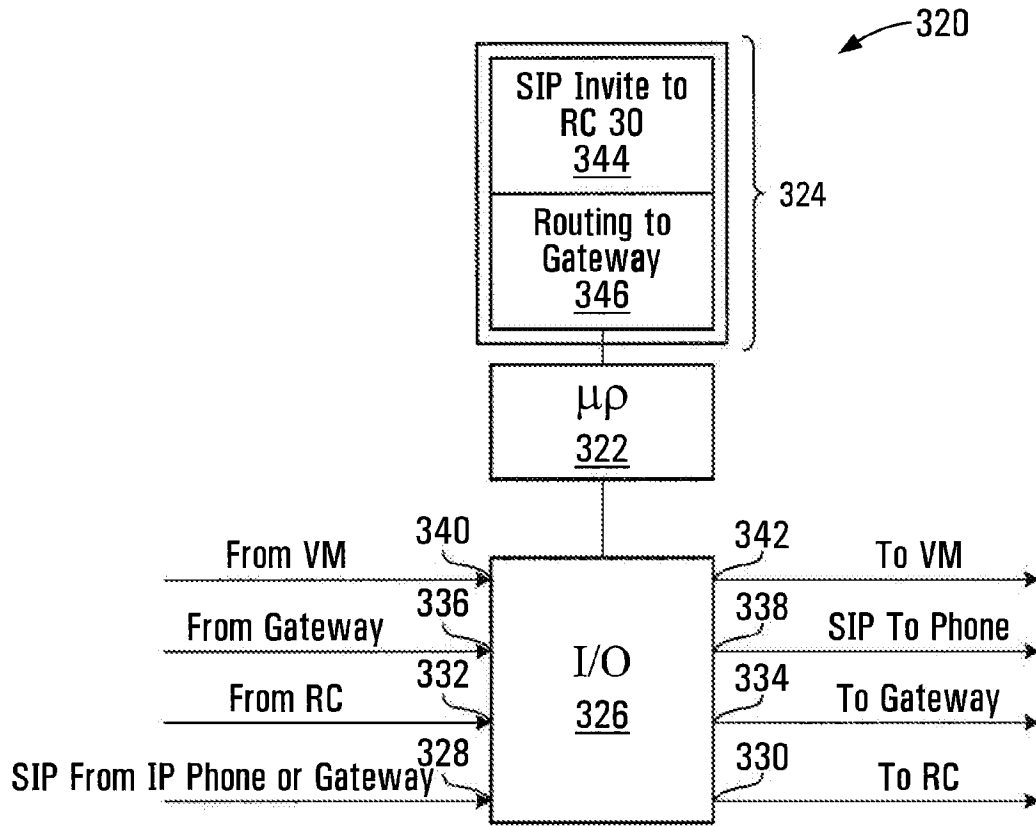

FIG. 15

13/17

SIP Invite Request Process

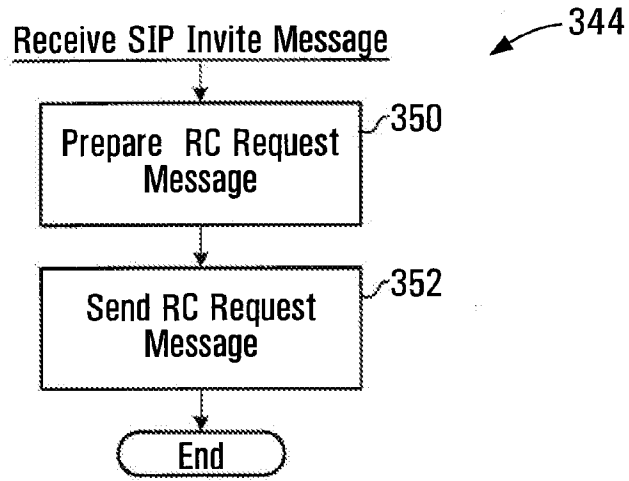

FIG. 16

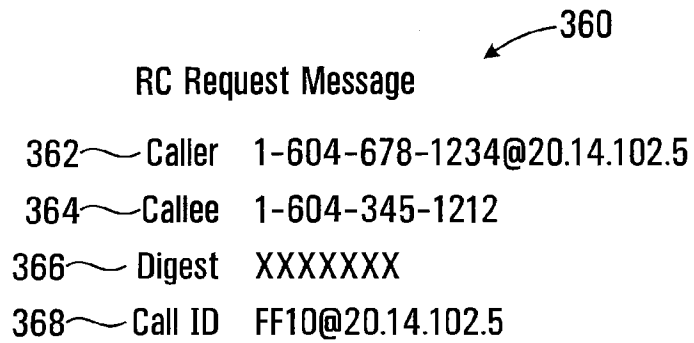

FIG. 17

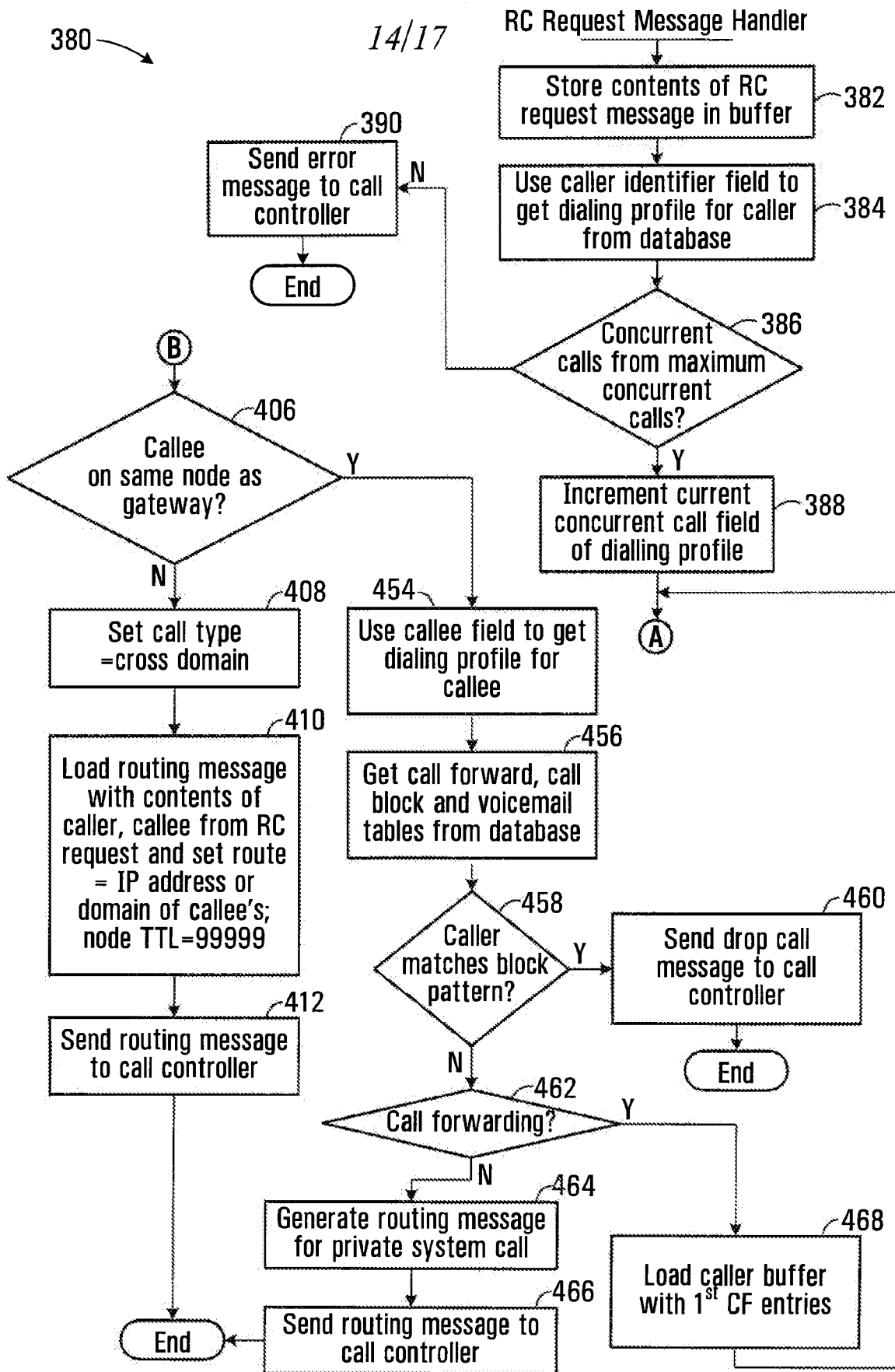

FIG. 18A

+

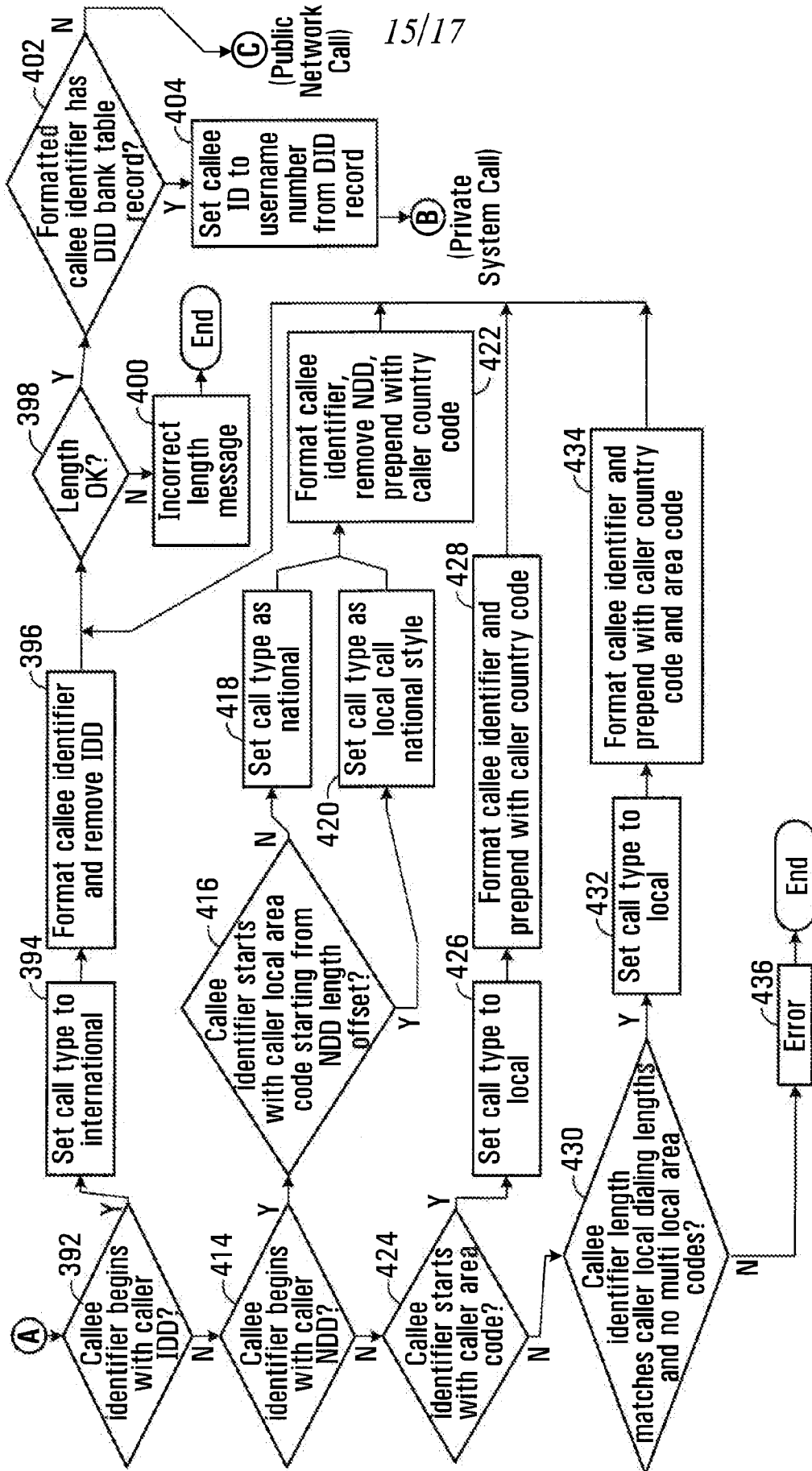

FIG. 18B

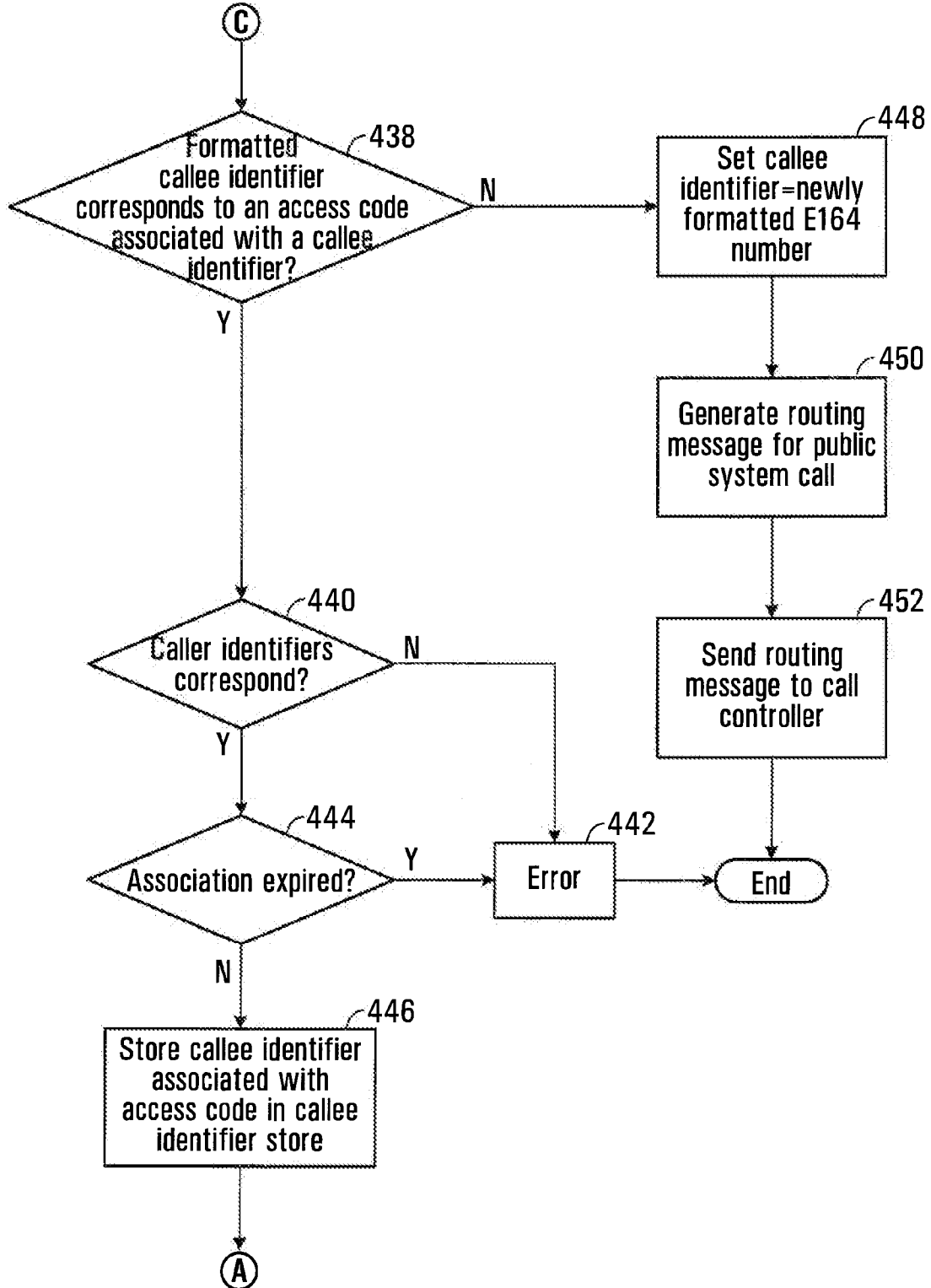

FIG. 18C

17/17

Gateway Node Association Table ↖ 480

	486	488
	Gateway IP Address	Node Identifier
482	20.14.102.5	2
484	104.12.131.12	5

FIG. 19

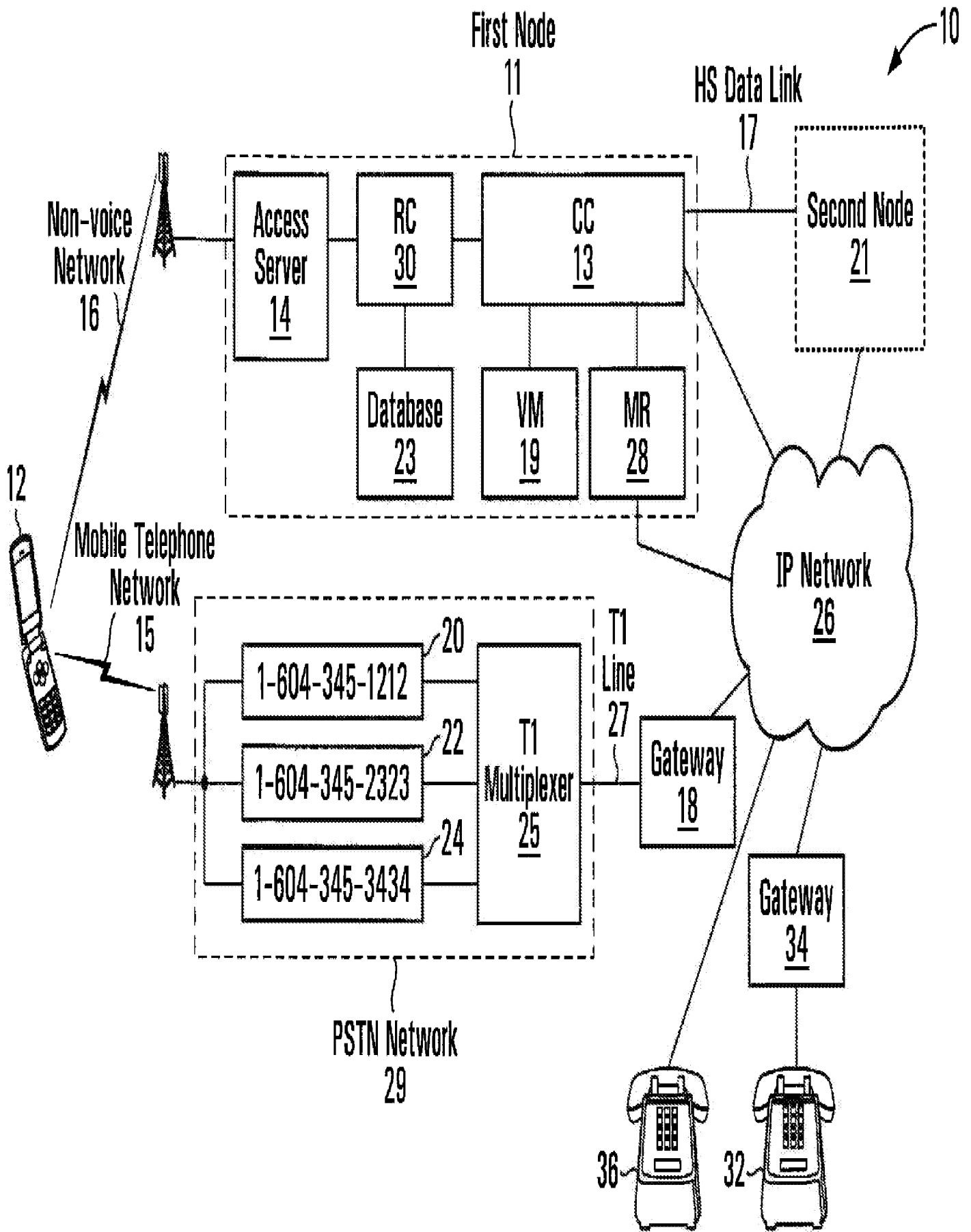

FIG. 1

associated with said callee identifier to identify the channel usable by the mobile telephone to initiate a call to the callee.

5 **68.** The system of claim **54** wherein said processor circuit is operably configured to store, in association with said access code, a timestamp for use in determining when the usability of said access code to initiate a call to the callee will expire.

10 **69.** The system of claim **68** wherein said processor circuit is operably configured to establish communication only if the usability of said access code to initiate a call to the callee has not expired.

15 **70.** The system of claim **52** wherein said means for transmitting comprises a non-voice network interface for transmitting said access code reply message on a non-voice network.

71. A system for enabling a mobile telephone to initiate a call to a callee through a channel, the system comprising:

20 a processor circuit;

 a network interface in communication with said processor circuit;
 and

25 a computer readable medium in communication with said processor circuit and encoded with codes for directing said processor circuit to:

30 receive from the mobile telephone an access code request message including a callee identifier associated with the callee;

communicate with said routing controller to obtain from said routing controller an access code identifying the channel, said access code being different from the callee identifier and useable by the mobile telephone to initiate a call to the callee using the channel; and

5

cause an access code reply message including said access code to be transmitted to the mobile telephone.

10 **72.** The system of claim **71** wherein said network interface comprises a non-voice network interface, and wherein said codes for directing said processor circuit to receive include codes for directing said processor circuit to cause said access code request message to be received using said non-voice network interface on a non-voice network.

15

73. The system of claim **71** wherein said computer readable medium is further encoded with codes for directing said processor circuit to cause said access code to be produced.

20 **74.** The system of claim **73** wherein said codes for directing said processor circuit to cause said access code to be produced cause said access code to be selected from a pool of access codes, where each access code in said pool of access codes identifies a respective telephone number.

25

75. The system of claim **74** wherein said computer readable medium is further encoded with codes for directing said processor circuit to cause to be determined a local calling area associated with the mobile telephone.

30

76. The system of claim **75** wherein said codes for directing said processor circuit to cause to be determined cause a dialing profile associated with

the caller to be accessed, said dialing profile including a location field having contents identifying at least a default location of the caller.

- 5
77. The system of claim 75 wherein said codes for directing said processor circuit to cause to be determined cause to be received an IP address of the mobile telephone in a wireless IP network.
- 10
78. The system of claim 75 wherein said codes for directing said processor circuit to cause to be determined cause to be received an identifier of a wireless voice signal station in wireless communication with the mobile telephone.
- 15
79. The system of claim 75 wherein said codes for directing said processor circuit to cause to be determined cause to be received a user-configured identifier of a location associated with the mobile telephone.
- 20
80. The system of claim 75 wherein said codes for directing said processor circuit to cause said access code to be produced further cause to be selected an access code in said local calling area associated with the mobile telephone.
- 25
81. The system of claim 74 wherein each access code in said pool of access codes further identifies a respective channel operably configured to cooperate with an IP network to cause a call involving the mobile telephone and the callee to be routed through the IP network.
- 30
82. The system of claim 81 wherein said computer readable medium is further encoded with codes for directing said processor circuit to cause communication through said IP network to be established in response to a call received on said channel.
83. The system of claim 82 wherein said codes for directing said processor circuit to cause said access code to be produced cause a caller

identifier associated with the mobile telephone to be stored in association with said access code.

- 5 **84.** The system of claim **83** wherein said codes for directing said processor circuit to cause communication to be established cause communication to be established only if said caller identifier associated with said access code identifies the mobile telephone.
- 10 **85.** The system of claim **74** wherein said codes for directing said processor circuit to cause said access code to be produced cause said callee identifier to be stored in association with said access code.
- 15 **86.** The system of claim **85** wherein said codes for directing said processor circuit to cause said access code to be produced cause said pool of access codes to be searched for an access code associated with said callee identifier to identify the channel usable by the mobile telephone to initiate a call to the callee.
- 20 **87.** The system of claim **73** wherein said codes for directing said processor circuit to cause said access code to be produced cause a timestamp for use in determining when the usability of said access code to initiate a call to the callee will expire, to be stored in association with said access code.
- 25 **88.** The system of claim **87** wherein said codes for directing said processor circuit to cause communication to be established cause communication to be established only if the usability of said access code to initiate a call to the callee has not expired.
- 30 **89.** The system of claim **71** wherein said network interface comprises a non-voice network interface, and wherein codes for directing said processor circuit to transmit include codes for directing said processor

circuit to cause said access code reply message to be transmitted using said non-voice network interface on a non-voice network.

5 **90.** A computer readable medium encoded with codes for directing a processor circuit to enable a mobile telephone to initiate a call to a callee through a channel, the codes being operable to direct the processor circuit:

10 receive from the mobile telephone an access code request message including a callee identifier associated with the callee;

15 communicate with said routing controller to obtain from said routing controller an access code identifying the channel, said access code being different from the callee identifier and useable by the mobile telephone to initiate a call to the callee using the channel; and

 cause an access code reply message including said access code to be transmitted to the mobile telephone.

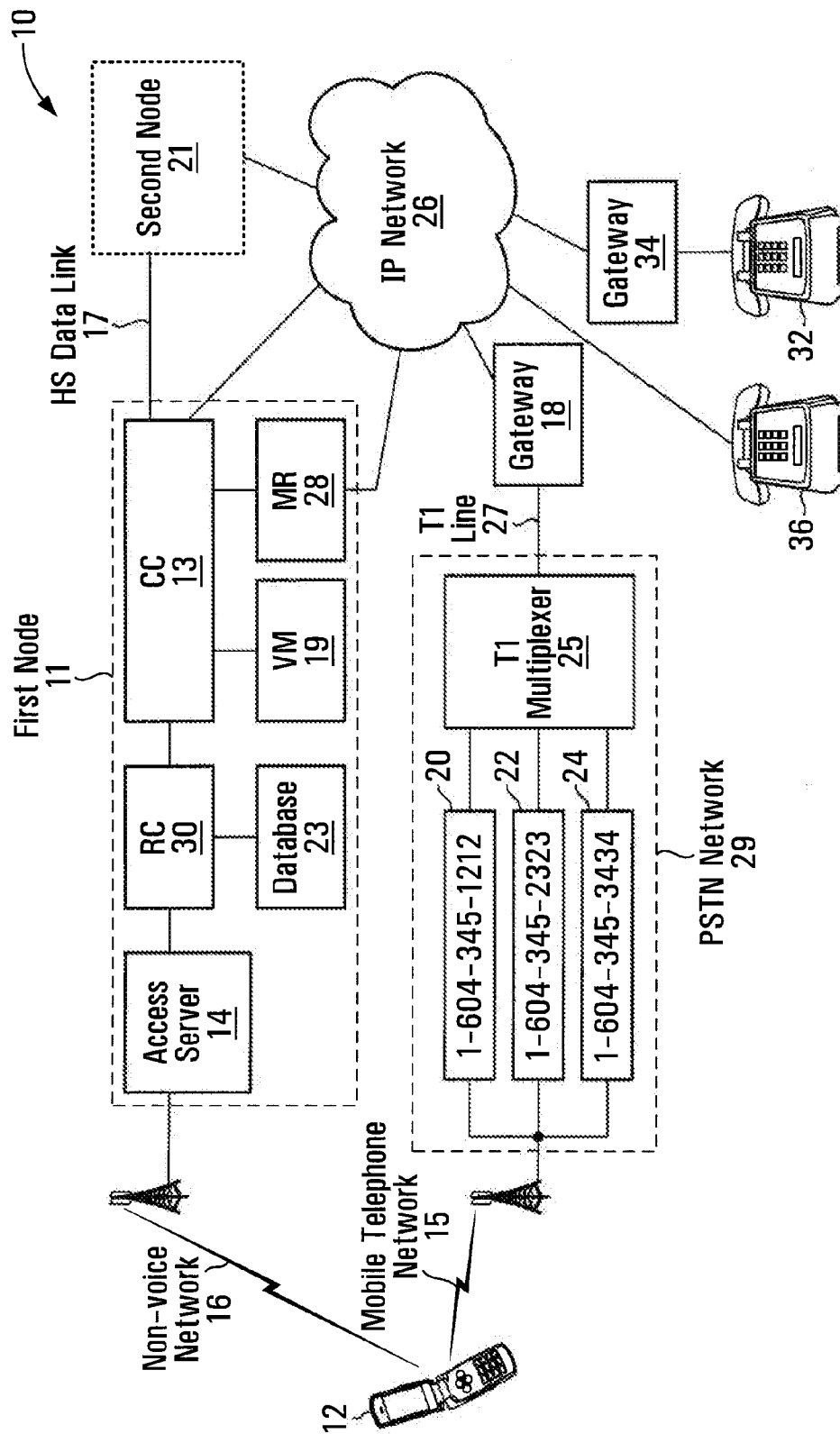

FIG. 1

2/17

Mobile Telephone (12)

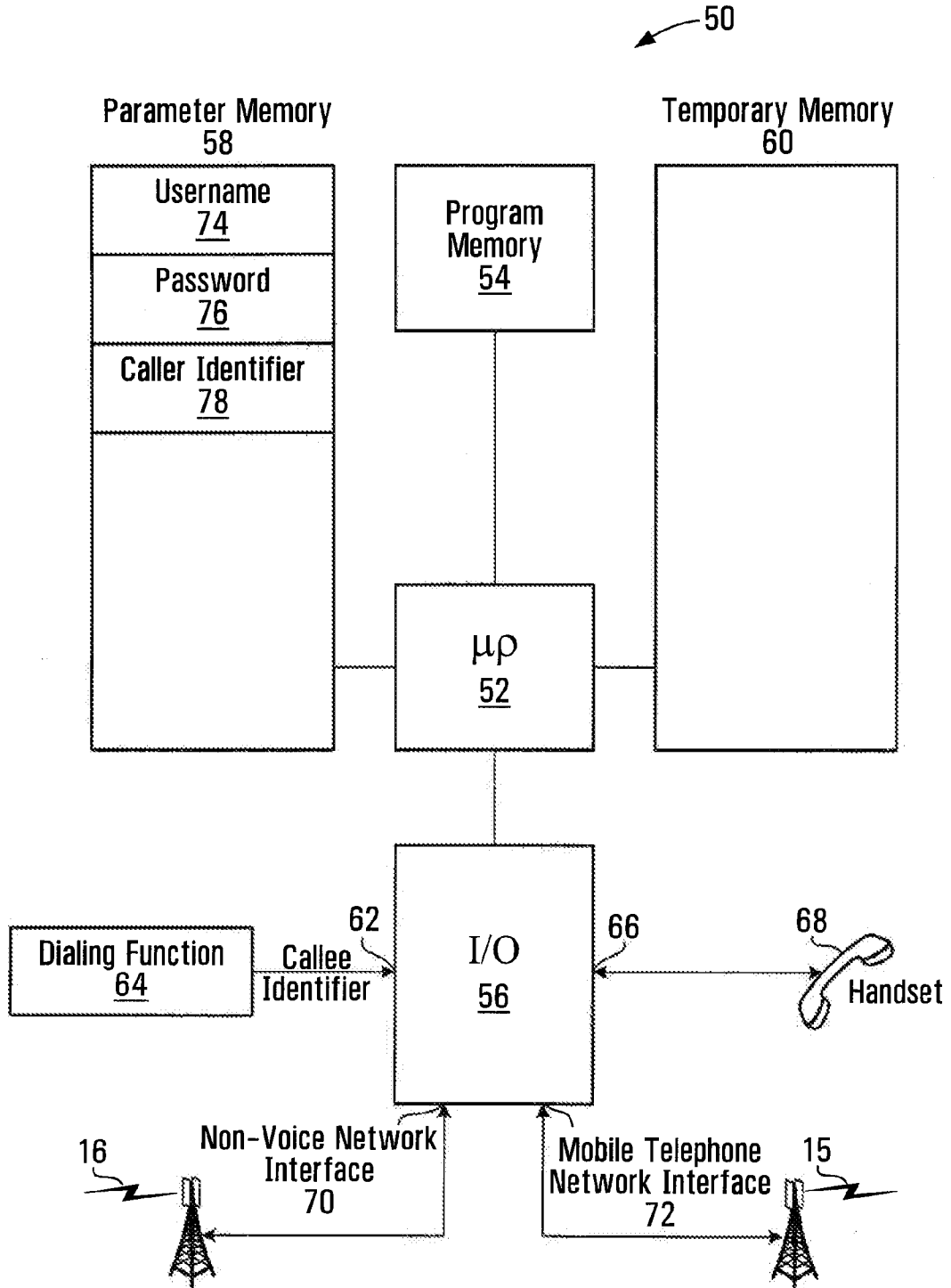

FIG. 2

3/17

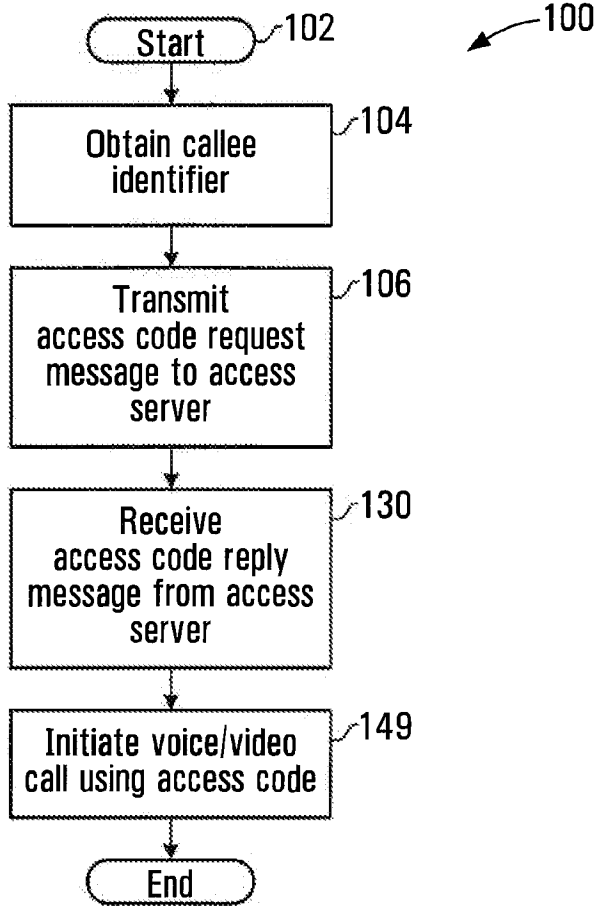

FIG. 3

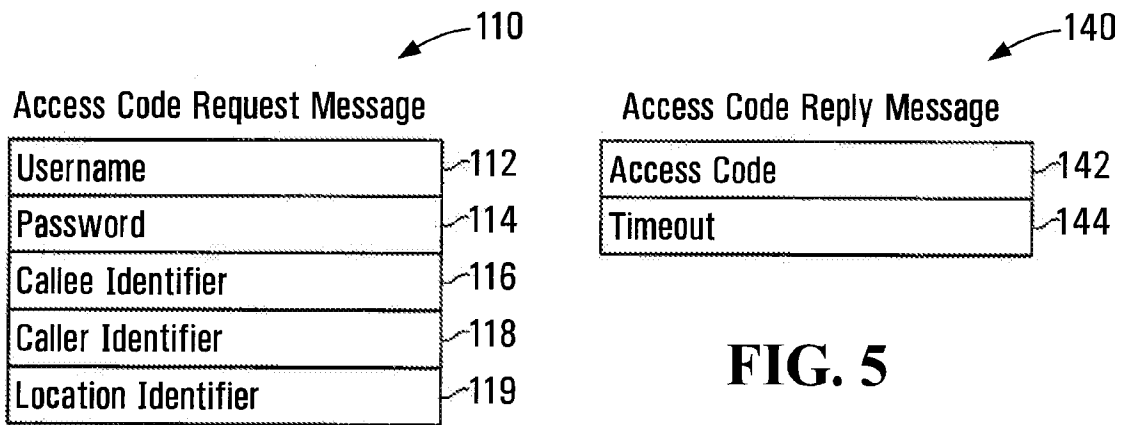
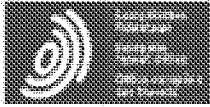

FIG. 4

FIG. 5



Espacenet

Bibliographic data: CA2812174 (A1) — 2011-03-24

**UNINTERRUPTED TRANSMISSION OF INTERNET PROTOCOL TRANSMISSIONS
DURING ENDPOINT CHANGES**

Inventor(s): HUTTUNEN PENTTI KALEVI [CA] ± (HUTTUNEN, PENTTI KALEVI)

Applicant(s): DIGIFONICA INTERNATIONAL LTD [CA] ± (DIGIFONICA (INTERNATIONAL) LIMITED)

Classification: - international: H04L12/66; H04L29/06; H04W36/02; H04W36/18
- cooperative: H04B7/15; H04L12/66; H04L45/74; H04L65/1006;
H04L65/608; H04W76/021; H04W76/041

Application number: CA20092812174 20090917

Priority number (s): WO2009CA01317 20090917

Also published as: WO2011032256 (A1) US2014153477 (A1) US2012170574 (A1)
US2012170574 (A1) US8675566 (B2) US8675566 (B2)
EP2478678 (A1) EP2478678 (A4) less

Abstract of CA2812174 (A1)

A method apparatus and computer readable medium for facilitating uninterrupted transmission of internet protocol (IP) transmissions containing real time transport protocol (RTP) data during endpoint changes. When an IP transmission is received at the caller RTP port or the callee RTP port, a call record having a caller RTP port identifier or a callee RTP port identifier matching a destination port identifier in the IP transmission is located and when the destination port identifier in the IP transmission matches the caller RTP port identifier of the record, a source IP address identifier and source port identifier from the IP transmission are set as the caller IP address identifier and caller port identifier respectively of the record when the caller IP address identifier

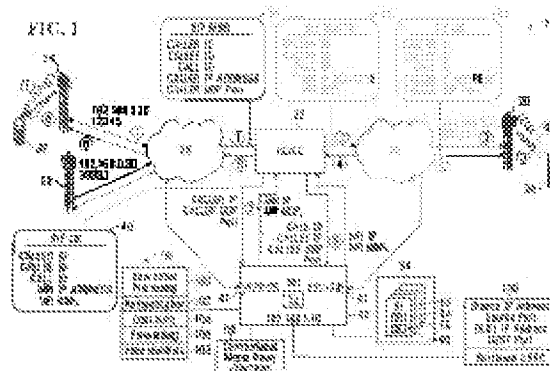

and caller port identifier do not match the source IP address identifier and source port identifier respectively and a received SSRC identifier in the IP transmission matches the caller SSRC identifier. When the destination port identifier in the IP transmission matches the callee RTP port identifier of the record, the source IP address identifier and source port identifier from the IP transmission are set as the callee IP address identifier and callee port identifier respectively of the record when the callee IP address identifier and callee port identifier do not match the source IP address identifier and source port identifier respectively and the received SSRC identifier in the IP transmission matches the callee SSRC identifier.



(86) Date de dépôt PCT/PCT Filing Date: 2009/09/17
 (87) Date publication PCT/PCT Publication Date: 2011/03/24
 (85) Entrée phase nationale/National Entry: 2013/03/15
 (86) N° demande PCT/PCT Application No.: CA 2009/001317
 (87) N° publication PCT/PCT Publication No.: 2011/032256

(51) Cl.Int./Int.Cl. *H04L 12/66* (2006.01),
H04L 29/06 (2006.01), *H04W 36/02* (2009.01),
H04W 36/18 (2009.01)
 (71) Demandeur/Applicant:
 DIGIFONICA (INTERNATIONAL) LIMITED, CA
 (72) Inventeur/Inventor:
 HUTTUNEN, PENTTI KALEVI, CA
 (74) Agent: SMART & BIGGAR

(54) Titre : TRANSMISSION ININTERROMPUE DE TRANSMISSIONS PAR PROTOCOLE INTERNET AU COURS DE CHANGEMENTS DE POINT D'EXTREMITÉ
 (54) Title: UNINTERRUPTED TRANSMISSION OF INTERNET PROTOCOL TRANSMISSIONS DURING ENDPOINT CHANGES

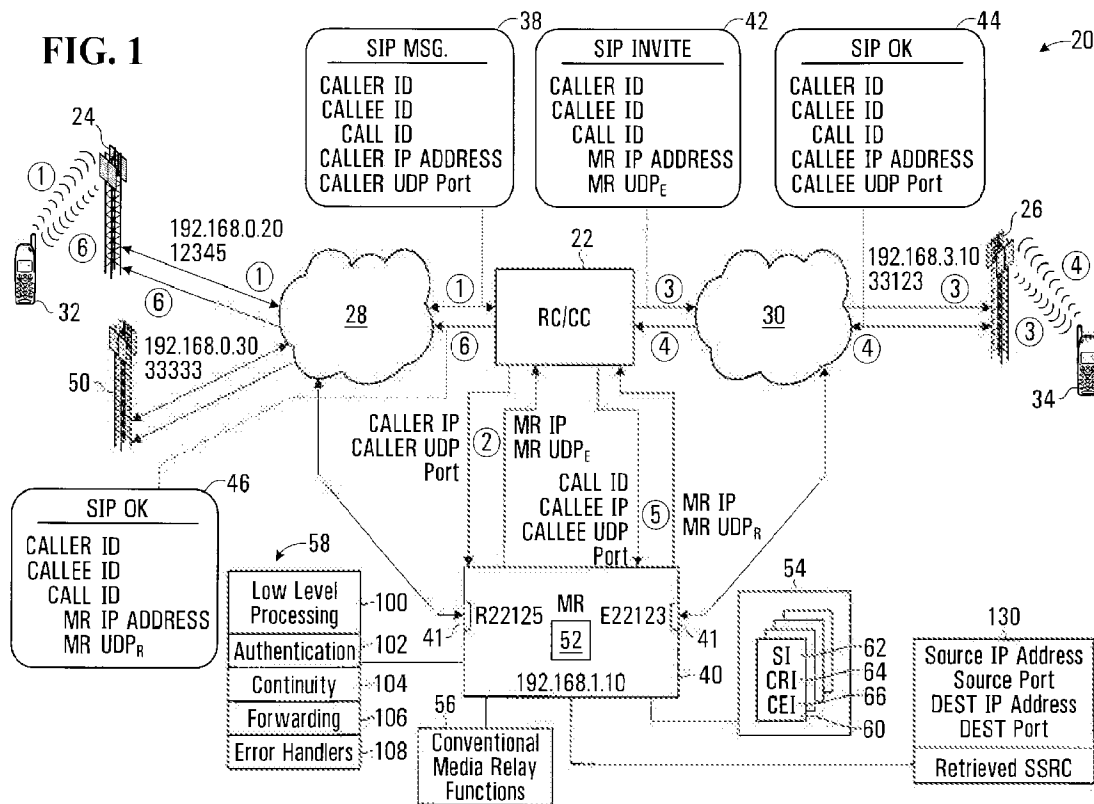

(57) Abrégé/Abstract:

A method apparatus and computer readable medium for facilitating uninterrupted transmission of internet protocol (IP) transmissions containing real time transport protocol (RTP) data during endpoint changes. When an IP transmission is received at



(57) **Abrégé(suite)/Abstract(continued):**

the caller RTP port or the callee RTP port, a call record having a caller RTP port identifier or a callee RTP port identifier matching a destination port identifier in the IP transmission is located and when the destination port identifier in the IP transmission matches the caller RTP port identifier of the record, a source IP address identifier and source port identifier from the IP transmission are set as the caller IP address identifier and caller port identifier respectively of the record when the caller IP address identifier and caller port identifier do not match the source IP address identifier and source port identifier respectively and a received SSRC identifier in the IP transmission matches the caller SSRC identifier. When the destination port identifier in the IP transmission matches the callee RTP port identifier of the record, the source IP address identifier and source port identifier from the IP transmission are set as the callee IP address identifier and callee port identifier respectively of the record when the callee IP address identifier and callee port identifier do not match the source IP address identifier and source port identifier respectively and the received SSRC identifier in the IP transmission matches the callee SSRC identifier.

(12) INTERNATIONAL APPLICATION PUBLISHED UNDER THE PATENT COOPERATION TREATY (PCT)

(19) World Intellectual Property Organization
International Bureau



(43) International Publication Date
24 March 2011 (24.03.2011)

PCT

(10) International Publication Number
WO 2011/032256 A1

- (51) **International Patent Classification:**
H04L 12/66 (2006.01) H04W 36/02 (2009.01)
H04L 29/06 (2006.01) H04W 36/18 (2009.01)
- (21) **International Application Number:**
PCT/CA2009/001317
- (22) **International Filing Date:**
17 September 2009 (17.09.2009)
- (25) **Filing Language:** English
- (26) **Publication Language:** English
- (71) **Applicant (for all designated States except US): DIGI-FONICA (INTERNATIONAL) LIMITED [CA/CA];** Suite #890, 999 West Hastings Street, Vancouver, British Columbia V6C 2W2 (CA).
- (72) **Inventor; and**
- (75) **Inventor/Applicant (for US only): HUTTUNEN, Pentti Kalevi [CA/CA];** 76-3180 East 58th Avenue, Vancouver, British Columbia V5S 3S8 (CA).
- (74) **Agent: KNOX, John W.; Smart & Biggar,** 2200-650 West Georgia Street, Vancouver, British Columbia V6B 4N8 (CA).

- (81) **Designated States (unless otherwise indicated, for every kind of national protection available):** AE, AG, AL, AM, AO, AT, AU, AZ, BA, BB, BG, BH, BR, BW, BY, BZ, CA, CH, CL, CN, CO, CR, CU, CZ, DE, DK, DM, DO, DZ, EC, EE, EG, ES, FI, GB, GD, GE, GH, GM, GT, HN, HR, HU, ID, IL, IN, IS, JP, KE, KG, KM, KN, KP, KR, KZ, LA, LC, LK, LR, LS, LT, LU, LY, MA, MD, ME, MG, MK, MN, MW, MX, MY, MZ, NA, NG, NI, NO, NZ, OM, PE, PG, PH, PL, PT, RO, RS, RU, SC, SD, SE, SG, SK, SL, SM, ST, SV, SY, TJ, TM, TN, TR, TT, TZ, UA, UG, US, UZ, VC, VN, ZA, ZM, ZW.
- (84) **Designated States (unless otherwise indicated, for every kind of regional protection available):** ARIPO (BW, GH, GM, KE, LS, MW, MZ, NA, SD, SL, SZ, TZ, UG, ZM, ZW), Eurasian (AM, AZ, BY, KG, KZ, MD, RU, TJ, TM), European (AT, BE, BG, CH, CY, CZ, DE, DK, EE, ES, FI, FR, GB, GR, HR, HU, IE, IS, IT, LT, LU, LV, MC, MK, MT, NL, NO, PL, PT, RO, SE, SI, SK, SM, TR), OAPI (BF, BJ, CF, CG, CI, CM, GA, GN, GQ, GW, ML, MR, NE, SN, TD, TG).

Declarations under Rule 4.17:

- as to the identity of the inventor (Rule 4.17(i))
- *** as to applicant's entitlement to apply for and be granted a patent (Rule 4.17(ii))

[Continued on next page]

(54) **Title:** UNINTERRUPTED TRANSMISSION OF INTERNET PROTOCOL TRANSMISSIONS DURING ENDPOINT CHANGES

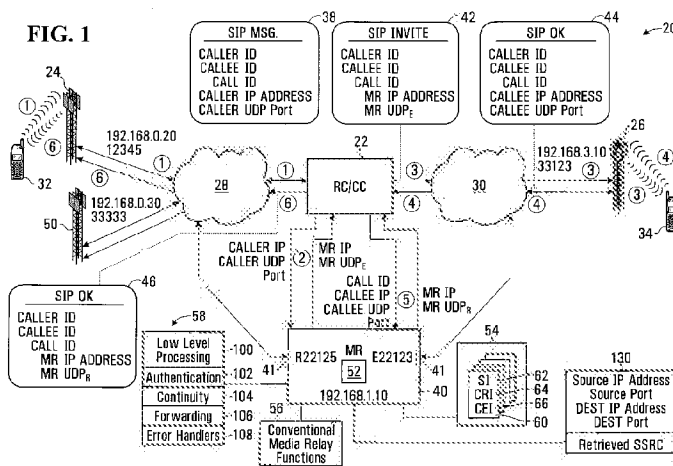

(57) **Abstract:** A method apparatus and computer readable medium for facilitating uninterrupted transmission of internet protocol (IP) transmissions containing real time transport protocol (RTP) data during endpoint changes. When an IP transmission is received at the caller RTP port or the callee RTP port, a call record having a caller RTP port identifier or a callee RTP port identifier matching a destination port identifier in the IP transmission is located and when the destination port identifier in the IP transmission matches the caller RTP port identifier of the record, a source IP address identifier and source port identifier from the IP transmission are set as the caller IP address identifier and caller port identifier respectively of the record when the caller IP address identifier and caller port identifier do not match the source IP address identifier and source port identifier respectively and a received SSRC identifier in the IP transmission matches the caller SSRC identifier. When the destination port identifier in the IP transmission matches the callee RTP port identifier of the record, the source IP address identifier and source port identifier from the IP transmission are set as the callee IP address identifier and callee port identifier respectively of the record when the callee IP address identifier and callee port identifier do not match the source IP address identifier and source port identifier respectively and the received SSRC identifier in the IP transmission matches the callee SSRC identifier.

WO 2011/032256 A1

WO 2011/032256 A1



— *of inventorship (Rule 4.17(iv))*

Published:

— *with international search report (Art. 21(3))*