

Under the Paperwork Reduction Act of 1995, no persons are required to respond to a collection of information unless it contains a valid OMB control number.

Application Data Sheet 37 CFR 1.76		Attorney Docket Number	SMARB19.001C1
		Application Number	
Title of Invention	PRODUCING ROUTING MESSAGES FOR VOICE OVER IP COMMUNICATIONS		
<p>The application data sheet is part of the provisional or nonprovisional application for which it is being submitted. The following form contains the bibliographic data arranged in a format specified by the United States Patent and Trademark Office as outlined in 37 CFR 1.76.</p> <p>This document may be completed electronically and submitted to the Office in electronic format using the Electronic Filing System (EFS) or the document may be printed and included in a paper filed application.</p>			

Secrecy Order 37 CFR 5.2

<input type="checkbox"/>	Portions or all of the application associated with this Application Data Sheet may fall under a Secrecy Order pursuant to 37 CFR 5.2 (Paper filers only. Applications that fall under Secrecy Order may not be filed electronically.)
--------------------------	---

Inventor Information:

Inventor 1					<input type="button" value="Remove"/>
Legal Name					
Prefix	Given Name	Middle Name	Family Name	Suffix	
	CLAY		PERRAULT		
Residence Information (Select One) <input type="radio"/> US Residency <input checked="" type="radio"/> Non US Residency <input type="radio"/> Active US Military Service					
City	PANAMA CITY	Country of Residenceⁱ	PA		
Mailing Address of Inventor:					
Address 1	340a COROZAL WEST				
Address 2					
City	PANAMA CITY	State/Province			
Postal Code		Countryⁱ	PA		
Inventor 2					<input type="button" value="Remove"/>
Legal Name					
Prefix	Given Name	Middle Name	Family Name	Suffix	
	STEVE		NICHOLSON		
Residence Information (Select One) <input type="radio"/> US Residency <input checked="" type="radio"/> Non US Residency <input type="radio"/> Active US Military Service					
City	HAMILTON	Country of Residenceⁱ	NZ		
Mailing Address of Inventor:					
Address 1	423 TAUWHARE ROAD, RD 3				
Address 2					
City	HAMILTON	State/Province			
Postal Code	3283	Countryⁱ	NZ		
Inventor 3					<input type="button" value="Remove"/>
Legal Name					

Under the Paperwork Reduction Act of 1995, no persons are required to respond to a collection of information unless it contains a valid OMB control number.

Application Data Sheet 37 CFR 1.76		Attorney Docket Number	SMARB19.001C1	
		Application Number		
Title of Invention	PRODUCING ROUTING MESSAGES FOR VOICE OVER IP COMMUNICATIONS			
Prefix	Given Name	Middle Name	Family Name	Suffix
	ROD		THOMSON	
Residence Information (Select One) <input type="radio"/> US Residency <input checked="" type="radio"/> Non US Residency <input type="radio"/> Active US Military Service				
City	NORTH VANCOUVER	Country of Residence ⁱ	CA	
Mailing Address of Inventor:				
Address 1	3320 GARABALDI DRIVE			
Address 2				
City	NORTH VANCOUVER	State/Province	BC	
Postal Code	V7H 2N9	Country ⁱ	CA	
Inventor 4	Remove			
Legal Name				
Prefix	Given Name	Middle Name	Family Name	Suffix
	JOHAN	EMIL VIKTOR	BJÖRSELL	
Residence Information (Select One) <input type="radio"/> US Residency <input checked="" type="radio"/> Non US Residency <input type="radio"/> Active US Military Service				
City	VANCOUVER	Country of Residence ⁱ	CA	
Mailing Address of Inventor:				
Address 1	2681 EAST HASTINGS STREET			
Address 2				
City	VANCOUVER	State/Province	BC	
Postal Code	V5K 1Z5	Country ⁱ	CA	
Inventor 5	Remove			
Legal Name				
Prefix	Given Name	Middle Name	Family Name	Suffix
	FUAD		ARAFA	
Residence Information (Select One) <input type="radio"/> US Residency <input checked="" type="radio"/> Non US Residency <input type="radio"/> Active US Military Service				
City	VANCOUVER	Country of Residence ⁱ	CA	
Mailing Address of Inventor:				
Address 1	782 WEST 22ND STREET			
Address 2				
City	VANCOUVER	State/Province	BC	
Postal Code	V5Z 17Z	Country ⁱ	CA	

Under the Paperwork Reduction Act of 1995, no persons are required to respond to a collection of information unless it contains a valid OMB control number.

Application Data Sheet 37 CFR 1.76	Attorney Docket Number	SMARB19.001C1
	Application Number	
Title of Invention	PRODUCING ROUTING MESSAGES FOR VOICE OVER IP COMMUNICATIONS	

All Inventors Must Be Listed - Additional Inventor Information blocks may be generated within this form by selecting the **Add** button.

Correspondence Information:

Enter either Customer Number or complete the Correspondence Information section below. For further information see 37 CFR 1.33(a).

An Address is being provided for the correspondence information of this application.

Customer Number	20995		
Email Address	efiling@knobbe.com	<input type="button" value="Add Email"/>	<input type="button" value="Remove Email"/>

Application Information:

Title of the Invention	PRODUCING ROUTING MESSAGES FOR VOICE OVER IP COMMUNICATIONS		
Attorney Docket Number	SMARB19.001C1	Small Entity Status Claimed	<input checked="" type="checkbox"/>
Application Type	Nonprovisional		
Subject Matter	Utility		
Total Number of Drawing Sheets (if any)	32	Suggested Figure for Publication (if any)	

Publication Information:

Request Early Publication (Fee required at time of Request 37 CFR 1.219)

Request Not to Publish. I hereby request that the attached application not be published under 35 U.S.C. 122(b) and certify that the invention disclosed in the attached application **has not and will not** be the subject of an application filed in another country, or under a multilateral international agreement, that requires publication at eighteen months after filing.

Representative Information:

Representative information should be provided for all practitioners having a power of attorney in the application. Providing this information in the Application Data Sheet does not constitute a power of attorney in the application (see 37 CFR 1.32). Either enter Customer Number or complete the Representative Name section below. If both sections are completed the customer number will be used for the Representative Information during processing.

Please Select One:	<input checked="" type="radio"/> Customer Number	<input type="radio"/> US Patent Practitioner	<input type="radio"/> Limited Recognition (37 CFR 11.9)
Customer Number	20995		

Domestic Benefit/National Stage Information:

This section allows for the applicant to either claim benefit under 35 U.S.C. 119(e), 120, 121, or 365(c) or indicate National Stage entry from a PCT application. Providing this information in the application data sheet constitutes the specific reference required by 35 U.S.C. 119(e) or 120, and 37 CFR 1.78.

Prior Application Status	Pending	<input type="button" value="Remove"/>
--------------------------	---------	---------------------------------------

Under the Paperwork Reduction Act of 1995, no persons are required to respond to a collection of information unless it contains a valid OMB control number.

Application Data Sheet 37 CFR 1.76	Attorney Docket Number	SMARB19.001C1
	Application Number	
Title of Invention	PRODUCING ROUTING MESSAGES FOR VOICE OVER IP COMMUNICATIONS	

Application Number	Continuity Type	Prior Application Number	Filing Date (YYYY-MM-DD)
	Continuation of	12/513147	2010-03-01
Prior Application Status	Expired	<input type="button" value="Remove"/>	
Application Number	Continuity Type	Prior Application Number	Filing Date (YYYY-MM-DD)
12/513147	a 371 of international	PCT/CA2007/001956	2007-11-01
Prior Application Status	Expired	<input type="button" value="Remove"/>	
Application Number	Continuity Type	Prior Application Number	Filing Date (YYYY-MM-DD)
PCT/CA2007/001956	non provisional of	60/856212	2006-11-02
Additional Domestic Benefit/National Stage Data may be generated within this form by selecting the Add button.			

Foreign Priority Information:

This section allows for the applicant to claim priority to a foreign application. Providing this information in the application data sheet constitutes the claim for priority as required by 35 U.S.C. 119(b) and 37 CFR 1.55(d). When priority is claimed to a foreign application that is eligible for retrieval under the priority document exchange program (PDX)¹ the information will be used by the Office to automatically attempt retrieval pursuant to 37 CFR 1.55(h)(1) and (2). Under the PDX program, applicant bears the ultimate responsibility for ensuring that a copy of the foreign application is received by the Office from the participating foreign intellectual property office, or a certified copy of the foreign priority application is filed, within the time period specified in 37 CFR 1.55(g)(1).

Application Number	Country ¹	Filing Date (YYYY-MM-DD)	Access Code ¹ (if applicable)
<input type="button" value="Remove"/>			
Additional Foreign Priority Data may be generated within this form by selecting the Add button.			

Statement under 37 CFR 1.55 or 1.78 for AIA (First Inventor to File) Transition Applications

This application (1) claims priority to or the benefit of an application filed before March 16, 2013 and (2) also contains, or contained at any time, a claim to a claimed invention that has an effective filing date on or after March 16, 2013.

NOTE: By providing this statement under 37 CFR 1.55 or 1.78, this application, with a filing date on or after March 16, 2013, will be examined under the first inventor to file provisions of the AIA.

Under the Paperwork Reduction Act of 1995, no persons are required to respond to a collection of information unless it contains a valid OMB control number.

Application Data Sheet 37 CFR 1.76	Attorney Docket Number	SMARB19.001C1
	Application Number	
Title of Invention	PRODUCING ROUTING MESSAGES FOR VOICE OVER IP COMMUNICATIONS	

Authorization to Permit Access:
 Authorization to Permit Access to the Instant Application by the Participating Offices

If checked, the undersigned hereby grants the USPTO authority to provide the European Patent Office (EPO), the Japan Patent Office (JPO), the Korean Intellectual Property Office (KIPO), the World Intellectual Property Office (WIPO), and any other intellectual property offices in which a foreign application claiming priority to the instant patent application is filed access to the instant patent application. See 37 CFR 1.14(c) and (h). This box should not be checked if the applicant does not wish the EPO, JPO, KIPO, WIPO, or other intellectual property office in which a foreign application claiming priority to the instant patent application is filed to have access to the instant patent application.

In accordance with 37 CFR 1.14(h)(3), access will be provided to a copy of the instant patent application with respect to: 1) the instant patent application-as-filed; 2) any foreign application to which the instant patent application claims priority under 35 U.S.C. 119(a)-(d) if a copy of the foreign application that satisfies the certified copy requirement of 37 CFR 1.55 has been filed in the instant patent application; and 3) any U.S. application-as-filed from which benefit is sought in the instant patent application.

In accordance with 37 CFR 1.14(c), access may be provided to information concerning the date of filing this Authorization.

Applicant Information:

Providing assignment information in this section does not substitute for compliance with any requirement of part 3 of Title 37 of CFR to have an assignment recorded by the Office.		
Applicant 1		
If the applicant is the inventor (or the remaining joint inventor or inventors under 37 CFR 1.45), this section should not be completed. The information to be provided in this section is the name and address of the legal representative who is the applicant under 37 CFR 1.43; or the name and address of the assignee, person to whom the inventor is under an obligation to assign the invention, or person who otherwise shows sufficient proprietary interest in the matter who is the applicant under 37 CFR 1.46. If the applicant is an applicant under 37 CFR 1.46 (assignee, person to whom the inventor is obligated to assign, or person who otherwise shows sufficient proprietary interest) together with one or more joint inventors, then the joint inventor or inventors who are also the applicant should be identified in this section.		
<input type="button" value="Clear"/>		
<input checked="" type="radio"/> Assignee	<input type="radio"/> Legal Representative under 35 U.S.C. 117	<input type="radio"/> Joint Inventor
<input type="radio"/> Person to whom the inventor is obligated to assign.	<input type="radio"/> Person who shows sufficient proprietary interest	
If applicant is the legal representative, indicate the authority to file the patent application, the inventor is:		
Name of the Deceased or Legally Incapacitated Inventor : <input type="text"/>		
If the Applicant is an Organization check here. <input checked="" type="checkbox"/>		
Organization Name	DIGIFONICA (INTERNATIONAL) LIMITED	

Under the Paperwork Reduction Act of 1995, no persons are required to respond to a collection of information unless it contains a valid OMB control number.

Application Data Sheet 37 CFR 1.76	Attorney Docket Number	SMARB19.001C1
	Application Number	
Title of Invention	PRODUCING ROUTING MESSAGES FOR VOICE OVER IP COMMUNICATIONS	

Mailing Address Information For Applicant:			
Address 1	773 HORNBY STREET		
Address 2			
City	VANCOUVER	State/Province	BC
Country	CA	Postal Code	V6Z 1S4
Phone Number		Fax Number	
Email Address			
Additional Applicant Data may be generated within this form by selecting the Add button.			

Non-Applicant Assignee Information:

Providing assignment information in this section does not substitute for compliance with any requirement of part 3 of Title 37 of CFR to have an assignment recorded by the Office.

Assignee 1				
Complete this section only if non-applicant assignee information is desired to be included on the patent application publication in accordance with 37 CFR 1.215(b). Do not include in this section an applicant under 37 CFR 1.46 (assignee, person to whom the inventor is obligated to assign, or person who otherwise shows sufficient proprietary interest), as the patent application publication will include the name of the applicant(s).				
If the Assignee is an Organization check here. <input type="checkbox"/>				
Prefix	Given Name	Middle Name	Family Name	Suffix
Mailing Address Information For Non-Applicant Assignee:				
Address 1				
Address 2				
City		State/Province		
Country		Postal Code		
Phone Number		Fax Number		
Email Address				
Additional Assignee Data may be generated within this form by selecting the Add button.				

Under the Paperwork Reduction Act of 1995, no persons are required to respond to a collection of information unless it contains a valid OMB control number.

Application Data Sheet 37 CFR 1.76	Attorney Docket Number	SMARB19.001C1
	Application Number	
Title of Invention	PRODUCING ROUTING MESSAGES FOR VOICE OVER IP COMMUNICATIONS	

Signature:

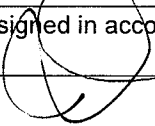
NOTE: This form must be signed in accordance with 37 CFR 1.33. See 37 CFR 1.4 for signature requirements and certifications.					
Signature				Date (YYYY-MM-DD)	2013-08-13
First Name	JOHN	Last Name	CARSON	Registration Number	34303
Additional Signature may be generated within this form by selecting the Add button.					

This collection of information is required by 37 CFR 1.76. The information is required to obtain or retain a benefit by the public which is to file (and by the USPTO to process) an application. Confidentiality is governed by 35 U.S.C. 122 and 37 CFR 1.14. This collection is estimated to take 23 minutes to complete, including gathering, preparing, and submitting the completed application data sheet form to the USPTO. Time will vary depending upon the individual case. Any comments on the amount of time you require to complete this form and/or suggestions for reducing this burden, should be sent to the Chief Information Officer, U.S. Patent and Trademark Office, U.S. Department of Commerce, P.O. Box 1450, Alexandria, VA 22313-1450. DO NOT SEND FEES OR COMPLETED FORMS TO THIS ADDRESS. **SEND TO: Commissioner for Patents, P.O. Box 1450, Alexandria, VA 22313-1450.**

PRODUCING ROUTING MESSAGES FOR VOICE OVER IP COMMUNICATIONS

BACKGROUND OF THE INVENTION

Cross Reference to Related Applications

[0001] This application is a continuation of U.S. Application No. 12/513,147, filed March 1, 2010, which is a national phase entry of PCT/CA2007/001956, filed November 1, 2007, which claims priority to U.S. Provisional Application No. 60/856,212, filed November 2, 2006, all of which are incorporated in their entirety.

Field of Invention

[0002] This invention relates to voice over IP communications and methods and apparatus for routing and billing.

Description of Related Art

[0003] Internet protocol (IP) telephones are typically personal computer (PC) based telephones connected within an IP network, such as the public Internet or a private network of a large organization. These IP telephones have installed “voice-over-IP” (VoIP) software enabling them to make and receive voice calls and send and receive information in data and video formats.

[0004] IP telephony switches installed within the IP network enable voice calls to be made within or between IP networks, and between an IP network and a switched circuit network (SCN), such as the public switched telephone network (PSTN). If the IP switch supports the Signaling System 7 (SS7) protocol, the IP telephone can also access PSTN databases.

[0005] The PSTN network typically includes complex network nodes that contain all information about a local calling service area including user authentication and call routing. The PSTN network typically aggregates all information and traffic into a single location or node, processes it locally and then passes it on to other network nodes, as necessary, by maintaining route tables at the node. PSTN nodes are redundant by design and thus provide reliable service, but if a node should fail due to an earthquake or other natural

disaster, significant, if not complete service outages can occur, with no other nodes being able to take up the load.

[0006] Existing VoIP systems do not allow for high availability and resiliency in delivering Voice Over IP based Session Initiation Protocol (SIP) Protocol service over a geographically dispersed area such as a city, region or continent. Most resiliency originates from the provision of IP based telephone services to one location or a small number of locations such as a single office or network of branch offices.

SUMMARY OF THE INVENTION

[0007] In accordance with one aspect of the invention, there is provided a process for operating a call routing controller to facilitate communication between callers and callees in a system comprising a plurality of nodes with which callers and callees are associated. The process involves, in response to initiation of a call by a calling subscriber, receiving a caller identifier and a callee identifier. The process also involves using call classification criteria associated with the caller identifier to classify the call as a public network call or a private network call. The process further involves producing a routing message identifying an address, on the private network, associated with the callee when the call is classified as a private network call. The process also involves producing a routing message identifying a gateway to the public network when the call is classified as a public network call.

[0008] The process may involve receiving a request to establish a call, from a call controller in communication with a caller identified by the callee identifier.

[0009] Using the call classification criteria may involve searching a database to locate a record identifying calling attributes associated with a caller identified by the caller identifier.

[0010] Locating a record may involve locating a caller dialing profile comprising a username associated with the caller, a domain associated with the caller, and at least one calling attribute.

[0011] Using the call classification criteria may involve comparing calling attributes associated with the caller dialing profile with aspects of the callee identifier.

[0012] Comparing may involve determining whether the callee identifier includes a portion that matches an IDD associated with the caller dialing profile.

[0013] Comparing may involve determining whether the callee identifier includes a portion that matches an NDD associated with the caller dialing profile.

[0014] Comparing may involve determining whether the callee identifier includes a portion that matches an area code associated with the caller dialing profile.

[0015] Comparing may involve determining whether the callee identifier has a length within a range specified in the caller dialing profile.

[0016] The process may involve formatting the callee identifier into a pre-defined digit format to produce a re-formatted callee identifier.

[0017] Formatting may involve removing an international dialing digit from the callee identifier, when the callee identifier begins with a digit matching an international dialing digit specified by the caller dialing profile associated with the caller.

[0018] Formatting may involve removing a national dialing digit from the callee identifier and prepending a caller country code to the callee identifier when the callee identifier begins with a national dialing digit.

[0019] Formatting may involve prepending a caller country code to the callee identifier when the callee identifier begins with digits identifying an area code specified by the caller dialing profile.

[0020] Formatting may involve prepending a caller country code and an area code to the callee identifier when the callee identifier has a length that matches a caller dialing number format specified by the caller dialing profile and only one area code is specified as being associated with the caller in the caller dialing profile.

[0021] The process may involve classifying the call as a private network call when the re-formatted callee identifier identifies a subscriber to the private network.

[0022] The process may involve determining whether the callee identifier complies with a pre-defined username format and if so, classifying the call as a private network call.

[0023] The process may involve causing a database of records to be searched to locate a direct in dial (DID) bank table record associating a public telephone number with the

reformatted callee identifier and if the DID bank table record is found, classifying the call as a private network call and if a DID bank table record is not found, classifying the call as a public network call.

[0024] Producing the routing message identifying a node on the private network may involve setting a callee identifier in response to a username associated with the DID bank table record.

[0025] Producing the routing message may involve determining whether a node associated with the reformatted callee identifier is the same as a node associated the caller identifier.

[0026] Determining whether a node associated with the reformatted callee identifier is the same as a node associated the caller identifier may involve determining whether a prefix of the re-formatted callee identifier matches a corresponding prefix of a username associated with the caller dialing profile.

[0027] When the node associated with the caller is not the same as the node associated with the callee, the process involves producing a routing message including the caller identifier, the reformatted callee identifier and an identification of a private network node associated with the callee and communicating the routing message to a call controller.

[0028] When the node associated with the caller is the same as the node associated with the callee, the process involves determining whether to perform at least one of the following: forward the call to another party, block the call and direct the caller to a voicemail server associated with the callee.

[0029] Producing the routing message may involve producing a routing message having an identification of at least one of the callee identifier, an identification of a party to whom the call should be forwarded and an identification of a voicemail server associated with the callee.

[0030] Producing a routing message identifying a gateway to the public network may involve searching a database of route records associating route identifiers with dialing codes to find a route record having a dialing code having a number pattern matching at least a portion of the reformatted callee identifier.

[0031] The process may involve communicating the routing message to a call controller.

[0032] The process may involve searching a database of supplier records associating supplier identifiers with the route identifiers to locate at least one supplier record associated with the route identifier associated with the route record having a dialing code having a number pattern matching at least a portion of the reformatted callee identifier.

[0033] The process may involve loading a routing message buffer with the reformatted callee identifier and an identification of specific routes associated respective ones of the supplier records associated with the route record and loading the routing message buffer with a time value and a timeout value.

[0034] The process may involve communicating a routing message involving the contents of the routing message buffer to a call controller.

[0035] The process may involve causing the dialing profile to include a maximum concurrent call value and a concurrent call count value and causing the concurrent call count value to be incremented when the user associated with the dialing profile initiates a call and causing the concurrent call count value to be decremented when a call with the user associated with the dialing profile is ended.

[0036] In accordance with another aspect of the invention, there is provided a call routing apparatus for facilitating communications between callers and callees in a system comprising a plurality of nodes with which callers and callees are associated. The apparatus includes receiving provisions for receiving a caller identifier and a callee identifier, in response to initiation of a call by a calling subscriber. The apparatus also includes classifying provisions for classifying the call as a private network call or a public network call according to call classification criteria associated with the caller identifier. The apparatus further includes provisions for producing a routing message identifying an address, on the private network, associated with the callee when the call is classified as a private network call. The apparatus also includes provisions for producing a routing message identifying a gateway to the public network when the call is classified as a public network call.

[0037] The receiving provisions may be operably configured to receive a request to establish a call, from a call controller in communication with a caller identified by the callee identifier.

[0038] The apparatus may further include searching provisions for searching a database including records associating calling attributes with subscribers to the private network to locate a record identifying calling attributes associated with a caller identified by the caller identifier.

[0039] The records may include dialing profiles each including a username associated with the subscriber, an identification of a domain associated with the subscriber, and an identification of at least one calling attribute associated with the subscriber.

[0040] The call classification provisions may be operably configured to compare calling attributes associated with the caller dialing profile with aspects of the callee identifier.

[0041] The calling attributes may include an international dialing digit and call classification provisions may be operably configured to determine whether the callee identifier includes a portion that matches an IDD associated with the caller dialing profile.

[0042] The calling attributes may include a national dialing digit and the call classification provisions may be operably configured to determine whether the callee identifier includes a portion that matches an NDD associated with the caller dialing profile.

[0043] The calling attributes may include an area code and the call classification provisions may be operably configured to determine whether the callee identifier includes a portion that matches an area code associated with the caller dialing profile.

[0044] The calling attribute may include a number length range and the call classification provisions may be operably configured to determine whether the callee identifier has a length within a number length range specified in the caller dialing profile.

[0045] The apparatus may further include formatting provisions for formatting the callee identifier into a pre-defined digit format to produce a re-formatted callee identifier.

[0046] The formatting provisions may be operably configured to remove an international dialing digit from the callee identifier, when the callee identifier begins with a digit matching an international dialing digit specified by the caller dialing profile associated with the caller.

[0047] The formatting provisions may be operably configured to remove a national dialing digit from the callee identifier and prepend a caller country code to the callee identifier when the callee identifier begins with a national dialing digit.

[0048] The formatting provisions may be operably configured to prepend a caller country code to the callee identifier when the callee identifier begins with digits identifying an area code specified by the caller dialing profile.

[0049] The formatting provisions may be operably configured to prepend a caller country code and area code to the callee identifier when the callee identifier has a length that matches a caller dialing number format specified by the caller dialing profile and only one area code is specified as being associated with the caller in the caller dialing profile.

[0050] The classifying provisions may be operably configured to classify the call as a private network call when the re-formatted callee identifier identifies a subscriber to the private network.

[0051] The classifying provisions may be operably configured to classify the call as a private network call when the callee identifier complies with a pre-defined username format.

[0052] The apparatus may further include searching provisions for searching a database of records to locate a direct in dial (DID) bank table record associating a public telephone number with the reformatted callee identifier and the classifying provisions may be operably configured to classify the call as a private network call when the DID bank table record is found and to classify the call as a public network call when a DID bank table record is not found

[0053] The private network routing message producing provisions may be operably configured to produce a routing message having a callee identifier set according to a username associated with the DID bank table record.

[0054] The private network routing message producing provisions may be operably configured to determine whether a node associated with the reformatted callee identifier is the same as a node associated the caller identifier.

[0055] The private network routing provisions may include provisions for determining whether a prefix of the re-formatted callee identifier matches a corresponding prefix of a username associated with the caller dialing profile.

[0056] The private network routing message producing provisions may be operably configured to produce a routing message including the caller identifier, the reformatted callee identifier and an identification of a private network node associated with the callee and to communicate the routing message to a call controller.

[0057] The private network routing message producing provisions may be operably configured to perform at least one of the following forward the call to another party, block the call and direct the caller to a voicemail server associated with the callee, when the node associated with the caller is the same as the node associated with the callee.

[0058] The provisions for producing the private network routing message may be operably configured to produce a routing message having an identification of at least one of the callee identifier, an identification of a party to whom the call should be forwarded and an identification of a voicemail server associated with the callee.

[0059] The apparatus further includes provisions for communicating the routing message to a call controller.

[0060] The provisions for producing a public network routing message identifying a gateway to the public network may include provisions for searching a database of route records associating route identifiers with dialing codes to find a route record having a dialing code having a number pattern matching at least a portion of the reformatted callee identifier.

[0061] The apparatus further includes provisions for searching a database of supplier records associating supplier identifiers with the route identifiers to locate at least one supplier record associated with the route identifier associated with the route record having a dialing code having a number pattern matching at least a portion of the reformatted callee identifier.

[0062] The apparatus further includes a routing message buffer and provisions for loading the routing message buffer with the reformatted callee identifier and an identification of specific routes associated respective ones of the supplier records associated with the route record and loading the routing message buffer with a time value and a timeout value.

[0063] The apparatus further includes provisions for communicating a routing message including the contents of the routing message buffer to a call controller.

[0064] The apparatus further includes means for causing said dialing profile to include a maximum concurrent call value and a concurrent call count value and for causing said concurrent call count value to be incremented when the user associated with said dialing profile initiates a call and for causing said concurrent call count value to be decremented when a call with said user associated with said dialing profile is ended.

[0065] In accordance with another aspect of the invention, there is provided a data structure for access by an apparatus for producing a routing message for use by a call routing controller in a communications system. The data structure includes dialing profile records comprising fields for associating with respective subscribers to the system, a subscriber user name, direct-in-dial records comprising fields for associating with respective subscriber usernames, a user domain and a direct-in-dial number, prefix to node records comprising fields for associating with at least a portion of the respective subscriber usernames, a node address of a node in the system, whereby a subscriber name can be used to find a user domain, at least a portion of the a subscriber name can be used to find a node with which the subscriber identified by the subscriber name is associated, and a user domain and subscriber name can be located in response to a direct-in-dial number.

[0066] In accordance with another aspect of the invention, there is provided a data structure for access by an apparatus for producing a routing message for use by a call routing controller in a communications system. The data structure includes master list records comprising fields for associating a dialing code with respective master list identifiers and supplier list records linked to master list records by the master list identifiers, said supplier list records comprising fields for associating with a communications services supplier, a supplier id, a master list id, a route identifier and a billing rate code, whereby communications services suppliers are associated with dialing codes, such that dialing codes can be used to locate suppliers capable of providing a communications link associated with a given dialing code.

[0067] In accordance with another aspect of the invention, there is provided a method for determining a time to permit a communication session to be conducted. The

method involves calculating a cost per unit time, calculating a first time value as a sum of a free time attributed to a participant in the communication session and the quotient of a funds balance held by the participant to the cost per unit time value and producing a second time value in response to the first time value and a billing pattern associated with the participant, the billing pattern including first and second billing intervals and the second time value being the time to permit a communication session to be conducted.

[0068] Calculating the first time value may involve retrieving a record associated with the participant and obtaining from the record at least one of the free time and the funds balance.

[0069] Producing the second time value may involve producing a remainder value representing a portion of the second billing interval remaining after dividing the second billing interval into a difference between the first time value and the first billing interval.

[0070] Producing the second time value may involve setting a difference between the first time value and the remainder as the second time value.

[0071] The method may further involve setting the second time value to zero when the remainder is greater than zero and the first time value is less than the free time associated with the participant.

[0072] Calculating the cost per unit time may involve locating a record in a database, the record comprising a markup type indicator, a markup value and a billing pattern and setting a reseller rate equal to the sum of the markup value and the buffer rate.

[0073] Locating the record in a database may involve locating at least one of a record associated with a reseller and a route associated with the reseller, a record associated with the reseller and a default reseller markup record.

[0074] Calculating the cost per unit time value further may involve locating at least one of an override record specifying a route cost per unit time amount associated with a route associated with the communication session, a reseller record associated with a reseller of the communications session, the reseller record specifying a reseller cost per unit time associated with the reseller for the communication session, a default operator markup record specifying a default cost per unit time.

[0075] The method may further involve setting as the cost per unit time the sum of the reseller rate and at least one of the route cost per unit time, the reseller cost per unit time and the default cost per unit time.

[0076] The method may further involve receiving a communication session time representing a duration of the communication session and incrementing a reseller balance by the product of the reseller rate and the communication session time.

[0077] The method may further involve receiving a communication session time representing a duration of the communication session and incrementing a system operator balance by a product of the buffer rate and the communication session time.

[0078] In accordance with another aspect of the invention, there is provided an apparatus for determining a time to permit a communication session to be conducted. The apparatus includes a processor circuit, a computer readable medium coupled to the processor circuit and encoded with instructions for directing the processor circuit to calculate a cost per unit time for the communication session, calculate a first time value as a sum of a free time attributed to a participant in the communication session and the quotient of a funds balance held by the participant to the cost per unit time value and produce a second time value in response to the first time value and a billing pattern associated with the participant, the billing pattern including first and second billing intervals and the second time value being the time to permit a communication session to be conducted.

[0079] The instructions may include instructions for directing the processor circuit to retrieve a record associated with the participant and obtain from the record at least one of the free time and the funds balance.

[0080] The instructions may include instructions for directing the processor circuit to produce the second time value by producing a remainder value representing a portion of the second billing interval remaining after dividing the second billing interval into a difference between the first time value and the first billing interval.

[0081] The instructions may include instructions for directing the processor circuit to produce the second time value comprises setting a difference between the first time value and the remainder as the second time value.

[0082] The instructions may include instructions for directing the processor circuit to set the second time value to zero when the remainder is greater than zero and the first time value is less than the free time associated with the participant.

[0083] The instructions for directing the processor circuit to calculate the cost per unit time may include instructions for directing the processor circuit to locate a record in a database, the record comprising a markup type indicator, a markup value and a billing pattern and set a reseller rate equal to the sum of the markup value and the buffer rate.

[0084] The instructions for directing the processor circuit to locate the record in a database may include instructions for directing the processor circuit to locate at least one of a record associated with a reseller and a route associated with the reseller, a record associated with the reseller, and a default reseller markup record. The instructions for directing the processor circuit to calculate the cost per unit time value may further include instructions for directing the processor circuit to locate at least one of an override record specifying a route cost per unit time amount associated with a route associated with the communication session, a reseller record associated with a reseller of the communications session, the reseller record specifying a reseller cost per unit time associated with the reseller for the communication session, a default operator markup record specifying a default cost per unit time.

[0085] The instructions may include instructions for directing the processor circuit to set as the cost per unit time the sum of the reseller rate and at least one of the route cost per unit time, the reseller cost per unit time and the default cost per unit time.

[0086] The instructions may include instructions for directing the processor circuit to receive a communication session time representing a duration of the communication session and increment a reseller balance by the product of the reseller rate and the communication session time.

[0087] The instructions may include instructions for directing the processor circuit to receive a communication session time representing a duration of the communication session and increment a system operator balance by a product of the buffer rate and the communication session time.

[0088] In accordance with another aspect of the invention, there is provided a process for attributing charges for communications services. The process involves

determining a first chargeable time in response to a communication session time and a pre-defined billing pattern, determining a user cost value in response to the first chargeable time and a free time value associated with a user of the communications services, changing an account balance associated with the user in response to a user cost per unit time. The process may further involve changing an account balance associated with a reseller of the communications services in response to a reseller cost per unit time and the communication session time and changing an account balance associated with an operator of the communications services in response to an operator cost per unit time and the communication session time.

[0089] Determining the first chargeable time may involve locating at least one of an override record specifying a route cost per unit time and billing pattern associated with a route associated with the communication session, a reseller record associated with a reseller of the communications session, the reseller record specifying a reseller cost per unit time and billing pattern associated with the reseller for the communication session and a default record specifying a default cost per unit time and billing pattern and setting as the pre-defined billing pattern the billing pattern of the record located. The billing pattern of the record located may involve a first billing interval and a second billing interval.

[0090] Determining the first chargeable time may involve setting the first chargeable time equal to the first billing interval when the communication session time is less than or equal to the first billing interval.

[0091] Determining the first chargeable time may involve producing a remainder value representing a portion of the second billing interval remaining after dividing the second billing interval into a difference between communication session time and the first interval when the communication session time is greater than the communication session time and setting the first chargeable time to a difference between the communication session time and the remainder when the remainder is greater than zero and setting the first chargeable time to the communication session time when the remainder is not greater than zero.

[0092] The process may further involve determining a second chargeable time in response to the first chargeable time and the free time value associated with the user of the

communications services when the first chargeable time is greater than or equal to the free time value associated with the user of the communications services.

[0093] Determining the second chargeable time may involve setting the second chargeable time to a difference between the first chargeable time.

[0094] The process may further involve resetting the free time value associated with the user to zero when the first chargeable time is greater than or equal to the free time value associated with the user of the communications services.

[0095] Changing an account balance associated with the user may involve calculating a user cost value in response to the second chargeable time and the user cost per unit time.

[0096] The process may further involve changing a user free cost balance in response to the user cost value.

[0097] The process may further involve setting the user cost to zero when the first chargeable time is less than the free time value associated with the user.

[0098] The process may further involve changing a user free time balance in response to the first chargeable time.

[0099] In accordance with another aspect of the invention, there is provided an apparatus for attributing charges for communications services. The apparatus includes a processor circuit, a computer readable medium in communication with the processor circuit and encoded with instructions for directing the processor circuit to determine a first chargeable time in response to a communication session time and a pre-defined billing pattern, determine a user cost value in response to the first chargeable time and a free time value associated with a user of the communications services, change an account balance associated with the user in response to a user cost per unit time.

[0100] The instructions may further include instructions for changing an account balance associated with a reseller of the communications services in response to a reseller cost per unit time and the communication session time and changing an account balance associated with an operator of the communications services in response to an operator cost per unit time and the communication session time.

[0101] The instructions for directing the processor circuit to determine the first chargeable time may further include instructions for causing the processor circuit to communicate with a database to locate at least one of an override record specifying a route cost per unit time and billing pattern associated with a route associated with the communication session, a reseller record associated with a reseller of the communications session, the reseller record specifying a reseller cost per unit time and billing pattern associated with the reseller for the communication session and a default record specifying a default cost per unit time and billing pattern and instructions for setting as the pre-defined billing pattern the billing pattern of the record located. The billing pattern of the record located may include a first billing interval and a second billing interval.

[0102] The instructions for causing the processor circuit to determine the first chargeable time may include instructions for directing the processor circuit to set the first chargeable time equal to the first billing interval when the communication session time is less than or equal to the first billing interval.

[0103] The instructions for causing the processor circuit to determine the first chargeable time may include instructions for producing a remainder value representing a portion of the second billing interval remaining after dividing the second billing interval into a difference between communication session time and the first interval when the communication session time is greater than the communication session time and instructions for causing the processor circuit to set the first chargeable time to a difference between the communication session time and the remainder when the remainder is greater than zero and instructions for causing the processor circuit to set the first chargeable time to the communication session time when the remainder is not greater than zero.

[0104] The instructions may further include instructions for causing the processor circuit to determine a second chargeable time in response to the first chargeable time and the free time value associated with the user of the communications services when the first chargeable time is greater than or equal to the free time value associated with the user of the communications services.

[0105] The instructions for causing the processor circuit to determine the second chargeable time may include instructions for causing the processor circuit to set the second chargeable time to a difference between the first chargeable time.

[0106] The instructions may further include instructions for causing the processor circuit to reset the free time value associated with the user to zero when the first chargeable time is greater than or equal to the free time value associated with the user of the communications services.

[0107] The instructions for causing the processor circuit to change an account balance associated with the user may include instructions for causing the processor circuit to calculate a user cost value in response to the second chargeable time and the user cost per unit time.

[0108] The instructions may further include instructions for causing the processor circuit to change a user free cost balance in response to the user cost value.

[0109] The instructions may further include instructions for causing the processor circuit to set the user cost to zero when the first chargeable time is less than the free time value associated with the user.

[0110] The instructions may further include instructions for causing the processor circuit to change a user free time balance in response to the first chargeable time.

[0111] In accordance with another aspect of the invention, there is provided a computer readable medium encoded with codes for directing a processor circuit to execute one or more of the methods described above and/or variants thereof.

[0112] Other aspects and features of the present invention will become apparent to those ordinarily skilled in the art upon review of the following description of specific embodiments of the invention in conjunction with the accompanying figures.

BRIEF DESCRIPTION OF THE DRAWINGS

[0113] In drawings which illustrate embodiments of the invention,

[0114] Figure 1 is a block diagram of a system according to a first embodiment of the invention;

[0115] Figure 2 is a block diagram of a caller telephone according to the first embodiment of the invention;

[0116] Figure 3 is a schematic representation of a SIP invite message transmitted between the caller telephone and a controller shown in Figure 1;

[0117] Figure 4 is a block diagram of a call controller shown in Figure 1;

[0118] Figure 5 is a flowchart of a process executed by the call controller shown in Figure 1 ;

[0119] Figure 6 is a schematic representation of a routing, billing and rating (RC) request message produced by the call controller shown in Figure 1;

[0120] Figure 7 is a block diagram of a processor circuit of a routing, billing, rating element of the system shown in Figure 1;

[0121] Figures 8A-8D is a flowchart of a RC request message handler executed by the RC. processor circuit shown in Figure 7;

[0122] Figure 9 is a tabular representation of a dialing profile stored in a database accessible by the RC shown in Figure 1;

[0123] Figure 10 is a tabular representation of a dialing profile for a caller using the caller telephone shown in Figure 1;

[0124] Figure 11 is a tabular representation of a callee profile for a callee located in Calgary;

[0125] Figure 12 is a tabular representation of a callee profile for a callee located in London;

[0126] Figure 13 is a tabular representation of a Direct-in-Dial (DID) bank table record stored in the database shown in Figure 1;

[0127] Figure 14 is a tabular representation of an exemplary DID bank table record for the Calgary callee referenced in Figure 11;

[0128] Figure 15 is a tabular representation of a routing message transmitted from the RC to the call controller shown in Figure 1 ;

[0129] Figure 16 is a schematic representation of a routing message buffer holding a routing message for routing a call to the Calgary callee referenced in Figure 11 ;

[0130] Figure 17 is a tabular representation of a prefix to supernode table record stored in the database shown in Figure 1;

[0131] Figure 18 is a tabular representation of a prefix to supernode table record that would be used for the Calgary callee referenced in Figure 11;

[0132] Figure 19 is a tabular representation of a master list record stored in a master list table in the database shown in Figure 1;

[0133] Figure 20 is a tabular representation of a populated master list record;

[0134] Figure 21 is a tabular representation of a suppliers list record stored in the database shown in Figure 1;

[0135] Figure 22 is a tabular representation of a specific supplier list record for a first supplier;

[0136] Figure 23 is a tabular representation of a specific supplier list record for a second supplier;

[0137] Figure 24 is a tabular representation of a specific supplier list record for a third supplier;

[0138] Figure 25 is a schematic representation of a routing message, held in a routing message buffer, identifying to the controller a plurality of possible suppliers that may carry the call;

[0139] Figure 26 is a tabular representation of a call block table record;

[0140] Figure 27 is a tabular representation of a call block table record for the Calgary callee;

[0141] Figure 28 is a tabular representation of a call forwarding table record;

[0142] Figure 29 is a tabular representation of a call forwarding table record specific for the Calgary callee;

[0143] Figure 30 is a tabular representation of a voicemail table record specifying voicemail parameters to enable the caller to leave a voicemail message for the callee;

[0144] Figure 31 is a tabular representation of a voicemail table record specific to the Calgary callee;

[0145] Figure 32 is a schematic representation of an exemplary routing message, held in a routing message buffer, indicating call forwarding numbers and a voicemail server identifier;

[0146] Figures 33A and 33B are respective portions of a flowchart of a process executed by the RC processor for determining a time to live value;

[0147] Figure 34 is a tabular representation of a subscriber bundle table record;

[0148] Figure 35 is a tabular representation of a subscriber bundle record for the Vancouver caller;

[0149] Figure 36 is a tabular representation of a bundle override table record;

[0150] Figure 37 is a tabular representation of bundle override record for a located master list ID;

[0151] Figure 38 is a tabular representation of a subscriber account table record;

[0152] Figure 39 is a tabular representation of a subscriber account record for the Vancouver caller;

[0153] Figure 40 is a flowchart of a process for producing a second time value executed by the RC processor circuit shown in Figure 7;

[0154] Figure 41 is a flowchart for calculating a call cost per unit time;

[0155] Figure 42 is a tabular representation of a system operator special rates table record;

[0156] Figure 43 is a tabular representation of a system operator special rates table record for a reseller named Klondike;

[0157] Figure 44 is a tabular representation of a system operator mark-up table record;

[0158] Figure 45 is a tabular representation of a system operator mark-up table record for the reseller Klondike;

[0159] Figure 46 is a tabular representation of a default system operator mark-up table record;

[0160] Figure 47 is a tabular representation of a reseller special destinations table record;

[0161] Figure 48 is a tabular representation of a reseller special destinations table record for the reseller Klondike;

[0162] Figure 49 is a tabular representation of a reseller global mark-up table record;

[0163] Figure 50 is a tabular representation of a reseller global mark-up table record for the reseller Klondike;

[0164] Figure 51 is a tabular representation of a SIP bye message transmitted from either of the telephones shown in Figure 1 to the call controller;

[0165] Figure 52 is a tabular representation of a SIP bye message sent to the controller from the Calgary callee;

[0166] Figure 53 is a flowchart of a process executed by the call controller for producing a RC stop message in response to receipt of a SIP bye message;

[0167] Figure 54 is a tabular representation of an exemplary RC call stop message;

[0168] Figure 55 is a tabular representation of an RC call stop message for the Calgary callee;

[0169] Figures 56A and 56B are respective portions of a flowchart of a RC call stop message handling routine executed by the RC shown in Figure 1;

[0170] Figure 57 is a tabular representation of a reseller accounts table record;

[0171] Figure 58 is a tabular representation of a reseller accounts table record for the reseller Klondike;

[0172] Figure 59 is a tabular representation of a system operator accounts table record; and

[0173] Figure 60 is a tabular representation of a system operator accounts record for the system operator described herein.

DETAILED DESCRIPTION

[0174] Referring to Figure 1, a system for making voice over IP telephone/videophone calls is shown generally at 10. The system includes a first super node shown generally at 11 and a second super node shown generally at 21. The first super node

11 is located in geographical area, such as Vancouver, B.C., Canada for example and the second super node 21 is located in London, England, for example. Different super nodes may be located in different geographical regions throughout the world to provide telephone/videophone service to subscribers in respective regions. These super nodes may be in communication with each other by high speed/ high data throughput links including optical fiber, satellite and/or cable links, forming a backbone to the system. These super nodes may alternatively or, in addition, be in communication with each other through conventional internet services.

[0175] In the embodiment shown, the Vancouver supernode 11 provides telephone/videophone service to western Canadian customers from Vancouver Island to Ontario. Another node (not shown) may be located in Eastern Canada to provide services to subscribers in that area.

[0176] Other nodes of the type shown may also be employed within the geographical area serviced by a supernode, to provide for call load sharing, for example within a region of the geographical area serviced by the supernode. However, in general, all nodes are similar and have the properties described below in connection with the Vancouver supernode 11.

[0177] In this embodiment, the Vancouver supernode includes a call controller (C) 14, a routing controller (RC) 16, a database 18 and a voicemail server 19 and a media relay 9. Each of these may be implemented as separate modules on a common computer system or by separate computers, for example. The voicemail server 19 need not be included in the node and can be provided by an outside service provider.

[0178] Subscribers such as a subscriber in Vancouver and a subscriber in Calgary communicate with the Vancouver supernode using their own internet service providers which route internet traffic from these subscribers over the internet shown generally at 13 in Figure 1. To these subscribers the Vancouver supernode is accessible at a pre-determined internet protocol (IP) address or a fully qualified domain name that can be accessed in the usual way through a subscriber's internet service provider. The subscriber in Vancouver uses a telephone 12 that is capable of communicating with the Vancouver supernode 11 using

Session Initiation Protocol (SIP) messages and the Calgary subscriber uses a similar telephone 15, in Calgary AB.

[0179] It should be noted that throughout the description of the embodiments of this invention, the IP/UDP addresses of all elements such as the caller and callee telephones, call controller, media relay, and any others, will be assumed to be valid IP/UDP addresses directly accessible via the Internet or a private IP network, for example, depending on the specific implementation of the system. As such, it will be assumed, for example, that the caller and callee telephones will have IP/UDP addresses directly accessible by the call controllers and the media relays on their respective supernodes, and those addresses will not be obscured by Network Address Translation (NAT) or similar mechanisms. In other words, the IP/UDP information contained in SIP messages (for example the SIP Invite message or the RC Request message which will be described below) will match the IP/UDP addresses of the IP packets carrying these SIP messages.

[0180] It will be appreciated that in many situations, the IP addresses assigned to various elements of the system may be in a private IP address space, and thus not directly accessible from other elements. Furthermore, it will also be appreciated that NAT is commonly used to share a “public” IP address between multiple devices, for example between home PCs and IP telephones sharing a single Internet connection. For example, a home PC may be assigned an IP address such as 192.168.0.101 and a Voice over IP telephone may be assigned an IP address of 192.168.0.103. These addresses are located in so called “non-routable” (IP) address space and cannot be accessed directly from the Internet. In order for these devices to communicate with other computers located on the Internet, these IP addresses have to be converted into a “public” IP address, for example 24.10.10.123 assigned by the Internet Service Provider to the subscriber, by a device performing NAT, typically a home router. In addition to translating the IP addresses, NAT typically also translates UDP port numbers, for example an audio path originating at a VoIP telephone and using a UDP port 12378 at its private IP address, may have be translated to a UDP port 23465 associated with the public IP address of the NAT device. In other words, when a packet originating from the above VoIP telephone arrives at an Internet-based supernode, the source IP/UDP address contained in the IP packet header will be 24.10.10.1 :23465, whereas the source IP/UDP

address information contained in the SIP message inside this IP packet will be 192.168.0.103:12378. The mismatch in the IP/UDP addresses may cause a problem for SIP-based VoIP systems because, for example, a supernode will attempt to send messages to a private address of a telephone but the messages will never get there.

[0181] Referring to Figure 1, in an attempt to make a call by the Vancouver telephone/videophone 12 to the Calgary telephone/videophone 15, the Vancouver telephone/videophone sends a SIP invite message to the Vancouver supernode 11 and in response, the call controller 14 sends an RC request message to the RC 16 which makes various enquiries of the database 18 to produce a routing message which is sent back to the call controller 14. The call controller 14 then communicates with the media relay 9 to cause a communications link including an audio path and a videophone (if a videopath call) to be established through the media relay to the same node, a different node or to a communications supplier gateway as shown generally at 20 to carry audio, and where applicable, video traffic to the call recipient or callee.

[0182] Generally, the RC 16 executes a process to facilitate communication between callers and callees. The process involves, in response to initiation of a call by a calling subscriber, receiving a callee identifier from the calling subscriber, using call classification criteria associated with the calling subscriber to classify the call as a public network call or a private network call and producing a routing message identifying an address on the private network, associated with the callee when the call is classified as a private network call and producing a routing message identifying a gateway to the public network when the call is classified as a public network call.

Subscriber Telephone

[0183] In greater detail, referring to Figure 2, in this embodiment, the telephone/videophone 12 includes a processor circuit shown generally at 30 comprising a microprocessor 32, program memory 34, an input/output (I/O) port 36, parameter memory 38 and temporary memory 40. The program memory 34, I/O port 36, parameter memory 38 and temporary memory 40 are all in communication with the microprocessor 32. The I/O port 36 has a dial input 42 for receiving a dialled telephone/videophone number from a keypad, for example, or from a voice recognition unit or from pre-stored telephone/videophone numbers

stored in the parameter memory 38, for example. For simplicity, in Figure 2 a box labelled dialing functions 44 represents any device capable of informing the microprocessor 32 of a callee identifier, e.g., a callee telephone/videophone number.

[0184] The processor 32 stores the callee identifier in a dialled number buffer 45. In this case, assume the dialled number is 2001 1050 2222 and that it is a number associated with the Calgary subscriber. The I/O port 36 also has a handset interface 46 for receiving and producing signals from and to a handset that the user may place to his ear. This interface 46 may include a BLUETOOTH™ wireless interface, a wired interface or speaker phone, for example. The handset acts as a termination point for an audio path (not shown) which will be appreciated later. The I/O port 36 also has an internet connection 48 which is preferably a high speed internet connection and is operable to connect the telephone/videophone to an internet service provider. The internet connection 48 also acts as a part of the voice path, as will be appreciated later. It will be appreciated that where the subscriber device is a videophone, a separate video path is established in the same way an audio path is established. For simplicity, the following description refers to a telephone call, but it is to be understood that a videophone call is handled similarly, with the call controller causing the media relay to facilitate both an audio path and a video path instead of only an audio path.

[0185] The parameter memory 38 has a username field 50, a password field 52 an IP address field 53 and a SIP proxy address field 54, for example. The user name field 50 is operable to hold a user name, which in this case is 2001 1050 8667. The user name is assigned upon subscription or registration into the system and, in this embodiment, includes a twelve digit number having a continent code 61 , a country code 63, a dealer code 70 and a unique number code 74. The continent code 61 is comprised of the first or left-most digit of the user name in this embodiment. The country code 63 is comprised of the next three digits. The dealer code 70 is comprised of the next four digits and the unique number code 74 is comprised of the last four digits. The password field 52 holds a password of up to 512 characters, in this example. The IP address field 53 stores an IP address of the telephone, which for this explanation is 192.168.0.20. The SIP proxy address field 54 holds an IP protocol compatible proxy address which may be provided to the telephone through the internet connection 48 as part of a registration procedure.

[0186] The program memory 34 stores blocks of codes for directing the processor 32 to carry out the functions of the telephone, one of which includes a firewall block 56 which provides firewall functions to the telephone, to prevent access by unauthorized persons to the microprocessor 32 and memories 34, 38 and 40 through the internet connection 48. The program memory 34 also stores codes 57 for establishing a call ID. The call ID codes 57 direct the processor 32 to produce a call identifier having a format comprising a hexadecimal string at an IP address, the IP address being the IP address of the telephone. Thus, an exemplary call identifier might be FF10@192.168.0.20.

[0187] Generally, in response to picking up the handset interface 46 and activating a dialing function 44, the microprocessor 32 produces and sends a SIP invite message as shown in Figure 3, to the routing controller 16 shown in Figure 1. This SIP invite message is essentially to initiate a call by a calling subscriber.

[0188] Referring to Figure 3, the SIP invite message includes a caller ID field 60, a callee identifier field 62, a digest parameters field 64, a call ID field 65 an IP address field 67 and a caller UDP port field 69. In this embodiment, the caller ID field 60 includes the user name 2001 10508667 that is the Vancouver user name stored in the user name field 50 of the parameter memory 38 in the telephone 12 shown in Figure 2. In addition, referring back to Figure 3, the callee identifier field 62 includes a callee identifier which in this embodiment is the user name 2001 1050 2222 that is the dialled number of the Calgary subscriber stored in the dialled number buffer 45 shown in Figure 2. The digest parameters field 64 includes digest parameters and the call ID field 65 includes a code comprising a generated prefix code (FF10) and a suffix which is the Internet Protocol (IP) address of the telephone 12 stored in the IP address field 53 of the telephone. The IP address field 67 holds the IP address assigned to the telephone, in this embodiment 192.168.0.20, and the caller UDP port field 69 includes a UDP port identifier identifying a UDP port at which the audio path will be terminated at the caller's telephone.

Call Controller

[0189] Referring to Figure 4, a call controller circuit of the call controller 14 (Figure 1) is shown in greater detail at 100. The call controller circuit 100 includes a microprocessor 102, program memory 104 and an I/O port 106. The circuit 100 may include

a plurality of microprocessors, a plurality of program memories and a plurality of I/O ports to be able to handle a large volume of calls. However, for simplicity, the call controller circuit 100 will be described as having only one microprocessor 102, program memory 104 and I/O port 106, it being understood that there may be more.

[0190] Generally, the I/O port 106 includes an input 108 for receiving messages such as the SIP invite message shown in Figure 3, from the telephone shown in Figure 2. The I/O port 106 also has an RC request message output 110 for transmitting an RC request message to the RC 16 of Figure 1, an RC message input 112 for receiving routing messages from the RC 16, a gateway output 114 for transmitting messages to one of the gateways 20 shown in Figure 1 to advise the gateway to establish an audio path, for example, and a gateway input 116 for receiving messages from the gateway. The I/O port 106 further includes a SIP output 118 for transmitting messages to the telephone 12 to advise the telephone of the IP addresses of the gateways which will establish the audio path. The I/O port 106 further includes a voicemail server input and output 117, 119 respectively for communicating with the voicemail server 19 shown in Figure 1.

[0191] While certain inputs and outputs have been shown as separate, it will be appreciated that some may be a single IP address and IP port. For example, the messages sent to the RC 16 and received from the RC 16 may be transmitted and received on the same single IP port.

[0192] The program memory 104 includes blocks of code for directing the microprocessor 102 to carry out various functions of the call controller 14. For example, these blocks of code include a first block 120 for causing the call controller circuit 100 to execute a SIP invite to RC request process to produce an RC request message in response to a received SIP invite message. In addition, there is a routing message to gateway message block 122 which causes the call controller circuit 100 to produce a gateway query message in response to a received routing message from the RC 16.

[0193] Referring to Figure 5, the SIP invite to RC request process is shown in more detail at 120. On receipt of a SIP invite message of the type shown in Figure 3, block 122 of Figure 5 directs the call controller circuit 100 of Figure 4 to authenticate the user. This may be done, for example, by prompting the user for a password, by sending a message back

to the telephone 12 which is interpreted at the telephone as a request for a password entry or the password may automatically be sent to the call controller 14 from the telephone, in response to the message. The call controller 14 may then make enquiries of databases to which it has access, to determine whether or not the user's password matches a password stored in the database. Various functions may be used to pass encryption keys or hash codes back and forth to ensure that the transmittal of passwords is secure.

[0194] Should the authentication process fail, the call controller circuit 100 is directed to an error handling routine 124 which causes messages to be displayed at the telephone 12 to indicate there was an authentication problem. If the authentication procedure is passed, block 121 directs the call controller circuit 100 to determine whether or not the contents of the caller ID field 60 of the SIP invite message received from the telephone is an IP address. If it is an IP address, then block 123 directs the call controller circuit 100 to set the contents of a type field variable maintained by the microprocessor 102 to a code representing that the call type is a third party invite. If at block 121 the caller ID field contents do not identify an IP address, then block 125 directs the microprocessor to set the contents of the type field to a code indicating that the call is being made by a system subscriber. Then, block 126 directs the call controller circuit to read the call identifier 65 provided in the SIP invite message from the telephone 12, and at block 128 the processor is directed to produce an RC request message that includes that call ID. Block 129 then directs the call controller circuit 100 to send the RC request to the RC 16.

[0195] Referring to Figure 6, an RC request message is shown generally at 150 and includes a caller field 152, a callee field 154, a digest field 156, a call ID field 158 and a type field 160. The caller, callee, digest call ID fields 152, 154, 156 and 158 contain copies of the caller, callee, digest parameters and call ID fields 60, 62, 64 and 65 of the SIP invite message shown in Figure 3. The type field 160 contains the type code established at blocks 123 or 125 of Figure 5 to indicate whether the call is from a third party or system subscriber, respectively. The caller identifier field may include a PSTN number or a system subscriber username as shown, for example.

Routing Controller (RC)

[0196] Referring to Figure 7, the RC 16 is shown in greater detail and includes an RC processor circuit shown generally at 200. The RC processor circuit 200 includes a processor 202, program memory 204, a table memory 206, buffer memory 207, and an I/O port 208, all in communication with the processor 202. (As earlier indicated, there may be a plurality of processor circuits (202), memories (204), etc.)

[0197] The buffer memory 207 includes a caller id buffer 209 and a callee id buffer 211.

[0198] The I/O port 208 includes a database request port 210 through which a request to the database (18 shown in Figure 1) can be made and includes a database response port 212 for receiving a reply from the database 18. The I/O port 208 further includes an RC request message input 214 for receiving the RC request message from the call controller (14 shown in Figure 1) and includes a routing message output 216 for sending a routing message back to the call controller 14. The I/O port 208 thus acts to receive caller identifier and a callee identifier contained in the RC request message from the call controller, the RC request message being received in response to initiation of a call by a calling subscriber.

[0199] The program memory 204 includes blocks of codes for directing the processor 202 to carry out various functions of the RC (16). One of these blocks includes an RC request message handler 250 which directs the RC to produce a routing message in response to a received RC request message. The RC request message handler process is shown in greater detail at 250 in Figures 8A through 8D.

RC Request Message Handler

[0200] Referring to Figure 8A, the RC request message handler begins with a first block 252 that directs the RC processor circuit (200) to store the contents of the RC request message (150) in buffers in the buffer memory 207 of Figure 7, one of which includes the caller ID buffer 209 of Figure 7 for separately storing the contents of the callee field 154 of the RC request message. Block 254 then directs the RC processor circuit to use the contents of the caller field 152 in the RC request message shown in Figure 6, to locate and retrieve from the database 18 a record associating calling attributes with the calling subscriber. The located record may be referred to as a dialing profile for the caller. The retrieved dialing profile may then be stored in the buffer memory 207, for example.

[0201] Referring to Figure 9, an exemplary data structure for a dialing profile is shown generally at 253 and includes a user name field 258, a domain field 260, and calling attributes comprising a national dialing digits (NDD) field 262, an international dialing digits (IDD) field 264, a country code field 266, a local area codes field 267, a caller minimum local length field 268, a caller maximum local length field 270, a reseller field 273, a maximum number of concurrent calls field 275 and a current number of concurrent calls field 277. Effectively the dialing profile is a record identifying calling attributes of the caller identified by the caller identifier. More generally, dialing profiles represent calling attributes of respective subscribers.

[0202] An exemplary caller profile for the Vancouver subscriber is shown generally at 276 in Figure 10 and indicates that the user name field 258 includes the user name (2001 1050 8667) that has been assigned to the subscriber and is stored in the user name field 50 in the telephone as shown in Figure 2.

[0203] Referring back to Figure 10, the domain field 260 includes a domain name as shown at 282, including a node type identifier 284, a location code identifier 286, a system provider identifier 288 and a domain portion 290. The domain field 260 effectively identifies a domain or node associated with the user identified by the contents of the user name field 258.

[0204] In this embodiment, the node type identifier 284 includes the code “sp” identifying a supernode and the location identifier 286 identifies the supernode as being in Vancouver (YVR). The system provider identifier 288 identifies the company supplying the service and the domain portion 290 identifies the “com” domain.

[0205] The national dialled digit field 262 in this embodiment includes the digit “1” and, in general, includes a number specified by the International Telecommunications Union (ITU) Telecommunications Standardization Sector (ITU-T) E. 164 Recommendation which assigns national dialing digits to countries.

[0206] The international dialing digit field 264 includes a code also assigned according to the ITU-T according to the country or location of the user.

[0207] The country code field 266 also includes the digit “1” and, in general, includes a number assigned according to the ITU-T to represent the country in which the user is located.

[0208] The local area codes field 267 includes a list of area codes that have been assigned by the ITU-T to the geographical area in which the subscriber is located. The caller minimum and maximum local number length fields 268 and 270 hold numbers representing minimum and maximum local number lengths permitted in the area code(s) specified by the contents of the local area codes field 267. The reseller field 273 is optional and holds a code identifying a retailer of the services, in this embodiment “Klondike”. The maximum number of concurrent calls field 275 holds a code identifying the maximum number of concurrent calls that the user is entitled to cause to concurrently exist. This permits more than one call to occur concurrently while all calls for the user are billed to the same account. The current number of concurrent calls field 277 is initially 0 and is incremented each time a concurrent call associated with the user is initiated and is decremented when a concurrent call is terminated.

[0209] The area codes associated with the user are the area codes associated with the location code identifier 286 of the contents of the domain field 260.

[0210] A dialing profile of the type shown in Figure 9 is produced whenever a user registers with the system or agrees to become a subscriber to the system. Thus, for example, a user wishing to subscribe to the system may contact an office maintained by a system operator and personnel in the office may ask the user certain questions about his location and service preferences, whereupon tables can be used to provide office personnel with appropriate information to be entered into the user name 258, domain 260, NDD 262, IDD 264, country code 266, local area codes 267, caller minimum and maximum local length fields 268 and 270 reseller field 273 and concurrent call fields 275 and 277 to establish a dialing profile for the user.

[0211] Referring to Figures 11 and 12, callee dialing profiles for users in Calgary and London, respectively for example, are shown.

[0212] In addition to creating dialing profiles when a user registers with the system, a direct-in-dial (DID) record of the type shown at 278 in Figure 13 is added to a

direct-in-dial bank table in the database (18 in Figure 1) to associate the username and a host name of the supernode with which the user is associated, with an E.164 number associated with the user on the PSTN network.

[0213] An exemplary DID table record entry for the Calgary callee is shown generally at 300 in Figure 14. The user name field 281 and user domain field 272 are analogous to the user name and user domain fields 258 and 260 of the caller dialing profile shown in Figure 10. The contents of the DID field 274 include a E.164 public telephone number including a country code 283, an area code 285, an exchange code 287 and a number 289. If the user has multiple telephone numbers, then multiple records of the type shown at 300 would be included in the DID bank table, each having the same user name and user domain, but different DID field 274 contents reflecting the different telephone numbers associated with that user.

[0214] In addition to creating dialing profiles as shown in Figure 9 and DID records as shown in Figure 13 when a user registers with the system, call blocking records of the type shown in Figure 26, call forwarding records of the type shown in Figure 28 and voicemail records of the type shown in Figure 30 may be added to the database 18 when a new subscriber is added to the system.

[0215] Referring back to Figure 8A, after retrieving a dialing profile for the caller, such as shown at 276 in Figure 10, the RC processor circuit 200 is directed to block 256 which directs the processor circuit (200) to determine whether the contents of the concurrent call field 277 are less than the contents of the maximum concurrent call field 275 of the dialing profile for the caller and, if so, block 271 directs the processor circuit to increment the contents of the concurrent call field 277. If the contents of concurrent call field 277 are equal to or greater than the contents of the maximum concurrent call field 275, block 259 directs the processor circuit 200 to send an error message back to the call controller (14) to cause the call controller to notify the caller that the maximum number of concurrent calls has been reached and no further calls can exist concurrently, including the presently requested call.

[0216] Assuming block 256 allows the call to proceed, the RC processor circuit 200 is directed to perform certain checks on the callee identifier provided by the contents of

the callee field 154 in Figure 6, of the RC request message 150. These checks are shown in greater detail in Figure 8B.

[0217] Referring to Figure 8B, the processor (202 in Figure 7) is directed to a first block 257 that causes it to determine whether a digit pattern of the callee identifier (154) provided in the RC request message (150) includes a pattern that matches the contents of the international dialing digits (IDD) field 264 in the caller profile shown in Figure 10. If so, then block 259 directs the processor (202) to set a call type code identifier variable maintained by the processor to indicate that the call is an international call and block 261 directs the processor to produce a reformatted callee identifier by reformatting the callee identifier into a predefined digit format. In this embodiment, this is done by removing the pattern of digits matching the IDD field contents 264 of the caller dialing profile to effectively shorten the callee identifier. Then, block 263 directs the processor 202 to determine whether or not the callee identifier has a length which meets criteria establishing it as a number compliant with the E.164 Standard set by the ITU. If the length does not meet this criteria, block 265 directs the processor 202 to send back to the call controller (14) a message indicating the length is not correct. The process is then ended. At the call controller 14, routines (not shown) stored in the program memory 104 may direct the processor (102 of Figure 4) to respond to the incorrect length message by transmitting a message back to the telephone (12 shown in Figure 1) to indicate that an invalid number has been dialed.

[0218] Still referring to Figure 8B, if the length of the amended callee identifier meets the criteria set forth at block 263, block 269 directs the processor (202 of Figure 7) to make a database request to determine whether or not the amended callee identifier is found in a record in the direct-in-dial bank (DID) table. Referring back to Figure 8B, at block 269, if the processor 202 receives a response from the database indicating that the reformatted callee identifier produced at block 261 is found in a record in the DID bank table, then the callee is a subscriber to the system and the call is classified as a private network call by directing the processor to block 279 which directs the processor to copy the contents of the corresponding user name field (281 in Figure 14) from the callee DID bank table record (300 in Figure 14) into the callee ID buffer (211 in Figure 7). Thus, the processor 202 locates a subscriber user

name associated with the reformatted callee identifier. The processor 202 is then directed to point B in Figure 8A.

Subscriber to Subscriber Calls Between Different Nodes

[0219] Referring to Figure 8A, block 280 directs the processor (202 of Figure 7) to execute a process to determine whether or not the node associated with the reformatted callee identifier is the same node that is associated with the caller identifier. To do this, the processor 202 determines whether or not a prefix (e.g., continent code 61) of the callee name held in the callee ID buffer (211 in Figure 7), is the same as the corresponding prefix of the caller name held in the username field 258 of the caller dialing profile shown in Figure 10. If the corresponding prefixes are not the same, block 302 in Figure 8A directs the processor (202 in Figure 7) to set a call type flag in the buffer memory (207 in Figure 7) to indicate the call is a cross-domain call. Then, block 350 of Figure 8A directs the processor (202 of Figure 7) to produce a routing message identifying an address on the private network with which the callee identified by the contents of the callee ID buffer is associated and to set a time to live for the call at a maximum value of 99999, for example.

[0220] Thus the routing message includes a caller identifier, a call identifier set according to a username associated with the located DID bank table record and includes an identifier of a node on the private network with which the callee is associated.

[0221] The node in the system with which the callee is associated is determined by using the callee identifier to address a supernode table having records of the type as shown at 370 in Figure 17. Each record 370 has a prefix field 372 and a supernode address field 374. The prefix field 372 includes the first n digits of the callee identifier. In this embodiment n=2. The supernode address field 374 holds a code representing the IP address or a fully qualified domain name of the node associated with the code stored in the callee identifier prefix field 372. Referring to Figure 18, for example, if the prefix is 20, the supernode address associated with that prefix is sp.yvr.digifonica.com.

[0222] Referring to Figure 15, a generic routing message is shown generally at 352 and includes an optional supplier prefix field 354, and optional delimiter field 356, a callee user name field 358, at least one route field 360, a time to live field 362 and other fields 364. The optional supplier prefix field 354 holds a code for identifying supplier traffic.

The optional delimiter field 356 holds a symbol that delimits the supplier prefix code from the callee user name field 358. In this embodiment, the symbol is a number sign (#). The route field 360 holds a domain name or IP address of a gateway or node that is to carry the call, and the time to live field 362 holds a value representing the number of seconds the call is permitted to be active, based on subscriber available minutes and other billing parameters.

[0223] Referring to Figure 8A and Figure 16, an example of a routing message produced by the processor at block 350 for a caller associated with a different node than the caller is shown generally at 366 and includes only a callee field 359, a route field 361 and a time to live field 362.

[0224] Referring to Figure 8A, having produced a routing message as shown in Figure 16, block 381 directs the processor (202 of Figure 7) to send the routing message shown in Figure 16 to the call controller 14 shown in Figure 1.

[0225] Referring back to Figure 8B, if at block 257, the callee identifier stored in the callee id buffer (211 in Figure 7) does not begin with an international dialing digit, block 380 directs the processor (202) to determine whether or not the callee identifier begins with the same national dial digit code as assigned to the caller. To do this, the processor (202) is directed to refer to the retrieved caller dialing profile as shown in Figure 10. In Figure 10, the national dialing digit code 262 is the number 1. Thus, if the callee identifier begins with the number 1, then the processor (202) is directed to block 382 in Figure 8B.

[0226] Block 382 directs the processor (202 of Figure 7) to examine the callee identifier to determine whether or not the digits following the NDD digit identify an area code that is the same as any of the area codes identified in the local area codes field 267 of the caller dialing profile 276 shown in Figure 10. If not, block 384 of Figure 8B directs the processor 202 to set the call type flag to indicate that the call is a national call. If the digits following the NDD digit identify an area code that is the same as a local area code associated with the caller as indicated by the caller dialing profile, block 386 directs the processor 202 to set the call type flag to indicate a local call, national style. After executing blocks 384 or 386, block 388 directs the processor 202 to format the callee identifier into a pre-defined digit format to produce a re-formatted callee identifier by removing the national dialled digit and prepending a caller country code identified by the country code field 266 of the caller dialing

profile shown in Figure 10. The processor (202) is then directed to block 263 of Figure 8B to perform other processing as already described above.

[0227] If at block 380, the callee identifier does not begin with a national dialled digit, block 390 directs the processor (202) to determine whether the callee identifier begins with digits that identify the same area code as the caller. Again, the reference for this is the retrieved caller dialing profile shown in Figure 10. The processor (202) determines whether or not the first few digits of the callee identifier identify an area code corresponding to the local area code field 267 of the retrieved caller dialing profile. If so, then block 392 directs the processor 202 to set the call type flag to indicate that the call is a local call and block 394 directs the processor (202) to format the callee identifier into a pre-defined digit format to produce a reformatted callee identifier by prepending the caller country code to the callee identifier, the caller country code being determined from the country code field 266 of the retrieved caller dialing profile shown in Figure 10. The processor (202) is then directed to block 263 for further processing as described above.

[0228] Referring back to Figure 8B, at block 390, the callee identifier does not start with the same area code as the caller, block 396 directs the processor (202 of Figure 7) to determine whether the number of digits in the callee identifier, i.e. the length of the callee identifier, is within the range of digits indicated by the caller minimum local number length field 268 and the caller maximum local number length field 270 of the retrieved caller dialing profile shown in Figure 10. If so, then block 398 directs the processor (202) to set the call type flag to indicate a local call and block 400 directs the processor (202) to format the callee identifier into a pre-defined digit format to produce a reformatted callee identifier by prepending to the callee identifier the caller country code (as indicated by the country code field 266 of the retrieved caller dialing profile shown in Figure 10) followed by the caller area code (as indicated by the local area code field 267 of the caller profile shown in Figure 10). The processor (202) is then directed to block 263 of Figure 8B for further processing as described above.

[0229] Referring back to Figure 8B, if at block 396, the callee identifier has a length that does not fall within the range specified by the caller minimum local number length field (268 in Figure 10) and the caller maximum local number length field (270 in

Figure 10), block 402 directs the processor 202 of Figure 7 to determine whether or not the callee identifier identifies a valid user name. To do this, the processor 202 searches through the database (18 of Figure 10 of dialing profiles to find a dialing profile having user name field contents (258 in Figure 10) that match the callee identifier. If no match is found, block 404 directs the processor (202) to send an error message back to the call controller (14). If at block 402, a dialing profile having a user name field 258 that matches the callee identifier is found, block 406 directs the processor 202 to set the call type flag to indicate that the call is a private network call and then the processor is directed to block 280 of Figure 8A. Thus, the call is classified as a private network call when the callee identifier identifies a subscriber to the private network.

[0230] From Figure 8B, it will be appreciated that there are certain groups of blocks of codes that direct the processor 202 in Figure 7 to determine whether the callee identifier has certain features such as an international dialing digit, a national dialing digit, an area code and a length that meet certain criteria, and cause the processor 202 to reformat the callee identifier stored in the callee id buffer 211 , as necessary into a predetermined target format including only a country code, area code, and a normal telephone number, for example, to cause the callee identifier to be compatible with the E.164 number plan standard in this embodiment. This enables block 269 in Figure 8B to have a consistent format of callee identifiers for use in searching through the DID bank table records of the type shown in Figure 13 to determine how to route calls for subscriber to subscriber calls on the same system. Effectively, therefore blocks 257, 380, 390, 396 and 402 establish call classification criteria for classifying the call as a public network call or a private network call. Block 269 classifies the call, depending on whether or not the formatted callee identifier has a DID bank table record and this depends on how the call classification criteria are met and block 402 directs the processor 202 of Figure 7 to classify the call as a private network call when the callee identifier complies with a pre-defined format, i.e. is a valid user name and identifies a subscriber to the private network, after the callee identifier has been subjected to the classification criteria of blocks 257, 380, 390 and 396.

Subscriber to Non-Subscriber Calls

[0231] Not all calls will be subscriber to subscriber calls and this will be detected by the processor 202 of Figure 7 when it executes block 269 in Figure 8B, and does not find a DID bank table record that is associated with the callee, in the DID bank table. When this occurs, the call is classified as a public network call by directing the processor 202 to block 408 of Figure 8B which causes it to set the contents of the callee id buffer 211 of Figure 7 equal to the newly formatted callee identifier, i.e., a number compatible with the E.164 standard. Then, block 410 of Figure 8B directs the processor (202) to search a database of route or master list records associating route identifiers with dialing codes shown in Figure 19 to locate a router having a dialing code having a number pattern matching at least a portion of the reformatted callee identifier.

[0232] Referring to Figure 19, a data structure for a master list or route list record is shown. Each master list record includes a master list ID field 500, a dialing code field 502, a country code field 504, a national sign number field 506, a minimum length field 508, a maximum length field 510, a national dialled digit field 512, an international dialled digit field 514 and a buffer rate field 516.

[0233] The master list ID field 500 holds a unique code such as 1019, for example, identifying the record. The dialing code field 502 holds a predetermined number pattern that the processor 202 of Figure 7 uses at block 410 in Figure 8B to find the master list record having a dialing code matching the first few digits of the amended callee identifier stored in the callee id buffer 211. The country code field 504 holds a number representing the country code associated with the record and the national sign number field 506 holds a number representing the area code associated with the record. (It will be observed that the dialing code is a combination of the contents of the country code field 504 and the national sign number field 506.) The minimum length field 508 holds a number representing the minimum length of digits associated with the record and the maximum length field 51 holds a number representing the maximum number of digits in a number with which the record may be compared. The national dialled digit (NDD) field 512 holds a number representing an access code used to make a call within the country specified by the country code, and the international dialled digit (IDD) field 514 holds a number representing the international prefix needed to dial a call from the country indicated by the country code.

[0234] Thus, for example, a master list record may have a format as shown in Figure 20 with exemplary field contents as shown.

[0235] Referring back to Figure 8B, using the country code and area code portions of the reformatted callee identifier stored in the callee id buffer 211, block 410 directs the processor 202 of Figure 7 to find a master list record such as the one shown in Figure 20 having a dialing code that matches the country code (1) and area code (604) of the callee identifier. Thus, in this example, the processor (202) would find a master list record having an ID field containing the number 1019. This number may be referred to as a route ID. Thus, a route ID number is found in the master list record associated with a predetermined number pattern in the reformatted callee identifier.

[0236] After executing block 410 in Figure 8B, the process continues as shown in Figure 8D. Referring to Figure 8D, block 412 directs the processor 202 of Figure 7 to use the route ID number to search a database of supplier records associating supplier identifiers with route identifiers to locate at least one supplier record associated with the route identifier to identify at least one supplier operable to supply a communications link for the route.

[0237] Referring to Figure 21, a data structure for a supplier list record is shown. Supplier list records include a supplier ID field 540, a master list ID field 542, an optional prefix field 544, a specific route identifier field 546, a NDD/IDD rewrite field 548, a rate field 550, and a timeout field 551. The supplier ID field 540 holds a code identifying the name of the supplier and the master list ID field 542 holds a code for associating the supplier record with a master list record. The prefix field 544 holds a string used to identify the supplier traffic and the specific route identifier field 546 holds an IP address of a gateway operated by the supplier indicated by the supplier ID field 540. The NDD/IDD rewrite field 548 holds a code representing a rewritten value of the NDD/IDD associated with this route for this supplier, and the rate field 550 holds a code indicating the cost per second to the system operator to use the route provided by the gateway specified by the contents of the route identifier field 546. The timeout field 551 holds a code indicating a time that the call controller should wait for a response from the associated gateway before giving up and trying the next gateway. This time value may be in seconds, for example. Exemplary supplier

records are shown in Figures 22, 23 and 24 for the exemplary suppliers shown at 20 in Figure 1, namely Telus, Shaw and Sprint.

[0238] Referring back to Figure 8D, at block 412 the processor 202 finds all supplier records that identify the master list ID found at block 410 of Figure 8B.

[0239] Referring back to Figure 8D, block 560 directs the processor 202 of Figure 7 to begin to produce a routing message of the type shown in Figure 15. To do this, the processor 202 loads a routing message buffer as shown in Figure 25 with a supplier prefix of the least costly supplier where the least costly supplier is determined from the rate fields 550 of Figure 21 of the records associated with respective suppliers.

[0240] Referring to Figures 22-24, in the embodiment shown, the supplier “Telus” has the lowest number in the rate field 550 and therefore the prefix 4973 associated with that supplier is loaded into the routing message buffer shown in Figure 25 first.

[0241] Block 562 in Figure 8D directs the processor to delimit the prefix 4973 by the number sign (#) and to next load the reformatted callee identifier into the routing message buffer shown in Figure 25. At block 563 of Figure 8D, the contents of the route identifier field 546 of Figure 21 of the record associated with the supplier “Telus” are added by the processor 202 of Figure 7 to the routing message buffer shown in Figure 25 after an @ sign delimiter, and then block 564 in Figure 8D directs the processor to get a time to live value, which in one embodiment may be 3600 seconds, for example. Block 566 then directs the processor 202 to load this time to live value and the timeout value (551) in Figure 21 in the routing message buffer of Figure 25. Accordingly, a first part of the routing message for the Telus gateway is shown generally at 570 in Figure 25.

[0242] Referring back to Figure 8D, block 571 directs the processor 202 back to block 560 and causes it to repeat blocks 560, 562, 563, 564 and 566 for each successive supplier until the routing message buffer is loaded with information pertaining to each supplier identified by the processor at block 412. Thus, a second portion of the routing message as shown at 572 in Figure 25 relates to the second supplier identified by the record shown in Figure 23. Referring back to Figure 25, a third portion of the routing message as shown at 574 and is associated with a third supplier as indicated by the supplier record shown in Figure 24.

[0243] Consequently, referring to Figure 25, the routing message buffer holds a routing message identifying a plurality of different suppliers able to provide gateways to the public telephone network (i.e. specific routes) to establish at least part of a communication link through which the caller may contact the callee. In this embodiment, each of the suppliers is identified, in succession, according to rate. Other criteria for determining the order in which suppliers are listed in the routing message may include preferred supplier priorities which may be established based on service agreements, for example.

[0244] Referring back to Figure 8D, block 568 directs the processor 202 of Figure 7 to send the routing message shown in Figure 25 to the call controller 14 in Figure 1.

Subscriber to Subscriber Calls Within the Same Node

[0245] Referring back to Figure 8A, if at block 280, the callee identifier received in the RC request message has a prefix that identifies the same node as that associated with the caller, block 600 directs the processor 202 to use the callee identifier in the callee id buffer 211 to locate and retrieve a dialing profile for the callee. The dialing profile may be of the type shown in Figure 11 or 12, for example. Block 602 of Figure 8A then directs the processor 202 of Figure 7 to get call block, call forward and voicemail records from the database 18 of Figure 1 based on the user name identified in the callee dialing profile retrieved by the processor at block 600. Call block, call forward and voicemail records may be as shown in Figures 26, 27, 28 and 30 for example.

[0246] Referring to Figure 26, the call block records include a user name field 604 and a block pattern field 606. The user name field holds a user name corresponding to the user name in the user name field (258 in Figure 10) of the callee profile and the block pattern field 606 holds one or more E.164-compatible numbers or user names identifying PSTN numbers or system subscribers from whom the subscriber identified in the user name field 604 does not wish to receive calls.

[0247] Referring to Figure 8A and Figure 27, block 608 directs the processor 202 of Figure 7 to determine whether or not the caller identifier received in the RC request message matches a block pattern stored in the block pattern field 606 of the call block record associated with the callee identified by the contents of the user name field 604 in Figure 26. If the caller identifier matches a block pattern, block 610 directs the processor to send a drop

call or non-completion message to the call controller (14) and the process is ended. If the caller identifier does not match a block pattern associated with the callee, block 609 directs the processor to store the username and domain of the callee, as determined from the callee dialing profile, and a time to live value in the routing message buffer as shown at 650 in Figure 32. Referring back to Figure 8A, block 612 then directs the processor 202 to determine whether or not call forwarding is required.

[0248] Referring to Figure 28, the call forwarding records include a user name field 614, a destination number field 616, and a sequence number field 618. The user name field 614 stores a code representing a user with which the record is associated. The destination number field 616 holds a user name representing a number to which the current call should be forwarded, and the sequence number field 618 holds an integer number indicating the order in which the user name associated with the corresponding destination number field 616 should be attempted for call forwarding. The call forwarding table may have a plurality of records for a given user. The processor 202 of Figure 7 uses the contents of the sequence number field 618 to place the records for a given user in order. As will be appreciated below, this enables the call forwarding numbers to be tried in an ordered sequence.

[0249] Referring to Figure 8A and Figure 29, if at block 612, the call forwarding record for the callee identified by the callee identifier contains no contents in the destination number field 616 and accordingly no contents in the sequence number field 618, there are no call forwarding entries for this callee, and the processor 202 is directed to block 620 in Figure 8C. If there are entries in the call forwarding table 27, block 622 in Figure 8A directs the processor 202 to search the dialing profile table to find a dialing profile record as shown in Figure 9, for the user identified by the destination number field 616 of the call forward record shown in Figure 28. The processor 202 of Figure 7 is further directed to store the username and domain for that user and a time to live value in the routing message buffer as shown at 652 in Figure 32, to produce a routing message as illustrated. This process is repeated for each call forwarding record associated with the callee identified by the callee id buffer 211 in Figure 7 to add to the routing message buffer all call forwarding usernames and domains associated with the callee.

[0250] Referring back to Figure 8A, if at block 612 there are no call forwarding records, then at block 620 in Figure 8C the processor 202 is directed to determine whether or not the user identified by the callee identifier has paid for voicemail service. This is done by checking to see whether or not a flag is set in a voicemail record of the type shown in Figure 30 in a voicemail table stored in the database 18 shown in Figure 1.

[0251] Referring to Figure 30, voicemail records in this embodiment may include a user name field 624, a voicemail server field 626, a seconds to voicemail field 628 and an enable field 630. The user name field 624 stores the user name of the callee. The voicemail server field 626 holds a code identifying a domain name of a voicemail server associated with the user identified by the user name field 624. The seconds to voicemail field 628 holds a code identifying the time to wait before engaging voicemail, and the enable field 630 holds a code representing whether or not voicemail is enabled for the user. Referring back to Figure 8C, at block 620 if the processor 202 of Figure 7 finds a voicemail record as shown in Figure 30 having user name field 624 contents matching the callee identifier, the processor is directed to examine the contents of the enable field 630 to determine whether or not voicemail is enabled. If voicemail is enabled, then block 640 in Figure 8C directs the processor 202 to Figure 7 to store the contents of the voicemail server field 626 and the contents of the seconds to voicemail field 628 in the routing message buffer, as shown at 654 in Figure 32. Block 642 then directs the processor 202 to get time to live values for each path specified by the routing message according to the cost of routing and the user's balance. These time to live values are then appended to corresponding paths already stored in the routing message buffer.

[0252] Referring back to Figure 8C, block 644 then directs the processor 202 of Figure 7 to store the IP address of the current node in the routing message buffer as shown at 656 in Figure 32. Block 646 then directs the processor 202 to send the routing message shown in Figure 32 to the call controller 14 in Figure 1. Thus in the embodiment described the routing controller will produce a routing message that will cause at least one of the following: forward the call to another party, block the call and direct the caller to a voicemail server.

[0253] Referring back to Figure 1 , the routing message whether of the type shown in Figures 16, 25 or 32, is received at the call controller 14 and the call controller interprets the receipt of the routing message as a request to establish a call.

[0254] Referring to Figure 4, the program memory 104 of the call controller 14 includes a routing to gateway routine depicted generally at 122.

[0255] Where a routing message of the type shown in Figure 32 is received by the call controller 14, the routing to gateway routine 122 shown in Figure 4 may direct the processor 102 cause a message to be sent back through the internet 13 shown in Figure 1 to the callee telephone 15, knowing the IP address of the callee telephone 15 from the user name.

[0256] Alternatively, if the routing message is of the type shown in Figure 16, which identifies a domain associated with another node in the system, the call controller may send a SIP invite message along the high speed backbone 17 connected to the other node. The other node functions as explained above, in response to receipt of a SIP invite message.

[0257] If the routing message is of the type shown in Figure 25 where there are a plurality of gateway suppliers available, the call controller sends a SIP invite message to the first supplier, in this case Telus, using a dedicated line or an internet connection to determine whether or not Telus is able to handle the call. If the Telus gateway returns a message indicating it is not able to handle the call, the call controller 14 then proceeds to send a SIP invite message to the next supplier, in this case Shaw. The process is repeated until one of the suppliers responds indicating that it is available to carry the call. Once a supplier responds indicating that it is able to carry the call, the supplier sends back to the call controller 14 an IP address for a gateway provided by the supplier through which the call or audio path of the call will be carried. This IP address is sent in a message from the call controller 14 to the media relay 9 which responds with a message indicating an IP address to which the caller telephone should send its audio/video, traffic and an IP address to which the gateway should send its audio/video for the call. The call controller conveys the IP address at which the media relay expects to receive audio/video from the caller telephone, to the caller telephone 12 in a message. The caller telephone replies to the call controller with an IP address at which it would like to receive audio/video and the call controller conveys that IP address to the

media relay. The call may then be conducted between the caller and callee through the media relay and gateway.

[0258] Referring back to Figure 1 , if the call controller 14 receives a routing message of the type shown in Figure 32, and which has at least one call forwarding number and/or a voicemail number, the call controller attempts to establish a call to the callee telephone 15 by seeking from the callee telephone a message indicating an IP address to which the media relay should send audio/video. If no such message is received from the callee telephone, no call is established. If no call is established within a pre-determined time, the call controller 14 attempts to establish a call with the next user identified in the call routing message in the same manner. This process is repeated until all call forwarding possibilities have been exhausted, in which case the call controller communicates with the voicemail server 19 identified in the routing message to obtain an IP address to which the media relay should send audio/video and the remainder of the process mentioned above for establishing IP addresses at the media relay 9 and the caller telephone is carried out to establish audio/video paths to allowing the caller to leave a voicemail message with the voicemail server.

[0259] When an audio/video path through the media relay is established, a call timer maintained by the call controller 14 logs the start date and time of the call and logs the call ID and an identification of the route (i.e., audio/video path IP address) for later use in billing.

Time to Live

[0260] Referring to Figures 33A and 33B, a process for determining a time to live value for any of blocks 642 in Figure 8C, 350 in Figure 8A or 564 in Figure 8D above is described. The process is executed by the processor 202 shown in Figure 7. Generally, the process involves calculating a cost per unit time, calculating a first time value as a sum of a free time attributed to a participant in the communication session and the quotient of a funds balance held by the participant to the cost per unit time value and producing a second time value in response to the first time value and a billing pattern associated with the participant, the billing pattern including first and second billing intervals and the second time value being the time to permit a communication session to be conducted.

[0261] Referring to Figure 33A, in this embodiment, the process begins with a first block 700 that directs the RC processor to determine whether or not the call type set at block 302 in Figure 8A indicates the call is a network or cross-domain call. If the call is a network or cross-domain call, block 702 of Figure 33A directs the RC processor to set the time to live equal to 99999 and the process is ended. Thus, the network or cross-domain call type has a long time to live. If at block 700 the call type is determined not to be a network or cross-domain type, block 704 directs the RC processor to get a subscriber bundle table record from the database 18 in Figure 1 and store it locally in the subscriber bundle record buffer at the RC 14.

[0262] Referring to Figure 34, a subscriber bundle table record is shown generally at 706. The record includes a user name field 708 and a services field 710. The user name field 708 holds a code identifying the subscriber user name and the services field 710 holds codes identifying service features assigned to the subscriber, such as free local calling, call blocking and voicemail, for example.

[0263] Figure 35 shows an exemplary subscriber bundle record for the Vancouver caller. In this record the user name field 708 is loaded with the user name 2001 1050 8667 and the services field 710 is loaded with codes 10, 14 and 16 corresponding to free local calling, call blocking and voicemail, respectively. Thus, user 2001 1050 8667 has free local calling, call blocking and voicemail features.

[0264] Referring back to Figure 33A, after having loaded a subscriber bundle record into the subscriber bundle record buffer, block 712 directs the RC processor to search the database (18) determine whether or not there is a bundle override table record for the master list ID value that was determined at block 410 in Figure 8B. An exemplary bundle override table record is shown at 714 in Figure 36. The bundle table record includes a master list ID field 716, an override type field 718, an override value field 720 a first interval field 722 and a second interval field 724. The master list ID field 716 holds a master list ID code. The override type field 718 holds an override type code indicating a fixed, percent or cent amount to indicate the amount by which a fee will be increased. The override value field 720 holds a real number representing the value of the override type. The first interval field 722

holds a value indicating the minimum number of seconds for a first level of charging and the second interval field 724 holds a number representing a second level of charging.

[0265] Referring to Figure 37, a bundle override record for the located master list ID code is shown generally at 726 and includes a master list ID field 716 holding the code 1019 which was the code located in block 410 of Figure 8B. The override type field 718 includes a code indicating the override type is a percentage value and the override value field 720 holds the value 10.0 indicating that the override will be 10.0% of the charged value. The first interval field 722 holds a value representing 30 seconds and the second interval field 724 holds a value representing 6 seconds. The 30 second value in the first interval field 722 indicates that charges for the route will be made at a first rate for 30 seconds and thereafter the charges will be made at a different rate in increments of 6 seconds, as indicated by the contents of the second interval field 724.

[0266] Referring back to Figure 33A, if at block 712 the processor finds a bundle override record of the type shown in Figure 37, block 728 directs the processor to store the bundle override record in local memory. In the embodiment shown, the bundle override record shown in Figure 37 is stored in the bundle override record buffer at the RC as shown in Figure 7. Still referring to Figure 33A, block 730 then directs the RC processor to determine whether or not the subscriber bundle table record 706 in Figure 35 has a services field including a code identifying that the user is entitled to free local calling and also directs the processor to determine whether or not the call type is not a cross domain cell, i.e. it is a local or local/national style. If both of these conditions are satisfied, block 732 directs the processor to set the time to live equal to 99999, giving the user a long period of time for the call. The process is then ended. If the conditions associated with block 730 are not satisfied, block 734 of Figure 33B directs the RC processor to retrieve a subscriber account record associated with a participant in the call. This is done by copying and storing in the subscriber account record buffer a subscriber account record for the caller.

[0267] Referring to Figure 38, an exemplary subscriber account table record is shown generally at 736. The record includes a user name field 738, a funds balance field 740 and a free time field 742. The user name field 738 holds a subscriber user name, the funds balance field 740 holds a real number representing the dollar value of credit available to the

subscriber and the free time field 742 holds an integer representing the number of free seconds that the user is entitled to.

[0268] An exemplary subscriber account record for the Vancouver caller is shown generally at 744 in Figure 39, wherein the user name field 738 holds the user name 2001 1050 8667, the funds balance field 740 holds the value \$10.00, and the free time field 742 holds the value 100. The funds balance field holding the value of \$10.00 indicates the user has \$10.00 worth of credit and the free time field having the value of 100 indicates that the user has a balance of 100 free seconds of call time.

[0269] Referring back to Figure 33B, after copying and storing the subscriber account record shown in Figure 39 from the database to the subscriber account record buffer RC, block 746 directs the processor to determine whether or not the subscriber account record funds balance field 740 or free time field 742 are greater than zero. If they are not greater than zero, block 748 directs the processor to set the time to live equal to zero and the process is ended. The RC then sends a message back to the call controller to cause the call controller to deny the call to the caller. If the conditions associated with block 746 are satisfied, block 750 directs the processor to calculate the call cost per unit time. A procedure for calculating the call cost per unit time is described below in connection with Figure 41.

[0270] Assuming the procedure for calculating the cost per second returns a number representing the call cost per second, block 752 directs the processor 202 in Figure 7 to determine whether or not the cost per second is equal to zero. If so, block 754 directs the processor to set the time to live to 99999 to give the caller a very long length of call and the process is ended.

[0271] If at block 752 the call cost per second is not equal to zero, block 756 directs the processor 202 in Figure 7 to calculate a first time to live value as a sum of a free time attributed to the participant in the communication session and the quotient of the funds balance held by the participant to the cost per unit time value. To do this, the processor 202 of Figure 7 is directed to set a first time value or temporary time to live value equal to the sum of the free time provided in the free time field 742 of the subscriber account record shown in Figure 39 and the quotient of the contents of the funds balance field 740 in the subscriber account record for the call shown in Figure 39 and the cost per second determined

at block 750 of Figure 33B. Thus, for example, if at block 750 the cost per second is determined to be three cents per second and the funds balance field holds the value \$10.00, the quotient of the funds balance and cost per second is 333 seconds and this is added to the contents of the free time field 742, which is 100, resulting in a time to live of 433 seconds.

[0272] Block 758 then directs the RC processor to produce a second time value in response to the first time value and the billing pattern associated with the participant as established by the bundle override record shown in Figure 37. This process is shown in greater detail at 760 in Figure 40 and generally involves producing a remainder value representing a portion of the second billing interval remaining after dividing the second billing interval into a difference between the first time value and the first billing interval.

[0273] Referring to Figure 40, the process for producing the second time value begins with a first block 762 that directs the processor 202 in Figure 7 to set a remainder value equal to the difference between the time to live value calculated at block 756 in Figure 33B and the contents of the first interval field 722 of the record shown in Figure 37, multiplied by the modulus of the contents of the second interval field 724 of Figure 37. Thus, in the example given, the difference between the time to live field and the first interval field is 433 minus 30, which is 403 and therefore the remainder produced by the mod of 403 divided by 6 is 0.17. Block 764 then directs the processor to determine whether or not this remainder value is greater than zero and, if so, block 766 directs the processor to subtract the remainder from the first time value and set the difference as the second time value. To do this the processor is directed to set the time to live value equal to the current time to live of 403 minus the remainder of 1, i.e., 402 seconds. The processor is then returned back to block 758 of Figure 33B.

[0274] Referring back to Figure 40, if at block 764 the remainder is not greater than zero, block 768 directs the processor 202 of Figure 7 to determine whether or not the time to live is less than the contents of the first interval field 722 in the record shown in Figure 37. If so, then block 770 of Figure 40 directs the processor to set the time to live equal to zero. Thus, the second time value is set to zero when the remainder is greater than zero and the first time value is less than the free time associated with the participant in the call. If at

block 768 the conditions of that block are not satisfied, the processor returns the first time to live value as the second time to live value.

[0275] Thus, referring to Figure 33B, after having produced a second time to live value, block 772 directs the processor to set the time to live value for use in blocks 342, 350 or 564.

Cost per Second

[0276] Referring back to Figure 33B, at block 750 it was explained that a call cost per unit time is calculated. The following explains how that call cost per unit time value is calculated.

[0277] Referring to Figure 41, a process for calculating a cost per unit time is shown generally at 780. The process is executed by the processor 202 in Figure 7 and generally involves locating a record in a database, the record comprising a markup type indicator, a markup value and a billing pattern and setting a reseller rate equal to the sum of the markup value and the buffer rate, locating at least one of an override record specifying a route cost per unit time amount associated with a route associated with the communication session, a reseller record associated with a reseller of the communications session, the reseller record specifying a reseller cost per unit time associated with the reseller for the communication session and a default operator markup record specifying a default cost per unit time and setting as the cost per unit time the sum of the reseller rate and at least one of the route cost per unit time, the reseller cost per unit time and the default cost per unit time.

[0278] The process begins with a first set of blocks 782, 802 and 820 which direct the processor 202 in Figure 7 to locate at least one of a record associated with a reseller and a route associated with the reseller, a record associated with the reseller, and a default reseller mark-up record. Block 782, in particular, directs the processor to address the database 18 to look for a record associated with a reseller and a route with the reseller by looking for a special rate record based on the master list ID established at block 410 in Figure 8C.

[0279] Referring to Figure 42, a system operator special rate table record is shown generally at 784. The record includes a reseller field 786, a master list ID field 788, a mark-up type field 790, a mark-up value field 792, a first interval field 794 and a second interval field 796. The reseller field 786 holds a reseller ID code and the master list ID field 788 holds

a master list ID code. The mark-up type field 790 holds a mark-up type such as fixed percent or cents and the mark-up value field 792 holds a real number representing the value corresponding to the mark-up type. The first interval field 794 holds a number representing a first level of charging and the second interval field 796 holds a number representing a second level of charging.

[0280] An exemplary system operator special rate table for a reseller known as “Klondike” is shown at 798 in Figure 43. In this record, the reseller field 786 holds a code indicating the retailer ID is Klondike, the master list ID field 788 holds the code 1019 to associate the record with the master list ID code 1019. The mark-up type field 790 holds a code indicating the mark-up type is cents and the mark-up value field 792 holds a mark-up value indicating 1/10 of one cent. The first interval field 794 holds the value 30 and the second interval field 796 holds the value 6, these two fields indicating that the operator allows 30 seconds for free and then billing is done in increments of 6 seconds after that.

[0281] Referring back to Figure 41, if at block 782 a record such as the one shown in Figure 43 is located in the system operator special rates table, the processor is directed to block 800 in Figure 41. If such a record is not found in the system operator special rates table, block 802 directs the processor to address the database 18 to look in a system operator mark-up table for a mark-up record associated with the reseller.

[0282] Referring to Figure 44, an exemplary system operator mark-up table record is shown generally at 804. The record includes a reseller field 806, a mark-up type field 808, a mark-up value field 810, a first interval field 812 and a second interval field 814. The reseller mark-up type, mark-up value, first interval and second interval fields are as described in connection with the fields by the same names in the system operator special rates table shown in Figure 42.

[0283] Figure 45 provides an exemplary system operator mark-up table record for the reseller known as Klondike and therefore the reseller field 806 holds the value “Klondike”, the mark-up type field 808 holds the value cents, the markup value field holds the value 0.01, the first interval field 812 holds the value 30 and the second interval field 814 holds the value 6. This indicates that the reseller “Klondike” charges by the cent at a rate of

one cent per minute. The first 30 seconds of the call are free and billing is charged at the rate of one cent per minute in increments of 6 seconds.

[0284] Figure 46 provides an exemplary system operator mark-up table record for cases where no specific system operator mark-up table record exists for a particular reseller, i.e., a default reseller mark-up record. This record is similar to the record shown in Figure 45 and the reseller field 806 holds the value “all”, the mark-up type field 808 is loaded with a code indicating mark-up is based on a percentage, the mark-up value field 810 holds the percentage by which the cost is marked up, and the first and second interval fields 812 and 814 identify first and second billing levels.

[0285] Referring back to Figure 41 , if at block 802 a specific mark-up record for the reseller identified at block 782 is not located, block 820 directs the processor to get the mark-up record shown in Figure 46, having the “all” code in the reseller field 806. The processor is then directed to block 800.

[0286] Referring back to Figure 41, at block 800, the processor 202 of Figure 7 is directed to set a reseller rate equal to the sum of the mark-up value of the record located by blocks 782, 802 or 820 and the buffer rate specified by the contents of the buffer rate field 516 of the master list record shown in Figure 20. To do this, the RC processor sets a variable entitled “reseller cost per second” to a value equal to the sum of the contents of the mark-up value field (792, 810) of the associated record, plus the contents of the buffer rate field (516) from the master list record associated with the master list ID. Then, block 822 directs the processor to set a system operator cost per second variable equal to the contents of the buffer rate field (516) from the master list record. Block 824 then directs the processor to determine whether the call type flag indicates the call is local or national/local style and whether the caller has free local calling. If both these conditions are met, then block 826 sets the user cost per second variable equal to zero and sets two increment variables equal to one, for use in later processing. The cost per second has thus be calculated and the process shown in Figure 41 is ended.

[0287] If at block 824 the conditions of that block are not met, the processor 202 of Figure 7 is directed to locate at least one of a bundle override table record specifying a route cost per unit time associated with a route associated with the communication session, a

reseller special destinations table record associated with a reseller of the communications session, the reseller record specifying a reseller cost per unit time associated with the reseller for the communication session and a default reseller global markup record specifying a default cost per unit time.

[0288] To do this block 828 directs the processor 202 of Figure 7 to determine whether or not the bundle override record 726 in Figure 37 located at block 712 in Figure 33A has a master list ID equal to the stored master list ID that was determined at block 410 in Figure 8B. If not, block 830 directs the processor to find a reseller special destinations table record in a reseller special destinations table in the database (18), having a master list ID code equal to the master list ID code of the master list ID that was determined at block 410 in Figure 8B. An exemplary reseller special destinations table record is shown in Figure 47 at 832. The reseller special destinations table record includes a reseller field 834, a master list ID field 836, a mark-up type field 838, a mark-up value field 840, a first interval field 842 and a second interval field 844. This record has the same format as the system operator special rates table record shown in Figure 42, but is stored in a different table to allow for different mark-up types and values and time intervals to be set according to resellers' preferences. Thus, for example, an exemplary reseller special destinations table record for the reseller "Klondike" is shown at 846 in Figure 48. The reseller field 834 holds a value indicating the reseller as the reseller "Klondike" and the master list ID field holds the code 1019. The markup type field 838 holds a code indicating the mark-up type is percent and the mark-up value field 840 holds a number representing the mark-up value as 5%. The first and second interval fields identify different billing levels used as described earlier.

[0289] Referring back to Figure 41, the record shown in Figure 48 may be located at block 830, for example. If at block 830 such a record is not found, then block 832 directs the processor to get a default operator global mark-up record based on the reseller ID.

[0290] Referring to Figure 49, an exemplary default reseller global mark-up table record is shown generally at 848. This record includes a reseller field 850, a mark-up type field 852, a mark-up value field 854, a first interval field 856 and a second interval field 858. The reseller field 850 holds a code identifying the reseller. The mark-up type field 852, the mark-up value field 854 and the first and second interval fields 856 and 858 are of the same

type as described in connection with fields of the same name in Figure 47, for example. The contents of the fields of this record 860 may be set according to system operator preferences, for example.

[0291] Referring to Figure 50, an exemplary reseller global mark-up table record is shown generally at 860. In this record, the reseller field 850 holds a code indicating the reseller is “Klondike”, the mark-up type field 852 holds a code indicating the mark-up type is percent, the mark-up value field 854 holds a value representing 10% as the mark-up value, the first interval field 856 holds the value 30 and the second interval field 858 holds the values 30 and 6 respectively to indicate the first 30 seconds are free and billing is to be done in 6 second increments after that.

[0292] Referring back to Figure 41, should the processor get to block 832, the reseller global mark-up table record as shown in Figure 50 is retrieved from the database and stored locally at the RC. As seen in Figure 41, it will be appreciated that if the conditions are met in blocks 828 or 830, or if the processor executes block 832, the processor is then directed to block 862 which causes it to set an override value equal to the contents of the mark-up value field of the located record, to set the first increment variable equal to the contents of the first interval field of the located record and to set the second increment variable equal to the contents of the second interval field of the located record. (The increment variables were alternatively set to specific values at block 826 in Figure 41.)

[0293] It will be appreciated that the located record could be a bundle override record of the type shown in Figure 37 or the located record could be a reseller special destination record of the type shown in Figure 48 or the record could be a reseller global mark-up table record of the type shown in Figure 50. After the override and first and second increment variables have been set at block 862, the processor 202 if Figure 7 is directed to set as the cost per unit time the sum of the reseller rate and at least one of the route cost per unit time, the reseller cost per unit time and the default cost per unit time, depending on which record was located. To do this, block 864 directs the processor to set the cost per unit time equal to the sum of the reseller cost set at block 800 in Figure 41, plus the contents of the override variable calculated in block 862 in Figure 41. The cost per unit time has thus been

calculated and it is this cost per unit time that is used in block 752 of Figure 33B, for example.

Terminating the Call

[0294] In the event that either the caller or the callee terminates a call, the telephone of the terminating party sends a SIP bye message to the controller 14. An exemplary SIP bye message is shown at 900 in Figure 51 and includes a caller field 902, a callee field 904 and a call ID field 906. The caller field 902 holds a twelve digit user name, the callee field 904 holds a PSTN compatible number or user name, and the call ID field 906 holds a unique call identifier field of the type shown in the call ID field 65 of the SIP invite message shown in Figure 3.

[0295] Thus, for example, referring to Figure 52, a SIP bye message for the Calgary callee is shown generally at 908 and the caller field 902 holds a user name identifying the caller, in this case 2001 1050 8667, the callee field 904 holds a user name identifying the Calgary callee, in this case 2001 1050 2222, and the call ID field 906 holds the code FA10 @ 192.168.0.20, which is the call ID for the call.

[0296] The SIP bye message shown in Figure 52 is received at the call controller 14 and the call controller executes a process as shown generally at 910 in Figure 53. The process includes a first block 912 that directs the call controller processor 202 of Figure 7 to copy the caller, callee and call ID field contents from the SIP bye message received from the terminating party to corresponding fields of an RC stop message buffer (not shown). Block 914 then directs the processor to copy the call start time from the call timer and to obtain a call stop time from the call timer. Block 916 then directs the call controller to calculate a communication session time by determining the difference in time between the call start time and the call stop time. This session time is then stored in a corresponding field of the RC call stop message buffer. Block 917 then directs the processor to decrement the contents of the current concurrent call field 277 of the dialing profile for the caller as shown in Figure 10, to indicate that there is one less concurrent call in progress. A copy of the amended dialing profile for the caller is then stored in the database 18 of Figure 1. Block 918 then directs the processor to copy the route from the call log. An RC call stop message produced as described

above is shown generally at 1000 in Figure 54. An RC call stop message specifically associated with the call made to the Calgary callee is shown generally at 1020 in Figure 55.

[0297] Referring to Figure 54, the RC stop call message includes a caller field 1002, callee field 1004, a call ID field 1006, an account start time field 1008, an account stop time field 1010, a communication session time 1012 and a route field 1014. The caller field 1002 holds a username, the callee field 1004 holds a PSTN-compatible number or system number, the call ID field 1006 hold the unique call identifier received from the SIP invite message shown in Figure 3, the account start time field 1008 holds the date and start time of the call, the account stop time field 1010 holds the date and time the call ended, the communication session time field 1012 holds a value representing the difference between the start time and the stop time, in seconds, and the route field 1014 holds the IP address for the communications link that was established.

[0298] Referring to Figure 55, an exemplary RC stop call message for the Calgary callee is shown generally at 1020. In this example the caller field 1002 holds the user name 2001 1050 8667 identifying the Vancouver-based caller and the callee field 1004 holds the user name 2001 1050 2222 identifying the Calgary callee. The contents of the call ID field 1006 are FA10 @ 192.168.0.20. The contents of the account start time field 1008 are 2006-12-30 12:12:12 and the contents of the account stop time field are 2006-12-30 12:12:14. The contents of the communication session time field 1012 are 2 to indicate 2 seconds call duration and the contents of the route field are 72.64.39.58.

[0299] Referring back to Figure 53, after having produced an RC call stop message, block 920 directs the processor 202 in Figure 7 to send the RC stop message compiled in the RC call stop message buffer to the RC 16 of Figure 1. Block 922 directs the call controller 14 to send a “bye” message back to the party that did not terminate the call.

[0300] The RC 16 of Figure 1 receives the call stop message and an RC call stop message process is invoked at the RC, the process being shown at 950 in Figures 56A, 56B and 56C. Referring to Figure 56A, the RC stop message process 950 begins with a first block 952 that directs the processor 202 in Figure 7 to determine whether or not the communication session time is less than or equal to the first increment value set by the cost calculation routine shown in Figure 41, specifically blocks 826 or 862 thereof. If this condition is met,

then block 954 of Figure 56A directs the RC processor to set a chargeable time variable equal to the first increment value set at block 826 or 862 of Figure 41. If at block 952 of Figure 56A the condition is not met, block 956 directs the RC processor to set a remainder variable equal to the difference between the communication session time and the first increment value mod the second increment value produced at block 826 or 862 of Figure 41. Then, the processor is directed to block 958 of Figure 56A which directs it to determine whether or not the remainder is greater than zero. If so, block 960 directs the RC processor to set the chargeable time variable equal to the difference between the communication session time and the remainder value. If at block 958 the remainder is not greater than zero, block 962 directs the RC processor to set the chargeable time variable equal to the contents of the communication session time from the RC stop message. The processor is then directed to block 964. In addition, after executing block 954 or block 960, the processor is directed to block 964.

[0301] Block 964 directs the processor 202 of Figure 7 to determine whether or not the chargeable time variable is greater than or equal to the free time balance as determined from the free time field 742 of the subscriber account record shown in Figure 39. If this condition is satisfied, block 966 of Figure 56A directs the processor to set the free time field 742 in the record shown in Figure 39, to zero. If the chargeable time variable is not greater than or equal to the free time balance, block 968 directs the RC processor to set a user cost variable to zero and Block 970 then decrements the free time field 742 of the subscriber account record for the caller by the chargeable time amount determined by block 954, 960 or 962.

[0302] If at Block 964 the processor 202 of Figure 7 was directed to Block 966 which causes the free time field (742 of Figure 39) to be set to zero, referring to Figure 56B, Block 972 directs the processor to set a remaining chargeable time variable equal to the difference between the chargeable time and the contents of the free time field (742 of Figure 39). Block 974 then directs the processor to set the user cost variable equal to the product of the remaining chargeable time and the cost per second calculated at Block 750 in Figure 33B. Block 976 then directs the processor to decrement the funds balance field (740) of the

subscriber account record shown in Figure 39 by the contents of the user cost variable calculated at Block 974.

[0303] After completing Block 976 or after completing Block 970 in Figure 56A, block 978 of Figure 56B directs the processor 202 of Figure 7 to calculate a reseller cost variable as the product of the reseller rate as indicated in the mark-up value field 810 of the system operator mark-up table record shown in Figure 45 and the communication session time determined at Block 916 in Figure 53. Then, Block 980 of Figure 56B directs the processor to add the reseller cost to the reseller balance field 986 of a reseller account record of the type shown in Figure 57 at 982.

[0304] The reseller account record includes a reseller ID field 984 and the aforementioned reseller balance field 986. The reseller ID field 984 holds a reseller ID code, and the reseller balance field 986 holds an accumulated balance of charges.

[0305] Referring to Figure 58, a specific reseller accounts record for the reseller “Klondike” is shown generally at 988. In this record the reseller ID field 984 holds a code representing the reseller “Klondike” and the reseller balance field 986 holds a balance of \$100.02. Thus, the contents of the reseller balance field 986 in Figure 58 are incremented by the reseller cost calculated at block 978 of Figure 56B.

[0306] Still referring to Figure 56B, after adding the reseller cost to the reseller balance field as indicated by Block 980, Block 990 directs the processor to 202 of Figure 7 calculate a system operator cost as the product of the system operator cost per second, as set at block 822 in Figure 41, and the communication session time as determined at Block 916 in Figure 53. Block 992 then directs the processor to add the system operator cost value calculated at Block 990 to a system operator accounts table record of the type shown at 994 in Figure 59. This record includes a system operator balance field 996 holding an accumulated charges balance. Referring to Figure 60 in the embodiment described, the system operator balance field 996 may hold the value \$1,000.02 for example, and to this value the system operator cost calculated at Block 990 is added when the processor executes Block 992 of Figure 56B.

[0307] Ultimately, the final reseller balance 986 in Figure 58 holds a number representing an amount owed to the reseller by the system operator and the system operator

balance 996 of Figure 59 holds a number representing an amount of profit for the system operator.

[0308] While specific embodiments of the invention have been described and illustrated, such embodiments should be considered illustrative of the invention only and not as limiting the invention as construed in accordance with the accompanying claims.

WHAT IS CLAIMED IS:

1. A process for producing a routing message for routing communications between a caller and a callee in a communication system, the process comprising:

using a caller identifier associated with the caller to locate a caller dialing profile comprising a plurality of calling attributes associated with the caller;

when at least one of said calling attributes and at least a portion of a callee identifier associated with the callee meet private network classification criteria, producing a private network routing message for receipt by a call controller, said private network routing message identifying an address, on the private network, associated with the callee; and

when at least one of said calling attributes and at least a portion of said callee identifier meet a public network classification criterion, producing a public network routing message for receipt by the call controller, said public network routing message identifying a gateway to the public network.

2. The process of claim **1**, wherein said private network classification criteria include:

a) said callee identifier does not begin with the same digit pattern as an international dialing digit (IDD) attribute of said callee identifier; and

b) said callee identifier does not begin with the same digit pattern as a national dialing digit (NDD) attribute of said callee identifier; and

c) said callee identifier does not begin with the same area code as an area code of said caller; and

d) said callee identifier does not have a length that is within a range of caller local number lengths; and

e) said callee identifier is a valid username.

3. The process of claim **2**, further comprising identifying the call as a cross-domain call on the private network when said callee identifier identifies a callee that is not associated with the same network node as said caller.

- 4.** The process of claim **2**, further comprising:
locating a callee dialing profile for the callee when said callee identifier identifies a callee that is associated with the same network node as said caller; and
retrieving call handling information associated with the callee, where said call handling information is available, said call handling information including at least one of call blocking information, call forwarding information, and voicemail information.
- 5.** The process of claim **4**, further comprising, where said call handling information including said call blocking information is available, blocking the call when said call blocking information identifies the caller as a caller from whom calls are to be blocked from being established with the callee.
- 6.** The process of claim **4**, further comprising, where said call handling information including said call forwarding information is available, causing said call forwarding information to be included in said private network routing message.
- 7.** The process of claim **4**, further comprising, where said call handling information including said voicemail information is available, causing said voicemail information to be included in said private network routing message.
- 8.** The process of claim **1**, further comprising associating at least one direct inward dial (DID) record with at least one subscriber to said communication system, each of said at least one direct inward dial records comprising a field storing a direct inward dial number associated with said at least one subscriber.
- 9.** The process of claim **8**, wherein said public network classification criteria include:

 - a) said callee identifier begins with the same digit pattern as an international dialing digit (IDD) attribute of said callee identifier; and
 - b) a reformatted callee identifier produced by removing the IDD attribute from said callee identifier has no DID bank table record.

10. The process of claim **8**, wherein said public network classification criteria include:

- a) said callee identifier begins with the same digit pattern as a national dialing digit (NDD) attribute of said callee identifier; and
- b) a reformatted callee identifier produced by removing the NDD attribute from said callee identifier and including a caller country code has no DID bank table record.

11. The process of claim **8**, wherein said public network classification criteria include:

- a) said callee identifier begins with the same area code as an area code of said caller; and
- b) a reformatted callee identifier produced by reformatting the callee identifier to include a caller country code has no DID bank table record.

12. The process of claim **8**, wherein said public network classification criteria include:

- a) said callee identifier has a length that is within a range of caller local number lengths; and
- b) a reformatted callee identifier produced by reformatting the callee identifier to include a caller country code and area code has no DID bank table record.

13. The process of claim **1**, wherein said plurality of calling attributes includes at least one of an international dialing digits identifier, a national dialing digits identifier, a country code identifier, a local area codes identifier, a caller minimum local length identifier, a caller maximum local length identifier, a reseller identifier, and a maximum number of concurrent calls identifier.

14. The process of claim **8**, wherein said DID record comprises a user name field, a user domain field and a DID number field.

15. The process of claim **1**, further comprising maintaining a list of public network route suppliers and when said public network classification criterion is met identifying at least one of said public network route suppliers that satisfies public network routing selection criteria.

16. The process of claim **15**, wherein said producing said public network routing message comprises producing a public network routing message identifying said at least one public network route supplier that satisfies said public network routing selection criteria.

17. The process of claim **16**, wherein producing said public network routing message comprises causing said public network routing message to include a gateway supplier identifier identifying a gateway supplier able to establish a communications link in a route through which communications between the caller and callee are to be conducted.

18. The process of claim **17**, further comprising causing said public network routing message to include a time value and a timeout value.

19. The process of claim **17**, wherein causing said public network routing message to include said gateway supplier identifier comprises causing said public network routing message to include a plurality of gateway supplier identifiers identifying a plurality of gateway suppliers able to supply respective communication links through which communications between the caller and callee can be conducted.

20. The process of claim **19**, further comprising causing said public network routing message to include priority information identifying a priority in which gateway suppliers associated with said gateway identifiers are to be considered for selection of a communication link through which communications between the caller and callee can be conducted.

21. The process of claim **19**, wherein causing said public network routing message to include priority information includes arranging said gateway supplier identifiers in said

public network routing message in order of rate, where rate is determined from rate fields of respective said gateway supplier records.

22. The process of claim **21**, wherein arranging said gateway supplier identifiers in order of rate comprises arranging said gateway supplier identifiers in order of increasing rate.

23. The process of claim **17**, further comprising arranging said gateway supplier identifiers in an order based on at least one provision in a service agreement.

24. The process of claim **1**, further comprising causing the private network routing message or the public network routing message to be communicated to a call controller to effect routing of the call.

25. A non-transitory computer readable medium encoded with codes for directing a processor to execute the method of claim **1**.

26. A call routing controller apparatus for producing a routing message for routing communications between a caller and a callee in a communication system, the apparatus comprising:

at least one processor operably configured to:

use a caller identifier associated with the caller to locate a caller dialing profile comprising a plurality of calling attributes associated with the caller;

when at least one of said calling attributes and at least a portion of a callee identifier associated with the callee meet private network classification criteria, produce a private network routing message for receipt by a call controller, said private network routing message identifying an address, on the private network, associated with the callee; and

when at least one of said calling attributes and at least a portion of said callee identifier meet a public network classification criterion, produce a public network

routing message for receipt by the call controller, said public network routing message identifying a gateway to the public network.

27. The apparatus of claim **26**, wherein said private network classification criteria include:

- a) said callee identifier does not begin with the same digit pattern as an international dialing digit (IDD) attribute of said callee identifier; and
- b) said callee identifier does not begin with the same digit pattern as a national dialing digit (NDD) attribute of said callee identifier; and
- c) said callee identifier does not begin with the same area code as an area code of said caller; and
- d) said callee identifier does not have a length that is within a range of caller local number lengths; and
- e) said callee identifier is a valid username.

28. The apparatus of claim **27**, wherein said at least one processor is further operably configured to identify the call as a cross-domain call on the private network when said callee identifier identifies a callee that is not associated with the same network node as said caller.

29. The apparatus of claim **27**, wherein said at least one processor is further configured to:

access the database of caller dialing profiles to locate a callee dialing profile for the callee when said callee identifier identifies a callee that is associated with the same network node as said caller; and

retrieve call handling information associated with the callee, where said call handling information is available, said call handling information including at least one of call blocking information, call forwarding information, and voicemail information.

30. The apparatus of claim **29**, wherein said at least one processor is further operably configured to determine whether said call handling information including said call

blocking information is available and to block the call when said call blocking information identifies the caller as a caller from whom calls are to be blocked.

31. The apparatus of claim **29**, wherein said at least one processor is further operably configured to determine whether said call handling information including said call forwarding information is available and to cause said call forwarding information to be included in said private network routing message.

32. The apparatus of claim **29**, wherein said at least one processor is further operably configured to determine whether said call handling information including said voicemail information is available and to cause said voicemail information to be included in said private network routing message.

33. The apparatus of claim **26**, wherein said at least one processor is further operably configured to access a database of direct inward dial records each associating at least one direct inward dial number with at least one subscriber to said communication system.

34. The apparatus of claim **33**, wherein said public network classification criteria include:

- a) said callee identifier begins with the same digit pattern as an international dialing digit (IDD) attribute of said callee identifier; and
- b) a reformatted callee identifier produced by removing the IDD attribute from said callee identifier has no DID record.

35. The apparatus of claim **33**, wherein said public network classification criteria include:

- a) said callee identifier begins with the same digit pattern as a national dialing digit (NDD) attribute of said callee identifier; and

b) a reformatted callee identifier produced by removing the NDD attribute from said callee identifier and including a caller country code has no DID record.

36. The apparatus of claim **33**, wherein said public network classification criteria include:

a) said callee identifier begins with the same area code as an area code of said caller; and

b) a reformatted callee identifier produced by reformatting the callee identifier to include a caller country code has no DID record.

37. The apparatus of claim **33**, wherein said public network classification criteria include:

a) said callee identifier has a length that is within a range of caller local number lengths; and

b) a reformatted callee identifier produced by reformatting the callee identifier to include a caller country code and area code has no DID record.

38. The apparatus of claim **26**, wherein said plurality of calling attributes includes at least one of an international dialing digits identifier, a national dialing digits identifier, a country code identifier, a local area codes identifier, a caller minimum local length identifier, a caller maximum local length identifier, a reseller identifier, and a maximum number of concurrent calls identifier.

39. The apparatus of claim **33**, wherein said DID record comprises a user name field, a user domain field and a DID number field.

40. The apparatus of claim **26**, wherein said at least one processor is further operably configured to access a list of public network route suppliers when said public network classification criterion is met and to identify at least one of said public network route suppliers that satisfies public network routing selection criteria.

41. The apparatus of claim **40**, wherein said at least one processor is further operably configured to produce a public network routing message identifying said at least one public network route supplier that satisfies said public network routing selection criteria.

42. The apparatus of claim **41**, wherein said at least one processor is operably configured to cause said public network routing message to include a gateway supplier identifier identifying a gateway supplier able to establish a communications link in a route through which communications between the caller and callee can be conducted.

43. The apparatus of claim **42**, wherein said at least one processor is operably configured to cause said public network routing message to include a time value and a timeout value.

44. The apparatus of claim **42**, wherein said at least one processor is operably configured to cause said public network routing message to include a plurality of gateway supplier identifiers identifying a plurality of gateway suppliers able to supply respective communication links through which communications between the caller and callee can be conducted.

45. The apparatus of claim **44**, wherein said at least one processor is operably configured to cause said public network routing message to include priority information identifying a priority in which gateway suppliers associated with said gateway identifiers are to be considered for selection of a communication link through which communications between the caller and callee can be conducted.

46. The apparatus of claim **44**, wherein said at least one processor is operably configured to arrange said gateway supplier identifiers in said public network routing message in order of rate, where rate is determined from rate fields of respective said gateway supplier records.

47. The apparatus of claim **46**, wherein said at least one processor is operably configured to arrange said gateway supplier identifiers in order of increasing rate.

48. The apparatus of claim **42**, wherein said at least one processor is operably configured to arrange said gateway supplier identifiers in an order based on at least one provision in a service agreement.

49. The apparatus of claim **26**, wherein said at least one processor is further operably configured to cause the private network routing message or the public network routing message to be communicated to a call controller to effect routing of the call.

50. A call routing controller apparatus for producing a routing message for routing communications between a caller and a callee in a communication system, the apparatus comprising:

means for using a caller identifier associated with the caller to locate a caller dialing profile comprising a plurality of calling attributes associated with the caller; and

means for, when at least one of said calling attributes and at least a portion of a callee identifier associated with the callee meet private network classification criteria, producing a private network routing message for receipt by a call controller, said private network routing message identifying an address, on the private network, associated with the callee; and

means for, when at least one of said calling attributes and at least a portion of said callee identifier meet a public network classification criterion, producing a public network routing message for receipt by the call controller, said public network routing message identifying a gateway to the public network.

51. The apparatus of claim **50**, wherein said private network classification criteria include:

a) said callee identifier does not begin with the same digit pattern as an international dialing digit (IDD) attribute of said callee identifier; and

b) said callee identifier does not begin with the same digit pattern as a national dialing digit (NDD) attribute of said callee identifier; and

c) said callee identifier does not begin with the same area code as an area code of said caller; and

said callee identifier does not have a length that is within a range of caller local number lengths; and

said callee identifier is a valid username.

52. The apparatus of claim **51**, further comprising means for identifying the call as a cross-domain call on the private network when said callee identifier identifies a callee that is not associated with the same network node as said caller.

53. The apparatus of claim **51**, further comprising:

means for accessing the database of caller dialing profiles to locate a callee dialing profile for the callee when said callee identifier identifies a callee that is associated with the same network node as said caller; and

means for retrieving call handling information associated with the callee, where said call handling information is available, said call handling information including at least one of call blocking information, call forwarding information, and voicemail information.

54. The apparatus of claim **53**, further comprising, where said call handling information including said call blocking information is available, means for blocking the call being established with the callee when said call blocking information identifies the caller as a caller from whom calls are to be blocked.

55. The apparatus of claim **53**, further comprising, means for causing said call forwarding information to be included in said private network routing message, where said call handling information including said call forwarding information is available.

56. The apparatus of claim **53**, further comprising, where said call handling information including said voicemail information is available, means for causing said voicemail information to be included in said private network routing message.

57. The apparatus of claim **50**, further comprising means for accessing a database of direct inward dial records each associating at least one direct inward dial number with at least one subscriber to said communication system.

58. The apparatus of claim **57**, wherein said public network classification criteria include:

- a) said callee identifier begins with the same digit pattern as an international dialing digit (IDD) attribute of said callee identifier; and
- b) a reformatted callee identifier produced by removing the IDD attribute from said callee identifier has no DID record.

59. The apparatus of claim **57**, wherein said public network classification criteria include:

- a) said callee identifier begins with the same digit pattern as a national dialing digit (NDD) attribute of said callee identifier; and
- b) a reformatted callee identifier produced by removing the NDD attribute from said callee identifier and including a caller country code has no DID record.

60. The apparatus of claim **57**, wherein said public network classification criteria include:

- a) said callee identifier begins with the same area code as an area code of said caller; and
- b) a reformatted callee identifier produced by reformatting the callee identifier to include a caller country code has no DID record.

61. The apparatus of claim **57**, wherein said public network classification criteria include:

- a) said callee identifier has a length that is within a range of caller local number lengths; and
- b) a reformatted callee identifier produced by reformatting the callee identifier to include a caller country code and area code has no DID record.

62. The apparatus of claim **50**, wherein said plurality of calling attributes includes at least one of an international dialing digits identifier, a national dialing digits identifier, a country code identifier, a local area codes identifier, a caller minimum local length identifier, a caller maximum local length identifier, a reseller identifier, and a maximum number of concurrent calls identifier.

63. The apparatus of claim **57**, wherein said DID record comprises a user name field, a user domain field and a DID number field.

64. The apparatus of claim **50**, further comprising means for accessing a list of public network route suppliers when said public network classification criterion is met and means for identifying at least one of said public network route suppliers that satisfies public network routing selection criteria.

65. The apparatus of claim **64**, wherein said means for producing said public network routing message comprises means for producing a public network routing message identifying said at least one public network route supplier that satisfies said public network routing selection criteria.

66. The apparatus of claim **65**, wherein said means for producing said public network routing message comprises means for causing said public network routing message to include a gateway supplier identifier identifying a gateway supplier able to establish a communications link in a route through which communications between the caller and callee can be conducted.

67. The apparatus of claim **66**, further comprising means for causing said public network routing message to include a time value and a timeout value.

68. The apparatus of claim **66**, wherein said means for causing said public network routing message to include said gateway supplier identifier comprises means for causing said public network routing message to include a plurality of gateway supplier identifiers identifying a plurality of gateway suppliers able to supply respective communication links through which communications between the caller and callee can be conducted.

69. The apparatus of claim **68**, further comprising means for causing said public network routing message to include priority information identifying a priority in which gateway suppliers associated with said gateway identifiers are to be considered for selection of a communication link through which communications between the caller and callee can be conducted.

70. The apparatus of claim **68**, wherein said means for causing said public network routing message to include priority information includes means for arranging said gateway supplier identifiers in said public network routing message in order of rate, where rate is determined from rate fields of respective said gateway supplier records.

71. The apparatus of claim **70**, wherein said means for arranging said gateway supplier identifiers in order of rate comprises means for arranging said gateway supplier identifiers in order of increasing rate.

72. The apparatus of claim **66**, further comprising means for arranging said gateway supplier identifiers in an order based on at least one provision in a service agreement.

73. The apparatus of claim **50**, further comprising means for causing the private network routing message or the public network routing message to be communicated to a call controller to effect routing of the call.

74. A non-transitory computer readable medium having stored thereon data structure for associating together a collection of information for use in producing a routing message for routing communications in a communications system, the data structure comprising:

dialing profile records comprising fields for associating a subscriber username with respective subscribers to the system;

direct-in-dial records comprising fields for associating a user domain and a direct-in-dial number with respective subscriber usernames;

prefix to node records comprising fields for associating a node address of a node in said system with at least a portion of said respective subscriber usernames:

whereby said subscriber username can be used to find said user domain, at least a portion of said subscriber username can be used to find said node with which a subscriber identified by said subscriber user name is associated, and said user domain and said subscriber username can be located in response to said direct-in-dial number.

75. A non-transitory computer readable medium having stored thereon a data structure for associating together a collection of information for use in producing a routing message in a communications system, the data structure comprising:

master list records comprising fields for associating a dialing code with respective master list identifiers; and

supplier list records linked to said master list records by said master list identifiers, said supplier list records comprising fields for associating the following information with a communications services supplier:

a supplier id;

a master list id;

a route identifier; and

a billing rate code,

whereby at least one communications service supplier is associated with said dialing code, such that said dialing code can be used to locate suppliers capable of providing a communications link associated with a given dialing code.

76. A non-transitory computer readable medium having stored thereon a data structure for associating together a collection of information for use in producing a routing message for routing communications, the data structure comprising:

- a username field;
- a domain field;
- a national dialing digits (NDD) field;
- an international dialing digits (IDD) field;
- a country code field;
- a local area code field;
- a caller minimum local length field; and
- a caller maximum local length field.

77. The non-transitory computer readable medium of claim **76**, further comprising a reseller field.

78. The non-transitory computer readable medium of claim **76**, further comprising:

- a maximum number of concurrent calls field; and
- a current number of concurrent calls field.

PRODUCING ROUTING MESSAGES FOR VOICE OVER IP COMMUNICATIONS

ABSTRACT OF THE DISCLOSURE

A process and apparatus to facilitate communication between callers and callees in a system comprising a plurality of nodes with which callers and callees are associated is disclosed. In response to initiation of a call by a calling subscriber, a caller identifier and a callee identifier are received. Call classification criteria associated with the caller identifier are used to classify the call as a public network call or a private network call. A routing message identifying an address, on the private network, associated with the callee is produced when the call is classified as a private network call and a routing message identifying a gateway to the public network is produced when the call is classified as a public network call.

15956892
080613

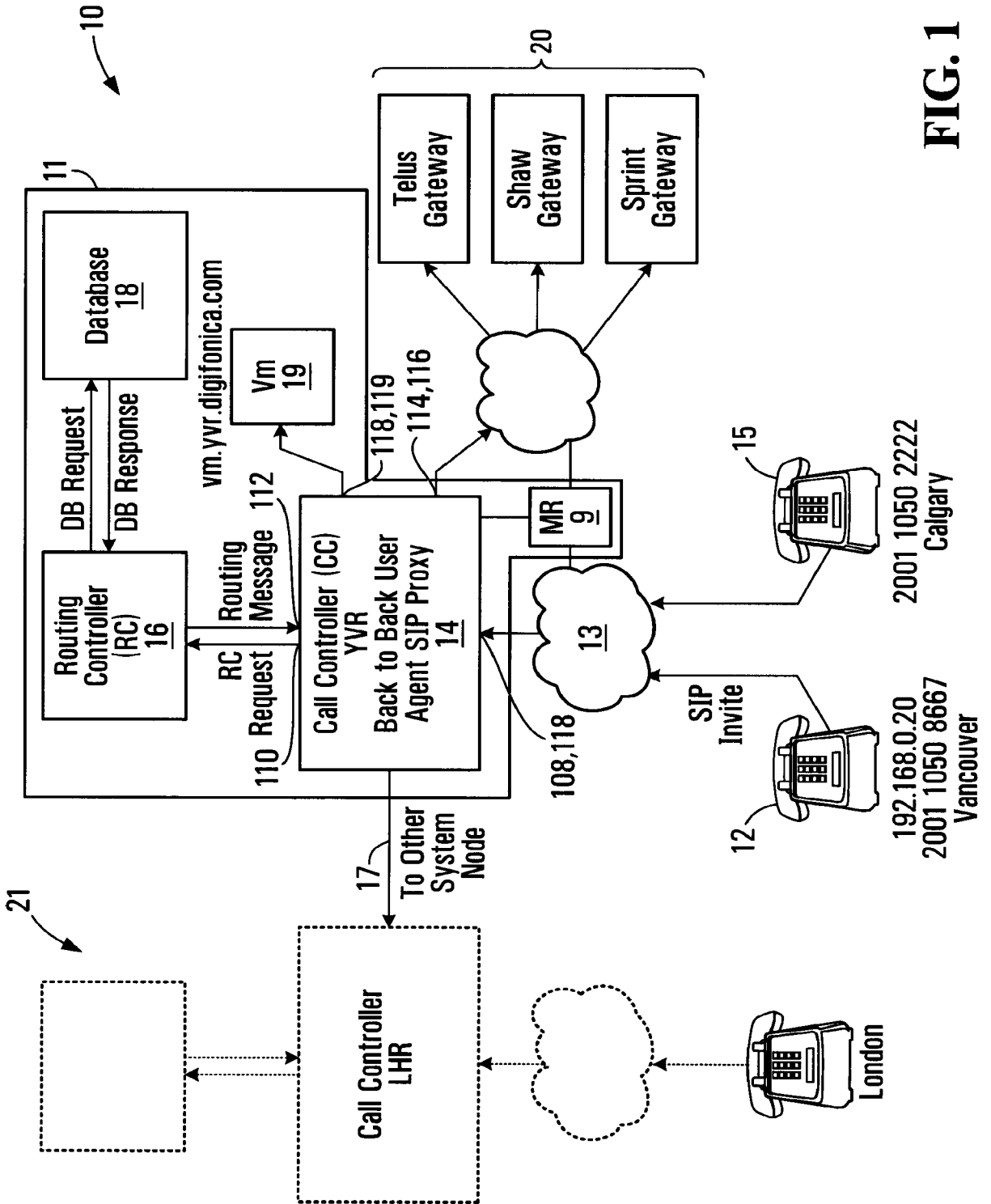

FIG. 1

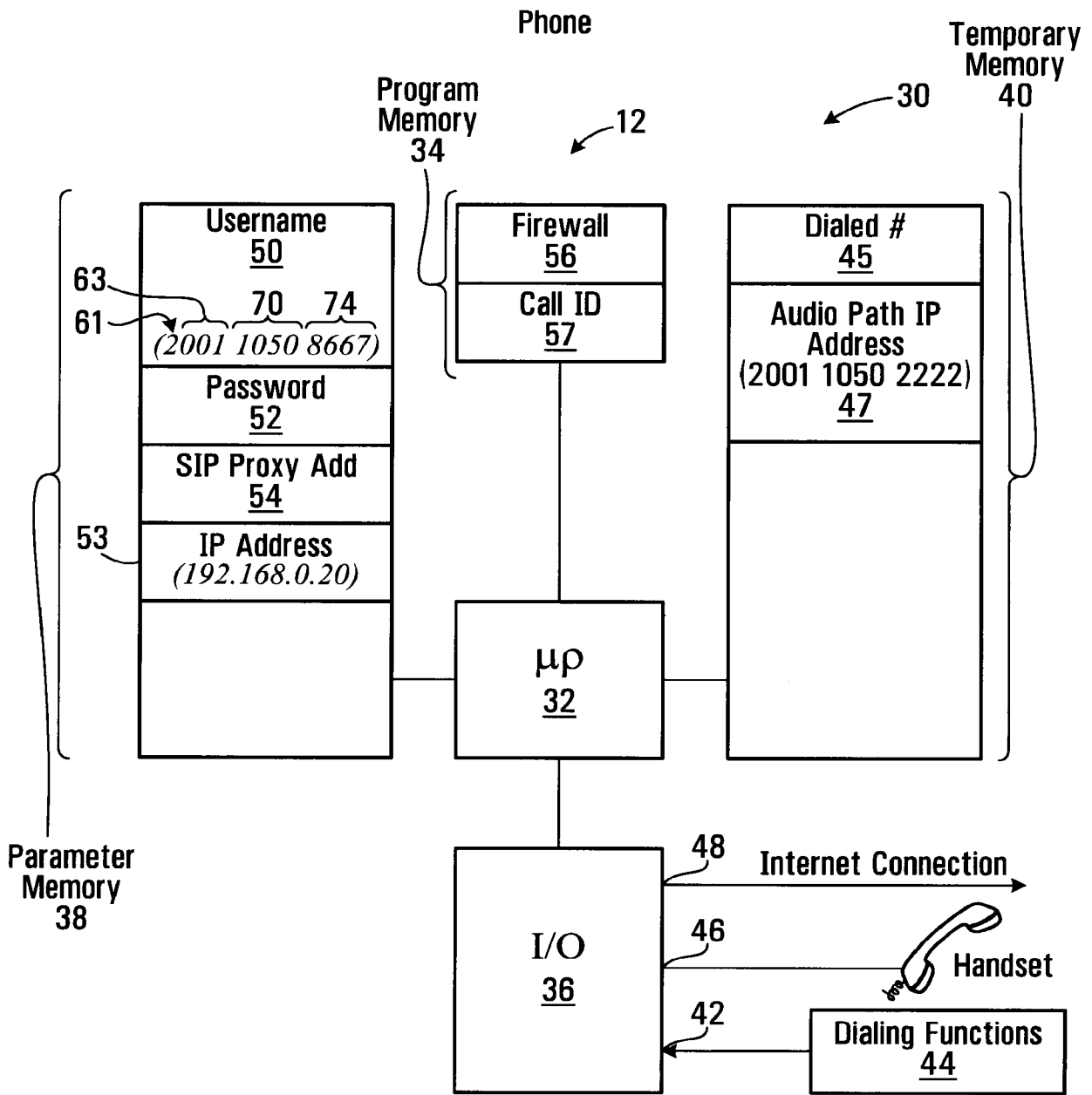

FIG. 2

SIP Invite Message

60 ~ Caller 2001 1050 8667
 62 ~ Callee 2001 1050 2222
 64 ~ Digest Parameters XXXXXXX
 65 ~ Call ID FF10@ 192.168.0.20
 67 ~ IP Address 192.168.0.20
 69 ~ Caller UDP Port 1

FIG. 3

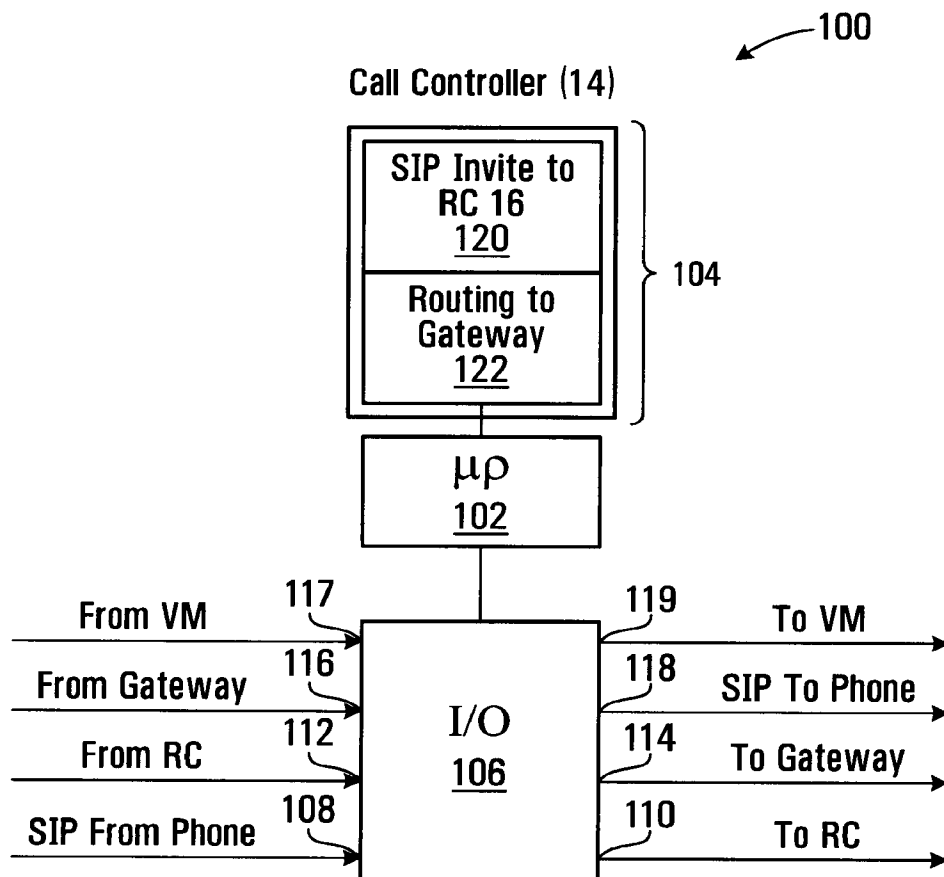

FIG. 4

Call Controller Process

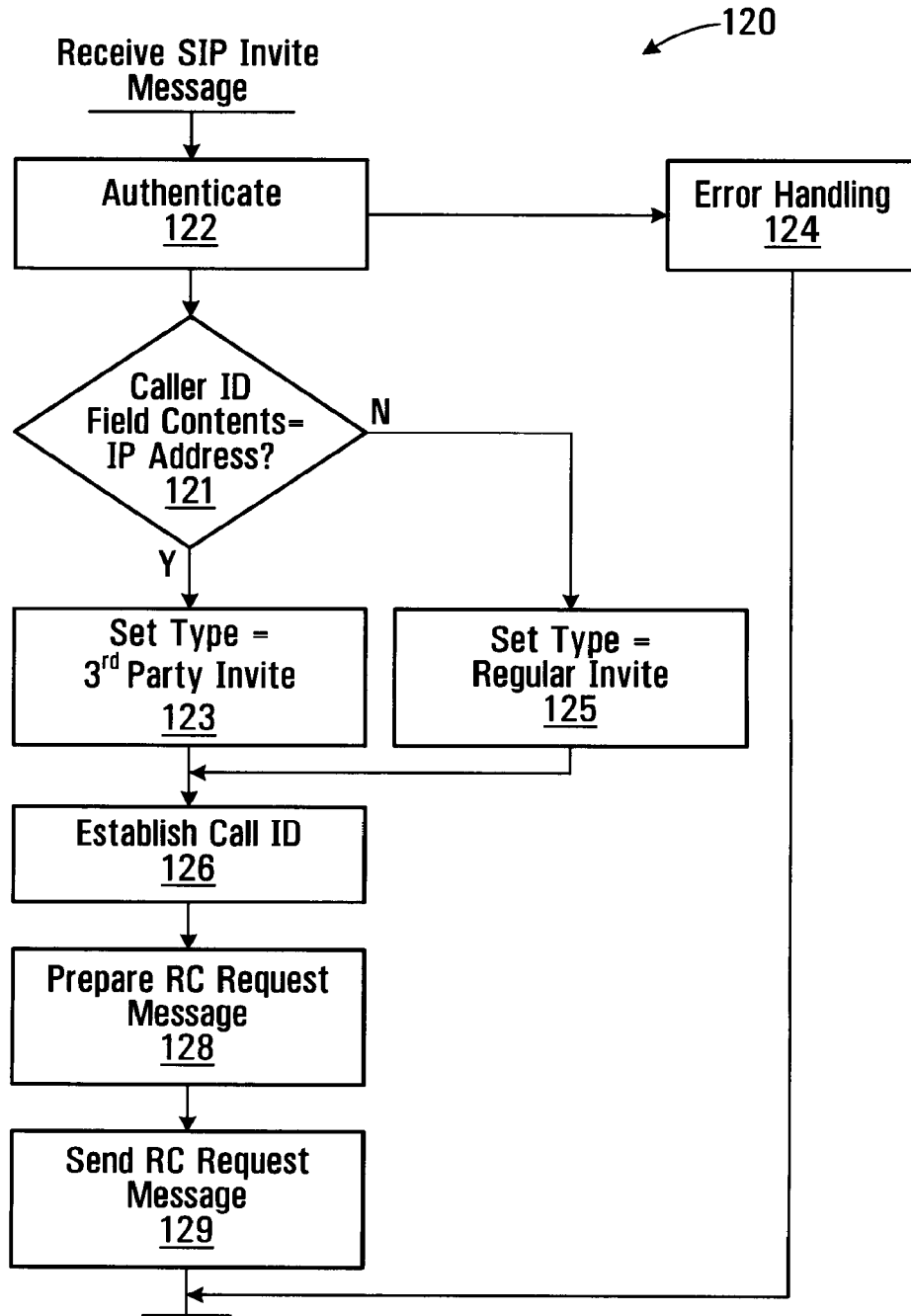

FIG. 5

150 ↙

RC Request Message

152 ~ Caller 2001 1050 8667
 154 ~ Callee 2001 1050 2222
 156 ~ Digest XXXXXXX
 158 ~ Call ID FF10@ 192.168.0.20
 160 ~ Type Subscriber

FIG. 6

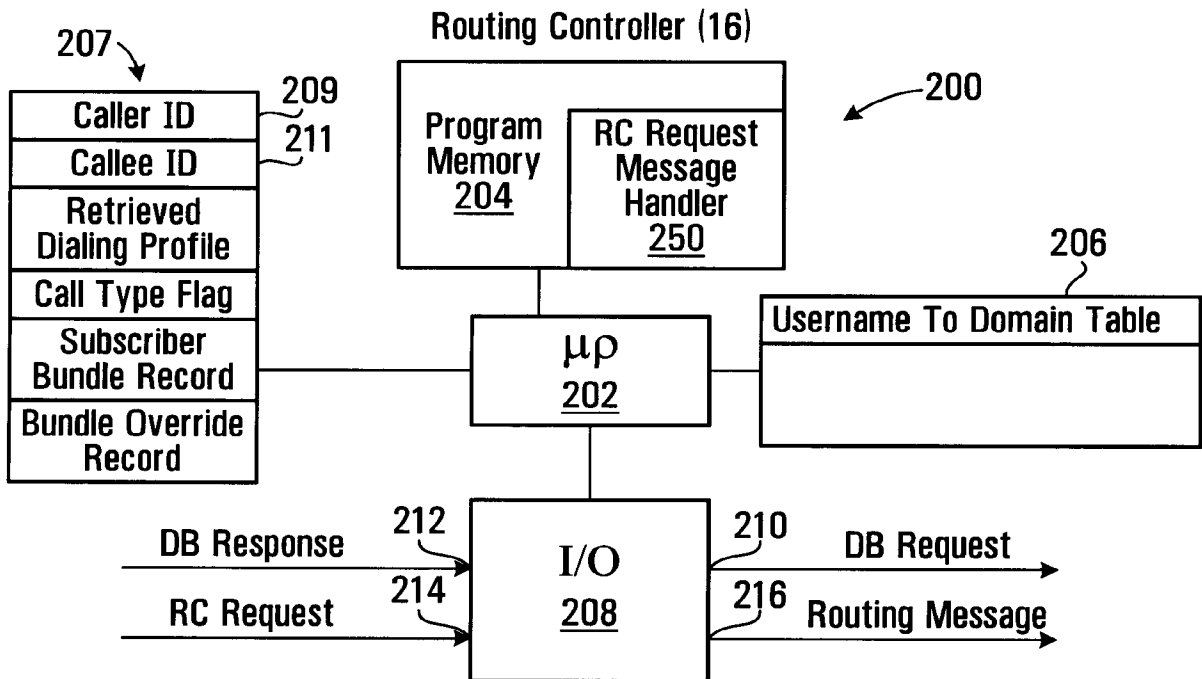

FIG. 7

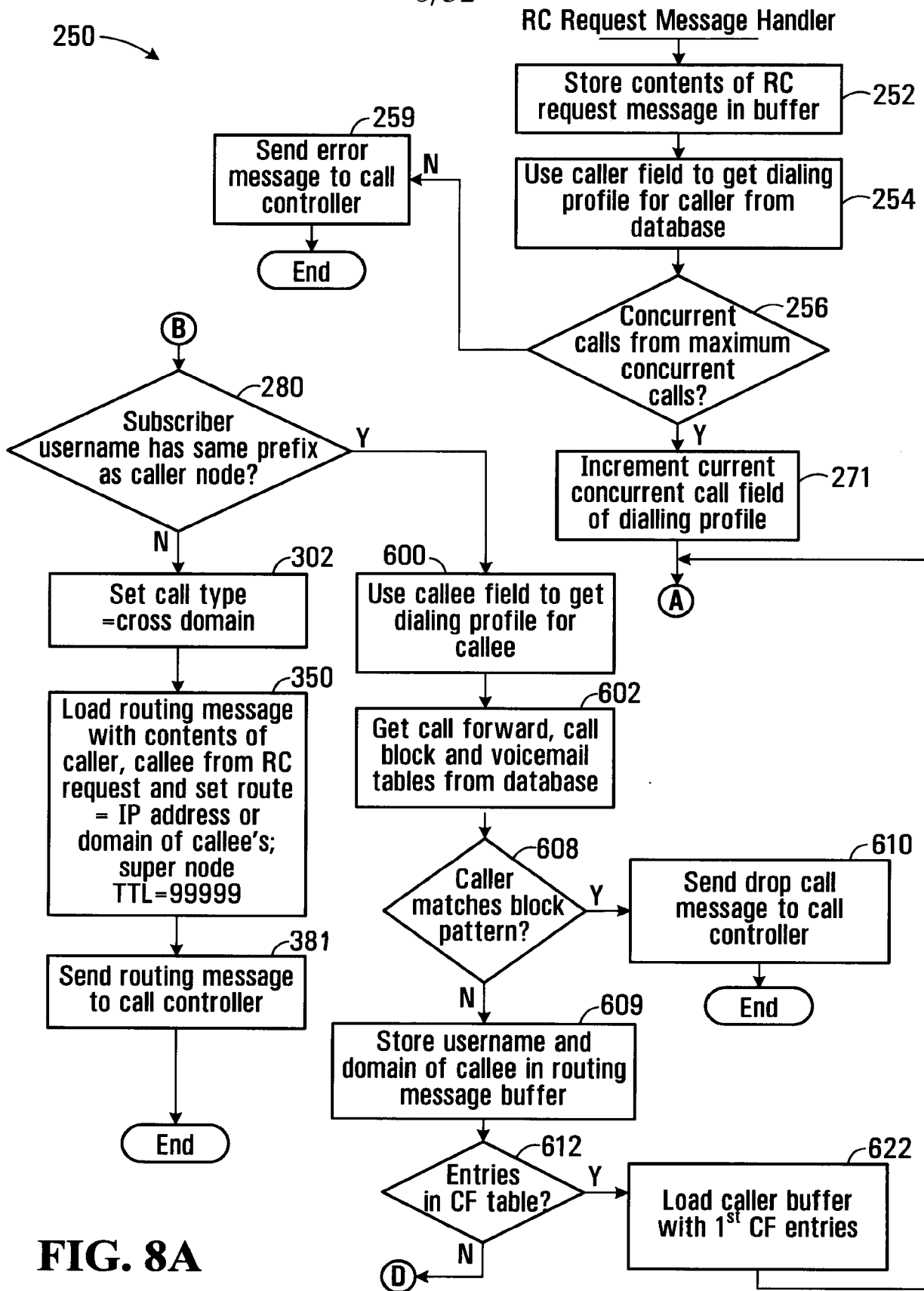

FIG. 8A

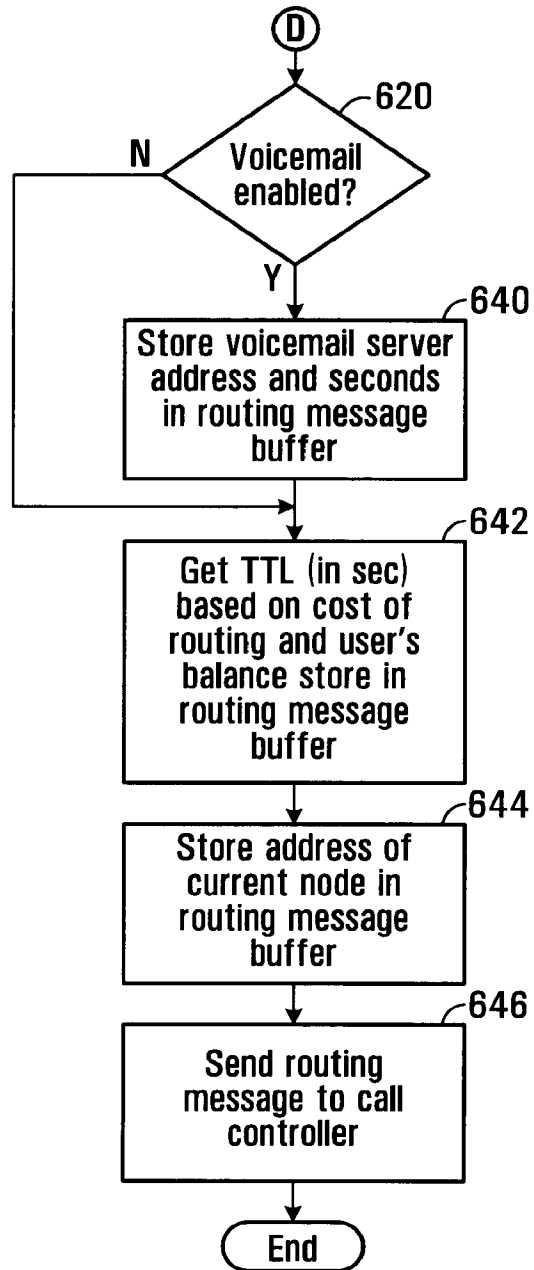

FIG. 8C

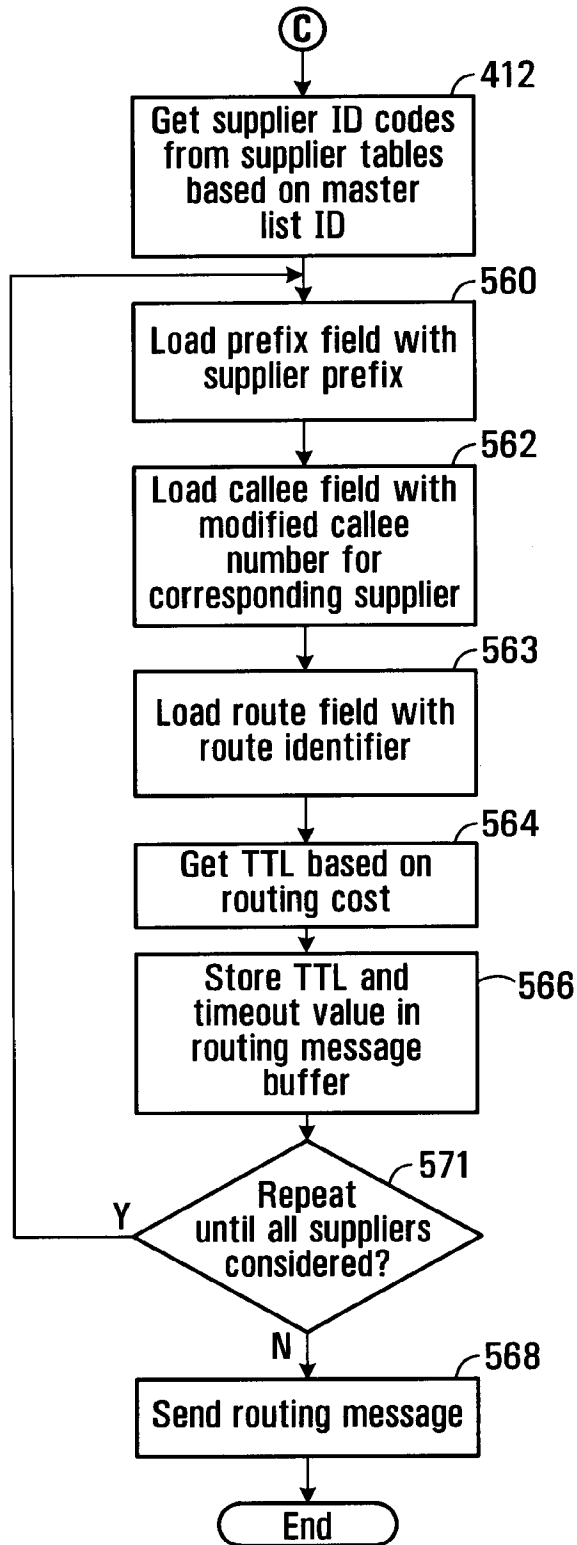

FIG. 8D

↖ 253

Dialing Profile for a User

258 ~ Username	Assigned on Subscription
260 ~ Domain	Domain Associated with User
262 ~ NDD	1
264 ~ IDD	011
266 ~ Country Code	1
267 ~ Local Area Codes	604;778
268 ~ Caller Minimum Local Length	10
270 ~ Caller Maximum Local Length	10
273 ~ Reseller	Retailer
275 ~ Maximum # of concurrent calls	Assigned on Subscription
277 ~ Current # of concurrent calls	Assigned on Subscription

FIG. 9

Dialing Profile for Caller (Vancouver Subscriber)

258 ~ Username	284	61	63	70	74	
260 ~ Domain	2001	1050	8667			↖ 276
262 ~ NDD	1	286	288	290		← 282
264 ~ IDD	011					
266 ~ Country Code	1					
267 ~ Local Area Codes	604;778 (Vancouver)					
268 ~ Caller Minimum Local Length	10					
270 ~ Caller Maximum Local Length	10					
273 ~ Reseller	Klondike					
275 ~ Maximum # of concurrent calls	5					
277 ~ Current # of concurrent calls	0					

FIG. 10

Callee Profile for Calgary Subscriber

Username	2001 1050 2222
Domain	sp.yvr.digifonica.com
NDD	1
IDD	011
Country Code	1
Local Area Codes	403 (Calgary)
Caller Minimum Local Length	7
Caller Maximum Local Length	10
Reseller	Deerfoot
Maximum # of concurrent calls	5
Current # of concurrent calls	0

FIG. 11

Callee Profile for London Subscriber

Username	4401 1062 4444
Domain	sp.lhr.digifonica.com
NDD	0
IDD	00
Country Code	44
Local Area Codes	20 (London)
Caller Minimum Local Length	10
Caller Maximum Local Length	11
Reseller	Marble Arch
Maximum # of concurrent calls	5
Current # of concurrent calls	0

FIG. 12

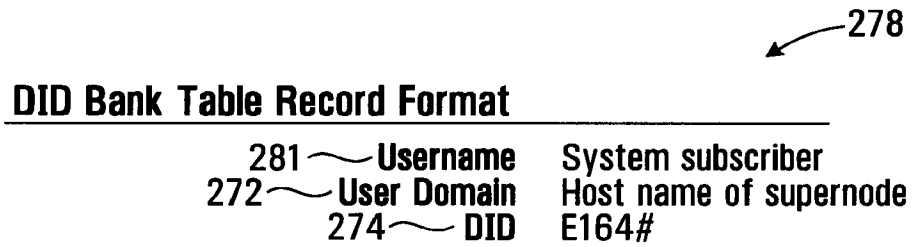

FIG. 13

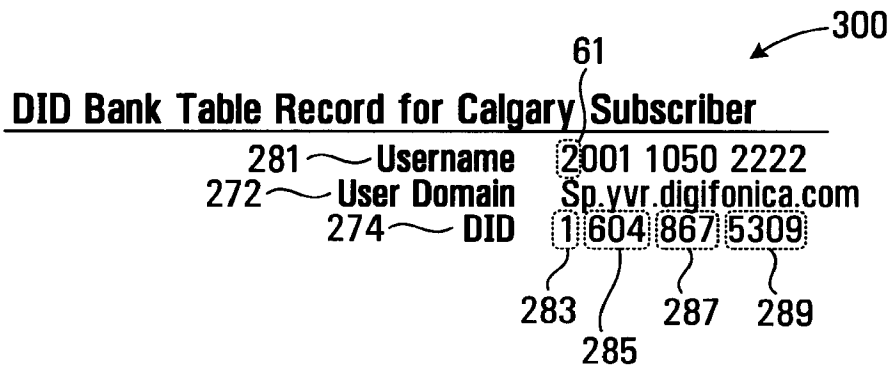

FIG. 14

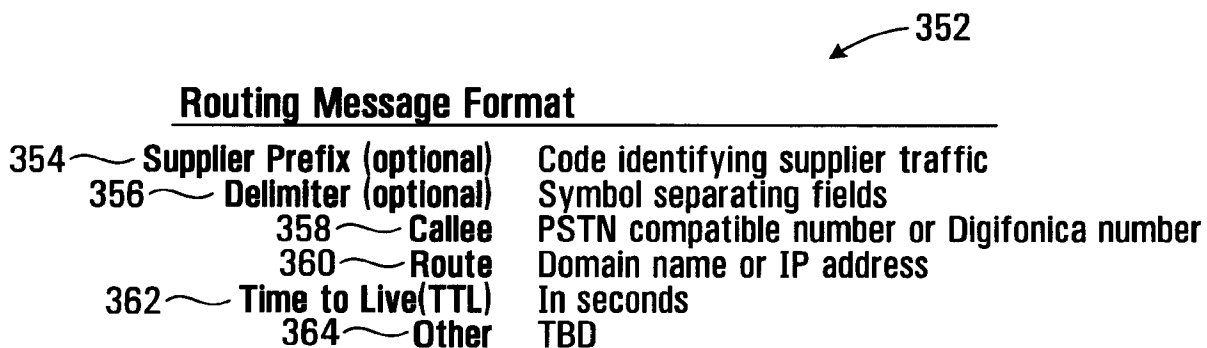

FIG. 15

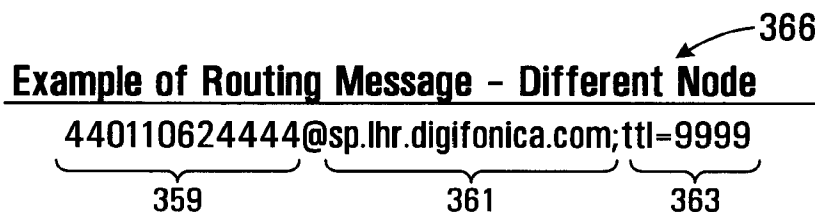

FIG. 16



FIG. 17



FIG. 18

Master List Record Format

500 ~	ml_id	Alphanumeric
502 ~	Dialing code	Number Sequence
504 ~	Country code	The country code is the national prefix to be used when dialing TO a particular country FROM another country.
506 ~	Nat Sign #(Area Code)	Number Sequence
508 ~	Min Length	Numeric
510 ~	Max Length	Numeric
512 ~	NDD	The NDD prefix is the access code used to make a call WITHIN that country from one city to another (when calling another city in the same vicinity, this may not be necessary).
514 ~	IDD	The IDD prefix is the international prefix needed to dial a call FROM the country listed TO another country.
516 ~	Buffer rate	Safe change rate above the highest rate charged by suppliers

FIG. 19

Example: Master List Record with Populated Fields

ml_id	1019
Dialing code	1604
Country code	1
Nat Sign #(Area Code)	604
Min Length	7
Max Length	7
NDD	1
IDD	011
Buffer rate	\$0.009/min

FIG. 20

Suppliers List Record Format

540 ~	Sup_id	Name code
542 ~	MI_id	Numeric code
544 ~	Prefix (optional)	String identifying supplier's traffic #
546 ~	Specific Route	IP address
548 ~	NDD/IDD rewrite	
550 ~	Rate	Cost per second to Digifonica to use this route
551 ~	Timeout	Maximum time to wait for a response when requesting this gateway

FIG. 21**Telus Supplier Record**

Sup_id	2010 (Telus)
MI_id	1019
Prefix (optional)	4973#
Specific Route	72.64.39.58
NDD/IDD rewrite	011
Rate	\$0.02/min
Timeout	20

FIG. 22**Shaw Supplier Record**

Sup_id	2011 (Shaw)
MI_id	1019
Prefix (optional)	4974#
Specific Route	73.65.40.59
NDD/IDD rewrite	011
Rate	\$0.025/min
Timeout	30

FIG. 23**Sprint Supplier Record**

Sup_id	2012 (Sprint)
MI_id	1019
Prefix (optional)	4975#
Specific Route	74.66.41.60
NDD/IDD rewrite	011
Rate	\$0.03/min
Timeout	40

FIG. 24

Routing Message Buffer for Gateway Call

4973#0116048675309@72.64.39.58;tll=3600;to=20 ~ 570
4974#0116048675309@73.65.40.59;tll=3600;to=30 ~ 572
4975#0116048675309@74.66.41.60;tll=3600;to=40 ~ 574

FIG. 25

Call Block Table Record Format

604 ~ Username Digifonica #
606 ~ Block Pattern PSTN compatible or Digifonica #

FIG. 26

Call Block Table Record for Calgary Callee

604 ~ Username of Callee 2001 1050 2222
606 ~ Block Pattern 2001 1050 8664

FIG. 27

Call Forwarding Table Record Format for Callee

614 ~ Username of Callee Digifonica #
616 ~ Destination Number Digifonica #
618 ~ Sequence Number Integer indicating order to try this

FIG. 28

Call Forwarding Table Record for Calgary Callee

614 ~ Username of Callee 2001 1050 2222
616 ~ Destination Number 2001 1055 2223
618 ~ Sequence Number 1

FIG. 29

Voicemail Table Record Format

624	Username of Callee	Digifonica #
626	Vm Server	domain name
628	Seconds to Voicemail	time to wait before engaging voicemail
630	Enabled	yes/no

FIG. 30

Voicemail Table Record for Calgary Callee

Username of Callee	2001 1050 2222
Vm Server	vm.yvr.digifonica.com
Seconds to Voicemail	20
Enabled	1

FIG. 31

Routing Message Buffer - Same Node

650	200110502222@sp.yvr.digifonica.com;ttl=3600
652	200110552223@sp.yvr.digifonica.com;ttl=3600
654	vm.yvr.digifonica.com;20;ttl=60
656	sp.yvr.digifonica.com

FIG. 32

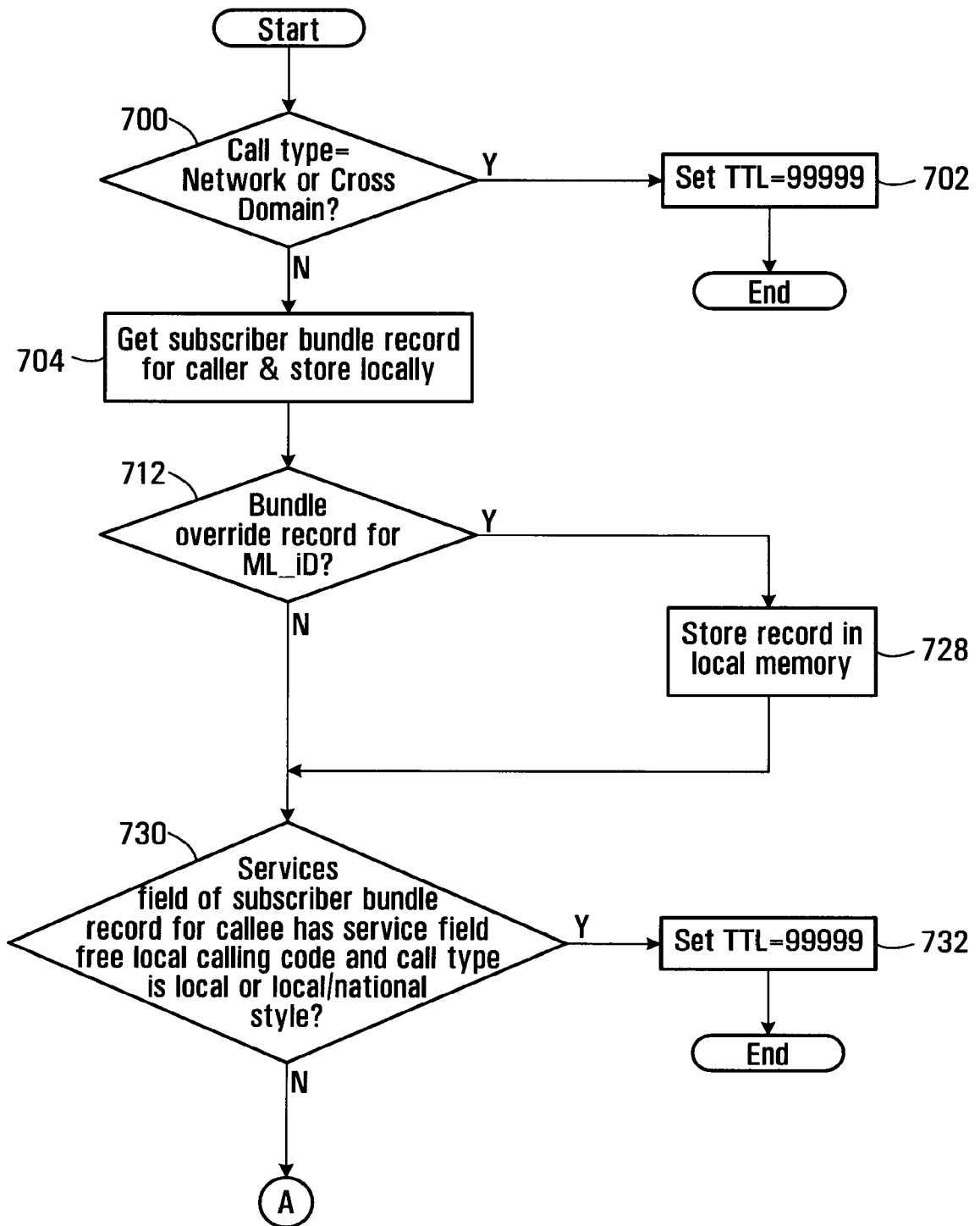

FIG. 33A

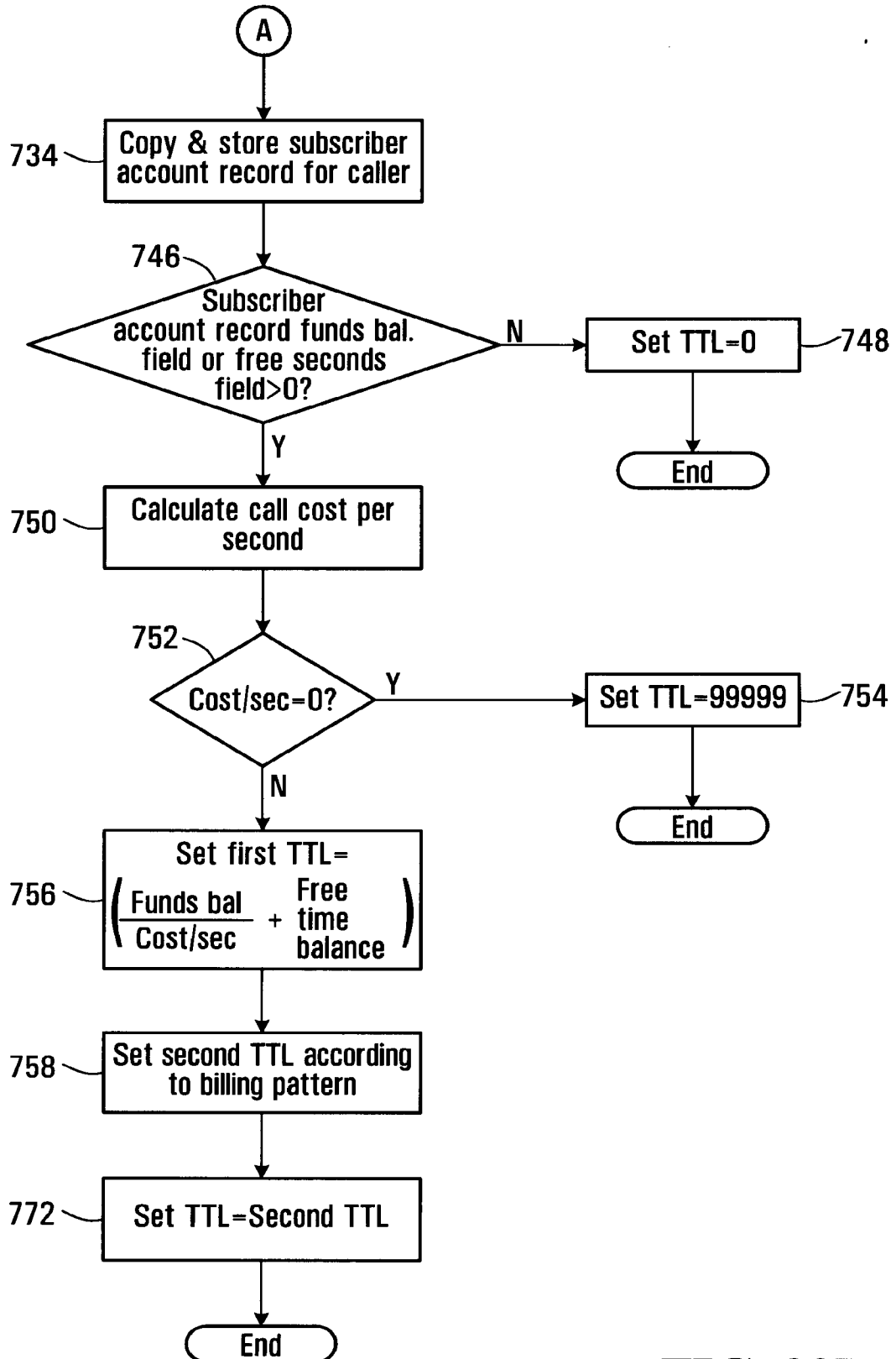

FIG. 33B

Subscriber Bundle Table Record

708 ~ Username Subscriber username
 710 ~ Services Codes identifying service features
 (e.g. Free local calling; call blocking, voicemail)

706

FIG. 34Subscriber Bundle Record for Vancouver Caller

708 ~ Username 2001 1050 8667
 710 ~ Services 10; 14; 16

FIG. 35Bundle Override Table Record

716 ~ ML_Id Master list ID code
 718 ~ Override type Fixed; percent; cents
 720 ~ Override value real number representing value of override type
 722 ~ Inc1 first level of charging (minimum # of seconds) charge
 724 ~ Inc2 second level of charging

714

FIG. 36Bundle Override Record for Located ML_id

716 ~ ML_Id 1019
 718 ~ Override type percent
 720 ~ Override value 10.0
 722 ~ Inc1 30 seconds
 724 ~ Inc2 6 seconds

726

FIG. 37

736 ↙

Subscriber Account Table Record

738 ~	Username	Subscriber username
740 ~	Funds balance	real number representing \$ value of credit
742 ~	Free time balance	integer representing # of free seconds

FIG. 38

744 ↙

Subscriber Account Record for Vancouver Caller

738 ~	Username	2001 1050 8667
740 ~	Funds balance	\$10.00
742 ~	Free time balance	100

FIG. 39

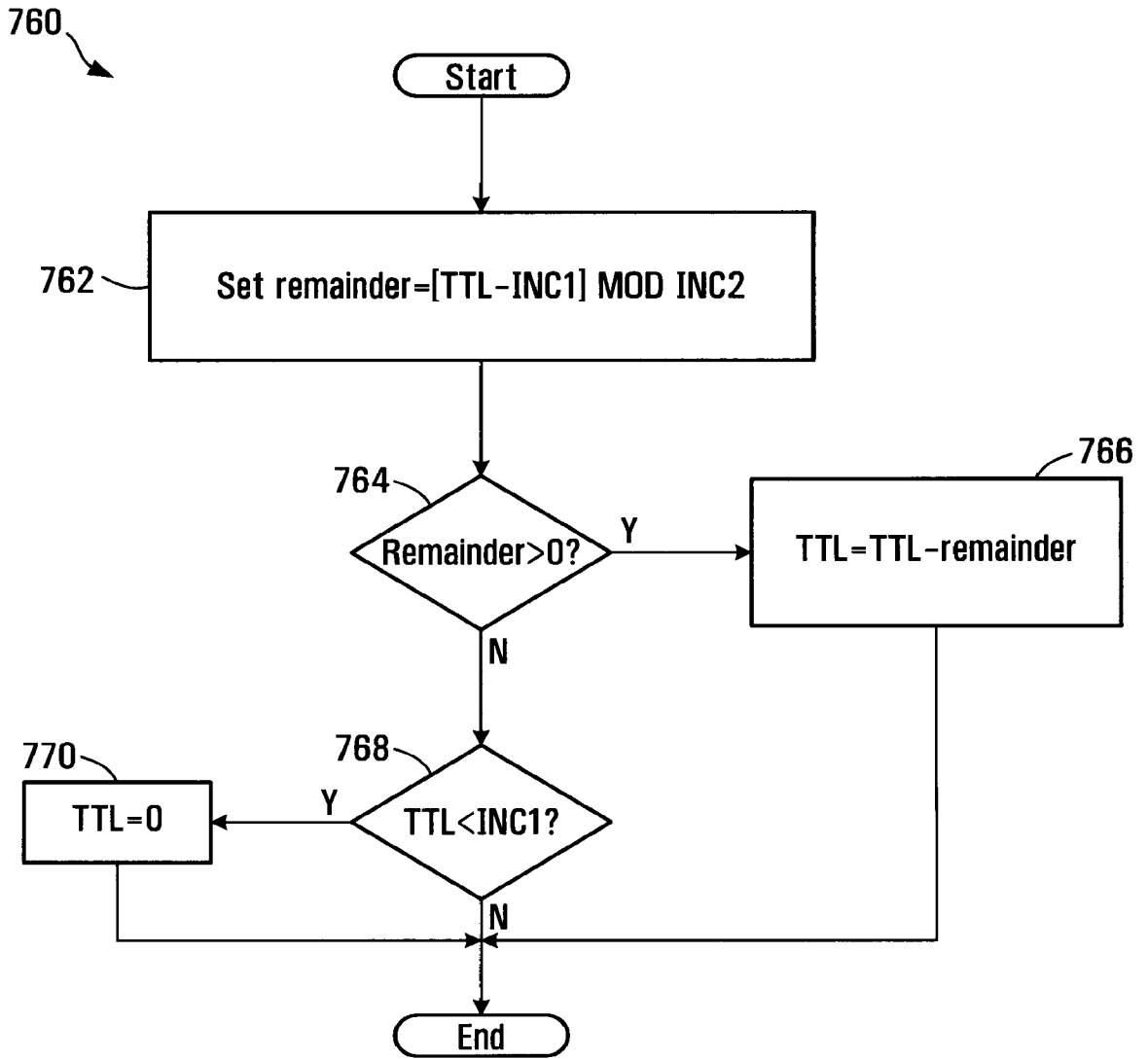

FIG. 40

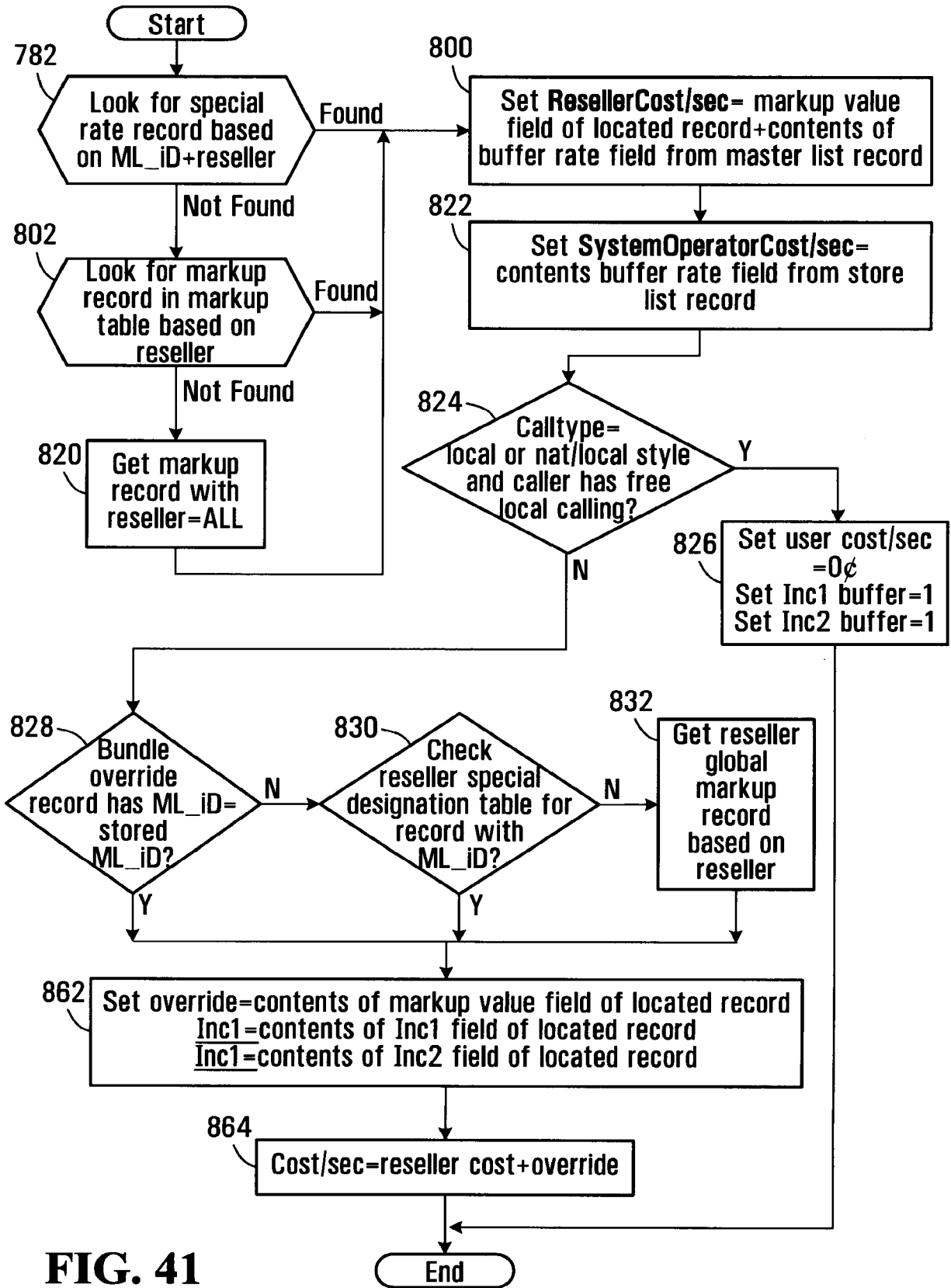

FIG. 41

System Operator Special Rates Table Record

786	Reseller	retailer id
788	ML_Id	master list id
790	Markup Table	fixed; percent; cents
792	Markup Value	real number representing value of markup type
794	Inc1	first level of charging (minimum # of seconds) charge
796	Inc2	second level of charging

FIG. 42

System Operator Special Rates Table Record for Klondike

786	Reseller	Klondike
788	ML_Id	1019
790	Markup Table	cents
792	Markup Value	\$0.001
794	Inc1	30
796	Inc2	6

FIG. 43

System Operator Markup Table Record

806	Reseller	reseller id code
808	Markup Table	fixed; percent; cents
810	Markup Value	real number representing value of markup type
812	Inc1	first level of charging (minimum # of seconds) charge
814	Inc2	second level of charging

804

FIG. 44**System Operator Markup Table Record for the Reseller Klondike**

806	Reseller	Klondike
808	Markup Table	cents
810	Markup Value	\$0.01
812	Inc1	30
814	Inc2	6

FIG. 45**System Operator Markup Table Record**

806	Reseller	all
808	Markup Table	percent
810	Markup Value	1.0
812	Inc1	30
814	Inc2	6

FIG. 46

Reseller Special Destinations Table Record

834	Reseller	reseller id code
836	ML_id	Master List ID code
838	Markup Table	fixed; percent; cents
840	Markup Value	real number representing value of markup type
842	Inc1	first level of charging (minimum # of seconds) charge
844	Inc2	second level of charging

FIG. 47Reseller Special Destinations Table Record for the Reseller Klondike

834	Reseller	Klondike
836	ML_id	1019
838	Markup Table	percent
840	Markup Value	5%
842	Inc1	30
844	Inc2	6

FIG. 48Reseller Global Markup Table Record

850	Reseller	reseller id code
852	Markup Table	fixed; percent; cents
854	Markup Value	real number representing value of markup type
856	Inc1	first level of charging (minimum # of seconds) charge
858	Inc2	second level of charging

FIG. 49Reseller Global Markup Table Record for the Reseller Klondike

850	Reseller	Klondike
852	Markup Table	percent
854	Markup Value	10%
856	Inc1	30
858	Inc2	6

FIG. 50

900

SIP Bye Message

902 ~	Caller	Username
904 ~	Callee	PSTN compatible # or Username
906 ~	Call ID	unique call identifier (hexadecimal string@IP)

FIG. 51

908

SIP Bye Message

902 ~	Caller	2001 1050 8667
904 ~	Callee	2001 1050 2222
906 ~	Call ID	<u>FA10@192.168.0.20</u>

FIG. 52

910 ↘

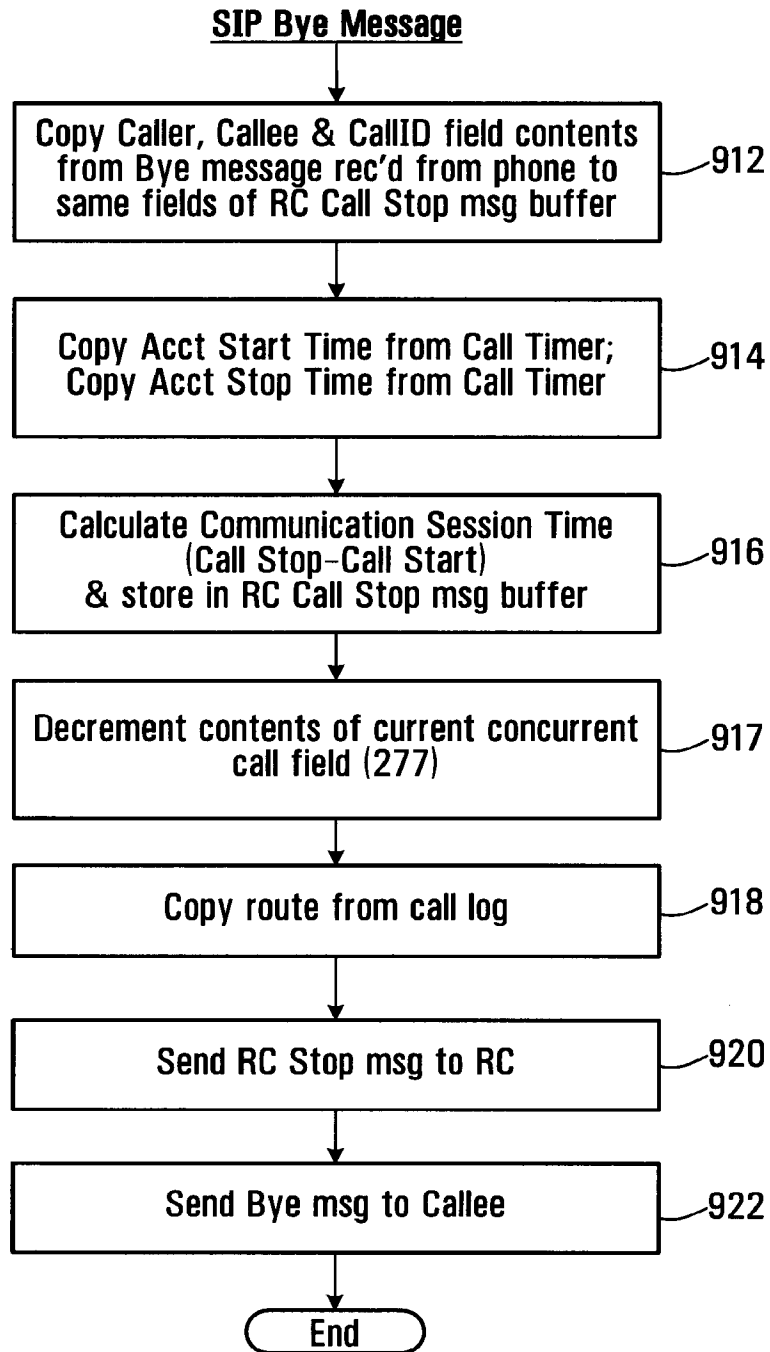

FIG. 53

1000
↙

RC Call Stop Message

1002	Caller	Username
1004	Callee	PSTN compatible # or Username
1006	Call ID	unique call identifier (hexadecimal string@IP)
1008	Acct Start Time	start time of call
1010	Acct Stop Time	time the call ended
1012	Acct Session Time	start time-stop time (in seconds)
1014	Route	IP address for the communications link that was established

FIG. 54

1020
↙

RC Call Stop Message for Calgary Callee

1002	Caller	2001 1050 8667
1004	Callee	2001 1050 2222
1006	Call ID	FA10@192.168.0.20
1008	Acct Start Time	2006-12-30 12:12:12
1010	Acct Stop Time	2006-12-30 12:12:14
1012	Acct Session Time	2
1014	Route	72.64.39.58

FIG. 55

950 ↘

30/32

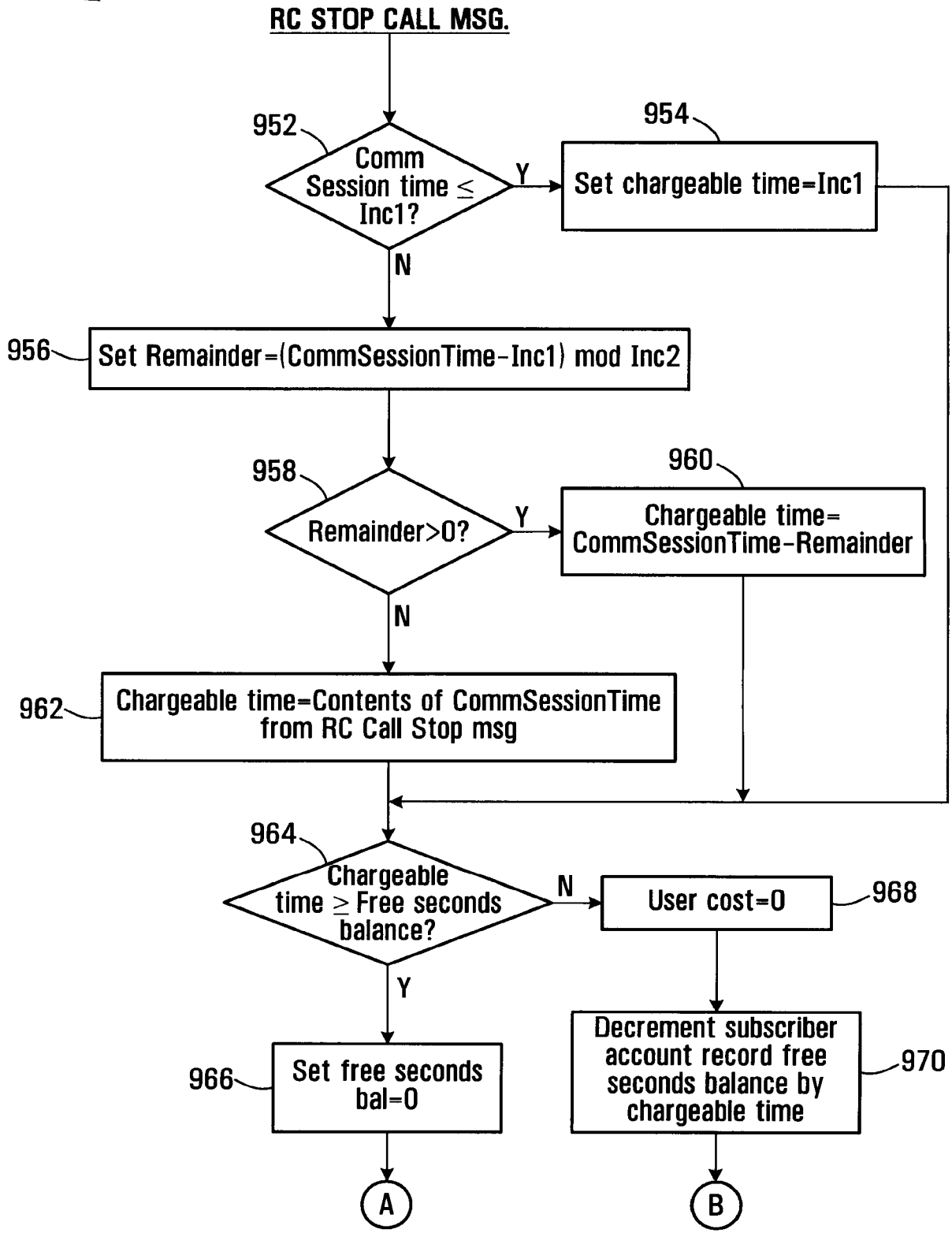

FIG. 56A

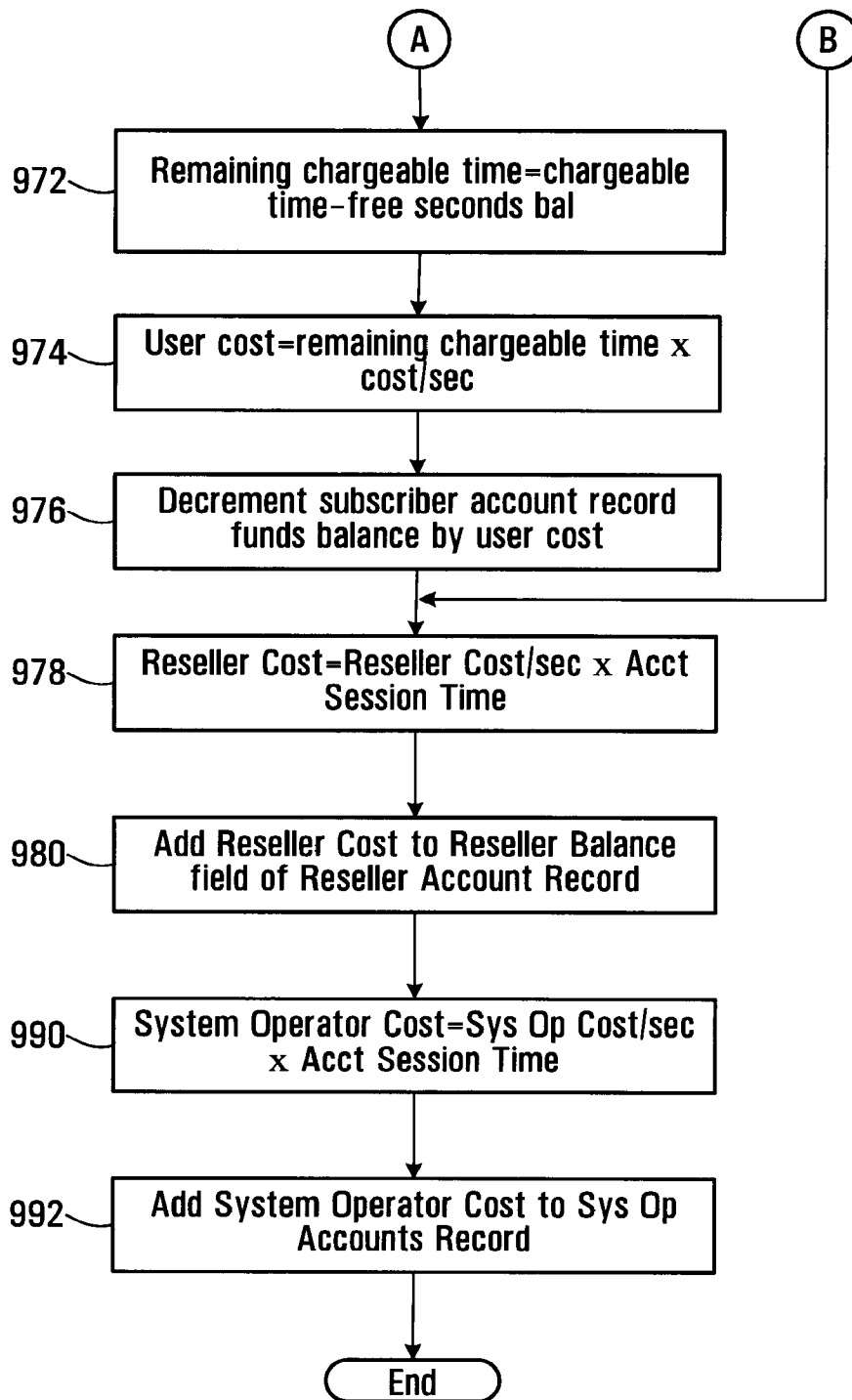

FIG. 56B

Reseller Accounts Table Record

984 ~	Reseller ID	reseller id code
986 ~	Reseller balance	accumulated balance of charges

982

FIG. 57Reseller Accounts Table Record for Klondike

984 ~	Reseller ID	Klondike
986 ~	Reseller balance	\$100.02

988

FIG. 58System Operator Accounts Table Record

996 ~	System Operator balance	accumulated balance of charges
-------	-------------------------	--------------------------------

994

FIG. 59System Operator Accounts Record for this System Operator

996 ~	System Operator balance	\$1000.02
-------	-------------------------	-----------

FIG. 60

Electronic Patent Application Fee Transmittal

Application Number:				
Filing Date:				
Title of Invention:	PRODUCING ROUTING MESSAGES FOR VOICE OVER IP COMMUNICATIONS			
First Named Inventor/Applicant Name:	CLAY PERRAULT			
Filer:	John M Carson/Catherine Tolo			
Attorney Docket Number:	SMARB19.001C1			
Filed as Small Entity				
Utility under 35 USC 111(a) Filing Fees				
Description	Fee Code	Quantity	Amount	Sub-Total in USD(\$)
Basic Filing:				
Utility filing Fee (Electronic filing)	4011	1	70	70
Utility Search Fee	2111	1	300	300
Utility Examination Fee	2311	1	360	360
Pages:				
Claims:				
Claims in excess of 20	2202	58	40	2320
Independent Claims in Excess of 3	2201	3	210	630
Miscellaneous-Filing:				

Description	Fee Code	Quantity	Amount	Sub-Total in USD(\$)
Late Filing Fee for Oath or Declaration	2051	1	70	70
Petition:				
Patent-Appeals-and-Interference:				
Post-Allowance-and-Post-Issuance:				
Extension-of-Time:				
Miscellaneous:				
Total in USD (\$)				3750

Electronic Acknowledgement Receipt

EFS ID:	16580231
Application Number:	13966096
International Application Number:	
Confirmation Number:	8712
Title of Invention:	PRODUCING ROUTING MESSAGES FOR VOICE OVER IP COMMUNICATIONS
First Named Inventor/Applicant Name:	CLAY PERRAULT
Customer Number:	20995
Filer:	John M Carson/Kevin Kraus
Filer Authorized By:	John M Carson
Attorney Docket Number:	SMARB19.001C1
Receipt Date:	13-AUG-2013
Filing Date:	
Time Stamp:	18:52:42
Application Type:	Utility under 35 USC 111(a)

Payment information:

Submitted with Payment	yes
Payment Type	Credit Card
Payment was successfully received in RAM	\$3750
RAM confirmation Number	5910
Deposit Account	
Authorized User	

File Listing:

Document Number	Document Description	File Name	File Size(Bytes)/ Message Digest	Multi Part /.zip	Pages (if appl.)
-----------------	----------------------	-----------	-------------------------------------	------------------	------------------

1	Application Data Sheet	SMARB19_001C1_ads.pdf	385933 2c17a3311de5605420618372204d08da6ba 26f9a	no	7
Warnings:					
Information:					
This is not an USPTO supplied ADS fillable form					
2		SMARB19_001C1_spec.pdf	253628 0213bf77a1f8a2306bbac38eba165201f99c 61d1	yes	75
	Multipart Description/PDF files in .zip description				
	Document Description		Start	End	
	Specification		1	58	
	Claims		59	74	
	Abstract		75	75	
Warnings:					
Information:					
3	Drawings-only black and white line drawings	SMARB19_001C1_figs.pdf	570200 8cd3df34f363e00fc00c9015df0727c0b902 3b28	no	32
Warnings:					
Information:					
4	Fee Worksheet (SB06)	fee-info.pdf	39790 c47b3e9ed064bdab250f8e35b4ca7dc6a53 b8d71	no	2
Warnings:					
Information:					
Total Files Size (in bytes):			1249551		

This Acknowledgement Receipt evidences receipt on the noted date by the USPTO of the indicated documents, characterized by the applicant, and including page counts, where applicable. It serves as evidence of receipt similar to a Post Card, as described in MPEP 503.

New Applications Under 35 U.S.C. 111

If a new application is being filed and the application includes the necessary components for a filing date (see 37 CFR 1.53(b)-(d) and MPEP 506), a Filing Receipt (37 CFR 1.54) will be issued in due course and the date shown on this Acknowledgement Receipt will establish the filing date of the application.

National Stage of an International Application under 35 U.S.C. 371

If a timely submission to enter the national stage of an international application is compliant with the conditions of 35 U.S.C. 371 and other applicable requirements a Form PCT/DO/EO/903 indicating acceptance of the application as a national stage submission under 35 U.S.C. 371 will be issued in addition to the Filing Receipt, in due course.

New International Application Filed with the USPTO as a Receiving Office

If a new international application is being filed and the international application includes the necessary components for an international filing date (see PCT Article 11 and MPEP 1810), a Notification of the International Application Number and of the International Filing Date (Form PCT/RO/105) will be issued in due course, subject to prescriptions concerning national security, and the date shown on this Acknowledgement Receipt will establish the international filing date of the application.

PATENT APPLICATION FEE DETERMINATION RECORD

Substitute for Form PTO-875

Application or Docket Number
13/966,096

APPLICATION AS FILED - PART I

(Column 1) (Column 2)

FOR	NUMBER FILED	NUMBER EXTRA
BASIC FEE (37 CFR 1.16(a), (b), or (c))	N/A	N/A
SEARCH FEE (37 CFR 1.16(k), (l), or (m))	N/A	N/A
EXAMINATION FEE (37 CFR 1.16(o), (p), or (q))	N/A	N/A
TOTAL CLAIMS (37 CFR 1.16(j))	78 minus 20 = *	58
INDEPENDENT CLAIMS (37 CFR 1.16(h))	6 minus 3 = *	3
APPLICATION SIZE FEE (37 CFR 1.16(s))	If the specification and drawings exceed 100 sheets of paper, the application size fee due is \$310 (\$155 for small entity) for each additional 50 sheets or fraction thereof. See 35 U.S.C. 41(a)(1)(G) and 37 CFR 1.16(s).	
MULTIPLE DEPENDENT CLAIM PRESENT (37 CFR 1.16(j))		

* If the difference in column 1 is less than zero, enter "0" in column 2.

SMALL ENTITY

RATE(\$)	FEE(\$)
N/A	70
N/A	300
N/A	360
x 40 =	2320
x 210 =	630
	0.00
	0.00
TOTAL	3680

OTHER THAN SMALL ENTITY

RATE(\$)	FEE(\$)
N/A	
N/A	
N/A	
TOTAL	

APPLICATION AS AMENDED - PART II

(Column 1) (Column 2) (Column 3)

AMENDMENT A		CLAIMS REMAINING AFTER AMENDMENT		HIGHEST NUMBER PREVIOUSLY PAID FOR	PRESENT EXTRA
	Total (37 CFR 1.16(i))	*	Minus	**	=
	Independent (37 CFR 1.16(h))	*	Minus	***	=
	Application Size Fee (37 CFR 1.16(s))				
FIRST PRESENTATION OF MULTIPLE DEPENDENT CLAIM (37 CFR 1.16(j))					

SMALL ENTITY

RATE(\$)	ADDITIONAL FEE(\$)
x =	
x =	
TOTAL ADD'L FEE	

OTHER THAN SMALL ENTITY

RATE(\$)	ADDITIONAL FEE(\$)
x =	
x =	
TOTAL ADD'L FEE	

(Column 1) (Column 2) (Column 3)

AMENDMENT B		CLAIMS REMAINING AFTER AMENDMENT		HIGHEST NUMBER PREVIOUSLY PAID FOR	PRESENT EXTRA
	Total (37 CFR 1.16(i))	*	Minus	**	=
	Independent (37 CFR 1.16(h))	*	Minus	***	=
	Application Size Fee (37 CFR 1.16(s))				
FIRST PRESENTATION OF MULTIPLE DEPENDENT CLAIM (37 CFR 1.16(j))					

RATE(\$)	ADDITIONAL FEE(\$)
x =	
x =	
TOTAL ADD'L FEE	

RATE(\$)	ADDITIONAL FEE(\$)
x =	
x =	
TOTAL ADD'L FEE	

* If the entry in column 1 is less than the entry in column 2, write "0" in column 3.

** If the "Highest Number Previously Paid For" IN THIS SPACE is less than 20, enter "20".

*** If the "Highest Number Previously Paid For" IN THIS SPACE is less than 3, enter "3".

The "Highest Number Previously Paid For" (Total or Independent) is the highest found in the appropriate box in column 1.



UNITED STATES PATENT AND TRADEMARK OFFICE

UNITED STATES DEPARTMENT OF COMMERCE
United States Patent and Trademark Office
Address: COMMISSIONER FOR PATENTS
P.O. Box 1450
Alexandria, Virginia 22313-1450
www.uspto.gov

Table with 6 columns: APPLICATION NUMBER, FILING or 371(c) DATE, GRP ART UNIT, FIL FEE REC'D, ATTY. DOCKET NO, TOT CLAIMS, IND CLAIMS. Row 1: 13/966,096, 08/13/2013, 2653, 3750, SMARB19.001C1, 78, 6

CONFIRMATION NO. 8712

20995
KNOBBE MARTENS OLSON & BEAR LLP
2040 MAIN STREET
FOURTEENTH FLOOR
IRVINE, CA 92614

FILING RECEIPT



Date Mailed: 09/05/2013

Receipt is acknowledged of this non-provisional patent application. The application will be taken up for examination in due course. Applicant will be notified as to the results of the examination. Any correspondence concerning the application must include the following identification information: the U.S. APPLICATION NUMBER, FILING DATE, NAME OF APPLICANT, and TITLE OF INVENTION. Fees transmitted by check or draft are subject to collection. Please verify the accuracy of the data presented on this receipt. If an error is noted on this Filing Receipt, please submit a written request for a Filing Receipt Correction. Please provide a copy of this Filing Receipt with the changes noted thereon. If you received a "Notice to File Missing Parts" for this application, please submit any corrections to this Filing Receipt with your reply to the Notice. When the USPTO processes the reply to the Notice, the USPTO will generate another Filing Receipt incorporating the requested corrections

Inventor(s)

CLAY PERRAULT, Panama City, PANAMA;
STEVE NICHOLSON, Hamilton, NEW ZEALAND;
ROD THOMSON, North Vancouver, CANADA;
JOHAN EMIL VIKTOR BJÖRSELL, Vancouver, CANADA;
FUAD ARAFA, Vancouver, CANADA;

Applicant(s)

Digifonica (INTERNATIONAL) Limited, Vancouver, CANADA

Assignment For Published Patent Application

Digifonica (INTERNATIONAL) Limited, Vancouver, CANADA

Power of Attorney: None

Domestic Priority data as claimed by applicant

This application is a CON of 12/513,147 03/01/2010 PAT 8542815
which is a 371 of PCT/CA07/01956 11/01/2007
which claims benefit of 60/856,212 11/02/2006

Foreign Applications for which priority is claimed (You may be eligible to benefit from the Patent Prosecution Highway program at the USPTO. Please see http://www.uspto.gov for more information.) - None.

Foreign application information must be provided in an Application Data Sheet in order to constitute a claim to foreign priority. See 37 CFR 1.55 and 1.76.

Permission to Access - A proper Authorization to Permit Access to Application by Participating Offices (PTO/SB/39 or its equivalent) has been received by the USPTO.

If Required, Foreign Filing License Granted: 08/28/2013

The country code and number of your priority application, to be used for filing abroad under the Paris Convention, is **US 13/966,096**

Projected Publication Date: 12/12/2013

Non-Publication Request: No

Early Publication Request: No

**** SMALL ENTITY ****

Title

PRODUCING ROUTING MESSAGES FOR VOICE OVER IP COMMUNICATIONS

Preliminary Class

379

Statement under 37 CFR 1.55 or 1.78 for AIA (First Inventor to File) Transition Applications: No

PROTECTING YOUR INVENTION OUTSIDE THE UNITED STATES

Since the rights granted by a U.S. patent extend only throughout the territory of the United States and have no effect in a foreign country, an inventor who wishes patent protection in another country must apply for a patent in a specific country or in regional patent offices. Applicants may wish to consider the filing of an international application under the Patent Cooperation Treaty (PCT). An international (PCT) application generally has the same effect as a regular national patent application in each PCT-member country. The PCT process **simplifies** the filing of patent applications on the same invention in member countries, but **does not result** in a grant of "an international patent" and does not eliminate the need of applicants to file additional documents and fees in countries where patent protection is desired.

Almost every country has its own patent law, and a person desiring a patent in a particular country must make an application for patent in that country in accordance with its particular laws. Since the laws of many countries differ in various respects from the patent law of the United States, applicants are advised to seek guidance from specific foreign countries to ensure that patent rights are not lost prematurely.

Applicants also are advised that in the case of inventions made in the United States, the Director of the USPTO must issue a license before applicants can apply for a patent in a foreign country. The filing of a U.S. patent application serves as a request for a foreign filing license. The application's filing receipt contains further information and guidance as to the status of applicant's license for foreign filing.

Applicants may wish to consult the USPTO booklet, "General Information Concerning Patents" (specifically, the section entitled "Treaties and Foreign Patents") for more information on timeframes and deadlines for filing foreign patent applications. The guide is available either by contacting the USPTO Contact Center at 800-786-9199, or it can be viewed on the USPTO website at <http://www.uspto.gov/web/offices/pac/doc/general/index.html>.

For information on preventing theft of your intellectual property (patents, trademarks and copyrights), you may wish to consult the U.S. Government website, <http://www.stopfakes.gov>. Part of a Department of Commerce initiative, this website includes self-help "toolkits" giving innovators guidance on how to protect intellectual property in specific countries such as China, Korea and Mexico. For questions regarding patent enforcement issues, applicants may call the U.S. Government hotline at 1-866-999-HALT (1-866-999-4258).

LICENSE FOR FOREIGN FILING UNDER
Title 35, United States Code, Section 184
Title 37, Code of Federal Regulations, 5.11 & 5.15

GRANTED

The applicant has been granted a license under 35 U.S.C. 184, if the phrase "IF REQUIRED, FOREIGN FILING LICENSE GRANTED" followed by a date appears on this form. Such licenses are issued in all applications where the conditions for issuance of a license have been met, regardless of whether or not a license may be required as set forth in 37 CFR 5.15. The scope and limitations of this license are set forth in 37 CFR 5.15(a) unless an earlier license has been issued under 37 CFR 5.15(b). The license is subject to revocation upon written notification. The date indicated is the effective date of the license, unless an earlier license of similar scope has been granted under 37 CFR 5.13 or 5.14.

This license is to be retained by the licensee and may be used at any time on or after the effective date thereof unless it is revoked. This license is automatically transferred to any related applications(s) filed under 37 CFR 1.53(d). This license is not retroactive.

The grant of a license does not in any way lessen the responsibility of a licensee for the security of the subject matter as imposed by any Government contract or the provisions of existing laws relating to espionage and the national security or the export of technical data. Licensees should apprise themselves of current regulations especially with respect to certain countries, of other agencies, particularly the Office of Defense Trade Controls, Department of State (with respect to Arms, Munitions and Implements of War (22 CFR 121-128)); the Bureau of Industry and Security, Department of Commerce (15 CFR parts 730-774); the Office of Foreign Assets Control, Department of Treasury (31 CFR Parts 500+) and the Department of Energy.

NOT GRANTED

No license under 35 U.S.C. 184 has been granted at this time, if the phrase "IF REQUIRED, FOREIGN FILING LICENSE GRANTED" DOES NOT appear on this form. Applicant may still petition for a license under 37 CFR 5.12, if a license is desired before the expiration of 6 months from the filing date of the application. If 6 months has lapsed from the filing date of this application and the licensee has not received any indication of a secrecy order under 35 U.S.C. 181, the licensee may foreign file the application pursuant to 37 CFR 5.15(b).

SelectUSA

The United States represents the largest, most dynamic marketplace in the world and is an unparalleled location for business investment, innovation, and commercialization of new technologies. The U.S. offers tremendous resources and advantages for those who invest and manufacture goods here. Through SelectUSA, our nation works to promote and facilitate business investment. SelectUSA provides information assistance to the international investor community; serves as an ombudsman for existing and potential investors; advocates on behalf of U.S. cities, states, and regions competing for global investment; and counsels U.S. economic development organizations on investment attraction best practices. To learn more about why the United States is the best country in the world to develop technology, manufacture products, deliver services, and grow your business, visit <http://www.SelectUSA.gov> or call +1-202-482-6800.



UNITED STATES PATENT AND TRADEMARK OFFICE

UNITED STATES DEPARTMENT OF COMMERCE
United States Patent and Trademark Office
Address: COMMISSIONER FOR PATENTS
P.O. Box 1450
Alexandria, Virginia 22313-1450
www.uspto.gov

Table with 4 columns: APPLICATION NUMBER (13/966,096), FILING OR 371(C) DATE (08/13/2013), FIRST NAMED APPLICANT (CLAY PERRAULT), ATTY. DOCKET NO./TITLE (SMARB19.001C1)

CONFIRMATION NO. 8712

20995
KNOBBE MARTENS OLSON & BEAR LLP
2040 MAIN STREET
FOURTEENTH FLOOR
IRVINE, CA 92614

NOTICE



Date Mailed: 09/05/2013

INFORMATIONAL NOTICE TO APPLICANT

Applicant is notified that the above-identified application contains the deficiencies noted below. No period for reply is set forth in this notice for correction of these deficiencies. However, if a deficiency relates to the inventor's oath or declaration, the applicant must file an oath or declaration in compliance with 37 CFR 1.63, or a substitute statement in compliance with 37 CFR 1.64, executed by or with respect to each actual inventor no later than the expiration of the time period set in the "Notice of Allowability" to avoid abandonment. See 37 CFR 1.53(f).

The item(s) indicated below are also required and should be submitted with any reply to this notice to avoid further processing delays.

- A properly executed inventor's oath or declaration has not been received for the following inventor(s):

CLAY PERRAULT
STEVE NICHOLSON
ROD THOMSON
JOHAN EMIL VIKTOR BJÖRSELL
FUAD ARAFA

Applicant may submit the inventor's oath or declaration at any time before the Notice of Allowance and Fee(s) Due, PTOL-85, is mailed.

Please Direct All Correspondence to Customer Number 20995

RESCISSION OF ANY PRIOR DISCLAIMERS AND REQUEST TO REVISIT ART

Inventor	: Clay Perrault et al.
App. No.	: 13/966,096
Filed	: August 13, 2013
For	: PRODUCING ROUTING MESSAGES FOR VOICE OVER IP COMMUNICATIONS
Examiner	: Unknown
Art Unit	: 2465
Conf. No.	: 8712

Commissioner for Patents
P.O. Box 1450
Alexandria, VA 22313-1450

Dear Sir:

The claims of the present application are different and possibly broader in scope than the claims pursued in the parent application(s). To the extent any prior amendments or characterizations of the scope of any claim or referenced art could be construed as a disclaimer of any subject matter supported by the present disclosure, Applicant hereby rescinds and retracts such disclaimer. Accordingly, the references previously considered in the parent application(s) may need to be re-visited.

Please charge any additional fees, including any fees for additional extension of time, or credit overpayment to Deposit Account No. 11-1410.

Knobbe, Martens, Olson & Bear, LLP

Respectfully submitted,



John M. Carson
Registration No. 34,303
Attorney of Record
Customer No. 20995
(858) 707-4000

Dated: 9/12/13

Electronic Acknowledgement Receipt

EFS ID:	16839909
Application Number:	13966096
International Application Number:	
Confirmation Number:	8712
Title of Invention:	PRODUCING ROUTING MESSAGES FOR VOICE OVER IP COMMUNICATIONS
First Named Inventor/Applicant Name:	CLAY PERRAULT
Customer Number:	20995
Filer:	John M Carson/Tony Do
Filer Authorized By:	John M Carson
Attorney Docket Number:	SMARB19.001C1
Receipt Date:	12-SEP-2013
Filing Date:	13-AUG-2013
Time Stamp:	17:06:31
Application Type:	Utility under 35 USC 111(a)

Payment information:

Submitted with Payment	no
------------------------	----

File Listing:

Document Number	Document Description	File Name	File Size(Bytes)/ Message Digest	Multi Part /.zip	Pages (if appl.)
1	Miscellaneous Incoming Letter	SMARB19001C1rescission.pdf	39927 <small>74ccd864aa53e9d79661ee9bffd18c8d5e9b8b4</small>	no	1

Warnings:

Information:

This Acknowledgement Receipt evidences receipt on the noted date by the USPTO of the indicated documents, characterized by the applicant, and including page counts, where applicable. It serves as evidence of receipt similar to a Post Card, as described in MPEP 503.

New Applications Under 35 U.S.C. 111

If a new application is being filed and the application includes the necessary components for a filing date (see 37 CFR 1.53(b)-(d) and MPEP 506), a Filing Receipt (37 CFR 1.54) will be issued in due course and the date shown on this Acknowledgement Receipt will establish the filing date of the application.

National Stage of an International Application under 35 U.S.C. 371

If a timely submission to enter the national stage of an international application is compliant with the conditions of 35 U.S.C. 371 and other applicable requirements a Form PCT/DO/EO/903 indicating acceptance of the application as a national stage submission under 35 U.S.C. 371 will be issued in addition to the Filing Receipt, in due course.

New International Application Filed with the USPTO as a Receiving Office

If a new international application is being filed and the international application includes the necessary components for an international filing date (see PCT Article 11 and MPEP 1810), a Notification of the International Application Number and of the International Filing Date (Form PCT/RO/105) will be issued in due course, subject to prescriptions concerning national security, and the date shown on this Acknowledgement Receipt will establish the international filing date of the application.

INFORMATION DISCLOSURE STATEMENT BY APPLICANT	Application No.	13/966,096
	Filing Date	August 13, 2013
	First Named Inventor	Perrault, Clay
	Art Unit	2472
<i>(Multiple sheets used when necessary)</i>	Examiner	Kizou, Hassan
SHEET 1 OF 7	Attorney Docket No.	SMARB19.001C1

U.S. PATENT DOCUMENTS					
Examiner Initials	Cite No.	Document Number <i>Number - Kind Code (if known)</i> Example: 1,234,567 B1	Publication Date MM-DD-YYYY	Name of Patentee or Applicant	Pages, Columns, Lines Where Relevant Passages or Relevant Figures Appear
	1	4,916,491	4/10/1990	Katoh	
	2	4,992,971	2/12/1991	Hayashi	
	3	5,146,491	9/8/1992	Silver et al.	
	4	5,247,571	9/21/1993	Kay et al.	
	5	5,303,297	4/12/1994	Hillis	
	6	5,359,642	10/25/1994	Castro	
	7	5,425,085	6/13/1995	Weinberger et al.	
	8	5,440,621	8/8/1995	Castro	
	9	5,454,030	9/26/1995	de Oliveira et al.	
	10	5,469,497	11/21/1995	Pierce et al.	
	11	5,506,893	4/9/1996	Buscher et al.	
	12	5,519,769	5/21/1996	Weinberger et al.	
	13	5,559,871	9/24/1996	Smith	
	14	5,590,133	12/31/1996	Billstrom et al.	
	15	5,608,786	3/4/1997	Gordon	
	16	5,621,787	4/15/1997	McKoy et al.	
	17	5,633,913	5/27/1997	Talarmo	
	18	5,661,790	8/26/1997	Hsu	
	19	5,712,907	1/27/1998	Wegner et al.	
	20	5,724,355	3/3/1998	Bruno et al.	
	21	5,726,984	3/10/1998	Kubler et al.	
	22	5,737,414	4/7/1998	Walker et al.	
	23	5,751,961	5/12/1998	Smyk	
	24	5,793,762	8/11/1998	Penners et al.	
	25	5,799,072	8/25/1998	Vulcan et al.	
	26	5,802,502	9/1/1998	Gell et al.	
	27	5,825,863	10/20/1998	Walker	
	28	5,828,740	10/27/1998	Khuc et al.	

Examiner Signature	Date Considered
<p>*Examiner: Initial if reference considered, whether or not citation is in conformance with MPEP 609. Draw line through citation if not in conformance and not considered. Include copy of this form with next communication to applicant.</p>	

T¹ - Place a check mark in this area when an English language Translation is attached. AT&T, Exh. 1002, p. 128

INFORMATION DISCLOSURE STATEMENT BY APPLICANT	Application No.	13/966,096
	Filing Date	August 13, 2013
	First Named Inventor	Perrault, Clay
	Art Unit	2472
<i>(Multiple sheets used when necessary)</i>	Examiner	Kizou, Hassan
SHEET 2 OF 7	Attorney Docket No.	SMARB19.001C1

U.S. PATENT DOCUMENTS					
Examiner Initials	Cite No.	Document Number Number - Kind Code (if known) Example: 1,234,567 B1	Publication Date MM-DD-YYYY	Name of Patentee or Applicant	Pages, Columns, Lines Where Relevant Passages or Relevant Figures Appear
	29	5,838,682	11/17/1998	Dekelbaum et al.	
	30	5,845,267	12/1/1998	Ronen	
	31	5,850,433	12/15/1998	Rondeau	
	32	5,864,610	1/26/1999	Ronen	
	33	5,867,495	2/2/1999	Elliott et al.	
	34	5,883,891	3/16/1999	Williams et al.	
	35	5,889,774	3/30/1999	Mirashrafi et al.	
	36	5,905,736	5/18/1999	Ronen et al.	
	37	5,907,547	5/25/1999	Foladare et al.	
	38	5,910,946	6/8/1999	Csapo	
	39	5,915,005	6/22/1999	He	
	40	5,923,659	7/13/1999	Curry et al.	
	41	5,930,343	7/27/1999	Vasquez	
	42	5,937,045	8/10/1999	Yaoya et al.	
	43	5,940,598	8/17/1999	Strauss et al.	
	44	5,953,504	9/14/1999	Sokal et al.	
	45	5,956,391	9/21/1999	Melen et al.	
	46	5,970,477	10/19/1999	Roden	
	47	5,974,043	10/26/1999	Solomon	
	48	5,991,291	11/23/1999	Asai et al.	
	49	6,005,926	12/21/1999	Mashinsky	
	50	6,014,379	1/11/2000	White et al.	
	51	6,021,126	2/1/2000	White et al.	
	52	6,052,445	4/18/2000	Bashoura et al.	
	53	6,058,300	5/2/2000	Hanson	
	54	6,069,890	5/30/2000	White et al.	
	55	6,073,013	6/6/2000	Agre et al.	
	56	6,078,647	6/20/2000	D'Eletto	
	57	6,104,704	8/15/2000	Buhler et al.	

Examiner Signature	Date Considered
<p>*Examiner: Initial if reference considered, whether or not citation is in conformance with MPEP 609. Draw line through citation if not in conformance and not considered. Include copy of this form with next communication to applicant.</p>	

T¹ - Place a check mark in this area when an English language Translation is attached, AT&T, Exh. 1002, p. 129

INFORMATION DISCLOSURE STATEMENT BY APPLICANT	Application No.	13/966,096
	Filing Date	August 13, 2013
	First Named Inventor	Perrault, Clay
	Art Unit	2472
<i>(Multiple sheets used when necessary)</i>	Examiner	Kizou, Hassan
SHEET 3 OF 7	Attorney Docket No.	SMARB19.001C1

	58	6,104,711	8/15/2000	Voit	
	59	6,115,737	9/5/2000	Ely et al.	
	60	6,128,304	10/3/2000	Gardell et al.	
	61	6,137,869	10/24/2000	Voit et al	
	62	6,141,404	10/31/2000	Westerlage et al.	
	63	6,151,385	11/21/2000	Reich et al.	
	64	6,188,752	2/13/2001	Lesley	
	65	6,282,574	8/28/2001	Voit	
	66	6,298,062	10/2/2001	Gardell et al.	
	67	6,351,464	2/26/2002	Galvin et al.	
	68	6,359,880	3/19/2002	Curry et al.	
	69	6,430,275	8/6/2002	Voit et al	
	70	6,507,644	1/14/2003	Henderson et al.	
	71	6,597,686	7/23/2003	Darek A Smyk	
	72	6,674,745	1/6/2004	Schuster et al.	
	73	6,724,860	4/20/2004	Stumer et al.	
	74	6,744,858	6/1/2004	Ryan et al.	
	75	6,766,159	7/20/2004	Lindholm	
	76	6,798,767	9/29/2004	Alexander et al.	
	77	6,819,929	11/16/2004	Antonucci et al.	
	78	6,954,453	10/11/2005	Schindler	
	79	6,963,557	11/8/2005	Mark Clinton Knox	
	80	7,046,658	5/16/2006	Vinay Kundaje	
	81	7,055,174	5/30/2006	Cope et al.	
	82	7,068,772	6/27/2006	Widger et al.	
	83	7,079,526	7/18/2006	Wipliez et al.	
	84	7,120,682	10/10/2006	Salama	
	85	7,212,522	5/1/2007	Shankar et al.	
	86	7,454,510	11/18/2008	Kleyman et al.	
	87	7,950,046	5/24/2011	Kropivny, Alexander	
	88	8,116,307	2/14/2012	Thesayi et al.	

Examiner Signature	Date Considered
--------------------	-----------------

***Examiner:** Initial if reference considered, whether or not citation is in conformance with MPEP 609. Draw line through citation if not in conformance and not considered. Include copy of this form with next communication to applicant.

INFORMATION DISCLOSURE STATEMENT BY APPLICANT	Application No.	13/966,096
	Filing Date	August 13, 2013
	First Named Inventor	Perrault, Clay
	Art Unit	2472
<i>(Multiple sheets used when necessary)</i>	Examiner	Kizou, Hassan
SHEET 4 OF 7	Attorney Docket No.	SMARB19.001C1

	89	2002/0051518 A1	5/2/2002	Bondy et al.	
	90	2002/0116464 A1	8/22/2002	Mak	
	91	2002/0122391 A1	9/5/2002	Shalit, Andrew L.	
	92	2003/0200311 A1	10/23/2003	Baum	
	93	2003/0219103 A1	11/27/2003	Rao et al.	
	94	2004/0022237 A1	2/5/2004	Elliot et al.	
	95	2004/0157629 A1	8/12/2004	Kallio et al.	
	96	2004/0165709 a1	8/26/2004	Pence et al.	
	97	2004/0181599 A1	9/16/2004	Kreusch et al.	
	98	2004/0202295 A1	10/14/2004	Shen et al.	
	99	2004/0240439 A1	12/2/2004	Castleberry et al.	
	100	2004/0255126 A1	12/16/2004	Reith	
	101	2005/0025043 A1	2/3/2005	Mussman et al	
	102	2005/0083911 A1	4/21/2005	Grabelsky et al.	
	103	2005/0094651 A1	5/5/2005	Lutz et al.	
	104	2005/0169248 A1	8/4/2005	Truesdale et al.	
	105	2005/0174937 A1	8/11/2005	Scoggins et al.	
	106	2005/0177843 A1	8/11/2005	Williams	
	107	2006/0072547 A1	4/6/2006	Florkey et al.	
	108	2006/0072550 A1	4/6/2006	Davis et al.	
	109	2006/0093135 A1	5/4/2006	Fiatel et al.	
	110	2006/0111116 A1	5/25/2006	Palmer et al.	
	111	2006/0153342 A1	7/13/2006	Syouichi Sasaki	
	112	2006/0160565 A1	7/20/2006	Singh et al.	
	113	2006/0177035 A1	8/10/2006	Cope et al.	
	114	2006/0209768 A1	9/21/2006	Yan et al.	
	115	2006/0258328 A1	11/16/2006	Mario Francisco Godoy	
	116	2006/0264200 A1	11/23/2006	Laiho et al.	
	117	2007/0036143 A1	2/15/2007	Alt et al.	
	118	2007/0112964 A1	5/17/2007	Guedalia et al.	
	119	2007/0127676 A1	6/7/2007	Khadri	
	120	2007/0253418 A1	11/1/2007	Shiri et al.	

Examiner Signature	Date Considered
<p>*Examiner: Initial if reference considered, whether or not citation is in conformance with MPEP 609. Draw line through citation if not in conformance and not considered. Include copy of this form with next communication to applicant.</p>	

INFORMATION DISCLOSURE STATEMENT BY APPLICANT	Application No.	13/966,096	
	Filing Date	August 13, 2013	
	First Named Inventor	Perrault, Clay	
	Art Unit	2472	
<i>(Multiple sheets used when necessary)</i>		Examiner	Kizou, Hassan
SHEET 5 OF 7		Attorney Docket No.	SMARB19.001C1

121	2008/0037715 A1	2/14/2008	Prozeniuk et al.	
122	2008/0056235 A1	3/6/2008	Albina et al.	
123	2008/0063153 A1	3/13/2008	Krivorot et al.	
124	2009/0028146 A1	1/29/2009	Kleyman et al.	
125	2009/0292539 A1	11/26/2009	Jaroker, Jon	
126	2009/0325558 A1	12/31/2009	Pridmore et al.	
127	2010/0086119 A1	4/8/2010	De Luca et al.	
128	2008/0056302 A1	3/6/2008	Erdal et al.	
129	2009/0135735 A1	5/28/2009	Zhang et al.	
130	2009/0141883 A1	6/4/2009	Bastien, Stephane	
131	2010/0128729 A1	5/27/2010	Yazaki et al.	
132	2012/0099599 A1	4/26/2012	Keränen et al.	
133	2012/0227101 A1	9/6/2012	Yuan, Wei	
134	2013/0114589 A1	5/9/2013	Fangman et al.	

FOREIGN PATENT DOCUMENTS

Examiner Initials	Cite No.	Foreign Patent Document Country Code-Number-Kind Code Example: JP 1234567 A1	Publication Date MM-DD-YYYY	Name of Patentee or Applicant	Pages, Columns, Lines Where Relevant Passages or Relevant Figures Appear	T ¹
	135	CA 2,249,668	4/7/1999	Bruno et al.		
	136	EP 1 389 862 A1	2/18/2004	Shen et al.		
	137	EP 1 389 862 B1	11/3/2004	Shen et al.		
	138	WO 01/89145 A2	11/22/2001	Foti, Georges		
	139	WO 2007/044454 A2	4/19/2007	Croy et al.		
	140	WO 2008/052340 A1	5/8/2008	Perreault et al.		
	141	WO 2008/064481 A1	6/5/2008	Bjorsell et al.		
	142	WO 2008/116296 A1	10/2/2008	Bjorsell et al.		

NON PATENT LITERATURE DOCUMENTS

Examiner Initials	Cite No.	Include name of the author (in CAPITAL LETTERS), title of the article (when appropriate), title of the item (book, magazine, journal, serial, symposium, catalog, etc.), date, page(s), volume-issue number(s), publisher, city and/or country where published.	T ¹
	143	F. Baker et al. "RFC 3924 - Cisco Architecture for Lawful Intercept in IP Networks." October 2004.	

Examiner Signature	Date Considered
--------------------	-----------------

***Examiner:** Initial if reference considered, whether or not citation is in conformance with MPEP 609. Draw line through citation if not in conformance and not considered. Include copy of this form with next communication to applicant.

T¹ - Place a check mark in this area when an English language Translation is attached AT&T, Exh. 1002, p. 132

INFORMATION DISCLOSURE STATEMENT BY APPLICANT	Application No.	13/966,096
	Filing Date	August 13, 2013
	First Named Inventor	Perrault, Clay
	Art Unit	2472
<i>(Multiple sheets used when necessary)</i>	Examiner	Kizou, Hassan
SHEET 6 OF 7	Attorney Docket No.	SMARB19.001C1

NON PATENT LITERATURE DOCUMENTS			
Examiner Initials	Cite No.	Include name of the author (in CAPITAL LETTERS), title of the article (when appropriate), title of the item (book, magazine, journal, serial, symposium, catalog, etc.), date, page(s), volume-issue number(s), publisher, city and/or country where published.	T ¹
	144	Cisco. "Lawful Intercept Requirements Summary." http://www.faqs.org/rfcs/rfc3924.html . November 8, 2006.	
	145	Sippy SIP B2BUA. "About Sippy RTPproxy." http://www.rtpproxy.org . July 15, 2009.	
	146	ETSI Technical Specification. "Lawful Interception (LI); Handover Interface and Service-Specific Details (SSD) for IP delivery; Part 5: Service-specific details for IP Multimedia Services." Apr 2008, 25 pgs, v.2.3.1, France.	
	147	M. Handley et al. "RFC 2543 - SIP: Session Initiation Protocol." March 1999.	
	148	A copy of the International Search Report and Written Opinion of the International Searching Authority completed June 6, 2008 for related PCT/CA2008/000545.	
	149	A copy of the International Search Report and Written Opinion of the International Searching Authority completed February 6, 2008 for corresponding PCT/CA2007/001956.	
	150	A copy of the International Preliminary Report on Patentability mailed May 14, 2009 for corresponding PCT/CA2007/001956.	
	151	A copy of the International Search Report and Written Opinion of the International Searching Authority completed March 3, 2008 for related PCT/CA2007/002150.	
	152	A copy of the International Preliminary Report on Patentability mailed February 13, 2009 for related PCT/CA2007/002150.	
	153	A copy of the International Preliminary Report on Patentability and Written Opinion of the International Searching Authority mailed February 10, 2011 for related PCT Application No. PCT/CA2009/001062, February 01, 2011.	
	154	A copy of the Written Opinion and International Search Report completed on June 18, 2010 for related PCT Application No. PCT/CA2009/001317.	
	155	A copy of the International Search Report and Written Opinion mailed on March 12, 2010 for corresponding PCT Application No. PCT/CA2009/001062.	
	156	A copy of the International Preliminary Report on Patentability issued on September 29, 2009 for PCT/CA2008/000545.	
	157	A copy of the International Preliminary Report on Patentability issued on March 20, 2012 for PCT/CA2009/001317.	
	158	Townsley, et al.; "RFC 2661 - Layer Two Tunneling Protocol 'L2TP' ", August 1999.	
	159	IP2Location, http://www.ip2location.com/ ; printed June 20, 2012.	
	160	DOTS IP Address Validation, "Overview", http://www.serviceobjects.com/products/dots_ipgeo.asp ; printed June 21, 2012.	
	161	List of North American Numbering Plan area codes, http://en.wikipedia.org/wiki/List_of_NANP_area_codes ; printed June 20, 2012.	

Examiner Signature	Date Considered
<p>*Examiner: Initial if reference considered, whether or not citation is in conformance with MPEP 609. Draw line through citation if not in conformance and not considered. Include copy of this form with next communication to applicant.</p>	

T¹ - Place a check mark in this area when an English language Translation is attached. AT&T, Exh. 1002, p. 133

INFORMATION DISCLOSURE STATEMENT BY APPLICANT	Application No.	13/966,096
	Filing Date	August 13, 2013
	First Named Inventor	Perrault, Clay
	Art Unit	2472
<i>(Multiple sheets used when necessary)</i>	Examiner	Kizou, Hassan
SHEET 7 OF 7	Attorney Docket No.	SMARB19.001C1

NON PATENT LITERATURE DOCUMENTS			
Examiner Initials	Cite No.	Include name of the author (in CAPITAL LETTERS), title of the article (when appropriate), title of the item (book, magazine, journal, serial, symposium, catalog, etc.), date, page(s), volume-issue number(s), publisher, city and/or country where published.	T ¹
	162	DOTS Phone Exchange, "Overview", http://www.serviceobjects.com/demos/PhoneExchangeDemo.asp (URL no longer valid, current URL is http://www.serviceobjects.com/products/phone/phone-exchange); printed June 21, 2012.	
	163	Rosenberg, et al.; "RFC 3261 - SIP: Session Initiation Protocol", June 2002.	
	164	Lind AT&T S: "ENUM Call Flows for VoIP Interworking; draft-lind-enum-callflows-03.txt", 20020201, no. 3, 1 February 2002, pages 1-17, XP015004214, ISSN: 0000-0004.	
	165	IETF ENUM WG R STASTNY OEFEG INFORMATIONAL NUMBERING FOR VOIP AND OTHER IP COMMUNICATIONS: "Numbering for ViOP and other IP Communications, draft-stastny-enum-numbering-voip-00.txt", 20031001, 1 October 2003, pages 1-43, XP015035676, ISSN: 0000-0004.	
	166	Supplementary European Search Report for European Application No. 07816106, dated June 18, 2012.	
	167	Supplementary European Search Report for European Application No. 07816106, dated November 2, 2012.	
	168	Wikipedia, "International mobile subscriber identity (IMSI)," http://en.wikipedia.org/wiki/IMSI , 7-16-2013.	
	169	Wikipedia, "Roaming," http://en.wikipedia.org/wiki/Roaming , 7-16-2013.	

16645405
111113

Examiner Signature	Date Considered
<p>*Examiner: Initial if reference considered, whether or not citation is in conformance with MPEP 609. Draw line through citation if not in conformance and not considered. Include copy of this form with next communication to applicant.</p>	

T¹ - Place a check mark in this area when an English language Translation is attached AT&T, Exh. 1002, p. 134

Electronic Acknowledgement Receipt

EFS ID:	17383340
Application Number:	13966096
International Application Number:	
Confirmation Number:	8712
Title of Invention:	PRODUCING ROUTING MESSAGES FOR VOICE OVER IP COMMUNICATIONS
First Named Inventor/Applicant Name:	CLAY PERRAULT
Customer Number:	20995
Filer:	Paul C. Steinhardt/Norman Green
Filer Authorized By:	Paul C. Steinhardt
Attorney Docket Number:	SMARB19.001C1
Receipt Date:	12-NOV-2013
Filing Date:	13-AUG-2013
Time Stamp:	18:17:58
Application Type:	Utility under 35 USC 111(a)

Payment information:

Submitted with Payment	no
------------------------	----

File Listing:

Document Number	Document Description	File Name	File Size(Bytes)/ Message Digest	Multi Part /.zip	Pages (if appl.)
1		IDS_SMARB19_001C1_11_12_2013.pdf	475461 196f792af5abaf2959d22b935ecdecec4b2e fb47	yes	9

Multipart Description/PDF files in .zip description			
	Document Description	Start	End
	Transmittal Letter	1	2
	Information Disclosure Statement (IDS) Form (SB08)	3	9

Warnings:

Information:

2	Non Patent Literature	Ref168__WIKI_IMSI.pdf	316123	no	4
			e2bf56b6db834ff63a7e776c6a468b8e033d7bd2		

Warnings:

Information:

3	Non Patent Literature	Ref169__WIKI_ROAMING.pdf	837516	no	8
			b56a3eb9a59331bd90d887ce6cbce1ad35e743b4		

Warnings:

Information:

Total Files Size (in bytes):			1629100		
-------------------------------------	--	--	---------	--	--

This Acknowledgement Receipt evidences receipt on the noted date by the USPTO of the indicated documents, characterized by the applicant, and including page counts, where applicable. It serves as evidence of receipt similar to a Post Card, as described in MPEP 503.

New Applications Under 35 U.S.C. 111

If a new application is being filed and the application includes the necessary components for a filing date (see 37 CFR 1.53(b)-(d) and MPEP 506), a Filing Receipt (37 CFR 1.54) will be issued in due course and the date shown on this Acknowledgement Receipt will establish the filing date of the application.

National Stage of an International Application under 35 U.S.C. 371

If a timely submission to enter the national stage of an international application is compliant with the conditions of 35 U.S.C. 371 and other applicable requirements a Form PCT/DO/EO/903 indicating acceptance of the application as a national stage submission under 35 U.S.C. 371 will be issued in addition to the Filing Receipt, in due course.

New International Application Filed with the USPTO as a Receiving Office

If a new international application is being filed and the international application includes the necessary components for an international filing date (see PCT Article 11 and MPEP 1810), a Notification of the International Application Number and of the International Filing Date (Form PCT/RO/105) will be issued in due course, subject to prescriptions concerning national security, and the date shown on this Acknowledgement Receipt will establish the international filing date of the application.

INFORMATION DISCLOSURE STATEMENT

Inventor	:	Clay Perrault, et al.
App. No.	:	13/966,096
Filed	:	August 13, 2013
For	:	PRODUCING ROUTING MESSAGES FOR VOICE OVER IP COMMUNICATIONS
Examiner	:	Kizou, Hassan
Art Unit	:	2472
Conf. No.	:	8712

Commissioner for Patents
P.O. Box 1450
Alexandria, VA 22313-1450

References and Listing

Submitted herewith in the above-identified application is an Information Disclosure Statement listing references for consideration. References numbered 1-127 and 135-167 are of record in U.S. patent application No. 12/513,147, filed March 1, 2010, which is relied upon for an earlier filing date under 35 USC 120. Accordingly, copies of references numbered 1-127 and 135-167 are not submitted pursuant to 37 CFR 1.98(d).

Timing of Disclosure

This Information Disclosure Statement is being filed within three months of the filing date or date of national phase entry, with an RCE or before receipt of a First Office Action after an RCE and no fee is required.

Application No.: 13/966,096
Filing Date: August 13, 2013

The Commissioner is hereby authorized to charge any additional fees which may be required, or credit any overpayment, to Account No. 11-1410.

Respectfully submitted,

KNOBBE, MARTENS, OLSON & BEAR, LLP

Dated: Nov. 12, 2013

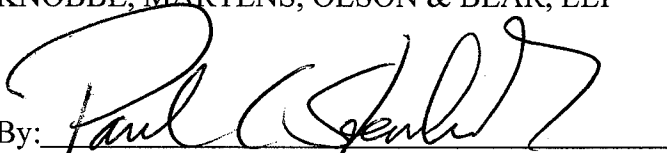
By: 

Paul C. Steinhardt
Registration No. 30,806
Attorney of Record
Customer No. 20995
(858) 707-4000

IDS
16645601
111113



UNITED STATES PATENT AND TRADEMARK OFFICE

UNITED STATES DEPARTMENT OF COMMERCE
United States Patent and Trademark Office
Address: COMMISSIONER FOR PATENTS
P.O. Box 1450
Alexandria, Virginia 22313-1450
www.uspto.gov

Table with 4 columns: APPLICATION NUMBER (13/966,096), FILING OR 371(C) DATE (08/13/2013), FIRST NAMED APPLICANT (CLAY PERRAULT), ATTY. DOCKET NO./TITLE (SMARB19.001C1)

CONFIRMATION NO. 8712

PUBLICATION NOTICE

20995
KNOBBE MARTENS OLSON & BEAR LLP
2040 MAIN STREET
FOURTEENTH FLOOR
IRVINE, CA 92614



Title: PRODUCING ROUTING MESSAGES FOR VOICE OVER IP COMMUNICATIONS

Publication No. US-2013-0329722-A1
Publication Date: 12/12/2013

NOTICE OF PUBLICATION OF APPLICATION

The above-identified application will be electronically published as a patent application publication pursuant to 37 CFR 1.211, et seq. The patent application publication number and publication date are set forth above.

The publication may be accessed through the USPTO's publically available Searchable Databases via the Internet at www.uspto.gov. The direct link to access the publication is currently http://www.uspto.gov/patft/.

The publication process established by the Office does not provide for mailing a copy of the publication to applicant. A copy of the publication may be obtained from the Office upon payment of the appropriate fee set forth in 37 CFR 1.19(a)(1). Orders for copies of patent application publications are handled by the USPTO's Office of Public Records. The Office of Public Records can be reached by telephone at (703) 308-9726 or (800) 972-6382, by facsimile at (703) 305-8759, by mail addressed to the United States Patent and Trademark Office, Office of Public Records, Alexandria, VA 22313-1450 or via the Internet.

In addition, information on the status of the application, including the mailing date of Office actions and the dates of receipt of correspondence filed in the Office, may also be accessed via the Internet through the Patent Electronic Business Center at www.uspto.gov using the public side of the Patent Application Information and Retrieval (PAIR) system. The direct link to access this status information is currently http://pair.uspto.gov/. Prior to publication, such status information is confidential and may only be obtained by applicant using the private side of PAIR.

Further assistance in electronically accessing the publication, or about PAIR, is available by calling the Patent Electronic Business Center at 1-866-217-9197.

Office of Data Management, Application Assistance Unit (571) 272-4000, or (571) 272-4200, or 1-888-786-0101

INFORMATION DISCLOSURE STATEMENT BY APPLICANT	Application No.	13/966,096	
	Filing Date	August 13, 2013	
	First Named Inventor	Perrault, Clay	
	Art Unit	2472	
<i>(Multiple sheets used when necessary)</i>		Examiner	Kizou, Hassan
SHEET 1 OF 1		Attorney Docket No.	SMARB19.001C1

U.S. PATENT DOCUMENTS					
Examiner Initials	Cite No.	Document Number <i>Number - Kind Code (if known)</i> Example: 1,234,567 B1	Publication Date MM-DD-YYYY	Name of Patentee or Applicant	Pages, Columns, Lines Where Relevant Passages or Relevant Figures Appear
	1	8,422,507 B2	4/16/2013	Björzell et al.	
	2	8,537,805 B2	9/17/2013	Björzell et al.	
	3	8,542,815 B2	9/24/2013	Perreault et al.	

FOREIGN PATENT DOCUMENTS						
Examiner Initials	Cite No.	Foreign Patent Document <i>Country Code-Number-Kind Code</i> Example: JP 1234567 A1	Publication Date MM-DD-YYYY	Name of Patentee or Applicant	Pages, Columns, Lines Where Relevant Passages or Relevant Figures Appear	T ¹
	4	WO 2010/012090 A2	2/4/2010	Bjorsell et al.		
	5	WO 2011/032256 A1	3/24/2011	Huttunen, Pentti Kalevi		

NON PATENT LITERATURE DOCUMENTS			
Examiner Initials	Cite No.	Include name of the author (in CAPITAL LETTERS), title of the article (when appropriate), title of the item (book, magazine, journal, serial, symposium, catalog, etc.), date, page(s), volume-issue number(s), publisher, city and/or country where published.	T ¹

16875512
121713

Examiner Signature	Date Considered
<p>*Examiner: Initial if reference considered, whether or not citation is in conformance with MPEP 609. Draw line through citation if not in conformance and not considered. Include copy of this form with next communication to applicant.</p>	

T¹ - Place a check mark in this area when an English language Translation is attached AT&T, Exh. 1002, p. 140

Electronic Acknowledgement Receipt

EFS ID:	17696996
Application Number:	13966096
International Application Number:	
Confirmation Number:	8712
Title of Invention:	PRODUCING ROUTING MESSAGES FOR VOICE OVER IP COMMUNICATIONS
First Named Inventor/Applicant Name:	CLAY PERRAULT
Customer Number:	20995
Filer:	John M Carson/Norman Green
Filer Authorized By:	John M Carson
Attorney Docket Number:	SMARB19.001C1
Receipt Date:	18-DEC-2013
Filing Date:	13-AUG-2013
Time Stamp:	15:10:13
Application Type:	Utility under 35 USC 111(a)

Payment information:

Submitted with Payment	no
------------------------	----

File Listing:

Document Number	Document Description	File Name	File Size(Bytes)/ Message Digest	Multi Part /.zip	Pages (if appl.)
1		IDS_SMARB19_001C1_12_18_2013.pdf	81860 e0a47025458c51f36055d8a74eb4b628d38631fa	yes	2

Multipart Description/PDF files in .zip description			
	Document Description	Start	End
	Transmittal Letter	1	1
	Information Disclosure Statement (IDS) Form (SB08)	2	2

Warnings:

Information:

2	Foreign Reference	Ref4_WO2010012090A2.pdf	7688587 93ceb3791ca6d43b46ee02fe8e924dfc32c92ae	no	99
---	-------------------	-------------------------	--	----	----

Warnings:

Information:

3	Foreign Reference	Ref5_WO2011032256A1.pdf	3571304 85006dddfdb1512fd629791aa7a43ac970a577a	no	48
---	-------------------	-------------------------	--	----	----

Warnings:

Information:

Total Files Size (in bytes):			11341751
-------------------------------------	--	--	----------

This Acknowledgement Receipt evidences receipt on the noted date by the USPTO of the indicated documents, characterized by the applicant, and including page counts, where applicable. It serves as evidence of receipt similar to a Post Card, as described in MPEP 503.

New Applications Under 35 U.S.C. 111

If a new application is being filed and the application includes the necessary components for a filing date (see 37 CFR 1.53(b)-(d) and MPEP 506), a Filing Receipt (37 CFR 1.54) will be issued in due course and the date shown on this Acknowledgement Receipt will establish the filing date of the application.

National Stage of an International Application under 35 U.S.C. 371

If a timely submission to enter the national stage of an international application is compliant with the conditions of 35 U.S.C. 371 and other applicable requirements a Form PCT/DO/EO/903 indicating acceptance of the application as a national stage submission under 35 U.S.C. 371 will be issued in addition to the Filing Receipt, in due course.

New International Application Filed with the USPTO as a Receiving Office

If a new international application is being filed and the international application includes the necessary components for an international filing date (see PCT Article 11 and MPEP 1810), a Notification of the International Application Number and of the International Filing Date (Form PCT/RO/105) will be issued in due course, subject to prescriptions concerning national security, and the date shown on this Acknowledgement Receipt will establish the international filing date of the application.

INFORMATION DISCLOSURE STATEMENT

Inventor : Clay Perrault, et al.
App. No. : 13/966,096
Filed : August 13, 2013
For : PRODUCING ROUTING MESSAGES FOR
VOICE OVER IP COMMUNICATIONS
Examiner : Kizou, Hassan
Art Unit : 2472
Conf. No. : 8712

Commissioner for Patents
P.O. Box 1450
Alexandria, VA 22313-1450

References and Listing

Submitted herewith in the above-identified application is an Information Disclosure Statement listing references for consideration. Copies of any listed foreign and non-patent literature references are being submitted.

Timing of Disclosure

This Information Disclosure Statement is being filed before the receipt of a First Office Action on the merits, and presumably no fee is required. If a First Office Action on the merits was mailed before the mailing date of this Statement, the Commissioner is authorized to charge the fee set forth in 37 CFR 1.17(p) to Deposit Account No. 11-1410.

Respectfully submitted,
KNOBBE, MARTENS, OLSON & BEAR, LLP

Dated: _____

12/18/13

By: _____

John M. Carson
Registration No. 34,303
Attorney of Record
Customer No. 20995
(858) 707-4000

IDS
16875589
121713

TRANSMITTAL FOR POWER OF ATTORNEY TO ONE OR MORE REGISTERED PRACTITIONERS

NOTE: This form is to be submitted with the Power of Attorney by Applicant form (PTO/AIA/82B) to identify the application to which the Power of Attorney is directed, in accordance with 37 CFR 1.5, unless the application number and filing date are identified in the Power of Attorney by Applicant form. If neither form PTO/AIA/82A nor form PTO/AIA82B identifies the application to which the Power of Attorney is directed, the Power of Attorney will not be recognized in the application.

Application Number	13/966,096
Filing Date	August 13, 2013
First Named Inventor	Clay Perrault et al.
Title	PRODUCING ROUTING MESSAGES FOR VOICE OVER IP COMMUNICATIONS
Art Unit	2472
Examiner Name	Hasson Kizou
Attorney Docket Number	SMARB19.001C1

SIGNATURE of Applicant or Patent Practitioner

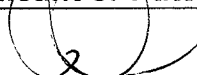
Signature		Date (Optional)	1/30/14
Name	John M. Carson	Registration Number	34,303
Title (if Applicant is a juristic entity)			
Applicant Name (if Applicant is a juristic entity)			
<p>NOTE: This form must be signed in accordance with 37 CFR 1.33. See 37 CFR 1.4(d) for signature requirements and certifications. If more than one applicant, use multiple forms.</p>			
<input checked="" type="checkbox"/> *Total of <u>One (1)</u> forms are submitted.			

This collection of information is required by 37 CFR 1.131, 1.32, and 1.33. The information is required to obtain or retain a benefit by the public which is to file (and by the USPTO to process) an application. Confidentiality is governed by 35 U.S.C. 122 and 37 CFR 1.11 and 1.14. This collection is estimated to take 3 minutes to complete, including gathering, preparing, and submitting the completed application form to the USPTO. Time will vary depending upon the individual case. Any comments on the amount of time you require to complete this form and/or suggestions for reducing this burden, should be sent to the Chief Information Officer, U.S. Patent and Trademark Office, U.S. Department of Commerce, P.O. Box 1450, Alexandria, VA 22313-1450. DO NOT SEND FEES OR COMPLETED FORMS TO THIS ADDRESS. SEND TO: Commissioner for Patents, P.O. Box 1450, Alexandria, VA 22313-1450.

Under the Paperwork Reduction Act of 1995, no persons are required to respond to a collection of information unless it displays a valid OMB control number

POWER OF ATTORNEY BY APPLICANT

I hereby revoke all previous powers of attorney given in the application identified in either the attached transmittal letter or the boxes below.

Table with 2 columns: Application Number, Filing Date

(Note: The boxes above may be left blank if information is provided on form PTO/AIA/82A.)

I hereby appoint the Patent Practitioner(s) associated with the following Customer Number as my/our attorney(s) or agent(s), and to transact all business in the United States Patent and Trademark Office connected therewith for the application referenced in the attached transmittal letter (form PTO/AIA/82A) or identified above:

OR

20995

I hereby appoint Practitioner(s) named in the attached list (form PTO/AIA/82C) as my/our attorney(s) or agent(s), and to transact all business in the United States Patent and Trademark Office connected therewith for the patent application referenced in the attached transmittal letter (form PTO/AIA/82A) or identified above. (Note: Complete form PTO/AIA/82C.)

Please recognize or change the correspondence address for the application identified in the attached transmittal letter or the boxes above to:

The address associated with the above-mentioned Customer Number

OR

The address associated with Customer Number:

OR

Form with fields: Firm or Individual Name, Address, City, State, Zip, Country, Telephone, Email

I am the Applicant (if the Applicant is a juristic entity, list the Applicant name in the box):

Digifonica (International) Limited

- Inventor or Joint Inventor (title not required below)
Legal Representative of a Deceased or Legally Incapacitated Inventor (title not required below)
Assignee or Person to Whom the Inventor is Under an Obligation to Assign (provide signer's title if applicant is a juristic entity)
Person Who Otherwise Shows Sufficient Proprietary Interest (e.g., a petition under 37 CFR 1.46(b)(2) was granted in the application or is concurrently being filed with this document) (provide signer's title if applicant is a juristic entity)

SIGNATURE of Applicant for Patent

The undersigned (whose title is supplied below) is authorized to act on behalf of the applicant (e.g., where the applicant is a juristic entity).

Signature, Name, Title, Date (Optional) fields with handwritten input

NOTE: Signature - This form must be signed by the applicant in accordance with 37 CFR 1.33. See 37 CFR 1.4 for signature requirements and certifications. If more than one applicant, use multiple forms.

Total of forms are submitted.

This collection of information is required by 37 CFR 1.131, 1.32, and 1.33. The information is required to obtain or retain a benefit by the public which is to file (and by the USPTO to process) an application. Confidentiality is governed by 35 U.S.C. 122 and 37 CFR 1.11 and 1.14. This collection is estimated to take 3 minutes to complete, including gathering, preparing, and submitting the completed application form to the USPTO. Time will vary depending upon the individual case. Any comments on the amount of time you require to complete this form and/or suggestions for reducing this burden, should be sent to the Chief Information Officer, U.S. Patent and Trademark Office, U.S. Department of Commerce, P.O. Box 1450, Alexandria, VA 22313-1450. DO NOT SEND FEES OR COMPLETED FORMS TO THIS ADDRESS. SEND TO: Commissioner for Patents, P.O. Box 1450, Alexandria, VA 22313-1450.

If you need assistance in completing the form, call 1-800-PTO-9199 and select option 2.

Electronic Acknowledgement Receipt

EFS ID:	18076386
Application Number:	13966096
International Application Number:	
Confirmation Number:	8712
Title of Invention:	PRODUCING ROUTING MESSAGES FOR VOICE OVER IP COMMUNICATIONS
First Named Inventor/Applicant Name:	CLAY PERRAULT
Customer Number:	20995
Filer:	John M Carson/Sandra Autry
Filer Authorized By:	John M Carson
Attorney Docket Number:	SMARB19.001C1
Receipt Date:	31-JAN-2014
Filing Date:	13-AUG-2013
Time Stamp:	13:06:04
Application Type:	Utility under 35 USC 111(a)

Payment information:

Submitted with Payment	no
------------------------	----

File Listing:

Document Number	Document Description	File Name	File Size(Bytes)/ Message Digest	Multi Part /.zip	Pages (if appl.)
1		SMARB19001C1responsetoinfo notice.pdf	1188904 fbc4173b533781982444095657df1908b1b 49915	yes	6

Multipart Description/PDF files in .zip description			
	Document Description	Start	End
	Miscellaneous Incoming Letter	1	1
	Oath or Declaration filed	2	6

Warnings:

Information:

2	Power of Attorney	SMARB19001C1poa.pdf	170602	no	2
			8e090e4fa39690f4aa00934160034d1d0cfe b6f7		

Warnings:

Information:

Total Files Size (in bytes):		1359506
-------------------------------------	--	---------

This Acknowledgement Receipt evidences receipt on the noted date by the USPTO of the indicated documents, characterized by the applicant, and including page counts, where applicable. It serves as evidence of receipt similar to a Post Card, as described in MPEP 503.

New Applications Under 35 U.S.C. 111

If a new application is being filed and the application includes the necessary components for a filing date (see 37 CFR 1.53(b)-(d) and MPEP 506), a Filing Receipt (37 CFR 1.54) will be issued in due course and the date shown on this Acknowledgement Receipt will establish the filing date of the application.

National Stage of an International Application under 35 U.S.C. 371

If a timely submission to enter the national stage of an international application is compliant with the conditions of 35 U.S.C. 371 and other applicable requirements a Form PCT/DO/EO/903 indicating acceptance of the application as a national stage submission under 35 U.S.C. 371 will be issued in addition to the Filing Receipt, in due course.

New International Application Filed with the USPTO as a Receiving Office

If a new international application is being filed and the international application includes the necessary components for an international filing date (see PCT Article 11 and MPEP 1810), a Notification of the International Application Number and of the International Filing Date (Form PCT/RO/105) will be issued in due course, subject to prescriptions concerning national security, and the date shown on this Acknowledgement Receipt will establish the international filing date of the application.

Please Direct All Correspondence to Customer Number 20995

RESPONSE TO INFORMATIONAL NOTICE

Inventor	:	Clay Perrault et al.
App. No.	:	13/966,096
Filed	:	August 13, 2013
For	:	PRODUCING ROUTING MESSAGES FOR VOICE OVER IP COMMUNICATIONS
Art Unit	:	2472
Conf. No.	:	8712

**Commissioner for Patents
P.O. Box 1450
Alexandria, VA 22313-1450**

Dear Sir:

The above-captioned application was filed without a Declaration and/or Substitute Statement. Enclosed in compliance with 37 CFR 1.53(f) are the following:

(X) Declaration(s) for:

**Clay Perrault, Steve Nicholson, Rod Thomson,
Johan Emil Viktor Björsell, and Fuad Arafa**

(X) Power of Attorney by Applicant.

The Commissioner is hereby authorized to charge any additional fees which may be required, now or in the future, or credit any overpayment, to Account No. 11-1410.

Date: _____

1/30/14

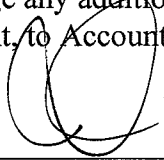

John M. Carson
Registration No. 34,303
Attorney of Record
Customer No. 20995
(858) 707-4000

Under the Paperwork Reduction Act of 1995, no persons are required to respond to a collection of information unless it displays a valid OMB control number.

DECLARATION (37 CFR 1.63) FOR UTILITY OR DESIGN APPLICATION USING AN APPLICATION DATA SHEET (37 CFR 1.76)

Title of Invention	PRODUCING ROUTING MESSAGES FOR VOICE OVER IP COMMUNICATIONS
-------------------------------	--

As the below named inventor, I hereby declare that:

This declaration is directed to: The attached application, or
 United States application or PCT international application number 13/966,096
filed on August 13, 2013

The above-identified application was made or authorized to be made by me.

I believe that I am the original inventor or an original joint inventor of a claimed invention in the application.

I hereby acknowledge that any willful false statement made in this declaration is punishable under 18 U.S.C. 1001 by fine or imprisonment of not more than five (5) years, or both.

WARNING:

Petitioner/applicant is cautioned to avoid submitting personal information in documents filed in a patent application that may contribute to identity theft. Personal information such as social security numbers, bank account numbers, or credit card numbers (other than a check or credit card authorization form PTO-2038 submitted for payment purposes) is never required by the USPTO to support a petition or an application. If this type of personal information is included in documents submitted to the USPTO, petitioners/applicants should consider redacting such personal information from the documents before submitting them to the USPTO. Petitioner/applicant is advised that the record of a patent application is available to the public after publication of the application (unless a non-publication request in compliance with 37 CFR 1.213(a) is made in the application) or issuance of a patent. Furthermore, the record from an abandoned application may also be available to the public if the application is referenced in a published application or an issued patent (see 37 CFR 1.14). Checks and credit card authorization forms PTO-2038 submitted for payment purposes are not retained in the application file and therefore are not publicly available.

LEGAL NAME OF INVENTOR

Inventor: Clay Perrault Date (Optional): Dec 9/13

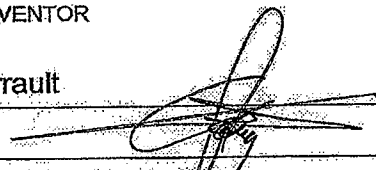
Signature: 

Note: An application data sheet (PTO/SB/14 or equivalent), including naming the entire inventive entity, must accompany this form or must have been previously filed. Use an additional PTO/AIA/01 form for each additional inventor.

This collection of information is required by 35 U.S.C. 115 and 37 CFR 1.63. The information is required to obtain or retain a benefit by the public which is to file (and by the USPTO to process) an application. Confidentiality is governed by 35 U.S.C. 122 and 37 CFR 1.11 and 1.14. This collection is estimated to take 1 minute to complete, including gathering, preparing, and submitting the completed application form to the USPTO. Time will vary depending upon the individual case. Any comments on the amount of time you require to complete this form and/or suggestions for reducing this burden, should be sent to the Chief Information Officer, U.S. Patent and Trademark Office, U.S. Department of Commerce, P.O. Box 1450, Alexandria, VA 22313-1450. DO NOT SEND FEES OR COMPLETED FORMS TO THIS ADDRESS. SEND TO: Commissioner for Patents, P.O. Box 1450, Alexandria, VA 22313-1450.

If you need assistance in completing the form, call 1-800-PTO-9199 and select option 2.

Under the Paperwork Reduction Act of 1995, no persons are required to respond to a collection of information unless it displays a valid OMB control number.

DECLARATION (37 CFR 1.63) FOR UTILITY OR DESIGN APPLICATION USING AN APPLICATION DATA SHEET (37 CFR 1.76)

Title of Invention: **PRODUCING ROUTING MESSAGES FOR VOICE OVER IP COMMUNICATIONS**

As the below named inventor, I hereby declare that:

This declaration is directed to: The attached application, or United States application or PCT international application number 13/966,096 filed on August 13, 2013

The above-identified application was made or authorized to be made by me.

I believe that I am the original inventor or an original joint inventor of a claimed invention in the application.

I hereby acknowledge that any willful false statement made in this declaration is punishable under 18 U.S.C. 1001 by fine or imprisonment of not more than five (5) years, or both.

WARNING:

Petitioner/applicant is cautioned to avoid submitting personal information in documents filed in a patent application that may contribute to identity theft. Personal information such as social security numbers, bank account numbers, or credit card numbers (other than a check or credit card authorization form PTO-2038 submitted for payment purposes) is never required by the USPTO to support a petition or an application. If this type of personal information is included in documents submitted to the USPTO, petitioners/applicants should consider redacting such personal information from the documents before submitting them to the USPTO. Petitioner/applicant is advised that the record of a patent application is available to the public after publication of the application (unless a non-publication request in compliance with 37 CFR 1.213(a) is made in the application) or issuance of a patent. Furthermore, the record from an abandoned application may also be available to the public if the application is referenced in a published application or an issued patent (see 37 CFR 1.14). Checks and credit card authorization forms PTO-2038 submitted for payment purposes are not retained in the application file and therefore are not publicly available.

LEGAL NAME OF INVENTOR
Inventor: Steve Nicholson Date (Optional) 9 Dec 2013
Signature: 

Note: An application data sheet (PTO/SB/14 or equivalent), including naming the entire inventive entity, must accompany this form or must have been previously filed. Use an additional PTO/AIA/01 form for each additional inventor.

This collection of information is required by 35 U.S.C. 115 and 37 CFR 1.63. The information is required to obtain or retain a benefit by the public which is to file (and by the USPTO to process) an application. Confidentiality is governed by 35 U.S.C. 122 and 37 CFR 1.11 and 1.14. This collection is estimated to take 1 minute to complete, including gathering, preparing, and submitting the completed application form to the USPTO. Time will vary depending upon the individual case. Any comments on the amount of time you require to complete this form and/or suggestions for reducing this burden, should be sent to the Chief Information Officer, U.S. Patent and Trademark Office, U.S. Department of Commerce, P.O. Box 1450, Alexandria, VA 22313-1450. DO NOT SEND FEES OR COMPLETED FORMS TO THIS ADDRESS. SEND TO: Commissioner for Patents, P.O. Box 1450, Alexandria, VA 22313-1450.
If you need assistance in completing this form, call 1-800-PTO-9199 and select option 2.

Under the Paperwork Reduction Act of 1995, no persons are required to respond to a collection of information unless it displays a valid OMB control number.

DECLARATION (37 CFR 1.63) FOR UTILITY OR DESIGN APPLICATION USING AN APPLICATION DATA SHEET (37 CFR 1.76)

Title of Invention	PRODUCING ROUTING MESSAGES FOR VOICE OVER IP COMMUNICATIONS
---------------------------	--

As the below named inventor, I hereby declare that:

This declaration is directed to: The attached application, or United States application or PCT international application number 13/966,096 filed on August 13, 2013

The above identified application was made or authorized to be made by me.

I believe that I am the original inventor or an original joint inventor of a claimed invention in the application.

I hereby acknowledge that any willful false statement made in this declaration is punishable under 18 U.S.C. 1001 by fine or imprisonment of not more than five (5) years, or both.

WARNING:

Petitioner/applicant is cautioned to avoid submitting personal information in documents filed in a patent application that may contribute to identity theft. Personal information such as social security numbers, bank account numbers, or credit card numbers (other than a check or credit card authorization form PTO-2038 submitted for payment purposes) is never required by the USPTO to support a petition or an application. If this type of personal information is included in documents submitted to the USPTO, petitioners/applicants should consider redacting such personal information from the documents before submitting them to the USPTO. Petitioner/applicant is advised that the record of a patent application is available to the public after publication of the application (unless a non-publication request in compliance with 37 CFR 1.213(a) is made in the application) or issuance of a patent. Furthermore, the record from an abandoned application may also be available to the public if the application is referenced in a published application or an issued patent (see 37 CFR 1.14). Checks and credit card authorization forms PTO-2038 submitted for payment purposes are not retained in the application file and therefore are not publicly available.

LEGAL NAME OF INVENTOR

Inventor: Rod Thomson Date (Optional): Dec 11, 2013
Signature: 

Note: An application data sheet (PTO/SB/14 or equivalent), including naming the entire inventive entity, must accompany this form or must have been previously filed. Use an additional PTO/AIA/01 form for each additional inventor.

This collection of information is required by 35 U.S.C. 115 and 37 CFR 1.63. The information is required to obtain or retain a benefit by the public which is to file (and by the USPTO to process) an application. Confidentiality is governed by 35 U.S.C. 122 and 37 CFR 1.11 and 1.14. This collection is estimated to take 1 minute to complete, including gathering, preparing, and submitting the completed application form to the USPTO. Time will vary depending upon the individual case. Any comments on the amount of time you require to complete this form and/or suggestions for reducing this burden, should be sent to the Chief Information Officer, U.S. Patent and Trademark Office, U.S. Department of Commerce, P.O. Box 1450, Alexandria, VA 22313-1450. DO NOT SEND FEES OR COMPLETED FORMS TO THIS ADDRESS. SEND TO: Commissioner for Patents, P.O. Box 1450, Alexandria, VA 22313-1450.
If you need assistance in completing the form, call 1-800-PTO-9199 and select option 2.

Under the Paperwork Reduction Act of 1995, no persons are required to respond to a collection of information unless it displays a valid OMB control number.

DECLARATION (37 CFR 1.63) FOR UTILITY OR DESIGN APPLICATION USING AN APPLICATION DATA SHEET (37 CFR 1.76)

Title of Invention	PRODUCING ROUTING MESSAGES FOR VOICE OVER IP COMMUNICATIONS
---------------------------	--

As the below named inventor, I hereby declare that:

This declaration is directed to: The attached application, or
 United States application or PCT international application number 13/966,096
filed on August 13, 2013

The above-identified application was made or authorized to be made by me.

I believe that I am the original inventor or an original joint inventor of a claimed invention in the application.

I hereby acknowledge that any willful false statement made in this declaration is punishable under 18 U.S.C. 1001 by fine or imprisonment of not more than five (5) years, or both.

WARNING:

Petitioner/applicant is cautioned to avoid submitting personal information in documents filed in a patent application that may contribute to identity theft. Personal information such as social security numbers, bank account numbers, or credit card numbers (other than a check or credit card authorization form PTO-2038 submitted for payment purposes) is never required by the USPTO to support a petition or an application. If this type of personal information is included in documents submitted to the USPTO, petitioners/applicants should consider redacting such personal information from the documents before submitting them to the USPTO. Petitioner/applicant is advised that the record of a patent application is available to the public after publication of the application (unless a non-publication request in compliance with 37 CFR 1.213(a) is made in the application) or issuance of a patent. Furthermore, the record from an abandoned application may also be available to the public if the application is referenced in a published application or an issued patent (see 37 CFR 1.14). Checks and credit card authorization forms PTO-2038 submitted for payment purposes are not retained in the application file and therefore are not publicly available.

LEGAL NAME OF INVENTOR

Inventor: Johan Emil Viktor Björzell Date (Optional): 9 Dec 2013

Signature: 

Note: An application data sheet (PTO/SB/14 or equivalent), including naming the entire inventive entity, must accompany this form or must have been previously filed. Use an additional PTO/AIA/01 form for each additional inventor.

This collection of information is required by 35 U.S.C. 115 and 37 CFR 1.63. The information is required to obtain or retain a benefit by the public which is to file (and by the USPTO to process) an application. Confidentiality is governed by 35 U.S.C. 122 and 37 CFR 1.11 and 1.14. This collection is estimated to take 1 minute to complete, including gathering, preparing, and submitting the completed application form to the USPTO. Time will vary depending upon the individual case. Any comments on the amount of time you require to complete this form and/or suggestions for reducing this burden, should be sent to the Chief Information Officer, U.S. Patent and Trademark Office, U.S. Department of Commerce, P.O. Box 1450, Alexandria, VA 22313-1450. DO NOT SEND FEES OR COMPLETED FORMS TO THIS ADDRESS. SEND TO: Commissioner for Patents, P.O. Box 1450, Alexandria, VA 22313-1450.

If you need assistance in completing the form, call 1-800-PTO-9199 and select option 2.

Under the Paperwork Reduction Act of 1995, no persons are required to respond to a collection of information unless it displays a valid OMB control number.

DECLARATION (37 CFR 1.63) FOR UTILITY OR DESIGN APPLICATION USING AN APPLICATION DATA SHEET (37 CFR 1.76)

Title of Invention: **PRODUCING ROUTING MESSAGES FOR VOICE OVER IP COMMUNICATIONS**

As the below named inventor, I hereby declare that:

This declaration is directed to: The attached application, or United States application or PCT international application number 13/966,096 filed on August 13, 2013

The above identified application was made or authorized to be made by me.

I believe that I am the original inventor or an original joint inventor of a claimed invention in the application.

I hereby acknowledge that any willful false statement made in this declaration is punishable under 18 U.S.C. 1001 by fine or imprisonment of not more than five (5) years, or both.

WARNING:

Petitioner/applicant is cautioned to avoid submitting personal information in documents filed in a patent application that may contribute to identity theft. Personal information such as social security numbers, bank account numbers, or credit card numbers (other than a check or credit card authorization form PTO-2038 submitted for payment purposes) is never required by the USPTO to support a petition or an application. If this type of personal information is included in documents submitted to the USPTO, petitioners/applicants should consider redacting such personal information from the documents before submitting them to the USPTO. Petitioner/applicant is advised that the record of a patent application is available to the public after publication of the application (unless a non-publication request in compliance with 37 CFR 1.213(a) is made in the application) or issuance of a patent. Furthermore, the record from an abandoned application may also be available to the public if the application is referenced in a published application or an issued patent (see 37 CFR 1.14). Checks and credit card authorization forms PTO-2038 submitted for payment purposes are not retained in the application file and therefore are not publicly available.

LEGAL NAME OF INVENTOR

Inventor: Fuad Arafa Date (Optional): Dec. 9, 2013

Signature: 

Note: An application data sheet (PTO/SB/14 or equivalent), including naming the entire inventive entity, must accompany this form or must have been previously filed. Use an additional PTO/AIA/01 form for each additional inventor.

This collection of information is required by 35 U.S.C. 115 and 37 CFR 1.63. The information is required to obtain or retain a benefit by the public which is to file (and by the USPTO to process) an application. Confidentiality is governed by 35 U.S.C. 122 and 37 CFR 1.11 and 1.14. This collection is estimated to take 1 minute to complete, including gathering, preparing, and submitting the completed application form to the USPTO. Time will vary depending upon the individual case. Any comments on the amount of time you require to complete this form and/or suggestions for reducing this burden, should be sent to the Chief Information Officer, U.S. Patent and Trademark Office, U.S. Department of Commerce, P.O. Box 1450, Alexandria, VA 22313-1450. DO NOT SEND FEES OR COMPLETED FORMS TO THIS ADDRESS. SEND TO: Commissioner for Patents, P.O. Box 1450, Alexandria, VA 22313-1450.

If you need assistance in completing the form, call 1-800-PTO-9199 and select option 2.



UNITED STATES PATENT AND TRADEMARK OFFICE

UNITED STATES DEPARTMENT OF COMMERCE
United States Patent and Trademark Office
Address: COMMISSIONER FOR PATENTS
P.O. Box 1450
Alexandria, Virginia 22313-1450
www.uspto.gov

APPLICATION NUMBER	FILING OR 371(C) DATE	FIRST NAMED APPLICANT	ATTY. DOCKET NO./TITLE
13/966,096	08/13/2013	CLAY PERRAULT	SMARB19.001C1

CONFIRMATION NO. 8712

POA ACCEPTANCE LETTER

20995
KNOBBE MARTENS OLSON & BEAR LLP
2040 MAIN STREET
FOURTEENTH FLOOR
IRVINE, CA 92614



Date Mailed: 02/10/2014

NOTICE OF ACCEPTANCE OF POWER OF ATTORNEY

This is in response to the Power of Attorney filed 01/31/2014.

The Power of Attorney in this application is accepted. Correspondence in this application will be mailed to the above address as provided by 37 CFR 1.33.

/ctuazon/

Office of Data Management, Application Assistance Unit (571) 272-4000, or (571) 272-4200, or 1-888-786-0101

IN THE UNITED STATES PATENT AND TRADEMARK OFFICE

Inventor	:	Clay Perrault
App. No.	:	13/966,096
Filed	:	August 13, 2013
For	:	PRODUCING ROUTING MESSAGES FOR VOICE OVER IP COMMUNICATIONS
Examiner	:	Kizou, Hasson
Art Unit	:	2472
Conf. No.	:	8712

PRELIMINARY AMENDMENT

Mail Stop Amendment
Commissioner for Patents
P.O. Box 1450
Alexandria, VA 22313-1450

Dear Sir:

Prior to examination on the merits, please amend the above-referenced patent application as follows:

Amendments to the Claims are reflected in the listing of claims which begins on page 2 of this paper.

Remarks begin on page 18 of this paper.

AMENDMENTS TO THE CLAIMS

1. (Original) A process for producing a routing message for routing communications between a caller and a callee in a communication system, the process comprising:

using a caller identifier associated with the caller to locate a caller dialing profile comprising a plurality of calling attributes associated with the caller;

when at least one of said calling attributes and at least a portion of a callee identifier associated with the callee meet private network classification criteria, producing a private network routing message for receipt by a call controller, said private network routing message identifying an address, on the private network, associated with the callee; and

when at least one of said calling attributes and at least a portion of said callee identifier meet a public network classification criterion, producing a public network routing message for receipt by the call controller, said public network routing message identifying a gateway to the public network.

2. (Original) The process of claim 1, wherein said private network classification criteria include:

a) said callee identifier does not begin with the same digit pattern as an international dialing digit (IDD) attribute of said callee identifier; and

b) said callee identifier does not begin with the same digit pattern as a national dialing digit (NDD) attribute of said callee identifier; and

c) said callee identifier does not begin with the same area code as an area code of said caller; and

d) said callee identifier does not have a length that is within a range of caller local number lengths; and

e) said callee identifier is a valid username.

3. (Original) The process of claim 2, further comprising identifying the call as a cross-domain call on the private network when said callee identifier identifies a callee that is not associated with the same network node as said caller.

4. (Original) The process of claim 2, further comprising:
locating a callee dialing profile for the callee when said callee identifier identifies a callee that is associated with the same network node as said caller; and
retrieving call handling information associated with the callee, where said call handling information is available, said call handling information including at least one of call blocking information, call forwarding information, and voicemail information.

5. (Original) The process of claim 4, further comprising, where said call handling information including said call blocking information is available, blocking the call when said call blocking information identifies the caller as a caller from whom calls are to be blocked from being established with the callee.

6. (Original) The process of claim 4, further comprising, where said call handling information including said call forwarding information is available, causing said call forwarding information to be included in said private network routing message.

7. (Original) The process of claim 4, further comprising, where said call handling information including said voicemail information is available, causing said voicemail information to be included in said private network routing message.

8. (Original) The process of claim 1, further comprising associating at least one direct inward dial (DID) record with at least one subscriber to said communication system, each of said at least one direct inward dial records comprising a field storing a direct inward dial number associated with said at least one subscriber.

9. (Original) The process of claim 8, wherein said public network classification criteria include:

Application No.: 13/966,096
Filing Date: August 13, 2013

a) said callee identifier begins with the same digit pattern as an international dialing digit (IDD) attribute of said callee identifier; and

b) a reformatted callee identifier produced by removing the IDD attribute from said callee identifier has no DID bank table record.

10. (Original) The process of claim 8, wherein said public network classification criteria include:

a) said callee identifier begins with the same digit pattern as a national dialing digit (NDD) attribute of said callee identifier; and

b) a reformatted callee identifier produced by removing the NDD attribute from said callee identifier and including a caller country code has no DID bank table record.

11. (Original) The process of claim 8, wherein said public network classification criteria include:

a) said callee identifier begins with the same area code as an area code of said caller; and

b) a reformatted callee identifier produced by reformatting the callee identifier to include a caller country code has no DID bank table record.

12. (Original) The process of claim 8, wherein said public network classification criteria include:

a) said callee identifier has a length that is within a range of caller local number lengths; and

b) a reformatted callee identifier produced by reformatting the callee identifier to include a caller country code and area code has no DID bank table record.

13. (Original) The process of claim 1, wherein said plurality of calling attributes includes at least one of an international dialing digits identifier, a national dialing digits identifier, a country code identifier, a local area codes identifier, a caller minimum local length

identifier, a caller maximum local length identifier, a reseller identifier, and a maximum number of concurrent calls identifier.

14. (Original) The process of claim 8, wherein said DID record comprises a user name field, a user domain field and a DID number field.

15. (Original) The process of claim 1, further comprising maintaining a list of public network route suppliers and when said public network classification criterion is met identifying at least one of said public network route suppliers that satisfies public network routing selection criteria.

16. (Original) The process of claim 15, wherein said producing said public network routing message comprises producing a public network routing message identifying said at least one public network route supplier that satisfies said public network routing selection criteria.

17. (Original) The process of claim 16, wherein producing said public network routing message comprises causing said public network routing message to include a gateway supplier identifier identifying a gateway supplier able to establish a communications link in a route through which communications between the caller and callee are to be conducted.

18. (Original) The process of claim 17, further comprising causing said public network routing message to include a time value and a timeout value.

19. (Original) The process of claim 17, wherein causing said public network routing message to include said gateway supplier identifier comprises causing said public network routing message to include a plurality of gateway supplier identifiers identifying a plurality of gateway suppliers able to supply respective communication links through which communications between the caller and callee can be conducted.

20. (Original) The process of claim 19, further comprising causing said public network routing message to include priority information identifying a priority in which gateway suppliers associated with said gateway identifiers are to be considered for selection of a communication link through which communications between the caller and callee can be conducted.

21. (Original) The process of claim 19, wherein causing said public network routing message to include priority information includes arranging said gateway supplier identifiers in said public network routing message in order of rate, where rate is determined from rate fields of respective said gateway supplier records.

22. (Original) The process of claim 21, wherein arranging said gateway supplier identifiers in order of rate comprises arranging said gateway supplier identifiers in order of increasing rate.

23. (Original) The process of claim 17, further comprising arranging said gateway supplier identifiers in an order based on at least one provision in a service agreement.

24. (Original) The process of claim 1, further comprising causing the private network routing message or the public network routing message to be communicated to a call controller to effect routing of the call.

25. (Original) A non-transitory computer readable medium encoded with codes for directing a processor to execute the method of claim 1.

26. (Original) A call routing controller apparatus for producing a routing message for routing communications between a caller and a callee in a communication system, the apparatus comprising:

at least one processor operably configured to:

use a caller identifier associated with the caller to locate a caller dialing profile comprising a plurality of calling attributes associated with the caller;

when at least one of said calling attributes and at least a portion of a callee identifier associated with the callee meet private network classification criteria, produce a private network routing message for receipt by a call controller, said private network routing message identifying an address, on the private network, associated with the callee; and

when at least one of said calling attributes and at least a portion of said callee identifier meet a public network classification criterion, produce a public network routing message for receipt by the call controller, said public network routing message identifying a gateway to the public network.

27. (Original) The apparatus of claim 26, wherein said private network classification criteria include:

- a) said callee identifier does not begin with the same digit pattern as an international dialing digit (IDD) attribute of said callee identifier; and
- b) said callee identifier does not begin with the same digit pattern as a national dialing digit (NDD) attribute of said callee identifier; and
- c) said callee identifier does not begin with the same area code as an area code of said caller; and
- d) said callee identifier does not have a length that is within a range of caller local number lengths; and
- e) said callee identifier is a valid username.

28. (Original) The apparatus of claim 27, wherein said at least one processor is further operably configured to identify the call as a cross-domain call on the private network when said callee identifier identifies a callee that is not associated with the same network node as said caller.

29. (Original) The apparatus of claim 27, wherein said at least one processor is further configured to:

access the database of caller dialing profiles to locate a callee dialing profile for the callee when said callee identifier identifies a callee that is associated with the same network node as said caller; and

retrieve call handling information associated with the callee, where said call handling information is available, said call handling information including at least one of call blocking information, call forwarding information, and voicemail information.

30. (Original) The apparatus of claim 29, wherein said at least one processor is further operably configured to determine whether said call handling information including said call blocking information is available and to block the call when said call blocking information identifies the caller as a caller from whom calls are to be blocked.

31. (Original) The apparatus of claim 29, wherein said at least one processor is further operably configured to determine whether said call handling information including said call forwarding information is available and to cause said call forwarding information to be included in said private network routing message.

32. (Original) The apparatus of claim 29, wherein said at least one processor is further operably configured to determine whether said call handling information including said voicemail information is available and to cause said voicemail information to be included in said private network routing message.

33. (Original) The apparatus of claim 26, wherein said at least one processor is further operably configured to access a database of direct inward dial records each associating at least one direct inward dial number with at least one subscriber to said communication system.

34. (Original) The apparatus of claim 33, wherein said public network classification criteria include:

- a) said callee identifier begins with the same digit pattern as an international dialing digit (IDD) attribute of said callee identifier; and

Application No.: 13/966,096
Filing Date: August 13, 2013

b) a reformatted callee identifier produced by removing the IDD attribute from said callee identifier has no DID record.

35. (Original) The apparatus of claim 33, wherein said public network classification criteria include:

a) said callee identifier begins with the same digit pattern as a national dialing digit (NDD) attribute of said callee identifier; and

b) a reformatted callee identifier produced by removing the NDD attribute from said callee identifier and including a caller country code has no DID record.

36. (Original) The apparatus of claim 33, wherein said public network classification criteria include:

a) said callee identifier begins with the same area code as an area code of said caller; and

b) a reformatted callee identifier produced by reformatting the callee identifier to include a caller country code has no DID record.

37. (Original) The apparatus of claim 33, wherein said public network classification criteria include:

a) said callee identifier has a length that is within a range of caller local number lengths; and

b) a reformatted callee identifier produced by reformatting the callee identifier to include a caller country code and area code has no DID record.

38. (Original) The apparatus of claim 26, wherein said plurality of calling attributes includes at least one of an international dialing digits identifier, a national dialing digits identifier, a country code identifier, a local area codes identifier, a caller minimum local length identifier, a caller maximum local length identifier, a reseller identifier, and a maximum number of concurrent calls identifier.

39. (Original) The apparatus of claim 33, wherein said DID record comprises a user name field, a user domain field and a DID number field.

40. (Original) The apparatus of claim 26, wherein said at least one processor is further operably configured to access a list of public network route suppliers when said public network classification criterion is met and to identify at least one of said public network route suppliers that satisfies public network routing selection criteria.

41. (Original) The apparatus of claim 40, wherein said at least one processor is further operably configured to produce a public network routing message identifying said at least one public network route supplier that satisfies said public network routing selection criteria.

42. (Original) The apparatus of claim 41, wherein said at least one processor is operably configured to cause said public network routing message to include a gateway supplier identifier identifying a gateway supplier able to establish a communications link in a route through which communications between the caller and callee can be conducted.

43. (Original) The apparatus of claim 42, wherein said at least one processor is operably configured to cause said public network routing message to include a time value and a timeout value.

44. (Original) The apparatus of claim 42, wherein said at least one processor is operably configured to cause said public network routing message to include a plurality of gateway supplier identifiers identifying a plurality of gateway suppliers able to supply respective communication links through which communications between the caller and callee can be conducted.

45. (Original) The apparatus of claim 44, wherein said at least one processor is operably configured to cause said public network routing message to include priority information identifying a priority in which gateway suppliers associated with said gateway identifiers are to

be considered for selection of a communication link through which communications between the caller and callee can be conducted.

46. (Original) The apparatus of claim 44, wherein said at least one processor is operably configured to arrange said gateway supplier identifiers in said public network routing message in order of rate, where rate is determined from rate fields of respective said gateway supplier records.

47. (Original) The apparatus of claim 46, wherein said at least one processor is operably configured to arrange said gateway supplier identifiers in order of increasing rate.

48. (Original) The apparatus of claim 42, wherein said at least one processor is operably configured to arrange said gateway supplier identifiers in an order based on at least one provision in a service agreement.

49. (Original) The apparatus of claim 26, wherein said at least one processor is further operably configured to cause the private network routing message or the public network routing message to be communicated to a call controller to effect routing of the call.

50. (Original) A call routing controller apparatus for producing a routing message for routing communications between a caller and a callee in a communication system, the apparatus comprising:

means for using a caller identifier associated with the caller to locate a caller dialing profile comprising a plurality of calling attributes associated with the caller; and

means for, when at least one of said calling attributes and at least a portion of a callee identifier associated with the callee meet private network classification criteria, producing a private network routing message for receipt by a call controller, said private network routing message identifying an address, on the private network, associated with the callee; and

means for, when at least one of said calling attributes and at least a portion of said callee identifier meet a public network classification criterion, producing a public

network routing message for receipt by the call controller, said public network routing message identifying a gateway to the public network.

51. (Original) The apparatus of claim 50, wherein said private network classification criteria include:

a) said callee identifier does not begin with the same digit pattern as an international dialing digit (IDD) attribute of said callee identifier; and

b) said callee identifier does not begin with the same digit pattern as a national dialing digit (NDD) attribute of said callee identifier; and

c) said callee identifier does not begin with the same area code as an area code of said caller; and

said callee identifier does not have a length that is within a range of caller local number lengths; and

said callee identifier is a valid username.

52. (Original) The apparatus of claim 51, further comprising means for identifying the call as a cross-domain call on the private network when said callee identifier identifies a callee that is not associated with the same network node as said caller.

53. (Original) The apparatus of claim 51, further comprising:

means for accessing the database of caller dialing profiles to locate a callee dialing profile for the callee when said callee identifier identifies a callee that is associated with the same network node as said caller; and

means for retrieving call handling information associated with the callee, where said call handling information is available, said call handling information including at least one of call blocking information, call forwarding information, and voicemail information.

54. (Original) The apparatus of claim 53, further comprising, where said call handling information including said call blocking information is available, means for blocking the call being established with the callee when said call blocking information identifies the caller as a caller from whom calls are to be blocked.

Application No.: 13/966,096
Filing Date: August 13, 2013

55. (Original) The apparatus of claim 53, further comprising, means for causing said call forwarding information to be included in said private network routing message, where said call handling information including said call forwarding information is available.

56. (Original) The apparatus of claim 53, further comprising, where said call handling information including said voicemail information is available, means for causing said voicemail information to be included in said private network routing message.

57. (Original) The apparatus of claim 50, further comprising means for accessing a database of direct inward dial records each associating at least one direct inward dial number with at least one subscriber to said communication system.

58. (Original) The apparatus of claim 57, wherein said public network classification criteria include:

- a) said callee identifier begins with the same digit pattern as an international dialing digit (IDD) attribute of said callee identifier; and
- b) a reformatted callee identifier produced by removing the IDD attribute from said callee identifier has no DID record.

59. (Original) The apparatus of claim 57, wherein said public network classification criteria include:

- a) said callee identifier begins with the same digit pattern as a national dialing digit (NDD) attribute of said callee identifier; and
- b) a reformatted callee identifier produced by removing the NDD attribute from said callee identifier and including a caller country code has no DID record.

60. (Original) The apparatus of claim 57, wherein said public network classification criteria include:

- a) said callee identifier begins with the same area code as an area code of said caller; and

Application No.: 13/966,096
Filing Date: August 13, 2013

b) a reformatted callee identifier produced by reformatting the callee identifier to include a caller country code has no DID record.

61. (Original) The apparatus of claim 57, wherein said public network classification criteria include:

a) said callee identifier has a length that is within a range of caller local number lengths; and

b) a reformatted callee identifier produced by reformatting the callee identifier to include a caller country code and area code has no DID record.

62. (Original) The apparatus of claim 50, wherein said plurality of calling attributes includes at least one of an international dialing digits identifier, a national dialing digits identifier, a country code identifier, a local area codes identifier, a caller minimum local length identifier, a caller maximum local length identifier, a reseller identifier, and a maximum number of concurrent calls identifier.

63. (Original) The apparatus of claim 57, wherein said DID record comprises a user name field, a user domain field and a DID number field.

64. (Original) The apparatus of claim 50, further comprising means for accessing a list of public network route suppliers when said public network classification criterion is met and means for identifying at least one of said public network route suppliers that satisfies public network routing selection criteria.

65. (Original) The apparatus of claim 64, wherein said means for producing said public network routing message comprises means for producing a public network routing message identifying said at least one public network route supplier that satisfies said public network routing selection criteria.

66. (Original) The apparatus of claim 65, wherein said means for producing said public network routing message comprises means for causing said public network routing

Application No.: 13/966,096
Filing Date: August 13, 2013

message to include a gateway supplier identifier identifying a gateway supplier able to establish a communications link in a route through which communications between the caller and callee can be conducted.

67. (Original) The apparatus of claim 66, further comprising means for causing said public network routing message to include a time value and a timeout value.

68. (Original) The apparatus of claim 66, wherein said means for causing said public network routing message to include said gateway supplier identifier comprises means for causing said public network routing message to include a plurality of gateway supplier identifiers identifying a plurality of gateway suppliers able to supply respective communication links through which communications between the caller and callee can be conducted.

69. (Original) The apparatus of claim 68, further comprising means for causing said public network routing message to include priority information identifying a priority in which gateway suppliers associated with said gateway identifiers are to be considered for selection of a communication link through which communications between the caller and callee can be conducted.

70. (Original) The apparatus of claim 68, wherein said means for causing said public network routing message to include priority information includes means for arranging said gateway supplier identifiers in said public network routing message in order of rate, where rate is determined from rate fields of respective said gateway supplier records.

71. (Original) The apparatus of claim 70, wherein said means for arranging said gateway supplier identifiers in order of rate comprises means for arranging said gateway supplier identifiers in order of increasing rate.

72. (Original) The apparatus of claim 66, further comprising means for arranging said gateway supplier identifiers in an order based on at least one provision in a service agreement.

73. (Original) The apparatus of claim 50, further comprising means for causing the private network routing message or the public network routing message to be communicated to a call controller to effect routing of the call.

74. (Original) A non-transitory computer readable medium having stored thereon data structure for associating together a collection of information for use in producing a routing message for routing communications in a communications system, the data structure comprising:

dialing profile records comprising fields for associating a subscriber username with respective subscribers to the system;

direct-in-dial records comprising fields for associating a user domain and a direct-in-dial number with respective subscriber usernames;

prefix to node records comprising fields for associating a node address of a node in said system with at least a portion of said respective subscriber usernames:

whereby said subscriber username can be used to find said user domain, at least a portion of said subscriber username can be used to find said node with which a subscriber identified by said subscriber user name is associated, and said user domain and said subscriber username can be located in response to said direct-in-dial number.

75. (Original) A non-transitory computer readable medium having stored thereon a data structure for associating together a collection of information for use in producing a routing message in a communications system, the data structure comprising:

master list records comprising fields for associating a dialing code with respective master list identifiers; and

supplier list records linked to said master list records by said master list identifiers, said supplier list records comprising fields for associating the following information with a communications services supplier:

a supplier id;

a master list id;

a route identifier; and

a billing rate code,

Application No.: 13/966,096
Filing Date: August 13, 2013

whereby at least one communications service supplier is associated with said dialing code, such that said dialing code can be used to locate suppliers capable of providing a communications link associated with a given dialing code.

76. (Original) A non-transitory computer readable medium having stored thereon a data structure for associating together a collection of information for use in producing a routing message for routing communications, the data structure comprising:

- a username field;
- a domain field;
- a national dialing digits (NDD) field;
- an international dialing digits (IDD) field;
- a country code field;
- a local area code field;
- a caller minimum local length field; and
- a caller maximum local length field.

77. (Original) The non-transitory computer readable medium of claim 76, further comprising a reseller field.

78. (Currently amended) The non-transitory computer readable medium of claim 76, further comprising:

- a maximum number of concurrent calls field; and
- a current ~~umber~~ number of concurrent calls field.

Application No.: 13/966,096
Filing Date: August 13, 2013

REMARKS

Please make the above indicated amendment to the claims, correcting a typographical error in Claim 78, prior to examination.

Conclusion

Although the present communication may include alterations to the application or claims, or characterizations of claim scope or referenced art, Applicant is not conceding in this application that previously pending claims are not patentable over the cited references. Rather, any alterations or characterizations are being made to facilitate expeditious prosecution of this application. Applicant reserves the right to pursue at a later date any previously pending or other broader or narrower claims that capture any subject matter supported by the present disclosure, including subject matter found to be specifically disclaimed herein or by any prior prosecution. Accordingly, reviewers of this or any parent, child or related prosecution history shall not reasonably infer that Applicant has made any disclaimers or disavowals of any subject matter supported by the present application.

If the Examiner requires any clarification, the Examiner is respectfully requested to call the undersigned at the provided telephone number in order to resolve any such issue promptly.

Please charge any additional fees, including any fees for additional extension of time, or credit overpayment to Deposit Account No. 11-1410.

Respectfully submitted,

KNOBBE, MARTENS, OLSON & BEAR, LLP

Dated: 3/4/14

By: 

John M. Carson
Registration No. 34,303
Attorney of Record
Customer No. 20995
(858) 707-4000

Electronic Acknowledgement Receipt

EFS ID:	18369097
Application Number:	13966096
International Application Number:	
Confirmation Number:	8712
Title of Invention:	PRODUCING ROUTING MESSAGES FOR VOICE OVER IP COMMUNICATIONS
First Named Inventor/Applicant Name:	CLAY PERRAULT
Customer Number:	20995
Filer:	John M Carson/Erica Directo
Filer Authorized By:	John M Carson
Attorney Docket Number:	SMARB19.001C1
Receipt Date:	04-MAR-2014
Filing Date:	13-AUG-2013
Time Stamp:	19:29:51
Application Type:	Utility under 35 USC 111(a)

Payment information:

Submitted with Payment	no
------------------------	----

File Listing:

Document Number	Document Description	File Name	File Size(Bytes)/ Message Digest	Multi Part /.zip	Pages (if appl.)
1		SMARB19001C1preliminaryamendment.pdf	801098 <small>33600fad5509c6892ea6b8816fb00d077fbc2faf</small>	yes	18

Multipart Description/PDF files in .zip description			
Document Description		Start	End
Preliminary Amendment		1	1
Claims		2	17
Applicant Arguments/Remarks Made in an Amendment		18	18

Warnings:

Information:

Total Files Size (in bytes):	801098
-------------------------------------	--------

This Acknowledgement Receipt evidences receipt on the noted date by the USPTO of the indicated documents, characterized by the applicant, and including page counts, where applicable. It serves as evidence of receipt similar to a Post Card, as described in MPEP 503.

New Applications Under 35 U.S.C. 111

If a new application is being filed and the application includes the necessary components for a filing date (see 37 CFR 1.53(b)-(d) and MPEP 506), a Filing Receipt (37 CFR 1.54) will be issued in due course and the date shown on this Acknowledgement Receipt will establish the filing date of the application.

National Stage of an International Application under 35 U.S.C. 371

If a timely submission to enter the national stage of an international application is compliant with the conditions of 35 U.S.C. 371 and other applicable requirements a Form PCT/DO/EO/903 indicating acceptance of the application as a national stage submission under 35 U.S.C. 371 will be issued in addition to the Filing Receipt, in due course.

New International Application Filed with the USPTO as a Receiving Office

If a new international application is being filed and the international application includes the necessary components for an international filing date (see PCT Article 11 and MPEP 1810), a Notification of the International Application Number and of the International Filing Date (Form PCT/RO/105) will be issued in due course, subject to prescriptions concerning national security, and the date shown on this Acknowledgement Receipt will establish the international filing date of the application.

Under the Paperwork Reduction Act of 1995, no persons are required to respond to a collection of information unless it displays a valid OMB control number.

PATENT APPLICATION FEE DETERMINATION RECORD Substitute for Form PTO-875	Application or Docket Number 13/966,096	Filing Date 08/13/2013	<input type="checkbox"/> To be Mailed
---	---	----------------------------------	---------------------------------------

ENTITY: LARGE SMALL MICRO

APPLICATION AS FILED – PART I

FOR	NUMBER FILED	NUMBER EXTRA	RATE (\$)	FEE (\$)
<input type="checkbox"/> BASIC FEE <small>(37 CFR 1.16(a), (b), or (c))</small>	N/A	N/A	N/A	
<input type="checkbox"/> SEARCH FEE <small>(37 CFR 1.16(k), (l), or (m))</small>	N/A	N/A	N/A	
<input type="checkbox"/> EXAMINATION FEE <small>(37 CFR 1.16(o), (p), or (q))</small>	N/A	N/A	N/A	
TOTAL CLAIMS <small>(37 CFR 1.16(i))</small>	minus 20 =	*	X \$ =	
INDEPENDENT CLAIMS <small>(37 CFR 1.16(h))</small>	minus 3 =	*	X \$ =	
<input type="checkbox"/> APPLICATION SIZE FEE <small>(37 CFR 1.16(s))</small>	If the specification and drawings exceed 100 sheets of paper, the application size fee due is \$310 (\$155 for small entity) for each additional 50 sheets or fraction thereof. See 35 U.S.C. 41(a)(1)(G) and 37 CFR 1.16(s).			
<input type="checkbox"/> MULTIPLE DEPENDENT CLAIM PRESENT <small>(37 CFR 1.16(j))</small>				
* If the difference in column 1 is less than zero, enter "0" in column 2.			TOTAL	

APPLICATION AS AMENDED – PART II

	(Column 1)	(Column 2)	(Column 3)	PRESENT EXTRA	RATE (\$)	ADDITIONAL FEE (\$)
AMENDMENT	03/04/2014	CLAIMS REMAINING AFTER AMENDMENT	HIGHEST NUMBER PREVIOUSLY PAID FOR			
	Total <small>(37 CFR 1.16(i))</small>	* 78	Minus	** 78	= 0	X \$40 = 0
	Independent <small>(37 CFR 1.16(h))</small>	* 6	Minus	***6	= 0	X \$210 = 0
	<input type="checkbox"/> Application Size Fee <small>(37 CFR 1.16(s))</small>					
<input type="checkbox"/> FIRST PRESENTATION OF MULTIPLE DEPENDENT CLAIM <small>(37 CFR 1.16(j))</small>						
					TOTAL ADD'L FEE	0

	(Column 1)	(Column 2)	(Column 3)	PRESENT EXTRA	RATE (\$)	ADDITIONAL FEE (\$)
AMENDMENT		CLAIMS REMAINING AFTER AMENDMENT	HIGHEST NUMBER PREVIOUSLY PAID FOR			
	Total <small>(37 CFR 1.16(i))</small>	*	Minus	**	=	X \$ =
	Independent <small>(37 CFR 1.16(h))</small>	*	Minus	***	=	X \$ =
	<input type="checkbox"/> Application Size Fee <small>(37 CFR 1.16(s))</small>					
<input type="checkbox"/> FIRST PRESENTATION OF MULTIPLE DEPENDENT CLAIM <small>(37 CFR 1.16(j))</small>						
					TOTAL ADD'L FEE	

* If the entry in column 1 is less than the entry in column 2, write "0" in column 3.
 ** If the "Highest Number Previously Paid For" IN THIS SPACE is less than 20, enter "20".
 *** If the "Highest Number Previously Paid For" IN THIS SPACE is less than 3, enter "3".
 The "Highest Number Previously Paid For" (Total or Independent) is the highest number found in the appropriate box in column 1.

LIE
/STELLA LITTLE/

This collection of information is required by 37 CFR 1.16. The information is required to obtain or retain a benefit by the public which is to file (and by the USPTO to process) an application. Confidentiality is governed by 35 U.S.C. 122 and 37 CFR 1.14. This collection is estimated to take 12 minutes to complete, including gathering, preparing, and submitting the completed application form to the USPTO. Time will vary depending upon the individual case. Any comments on the amount of time you require to complete this form and/or suggestions for reducing this burden, should be sent to the Chief Information Officer, U.S. Patent and Trademark Office, U.S. Department of Commerce, P.O. Box 1450, Alexandria, VA 22313-1450. DO NOT SEND FEES OR COMPLETED FORMS TO THIS ADDRESS. **SEND TO: Commissioner for Patents, P.O. Box 1450, Alexandria, VA 22313-1450.**

If you need assistance in completing the form, call 1-800-PTO-9199 and select option 2.

INFORMATION DISCLOSURE STATEMENT BY APPLICANT	Application No.	13/966,096	
	Filing Date	August 13, 2013	
	First Named Inventor	Perrault, Clay	
	Art Unit	2472	
<i>(Multiple sheets used when necessary)</i>		Examiner	Kizou, Hassan
SHEET 1 OF 1		Attorney Docket No.	SMARBI9.001C1

U.S. PATENT DOCUMENTS					
Examiner Initials	Cite No.	Document Number Number - Kind Code (if known) Example: 1,234,567 B1	Publication Date MM-DD-YYYY	Name of Patentee or Applicant	Pages, Columns, Lines Where Relevant Passages or Relevant Figures Appear
	1	5,719,926	2/17/1998	Hill, Vincent F.	
	2	5,722,067	2/24/1998	Fougnyes et al.	
	3	5,915,093	6/22/1999	Berlin et al.	
	4	6,029,062	2/22/2000	Hanson, Daniel A.	
	5	6,249,573	6/19/2001	Hudson, Dan	
	6	7,454,200	11/18/2008	Cai et al.	
	7	8,630,234	1/14/2014	Björzell et al.	
	8	8,675,566	3/18/2014	Huttunen et al.	
	9	2005/0198499 A1	9/8/2005	Salapaka et al.	
	10	2010/0150138 A1	6/17/2010	Björzell et al.	
	11	2010/0150328 A1	6/17/2010	Perrault et al.	
	12	2010/0172345 A1	7/8/2010	Björzell et al.	
	13	2011/0122827 A1	5/26/2011	Björzell et al.	
	14	2012/0170574 A1	7/5/2012	Huttunen et al.	

FOREIGN PATENT DOCUMENTS						
Examiner Initials	Cite No.	Foreign Patent Document Country Code-Number-Kind Code Example: JP 1234567 A1	Publication Date MM-DD-YYYY	Name of Patentee or Applicant	Pages, Columns, Lines Where Relevant Passages or Relevant Figures Appear	T ¹

NON PATENT LITERATURE DOCUMENTS			
Examiner Initials	Cite No.	Include name of the author (in CAPITAL LETTERS), title of the article (when appropriate), title of the item (book, magazine, journal, serial, symposium, catalog, etc.), date, page(s), volume-issue number(s), publisher, city and/or country where published.	T ¹
	15	Extended European Search Report dated December 20, 2013 for European Application No. 09849358.8 dated June 18, 2012.	

17407609
030514

Examiner Signature	Date Considered
--------------------	-----------------

***Examiner:** Initial if reference considered, whether or not citation is in conformance with MPEP 609. Draw line through citation if not in conformance and not considered. Include copy of this form with next communication to applicant.

T¹ - Place a check mark in this area when an English language Translation is attached. AT&T, Exh. 1002, p. 176

Electronic Acknowledgement Receipt

EFS ID:	18515250
Application Number:	13966096
International Application Number:	
Confirmation Number:	8712
Title of Invention:	PRODUCING ROUTING MESSAGES FOR VOICE OVER IP COMMUNICATIONS
First Named Inventor/Applicant Name:	CLAY PERRAULT
Customer Number:	20995
Filer:	John M Carson/Norman Green
Filer Authorized By:	John M Carson
Attorney Docket Number:	SMARB19.001C1
Receipt Date:	18-MAR-2014
Filing Date:	13-AUG-2013
Time Stamp:	18:59:42
Application Type:	Utility under 35 USC 111(a)

Payment information:

Submitted with Payment	no
------------------------	----

File Listing:

Document Number	Document Description	File Name	File Size(Bytes)/ Message Digest	Multi Part /.zip	Pages (if appl.)
1		IDS_SMARB19_001C1_03_18_2014.pdf	95976 26c3c9b0481edbf675d966bab847c42a0ad0d589	yes	2

Multipart Description/PDF files in .zip description			
	Document Description	Start	End
	Transmittal Letter	1	1
	Information Disclosure Statement (IDS) Form (SB08)	2	2

Warnings:

Information:

2	Non Patent Literature	Ref15_EP_EESR_EP09849358.pdf	470227 f5f3f1c6e6abaa38858e902fdcd371a4916b5fff	no	5
---	-----------------------	------------------------------	--	----	---

Warnings:

Information:

Total Files Size (in bytes):		566203
-------------------------------------	--	--------

This Acknowledgement Receipt evidences receipt on the noted date by the USPTO of the indicated documents, characterized by the applicant, and including page counts, where applicable. It serves as evidence of receipt similar to a Post Card, as described in MPEP 503.

New Applications Under 35 U.S.C. 111

If a new application is being filed and the application includes the necessary components for a filing date (see 37 CFR 1.53(b)-(d) and MPEP 506), a Filing Receipt (37 CFR 1.54) will be issued in due course and the date shown on this Acknowledgement Receipt will establish the filing date of the application.

National Stage of an International Application under 35 U.S.C. 371

If a timely submission to enter the national stage of an international application is compliant with the conditions of 35 U.S.C. 371 and other applicable requirements a Form PCT/DO/EO/903 indicating acceptance of the application as a national stage submission under 35 U.S.C. 371 will be issued in addition to the Filing Receipt, in due course.

New International Application Filed with the USPTO as a Receiving Office

If a new international application is being filed and the international application includes the necessary components for an international filing date (see PCT Article 11 and MPEP 1810), a Notification of the International Application Number and of the International Filing Date (Form PCT/RO/105) will be issued in due course, subject to prescriptions concerning national security, and the date shown on this Acknowledgement Receipt will establish the international filing date of the application.

INFORMATION DISCLOSURE STATEMENT

Inventor	: Clay Perrault et al.
App. No.	: 13/966,096
Filed	: August 13, 2013
For	: PRODUCING ROUTING MESSAGES FOR VOICE OVER IP COMMUNICATIONS
Examiner	: Kizou, Hassan
Art Unit	: 2472
Conf. No.	: 8712

Commissioner for Patents
P.O. Box 1450
Alexandria, VA 22313-1450

References and Listing

Submitted herewith in the above-identified application is an Information Disclosure Statement listing references for consideration. Copies of any listed foreign and non-patent literature references are being submitted.

Timing of Disclosure

This Information Disclosure Statement is being filed before the receipt of a First Office Action on the merits, and presumably no fee is required. If a First Office Action on the merits was mailed before the mailing date of this Statement, the Commissioner is authorized to charge the fee set forth in 37 CFR 1.17(p) to Deposit Account No. 11-1410.

Respectfully submitted,

KNOBBE, MARTENS, OLSON & BEAR, LLP

Dated: _____

3/18/14

By: _____

John M. Carson
Registration No. 34,303
Attorney of Record
Customer No. 20995
(858) 707-4000

IDS
17407973
030514

INFORMATION DISCLOSURE STATEMENT BY APPLICANT	Application No.	13/966,096	
	Filing Date	August 13, 2013	
	First Named Inventor	Perrault, Clay	
	Art Unit	2472	
<i>(Multiple sheets used when necessary)</i>		Examiner	Kizou, Hassan
SHEET 1 OF 1		Attorney Docket No.	SMARB19.001C1

U.S. PATENT DOCUMENTS					
Examiner Initials	Cite No.	Document Number <i>Number - Kind Code (if known)</i> Example: 1,234,567 B1	Publication Date MM-DD-YYYY	Name of Patentee or Applicant	Pages, Columns, Lines Where Relevant Passages or Relevant Figures Appear

FOREIGN PATENT DOCUMENTS						
Examiner Initials	Cite No.	Foreign Patent Document <i>Country Code-Number-Kind Code</i> Example: JP 1234567 A1	Publication Date MM-DD-YYYY	Name of Patentee or Applicant	Pages, Columns, Lines Where Relevant Passages or Relevant Figures Appear	T ¹
	1	EP 2 090 024 A0	8/19/2009	Björzell et al.		

NON PATENT LITERATURE DOCUMENTS			
Examiner Initials	Cite No.	Include name of the author (in CAPITAL LETTERS), title of the article (when appropriate), title of the item (book, magazine, journal, serial, symposium, catalog, etc.), date, page(s), volume-issue number(s), publisher, city and/or country where published.	T ¹
	2	Extended European Search Report dated November 2, 2012 for European Application No. EP 07 855 436.7	

17537789
032014

Examiner Signature	Date Considered
<p>*Examiner: Initial if reference considered, whether or not citation is in conformance with MPEP 609. Draw line through citation if not in conformance and not considered. Include copy of this form with next communication to applicant.</p>	

T¹ - Place a check mark in this area when an English language Translation is attached AT&T, Exh. 1002, p. 180

Electronic Acknowledgement Receipt

EFS ID:	18540746
Application Number:	13966096
International Application Number:	
Confirmation Number:	8712
Title of Invention:	PRODUCING ROUTING MESSAGES FOR VOICE OVER IP COMMUNICATIONS
First Named Inventor/Applicant Name:	CLAY PERRAULT
Customer Number:	20995
Filer:	John M Carson/Norman Green
Filer Authorized By:	John M Carson
Attorney Docket Number:	SMARB19.001C1
Receipt Date:	20-MAR-2014
Filing Date:	13-AUG-2013
Time Stamp:	17:36:19
Application Type:	Utility under 35 USC 111(a)

Payment information:

Submitted with Payment	no
------------------------	----

File Listing:

Document Number	Document Description	File Name	File Size(Bytes)/ Message Digest	Multi Part /.zip	Pages (if appl.)
1		IDS_SMARB19_001C1_03_20_2014.pdf	79336 7979cde53b0ce29ed4f52e472996e05d143ba77d	yes	2

Multipart Description/PDF files in .zip description			
	Document Description	Start	End
	Transmittal Letter	1	1
	Information Disclosure Statement (IDS) Form (SB08)	2	2

Warnings:

Information:

2	Foreign Reference	Ref1_EP2090024A0.pdf	8168641 c410226fbd6fd4a44f5f412ebbc2cdd7e96e97be	no	110
---	-------------------	----------------------	---	----	-----

Warnings:

Information:

3	Non Patent Literature	Ref2_EP_EESR_EP07855436_7.pdf	681617 01098ae2cd6851494b2d3cecd5488d754557d40	no	8
---	-----------------------	-------------------------------	---	----	---

Warnings:

Information:

Total Files Size (in bytes):			8929594
-------------------------------------	--	--	---------

This Acknowledgement Receipt evidences receipt on the noted date by the USPTO of the indicated documents, characterized by the applicant, and including page counts, where applicable. It serves as evidence of receipt similar to a Post Card, as described in MPEP 503.

New Applications Under 35 U.S.C. 111

If a new application is being filed and the application includes the necessary components for a filing date (see 37 CFR 1.53(b)-(d) and MPEP 506), a Filing Receipt (37 CFR 1.54) will be issued in due course and the date shown on this Acknowledgement Receipt will establish the filing date of the application.

National Stage of an International Application under 35 U.S.C. 371

If a timely submission to enter the national stage of an international application is compliant with the conditions of 35 U.S.C. 371 and other applicable requirements a Form PCT/DO/EO/903 indicating acceptance of the application as a national stage submission under 35 U.S.C. 371 will be issued in addition to the Filing Receipt, in due course.

New International Application Filed with the USPTO as a Receiving Office

If a new international application is being filed and the international application includes the necessary components for an international filing date (see PCT Article 11 and MPEP 1810), a Notification of the International Application Number and of the International Filing Date (Form PCT/RO/105) will be issued in due course, subject to prescriptions concerning national security, and the date shown on this Acknowledgement Receipt will establish the international filing date of the application.

INFORMATION DISCLOSURE STATEMENT

Inventor : Clay Perrault et al.
App. No. : 13/966,096
Filed : August 13, 2013
For : PRODUCING ROUTING MESSAGES FOR
VOICE OVER IP COMMUNICATIONS
Examiner : Kizou, Hassan
Art Unit : 2472
Conf. No. : 8712

Commissioner for Patents
P.O. Box 1450
Alexandria, VA 22313-1450

References and Listing

Submitted herewith in the above-identified application is an Information Disclosure Statement listing references for consideration. Copies of any listed foreign and non-patent literature references are being submitted.

Timing of Disclosure

This Information Disclosure Statement is being filed before the receipt of a First Office Action on the merits, and presumably no fee is required. If a First Office Action on the merits was mailed before the mailing date of this Statement, the Commissioner is authorized to charge the fee set forth in 37 CFR 1.17(p) to Deposit Account No. 11-1410.

Respectfully submitted,
KNOBBE, MARTENS, OLSON & BEAR, LLP

Dated: _____

3/20/14

By: _____

John M. Carson
Registration No. 34,303
Attorney of Record
Customer No. 20995
(858) 707-4000

IDS
17537813
032014

INFORMATION DISCLOSURE STATEMENT BY APPLICANT	Application No.	13/966,096
	Filing Date	August 13, 2013
	First Named Inventor	Clay Perrault
	Art Unit	2472
<i>(Multiple sheets used when necessary)</i>	Examiner	Kizou, Hassan
SHEET 1 OF 1	Attorney Docket No.	SMARB19.001C1

U.S. PATENT DOCUMENTS					
Examiner Initials	Cite No.	Document Number <i>Number - Kind Code (if known)</i> Example: 1,234,567 B1	Publication Date MM-DD-YYYY	Name of Patentee or Applicant	Pages, Columns, Lines Where Relevant Passages or Relevant Figures Appear

FOREIGN PATENT DOCUMENTS						
Examiner Initials	Cite No.	Foreign Patent Document <i>Country Code-Number-Kind Code</i> Example: JP 1234567 A1	Publication Date MM-DD-YYYY	Name of Patentee or Applicant	Pages, Columns, Lines Where Relevant Passages or Relevant Figures Appear	T ¹
	1	WO 2007/056158 A2	05-18-2007	Roamware, Inc.		
	2	WO 2008/027065 A1	03-06-2008	Syniverse Technologies, Inc.		

NON PATENT LITERATURE DOCUMENTS			
Examiner Initials	Cite No.	Include name of the author (in CAPITAL LETTERS), title of the article (when appropriate), title of the item (book, magazine, journal, serial, symposium, catalog, etc.), date, page(s), volume-issue number(s), publisher, city and/or country where published.	T ¹
	3	Extended European Search Report dated April 16, 2014 for European Patent Application No. EP 09 802 316.1 which shares priority of U.S. Provisional Application No. 61/129,898, filed July 28, 2008 with U.S. Application No. 13/056,277, filed January 27, 2011, which is related to captioned U.S. Application No. 13/966,096, and cites above-identified reference numbers 1 and 2.	

17875349
042814

Examiner Signature	Date Considered
<p>*Examiner: Initial if reference considered, whether or not citation is in conformance with MPEP 609. Draw line through citation if not in conformance and not considered. Include copy of this form with next communication to applicant.</p>	

T¹ - Place a check mark in this area when an English language Translation is attached. AT&T, Exh. 1002, p. 184

Electronic Acknowledgement Receipt

EFS ID:	18910180
Application Number:	13966096
International Application Number:	
Confirmation Number:	8712
Title of Invention:	PRODUCING ROUTING MESSAGES FOR VOICE OVER IP COMMUNICATIONS
First Named Inventor/Applicant Name:	CLAY PERRAULT
Customer Number:	20995
Filer:	John M Carson/Norman Green
Filer Authorized By:	John M Carson
Attorney Docket Number:	SMARB19.001C1
Receipt Date:	30-APR-2014
Filing Date:	13-AUG-2013
Time Stamp:	18:02:24
Application Type:	Utility under 35 USC 111(a)

Payment information:

Submitted with Payment	no
------------------------	----

File Listing:

Document Number	Document Description	File Name	File Size(Bytes)/ Message Digest	Multi Part /.zip	Pages (if appl.)
1		IDS_SMARB19_001C1_04_30_2014.pdf	85368 b6d6f32707ed7af98a0bb231ba66b0a2285d05eb	yes	2

Multipart Description/PDF files in .zip description			
	Document Description	Start	End
	Transmittal Letter	1	1
	Information Disclosure Statement (IDS) Form (SB08)	2	2

Warnings:

Information:

2	Foreign Reference	REF1__WO2007056158A2.pdf	6843532 8950d1de610127108591cf89be266fa3413e824b	no	90
---	-------------------	--------------------------	---	----	----

Warnings:

Information:

3	Foreign Reference	REF2__WO2008027065A1.pdf	4387615 70db7096cec475d9bfa1e11c34142e8153f28778	no	57
---	-------------------	--------------------------	---	----	----

Warnings:

Information:

4	Non Patent Literature	REF3__EP_EESR_EP09802316_1.pdf	500450 c10eecf83d282b4c70eb4a7303a4c34dcaf5ccd1	no	6
---	-----------------------	--------------------------------	--	----	---

Warnings:

Information:

Total Files Size (in bytes):			11816965		
-------------------------------------	--	--	----------	--	--

This Acknowledgement Receipt evidences receipt on the noted date by the USPTO of the indicated documents, characterized by the applicant, and including page counts, where applicable. It serves as evidence of receipt similar to a Post Card, as described in MPEP 503.

New Applications Under 35 U.S.C. 111

If a new application is being filed and the application includes the necessary components for a filing date (see 37 CFR 1.53(b)-(d) and MPEP 506), a Filing Receipt (37 CFR 1.54) will be issued in due course and the date shown on this Acknowledgement Receipt will establish the filing date of the application.

National Stage of an International Application under 35 U.S.C. 371

If a timely submission to enter the national stage of an international application is compliant with the conditions of 35 U.S.C. 371 and other applicable requirements a Form PCT/DO/EO/903 indicating acceptance of the application as a national stage submission under 35 U.S.C. 371 will be issued in addition to the Filing Receipt, in due course.

New International Application Filed with the USPTO as a Receiving Office

If a new international application is being filed and the international application includes the necessary components for an international filing date (see PCT Article 11 and MPEP 1810), a Notification of the International Application Number and of the International Filing Date (Form PCT/RO/105) will be issued in due course, subject to prescriptions concerning national security, and the date shown on this Acknowledgement Receipt will establish the international filing date of the application.

INFORMATION DISCLOSURE STATEMENT

Inventor : Clay Perrault, et al.
App. No. : 13/966,096
Filed : August 13, 2013
For : PRODUCING ROUTING MESSAGES FOR
VOICE OVER IP COMMUNICATIONS
Examiner : Kizou, Hassan
Art Unit : 2472
Conf. No. : 8712

Commissioner for Patents
P.O. Box 1450
Alexandria, VA 22313-1450

References and Listing

Submitted herewith in the above-identified application is an Information Disclosure Statement listing references for consideration. Copies of any listed foreign and non-patent literature references are being submitted.

Timing of Disclosure

This Information Disclosure Statement is being filed before the receipt of a First Office Action on the merits, and presumably no fee is required. If a First Office Action on the merits was mailed before the mailing date of this Statement, the Commissioner is authorized to charge the fee set forth in 37 CFR 1.17(p) to Deposit Account No. 11-1410.

Respectfully submitted,
KNOBBE, MARTENS, OLSON & BEAR, LLP

Dated: _____

4/30/14

By: _____

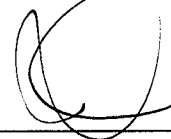

John M. Carson
Registration No. 34,303
Attorney of Record
Customer No. 20995
(858) 707-4000

IDS
17875834
042814

Please Direct All Correspondence to Customer Number 20995

REQUEST TO CORRECT INVENTORSHIP

Inventor	:	Clay Perrault
App. No	:	13/966,096
Filed	:	August 13, 2013
For	:	PRODUCING ROUTING MESSAGES FOR VOICE OVER IP COMMUNICATIONS
Examiner	:	Kizou, Hassan
Art Unit	:	2653

Commissioner for Patents
P.O. Box 1450
Alexandria, VA 22313-1450

Dear Sir:

Pursuant to 37 CFR 1.48, this Request is being made to correct or change inventorship which may include; the addition or deletion of inventors, or correction to an inventor's name.

This Request is being made after examination and is accompanied by:

1. An Application Data Sheet including markings under 1.76(c) identifying changes being made to inventorship; and
2. \$70 as directed under 37 CFR 1.17(i)(1) for small entity.

Please charge any additional fees, including any fees for additional extension of time, or credit overpayment to Deposit Account No. 11-1410.

Respectfully submitted,

KNOBBE MARTENS OLSON & BEAR LLP



Dated: November 14, 2014

By: _____

John M. Carson
Registration No. 34,303
Attorney of Record
Customer No. 20995
(858) 707-4000

19340047
111414

Electronic Patent Application Fee Transmittal

Application Number:	13966096
Filing Date:	13-Aug-2013
Title of Invention:	PRODUCING ROUTING MESSAGES FOR VOICE OVER IP COMMUNICATIONS
First Named Inventor/Applicant Name:	CLAY PERRAULT
Filer:	John M Carson/Noriko Cook
Attorney Docket Number:	SMARB19.001C1

Filed as Small Entity

Utility under 35 USC 111(a) Filing Fees

Description	Fee Code	Quantity	Amount	Sub-Total in USD(\$)
Basic Filing:				
Pages:				
Claims:				
Miscellaneous-Filing:				
PROCESSING FEE, EXCEPT PROV. APPLS.	2830	1	70	70

Petition:

Patent-Appeals-and-Interference:

Post-Allowance-and-Post-Issuance:

Extension-of-Time:

AT&T, Exh. 1002, p. 189

Description	Fee Code	Quantity	Amount	Sub-Total in USD(\$)
Miscellaneous:				
Total in USD (\$)				70

Electronic Acknowledgement Receipt

EFS ID:	20706593
Application Number:	13966096
International Application Number:	
Confirmation Number:	8712
Title of Invention:	PRODUCING ROUTING MESSAGES FOR VOICE OVER IP COMMUNICATIONS
First Named Inventor/Applicant Name:	CLAY PERRAULT
Customer Number:	20995
Filer:	John M Carson/Mason Leu
Filer Authorized By:	John M Carson
Attorney Docket Number:	SMARB19.001C1
Receipt Date:	14-NOV-2014
Filing Date:	13-AUG-2013
Time Stamp:	19:14:20
Application Type:	Utility under 35 USC 111(a)

Payment information:

Submitted with Payment	yes
Payment Type	Credit Card
Payment was successfully received in RAM	\$70
RAM confirmation Number	5573
Deposit Account	111410
Authorized User	KNOBBE MARTENS OLSON AND BEAR

The Director of the USPTO is hereby authorized to charge indicated fees and credit any overpayment as follows:

Charge any Additional Fees required under 37 C.F.R. Section 1.16 (National application filing, search, and examination fees)

Charge any Additional Fees required under 37 C.F.R. Section 1.17 (Patent application and reexamination processing fees)

File Listing:					
Document Number	Document Description	File Name	File Size(Bytes)/ Message Digest	Multi Part /.zip	Pages (if appl.)
1		SMARB19_001C1_CorrectedADS.pdf	74928 2c2596b6ba104d3333ca12a8e0aadb80ceb7ed57	yes	3
Multipart Description/PDF files in .zip description					
Document Description			Start	End	
Application Data Sheet			1	2	
Request under Rule 48 correcting inventorship			3	3	
Warnings:					
Information:					
2	Fee Worksheet (SB06)	fee-info.pdf	30201 eb458e415ae74a5a47db9375508faab35d7dba15	no	2
Warnings:					
Information:					
Total Files Size (in bytes):			105129		
<p>This Acknowledgement Receipt evidences receipt on the noted date by the USPTO of the indicated documents, characterized by the applicant, and including page counts, where applicable. It serves as evidence of receipt similar to a Post Card, as described in MPEP 503.</p> <p><u>New Applications Under 35 U.S.C. 111</u> If a new application is being filed and the application includes the necessary components for a filing date (see 37 CFR 1.53(b)-(d) and MPEP 506), a Filing Receipt (37 CFR 1.54) will be issued in due course and the date shown on this Acknowledgement Receipt will establish the filing date of the application.</p> <p><u>National Stage of an International Application under 35 U.S.C. 371</u> If a timely submission to enter the national stage of an international application is compliant with the conditions of 35 U.S.C. 371 and other applicable requirements a Form PCT/DO/EO/903 indicating acceptance of the application as a national stage submission under 35 U.S.C. 371 will be issued in addition to the Filing Receipt, in due course.</p> <p><u>New International Application Filed with the USPTO as a Receiving Office</u> If a new international application is being filed and the international application includes the necessary components for an international filing date (see PCT Article 11 and MPEP 1810), a Notification of the International Application Number and of the International Filing Date (Form PCT/RO/105) will be issued in due course, subject to prescriptions concerning national security, and the date shown on this Acknowledgement Receipt will establish the international filing date of the application.</p>					

CORRECTED APPLICATION DATA SHEET

Application Information

Application Number: 13/966,096
Filing Date: August 13, 2013
Title: PRODUCING ROUTING MESSAGES FOR VOICE
OVER IP COMMUNICATIONS
Attorney Docket Number: SMARB19.001C1

1st Inventor Information

Given Name: * CLAY|
Middle Name: *|
Family Name: * PERRAULT PERREAULT

2nd Inventor Information

Given Name: * STEVE|
Middle Name: *|
Family Name: * NICHOLSON

3rd Inventor Information

Given Name: * ROD|
Middle Name: *|
Family Name: * THOMSON

4th Inventor Information

Given Name: * JOHAN|
Middle Name: * EMIL VIKTOR|
Family Name: * BJÖRSELL

5th Inventor Information

Given Name: * FUAD|
Middle Name: *|
Family Name: * ARAFA

Correspondence Information

Correspondence Customer Number: 20995
Phone Number: (949) 760-0404
Fax Number: (949) 760-9502
E-Mail Address: efilings@knobbe.com

Representative Information

Representative Customer Number: 20995



Dated: November 14, 2014

By: _____

John M. Carson
Registration No. 34,303
Attorney of Record
Customer No. 20995
(858) 707-4000

19338747
111414



UNITED STATES PATENT AND TRADEMARK OFFICE

UNITED STATES DEPARTMENT OF COMMERCE
United States Patent and Trademark Office
Address: COMMISSIONER FOR PATENTS
P.O. Box 1450
Alexandria, Virginia 22313-1450
www.uspto.gov

Table with 6 columns: APPLICATION NUMBER, FILING or 371(c) DATE, GRP ART UNIT, FIL FEE REC'D, ATTY. DOCKET NO, TOT CLAIMS, IND CLAIMS. Row 1: 13/966,096, 08/13/2013, 2653, 3750, SMARB19.001C1, 78, 6

CONFIRMATION NO. 8712

CORRECTED FILING RECEIPT

20995
KNOBBE MARTENS OLSON & BEAR LLP
2040 MAIN STREET
FOURTEENTH FLOOR
IRVINE, CA 92614



Date Mailed: 11/20/2014

Receipt is acknowledged of this non-provisional patent application. The application will be taken up for examination in due course. Applicant will be notified as to the results of the examination. Any correspondence concerning the application must include the following identification information: the U.S. APPLICATION NUMBER, FILING DATE, NAME OF APPLICANT, and TITLE OF INVENTION. Fees transmitted by check or draft are subject to collection. Please verify the accuracy of the data presented on this receipt. If an error is noted on this Filing Receipt, please submit a written request for a Filing Receipt Correction. Please provide a copy of this Filing Receipt with the changes noted thereon. If you received a "Notice to File Missing Parts" for this application, please submit any corrections to this Filing Receipt with your reply to the Notice. When the USPTO processes the reply to the Notice, the USPTO will generate another Filing Receipt incorporating the requested corrections

Inventor(s)

CLAY PERREAULT, Panama City, PANAMA;
STEVE NICHOLSON, Hamilton, NEW ZEALAND;
ROD THOMSON, North Vancouver, CANADA;
JOHAN EMIL VIKTOR BJÖRSELL, Vancouver, CANADA;
FUAD ARAFA, Vancouver, CANADA;

Applicant(s)

Digifonica (INTERNATIONAL) Limited, Vancouver, CANADA

Assignment For Published Patent Application

Digifonica (INTERNATIONAL) Limited, Vancouver, CANADA

Power of Attorney: The patent practitioners associated with Customer Number 20995

Domestic Priority data as claimed by applicant

This application is a CON of 12/513,147 03/01/2010 PAT 8542815
which is a 371 of PCT/CA07/01956 11/01/2007
which claims benefit of 60/856,212 11/02/2006

Foreign Applications for which priority is claimed (You may be eligible to benefit from the Patent Prosecution Highway program at the USPTO. Please see http://www.uspto.gov for more information.) - None.

Foreign application information must be provided in an Application Data Sheet in order to constitute a claim to foreign priority. See 37 CFR 1.55 and 1.76.

Permission to Access - A proper Authorization to Permit Access to Application by Participating Offices (PTO/SB/39 or its equivalent) has been received by the USPTO.

If Required, Foreign Filing License Granted: 08/28/2013

The country code and number of your priority application, to be used for filing abroad under the Paris Convention, is **US 13/966,096**

Projected Publication Date: Not Applicable

Non-Publication Request: No

Early Publication Request: No

**** SMALL ENTITY ****

Title

PRODUCING ROUTING MESSAGES FOR VOICE OVER IP COMMUNICATIONS

Preliminary Class

379

Statement under 37 CFR 1.55 or 1.78 for AIA (First Inventor to File) Transition Applications: No

PROTECTING YOUR INVENTION OUTSIDE THE UNITED STATES

Since the rights granted by a U.S. patent extend only throughout the territory of the United States and have no effect in a foreign country, an inventor who wishes patent protection in another country must apply for a patent in a specific country or in regional patent offices. Applicants may wish to consider the filing of an international application under the Patent Cooperation Treaty (PCT). An international (PCT) application generally has the same effect as a regular national patent application in each PCT-member country. The PCT process **simplifies** the filing of patent applications on the same invention in member countries, but **does not result** in a grant of "an international patent" and does not eliminate the need of applicants to file additional documents and fees in countries where patent protection is desired.

Almost every country has its own patent law, and a person desiring a patent in a particular country must make an application for patent in that country in accordance with its particular laws. Since the laws of many countries differ in various respects from the patent law of the United States, applicants are advised to seek guidance from specific foreign countries to ensure that patent rights are not lost prematurely.

Applicants also are advised that in the case of inventions made in the United States, the Director of the USPTO must issue a license before applicants can apply for a patent in a foreign country. The filing of a U.S. patent application serves as a request for a foreign filing license. The application's filing receipt contains further information and guidance as to the status of applicant's license for foreign filing.

Applicants may wish to consult the USPTO booklet, "General Information Concerning Patents" (specifically, the section entitled "Treaties and Foreign Patents") for more information on timeframes and deadlines for filing foreign patent applications. The guide is available either by contacting the USPTO Contact Center at 800-786-9199, or it can be viewed on the USPTO website at <http://www.uspto.gov/web/offices/pac/doc/general/index.html>.

For information on preventing theft of your intellectual property (patents, trademarks and copyrights), you may wish to consult the U.S. Government website, <http://www.stopfakes.gov>. Part of a Department of Commerce initiative, this website includes self-help "toolkits" giving innovators guidance on how to protect intellectual property in specific countries such as China, Korea and Mexico. For questions regarding patent enforcement issues, applicants may call the U.S. Government hotline at 1-866-999-HALT (1-866-999-4258).

LICENSE FOR FOREIGN FILING UNDER
Title 35, United States Code, Section 184
Title 37, Code of Federal Regulations, 5.11 & 5.15

GRANTED

The applicant has been granted a license under 35 U.S.C. 184, if the phrase "IF REQUIRED, FOREIGN FILING LICENSE GRANTED" followed by a date appears on this form. Such licenses are issued in all applications where the conditions for issuance of a license have been met, regardless of whether or not a license may be required as set forth in 37 CFR 5.15. The scope and limitations of this license are set forth in 37 CFR 5.15(a) unless an earlier license has been issued under 37 CFR 5.15(b). The license is subject to revocation upon written notification. The date indicated is the effective date of the license, unless an earlier license of similar scope has been granted under 37 CFR 5.13 or 5.14.

This license is to be retained by the licensee and may be used at any time on or after the effective date thereof unless it is revoked. This license is automatically transferred to any related applications(s) filed under 37 CFR 1.53(d). This license is not retroactive.

The grant of a license does not in any way lessen the responsibility of a licensee for the security of the subject matter as imposed by any Government contract or the provisions of existing laws relating to espionage and the national security or the export of technical data. Licensees should apprise themselves of current regulations especially with respect to certain countries, of other agencies, particularly the Office of Defense Trade Controls, Department of State (with respect to Arms, Munitions and Implements of War (22 CFR 121-128)); the Bureau of Industry and Security, Department of Commerce (15 CFR parts 730-774); the Office of Foreign Assets Control, Department of Treasury (31 CFR Parts 500+) and the Department of Energy.

NOT GRANTED

No license under 35 U.S.C. 184 has been granted at this time, if the phrase "IF REQUIRED, FOREIGN FILING LICENSE GRANTED" DOES NOT appear on this form. Applicant may still petition for a license under 37 CFR 5.12, if a license is desired before the expiration of 6 months from the filing date of the application. If 6 months has lapsed from the filing date of this application and the licensee has not received any indication of a secrecy order under 35 U.S.C. 181, the licensee may foreign file the application pursuant to 37 CFR 5.15(b).

SelectUSA

The United States represents the largest, most dynamic marketplace in the world and is an unparalleled location for business investment, innovation, and commercialization of new technologies. The U.S. offers tremendous resources and advantages for those who invest and manufacture goods here. Through SelectUSA, our nation works to promote and facilitate business investment. SelectUSA provides information assistance to the international investor community; serves as an ombudsman for existing and potential investors; advocates on behalf of U.S. cities, states, and regions competing for global investment; and counsels U.S. economic development organizations on investment attraction best practices. To learn more about why the United States is the best country in the world to develop technology, manufacture products, deliver services, and grow your business, visit <http://www.SelectUSA.gov> or call +1-202-482-6800.

INFORMATION DISCLOSURE STATEMENT BY APPLICANT	Application No.	13/966,096	
	Filing Date	August 13, 2013	
	First Named Inventor	Perreault, Clay	
	Art Unit	2653	
<i>(Multiple sheets used when necessary)</i>		Examiner	8712
SHEET 1 OF 11		Attorney Docket No.	SMARB19.001C1

U.S. PATENT DOCUMENTS					
Examiner Initials	Cite No.	Document Number <i>Number - Kind Code (if known)</i> Example: 1,234,567 B1	Publication Date MM-DD-YYYY	Name	Pages, Columns, Lines Where Relevant Passages or Relevant Figures Appear
	1	5,325,421	06-28-1994	Hou et al.	
	2	6,553,025 B1	04-22-2003	Kung et al.	
	3	6,560,224 B1	05-06-2003	Kung et al.	
	4	6,650,641 B1	11-18-2003	Albert et al.	
	5	6,775,534 B2	08-10-2004	Lindgren et al.	
	6	6,934,279 B1	08-23-2005	Sollee et al.	
	7	6,963,739 B2	11-08-2005	Dorenbosch et al.	
	8	6,985,440 B1	01-10-2006	Albert et al.	
	9	6,993,015 B2	01-31-2006	Kobayashi, Toshihiko	
	10	7,006,508 B2	02-28-2006	Bondy et al.	
	11	7,027,564 B2	04-11-2006	James, Anthony W.	
	12	7,068,668 B2	06-27-2006	Feuer, Donald S.	
	13	7,151,772 B1	12-19-2006	Kalmanek, Jr. et al.	
	14	7,177,399 B2	02-13-2007	Dawson et al.	
	15	7,277,528 B2	10-02-2007	Rao et al.	
	16	7,400,881 B2	07-15-2008	Kallio, Juha	
	17	7,436,835 B2	10-14-2008	Castleberry et al.	
	18	7,440,442 B2	10-21-2008	Grabelsky et al.	
	19	7,486,667 B2	02-03-2009	Feuer, Donald S.	
	20	7,567,131 B2	07-21-2009	Rollender et al.	
	21	7,573,982 B2	08-11-2009	Breen et al.	
	22	7,593,390 B2	09-22-2009	Lebizay, Gerald	
	23	7,639,792 B2	12-29-2009	Qiu et al.	
	24	7,657,011 B1	02-02-2010	Zielinski et al.	
	25	7,664,495 B1	02-16-2010	Bonner et al.	
	26	7,676,215 B2	03-09-2010	Chin et al.	
	27	7,680,114 B2	03-16-2010	Yazaki et al.	
	28	7,702,308 B2	04-20-2010	Rollender, Douglas Harold	

Examiner Signature	Date Considered
<p>*Examiner: Initial if reference considered, whether or not citation is in conformance with MPEP 609. Draw line through citation if not in conformance and not considered. Include copy of this form with next communication to applicant.</p>	

T¹ - Place a check mark in this area when an English language Translation is attached AT&T, Exh. 1002, p. 198

INFORMATION DISCLOSURE STATEMENT BY APPLICANT	Application No.	13/966,096	
	Filing Date	August 13, 2013	
	First Named Inventor	Perreault, Clay	
	Art Unit	2653	
<i>(Multiple sheets used when necessary)</i>		Examiner	8712
SHEET 2 OF 11		Attorney Docket No.	SMARB19.001C1

U.S. PATENT DOCUMENTS					
Examiner Initials	Cite No.	Document Number Number - Kind Code (if known) Example: 1,234,567 B1	Publication Date MM-DD-YYYY	Name	Pages, Columns, Lines Where Relevant Passages or Relevant Figures Appear
	29	7,715,821 B2	05-11-2010	Rollender, Douglas Harold	
	30	7,738,384 B2	06-15-2010	Pelletier, Jeffrey P.	
	31	7,764,944 B2	07-27-2010	Rollender, Douglas Harold	
	32	7,797,459 B1	09-14-2010	Roy et al.	
	33	7,894,441 B2	02-22-2011	Yazaki et al.	
	34	7,907,551 B2	03-15-2011	Croy et al.	
	35	7,929,955 B1	04-19-2011	Bonner, Thomas W.	
	36	7,944,909 B2	05-17-2011	James, Anthony W.	
	37	7,965,645 B2	06-21-2011	Pelletier, Jeffrey P.	
	38	7,979,529 B2	07-12-2011	Kreusch et al.	
	39	7,995,589 B2	08-09-2011	Sollee et al.	
	40	8,024,785 B2	09-20-2011	Andress et al.	
	41	8,027,333 B2	09-27-2011	Grabelsky et al.	
	42	8,041,022 B1	10-18-2011	Andreasen et al.	
	43	8,050,273 B2	11-01-2011	Gass, Raymond	
	44	8,125,982 B2	02-28-2012	Feuer, Donald S.	
	45	8,145,182 B2	03-27-2012	Rudolf et al.	
	46	8,166,533 B2	04-24-2012	Yuan, Wei	
	47	8,189,568 B2	05-29-2012	Qiu et al.	
	48	8,204,044 B2	06-19-2012	Lebizay, Gerald	
	49	8,228,897 B2	07-24-2012	Mitchell, Don	
	50	8,244,204 B1	08-14-2012	Chen et al.	
	51	8,306,063 B2	11-06-2012	Erdal et al.	
	52	8,363,647 B2	01-29-2013	Fangman et al.	
	53	8,427,981 B2	04-23-2013	Wyss et al.	
	54	8,437,340 B2	05-07-2013	James, Anthony W.	
	55	8,462,915 B2	06-11-2013	Breen et al.	
	56	8,509,225 B2	08-13-2013	Grabelsky et al.	
	57	8,605,714 B2	12-10-2013	Lebizay, Gerald	

Examiner Signature	Date Considered
<p>*Examiner: Initial if reference considered, whether or not citation is in conformance with MPEP 609. Draw line through citation if not in conformance and not considered. Include copy of this form with next communication to applicant.</p>	

T¹ - Place a check mark in this area when an English language Translation is attached AT&T, Exh. 1002, p. 199

INFORMATION DISCLOSURE STATEMENT BY APPLICANT	Application No.	13/966,096	
	Filing Date	August 13, 2013	
	First Named Inventor	Perreault, Clay	
	Art Unit	2653	
<i>(Multiple sheets used when necessary)</i>		Examiner	8712
SHEET 3 OF 11		Attorney Docket No.	SMARB19.001C1

U.S. PATENT DOCUMENTS					
Examiner Initials	Cite No.	Document Number Number - Kind Code (if known) Example: 1,234,567 B1	Publication Date MM-DD-YYYY	Name	Pages, Columns, Lines Where Relevant Passages or Relevant Figures Appear
	58	8,605,869 B1	12-10-2013	Mobarak et al.	
	59	8,607,323 B2	12-10-2013	Yuan, Wei	
	60	8,611,354 B2	12-17-2013	Keränen et al.	
	61	8,625,578 B2	01-07-2014	Roy et al.	
	62	8,724,643 B2	05-13-2014	Feuer, Donald S.	
	63	8,750,290 B2	06-10-2014	Vance et al.	
	64	8,763,081 B2	06-24-2014	Bogdanovic et al.	
	65	8,768,951 B2	07-01-2014	Crago, William Barry	
	66	8,774,171 B2	07-08-2014	Mitchell, Don	
	67	8,804,705 B2	08-12-2014	Voxpath Networks, Inc.	
	68	2001/0052081 A1	12-13-2001	McKibben et al.	
	69	2002/0002041 A1	01-03-2002	Lindgren et al.	
	70	2002/0018445 A1	02-14-2002	Kobayashi, Toshihiko	
	71	2002/0141352 A1	10-03-2002	Fangman et al.	
	72	2003/0012196 A1	01-16-2003	Ramakrishnan, Kadangode K.	
	73	2003/0095539 A1	05-22-2003	Feuer, Donald S.	
	74	2003/0179747 A1	09-25-2003	Pyke et al.	
	75	2003/0219103 A1	11-27-2003	Rao et al.	
	76	2004/0034793 A1	02-19-2004	Yuan, Wei	
	77	2004/0203582 A1	10-14-2004	Dorenbosch et al.	
	78	2004/0203565 A1	10-14-2004	Chin et al.	
	79	2005/0063519 A1	03-24-2005	James, Anthony W.	
	80	2005/0188081 A1	08-25-2005	Gibson et al.	
	81	2005/0190892 A1	09-01-2005	Dawson et al.	
	82	2005/0202799 A1	09-15-2005	Rollender, Douglas Harold	
	83	2005/0287979 A1	12-29-2005	Rollender, Douglas Harold	
	84	2006/0007940 A1	01-12-2006	Sollee et al.	
	85	2006/0013266 A1	01-19-2006	Vega-Garcia et al.	
	86	2006/0030290 A1	02-09-2006	Rudolf et al.	

Examiner Signature	Date Considered
<p>*Examiner: Initial if reference considered, whether or not citation is in conformance with MPEP 609. Draw line through citation if not in conformance and not considered. Include copy of this form with next communication to applicant.</p>	

T¹ - Place a check mark in this area when an English language Translation is attached AT&T, Exh. 1002, p. 200

INFORMATION DISCLOSURE STATEMENT BY APPLICANT	Application No.	13/966,096	
	Filing Date	August 13, 2013	
	First Named Inventor	Perreault, Clay	
	Art Unit	2653	
<i>(Multiple sheets used when necessary)</i>		Examiner	8712
SHEET 4 OF 11		Attorney Docket No.	SMARB19.001C1

U.S. PATENT DOCUMENTS					
Examiner Initials	Cite No.	Document Number Number - Kind Code (if known) Example: 1,234,567 B1	Publication Date MM-DD-YYYY	Name	Pages, Columns, Lines Where Relevant Passages or Relevant Figures Appear
	87	2006/0078094 A1	04-13-2006	Breen et al.	
	88	2006/0142011 A1	06-29-2006	Kallio, Juha	
	89	2006/0146797 A1	07-06-2006	Lebizay, Gerald	
	90	2006/0189303 A1	08-24-2006	Rollender, Douglas Harold	
	91	2006/0205383 A1	09-14-2006	Rollender et al.	
	92	2006/0248186 A1	11-02-2006	Smith, Richard James	
	93	2006/0251056 A1	11-09-2006	Feuer, Donald S.	
	94	2006/0268921 A1	11-30-2006	Ekstrom et al.	
	95	2006/0281437 A1	12-14-2006	Cook, Charles I.	
	96	2007/0047548 A1	03-01-2007	Yazaki et al.	
	97	2007/0092070 A1	04-26-2007	Croy et al.	
	98	2007/0115935 A1	05-24-2007	Qiu et al.	
	99	2007/0121593 A1	05-31-2007	Vance et al.	
	100	2007/0174469 A1	07-26-2007	Andress et al.	
	101	2007/0220038 A1	09-20-2007	Crago, William Barry	
	102	2007/0253429 A1	11-01-2007	James, Anthony W.	
	103	2007/0263609 A1	11-15-2007	Mitchell, Don	
	104	2007/0297376 A1	12-27-2007	Gass, Raymond	
	105	2008/0013523 A1	01-17-2008	Nambakkam, Sampath	
	106	2008/0056243 A1	03-06-2008	Roy et al.	
	107	2008/0167039 A1	07-10-2008	Guedalia et al.	
	108	2008/0167020 A1	07-10-2008	Guedalia et al.	
	109	2008/0167019 A1	07-10-2008	Guedalia et al.	
	110	2008/0166999 A1	07-10-2008	Guedalia et al.	
	111	2008/0188227 A1	08-07-2008	Guedalia et al.	
	112	2008/0188198 A1	08-07-2008	Patel et al.	
	113	2008/0187122 A1	08-07-2008	Baker, Colin Lawrence Melvin	
	114	2008/0205378 A1	08-28-2008	Wyss et al.	
	115	2008/0310599 A1	12-18-2008	Purnadi et al.	

Examiner Signature	Date Considered
--------------------	-----------------

***Examiner:** Initial if reference considered, whether or not citation is in conformance with MPEP 609. Draw line through citation if not in conformance and not considered. Include copy of this form with next communication to applicant.

T¹ - Place a check mark in this area when an English language Translation is attached AT&T, Exh. 1002, p. 201

INFORMATION DISCLOSURE STATEMENT BY APPLICANT	Application No.	13/966,096
	Filing Date	August 13, 2013
	First Named Inventor	Perreault, Clay
	Art Unit	2653
<i>(Multiple sheets used when necessary)</i>	Examiner	8712
SHEET 5 OF 11	Attorney Docket No.	SMARB19.001C1

U.S. PATENT DOCUMENTS					
Examiner Initials	Cite No.	Document Number <i>Number - Kind Code (if known)</i> Example: 1,234,567 B1	Publication Date MM-DD-YYYY	Name	Pages, Columns, Lines Where Relevant Passages or Relevant Figures Appear
	116	2009/0003535 A1	01-01-2009	Grabelsky et al.	
	117	2009/0129566 A1	05-21-2009	Feuer, Donald S.	
	118	2009/0135724 A1	05-28-2009	Zhang et al.	
	119	2009/0135735 A1	05-28-2009	Zhang et al.	
	120	2009/0214000 A1	08-27-2009	Patel et al.	
	121	2009/0268615 A1	10-29-2009	Pelletier, Jeffrey P.	
	122	2009/0296900 A1	12-03-2009	Breen et al.	
	123	2010/0008345 A1	01-14-2010	Lebizay, Gerald	
	124	2010/0039946 A1	02-18-2010	Imbimbo et al.	
	125	2010/0105379 A1	04-29-2010	Bonner et al.	
	126	2010/0177671 A1	07-15-2010	Qiu et al.	
	127	2010/0246589 A1	09-30-2010	Pelletier, Jeffrey P.	
	128	2010/0272242 A1	10-28-2010	Croy et al.	
	129	2011/0013541 A1	01-20-2011	Croy et al.	
	130	2011/0153809 A1	06-23-2011	Ghanem et al.	
	131	2011/0176541 A1	07-21-2011	James, Anthony W.	
	132	2011/0201321 A1	08-18-2011	Bonner, Thomas W.	
	133	2011/0267986 A1	11-03-2011	Grabelsky et al.	
	134	2012/0014383 A1	01-19-2012	Geromel et al.	
	135	2012/0113981 A1	05-10-2012	Feuer, Donald S.	
	136	2012/0195415 A1	08-02-2012	Wyss et al.	
	137	2012/0250624 A1	10-04-2012	Lebizay, Gerald	
	138	2012/0282881 A1	11-08-2012	Mitchell, Don	
	139	2012/0314699 A1	12-13-2012	Qiu et al.	
	140	2013/0272297 A1	10-17-2013	AT&T Intellectual Property I, L.P.	
	141	2014/0101749 A1	04-10-2014	Rockstar Consortium US LP	
	142	2014/0211789 A1	07-31-2014	Centre One	

Examiner Signature	Date Considered
*Examiner: Initial if reference considered, whether or not citation is in conformance with MPEP 609. Draw line through citation if not in conformance and not considered. Include copy of this form with next communication to applicant.	

T¹ - Place a check mark in this area when an English language Translation is attached. AT&T, Exh. 1002, p. 202

INFORMATION DISCLOSURE STATEMENT BY APPLICANT	Application No.	13/966,096	
	Filing Date	August 13, 2013	
	First Named Inventor	Perreault, Clay	
	Art Unit	2653	
<i>(Multiple sheets used when necessary)</i>		Examiner	8712
SHEET 6 OF 11		Attorney Docket No.	SMARB19.001C1

FOREIGN PATENT DOCUMENTS						
Examiner Initials	Cite No.	Foreign Patent Document Country Code-Number-Kind Code Example: JP 1234567 A1	Publication Date MM-DD-YYYY	Name	Pages, Columns, Lines Where Relevant Passages or Relevant Figures Appear	T ¹
	143	CA 2 218 218 A1	10-14-1997	AT&T Corp.		
	144	CA 2 299 037 A1	08-22-2000	Selex Communications, LLC		Abstract
	145	CA 2 437 275 A1	10-17-2002	Nortel Networks Limited		Abstract
	146	CA 2 690 236 A1	12-18-2008	Research In Motion Ltd		Abstract
	147	CN 1498029 A	05-19-2004	Lucent Technologies Inc		Abstract
	148	CN 1498482 A	05-19-2004	Siemens AG		Abstract
	149	CN 1668137 A	09-14-2005	Lucent Technologies Inc		Abstract
	150	CN 1274114 C	09-06-2006	Siemens AG		Abstract
	151	CN 101005503 A	07-25-2007	IBM		Abstract
	152	CN 101069390 A	11-07-2007	Nokia Corp		Abstract
	153	CN 101095329 A	12-26-2007	Intel Corp		Abstract
	154	CN 1498029 B	05-12-2010	Lucent Technologies Inc		Abstract
	155	CN 101772929 A	07-07-2010	Research In Motion Ltd		Abstract
	156	CN 101069390 B	12-22-2010	Nokia Corp		Abstract
	157	CN 102484656 A	05-30-2012	Telefonaktiebolaget LM Ericsson		Abstract
	158	CN 101095329 B	10-10-2012	Intel Corp		Abstract
	159	CN 102833232 A	12-19-2012	Intel Corp		Abstract
	160	CN 101005503 B	01-16-2013	IBM		Abstract
	161	CN 101772929 B	07-02-2014	Research In Motion Ltd		Abstract
	162	DE 602 01 827 T2	11-10-2005	Alcatel SA		Abstract
	163	DE 11 2005 003 306 T5	01-24-2008	Intel Corp	<i>Corresponding Abstract: International Publication No. WO 2006/072099 A1 published 07-06-2006; is supplied with this document</i>	Abstract
	164	DE 601 33 316 T2	07-10-2008	Nortel Networks Ltd.		Abstract
	165	DE 603 17 751 T2	11-06-2008	Lucent Technologies Inc		Abstract
	166	EP 0 841 832 A2	05-13-1998	AT&T Corp.		
	167	EP 0 841 832 A3	05-19-1999	AT&T Corp.		

Examiner Signature	Date Considered
*Examiner: Initial if reference considered, whether or not citation is in conformance with MPEP 609. Draw line through citation if not in conformance and not considered. Include copy of this form with next communication to applicant.	

T¹ - Place a check mark in this area when an English language Translation is attached. AT&T, Exh. 1002, p. 203

INFORMATION DISCLOSURE STATEMENT BY APPLICANT	Application No.	13/966,096	
	Filing Date	August 13, 2013	
	First Named Inventor	Perreault, Clay	
	Art Unit	2653	
<i>(Multiple sheets used when necessary)</i>		Examiner	8712
SHEET 7 OF 11		Attorney Docket No.	SMARB19.001C1

FOREIGN PATENT DOCUMENTS						
Examiner Initials	Cite No.	Foreign Patent Document Country Code-Number-Kind Code Example: JP 1234567 A1	Publication Date MM-DD-YYYY	Name	Pages, Columns, Lines Where Relevant Passages or Relevant Figures Appear	T ¹
	168	EP 1 032 224 A2	08-30-2000	Selex Communications, LLC		
	169	EP 1 032 224 A3	08-30-2000	Selex Communications, LLC		
	170	EP 1 244 250 A1	09-25-2002	Siemens AG		Abstract
	171	EP 1 266 516 A2	12-18-2002	Nortel Networks Ltd	<i>Published by WIPO under: International Publication No. WO 01/069899 A2 published 12-18-2002; Abstract of which is supplied with this document</i>	Abstract
	172	EP 1 362 456 A2	11-19-2003	Nortel Networks Ltd	<i>Published by WIPO under: International Publication No. WO 02/082782 A2 published 10-17-2002; Abstract of which is supplied with this document</i>	Abstract
	173	EP 1 371 173 A1	12-17-2003	Siemens AG	<i>Published by WIPO under: International Publication No. WO 02/082728 A1 published 10-17-2002; Abstract of which is supplied with this document</i>	Abstract
	174	EP 1 411 743 A1	04-21-2004	Lucent Technologies Inc.		
	175	EP 1 526 697 A2	04-27-2005	3COM Corporation		
	176	EP 1 362 456 A4	05-25-2005	Nortel Networks Ltd		Abstract
	177	EP 1 575 327 A1	09-14-2005	Lucent Technologies Inc.		
	178	EP 1 610 583 A1	12-28-2005	Lucent Technologies Inc.		
	179	EP 1 526 697 A3	03-22-2006	3COM Corporation		
	180	EP 1 721 446 A1	11-15-2006	Nortel Networks Ltd	<i>Published by WIPO under: International Publication No. WO 2005/084002 A1 published 10-09-2005; Abstract of which is supplied with this document</i>	Abstract

Examiner Signature	Date Considered
--------------------	-----------------

***Examiner:** Initial if reference considered, whether or not citation is in conformance with MPEP 609. Draw line through citation if not in conformance and not considered. Include copy of this form with next communication to applicant.

T¹ - Place a check mark in this area when an English language Translation is attached AT&T, Exh. 1002, p. 204

INFORMATION DISCLOSURE STATEMENT BY APPLICANT	Application No.	13/966,096	
	Filing Date	August 13, 2013	
	First Named Inventor	Perreault, Clay	
	Art Unit	2653	
<i>(Multiple sheets used when necessary)</i>		Examiner	8712
SHEET 8 OF 11		Attorney Docket No.	SMARB19.001C1

FOREIGN PATENT DOCUMENTS						
Examiner Initials	Cite No.	Foreign Patent Document Country Code-Number-Kind Code Example: JP 1234567 A1	Publication Date MM-DD-YYYY	Name	Pages, Columns, Lines Where Relevant Passages or Relevant Figures Appear	T ¹
	181	EP 1 829 300 A1	09-05-2007	Nokia Corp	Published by WIPO under: International Publication No. WO 2006/067269 A1 published 06-29-2006; Abstract of which is supplied with this document	Abstract
	182	EP 1 371 173 B1	11-28-2007	Siemens AG		Abstract
	183	EP 1 411 743 B1	11-28-2007	Lucent Technologies Inc.		
	184	EP 1 362 456 B1	03-19-2008	Nortel Networks Ltd		
	185	EP 1 974 304 A2	10-01-2008	Medical Envelope LLC	<i>Published by WIPO under: International Publication No. WO 2007/087077 A2 published 08-02-2007; Abstract of which is supplied with this document</i>	Abstract
	186	EP 1 974 304 A4	10-01-2008	Medical Envelope LLC		Abstract
	187	EP 1 610 583 B1	08-26-2009	Lucent Technologies Inc.		
	188	EP 2 127 232 A1	12-02-2009	Interactive Intelligence Inc	<i>Published by WIPO under: International Publication No. WO 2008/103652 A1 published 08-28-2008; Abstract of which is supplied with this document</i>	Abstract
	189	EP 2 165 489 A1	03-24-2010	Research In Motion Ltd	<i>Published by WIPO under: International Publication No. WO 2008/103652 A1 published 08-28-2008; Abstract of which is supplied with this document</i>	Abstract
	190	EP 2 215 755 A1	08-11-2010	Broadsoft Inc	<i>Published by WIPO under: International Publication No. WO 2009/070278 A1 published 06-04-2009; Abstract of which is supplied with this document</i>	Abstract
	191	EP 2 165 489 A4	03-02-2011	Research In Motion Ltd		Abstract
	192	EP 2 127 232 A4	03-16-2011	Interactive Intelligence Inc		Abstract

Examiner Signature	Date Considered
*Examiner: Initial if reference considered, whether or not citation is in conformance with MPEP 609. Draw line through citation if not in conformance and not considered. Include copy of this form with next communication to applicant.	

T¹ - Place a check mark in this area when an English language Translation is attached AT&T, Exh. 1002, p. 205

INFORMATION DISCLOSURE STATEMENT BY APPLICANT	Application No.	13/966,096	
	Filing Date	August 13, 2013	
	First Named Inventor	Perreault, Clay	
	Art Unit	2653	
<i>(Multiple sheets used when necessary)</i>		Examiner	8712
SHEET 9 OF 11		Attorney Docket No.	SMARB19.001C1

FOREIGN PATENT DOCUMENTS						
Examiner Initials	Cite No.	Foreign Patent Document Country Code-Number-Kind Code Example: JP 1234567 A1	Publication Date MM-DD-YYYY	Name	Pages, Columns, Lines Where Relevant Passages or Relevant Figures Appear	T ¹
	193	EP 1 829 300 A4	05-02-2012	Nokia Corp	Corresponding Abstract: International Publication No. WO 2006/067269 A1 published 06-29-2006; is supplied with this document	Abstract
	194	EP 2 449 749 A1	05-09-2012	Telefonaktiebolaget LM Ericsson	<i>Published by WIPO under: International Publication No. WO 2011/000405 A1 published 01-06-2011; Abstract of which is supplied with this document</i>	Abstract
	195	EP 2 215 755 A4	10-24-2012	Broadsoft Inc		Abstract
	196	EP 1 829 300 B1	11-21-2012	Nokia Corp	<i>Corresponding Abstract: International Publication No. WO 2006/067269 A1 published 06-29-2006; is supplied with this document</i>	Abstract
	197	EP 2 449 749 B1	03-12-2014	Telefonaktiebolaget LM Ericsson		
	198	EP 1 266 516 B1	05-07-2014	Genband US LLC		
	199	WO 01/69899 A2	09-20-2001	Nortel Networks Ltd.		
	200	WO 01/69899 A3	09-20-2001	Nortel Networks Ltd.		
	201	WO 01/80587 A1	10-25-2001	Telefonaktiebolaget LM Ericsson		
	202	WO 02/082728 A1	10-17-2002	Siemens AG		Abstract
	203	WO 02/082782 A2	10-17-2002	Nortel Networks Limited		
	204	WO 02/082782 A3	10-17-2002	Nortel Networks Limited		
	205	WO 2005/084002 A1	09-09-2005	Nortel Networks Limited		
	206	WO 2006/067269 A1	06-29-2006	Nokia Corporation		
	207	WO 2006/072099 A1	07-06-2006	Intel Corporation		
	208	WO 2006/078175 A2	07-27-2006	Baker, Colin et al.		
	209	WO 2006/078175 A3	07-27-2006	Baker, Colin et al.		
	210	WO 2007/044454 A2	04-19-2007	Telecommunication Systems, Inc.		
	211	WO 2007/087077 A2	08-02-2007	Medical Envelope LLC		

Examiner Signature	Date Considered
*Examiner: Initial if reference considered, whether or not citation is in conformance with MPEP 609. Draw line through citation if not in conformance and not considered. Include copy of this form with next communication to applicant.	

T¹ - Place a check mark in this area when an English language Translation is attached AT&T, Exh. 1002, p. 206

INFORMATION DISCLOSURE STATEMENT BY APPLICANT	Application No.	13/966,096	
	Filing Date	August 13, 2013	
	First Named Inventor	Perreault, Clay	
	Art Unit	2653	
(Multiple sheets used when necessary)		Examiner	8712
SHEET 10 OF 11		Attorney Docket No.	SMARB19.001C1

FOREIGN PATENT DOCUMENTS						
Examiner Initials	Cite No.	Foreign Patent Document Country Code-Number-Kind Code Example: JP 1234567 A1	Publication Date MM-DD-YYYY	Name	Pages, Columns, Lines Where Relevant Passages or Relevant Figures Appear	T ¹
	212	WO 2007/087077 A3	08-02-2007	Medical Envelope LLC		
	213	WO 2008/085614 A2	07-17-2008	ISKOOT, Inc.		
	214	WO 2008/085614 A3	07-17-2008	ISKOOT, Inc.		
	215	WO 2008/086350 A2	07-17-2008	ISKOOT, Inc.		
	216	WO 2008/086350 A3	07-17-2008	ISKOOT, Inc.		
	217	WO 2008/103652 A1	08-28-2008	Interactive Intelligence, Inc.		
	218	WO 2008/085614 A8	12-11-2008	ISKOOT, Inc.		
	219	WO 2008/151406 A1	12-18-2008	Research In Motion Ltd		
	220	WO 2008/151406 A8	12-18-2008	Research In Motion Ltd		
	221	WO 2009/070202 A1	06-04-2009	Tellabs Operations, Inc.		
	222	WO 2009/070278 A1	06-04-2009	Broadsoft, Inc.		
	223	WO 2011/000405 A1	01-06-2011	Telefonaktiebolaget LM Ericsson		

NON PATENT LITERATURE DOCUMENTS			
Examiner Initials	Cite No.	Include name of the author (in CAPITAL LETTERS), title of the article (when appropriate), title of the item (book, magazine, journal, serial, symposium, catalog, etc.), date, page(s), volume-issue number(s), publisher, city and/or country where published.	T ¹
	224	Baker <i>et al.</i> , "Cisco Support for Lawful Intercept In IP Networks," Internet Draft - working document of the Internet Engineering Task Force (IETF), accessible at http://www.ietf.org/ietf/lid-abstracts.txt , April 2003, expires September 30, 2003, pages 1-15.	
	225	Bhushan <i>et al.</i> , "Federated Accounting: Service Charging and Billing in a Business-to-Business Environment," 0-7803-6719-7/01, © 2001 IEEE, pages 107-121.	
	226	Jajszczyk <i>et al.</i> , "Emergency Calls in Flow-Aware Networks," <i>IEEE Communications Letters</i> , Vol. 11, No. 9, September 2007, pages 753-755.	
	227	Kim <i>et al.</i> , "An Enhanced VoIP Emergency Services Prototype," <i>Proceedings of the 3rd International ISCRAM Conference (B. Van de Walle and M. Turoff, eds.), Newark, NJ (USA), May 2006, pages 1-8.</i>	
	228	Kornfeld <i>et al.</i> , "DVB-H and IP Datacast—Broadcast to Handheld Devices," <i>IEEE Transactions On Broadcasting</i> , Vol. 53, No. 1, March 2007, pages 161-170.	
	229	Kortebi <i>et al.</i> , "SINR-Based Routing in Multi-Hop Wireless Networks to Improve VoIP Applications Support," 1-4244-0667-6/07, © 2007 IEEE, pages 491-496.	
	230	Lee <i>et al.</i> , "VoIP Interoperation with KT-NGN," in <i>The 6th International Conference on Advanced Communication Technology</i> , Technical Proceedings, 2004, pages 126-128, accompanied by Title and Contents - 4 pages.	

Examiner Signature	Date Considered
--------------------	-----------------

*Examiner: Initial if reference considered, whether or not citation is in conformance with MPEP 609. Draw line through citation if not in conformance and not considered. Include copy of this form with next communication to applicant.

INFORMATION DISCLOSURE STATEMENT BY APPLICANT	Application No.	13/966,096
	Filing Date	August 13, 2013
	First Named Inventor	Perreault, Clay
	Art Unit	2653
(Multiple sheets used when necessary)	Examiner	8712
SHEET 11 OF 11	Attorney Docket No.	SMARB19.001C1

NON PATENT LITERATURE DOCUMENTS

Examiner Initials	Cite No.	Include name of the author (in CAPITAL LETTERS), title of the article (when appropriate), title of the item (book, magazine, journal, serial, symposium, catalog, etc.), date, page(s), volume-issue number(s), publisher, city and/or country where published.	T ¹
	231	Lin <i>et al.</i> , "Effective VoIP Call Routing in WLAN and Cellular Integration," <i>IEEE Communications Letters</i> , Vol. 9, No. 10, October 2005, pages 874-876.	
	232	Ma <i>et al.</i> , "Realizing MPEG4 Video Transmission Based on Mobile Station over GPRS," <i>0-7803-9335-X/05</i> , © 2005 IEEE, pages 1241-1244.	
	233	Mintz-Habib <i>et al.</i> , "A VoIP Emergency Services Architecture and Prototype," <i>{mm2571,asr,hgs,xiaotaow}@cs.columbia.edu</i> , <i>0-7803-9428-3/05</i> , © 2005 IEEE, pages 523-528.	
	234	Munir, Muhammad Farukh, "Study of an Adaptive Scheme for Voice Transmission on IP in a Wireless Networking Environment 802.11e," <i>Dept. of Networks and Distributed Computing, Ecole Supérieure En Sciences Informatiques (ESSI), Université De Nice</i> , June 2005, (pages 1-35), BEST AVAILABLE COPY - pages 1-11.	
	235	Sripanidkulchai <i>et al.</i> , "Call Routing Management in Enterprise VoIP Networks," <i>Copyright 2007 ACM 978-1-59593-788-9/07/0008</i> , 6 pages.	
	236	Thernelius, Fredrik, "SIP, NAT, and Firewalls," Master's Thesis, <i>ERICSSON, Department of Teleinformatics</i> , May 2000, pages 1-69.	
	237	Trad <i>et al.</i> , "Adaptive VoIP Transmission over Heterogeneous Wired/Wireless Networks," <i>V. Roca and F. Rousscau (Eds.): MIPS 2004, LNCS 3311</i> , pp. 25-36, 2004, © Springer-Verlag Berlin Heidelberg 2004.	
	238	Yu <i>et al.</i> , "Service-Oriented Issues: Mobility, Security, Charging and Billing Management in Mobile Next Generation Networks," <i>IEEE BcN2006, 1-4244-0146-1/06</i> , © 2006 IEEE, pages 1-10.	

19420768
112614

Examiner Signature	Date Considered
<p>*Examiner: Initial if reference considered, whether or not citation is in conformance with MPEP 609. Draw line through citation if not in conformance and not considered. Include copy of this form with next communication to applicant.</p>	

T¹ - Place a check mark in this area when an English language Translation is attached AT&T, Exh. 1002, p. 208

Electronic Acknowledgement Receipt

EFS ID:	20803282
Application Number:	13966096
International Application Number:	
Confirmation Number:	8712
Title of Invention:	PRODUCING ROUTING MESSAGES FOR VOICE OVER IP COMMUNICATIONS
First Named Inventor/Applicant Name:	CLAY PERREAULT
Customer Number:	20995
Filer:	John M Carson/Norman Green
Filer Authorized By:	John M Carson
Attorney Docket Number:	SMARB19.001C1
Receipt Date:	26-NOV-2014
Filing Date:	13-AUG-2013
Time Stamp:	18:44:35
Application Type:	Utility under 35 USC 111(a)

Payment information:

Submitted with Payment	no
------------------------	----

File Listing:

Document Number	Document Description	File Name	File Size(Bytes)/ Message Digest	Multi Part /.zip	Pages (if appl.)
1	Foreign Reference	FRef1_CA2218218A1.pdf	1303485 <small>8736889d78c5b43bf8f57298ce30628fb0d007c</small>	no	19

Warnings:

Information:

2	Foreign Reference	FRef2_CA2299037A1.pdf	2459515	no	30
			9204e3cdb1b58140db00988366a0f36fc16dd4a7		
Warnings:					
Information:					
3	Foreign Reference	FRef3_CA2437275A1.pdf	3218137	no	48
			659abad897a7d73180ff704a58b5907c2c23c72c		
Warnings:					
Information:					
4	Foreign Reference	FRef4_CA2690236A1.pdf	2261223	no	28
			c7229f41c59c93ce1862877d0fe339098e81ade0		
Warnings:					
Information:					
5	Foreign Reference	FRef5_CN1498029A.pdf	1083455	no	13
			d05ac1a88ebe6c0316a78a157cbcd428bc6b09a		
Warnings:					
Information:					
6	Foreign Reference	FRef6_CN1498482A.pdf	1650102	no	18
			ffa6dc51f75f3fa22a12712bbfbfeb6864f79396		
Warnings:					
Information:					
7	Foreign Reference	FRef7_CN1668137A.pdf	1807688	no	21
			cca62540137fe451056660dd218429fa05bfbb1a		
Warnings:					
Information:					
8	Foreign Reference	FRef8_CN1274114C.pdf	1732150	no	19
			f51ca2146d1c92841272b80a9d412fe7fed8667b		
Warnings:					
Information:					
9	Foreign Reference	FRef9_CN101005503A.pdf	2237498	no	26
			f35007d260013445bfee706d2b6e9ee5d32eda85		
Warnings:					
Information:					
10	Foreign Reference	FRef10_CN101069390A.pdf	2768939	no	30
			8194859e193c669f747f67f33ba9386370dfb4e		
Warnings:					
Information:					

11	Foreign Reference	FRef11_CN101095329A.pdf	1902050	no	23
			6c7ebb38c8723d53710267bf54bf44be921e2d3		
Warnings:					
Information:					
12	Foreign Reference	FRef12_CN1498029B.pdf	833982	no	9
			a75f29202e36f404eb0634ff889ff4d38f41586f		
Warnings:					
Information:					
13	Foreign Reference	FRef13_CN101772929A.pdf	1629030	no	17
			08c526bd92a9cf2b1b50964b69b1a2134d1aad0		
Warnings:					
Information:					
14	Foreign Reference	FRef14_CN101069390B.pdf	2209004	no	22
			f8f44c75aba5224c84d0b9adbd9fef15f35c544d		
Warnings:					
Information:					
15	Foreign Reference	FRef15_CN102484656A.pdf	1705748	no	19
			f307d672b2d5a27e6a0b525f6e994823c8651fea		
Warnings:					
Information:					
16	Foreign Reference	FRef16_CN101095329B.pdf	1361015	no	15
			51e0d6311708aa7d42f82d3d60b6446a3a811661		
Warnings:					
Information:					
17	Foreign Reference	FRef17_CN102833232A.pdf	1652929	no	17
			77419d14a25a03114612d4a255d723e7966cd4c4		
Warnings:					
Information:					
18	Foreign Reference	FRef18_CN101005503B.pdf	1847539	no	20
			aac46ec05928d6c74fc32767f9ef3699681e4479		
Warnings:					
Information:					
19	Foreign Reference	FRef19_CN101772929B.pdf	1551207	no	16
			80c03d8efc95fb8b627efd3e192342a2efd8d77		
Warnings:					
Information:					

20	Foreign Reference	FRef20_DE60201827T2.pdf	1119159	no	12
			9f9d8053d06921fd7454c6f4950161d285d9e123		
Warnings:					
Information:					
21	Foreign Reference	FRef21_DE112005003306T5.pdf	1512167	no	15
			6eace51bedcfe71dc8ea6f0a658421a8c681e17		
Warnings:					
Information:					
22	Foreign Reference	FRef22_DE60133316T2.pdf	2073005	no	22
			0b7d9cb1fe49ab2c8fb09ba4a79bba61c579fead		
Warnings:					
Information:					
23	Foreign Reference	FRef23_DE60317751T2.pdf	826323	no	9
			483daaec48a2ae1ea36632e06273ad6e14c39926		
Warnings:					
Information:					
24	Foreign Reference	FRef24_EP0841832A2.pdf	758379	no	9
			4d5156c5c3db4d33e8f390e708b23c898eefac1e		
Warnings:					
Information:					
25	Foreign Reference	FRef25_EP0841832A3.pdf	235091	no	3
			a6d030529f93eba0307027ca64fa6351eff52f30		
Warnings:					
Information:					
26	Foreign Reference	FRef26_EP1032224A2.pdf	1507492	no	15
			b66fdda86c09b5cb6355ff4d794ebe1c29c2ab22		
Warnings:					
Information:					
27	Foreign Reference	FRef27_EP1032224A3.pdf	227098	no	3
			fab9d807b0fcb48e55f6bb0965f2a86aa21a2e2		
Warnings:					
Information:					
28	Foreign Reference	FRef28_EP1244250A1.pdf	1375810	no	15
			491c74c40bc6870daf6ebba229ee1bcfb74f3a49e		
Warnings:					
Information:					

29	Foreign Reference	FRef29_EP1266516A2.pdf	232303	no	3
			32c6c3e74bcab714f623d0b7164c0865703d70cb		
Warnings:					
Information:					
30	Foreign Reference	FRef30_EP1362456A2.pdf	201764	no	3
			d414145f3edbae068ab741133e25a8547bab204c		
Warnings:					
Information:					
31	Foreign Reference	FRef31_EP1371173A1.pdf	192586	no	3
			27004385fcd7f33d6eaa4cc950db18e1da222da8		
Warnings:					
Information:					
32	Foreign Reference	FRef32_EP1411743A1.pdf	758578	no	9
			07e12820c2ddf8741baf850d8b18bf16010f1761		
Warnings:					
Information:					
33	Foreign Reference	FRef33_EP1526697A2.pdf	2485309	no	24
			836e62ccb6d63dc4a8844c19d299de31b2cdf35		
Warnings:					
Information:					
34	Foreign Reference	FRef34_EP1362456A4.pdf	448171	no	6
			1cbee57f439c649369b71939e4787981fd6c2fb		
Warnings:					
Information:					
35	Foreign Reference	FRef35_EP1575327A1.pdf	1278549	no	14
			c5ff8e8c1636b7ef99aa10efa8e3542fe08a0822		
Warnings:					
Information:					
36	Foreign Reference	FRef36_EP1610583A1.pdf	1280817	no	14
			6f886a1fe38cc7944e2affb538f6de4c7c3fb9d4		
Warnings:					
Information:					
37	Foreign Reference	FRef37_EP1526697A3.pdf	230778	no	3
			bdb80ac61450132c8f6c8b1f497bf7bbc087debf		
Warnings:					
Information:					

38	Foreign Reference	FRef38_EP1721446A1.pdf	149760	no	2
			c12dc86950622c5a9e01fc16ee3a682c06f31477		
Warnings:					
Information:					
39	Foreign Reference	FRef39_EP1829300A1.pdf	195921	no	3
			8a3ed67caaa669f3183ff35c05ae3a647423fb25		
Warnings:					
Information:					
40	Foreign Reference	FRef40_EP1371173B1.pdf	1738177	no	18
			069f2f942db1a537019c200d9b0530c5e6966b2		
Warnings:					
Information:					
41	Foreign Reference	FRef41_EP1411743B1.pdf	762770	no	9
			ebf3851c31f7662d9c1eda59c96efaab992660bb		
Warnings:					
Information:					
42	Foreign Reference	FRef42_EP1362456B1.pdf	1883717	no	21
			9b750b843d6f5b3bd04545d2ff7ffbcbf621578f		
Warnings:					
Information:					
43	Foreign Reference	FRef43_EP1974304A2.pdf	196381	no	3
			29d2f3d1725d7837fed4e5a7004fc85719dff047b		
Warnings:					
Information:					
44	Foreign Reference	FRef44_EP1974304A4.pdf	293312	no	4
			66f9f1c13f96df8c3f50066776d3a467b53f111d		
Warnings:					
Information:					
45	Foreign Reference	FRef45_EP1610583B1.pdf	1470579	no	15
			0681150b1e402dbf0998e175d07302dabf0b7c25		
Warnings:					
Information:					
46	Foreign Reference	FRef46_EP2127232A1.pdf	136823	no	2
			a9b65fe4007f068dd4365d3f2095d37c5eeef36		
Warnings:					
Information:					

47	Foreign Reference	FRef47_EP2165489A1.pdf	135448	no	2
			f2d181122dfddc9eeec51199f46eaa5b385a8de1		
Warnings:					
Information:					
48	Foreign Reference	FRef48_EP2215755A1.pdf	187623	no	3
			3ab8f469911de18093cbee37b4a4b5db5e72c05c		
Warnings:					
Information:					
49	Foreign Reference	FRef49_EP2165489A4.pdf	226305	no	3
			00c9292cd9e75dded893480f1ba1b308dc19f114		
Warnings:					
Information:					
50	Foreign Reference	FRef50_EP2127232A4.pdf	315613	no	4
			1d188490c5ca6d1e13dc000eb4b54d2fa8b7afb8		
Warnings:					
Information:					
51	Foreign Reference	FRef51_EP1829300A4.pdf	276173	no	4
			8977d6f4a2ab5bc505f6c35919da14078dc02afa		
Warnings:					
Information:					
52	Foreign Reference	FRef52_EP2449749A1.pdf	144780	no	2
			c4d5646435417ab1b6d0627af130c3fe97982e29		
Warnings:					
Information:					
53	Foreign Reference	FRef53_EP2215755A4.pdf	269752	no	4
			f7fb64ae232ffc99f8066abbace5058d05cd1abd		
Warnings:					
Information:					
54	Foreign Reference	FRef54_EP1829300B1.pdf	220531	no	3
			d3100d5fbd37a0343df1755b3197f1c87a796507		
Warnings:					
Information:					
55		IDS_SMARB19_001C1_11_26_2014.pdf	761098	yes	13
			e7e70df3b0c5345f8ffc8cc836067f85f26136ff		

Multipart Description/PDF files in .zip description			
Document Description		Start	End
Transmittal Letter		1	2
Information Disclosure Statement (IDS) Form (SB08)		3	13

Warnings:

Information:

Total Files Size (in bytes):	61322838
-------------------------------------	----------

This Acknowledgement Receipt evidences receipt on the noted date by the USPTO of the indicated documents, characterized by the applicant, and including page counts, where applicable. It serves as evidence of receipt similar to a Post Card, as described in MPEP 503.

New Applications Under 35 U.S.C. 111

If a new application is being filed and the application includes the necessary components for a filing date (see 37 CFR 1.53(b)-(d) and MPEP 506), a Filing Receipt (37 CFR 1.54) will be issued in due course and the date shown on this Acknowledgement Receipt will establish the filing date of the application.

National Stage of an International Application under 35 U.S.C. 371

If a timely submission to enter the national stage of an international application is compliant with the conditions of 35 U.S.C. 371 and other applicable requirements a Form PCT/DO/EO/903 indicating acceptance of the application as a national stage submission under 35 U.S.C. 371 will be issued in addition to the Filing Receipt, in due course.

New International Application Filed with the USPTO as a Receiving Office

If a new international application is being filed and the international application includes the necessary components for an international filing date (see PCT Article 11 and MPEP 1810), a Notification of the International Application Number and of the International Filing Date (Form PCT/RO/105) will be issued in due course, subject to prescriptions concerning national security, and the date shown on this Acknowledgement Receipt will establish the international filing date of the application.

INFORMATION DISCLOSURE STATEMENT

Inventor	:	Clay Perreault, et al.
App. No.	:	13/966,096
Filed	:	August 13, 2013
For	:	PRODUCING ROUTING MESSAGES FOR VOICE OVER IP COMMUNICATIONS
Examiner	:	Sing, Simon P.
Art Unit	:	2653
Conf. No.	:	8712

Commissioner for Patents
P.O. Box 1450
Alexandria, VA 22313-1450

References and Listing

Pursuant to 37 CFR 1.56, an Information Disclosure Statement listing references is provided herewith. Copies of any listed foreign and non-patent literature references are being submitted.

No Disclaimers

To the extent that anything in the Information Disclosure Statement or the listed references could be construed as a disclaimer of any subject matter supported by the present application, Applicant hereby rescinds and retracts such disclaimer.

Timing of Disclosure

This Information Disclosure Statement is being filed before the receipt of a First Office Action on the merits, and presumably no fee is required. If a First Office Action on the merits

Application No.: 13/966,096
Filing Date: August 13, 2013

was mailed before the mailing date of this Statement, the Commissioner is authorized to charge the fee set forth in 37 CFR 1.17(p) to Deposit Account No. 11-1410.

Respectfully submitted,
KNOBBE, MARTENS, OLSON & BEAR, LLP

Dated: 11/26/14

By: _____
John M. Carson
Registration No. 34,303
Attorney of Record
Customer No. 20995
(858) 707-4000

IDS
19421508
112614

Please Direct All Correspondence to Customer Number 20995

EFS WEB CONTINUING IDS COVER LETTER

Inventor	:	Clay Perreault, et al.
App. No.	:	13/966,096
Filed	:	August 13, 2013
For	:	PRODUCING ROUTING MESSAGES FOR VOICE OVER IP COMMUNICATIONS
Examiner	:	Sing, Simon P.
Art Unit	:	2653
Conf No.	:	8712

Commissioner for Patents
P.O. Box 1450
Alexandria, VA 22313-1450

Dear Sir:

Submitted herewith are references numbered 197 to 238 listed on the PTO/SB/08 or equivalent filed under EFS ID 20803282.

Please charge any additional fees, including any fees for additional extension of time, or credit overpayment to Deposit Account No. 11-1410.

Respectfully submitted,

KNOBBE, MARTENS, OLSON & BEAR, LLP

Dated: _____

11/26/14

By: _____



John M. Carson
Registration No. 34,303
Attorney of Record
Customer No. 20995
(858) 707-4000

IDS-CON
19421570
112614

Electronic Acknowledgement Receipt

EFS ID:	20803634
Application Number:	13966096
International Application Number:	
Confirmation Number:	8712
Title of Invention:	PRODUCING ROUTING MESSAGES FOR VOICE OVER IP COMMUNICATIONS
First Named Inventor/Applicant Name:	CLAY PERREAULT
Customer Number:	20995
Filer:	John M Carson/Norman Green
Filer Authorized By:	John M Carson
Attorney Docket Number:	SMARB19.001C1
Receipt Date:	26-NOV-2014
Filing Date:	13-AUG-2013
Time Stamp:	18:48:13
Application Type:	Utility under 35 USC 111(a)

Payment information:

Submitted with Payment	no
------------------------	----

File Listing:

Document Number	Document Description	File Name	File Size(Bytes)/ Message Digest	Multi Part /.zip	Pages (if appl.)
1	Foreign Reference	FRef55_EP2449749B1.pdf	1916042 <small>c7ec55e0d9f34481443305592ea860b6979bb21d</small>	no	21

Warnings:

Information:

2	Foreign Reference	FRef56_EP1266516B1.pdf	1664204	no	18
			d52be8321c2a689d0166ecd32ebd803ccf7009f		
Warnings:					
Information:					
3	Foreign Reference	FRef57_WO01069899A2.pdf	2259314	no	28
			94e933342c98664c8d506ccea63b1bc08fbb3fb		
Warnings:					
Information:					
4	Foreign Reference	FRef58_WO01069899A3.pdf	416928	no	5
			bda88f4ab9a34fa3c2286ac66015aff2a43392a4		
Warnings:					
Information:					
5	Foreign Reference	FRef59_WO0180587A1.pdf	1619706	no	22
			85242829c5647845bc45ffd8aac6a19d342dfbbd		
Warnings:					
Information:					
6	Foreign Reference	FRef60_WO02082728A1.pdf	2591192	no	34
			16384beb042c600be3c0e0a879ee9503d244138c		
Warnings:					
Information:					
7	Foreign Reference	FRef61_WO02082782A2.pdf	2914857	no	43
			f0d50b28dfa8ff26b3fd3d549cca52021cd732d		
Warnings:					
Information:					
8	Foreign Reference	FRef62_WO02082782A3.pdf	257211	no	3
			f2a654e281f862589306515292e189bb735b52a5		
Warnings:					
Information:					
9	Foreign Reference	FRef63_WO2005084002A1.pdf	3900912	no	47
			bfc5c5251907802e72fe06271a28ee022af6b3e1b		
Warnings:					
Information:					
10	Foreign Reference	FRef64_WO2006067269A1.pdf	3463501	no	42
			2d7411d22abd0087e0e6286a27992edb9df69c28		
Warnings:					
Information:					

11	Foreign Reference	FRef65_WO2006072099A1.pdf	2394748 ac5dfcf6234eafca9d46b61e13d08eca85c3aa5a	no	30
Warnings:					
Information:					
12	Foreign Reference	FRef66_WO2006078175A2.pdf	1037300 55a67b931a84a2b31550663a1166ec807d0f377c	no	13
Warnings:					
Information:					
13	Foreign Reference	FRef67_WO2006078175A3.pdf	271651 cb7df71eb16430d59ee154d3d7dc86b94ddfd26	no	3
Warnings:					
Information:					
14	Foreign Reference	FRef68_WO2007044454A2.pdf	1995500 c9fa9928d60dffdaf6fcd504c08952b08345a	no	27
Warnings:					
Information:					
15	Foreign Reference	FRef69_WO2007087077A2.pdf	2004508 7f50929c2a209f3db466f990ac35a95b11071766	no	25
Warnings:					
Information:					
16	Foreign Reference	FRef70_WO2007087077A3.pdf	261160 071fc65c3cd0719ba4b2885bcf92de7e0ed0495d	no	3
Warnings:					
Information:					
17	Foreign Reference	FRef71_WO2008085614A2.pdf	3347354 12b402d41f292c3dd44c36531932dd683fe4b4fb	no	40
Warnings:					
Information:					
18	Foreign Reference	FRef72_WO2008085614A3.pdf	415791 7fea40fec0ec0117d53a4341437056129a65c9b7	no	5
Warnings:					
Information:					
19	Foreign Reference	FRef73_WO2008085614A8.pdf	254937 de8b70f513957e08800b0223bef3f82bf5d0ae4	no	4
Warnings:					
Information:					

20	Foreign Reference	FRef74_WO2008086350A2.pdf	2960802 65a44accd0215e7ebf8c8fd92d21781fc62826f5	no	45
Warnings:					
Information:					
21	Foreign Reference	FRef75_WO2008086350A3.pdf	450316 bc738f5e7ed1ff2182902835b4806e906470b4e3	no	6
Warnings:					
Information:					
22	Foreign Reference	FRef76_WO2008103652A1.pdf	2049308 57f7119548f95d8f26aa560cc9a18197c529784d	no	28
Warnings:					
Information:					
23	Foreign Reference	FRef77_WO2008151406A1.pdf	2190191 270b6309c2aac77688db0bc59630f0ba505dba0c	no	27
Warnings:					
Information:					
24	Foreign Reference	FRef78_WO2008151406A8.pdf	101547 58dfd5ffe0133f48384e374a19e46c1afd652a32	no	1
Warnings:					
Information:					
25	Foreign Reference	FRef79_WO2009070202A1.pdf	4494015 b182cddf1e218b2914e6c531e9389f46d3ef89c0	no	60
Warnings:					
Information:					
26	Foreign Reference	FRef80_WO2009070278A1.pdf	3899512 a1c07b2bba7574e3c53857c90de4ff95291c67b3	no	49
Warnings:					
Information:					
27	Foreign Reference	FRef81_WO2011000405A1.pdf	2061771 7a0c468264115ea323bbd3f980ad7c941f44ec2f	no	27
Warnings:					
Information:					
28	Non Patent Literature	NRef1_Baker_Cisco_Support_Apr_2003.pdf	1089613 60278da852d7b93e5b5ab60105289f93cdf4fd5a	no	15
Warnings:					
Information:					

29	Non Patent Literature	NRef2_Bhushan_Federated_Ac counting_2001.pdf	1342637 2ed16b50935f7a7bcb45d50b4551263447 076c9	no	15
Warnings:					
Information:					
30	Non Patent Literature	NRef3_Jajszczyk_Emergency_C alls_Sept_2007.pdf	435620 54549733f533cde854ba14e0caf64fb35f67 bce	no	3
Warnings:					
Information:					
31	Non Patent Literature	NRef4_Kim_Enhanced_VoIP_M ay_2006.pdf	904746 25d3bd2fd692570be10dbf833bb335f0965 15a60	no	8
Warnings:					
Information:					
32	Non Patent Literature	NRef5_Kornfeld_DVB_H_and_I P_Datacast_March_2007.pdf	1363178 24d14dd9f69e8c8c66ae9c1945cb711c889 15afa	no	10
Warnings:					
Information:					
33	Non Patent Literature	NRef6_Kortebi_Meddour_SINR _Based_Routing_2007.pdf	841024 9cfabaeac68aaa41468a53a9f379b6b588cff 735	no	6
Warnings:					
Information:					
34	Non Patent Literature	NRef7_Lee_VoIP_Interoperatio n_2004.pdf	644808 59423980e4c93115b22c514e44246eb926b 24f29	no	7
Warnings:					
Information:					
35	Non Patent Literature	NRef8_Lin_Effective_VoIP_Call _Routing_2005.pdf	335804 d166b8fc7eea322422ac929d424a66c492 6aec9	no	3
Warnings:					
Information:					
36	Non Patent Literature	NRef9_Ma_Realizing_MPEG4_2 005.pdf	514335 065f46bed6d8068577cbad7cb707f6f31f0f 3d85	no	4
Warnings:					
Information:					
37	Non Patent Literature	NRef10_Mintz- Habib_A_VoIP_Emergency_20 05.pdf	829844 0cde14452c1c8cfb988b4b4f2f5c8c339ac7 7657	no	6
Warnings:					
Information:					

38	Non Patent Literature	NRef11_Munir_Study_Adaptive_Scheme_2005.pdf	1516334 a6d2fc388fcc9647095760fbbc775ffb70cfa bb1	no	17
Warnings:					
Information:					
39	Non Patent Literature	NRef12_Sripanidkulchai_Call_Routing_2007.pdf	784493 59615b3a52b42334065bf89d62a86c2c89a 912e4	no	6
Warnings:					
Information:					
40	Non Patent Literature	NRef13_Thernelius_SIP_NAT_May_2000.pdf	5744783 0e8aa8758c56b1027d0655bcab94eecea0 079b2	no	69
Warnings:					
Information:					
41	Non Patent Literature	NRef14_Trad_Adaptive_VoIP_2004.pdf	1055406 b5546a1dd148b40bc8ec8f7d7aa4613f230 1c09	no	12
Warnings:					
Information:					
42	Non Patent Literature	NRef15_Yu_Service-Oriented_Issues_2006.pdf	901174 a1911e8afcc7ef5dfa2fcb549b65d2baca2f 77c	no	10
Warnings:					
Information:					
43	Transmittal Letter	IDS_Con_Trans_SMARB19_001_C1_11_26_2014.pdf	31131 250f29146fcd990e428761d6d0df2e44fd 267e	no	1
Warnings:					
Information:					
Total Files Size (in bytes):			69529208		

This Acknowledgement Receipt evidences receipt on the noted date by the USPTO of the indicated documents, characterized by the applicant, and including page counts, where applicable. It serves as evidence of receipt similar to a Post Card, as described in MPEP 503.

New Applications Under 35 U.S.C. 111

If a new application is being filed and the application includes the necessary components for a filing date (see 37 CFR 1.53(b)-(d) and MPEP 506), a Filing Receipt (37 CFR 1.54) will be issued in due course and the date shown on this Acknowledgement Receipt will establish the filing date of the application.

National Stage of an International Application under 35 U.S.C. 371

If a timely submission to enter the national stage of an international application is compliant with the conditions of 35 U.S.C. 371 and other applicable requirements a Form PCT/DO/EO/903 indicating acceptance of the application as a national stage submission under 35 U.S.C. 371 will be issued in addition to the Filing Receipt, in due course.

New International Application Filed with the USPTO as a Receiving Office

If a new international application is being filed and the international application includes the necessary components for an international filing date (see PCT Article 11 and MPEP 1810), a Notification of the International Application Number and of the International Filing Date (Form PCT/RO/105) will be issued in due course, subject to prescriptions concerning national security, and the date shown on this Acknowledgement Receipt will establish the international filing date of the application.

INFORMATION DISCLOSURE STATEMENT BY APPLICANT	Application No.	13/966,096	
	Filing Date	August 13, 2013	
	First Named Inventor	Perreault, Clay	
	Art Unit	2653	
<i>(Multiple sheets used when necessary)</i>		Examiner	Sing, Simon P.
SHEET 1 OF 1		Attorney Docket No.	SMARB19.001C1

U.S. PATENT DOCUMENTS					
Examiner Initials	Cite No.	Document Number Number - Kind Code (if known) Example: 1,234,567 B1	Publication Date MM-DD-YYYY	Name	Pages, Columns, Lines Where Relevant Passages or Relevant Figures Appear
	1	6,445,694 B1	09-03-2002	Swartz, Robert	
	2	6,574,328 B1	06-03-2003	Wood et al.	
	3	6,785,266 B2	08-31-2004	Swartz, Robert	
	4	7,486,664 B2	02-03-2009	Swartz, Robert	
	5	7,512,117 B2	03-31-2009	Swartz, Robert	
	6	7,587,036 B2	09-08-2009	Wood et al.	
	7	7,764,777 B2	07-27-2010	Wood et al.	

FOREIGN PATENT DOCUMENTS						
Examiner Initials	Cite No.	Foreign Patent Document Country Code-Number-Kind Code Example: JP 1234567 A1	Publication Date MM-DD-YYYY	Name	Pages, Columns, Lines Where Relevant Passages or Relevant Figures Appear	T ¹

NON PATENT LITERATURE DOCUMENTS			
Examiner Initials	Cite No.	Include name of the author (in CAPITAL LETTERS), title of the article (when appropriate), title of the item (book, magazine, journal, serial, symposium, catalog, etc.), date, page(s), volume-issue number(s), publisher, city and/or country where published.	T ¹

19561108
121614

Examiner Signature	Date Considered
--------------------	-----------------

***Examiner:** Initial if reference considered, whether or not citation is in conformance with MPEP 609. Draw line through citation if not in conformance and not considered. Include copy of this form with next communication to applicant.

T¹ - Place a check mark in this area when an English language Translation is attached AT&T, Exh. 1002, p. 227

Electronic Acknowledgement Receipt

EFS ID:	21002018
Application Number:	13966096
International Application Number:	
Confirmation Number:	8712
Title of Invention:	PRODUCING ROUTING MESSAGES FOR VOICE OVER IP COMMUNICATIONS
First Named Inventor/Applicant Name:	CLAY PERREAULT
Customer Number:	20995
Filer:	John M Carson/Norman Green
Filer Authorized By:	John M Carson
Attorney Docket Number:	SMARB19.001C1
Receipt Date:	18-DEC-2014
Filing Date:	13-AUG-2013
Time Stamp:	12:57:02
Application Type:	Utility under 35 USC 111(a)

Payment information:

Submitted with Payment	no
------------------------	----

File Listing:

Document Number	Document Description	File Name	File Size(Bytes)/ Message Digest	Multi Part /.zip	Pages (if appl.)
1		IDS_SMARB19_001C1_12_18_2014.pdf	91252 ca5acb691f4373027c439d41c352c15cd78e9e59	yes	3

Multipart Description/PDF files in .zip description			
Document Description		Start	End
Transmittal Letter		1	2
Information Disclosure Statement (IDS) Form (SB08)		3	3

Warnings:

Information:

Total Files Size (in bytes):	91252
-------------------------------------	-------

This Acknowledgement Receipt evidences receipt on the noted date by the USPTO of the indicated documents, characterized by the applicant, and including page counts, where applicable. It serves as evidence of receipt similar to a Post Card, as described in MPEP 503.

New Applications Under 35 U.S.C. 111

If a new application is being filed and the application includes the necessary components for a filing date (see 37 CFR 1.53(b)-(d) and MPEP 506), a Filing Receipt (37 CFR 1.54) will be issued in due course and the date shown on this Acknowledgement Receipt will establish the filing date of the application.

National Stage of an International Application under 35 U.S.C. 371

If a timely submission to enter the national stage of an international application is compliant with the conditions of 35 U.S.C. 371 and other applicable requirements a Form PCT/DO/EO/903 indicating acceptance of the application as a national stage submission under 35 U.S.C. 371 will be issued in addition to the Filing Receipt, in due course.

New International Application Filed with the USPTO as a Receiving Office

If a new international application is being filed and the international application includes the necessary components for an international filing date (see PCT Article 11 and MPEP 1810), a Notification of the International Application Number and of the International Filing Date (Form PCT/RO/105) will be issued in due course, subject to prescriptions concerning national security, and the date shown on this Acknowledgement Receipt will establish the international filing date of the application.

INFORMATION DISCLOSURE STATEMENT

Inventor	:	Clay Perreault, et al.
App. No.	:	13/966,096
Filed	:	August 13, 2013
For	:	PRODUCING ROUTING MESSAGES FOR VOICE OVER IP COMMUNICATIONS
Examiner	:	Sing, Simon P
Art Unit	:	2653
Conf. No.	:	8712

Commissioner for Patents
P.O. Box 1450
Alexandria, VA 22313-1450

References and Listing

Pursuant to 37 CFR 1.56, an Information Disclosure Statement listing references is provided herewith. Copies of any listed foreign and non-patent literature references are being submitted.

No Disclaimers

To the extent that anything in the Information Disclosure Statement or the listed references could be construed as a disclaimer of any subject matter supported by the present application, Applicant hereby rescinds and retracts such disclaimer.

Timing of Disclosure

This Information Disclosure Statement is being filed before the receipt of a First Office Action on the merits, and presumably no fee is required. If a First Office Action on the merits

Application No.: 13/966,096
Filing Date: August 13, 2013

was mailed before the mailing date of this Statement, the Commissioner is authorized to charge the fee set forth in 37 CFR 1.17(p) to Deposit Account No. 11-1410.

Respectfully submitted,
KNOBBE, MARTENS, OLSON & BEAR, LLP

Dated: 12/18/14

By: _____
John M. Carson
Registration No. 34,303
Attorney of Record
Customer No. 20995
(858) 707-4000

IDS
19561154
121614

INFORMATION DISCLOSURE STATEMENT BY APPLICANT	Application No.	13/966,096
	Filing Date	August 13, 2013
	First Named Inventor	Perreault, Clay
	Art Unit	2653
<i>(Multiple sheets used when necessary)</i>	Examiner	Sing, Simon P.
SHEET 1 OF 3	Attorney Docket No.	SMARB19.001C1

U.S. PATENT DOCUMENTS					
Examiner Initials	Cite No.	Document Number Number - Kind Code (if known) Example: 1,234,567 B1	Publication Date MM-DD-YYYY	Name	Pages, Columns, Lines Where Relevant Passages or Relevant Figures Appear
	1	6,937,713 B1	08-30-2005	Kung et al.	
	2	8,111,690 B2	02-07-2012	Hussain et al.	
	3	8,219,115 B1	07-10-2012	Nelissen, Marco	
	4	8,228,837 B2	07-24-2012	Sheriff et al.	
	5	8,243,730 B1	08-14-2012	Wong et al.	
	6	8,275,404 B2	09-25-2012	Berger et al.	
	7	8,364,172 B2	01-29-2013	Guanfeng et al.	
	8	8,410,907 B2	04-02-2013	Twitchell, Jr., Robert W.	
	9	8,417,791 B1	04-09-2013	Peretz et al.	
	10	8,423,791 B1	04-16-2013	Yu et al.	
	11	8,468,196 B1	06-18-2013	Roskind et al.	
	12	8,493,931 B1	07-23-2013	Nix, John A.	
	13	8,532,075 B2	09-10-2013	Rassool et al.	
	14	8,682,919 B1	03-25-2014	Golliher, Geoffrey	
	15	8,713,098 B1	04-29-2014	Adya et al.	
	16	8,749,610 B1	06-10-2014	Gossweiler et al.	
	17	8,767,717 B2	07-01-2014	Siegel et al.	
	18	8,774,721 B2	07-08-2014	Hertel et al.	
	19	8,780,703 B1	07-15-2014	Eidelson et al.	
	20	8,792,374 B1	07-29-2014	Jain et al.	
	21	8,792,905 B1	07-29-2014	Li et al.	
	22	8,805,345 B2	08-12-2014	Ling et al.	
	23	8,810,392 B1	08-19-2014	Teller et al.	
	24	8,837,360 B1	09-16-2014	Mishra et al.	
	25	8,838,539 B1	09-16-2014	Ashcraft et al.	
	26	2001/0027478 A1	10-04-2001	Meier et al.	
	27	2011/0255553 A1	10-20-2011	Bobba et al.	
	28	2011/0261717 A1	10-27-2011	Akuzuwa et al.	

Examiner Signature	Date Considered
*Examiner: Initial if reference considered, whether or not citation is in conformance with MPEP 609. Draw line through citation if not in conformance and not considered. Include copy of this form with next communication to applicant.	

T¹ - Place a check mark in this area when an English language Translation is attached AT&T, Exh. 1002, p. 232

INFORMATION DISCLOSURE STATEMENT BY APPLICANT	Application No.	13/966,096	
	Filing Date	August 13, 2013	
	First Named Inventor	Perreault, Clay	
	Art Unit	2653	
<i>(Multiple sheets used when necessary)</i>		Examiner	Sing, Simon P.
SHEET 2 OF 3		Attorney Docket No.	SMARB19.001C1

U.S. PATENT DOCUMENTS					
Examiner Initials	Cite No.	Document Number Number - Kind Code (if known) Example: 1,234,567 B1	Publication Date MM-DD-YYYY	Name	Pages, Columns, Lines Where Relevant Passages or Relevant Figures Appear
	29	2013/0223276 A1	08-29-2013	Padgett, Steven	
	30	2013/0237198 A1	09-12-2013	Vashi et al.	
	31	2013/0254301 A1	09-26-2013	Lin et al.	
	32	2013/0272297 A1	10-17-2013	Breen et al.	
	33	2013/0281147 A1	10-24-2013	Denman et al.	
	34	2014/0220944 A1	08-07-2014	Balasubramanian, Sanjeevi	
	35	2014/0244393 A1	08-28-2014	Rimmer et al.	
	36	2014/0247730 A1	09-04-2014	Thota et al.	
	37	2014/0269624 A1	09-18-2014	Khay-Ibbat et al.	
	38	2014/0324969 A1	10-30-2014	Riddle, Guy	
	39	2014/0337962 A1	11-13-2014	Brandstatter, Klaus	
	40	2014/0337961 A1	11-13-2014	Chien et al.	
	41	2014/0349602 A1	11-27-2014	Majumdar et al.	

FOREIGN PATENT DOCUMENTS						
Examiner Initials	Cite No.	Foreign Patent Document Country Code-Number-Kind Code Example: JP 1234567 A1	Publication Date MM-DD-YYYY	Name	Pages, Columns, Lines Where Relevant Passages or Relevant Figures Appear	T ¹
	42	CA 2 659 007 A1	09-27-2009	Google Inc		Abstract
	43	CA 2 778 905 A1	08-26-2010	Google Inc		Abstract
	44	CN 102137024 A	07-27-2011	Fujian Star Net Comm Co Ltd		Abstract
	45	JP 2011-199384 (A)	10-06-2011	Ricoh Co Ltd		Abstract
	46	WO 01/50693 A1	07-12-2001	WWW.Internet Solutions Limited		
	47	WO 03/027801 A2	04-03-2003	Bell-South Intellectual Property Corporation		
	48	WO 2013/120069 A1	08-15-2013	Connectify		
	49	WO 2014/066155 A2	05-01-2014	Google Inc.		
	50	WO 2014/117599 A1	08-07-2014	Huawei Tech Co Ltd		Abstract
	51	WO 2014-166258 A1	10-16-2014	ZTE Corp		Abstract

Examiner Signature	Date Considered
--------------------	-----------------

***Examiner:** Initial if reference considered, whether or not citation is in conformance with MPEP 609. Draw line through citation if not in conformance and not considered. Include copy of this form with next communication to applicant.

T¹ - Place a check mark in this area when an English language Translation is attached AT&T, Exh. 1002, p. 233

INFORMATION DISCLOSURE STATEMENT BY APPLICANT	Application No.	13/966,096
	Filing Date	August 13, 2013
	First Named Inventor	Perreault, Clay
	Art Unit	2653
<i>(Multiple sheets used when necessary)</i>	Examiner	Sing, Simon P.
SHEET 3 OF 3	Attorney Docket No.	SMARB19.001C1

NON PATENT LITERATURE DOCUMENTS			
Examiner Initials	Cite No.	Include name of the author (in CAPITAL LETTERS), title of the article (when appropriate), title of the item (book, magazine, journal, serial, symposium, catalog, etc.), date, page(s), volume-issue number(s), publisher, city and/or country where published.	T ¹
	52	ETSI TS 122 173 V12.7.0 (2014-10) Digital cellular telecommunications system (Phase 2+); TECHNICAL SPECIFICATION 8.2.2.3- Interoperability with PSTN/ISDN and mobile CS Networks, Contents and Forward, pages 1-9; Sec. 8, pages 14-17.	
	53	Huitema <i>et al.</i> , "Architecture for Internet Telephony Service for Residential Customers," Academic Paper for <i>Bellcore</i> , March 2, 1999, pages 1-14.	
	54	Stallings, William, "The Session Initiation Protocol," <i>The Internet Protocol Journal</i> , Vol. 6, No. 1, March 2003, pages 20-30.	

19658743
010615

Examiner Signature	Date Considered
<p>*Examiner: Initial if reference considered, whether or not citation is in conformance with MPEP 609. Draw line through citation if not in conformance and not considered. Include copy of this form with next communication to applicant.</p>	

T¹ - Place a check mark in this area when an English language Translation is attached AT&T, Exh. 1002, p. 234

Electronic Acknowledgement Receipt

EFS ID:	21149007
Application Number:	13966096
International Application Number:	
Confirmation Number:	8712
Title of Invention:	PRODUCING ROUTING MESSAGES FOR VOICE OVER IP COMMUNICATIONS
First Named Inventor/Applicant Name:	CLAY PERREAULT
Customer Number:	20995
Filer:	John M Carson/Norman Green
Filer Authorized By:	John M Carson
Attorney Docket Number:	SMARB19.001C1
Receipt Date:	07-JAN-2015
Filing Date:	13-AUG-2013
Time Stamp:	18:27:59
Application Type:	Utility under 35 USC 111(a)

Payment information:

Submitted with Payment	no
------------------------	----

File Listing:

Document Number	Document Description	File Name	File Size(Bytes)/ Message Digest	Multi Part /.zip	Pages (if appl.)
1		IDS_SMARB19_001C1_01_07_2015.pdf	220905 <small>9b828e8743d3fa0a5117104bd5f1dad6d623e82a</small>	yes	5

Multipart Description/PDF files in .zip description					
Document Description			Start	End	
Transmittal Letter			1	2	
Information Disclosure Statement (IDS) Form (SB08)			3	5	
Warnings:					
Information:					
2	Foreign Reference	Ref42_CA2659007.pdf	4712669 b8ffbd7ea248ee05a2ef93c71c00676e2e6de4fb	no	62
Warnings:					
Information:					
3	Foreign Reference	Ref43_CA2778905.pdf	7009768 b8f04de5e7d508ab8261631df13fd3f7fa20a564	no	82
Warnings:					
Information:					
4	Foreign Reference	Ref44_CN102137024A.pdf	1808580 4c531eb36dcb3065d8bb1903b2f67665b453d65b	no	18
Warnings:					
Information:					
5	Foreign Reference	Ref45_JP2011199384.pdf	1171823 300397098b0e1107a3b04e309dcb11191ade6184	no	13
Warnings:					
Information:					
6	Foreign Reference	Ref46_WO01050693A1.pdf	9161416 27e9e469d8be5d592552b89122af00384eb2231f	no	126
Warnings:					
Information:					
7	Foreign Reference	Ref47_WO03027801A2.pdf	1589172 35be5edf47019053d41eef2b46cb43d61c0ca754	no	20
Warnings:					
Information:					
8	Foreign Reference	Ref48_WO2013120069A1.pdf	2034106 9705f71c44c96dbd8fea783951cd4fe571a3844c	no	26
Warnings:					
Information:					

9	Foreign Reference	Ref49_WO2014066155A2.pdf	1656227 9edd609c44ff99c765f8f4c8b77d8dea81d70727	no	21
Warnings:					
Information:					
10	Foreign Reference	Ref50_WO2014117599A1.pdf	3367344 dbf3e55e175a40313dac74f70d297103fc7ef74f	no	40
Warnings:					
Information:					
11	Foreign Reference	Ref51_WO2014166258A1.pdf	1536864 76474f066e67258940cb8ef7502c820178cb4c19	no	22
Warnings:					
Information:					
12	Non Patent Literature	Ref52_ETSI_TS_122_173_V12_7_0_2014-10.pdf	1188696 6cf93c7e9b550351efec483bbf9b8b8536fe9d45	no	14
Warnings:					
Information:					
13	Non Patent Literature	Ref53_Huitema_et_al_Bellcore_1999.pdf	1361023 7efed91bc1685bbfb103874f69d7bfa6dff08f0f	no	14
Warnings:					
Information:					
14	Non Patent Literature	Ref54_Stallings_2003.pdf	1058786 3b18d11f32ef6c0efa3501eb9ab07965ec7e7ba4	no	12
Warnings:					
Information:					
Total Files Size (in bytes):			37877379		

This Acknowledgement Receipt evidences receipt on the noted date by the USPTO of the indicated documents, characterized by the applicant, and including page counts, where applicable. It serves as evidence of receipt similar to a Post Card, as described in MPEP 503.

New Applications Under 35 U.S.C. 111

If a new application is being filed and the application includes the necessary components for a filing date (see 37 CFR 1.53(b)-(d) and MPEP 506), a Filing Receipt (37 CFR 1.54) will be issued in due course and the date shown on this Acknowledgement Receipt will establish the filing date of the application.

National Stage of an International Application under 35 U.S.C. 371

If a timely submission to enter the national stage of an international application is compliant with the conditions of 35 U.S.C. 371 and other applicable requirements a Form PCT/DO/EO/903 indicating acceptance of the application as a national stage submission under 35 U.S.C. 371 will be issued in addition to the Filing Receipt, in due course.

New International Application Filed with the USPTO as a Receiving Office

If a new international application is being filed and the international application includes the necessary components for an international filing date (see PCT Article 11 and MPEP 1810), a Notification of the International Application Number and of the International Filing Date (Form PCT/RO/105) will be issued in due course, subject to prescriptions concerning national security, and the date shown on this Acknowledgement Receipt will establish the international filing date of the application.

INFORMATION DISCLOSURE STATEMENT

Inventor	:	Clay Perreault, et al.
App. No.	:	13/966,096
Filed	:	August 13, 2013
For	:	PRODUCING ROUTING MESSAGES FOR VOICE OVER IP COMMUNICATIONS
Examiner	:	Sing, Simon P.
Art Unit	:	2653
Conf. No.	:	8712

Commissioner for Patents
P.O. Box 1450
Alexandria, VA 22313-1450

References and Listing

Pursuant to 37 CFR 1.56, an Information Disclosure Statement listing references is provided herewith. Copies of any listed foreign and non-patent literature references are being submitted. Any foreign references may also include English abstract(s) and/or machine translation(s), but no representation is made as to their accuracy.

If the Examiner would like additional information regarding these references or if anything is unclear, the Examiner is invited to contact the undersigned for assistance.

No Disclaimers

To the extent that anything in the Information Disclosure Statement or the listed references could be construed as a disclaimer of any subject matter supported by the present application, Applicant hereby rescinds and retracts such disclaimer.

Timing of Disclosure

This Information Disclosure Statement is being filed before the receipt of a First Office Action on the merits, and presumably no fee is required. If a First Office Action on the merits

Application No.: 13/966,096
Filing Date: August 13, 2013

was mailed before the mailing date of this Statement, the Commissioner is authorized to charge the fee set forth in 37 CFR 1.17(p) to Deposit Account No. 11-1410.

Respectfully submitted,
KNOBBE, MARTENS, OLSON & BEAR, LLP

Dated: _____

1/7/15

By: _____



John M. Carson
Registration No. 34,303
Attorney of Record
Customer No. 20995
(858) 707-4000

IDS
19660493
010615

IN THE UNITED STATES PATENT AND TRADEMARK OFFICE

Inventor	: Clay Perreault
App. No.	: 13/966,096
Filed	: August 13, 2013
For	: PRODUCING ROUTING MESSAGES FOR VOICE OVER IP COMMUNICATIONS
Examiner	: Sing, Simon P.
Art Unit	: 2653
Conf. No.	: 8712

PRELIMINARY AMENDMENT**Mail Stop Amendment**

Commissioner for Patents

P.O. Box 1450

Alexandria, VA 22313-1450

Dear Sir:

Prior to examination on the merits, please amend the above-referenced patent application as follows:

Amendments to the Claims are reflected in the listing of claims which begins on page 2 of this paper.

Remarks begin on page 21 of this paper.

AMENDMENTS TO THE CLAIMS

1. (Original) A process for producing a routing message for routing communications between a caller and a callee in a communication system, the process comprising:

using a caller identifier associated with the caller to locate a caller dialing profile comprising a plurality of calling attributes associated with the caller;

when at least one of said calling attributes and at least a portion of a callee identifier associated with the callee meet private network classification criteria, producing a private network routing message for receipt by a call controller, said private network routing message identifying an address, on the private network, associated with the callee; and

when at least one of said calling attributes and at least a portion of said callee identifier meet a public network classification criterion, producing a public network routing message for receipt by the call controller, said public network routing message identifying a gateway to the public network.

2. (Original) The process of claim 1, wherein said private network classification criteria include:

a) said callee identifier does not begin with the same digit pattern as an international dialing digit (IDD) attribute of said callee identifier; and

b) said callee identifier does not begin with the same digit pattern as a national dialing digit (NDD) attribute of said callee identifier; and

c) said callee identifier does not begin with the same area code as an area code of said caller; and

d) said callee identifier does not have a length that is within a range of caller local number lengths; and

e) said callee identifier is a valid username.

3. (Original) The process of claim 2, further comprising identifying the call as a cross-domain call on the private network when said callee identifier identifies a callee that is not associated with the same network node as said caller.

4. (Original) The process of claim 2, further comprising:
locating a callee dialing profile for the callee when said callee identifier identifies a callee that is associated with the same network node as said caller; and
retrieving call handling information associated with the callee, where said call handling information is available, said call handling information including at least one of call blocking information, call forwarding information, and voicemail information.

5. (Original) The process of claim 4, further comprising, where said call handling information including said call blocking information is available, blocking the call when said call blocking information identifies the caller as a caller from whom calls are to be blocked from being established with the callee.

6. (Original) The process of claim 4, further comprising, where said call handling information including said call forwarding information is available, causing said call forwarding information to be included in said private network routing message.

7. (Original) The process of claim 4, further comprising, where said call handling information including said voicemail information is available, causing said voicemail information to be included in said private network routing message.

8. (Original) The process of claim 1, further comprising associating at least one direct inward dial (DID) record with at least one subscriber to said communication system, each of said at least one direct inward dial records comprising a field storing a direct inward dial number associated with said at least one subscriber.

9. (Original) The process of claim 8, wherein said public network classification criteria include:

Application No.: 13/966,096
Filing Date: August 13, 2013

a) said callee identifier begins with the same digit pattern as an international dialing digit (IDD) attribute of said callee identifier; and

b) a reformatted callee identifier produced by removing the IDD attribute from said callee identifier has no DID bank table record.

10. (Original) The process of claim 8, wherein said public network classification criteria include:

a) said callee identifier begins with the same digit pattern as a national dialing digit (NDD) attribute of said callee identifier; and

b) a reformatted callee identifier produced by removing the NDD attribute from said callee identifier and including a caller country code has no DID bank table record.

11. (Original) The process of claim 8, wherein said public network classification criteria include:

a) said callee identifier begins with the same area code as an area code of said caller; and

b) a reformatted callee identifier produced by reformatting the callee identifier to include a caller country code has no DID bank table record.

12. (Original) The process of claim 8, wherein said public network classification criteria include:

a) said callee identifier has a length that is within a range of caller local number lengths; and

b) a reformatted callee identifier produced by reformatting the callee identifier to include a caller country code and area code has no DID bank table record.

13. (Original) The process of claim 1, wherein said plurality of calling attributes includes at least one of an international dialing digits identifier, a national dialing digits identifier, a country code identifier, a local area codes identifier, a caller minimum local length

identifier, a caller maximum local length identifier, a reseller identifier, and a maximum number of concurrent calls identifier.

14. (Original) The process of claim 8, wherein said DID record comprises a user name field, a user domain field and a DID number field.

15. (Original) The process of claim 1, further comprising maintaining a list of public network route suppliers and when said public network classification criterion is met identifying at least one of said public network route suppliers that satisfies public network routing selection criteria.

16. (Original) The process of claim 15, wherein said producing said public network routing message comprises producing a public network routing message identifying said at least one public network route supplier that satisfies said public network routing selection criteria.

17. (Original) The process of claim 16, wherein producing said public network routing message comprises causing said public network routing message to include a gateway supplier identifier identifying a gateway supplier able to establish a communications link in a route through which communications between the caller and callee are to be conducted.

18. (Original) The process of claim 17, further comprising causing said public network routing message to include a time value and a timeout value.

19. (Original) The process of claim 17, wherein causing said public network routing message to include said gateway supplier identifier comprises causing said public network routing message to include a plurality of gateway supplier identifiers identifying a plurality of gateway suppliers able to supply respective communication links through which communications between the caller and callee can be conducted.

20. (Original) The process of claim 19, further comprising causing said public network routing message to include priority information identifying a priority in which gateway suppliers associated with said gateway identifiers are to be considered for selection of a communication link through which communications between the caller and callee can be conducted.

21. (Original) The process of claim 19, wherein causing said public network routing message to include priority information includes arranging said gateway supplier identifiers in said public network routing message in order of rate, where rate is determined from rate fields of respective said gateway supplier records.

22. (Original) The process of claim 21, wherein arranging said gateway supplier identifiers in order of rate comprises arranging said gateway supplier identifiers in order of increasing rate.

23. (Original) The process of claim 17, further comprising arranging said gateway supplier identifiers in an order based on at least one provision in a service agreement.

24. (Original) The process of claim 1, further comprising causing the private network routing message or the public network routing message to be communicated to a call controller to effect routing of the call.

25. (Original) A non-transitory computer readable medium encoded with codes for directing a processor to execute the method of claim 1.

26. (Original) A call routing controller apparatus for producing a routing message for routing communications between a caller and a callee in a communication system, the apparatus comprising:

at least one processor operably configured to:

use a caller identifier associated with the caller to locate a caller dialing profile comprising a plurality of calling attributes associated with the caller;

when at least one of said calling attributes and at least a portion of a callee identifier associated with the callee meet private network classification criteria, produce a private network routing message for receipt by a call controller, said private network routing message identifying an address, on the private network, associated with the callee; and

when at least one of said calling attributes and at least a portion of said callee identifier meet a public network classification criterion, produce a public network routing message for receipt by the call controller, said public network routing message identifying a gateway to the public network.

27. (Original) The apparatus of claim 26, wherein said private network classification criteria include:

- a) said callee identifier does not begin with the same digit pattern as an international dialing digit (IDD) attribute of said callee identifier; and
- b) said callee identifier does not begin with the same digit pattern as a national dialing digit (NDD) attribute of said callee identifier; and
- c) said callee identifier does not begin with the same area code as an area code of said caller; and
- d) said callee identifier does not have a length that is within a range of caller local number lengths; and
- e) said callee identifier is a valid username.

28. (Original) The apparatus of claim 27, wherein said at least one processor is further operably configured to identify the call as a cross-domain call on the private network when said callee identifier identifies a callee that is not associated with the same network node as said caller.

29. (Original) The apparatus of claim 27, wherein said at least one processor is further configured to:

Application No.: 13/966,096
Filing Date: August 13, 2013

access the database of caller dialing profiles to locate a callee dialing profile for the callee when said callee identifier identifies a callee that is associated with the same network node as said caller; and

retrieve call handling information associated with the callee, where said call handling information is available, said call handling information including at least one of call blocking information, call forwarding information, and voicemail information.

30. (Original) The apparatus of claim 29, wherein said at least one processor is further operably configured to determine whether said call handling information including said call blocking information is available and to block the call when said call blocking information identifies the caller as a caller from whom calls are to be blocked.

31. (Original) The apparatus of claim 29, wherein said at least one processor is further operably configured to determine whether said call handling information including said call forwarding information is available and to cause said call forwarding information to be included in said private network routing message.

32. (Original) The apparatus of claim 29, wherein said at least one processor is further operably configured to determine whether said call handling information including said voicemail information is available and to cause said voicemail information to be included in said private network routing message.

33. (Original) The apparatus of claim 26, wherein said at least one processor is further operably configured to access a database of direct inward dial records each associating at least one direct inward dial number with at least one subscriber to said communication system.

34. (Original) The apparatus of claim 33, wherein said public network classification criteria include:

a) said callee identifier begins with the same digit pattern as an international dialing digit (IDD) attribute of said callee identifier; and

Application No.: 13/966,096
Filing Date: August 13, 2013

b) a reformatted callee identifier produced by removing the IDD attribute from said callee identifier has no DID record.

35. (Original) The apparatus of claim 33, wherein said public network classification criteria include:

a) said callee identifier begins with the same digit pattern as a national dialing digit (NDD) attribute of said callee identifier; and

b) a reformatted callee identifier produced by removing the NDD attribute from said callee identifier and including a caller country code has no DID record.

36. (Original) The apparatus of claim 33, wherein said public network classification criteria include:

a) said callee identifier begins with the same area code as an area code of said caller; and

b) a reformatted callee identifier produced by reformatting the callee identifier to include a caller country code has no DID record.

37. (Original) The apparatus of claim 33, wherein said public network classification criteria include:

a) said callee identifier has a length that is within a range of caller local number lengths; and

b) a reformatted callee identifier produced by reformatting the callee identifier to include a caller country code and area code has no DID record.

38. (Original) The apparatus of claim 26, wherein said plurality of calling attributes includes at least one of an international dialing digits identifier, a national dialing digits identifier, a country code identifier, a local area codes identifier, a caller minimum local length identifier, a caller maximum local length identifier, a reseller identifier, and a maximum number of concurrent calls identifier.

39. (Original) The apparatus of claim 33, wherein said DID record comprises a user name field, a user domain field and a DID number field.

40. (Original) The apparatus of claim 26, wherein said at least one processor is further operably configured to access a list of public network route suppliers when said public network classification criterion is met and to identify at least one of said public network route suppliers that satisfies public network routing selection criteria.

41. (Original) The apparatus of claim 40, wherein said at least one processor is further operably configured to produce a public network routing message identifying said at least one public network route supplier that satisfies said public network routing selection criteria.

42. (Original) The apparatus of claim 41, wherein said at least one processor is operably configured to cause said public network routing message to include a gateway supplier identifier identifying a gateway supplier able to establish a communications link in a route through which communications between the caller and callee can be conducted.

43. (Original) The apparatus of claim 42, wherein said at least one processor is operably configured to cause said public network routing message to include a time value and a timeout value.

44. (Original) The apparatus of claim 42, wherein said at least one processor is operably configured to cause said public network routing message to include a plurality of gateway supplier identifiers identifying a plurality of gateway suppliers able to supply respective communication links through which communications between the caller and callee can be conducted.

45. (Original) The apparatus of claim 44, wherein said at least one processor is operably configured to cause said public network routing message to include priority information identifying a priority in which gateway suppliers associated with said gateway identifiers are to

be considered for selection of a communication link through which communications between the caller and callee can be conducted.

46. (Original) The apparatus of claim 44, wherein said at least one processor is operably configured to arrange said gateway supplier identifiers in said public network routing message in order of rate, where rate is determined from rate fields of respective said gateway supplier records.

47. (Original) The apparatus of claim 46, wherein said at least one processor is operably configured to arrange said gateway supplier identifiers in order of increasing rate.

48. (Original) The apparatus of claim 42, wherein said at least one processor is operably configured to arrange said gateway supplier identifiers in an order based on at least one provision in a service agreement.

49. (Original) The apparatus of claim 26, wherein said at least one processor is further operably configured to cause the private network routing message or the public network routing message to be communicated to a call controller to effect routing of the call.

50. (Original) A call routing controller apparatus for producing a routing message for routing communications between a caller and a callee in a communication system, the apparatus comprising:

means for using a caller identifier associated with the caller to locate a caller dialing profile comprising a plurality of calling attributes associated with the caller; and

means for, when at least one of said calling attributes and at least a portion of a callee identifier associated with the callee meet private network classification criteria, producing a private network routing message for receipt by a call controller, said private network routing message identifying an address, on the private network, associated with the callee; and

means for, when at least one of said calling attributes and at least a portion of said callee identifier meet a public network classification criterion, producing a public

network routing message for receipt by the call controller, said public network routing message identifying a gateway to the public network.

51. (Original) The apparatus of claim **50**, wherein said private network classification criteria include:

a) said callee identifier does not begin with the same digit pattern as an international dialing digit (IDD) attribute of said callee identifier; and

b) said callee identifier does not begin with the same digit pattern as a national dialing digit (NDD) attribute of said callee identifier; and

c) said callee identifier does not begin with the same area code as an area code of said caller; and

said callee identifier does not have a length that is within a range of caller local number lengths; and

said callee identifier is a valid username.

52. (Original) The apparatus of claim **51**, further comprising means for identifying the call as a cross-domain call on the private network when said callee identifier identifies a callee that is not associated with the same network node as said caller.

53. (Original) The apparatus of claim **51**, further comprising:

means for accessing the database of caller dialing profiles to locate a callee dialing profile for the callee when said callee identifier identifies a callee that is associated with the same network node as said caller; and

means for retrieving call handling information associated with the callee, where said call handling information is available, said call handling information including at least one of call blocking information, call forwarding information, and voicemail information.

54. (Original) The apparatus of claim **53**, further comprising, where said call handling information including said call blocking information is available, means for blocking the call being established with the callee when said call blocking information identifies the caller as a caller from whom calls are to be blocked.

Application No.: 13/966,096
Filing Date: August 13, 2013

55. (Original) The apparatus of claim 53, further comprising, means for causing said call forwarding information to be included in said private network routing message, where said call handling information including said call forwarding information is available.

56. (Original) The apparatus of claim 53, further comprising, where said call handling information including said voicemail information is available, means for causing said voicemail information to be included in said private network routing message.

57. (Original) The apparatus of claim 50, further comprising means for accessing a database of direct inward dial records each associating at least one direct inward dial number with at least one subscriber to said communication system.

58. (Original) The apparatus of claim 57, wherein said public network classification criteria include:

- a) said callee identifier begins with the same digit pattern as an international dialing digit (IDD) attribute of said callee identifier; and
- b) a reformatted callee identifier produced by removing the IDD attribute from said callee identifier has no DID record.

59. (Original) The apparatus of claim 57, wherein said public network classification criteria include:

- a) said callee identifier begins with the same digit pattern as a national dialing digit (NDD) attribute of said callee identifier; and
- b) a reformatted callee identifier produced by removing the NDD attribute from said callee identifier and including a caller country code has no DID record.

60. (Original) The apparatus of claim 57, wherein said public network classification criteria include:

- a) said callee identifier begins with the same area code as an area code of said caller; and

Application No.: 13/966,096
Filing Date: August 13, 2013

b) a reformatted callee identifier produced by reformatting the callee identifier to include a caller country code has no DID record.

61. (Original) The apparatus of claim 57, wherein said public network classification criteria include:

a) said callee identifier has a length that is within a range of caller local number lengths; and

b) a reformatted callee identifier produced by reformatting the callee identifier to include a caller country code and area code has no DID record.

62. (Original) The apparatus of claim 50, wherein said plurality of calling attributes includes at least one of an international dialing digits identifier, a national dialing digits identifier, a country code identifier, a local area codes identifier, a caller minimum local length identifier, a caller maximum local length identifier, a reseller identifier, and a maximum number of concurrent calls identifier.

63. (Original) The apparatus of claim 57, wherein said DID record comprises a user name field, a user domain field and a DID number field.

64. (Original) The apparatus of claim 50, further comprising means for accessing a list of public network route suppliers when said public network classification criterion is met and means for identifying at least one of said public network route suppliers that satisfies public network routing selection criteria.

65. (Original) The apparatus of claim 64, wherein said means for producing said public network routing message comprises means for producing a public network routing message identifying said at least one public network route supplier that satisfies said public network routing selection criteria.

66. (Original) The apparatus of claim 65, wherein said means for producing said public network routing message comprises means for causing said public network routing

Application No.: 13/966,096
Filing Date: August 13, 2013

message to include a gateway supplier identifier identifying a gateway supplier able to establish a communications link in a route through which communications between the caller and callee can be conducted.

67. (Original) The apparatus of claim 66, further comprising means for causing said public network routing message to include a time value and a timeout value.

68. (Original) The apparatus of claim 66, wherein said means for causing said public network routing message to include said gateway supplier identifier comprises means for causing said public network routing message to include a plurality of gateway supplier identifiers identifying a plurality of gateway suppliers able to supply respective communication links through which communications between the caller and callee can be conducted.

69. (Original) The apparatus of claim 68, further comprising means for causing said public network routing message to include priority information identifying a priority in which gateway suppliers associated with said gateway identifiers are to be considered for selection of a communication link through which communications between the caller and callee can be conducted.

70. (Original) The apparatus of claim 68, wherein said means for causing said public network routing message to include priority information includes means for arranging said gateway supplier identifiers in said public network routing message in order of rate, where rate is determined from rate fields of respective said gateway supplier records.

71. (Original) The apparatus of claim 70, wherein said means for arranging said gateway supplier identifiers in order of rate comprises means for arranging said gateway supplier identifiers in order of increasing rate.

72. (Original) The apparatus of claim 66, further comprising means for arranging said gateway supplier identifiers in an order based on at least one provision in a service agreement.

73. (Original) The apparatus of claim 50, further comprising means for causing the private network routing message or the public network routing message to be communicated to a call controller to effect routing of the call.

74. (Canceled).

75. (Canceled).

76. (Canceled).

77. (Canceled).

78. (Canceled).

79. (New) A method of routing communications in a packet switched network in which a first participant identifier is associated with a first participant and a second participant identifier is associated with a second participant in a communication, the method comprising:

after the first participant has accessed the packet switched network to initiate the communication, using the first participant identifier to locate a first participant profile comprising a plurality of attributes associated with the first participant;

when at least one of the first participant attributes and at least a portion of the second participant identifier meet a first network classification criterion, producing a first network routing message for receipt by a controller, the first network routing message identifying an address in a first portion of the packet switched network, the address being associated with the second participant, the first portion being controlled by an entity; and

when at least one of the first participant attributes and at least a portion of the second participant identifier meet a second network classification criterion, producing a second network routing message for receipt by the controller, the second network routing message identifying an address in a second portion of the packet switched network, the second portion not controlled by the entity.

Application No.: 13/966,096
Filing Date: August 13, 2013

80. (New) The method of Claim 79, wherein the packet switched network comprises the Internet.

81. (New) The method of Claim 79, wherein the first participant identifier comprises a first participant telephone number or username.

82. (New) The method of Claim 79, wherein the second participant identifier comprises a second participant telephone number or username.

83. (New) The method of Claim 79, wherein the communication comprises a voice-over-IP communication.

84. (New) The method of Claim 79, wherein the packet switched network is accessed via an Internet service provider.

85. (New) The method of Claim 79, wherein the first participant profile further comprises a username and a domain associated with first participant.

86. (New) The method of Claim 79, wherein the attributes comprise at least one of an international dialing digit (IDD), a national dialing digit (NDD), an area code, a country code and a number length range.

87. (New) The method of Claim 79, wherein the first classification criterion is satisfied when the first participant identifier does not begin with the same international dialing digit (IDD) digit pattern as the second participant identifier.

88. (New) The method of Claim 79, wherein the first classification criterion is satisfied when an address associated with the first participant and the address associated with the second participant are both in the first portion of the packet switched network.

89. (New) The method of Claim 79, wherein the address in the first portion is accessible through the first participant's Internet service provider.

90. (New) The method of Claim 79, wherein the first portion comprises one or more supernodes.

91. (New) The method of Claim 79, further comprising storing in a database a direct inward dial (DID) record associated with at least one of the first participant and the second participant.

92. (New) The method of Claim 91, wherein the stored DID record for the second participant comprises a username, a user domain and a record number.

93. (New) The method of Claim 79, wherein the entity is an entity supplying communication services for the first portion.

94. (New) The method of Claim 79, wherein the second network classification criterion is satisfied when access to the second participant requires routing through a portion of the packet switched network operated by a communication service supplier.

95. (New) The method of Claim 91, wherein the second network classification criterion is satisfied when the second participant identifier is not associated with a stored DID record in the database.

96. (New) The method of Claim 91, wherein the second network classification criterion is satisfied when:

the second participant identifier begins with the same international dialing digit (IDD) digit pattern as the first participant identifier; and

the second participant identifier, without considering the IDD digit pattern, has no stored DID record in the database.

97. (New) The method of Claim 79, wherein the address in the second portion of the packet switched network comprises an address accessed by a communication service supplier.

98. (New) The method of Claim 79, wherein producing the second network routing message identifying the address in the second portion comprises searching a database of route

Application No.: 13/966,096
Filing Date: August 13, 2013

records associating route identifiers with dialing codes, in an attempt to find a route record having a dialing code with a number pattern matching at least a portion of second participant identifier.

99. (New) A system for routing communications in a packet switched network in which a first participant in a communication has an associated first participant identifier and a second participant in the communication has an associated second participant identifier, the system comprising:

a controller comprising:

a processor operably configured to access a memory,

wherein the processor is configured to:

after the first participant has accessed the packet switched network to initiate the communication, locate a first participant profile in the memory using the first participant identifier, the first participant profile comprising a plurality of attributes associated with the first participant;

produce a first network routing message when at least one of the first participant attributes and at least a portion of the second participant identifier meet a first network classification criterion, the first network routing message identifying an address in a first portion of the packet switched network, the address being associated with the second participant, the first portion being controlled by an entity; and

produce a second network routing message when at least one of the first participant attributes and at least a portion of the second participant identifier meet a second network classification criterion, the second network routing message identifying an address in a second portion of the packet switched network, the second portion not controlled by the entity.

100. (New) The system of Claim 99, wherein the communication comprises a voice-over-IP communication.

101. (New) The system of Claim 99, wherein the packet switched network is accessed via an Internet service provider.

102. (New) The system of Claim 99, wherein the first classification criterion is satisfied when the first participant identifier does not begin with the same international dialing digit (IDD) digit pattern as the second participant identifier.

103. (New) The system of Claim 99, wherein the second network classification criterion is satisfied when access to the second participant requires routing through a portion of the packet switched network operated by a communication service supplier.

104. (New) A non-transitory computer readable medium comprising instructions that when executed cause a processor to perform a method of routing communications in a packet switched network in which a first participant identifier is associated with a first participant and a second participant identifier is associated with a second participant in a communication, the method comprising:

after the first participant has accessed the packet switched network to initiate the communication, using the first participant identifier to locate a first participant profile comprising a plurality of attributes associated with the first participant;

when at least one of the first participant attributes and at least a portion of the second participant identifier meet a first network classification criterion, producing a first network routing message for receipt by a controller, the first network routing message identifying an address in a first portion of the packet switched network, the address being associated with the second participant, the first portion being controlled by an entity; and

when at least one of the first participant attributes and at least a portion of the second participant identifier meet a second network classification criterion, producing a second network routing message for receipt by the controller, the second network routing message identifying an address in a second portion of the packet switched network, the second portion not controlled by the entity.

Application No.: 13/966,096
Filing Date: August 13, 2013

REMARKS

Claims 74-78 have been canceled and new Claims 79-104 have been added by this paper. The new claims are supported by the application as filed, for example at least in Figures 1, 7 and 8B. Applicant reserves the right to refile Claims 74-78 in a continuation application.

Conclusion

Although the present communication may include alterations to the application or claims, or characterizations of claim scope or referenced art, Applicant is not conceding in this application that previously pending claims are not patentable over the cited references. Rather, any alterations or characterizations are being made to facilitate expeditious prosecution of this application. Applicant reserves the right to pursue at a later date any previously pending or other broader or narrower claims that capture any subject matter supported by the present disclosure, including subject matter found to be specifically disclaimed herein or by any prior prosecution. Accordingly, reviewers of this or any parent, child or related prosecution history shall not reasonably infer that Applicant has made any disclaimers or disavowals of any subject matter supported by the present application.

If the Examiner requires any clarification, the Examiner is respectfully requested to call the undersigned at the provided telephone number in order to resolve any such issue promptly.

Please charge any additional fees, including any fees for additional extension of time, or credit overpayment to Deposit Account No. 11-1410.

Respectfully submitted,

KNOBBE, MARTENS, OLSON & BEAR, LLP

Dated: _____

1/19/15

By: _____

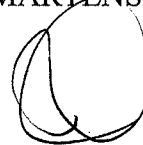

John M. Carson
Registration No. 34,303
Attorney of Record
Customer No. 20995
(858) 707-4000

Electronic Patent Application Fee Transmittal

Application Number:	13966096			
Filing Date:	13-Aug-2013			
Title of Invention:	PRODUCING ROUTING MESSAGES FOR VOICE OVER IP COMMUNICATIONS			
First Named Inventor/Applicant Name:	CLAY PERREAULT			
Filer:	John M Carson/Noriko Cook			
Attorney Docket Number:	SMARB19.001C1			
Filed as Small Entity				
Filing Fees for Utility under 35 USC 111(a)				
Description	Fee Code	Quantity	Amount	Sub-Total in USD(\$)
Basic Filing:				
Pages:				
Claims:				
Claims in excess of 20	2202	21	40	840
Miscellaneous-Filing:				
Petition:				
Patent-Appeals-and-Interference:				
Post-Allowance-and-Post-Issuance:				

Description	Fee Code	Quantity	Amount	Sub-Total in USD(\$)
Extension-of-Time:				
Miscellaneous:				
Total in USD (\$)				840

Electronic Acknowledgement Receipt

EFS ID:	21244332
Application Number:	13966096
International Application Number:	
Confirmation Number:	8712
Title of Invention:	PRODUCING ROUTING MESSAGES FOR VOICE OVER IP COMMUNICATIONS
First Named Inventor/Applicant Name:	CLAY PERREAULT
Customer Number:	20995
Filer:	John M Carson/Kevin Kraus
Filer Authorized By:	John M Carson
Attorney Docket Number:	SMARB19.001C1
Receipt Date:	19-JAN-2015
Filing Date:	13-AUG-2013
Time Stamp:	19:31:30
Application Type:	Utility under 35 USC 111(a)

Payment information:

Submitted with Payment	yes
Payment Type	Credit Card
Payment was successfully received in RAM	\$840
RAM confirmation Number	11540
Deposit Account	111410
Authorized User	KNOBBE MARTENS OLSON AND BEAR

The Director of the USPTO is hereby authorized to charge indicated fees and credit any overpayment as follows:

Charge any Additional Fees required under 37 C.F.R. Section 1.16 (National application filing, search, and examination fees)

Charge any Additional Fees required under 37 C.F.R. Section 1.17 (Patent application and reexamination processing fees)

--	--	--	--	--	--

File Listing:

Document Number	Document Description	File Name	File Size(Bytes)/ Message Digest	Multi Part /.zip	Pages (if appl.)
1		SMARB19_001C1_PreliminaryAmendment.pdf	970181 1b5d188efec0ce8c0af827781a2d4a49b8ee1adcb	yes	21

Multipart Description/PDF files in .zip description				
	Document Description	Start	End	
	Preliminary Amendment	1	1	
	Claims	2	20	
	Applicant Arguments/Remarks Made in an Amendment	21	21	

Warnings:

Information:

2	Fee Worksheet (SB06)	fee-info.pdf	30752 ae0ac66eac19e39fa014165485ca8014343cdf18	no	2
---	----------------------	--------------	---	----	---

Warnings:

Information:

Total Files Size (in bytes):			1000933		
-------------------------------------	--	--	---------	--	--

This Acknowledgement Receipt evidences receipt on the noted date by the USPTO of the indicated documents, characterized by the applicant, and including page counts, where applicable. It serves as evidence of receipt similar to a Post Card, as described in MPEP 503.

New Applications Under 35 U.S.C. 111

If a new application is being filed and the application includes the necessary components for a filing date (see 37 CFR 1.53(b)-(d) and MPEP 506), a Filing Receipt (37 CFR 1.54) will be issued in due course and the date shown on this Acknowledgement Receipt will establish the filing date of the application.

National Stage of an International Application under 35 U.S.C. 371

If a timely submission to enter the national stage of an international application is compliant with the conditions of 35 U.S.C. 371 and other applicable requirements a Form PCT/DO/EO/903 indicating acceptance of the application as a national stage submission under 35 U.S.C. 371 will be issued in addition to the Filing Receipt, in due course.

New International Application Filed with the USPTO as a Receiving Office

If a new international application is being filed and the international application includes the necessary components for an international filing date (see PCT Article 11 and MPEP 1810), a Notification of the International Application Number and of the International Filing Date (Form PCT/RO/105) will be issued in due course, subject to prescriptions concerning national security, and the date shown on this Acknowledgement Receipt will establish the international filing date of the application.

Under the Paperwork Reduction Act of 1995, no persons are required to respond to a collection of information unless it displays a valid OMB control number.

PATENT APPLICATION FEE DETERMINATION RECORD Substitute for Form PTO-875	Application or Docket Number 13/966,096	Filing Date 08/13/2013	<input type="checkbox"/> To be Mailed
---	---	----------------------------------	---------------------------------------

ENTITY: LARGE SMALL MICRO

APPLICATION AS FILED – PART I

FOR	NUMBER FILED	NUMBER EXTRA	RATE (\$)	FEE (\$)
<input type="checkbox"/> BASIC FEE <small>(37 CFR 1.16(a), (b), or (c))</small>	N/A	N/A	N/A	
<input type="checkbox"/> SEARCH FEE <small>(37 CFR 1.16(k), (l), or (m))</small>	N/A	N/A	N/A	
<input type="checkbox"/> EXAMINATION FEE <small>(37 CFR 1.16(o), (p), or (q))</small>	N/A	N/A	N/A	
TOTAL CLAIMS <small>(37 CFR 1.16(i))</small>	minus 20 =	*	X \$ =	
INDEPENDENT CLAIMS <small>(37 CFR 1.16(h))</small>	minus 3 =	*	X \$ =	
<input type="checkbox"/> APPLICATION SIZE FEE <small>(37 CFR 1.16(s))</small>	If the specification and drawings exceed 100 sheets of paper, the application size fee due is \$310 (\$155 for small entity) for each additional 50 sheets or fraction thereof. See 35 U.S.C. 41(a)(1)(G) and 37 CFR 1.16(s).			
<input type="checkbox"/> MULTIPLE DEPENDENT CLAIM PRESENT <small>(37 CFR 1.16(j))</small>				
* If the difference in column 1 is less than zero, enter "0" in column 2.			TOTAL	

APPLICATION AS AMENDED – PART II

	(Column 1)	(Column 2)	(Column 3)	PRESENT EXTRA	RATE (\$)	ADDITIONAL FEE (\$)
AMENDMENT	01/19/2015	CLAIMS REMAINING AFTER AMENDMENT	HIGHEST NUMBER PREVIOUSLY PAID FOR			
	Total <small>(37 CFR 1.16(i))</small>	* 99	Minus	** 78 = 21	X \$40 =	840
	Independent <small>(37 CFR 1.16(h))</small>	* 6	Minus	***6 = 0	X \$210 =	0
	<input type="checkbox"/> Application Size Fee <small>(37 CFR 1.16(s))</small>					
<input type="checkbox"/> FIRST PRESENTATION OF MULTIPLE DEPENDENT CLAIM <small>(37 CFR 1.16(j))</small>						
					TOTAL ADD'L FEE	840

	(Column 1)	(Column 2)	(Column 3)	PRESENT EXTRA	RATE (\$)	ADDITIONAL FEE (\$)
AMENDMENT		CLAIMS REMAINING AFTER AMENDMENT	HIGHEST NUMBER PREVIOUSLY PAID FOR			
	Total <small>(37 CFR 1.16(i))</small>	*	Minus	** =	X \$ =	
	Independent <small>(37 CFR 1.16(h))</small>	*	Minus	*** =	X \$ =	
	<input type="checkbox"/> Application Size Fee <small>(37 CFR 1.16(s))</small>					
<input type="checkbox"/> FIRST PRESENTATION OF MULTIPLE DEPENDENT CLAIM <small>(37 CFR 1.16(j))</small>						
					TOTAL ADD'L FEE	

* If the entry in column 1 is less than the entry in column 2, write "0" in column 3.
 ** If the "Highest Number Previously Paid For" IN THIS SPACE is less than 20, enter "20".
 *** If the "Highest Number Previously Paid For" IN THIS SPACE is less than 3, enter "3".

The "Highest Number Previously Paid For" (Total or Independent) is the highest number found in the appropriate box in column 1.

LIE
/TARA WASHINGTON/

This collection of information is required by 37 CFR 1.16. The information is required to obtain or retain a benefit by the public which is to file (and by the USPTO to process) an application. Confidentiality is governed by 35 U.S.C. 122 and 37 CFR 1.14. This collection is estimated to take 12 minutes to complete, including gathering, preparing, and submitting the completed application form to the USPTO. Time will vary depending upon the individual case. Any comments on the amount of time you require to complete this form and/or suggestions for reducing this burden, should be sent to the Chief Information Officer, U.S. Patent and Trademark Office, U.S. Department of Commerce, P.O. Box 1450, Alexandria, VA 22313-1450. DO NOT SEND FEES OR COMPLETED FORMS TO THIS ADDRESS. **SEND TO: Commissioner for Patents, P.O. Box 1450, Alexandria, VA 22313-1450.**

If you need assistance in completing the form, call 1-800-PTO-9199 and select option 2.



UNITED STATES PATENT AND TRADEMARK OFFICE

UNITED STATES DEPARTMENT OF COMMERCE
United States Patent and Trademark Office
Address: COMMISSIONER FOR PATENTS
P.O. Box 1450
Alexandria, Virginia 22313-1450
www.uspto.gov

Table with 5 columns: APPLICATION NO., FILING DATE, FIRST NAMED INVENTOR, ATTORNEY DOCKET NO., CONFIRMATION NO.
13/966,096 08/13/2013 CLAY PERREAULT SMARB19.001C1 8712

20995 7590 04/09/2015
KNOBBE MARTENS OLSON & BEAR LLP
2040 MAIN STREET
FOURTEENTH FLOOR
IRVINE, CA 92614

EXAMINER

SING, SIMON P

ART UNIT PAPER NUMBER

2653

NOTIFICATION DATE DELIVERY MODE

04/09/2015

ELECTRONIC

Please find below and/or attached an Office communication concerning this application or proceeding.

The time period for reply, if any, is set in the attached communication.

Notice of the Office communication was sent electronically on above-indicated "Notification Date" to the following e-mail address(es):

jayna.cartee@knobbe.com
efiling@knobbe.com

DETAILED ACTION

1. The present application is being examined under the pre-AIA first to invent provisions.

Double Patenting

The nonstatutory double patenting rejection is based on a judicially created doctrine grounded in public policy (a policy reflected in the statute) so as to prevent the unjustified or improper timewise extension of the “right to exclude” granted by a patent and to prevent possible harassment by multiple assignees. A nonstatutory double patenting rejection is appropriate where the claims at issue are not identical, but at least one examined application claim is not patentably distinct from the reference claim(s) because the examined application claim is either anticipated by, or would have been obvious over, the reference claim(s). See, e.g., *In re Berg*, 140 F.3d 1428, 46 USPQ2d 1226 (Fed. Cir. 1998); *In re Goodman*, 11 F.3d 1046, 29 USPQ2d 2010 (Fed. Cir. 1993); *In re Longi*, 759 F.2d 887, 225 USPQ 645 (Fed. Cir. 1985); *In re Van Ornum*, 686 F.2d 937, 214 USPQ 761 (CCPA 1982); *In re Vogel*, 422 F.2d 438, 164 USPQ 619 (CCPA 1970); and *In re Thorington*, 418 F.2d 528, 163 USPQ 644 (CCPA 1969).

A timely filed terminal disclaimer in compliance with 37 CFR 1.321(c) or 1.321(d) may be used to overcome an actual or provisional rejection based on a nonstatutory double patenting ground provided the reference application or patent either is shown to be commonly owned with this application, or claims an invention made as a result of

Art Unit: 2653

activities undertaken within the scope of a joint research agreement. A terminal disclaimer must be signed in compliance with 37 CFR 1.321(b).

The USPTO internet Web site contains terminal disclaimer forms which may be used. Please visit <http://www.uspto.gov/forms/>. The filing date of the application will determine what form should be used. A web-based eTerminal Disclaimer may be filled out completely online using web-screens. An eTerminal Disclaimer that meets all requirements is auto-processed and approved immediately upon submission. For more information about eTerminal Disclaimers, refer to

<http://www.uspto.gov/patents/process/file/efs/guidance/eTD-info-I.jsp>.

2. Claims 1-73 and 79-104 are rejected on the ground of nonstatutory double patenting as being unpatentable over claims 1-111 of U.S. Patent No. 8,542,815. Although the claims at issue are not identical, they are not patentably distinct from each other. For example, claim 1 of current invention claims the same but broader limitations in claim 1 of the Patent.

Claim Rejections - 35 USC § 103

The following is a quotation of pre-AIA 35 U.S.C. 103(a) which forms the basis for all obviousness rejections set forth in this Office action:

(a) A patent may not be obtained though the invention is not identically disclosed or described as set forth in section 102 of this title, if the differences between the subject matter sought to be patented and the prior art are such that the subject matter as a whole would have been obvious at the time the invention was made to a person having ordinary skill in the art to which said subject matter pertains. Patentability shall not be negated by the manner in which the invention was made.

Art Unit: 2653

3. Claims 1, 13, 15-17, 19-26, 38, 40-42, 44-50, 62, 64-66, 68-73 and 79-104 are rejected under pre-AIA 35 U.S.C. 103(a) as being unpatentable over Alexander et al. US 6,798,767.

3.1 Regarding claims 1, 26 and 50, Alexander discloses a system (figure 1) and method for routing a call between a caller and a callee in a communication system, comprising:

using a caller identifier associated with the caller to locate a caller dialing profile comprising a plurality of calling attributes associated with the caller (Call manager obviously stores attributes of IP phone 22, including user's or caller's name, telephone number and IP address, etc.) (figures 1-3; column 5, line 52 – column 7, line 45);

when at least one of said calling attributes and at least a portion of a callee identifier associated with the callee meet private network classification criteria (when phone 22 calls phone 23, both are identified, by either phone number or IP address, as IP phones within the same LAN 20a), obviously producing a private network routing message for receipt by a call controller (a call router in LAN 20a; figure 5A, steps 204-208); said private network routing message identifying an address (IP address), on the private network, associated with the callee (figures 4A and 4B; column 6, lines 1-17;

Note: Alexander does not explicitly disclose a routing message. However, it was well known in the art that a network control node produced a routing message to route a call through a network, see Moss et al. US 5,917,899, column 4, lines 59-61, also Buckley US 2007/0217354, paragraph [0020]); and

Art Unit: 2653

when at least one of said calling attributes and at least a portion of said callee identifier meet a public network classification criterion (callee is a PSTN subscriber, not in the same LAN) producing a public network routing message for receipt by the call controller, said public network routing message identifying a gateway to the public network (column 5, lines 52-67; column 8, lines 47 – column 9, line 60; figures 4A and 4B).

3.2 Regarding claims 13, 38 and 62, Alexander teaches a caller minimum length local identifier (figure 4A, phone 1 with a phone number 1001).

3.3 Regarding claims 15, 40 and 64, Alexander teaches public network routing selection criteria (figure 4A, phone numbers corresponding to gateways).

3.4 Regarding claims 16, 17, 41, 42, 65 and 66, Alexander teaches routing a call to a gateway (column 5, lines 52-67).

3.5 Regarding claims 19-22, 44-47, and 68-71, Alexander teaches gateway groups (figure 4A).

3.6 Regarding claims 23, 48 and 72, Alexander teaches arrange gateway groups in order (figure 4A).

Art Unit: 2653

3.7 Regarding claims 24, 49 and 73, the routing message obviously must be sent to a controller/router in LAN 20a to route the call to the callee.

3.8 Regarding claim 25, Alexander teaches a call manager 26 which obviously comprises memories for storing computer codes to execute the method of claim 1.

3.9 Regarding claims 79, 99 and 104, Alexander teaches a packet switching network LAN 20 (column 4, line 63 – column 5, line 5; column 6, lines 1-8), and the rest limitations as in claim 1.

3.10 Regarding claim 80, Alexander teaches Internet 40 in figure 1.

3.11 Regarding claims 81 and 82, Alexander teaches telephone numbers (figure 4A).

3.12 Regarding claims 83 and 100, Alexander teaches voice over IP (VoIP) (column 6, lines 1-8).

3.13 Regarding claims 84 and 101, examiner takes an official notice that it was well known and obvious for computer 44 and IP phone 44 to access Internet 40 via an Internet service provider.

Art Unit: 2653

3.14 Regarding claims 85, examiner takes an official notice that it was well known and obvious that an IP phone is associated with a user name and domain name (Stucker: column 4, line 26 – column 5, line 12).

3.15 Regarding claim 86, Alexander teaches an area code (a user's attribute) in figure 3 (column 33-42).

3.16 Regarding claims 87 and 102, Alexander teaches an identifier does not begin with an international dialing digit (figure 3).

3.17 Regarding claim 88, Alexander teaches that a caller and a callee are in the same LAN (column 4, lines 38-46).

3.18 Regarding claim 89, Alexander teaches routing calls through Internet 40 (column 6, lines 1-3).

3.19 Regarding claim 90, a LAN 20 or an Internet 40 obviously comprises a (super) node (figure 1).

3.20 Regarding claims 91, 92, 95 and 96, see the rejection of claim 8.

Art Unit: 2653

3.21 Regarding claim 93, Alexander teaches that LAN 20a supplies communications between IP phones (column 4, lines 38-46).

3.22 Regarding claims 94 and 103, Alexander teaches routing a call from LAN 20a to LAN 20b through Internet 40 (column 6, lines 1-8).

3.23 Regarding claims 97 and 98, Alexander teaches looking up communication address (figure 4A; column 6, lines -1-8).

4. Claims 2-7, 27-32 and 51-56 are rejected under pre-AIA 35 U.S.C. 103(a) as being unpatentable over Alexander et al. US 6,798,767 in view of Stucker US 7,010,727.

4.1 Regarding claims 2, 27 and 51, Alexander teaches IP phone 22 and 23, but does not teach that the callee identification comprises a valid user name (not begin with a digit).

However, Stucker teaches that IP phones may use session initiation protocol (SIP) to initiating a call. Stucker teaches that the callee identification is a user name (column 4, line 26 – column 5, line 12).

Therefore, it would have been obvious to one of ordinary skill in the art at the time the current invention was made to modify the Alexandria reference, so that a

Art Unit: 2653

callee's identification would have comprised a user name, by combining known prior art elements according to known methods to yield predictable results.

4.2 Regarding claims 3, 28 and 52, Alexander teaches a caller at IP phone 22, associated with LAN 20a, calling a callee at IP phone 25, associated with LAN 20b (difference domain), but does not teach that the callee identifier identifies a different domain.

However, Stucker teaches that when a caller calls a callee, a domain name associated with a caller or callee is identified (e.g. @bell-tel.com).

Therefore, it would have been obvious to one of ordinary skill in the art at the time the current invention was made to further modify the Alexandria reference with the teaching of Stucker, so that a caller's identification and a callee's identification would have comprised domain names if the caller and the callee were at difference network (e.g. LAN 20 and LAN 20b), and identified the call as a cross domain call, by combining known prior art elements according to known methods to yield predictable results.

4.3 Regarding claims 4-7, 29-32 and 53-56, examiner takes an official notice that it was well known and obvious that a telephone subscriber was able to set up a call profile for managing his incoming calls (see Leung et al. US 6,005,870, figure 2).

Art Unit: 2653

5. Claims 8-12, 14, 33-37, 39, 57-61 and 63 are rejected under pre-AIA 35 U.S.C. 103(a) as being unpatentable over Alexander et al. US 6,798,767 in view of Tada et al. US 6,597,783.

5.1 Regarding claims 8, 33 and 57, the modified Alexander reference does not teach direct inward dialing record.

However, Tada teaches direct inward dialing record for a telephone number (column 4, lines 30-35).

Therefore, it would have been obvious to one of ordinary skill in the art at the time the current invention was made to modify the Alexandria reference with the teaching of Tada, so that a record of direct inward dialing would have been kept for a subscriber, by combining known prior art elements according to known methods to yield predictable results.

5.2 Regarding claims 9, 34 and 58, examiner takes an official notice that it would be obvious that an international call (which would be terminated outside LAN 20a) initiated by IP phone 22 would be routed through a public network (i.e. Internet or 40 of PSTN 60, see figure 1).

5.3 Regarding claims 10, 35 and 59, examiner takes an official notice that it would be obvious to route a call initiated by IP phone 22 with national digit (which would be terminated outside LAN 20a) would be routed through PSTN 60.

Art Unit: 2653

5.4 Regarding claims 11, 36 and 60, examiner takes an official notice that it would be obvious to route a call initiated by IP phone 22 with area code national digit (which would be terminated outside LAN 20a) would be routed through PSTN 60.

5.5 Regarding claims 12, 37 and 61, examiner takes an official notice that it would be obvious that a callee's identification has a length within the range of a national dialing plan, e.g. a North America Dialing Plan, or NANP.

5.6 Regarding claims 14, 39 and 63, the modified Alexander reference teaches a user name and DID number (Tada: column 4, lines 30-35).

6. Claims 18, 43 and 67 are rejected under pre-AIA 35 U.S.C. 103(a) as being unpatentable over Alexander et al. US 6,798,767 in view of Han US 6,873,599.

Alexander does not teach a timeout for the routing message.

However, it would be obvious to add information to a message, and Han teaches a time out for a routing message,

Therefore, it would have been obvious to one of ordinary skill in the art at the time the current invention was made to modify the Alexandria reference with the teaching of Han, so that a the routing message would have been included a timeout, by

Art Unit: 2653

combining known prior art elements according to known methods to yield predictable results.

Conclusion

Any inquiry concerning this communication or earlier communication from the examiner should be directed to Simon Sing whose telephone number is 571-272-7545. The examiner can normally be reached on Monday - Friday from 9:30 AM to 5:30 PM. If attempts to reach the examiner by telephone are unsuccessful, the examiner's supervisor, Fan Tsang, can be reached at 571-272-7547. The fax phone number for the organization where this application or proceeding is assigned is 571-273-8300. Any inquiry of a general nature or relating to the status of this application or proceeding should be directed to the receptionist whose telephone number is 571-272-2600.

/Simon Sing/

Primary Examiner, Art Unit 2653

Notice of References Cited	Application/Control No. 13/966,096	Applicant(s)/Patent Under Reexamination PERREAULT ET AL.	
	Examiner SIMON SING	Art Unit 2653	Page 1 of 1

U.S. PATENT DOCUMENTS

*	Document Number Country Code-Number-Kind Code	Date MM-YYYY	Name	Classification
*	A US-6,798,767	09-2004	Alexander et al.	370/352
*	B US-5,917,899	06-1999	Moss et al.	379/221.08
*	C US-2007/0217354	09-2007	Buckley, Adrian	370/328
*	D US-7,010,727	03-2006	Stucker, Brian	714/52
*	E US-6,005,870	12-1999	Leung et al.	370/466
*	F US-6,597,783	07-2003	Tada et al.	379/265.09
*	G US-6,873,599	03-2005	Han, Yihwu	370/249
	H US-			
	I US-			
	J US-			
	K US-			
	L US-			
	M US-			

FOREIGN PATENT DOCUMENTS

*	Document Number Country Code-Number-Kind Code	Date MM-YYYY	Country	Name	Classification
	N				
	O				
	P				
	Q				
	R				
	S				
	T				

NON-PATENT DOCUMENTS

*	Document Number Country Code-Number-Kind Code	Date MM-YYYY	Country	Name	Classification
	Include as applicable: Author, Title Date, Publisher, Edition or Volume, Pertinent Pages)				
	U				
	V				
	W				
	X				

*A copy of this reference is not being furnished with this Office action. (See MPEP § 707.05(a).)
Dates in MM-YYYY format are publication dates. Classifications may be US or foreign.

INFORMATION DISCLOSURE STATEMENT BY APPLICANT	Application No.	13/966,096	
	Filing Date	August 13, 2013	
	First Named Inventor	Perrault, Clay	
	Art Unit	2472	
<i>(Multiple sheets used when necessary)</i>		Examiner	Kizou, Hassan
SHEET 1 OF 1		Attorney Docket No.	SMARBI9.001C1

U.S. PATENT DOCUMENTS					
Examiner Initials	Cite No.	Document Number Number - Kind Code (if known) Example: 1,234,567 B1	Publication Date MM-DD-YYYY	Name of Patentee or Applicant	Pages, Columns, Lines Where Relevant Passages or Relevant Figures Appear
	1	5,719,926	2/17/1998	Hill, Vincent F.	
	2	5,722,067	2/24/1998	Fougnyes et al.	
	3	5,915,093	6/22/1999	Berlin et al.	
	4	6,029,062	2/22/2000	Hanson, Daniel A.	
	5	6,249,573	6/19/2001	Hudson, Dan	
	6	7,454,200	11/18/2008	Cai et al.	
	7	8,630,234	1/14/2014	Björzell et al.	
	8	8,675,566	3/18/2014	Huttunen et al.	
	9	2005/0198499 A1	9/8/2005	Salapaka et al.	
	10	2010/0150138 A1	6/17/2010	Björzell et al.	
	11	2010/0150328 A1	6/17/2010	Perrault et al.	
	12	2010/0172345 A1	7/8/2010	Björzell et al.	
	13	2011/0122827 A1	5/26/2011	Björzell et al.	
	14	2012/0170574 A1	7/5/2012	Huttunen et al.	

FOREIGN PATENT DOCUMENTS						
Examiner Initials	Cite No.	Foreign Patent Document Country Code-Number-Kind Code Example: JP 1234567 A1	Publication Date MM-DD-YYYY	Name of Patentee or Applicant	Pages, Columns, Lines Where Relevant Passages or Relevant Figures Appear	T ¹

NON PATENT LITERATURE DOCUMENTS			
Examiner Initials	Cite No.	Include name of the author (in CAPITAL LETTERS), title of the article (when appropriate), title of the item (book, magazine, journal, serial, symposium, catalog, etc.), date, page(s), volume-issue number(s), publisher, city and/or country where published.	T ¹
	15	Extended European Search Report dated December 20, 2013 for European Application No. 09849358.8 dated June 18, 2012.	

17407609
030514

Examiner Signature /Simon Sing/	Date Considered 04/04/2015
---------------------------------	----------------------------

*Examiner: Initial if reference considered, whether or not citation is in conformance with MPEP 609. Draw line through citation if not in conformance and not considered. Include copy of this form with next communication to applicant.

T¹ - Place a check mark in this area when an English language Translation is attached AT&T, Exh. 1002, p. 281

ALL REFERENCES CONSIDERED EXCEPT WHERE LINED THROUGH. /SS/

INFORMATION DISCLOSURE STATEMENT BY APPLICANT	Application No.	13/966,096
	Filing Date	August 13, 2013
	First Named Inventor	Clay Perrault
	Art Unit	2472
<i>(Multiple sheets used when necessary)</i>	Examiner	Kizou, Hassan
SHEET 1 OF 1	Attorney Docket No.	SMARB19.001C1

U.S. PATENT DOCUMENTS					
Examiner Initials	Cite No.	Document Number <i>Number - Kind Code (if known)</i> Example: 1,234,567 B1	Publication Date MM-DD-YYYY	Name of Patentee or Applicant	Pages, Columns, Lines Where Relevant Passages or Relevant Figures Appear

FOREIGN PATENT DOCUMENTS						
Examiner Initials	Cite No.	Foreign Patent Document <i>Country Code-Number-Kind Code</i> Example: JP 1234567 A1	Publication Date MM-DD-YYYY	Name of Patentee or Applicant	Pages, Columns, Lines Where Relevant Passages or Relevant Figures Appear	T ¹
	1	WO 2007/056158 A2	05-18-2007	Roamware, Inc.		
	2	WO 2008/027065 A1	03-06-2008	Syniverse Technologies, Inc.		

NON PATENT LITERATURE DOCUMENTS			
Examiner Initials	Cite No.	Include name of the author (in CAPITAL LETTERS), title of the article (when appropriate), title of the item (book, magazine, journal, serial, symposium, catalog, etc.), date, page(s), volume-issue number(s), publisher, city and/or country where published.	T ¹
	3	Extended European Search Report dated April 16, 2014 for European Patent Application No. EP 09 802 316.1 which shares priority of U.S. Provisional Application No. 61/129,898, filed July 28, 2008 with U.S. Application No. 13/056,277, filed January 27, 2011, which is related to captioned U.S. Application No. 13/966,096, and cites above-identified reference numbers 1 and 2.	

17875349
042814

Examiner Signature /Simon Sing/	Date Considered 04/04/2015
*Examiner: Initial if reference considered, whether or not citation is in conformance with MPEP 609. Draw line through citation if not in conformance and not considered. Include copy of this form with next communication to applicant.	

T¹ - Place a check mark in this area when an English language Translation is attached AT&T, Exh. 1002, p. 282

ALL REFERENCES CONSIDERED EXCEPT WHERE LINED THROUGH. /SS/

INFORMATION DISCLOSURE STATEMENT BY APPLICANT	Application No.	13/966,096	
	Filing Date	August 13, 2013	
	First Named Inventor	Perrault, Clay	
	Art Unit	2472	
<i>(Multiple sheets used when necessary)</i>		Examiner	Kizou, Hassan
SHEET 1 OF 1		Attorney Docket No.	SMARB19.001C1

U.S. PATENT DOCUMENTS					
Examiner Initials	Cite No.	Document Number <i>Number - Kind Code (if known)</i> Example: 1,234,567 B1	Publication Date MM-DD-YYYY	Name of Patentee or Applicant	Pages, Columns, Lines Where Relevant Passages or Relevant Figures Appear

FOREIGN PATENT DOCUMENTS						
Examiner Initials	Cite No.	Foreign Patent Document <i>Country Code-Number-Kind Code</i> Example: JP 1234567 A1	Publication Date MM-DD-YYYY	Name of Patentee or Applicant	Pages, Columns, Lines Where Relevant Passages or Relevant Figures Appear	T ¹
	1	EP 2 090 024 A0	8/19/2009	Björzell et al.		

NON PATENT LITERATURE DOCUMENTS			
Examiner Initials	Cite No.	Include name of the author (in CAPITAL LETTERS), title of the article (when appropriate), title of the item (book, magazine, journal, serial, symposium, catalog, etc.), date, page(s), volume-issue number(s), publisher, city and/or country where published.	T ¹
	2	Extended European Search Report dated November 2, 2012 for European Application No. EP 07 855 436.7	

17537789
032014

Examiner Signature /Simon Sing/	Date Considered 04/04/2015
---------------------------------	----------------------------

*Examiner: Initial if reference considered, whether or not citation is in conformance with MPEP 609. Draw line through citation if not in conformance and not considered. Include copy of this form with next communication to applicant.

T¹ - Place a check mark in this area when an English language Translation is attached AT&T, Exh. 1002, p. 283

ALL REFERENCES CONSIDERED EXCEPT WHERE LINED THROUGH. /SS/

INFORMATION DISCLOSURE STATEMENT BY APPLICANT	Application No.	13/966,096	
	Filing Date	August 13, 2013	
	First Named Inventor	Perreault, Clay	
	Art Unit	2653	
<i>(Multiple sheets used when necessary)</i>		Examiner	Sing, Simon P.
SHEET 1 OF 1		Attorney Docket No.	SMARB19.001C1

U.S. PATENT DOCUMENTS					
Examiner Initials	Cite No.	Document Number Number - Kind Code (if known) Example: 1,234,567 B1	Publication Date MM-DD-YYYY	Name	Pages, Columns, Lines Where Relevant Passages or Relevant Figures Appear
	1	6,445,694 B1	09-03-2002	Swartz, Robert	
	2	6,574,328 B1	06-03-2003	Wood et al.	
	3	6,785,266 B2	08-31-2004	Swartz, Robert	
	4	7,486,664 B2	02-03-2009	Swartz, Robert	
	5	7,512,117 B2	03-31-2009	Swartz, Robert	
	6	7,587,036 B2	09-08-2009	Wood et al.	
	7	7,764,777 B2	07-27-2010	Wood et al.	

FOREIGN PATENT DOCUMENTS						
Examiner Initials	Cite No.	Foreign Patent Document Country Code-Number-Kind Code Example: JP 1234567 A1	Publication Date MM-DD-YYYY	Name	Pages, Columns, Lines Where Relevant Passages or Relevant Figures Appear	T ¹

NON PATENT LITERATURE DOCUMENTS			
Examiner Initials	Cite No.	Include name of the author (in CAPITAL LETTERS), title of the article (when appropriate), title of the item (book, magazine, journal, serial, symposium, catalog, etc.), date, page(s), volume-issue number(s), publisher, city and/or country where published.	T ¹

19561108
121614

Examiner Signature /Simon Sing/	Date Considered 04/04/2015
---------------------------------	----------------------------

*Examiner: Initial if reference considered, whether or not citation is in conformance with MPEP 609. Draw line through citation if not in conformance and not considered. Include copy of this form with next communication to applicant.

T¹ - Place a check mark in this area when an English language Translation is attached AT&T, Exh. 1002, p. 284

INFORMATION DISCLOSURE STATEMENT BY APPLICANT	Application No.	13/966,096	
	Filing Date	August 13, 2013	
	First Named Inventor	Perrault, Clay	
	Art Unit	2472	
<i>(Multiple sheets used when necessary)</i>		Examiner	Kizou, Hassan
SHEET 1 OF 7		Attorney Docket No.	SMARB19.001C1

U.S. PATENT DOCUMENTS					
Examiner Initials	Cite No.	Document Number Number - Kind Code (if known) Example: 1,234,567 B1	Publication Date MM-DD-YYYY	Name of Patentee or Applicant	Pages, Columns, Lines Where Relevant Passages or Relevant Figures Appear
	1	4,916,491	4/10/1990	Katoh	
	2	4,992,971	2/12/1991	Hayashi	
	3	5,146,491	9/8/1992	Silver et al.	
	4	5,247,571	9/21/1993	Kay et al.	
	5	5,303,297	4/12/1994	Hillis	
	6	5,359,642	10/25/1994	Castro	
	7	5,425,085	6/13/1995	Weinberger et al.	
	8	5,440,621	8/8/1995	Castro	
	9	5,454,030	9/26/1995	de Oliveira et al.	
	10	5,469,497	11/21/1995	Pierce et al.	
	11	5,506,893	4/9/1996	Buscher et al.	
	12	5,519,769	5/21/1996	Weinberger et al.	
	13	5,559,871	9/24/1996	Smith	
	14	5,590,133	12/31/1996	Billstrom et al.	
	15	5,608,786	3/4/1997	Gordon	
	16	5,621,787	4/15/1997	McKoy et al.	
	17	5,633,913	5/27/1997	Talarmo	
	18	5,661,790	8/26/1997	Hsu	
	19	5,712,907	1/27/1998	Wegner et al.	
	20	5,724,355	3/3/1998	Bruno et al.	
	21	5,726,984	3/10/1998	Kubler et al.	
	22	5,737,414	4/7/1998	Walker et al.	
	23	5,751,961	5/12/1998	Smyk	
	24	5,793,762	8/11/1998	Penners et al.	
	25	5,799,072	8/25/1998	Vulcan et al.	
	26	5,802,502	9/1/1998	Gell et al.	
	27	5,825,863	10/20/1998	Walker	
	28	5,828,740	10/27/1998	Khuc et al.	

Examiner Signature /Simon Sing/	Date Considered 04/04/2015
---------------------------------	----------------------------

***Examiner:** Initial if reference considered, whether or not citation is in conformance with MPEP 609. Draw line through citation if not in conformance and not considered. Include copy of this form with next communication to applicant.

T¹ - Place a check mark in this area when an English language Translation is attached AT&T, Exh. 1002, p. 285

ALL REFERENCES CONSIDERED EXCEPT WHERE LINED THROUGH. /SS/

INFORMATION DISCLOSURE STATEMENT BY APPLICANT	Application No.	13/966,096
	Filing Date	August 13, 2013
	First Named Inventor	Perrault, Clay
	Art Unit	2472
<i>(Multiple sheets used when necessary)</i>	Examiner	Kizou, Hassan
SHEET 2 OF 7	Attorney Docket No.	SMARB19.001C1

U.S. PATENT DOCUMENTS					
Examiner Initials	Cite No.	Document Number Number - Kind Code (if known) Example: 1,234,567 B1	Publication Date MM-DD-YYYY	Name of Patentee or Applicant	Pages, Columns, Lines Where Relevant Passages or Relevant Figures Appear
	29	5,838,682	11/17/1998	Dekelbaum et al.	
	30	5,845,267	12/1/1998	Ronen	
	31	5,850,433	12/15/1998	Rondeau	
	32	5,864,610	1/26/1999	Ronen	
	33	5,867,495	2/2/1999	Elliott et al.	
	34	5,883,891	3/16/1999	Williams et al.	
	35	5,889,774	3/30/1999	Mirashrafi et al.	
	36	5,905,736	5/18/1999	Ronen et al.	
	37	5,907,547	5/25/1999	Foladare et al.	
	38	5,910,946	6/8/1999	Csapo	
	39	5,915,005	6/22/1999	He	
	40	5,923,659	7/13/1999	Curry et al.	
	41	5,930,343	7/27/1999	Vasquez	
	42	5,937,045	8/10/1999	Yaoya et al.	
	43	5,940,598	8/17/1999	Strauss et al.	
	44	5,953,504	9/14/1999	Sokal et al.	
	45	5,956,391	9/21/1999	Melen et al.	
	46	5,970,477	10/19/1999	Roden	
	47	5,974,043	10/26/1999	Solomon	
	48	5,991,291	11/23/1999	Asai et al.	
	49	6,005,926	12/21/1999	Mashinsky	
	50	6,014,379	1/11/2000	White et al.	
	51	6,021,126	2/1/2000	White et al.	
	52	6,052,445	4/18/2000	Bashoura et al.	
	53	6,058,300	5/2/2000	Hanson	
	54	6,069,890	5/30/2000	White et al.	
	55	6,073,013	6/6/2000	Agre et al.	
	56	6,078,647	6/20/2000	D'Eletto	
	57	6,104,704	8/15/2000	Buhler et al.	

Examiner Signature /Simon Sing/	Date Considered 04/04/2015
---------------------------------	----------------------------

*Examiner: Initial if reference considered, whether or not citation is in conformance with MPEP 609. Draw line through citation if not in conformance and not considered. Include copy of this form with next communication to applicant.

T¹ - Place a check mark in this area when an English language Translation is attached AT&T, Exh. 1002, p. 286

ALL REFERENCES CONSIDERED EXCEPT WHERE LINED THROUGH. /SS/

INFORMATION DISCLOSURE STATEMENT BY APPLICANT	Application No.	13/966,096
	Filing Date	August 13, 2013
	First Named Inventor	Perrault, Clay
	Art Unit	2472
<i>(Multiple sheets used when necessary)</i>	Examiner	Kizou, Hassan
SHEET 3 OF 7	Attorney Docket No.	SMARB19.001C1

	58	6,104,711	8/15/2000	Voit	
	59	6,115,737	9/5/2000	Ely et al.	
	60	6,128,304	10/3/2000	Gardell et al.	
	61	6,137,869	10/24/2000	Voit et al	
	62	6,141,404	10/31/2000	Westerlage et al.	
	63	6,151,385	11/21/2000	Reich et al.	
	64	6,188,752	2/13/2001	Lesley	
	65	6,282,574	8/28/2001	Voit	
	66	6,298,062	10/2/2001	Gardell et al.	
	67	6,351,464	2/26/2002	Galvin et al.	
	68	6,359,880	3/19/2002	Curry et al.	
	69	6,430,275	8/6/2002	Voit et al	
	70	6,507,644	1/14/2003	Henderson et al.	
	71	6,597,686	7/23/2003	Darek A Smyk	
	72	6,674,745	1/6/2004	Schuster et al.	
	73	6,724,860	4/20/2004	Stumer et al.	
	74	6,744,858	6/1/2004	Ryan et al.	
	75	6,766,159	7/20/2004	Lindholm	
	76	6,798,767	9/29/2004	Alexander et al.	
	77	6,819,929	11/16/2004	Antonucci et al.	
	78	6,954,453	10/11/2005	Schindler	
	79	6,963,557	11/8/2005	Mark Clinton Knox	
	80	7,046,658	5/16/2006	Vinay Kundaje	
	81	7,055,174	5/30/2006	Cope et al.	
	82	7,068,772	6/27/2006	Widger et al.	
	83	7,079,526	7/18/2006	Wipliez et al.	
	84	7,120,682	10/10/2006	Salama	
	85	7,212,522	5/1/2007	Shankar et al.	
	86	7,454,510	11/18/2008	Kleyman et al.	
	87	7,950,046	5/24/2011	Kropivny, Alexander	
	88	8,116,307	2/14/2012	Thesayi et al.	

Examiner Signature	/Simon Sing/	Date Considered	04/04/2015
*Examiner: Initial if reference considered, whether or not citation is in conformance with MPEP 609. Draw line through citation if not in conformance and not considered. Include copy of this form with next communication to applicant.			

T¹ - Place a check mark in this area when an English language Translation is attached AT&T, Exh. 1002, p. 287

ALL REFERENCES CONSIDERED EXCEPT WHERE LINED THROUGH. /SS/

INFORMATION DISCLOSURE STATEMENT BY APPLICANT	Application No.	13/966,096
	Filing Date	August 13, 2013
	First Named Inventor	Perrault, Clay
	Art Unit	2472
<i>(Multiple sheets used when necessary)</i>	Examiner	Kizou, Hassan
SHEET 4 OF 7	Attorney Docket No.	SMARB19.001C1

	89	2002/0051518 A1	5/2/2002	Bondy et al.	
	90	2002/0116464 A1	8/22/2002	Mak	
	91	2002/0122391 A1	9/5/2002	Shalit, Andrew L.	
	92	2003/0200311 A1	10/23/2003	Baum	
	93	2003/0219103 A1	11/27/2003	Rao et al.	
	94	2004/0022237 A1	2/5/2004	Elliot et al.	
	95	2004/0157629 A1	8/12/2004	Kallio et al.	
	96	2004/0165709 a1	8/26/2004	Pence et al.	
	97	2004/0181599 A1	9/16/2004	Kreusch et al.	
	98	2004/0202295 A1	10/14/2004	Shen et al.	
	99	2004/0240439 A1	12/2/2004	Castleberry et al.	
	100	2004/0255126 A1	12/16/2004	Reith	
	101	2005/0025043 A1	2/3/2005	Mussman et al	
	102	2005/0083911 A1	4/21/2005	Grabelsky et al.	
	103	2005/0094651 A1	5/5/2005	Lutz et al.	
	104	2005/0169248 A1	8/4/2005	Truesdale et al.	
	105	2005/0174937 A1	8/11/2005	Scoggins et al.	
	106	2005/0177843 A1	8/11/2005	Williams	
	107	2006/0072547 A1	4/6/2006	Florkey et al.	
	108	2006/0072550 A1	4/6/2006	Davis et al.	
	109	2006/0093135 A1	5/4/2006	Fiatel et al.	
	110	2006/0111116 A1	5/25/2006	Palmer et al.	
	111	2006/0153342 A1	7/13/2006	Syouichi Sasaki	
	112	2006/0160565 A1	7/20/2006	Singh et al.	
	113	2006/0177035 A1	8/10/2006	Cope et al.	
	114	2006/0209768 A1	9/21/2006	Yan et al.	
	115	2006/0258328 A1	11/16/2006	Mario Francisco Godoy	
	116	2006/0264200 A1	11/23/2006	Laiho et al.	
	117	2007/0036143 A1	2/15/2007	Alt et al.	
	118	2007/0112964 A1	5/17/2007	Guedalia et al.	
	119	2007/0127676 A1	6/7/2007	Khadri	
	120	2007/0253418 A1	11/1/2007	Shiri et al.	

Examiner Signature /Simon Sing/	Date Considered 04/04/2015
---------------------------------	----------------------------

*Examiner: Initial if reference considered, whether or not citation is in conformance with MPEP 609. Draw line through citation if not in conformance and not considered. Include copy of this form with next communication to applicant.

T¹ - Place a check mark in this area when an English language Translation is attached AT&T, Exh. 1002, p. 288

ALL REFERENCES CONSIDERED EXCEPT WHERE LINED THROUGH. /SS/

INFORMATION DISCLOSURE STATEMENT BY APPLICANT	Application No.	13/966,096	
	Filing Date	August 13, 2013	
	First Named Inventor	Perrault, Clay	
	Art Unit	2472	
<i>(Multiple sheets used when necessary)</i>		Examiner	Kizou, Hassan
SHEET 5 OF 7		Attorney Docket No.	SMARB19.001C1

121	2008/0037715 A1	2/14/2008	Prozeniuk et al.	
122	2008/0056235 A1	3/6/2008	Albina et al.	
123	2008/0063153 A1	3/13/2008	Krivorot et al.	
124	2009/0028146 A1	1/29/2009	Kleyman et al.	
125	2009/0292539 A1	11/26/2009	Jaroker, Jon	
126	2009/0325558 A1	12/31/2009	Pridmore et al.	
127	2010/0086119 A1	4/8/2010	De Luca et al.	
128	2008/0056302 A1	3/6/2008	Erdal et al.	
129	2009/0135735 A1	5/28/2009	Zhang et al.	
130	2009/0141883 A1	6/4/2009	Bastien, Stephane	
131	2010/0128729 A1	5/27/2010	Yazaki et al.	
132	2012/0099599 A1	4/26/2012	Keränen et al.	
133	2012/0227101 A1	9/6/2012	Yuan, Wei	
134	2013/0114589 A1	5/9/2013	Fangman et al.	

FOREIGN PATENT DOCUMENTS						
Examiner Initials	Cite No.	Foreign Patent Document Country Code-Number-Kind Code Example: JP 1234567 A1	Publication Date MM-DD-YYYY	Name of Patentee or Applicant	Pages, Columns, Lines Where Relevant Passages or Relevant Figures Appear	T ¹
	135	CA 2,249,668	4/7/1999	Bruno et al.		
	136	EP 1 389 862 A1	2/18/2004	Shen et al.		
	137	EP 1 389 862 B1	11/3/2004	Shen et al.		
	138	WO 01/89145 A2	11/22/2001	Foti, Georges		
	139	WO 2007/044454 A2	4/19/2007	Croy et al.		
	140	WO 2008/052340 A1	5/8/2008	Perreault et al.		
	141	WO 2008/064481 A1	6/5/2008	Bjorsell et al.		
	142	WO 2008/116296 A1	10/2/2008	Bjorsell et al.		

NON PATENT LITERATURE DOCUMENTS			
Examiner Initials	Cite No.	Include name of the author (in CAPITAL LETTERS), title of the article (when appropriate), title of the item (book, magazine, journal, serial, symposium, catalog, etc.), date, page(s), volume-issue number(s), publisher, city and/or country where published.	T ¹
	143	F. Baker et al. "RFC 3924 - Cisco Architecture for Lawful Intercept in IP Networks." October 2004.	

Examiner Signature	/Simon Sing/	Date Considered	04/04/2015
--------------------	--------------	-----------------	------------

*Examiner: Initial if reference considered, whether or not citation is in conformance with MPEP 609. Draw line through citation if not in conformance and not considered. Include copy of this form with next communication to applicant.

T¹ - Place a check mark in this area when an English language Translation is attached AT&T, Exh. 1002, p. 289

ALL REFERENCES CONSIDERED EXCEPT WHERE LINED THROUGH. /SS/

INFORMATION DISCLOSURE STATEMENT BY APPLICANT	Application No.	13/966,096	
	Filing Date	August 13, 2013	
	First Named Inventor	Perrault, Clay	
	Art Unit	2472	
<i>(Multiple sheets used when necessary)</i>		Examiner	Kizou, Hassan
SHEET 6 OF 7		Attorney Docket No.	SMARB19.001C1

NON PATENT LITERATURE DOCUMENTS			
Examiner Initials	Cite No.	Include name of the author (in CAPITAL LETTERS), title of the article (when appropriate), title of the item (book, magazine, journal, serial, symposium, catalog, etc.), date, page(s), volume-issue number(s), publisher, city and/or country where published.	T ¹
	144	Cisco. "Lawful Intercept Requirements Summary." http://www.faqs.org/rfcs/rfc3924.html . <u>November 8, 2006.</u>	
	145	Sippy SIP B2BUA. "About Sippy RTPproxy." http://www.rtpproxy.org . July 15, 2009.	
	146	ETSI Technical Specification. "Lawful Interception (LI); Handover Interface and Service-Specific Details (SSD) for IP delivery; Part 5: Service-specific details for IP Multimedia Services." Apr 2008, 25 pgs, v.2.3.1, France.	
	147	M. Handley et al. "RFC 2543 - SIP: Session Initiation Protocol." March 1999.	
	148	A copy of the International Search Report and Written Opinion of the International Searching Authority completed June 6, 2008 for related PCT/CA2008/000545.	
	149	A copy of the International Search Report and Written Opinion of the International Searching Authority completed February 6, 2008 for corresponding PCT/CA2007/001956.	
	150	A copy of the International Preliminary Report on Patentability mailed May 14, 2009 for corresponding PCT/CA2007/001956.	
	151	A copy of the International Search Report and Written Opinion of the International Searching Authority completed March 3, 2008 for related PCT/CA2007/002150.	
	152	A copy of the International Preliminary Report on Patentability mailed February 13, 2009 for related PCT/CA2007/002150.	
	153	A copy of the International Preliminary Report on Patentability and Written Opinion of the International Searching Authority mailed February 10, 2011 for related PCT Application No. PCT/CA2009/001062, February 01, 2011.	
	154	A copy of the Written Opinion and International Search Report completed on June 18, 2010 for related PCT Application No. PCT/CA2009/001317.	
	155	A copy of the International Search Report and Written Opinion mailed on March 12, 2010 for corresponding PCT Application No. PCT/CA2009/001062.	
	156	A copy of the International Preliminary Report on Patentability issued on September 29, 2009 for PCT/CA2008/000545.	
	157	A copy of the International Preliminary Report on Patentability issued on March 20, 2012 for PCT/CA2009/001317.	
	158	Townsley, et al.; "RFC 2661 - Layer Two Tunneling Protocol 'L2TP' ", August 1999.	
	159	IP2Location, http://www.ip2location.com/ ; printed June 20, 2012.	
	160	DOTS IP Address Validation, "Overview", http://www.serviceobjects.com/products/dots_ipgeo.asp ; printed June 21, 2012.	
	161	List of North American Numbering Plan area codes, http://en.wikipedia.org/wiki/List_of_NANP_area_codes ; printed June 20, 2012.	

Examiner Signature	/Simon Sing/	Date Considered	04/04/2015
--------------------	--------------	-----------------	------------

*Examiner: Initial if reference considered, whether or not citation is in conformance with MPEP 609. Draw line through citation if not in conformance and not considered. Include copy of this form with next communication to applicant.

T¹ - Place a check mark in this area when an English language Translation is attached AT&T, Exh. 1002, p. 290

ALL REFERENCES CONSIDERED EXCEPT WHERE LINED THROUGH. /SS/

INFORMATION DISCLOSURE STATEMENT BY APPLICANT	Application No.	13/966,096	
	Filing Date	August 13, 2013	
	First Named Inventor	Perrault, Clay	
	Art Unit	2472	
<i>(Multiple sheets used when necessary)</i>		Examiner	Kizou, Hassan
SHEET 7 OF 7		Attorney Docket No.	SMARB19.001C1

NON PATENT LITERATURE DOCUMENTS			
Examiner Initials	Cite No.	Include name of the author (in CAPITAL LETTERS), title of the article (when appropriate), title of the item (book, magazine, journal, serial, symposium, catalog, etc.), date, page(s), volume-issue number(s), publisher, city and/or country where published.	T ¹
	162	DOTS Phone Exchange, "Overview", http://www.serviceobjects.com/demos/PhoneExchangeDemo.asp (URL no longer valid, current URL is http://www.serviceobjects.com/products/phone/phone-exchange); printed June 21, 2012.	
	163	Rosenberg, et al.; "RFC 3261 - SIP: Session Initiation Protocol", June 2002.	
	164	Lind AT&T S: "ENUM Call Flows for VoIP Interworking; draft-lind-enum-callflows-03.txt", 20020201, no. 3, 1 February 2002, pages 1-17, XP015004214, ISSN: 0000-0004.	
	165	IETF ENUM WG R STASTNY OEFEG INFORMATIONAL NUMBERING FOR VOIP AND OTHER IP COMMUNICATIONS: "Numbering for ViOP and other IP Communications, draft-stastny-enum-numbering-voip-00.txt", 20031001, 1 October 2003, pages 1-43, XP015035676, ISSN: 0000-0004.	
	166	Supplementary European Search Report for European Application No. 07816106, dated June 18, 2012.	
	167	Supplementary European Search Report for European Application No. 07816106, dated November 2, 2012.	
	168	Wikipedia, "International mobile subscriber identity (IMSI)," http://en.wikipedia.org/wiki/IMSI , 7-16-2013.	
	169	Wikipedia, "Roaming," http://en.wikipedia.org/wiki/Roaming , 7-16-2013.	

16645405
111113

Examiner Signature /Simon Sing/	Date Considered 04/04/2015
<p>*Examiner: Initial if reference considered, whether or not citation is in conformance with MPEP 609. Draw line through citation if not in conformance and not considered. Include copy of this form with next communication to applicant.</p>	

T¹ - Place a check mark in this area when an English language Translation is attached AT&T, Exh. 1002, p. 291

INFORMATION DISCLOSURE STATEMENT BY APPLICANT	Application No.	13/966,096	
	Filing Date	August 13, 2013	
	First Named Inventor	Perrault, Clay	
	Art Unit	2472	
<i>(Multiple sheets used when necessary)</i>		Examiner	Kizou, Hassan
SHEET 1 OF 1		Attorney Docket No.	SMARB19.001C1

U.S. PATENT DOCUMENTS					
Examiner Initials	Cite No.	Document Number <i>Number - Kind Code (if known)</i> Example: 1,234,567 B1	Publication Date MM-DD-YYYY	Name of Patentee or Applicant	Pages, Columns, Lines Where Relevant Passages or Relevant Figures Appear
	1	8,422,507 B2	4/16/2013	Björzell et al.	
	2	8,537,805 B2	9/17/2013	Björzell et al.	
	3	8,542,815 B2	9/24/2013	Perreault et al.	

FOREIGN PATENT DOCUMENTS						
Examiner Initials	Cite No.	Foreign Patent Document <i>Country Code-Number-Kind Code</i> Example: JP 1234567 A1	Publication Date MM-DD-YYYY	Name of Patentee or Applicant	Pages, Columns, Lines Where Relevant Passages or Relevant Figures Appear	T ¹
	4	WO 2010/012090 A2	2/4/2010	Bjorsell et al.		
	5	WO 2011/032256 A1	3/24/2011	Huttunen, Pentti Kalevi		

NON PATENT LITERATURE DOCUMENTS			
Examiner Initials	Cite No.	Include name of the author (in CAPITAL LETTERS), title of the article (when appropriate), title of the item (book, magazine, journal, serial, symposium, catalog, etc.), date, page(s), volume-issue number(s), publisher, city and/or country where published.	T ¹

16875512
121713

Examiner Signature	/Simon Sing/	Date Considered	04/04/2015
--------------------	--------------	-----------------	------------

*Examiner: Initial if reference considered, whether or not citation is in conformance with MPEP 609. Draw line through citation if not in conformance and not considered. Include copy of this form with next communication to applicant.

T¹ - Place a check mark in this area when an English language Translation is attached AT&T, Exh. 1002, p. 292

ALL REFERENCES CONSIDERED EXCEPT WHERE LINED THROUGH. /SS/

INFORMATION DISCLOSURE STATEMENT BY APPLICANT	Application No.	13/966,096	
	Filing Date	August 13, 2013	
	First Named Inventor	Perreault, Clay	
	Art Unit	2653	
<i>(Multiple sheets used when necessary)</i>		Examiner	8712
SHEET 1 OF 11		Attorney Docket No.	SMARB19.001C1

U.S. PATENT DOCUMENTS					
Examiner Initials	Cite No.	Document Number <i>Number - Kind Code (if known)</i> Example: 1,234,567 B1	Publication Date MM-DD-YYYY	Name	Pages, Columns, Lines Where Relevant Passages or Relevant Figures Appear
	1	5,325,421	06-28-1994	Hou et al.	
	2	6,553,025 B1	04-22-2003	Kung et al.	
	3	6,560,224 B1	05-06-2003	Kung et al.	
	4	6,650,641 B1	11-18-2003	Albert et al.	
	5	6,775,534 B2	08-10-2004	Lindgren et al.	
	6	6,934,279 B1	08-23-2005	Sollee et al.	
	7	6,963,739 B2	11-08-2005	Dorenbosch et al.	
	8	6,985,440 B1	01-10-2006	Albert et al.	
	9	6,993,015 B2	01-31-2006	Kobayashi, Toshihiko	
	10	7,006,508 B2	02-28-2006	Bondy et al.	
	11	7,027,564 B2	04-11-2006	James, Anthony W.	
	12	7,068,668 B2	06-27-2006	Feuer, Donald S.	
	13	7,151,772 B1	12-19-2006	Kalmanek, Jr. et al.	
	14	7,177,399 B2	02-13-2007	Dawson et al.	
	15	7,277,528 B2	10-02-2007	Rao et al.	
	16	7,400,881 B2	07-15-2008	Kallio, Juha	
	17	7,436,835 B2	10-14-2008	Castleberry et al.	
	18	7,440,442 B2	10-21-2008	Grabelsky et al.	
	19	7,486,667 B2	02-03-2009	Feuer, Donald S.	
	20	7,567,131 B2	07-21-2009	Rollender et al.	
	21	7,573,982 B2	08-11-2009	Breen et al.	
	22	7,593,390 B2	09-22-2009	Lebizay, Gerald	
	23	7,639,792 B2	12-29-2009	Qiu et al.	
	24	7,657,011 B1	02-02-2010	Zielinski et al.	
	25	7,664,495 B1	02-16-2010	Bonner et al.	
	26	7,676,215 B2	03-09-2010	Chin et al.	
	27	7,680,114 B2	03-16-2010	Yazaki et al.	
	28	7,702,308 B2	04-20-2010	Rollender, Douglas Harold	

Examiner Signature /Simon Sing/	Date Considered /Simon Sing/
---------------------------------	------------------------------

*Examiner: Initial if reference considered, whether or not citation is in conformance with MPEP 609. Draw line through citation if not in conformance and not considered. Include copy of this form with next communication to applicant.

T¹ - Place a check mark in this area when an English language Translation is attached AT&T, Exh. 1002, p. 293

ALL REFERENCES CONSIDERED EXCEPT WHERE LINED THROUGH. /SS/

INFORMATION DISCLOSURE STATEMENT BY APPLICANT	Application No.	13/966,096	
	Filing Date	August 13, 2013	
	First Named Inventor	Perreault, Clay	
	Art Unit	2653	
<i>(Multiple sheets used when necessary)</i>		Examiner	8712
SHEET 2 OF 11		Attorney Docket No.	SMARB19.001C1

U.S. PATENT DOCUMENTS					
Examiner Initials	Cite No.	Document Number Number - Kind Code (if known) Example: 1,234,567 B1	Publication Date MM-DD-YYYY	Name	Pages, Columns, Lines Where Relevant Passages or Relevant Figures Appear
	29	7,715,821 B2	05-11-2010	Rollender, Douglas Harold	
	30	7,738,384 B2	06-15-2010	Pelletier, Jeffrey P.	
	31	7,764,944 B2	07-27-2010	Rollender, Douglas Harold	
	32	7,797,459 B1	09-14-2010	Roy et al.	
	33	7,894,441 B2	02-22-2011	Yazaki et al.	
	34	7,907,551 B2	03-15-2011	Croy et al.	
	35	7,929,955 B1	04-19-2011	Bonner, Thomas W.	
	36	7,944,909 B2	05-17-2011	James, Anthony W.	
	37	7,965,645 B2	06-21-2011	Pelletier, Jeffrey P.	
	38	7,979,529 B2	07-12-2011	Kreusch et al.	
	39	7,995,589 B2	08-09-2011	Sollee et al.	
	40	8,024,785 B2	09-20-2011	Andress et al.	
	41	8,027,333 B2	09-27-2011	Grabelsky et al.	
	42	8,041,022 B1	10-18-2011	Andreasen et al.	
	43	8,050,273 B2	11-01-2011	Gass, Raymond	
	44	8,125,982 B2	02-28-2012	Feuer, Donald S.	
	45	8,145,182 B2	03-27-2012	Rudolf et al.	
	46	8,166,533 B2	04-24-2012	Yuan, Wei	
	47	8,189,568 B2	05-29-2012	Qiu et al.	
	48	8,204,044 B2	06-19-2012	Lebizay, Gerald	
	49	8,228,897 B2	07-24-2012	Mitchell, Don	
	50	8,244,204 B1	08-14-2012	Chen et al.	
	51	8,306,063 B2	11-06-2012	Erdal et al.	
	52	8,363,647 B2	01-29-2013	Fangman et al.	
	53	8,427,981 B2	04-23-2013	Wyss et al.	
	54	8,437,340 B2	05-07-2013	James, Anthony W.	
	55	8,462,915 B2	06-11-2013	Breen et al.	
	56	8,509,225 B2	08-13-2013	Grabelsky et al.	
	57	8,605,714 B2	12-10-2013	Lebizay, Gerald	

Examiner Signature	/Simon Sing/	Date Considered	/Simon Sing/
*Examiner: Initial if reference considered, whether or not citation is in conformance with MPEP 609. Draw line through citation if not in conformance and not considered. Include copy of this form with next communication to applicant.			

T¹ - Place a check mark in this area when an English language Translation is attached AT&T, Exh. 1002, p. 294

ALL REFERENCES CONSIDERED EXCEPT WHERE LINED THROUGH. /SS/

INFORMATION DISCLOSURE STATEMENT BY APPLICANT	Application No.	13/966,096	
	Filing Date	August 13, 2013	
	First Named Inventor	Perreault, Clay	
	Art Unit	2653	
<i>(Multiple sheets used when necessary)</i>		Examiner	8712
SHEET 3 OF 11		Attorney Docket No.	SMARB19.001C1

U.S. PATENT DOCUMENTS					
Examiner Initials	Cite No.	Document Number Number - Kind Code (if known) Example: 1,234,567 B1	Publication Date MM-DD-YYYY	Name	Pages, Columns, Lines Where Relevant Passages or Relevant Figures Appear
	58	8,605,869 B1	12-10-2013	Mobarak et al.	
	59	8,607,323 B2	12-10-2013	Yuan, Wei	
	60	8,611,354 B2	12-17-2013	Keränen et al.	
	61	8,625,578 B2	01-07-2014	Roy et al.	
	62	8,724,643 B2	05-13-2014	Feuer, Donald S.	
	63	8,750,290 B2	06-10-2014	Vance et al.	
	64	8,763,081 B2	06-24-2014	Bogdanovic et al.	
	65	8,768,951 B2	07-01-2014	Crago, William Barry	
	66	8,774,171 B2	07-08-2014	Mitchell, Don	
	67	8,804,705 B2	08-12-2014	Voxpath Networks, Inc.	
	68	2001/0052081 A1	12-13-2001	McKibben et al.	
	69	2002/0002041 A1	01-03-2002	Lindgren et al.	
	70	2002/0018445 A1	02-14-2002	Kobayashi, Toshihiko	
	71	2002/0141352 A1	10-03-2002	Fangman et al.	
	72	2003/0012196 A1	01-16-2003	Ramakrishnan, Kadangode K.	
	73	2003/0095539 A1	05-22-2003	Feuer, Donald S.	
	74	2003/0179747 A1	09-25-2003	Pyke et al.	
	75	2003/0219103 A1	11-27-2003	Rao et al.	
	76	2004/0034793 A1	02-19-2004	Yuan, Wei	
	77	2004/0203582 A1	10-14-2004	Dorenbosch et al.	
	78	2004/0203565 A1	10-14-2004	Chin et al.	
	79	2005/0063519 A1	03-24-2005	James, Anthony W.	
	80	2005/0188081 A1	08-25-2005	Gibson et al.	
	81	2005/0190892 A1	09-01-2005	Dawson et al.	
	82	2005/0202799 A1	09-15-2005	Rollender, Douglas Harold	
	83	2005/0287979 A1	12-29-2005	Rollender, Douglas Harold	
	84	2006/0007940 A1	01-12-2006	Sollee et al.	
	85	2006/0013266 A1	01-19-2006	Vega-Garcia et al.	
	86	2006/0030290 A1	02-09-2006	Rudolf et al.	

Examiner Signature	/Simon Sing/	Date Considered	04/04/2015
--------------------	--------------	-----------------	------------

*Examiner: Initial if reference considered, whether or not citation is in conformance with MPEP 609. Draw line through citation if not in conformance and not considered. Include copy of this form with next communication to applicant.

T¹ - Place a check mark in this area when an English language Translation is attached AT&T, Exh. 1002, p. 295

ALL REFERENCES CONSIDERED EXCEPT WHERE LINED THROUGH. /SS/

INFORMATION DISCLOSURE STATEMENT BY APPLICANT	Application No.	13/966,096	
	Filing Date	August 13, 2013	
	First Named Inventor	Perreault, Clay	
	Art Unit	2653	
<i>(Multiple sheets used when necessary)</i>		Examiner	8712
SHEET 4 OF 11		Attorney Docket No.	SMARB19.001C1

U.S. PATENT DOCUMENTS					
Examiner Initials	Cite No.	Document Number Number - Kind Code (if known) Example: 1,234,567 B1	Publication Date MM-DD-YYYY	Name	Pages, Columns, Lines Where Relevant Passages or Relevant Figures Appear
	87	2006/0078094 A1	04-13-2006	Breen et al.	
	88	2006/0142011 A1	06-29-2006	Kallio, Juha	
	89	2006/0146797 A1	07-06-2006	Lebizay, Gerald	
	90	2006/0189303 A1	08-24-2006	Rollender, Douglas Harold	
	91	2006/0205383 A1	09-14-2006	Rollender et al.	
	92	2006/0248186 A1	11-02-2006	Smith, Richard James	
	93	2006/0251056 A1	11-09-2006	Feuer, Donald S.	
	94	2006/0268921 A1	11-30-2006	Ekstrom et al.	
	95	2006/0281437 A1	12-14-2006	Cook, Charles I.	
	96	2007/0047548 A1	03-01-2007	Yazaki et al.	
	97	2007/0092070 A1	04-26-2007	Croy et al.	
	98	2007/0115935 A1	05-24-2007	Qiu et al.	
	99	2007/0121593 A1	05-31-2007	Vance et al.	
	100	2007/0174469 A1	07-26-2007	Andress et al.	
	101	2007/0220038 A1	09-20-2007	Crago, William Barry	
	102	2007/0253429 A1	11-01-2007	James, Anthony W.	
	103	2007/0263609 A1	11-15-2007	Mitchell, Don	
	104	2007/0297376 A1	12-27-2007	Gass, Raymond	
	105	2008/0013523 A1	01-17-2008	Nambakkam, Sampath	
	106	2008/0056243 A1	03-06-2008	Roy et al.	
	107	2008/0167039 A1	07-10-2008	Guedalia et al.	
	108	2008/0167020 A1	07-10-2008	Guedalia et al.	
	109	2008/0167019 A1	07-10-2008	Guedalia et al.	
	110	2008/0166999 A1	07-10-2008	Guedalia et al.	
	111	2008/0188227 A1	08-07-2008	Guedalia et al.	
	112	2008/0188198 A1	08-07-2008	Patel et al.	
	113	2008/0187122 A1	08-07-2008	Baker, Colin Lawrence Melvin	
	114	2008/0205378 A1	08-28-2008	Wyss et al.	
	115	2008/0310599 A1	12-18-2008	Purnadi et al.	

Examiner Signature	/Simon Sing/	Date Considered	04/04/2015
--------------------	--------------	-----------------	------------

*Examiner: Initial if reference considered, whether or not citation is in conformance with MPEP 609. Draw line through citation if not in conformance and not considered. Include copy of this form with next communication to applicant.

T¹ - Place a check mark in this area when an English language Translation is attached AT&T, Exh. 1002, p. 296

ALL REFERENCES CONSIDERED EXCEPT WHERE LINED THROUGH. /SS/

INFORMATION DISCLOSURE STATEMENT BY APPLICANT	Application No.	13/966,096
	Filing Date	August 13, 2013
	First Named Inventor	Perreault, Clay
	Art Unit	2653
<i>(Multiple sheets used when necessary)</i>	Examiner	8712
SHEET 5 OF 11	Attorney Docket No.	SMARB19.001C1

U.S. PATENT DOCUMENTS					
Examiner Initials	Cite No.	Document Number Number - Kind Code (if known) Example: 1,234,567 B1	Publication Date MM-DD-YYYY	Name	Pages, Columns, Lines Where Relevant Passages or Relevant Figures Appear
	116	2009/0003535 A1	01-01-2009	Grabelsky et al.	
	117	2009/0129566 A1	05-21-2009	Feuer, Donald S.	
	118	2009/0135724 A1	05-28-2009	Zhang et al.	
	119	2009/0135735 A1	05-28-2009	Zhang et al.	
	120	2009/0214000 A1	08-27-2009	Patel et al.	
	121	2009/0268615 A1	10-29-2009	Pelletier, Jeffrey P.	
	122	2009/0296900 A1	12-03-2009	Breen et al.	
	123	2010/0008345 A1	01-14-2010	Lebizay, Gerald	
	124	2010/0039946 A1	02-18-2010	Imbimbo et al.	
	125	2010/0105379 A1	04-29-2010	Bonner et al.	
	126	2010/0177671 A1	07-15-2010	Qiu et al.	
	127	2010/0246589 A1	09-30-2010	Pelletier, Jeffrey P.	
	128	2010/0272242 A1	10-28-2010	Croy et al.	
	129	2011/0013541 A1	01-20-2011	Croy et al.	
	130	2011/0153809 A1	06-23-2011	Ghanem et al.	
	131	2011/0176541 A1	07-21-2011	James, Anthony W.	
	132	2011/0201321 A1	08-18-2011	Bonner, Thomas W.	
	133	2011/0267986 A1	11-03-2011	Grabelsky et al.	
	134	2012/0014383 A1	01-19-2012	Geromel et al.	
	135	2012/0113981 A1	05-10-2012	Feuer, Donald S.	
	136	2012/0195415 A1	08-02-2012	Wyss et al.	
	137	2012/0250624 A1	10-04-2012	Lebizay, Gerald	
	138	2012/0282881 A1	11-08-2012	Mitchell, Don	
	139	2012/0314699 A1	12-13-2012	Qiu et al.	
	140	2013/0272297 A1	10-17-2013	AT&T Intellectual Property I, L.P.	
	141	2014/0101749 A1	04-10-2014	Rockstar Consortium US LP	
	142	2014/0211789 A1	07-31-2014	Centre One	

Examiner Signature /Simon Sing/	Date Considered 04/04/2015
*Examiner: Initial if reference considered, whether or not citation is in conformance with MPEP 609. Draw line through citation if not in conformance and not considered. Include copy of this form with next communication to applicant.	

T¹ - Place a check mark in this area when an English language Translation is attached AT&T, Exh. 1002, p. 297

ALL REFERENCES CONSIDERED EXCEPT WHERE LINED THROUGH. /SS/

INFORMATION DISCLOSURE STATEMENT BY APPLICANT	Application No.	13/966,096	
	Filing Date	August 13, 2013	
	First Named Inventor	Perreault, Clay	
	Art Unit	2653	
<i>(Multiple sheets used when necessary)</i>		Examiner	8712
SHEET 6 OF 11		Attorney Docket No.	SMARB19.001C1

FOREIGN PATENT DOCUMENTS						
Examiner Initials	Cite No.	Foreign Patent Document Country Code-Number-Kind Code Example: JP 1234567 A1	Publication Date MM-DD-YYYY	Name	Pages, Columns, Lines Where Relevant Passages or Relevant Figures Appear	T ¹
	143	CA 2 218 218 A1	10-14-1997	AT&T Corp.		
	144	CA 2 299 037 A1	08-22-2000	Selex Communications, LLC		Abstract
	145	CA 2 437 275 A1	10-17-2002	Nortel Networks Limited		Abstract
	146	CA 2 690 236 A1	12-18-2008	Research In Motion Ltd		Abstract
	147	CN 1498029 A	05-19-2004	Lucent Technologies Inc		Abstract
	148	CN 1498482 A	05-19-2004	Siemens AG		Abstract
	149	CN 1668137 A	09-14-2005	Lucent Technologies Inc		Abstract
	150	CN 1274114 C	09-06-2006	Siemens AG		Abstract
	151	CN 101005503 A	07-25-2007	IBM		Abstract
	152	CN 101069390 A	11-07-2007	Nokia Corp		Abstract
	153	CN 101095329 A	12-26-2007	Intel Corp		Abstract
	154	CN 1498029 B	05-12-2010	Lucent Technologies Inc		Abstract
	155	CN 101772929 A	07-07-2010	Research In Motion Ltd		Abstract
	156	CN 101069390 B	12-22-2010	Nokia Corp		Abstract
	157	CN 102484656 A	05-30-2012	Telefonaktiebolaget LM Ericsson		Abstract
	158	CN 101095329 B	10-10-2012	Intel Corp		Abstract
	159	CN 102833232 A	12-19-2012	Intel Corp		Abstract
	160	CN 101005503 B	01-16-2013	IBM		Abstract
	161	CN 101772929 B	07-02-2014	Research In Motion Ltd		Abstract
	162	DE 602 01 827 T2	11-10-2005	Alcatel SA		Abstract
	163	DE 11 2005 003 306 T5	01-24-2008	Intel Corp	<i>Corresponding Abstract: International Publication No. WO 2006/072099 A1 published 07-06-2006; is supplied with this document</i>	Abstract
	164	DE 601 33 316 T2	07-10-2008	Nortel Networks Ltd.		Abstract
	165	DE 603 17 751 T2	11-06-2008	Lucent Technologies Inc		Abstract
	166	EP 0 841 832 A2	05-13-1998	AT&T Corp.		
	167	EP 0 841 832 A3	05-19-1999	AT&T Corp.		

Examiner Signature	/Simon Sing/	Date Considered	04/04/2015
--------------------	--------------	-----------------	------------

*Examiner: Initial if reference considered, whether or not citation is in conformance with MPEP 609. Draw line through citation if not in conformance and not considered. Include copy of this form with next communication to applicant.

T¹ - Place a check mark in this area when an English language Translation is attached. AT&T, Exh. 1002, p. 298

ALL REFERENCES CONSIDERED EXCEPT WHERE LINED THROUGH. /SS/

INFORMATION DISCLOSURE STATEMENT BY APPLICANT	Application No.	13/966,096	
	Filing Date	August 13, 2013	
	First Named Inventor	Perreault, Clay	
	Art Unit	2653	
<i>(Multiple sheets used when necessary)</i>		Examiner	8712
SHEET 7 OF 11		Attorney Docket No.	SMARB19.001C1

FOREIGN PATENT DOCUMENTS						
Examiner Initials	Cite No.	Foreign Patent Document Country Code-Number-Kind Code Example: JP 1234567 A1	Publication Date MM-DD-YYYY	Name	Pages, Columns, Lines Where Relevant Passages or Relevant Figures Appear	T ¹
	168	EP 1 032 224 A2	08-30-2000	Selex Communications, LLC		
	169	EP 1 032 224 A3	08-30-2000	Selex Communications, LLC		
	170	EP 1 244 250 A1	09-25-2002	Siemens AG		Abstract
	171	EP 1 266 516 A2	12-18-2002	Nortel Networks Ltd	<i>Published by WIPO under: International Publication No. WO 01/069899 A2 published 12-18-2002; Abstract of which is supplied with this document</i>	Abstract
	172	EP 1 362 456 A2	11-19-2003	Nortel Networks Ltd	<i>Published by WIPO under: International Publication No. WO 02/082782 A2 published 10-17-2002; Abstract of which is supplied with this document</i>	Abstract
	173	EP 1 371 173 A1	12-17-2003	Siemens AG	<i>Published by WIPO under: International Publication No. WO 02/082728 A1 published 10-17-2002; Abstract of which is supplied with this document</i>	Abstract
	174	EP 1 411 743 A1	04-21-2004	Lucent Technologies Inc.		
	175	EP 1 526 697 A2	04-27-2005	3COM Corporation		
	176	EP 1 362 456 A4	05-25-2005	Nortel Networks Ltd		Abstract
	177	EP 1 575 327 A1	09-14-2005	Lucent Technologies Inc.		
	178	EP 1 610 583 A1	12-28-2005	Lucent Technologies Inc.		
	179	EP 1 526 697 A3	03-22-2006	3COM Corporation		
	180	EP 1 721 446 A1	11-15-2006	Nortel Networks Ltd	<i>Published by WIPO under: International Publication No. WO 2005/084002 A1 published 10-09-2005; Abstract of which is supplied with this document</i>	Abstract

Examiner Signature /Simon Sing/	Date Considered 04/04/2015
---------------------------------	----------------------------

*Examiner: Initial if reference considered, whether or not citation is in conformance with MPEP 609. Draw line through citation if not in conformance and not considered. Include copy of this form with next communication to applicant.

T¹ - Place a check mark in this area when an English language Translation is attached AT&T, Exh. 1002, p. 299

INFORMATION DISCLOSURE STATEMENT BY APPLICANT	Application No.	13/966,096	
	Filing Date	August 13, 2013	
	First Named Inventor	Perreault, Clay	
	Art Unit	2653	
<i>(Multiple sheets used when necessary)</i>		Examiner	8712
SHEET 8 OF 11		Attorney Docket No.	SMARB19.001C1

FOREIGN PATENT DOCUMENTS						
Examiner Initials	Cite No.	Foreign Patent Document Country Code-Number-Kind Code Example: JP 1234567 A1	Publication Date MM-DD-YYYY	Name	Pages, Columns, Lines Where Relevant Passages or Relevant Figures Appear	T ¹
	181	EP 1 829 300 A1	09-05-2007	Nokia Corp	Published by WIPO under: International Publication No. WO 2006/067269 A1 published 06-29-2006; Abstract of which is supplied with this document	Abstract
	182	EP 1 371 173 B1	11-28-2007	Siemens AG		Abstract
	183	EP 1 411 743 B1	11-28-2007	Lucent Technologies Inc.		
	184	EP 1 362 456 B1	03-19-2008	Nortel Networks Ltd		
	185	EP 1 974 304 A2	10-01-2008	Medical Envelope LLC	Published by WIPO under: International Publication No. WO 2007/087077 A2 published 08-02-2007; Abstract of which is supplied with this document	Abstract
	186	EP 1 974 304 A4	10-01-2008	Medical Envelope LLC		Abstract
	187	EP 1 610 583 B1	08-26-2009	Lucent Technologies Inc.		
	188	EP 2 127 232 A1	12-02-2009	Interactive Intelligence Inc	Published by WIPO under: International Publication No. WO 2008/103652 A1 published 08-28-2008; Abstract of which is supplied with this document	Abstract
	189	EP 2 165 489 A1	03-24-2010	Research In Motion Ltd	Published by WIPO under: International Publication No. WO 2008/103652 A1 published 08-28-2008; Abstract of which is supplied with this document	Abstract
	190	EP 2 215 755 A1	08-11-2010	Broadsoft Inc	Published by WIPO under: International Publication No. WO 2009/070278 A1 published 06-04-2009; Abstract of which is supplied with this document	Abstract
	191	EP 2 165 489 A4	03-02-2011	Research In Motion Ltd		Abstract
	192	EP 2 127 232 A4	03-16-2011	Interactive Intelligence Inc		Abstract

Examiner Signature /Simon Sing/	Date Considered 04/04/2015
---------------------------------	----------------------------

*Examiner: Initial if reference considered, whether or not citation is in conformance with MPEP 609. Draw line through citation if not in conformance and not considered. Include copy of this form with next communication to applicant.

T¹ - Place a check mark in this area when an English language Translation is attached AT&T, Exh. 1002, p. 300

ALL REFERENCES CONSIDERED EXCEPT WHERE LINED THROUGH. /SS/

INFORMATION DISCLOSURE STATEMENT BY APPLICANT	Application No.	13/966,096	
	Filing Date	August 13, 2013	
	First Named Inventor	Perreault, Clay	
	Art Unit	2653	
<i>(Multiple sheets used when necessary)</i>		Examiner	8712
SHEET 9 OF 11		Attorney Docket No.	SMARB19.001C1

FOREIGN PATENT DOCUMENTS						
Examiner Initials	Cite No.	Foreign Patent Document Country Code-Number-Kind Code Example: JP 1234567 A1	Publication Date MM-DD-YYYY	Name	Pages, Columns, Lines Where Relevant Passages or Relevant Figures Appear	T ¹
	193	EP 1 829 300 A4	05-02-2012	Nokia Corp	Corresponding Abstract: International Publication No. WO 2006/067269 A1 published 06-29-2006; is supplied with this document	Abstract
	194	EP 2 449 749 A1	05-09-2012	Telefonaktiebolaget LM Ericsson	Published by WIPO under: International Publication No. WO 2011/000405 A1 published 01-06-2011; Abstract of which is supplied with this document	Abstract
	195	EP 2 215 755 A4	10-24-2012	Broadsoft Inc		Abstract
	196	EP 1 829 300 B1	11-21-2012	Nokia Corp	Corresponding Abstract: International Publication No. WO 2006/067269 A1 published 06-29-2006; is supplied with this document	Abstract
	197	EP 2 449 749 B1	03-12-2014	Telefonaktiebolaget LM Ericsson		
	198	EP 1 266 516 B1	05-07-2014	Genband US LLC		
	199	WO 01/69899 A2	09-20-2001	Nortel Networks Ltd.		
	200	WO 01/69899 A3	09-20-2001	Nortel Networks Ltd.		
	201	WO 01/80587 A1	10-25-2001	Telefonaktiebolaget LM Ericsson		
	202	WO 02/082728 A1	10-17-2002	Siemens AG		Abstract
	203	WO 02/082782 A2	10-17-2002	Nortel Networks Limited		
	204	WO 02/082782 A3	10-17-2002	Nortel Networks Limited		
	205	WO 2005/084002 A1	09-09-2005	Nortel Networks Limited		
	206	WO 2006/067269 A1	06-29-2006	Nokia Corporation		
	207	WO 2006/072099 A1	07-06-2006	Intel Corporation		
	208	WO 2006/078175 A2	07-27-2006	Baker, Colin et al.		
	209	WO 2006/078175 A3	07-27-2006	Baker, Colin et al.		
	210	WO 2007/044454 A2	04-19-2007	Telecommunication Systems, Inc.		
	211	WO 2007/087077 A2	08-02-2007	Medical Envelope LLC		

Examiner Signature	/Simon Sing/	Date Considered	04/04/2015
--------------------	--------------	-----------------	------------

*Examiner: Initial if reference considered, whether or not citation is in conformance with MPEP 609. Draw line through citation if not in conformance and not considered. Include copy of this form with next communication to applicant.

T¹ - Place a check mark in this area when an English language Translation is attached AT&T, Exh. 1002, p. 301

ALL REFERENCES CONSIDERED EXCEPT WHERE LINED THROUGH. /SS/

INFORMATION DISCLOSURE STATEMENT BY APPLICANT	Application No.	13/966,096	
	Filing Date	August 13, 2013	
	First Named Inventor	Perreault, Clay	
	Art Unit	2653	
(Multiple sheets used when necessary)		Examiner	8712
SHEET 10 OF 11		Attorney Docket No.	SMARB19.001C1

FOREIGN PATENT DOCUMENTS						
Examiner Initials	Cite No.	Foreign Patent Document Country Code-Number-Kind Code Example: JP 1234567 A1	Publication Date MM-DD-YYYY	Name	Pages, Columns, Lines Where Relevant Passages or Relevant Figures Appear	T ¹
	212	WO 2007/087077 A3	08-02-2007	Medical Envelope LLC		
	213	WO 2008/085614 A2	07-17-2008	ISKOOT, Inc.		
	214	WO 2008/085614 A3	07-17-2008	ISKOOT, Inc.		
	215	WO 2008/086350 A2	07-17-2008	ISKOOT, Inc.		
	216	WO 2008/086350 A3	07-17-2008	ISKOOT, Inc.		
	217	WO 2008/103652 A1	08-28-2008	Interactive Intelligence, Inc.		
	218	WO 2008/085614 A8	12-11-2008	ISKOOT, Inc.		
	219	WO 2008/151406 A1	12-18-2008	Research In Motion Ltd		
	220	WO 2008/151406 A8	12-18-2008	Research In Motion Ltd		
	221	WO 2009/070202 A1	06-04-2009	Tellabs Operations, Inc.		
	222	WO 2009/070278 A1	06-04-2009	Broadsoft, Inc.		
	223	WO 2011/000405 A1	01-06-2011	Telefonaktiebolaget LM Ericsson		

NON PATENT LITERATURE DOCUMENTS			
Examiner Initials	Cite No.	Include name of the author (in CAPITAL LETTERS), title of the article (when appropriate), title of the item (book, magazine, journal, serial, symposium, catalog, etc.), date, page(s), volume-issue number(s), publisher, city and/or country where published.	T ¹
	224	Baker <i>et al.</i> , "Cisco Support for Lawful Intercept In IP Networks," Internet Draft - working document of the Internet Engineering Task Force (IETF), accessible at http://www.ietf.org/ietf/lid-abstracts.txt , April 2003, expires September 30, 2003, pages 1-15.	
	225	Bhushan <i>et al.</i> , "Federated Accounting: Service Charging and Billing in a Business-to-Business Environment," 0-7803-6719-7/01, © 2001 IEEE, pages 107-121.	
	226	Jajszczyk <i>et al.</i> , "Emergency Calls in Flow-Aware Networks," <i>IEEE Communications Letters</i> , Vol. 11, No. 9, September 2007, pages 753-755.	
	227	Kim <i>et al.</i> , "An Enhanced VoIP Emergency Services Prototype," <i>Proceedings of the 3rd International ISCRAM Conference (B. Van de Walle and M. Turoff, eds.), Newark, NJ (USA), May 2006, pages 1-8.</i>	
	228	Kornfeld <i>et al.</i> , "DVB-H and IP Datacast—Broadcast to Handheld Devices," <i>IEEE Transactions On Broadcasting</i> , Vol. 53, No. 1, March 2007, pages 161-170.	
	229	Kortebi <i>et al.</i> , "SINR-Based Routing in Multi-Hop Wireless Networks to Improve VoIP Applications Support," 1-4244-0667-6/07, © 2007 IEEE, pages 491-496.	
	230	Lee <i>et al.</i> , "VoIP Interoperation with KT-NGN," in <i>The 6th International Conference on Advanced Communication Technology</i> , Technical Proceedings, 2004, pages 126-128, accompanied by Title and Contents - 4 pages.	

Examiner Signature /Simon Sing/	Date Considered 04/04/2015
---------------------------------	----------------------------

*Examiner: Initial if reference considered, whether or not citation is in conformance with MPEP 609. Draw line through citation if not in conformance and not considered. Include copy of this form with next communication to applicant.

T¹ - Place a check mark in this area when an English language Translation is attached AT&T, Exh. 1002, p. 302

INFORMATION DISCLOSURE STATEMENT BY APPLICANT	Application No.	13/966,096
	Filing Date	August 13, 2013
	First Named Inventor	Perreault, Clay
	Art Unit	2653
(Multiple sheets used when necessary)	Examiner	8712
SHEET 11 OF 11	Attorney Docket No.	SMARB19.001C1

NON PATENT LITERATURE DOCUMENTS

Examiner Initials	Cite No.	Include name of the author (in CAPITAL LETTERS), title of the article (when appropriate), title of the item (book, magazine, journal, serial, symposium, catalog, etc.), date, page(s), volume-issue number(s), publisher, city and/or country where published.	T ¹
	231	Lin <i>et al.</i> , "Effective VoIP Call Routing in WLAN and Cellular Integration," <i>IEEE Communications Letters</i> , Vol. 9, No. 10, October 2005, pages 874-876.	
	232	Ma <i>et al.</i> , "Realizing MPEG4 Video Transmission Based on Mobile Station over GPRS," <i>0-7803-9335-X/05</i> , © 2005 IEEE, pages 1241-1244.	
	233	Mintz-Habib <i>et al.</i> , "A VoIP Emergency Services Architecture and Prototype," <i>{mm2571,asr,hgs,xiaotaow}@cs.columbia.edu</i> , <i>0-7803-9428-3/05</i> , © 2005 IEEE, pages 523-528.	
	234	Munir, Muhammad Farukh, "Study of an Adaptive Scheme for Voice Transmission on IP in a Wireless Networking Environment 802.11e," <i>Dept. of Networks and Distributed Computing, Ecole Supérieure En Sciences Informatiques (ESSI), Université De Nice</i> , June 2005, (pages 1-35), BEST AVAILABLE COPY - pages 1-11.	
	235	Sripanidkulchai <i>et al.</i> , "Call Routing Management in Enterprise VoIP Networks," <i>Copyright 2007 ACM 978-1-59593-788-9/07/0008</i> , 6 pages.	
	236	Thernelius, Fredrik, "SIP, NAT, and Firewalls," Master's Thesis, <i>ERICSSON, Department of Teleinformatics</i> , May 2000, pages 1-69.	
	237	Trad <i>et al.</i> , "Adaptive VoIP Transmission over Heterogeneous Wired/Wireless Networks," <i>V. Roca and F. Rousscau (Eds.): MIPS 2004, LNCS 3311</i> , pp. 25-36, 2004, © Springer-Verlag Berlin Heidelberg 2004.	
	238	Yu <i>et al.</i> , "Service-Oriented Issues: Mobility, Security, Charging and Billing Management in Mobile Next Generation Networks," <i>IEEE BcN2006, 1-4244-0146-1/06</i> , © 2006 IEEE, pages 1-10.	

19420768
112614

Examiner Signature	/Simon Sing/	Date Considered	04/04/2015
--------------------	--------------	-----------------	------------

*Examiner: Initial if reference considered, whether or not citation is in conformance with MPEP 609. Draw line through citation if not in conformance and not considered. Include copy of this form with next communication to applicant.

T¹ - Place a check mark in this area when an English language Translation is attached AT&T, Exh. 1002, p. 303

ALL REFERENCES CONSIDERED EXCEPT WHERE LINED THROUGH. /SS/

UNITED STATES PATENT AND TRADEMARK OFFICE

UNITED STATES DEPARTMENT OF COMMERCE
United States Patent and Trademark Office
 Address: COMMISSIONER FOR PATENTS
 P.O. Box 1450
 Alexandria, Virginia 22313-1450
 www.uspto.gov

BIB DATA SHEET
CONFIRMATION NO. 8712

SERIAL NUMBER	FILING or 371(c) DATE	CLASS	GROUP ART UNIT	ATTORNEY DOCKET NO.	
13/966,096	08/13/2013	379	2653	SMARB19.001C1	
APPLICANTS Digifonica (INTERNATIONAL) Limited, Vancouver, CANADA, Assignee (with 37 CFR 1.172 Interest); INVENTORS CLAY PERREAULT, Panama City, PANAMA; STEVE NICHOLSON, Hamilton, NEW ZEALAND; ROD THOMSON, North Vancouver, CANADA; JOHAN EMIL VIKTOR BJÖRSELL, Vancouver, CANADA; FUAD ARAFA, Vancouver, CANADA; ** CONTINUING DATA ***** This application is a CON of 12/513,147 03/01/2010 PAT 8542815 which is a 371 of PCT/CA07/01956 11/01/2007 which claims benefit of 60/856,212 11/02/2006 ** FOREIGN APPLICATIONS ***** ** IF REQUIRED, FOREIGN FILING LICENSE GRANTED ** ** SMALL ENTITY ** 08/28/2013					
Foreign Priority claimed <input type="checkbox"/> Yes <input checked="" type="checkbox"/> No 35 USC 119(a-d) conditions met <input type="checkbox"/> Yes <input checked="" type="checkbox"/> No Verified and Acknowledged <u>/SIMON P SING/</u> Examiner's Signature	<input type="checkbox"/> Met after Allowance Initials	STATE OR COUNTRY PANAMA	SHEETS DRAWINGS 32	TOTAL CLAIMS 78	INDEPENDENT CLAIMS 6
ADDRESS KNOBBE MARTENS OLSON & BEAR LLP 2040 MAIN STREET FOURTEENTH FLOOR IRVINE, CA 92614 UNITED STATES					
TITLE PRODUCING ROUTING MESSAGES FOR VOICE OVER IP COMMUNICATIONS					
FILING FEE RECEIVED 4590	FEES: Authority has been given in Paper No. _____ to charge/credit DEPOSIT ACCOUNT No. _____ for following:			<input type="checkbox"/> All Fees <input type="checkbox"/> 1.16 Fees (Filing) <input type="checkbox"/> 1.17 Fees (Processing Ext. of time) <input type="checkbox"/> 1.18 Fees (Issue) <input type="checkbox"/> Other _____ <input type="checkbox"/> Credit	

Search Notes 	Application/Control No. 13966096	Applicant(s)/Patent Under Reexamination PERREAULT ET AL.
	Examiner SIMON SING	Art Unit 2653

CPC- SEARCHED		
Symbol	Date	Examiner

CPC COMBINATION SETS - SEARCHED		
Symbol	Date	Examiner

US CLASSIFICATION SEARCHED			
Class	Subclass	Date	Examiner

SEARCH NOTES		
Search Notes	Date	Examiner
EAST	04/03/2015	SS

INTERFERENCE SEARCH			
US Class/ CPC Symbol	US Subclass / CPC Group	Date	Examiner

--	--

Index of Claims 	Application/Control No. 13966096	Applicant(s)/Patent Under Reexamination PERREULT ET AL.
	Examiner SIMON SING	Art Unit 2653

✓	Rejected
=	Allowed

-	Cancelled
÷	Restricted

N	Non-Elected
I	Interference

A	Appeal
O	Objected

Claims renumbered in the same order as presented by applicant
 CPA
 T.D.
 R.1.47

CLAIM		DATE							
Final	Original	04/04/2015							
	1	✓							
	2	✓							
	3	✓							
	4	✓							
	5	✓							
	6	✓							
	7	✓							
	8	✓							
	9	✓							
	10	✓							
	11	✓							
	12	✓							
	13	✓							
	14	✓							
	15	✓							
	16	✓							
	17	✓							
	18	✓							
	19	✓							
	20	✓							
	21	✓							
	22	✓							
	23	✓							
	24	✓							
	25	✓							
	26	✓							
	27	✓							
	28	✓							
	29	✓							
	30	✓							
	31	✓							
	32	✓							
	33	✓							
	34	✓							
	35	✓							
	36	✓							

<i>Index of Claims</i> 	Application/Control No. 13966096	Applicant(s)/Patent Under Reexamination PERREault ET AL.
	Examiner SIMON SING	Art Unit 2653

✓	Rejected
=	Allowed

-	Cancelled
÷	Restricted

N	Non-Elected
I	Interference

A	Appeal
O	Objected

Claims renumbered in the same order as presented by applicant
 CPA
 T.D.
 R.1.47

CLAIM		DATE							
Final	Original	04/04/2015							
	37	✓							
	38	✓							
	39	✓							
	40	✓							
	41	✓							
	42	✓							
	43	✓							
	44	✓							
	45	✓							
	46	✓							
	47	✓							
	48	✓							
	49	✓							
	50	✓							
	51	✓							
	52	✓							
	53	✓							
	54	✓							
	55	✓							
	56	✓							
	57	✓							
	58	✓							
	59	✓							
	60	✓							
	61	✓							
	62	✓							
	63	✓							
	64	✓							
	65	✓							
	66	✓							
	67	✓							
	68	✓							
	69	✓							
	70	✓							
	71	✓							
	72	✓							

Index of Claims 	Application/Control No. 13966096	Applicant(s)/Patent Under Reexamination PERREULT ET AL.
	Examiner SIMON SING	Art Unit 2653

✓	Rejected
=	Allowed

-	Cancelled
÷	Restricted

N	Non-Elected
I	Interference

A	Appeal
O	Objected

Claims renumbered in the same order as presented by applicant
 CPA
 T.D.
 R.1.47

CLAIM		DATE							
Final	Original	04/04/2015							
	73	✓							
	74	-							
	75	-							
	76	-							
	77	-							
	78	-							
	79	✓							
	80	✓							
	81	✓							
	82	✓							
	83	✓							
	84	✓							
	85	✓							
	86	✓							
	87	✓							
	88	✓							
	89	✓							
	90	✓							
	91	✓							
	92	✓							
	93	✓							
	94	✓							
	95	✓							
	96	✓							
	97	✓							
	98	✓							
	99	✓							
	100	✓							
	101	✓							
	102	✓							
	103	✓							
	104	✓							

INFORMATION DISCLOSURE STATEMENT BY APPLICANT	Application No.	13/966,096	
	Filing Date	August 13, 2013	
	First Named Inventor	Perreault, Clay	
	Art Unit	2653	
<i>(Multiple sheets used when necessary)</i>		Examiner	Sing, Simon P.
SHEET 1 OF 3		Attorney Docket No.	SMARB19.001C1

U.S. PATENT DOCUMENTS					
Examiner Initials	Cite No.	Document Number Number - Kind Code (if known) Example: 1,234,567 B1	Publication Date MM-DD-YYYY	Name	Pages, Columns, Lines Where Relevant Passages or Relevant Figures Appear
	1	6,937,713 B1	08-30-2005	Kung et al.	
	2	8,111,690 B2	02-07-2012	Hussain et al.	
	3	8,219,115 B1	07-10-2012	Nelissen, Marco	
	4	8,228,837 B2	07-24-2012	Sheriff et al.	
	5	8,243,730 B1	08-14-2012	Wong et al.	
	6	8,275,404 B2	09-25-2012	Berger et al.	
	7	8,364,172 B2	01-29-2013	Guanfeng et al.	
	8	8,410,907 B2	04-02-2013	Twitchell, Jr., Robert W.	
	9	8,417,791 B1	04-09-2013	Peretz et al.	
	10	8,423,791 B1	04-16-2013	Yu et al.	
	11	8,468,196 B1	06-18-2013	Roskind et al.	
	12	8,493,931 B1	07-23-2013	Nix, John A.	
	13	8,532,075 B2	09-10-2013	Rassool et al.	
	14	8,682,919 B1	03-25-2014	Golliher, Geoffrey	
	15	8,713,098 B1	04-29-2014	Adya et al.	
	16	8,749,610 B1	06-10-2014	Gossweiler et al.	
	17	8,767,717 B2	07-01-2014	Siegel et al.	
	18	8,774,721 B2	07-08-2014	Hertel et al.	
	19	8,780,703 B1	07-15-2014	Eidelson et al.	
	20	8,792,374 B1	07-29-2014	Jain et al.	
	21	8,792,905 B1	07-29-2014	Li et al.	
	22	8,805,345 B2	08-12-2014	Ling et al.	
	23	8,810,392 B1	08-19-2014	Teller et al.	
	24	8,837,360 B1	09-16-2014	Mishra et al.	
	25	8,838,539 B1	09-16-2014	Ashcraft et al.	
	26	2001/0027478 A1	10-04-2001	Meier et al.	
	27	2011/0255553 A1	10-20-2011	Bobba et al.	
	28	2011/0261717 A1	10-27-2011	Akuzuwa et al.	

Examiner Signature /Simon Sing/	Date Considered 04/04/2015
*Examiner: Initial if reference considered, whether or not citation is in conformance with MPEP 609. Draw line through citation if not in conformance and not considered. Include copy of this form with next communication to applicant.	

T¹ - Place a check mark in this area when an English language Translation is attached AT&T, Exh. 1002, p. 309

ALL REFERENCES CONSIDERED EXCEPT WHERE LINED THROUGH. /SS/

INFORMATION DISCLOSURE STATEMENT BY APPLICANT	Application No.	13/966,096	
	Filing Date	August 13, 2013	
	First Named Inventor	Perreault, Clay	
	Art Unit	2653	
<i>(Multiple sheets used when necessary)</i>		Examiner	Sing, Simon P.
SHEET 2 OF 3		Attorney Docket No.	SMARB19.001C1

U.S. PATENT DOCUMENTS					
Examiner Initials	Cite No.	Document Number Number - Kind Code (if known) Example: 1,234,567 B1	Publication Date MM-DD-YYYY	Name	Pages, Columns, Lines Where Relevant Passages or Relevant Figures Appear
	29	2013/0223276 A1	08-29-2013	Padgett, Steven	
	30	2013/0237198 A1	09-12-2013	Vashi et al.	
	31	2013/0254301 A1	09-26-2013	Lin et al.	
	32	2013/0272297 A1	10-17-2013	Breen et al.	
	33	2013/0281147 A1	10-24-2013	Denman et al.	
	34	2014/0220944 A1	08-07-2014	Balasubramanian, Sanjeevi	
	35	2014/0244393 A1	08-28-2014	Rimmer et al.	
	36	2014/0247730 A1	09-04-2014	Thota et al.	
	37	2014/0269624 A1	09-18-2014	Khay-Ibbat et al.	
	38	2014/0324969 A1	10-30-2014	Riddle, Guy	
	39	2014/0337962 A1	11-13-2014	Brandstatter, Klaus	
	40	2014/0337961 A1	11-13-2014	Chien et al.	
	41	2014/0349602 A1	11-27-2014	Majumdar et al.	

FOREIGN PATENT DOCUMENTS						
Examiner Initials	Cite No.	Foreign Patent Document Country Code-Number-Kind Code Example: JP 1234567 A1	Publication Date MM-DD-YYYY	Name	Pages, Columns, Lines Where Relevant Passages or Relevant Figures Appear	T ¹
	42	CA 2 659 007 A1	09-27-2009	Google Inc		Abstract
	43	CA 2 778 905 A1	08-26-2010	Google Inc		Abstract
	44	CN 102137024 A	07-27-2011	Fujian Star Net Comm Co Ltd		Abstract
	45	JP 2011-199384 (A)	10-06-2011	Ricoh Co Ltd		Abstract
	46	WO 01/50693 A1	07-12-2001	WWW.Internet Solutions Limited		
	47	WO 03/027801 A2	04-03-2003	Bell-South Intellectual Property Corporation		
	48	WO 2013/120069 A1	08-15-2013	Connectify		
	49	WO 2014/066155 A2	05-01-2014	Google Inc.		
	50	WO 2014/117599 A1	08-07-2014	Huawei Tech Co Ltd		Abstract
	51	WO 2014-166258 A1	10-16-2014	ZTE Corp		Abstract

Examiner Signature	/Simon Sing/	Date Considered	04/04/2015
--------------------	--------------	-----------------	------------

*Examiner: Initial if reference considered, whether or not citation is in conformance with MPEP 609. Draw line through citation if not in conformance and not considered. Include copy of this form with next communication to applicant.

T¹ - Place a check mark in this area when an English language Translation is attached AT&T, Exh. 1002, p. 310

ALL REFERENCES CONSIDERED EXCEPT WHERE LINED THROUGH. /SS/

INFORMATION DISCLOSURE STATEMENT BY APPLICANT	Application No.	13/966,096
	Filing Date	August 13, 2013
	First Named Inventor	Perreault, Clay
	Art Unit	2653
<i>(Multiple sheets used when necessary)</i>	Examiner	Sing, Simon P.
SHEET 3 OF 3	Attorney Docket No.	SMARB19.001C1

NON PATENT LITERATURE DOCUMENTS			
Examiner Initials	Cite No.	Include name of the author (in CAPITAL LETTERS), title of the article (when appropriate), title of the item (book, magazine, journal, serial, symposium, catalog, etc.), date, page(s), volume-issue number(s), publisher, city and/or country where published.	T ¹
	52	ETSI TS 122 173 V12.7.0 (2014-10) Digital cellular telecommunications system (Phase 2+); TECHNICAL SPECIFICATION 8.2.2.3- Interoperability with PSTN/ISDN and mobile CS Networks, Contents and Forward, pages 1-9; Sec. 8, pages 14-17.	
	53	Huitema <i>et al.</i> , "Architecture for Internet Telephony Service for Residential Customers," Academic Paper for <i>Bellcore</i> , March 2, 1999, pages 1-14.	
	54	Stallings, William, "The Session Initiation Protocol," <i>The Internet Protocol Journal</i> , Vol. 6, No. 1, March 2003, pages 20-30.	

19658743
010615

Examiner Signature /Simon Sing/	Date Considered 04/04/2015
---------------------------------	----------------------------

*Examiner: Initial if reference considered, whether or not citation is in conformance with MPEP 609. Draw line through citation if not in conformance and not considered. Include copy of this form with next communication to applicant.

T¹ - Place a check mark in this area when an English language Translation is attached AT&T, Exh. 1002, p. 311

EAST Search History

EAST Search History (Prior Art)

Ref #	Hits	Search Query	DBs	Default Operator	Plurals	Time Stamp
S57	27247	((local adj area) or private) adj network) and (IP or internt or WAN) and PSTN and gateway	US-PGPUB; USPAT; USOCR; FPRS; EPO; JPO; DERWENT; IBM_TDB	OR	ON	2015/04/01 16:58
S58	711	S57 and 379/88.17	US-PGPUB; USPAT; USOCR; FPRS; EPO; JPO; DERWENT; IBM_TDB	OR	ON	2015/04/01 16:58
S59	714	S57 and (routing adj message)	US-PGPUB; USPAT; USOCR; FPRS; EPO; JPO; DERWENT; IBM_TDB	OR	ON	2015/04/01 16:59
S61	24	S59 and 379/88.17	US-PGPUB; USPAT; USOCR; FPRS; EPO; JPO; DERWENT; IBM_TDB	OR	ON	2015/04/01 17:00
S62	28	donovan.in. and (IP adj phone)	US-PGPUB; USPAT; USOCR; FPRS; EPO; JPO; DERWENT; IBM_TDB	OR	ON	2015/04/01 17:10
S64	872	(generat\$3 or produc\$3) with (routing adj message)	US-PGPUB; USPAT; USOCR; FPRS; EPO; JPO; DERWENT; IBM_TDB	OR	ON	2015/04/03 12:49
S66	21	S64 and IAM	US-PGPUB; USPAT; USOCR; FPRS; EPO; JPO; DERWENT; IBM_TDB	OR	ON	2015/04/03 12:50
S67	113	S64 and SIP	US-PGPUB; USPAT; USOCR; FPRS; EPO; JPO; DERWENT; IBM_TDB	OR	ON	2015/04/03 12:51
S68	50	S64 and stp	US-PGPUB; USPAT; USOCR; FPRS; EPO; JPO; DERWENT; IBM_TDB	OR	ON	2015/04/03 12:52
S69	73	S64 and ss7	US-PGPUB; USPAT; USOCR; FPRS; EPO; JPO; DERWENT; IBM_TDB	OR	ON	2015/04/03 12:53
S71	905	sip same (user adj name)	US-PGPUB; USPAT; USOCR; FPRS; EPO; JPO; DERWENT; IBM_TDB	OR	ON	2015/04/03 15:43
S72	492	sip with (user adj name)	US-PGPUB; USPAT; USOCR; FPRS; EPO; JPO; DERWENT; IBM_TDB	OR	ON	2015/04/03 15:44

S73	51	(caller or callee) same S72	US-PGPUB; USPAT; USOCR; FPRS; EPO; JPO; DERWENT; IBM_TDB	OR	ON	2015/04/03 15:44
S74	19	leung.in. and family and friend	US-PGPUB; USPAT; USOCR; FPRS; EPO; JPO; DERWENT; IBM_TDB	OR	ON	2015/04/03 16:25
S75	2210	direct with inward with dial\$3	US-PGPUB; USPAT; USOCR; FPRS; EPO; JPO; DERWENT; IBM_TDB	OR	ON	2015/04/03 16:35
S76	58	S75 with record	US-PGPUB; USPAT; USOCR; FPRS; EPO; JPO; DERWENT; IBM_TDB	OR	ON	2015/04/03 16:35
S77	156	national with dialing with plan	US-PGPUB; USPAT; USOCR; FPRS; EPO; JPO; DERWENT; IBM_TDB	OR	ON	2015/04/03 17:48
S78	785	(time stamp) with (routing adj message)	US-PGPUB; USPAT; USOCR; FPRS; EPO; JPO; DERWENT; IBM_TDB	OR	ON	2015/04/03 18:38
S79	31	S78 same ((time adj out) or timeout)	US-PGPUB; USPAT; USOCR; FPRS; EPO; JPO; DERWENT; IBM_TDB	OR	ON	2015/04/03 18:39
S80	776	S78 with time	US-PGPUB; USPAT; USOCR; FPRS; EPO; JPO; DERWENT; IBM_TDB	OR	ON	2015/04/03 18:42
S82	55	S80 and ss7	US-PGPUB; USPAT; USOCR; FPRS; EPO; JPO; DERWENT; IBM_TDB	OR	ON	2015/04/03 18:47
S83	14	S78 same (time adj out)	US-PGPUB; USPAT; USOCR; FPRS; EPO; JPO; DERWENT; IBM_TDB	OR	ON	2015/04/03 18:49
S84	23	S78 same timeout	US-PGPUB; USPAT; USOCR; FPRS; EPO; JPO; DERWENT; IBM_TDB	OR	ON	2015/04/03 18:49
S85	0	(time adj stamp) with (routing adj message)	US-PGPUB; USPAT; USOCR; FPRS; EPO; JPO; DERWENT; IBM_TDB	OR	ON	2015/04/03 18:51
S86	776	time with (routing adj message)	US-PGPUB; USPAT; USOCR; FPRS; EPO; JPO; DERWENT; IBM_TDB	OR	ON	2015/04/03 18:51
S88	111	S86 and PSTN	US-PGPUB; USPAT; USOCR; FPRS; EPO; JPO; DERWENT; IBM_TDB	OR	ON	2015/04/03 18:52
S89	55	S86 and (ss7 or ss5)	US-PGPUB; USPAT; USOCR; FPRS; EPO; JPO; DERWENT;	OR	ON	2015/04/03 18:55

			IBM_TDB			
S92	15	timeout with (routing adj message)	US-PGPUB; USPAT; USOCR; FPRS; EPO; JPO; DERWENT; IBM_TDB	OR	ON	2015/04/04 11:13
S93	14	(time near2 out) with (routing adj message)	US-PGPUB; USPAT; USOCR; FPRS; EPO; JPO; DERWENT; IBM_TDB	OR	ON	2015/04/04 11:15

4/ 4/ 2015 1:55:44 PM

C:\Users\ssing\Documents\EAST\Workspaces\default.wsp

IN THE UNITED STATES PATENT AND TRADEMARK OFFICE

Inventor	:	Clay Perreault, et al.
App. No.	:	13/966,096
Filed	:	August 13, 2013
For	:	PRODUCING ROUTING MESSAGES FOR VOICE OVER IP COMMUNICATIONS
Examiner	:	Simon P. Sing
Art Unit	:	2653
Conf. No.	:	8712

REPLY TO NON-FINAL OFFICE ACTION**Mail Stop Amendment**

Commissioner for Patents
P.O. Box 1450
Alexandria, VA 22313-1450

Dear Sir:

In reply to the non-final Office Action dated April 9, 2015, Applicant presents the following amendments and remarks.

Listing of the Claims begin on page 2 of this paper.

Remarks begin on page 22 of this paper.

LISTING OF THE CLAIMS

1. (Original) A process for producing a routing message for routing communications between a caller and a callee in a communication system, the process comprising:

using a caller identifier associated with the caller to locate a caller dialing profile comprising a plurality of calling attributes associated with the caller;

when at least one of said calling attributes and at least a portion of a callee identifier associated with the callee meet private network classification criteria, producing a private network routing message for receipt by a call controller, said private network routing message identifying an address, on the private network, associated with the callee; and

when at least one of said calling attributes and at least a portion of said callee identifier meet a public network classification criterion, producing a public network routing message for receipt by the call controller, said public network routing message identifying a gateway to the public network.

2. (Original) The process of claim 1, wherein said private network classification criteria include:

a) said callee identifier does not begin with the same digit pattern as an international dialing digit (IDD) attribute of said callee identifier; and

b) said callee identifier does not begin with the same digit pattern as a national dialing digit (NDD) attribute of said callee identifier; and

c) said callee identifier does not begin with the same area code as an area code of said caller; and

d) said callee identifier does not have a length that is within a range of caller local number lengths; and

e) said callee identifier is a valid username.

3. (Original) The process of claim 2, further comprising identifying the call as a cross-domain call on the private network when said callee identifier identifies a callee that is not associated with the same network node as said caller.

4. (Original) The process of claim 2, further comprising:
locating a callee dialing profile for the callee when said callee identifier identifies a callee that is associated with the same network node as said caller; and
retrieving call handling information associated with the callee, where said call handling information is available, said call handling information including at least one of call blocking information, call forwarding information, and voicemail information.

5. (Original) The process of claim 4, further comprising, where said call handling information including said call blocking information is available, blocking the call when said call blocking information identifies the caller as a caller from whom calls are to be blocked from being established with the callee.

6. (Original) The process of claim 4, further comprising, where said call handling information including said call forwarding information is available, causing said call forwarding information to be included in said private network routing message.

7. (Original) The process of claim 4, further comprising, where said call handling information including said voicemail information is available, causing said voicemail information to be included in said private network routing message.

8. (Original) The process of claim 1, further comprising associating at least one direct inward dial (DID) record with at least one subscriber to said communication system, each of said at least one direct inward dial records comprising a field storing a direct inward dial number associated with said at least one subscriber.

9. (Original) The process of claim 8, wherein said public network classification criteria include:

Application No.: 13/966,096
Filing Date: August 13, 2013

a) said callee identifier begins with the same digit pattern as an international dialing digit (IDD) attribute of said callee identifier; and

b) a reformatted callee identifier produced by removing the IDD attribute from said callee identifier has no DID bank table record.

10. (Original) The process of claim 8, wherein said public network classification criteria include:

a) said callee identifier begins with the same digit pattern as a national dialing digit (NDD) attribute of said callee identifier; and

b) a reformatted callee identifier produced by removing the NDD attribute from said callee identifier and including a caller country code has no DID bank table record.

11. (Original) The process of claim 8, wherein said public network classification criteria include:

a) said callee identifier begins with the same area code as an area code of said caller; and

b) a reformatted callee identifier produced by reformatting the callee identifier to include a caller country code has no DID bank table record.

12. (Original) The process of claim 8, wherein said public network classification criteria include:

a) said callee identifier has a length that is within a range of caller local number lengths; and

b) a reformatted callee identifier produced by reformatting the callee identifier to include a caller country code and area code has no DID bank table record.

13. (Original) The process of claim 1, wherein said plurality of calling attributes includes at least one of an international dialing digits identifier, a national dialing digits identifier, a country code identifier, a local area codes identifier, a caller minimum local length

identifier, a caller maximum local length identifier, a reseller identifier, and a maximum number of concurrent calls identifier.

14. (Original) The process of claim 8, wherein said DID record comprises a user name field, a user domain field and a DID number field.

15. (Original) The process of claim 1, further comprising maintaining a list of public network route suppliers and when said public network classification criterion is met identifying at least one of said public network route suppliers that satisfies public network routing selection criteria.

16. (Original) The process of claim 15, wherein said producing said public network routing message comprises producing a public network routing message identifying said at least one public network route supplier that satisfies said public network routing selection criteria.

17. (Original) The process of claim 16, wherein producing said public network routing message comprises causing said public network routing message to include a gateway supplier identifier identifying a gateway supplier able to establish a communications link in a route through which communications between the caller and callee are to be conducted.

18. (Original) The process of claim 17, further comprising causing said public network routing message to include a time value and a timeout value.

19. (Original) The process of claim 17, wherein causing said public network routing message to include said gateway supplier identifier comprises causing said public network routing message to include a plurality of gateway supplier identifiers identifying a plurality of gateway suppliers able to supply respective communication links through which communications between the caller and callee can be conducted.

20. (Original) The process of claim 19, further comprising causing said public network routing message to include priority information identifying a priority in which gateway suppliers associated with said gateway identifiers are to be considered for selection of a communication link through which communications between the caller and callee can be conducted.

21. (Original) The process of claim 19, wherein causing said public network routing message to include priority information includes arranging said gateway supplier identifiers in said public network routing message in order of rate, where rate is determined from rate fields of respective said gateway supplier records.

22. (Original) The process of claim 21, wherein arranging said gateway supplier identifiers in order of rate comprises arranging said gateway supplier identifiers in order of increasing rate.

23. (Original) The process of claim 17, further comprising arranging said gateway supplier identifiers in an order based on at least one provision in a service agreement.

24. (Original) The process of claim 1, further comprising causing the private network routing message or the public network routing message to be communicated to a call controller to effect routing of the call.

25. (Original) A non-transitory computer readable medium encoded with codes for directing a processor to execute the method of claim 1.

26. (Original) A call routing controller apparatus for producing a routing message for routing communications between a caller and a callee in a communication system, the apparatus comprising:

at least one processor operably configured to:

use a caller identifier associated with the caller to locate a caller dialing profile comprising a plurality of calling attributes associated with the caller;

when at least one of said calling attributes and at least a portion of a callee identifier associated with the callee meet private network classification criteria, produce a private network routing message for receipt by a call controller, said private network routing message identifying an address, on the private network, associated with the callee; and

when at least one of said calling attributes and at least a portion of said callee identifier meet a public network classification criterion, produce a public network routing message for receipt by the call controller, said public network routing message identifying a gateway to the public network.

27. (Original) The apparatus of claim 26, wherein said private network classification criteria include:

- a) said callee identifier does not begin with the same digit pattern as an international dialing digit (IDD) attribute of said callee identifier; and
- b) said callee identifier does not begin with the same digit pattern as a national dialing digit (NDD) attribute of said callee identifier; and
- c) said callee identifier does not begin with the same area code as an area code of said caller; and
- d) said callee identifier does not have a length that is within a range of caller local number lengths; and
- e) said callee identifier is a valid username.

28. (Original) The apparatus of claim 27, wherein said at least one processor is further operably configured to identify the call as a cross-domain call on the private network when said callee identifier identifies a callee that is not associated with the same network node as said caller.

29. (Original) The apparatus of claim 27, wherein said at least one processor is further configured to:

access the database of caller dialing profiles to locate a callee dialing profile for the callee when said callee identifier identifies a callee that is associated with the same network node as said caller; and

retrieve call handling information associated with the callee, where said call handling information is available, said call handling information including at least one of call blocking information, call forwarding information, and voicemail information.

30. (Original) The apparatus of claim **29**, wherein said at least one processor is further operably configured to determine whether said call handling information including said call blocking information is available and to block the call when said call blocking information identifies the caller as a caller from whom calls are to be blocked.

31. (Original) The apparatus of claim **29**, wherein said at least one processor is further operably configured to determine whether said call handling information including said call forwarding information is available and to cause said call forwarding information to be included in said private network routing message.

32. (Original) The apparatus of claim **29**, wherein said at least one processor is further operably configured to determine whether said call handling information including said voicemail information is available and to cause said voicemail information to be included in said private network routing message.

33. (Original) The apparatus of claim **26**, wherein said at least one processor is further operably configured to access a database of direct inward dial records each associating at least one direct inward dial number with at least one subscriber to said communication system.

34. (Original) The apparatus of claim **33**, wherein said public network classification criteria include:

- a) said callee identifier begins with the same digit pattern as an international dialing digit (IDD) attribute of said callee identifier; and

Application No.: 13/966,096
Filing Date: August 13, 2013

b) a reformatted callee identifier produced by removing the IDD attribute from said callee identifier has no DID record.

35. (Original) The apparatus of claim 33, wherein said public network classification criteria include:

a) said callee identifier begins with the same digit pattern as a national dialing digit (NDD) attribute of said callee identifier; and

b) a reformatted callee identifier produced by removing the NDD attribute from said callee identifier and including a caller country code has no DID record.

36. (Original) The apparatus of claim 33, wherein said public network classification criteria include:

a) said callee identifier begins with the same area code as an area code of said caller; and

b) a reformatted callee identifier produced by reformatting the callee identifier to include a caller country code has no DID record.

37. (Original) The apparatus of claim 33, wherein said public network classification criteria include:

a) said callee identifier has a length that is within a range of caller local number lengths; and

b) a reformatted callee identifier produced by reformatting the callee identifier to include a caller country code and area code has no DID record.

38. (Original) The apparatus of claim 26, wherein said plurality of calling attributes includes at least one of an international dialing digits identifier, a national dialing digits identifier, a country code identifier, a local area codes identifier, a caller minimum local length identifier, a caller maximum local length identifier, a reseller identifier, and a maximum number of concurrent calls identifier.

39. (Original) The apparatus of claim 33, wherein said DID record comprises a user name field, a user domain field and a DID number field.

40. (Original) The apparatus of claim 26, wherein said at least one processor is further operably configured to access a list of public network route suppliers when said public network classification criterion is met and to identify at least one of said public network route suppliers that satisfies public network routing selection criteria.

41. (Original) The apparatus of claim 40, wherein said at least one processor is further operably configured to produce a public network routing message identifying said at least one public network route supplier that satisfies said public network routing selection criteria.

42. (Original) The apparatus of claim 41, wherein said at least one processor is operably configured to cause said public network routing message to include a gateway supplier identifier identifying a gateway supplier able to establish a communications link in a route through which communications between the caller and callee can be conducted.

43. (Original) The apparatus of claim 42, wherein said at least one processor is operably configured to cause said public network routing message to include a time value and a timeout value.

44. (Original) The apparatus of claim 42, wherein said at least one processor is operably configured to cause said public network routing message to include a plurality of gateway supplier identifiers identifying a plurality of gateway suppliers able to supply respective communication links through which communications between the caller and callee can be conducted.

45. (Original) The apparatus of claim 44, wherein said at least one processor is operably configured to cause said public network routing message to include priority information identifying a priority in which gateway suppliers associated with said gateway identifiers are to

be considered for selection of a communication link through which communications between the caller and callee can be conducted.

46. (Original) The apparatus of claim 44, wherein said at least one processor is operably configured to arrange said gateway supplier identifiers in said public network routing message in order of rate, where rate is determined from rate fields of respective said gateway supplier records.

47. (Original) The apparatus of claim 46, wherein said at least one processor is operably configured to arrange said gateway supplier identifiers in order of increasing rate.

48. (Original) The apparatus of claim 42, wherein said at least one processor is operably configured to arrange said gateway supplier identifiers in an order based on at least one provision in a service agreement.

49. (Original) The apparatus of claim 26, wherein said at least one processor is further operably configured to cause the private network routing message or the public network routing message to be communicated to a call controller to effect routing of the call.

50. (Original) A call routing controller apparatus for producing a routing message for routing communications between a caller and a callee in a communication system, the apparatus comprising:

means for using a caller identifier associated with the caller to locate a caller dialing profile comprising a plurality of calling attributes associated with the caller; and

means for, when at least one of said calling attributes and at least a portion of a callee identifier associated with the callee meet private network classification criteria, producing a private network routing message for receipt by a call controller, said private network routing message identifying an address, on the private network, associated with the callee; and

means for, when at least one of said calling attributes and at least a portion of said callee identifier meet a public network classification criterion, producing a public

network routing message for receipt by the call controller, said public network routing message identifying a gateway to the public network.

51. (Original) The apparatus of claim 50, wherein said private network classification criteria include:

a) said callee identifier does not begin with the same digit pattern as an international dialing digit (IDD) attribute of said callee identifier; and

b) said callee identifier does not begin with the same digit pattern as a national dialing digit (NDD) attribute of said callee identifier; and

c) said callee identifier does not begin with the same area code as an area code of said caller; and

said callee identifier does not have a length that is within a range of caller local number lengths; and

said callee identifier is a valid username.

52. (Original) The apparatus of claim 51, further comprising means for identifying the call as a cross-domain call on the private network when said callee identifier identifies a callee that is not associated with the same network node as said caller.

53. (Original) The apparatus of claim 51, further comprising:

means for accessing the database of caller dialing profiles to locate a callee dialing profile for the callee when said callee identifier identifies a callee that is associated with the same network node as said caller; and

means for retrieving call handling information associated with the callee, where said call handling information is available, said call handling information including at least one of call blocking information, call forwarding information, and voicemail information.

54. (Original) The apparatus of claim 53, further comprising, where said call handling information including said call blocking information is available, means for blocking the call being established with the callee when said call blocking information identifies the caller as a caller from whom calls are to be blocked.

55. (Original) The apparatus of claim 53, further comprising, means for causing said call forwarding information to be included in said private network routing message, where said call handling information including said call forwarding information is available.

56. (Original) The apparatus of claim 53, further comprising, where said call handling information including said voicemail information is available, means for causing said voicemail information to be included in said private network routing message.

57. (Original) The apparatus of claim 50, further comprising means for accessing a database of direct inward dial records each associating at least one direct inward dial number with at least one subscriber to said communication system.

58. (Original) The apparatus of claim 57, wherein said public network classification criteria include:

- a) said callee identifier begins with the same digit pattern as an international dialing digit (IDD) attribute of said callee identifier; and
- b) a reformatted callee identifier produced by removing the IDD attribute from said callee identifier has no DID record.

59. (Original) The apparatus of claim 57, wherein said public network classification criteria include:

- a) said callee identifier begins with the same digit pattern as a national dialing digit (NDD) attribute of said callee identifier; and
- b) a reformatted callee identifier produced by removing the NDD attribute from said callee identifier and including a caller country code has no DID record.

60. (Original) The apparatus of claim 57, wherein said public network classification criteria include:

- a) said callee identifier begins with the same area code as an area code of said caller; and

Application No.: 13/966,096
Filing Date: August 13, 2013

b) a reformatted callee identifier produced by reformatting the callee identifier to include a caller country code has no DID record.

61. (Original) The apparatus of claim 57, wherein said public network classification criteria include:

a) said callee identifier has a length that is within a range of caller local number lengths; and

b) a reformatted callee identifier produced by reformatting the callee identifier to include a caller country code and area code has no DID record.

62. (Original) The apparatus of claim 50, wherein said plurality of calling attributes includes at least one of an international dialing digits identifier, a national dialing digits identifier, a country code identifier, a local area codes identifier, a caller minimum local length identifier, a caller maximum local length identifier, a reseller identifier, and a maximum number of concurrent calls identifier.

63. (Original) The apparatus of claim 57, wherein said DID record comprises a user name field, a user domain field and a DID number field.

64. (Original) The apparatus of claim 50, further comprising means for accessing a list of public network route suppliers when said public network classification criterion is met and means for identifying at least one of said public network route suppliers that satisfies public network routing selection criteria.

65. (Original) The apparatus of claim 64, wherein said means for producing said public network routing message comprises means for producing a public network routing message identifying said at least one public network route supplier that satisfies said public network routing selection criteria.

66. (Original) The apparatus of claim 65, wherein said means for producing said public network routing message comprises means for causing said public network routing

Application No.: 13/966,096
Filing Date: August 13, 2013

message to include a gateway supplier identifier identifying a gateway supplier able to establish a communications link in a route through which communications between the caller and callee can be conducted.

67. (Original) The apparatus of claim **66**, further comprising means for causing said public network routing message to include a time value and a timeout value.

68. (Original) The apparatus of claim **66**, wherein said means for causing said public network routing message to include said gateway supplier identifier comprises means for causing said public network routing message to include a plurality of gateway supplier identifiers identifying a plurality of gateway suppliers able to supply respective communication links through which communications between the caller and callee can be conducted.

69. (Original) The apparatus of claim **68**, further comprising means for causing said public network routing message to include priority information identifying a priority in which gateway suppliers associated with said gateway identifiers are to be considered for selection of a communication link through which communications between the caller and callee can be conducted.

70. (Original) The apparatus of claim **68**, wherein said means for causing said public network routing message to include priority information includes means for arranging said gateway supplier identifiers in said public network routing message in order of rate, where rate is determined from rate fields of respective said gateway supplier records.

71. (Original) The apparatus of claim **70**, wherein said means for arranging said gateway supplier identifiers in order of rate comprises means for arranging said gateway supplier identifiers in order of increasing rate.

72. (Original) The apparatus of claim **66**, further comprising means for arranging said gateway supplier identifiers in an order based on at least one provision in a service agreement.

73. (Original) The apparatus of claim 50, further comprising means for causing the private network routing message or the public network routing message to be communicated to a call controller to effect routing of the call.

74. (Canceled).

75. (Canceled).

76. (Canceled).

77. (Canceled).

78. (Canceled).

79. (Previously Presented) A method of routing communications in a packet switched network in which a first participant identifier is associated with a first participant and a second participant identifier is associated with a second participant in a communication, the method comprising:

after the first participant has accessed the packet switched network to initiate the communication, using the first participant identifier to locate a first participant profile comprising a plurality of attributes associated with the first participant;

when at least one of the first participant attributes and at least a portion of the second participant identifier meet a first network classification criterion, producing a first network routing message for receipt by a controller, the first network routing message identifying an address in a first portion of the packet switched network, the address being associated with the second participant, the first portion being controlled by an entity; and

when at least one of the first participant attributes and at least a portion of the second participant identifier meet a second network classification criterion, producing a second network routing message for receipt by the controller, the second network routing

Application No.: 13/966,096
Filing Date: August 13, 2013

message identifying an address in a second portion of the packet switched network, the second portion not controlled by the entity.

80. (Previously Presented) The method of Claim 79, wherein the packet switched network comprises the Internet.

81. (Previously Presented) The method of Claim 79, wherein the first participant identifier comprises a first participant telephone number or username.

82. (Previously Presented) The method of Claim 79, wherein the second participant identifier comprises a second participant telephone number or username.

83. (Previously Presented) The method of Claim 79, wherein the communication comprises a voice-over-IP communication.

84. (Previously Presented) The method of Claim 79, wherein the packet switched network is accessed via an Internet service provider.

85. (Previously Presented) The method of Claim 79, wherein the first participant profile further comprises a username and a domain associated with first participant.

86. (Previously Presented) The method of Claim 79, wherein the attributes comprise at least one of an international dialing digit (IDD), a national dialing digit (NDD), an area code, a country code and a number length range.

87. (Previously Presented) The method of Claim 79, wherein the first classification criterion is satisfied when the first participant identifier does not begin with the same international dialing digit (IDD) digit pattern as the second participant identifier.

88. (Previously Presented) The method of Claim 79, wherein the first classification criterion is satisfied when an address associated with the first participant and the address

associated with the second participant are both in the first portion of the packet switched network.

89. (Previously Presented) The method of Claim 79, wherein the address in the first portion is accessible through the first participant's Internet service provider.

90. (Previously Presented) The method of Claim 79, wherein the first portion comprises one or more supernodes.

91. (Previously Presented) The method of Claim 79, further comprising storing in a database a direct inward dial (DID) record associated with at least one of the first participant and the second participant.

92. (Previously Presented) The method of Claim 91, wherein the stored DID record for the second participant comprises a username, a user domain and a record number.

93. (Previously Presented) The method of Claim 79, wherein the entity is an entity supplying communication services for the first portion.

94. (Previously Presented) The method of Claim 79, wherein the second network classification criterion is satisfied when access to the second participant requires routing through a portion of the packet switched network operated by a communication service supplier.

95. (Previously Presented) The method of Claim 91, wherein the second network classification criterion is satisfied when the second participant identifier is not associated with a stored DID record in the database.

96. (Previously Presented) The method of Claim 91, wherein the second network classification criterion is satisfied when:

the second participant identifier begins with the same international dialing digit (IDD) digit pattern as the first participant identifier; and

the second participant identifier, without considering the IDD digit pattern, has no stored DID record in the database.

97. (Previously Presented) The method of Claim 79, wherein the address in the second portion of the packet switched network comprises an address accessed by a communication service supplier.

98. (Previously Presented) The method of Claim 79, wherein producing the second network routing message identifying the address in the second portion comprises searching a database of route records associating route identifiers with dialing codes, in an attempt to find a route record having a dialing code with a number pattern matching at least a portion of second participant identifier.

99. (Previously Presented) A system for routing communications in a packet switched network in which a first participant in a communication has an associated first participant identifier and a second participant in the communication has an associated second participant identifier, the system comprising:

a controller comprising:

a processor operably configured to access a memory,

wherein the processor is configured to:

after the first participant has accessed the packet switched network to initiate the communication, locate a first participant profile in the memory using the first participant identifier, the first participant profile comprising a plurality of attributes associated with the first participant;

produce a first network routing message when at least one of the first participant attributes and at least a portion of the second participant identifier meet a first network classification criterion, the first network routing message identifying an address in a first portion of the packet switched network, the address being associated with the second participant, the first portion being controlled by an entity; and

produce a second network routing message when at least one of the first participant attributes and at least a portion of the second participant identifier meet a second network classification criterion, the second network routing message

identifying an address in a second portion of the packet switched network, the second portion not controlled by the entity.

100. (Previously Presented) The system of Claim 99, wherein the communication comprises a voice-over-IP communication.

101. (Previously Presented) The system of Claim 99, wherein the packet switched network is accessed via an Internet service provider.

102. (Previously Presented) The system of Claim 99, wherein the first classification criterion is satisfied when the first participant identifier does not begin with the same international dialing digit (IDD) digit pattern as the second participant identifier.

103. (Previously Presented) The system of Claim 99, wherein the second network classification criterion is satisfied when access to the second participant requires routing through a portion of the packet switched network operated by a communication service supplier.

104. (Previously Presented) A non-transitory computer readable medium comprising instructions that when executed cause a processor to perform a method of routing communications in a packet switched network in which a first participant identifier is associated with a first participant and a second participant identifier is associated with a second participant in a communication, the method comprising:

after the first participant has accessed the packet switched network to initiate the communication, using the first participant identifier to locate a first participant profile comprising a plurality of attributes associated with the first participant;

when at least one of the first participant attributes and at least a portion of the second participant identifier meet a first network classification criterion, producing a first network routing message for receipt by a controller, the first network routing message identifying an address in a first portion of the packet switched network, the address being associated with the second participant, the first portion being controlled by an entity; and

Application No.: 13/966,096
Filing Date: August 13, 2013

when at least one of the first participant attributes and at least a portion of the second participant identifier meet a second network classification criterion, producing a second network routing message for receipt by the controller, the second network routing message identifying an address in a second portion of the packet switched network, the second portion not controlled by the entity.

Application No.: 13/966,096
Filing Date: August 13, 2013

REMARKS

In the Office Action, the Examiner rejected Claims 1-73 and 79-104. Applicant respectfully requests reconsideration of the rejections in light of the amendments and the following remarks. Claims 1-73 and 79-104 are pending.

Discussion of Double Patenting Rejection

The Examiner has provisionally rejected Claims 1-73 and 79-104 on the ground of non-statutory double patenting as being unpatentable over Claims 1-111 of U.S. Patent No. 8,542,815. *Office Action*, p. 3. If appropriate, Applicant will further address the rejection when the claims are otherwise in condition for allowance.

Discussion of Claim Rejections Under 35 U.S.C. § 103(a)

The Examiner has rejected Claims 1, 13, 15-17, 19-26, 38, 40-42, 44-50, 62, 64-66, 68-73, and 79-104 as being unpatentable over Alexander et al. (U.S. Patent No. 6,798,767). Applicant respectfully submits that all pending claims are patentable over the prior art of record as discussed below.

Standard of *Prima facie* Obviousness

The Patent and Trademark Office has the burden under section 103 to establish a *prima facie* case of obviousness. The rationale to support a conclusion that the claim would have been obvious is that **all the claimed elements** were known in the prior art and one skilled in the art could have combined the elements as claimed by known methods with no change in their respective functions, and the combination yielded nothing more than predictable results to one of ordinary skill in the art. It can be important to identify **a reason that would have prompted a person of ordinary skill in the relevant field to combine the elements** in the way the claimed new invention does. If any of these findings cannot be made, then this rationale cannot be used to support a conclusion that the claim would have been obvious to one of ordinary skill in the art. M.P.E.P. § 2143; *see also KSR v. Teleflex*, 82 U.S.P.Q.2d 1385 (2007); *In re Royka*, 180 U.S.P.Q. 580 (1974).

Application No.: 13/966,096
Filing Date: August 13, 2013

Additionally, MPEP § 2143 states that “[t]he key to supporting any rejection under 35 U.S.C. 103 is the **clear articulation** of the reason(s) why the claimed invention would have been obvious. *Id.* The Supreme Court in *KSR* noted that the analysis supporting a rejection under 35 U.S.C. 103 should be **made explicit**” (emphasis added). See *KSR v. Teleflex*, 550 US 398 (2007).

Discussion of Patentability of Pending Claims

Applicant’s independent Claim 1 recites:

using a caller identifier associated with the caller to locate a caller dialing profile comprising a plurality of calling attributes associated with the caller;

Alexander generally relates to a “system and method for generating multiple line appearances in a communication network.” *Alexander*, col. 1, ll. 7-10. The Examiner states that a call manager of Alexander “obviously stores attributes of IP phone 22, including user's or caller's name, telephone number and IP address, etc.” *Office Action*, p. 4. The Examiner also references that figures 1-3 and column 5, line 52 - column 7, line 45 disclose the above feature. The Examiner appears to suggest that the call manager 26 illustrated in FIG. 2 of Alexander uses a caller identifier “to locate a caller dialing profile comprising a plurality of calling attributes associated with the caller” as recited in Claim 1. Applicant respectfully submits that neither the call manager 26 nor any other part of the Alexander system uses a caller identifier to locate a caller dialing profile comprising a plurality of calling attributes.

For example, Alexander discloses that when a call is initiated, and “once call manager 26a receives the call initiation request, call manager 26a sends a signal to the target IP telephony device offering the call to the telephony device.” *Alexander*, col. 6, ll. 28-31. Nowhere does Alexander disclose that the call initiation request comprises a caller identifier much less is used to locate a caller dialing profile comprising a plurality of calling attributes. Indeed, FIG. 5A of Alexander discloses that the call manager receives a call initiation request and “determines the telephone number of the target telephony device from the call initiation request and determines an associated IP address 124 of the target telephony device using mapping tables 120a and 120b.” *Id.* at col. 10, ll. 37-42. Alexander is completely silent as to performing any functions

Application No.: 13/966,096
Filing Date: August 13, 2013

related to the caller or caller dialing profile and only locates a callee telephone number. Therefore the telephone number of the target telephony device that is located by Alexander is not a dialing profile associated with the caller as in Applicant's claimed invention. Alexander makes no mention of locating any information associated with the caller and provides no suggestion or motivation to do so. Furthermore, while the entries in the database tables of Alexander include callee phone number, device/group name and IP address, none of these entries can be regarded by one skilled in the art as a "calling attribute associated with the caller." *See id.* at FIGs. 1-4B, col. 8, l. 47-col. 9, l. 15. Therefore, it is respectfully submitted that Alexander fails to disclose *using a caller identifier associated with the caller to locate a caller dialing profile comprising a plurality of calling attributes associated with the caller*, as claimed by Applicant.

Additionally, the Examiner provides no explicit citation (e.g., pinpoint cite) to Alexander as disclosing "using a caller identifier associated with the caller to locate a caller dialing profile." *See Office Action*, p. 4. Instead, the Examiner makes a conclusory statement that the call manager of Alexander "obviously stores attributes of IP phone 22, including user's or caller's name, telephone number and IP address, etc." *Office Action*, p. 4. The Examiner is reminded that "whenever, on examination, any claim for a patent is rejected, or any objection ... made, notification of the reasons for rejection and/or objection together with such information and references as may be useful in judging the propriety of continuing the prosecution (35 U.S.C. 132) should be given." *M.P.E.P.* § 707. Additionally, MPEP § 2143, citing *KSR*, states that "[t]he key to supporting any rejection under 35 U.S.C. 103 is the **clear articulation** of the reason(s) why the claimed invention would have been obvious. The Supreme Court in *KSR* noted that the analysis supporting a rejection under 35 U.S.C. 103 should be **made explicit**" (emphasis added, see also *KSR*, 550 US at 408-410).

Applicant respectfully submits that the Examiner's conclusory statement, without citing to specific portion(s) of Alexander, amounts to depriving Applicant of the opportunity to respond completely and with particularity as to why the claims are patentable. Thus, if the Examiner wishes to sustain the rejection of Claim 1 based on the Alexander, the Examiner is respectfully requested to "clearly articulate any rejection early in the prosecution process so the applicant has the opportunity to provide evidence of patentability and otherwise respond completely at the earliest opportunity." *See M.P.E.P.* § 706. More particularly, the Examiner is respectfully

Application No.: 13/966,096
Filing Date: August 13, 2013

requested to provide the Applicant with specific citations to passages of Alexander and to explain where and how Alexander teaches that the call manager “obviously stores attributes of IP phone 22, including user's or caller's name, telephone number and IP address, etc.” *See Office Action*, p. 4.

Instead of making an explicit citation to the reference, it appears that the Examiner is making an inherency argument that the call manager of Alexander “obviously stores attributes of IP phone 22, including user's or caller's name, telephone number and IP address, etc.” *Id.* at p. 4. “The inherent teaching of a prior art reference, a question of fact, arises both in the context of anticipation and obviousness.” *In re Napier*, 55 F.3d 610, 613 (Fed. Cir. 1995). However, the Examiner must provide rationale or evidence tending to show inherency. *See* MPEP 2112.IV. The fact that a certain result or characteristic may occur or be present in the prior art is not sufficient to establish the inherency of that result or characteristic. *In re Rijckaert*, 9 F.3d 1531, 1534 (Fed. Cir. 1993) (reversed rejection because inherency was based on what would result due to optimization of conditions, not what was necessarily present in the prior art). “To establish inherency, the extrinsic evidence ‘must make clear that the missing descriptive matter is necessarily present in the thing described in the reference, and that it would be so recognized by persons of ordinary skill.’” *In re Robertson*, 169 F.3d 743, 745 (Fed. Cir. 1999). “In relying upon the theory of inherency, the examiner must provide a basis in fact and/or technical reasoning to reasonably support the determination that the allegedly inherent characteristic necessarily flows from the teachings of the applied prior art.” *Ex parte Levy*, 17 USPQ2d 1461, 1464 (Bd. Pat. App. & Inter. 1990). Additionally, “[o]bviousness cannot be predicated on what is not known at the time an invention is made, even if the inherency of a certain feature is later established.” M.P.E.P. § 2141.02 at ¶ V (*citing In re Rijckaert*, 9 F.2d 1531). Therefore, when used in an obviousness rejection, any reliance on what is inherent must be supported by what was known at the time of the invention.

Applicant respectfully submits that the Examiner has made no finding or referred to any evidence that a person of ordinary skill in the art (POSITA) would have recognized that the call manager of Alexander inherently “stores attributes of IP phone 22” at the time of the invention. The Examiner has not shown that the call manager necessarily stores such attributes and instead makes the conclusory statement that the call manager “obviously stores attributes of IP phone 22,

Application No.: 13/966,096
Filing Date: August 13, 2013

including user's or caller's name, telephone number and IP address, etc.” Indeed, Alexander’s disclosure with respect to routing implies that storing attributes of the caller is not necessary because the call manager “sends a signal to the target IP telephony device offering the call to the telephony device” based on the call manager locating the callee IP address or gateway and not based on any calling attribute associated with the caller. *See Alexander*, FIG. 5A, col. 6, ll. 28-55. For the sake of argument, even if the call manager did store “attributes of IP phone 22,” Alexander does not disclose that the call manager uses “a caller identifier associated with the caller to locate a caller dialing profile comprising” the attributes, as recited in Claim 1. Therefore, Applicant respectfully submits that the Examiner has not met the burden of presenting a *prima facie* ground to support an obviousness rejection based on his apparent inherency assertion.

Claim 1 also recites:

when at least one of said calling attributes and at least a portion of a callee identifier associated with the callee meet private network classification criteria, producing a private network routing message for receipt by a call controller, said private network routing message identifying an address, on the private network, associated with the callee;

The Examiner takes the position that “when phone 22 calls phone 23, both are identified, by either phone number or IP address, as IP phones within the same LAN 20a” corresponds to Claim 1’s feature of “when at least one of said calling attributes and at least a portion of a callee identifier associated with the callee meet private network classification criteria.” *See Office Action*, p. 4. Here, the Examiner does not reference a specific passage of Alexander that discloses this feature. Again, Applicant notes that “whenever, on examination, any claim for a patent is rejected, or any objection ... made, notification of the reasons for rejection and/or objection together with such information and references as may be useful in judging the propriety of continuing the prosecution (35 U.S.C. 132) should be given.” *M.P.E.P.* § 707. As discussed above, when attempting to route a call, Alexander locates a database table entry associated with the callee, not the caller and neither describes nor suggests anything like a calling attribute of the

Application No.: 13/966,096
Filing Date: August 13, 2013

type recited in Applicant's claims. For the sake of argument, even if it could be shown that a field of any of the entries in Alexander's database table (120) could be interpreted to be a calling attribute, such attribute would be associated with the callee and not the caller. Moreover, there is no disclosure in Alexander of determining "when at least one of said calling attributes and at least a portion of a callee identifier associated with the callee meet private network classification criteria" and producing the private network routing message when such criteria is met. Instead, Alexander only describes a call manager that performs a table lookup to determine the IP address of the target telephony device and "directs the call to the target telephony device by signaling the target telephony device." *Alexander*, col. 10, ll. 37-45, FIG. 5A. The call manager in Alexander does not make a determination of whether "at least one of said calling attributes and ... meet private network classification criteria."

Additionally, the Examiner correctly observed that "Alexander does not explicitly discloses [sic] a routing message." *Office Action*, p. 4. However, the Examiner suggests that the call manager "obviously producing a private network routing message for receipt by a call controller (a call router in LAN 20a; figure 5A, steps 204-208)." *Id.* Applicant respectfully submits that none of the passages cited by the Examiner, or any other disclosure in Alexander, discloses or suggests the production of a private network routing message. Applicant respectfully submits that routing provides the path selection in a network, based on different criteria. Routing does not transfer useful payload (e.g., voice, video, data), as forwarding does, but routing tells how/which way to forward packets with payload. Applicant directs the Examiner to column 6, lines 28-31 of Alexander which states, in reference to whether the originating telephony device is an IP telephony device or a non-IP telephony device: "In either case, once call manager 26a receives the call initiation request, call manager 26a sends a signal to the target IP telephony device offering the call to the telephony device." Furthermore, column 10, lines 37-45 describe steps 204-208 of FIG. 5A and disclose that "Call manager 26 directs the call to the target telephony device by signaling the target telephony device to indicate the presence of the incoming call at step 206." *See also*, Alexander at FIG. 5A. There is nothing to suggest that this signal or signaling is a routing message in the sense one skilled in the art would understand this term, and it seems quite clear that the call manager sends a signal directly to the target IP telephony device to try to set up the call. When describing calls between devices in different

Application No.: 13/966,096
Filing Date: August 13, 2013

LANs, Alexander discloses that “a router (or other similar device) directs the [data] packets to the IP address of the target IP telephony device 25.” See *Alexander*, col. 6, ll. 1-17. However, as clearly stated in Alexander, the router only forwards data packets, **not routing messages**, to the address of the target IP telephony device. Contrast this with the Applicant’s Claim 1 which recites that the private network routing message is produced and provides path selection (i.e., “an address, on the private network, associated with the callee”) based on certain criteria (i.e., private network classification criteria).

Indeed, in the Private Branch Exchange (PBX) system of Alexander, once an IP address is known to an IP telephony device, it may directly initiate a connection on its own to another LAN/WAN connected IP telephony device without the need for routing messages to direct the call to the other IP telephony device. Contrast this with Applicant’s Claim 1 which recites that the private network routing message is for receipt by a call controller. Simply put, a person of ordinary skill in the art (POSITA) would recognize that the target IP telephony device of Alexander is not a call controller. The Examiner takes the position that the call manager is “obviously producing a private network routing message for receipt by a call controller (a call router in LAN 20a; figure 5A, steps 204-208).” Applicant respectfully submits it is unclear whether the Examiner is stating a call router in LAN 20a is a call controller or whether the Examiner meant to say a “call manager” in LAN 20a is a call controller. If the Examiner believes that there exists a call router in LAN 20a that is the call controller, then Applicant respectfully refers the Examiner again to column 6, lines 1-17, which contain the only mention of a “router” in Alexander. As discussed above, this router only receives and forwards **data packets** and not a **private network routing message** as recited in Claim 1. Thus, the router does not correlate to the call controller recited in Claim 1.

If the Examiner meant to write “call manager” instead of “call router,” Applicant respectfully submits call manager 26a in LAN 20a is not a call controller because that would mean that the call manager both produces and receives a private network routing message. There is no disclosure in Alexander that the call manager sends a private network routing message to itself. Therefore, Alexander’s “call manager” does not and cannot correlate to the call controller recited in Claim 1.

Application No.: 13/966,096
Filing Date: August 13, 2013

Thus, while Alexander may disclose that the call manager “controls call processing, routing, telephone features and options, device configuration and other telephony functions and parameters” and that the call manager may route calls in the sense that it decides which device to send a call signal to, however, as discussed above, there is nothing in Alexander that discloses or suggests producing a routing message at all, let alone producing a private network routing message and sending it to a call controller “when at least one of said calling attributes and at least a portion of a callee identifier associated with the callee meet private network classification criteria.”

Similarly, since Alexander does not disclose a private network routing message, *a fortiori*, Alexander also does not disclose that a private network routing message identifies “an address, on the private network, associated with the callee.” Therefore, it is respectfully submitted that Alexander fails to recite *when at least one of said calling attributes and at least a portion of a callee identifier associated with the callee meet private network classification criteria, producing a private network routing message for receipt by a call controller, said private network routing message identifying an address, on the private network, associated with the callee*, as recited in Claim 1.

Since the Examiner correctly observed that “Alexander does not explicitly discloses [sic] a routing message,” the Examiner appears to be making another inherency argument that the call manager of Alexander is “obviously producing a private network routing message for receipt by a call controller (a call router in LAN 20a; figure 5A, steps 204-208).” *Office Action*, p. 4. Applicant respectfully submits that the Examiner has made no finding or referred to any evidence that a POSITA would have recognized at the time of the invention that the call manager of Alexander inherently produces “a private network routing message for receipt by a call controller.” The Examiner has not shown that the call manager necessarily produces the private network routing message, while conceding that “Alexander does not explicitly discloses a routing message.” *See id.* For the sake of argument, even if the call manager did produce a “private network routing message” as suggested by Examiner, Alexander does not disclose a private network routing message being produced for receipt by a call controller. The Examiner merely makes a conclusory statement and implies that there must be an unidentified “call router in LAN 20a” that would receive the private network routing message, as recited in Claim 1. Additionally,

Application No.: 13/966,096
Filing Date: August 13, 2013

and again for the sake of argument, even if the call manager did produce a “private network routing message” as suggested by Examiner, Alexander does not disclose a private network routing message being produced “when at least one of said calling attributes and at least a portion of a callee identifier associated with the callee meet private network classification criteria” as recited in Claim 1. Therefore, Applicant respectfully submits that the Examiner has not met the burden of presenting a *prima facie* ground to support an obviousness rejection based on his apparent inherency assertion.

As discussed above, the Examiner concedes that “Alexander does not explicitly disclose [sic] a routing message” and instead relies on Moss et al. US 5,917,899, column 4, lines 59-61, and Buckley US 2007/0217354, paragraph [0020] as disclosing a routing message. *Office Action*, p. 4. The cited portion of Moss discloses a switching control point (SCP) that “sends an analyzed route message containing a routing instruction.” Moss, col. 4, ll. 59-63. However, there is no disclosure in Moss that this analyzed route message is produced “when at least one of said calling attributes and at least a portion of a callee identifier associated with the callee meet private network classification criteria” or that the analyzed route message is “for receipt by a call controller” as recited by Claim 1.

The cited portion of Buckley discloses that a voice call continuity (VCC) application server (AS) node “is operable to effectuate generation of appropriate routing messages when a call is originated by a UE device.” Buckley, [0020]. There is no disclosure in Buckley that these routing messages are produced “when at least one of said calling attributes and at least a portion of a callee identifier associated with the callee meet private network classification criteria” or that the routing messages are “for receipt by a call controller.” On the contrary, Buckley only mentions that routing messages are generated “when a call is originated by a UE device.”

Accordingly, neither Moss nor Buckley cure the deficiencies of Alexander discussed above with respect to producing a private network routing message for receipt by a call controller much less “when at least one of said calling attributes and at least a portion of a callee identifier associated with the callee meet private network classification criteria.”

Lastly, the Examiner’s statement that “it was well known in the art that a network control node produced a routing message to route a call through a network, see Moss et al. US 5,917,899, column 4, lines 59-61, also Buckley US 2007/0217354, paragraph [0020]”, has not

Application No.: 13/966,096
Filing Date: August 13, 2013

met the burden of presenting a *prima facie* ground to support an obviousness rejection based on such a limited assertion as to what the secondary references may disclose.

As discussed above, “it can be important to identify a reason that would have prompted a person of ordinary skill in the relevant field to combine the elements in the way the claimed new invention does” (emphasis added). *KSR*, 550 U.S. at 403. “Although the Supreme Court in *KSR* cautioned against an overly rigid application of [teaching, suggestion, or motivation] TSM, it also recognized that TSM was one of a number of valid rationales that could be used to determine obviousness.” M.P.E.P. § 2141; *see also KSR*, 550 U.S. at 418. Obviousness can be established by combining or modifying the teachings of the prior art to produce the claimed invention where there is some teaching, suggestion, or motivation to do so. *In re Kahn*, 441 F.3d 977, 986, 78 USPQ2d 1329, 1335 (Fed. Cir. 2006). However, a statement that modifications of the prior art to meet the claimed invention would have been “well within the ordinary skill of the art at the time the claimed invention was made” because the references relied upon teach that all aspects of the claimed invention were individually known in the art is not sufficient to establish a *prima facie* case of obviousness without some objective reason to combine the teachings of the references. See M.P.E.P. § 2143.01 (citing *Ex parte Levengood*, 28 USPQ2d 1300 (Bd. Pat. App. & Inter. 1993)). “[R]ejections on obviousness cannot be sustained by mere conclusory statements; instead, there must be some articulated reasoning with some rational underpinning to support the legal conclusion of obviousness.” *KSR*, 550 U.S. at 418, (quoting *In re Kahn*, 441 F.3d 977, 988, 78 USPQ2d 1329, 1336 (Fed. Cir. 2006)).

Here, the Examiner has not met the *KSR* burden of providing an articulated reason for combining the cited prior art references. Instead, the Examiner merely states that it was known that routing messages can be used to route calls through a network and has not provided any rationale how a POSITA would have combined the routing of Alexander, which does not contain a routing message, let alone a private network routing message produced “when at least one of said calling attributes and at least a portion of a callee identifier associated with the callee meet private network classification criteria”, with a generic routing message of Moss and/or Buckley to arrive at Applicant’s claimed invention. Therefore, Applicant respectfully submits that the Examiner has not met the burden of presenting a *prima facie* ground to support an obviousness rejection, and thus, it is improper and must be withdrawn.

Application No.: 13/966,096
Filing Date: August 13, 2013

Claim 1 further recites:

when at least one of said calling attributes and at least a portion of said callee identifier meet a public network classification criterion, producing a public network routing message for receipt by the call controller, said public network routing message identifying a gateway to the public network;

As similarly discussed above with respect to private network classification criteria, Applicant respectfully submits that there is no disclosure by Alexander to determine when at least one of said calling attributes and at least a portion of a callee identifier associated with the callee meet public network classification criteria. To the contrary, the call manager in Alexander simply looks up the callee number in the mapping table (120) to find the associated IP address and causes the call signal to be routed there. *See Alexander*, col. 10, ll. 37-41. Alexander fails to disclose or suggest any criteria that are used in conjunction with the comparison involving calling attributes of the caller, a portion of the callee identifier, and public network classification criterion, as recited in Claim 1 to classify a call. Rather, in Alexander, it appears that calls are merely routed to the gateway associated with the callee, when the callee is on a public network, where the gateway is identified by an entry associated with the callee in the database table (120). The Examiner has not presented any suggestion or motivation for a POSITA to modify Alexander to classify a call as a public network call “when at least one of said calling attributes and at least a portion of said callee identifier meet a public network classification criterion.”

Therefore, it is respectfully submitted that Alexander fails to disclose or suggest *when at least one of said calling attributes and at least a portion of said callee identifier meet a public network classification criterion, producing a public network routing message for receipt by the call controller, said public network routing message identifying a gateway to the public network*, as recited in Claim 1.

Applicant further wishes to draw the Examiner’s attention to the fact that Claim 1 recites two separate and distinct routing messages, a private network routing message and a public network routing message. As the Examiner concedes, “Alexander does not explicitly disclose [sic] a routing message,” let alone two different and distinct routing messages performing

Application No.: 13/966,096
Filing Date: August 13, 2013

different functions. *Office Action*, p. 4. For the sake of argument, even if the Examiner's conclusory statement that the call manager of Alexander is "obviously producing" routing messages, there is no mention of different types of routing messages that are produced when different classification criteria are met. Accordingly, Applicant further respectfully submits that Alexander fails to disclose all the features recited in Claim 1.

Additionally, Applicant's arguments above with respect to the Examiner's apparent position of inherency that the call manager "obviously" produces a private network routing message and with respect to the combination with Moss and/or Buckley also apply to producing the public network routing message. Thus, Applicant respectfully submits that the Examiner has not met the Office's burden of presenting a *prima facie* ground to support an obviousness rejection based on his apparent inherency assertion and his asserted combination, and thus, the rejection is improper and must be withdrawn.

Applicant has made the observation that the Examiner addressed independent Claims 1, 26 and 50 together in the Office Action. *Office Action*, p. 4. Thus, Applicant respectfully submits that independent Claims 26 and 50 recite at least similar patentable features to those specified in Claim 1 and are also patentable over Alexander for similar reasons as discussed above with respect to Claim 1.

Applicant has made the observation that the Examiner addressed independent Claims 79, 99, and 104 together in the Office Action. *Office Action*, p. 6. In rejecting Claims 79, 99, and 104, the Examiner stated that "Alexander teaches a packet switching network LAN 20 (column 4, line 63 - column 5, line 5; column 6, lines 1-8), and the rest limitations as in claim 1." *Id.* For the sake of argument, even if Alexander indicates the existence of a packet switching network, as discussed above, Alexander does not disclose the limitations of Claim 1. Accordingly, Claims 79, 99, and 104 are similarly patentable over Alexander because they recite at least similar patentable limitations to those specified in Claim 1. Applicant respectfully requests withdrawal of the rejections for independent Claims 1, 26, 50, 79, 99 and 104.

The Examiner has rejected Claims 2-7, 27-32 and 51-56 under pre-AIA 35 U.S.C. 103(a) as being unpatentable over Alexander in view of Stucker (U.S. Patent No. 7,010,727). *Office Action* at p. 8. Applicant respectfully submits that Stucker fails to cure the deficiencies of Alexander identified above. Furthermore, Claims 2-7, 27-32 and 51-56 depend directly or

Application No.: 13/966,096
Filing Date: August 13, 2013

indirectly on one of independent Claims 1, 26 or 50 and are patentable over the combination of Alexander and Stucker at least by virtue of their dependency.

The Examiner rejected Claims 8-12, 14, 33-37, 39, 57-61 and 63 under 35 U.S.C. § 103(a) as being unpatentable over Alexander in view of Tada et al. (U.S. Patent No. 6,597,783). *Office Action* at p. 10. Applicant respectfully submits that Tada fails to cure the deficiencies of Alexander identified above. Furthermore, Claims 8-12, 14, 33-37, 39, 57-61 and 63 depend directly or indirectly on one of independent Claims 1, 26 or 50 and are patentable over the combination of Alexander and Tada at least by virtue of their dependency.

The Examiner rejected Claims 18, 43, and 67 under 35 U.S.C. § 103(a) as allegedly being unpatentable over Alexander in view of Han (U.S. Patent No. 6,873,599). *Office Action* at p. 11. Applicant respectfully submits that Han fails to cure the deficiencies of Alexander identified above. Furthermore, Claims 18, 43, and 67 depend directly or indirectly on one of independent Claims 1, 26 or 50 and are patentable over the combination of Alexander and Han at least by virtue of their dependency.

Discussion of Dependent Claims

Although Applicant has not addressed all the issues of the dependent claims, Applicant respectfully submits that Applicant does not necessarily agree with the characterization and assessments of the dependent claims made by the Examiner, and Applicant believes that each claim is patentable on its own merits. The dependent claims are dependent either directly or indirectly on the above-discussed independent claims. Applicant respectfully submits that pursuant to 35 U.S.C. § 112, ¶ 4, the dependent claims incorporate by reference all the features of the claim to which they refer and include their own patentable features, and are therefore in condition for allowance. Therefore, Applicant respectfully requests the withdrawal of all claim rejections and prompt allowance of the claims.

Official Notice

Applicant wishes to place on the record that official notice unsupported by documentary evidence should only be taken by the examiner where the facts asserted to be well-known, or to be common knowledge in the art are capable of **instant and unquestionable demonstration** as

Application No.: 13/966,096
Filing Date: August 13, 2013

being well-known. As noted by the court in *In re Ahlert*, 424 F.2d 1088, 1091, 165 USPQ 418, 420 (CCPA 1970), the notice of **facts** beyond the record which may be taken by the examiner **must be “capable of such instant and unquestionable demonstration as to defy dispute”** (citing *In re Knapp Monarch Co.*, 296 F.2d 230, 132 USPQ 6 (CCPA 1961)). MPEP § 2144.03 (emphasis added).

Regarding Claims 84 and 101, the Examiner took “official notice that it was well known and obvious for computer 44 and IP phone 44 to access Internet 40 via an Internet service provider.” *Office Action*, p. 6. Applicant respectfully submits that the Official Notice is improper and respectfully requests that, if the rejection is to be maintained, the factual assertions made by the Examiner be supported by adequate evidence per MPEP § 2144.03(C).

Regarding Claim 85, the Examiner took “official notice that it was well known and obvious that an IP phone is associated with a user name and domain name.” *Office Action*, p. 7. Applicant respectfully submits that the Official Notice is improper and respectfully requests that, if the rejection is to be maintained, the factual assertions made by the Examiner be supported by adequate evidence per MPEP § 2144.03(C).

Regarding Claims 4-7, 29-32 and 53-56, the Examiner took “official notice that it was well known and obvious that a telephone subscriber was able to set up a call profile for managing his incoming calls.” *Office Action*, p. 9. Applicant respectfully submits that the Official Notice is improper and respectfully requests that, if the rejection is to be maintained, the factual assertions made by the Examiner be supported by adequate evidence per MPEP § 2144.03(C).

Regarding Claims 9, 34 and 58, the Examiner took “official notice that it would be obvious that an international call (which would be terminated outside LAN 20a) initiated by IP phone 22 would be routed through a public network (i.e. Internet or 40 of PSTN 60, see figure 1).” *Office Action*, p. 10. Applicant respectfully submits that the Official Notice is improper and respectfully requests that, if the rejection is to be maintained, the factual assertions made by the Examiner be supported by adequate evidence per MPEP § 2144.03(C).

Regarding Claims 10, 35 and 59, the Examiner took “official notice that it would be obvious to route a call initiated by IP phone 22 with national digit (which would be terminated outside LAN 20a) would be routed through PSTN 60.” *Office Action*, p. 10. Applicant respectfully submits that the Official Notice is improper and respectfully requests that, if the

Application No.: 13/966,096
Filing Date: August 13, 2013

rejection is to be maintained, the factual assertions made by the Examiner be supported by adequate evidence per MPEP § 2144.03(C).

Regarding Claims 11, 36 and 60, the Examiner took “official notice that it would be obvious to route a call initiated by IP phone 22 with area code national digit (which would be terminated outside LAN 20a) would be routed through PSTN 60.” *Office Action*, p. 11. Applicant respectfully submits that the Official Notice is improper and respectfully requests that, if the rejection is to be maintained, the factual assertions made by the Examiner be supported by adequate evidence per MPEP § 2144.03(C).

Regarding Claims 12, 37 and 61, the Examiner took “official notice that it would be obvious that a callee's identification has a length within the range of a national dialing plan, e.g. a North America Dialing Plan, or NANP.” *Office Action*, p. 11. Applicant respectfully submits that the Official Notice is improper and respectfully requests that, if the rejection is to be maintained, the factual assertions made by the Examiner be supported by adequate evidence per MPEP § 2144.03(C).

Co-Pending Applications of Assignee

Applicant wishes to draw the Examiner's attention to the following co-pending applications assigned to Applicant's assignee.

Docket No.	Serial No.	Title	Filed
DIGIF.001C2 (formally known as SMARB19.001C2)	14/029671	Determining a Time to Permit a Communications Session to be Conducted	09/17/13
DIGIF.001C4 (formally known as SMARB19.001C4)	14/325181	Allocating Charges for Communications Services	07/07/14
DIGIF.002C1 (formally known as SMARB19.002C1)	13/863306	Intercepting Voice Over IP Communications and Other Data Communications	04/15/13
DIGIF.003C1 (formally known as SMARB19.003C1)	13/968217	Emergency Assistance Calling for Voice Over IP Communications Systems	08/15/13
DIGIF.004C1 (formally known as SMARB19.004C1)	14/035806	Mobile Gateway	09/24/13

Application No.: 13/966,096
Filing Date: August 13, 2013

DIGIF.005C1 (formally known as SMARB19.005C1)	14/092831	Uninterrupted Transmission of Internet Protocol Transmissions During Endpoint Changes	11/27/13
---	-----------	---	----------

Conclusion

Although the present communication may include alterations to the application or claims, or characterizations of claim scope or referenced art, Applicant is not conceding in this application that previously pending claims are not patentable over the cited references. Rather, any alterations or characterizations are being made to facilitate expeditious prosecution of this application. Applicant reserves the right to pursue at a later date any previously pending or other broader or narrower claims that capture any subject matter supported by the present disclosure, including subject matter found to be specifically disclaimed herein or by any prior prosecution. Accordingly, reviewers of this or any parent, child or related prosecution history shall not reasonably infer that Applicant has made any disclaimers or disavowals of any subject matter supported by the present application.

Applicant has endeavored to address all of the Examiner's concerns as expressed in the outstanding Office Action. In light of the above remarks, reconsideration and withdrawal of the outstanding rejections is respectfully requested. If the Examiner has any questions which may be answered by telephone, the Examiner is invited to call the undersigned directly.

Any remarks in support of patentability of one claim should not be imputed to any other claim in this or a related application, even if similar terminology is used. Any remarks referring to only a portion of a claim should not be understood to base patentability on solely that portion; rather, patentability must rest on each claim taken as a whole.

Application No.: 13/966,096
Filing Date: August 13, 2013

Please charge any additional fees, including any fees for additional extension of time, or credit overpayment to Deposit Account No. 11-1410.

Respectfully submitted,

KNOBBE, MARTENS, OLSON & BEAR, LLP

Dated: 5/14/15

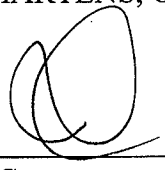
By:  _____

John M. Carson
Registration No. 34,303
Attorney of Record
Customer No. 20995
(858) 707-4000

20441102
041415

INFORMATION DISCLOSURE STATEMENT

Inventor	:	Clay Perreault, et al.
App. No.	:	13/966,096
Filed	:	August 13, 2013
For	:	PRODUCING ROUTING MESSAGES FOR VOICE OVER IP COMMUNICATIONS
Examiner	:	Sing, Simon P.
Art Unit	:	2653
Conf. No.	:	8712

Mail Stop Amendment
Commissioner for Patents
P.O. Box 1450
Alexandria, VA 22313-1450

References and Listing

Pursuant to 37 CFR 1.56, an Information Disclosure Statement listing references is provided herewith. Copies of any listed foreign and non-patent literature references are being submitted.

No Disclaimers

To the extent that anything in the Information Disclosure Statement or the listed references could be construed as a disclaimer of any subject matter supported by the present application, Applicant hereby rescinds and retracts such disclaimer.

Timing of Disclosure

This Information Disclosure Statement is being filed after receipt of a First Office Action, but before the mailing date of a Final Action and before the mailing date of a Notice of Allowance. This Statement is accompanied by the fees set forth in 37 CFR.1.17(p). The

Application No.: 13/966,096
Filing Date: August 13, 2013

Commissioner is hereby authorized to charge any additional fees which may be required or to credit any overpayment to Account No. 11-1410.

Respectfully submitted,
KNOBBE, MARTENS, OLSON & BEAR, LLP

Dated: 5/14/15

By: _____
John M. Carson
Registration No. 34,303
Attorney of Record
Customer No. 20995
(858) 707-4000

IDS
20683524
051415

INFORMATION DISCLOSURE STATEMENT BY APPLICANT	Application No.	13/966,096
	Filing Date	August 13, 2013
	First Named Inventor	Perreault, Clay
	Art Unit	2653
<i>(Multiple sheets used when necessary)</i>	Examiner	Sing, Simon P.
SHEET 1 OF 5	Attorney Docket No.	DIGIF.001C1

U.S. PATENT DOCUMENTS					
Examiner Initials	Cite No.	Document Number <i>Number - Kind Code (if known)</i> Example: 1,234,567 B1	Publication Date MM-DD-YYYY	Name	Pages, Columns, Lines Where Relevant Passages or Relevant Figures Appear
	1	7,958,233 B2	06-07-2011	Gutierrez, Alvaro Fernández	
	2	8,078,164 B2	12-13-2011	Ganesan, Vasudevan	
	3	8,127,005 B2	02-28-2012	Gutierrez, Alvaro Fernández	
	4	8,166,547 B2	04-24-2012	Bevan et al.	
	5	8,190,739 B2	05-29-2012	Gutierrez, Alvaro Fernández	
	6	8,223,927 B2	07-17-2012	Di Serio et al.	
	7	8,300,632 B2	10-30-2012	Davis et al.	
	8	8,315,521 B2	11-20-2012	Leiden et al.	
	9	8,396,445 B2	03-12-2013	Crawford et al.	
	10	8,526,306 B2	09-03-2013	Jungck et al.	
	11	8,542,815 B2	09-24-2013	Perreault et al.	
	12	8,599,747 B1	12-03-2013	Saleem et al.	
	13	8,599,837 B2	12-03-2013	Kyle, Andre B.	
	14	8,634,838 B2	01-21-2014	Hellwig et al.	
	15	8,774,378 B2	07-08-2014	Björzell et al.	
	16	8,819,566 B2	08-26-2014	Mehin et al.	
	17	8,848,887 B2	09-30-2014	Willman et al.	
	18	8,862,701 B2	10-14-2014	Havriluk, George	
	19	8,885,609 B2	11-11-2014	Nix, John A.	
	20	8,903,051 B2	12-02-2014	Li et al.	
	21	8,903,360 B2	12-02-2014	Celi, Jr. et al.	
	22	8,909,556 B2	12-09-2014	Huxham, Horatio Nelson	
	23	8,938,209 B2	01-20-2015	Crawford et al.	
	24	8,938,534 B2	01-20-2015	Le et al.	
	25	8,948,061 B2	02-03-2015	Sridhar, Sriram	
	26	8,972,612 B2	03-03-2015	Le et al.	
	27	8,982,719 B2	03-17-2015	Seetharaman et al.	
	28	8,995,428 B2	03-31-2015	Haster, Lars-Olof	

Examiner Signature	Date Considered
*Examiner: Initial if reference considered, whether or not citation is in conformance with MPEP 609. Draw line through citation if not in conformance and not considered. Include copy of this form with next communication to applicant.	

T¹ - Place a check mark in this area when an English language Translation is attached AT&T, Exh. 1002, p. 355

INFORMATION DISCLOSURE STATEMENT BY APPLICANT	Application No.	13/966,096	
	Filing Date	August 13, 2013	
	First Named Inventor	Perreault, Clay	
	Art Unit	2653	
<i>(Multiple sheets used when necessary)</i>		Examiner	Sing, Simon P.
SHEET 2 OF 5		Attorney Docket No.	DIGIF.001C1

U.S. PATENT DOCUMENTS					
Examiner Initials	Cite No.	Document Number <i>Number - Kind Code (if known)</i> Example: 1,234,567 B1	Publication Date MM-DD-YYYY	Name	Pages, Columns, Lines Where Relevant Passages or Relevant Figures Appear
	29	9,003,306 B2	04-07-2015	Mehin et al.	
	30	2007/0053382 A1	03-08-2007	Bevan et al.	
	31	2009/0213839 A1	08-27-2009	Davis et al.	
	32	2010/0083364 A1	04-01-2010	Gutierrez, Alvaro Fernández	
	33	2010/0114896 A1	05-06-2010	Clark et al.	
	34	2010/0115018 A1	05-06-2010	Yoon et al.	
	35	2010/0142382 A1	06-10-2010	Jungck et al.	
	36	2010/0220852 A1	09-02-2010	Willman et al.	
	37	2010/0233991 A1	09-16-2010	Crawford et al.	
	38	2010/0278534 A1	11-04-2010	Leiden et al.	
	39	2010/0316195 A1	12-16-2010	Di Serio et al.	
	40	2011/0072095 A1	03-24-2011	Havriluk, George	
	41	2011/0167164 A1	07-07-2011	Gutierrez, Alvaro Fernández	
	42	2011/0208859 A1	08-25-2011	Gutierrez, Alvaro Fernández	
	43	2011/0235543 A1	09-29-2011	Seetharaman et al.	
	44	2011/0273526 A1	11-10-2011	Mehin et al.	
	45	2011/0276903 A1	11-10-2011	Mehin et al.	
	46	2011/0276904 A1	11-10-2011	Mehin et al.	
	47	2011/0292929 A1	12-01-2011	Haster, Lars-Olof	
	48	2012/0089717 A1	04-12-2012	Chen, Yanheng	
	49	2012/0096145 A1	04-19-2012	Le et al.	
	50	2012/0155333 A1	06-21-2012	Yoon et al.	
	51	2012/0195236 A1	08-02-2012	Knight, Eric	
	52	2012/0259975 A1	10-11-2012	Le et al.	
	53	2012/0270554 A1	10-25-2012	Hellwig et al.	
	54	2013/0039226 A1	02-14-2013	Sridhar, Sriram	
	55	2013/0097308 A1	04-18-2013	Le et al.	
	56	2013/0128879 A1	05-23-2013	Kyle, Andre B.	
	57	2013/0148549 A1	06-13-2013	Crawford et al.	

Examiner Signature	Date Considered
<p>*Examiner: Initial if reference considered, whether or not citation is in conformance with MPEP 609. Draw line through citation if not in conformance and not considered. Include copy of this form with next communication to applicant.</p>	

INFORMATION DISCLOSURE STATEMENT BY APPLICANT	Application No.	13/966,096	
	Filing Date	August 13, 2013	
	First Named Inventor	Perreault, Clay	
	Art Unit	2653	
<i>(Multiple sheets used when necessary)</i>		Examiner	Sing, Simon P.
SHEET 3 OF 5		Attorney Docket No.	DIGIF.001C1

U.S. PATENT DOCUMENTS					
Examiner Initials	Cite No.	Document Number Number - Kind Code (if known) Example: 1,234,567 B1	Publication Date MM-DD-YYYY	Name	Pages, Columns, Lines Where Relevant Passages or Relevant Figures Appear
	58	2013/0173534 A1	07-04-2013	Nelakonda et al.	
	59	2013/0229950 A1	09-05-2013	Björzell et al.	
	60	2013/0287006 A1	10-31-2013	Nix, John A.	
	61	2013/0310002 A1	11-21-2013	Celi, Jr. et al.	
	62	2013/0318166 A1	11-28-2013	Jungck et al.	
	63	2013/0329864 A1	12-12-2013	Björzell et al.	
	64	2014/0010119 A1	01-09-2014	Björzell et al.	
	65	2014/0016764 A1	01-16-2014	Björzell et al.	
	66	2014/0024367 A1	01-23-2014	Björzell et al.	
	67	2014/0153477 A1	06-05-2014	Huttunen et al.	
	68	2014/0215642 A1	07-31-2014	Huxham, Horatio Nelson	
	69	2014/0307858 A1	10-16-2014	Li et al.	
	70	2014/0321333 A1	10-30-2014	Björzell et al.	

FOREIGN PATENT DOCUMENTS						
Examiner Initials	Cite No.	Foreign Patent Document Country Code-Number-Kind Code Example: JP 1234567 A1	Publication Date MM-DD-YYYY	Name	Pages, Columns, Lines Where Relevant Passages or Relevant Figures Appear	T ¹
	71	BR PI 0718312-7 A2	11-26-2013	Digifonica International Ltd	<i>Corresponds to International Publication No. WO 2008-052340 A1 previously disclosed</i>	Abstract
	72	BR PI 0719682-2 A2	01-14-2014	Digifonica International Ltd	<i>Corresponds to International Publication No. WO 2008/064481 A1 previously disclosed</i>	Abstract
	73	CA 2,668,025 A1	05-08-2008	Digifonica International Ltd	<i>Corresponds to International Publication No. WO 2008-052340 A1 previously disclosed</i>	Abstract
	74	CA 2,670,510 A1	06-05-2008	Digifonica International Ltd	<i>Corresponds to International Publication No. WO 2008-064481 A1; previously disclosed</i>	Abstract

Examiner Signature	Date Considered
<p>*Examiner: Initial if reference considered, whether or not citation is in conformance with MPEP 609. Draw line through citation if not in conformance and not considered. Include copy of this form with next communication to applicant.</p>	

T¹ - Place a check mark in this area when an English language Translation is attached AT&T, Exh. 1002, p. 357

INFORMATION DISCLOSURE STATEMENT BY APPLICANT	Application No.	13/966,096
	Filing Date	August 13, 2013
	First Named Inventor	Perreault, Clay
	Art Unit	2653
<i>(Multiple sheets used when necessary)</i>	Examiner	Sing, Simon P.
SHEET 4 OF 5	Attorney Docket No.	DIGIF.001C1

FOREIGN PATENT DOCUMENTS						
Examiner Initials	Cite No.	Foreign Patent Document Country Code-Number-Kind Code Example: JP 1234567 A1	Publication Date MM-DD-YYYY	Name	Pages, Columns, Lines Where Relevant Passages or Relevant Figures Appear	T ¹
	75	CA 2,681,984 A1	10-02-2008	Digifonica International Ltd	<i>Corresponds to International Publication No. WO 2008/116296 A1; previously disclosed</i>	Abstract
	76	CA 2,732,148 A1	02-04-2010	Digifonica International Ltd	<i>Corresponds to International Publication No. WO 2010/012090 A2; previously disclosed</i>	Abstract
	77	CA 2,812,174 A1	03-24-2011	Digifonica International Ltd	<i>Corresponds to International Publication No. WO 2011/032256 A1; previously disclosed</i>	Abstract
	78	CN 101584150 A	11-18-2009	Digifonica International Ltd	<i>Corresponds to International Publication No. WO 2008/064481 A1 previously disclosed</i>	Abstract
	79	CN 101584166 A	11-18-2009	Digifonica International Ltd	<i>Corresponds to International Publication No. WO 2008-052340 A1 previously disclosed</i>	Abstract
	80	CN 101605342 A	12-16-2009	ZTE Corp [CN]		Abstract
	81	CN 102457494 A	05-16-2012	China Mobile Comm Corp Sichuan Co Ltd		Abstract
	82	CN 102572123 A	07-11-2012	Chengdu 30RTOM Mobile Comm Co Ltd		Abstract
	83	CN 101605342 B	12-19-2012	ZTE Corp [CN]	<i>Corresponds to Chinese Publication No. CN 101605342 A shown above</i>	
	84	CN 102457494 B	10-01-2014	China Mobile Comm Corp Sichuan Co Ltd	<i>Corresponds to Chinese Publication No. CN 102457494 A shown above</i>	
	85	EP 2 084 868 A0	08-05-2009	Digifonica International Ltd	<i>Corresponds to International Publication No. WO 2008-052340 A1 previously disclosed</i>	Abstract
	86	EP 2 227 048 A1	09-08-2010	France Telecom [FR]		Abstract

Examiner Signature	Date Considered
*Examiner: Initial if reference considered, whether or not citation is in conformance with MPEP 609. Draw line through citation if not in conformance and not considered. Include copy of this form with next communication to applicant.	

T¹ - Place a check mark in this area when an English language Translation is attached AT&T, Exh. 1002, p. 358

INFORMATION DISCLOSURE STATEMENT BY APPLICANT	Application No.	13/966,096	
	Filing Date	August 13, 2013	
	First Named Inventor	Perreault, Clay	
	Art Unit	2653	
<i>(Multiple sheets used when necessary)</i>		Examiner	Sing, Simon P.
SHEET 5 OF 5		Attorney Docket No.	DIGIF.001C1

FOREIGN PATENT DOCUMENTS						
Examiner Initials	Cite No.	Foreign Patent Document Country Code-Number-Kind Code Example: JP 1234567 A1	Publication Date MM-DD-YYYY	Name	Pages, Columns, Lines Where Relevant Passages or Relevant Figures Appear	T ¹
	87	EP 2 311 292 A0	04-20-2011	Digifonica International Ltd	<i>Corresponds to International Publication No. WO 2010/012090 A2 previously disclosed</i>	Abstract
	88	EP 2 478 678 A0	07-25-2012	Digifonica International Ltd	<i>Corresponds to International Publication No. WO 2011/032256 A1 previously disclosed</i>	Abstract
	89	KR 10-2009-0086428 (A)	08-12-2009	Digifonica International Ltd	<i>Korean Publication Unavailable Corresponds to International Publication No. WO 2008-052340 A1 previously disclosed</i>	Abstract
	90	KR 10-2009-0095621 (A)	09-09-2009	Digifonica International Ltd	<i>Corresponds to International Publication No. WO 2008-064481 A1 previously disclosed</i>	Abstract
	91	MX 2009005751 A	08-26-2009	Digifonica International Ltd	<i>Corresponds to International Publication No. WO 2008-064481 A1 previously disclosed</i>	Abstract
	92	MX 2009004811 A	08-28-2009	Digifonica International Ltd	<i>Corresponds to International Publication No. WO 2008-052340 A1 previously disclosed</i>	Abstract
	93	WO 2013/013189 A2	01-24-2013	VISA Int Service ASS [US]		

NON PATENT LITERATURE DOCUMENTS			
Examiner Initials	Cite No.	Include name of the author (in CAPITAL LETTERS), title of the article (when appropriate), title of the item (book, magazine, journal, serial, symposium, catalog, etc.), date, page(s), volume-issue number(s), publisher, city and/or country where published.	T ¹

20682667
051415

Examiner Signature	Date Considered
*Examiner: Initial if reference considered, whether or not citation is in conformance with MPEP 609. Draw line through citation if not in conformance and not considered. Include copy of this form with next communication to applicant.	

T¹ - Place a check mark in this area when an English language Translation is attached AT&T, Exh. 1002, p. 359

Electronic Patent Application Fee Transmittal

Application Number:	13966096
Filing Date:	13-Aug-2013
Title of Invention:	PRODUCING ROUTING MESSAGES FOR VOICE OVER IP COMMUNICATIONS
First Named Inventor/Applicant Name:	CLAY PERREAULT
Filer:	John M Carson/Norman Green
Attorney Docket Number:	DIGIF.001C1

Filed as Small Entity

Filing Fees for Utility under 35 USC 111(a)

Description	Fee Code	Quantity	Amount	Sub-Total in USD(\$)
Basic Filing:				
Pages:				
Claims:				
Miscellaneous-Filing:				
Petition:				
Patent-Appeals-and-Interference:				
Post-Allowance-and-Post-Issuance:				
Extension-of-Time:				

Description	Fee Code	Quantity	Amount	Sub-Total in USD(\$)
Miscellaneous:				
Submission- Information Disclosure Stmt	2806	1	90	90
Total in USD (\$)				90

Electronic Acknowledgement Receipt

EFS ID:	22357158
Application Number:	13966096
International Application Number:	
Confirmation Number:	8712
Title of Invention:	PRODUCING ROUTING MESSAGES FOR VOICE OVER IP COMMUNICATIONS
First Named Inventor/Applicant Name:	CLAY PERREAULT
Customer Number:	20995
Filer:	John M Carson/Norman Green
Filer Authorized By:	John M Carson
Attorney Docket Number:	DIGIF.001C1
Receipt Date:	15-MAY-2015
Filing Date:	13-AUG-2013
Time Stamp:	13:42:05
Application Type:	Utility under 35 USC 111(a)

Payment information:

Submitted with Payment	yes
Payment Type	Credit Card
Payment was successfully received in RAM	\$90
RAM confirmation Number	9673
Deposit Account	111410
Authorized User	KNOBBE MARTENS OLSON AND BEAR

The Director of the USPTO is hereby authorized to charge indicated fees and credit any overpayment as follows:

Charge any Additional Fees required under 37 C.F.R. Section 1.16 (National application filing, search, and examination fees)

Charge any Additional Fees required under 37 C.F.R. Section 1.17 (Patent application and reexamination processing fees)

File Listing:					
Document Number	Document Description	File Name	File Size(Bytes)/ Message Digest	Multi Part /.zip	Pages (if appl.)
1		Amendment_DIGIF-001C1.pdf	1944571 4195233b6f172d76dd12a20b6a77b6897d79bd74	yes	38
Multipart Description/PDF files in .zip description					
		Document Description	Start	End	
		Amendment/Req. Reconsideration-After Non-Final Reject	1	1	
		Claims	2	21	
		Applicant Arguments/Remarks Made in an Amendment	22	38	
Warnings:					
Information:					
2		IDS_DIGIF_001C1_05_15_2015.pdf	358237 00d499d70b27181f2d98348d299f94d7b33f96a9	yes	7
Multipart Description/PDF files in .zip description					
		Document Description	Start	End	
		Transmittal Letter	1	2	
		Information Disclosure Statement (IDS) Form (SB08)	3	7	
Warnings:					
Information:					
3	Foreign Reference	Ref71_BPRI0728312.pdf	10587766 2ddf834ffb30db2f0831013fedd92133d9480439	no	132
Warnings:					
Information:					
4	Foreign Reference	Ref72_BRPI0719682.pdf	8563315 85dae598b9976f5f3d7ce88a0b8e09d70cecc96	no	107
Warnings:					
Information:					

5	Foreign Reference	Ref73_CA2668025_WO200805 2340A1.pdf	9898083	no	136
			f8686dc663e9f2bcb9c7554ce8d4f355dac a2aa		
Warnings:					
Information:					
6	Foreign Reference	Ref74_CA2670510_WO200806 4481A1.pdf	7748841	no	103
			6a738a50ba254d9f86b4d744263ac9c1330 a35cc		
Warnings:					
Information:					
7	Foreign Reference	Ref75_CA2681984.pdf	6873015	no	91
			9e9c480b5b7628f7303b82deae244cbde23 ab51b		
Warnings:					
Information:					
8	Foreign Reference	Ref76_CA2732148.pdf	8658833	no	111
			464ae16e17c772b934273465ec269464100 05d66		
Warnings:					
Information:					
9	Foreign Reference	Ref77_CA2812174.pdf	3824762	no	51
			eb99ec138367105475eadd40bc9d52bcad 6f49bc		
Warnings:					
Information:					
10	Foreign Reference	Ref78_CN101584150A.pdf	6887355	no	75
			aeb01e38861a0549c9dea6b74c10647aa8 2e47a		
Warnings:					
Information:					
11	Foreign Reference	Ref79_CN101584166A.pdf	9197185	no	98
			7ecc8f6c749df448f0a7b84f47e42bf1e715 71f		
Warnings:					
Information:					
12	Foreign Reference	Ref80_CN101605342A.pdf	2450739	no	29
			61c2e4fa7c8ed80ac740cb0cb5f112f68c1bf fd2		
Warnings:					
Information:					
13	Foreign Reference	Ref81_CN102457494A.pdf	984166	no	12
			c01704bace68d7d2eb27c3b3051ee63b41c 05d9f		
Warnings:					
Information:					

14	Foreign Reference	Ref82_CN102572123A.pdf	679509	no	7
			4d8ea199801314f18f6973942c385b4e83fe9212		
Warnings:					
Information:					
15	Foreign Reference	Ref83_CN101605342B.pdf	94467	no	1
			1becc1d77fae73b18f836015547f4d53de1bb5eb		
Warnings:					
Information:					
16	Foreign Reference	Ref84_CN102457494B.pdf	77678	no	1
			86d9c570f7b9dd0df777d6c2eec724226da44d4		
Warnings:					
Information:					
17	Foreign Reference	Ref85_EP2084868A0.pdf	195322	no	3
			de4022aec73dd6ca1c5ceb3b4ceb8baa5d02e4e		
Warnings:					
Information:					
18	Foreign Reference	Ref86_EP2227048A1.pdf	1516205	no	16
			ac7d9f3cd437650a7c12b6fc8cd251a75d6bbccd		
Warnings:					
Information:					
19	Foreign Reference	Ref87_EP2311292A0.pdf	8040314	no	104
			33531d81b17ffa4268c15b5a19199734d2ac6d87		
Warnings:					
Information:					
20	Foreign Reference	Ref88_EP2478678A0.pdf	3797263	no	51
			57c1da083e7e6c5911791123969e53f0ab5e7f27		
Warnings:					
Information:					
21	Foreign Reference	Ref89_KR1020090086428.pdf	219273	no	3
			2cbee4e099b007bc07a22947ab1ce94970d4b5d		
Warnings:					
Information:					
22	Foreign Reference	Ref90_KR1020090095621.pdf	4476378	no	55
			1f4d982b224d76afd52f7110b061421df103da36		
Warnings:					
Information:					

23	Foreign Reference	Ref91_MX2009005751.pdf	11506464 0df7ccea1f7ac540216ba2b4c23bb65b7488c1b7	no	149
Warnings:					
Information:					
24	Foreign Reference	Ref92_MX2009004811.pdf	12380320 9849c92f9993a505d1036b7f72b1eb0530242f4b	no	192
Warnings:					
Information:					
25	Foreign Reference	Ref93_WO2013013189A2.pdf	4852562 bd296b7327505f9d7f10b2bcb4ae63b5cab0b43	no	55
Warnings:					
Information:					
26	Fee Worksheet (SB06)	fee-info.pdf	30465 94d31afc391977ad7cec6529f28bdcf0e46a2d66	no	2
Warnings:					
Information:					
Total Files Size (in bytes):			125843088		

This Acknowledgement Receipt evidences receipt on the noted date by the USPTO of the indicated documents, characterized by the applicant, and including page counts, where applicable. It serves as evidence of receipt similar to a Post Card, as described in MPEP 503.

New Applications Under 35 U.S.C. 111

If a new application is being filed and the application includes the necessary components for a filing date (see 37 CFR 1.53(b)-(d) and MPEP 506), a Filing Receipt (37 CFR 1.54) will be issued in due course and the date shown on this Acknowledgement Receipt will establish the filing date of the application.

National Stage of an International Application under 35 U.S.C. 371

If a timely submission to enter the national stage of an international application is compliant with the conditions of 35 U.S.C. 371 and other applicable requirements a Form PCT/DO/EO/903 indicating acceptance of the application as a national stage submission under 35 U.S.C. 371 will be issued in addition to the Filing Receipt, in due course.

New International Application Filed with the USPTO as a Receiving Office

If a new international application is being filed and the international application includes the necessary components for an international filing date (see PCT Article 11 and MPEP 1810), a Notification of the International Application Number and of the International Filing Date (Form PCT/RO/105) will be issued in due course, subject to prescriptions concerning national security, and the date shown on this Acknowledgement Receipt will establish the international filing date of the application.

Under the Paperwork Reduction Act of 1995, no persons are required to respond to a collection of information unless it displays a valid OMB control number.

PATENT APPLICATION FEE DETERMINATION RECORD Substitute for Form PTO-875	Application or Docket Number 13/966,096	Filing Date 08/13/2013	<input type="checkbox"/> To be Mailed
---	---	----------------------------------	---------------------------------------

ENTITY: LARGE SMALL MICRO

APPLICATION AS FILED – PART I

FOR	NUMBER FILED	NUMBER EXTRA	RATE (\$)	FEE (\$)
<input type="checkbox"/> BASIC FEE <small>(37 CFR 1.16(a), (b), or (c))</small>	N/A	N/A	N/A	
<input type="checkbox"/> SEARCH FEE <small>(37 CFR 1.16(k), (l), or (m))</small>	N/A	N/A	N/A	
<input type="checkbox"/> EXAMINATION FEE <small>(37 CFR 1.16(o), (p), or (q))</small>	N/A	N/A	N/A	
TOTAL CLAIMS <small>(37 CFR 1.16(i))</small>	minus 20 =	*	X \$ =	
INDEPENDENT CLAIMS <small>(37 CFR 1.16(h))</small>	minus 3 =	*	X \$ =	
<input type="checkbox"/> APPLICATION SIZE FEE <small>(37 CFR 1.16(s))</small>	If the specification and drawings exceed 100 sheets of paper, the application size fee due is \$310 (\$155 for small entity) for each additional 50 sheets or fraction thereof. See 35 U.S.C. 41(a)(1)(G) and 37 CFR 1.16(s).			
<input type="checkbox"/> MULTIPLE DEPENDENT CLAIM PRESENT <small>(37 CFR 1.16(j))</small>				
* If the difference in column 1 is less than zero, enter "0" in column 2.			TOTAL	

APPLICATION AS AMENDED – PART II

	(Column 1)	(Column 2)	(Column 3)	PRESENT EXTRA	RATE (\$)	ADDITIONAL FEE (\$)
AMENDMENT	05/15/2015	CLAIMS REMAINING AFTER AMENDMENT	HIGHEST NUMBER PREVIOUSLY PAID FOR			
	Total <small>(37 CFR 1.16(i))</small>	* 99	Minus	** 99	= 0	X \$40 = 0
	Independent <small>(37 CFR 1.16(h))</small>	* 6	Minus	***6	= 0	X \$210 = 0
	<input type="checkbox"/> Application Size Fee <small>(37 CFR 1.16(s))</small>					
<input type="checkbox"/> FIRST PRESENTATION OF MULTIPLE DEPENDENT CLAIM <small>(37 CFR 1.16(j))</small>						
					TOTAL ADD'L FEE	0

	(Column 1)	(Column 2)	(Column 3)	PRESENT EXTRA	RATE (\$)	ADDITIONAL FEE (\$)
AMENDMENT		CLAIMS REMAINING AFTER AMENDMENT	HIGHEST NUMBER PREVIOUSLY PAID FOR			
	Total <small>(37 CFR 1.16(i))</small>	*	Minus	**	=	X \$ =
	Independent <small>(37 CFR 1.16(h))</small>	*	Minus	***	=	X \$ =
	<input type="checkbox"/> Application Size Fee <small>(37 CFR 1.16(s))</small>					
<input type="checkbox"/> FIRST PRESENTATION OF MULTIPLE DEPENDENT CLAIM <small>(37 CFR 1.16(j))</small>						
					TOTAL ADD'L FEE	

* If the entry in column 1 is less than the entry in column 2, write "0" in column 3.
 ** If the "Highest Number Previously Paid For" IN THIS SPACE is less than 20, enter "20".
 *** If the "Highest Number Previously Paid For" IN THIS SPACE is less than 3, enter "3".
 The "Highest Number Previously Paid For" (Total or Independent) is the highest number found in the appropriate box in column 1.

LIE
/TARA WASHINGTON/

This collection of information is required by 37 CFR 1.16. The information is required to obtain or retain a benefit by the public which is to file (and by the USPTO to process) an application. Confidentiality is governed by 35 U.S.C. 122 and 37 CFR 1.14. This collection is estimated to take 12 minutes to complete, including gathering, preparing, and submitting the completed application form to the USPTO. Time will vary depending upon the individual case. Any comments on the amount of time you require to complete this form and/or suggestions for reducing this burden, should be sent to the Chief Information Officer, U.S. Patent and Trademark Office, U.S. Department of Commerce, P.O. Box 1450, Alexandria, VA 22313-1450. DO NOT SEND FEES OR COMPLETED FORMS TO THIS ADDRESS. **SEND TO: Commissioner for Patents, P.O. Box 1450, Alexandria, VA 22313-1450.**

If you need assistance in completing the form, call 1-800-PTO-9199 and select option 2.



UNITED STATES PATENT AND TRADEMARK OFFICE

UNITED STATES DEPARTMENT OF COMMERCE
United States Patent and Trademark Office
Address: COMMISSIONER FOR PATENTS
P.O. Box 1450
Alexandria, Virginia 22313-1450
www.uspto.gov

Table with 5 columns: APPLICATION NO., FILING DATE, FIRST NAMED INVENTOR, ATTORNEY DOCKET NO., CONFIRMATION NO.
13/966,096 08/13/2013 CLAY PERREAULT DIGIF.001C1 8712

20995 7590 06/02/2015
KNOBBE MARTENS OLSON & BEAR LLP
2040 MAIN STREET
FOURTEENTH FLOOR
IRVINE, CA 92614

EXAMINER

SING, SIMON P

ART UNIT PAPER NUMBER

2653

NOTIFICATION DATE DELIVERY MODE

06/02/2015

ELECTRONIC

Please find below and/or attached an Office communication concerning this application or proceeding.

The time period for reply, if any, is set in the attached communication.

Notice of the Office communication was sent electronically on above-indicated "Notification Date" to the following e-mail address(es):

jayna.cartee@knobbe.com
efiling@knobbe.com

Applicant-Initiated Interview Summary	Application No. 13/966,096	Applicant(s) PERREAULT ET AL.	
	Examiner SIMON SING	Art Unit 2653	

All participants (applicant, applicant's representative, PTO personnel):

- (1) SIMON SING. (3) _____.
(2) Mr. John Carson. (4) _____.

Date of Interview: 28 May 2015.

Type: Telephonic Video Conference
 Personal [copy given to: applicant applicant's representative]

Exhibit shown or demonstration conducted: Yes No.
If Yes, brief description: _____.

Issues Discussed 101 112 102 103 Others
(For each of the checked box(es) above, please describe below the issue and detailed description of the discussion)

Claim(s) discussed: 1.

Identification of prior art discussed: US 6,798,767 (Alexander et al).

Substance of Interview

(For each issue discussed, provide a detailed description and indicate if agreement was reached. Some topics may include: identification or clarification of a reference or a portion thereof, claim interpretation, proposed amendments, arguments of any applied references etc...)

Applicant argues that Alexander teaches routing a call by looking up a table, based on a callee's number, to determining a callee's IP address. Alexander fails to teach claimed limitations of determining if a calling attribute meets (matches) a portion of a callee's identifier, and producing a routing message accordingly. Examiner agrees with the applicant. A new search will be conducted to find applicable prior arts, and patentability will be determined based on the new search.

Applicant recordation instructions: The formal written reply to the last Office action must include the substance of the interview. (See MPEP section 713.04). If a reply to the last Office action has already been filed, applicant is given a non-extendable period of the longer of one month or thirty days from this interview date, or the mailing date of this interview summary form, whichever is later, to file a statement of the substance of the interview

Examiner recordation instructions: Examiners must summarize the substance of any interview of record. A complete and proper recordation of the substance of an interview should include the items listed in MPEP 713.04 for complete and proper recordation including the identification of the general thrust of each argument or issue discussed, a general indication of any other pertinent matters discussed regarding patentability and the general results or outcome of the interview, to include an indication as to whether or not agreement was reached on the issues raised.

Attachment

/SIMON SING/
Primary Examiner, Art Unit 2653

Summary of Record of Interview Requirements

Manual of Patent Examining Procedure (MPEP), Section 713.04, Substance of Interview Must be Made of Record

A complete written statement as to the substance of any face-to-face, video conference, or telephone interview with regard to an application must be made of record in the application whether or not an agreement with the examiner was reached at the interview.

Title 37 Code of Federal Regulations (CFR) § 1.133 Interviews

Paragraph (b)

In every instance where reconsideration is requested in view of an interview with an examiner, a complete written statement of the reasons presented at the interview as warranting favorable action must be filed by the applicant. An interview does not remove the necessity for reply to Office action as specified in §§ 1.111, 1.135. (35 U.S.C. 132)

37 CFR §1.2 Business to be transacted in writing.

All business with the Patent or Trademark Office should be transacted in writing. The personal attendance of applicants or their attorneys or agents at the Patent and Trademark Office is unnecessary. The action of the Patent and Trademark Office will be based exclusively on the written record in the Office. No attention will be paid to any alleged oral promise, stipulation, or understanding in relation to which there is disagreement or doubt.

The action of the Patent and Trademark Office cannot be based exclusively on the written record in the Office if that record is itself incomplete through the failure to record the substance of interviews.

It is the responsibility of the applicant or the attorney or agent to make the substance of an interview of record in the application file, unless the examiner indicates he or she will do so. It is the examiner's responsibility to see that such a record is made and to correct material inaccuracies which bear directly on the question of patentability.

Examiners must complete an Interview Summary Form for each interview held where a matter of substance has been discussed during the interview by checking the appropriate boxes and filling in the blanks. Discussions regarding only procedural matters, directed solely to restriction requirements for which interview recordation is otherwise provided for in Section 812.01 of the Manual of Patent Examining Procedure, or pointing out typographical errors or unreadable script in Office actions or the like, are excluded from the interview recordation procedures below. Where the substance of an interview is completely recorded in an Examiners Amendment, no separate Interview Summary Record is required.

The Interview Summary Form shall be given an appropriate Paper No., placed in the right hand portion of the file, and listed on the "Contents" section of the file wrapper. In a personal interview, a duplicate of the Form is given to the applicant (or attorney or agent) at the conclusion of the interview. In the case of a telephone or video-conference interview, the copy is mailed to the applicant's correspondence address either with or prior to the next official communication. If additional correspondence from the examiner is not likely before an allowance or if other circumstances dictate, the Form should be mailed promptly after the interview rather than with the next official communication.

The Form provides for recordation of the following information:

- Application Number (Series Code and Serial Number)
- Name of applicant
- Name of examiner
- Date of interview
- Type of interview (telephonic, video-conference, or personal)
- Name of participant(s) (applicant, attorney or agent, examiner, other PTO personnel, etc.)
- An indication whether or not an exhibit was shown or a demonstration conducted
- An identification of the specific prior art discussed
- An indication whether an agreement was reached and if so, a description of the general nature of the agreement (may be by attachment of a copy of amendments or claims agreed as being allowable). Note: Agreement as to allowability is tentative and does not restrict further action by the examiner to the contrary.
- The signature of the examiner who conducted the interview (if Form is not an attachment to a signed Office action)

It is desirable that the examiner orally remind the applicant of his or her obligation to record the substance of the interview of each case. It should be noted, however, that the Interview Summary Form will not normally be considered a complete and proper recordation of the interview unless it includes, or is supplemented by the applicant or the examiner to include, all of the applicable items required below concerning the substance of the interview.

A complete and proper recordation of the substance of any interview should include at least the following applicable items:

- 1) A brief description of the nature of any exhibit shown or any demonstration conducted,
- 2) an identification of the claims discussed,
- 3) an identification of the specific prior art discussed,
- 4) an identification of the principal proposed amendments of a substantive nature discussed, unless these are already described on the Interview Summary Form completed by the Examiner,
- 5) a brief identification of the general thrust of the principal arguments presented to the examiner,
(The identification of arguments need not be lengthy or elaborate. A verbatim or highly detailed description of the arguments is not required. The identification of the arguments is sufficient if the general nature or thrust of the principal arguments made to the examiner can be understood in the context of the application file. Of course, the applicant may desire to emphasize and fully describe those arguments which he or she feels were or might be persuasive to the examiner.)
- 6) a general indication of any other pertinent matters discussed, and
- 7) if appropriate, the general results or outcome of the interview unless already described in the Interview Summary Form completed by the examiner.

Examiners are expected to carefully review the applicant's record of the substance of an interview. If the record is not complete and accurate, the examiner will give the applicant an extendable one month time period to correct the record.

Examiner to Check for Accuracy

If the claims are allowable for other reasons of record, the examiner should send a letter setting forth the examiner's version of the statement attributed to him or her. If the record is complete and accurate, the examiner should place the indication, "Interview Record OK" on the paper recording the substance of the interview along with the date and the examiner's initials.

INFORMATION DISCLOSURE STATEMENT BY APPLICANT	Application No.	13/966,096	
	Filing Date	August 13, 2013	
	First Named Inventor	Perreault, Clay	
	Art Unit	2653	
<i>(Multiple sheets used when necessary)</i>		Examiner	Sing, Simon P.
SHEET 1 OF 2		Attorney Docket No.	DIGIF.001C1

U.S. PATENT DOCUMENTS					
Examiner Initials	Cite No.	Document Number <i>Number - Kind Code (if known)</i> Example: 1,234,567 B1	Publication Date MM-DD-YYYY	Name	Pages, Columns, Lines Where Relevant Passages or Relevant Figures Appear

FOREIGN PATENT DOCUMENTS						
Examiner Initials	Cite No.	Foreign Patent Document <i>Country Code-Number-Kind Code</i> Example: JP 1234567 A1	Publication Date MM-DD-YYYY	Name	Pages, Columns, Lines Where Relevant Passages or Relevant Figures Appear	T ¹
	1	IN 24/2009	06-12-2009	Digifonica International Ltd	<i>Corresponding International Publication No. WO 2008-052340 A1 previously disclosed</i>	
	2	IN 29/2009	07-17-2009	Digifonica International Ltd	<i>Corresponding International Publication No. WO 2008/064481 A1 previously disclosed</i>	
	3	SG151991A1	06-29-2009	Digifonica International Ltd	<i>Corresponding International Publication No. WO 2008-052340 A1 previously disclosed</i>	✓
	4	SG152752A1	06-29-2009	Digifonica International Ltd	<i>Corresponding International Publication No. WO 2008/064481 A1 previously disclosed</i>	✓
	5	SG155474	10-29-2009	Digifonica International Ltd	<i>Corresponding International Publication No. WO 2008/116296 A1 previously disclosed</i>	Abstract

NON PATENT LITERATURE DOCUMENTS			
Examiner Initials	Cite No.	Include name of the author (in CAPITAL LETTERS), title of the article (when appropriate), title of the item (book, magazine, journal, serial, symposium, catalog, etc.), date, page(s), volume-issue number(s), publisher, city and/or country where published.	T ¹
	6	Chinese Office Action dated March 24, 2011 for Chinese Patent Application No. CN 200780049791.5	✓
	7	Chinese Office Action dated June 23, 2011 for Chinese Patent Application No. CN 200780049136.X.	✓
	8	Indonesian Examination Report dated July 5, 2012 for Indonesian Patent Application No. W-00200901414.	✓
	9	Indonesian Examination Report dated February 8, 2013 for Indonesian Patent Application No. W-00200901165.	✓

Examiner Signature	Date Considered
--------------------	-----------------

***Examiner:** Initial if reference considered, whether or not citation is in conformance with MPEP 609. Draw line through citation if not in conformance and not considered. Include copy of this form with next communication to applicant.

INFORMATION DISCLOSURE STATEMENT BY APPLICANT	Application No.	13/966,096
	Filing Date	August 13, 2013
	First Named Inventor	Perreault, Clay
	Art Unit	2653
<i>(Multiple sheets used when necessary)</i>	Examiner	Sing, Simon P.
SHEET 2 OF 2	Attorney Docket No.	DIGIF.001C1

NON PATENT LITERATURE DOCUMENTS

Examiner Initials	Cite No.	Include name of the author (in CAPITAL LETTERS), title of the article (when appropriate), title of the item (book, magazine, journal, serial, symposium, catalog, etc.), date, page(s), volume-issue number(s), publisher, city and/or country where published.	T ¹
	10	Mexican Exam Report dated July 11, 2011 for Mexican Patent Application No. MX/a/2009/004811.	✓
	11	Mexican Notice of Allowance dated September 2, 2011 for Mexican Patent Application No. MX/a/2009/005751.	✓

20811010
060215

Examiner Signature	Date Considered
<p>*Examiner: Initial if reference considered, whether or not citation is in conformance with MPEP 609. Draw line through citation if not in conformance and not considered. Include copy of this form with next communication to applicant.</p>	

T¹ - Place a check mark in this area when an English language Translation is attached AT&T, Exh. 1002, p. 372

Electronic Patent Application Fee Transmittal

Application Number:	13966096
Filing Date:	13-Aug-2013
Title of Invention:	PRODUCING ROUTING MESSAGES FOR VOICE OVER IP COMMUNICATIONS
First Named Inventor/Applicant Name:	CLAY PERREAULT
Filer:	John M Carson/Norman Green
Attorney Docket Number:	DIGIF.001C1

Filed as Small Entity

Filing Fees for Utility under 35 USC 111(a)

Description	Fee Code	Quantity	Amount	Sub-Total in USD(\$)
Basic Filing:				
Pages:				
Claims:				
Miscellaneous-Filing:				
Petition:				
Patent-Appeals-and-Interference:				
Post-Allowance-and-Post-Issuance:				
Extension-of-Time:				

Description	Fee Code	Quantity	Amount	Sub-Total in USD(\$)
Miscellaneous:				
Submission- Information Disclosure Stmt	2806	1	90	90
Total in USD (\$)				90

Electronic Acknowledgement Receipt

EFS ID:	22610217
Application Number:	13966096
International Application Number:	
Confirmation Number:	8712
Title of Invention:	PRODUCING ROUTING MESSAGES FOR VOICE OVER IP COMMUNICATIONS
First Named Inventor/Applicant Name:	CLAY PERREAULT
Customer Number:	20995
Filer:	John M Carson/Norman Green
Filer Authorized By:	John M Carson
Attorney Docket Number:	DIGIF.001C1
Receipt Date:	11-JUN-2015
Filing Date:	13-AUG-2013
Time Stamp:	20:54:14
Application Type:	Utility under 35 USC 111(a)

Payment information:

Submitted with Payment	yes
Payment Type	Credit Card
Payment was successfully received in RAM	\$90
RAM confirmation Number	19831
Deposit Account	111410
Authorized User	KNOBBE MARTENS OLSON AND BEAR

The Director of the USPTO is hereby authorized to charge indicated fees and credit any overpayment as follows:

Charge any Additional Fees required under 37 C.F.R. Section 1.16 (National application filing, search, and examination fees)

Charge any Additional Fees required under 37 C.F.R. Section 1.17 (Patent application and reexamination processing fees)

File Listing:					
Document Number	Document Description	File Name	File Size(Bytes)/ Message Digest	Multi Part /.zip	Pages (if appl.)
1		2015_06_11_IDS_DIGIF_001C1.pdf	141201 6a18350b76d298a1a18d7e09b996421454007542	yes	4
	Multipart Description/PDF files in .zip description				
	Document Description		Start		End
	Transmittal Letter		1		2
	Information Disclosure Statement (IDS) Form (SB08)		3		4
Warnings:					
Information:					
2	Foreign Reference	Ref1_IN_24_2009.pdf	1103891 40d8a0992d759c4f2569bd987a6c9cce499c518d	no	17
Warnings:					
Information:					
3	Foreign Reference	Ref2_IN_29_2009.pdf	1939525 f8775ab91d9328df3641585646d89fc6de8b61e0	no	31
Warnings:					
Information:					
4	Foreign Reference	Ref3_SG151991_Full_Trans.pdf	12232700 c960041e75c6f056db7b9624dbae052d2e5f9580	no	138
Warnings:					
Information:					
5	Foreign Reference	Ref4_SG152752_Full_Trans.pdf	9304036 c29ff052a03261eb8661b97b03063bf2b140e243	no	101
Warnings:					
Information:					
6	Foreign Reference	Ref5_SG155474_Abst.pdf	851694 cb9b542eb3ba64ab703aab6535b2d0010c9c9969	no	69
Warnings:					
Information:					

7	Non Patent Literature	Ref6_CN_First_OA_CN2007800 49791_5_03_24_2011.pdf	1133474 b480ace607a90e9d8ea8ea1d3a70734c80a78d65	no	11
Warnings:					
Information:					
8	Non Patent Literature	Ref7_CN_First_OA_CN2007800 49136_X_06_23_2011.pdf	922066 c2267b042a38fd97a4e37a3f894bf2f1decff2f	no	8
Warnings:					
Information:					
9	Non Patent Literature	Ref8_IN_Exam_Report_7_5_20 12_W-00200901414.pdf	196694 f6cbabf78c1eb03e2e05d38c05fbb7b20d802ff0	no	2
Warnings:					
Information:					
10	Non Patent Literature	Ref9_IN_Exam_Report_2_8_20 13_W-00200901165.pdf	100609 ada54ac139d65a31dd44d0e6662fc2aef61a63574	no	2
Warnings:					
Information:					
11	Non Patent Literature	Ref10_MX_OA_MXa200900481 1.pdf	417661 7edb8842a712a3dc31bdce6fa353415291c84eca	no	4
Warnings:					
Information:					
12	Non Patent Literature	Ref11_MX_NOA_MXa20090057 51.pdf	332934 67c89c7f57e87920f63c8ce00f6409b9e50dfbc2	no	4
Warnings:					
Information:					
13	Fee Worksheet (SB06)	fee-info.pdf	30465 e823c2bcf3698687700ecc8d2584c7b1030e8a27	no	2
Warnings:					
Information:					
Total Files Size (in bytes):			28706950		

This Acknowledgement Receipt evidences receipt on the noted date by the USPTO of the indicated documents, characterized by the applicant, and including page counts, where applicable. It serves as evidence of receipt similar to a Post Card, as described in MPEP 503.

New Applications Under 35 U.S.C. 111

If a new application is being filed and the application includes the necessary components for a filing date (see 37 CFR 1.53(b)-(d) and MPEP 506), a Filing Receipt (37 CFR 1.54) will be issued in due course and the date shown on this Acknowledgement Receipt will establish the filing date of the application.

National Stage of an International Application under 35 U.S.C. 371

If a timely submission to enter the national stage of an international application is compliant with the conditions of 35 U.S.C. 371 and other applicable requirements a Form PCT/DO/EO/903 indicating acceptance of the application as a national stage submission under 35 U.S.C. 371 will be issued in addition to the Filing Receipt, in due course.

New International Application Filed with the USPTO as a Receiving Office

If a new international application is being filed and the international application includes the necessary components for an international filing date (see PCT Article 11 and MPEP 1810), a Notification of the International Application Number and of the International Filing Date (Form PCT/RO/105) will be issued in due course, subject to prescriptions concerning national security, and the date shown on this Acknowledgement Receipt will establish the international filing date of the application.

INFORMATION DISCLOSURE STATEMENT

Inventor	:	Clay Perreault, et al.
App. No.	:	13/966,096
Filed	:	August 13, 2013
For	:	PRODUCING ROUTING MESSAGES FOR VOICE OVER IP COMMUNICATIONS
Examiner	:	Sing, Simon P.
Art Unit	:	2653
Conf. No.	:	8712

Commissioner for Patents
P.O. Box 1450
Alexandria, VA 22313-1450

References and Listing

Pursuant to 37 CFR 1.56, an Information Disclosure Statement listing references is provided herewith. Copies of any listed foreign and non-patent literature references are being submitted.

No Disclaimers

To the extent that anything in the Information Disclosure Statement or the listed references could be construed as a disclaimer of any subject matter supported by the present application, Applicant hereby rescinds and retracts such disclaimer.

Timing of Disclosure

This Information Disclosure Statement is being filed after receipt of a First Office Action, but before the mailing date of a Final Action and before the mailing date of a Notice of Allowance. This Statement is accompanied by the fees set forth in 37 CFR 1.17(p). The

Application No.: 13/966,096
Filing Date: August 13, 2013

Commissioner is hereby authorized to charge any additional fees which may be required or to credit any overpayment to Account No. 11-1410.

Respectfully submitted,
KNOBBE, MARTENS, OLSON & BEAR, LLP

Dated: 6/11/15

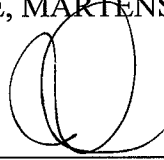
By: 
John M. Carson
Registration No. 34,303
Attorney of Record
Customer No. 20995
(858) 707-4000

IDS
20878651
061015

INFORMATION DISCLOSURE STATEMENT BY APPLICANT	Application No.	13/966,096	
	Filing Date	August 13, 2013	
	First Named Inventor	Perreault, Clay	
	Art Unit	2653	
<i>(Multiple sheets used when necessary)</i>		Examiner	Sing, Simon P.
SHEET 1 OF 1		Attorney Docket No.	DIGIF.001C1

U.S. PATENT DOCUMENTS					
Examiner Initials	Cite No.	Document Number <i>Number - Kind Code (if known)</i> Example: 1,234,567 B1	Publication Date MM-DD-YYYY	Name	Pages, Columns, Lines Where Relevant Passages or Relevant Figures Appear

FOREIGN PATENT DOCUMENTS						
Examiner Initials	Cite No.	Foreign Patent Document <i>Country Code-Number-Kind Code</i> Example: JP 1234567 A1	Publication Date MM-DD-YYYY	Name	Pages, Columns, Lines Where Relevant Passages or Relevant Figures Appear	T ¹
	1	CA 2,598,200 A1	02-21-2008	Connexon Telecom Inc.		
	2	W00200902627 <i>(Indonesia)</i>	09-17-2009	Digifonica International Ltd	<i>Corresponding International Publication No. WO 2008/116296 A1 previously disclosed</i>	Abstract Only

NON PATENT LITERATURE DOCUMENTS			
Examiner Initials	Cite No.	Include name of the author (in CAPITAL LETTERS), title of the article (when appropriate), title of the item (book, magazine, journal, serial, symposium, catalog, etc.), date, page(s), volume-issue number(s), publisher, city and/or country where published.	T ¹
	3	Canadian Office Action dated January 27, 2015 for Canadian Patent Application No. CA 2,681,984.	

20995995
062515

Examiner Signature	Date Considered
<p>*Examiner: Initial if reference considered, whether or not citation is in conformance with MPEP 609. Draw line through citation if not in conformance and not considered. Include copy of this form with next communication to applicant.</p>	

T¹ - Place a check mark in this area when an English language Translation is attached AT&T, Exh. 1002, p. 381

Electronic Patent Application Fee Transmittal

Application Number:	13966096
Filing Date:	13-Aug-2013
Title of Invention:	PRODUCING ROUTING MESSAGES FOR VOICE OVER IP COMMUNICATIONS
First Named Inventor/Applicant Name:	CLAY PERREAULT
Filer:	John M Carson/Norman Green
Attorney Docket Number:	DIGIF.001C1

Filed as Small Entity

Filing Fees for Utility under 35 USC 111(a)

Description	Fee Code	Quantity	Amount	Sub-Total in USD(\$)
Basic Filing:				
Pages:				
Claims:				
Miscellaneous-Filing:				
Petition:				
Patent-Appeals-and-Interference:				
Post-Allowance-and-Post-Issuance:				
Extension-of-Time:				

Description	Fee Code	Quantity	Amount	Sub-Total in USD(\$)
Miscellaneous:				
Submission- Information Disclosure Stmt	2806	1	90	90
Total in USD (\$)				90

Electronic Acknowledgement Receipt

EFS ID:	22747646
Application Number:	13966096
International Application Number:	
Confirmation Number:	8712
Title of Invention:	PRODUCING ROUTING MESSAGES FOR VOICE OVER IP COMMUNICATIONS
First Named Inventor/Applicant Name:	CLAY PERREAULT
Customer Number:	20995
Filer:	John M Carson/Norman Green
Filer Authorized By:	John M Carson
Attorney Docket Number:	DIGIF.001C1
Receipt Date:	25-JUN-2015
Filing Date:	13-AUG-2013
Time Stamp:	20:12:42
Application Type:	Utility under 35 USC 111(a)

Payment information:

Submitted with Payment	yes
Payment Type	Credit Card
Payment was successfully received in RAM	\$90
RAM confirmation Number	10764
Deposit Account	111410
Authorized User	KNOBBE MARTENS OLSON AND BEAR

The Director of the USPTO is hereby authorized to charge indicated fees and credit any overpayment as follows:

Charge any Additional Fees required under 37 C.F.R. Section 1.16 (National application filing, search, and examination fees)

Charge any Additional Fees required under 37 C.F.R. Section 1.17 (Patent application and reexamination processing fees)

File Listing:					
Document Number	Document Description	File Name	File Size(Bytes)/ Message Digest	Multi Part /.zip	Pages (if appl.)
1		IDS_06_25_2015_DIGIF_001C1.pdf	92104 67be98c1d32905d3f59d3aa011ded3137649368c	yes	3
	Multipart Description/PDF files in .zip description				
	Document Description		Start		End
	Transmittal Letter		1		2
	Information Disclosure Statement (IDS) Form (SB08)		3		3
Warnings:					
Information:					
2	Foreign Reference	Ref1_CA2598200.pdf	1360191 af57de8cddb6de54ddb7f4b10e48dd939d78fae3	no	20
Warnings:					
Information:					
3	Foreign Reference	Ref2_W00200902627.pdf	324443 00aa4f6a017baab01c1c0a3c3344b968c9740947	no	3
Warnings:					
Information:					
4	Non Patent Literature	Ref3_CA_OA_CA2681984.pdf	358492 3428281b43b6b4ee05e9734f16ceef9ab6d83333	no	8
Warnings:					
Information:					
5	Fee Worksheet (SB06)	fee-info.pdf	30465 0caf15da257fce84a09baf72f13931d4554eb750	no	2
Warnings:					
Information:					
Total Files Size (in bytes):			2165695		

This Acknowledgement Receipt evidences receipt on the noted date by the USPTO of the indicated documents, characterized by the applicant, and including page counts, where applicable. It serves as evidence of receipt similar to a Post Card, as described in MPEP 503.

New Applications Under 35 U.S.C. 111

If a new application is being filed and the application includes the necessary components for a filing date (see 37 CFR 1.53(b)-(d) and MPEP 506), a Filing Receipt (37 CFR 1.54) will be issued in due course and the date shown on this Acknowledgement Receipt will establish the filing date of the application.

National Stage of an International Application under 35 U.S.C. 371

If a timely submission to enter the national stage of an international application is compliant with the conditions of 35 U.S.C. 371 and other applicable requirements a Form PCT/DO/EO/903 indicating acceptance of the application as a national stage submission under 35 U.S.C. 371 will be issued in addition to the Filing Receipt, in due course.

New International Application Filed with the USPTO as a Receiving Office

If a new international application is being filed and the international application includes the necessary components for an international filing date (see PCT Article 11 and MPEP 1810), a Notification of the International Application Number and of the International Filing Date (Form PCT/RO/105) will be issued in due course, subject to prescriptions concerning national security, and the date shown on this Acknowledgement Receipt will establish the international filing date of the application.

INFORMATION DISCLOSURE STATEMENT

Inventor	:	Clay Perreault, et al.
App. No.	:	13/966,096
Filed	:	August 13, 2013
For	:	PRODUCING ROUTING MESSAGES FOR VOICE OVER IP COMMUNICATIONS
Examiner	:	Sing, Simon P.
Art Unit	:	2653
Conf. No.	:	8712

Commissioner for Patents
P.O. Box 1450
Alexandria, VA 22313-1450

References and Listing

Pursuant to 37 CFR 1.56, an Information Disclosure Statement listing references is provided herewith. Copies of any listed foreign and non-patent literature references are being submitted.

No Disclaimers

To the extent that anything in the Information Disclosure Statement or the listed references could be construed as a disclaimer of any subject matter supported by the present application, Applicant hereby rescinds and retracts such disclaimer.

Timing of Disclosure

This Information Disclosure Statement is being filed after receipt of a First Office Action, but before the mailing date of a Final Action and before the mailing date of a Notice of Allowance. This Statement is accompanied by the fees set forth in 37 CFR 1.17(p). The

Application No.: 13/966,096
Filing Date: August 13, 2013

Commissioner is hereby authorized to charge any additional fees which may be required or to credit any overpayment to Account No. 11-1410.

Respectfully submitted,

KNOBBE, MARTENS, OLSON & BEAR, LLP

Dated: 6/25/15

By: _____

John M. Carson
Registration No. 34,303
Attorney of Record
Customer No. 20995
(858) 707-4000

IDS
20996114
062515

IN THE UNITED STATES PATENT AND TRADEMARK OFFICE

Inventor	:	Clay Perreault
App. No.	:	13/966,096
Filed	:	August 13, 2013
For	:	PRODUCING ROUTING MESSAGES FOR VOICE OVER IP COMMUNICATIONS
Examiner	:	Sing, Simon P.
Art Unit	:	2653
Conf. No.	:	8712

STATEMENT OF THE SUBSTANCE OF INTERVIEW**Mail Stop Amendment**

Commissioner for Patents
P.O. Box 1450
Alexandria, VA 22313-1450

Dear Sir:

Further to the Office Communication dated June 2, 2015, containing the Examiner's Interview Summary, Applicant provides herein a summary statement of the substance of the interview pursuant to MPEP 713.04.

Summary of Interview begins on page 2 of this paper.

Application No.: 13/966,096
Filing Date: August 13, 2013

SUMMARY OF INTERVIEW

Attendees, Date and Type of Interview

The personal interview was conducted on May 28, 2015 and was attended by Primary Examiner Simon Sing and Applicant's representative, John M. Carson, Reg. No. 34,303.

Identification of Claims Discussed

Claim 1 was discussed as a representative claim.

Identification of Prior Art Discussed

U.S. Patent No. 6,798,767 (Alexander et al.) was discussed.

Proposed Amendments

No amendments were proposed.

Principal Arguments and Other Matters

The cited art does not disclose all the features of the pending claims.

Results of Interview

The Examiner agreed that the cited art does not disclose all the features of the pending claims. The Examiner will perform an update search and determine patentability based on the new search.

Application No.: 13/966,096
Filing Date: August 13, 2013

Please charge any additional fees, including any fees for additional extension of time, or credit overpayment to Deposit Account No. 11-1410.

Respectfully submitted,

KNOBBE, MARTENS, OLSON & BEAR, LLP

Dated: 6/29/15

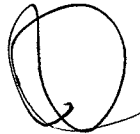
By:  _____

John M. Carson
Registration No. 34,303
Attorney of Record
Customer No. 20995
(858) 707-4000

21007903
062615

Electronic Acknowledgement Receipt

EFS ID:	22771507
Application Number:	13966096
International Application Number:	
Confirmation Number:	8712
Title of Invention:	PRODUCING ROUTING MESSAGES FOR VOICE OVER IP COMMUNICATIONS
First Named Inventor/Applicant Name:	CLAY PERREAULT
Customer Number:	20995
Filer:	John M Carson/Kevin Kraus
Filer Authorized By:	John M Carson
Attorney Docket Number:	DIGIF.001C1
Receipt Date:	29-JUN-2015
Filing Date:	13-AUG-2013
Time Stamp:	18:00:19
Application Type:	Utility under 35 USC 111(a)

Payment information:

Submitted with Payment	no
------------------------	----

File Listing:

Document Number	Document Description	File Name	File Size(Bytes)/ Message Digest	Multi Part /.zip	Pages (if appl.)
1	Applicant summary of interview with examiner	DIGIF001C1interviewsummary.pdf	62382 <small>b7f8339f4ca838a74b909fbc997f291df8c5d9e2</small>	no	3

Warnings:

Information:

This Acknowledgement Receipt evidences receipt on the noted date by the USPTO of the indicated documents, characterized by the applicant, and including page counts, where applicable. It serves as evidence of receipt similar to a Post Card, as described in MPEP 503.

New Applications Under 35 U.S.C. 111

If a new application is being filed and the application includes the necessary components for a filing date (see 37 CFR 1.53(b)-(d) and MPEP 506), a Filing Receipt (37 CFR 1.54) will be issued in due course and the date shown on this Acknowledgement Receipt will establish the filing date of the application.

National Stage of an International Application under 35 U.S.C. 371

If a timely submission to enter the national stage of an international application is compliant with the conditions of 35 U.S.C. 371 and other applicable requirements a Form PCT/DO/EO/903 indicating acceptance of the application as a national stage submission under 35 U.S.C. 371 will be issued in addition to the Filing Receipt, in due course.

New International Application Filed with the USPTO as a Receiving Office

If a new international application is being filed and the international application includes the necessary components for an international filing date (see PCT Article 11 and MPEP 1810), a Notification of the International Application Number and of the International Filing Date (Form PCT/RO/105) will be issued in due course, subject to prescriptions concerning national security, and the date shown on this Acknowledgement Receipt will establish the international filing date of the application.

Electronic Petition Request	TERMINAL DISCLAIMER TO OBIATE A DOUBLE PATENTING REJECTION OVER A "PRIOR" PATENT
Application Number	13966096
Filing Date	13-Aug-2013
First Named Inventor	CLAY PERREAUULT
Attorney Docket Number	DIGIF.001C1
Title of Invention	PRODUCING ROUTING MESSAGES FOR VOICE OVER IP COMMUNICATIONS

- Filing of terminal disclaimer does not obviate requirement for response under 37 CFR 1.111 to outstanding Office Action
- This electronic Terminal Disclaimer is not being used for a Joint Research Agreement.

Owner	Percent Interest
Digifonica (International) Limited	100%

The owner(s) with percent interest listed above in the instant application hereby disclaims, except as provided below, the terminal part of the statutory term of any patent granted on the instant application which would extend beyond the expiration date of the full statutory term of prior patent number(s)

8542815

as the term of said prior patent is presently shortened by any terminal disclaimer. The owner hereby agrees that any patent so granted on the instant application shall be enforceable only for and during such period that it and the prior patent are commonly owned. This agreement runs with any patent granted on the instant application and is binding upon the grantee, its successors or assigns.

In making the above disclaimer, the owner does not disclaim the terminal part of the term of any patent granted on the instant application that would extend to the expiration date of the full statutory term of the prior patent, "as the term of said prior patent is presently shortened by any terminal disclaimer," in the event that said prior patent later:

- expires for failure to pay a maintenance fee;
- is held unenforceable;
- is found invalid by a court of competent jurisdiction;
- is statutorily disclaimed in whole or terminally disclaimed under 37 CFR 1.321;
- has all claims canceled by a reexamination certificate;
- is reissued; or
- is in any manner terminated prior to the expiration of its full statutory term as presently shortened by any terminal disclaimer.

Terminal disclaimer fee under 37 CFR 1.20(d) is included with Electronic Terminal Disclaimer request.

I certify, in accordance with 37 CFR 1.4(d)(4), that the terminal disclaimer fee under 37 CFR 1.20(d) required for this terminal disclaimer has already been paid in the above-identified application.

Applicant claims the following fee status:

- Small Entity
- Micro Entity
- Regular Undiscounted

I hereby declare that all statements made herein of my own knowledge are true and that all statements made on information and belief are believed to be true; and further that these statements were made with the knowledge that willful false statements and the like so made are punishable by fine or imprisonment, or both, under Section 1001 of Title 18 of the United States Code and that such willful false statements may jeopardize the validity of the application or any patent issued thereon.

THIS PORTION MUST BE COMPLETED BY THE SIGNATORY OR SIGNATORIES

I certify, in accordance with 37 CFR 1.4(d)(4) that I am:

- An attorney or agent registered to practice before the Patent and Trademark Office who is of record in this application

Registration Number 34303
- A sole inventor
- A joint inventor; I certify that I am authorized to sign this submission on behalf of all of the inventors as evidenced by the power of attorney in the application
- A joint inventor; all of whom are signing this request

Signature	/John M. Carson/
Name	John M. Carson

*Statement under 37 CFR 3.73(b) is required if terminal disclaimer is signed by the assignee (owner).
Form PTO/SB/96 may be used for making this certification. See MPEP § 324.

Electronic Patent Application Fee Transmittal

Application Number:	13966096
Filing Date:	13-Aug-2013
Title of Invention:	PRODUCING ROUTING MESSAGES FOR VOICE OVER IP COMMUNICATIONS
First Named Inventor/Applicant Name:	CLAY PERREAULT
Filer:	John M Carson/Anthony Bonilla
Attorney Docket Number:	DIGIF.001C1

Filed as Small Entity

Filing Fees for Utility under 35 USC 111(a)

Description	Fee Code	Quantity	Amount	Sub-Total in USD(\$)
Basic Filing:				
Statutory or Terminal Disclaimer	1814	1	160	160

Pages:

Claims:

Miscellaneous-Filing:

Petition:

Patent-Appeals-and-Interference:

Post-Allowance-and-Post-Issuance:

Description	Fee Code	Quantity	Amount	Sub-Total in USD(\$)
Extension-of-Time:				
Miscellaneous:				
Total in USD (\$)				160

Doc Code: DISQ.E.FILE

Document Description: Electronic Terminal Disclaimer – Approved

Application No.: 13966096

Filing Date: 13-Aug-2013

Applicant/Patent under Reexamination: PERREAULT et al.

Electronic Terminal Disclaimer filed on June 29, 2015

APPROVED

This patent is subject to a terminal disclaimer

DISAPPROVED

Approved/Disapproved by: Electronic Terminal Disclaimer automatically approved by EFS-Web

U.S. Patent and Trademark Office

Electronic Acknowledgement Receipt

EFS ID:	22777858
Application Number:	13966096
International Application Number:	
Confirmation Number:	8712
Title of Invention:	PRODUCING ROUTING MESSAGES FOR VOICE OVER IP COMMUNICATIONS
First Named Inventor/Applicant Name:	CLAY PERREAULT
Customer Number:	20995
Filer:	John M Carson/Anthony Bonilla
Filer Authorized By:	John M Carson
Attorney Docket Number:	DIGIF.001C1
Receipt Date:	29-JUN-2015
Filing Date:	13-AUG-2013
Time Stamp:	19:19:19
Application Type:	Utility under 35 USC 111(a)

Payment information:

Submitted with Payment	yes
Payment Type	Credit Card
Payment was successfully received in RAM	\$160
RAM confirmation Number	6583
Deposit Account	111410
Authorized User	KNOBBE MARTENS OLSON AND BEAR

The Director of the USPTO is hereby authorized to charge indicated fees and credit any overpayment as follows:

Charge any Additional Fees required under 37 C.F.R. Section 1.16 (National application filing, search, and examination fees)

Charge any Additional Fees required under 37 C.F.R. Section 1.17 (Patent application and reexamination processing fees)

--	--	--	--	--	--

File Listing:

Document Number	Document Description	File Name	File Size(Bytes)/ Message Digest	Multi Part /.zip	Pages (if appl.)
1	Electronic Terminal Disclaimer-Filed	eTerminal-Disclaimer.pdf	33429	no	2
			af7bbe18303fd60686cc027738dbae05d3268b05		

Warnings:

Information:

2	Fee Worksheet (SB06)	fee-info.pdf	30470	no	2
			248e9b4e8e1602643763fbb9ba9629a0ee798121		

Warnings:

Information:

Total Files Size (in bytes):	63899
-------------------------------------	-------

This Acknowledgement Receipt evidences receipt on the noted date by the USPTO of the indicated documents, characterized by the applicant, and including page counts, where applicable. It serves as evidence of receipt similar to a Post Card, as described in MPEP 503.

New Applications Under 35 U.S.C. 111

If a new application is being filed and the application includes the necessary components for a filing date (see 37 CFR 1.53(b)-(d) and MPEP 506), a Filing Receipt (37 CFR 1.54) will be issued in due course and the date shown on this Acknowledgement Receipt will establish the filing date of the application.

National Stage of an International Application under 35 U.S.C. 371

If a timely submission to enter the national stage of an international application is compliant with the conditions of 35 U.S.C. 371 and other applicable requirements a Form PCT/DO/EO/903 indicating acceptance of the application as a national stage submission under 35 U.S.C. 371 will be issued in addition to the Filing Receipt, in due course.

New International Application Filed with the USPTO as a Receiving Office

If a new international application is being filed and the international application includes the necessary components for an international filing date (see PCT Article 11 and MPEP 1810), a Notification of the International Application Number and of the International Filing Date (Form PCT/RO/105) will be issued in due course, subject to prescriptions concerning national security, and the date shown on this Acknowledgement Receipt will establish the international filing date of the application.

INFORMATION DISCLOSURE STATEMENT BY APPLICANT <i>(Multiple sheets used when necessary)</i> SHEET 1 OF 1	Application No.	13/966,096
	Filing Date	August 13, 2013
	First Named Inventor	Perreault, Clay
	Art Unit	2633
	Examiner	Sing, Simon P.
	Attorney Docket No.	DIGIF.001C1

U.S. PATENT DOCUMENTS					
Examiner Initials	Cite No.	Document Number Number - Kind Code (if known) Example: 1,234,567 B1	Publication Date MM-DD-YYYY	Name	Pages, Columns, Lines Where Relevant Passages or Relevant Figures Appear
	1	6,327,351 B1	12-04-2001	Walker et al.	
	2	7,203,478 B2	04-10-2007	Benco et al.	

FOREIGN PATENT DOCUMENTS						
Examiner Initials	Cite No.	Foreign Patent Document Country Code-Number-Kind Code Example: JP 1234567 A1	Publication Date MM-DD-YYYY	Name	Pages, Columns, Lines Where Relevant Passages or Relevant Figures Appear	T ¹

NON PATENT LITERATURE DOCUMENTS			
Examiner Initials	Cite No.	Include name of the author (in CAPITAL LETTERS), title of the article (when appropriate), title of the item (book, magazine, journal, serial, symposium, catalog, etc.), date, page(s), volume-issue number(s), publisher, city and/or country where published.	T ¹

21034262
063015

Examiner Signature	Date Considered
*Examiner: Initial if reference considered, whether or not citation is in conformance with MPEP 609. Draw line through citation if not in conformance and not considered. Include copy of this form with next communication to applicant.	

T¹ - Place a check mark in this area when an English language Translation is attached. AT&T, Exh. 1002, p. 401

Electronic Patent Application Fee Transmittal

Application Number:	13966096			
Filing Date:	13-Aug-2013			
Title of Invention:	PRODUCING ROUTING MESSAGES FOR VOICE OVER IP COMMUNICATIONS			
First Named Inventor/Applicant Name:	CLAY PERREAULT			
Filer:	John M Carson/Norman Green			
Attorney Docket Number:	DIGIF.001C1			
Filed as Small Entity				
Filing Fees for Utility under 35 USC 111(a)				
Description	Fee Code	Quantity	Amount	Sub-Total in USD(\$)
Basic Filing:				
Pages:				
Claims:				
Miscellaneous-Filing:				
Petition:				
Patent-Appeals-and-Interference:				
Post-Allowance-and-Post-Issuance:				
Extension-of-Time:				

Description	Fee Code	Quantity	Amount	Sub-Total in USD(\$)
Miscellaneous:				
Submission- Information Disclosure Stmt	2806	1	90	90
Total in USD (\$)				90

Electronic Acknowledgement Receipt

EFS ID:	22794407
Application Number:	13966096
International Application Number:	
Confirmation Number:	8712
Title of Invention:	PRODUCING ROUTING MESSAGES FOR VOICE OVER IP COMMUNICATIONS
First Named Inventor/Applicant Name:	CLAY PERREAULT
Customer Number:	20995
Filer:	John M Carson/Norman Green
Filer Authorized By:	John M Carson
Attorney Docket Number:	DIGIF.001C1
Receipt Date:	30-JUN-2015
Filing Date:	13-AUG-2013
Time Stamp:	19:06:36
Application Type:	Utility under 35 USC 111(a)

Payment information:

Submitted with Payment	yes
Payment Type	Credit Card
Payment was successfully received in RAM	\$90
RAM confirmation Number	7217
Deposit Account	111410
Authorized User	KNOBBE MARTENS OLSON AND BEAR

The Director of the USPTO is hereby authorized to charge indicated fees and credit any overpayment as follows:

Charge any Additional Fees required under 37 C.F.R. Section 1.16 (National application filing, search, and examination fees)

Charge any Additional Fees required under 37 C.F.R. Section 1.17 (Patent application and reexamination processing fees)

--	--	--	--	--	--

File Listing:

Document Number	Document Description	File Name	File Size(Bytes)/ Message Digest	Multi Part /.zip	Pages (if appl.)
1		IDS_DIGIF_001C1_06_30_2015.pdf	220562 4888eb3e0ce8037036c11973fdac8857d4fd a09e	yes	3

Multipart Description/PDF files in .zip description				
	Document Description	Start	End	
	Transmittal Letter	1	2	
	Information Disclosure Statement (IDS) Form (SB08)	3	3	

Warnings:

Information:

2	Fee Worksheet (SB06)	fee-info.pdf	30465 94d822a6e13c1edc809dadbcc0c1b4a0c6b a6866	no	2
---	----------------------	--------------	---	----	---

Warnings:

Information:

Total Files Size (in bytes):			251027		
-------------------------------------	--	--	--------	--	--

This Acknowledgement Receipt evidences receipt on the noted date by the USPTO of the indicated documents, characterized by the applicant, and including page counts, where applicable. It serves as evidence of receipt similar to a Post Card, as described in MPEP 503.

New Applications Under 35 U.S.C. 111

If a new application is being filed and the application includes the necessary components for a filing date (see 37 CFR 1.53(b)-(d) and MPEP 506), a Filing Receipt (37 CFR 1.54) will be issued in due course and the date shown on this Acknowledgement Receipt will establish the filing date of the application.

National Stage of an International Application under 35 U.S.C. 371

If a timely submission to enter the national stage of an international application is compliant with the conditions of 35 U.S.C. 371 and other applicable requirements a Form PCT/DO/EO/903 indicating acceptance of the application as a national stage submission under 35 U.S.C. 371 will be issued in addition to the Filing Receipt, in due course.

New International Application Filed with the USPTO as a Receiving Office

If a new international application is being filed and the international application includes the necessary components for an international filing date (see PCT Article 11 and MPEP 1810), a Notification of the International Application Number and of the International Filing Date (Form PCT/RO/105) will be issued in due course, subject to prescriptions concerning national security, and the date shown on this Acknowledgement Receipt will establish the international filing date of the application.

INFORMATION DISCLOSURE STATEMENT

Inventor : Clay Perreault, et al.
App. No. : 13/966,096
Filed : August 13, 2013
For : PRODUCING ROUTING MESSAGES FOR
VOICE OVER IP COMMUNICATIONS
Examiner : Sing, Simon P.
Art Unit : 2653
Conf. No. : 8712

Commissioner for Patents
P.O. Box 1450
Alexandria, VA 22313-1450

References and Listing

Pursuant to 37 CFR 1.56, an Information Disclosure Statement listing references is provided herewith. Copies of any listed foreign and non-patent literature references are being submitted.

No Disclaimers

To the extent that anything in the Information Disclosure Statement or the listed references could be construed as a disclaimer of any subject matter supported by the present application, Applicant hereby rescinds and retracts such disclaimer.

Timing of Disclosure

This Information Disclosure Statement is being filed after receipt of a First Office Action, but before the mailing date of a Final Action and before the mailing date of a Notice of Allowance. This Statement is accompanied by the fees set forth in 37 CFR 1.17(p). The

Application No.: 13/966,096
Filing Date: August 13, 2013

Commissioner is hereby authorized to charge any additional fees which may be required or to credit any overpayment to Account No. 11-1410.

Respectfully submitted,
KNOBBE, MARTENS, OLSON & BEAR, LLP

Dated: 6/30/15

By: 
John M. Carson
Registration No. 34,303
Attorney of Record
Customer No. 20995
(858) 707-4000

IDS
21034347
063015

INFORMATION DISCLOSURE STATEMENT BY APPLICANT	Application No.	13/966,096	
	Filing Date	August 13, 2013	
	First Named Inventor	Perreault, Clay	
	Art Unit	2653	
<i>(Multiple sheets used when necessary)</i>		Examiner	Sing, Simon P.
SHEET 1 OF 2		Attorney Docket No.	DIGIF.001C1

U.S. PATENT DOCUMENTS					
Examiner Initials	Cite No.	Document Number Number - Kind Code (if known) Example: 1,234,567 B1	Publication Date MM-DD-YYYY	Name	Pages, Columns, Lines Where Relevant Passages or Relevant Figures Appear
	1	5,677,955 A1	10-14-1995	Doggett et al.	
	2	5,883,810 A1	03-16-1999	Franklin et al.	
	3	6,173,272 B1	01-09-2001	Thomas et al.	
	4	6,243,689 B1	06-05-2001	Norton, Robert G.	
	5	6,636,833 B1	10-21-2003	Fitcroft et al.	
	6	6,772,188 B1	08-03-2004	Cheng-Sheng et al.	
	7	6,892,184 B1	05-10-2005	Komen et al.	
	8	7,051,072 B2	05-23-2006	Stewart et al.	
	9	7,330,835 B2	02-12-2008	Deggendorf, Theresa M.	
	10	7,426,492 B2	09-16-2008	Bishop et al.	
	11	7,437,665 B2	10-14-2008	Perham, Michael	
	12	7,447,707 B2	11-04-2008	Gaurav et al.	
	13	7,580,886 B1	08-25-2009	Schulz, Larry	
	14	7,593,884 B2	09-22-2009	Rothman et al.	
	15	7,599,944 B2	10-06-2009	Gaurav et al.	
	16	7,644,037 B1	01-05-2010	Ostrovsky, Vladimir	
	17	7,647,500 B2	01-12-2010	Machiraju et al.	
	18	7,676,431 B2	03-09-2010	O'Leary et al.	
	19	7,680,737 B2	03-16-2010	Smith et al.	
	20	7,734,544 B2	06-08-2010	Schleicher, Joerg	
	21	7,765,261 B2	07-27-2010	Kropivny, Alexander	
	22	7,765,266 B2	07-27-2010	Kropivny, Alexander	
	23	7,882,011 B2	02-01-2011	Sandhu et al.	
	24	7,899,742 B2	03-11-2011	Berkert et al.	
	25	8,060,887 B2	11-15-2011	Kropivny, Alexander	
	26	8,161,078 B2	04-17-2012	Gaurav et al.	
	27	8,200,575 B2	06-12-2012	Torres et al.	
	28	8,543,477 B2	09-24-2013	Love et al.	
	29	8,627,211 B2	01-07-2014	Kropivny, Alexander	

Examiner Signature	Date Considered
*Examiner: Initial if reference considered, whether or not citation is in conformance with MPEP 609. Draw line through citation if not in conformance and not considered. Include copy of this form with next communication to applicant.	

T¹ - Place a check mark in this area when an English language Translation is attached. AT&T, Exh. 1002, p. 408

INFORMATION DISCLOSURE STATEMENT BY APPLICANT	Application No.	13/966,096	
	Filing Date	August 13, 2013	
	First Named Inventor	Perreault, Clay	
	Art Unit	2653	
<i>(Multiple sheets used when necessary)</i>		Examiner	Sing, Simon P.
SHEET 2 OF 2		Attorney Docket No.	DIGIF.001C1

U.S. PATENT DOCUMENTS					
Examiner Initials	Cite No.	Document Number Number - Kind Code (if known) Example: 1,234,567 B1	Publication Date MM-DD-YYYY	Name	Pages, Columns, Lines Where Relevant Passages or Relevant Figures Appear
	30	8,702,505 B2	04-22-2014	Kropivny, Alexander	
	31	2005/0131813 A1	06-16-2005	Gallagher et al.	
	32	2005/0171898 A1	08-04-2005	Bishop et al.	
	33	2005/0192897 A1	09-01-2005	Rogers et al.	
	34	2005/0192901 A1	09-01-2005	McCoy et al.	
	35	2005/0222952 A1	10-06-2005	Garrett et al.	
	36	2005/0267842 A1	12-01-2005	Weichert et al.	
	37	2006/0006224 A1	01-12-2006	Modi, Vikram	
	38	2006/0036522 A1	02-15-2006	Perham, Michael	
	39	2006/0095320 A1	05-04-2006	Jones, Lisa	
	40	2006/0116892 A1	06-01-2006	Grimes et al.	
	41	2006/0195398 A1	08-31-2006	Dheer et al.	
	42	2007/0016524 A1	01-18-2007	Diveley, et al.	
	43	2014/0141884 A1	05-22-2014	Kropivny, Alexander	

FOREIGN PATENT DOCUMENTS						
Examiner Initials	Cite No.	Foreign Patent Document Country Code-Number-Kind Code Example: JP 1234567 A1	Publication Date MM-DD-YYYY	Name	Pages, Columns, Lines Where Relevant Passages or Relevant Figures Appear	T ¹

NON PATENT LITERATURE DOCUMENTS			
Examiner Initials	Cite No.	Include name of the author (in CAPITAL LETTERS), title of the article (when appropriate), title of the item (book, magazine, journal, serial, symposium, catalog, etc.), date, page(s), volume-issue number(s), publisher, city and/or country where published.	T ¹
	44	Ketchpel et al. "U-PAI: A universal payment application interface" <i>Second USENIX Workshop on Electronic Commerce Proceedings</i> , 1996-8, pages 1-17.	
	45	Moberg & Drummond, "MIME-Based Secure Peer-to-Peer Business Data Interchange Using HTTP, Applicability Statement 2 (AS2)," <i>Network Working Group, Request for Comments: 4130, Category: Standards Track</i> , Copyright © The Internet Society July 2005, pages 1-47.	
	46	Abrazhevich, Dennis. "Electronic Payment Systems: a User-Centered Perspective and Interaction Design," <i>Thesis under the auspices of the J.F. Schouten School for User-System Interaction Research</i> , Technische Universiteit Eindhoven, Netherlands, 2004, pages Cover page - page 189.	

21269338
080315

Examiner Signature	Date Considered
--------------------	-----------------

*Examiner: Initial if reference considered, whether or not citation is in conformance with MPEP 609. Draw line through citation if not in conformance and not considered. Include copy of this form with next communication to applicant.

T¹ - Place a check mark in this area when an English language Translation is attached. AT&T, Exh. 1002, p. 409

Electronic Patent Application Fee Transmittal

Application Number:	13966096
Filing Date:	13-Aug-2013
Title of Invention:	PRODUCING ROUTING MESSAGES FOR VOICE OVER IP COMMUNICATIONS
First Named Inventor/Applicant Name:	CLAY PERREAULT
Filer:	Paul S. Brockland/Norman Green
Attorney Docket Number:	DIGIF.001C1

Filed as Small Entity

Filing Fees for Utility under 35 USC 111(a)

Description	Fee Code	Quantity	Amount	Sub-Total in USD(\$)
Basic Filing:				
Pages:				
Claims:				
Miscellaneous-Filing:				
Petition:				
Patent-Appeals-and-Interference:				
Post-Allowance-and-Post-Issuance:				
Extension-of-Time:				

Description	Fee Code	Quantity	Amount	Sub-Total in USD(\$)
Miscellaneous:				
Submission- Information Disclosure Stmt	2806	1	90	90
Total in USD (\$)				90

Electronic Acknowledgement Receipt

EFS ID:	23102469
Application Number:	13966096
International Application Number:	
Confirmation Number:	8712
Title of Invention:	PRODUCING ROUTING MESSAGES FOR VOICE OVER IP COMMUNICATIONS
First Named Inventor/Applicant Name:	CLAY PERREAULT
Customer Number:	20995
Filer:	Paul S. Brockland/Norman Green
Filer Authorized By:	Paul S. Brockland
Attorney Docket Number:	DIGIF.001C1
Receipt Date:	03-AUG-2015
Filing Date:	13-AUG-2013
Time Stamp:	19:21:59
Application Type:	Utility under 35 USC 111(a)

Payment information:

Submitted with Payment	yes
Payment Type	Credit Card
Payment was successfully received in RAM	\$90
RAM confirmation Number	6101
Deposit Account	111410
Authorized User	KNOBBE MARTENS OLSON AND BEAR

The Director of the USPTO is hereby authorized to charge indicated fees and credit any overpayment as follows:

Charge any Additional Fees required under 37 C.F.R. Section 1.16 (National application filing, search, and examination fees)

Charge any Additional Fees required under 37 C.F.R. Section 1.17 (Patent application and reexamination processing fees)

File Listing:					
Document Number	Document Description	File Name	File Size(Bytes)/ Message Digest	Multi Part /.zip	Pages (if appl.)
1		IDS_DIGIF_001C1_08_03_2015.pdf	197803 fa85930406d4fcc07a9224b729b559dddcb5a14f	yes	4
	Multipart Description/PDF files in .zip description				
	Document Description		Start		End
	Transmittal Letter		1		2
	Information Disclosure Statement (IDS) Form (SB08)		3		4
Warnings:					
Information:					
2	Foreign Reference	Ref44_Ketchpel_U_PAI_1996.pdf	1651947 4b63607eda118f5a951c977ab8f89fc2867fa601	no	17
Warnings:					
Information:					
3	Foreign Reference	Ref45_Moberg_MIME_Based_July_2005.pdf	3541379 076126a8cc567e0a04610824d48a06aad446f5ca	no	47
Warnings:					
Information:					
4	Foreign Reference	Ref46_Abrazhevich_Elec_Pay_Sys_2004.pdf	15745553 1297206b1690e9c4399031d7d4378c7554750e34	no	202
Warnings:					
Information:					
5	Fee Worksheet (SB06)	fee-info.pdf	30527 5f45167d8a51d8a981f8ada294e4f7797280d33	no	2
Warnings:					
Information:					
Total Files Size (in bytes):			21167209		

This Acknowledgement Receipt evidences receipt on the noted date by the USPTO of the indicated documents, characterized by the applicant, and including page counts, where applicable. It serves as evidence of receipt similar to a Post Card, as described in MPEP 503.

New Applications Under 35 U.S.C. 111

If a new application is being filed and the application includes the necessary components for a filing date (see 37 CFR 1.53(b)-(d) and MPEP 506), a Filing Receipt (37 CFR 1.54) will be issued in due course and the date shown on this Acknowledgement Receipt will establish the filing date of the application.

National Stage of an International Application under 35 U.S.C. 371

If a timely submission to enter the national stage of an international application is compliant with the conditions of 35 U.S.C. 371 and other applicable requirements a Form PCT/DO/EO/903 indicating acceptance of the application as a national stage submission under 35 U.S.C. 371 will be issued in addition to the Filing Receipt, in due course.

New International Application Filed with the USPTO as a Receiving Office

If a new international application is being filed and the international application includes the necessary components for an international filing date (see PCT Article 11 and MPEP 1810), a Notification of the International Application Number and of the International Filing Date (Form PCT/RO/105) will be issued in due course, subject to prescriptions concerning national security, and the date shown on this Acknowledgement Receipt will establish the international filing date of the application.

INFORMATION DISCLOSURE STATEMENT

Inventor	:	Clay Perreault, et al.
App. No.	:	13/966,096
Filed	:	August 13, 2013
For	:	PRODUCING ROUTING MESSAGES FOR VOICE OVER IP COMMUNICATIONS
Examiner	:	Sing, Simon P.
Art Unit	:	2653
Conf. No.	:	8712

Commissioner for Patents
P.O. Box 1450
Alexandria, VA 22313-1450

References and Listing

Pursuant to 37 CFR 1.56, an Information Disclosure Statement listing references is provided herewith. Copies of any listed foreign and non-patent literature references are being submitted.

No Disclaimers

To the extent that anything in the Information Disclosure Statement or the listed references could be construed as a disclaimer of any subject matter supported by the present application, Applicant hereby rescinds and retracts such disclaimer.

Timing of Disclosure

This Information Disclosure Statement is being filed after receipt of a First Office Action, but before the mailing date of a Final Action and before the mailing date of a Notice of Allowance. This Statement is accompanied by the fees set forth in 37 CFR 1.17(p). The

Application No.: 13/966,096
Filing Date: August 13, 2013

Commissioner is hereby authorized to charge any additional fees which may be required or to credit any overpayment to Account No. 11-1410.

Respectfully submitted,
KNOBBE, MARTENS, OLSON & BEAR, LLP

Dated: 8/3/2015

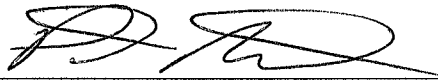
By: 
Paul Brockland
Registration No. 61,130
Attorney of Record
Customer No. 20995
(858) 707-4000

IDS
21273187
080315

INFORMATION DISCLOSURE STATEMENT BY APPLICANT	Application No.	13/966,096	
	Filing Date	August 13, 2013	
	First Named Inventor	Perreault, Clay	
	Art Unit	2653	
<i>(Multiple sheets used when necessary)</i>		Examiner	Sing, Simon P.
SHEET 1 OF 2		Attorney Docket No.	DIGIF.001C1

U.S. PATENT DOCUMENTS					
Examiner Initials	Cite No.	Document Number Number - Kind Code (if known) Example: 1,234,567 B1	Publication Date MM-DD-YYYY	Name	Pages, Columns, Lines Where Relevant Passages or Relevant Figures Appear
	1	5,677,955 A1	10-14-1995	Doggett et al.	
	2	5,883,810 A1	03-16-1999	Franklin et al.	
	3	6,173,272 B1	01-09-2001	Thomas et al.	
	4	6,243,689 B1	06-05-2001	Norton, Robert G.	
	5	6,636,833 B1	10-21-2003	Fitcroft et al.	
	6	6,772,188 B1	08-03-2004	Cheng-Sheng et al.	
	7	6,892,184 B1	05-10-2005	Komen et al.	
	8	7,051,072 B2	05-23-2006	Stewart et al.	
	9	7,330,835 B2	02-12-2008	Deggendorf, Theresa M.	
	10	7,426,492 B2	09-16-2008	Bishop et al.	
	11	7,437,665 B2	10-14-2008	Perham, Michael	
	12	7,447,707 B2	11-04-2008	Gaurav et al.	
	13	7,580,886 B1	08-25-2009	Schulz, Larry	
	14	7,593,884 B2	09-22-2009	Rothman et al.	
	15	7,599,944 B2	10-06-2009	Gaurav et al.	
	16	7,644,037 B1	01-05-2010	Ostrovsky, Vladimir	
	17	7,647,500 B2	01-12-2010	Machiraju et al.	
	18	7,676,431 B2	03-09-2010	O'Leary et al.	
	19	7,680,737 B2	03-16-2010	Smith et al.	
	20	7,734,544 B2	06-08-2010	Schleicher, Joerg	
	21	7,765,261 B2	07-27-2010	Kropivny, Alexander	
	22	7,765,266 B2	07-27-2010	Kropivny, Alexander	
	23	7,882,011 B2	02-01-2011	Sandhu et al.	
	24	7,899,742 B2	03-11-2011	Berkert et al.	
	25	8,060,887 B2	11-15-2011	Kropivny, Alexander	
	26	8,161,078 B2	04-17-2012	Gaurav et al.	
	27	8,200,575 B2	06-12-2012	Torres et al.	
	28	8,543,477 B2	09-24-2013	Love et al.	
	29	8,627,211 B2	01-07-2014	Kropivny, Alexander	

Examiner Signature	Date Considered
*Examiner: Initial if reference considered, whether or not citation is in conformance with MPEP 609. Draw line through citation if not in conformance and not considered. Include copy of this form with next communication to applicant.	

T¹ - Place a check mark in this area when an English language Translation is attached. AT&T, Exh. 1002, p. 417

INFORMATION DISCLOSURE STATEMENT BY APPLICANT	Application No.	13/966,096	
	Filing Date	August 13, 2013	
	First Named Inventor	Perreault, Clay	
	Art Unit	2653	
<i>(Multiple sheets used when necessary)</i>		Examiner	Sing, Simon P.
SHEET 2 OF 2		Attorney Docket No.	DIGIF.001C1

U.S. PATENT DOCUMENTS					
Examiner Initials	Cite No.	Document Number Number - Kind Code (if known) Example: 1,234,567 B1	Publication Date MM-DD-YYYY	Name	Pages, Columns, Lines Where Relevant Passages or Relevant Figures Appear
	30	8,702,505 B2	04-22-2014	Kropivny, Alexander	
	31	2005/0131813 A1	06-16-2005	Gallagher et al.	
	32	2005/0171898 A1	08-04-2005	Bishop et al.	
	33	2005/0192897 A1	09-01-2005	Rogers et al.	
	34	2005/0192901 A1	09-01-2005	McCoy et al.	
	35	2005/0222952 A1	10-06-2005	Garrett et al.	
	36	2005/0267842 A1	12-01-2005	Weichert et al.	
	37	2006/0006224 A1	01-12-2006	Modi, Vikram	
	38	2006/0036522 A1	02-15-2006	Perham, Michael	
	39	2006/0095320 A1	05-04-2006	Jones, Lisa	
	40	2006/0116892 A1	06-01-2006	Grimes et al.	
	41	2006/0195398 A1	08-31-2006	Dheer et al.	
	42	2007/0016524 A1	01-18-2007	Diveley, et al.	
	43	2014/0141884 A1	05-22-2014	Kropivny, Alexander	

FOREIGN PATENT DOCUMENTS						
Examiner Initials	Cite No.	Foreign Patent Document Country Code-Number-Kind Code Example: JP 1234567 A1	Publication Date MM-DD-YYYY	Name	Pages, Columns, Lines Where Relevant Passages or Relevant Figures Appear	T ¹

NON PATENT LITERATURE DOCUMENTS			
Examiner Initials	Cite No.	Include name of the author (in CAPITAL LETTERS), title of the article (when appropriate), title of the item (book, magazine, journal, serial, symposium, catalog, etc.), date, page(s), volume-issue number(s), publisher, city and/or country where published.	T ¹
	44	Ketchpel et al. "U-PAI: A universal payment application interface" <i>Second USENIX Workshop on Electronic Commerce Proceedings</i> , 1996-8, pages 1-17.	
	45	Moberg & Drummond, "MIME-Based Secure Peer-to-Peer Business Data Interchange Using HTTP, Applicability Statement 2 (AS2)," <i>Network Working Group, Request for Comments: 4130, Category: Standards Track</i> , Copyright © The Internet Society July 2005, pages 1-47.	
	46	Abrazhevich, Dennis. "Electronic Payment Systems: a User-Centered Perspective and Interaction Design," <i>Thesis under the auspices of the J.F. Schouten School for User-System Interaction Research</i> , Technische Universiteit Eindhoven, Netherlands, 2004, pages Cover page - page 189.	

21269338
080315

Examiner Signature	Date Considered
--------------------	-----------------

*Examiner: Initial if reference considered, whether or not citation is in conformance with MPEP 609. Draw line through citation if not in conformance and not considered. Include copy of this form with next communication to applicant.

T¹ - Place a check mark in this area when an English language Translation is attached.

Electronic Patent Application Fee Transmittal

Application Number:	13966096
Filing Date:	13-Aug-2013
Title of Invention:	PRODUCING ROUTING MESSAGES FOR VOICE OVER IP COMMUNICATIONS
First Named Inventor/Applicant Name:	CLAY PERREAULT
Filer:	Paul S. Brockland/Norman Green
Attorney Docket Number:	DIGIF.001C1

Filed as Small Entity

Filing Fees for Utility under 35 USC 111(a)

Description	Fee Code	Quantity	Amount	Sub-Total in USD(\$)
Basic Filing:				
Pages:				
Claims:				
Miscellaneous-Filing:				
Petition:				
Patent-Appeals-and-Interference:				
Post-Allowance-and-Post-Issuance:				
Extension-of-Time:				

Description	Fee Code	Quantity	Amount	Sub-Total in USD(\$)
Miscellaneous:				
Submission- Information Disclosure Stmt	2806	1	90	90
Total in USD (\$)				90

Electronic Acknowledgement Receipt

EFS ID:	23102375
Application Number:	13966096
International Application Number:	
Confirmation Number:	8712
Title of Invention:	PRODUCING ROUTING MESSAGES FOR VOICE OVER IP COMMUNICATIONS
First Named Inventor/Applicant Name:	CLAY PERREAULT
Customer Number:	20995
Filer:	Paul S. Brockland/Norman Green
Filer Authorized By:	Paul S. Brockland
Attorney Docket Number:	DIGIF.001C1
Receipt Date:	03-AUG-2015
Filing Date:	13-AUG-2013
Time Stamp:	19:13:59
Application Type:	Utility under 35 USC 111(a)

Payment information:

Submitted with Payment	no
------------------------	----

File Listing:

Document Number	Document Description	File Name	File Size(Bytes)/ Message Digest	Multi Part /.zip	Pages (if appl.)
1		IDS_DIGIF_001C1_08_03_2015.pdf	197803 fa85930406d4fcc07a9224b729b559dddcb5a14f	yes	4

Multipart Description/PDF files in .zip description					
Document Description			Start	End	
Transmittal Letter			1	2	
Information Disclosure Statement (IDS) Form (SB08)			3	4	
Warnings:					
Information:					
2	Non Patent Literature	Ref44_Ketchpel_U_PAI_1996.pdf	1651947 4b63607eda118f5a951c977ab8f89fc2867fa601	no	17
Warnings:					
Information:					
3	Non Patent Literature	Ref45_Moberg_MIME_Based_July_2005.pdf	3541379 076126a8cc567e0a04610824d48a06aad446f5ca	no	47
Warnings:					
Information:					
4	Non Patent Literature	Ref46_Abrazhevich_Elec_Pay_Sys_2004.pdf	15745553 1297206b1690e9c4399031d7d4378c7554750e34	no	202
Warnings:					
Information:					
5	Fee Worksheet (SB06)	fee-info.pdf	30527 0d6a55393d7f48a157ca028958053b76a2da9813	no	2
Warnings:					
Information:					
Total Files Size (in bytes):			21167209		

This Acknowledgement Receipt evidences receipt on the noted date by the USPTO of the indicated documents, characterized by the applicant, and including page counts, where applicable. It serves as evidence of receipt similar to a Post Card, as described in MPEP 503.

New Applications Under 35 U.S.C. 111

If a new application is being filed and the application includes the necessary components for a filing date (see 37 CFR 1.53(b)-(d) and MPEP 506), a Filing Receipt (37 CFR 1.54) will be issued in due course and the date shown on this Acknowledgement Receipt will establish the filing date of the application.

National Stage of an International Application under 35 U.S.C. 371

If a timely submission to enter the national stage of an international application is compliant with the conditions of 35 U.S.C. 371 and other applicable requirements a Form PCT/DO/EO/903 indicating acceptance of the application as a national stage submission under 35 U.S.C. 371 will be issued in addition to the Filing Receipt, in due course.

New International Application Filed with the USPTO as a Receiving Office

If a new international application is being filed and the international application includes the necessary components for an international filing date (see PCT Article 11 and MPEP 1810), a Notification of the International Application Number and of the International Filing Date (Form PCT/RO/105) will be issued in due course, subject to prescriptions concerning national security, and the date shown on this Acknowledgement Receipt will establish the international filing date of the application.

INFORMATION DISCLOSURE STATEMENT

Inventor	:	Clay Perreault, et al.
App. No.	:	13/966,096
Filed	:	August 13, 2013
For	:	PRODUCING ROUTING MESSAGES FOR VOICE OVER IP COMMUNICATIONS
Examiner	:	Sing, Simon P.
Art Unit	:	2653
Conf. No.	:	8712

Commissioner for Patents
P.O. Box 1450
Alexandria, VA 22313-1450

References and Listing

Pursuant to 37 CFR 1.56, an Information Disclosure Statement listing references is provided herewith. Copies of any listed foreign and non-patent literature references are being submitted.

No Disclaimers

To the extent that anything in the Information Disclosure Statement or the listed references could be construed as a disclaimer of any subject matter supported by the present application, Applicant hereby rescinds and retracts such disclaimer.

Timing of Disclosure

This Information Disclosure Statement is being filed after receipt of a First Office Action, but before the mailing date of a Final Action and before the mailing date of a Notice of Allowance. This Statement is accompanied by the fees set forth in 37 CFR 1.17(p). The

Application No.: 13/966,096
Filing Date: August 13, 2013

Commissioner is hereby authorized to charge any additional fees which may be required or to credit any overpayment to Account No. 11-1410.

Respectfully submitted,
KNOBBE, MARTENS, OLSON & BEAR, LLP

Dated: 8/3/2015

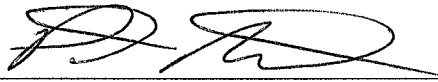
By: 
Paul Brockland
Registration No. 61,130
Attorney of Record
Customer No. 20995
(858) 707-4000

IDS
21273187
080315



NOTICE OF ALLOWANCE AND FEE(S) DUE

20995 7590 08/13/2015
KNOBBE MARTENS OLSON & BEAR LLP
2040 MAIN STREET
FOURTEENTH FLOOR
IRVINE, CA 92614

Table with 2 columns: EXAMINER (SING, SIMON P), ART UNIT (2653), PAPER NUMBER (8712)

DATE MAILED: 08/13/2015

Table with 5 columns: APPLICATION NO., FILING DATE, FIRST NAMED INVENTOR, ATTORNEY DOCKET NO., CONFIRMATION NO.

TITLE OF INVENTION: PRODUCING ROUTING MESSAGES FOR VOICE OVER IP COMMUNICATIONS

Table with 7 columns: APPLN. TYPE, ENTITY STATUS, ISSUE FEE DUE, PUBLICATION FEE DUE, PREV. PAID ISSUE FEE, TOTAL FEE(S) DUE, DATE DUE

THE APPLICATION IDENTIFIED ABOVE HAS BEEN EXAMINED AND IS ALLOWED FOR ISSUANCE AS A PATENT. PROSECUTION ON THE MERITS IS CLOSED. THIS NOTICE OF ALLOWANCE IS NOT A GRANT OF PATENT RIGHTS. THIS APPLICATION IS SUBJECT TO WITHDRAWAL FROM ISSUE AT THE INITIATIVE OF THE OFFICE OR UPON PETITION BY THE APPLICANT. SEE 37 CFR 1.313 AND MPEP 1308.

THE ISSUE FEE AND PUBLICATION FEE (IF REQUIRED) MUST BE PAID WITHIN THREE MONTHS FROM THE MAILING DATE OF THIS NOTICE OR THIS APPLICATION SHALL BE REGARDED AS ABANDONED. THIS STATUTORY PERIOD CANNOT BE EXTENDED. SEE 35 U.S.C. 151. THE ISSUE FEE DUE INDICATED ABOVE DOES NOT REFLECT A CREDIT FOR ANY PREVIOUSLY PAID ISSUE FEE IN THIS APPLICATION. IF AN ISSUE FEE HAS PREVIOUSLY BEEN PAID IN THIS APPLICATION (AS SHOWN ABOVE), THE RETURN OF PART B OF THIS FORM WILL BE CONSIDERED A REQUEST TO REAPPLY THE PREVIOUSLY PAID ISSUE FEE TOWARD THE ISSUE FEE NOW DUE.

HOW TO REPLY TO THIS NOTICE:

I. Review the ENTITY STATUS shown above. If the ENTITY STATUS is shown as SMALL or MICRO, verify whether entitlement to that entity status still applies.

If the ENTITY STATUS is the same as shown above, pay the TOTAL FEE(S) DUE shown above.

If the ENTITY STATUS is changed from that shown above, on PART B - FEE(S) TRANSMITTAL, complete section number 5 titled "Change in Entity Status (from status indicated above)".

For purposes of this notice, small entity fees are 1/2 the amount of undiscounted fees, and micro entity fees are 1/2 the amount of small entity fees.

II. PART B - FEE(S) TRANSMITTAL, or its equivalent, must be completed and returned to the United States Patent and Trademark Office (USPTO) with your ISSUE FEE and PUBLICATION FEE (if required). If you are charging the fee(s) to your deposit account, section "4b" of Part B - Fee(s) Transmittal should be completed and an extra copy of the form should be submitted. If an equivalent of Part B is filed, a request to reapply a previously paid issue fee must be clearly made, and delays in processing may occur due to the difficulty in recognizing the paper as an equivalent of Part B.

III. All communications regarding this application must give the application number. Please direct all communications prior to issuance to Mail Stop ISSUE FEE unless advised to the contrary.

IMPORTANT REMINDER: Utility patents issuing on applications filed on or after Dec. 12, 1980 may require payment of maintenance fees. It is patentee's responsibility to ensure timely payment of maintenance fees when due.

PART B - FEE(S) TRANSMITTAL

**Complete and send this form, together with applicable fee(s), to: Mail Mail Stop ISSUE FEE
 Commissioner for Patents
 P.O. Box 1450
 Alexandria, Virginia 22313-1450
 or Fax (571)-273-2885**

INSTRUCTIONS: This form should be used for transmitting the ISSUE FEE and PUBLICATION FEE (if required). Blocks 1 through 5 should be completed where appropriate. All further correspondence including the Patent, advance orders and notification of maintenance fees will be mailed to the current correspondence address as indicated unless corrected below or directed otherwise in Block 1, by (a) specifying a new correspondence address; and/or (b) indicating a separate "FEE ADDRESS" for maintenance fee notifications.

CURRENT CORRESPONDENCE ADDRESS (Note: Use Block 1 for any change of address)

Note: A certificate of mailing can only be used for domestic mailings of the Fee(s) Transmittal. This certificate cannot be used for any other accompanying papers. Each additional paper, such as an assignment or formal drawing, must have its own certificate of mailing or transmission.

20995 7590 08/13/2015
KNOBBE MARTENS OLSON & BEAR LLP
 2040 MAIN STREET
 FOURTEENTH FLOOR
 IRVINE, CA 92614

Certificate of Mailing or Transmission

I hereby certify that this Fee(s) Transmittal is being deposited with the United States Postal Service with sufficient postage for first class mail in an envelope addressed to the Mail Stop ISSUE FEE address above, or being facsimile transmitted to the USPTO (571) 273-2885, on the date indicated below.

(Depositor's name)
(Signature)
(Date)

APPLICATION NO.	FILING DATE	FIRST NAMED INVENTOR	ATTORNEY DOCKET NO.	CONFIRMATION NO.
13/966,096	08/13/2013	CLAY PERREAULT	DIGIF.001C1	8712

TITLE OF INVENTION: PRODUCING ROUTING MESSAGES FOR VOICE OVER IP COMMUNICATIONS

APPLN. TYPE	ENTITY STATUS	ISSUE FEE DUE	PUBLICATION FEE DUE	PREV. PAID ISSUE FEE	TOTAL FEE(S) DUE	DATE DUE
nonprovisional	SMALL	\$480	\$0	\$0	\$480	11/13/2015

EXAMINER	ART UNIT	CLASS-SUBCLASS
SING, SIMON P	2653	379-142040

<p>1. Change of correspondence address or indication of "Fee Address" (37 CFR 1.363).</p> <p><input type="checkbox"/> Change of correspondence address (or Change of Correspondence Address form PTO/SB/122) attached.</p> <p><input type="checkbox"/> "Fee Address" indication (or "Fee Address" Indication form PTO/SB/47; Rev 03-02 or more recent) attached. Use of a Customer Number is required.</p>	<p>2. For printing on the patent front page, list</p> <p>(1) The names of up to 3 registered patent attorneys or agents OR, alternatively, _____ 1</p> <p>(2) The name of a single firm (having as a member a registered attorney or agent) and the names of up to 2 registered patent attorneys or agents. If no name is listed, no name will be printed. _____ 2</p> <p>_____ 3</p>
---	---

3. ASSIGNEE NAME AND RESIDENCE DATA TO BE PRINTED ON THE PATENT (print or type)

PLEASE NOTE: Unless an assignee is identified below, no assignee data will appear on the patent. If an assignee is identified below, the document has been filed for recordation as set forth in 37 CFR 3.11. Completion of this form is NOT a substitute for filing an assignment.

(A) NAME OF ASSIGNEE _____ (B) RESIDENCE: (CITY and STATE OR COUNTRY) _____

Please check the appropriate assignee category or categories (will not be printed on the patent) : Individual Corporation or other private group entity Government

<p>4a. The following fee(s) are submitted:</p> <p><input type="checkbox"/> Issue Fee</p> <p><input type="checkbox"/> Publication Fee (No small entity discount permitted)</p> <p><input type="checkbox"/> Advance Order - # of Copies _____</p>	<p>4b. Payment of Fee(s): (Please first reapply any previously paid issue fee shown above)</p> <p><input type="checkbox"/> A check is enclosed.</p> <p><input type="checkbox"/> Payment by credit card. Form PTO-2038 is attached.</p> <p><input type="checkbox"/> The director is hereby authorized to charge the required fee(s), any deficiency, or credits any overpayment, to Deposit Account Number _____ (enclose an extra copy of this form).</p>
---	--

5. **Change in Entity Status** (from status indicated above)

Applicant certifying micro entity status. See 37 CFR 1.29

Applicant asserting small entity status. See 37 CFR 1.27

Applicant changing to regular undiscounted fee status.

NOTE: Absent a valid certification of Micro Entity Status (see forms PTO/SB/15A and 15B), issue fee payment in the micro entity amount will not be accepted at the risk of application abandonment.

NOTE: If the application was previously under micro entity status, checking this box will be taken to be a notification of loss of entitlement to micro entity status.

NOTE: Checking this box will be taken to be a notification of loss of entitlement to small or micro entity status, as applicable.

NOTE: This form must be signed in accordance with 37 CFR 1.31 and 1.33. See 37 CFR 1.4 for signature requirements and certifications.

Authorized Signature _____ Date _____

Typed or printed name _____ Registration No. _____



UNITED STATES DEPARTMENT OF COMMERCE
United States Patent and Trademark Office
Address: COMMISSIONER FOR PATENTS
P.O. Box 1450
Alexandria, Virginia 22313-1450
www.uspto.gov

Table with 5 columns: APPLICATION NO., FILING DATE, FIRST NAMED INVENTOR, ATTORNEY DOCKET NO., CONFIRMATION NO.
13/966,096 08/13/2013 CLAY PERREAULT DIGIF.001C1 8712

20995 7590 08/13/2015
KNOBBE MARTENS OLSON & BEAR LLP
2040 MAIN STREET
FOURTEENTH FLOOR
IRVINE, CA 92614

EXAMINER

SING, SIMON P

ART UNIT PAPER NUMBER

2653

DATE MAILED: 08/13/2015

Determination of Patent Term Adjustment under 35 U.S.C. 154 (b)
(Applications filed on or after May 29, 2000)

The Office has discontinued providing a Patent Term Adjustment (PTA) calculation with the Notice of Allowance.

Section 1(h)(2) of the AIA Technical Corrections Act amended 35 U.S.C. 154(b)(3)(B)(i) to eliminate the requirement that the Office provide a patent term adjustment determination with the notice of allowance. See Revisions to Patent Term Adjustment, 78 Fed. Reg. 19416, 19417 (Apr. 1, 2013). Therefore, the Office is no longer providing an initial patent term adjustment determination with the notice of allowance. The Office will continue to provide a patent term adjustment determination with the Issue Notification Letter that is mailed to applicant approximately three weeks prior to the issue date of the patent, and will include the patent term adjustment on the patent. Any request for reconsideration of the patent term adjustment determination (or reinstatement of patent term adjustment) should follow the process outlined in 37 CFR 1.705.

Any questions regarding the Patent Term Extension or Adjustment determination should be directed to the Office of Patent Legal Administration at (571)-272-7702. Questions relating to issue and publication fee payments should be directed to the Customer Service Center of the Office of Patent Publication at 1-(888)-786-0101 or (571)-272-4200.

OMB Clearance and PRA Burden Statement for PTOL-85 Part B

The Paperwork Reduction Act (PRA) of 1995 requires Federal agencies to obtain Office of Management and Budget approval before requesting most types of information from the public. When OMB approves an agency request to collect information from the public, OMB (i) provides a valid OMB Control Number and expiration date for the agency to display on the instrument that will be used to collect the information and (ii) requires the agency to inform the public about the OMB Control Number's legal significance in accordance with 5 CFR 1320.5(b).

The information collected by PTOL-85 Part B is required by 37 CFR 1.311. The information is required to obtain or retain a benefit by the public which is to file (and by the USPTO to process) an application. Confidentiality is governed by 35 U.S.C. 122 and 37 CFR 1.14. This collection is estimated to take 12 minutes to complete, including gathering, preparing, and submitting the completed application form to the USPTO. Time will vary depending upon the individual case. Any comments on the amount of time you require to complete this form and/or suggestions for reducing this burden, should be sent to the Chief Information Officer, U.S. Patent and Trademark Office, U.S. Department of Commerce, P.O. Box 1450, Alexandria, Virginia 22313-1450. DO NOT SEND FEES OR COMPLETED FORMS TO THIS ADDRESS. SEND TO: Commissioner for Patents, P.O. Box 1450, Alexandria, Virginia 22313-1450. Under the Paperwork Reduction Act of 1995, no persons are required to respond to a collection of information unless it displays a valid OMB control number.

Privacy Act Statement

The Privacy Act of 1974 (P.L. 93-579) requires that you be given certain information in connection with your submission of the attached form related to a patent application or patent. Accordingly, pursuant to the requirements of the Act, please be advised that: (1) the general authority for the collection of this information is 35 U.S.C. 2(b)(2); (2) furnishing of the information solicited is voluntary; and (3) the principal purpose for which the information is used by the U.S. Patent and Trademark Office is to process and/or examine your submission related to a patent application or patent. If you do not furnish the requested information, the U.S. Patent and Trademark Office may not be able to process and/or examine your submission, which may result in termination of proceedings or abandonment of the application or expiration of the patent.

The information provided by you in this form will be subject to the following routine uses:

1. The information on this form will be treated confidentially to the extent allowed under the Freedom of Information Act (5 U.S.C. 552) and the Privacy Act (5 U.S.C. 552a). Records from this system of records may be disclosed to the Department of Justice to determine whether disclosure of these records is required by the Freedom of Information Act.
2. A record from this system of records may be disclosed, as a routine use, in the course of presenting evidence to a court, magistrate, or administrative tribunal, including disclosures to opposing counsel in the course of settlement negotiations.
3. A record in this system of records may be disclosed, as a routine use, to a Member of Congress submitting a request involving an individual, to whom the record pertains, when the individual has requested assistance from the Member with respect to the subject matter of the record.
4. A record in this system of records may be disclosed, as a routine use, to a contractor of the Agency having need for the information in order to perform a contract. Recipients of information shall be required to comply with the requirements of the Privacy Act of 1974, as amended, pursuant to 5 U.S.C. 552a(m).
5. A record related to an International Application filed under the Patent Cooperation Treaty in this system of records may be disclosed, as a routine use, to the International Bureau of the World Intellectual Property Organization, pursuant to the Patent Cooperation Treaty.
6. A record in this system of records may be disclosed, as a routine use, to another federal agency for purposes of National Security review (35 U.S.C. 181) and for review pursuant to the Atomic Energy Act (42 U.S.C. 218(c)).
7. A record from this system of records may be disclosed, as a routine use, to the Administrator, General Services, or his/her designee, during an inspection of records conducted by GSA as part of that agency's responsibility to recommend improvements in records management practices and programs, under authority of 44 U.S.C. 2904 and 2906. Such disclosure shall be made in accordance with the GSA regulations governing inspection of records for this purpose, and any other relevant (i.e., GSA or Commerce) directive. Such disclosure shall not be used to make determinations about individuals.
8. A record from this system of records may be disclosed, as a routine use, to the public after either publication of the application pursuant to 35 U.S.C. 122(b) or issuance of a patent pursuant to 35 U.S.C. 151. Further, a record may be disclosed, subject to the limitations of 37 CFR 1.14, as a routine use, to the public if the record was filed in an application which became abandoned or in which the proceedings were terminated and which application is referenced by either a published application, an application open to public inspection or an issued patent.
9. A record from this system of records may be disclosed, as a routine use, to a Federal, State, or local law enforcement agency, if the USPTO becomes aware of a violation or potential violation of law or regulation.

Notice of Allowability	Application No. 13/966,096	Applicant(s) PERREAULT ET AL.	
	Examiner SIMON SING	Art Unit 2653	AIA (First Inventor to File) Status No

-- The MAILING DATE of this communication appears on the cover sheet with the correspondence address--

All claims being allowable, PROSECUTION ON THE MERITS IS (OR REMAINS) CLOSED in this application. If not included herewith (or previously mailed), a Notice of Allowance (PTOL-85) or other appropriate communication will be mailed in due course. **THIS NOTICE OF ALLOWABILITY IS NOT A GRANT OF PATENT RIGHTS.** This application is subject to withdrawal from issue at the initiative of the Office or upon petition by the applicant. See 37 CFR 1.313 and MPEP 1308.

1. This communication is responsive to terminal disclaimer filed on 06/29/2015.
 A declaration(s)/affidavit(s) under **37 CFR 1.130(b)** was/were filed on _____.
2. An election was made by the applicant in response to a restriction requirement set forth during the interview on _____; the restriction requirement and election have been incorporated into this action.
3. The allowed claim(s) is/are 1-73 and 79-104. As a result of the allowed claim(s), you may be eligible to benefit from the **Patent Prosecution Highway** program at a participating intellectual property office for the corresponding application. For more information, please see http://www.uspto.gov/patents/init_events/oph/index.jsp or send an inquiry to PPHfeedback@uspto.gov.
4. Acknowledgment is made of a claim for foreign priority under 35 U.S.C. § 119(a)-(d) or (f).

Certified copies:

- a) All b) Some *c) None of the:
1. Certified copies of the priority documents have been received.
 2. Certified copies of the priority documents have been received in Application No. _____.
 3. Copies of the certified copies of the priority documents have been received in this national stage application from the International Bureau (PCT Rule 17.2(a)).

* Certified copies not received: _____.

Applicant has THREE MONTHS FROM THE "MAILING DATE" of this communication to file a reply complying with the requirements noted below. Failure to timely comply will result in ABANDONMENT of this application.

THIS THREE-MONTH PERIOD IS NOT EXTENDABLE.

5. CORRECTED DRAWINGS (as "replacement sheets") must be submitted.
 including changes required by the attached Examiner's Amendment / Comment or in the Office action of Paper No./Mail Date _____.
Identifying indicia such as the application number (see 37 CFR 1.84(c)) should be written on the drawings in the front (not the back) of each sheet. Replacement sheet(s) should be labeled as such in the header according to 37 CFR 1.121(d).
6. DEPOSIT OF and/or INFORMATION about the deposit of BIOLOGICAL MATERIAL must be submitted. Note the attached Examiner's comment regarding REQUIREMENT FOR THE DEPOSIT OF BIOLOGICAL MATERIAL.

Attachment(s)

- | | |
|---|---|
| <ol style="list-style-type: none"> 1. <input type="checkbox"/> Notice of References Cited (PTO-892) 2. <input checked="" type="checkbox"/> Information Disclosure Statements (PTO/SB/08),
Paper No./Mail Date <u>05/15/15, 06/11/15, 06/25/15, 06/30/15</u> 3. <input type="checkbox"/> Examiner's Comment Regarding Requirement for Deposit of Biological Material 4. <input type="checkbox"/> Interview Summary (PTO-413),
Paper No./Mail Date _____. | <ol style="list-style-type: none"> 5. <input type="checkbox"/> Examiner's Amendment/Comment 6. <input type="checkbox"/> Examiner's Statement of Reasons for Allowance 7. <input type="checkbox"/> Other _____. |
|---|---|

/SIMON SING/
Primary Examiner, Art Unit 2653

Issue Classification 	Application/Control No. 13966096	Applicant(s)/Patent Under Reexamination PERREAULT ET AL.	
	Examiner SIMON SING	Art Unit 2653	

CPC						
Symbol					Type	Version
H04M		15		51	F	2013-01-01
H04L		9		3226	I	2013-01-01
H04L		12		14	I	2013-01-01
H04L		12		1439	I	2013-01-01
H04L		12		1496	I	2013-01-01
H04L		12		66	I	2013-01-01
H04Q		3		66	I	2013-01-01
H04Q		3		70	I	2013-01-01
H04Q		2213		13091	A	2013-01-01
H04Q		2213		13141	A	2013-01-01
H04Q		2213		13196	A	2013-01-01
H04Q		2213		1322	A	2013-01-01
H04Q		2213		13384	A	2013-01-01
H04M		7		0075	I	2013-01-01
H04M		15		56	I	2013-01-01

CPC Combination Sets				
Symbol	Type	Set	Ranking	Version

NONE		Total Claims Allowed:	
(Assistant Examiner)	(Date)	99	
/SIMON SING/ Primary Examiner.Art Unit 2653	08/01/2015	O.G. Print Claim(s)	O.G. Print Figure
(Primary Examiner)	(Date)	1	1

Issue Classification 	Application/Control No. 13966096	Applicant(s)/Patent Under Reexamination PERREAULT ET AL.
	Examiner SIMON SING	Art Unit 2653

<input type="checkbox"/> Claims renumbered in the same order as presented by applicant		<input type="checkbox"/> CPA		<input checked="" type="checkbox"/> T.D.		<input type="checkbox"/> R.1.47									
Final	Original	Final	Original	Final	Original	Final	Original	Final	Original	Final	Original	Final	Original	Final	Original
1	1	17	17	33	33	49	49	65	65	76	81	92	97		
2	2	18	18	34	34	50	50	66	66	77	82	93	98		
3	3	19	19	35	35	51	51	67	67	78	83	94	99		
4	4	20	20	36	36	52	52	68	68	79	84	95	100		
5	5	21	21	37	37	53	53	69	69	80	85	96	101		
6	6	22	22	38	38	54	54	70	70	81	86	97	102		
7	7	23	23	39	39	55	55	71	71	82	87	98	103		
8	8	24	24	40	40	56	56	72	72	83	88	99	104		
9	9	25	25	41	41	57	57	73	73	84	89				
10	10	26	26	42	42	58	58	-	74	85	90				
11	11	27	27	43	43	59	59	-	75	86	91				
12	12	28	28	44	44	60	60	-	76	87	92				
13	13	29	29	45	45	61	61	-	77	88	93				
14	14	30	30	46	46	62	62	-	78	89	94				
15	15	31	31	47	47	63	63	74	79	90	95				
16	16	32	32	48	48	64	64	75	80	91	96				

NONE		Total Claims Allowed:	
(Assistant Examiner)	(Date)	99	
/SIMON SING/ Primary Examiner.Art Unit 2653	08/01/2015	O.G. Print Claim(s)	O.G. Print Figure
(Primary Examiner)	(Date)	1	1

Search Notes 	Application/Control No. 13966096	Applicant(s)/Patent Under Reexamination PERREault ET AL.
	Examiner SIMON SING	Art Unit 2653

CPC- SEARCHED		
Symbol	Date	Examiner
H04M: 1/573, 3/42059; H04Q: 3/0025, 2213/13091	07/31/2015	SS

CPC COMBINATION SETS - SEARCHED		
Symbol	Date	Examiner

US CLASSIFICATION SEARCHED			
Class	Subclass	Date	Examiner

SEARCH NOTES		
Search Notes	Date	Examiner
EAST	04/03/2015	SS
EAST	07/31/2015	SS

INTERFERENCE SEARCH			
US Class/ CPC Symbol	US Subclass / CPC Group	Date	Examiner
H04M	1/573, 3/42059	07/31/2015	SS
H04Q	3/0025, 2213/13091	07/31/2015	SS

--	--

INFORMATION DISCLOSURE STATEMENT BY APPLICANT <i>(Multiple sheets used when necessary)</i> SHEET 1 OF 1	Application No.	13/966,096
	Filing Date	August 13, 2013
	First Named Inventor	Perreault, Clay
	Art Unit	2633
	Examiner	Sing, Simon P.
	Attorney Docket No.	DIGIF.001C1

U.S. PATENT DOCUMENTS					
Examiner Initials	Cite No.	Document Number Number - Kind Code (if known) Example: 1,234,567 B1	Publication Date MM-DD-YYYY	Name	Pages, Columns, Lines Where Relevant Passages or Relevant Figures Appear
/SS/	1	6,327,351 B1	12-04-2001	Walker et al.	
/SS/	2	7,203,478 B2	04-10-2007	Benco et al.	

FOREIGN PATENT DOCUMENTS						
Examiner Initials	Cite No.	Foreign Patent Document Country Code-Number-Kind Code Example: JP 1234567 A1	Publication Date MM-DD-YYYY	Name	Pages, Columns, Lines Where Relevant Passages or Relevant Figures Appear	T ¹

NON PATENT LITERATURE DOCUMENTS			
Examiner Initials	Cite No.	Include name of the author (in CAPITAL LETTERS), title of the article (when appropriate), title of the item (book, magazine, journal, serial, symposium, catalog, etc.), date, page(s), volume-issue number(s), publisher, city and/or country where published.	T ¹

21034262
063015

Examiner Signature	/Simon Sing/	Date Considered	07/31/2015
--------------------	--------------	-----------------	------------

*Examiner: Initial if reference considered, whether or not citation is in conformance with MPEP 609. Draw line through citation if not in conformance and not considered. Include copy of this form with next communication to applicant.

T¹ - Place a check mark in this area when an English language Translation is attached. AT&T, Exh. 1002, p. 435

INFORMATION DISCLOSURE STATEMENT BY APPLICANT	Application No.	13/966,096
	Filing Date	August 13, 2013
	First Named Inventor	Perreault, Clay
	Art Unit	2653
<i>(Multiple sheets used when necessary)</i>	Examiner	Sing, Simon P.
SHEET 1 OF 5	Attorney Docket No.	DIGIF.001C1

U.S. PATENT DOCUMENTS					
Examiner Initials	Cite No.	Document Number <i>Number - Kind Code (if known)</i> Example: 1,234,567 B1	Publication Date MM-DD-YYYY	Name	Pages, Columns, Lines Where Relevant Passages or Relevant Figures Appear
	1	7,958,233 B2	06-07-2011	Gutierrez, Alvaro Fernández	
	2	8,078,164 B2	12-13-2011	Ganesan, Vasudevan	
	3	8,127,005 B2	02-28-2012	Gutierrez, Alvaro Fernández	
	4	8,166,547 B2	04-24-2012	Bevan et al.	
	5	8,190,739 B2	05-29-2012	Gutierrez, Alvaro Fernández	
	6	8,223,927 B2	07-17-2012	Di Serio et al.	
	7	8,300,632 B2	10-30-2012	Davis et al.	
	8	8,315,521 B2	11-20-2012	Leiden et al.	
	9	8,396,445 B2	03-12-2013	Crawford et al.	
	10	8,526,306 B2	09-03-2013	Jungck et al.	
	11	8,542,815 B2	09-24-2013	Perreault et al.	
	12	8,599,747 B1	12-03-2013	Saleem et al.	
	13	8,599,837 B2	12-03-2013	Kyle, Andre B.	
	14	8,634,838 B2	01-21-2014	Hellwig et al.	
	15	8,774,378 B2	07-08-2014	Björzell et al.	
	16	8,819,566 B2	08-26-2014	Mehin et al.	
	17	8,848,887 B2	09-30-2014	Willman et al.	
	18	8,862,701 B2	10-14-2014	Havriluk, George	
	19	8,885,609 B2	11-11-2014	Nix, John A.	
	20	8,903,051 B2	12-02-2014	Li et al.	
	21	8,903,360 B2	12-02-2014	Celi, Jr. et al.	
	22	8,909,556 B2	12-09-2014	Huxham, Horatio Nelson	
	23	8,938,209 B2	01-20-2015	Crawford et al.	
	24	8,938,534 B2	01-20-2015	Le et al.	
	25	8,948,061 B2	02-03-2015	Sridhar, Sriram	
	26	8,972,612 B2	03-03-2015	Le et al.	
	27	8,982,719 B2	03-17-2015	Seetharaman et al.	
	28	8,995,428 B2	03-31-2015	Haster, Lars-Olof	

Examiner Signature	/Simon Sing/	Date Considered	07/31/2015
--------------------	--------------	-----------------	------------

***Examiner:** Initial if reference considered, whether or not citation is in conformance with MPEP 609. Draw line through citation if not in conformance and not considered. Include copy of this form with next communication to applicant.

T¹ - Place a check mark in this area when an English language Translation is attached AT&T, Exh. 1002, p. 436

ALL REFERENCES CONSIDERED EXCEPT WHERE LINED THROUGH. /SS/

INFORMATION DISCLOSURE STATEMENT BY APPLICANT	Application No.	13/966,096	
	Filing Date	August 13, 2013	
	First Named Inventor	Perreault, Clay	
	Art Unit	2653	
<i>(Multiple sheets used when necessary)</i>		Examiner	Sing, Simon P.
SHEET 2 OF 5		Attorney Docket No.	DIGIF.001C1

U.S. PATENT DOCUMENTS					
Examiner Initials	Cite No.	Document Number <i>Number - Kind Code (if known)</i> Example: 1,234,567 B1	Publication Date MM-DD-YYYY	Name	Pages, Columns, Lines Where Relevant Passages or Relevant Figures Appear
	29	9,003,306 B2	04-07-2015	Mehin et al.	
	30	2007/0053382 A1	03-08-2007	Bevan et al.	
	31	2009/0213839 A1	08-27-2009	Davis et al.	
	32	2010/0083364 A1	04-01-2010	Gutierrez, Alvaro Fernández	
	33	2010/0114896 A1	05-06-2010	Clark et al.	
	34	2010/0115018 A1	05-06-2010	Yoon et al.	
	35	2010/0142382 A1	06-10-2010	Jungck et al.	
	36	2010/0220852 A1	09-02-2010	Willman et al.	
	37	2010/0233991 A1	09-16-2010	Crawford et al.	
	38	2010/0278534 A1	11-04-2010	Leiden et al.	
	39	2010/0316195 A1	12-16-2010	Di Serio et al.	
	40	2011/0072095 A1	03-24-2011	Havriluk, George	
	41	2011/0167164 A1	07-07-2011	Gutierrez, Alvaro Fernández	
	42	2011/0208859 A1	08-25-2011	Gutierrez, Alvaro Fernández	
	43	2011/0235543 A1	09-29-2011	Seetharaman et al.	
	44	2011/0273526 A1	11-10-2011	Mehin et al.	
	45	2011/0276903 A1	11-10-2011	Mehin et al.	
	46	2011/0276904 A1	11-10-2011	Mehin et al.	
	47	2011/0292929 A1	12-01-2011	Haster, Lars-Olof	
	48	2012/0089717 A1	04-12-2012	Chen, Yanheng	
	49	2012/0096145 A1	04-19-2012	Le et al.	
	50	2012/0155333 A1	06-21-2012	Yoon et al.	
	51	2012/0195236 A1	08-02-2012	Knight, Eric	
	52	2012/0259975 A1	10-11-2012	Le et al.	
	53	2012/0270554 A1	10-25-2012	Hellwig et al.	
	54	2013/0039226 A1	02-14-2013	Sridhar, Sriram	
	55	2013/0097308 A1	04-18-2013	Le et al.	
	56	2013/0128879 A1	05-23-2013	Kyle, Andre B.	
	57	2013/0148549 A1	06-13-2013	Crawford et al.	

Examiner Signature	/Simon Sing/	Date Considered	07/31/2015
<p>*Examiner: Initial if reference considered, whether or not citation is in conformance with MPEP 609. Draw line through citation if not in conformance and not considered. Include copy of this form with next communication to applicant.</p>			

T¹ - Place a check mark in this area when an English language Translation is attached AT&T, Exh. 1002, p. 437

ALL REFERENCES CONSIDERED EXCEPT WHERE LINED THROUGH. //S/

INFORMATION DISCLOSURE STATEMENT BY APPLICANT	Application No.	13/966,096	
	Filing Date	August 13, 2013	
	First Named Inventor	Perreault, Clay	
	Art Unit	2653	
<i>(Multiple sheets used when necessary)</i>		Examiner	Sing, Simon P.
SHEET 3 OF 5		Attorney Docket No.	DIGIF.001C1

U.S. PATENT DOCUMENTS					
Examiner Initials	Cite No.	Document Number Number - Kind Code (if known) Example: 1,234,567 B1	Publication Date MM-DD-YYYY	Name	Pages, Columns, Lines Where Relevant Passages or Relevant Figures Appear
	58	2013/0173534 A1	07-04-2013	Nelakonda et al.	
	59	2013/0229950 A1	09-05-2013	Björzell et al.	
	60	2013/0287006 A1	10-31-2013	Nix, John A.	
	61	2013/0310002 A1	11-21-2013	Celi, Jr. et al.	
	62	2013/0318166 A1	11-28-2013	Jungck et al.	
	63	2013/0329864 A1	12-12-2013	Björzell et al.	
	64	2014/0010119 A1	01-09-2014	Björzell et al.	
	65	2014/0016764 A1	01-16-2014	Björzell et al.	
	66	2014/0024367 A1	01-23-2014	Björzell et al.	
	67	2014/0153477 A1	06-05-2014	Huttunen et al.	
	68	2014/0215642 A1	07-31-2014	Huxham, Horatio Nelson	
	69	2014/0307858 A1	10-16-2014	Li et al.	
	70	2014/0321333 A1	10-30-2014	Björzell et al.	

FOREIGN PATENT DOCUMENTS						
Examiner Initials	Cite No.	Foreign Patent Document Country Code-Number-Kind Code Example: JP 1234567 A1	Publication Date MM-DD-YYYY	Name	Pages, Columns, Lines Where Relevant Passages or Relevant Figures Appear	T ¹
	71	BR PI 0718312-7 A2	11-26-2013	Digifonica International Ltd	<i>Corresponds to International Publication No. WO 2008-052340 A1 previously disclosed</i>	Abstract
	72	BR PI 0719682-2 A2	01-14-2014	Digifonica International Ltd	<i>Corresponds to International Publication No. WO 2008/064481 A1 previously disclosed</i>	Abstract
	73	CA 2,668,025 A1	05-08-2008	Digifonica International Ltd	<i>Corresponds to International Publication No. WO 2008-052340 A1 previously disclosed</i>	Abstract
	74	CA 2,670,510 A1	06-05-2008	Digifonica International Ltd	<i>Corresponds to International Publication No. WO 2008-064481 A1; previously disclosed</i>	Abstract

Examiner Signature	/Simon Sing/	Date Considered	07/31/2015
--------------------	--------------	-----------------	------------

*Examiner: Initial if reference considered, whether or not citation is in conformance with MPEP 609. Draw line through citation if not in conformance and not considered. Include copy of this form with next communication to applicant.

T¹ - Place a check mark in this area when an English language Translation is attached AT&T, Exh. 1002, p. 438

ALL REFERENCES CONSIDERED EXCEPT WHERE LINED THROUGH. /S/

INFORMATION DISCLOSURE STATEMENT BY APPLICANT	Application No.	13/966,096
	Filing Date	August 13, 2013
	First Named Inventor	Perreault, Clay
	Art Unit	2653
<i>(Multiple sheets used when necessary)</i>	Examiner	Sing, Simon P.
SHEET 4 OF 5	Attorney Docket No.	DIGIF.001C1

FOREIGN PATENT DOCUMENTS						
Examiner Initials	Cite No.	Foreign Patent Document Country Code-Number-Kind Code Example: JP 1234567 A1	Publication Date MM-DD-YYYY	Name	Pages, Columns, Lines Where Relevant Passages or Relevant Figures Appear	T ¹
	75	CA 2,681,984 A1	10-02-2008	Digifonica International Ltd	<i>Corresponds to International Publication No. WO 2008/116296 A1; previously disclosed</i>	Abstract
	76	CA 2,732,148 A1	02-04-2010	Digifonica International Ltd	<i>Corresponds to International Publication No. WO 2010/012090 A2; previously disclosed</i>	Abstract
	77	CA 2,812,174 A1	03-24-2011	Digifonica International Ltd	<i>Corresponds to International Publication No. WO 2011/032256 A1; previously disclosed</i>	Abstract
	78	CN 101584150 A	11-18-2009	Digifonica International Ltd	<i>Corresponds to International Publication No. WO 2008/064481 A1 previously disclosed</i>	Abstract
	79	CN 101584166 A	11-18-2009	Digifonica International Ltd	<i>Corresponds to International Publication No. WO 2008-052340 A1 previously disclosed</i>	Abstract
	80	CN 101605342 A	12-16-2009	ZTE Corp [CN]		Abstract
	81	CN 102457494 A	05-16-2012	China Mobile Comm Corp Sichuan Co Ltd		Abstract
	82	CN 102572123 A	07-11-2012	Chengdu 30RTOM Mobile Comm Co Ltd		Abstract
	83	CN 101605342 B	12-19-2012	ZTE Corp [CN]	<i>Corresponds to Chinese Publication No. CN 101605342 A shown above</i>	
	84	CN 102457494 B	10-01-2014	China Mobile Comm Corp Sichuan Co Ltd	<i>Corresponds to Chinese Publication No. CN 102457494 A shown above</i>	
	85	EP 2 084 868 A0	08-05-2009	Digifonica International Ltd	<i>Corresponds to International Publication No. WO 2008-052340 A1 previously disclosed</i>	Abstract
	86	EP 2 227 048 A1	09-08-2010	France Telecom [FR]		Abstract

Examiner Signature	/Simon Sing/	Date Considered	07/31/2015
--------------------	--------------	-----------------	------------

*Examiner: Initial if reference considered, whether or not citation is in conformance with MPEP 609. Draw line through citation if not in conformance and not considered. Include copy of this form with next communication to applicant.

T¹ - Place a check mark in this area when an English language Translation is attached AT&T, Exh. 1002, p. 439

ALL REFERENCES CONSIDERED EXCEPT WHERE LINED THROUGH. /S/

INFORMATION DISCLOSURE STATEMENT BY APPLICANT	Application No.	13/966,096	
	Filing Date	August 13, 2013	
	First Named Inventor	Perreault, Clay	
	Art Unit	2653	
<i>(Multiple sheets used when necessary)</i>		Examiner	Sing, Simon P.
SHEET 5 OF 5		Attorney Docket No.	DIGIF.001C1

FOREIGN PATENT DOCUMENTS						
Examiner Initials	Cite No.	Foreign Patent Document Country Code-Number-Kind Code Example: JP 1234567 A1	Publication Date MM-DD-YYYY	Name	Pages, Columns, Lines Where Relevant Passages or Relevant Figures Appear	T ¹
	87	EP 2 311 292 A0	04-20-2011	Digifonica International Ltd	<i>Corresponds to International Publication No. WO 2010/012090 A2 previously disclosed</i>	Abstract
	88	EP 2 478 678 A0	07-25-2012	Digifonica International Ltd	<i>Corresponds to International Publication No. WO 2011/032256 A1 previously disclosed</i>	Abstract
	89	KR 10-2009-0086428 (A)	08-12-2009	Digifonica International Ltd	<i>Korean Publication Unavailable Corresponds to International Publication No. WO 2008-052340 A1 previously disclosed</i>	Abstract
	90	KR 10-2009-0095621 (A)	09-09-2009	Digifonica International Ltd	<i>Corresponds to International Publication No. WO 2008-064481 A1 previously disclosed</i>	Abstract
	91	MX 2009005751 A	08-26-2009	Digifonica International Ltd	<i>Corresponds to International Publication No. WO 2008-064481 A1 previously disclosed</i>	Abstract
	92	MX 2009004811 A	08-28-2009	Digifonica International Ltd	<i>Corresponds to International Publication No. WO 2008-052340 A1 previously disclosed</i>	Abstract
	93	WO 2013/013189 A2	01-24-2013	VISA Int Service ASS [US]		

NON PATENT LITERATURE DOCUMENTS			
Examiner Initials	Cite No.	Include name of the author (in CAPITAL LETTERS), title of the article (when appropriate), title of the item (book, magazine, journal, serial, symposium, catalog, etc.), date, page(s), volume-issue number(s), publisher, city and/or country where published.	T ¹

20682667
051415

Examiner Signature	/Simon Sing/	Date Considered	07/31/2015
--------------------	--------------	-----------------	------------

*Examiner: Initial if reference considered, whether or not citation is in conformance with MPEP 609. Draw line through citation if not in conformance and not considered. Include copy of this form with next communication to applicant.

T¹ - Place a check mark in this area when an English language Translation is attached AT&T, Exh. 1002, p. 440

ALL REFERENCES CONSIDERED EXCEPT WHERE LINED THROUGH. /SS/

INFORMATION DISCLOSURE STATEMENT BY APPLICANT	Application No.	13/966,096	
	Filing Date	August 13, 2013	
	First Named Inventor	Perreault, Clay	
	Art Unit	2653	
<i>(Multiple sheets used when necessary)</i>		Examiner	Sing, Simon P.
SHEET 1 OF 2		Attorney Docket No.	DIGIF.001C1

U.S. PATENT DOCUMENTS					
Examiner Initials	Cite No.	Document Number <i>Number - Kind Code (if known)</i> Example: 1,234,567 B1	Publication Date MM-DD-YYYY	Name	Pages, Columns, Lines Where Relevant Passages or Relevant Figures Appear

FOREIGN PATENT DOCUMENTS						
Examiner Initials	Cite No.	Foreign Patent Document <i>Country Code-Number-Kind Code</i> Example: JP 1234567 A1	Publication Date MM-DD-YYYY	Name	Pages, Columns, Lines Where Relevant Passages or Relevant Figures Appear	T ¹
	1	IN 24/2009	06-12-2009	Digifonica International Ltd	<i>Corresponding International Publication No. WO 2008-052340 A1 previously disclosed</i>	
	2	IN 29/2009	07-17-2009	Digifonica International Ltd	<i>Corresponding International Publication No. WO 2008/064481 A1 previously disclosed</i>	
	3	SG151991A1	06-29-2009	Digifonica International Ltd	<i>Corresponding International Publication No. WO 2008-052340 A1 previously disclosed</i>	✓
	4	SG152752A1	06-29-2009	Digifonica International Ltd	<i>Corresponding International Publication No. WO 2008/064481 A1 previously disclosed</i>	✓
	5	SG155474	10-29-2009	Digifonica International Ltd	<i>Corresponding International Publication No. WO 2008/116296 A1 previously disclosed</i>	Abstract

NON PATENT LITERATURE DOCUMENTS			
Examiner Initials	Cite No.	Include name of the author (in CAPITAL LETTERS), title of the article (when appropriate), title of the item (book, magazine, journal, serial, symposium, catalog, etc.), date, page(s), volume-issue number(s), publisher, city and/or country where published.	T ¹
	6	Chinese Office Action dated March 24, 2011 for Chinese Patent Application No. CN 200780049791.5	✓
	7	Chinese Office Action dated June 23, 2011 for Chinese Patent Application No. CN 200780049136.X.	✓
	8	Indonesian Examination Report dated July 5, 2012 for Indonesian Patent Application No. W-00200901414.	✓
	9	Indonesian Examination Report dated February 8, 2013 for Indonesian Patent Application No. W-00200901165.	✓

Examiner Signature	/Simon Sing/	Date Considered	07/31/2015
--------------------	--------------	-----------------	------------

*Examiner: Initial if reference considered, whether or not citation is in conformance with MPEP 609. Draw line through citation if not in conformance and not considered. Include copy of this form with next communication to applicant.

T¹ - Place a check mark in this area when an English language Translation is attached AT&T, Exh. 1002, p. 441

ALL REFERENCES CONSIDERED EXCEPT WHERE LINED THROUGH. /SS/

INFORMATION DISCLOSURE STATEMENT BY APPLICANT	Application No.	13/966,096
	Filing Date	August 13, 2013
	First Named Inventor	Perreault, Clay
	Art Unit	2653
<i>(Multiple sheets used when necessary)</i>	Examiner	Sing, Simon P.
SHEET 2 OF 2	Attorney Docket No.	DIGIF.001C1

NON PATENT LITERATURE DOCUMENTS			
Examiner Initials	Cite No.	Include name of the author (in CAPITAL LETTERS), title of the article (when appropriate), title of the item (book, magazine, journal, serial, symposium, catalog, etc.), date, page(s), volume-issue number(s), publisher, city and/or country where published.	T ¹
	10	Mexican Exam Report dated July 11, 2011 for Mexican Patent Application No. MX/a/2009/004811.	✓
	11	Mexican Notice of Allowance dated September 2, 2011 for Mexican Patent Application No. MX/a/2009/005751.	✓

20811010
060215

Examiner Signature	/Simon Sing/	Date Considered	07/31/2015
<p>*Examiner: Initial if reference considered, whether or not citation is in conformance with MPEP 609. Draw line through citation if not in conformance and not considered. Include copy of this form with next communication to applicant.</p>			

T¹ - Place a check mark in this area when an English language Translation is attached AT&T, Exh. 1002, p. 442

ALL REFERENCES CONSIDERED EXCEPT WHERE LINED THROUGH. /SS/

INFORMATION DISCLOSURE STATEMENT BY APPLICANT	Application No.	13/966,096	
	Filing Date	August 13, 2013	
	First Named Inventor	Perreault, Clay	
	Art Unit	2653	
<i>(Multiple sheets used when necessary)</i>		Examiner	Sing, Simon P.
SHEET 1 OF 1		Attorney Docket No.	DIGIF.001C1

U.S. PATENT DOCUMENTS					
Examiner Initials	Cite No.	Document Number <i>Number - Kind Code (if known)</i> Example: 1,234,567 B1	Publication Date MM-DD-YYYY	Name	Pages, Columns, Lines Where Relevant Passages or Relevant Figures Appear

FOREIGN PATENT DOCUMENTS						
Examiner Initials	Cite No.	Foreign Patent Document <i>Country Code-Number-Kind Code</i> Example: JP 1234567 A1	Publication Date MM-DD-YYYY	Name	Pages, Columns, Lines Where Relevant Passages or Relevant Figures Appear	T ¹
/SS/	1	CA 2,598,200 A1	02-21-2008	Connexon Telecom Inc.		
/SS/	2	W00200902627 <i>(Indonesia)</i>	09-17-2009	Digifonica International Ltd	<i>Corresponding International Publication No. WO 2008/116296 A1 previously disclosed</i>	Abstract Only

NON PATENT LITERATURE DOCUMENTS			
Examiner Initials	Cite No.	Include name of the author (in CAPITAL LETTERS), title of the article (when appropriate), title of the item (book, magazine, journal, serial, symposium, catalog, etc.), date, page(s), volume-issue number(s), publisher, city and/or country where published.	T ¹
/SS/	3	Canadian Office Action dated January 27, 2015 for Canadian Patent Application No. CA 2,681,984.	

20995995
062515

Examiner Signature /Simon Sing/	Date Considered 07/31/2015
------------------------------------	-------------------------------

*Examiner: Initial if reference considered, whether or not citation is in conformance with MPEP 609. Draw line through citation if not in conformance and not considered. Include copy of this form with next communication to applicant.

T¹ - Place a check mark in this area when an English language Translation is attached AT&T, Exh. 1002, p. 443

EAST Search History

EAST Search History (Prior Art)

Ref #	Hits	Search Query	DBs	Default Operator	Plurals	Time Stamp
L1	187	attribute with (caller or (calling adj party)) with ((called adj party) or receipt)	US-PGPUB; USPAT; USOCR; FPRS; EPO; JPO; DERWENT; IBM_TDB	OR	ON	2015/07/31 17:14
L2	34	1 same rout\$	US-PGPUB; USPAT; USOCR; FPRS; EPO; JPO; DERWENT; IBM_TDB	OR	ON	2015/07/31 17:14
L3	0	2 same (internal or external)	US-PGPUB; USPAT; USOCR; FPRS; EPO; JPO; DERWENT; IBM_TDB	OR	ON	2015/07/31 17:18
L4	6	1 same match\$3	US-PGPUB; USPAT; USOCR; FPRS; EPO; JPO; DERWENT; IBM_TDB	OR	ON	2015/07/31 17:23
L5	9	H04M1/573.CPC. and 1	US-PGPUB; USPAT; USOCR; FPRS; EPO; JPO; DERWENT; IBM_TDB	OR	ON	2015/07/31 17:44
L6	5	H04M3/42059.CPC. and 1	US-PGPUB; USPAT; USOCR; FPRS; EPO; JPO; DERWENT; IBM_TDB	OR	ON	2015/07/31 17:45
L7	3	H04Q3/0025.CPC. and 1	US-PGPUB; USPAT; USOCR; FPRS; EPO; JPO; DERWENT; IBM_TDB	OR	ON	2015/07/31 17:47
L8	2	H04Q2213/13091.CPC. and 1	US-PGPUB; USPAT; USOCR; FPRS; EPO; JPO; DERWENT; IBM_TDB	OR	ON	2015/07/31 17:49
L9	381	rout\$3 same (caller or (calling adj party)) same ((called adj party) or receipt) same (internal or external)	US-PGPUB; USPAT; USOCR; FPRS; EPO; JPO; DERWENT; IBM_TDB	OR	ON	2015/07/31 17:50
L10	0	H04M1/573.CPC. and 9	US-PGPUB; USPAT; USOCR; FPRS; EPO; JPO; DERWENT; IBM_TDB	OR	ON	2015/07/31 17:50
L11	25	H04M3/42059.CPC. and 9	US-PGPUB; USPAT; USOCR; FPRS; EPO; JPO; DERWENT; IBM_TDB	OR	ON	2015/07/31 17:51
L12	0	H04M2213/13091.CPC. and 9	US-PGPUB; USPAT; USOCR; FPRS; EPO; JPO; DERWENT; IBM_TDB	OR	ON	2015/07/31 17:58

7/31/2015 6:52:21 PM

C:\Users\ssing\Documents\EAST\Workspaces\default.wsp

INFORMATION DISCLOSURE STATEMENT BY APPLICANT	Application No.	13/966,096	
	Filing Date	August 13, 2013	
	First Named Inventor	Perreault, Clay	
	Art Unit	2653	
<i>(Multiple sheets used when necessary)</i>		Examiner	Sing, Simon P.
SHEET 1 OF 2		Attorney Docket No.	DIGIF.001C1

U.S. PATENT DOCUMENTS					
Examiner Initials	Cite No.	Document Number Number - Kind Code (if known) Example: 1,234,567 B1	Publication Date MM-DD-YYYY	Name	Pages, Columns, Lines Where Relevant Passages or Relevant Figures Appear
	1	5,677,955 A1	10-14-1995	Doggett et al.	
	2	5,883,810 A1	03-16-1999	Franklin et al.	
	3	6,173,272 B1	01-09-2001	Thomas et al.	
	4	6,243,689 B1	06-05-2001	Norton, Robert G.	
	5	6,636,833 B1	10-21-2003	Fitcroft et al.	
	6	6,772,188 B1	08-03-2004	Cheng-Sheng et al.	
	7	6,892,184 B1	05-10-2005	Komen et al.	
	8	7,051,072 B2	05-23-2006	Stewart et al.	
	9	7,330,835 B2	02-12-2008	Deggendorf, Theresa M.	
	10	7,426,492 B2	09-16-2008	Bishop et al.	
	11	7,437,665 B2	10-14-2008	Perham, Michael	
	12	7,447,707 B2	11-04-2008	Gaurav et al.	
	13	7,580,886 B1	08-25-2009	Schulz, Larry	
	14	7,593,884 B2	09-22-2009	Rothman et al.	
	15	7,599,944 B2	10-06-2009	Gaurav et al.	
	16	7,644,037 B1	01-05-2010	Ostrovsky, Vladimir	
	17	7,647,500 B2	01-12-2010	Machiraju et al.	
	18	7,676,431 B2	03-09-2010	O'Leary et al.	
	19	7,680,737 B2	03-16-2010	Smith et al.	
	20	7,734,544 B2	06-08-2010	Schleicher, Joerg	
	21	7,765,261 B2	07-27-2010	Kropivny, Alexander	
	22	7,765,266 B2	07-27-2010	Kropivny, Alexander	
	23	7,882,011 B2	02-01-2011	Sandhu et al.	
	24	7,899,742 B2	03-11-2011	Berkert et al.	
	25	8,060,887 B2	11-15-2011	Kropivny, Alexander	
	26	8,161,078 B2	04-17-2012	Gaurav et al.	
	27	8,200,575 B2	06-12-2012	Torres et al.	
	28	8,543,477 B2	09-24-2013	Love et al.	
	29	8,627,211 B2	01-07-2014	Kropivny, Alexander	

Examiner Signature	/Simon Sing/	Date Considered	08/24/2015
--------------------	--------------	-----------------	------------

*Examiner: Initial if reference considered, whether or not citation is in conformance with MPEP 609. Draw line through citation if not in conformance and not considered. Include copy of this form with next communication to applicant.

T¹ - Place a check mark in this area when an English language Translation is attached. AT&T, Exh. 1002, p. 446

ALL REFERENCES CONSIDERED EXCEPT WHERE LINED THROUGH. /SS/

INFORMATION DISCLOSURE STATEMENT BY APPLICANT	Application No.	13/966,096	
	Filing Date	August 13, 2013	
	First Named Inventor	Perreault, Clay	
	Art Unit	2653	
<i>(Multiple sheets used when necessary)</i>		Examiner	Sing, Simon P.
SHEET 2 OF 2		Attorney Docket No.	DIGIF.001C1

U.S. PATENT DOCUMENTS					
Examiner Initials	Cite No.	Document Number Number - Kind Code (if known) Example: 1,234,567 B1	Publication Date MM-DD-YYYY	Name	Pages, Columns, Lines Where Relevant Passages or Relevant Figures Appear
	30	8,702,505 B2	04-22-2014	Kropivny, Alexander	
	31	2005/0131813 A1	06-16-2005	Gallagher et al.	
	32	2005/0171898 A1	08-04-2005	Bishop et al.	
	33	2005/0192897 A1	09-01-2005	Rogers et al.	
	34	2005/0192901 A1	09-01-2005	McCoy et al.	
	35	2005/0222952 A1	10-06-2005	Garrett et al.	
	36	2005/0267842 A1	12-01-2005	Weichert et al.	
	37	2006/0006224 A1	01-12-2006	Modi, Vikram	
	38	2006/0036522 A1	02-15-2006	Perham, Michael	
	39	2006/0095320 A1	05-04-2006	Jones, Lisa	
	40	2006/0116892 A1	06-01-2006	Grimes et al.	
	41	2006/0195398 A1	08-31-2006	Dheer et al.	
	42	2007/0016524 A1	01-18-2007	Diveley, et al.	
	43	2014/0141884 A1	05-22-2014	Kropivny, Alexander	

FOREIGN PATENT DOCUMENTS						
Examiner Initials	Cite No.	Foreign Patent Document Country Code-Number-Kind Code Example: JP 1234567 A1	Publication Date MM-DD-YYYY	Name	Pages, Columns, Lines Where Relevant Passages or Relevant Figures Appear	T ¹

NON PATENT LITERATURE DOCUMENTS			
Examiner Initials	Cite No.	Include name of the author (in CAPITAL LETTERS), title of the article (when appropriate), title of the item (book, magazine, journal, serial, symposium, catalog, etc.), date, page(s), volume-issue number(s), publisher, city and/or country where published.	T ¹
	44	Ketchpel et al. "U-PAI: A universal payment application interface" <i>Second USENIX Workshop on Electronic Commerce Proceedings</i> , 1996-8, pages 1-17.	
	45	Moberg & Drummond, "MIME-Based Secure Peer-to-Peer Business Data Interchange Using HTTP, Applicability Statement 2 (AS2)," <i>Network Working Group, Request for Comments: 4130, Category: Standards Track</i> , Copyright © The Internet Society July 2005, pages 1-47.	
	46	Abrazhevich, Dennis. "Electronic Payment Systems: a User-Centered Perspective and Interaction Design," <i>Thesis under the auspices of the J.F. Schouten School for User-System Interaction Research</i> , Technische Universiteit Eindhoven, Netherlands, 2004, pages Cover page - page 189.	

21269338
080315

Examiner Signature	/Simon Sing/	Date Considered	08/24/2015
--------------------	--------------	-----------------	------------

*Examiner: Initial if reference considered, whether or not citation is in conformance with MPEP 609. Draw line through citation if not in conformance and not considered. Include copy of this form with next communication to applicant.

T¹ - Place a check mark in this area when an English language Translation is attached. AT&T, Exh. 1002, p. 447

ALL REFERENCES CONSIDERED EXCEPT WHERE LINED THROUGH. /SS/



UNITED STATES PATENT AND TRADEMARK OFFICE

UNITED STATES DEPARTMENT OF COMMERCE
United States Patent and Trademark Office
Address: COMMISSIONER FOR PATENTS
P.O. Box 1450
Alexandria, Virginia 22313-1450
www.uspto.gov

Table with 5 columns: APPLICATION NO., FILING DATE, FIRST NAMED INVENTOR, ATTORNEY DOCKET NO., CONFIRMATION NO.
13/966,096 08/13/2013 CLAY PERREAULT DIGIF.001C1 8712

20995 7590 08/27/2015
KNOBBE MARTENS OLSON & BEAR LLP
2040 MAIN STREET
FOURTEENTH FLOOR
IRVINE, CA 92614

EXAMINER

SING, SIMON P

ART UNIT PAPER NUMBER

2653

NOTIFICATION DATE DELIVERY MODE

08/27/2015

ELECTRONIC

Please find below and/or attached an Office communication concerning this application or proceeding.

The time period for reply, if any, is set in the attached communication.

Notice of the Office communication was sent electronically on above-indicated "Notification Date" to the following e-mail address(es):

jayna.cartee@knobbe.com
efiling@knobbe.com

**Supplemental
Notice of Allowability**

Application No. 13/966,096	Applicant(s) PERREAULT ET AL.	
Examiner SIMON SING	Art Unit 2653	AIA (First Inventor to File) Status No

-- The MAILING DATE of this communication appears on the cover sheet with the correspondence address--

All claims being allowable, PROSECUTION ON THE MERITS IS (OR REMAINS) CLOSED in this application. If not included herewith (or previously mailed), a Notice of Allowance (PTOL-85) or other appropriate communication will be mailed in due course. **THIS NOTICE OF ALLOWABILITY IS NOT A GRANT OF PATENT RIGHTS.** This application is subject to withdrawal from issue at the initiative of the Office or upon petition by the applicant. See 37 CFR 1.313 and MPEP 1308.

1. This communication is responsive to IDS filed on 08/03/2015.
 A declaration(s)/affidavit(s) under **37 CFR 1.130(b)** was/were filed on _____.
2. An election was made by the applicant in response to a restriction requirement set forth during the interview on _____; the restriction requirement and election have been incorporated into this action.
3. The allowed claim(s) is/are _____. As a result of the allowed claim(s), you may be eligible to benefit from the **Patent Prosecution Highway** program at a participating intellectual property office for the corresponding application. For more information, please see http://www.uspto.gov/patents/init_events/oph/index.jsp or send an inquiry to PPHfeedback@uspto.gov.
4. Acknowledgment is made of a claim for foreign priority under 35 U.S.C. § 119(a)-(d) or (f).

Certified copies:

- a) All b) Some *c) None of the:
1. Certified copies of the priority documents have been received.
 2. Certified copies of the priority documents have been received in Application No. _____.
 3. Copies of the certified copies of the priority documents have been received in this national stage application from the International Bureau (PCT Rule 17.2(a)).

* Certified copies not received: _____.

Applicant has THREE MONTHS FROM THE "MAILING DATE" of this communication to file a reply complying with the requirements noted below. Failure to timely comply will result in ABANDONMENT of this application.

THIS THREE-MONTH PERIOD IS NOT EXTENDABLE.

5. CORRECTED DRAWINGS (as "replacement sheets") must be submitted.
 including changes required by the attached Examiner's Amendment / Comment or in the Office action of Paper No./Mail Date _____.
Identifying indicia such as the application number (see 37 CFR 1.84(c)) should be written on the drawings in the front (not the back) of each sheet. Replacement sheet(s) should be labeled as such in the header according to 37 CFR 1.121(d).
6. DEPOSIT OF and/or INFORMATION about the deposit of BIOLOGICAL MATERIAL must be submitted. Note the attached Examiner's comment regarding REQUIREMENT FOR THE DEPOSIT OF BIOLOGICAL MATERIAL.

Attachment(s)

- | | |
|--|---|
| 1. <input type="checkbox"/> Notice of References Cited (PTO-892) | 5. <input type="checkbox"/> Examiner's Amendment/Comment |
| 2. <input checked="" type="checkbox"/> Information Disclosure Statements (PTO/SB/08),
Paper No./Mail Date <u>08/03/2015</u> | 6. <input type="checkbox"/> Examiner's Statement of Reasons for Allowance |
| 3. <input type="checkbox"/> Examiner's Comment Regarding Requirement for Deposit
of Biological Material | 7. <input type="checkbox"/> Other _____. |
| 4. <input type="checkbox"/> Interview Summary (PTO-413),
Paper No./Mail Date _____. | |

/SIMON SING/
Primary Examiner, Art Unit 2653

INFORMATION DISCLOSURE STATEMENT BY APPLICANT	Application No.	13/966,096	
	Filing Date	August 13, 2013	
	First Named Inventor	Perreault, Clay	
	Art Unit	2653	
<i>(Multiple sheets used when necessary)</i>		Examiner	Sing, Simon P.
SHEET 1 OF 2		Attorney Docket No.	DIGIF.001C1

U.S. PATENT DOCUMENTS					
Examiner Initials	Cite No.	Document Number Number - Kind Code (if known) Example: 1,234,567 B1	Publication Date MM-DD-YYYY	Name	Pages, Columns, Lines Where Relevant Passages or Relevant Figures Appear
	1	5,677,955 A1	10-14-1995	Doggett et al.	
	2	5,883,810 A1	03-16-1999	Franklin et al.	
	3	6,173,272 B1	01-09-2001	Thomas et al.	
	4	6,243,689 B1	06-05-2001	Norton, Robert G.	
	5	6,636,833 B1	10-21-2003	Fitcroft et al.	
	6	6,772,188 B1	08-03-2004	Cheng-Sheng et al.	
	7	6,892,184 B1	05-10-2005	Komen et al.	
	8	7,051,072 B2	05-23-2006	Stewart et al.	
	9	7,330,835 B2	02-12-2008	Deggendorf, Theresa M.	
	10	7,426,492 B2	09-16-2008	Bishop et al.	
	11	7,437,665 B2	10-14-2008	Perham, Michael	
	12	7,447,707 B2	11-04-2008	Gaurav et al.	
	13	7,580,886 B1	08-25-2009	Schulz, Larry	
	14	7,593,884 B2	09-22-2009	Rothman et al.	
	15	7,599,944 B2	10-06-2009	Gaurav et al.	
	16	7,644,037 B1	01-05-2010	Ostrovsky, Vladimir	
	17	7,647,500 B2	01-12-2010	Machiraju et al.	
	18	7,676,431 B2	03-09-2010	O'Leary et al.	
	19	7,680,737 B2	03-16-2010	Smith et al.	
	20	7,734,544 B2	06-08-2010	Schleicher, Joerg	
	21	7,765,261 B2	07-27-2010	Kropivny, Alexander	
	22	7,765,266 B2	07-27-2010	Kropivny, Alexander	
	23	7,882,011 B2	02-01-2011	Sandhu et al.	
	24	7,899,742 B2	03-11-2011	Berkert et al.	
	25	8,060,887 B2	11-15-2011	Kropivny, Alexander	
	26	8,161,078 B2	04-17-2012	Gaurav et al.	
	27	8,200,575 B2	06-12-2012	Torres et al.	
	28	8,543,477 B2	09-24-2013	Love et al.	
	29	8,627,211 B2	01-07-2014	Kropivny, Alexander	

Examiner Signature	/Simon Sing/	Date Considered	08/24/2015
--------------------	--------------	-----------------	------------

*Examiner: Initial if reference considered, whether or not citation is in conformance with MPEP 609. Draw line through citation if not in conformance and not considered. Include copy of this form with next communication to applicant.

T¹ - Place a check mark in this area when an English language Translation is attached. AT&T, Exh. 1002, p. 450

ALL REFERENCES CONSIDERED EXCEPT WHERE LINED THROUGH. /SS/

INFORMATION DISCLOSURE STATEMENT BY APPLICANT	Application No.	13/966,096	
	Filing Date	August 13, 2013	
	First Named Inventor	Perreault, Clay	
	Art Unit	2653	
(Multiple sheets used when necessary)		Examiner	Sing, Simon P.
SHEET 2 OF 2		Attorney Docket No.	DIGIF.001C1

U.S. PATENT DOCUMENTS					
Examiner Initials	Cite No.	Document Number Number - Kind Code (if known) Example: 1,234,567 B1	Publication Date MM-DD-YYYY	Name	Pages, Columns, Lines Where Relevant Passages or Relevant Figures Appear
	30	8,702,505 B2	04-22-2014	Kropivny, Alexander	
	31	2005/0131813 A1	06-16-2005	Gallagher et al.	
	32	2005/0171898 A1	08-04-2005	Bishop et al.	
	33	2005/0192897 A1	09-01-2005	Rogers et al.	
	34	2005/0192901 A1	09-01-2005	McCoy et al.	
	35	2005/0222952 A1	10-06-2005	Garrett et al.	
	36	2005/0267842 A1	12-01-2005	Weichert et al.	
	37	2006/0006224 A1	01-12-2006	Modi, Vikram	
	38	2006/0036522 A1	02-15-2006	Perham, Michael	
	39	2006/0095320 A1	05-04-2006	Jones, Lisa	
	40	2006/0116892 A1	06-01-2006	Grimes et al.	
	41	2006/0195398 A1	08-31-2006	Dheer et al.	
	42	2007/0016524 A1	01-18-2007	Diveley, et al.	
	43	2014/0141884 A1	05-22-2014	Kropivny, Alexander	

FOREIGN PATENT DOCUMENTS						
Examiner Initials	Cite No.	Foreign Patent Document Country Code-Number-Kind Code Example: JP 1234567 A1	Publication Date MM-DD-YYYY	Name	Pages, Columns, Lines Where Relevant Passages or Relevant Figures Appear	T ¹

NON PATENT LITERATURE DOCUMENTS			
Examiner Initials	Cite No.	Include name of the author (in CAPITAL LETTERS), title of the article (when appropriate), title of the item (book, magazine, journal, serial, symposium, catalog, etc.), date, page(s), volume-issue number(s), publisher, city and/or country where published.	T ¹
	44	Ketchpel et al. "U-PAI: A universal payment application interface" <i>Second USENIX Workshop on Electronic Commerce Proceedings</i> , 1996-8, pages 1-17.	
	45	Moberg & Drummond, "MIME-Based Secure Peer-to-Peer Business Data Interchange Using HTTP, Applicability Statement 2 (AS2)," <i>Network Working Group, Request for Comments: 4130, Category: Standards Track</i> , Copyright © The Internet Society July 2005, pages 1-47.	
	46	Abrazhevich, Dennis. "Electronic Payment Systems: a User-Centered Perspective and Interaction Design," <i>Thesis under the auspices of the J.F. Schouten School for User-System Interaction Research</i> , Technische Universiteit Eindhoven, Netherlands, 2004, pages Cover page - page 189.	

21269338
080315

Examiner Signature /Simon Sing/	Date Considered 08/24/2015
---------------------------------	----------------------------

*Examiner: Initial if reference considered, whether or not citation is in conformance with MPEP 609. Draw line through citation if not in conformance and not considered. Include copy of this form with next communication to applicant.

T¹ - Place a check mark in this area when an English language Translation is attached. AT&T, Exh. 1002, p. 451

ALL REFERENCES CONSIDERED EXCEPT WHERE LINED THROUGH. /SS/

PART B - FEE(S) TRANSMITTAL

Complete and send this form, together with applicable fee(s), to: **Mail** Mail Stop ISSUE FEE
 Commissioner for Patents
 P.O. Box 1450
 Alexandria, Virginia 22313-1450
or Fax (571)-273-2885

INSTRUCTIONS: This form should be used for transmitting the ISSUE FEE and PUBLICATION FEE (if required). Blocks 1 through 5 should be completed where appropriate. All further correspondence including the Patent, advance orders and notification of maintenance fees will be mailed to the current correspondence address as indicated unless corrected below or directed otherwise in Block 1, by (a) specifying a new correspondence address; and/or (b) indicating a separate "FEE ADDRESS" for maintenance fee notifications.

CURRENT CORRESPONDENCE ADDRESS (Note: Use Block 1 for any change of address)

20995 7590 08/13/2015
Knobbe Martens Olson & Bear LLP
 2040 MAIN STREET
 FOURTEENTH FLOOR
 IRVINE, CA 92614

Note: A certificate of mailing can only be used for domestic mailings of the Fee(s) Transmittal. This certificate cannot be used for any other accompanying papers. Each additional paper, such as an assignment or formal drawing, must have its own certificate of mailing or transmission.

Certificate of Mailing or Transmission

I hereby certify that this Fee(s) Transmittal is being deposited with the United States Postal Service with sufficient postage for first class mail in an envelope addressed to the Mail Stop ISSUE FEE address above, or being facsimile transmitted to the USPTO (571) 273-2885, on the date indicated below.

(Depositor's name)
(Signature)
(Date)

APPLICATION NO.	FILING DATE	FIRST NAMED INVENTOR	ATTORNEY DOCKET NO.	CONFIRMATION NO.
13/966,096	08/13/2013	CLAY PERREAULT	DIGIF.001C1	8712

TITLE OF INVENTION: PRODUCING ROUTING MESSAGES FOR VOICE OVER IP COMMUNICATIONS

APPLN. TYPE	ENTITY STATUS	ISSUE FEE DUE	PUBLICATION FEE DUE	PREV. PAID ISSUE FEE	TOTAL FEE(S) DUE	DATE DUE
nonprovisional	SMALL	\$480	\$0	\$0	\$480	11/13/2015

EXAMINER	ART UNIT	CLASS-SUBCLASS
SING. SIMON P	2653	379-142040

1. Change of correspondence address or indication of "Fee Address" (37 CFR 1.363).

Change of correspondence address (or Change of Correspondence Address form PTO/SB/122) attached.

"Fee Address" indication (or "Fee Address" Indication form PTO/SB/47; Rev 03-02 or more recent) attached. Use of a Customer Number is required.

2. For printing on the patent front page, list

(1) The names of up to 3 registered patent attorneys or agents OR, alternatively,

(2) The name of a single firm (having as a member a registered attorney or agent) and the names of up to 2 registered patent attorneys or agents. If no name is listed, no name will be printed.

1. Knobbe Martens Olson & Bear, LLP

2. _____

3. _____

3. ASSIGNEE NAME AND RESIDENCE DATA TO BE PRINTED ON THE PATENT (print or type)

PLEASE NOTE: Unless an assignee is identified below, no assignee data will appear on the patent. If an assignee is identified below, the document has been filed for recordation as set forth in 37 CFR 3.11. Completion of this form is NOT a substitute for filing an assignment.

(A) NAME OF ASSIGNEE: Digifonica (International) Limited

(B) RESIDENCE: (CITY and STATE OR COUNTRY) Vancouver, Canada

Please check the appropriate assignee category or categories (will not be printed on the patent): Individual Corporation or other private group entity Government

4a. The following fee(s) are submitted:

Issue Fee

Publication Fee (No small entity discount permitted)

Advance Order - # of Copies _____

4b. Payment of Fee(s): (Please first reapply any previously paid issue fee shown above)

A check is enclosed,

Payment by credit card. Form PTO-2038 is attached.

The director is hereby authorized to charge the required fee(s); any deficiency, or credits any overpayment, to Deposit Account Number 11-1410 (enclose an extra copy of this form).

5. Change in Entity Status (from status indicated above)

Applicant certifying micro entity status. See 37 CFR 1.29

Applicant asserting small entity status. See 37 CFR 1.27

Applicant changing to regular undiscounted fee status.

NOTE: Absent a valid certification of Micro Entity Status (see forms PTO/SB/15A and 15B), issue fee payment in the micro entity amount will not be accepted at the risk of application abandonment.

NOTE: If the application was previously under micro entity status, checking this box will be taken to be a notification of loss of entitlement to micro entity status.

NOTE: Checking this box will be taken to be a notification of loss of entitlement to small or micro entity status, as applicable.

NOTE: This form must be signed in accordance with 37 CFR 1.31 and 1.33. See 37 CFR 1.4 for signature requirements and certifications.

Authorized Signature: John Carson Date: 9/8/15

Typed or printed name: John Carson Registration No.: 34,303

IN THE UNITED STATES PATENT AND TRADEMARK OFFICE

Inventor	: Clay Perreault
App. No.	: 13/966,096
Filed	: August 13, 2013
For	: PRODUCING ROUTING MESSAGES FOR VOICE OVER IP COMMUNICATIONS
Examiner	: Sing, Simon P.
Art Unit	: 2653
Conf. No.	: 8712

AMENDMENT AFTER ALLOWANCE UNDER 37 C.F.R. 1.312**Mail Stop Issue Fee**

Commissioner for Patents
P.O. Box 1450
Alexandria, VA 22313-1450

Dear Sir:

Further to the Notice of Allowance dated August 13, 2015, and the Supplemental Notice of Allowability dated August 27, 2015, Applicant requests the following amendments in the above-captioned patent application.

Amendments to the Claims are reflected in the listing of claims which begins on page 2 of this paper.

Remarks begin on page 22 of this paper.

AMENDMENTS TO THE CLAIMS

1. (Original) A process for producing a routing message for routing communications between a caller and a callee in a communication system, the process comprising:

using a caller identifier associated with the caller to locate a caller dialing profile comprising a plurality of calling attributes associated with the caller;

when at least one of said calling attributes and at least a portion of a callee identifier associated with the callee meet private network classification criteria, producing a private network routing message for receipt by a call controller, said private network routing message identifying an address, on the private network, associated with the callee; and

when at least one of said calling attributes and at least a portion of said callee identifier meet a public network classification criterion, producing a public network routing message for receipt by the call controller, said public network routing message identifying a gateway to the public network.

2. (Original) The process of claim 1, wherein said private network classification criteria include:

a) said callee identifier does not begin with the same digit pattern as an international dialing digit (IDD) attribute of said callee identifier; and

b) said callee identifier does not begin with the same digit pattern as a national dialing digit (NDD) attribute of said callee identifier; and

c) said callee identifier does not begin with the same area code as an area code of said caller; and

d) said callee identifier does not have a length that is within a range of caller local number lengths; and

e) said callee identifier is a valid username.

3. (Original) The process of claim 2, further comprising identifying the call as a cross-domain call on the private network when said callee identifier identifies a callee that is not associated with the same network node as said caller.
4. (Original) The process of claim 2, further comprising:
 - locating a callee dialing profile for the callee when said callee identifier identifies a callee that is associated with the same network node as said caller; and
 - retrieving call handling information associated with the callee, where said call handling information is available, said call handling information including at least one of call blocking information, call forwarding information, and voicemail information.
5. (Original) The process of claim 4, further comprising, where said call handling information including said call blocking information is available, blocking the call when said call blocking information identifies the caller as a caller from whom calls are to be blocked from being established with the callee.
6. (Original) The process of claim 4, further comprising, where said call handling information including said call forwarding information is available, causing said call forwarding information to be included in said private network routing message.
7. (Original) The process of claim 4, further comprising, where said call handling information including said voicemail information is available, causing said voicemail information to be included in said private network routing message.
8. (Original) The process of claim 1, further comprising associating at least one direct inward dial (DID) record with at least one subscriber to said communication system, each of said at least one direct inward dial records comprising a field storing a direct inward dial number associated with said at least one subscriber.

Application No.: 13/966,096
Filing Date: August 13, 2013

9. (Original) The process of claim 8, wherein said public network classification criteria include:

- a) said callee identifier begins with the same digit pattern as an international dialing digit (IDD) attribute of said callee identifier; and
- b) a reformatted callee identifier produced by removing the IDD attribute from said callee identifier has no DID bank table record.

10. (Original) The process of claim 8, wherein said public network classification criteria include:

- a) said callee identifier begins with the same digit pattern as a national dialing digit (NDD) attribute of said callee identifier; and
- b) a reformatted callee identifier produced by removing the NDD attribute from said callee identifier and including a caller country code has no DID bank table record.

11. (Original) The process of claim 8, wherein said public network classification criteria include:

- a) said callee identifier begins with the same area code as an area code of said caller; and
- b) a reformatted callee identifier produced by reformatting the callee identifier to include a caller country code has no DID bank table record.

12. (Original) The process of claim 8, wherein said public network classification criteria include:

- a) said callee identifier has a length that is within a range of caller local number lengths; and
- b) a reformatted callee identifier produced by reformatting the callee identifier to include a caller country code and area code has no DID bank table record.

13. (Original) The process of claim 1, wherein said plurality of calling attributes includes at least one of an international dialing digits identifier, a national dialing digits identifier, a

Application No.: 13/966,096
Filing Date: August 13, 2013

country code identifier, a local area codes identifier, a caller minimum local length identifier, a caller maximum local length identifier, a reseller identifier, and a maximum number of concurrent calls identifier.

14. (Original) The process of claim 8, wherein said DID record comprises a user name field, a user domain field and a DID number field.

15. (Original) The process of claim 1, further comprising maintaining a list of public network route suppliers and when said public network classification criterion is met identifying at least one of said public network route suppliers that satisfies public network routing selection criteria.

16. (Original) The process of claim 15, wherein said producing said public network routing message comprises producing a public network routing message identifying said at least one public network route supplier that satisfies said public network routing selection criteria.

17. (Original) The process of claim 16, wherein producing said public network routing message comprises causing said public network routing message to include a gateway supplier identifier identifying a gateway supplier able to establish a communications link in a route through which communications between the caller and callee are to be conducted.

18. (Original) The process of claim 17, further comprising causing said public network routing message to include a time value and a timeout value.

19. (Original) The process of claim 17, wherein causing said public network routing message to include said gateway supplier identifier comprises causing said public network routing message to include a plurality of gateway supplier identifiers identifying a plurality of gateway suppliers able to supply respective communication links through which communications between the caller and callee can be conducted.

Application No.: 13/966,096
Filing Date: August 13, 2013

20. (Original) The process of claim 19, further comprising causing said public network routing message to include priority information identifying a priority in which gateway suppliers associated with said gateway identifiers are to be considered for selection of a communication link through which communications between the caller and callee can be conducted.

21. (Original) The process of claim 19, wherein causing said public network routing message to include priority information includes arranging said gateway supplier identifiers in said public network routing message in order of rate, where rate is determined from rate fields of respective said gateway supplier records.

22. (Original) The process of claim 21, wherein arranging said gateway supplier identifiers in order of rate comprises arranging said gateway supplier identifiers in order of increasing rate.

23. (Original) The process of claim 17, further comprising arranging said gateway supplier identifiers in an order based on at least one provision in a service agreement.

24. (Original) The process of claim 1, further comprising causing the private network routing message or the public network routing message to be communicated to a call controller to effect routing of the call.

25. (Original) A non-transitory computer readable medium encoded with codes for directing a processor to execute the method of claim 1.

26. (Original) A call routing controller apparatus for producing a routing message for routing communications between a caller and a callee in a communication system, the apparatus comprising:

at least one processor operably configured to:

use a caller identifier associated with the caller to locate a caller dialing profile comprising a plurality of calling attributes associated with the caller;

when at least one of said calling attributes and at least a portion of a callee identifier associated with the callee meet private network classification criteria, produce a private network routing message for receipt by a call controller, said private network routing message identifying an address, on the private network, associated with the callee; and

when at least one of said calling attributes and at least a portion of said callee identifier meet a public network classification criterion, produce a public network routing message for receipt by the call controller, said public network routing message identifying a gateway to the public network.

27. (Original) The apparatus of claim 26, wherein said private network classification criteria include:

- a) said callee identifier does not begin with the same digit pattern as an international dialing digit (IDD) attribute of said callee identifier; and
- b) said callee identifier does not begin with the same digit pattern as a national dialing digit (NDD) attribute of said callee identifier; and
- c) said callee identifier does not begin with the same area code as an area code of said caller; and
- d) said callee identifier does not have a length that is within a range of caller local number lengths; and
- e) said callee identifier is a valid username.

28. (Original) The apparatus of claim 27, wherein said at least one processor is further operably configured to identify the call as a cross-domain call on the private network when said callee identifier identifies a callee that is not associated with the same network node as said caller.

29. (Original) The apparatus of claim 27, wherein said at least one processor is further configured to:

access the database of caller dialing profiles to locate a callee dialing profile for the callee when said callee identifier identifies a callee that is associated with the same network node as said caller; and

retrieve call handling information associated with the callee, where said call handling information is available, said call handling information including at least one of call blocking information, call forwarding information, and voicemail information.

30. (Original) The apparatus of claim 29, wherein said at least one processor is further operably configured to determine whether said call handling information including said call blocking information is available and to block the call when said call blocking information identifies the caller as a caller from whom calls are to be blocked.

31. (Original) The apparatus of claim 29, wherein said at least one processor is further operably configured to determine whether said call handling information including said call forwarding information is available and to cause said call forwarding information to be included in said private network routing message.

32. (Original) The apparatus of claim 29, wherein said at least one processor is further operably configured to determine whether said call handling information including said voicemail information is available and to cause said voicemail information to be included in said private network routing message.

33. (Original) The apparatus of claim 26, wherein said at least one processor is further operably configured to access a database of direct inward dial records each associating at least one direct inward dial number with at least one subscriber to said communication system.

Application No.: 13/966,096
Filing Date: August 13, 2013

34. (Original) The apparatus of claim 33, wherein said public network classification criteria include:

- a) said callee identifier begins with the same digit pattern as an international dialing digit (IDD) attribute of said callee identifier; and
- b) a reformatted callee identifier produced by removing the IDD attribute from said callee identifier has no DID record.

35. (Original) The apparatus of claim 33, wherein said public network classification criteria include:

- a) said callee identifier begins with the same digit pattern as a national dialing digit (NDD) attribute of said callee identifier; and
- b) a reformatted callee identifier produced by removing the NDD attribute from said callee identifier and including a caller country code has no DID record.

36. (Original) The apparatus of claim 33, wherein said public network classification criteria include:

- a) said callee identifier begins with the same area code as an area code of said caller; and
- b) a reformatted callee identifier produced by reformatting the callee identifier to include a caller country code has no DID record.

37. (Original) The apparatus of claim 33, wherein said public network classification criteria include:

- a) said callee identifier has a length that is within a range of caller local number lengths; and
- b) a reformatted callee identifier produced by reformatting the callee identifier to include a caller country code and area code has no DID record.

Application No.: 13/966,096
Filing Date: August 13, 2013

38. (Original) The apparatus of claim 26, wherein said plurality of calling attributes includes at least one of an international dialing digits identifier, a national dialing digits identifier, a country code identifier, a local area codes identifier, a caller minimum local length identifier, a caller maximum local length identifier, a reseller identifier, and a maximum number of concurrent calls identifier.

39. (Original) The apparatus of claim 33, wherein said DID record comprises a user name field, a user domain field and a DID number field.

40. (Original) The apparatus of claim 26, wherein said at least one processor is further operably configured to access a list of public network route suppliers when said public network classification criterion is met and to identify at least one of said public network route suppliers that satisfies public network routing selection criteria.

41. (Original) The apparatus of claim 40, wherein said at least one processor is further operably configured to produce a public network routing message identifying said at least one public network route supplier that satisfies said public network routing selection criteria.

42. (Original) The apparatus of claim 41, wherein said at least one processor is operably configured to cause said public network routing message to include a gateway supplier identifier identifying a gateway supplier able to establish a communications link in a route through which communications between the caller and callee can be conducted.

43. (Original) The apparatus of claim 42, wherein said at least one processor is operably configured to cause said public network routing message to include a time value and a timeout value.

44. (Original) The apparatus of claim 42, wherein said at least one processor is operably configured to cause said public network routing message to include a plurality of gateway supplier identifiers identifying a plurality of gateway suppliers able to supply respective

communication links through which communications between the caller and callee can be conducted.

45. (Original) The apparatus of claim 44, wherein said at least one processor is operably configured to cause said public network routing message to include priority information identifying a priority in which gateway suppliers associated with said gateway identifiers are to be considered for selection of a communication link through which communications between the caller and callee can be conducted.

46. (Original) The apparatus of claim 44, wherein said at least one processor is operably configured to arrange said gateway supplier identifiers in said public network routing message in order of rate, where rate is determined from rate fields of respective said gateway supplier records.

47. (Original) The apparatus of claim 46, wherein said at least one processor is operably configured to arrange said gateway supplier identifiers in order of increasing rate.

48. (Original) The apparatus of claim 42, wherein said at least one processor is operably configured to arrange said gateway supplier identifiers in an order based on at least one provision in a service agreement.

49. (Original) The apparatus of claim 26, wherein said at least one processor is further operably configured to cause the private network routing message or the public network routing message to be communicated to a call controller to effect routing of the call.

50. (Original) A call routing controller apparatus for producing a routing message for routing communications between a caller and a callee in a communication system, the apparatus comprising:

means for using a caller identifier associated with the caller to locate a caller dialing profile comprising a plurality of calling attributes associated with the caller; and

means for, when at least one of said calling attributes and at least a portion of a callee identifier associated with the callee meet private network classification criteria, producing a private network routing message for receipt by a call controller, said private network routing message identifying an address, on the private network, associated with the callee; and

means for, when at least one of said calling attributes and at least a portion of said callee identifier meet a public network classification criterion, producing a public network routing message for receipt by the call controller, said public network routing message identifying a gateway to the public network.

51. **(Currently amended)** The apparatus of claim 50, wherein said private network classification criteria include:

- a) said callee identifier does not begin with the same digit pattern as an international dialing digit (IDD) attribute of said callee identifier; and
- b) said callee identifier does not begin with the same digit pattern as a national dialing digit (NDD) attribute of said callee identifier; and
- c) said callee identifier does not begin with the same area code as an area code of said caller; and
- d) said callee identifier does not have a length that is within a range of caller local number lengths; and
- e) said callee identifier is a valid username.

52. **(Original)** The apparatus of claim 51, further comprising means for identifying the call as a cross-domain call on the private network when said callee identifier identifies a callee that is not associated with the same network node as said caller.

53. **(Original)** The apparatus of claim 51, further comprising:

means for accessing the database of caller dialing profiles to locate a callee dialing profile for the callee when said callee identifier identifies a callee that is associated with the same network node as said caller; and

Application No.: 13/966,096
Filing Date: August 13, 2013

means for retrieving call handling information associated with the callee, where said call handling information is available, said call handling information including at least one of call blocking information, call forwarding information, and voicemail information.

54. (Original) The apparatus of claim 53, further comprising, where said call handling information including said call blocking information is available, means for blocking the call being established with the callee when said call blocking information identifies the caller as a caller from whom calls are to be blocked.

55. (Original) The apparatus of claim 53, further comprising, means for causing said call forwarding information to be included in said private network routing message, where said call handling information including said call forwarding information is available.

56. (Original) The apparatus of claim 53, further comprising, where said call handling information including said voicemail information is available, means for causing said voicemail information to be included in said private network routing message.

57. (Original) The apparatus of claim 50, further comprising means for accessing a database of direct inward dial records each associating at least one direct inward dial number with at least one subscriber to said communication system.

58. (Original) The apparatus of claim 57, wherein said public network classification criteria include:

- a) said callee identifier begins with the same digit pattern as an international dialing digit (IDD) attribute of said callee identifier; and
- b) a reformatted callee identifier produced by removing the IDD attribute from said callee identifier has no DID record.

Application No.: 13/966,096
Filing Date: August 13, 2013

59. (Original) The apparatus of claim 57, wherein said public network classification criteria include:

- a) said callee identifier begins with the same digit pattern as a national dialing digit (NDD) attribute of said callee identifier; and
- b) a reformatted callee identifier produced by removing the NDD attribute from said callee identifier and including a caller country code has no DID record.

60. (Original) The apparatus of claim 57, wherein said public network classification criteria include:

- a) said callee identifier begins with the same area code as an area code of said caller; and
- b) a reformatted callee identifier produced by reformatting the callee identifier to include a caller country code has no DID record.

61. (Original) The apparatus of claim 57, wherein said public network classification criteria include:

- a) said callee identifier has a length that is within a range of caller local number lengths; and
- b) a reformatted callee identifier produced by reformatting the callee identifier to include a caller country code and area code has no DID record.

62. (Original) The apparatus of claim 50, wherein said plurality of calling attributes includes at least one of an international dialing digits identifier, a national dialing digits identifier, a country code identifier, a local area codes identifier, a caller minimum local length identifier, a caller maximum local length identifier, a reseller identifier, and a maximum number of concurrent calls identifier.

63. (Original) The apparatus of claim 57, wherein said DID record comprises a user name field, a user domain field and a DID number field.

Application No.: 13/966,096
Filing Date: August 13, 2013

64. (Original) The apparatus of claim 50, further comprising means for accessing a list of public network route suppliers when said public network classification criterion is met and means for identifying at least one of said public network route suppliers that satisfies public network routing selection criteria.

65. (Original) The apparatus of claim 64, wherein said means for producing said public network routing message comprises means for producing a public network routing message identifying said at least one public network route supplier that satisfies said public network routing selection criteria.

66. (Original) The apparatus of claim 65, wherein said means for producing said public network routing message comprises means for causing said public network routing message to include a gateway supplier identifier identifying a gateway supplier able to establish a communications link in a route through which communications between the caller and callee can be conducted.

67. (Original) The apparatus of claim 66, further comprising means for causing said public network routing message to include a time value and a timeout value.

68. (Original) The apparatus of claim 66, wherein said means for causing said public network routing message to include said gateway supplier identifier comprises means for causing said public network routing message to include a plurality of gateway supplier identifiers identifying a plurality of gateway suppliers able to supply respective communication links through which communications between the caller and callee can be conducted.

69. (Original) The apparatus of claim 68, further comprising means for causing said public network routing message to include priority information identifying a priority in which gateway suppliers associated with said gateway identifiers are to be considered for selection of a communication link through which communications between the caller and callee can be conducted.

Application No.: 13/966,096
Filing Date: August 13, 2013

70. (Original) The apparatus of claim 68, wherein said means for causing said public network routing message to include priority information includes means for arranging said gateway supplier identifiers in said public network routing message in order of rate, where rate is determined from rate fields of respective said gateway supplier records.

71. (Original) The apparatus of claim 70, wherein said means for arranging said gateway supplier identifiers in order of rate comprises means for arranging said gateway supplier identifiers in order of increasing rate.

72. (Original) The apparatus of claim 66, further comprising means for arranging said gateway supplier identifiers in an order based on at least one provision in a service agreement.

73. (Original) The apparatus of claim 50, further comprising means for causing the private network routing message or the public network routing message to be communicated to a call controller to effect routing of the call.

74. (Canceled).

75. (Canceled).

76. (Canceled).

77. (Canceled).

78. (Canceled).

79. (Previously Presented) A method of routing communications in a packet switched network in which a first participant identifier is associated with a first participant and a second participant identifier is associated with a second participant in a communication, the method comprising:

after the first participant has accessed the packet switched network to initiate the communication, using the first participant identifier to locate a first participant profile comprising a plurality of attributes associated with the first participant;

when at least one of the first participant attributes and at least a portion of the second participant identifier meet a first network classification criterion, producing a first network routing message for receipt by a controller, the first network routing message identifying an address in a first portion of the packet switched network, the address being associated with the second participant, the first portion being controlled by an entity; and

when at least one of the first participant attributes and at least a portion of the second participant identifier meet a second network classification criterion, producing a second network routing message for receipt by the controller, the second network routing message identifying an address in a second portion of the packet switched network, the second portion not controlled by the entity.

80. (Previously Presented) The method of Claim 79, wherein the packet switched network comprises the Internet.

81. (Previously Presented) The method of Claim 79, wherein the first participant identifier comprises a first participant telephone number or username.

82. (Previously Presented) The method of Claim 79, wherein the second participant identifier comprises a second participant telephone number or username.

83. (Previously Presented) The method of Claim 79, wherein the communication comprises a voice-over-IP communication.

Application No.: 13/966,096
Filing Date: August 13, 2013

84. (Previously Presented) The method of Claim 79, wherein the packet switched network is accessed via an Internet service provider.
85. (Previously Presented) The method of Claim 79, wherein the first participant profile further comprises a username and a domain associated with first participant.
86. (Previously Presented) The method of Claim 79, wherein the attributes comprise at least one of an international dialing digit (IDD), a national dialing digit (NDD), an area code, a country code and a number length range.
87. **(Currently amended)** The method of Claim 79, wherein the first network classification criterion is satisfied when the first participant identifier does not begin with the same international dialing digit (IDD) digit pattern as the second participant identifier.
88. **(Currently amended)** The method of Claim 79, wherein the first network classification criterion is satisfied when an address associated with the first participant and the address associated with the second participant are both in the first portion of the packet switched network.
89. (Previously Presented) The method of Claim 79, wherein the address in the first portion is accessible through the first participant's Internet service provider.
90. (Previously Presented) The method of Claim 79, wherein the first portion comprises one or more supernodes.
91. (Previously Presented) The method of Claim 79, further comprising storing in a database a direct inward dial (DID) record associated with at least one of the first participant and the second participant.

92. (Previously Presented) The method of Claim 91, wherein the stored DID record for the second participant comprises a username, a user domain and a record number.

93. (Previously Presented) The method of Claim 79, wherein the entity is an entity supplying communication services for the first portion.

94. (Previously Presented) The method of Claim 79, wherein the second network classification criterion is satisfied when access to the second participant requires routing through a portion of the packet switched network operated by a communication service supplier.

95. (Previously Presented) The method of Claim 91, wherein the second network classification criterion is satisfied when the second participant identifier is not associated with a stored DID record in the database.

96. (Previously Presented) The method of Claim 91, wherein the second network classification criterion is satisfied when:

the second participant identifier begins with the same international dialing digit (IDD) digit pattern as the first participant identifier; and

the second participant identifier, without considering the IDD digit pattern, has no stored DID record in the database.

97. (Previously Presented) The method of Claim 79, wherein the address in the second portion of the packet switched network comprises an address accessed by a communication service supplier.

98. (Previously Presented) The method of Claim 79, wherein producing the second network routing message identifying the address in the second portion comprises searching a database of route records associating route identifiers with dialing codes, in an attempt to find a route record having a dialing code with a number pattern matching at least a portion of second participant identifier.

Application No.: 13/966,096
Filing Date: August 13, 2013

99. (Previously Presented) A system for routing communications in a packet switched network in which a first participant in a communication has an associated first participant identifier and a second participant in the communication has an associated second participant identifier, the system comprising:

a controller comprising:

a processor operably configured to access a memory,
wherein the processor is configured to:

after the first participant has accessed the packet switched network to initiate the communication, locate a first participant profile in the memory using the first participant identifier, the first participant profile comprising a plurality of attributes associated with the first participant;

produce a first network routing message when at least one of the first participant attributes and at least a portion of the second participant identifier meet a first network classification criterion, the first network routing message identifying an address in a first portion of the packet switched network, the address being associated with the second participant, the first portion being controlled by an entity; and

produce a second network routing message when at least one of the first participant attributes and at least a portion of the second participant identifier meet a second network classification criterion, the second network routing message identifying an address in a second portion of the packet switched network, the second portion not controlled by the entity.

100. (Previously Presented) The system of Claim 99, wherein the communication comprises a voice-over-IP communication.

101. (Previously Presented) The system of Claim 99, wherein the packet switched network is accessed via an Internet service provider.

Application No.: 13/966,096
Filing Date: August 13, 2013

102. **(Currently amended)** The system of Claim 99, wherein the first network classification criterion is satisfied when the first participant identifier does not begin with the same international dialing digit (IDD) digit pattern as the second participant identifier.

103. (Previously Presented) The system of Claim 99, wherein the second network classification criterion is satisfied when access to the second participant requires routing through a portion of the packet switched network operated by a communication service supplier.

104. (Previously Presented) A non-transitory computer readable medium comprising instructions that when executed cause a processor to perform a method of routing communications in a packet switched network in which a first participant identifier is associated with a first participant and a second participant identifier is associated with a second participant in a communication, the method comprising:

after the first participant has accessed the packet switched network to initiate the communication, using the first participant identifier to locate a first participant profile comprising a plurality of attributes associated with the first participant;

when at least one of the first participant attributes and at least a portion of the second participant identifier meet a first network classification criterion, producing a first network routing message for receipt by a controller, the first network routing message identifying an address in a first portion of the packet switched network, the address being associated with the second participant, the first portion being controlled by an entity; and

when at least one of the first participant attributes and at least a portion of the second participant identifier meet a second network classification criterion, producing a second network routing message for receipt by the controller, the second network routing message identifying an address in a second portion of the packet switched network, the second portion not controlled by the entity.

Application No.: 13/966,096
Filing Date: August 13, 2013

REMARKS

The allowed claims are Claims 1-73 and 79-104. Claims 51, 87, 88 and 102 are amended by this paper. Claim 51 is amended is to correct a clerical error by adding the missing labels d) and e) for the last two steps. Claims 87, 88 and 102 are amended to add the inadvertently omitted word "network" prior to "classification" for proper antecedent basis.

Applicant respectfully submits that reasons for the amendments have been provided and that a) this amendment does not necessitate an additional search, b) no more than a cursory review of the record is necessary, and c) the amendment does not involve materially added work on the part of the Office. MPEP §714.16. Applicant respectfully submits that the amendments should be entered and all claims remain patentable.

Co-Pending Applications of Assignee

Applicant wishes to draw the Examiner's attention to the following co-pending applications owned by the same assignee.

Docket No.	Serial No.	Title	Filed
DIGIF.002C2	14/802929	Intercepting Voice Over IP Communications and Other Data Communications	07/17/15
DIGIF.005C2	14/802872	Uninterrupted Transmission of Internet Protocol Transmissions During Endpoint Changes	07/17/15

Application No.: 13/966,096
Filing Date: August 13, 2013

Conclusion

Although the present communication may include alterations to the application or claims, or characterizations of claim scope or referenced art, Applicant is not conceding in this application that previously pending claims are not patentable over the cited references. Rather, any alterations or characterizations are being made to facilitate expeditious prosecution of this application. Applicant reserves the right to pursue at a later date any previously pending or other broader or narrower claims that capture any subject matter supported by the present disclosure, including subject matter found to be specifically disclaimed herein or by any prior prosecution. Accordingly, reviewers of this or any parent, child or related prosecution history shall not reasonably infer that Applicant has made any disclaimers or disavowals of any subject matter supported by the present application.

If the Examiner has any questions which may be answered by telephone, the Examiner is invited to call the undersigned directly.

Please charge any additional fees, including any fees for additional extension of time, or credit overpayment to Deposit Account No. 11-1410.

Respectfully submitted,

KNOBBE, MARTENS, OLSON & BEAR, LLP

Dated: 9/18/15

By: 

John M. Carson
Registration No. 34,303
Attorney of Record
Customer No. 20995
(858) 707-4000

21489317
090115

Electronic Patent Application Fee Transmittal

Application Number:	13966096
Filing Date:	13-Aug-2013
Title of Invention:	PRODUCING ROUTING MESSAGES FOR VOICE OVER IP COMMUNICATIONS
First Named Inventor/Applicant Name:	CLAY PERREAULT
Filer:	John M Carson/Noriko Cook
Attorney Docket Number:	DIGIF.001C1

Filed as Small Entity

Filing Fees for Utility under 35 USC 111(a)

Description	Fee Code	Quantity	Amount	Sub-Total in USD(\$)
Basic Filing:				
Pages:				
Claims:				
Miscellaneous-Filing:				
Petition:				
Patent-Appeals-and-Interference:				
Post-Allowance-and-Post-Issuance:				
Utility Appl Issue Fee	2501	1	480	480

Description	Fee Code	Quantity	Amount	Sub-Total in USD(\$)
Extension-of-Time:				
Miscellaneous:				
Total in USD (\$)				480

Electronic Acknowledgement Receipt

EFS ID:	23432597
Application Number:	13966096
International Application Number:	
Confirmation Number:	8712
Title of Invention:	PRODUCING ROUTING MESSAGES FOR VOICE OVER IP COMMUNICATIONS
First Named Inventor/Applicant Name:	CLAY PERREAULT
Customer Number:	20995
Filer:	John M Carson/Sandra Autry
Filer Authorized By:	John M Carson
Attorney Docket Number:	DIGIF.001C1
Receipt Date:	08-SEP-2015
Filing Date:	13-AUG-2013
Time Stamp:	19:57:30
Application Type:	Utility under 35 USC 111(a)

Payment information:

Submitted with Payment	yes
Payment Type	Credit Card
Payment was successfully received in RAM	\$480
RAM confirmation Number	7864
Deposit Account	111410
Authorized User	KNOBBE MARTENS OLSON AND BEAR

The Director of the USPTO is hereby authorized to charge indicated fees and credit any overpayment as follows:

Charge any Additional Fees required under 37 C.F.R. Section 1.16 (National application filing, search, and examination fees)

Charge any Additional Fees required under 37 C.F.R. Section 1.17 (Patent application and reexamination processing fees)

File Listing:					
Document Number	Document Description	File Name	File Size(Bytes)/ Message Digest	Multi Part /.zip	Pages (if appl.)
1	Issue Fee Payment (PTO-85B)	DIGIF_001C1_IssueFee.pdf	156332 1fa1e43a7021772a7a3d82a8a1a77b3c57c92c7c	no	1
Warnings:					
Information:					
2		DIGIF_001C1_Amend.pdf	1064283 f761642f8b559df030b57f5de07cd354fd162e28	yes	23
	Multipart Description/PDF files in .zip description				
	Document Description		Start	End	
	Amendment after Notice of Allowance (Rule 312)		1	1	
	Claims		2	21	
Applicant Arguments/Remarks Made in an Amendment		22	23		
Warnings:					
Information:					
3	Fee Worksheet (SB06)	fee-info.pdf	30603 099cd7dbec4324ee3007707b64cd517b95cad5c8	no	2
Warnings:					
Information:					
Total Files Size (in bytes):			1251218		

This Acknowledgement Receipt evidences receipt on the noted date by the USPTO of the indicated documents, characterized by the applicant, and including page counts, where applicable. It serves as evidence of receipt similar to a Post Card, as described in MPEP 503.

New Applications Under 35 U.S.C. 111

If a new application is being filed and the application includes the necessary components for a filing date (see 37 CFR 1.53(b)-(d) and MPEP 506), a Filing Receipt (37 CFR 1.54) will be issued in due course and the date shown on this Acknowledgement Receipt will establish the filing date of the application.

National Stage of an International Application under 35 U.S.C. 371

If a timely submission to enter the national stage of an international application is compliant with the conditions of 35 U.S.C. 371 and other applicable requirements a Form PCT/DO/EO/903 indicating acceptance of the application as a national stage submission under 35 U.S.C. 371 will be issued in addition to the Filing Receipt, in due course.

New International Application Filed with the USPTO as a Receiving Office

If a new international application is being filed and the international application includes the necessary components for an international filing date (see PCT Article 11 and MPEP 1810), a Notification of the International Application Number and of the International Filing Date (Form PCT/RO/105) will be issued in due course, subject to prescriptions concerning national security, and the date shown on this Acknowledgement Receipt will establish the international filing date of the application.



UNITED STATES PATENT AND TRADEMARK OFFICE

UNITED STATES DEPARTMENT OF COMMERCE
United States Patent and Trademark Office
Address: COMMISSIONER FOR PATENTS
P.O. Box 1450
Alexandria, Virginia 22313-1450
www.uspto.gov

Table with 5 columns: APPLICATION NO., FILING DATE, FIRST NAMED INVENTOR, ATTORNEY DOCKET NO., CONFIRMATION NO.
13/966,096 08/13/2013 CLAY PERREAULT DIGIF.001C1 8712

20995 7590 09/15/2015
KNOBBE MARTENS OLSON & BEAR LLP
2040 MAIN STREET
FOURTEENTH FLOOR
IRVINE, CA 92614

EXAMINER

SING, SIMON P

ART UNIT PAPER NUMBER

2653

NOTIFICATION DATE DELIVERY MODE

09/15/2015

ELECTRONIC

Please find below and/or attached an Office communication concerning this application or proceeding.

The time period for reply, if any, is set in the attached communication.

Notice of the Office communication was sent electronically on above-indicated "Notification Date" to the following e-mail address(es):

jayna.cartee@knobbe.com
efiling@knobbe.com

**Supplemental
Notice of Allowability**

Application No. 13/966,096	Applicant(s) PERREAULT ET AL.	
Examiner SIMON SING	Art Unit 2653	AIA (First Inventor to File) Status No

-- The MAILING DATE of this communication appears on the cover sheet with the correspondence address--

All claims being allowable, PROSECUTION ON THE MERITS IS (OR REMAINS) CLOSED in this application. If not included herewith (or previously mailed), a Notice of Allowance (PTOL-85) or other appropriate communication will be mailed in due course. **THIS NOTICE OF ALLOWABILITY IS NOT A GRANT OF PATENT RIGHTS.** This application is subject to withdrawal from issue at the initiative of the Office or upon petition by the applicant. See 37 CFR 1.313 and MPEP 1308.

1. This communication is responsive to 312 amendment filed on 09/08/2015.
 A declaration(s)/affidavit(s) under **37 CFR 1.130(b)** was/were filed on _____.
2. An election was made by the applicant in response to a restriction requirement set forth during the interview on _____; the restriction requirement and election have been incorporated into this action.
3. The allowed claim(s) is/are _____. As a result of the allowed claim(s), you may be eligible to benefit from the **Patent Prosecution Highway** program at a participating intellectual property office for the corresponding application. For more information, please see http://www.uspto.gov/patents/init_events/oph/index.jsp or send an inquiry to PPHfeedback@uspto.gov.
4. Acknowledgment is made of a claim for foreign priority under 35 U.S.C. § 119(a)-(d) or (f).

Certified copies:

- a) All b) Some *c) None of the:
1. Certified copies of the priority documents have been received.
 2. Certified copies of the priority documents have been received in Application No. _____.
 3. Copies of the certified copies of the priority documents have been received in this national stage application from the International Bureau (PCT Rule 17.2(a)).

* Certified copies not received: _____.

Applicant has THREE MONTHS FROM THE "MAILING DATE" of this communication to file a reply complying with the requirements noted below. Failure to timely comply will result in ABANDONMENT of this application.

THIS THREE-MONTH PERIOD IS NOT EXTENDABLE.

5. CORRECTED DRAWINGS (as "replacement sheets") must be submitted.
 including changes required by the attached Examiner's Amendment / Comment or in the Office action of Paper No./Mail Date _____.
Identifying indicia such as the application number (see 37 CFR 1.84(c)) should be written on the drawings in the front (not the back) of each sheet. Replacement sheet(s) should be labeled as such in the header according to 37 CFR 1.121(d).
6. DEPOSIT OF and/or INFORMATION about the deposit of BIOLOGICAL MATERIAL must be submitted. Note the attached Examiner's comment regarding REQUIREMENT FOR THE DEPOSIT OF BIOLOGICAL MATERIAL.

Attachment(s)

- | | |
|--|---|
| 1. <input type="checkbox"/> Notice of References Cited (PTO-892) | 5. <input type="checkbox"/> Examiner's Amendment/Comment |
| 2. <input type="checkbox"/> Information Disclosure Statements (PTO/SB/08),
Paper No./Mail Date _____ | 6. <input type="checkbox"/> Examiner's Statement of Reasons for Allowance |
| 3. <input type="checkbox"/> Examiner's Comment Regarding Requirement for Deposit
of Biological Material | 7. <input checked="" type="checkbox"/> Other <u>PTO-271</u> . |
| 4. <input type="checkbox"/> Interview Summary (PTO-413),
Paper No./Mail Date _____. | |

/SIMON SING/
Primary Examiner, Art Unit 2653

DIGIF.001C1

PATENT

IN THE UNITED STATES PATENT AND TRADEMARK OFFICE

Inventor	: Clay Perreault
App. No.	: 13/966,096
Filed	: August 13, 2013
For	: PRODUCING ROUTING MESSAGES FOR VOICE OVER IP COMMUNICATIONS
Examiner	: Sing, Simon P.
Art Unit	: 2653
Conf. No.	: 8712

AMENDMENT AFTER ALLOWANCE UNDER 37 C.F.R. 1.312

Mail Stop Issue Fee

Commissioner for Patents
P.O. Box 1450
Alexandria, VA 22313-1450

Dear Sir:

Further to the Notice of Allowance dated August 13, 2015, and the Supplemental Notice of Allowability dated August 27, 2015, Applicant requests the following amendments in the above-captioned patent application.

Amendments to the Claims are reflected in the listing of claims which begins on page 2 of this paper.

Remarks begin on page 22 of this paper.

OK TO ENTER: /SS/

Response to Rule 312 Communication	Application No. 13/966,096	Applicant(s) PERREAULT ET AL.
	Examiner SIMON SING	Art Unit 2653

-- The MAILING DATE of this communication appears on the cover sheet with the correspondence address --

1. The amendment filed on 08 September 2015 under 37 CFR 1.312 has been considered, and has been:
- a) entered.
 - b) entered as directed to matters of form not affecting the scope of the invention.
 - c) disapproved because the amendment was filed after the payment of the issue fee.
Any amendment filed after the date the issue fee is paid must be accompanied by a petition under 37 CFR 1.313(c)(1) and the required fee to withdraw the application from issue.
 - d) disapproved. See explanation below.
 - e) entered in part. See explanation below.

	/SIMON SING/ Primary Examiner, Art Unit 2653
--	---

DIGIF.001C1

PATENT

IN THE UNITED STATES PATENT AND TRADEMARK OFFICE

Inventor	: Clay Perreault
App. No.	: 13/966,096
Filed	: August 13, 2013
For	: PRODUCING ROUTING MESSAGES FOR VOICE OVER IP COMMUNICATIONS
Examiner	: Sing, Simon P.
Art Unit	: 2653
Conf. No.	: 8712

AMENDMENT AFTER ALLOWANCE UNDER 37 C.F.R. 1.312

Mail Stop Issue Fee

Commissioner for Patents
P.O. Box 1450
Alexandria, VA 22313-1450

Dear Sir:

Further to the Notice of Allowance dated August 13, 2015, and the Supplemental Notice of Allowability dated August 27, 2015, Applicant requests the following amendments in the above-captioned patent application.

Amendments to the Claims are reflected in the listing of claims which begins on page 2 of this paper.

Remarks begin on page 22 of this paper.

OK TO ENTER: /SS/

INFORMATION DISCLOSURE STATEMENT BY APPLICANT	Application No.	13/966,096	
	Filing Date	August 13, 2013	
	First Named Inventor	Perreault, Clay	
	Art Unit	2653	
<i>(Multiple sheets used when necessary)</i>		Examiner	8712
SHEET 5 OF 11		Attorney Docket No.	SMARB19.001C1

U.S. PATENT DOCUMENTS					
Examiner Initials	Cite No.	Document Number Number - Kind Code (if known) Example: 1,234,567 B1	Publication Date MM-DD-YYYY	Name	Pages, Columns, Lines Where Relevant Passages or Relevant Figures Appear
	116	2009/0003535 A1	01-01-2009	Grabelsky et al.	
	117	2009/0129566 A1	05-21-2009	Feuer, Donald S.	
	118	2009/0135724 A1	05-28-2009	Zhang et al.	
	119	2009/0135735 A1	05-28-2009	Zhang et al.	
	120	2009/0214000 A1	08-27-2009	Patel et al.	
	121	2009/0268615 A1	10-29-2009	Pelletier, Jeffrey P.	
	122	2009/0296900 A1	12-03-2009	Breen et al.	
	123	2010/0008345 A1	01-14-2010	Lebizay, Gerald	
	124	2010/0039946 A1	02-18-2010	Imbimbo et al.	
	125	2010/0105379 A1	04-29-2010	Bonner et al.	
	126	2010/0177671 A1	07-15-2010	Qiu et al.	
	127	2010/0246589 A1	09-30-2010	Pelletier, Jeffrey P.	
	128	2010/0272242 A1	10-28-2010	Croy et al.	
	129	2011/0013541 A1	01-20-2011	Croy et al.	
	130	2011/0153809 A1	06-23-2011	Ghanem et al.	
	131	2011/0176541 A1	07-21-2011	James, Anthony W.	
	132	2011/0201321 A1	08-18-2011	Bonner, Thomas W.	
	133	2011/0267986 A1	11-03-2011	Grabelsky et al.	
	134	2012/0014383 A1	01-19-2012	Geromel et al.	
	135	2012/0113981 A1	05-10-2012	Feuer, Donald S.	
	136	2012/0195415 A1	08-02-2012	Wyss et al.	
	137	2012/0250624 A1	10-04-2012	Lebizay, Gerald	
	138	2012/0282881 A1	11-08-2012	Mitchell, Don	
	139	2012/0314699 A1	12-13-2012	Qiu et al.	
	140	2013/0272297 A1	10-17-2013	AT&T Intellectual Property I, L.P. BREEN et al.	
	141	2014/0101749 A1	04-10-2014	Rockstar Consortium US LP YUAN	
	142	2014/0211789 A1	07-31-2014	Centre One Feuer	

Change(s) applied
to document,
/Q.N./
8/21/2015

Examiner Signature /Simon Sing/	Date Considered 04/04/2015
---------------------------------	----------------------------

*Examiner: Initial if reference considered, whether or not citation is in conformance with MPEP 609. Draw line through citation if not in conformance and not considered. Include copy of this form with next communication to applicant.

T¹ - Place a check mark in this area when an English language Translation is attached AT&T, Exh. 1002, p. 486

ALL REFERENCES CONSIDERED EXCEPT WHERE LINED THROUGH. /SS/

INFORMATION DISCLOSURE STATEMENT BY APPLICANT	Application No.	13/966,096	
	Filing Date	August 13, 2013	
	First Named Inventor	Perreault, Clay	
	Art Unit	2653	
<i>(Multiple sheets used when necessary)</i>		Examiner	8712
SHEET 3 OF 11		Attorney Docket No.	SMARB19.001C1

U.S. PATENT DOCUMENTS					
Examiner Initials	Cite No.	Document Number Number - Kind Code (if known) Example: 1,234,567 B1	Publication Date MM-DD-YYYY	Name	Pages, Columns, Lines Where Relevant Passages or Relevant Figures Appear
	58	8,605,869 B1	12-10-2013	Mobarak et al.	
	59	8,607,323 B2	12-10-2013	Yuan, Wei	
	60	8,611,354 B2	12-17-2013	Keränen et al.	
	61	8,625,578 B2	01-07-2014	Roy et al.	
	62	8,724,643 B2	05-13-2014	Feuer, Donald S.	
	63	8,750,290 B2	06-10-2014	Vance et al.	
	64	8,763,081 B2	06-24-2014	Bogdanovic et al.	
	65	8,768,951 B2	07-01-2014	Crago, William Barry	
	66	8,774,171 B2	07-08-2014	Mitchell, Don	
	67	8,804,705 B2	08-12-2014	Voxpath Networks, Inc. Fangman et al.	
	68	2001/0052081 A1	12-13-2001	McKibben et al.	
	69	2002/0002041 A1	01-03-2002	Lindgren et al.	
	70	2002/0018445 A1	02-14-2002	Kobayashi, Toshihiko	
	71	2002/0141352 A1	10-03-2002	Fangman et al.	
	72	2003/0012196 A1	01-16-2003	Ramakrishnan, Kadangode K.	
	73	2003/0095539 A1	05-22-2003	Feuer, Donald S.	
	74	2003/0179747 A1	09-25-2003	Pyke et al.	
	75	2003/0219103 A1	11-27-2003	Rao et al.	
	76	2004/0034793 A1	02-19-2004	Yuan, Wei	
	77	2004/0203582 A1	10-14-2004	Dorenbosch et al.	
	78	2004/0203565 A1	10-14-2004	Chin et al.	
	79	2005/0063519 A1	03-24-2005	James, Anthony W.	
	80	2005/0188081 A1	08-25-2005	Gibson et al.	
	81	2005/0190892 A1	09-01-2005	Dawson et al.	
	82	2005/0202799 A1	09-15-2005	Rollender, Douglas Harold	
	83	2005/0287979 A1	12-29-2005	Rollender, Douglas Harold	
	84	2006/0007940 A1	01-12-2006	Sollee et al.	
	85	2006/0013266 A1	01-19-2006	Vega-Garcia et al.	
	86	2006/0030290 A1	02-09-2006	Rudolf et al.	

Change(s) applied
to document,
/Q.N/
9/1/2015

Examiner Signature	/Simon Sing/	Date Considered	04/04/2015
--------------------	--------------	-----------------	------------

*Examiner: Initial if reference considered, whether or not citation is in conformance with MPEP 609. Draw line through citation if not in conformance and not considered. Include copy of this form with next communication to applicant.

T¹ - Place a check mark in this area when an English language Translation is attached AT&T, Exh. 1002, p. 487

INFORMATION DISCLOSURE STATEMENT BY APPLICANT	Application No.	13/966,096	
	Filing Date	August 13, 2013	
	First Named Inventor	Perreault, Clay	
	Art Unit	2653	
<i>(Multiple sheets used when necessary)</i>		Examiner	8712
SHEET 1 OF 11		Attorney Docket No.	SMARB19.001C1

U.S. PATENT DOCUMENTS					
Examiner Initials	Cite No.	Document Number <i>Number - Kind Code (if known)</i> Example: 1,234,567 B1	Publication Date MM-DD-YYYY	Name	Pages, Columns, Lines Where Relevant Passages or Relevant Figures Appear
	1	5,325,421	06-28-1994	Hou et al.	
	2	6,553,025 B1	04-22-2003	Kung et al.	
	3	6,560,224 B1	05-06-2003	Kung et al.	
	4	6,650,641 B1	11-18-2003	Albert et al.	
	5	6,775,534 B2	08-10-2004	Lindgren et al.	
	6	6,934,279 B1	08-23-2005	Sollee et al.	
	7	6,963,739 B2	11-08-2005	Dorenbosch et al.	
	8	6,985,440 B1	01-10-2006	Albert et al.	
	9	6,993,015 B2	01-31-2006	Kobayashi, Toshihiko	
	10	7,006,508 B2	02-28-2006	Bondy et al.	
	11	7,027,564 B2	04-11-2006	James, Anthony W.	
	12	7,068,668 B2	06-27-2006	Feuer, Donald S.	
	13	7,151,772 B1	12-19-2006	Kalmanek, Jr. et al.	
	14	7,177,399 B2	02-13-2007	Dawson et al.	
	15	7,277,528 B2	10-02-2007	Rao et al.	
	16	7,400,881 B2	07-15-2008	Kallio, Juha	
	17	7,436,835 B2	10-14-2008	Castleberry et al.	
	18	7,440,442 B2	10-21-2008	Grabelsky et al.	
	19	7,486,667 B2	02-03-2009	Feuer, Donald S.	
Change(s) applied to document, /Q.N./ 9/1/2015	20	7,507,131 B2 7,565,131	07-21-2009	Rollender et al.	
	21	7,573,982 B2	08-11-2009	Breen et al.	
	22	7,593,390 B2	09-22-2009	Lebizay, Gerald	
	23	7,639,792 B2	12-29-2009	Qiu et al.	
	24	7,657,011 B1	02-02-2010	Zielinski et al.	
	25	7,664,495 B1	02-16-2010	Bonner et al.	
	26	7,676,215 B2	03-09-2010	Chin et al.	
	27	7,680,114 B2	03-16-2010	Yazaki et al.	
	28	7,702,308 B2	04-20-2010	Rollender, Douglas Harold	

Examiner Signature /Simon Sing/	Date Considered /Simon Sing/
---------------------------------	------------------------------

*Examiner: Initial if reference considered, whether or not citation is in conformance with MPEP 609. Draw line through citation if not in conformance and not considered. Include copy of this form with next communication to applicant.

T¹ - Place a check mark in this area when an English language Translation is attached AT&T, Exh. 1002, p. 488

ALL REFERENCES CONSIDERED EXCEPT WHERE LINED THROUGH. /SS/

INFORMATION DISCLOSURE STATEMENT BY APPLICANT	Application No.	13/966,096	
	Filing Date	August 13, 2013	
	First Named Inventor	Perreault, Clay	
	Art Unit	2653	
<i>(Multiple sheets used when necessary)</i>		Examiner	Sing, Simon P.
SHEET 1 OF 2		Attorney Docket No.	DIGIF.001CI

Change(s)

applied
to

document,

/Q.N./

9/11/2015

U.S. PATENT DOCUMENTS

Examiner Initials	Cite No.	Document Number Number - Kind Code (if known) Example: 1,234,567 B1	Publication Date MM-DD-YYYY	Name	Pages, Columns, Lines Where Relevant Passages or Relevant Figures Appear
	1	5,677,955 A1	10/1997 10-14-1995	Doggett et al.	
	2	5,883,810 A1	03-16-1999	Franklin et al.	
	3	6,173,272 B1	01-09-2001	Thomas et al.	
	4	6,243,689 B1	06-05-2001	Norton, Robert G.	
	5	6,636,833 B1	10-21-2003	Flitcroft et al. Flitcroft, et al.	
	6	6,772,188 B1	08-03-2004	Cheng-Cheng et al. Cloutier	
	7	6,892,184 B1	05-10-2005	Komen et al.	
	8	7,051,072 B2	05-23-2006	Stewart et al.	
	9	7,330,835 B2	02-12-2008	Deggendorf, Theresa M.	
	10	7,426,492 B2	09-16-2008	Bishop et al.	
	11	7,437,665 B2	10-14-2008	Perham, Michael	
	12	7,447,707 B2	11-04-2008	Gaurav et al.	
	13	7,580,886 B1	08-25-2009	Schulz, Larry	
	14	7,593,884 B2	09-22-2009	Rothman et al.	
	15	7,599,944 B2	10-06-2009	Gaurav et al.	
	16	7,644,037 B1	01-05-2010	Ostrovsky, Vladimir	
	17	7,647,500 B2	01-12-2010	Machiraju et al.	
	18	7,676,431 B2	03-09-2010	O'Leary et al.	
	19	7,680,737 B2	03-16-2010	Smith et al.	
	20	7,734,544 B2	06-08-2010	Schleicher, Joerg	
	21	7,765,261 B2	07-27-2010	Kropivny, Alexander	
	22	7,765,266 B2	07-27-2010	Kropivny, Alexander	
	23	7,882,011 B2	02-01-2011	Sandhu et al.	
	24	7,899,742 B2	03-11-2011	Berkert et al.	
	25	8,060,887 B2	11-15-2011	Kropivny, Alexander	
	26	8,161,078 B2	04-17-2012	Gaurav et al.	
	27	8,200,575 B2	06-12-2012	Torres et al.	
	28	8,543,477 B2	09-24-2013	Love et al.	
	29	8,627,211 B2	01-07-2014	Kropivny, Alexander	

Change(s) applied

to document,

/Q.N./

9/1/2015

Examiner Signature	/Simon Sing/	Date Considered	08/24/2015
*Examiner: Initial if reference considered, whether or not citation is in conformance with MPEP 609. Draw line through citation if not in conformance and not considered. Include copy of this form with next communication to applicant.			

T¹ - Place a check mark in this area when an English language Translation is attached.

ALL REFERENCES CONSIDERED EXCEPT WHERE LINED THROUGH. /SS/

AT&T, Exh. 1002, p. 489

INFORMATION DISCLOSURE STATEMENT BY APPLICANT	Application No.	13/966,096	
	Filing Date	August 13, 2013	
	First Named Inventor	Perreault, Clay	
	Art Unit	2653	
<i>(Multiple sheets used when necessary)</i>		Examiner	Sing, Simon P.
SHEET 1 OF 1		Attorney Docket No.	DIGIF.001C1

U.S. PATENT DOCUMENTS					
Examiner Initials	Cite No.	Document Number <i>Number - Kind Code (if known)</i> Example: 1,234,567 B1	Publication Date MM-DD-YYYY	Name	Pages, Columns, Lines Where Relevant Passages or Relevant Figures Appear

FOREIGN PATENT DOCUMENTS						
Examiner Initials	Cite No.	Foreign Patent Document <i>Country Code-Number-Kind Code</i> Example: JP 1234567 A1	Publication Date MM-DD-YYYY	Name	Pages, Columns, Lines Where Relevant Passages or Relevant Figures Appear	T ¹
/SS/	1	CA 2,598,200 A1	02-21-2008	Connexon Telecom Inc.		
/SS/	2	W00200902627 ID (Indonesia)	09-17-2009	Digifonica International Ltd	<i>Corresponding International Publication No. WO 2008/116296 A1 previously disclosed</i>	Abstract Only

NON PATENT LITERATURE DOCUMENTS			
Examiner Initials	Cite No.	Include name of the author (in CAPITAL LETTERS), title of the article (when appropriate), title of the item (book, magazine, journal, serial, symposium, catalog, etc.), date, page(s), volume-issue number(s), publisher, city and/or country where published.	T ¹
/SS/	3	Canadian Office Action dated January 27, 2015 for Canadian Patent Application No. CA 2,681,984.	

20995995
062516
Change(s) applied
to document,
/Q.N./
9/11/2015

Examiner Signature	/Simon Sing/	Date Considered	07/31/2015
--------------------	--------------	-----------------	------------

*Examiner: Initial if reference considered, whether or not citation is in conformance with MPEP 609. Draw line through citation if not in conformance and not considered. Include copy of this form with next communication to applicant.

T¹ - Place a check mark in this area when an English language Translation is attached AT&T, Exh. 1002, p. 490



UNITED STATES PATENT AND TRADEMARK OFFICE

UNITED STATES DEPARTMENT OF COMMERCE
United States Patent and Trademark Office
Address: COMMISSIONER FOR PATENTS
P.O. Box 1450
Alexandria, Virginia 22313-1450
www.uspto.gov

APPLICATION NO.	ISSUE DATE	PATENT NO.	ATTORNEY DOCKET NO.	CONFIRMATION NO.
13/966,096	11/03/2015	9179005	DIGIF.001C1	8712

20995 7590 10/14/2015
KNOBBE MARTENS OLSON & BEAR LLP
2040 MAIN STREET
FOURTEENTH FLOOR
IRVINE, CA 92614

ISSUE NOTIFICATION

The projected patent number and issue date are specified above.

Determination of Patent Term Adjustment under 35 U.S.C. 154 (b) (application filed on or after May 29, 2000)

The Patent Term Adjustment is 90 day(s). Any patent to issue from the above-identified application will include an indication of the adjustment on the front page.

If a Continued Prosecution Application (CPA) was filed in the above-identified application, the filing date that determines Patent Term Adjustment is the filing date of the most recent CPA.

Applicant will be able to obtain more detailed information by accessing the Patent Application Information Retrieval (PAIR) WEB site (<http://pair.uspto.gov>).

Any questions regarding the Patent Term Extension or Adjustment determination should be directed to the Office of Patent Legal Administration at (571)-272-7702. Questions relating to issue and publication fee payments should be directed to the Application Assistance Unit (AAU) of the Office of Data Management (ODM) at (571)-272-4200.

APPLICANT(s) (Please see PAIR WEB site <http://pair.uspto.gov> for additional applicants):

Digifonica (INTERNATIONAL) Limited, Vancouver, CANADA;
CLAY PERREAULT, Panama City, PANAMA;
STEVE NICHOLSON, Hamilton, NEW ZEALAND;
ROD THOMSON, North Vancouver, CANADA;
JOHAN EMIL VIKTOR BJÖRSELL, Vancouver, CANADA;
FUAD ARAFA, Vancouver, CANADA;

The United States represents the largest, most dynamic marketplace in the world and is an unparalleled location for business investment, innovation, and commercialization of new technologies. The USA offers tremendous resources and advantages for those who invest and manufacture goods here. Through SelectUSA, our nation works to encourage and facilitate business investment. To learn more about why the USA is the best country in the world to develop technology, manufacture products, and grow your business, visit SelectUSA.gov.

Under the Paperwork Reduction Act of 1995, no persons are required to respond to a collection of information unless it displays a valid OMB control number.

TRANSMITTAL FOR POWER OF ATTORNEY TO ONE OR MORE REGISTERED PRACTITIONERS

NOTE: This form is to be submitted with the Power of Attorney by Applicant form (PTO/AIA/82B) to identify the application to which the Power of Attorney is directed, in accordance with 37 CFR 1.5, unless the application number and filing date are identified in the Power of Attorney by Applicant form. If neither form PTO/AIA/82A nor form PTO/AIA/82B identifies the application to which the Power of Attorney is directed, the Power of Attorney will not be recognized in the application.

Application Number	13/966,096
Filing Date	August 13, 2013
First Named Inventor	Clay Perreault
Title	PRODUCING ROUTING MESSAGES FOR VOICE OVER IP COMMUNICATIONS
Art Unit	2653
Examiner Name	Simon P. Sing
Attorney Docket Number	DIGIF.001C1

SIGNATURE of Applicant or Patent Practitioner

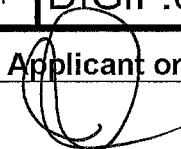
Signature		Date (Optional)	6/22/16
Name	John M. Carson	Registration Number	34,303
Title (if Applicant is a juristic entity)			
Applicant Name (if Applicant is a juristic entity)			

NOTE: This form must be signed in accordance with 37 CFR 1.33. See 37 CFR 1.4(d) for signature requirements and certifications. If more than one applicant, use multiple forms.

*Total of _____ forms are submitted.

This collection of information is required by 37 CFR 1.131, 1.32, and 1.33. The information is required to obtain or retain a benefit by the public which is to file (and by the USPTO to process) an application. Confidentiality is governed by 35 U.S.C. 122 and 37 CFR 1.11 and 1.14. This collection is estimated to take 3 minutes to complete, including gathering, preparing, and submitting the completed application form to the USPTO. Time will vary depending upon the individual case. Any comments on the amount of time you require to complete this form and/or suggestions for reducing this burden, should be sent to the Chief Information Officer, U.S. Patent and Trademark Office, U.S. Department of Commerce, P.O. Box 1450, Alexandria, VA 22313-1450. DO NOT SEND FEES OR COMPLETED FORMS TO THIS ADDRESS. SEND TO: Commissioner for Patents, P.O. Box 1450, Alexandria, VA 22313-1450.

If you need assistance in completing the form, call 1-800-PTO-9199 and select option 2.

Under the Paperwork Reduction Act of 1995, no persons are required to respond to a collection of information unless it displays a valid OMB control number

POWER OF ATTORNEY BY APPLICANT

I hereby revoke all previous powers of attorney given in the application identified in either the attached transmittal letter or the boxes below.

Table with 2 columns: Application Number, Filing Date

(Note: The boxes above may be left blank if information is provided on form PTO/AIA/82A.)

I hereby appoint the Patent Practitioner(s) associated with the following Customer Number as my/our attorney(s) or agent(s), and to transact all business in the United States Patent and Trademark Office connected therewith for the application referenced in the attached transmittal letter (form PTO/AIA/82A) or identified above:

20995

OR

I hereby appoint Practitioner(s) named in the attached list (form PTO/AIA/82C) as my/our attorney(s) or agent(s), and to transact all business in the United States Patent and Trademark Office connected therewith for the patent application referenced in the attached transmittal letter (form PTO/AIA/82A) or identified above. (Note: Complete form PTO/AIA/82C.)

Please recognize or change the correspondence address for the application identified in the attached transmittal letter or the boxes above to:

The address associated with the above-mentioned Customer Number

OR

The address associated with Customer Number:

OR

Form with fields: Firm or Individual Name, Address, City, State, Zip, Country, Telephone, Email

I am the Applicant (if the Applicant is a juristic entity, list the Applicant name in the box):

Empty box for Applicant name

- Inventory or Joint Inventor (title not required below)
Legal Representative of a Deceased or Legally Incapacitated Inventor (title not required below)
Assignee or Person to Whom the Inventor is Under an Obligation to Assign (provide signer's title if applicant is a juristic entity)
Person Who Otherwise Shows Sufficient Proprietary Interest (e.g., a petition under 37 CFR 1.46(b)(2) was granted in the application or is concurrently being filed with this document) (provide signer's title if applicant is a juristic entity)

SIGNATURE of Applicant for Patent

The undersigned (whose title is supplied below) is authorized to act on behalf of the applicant (e.g., where the applicant is a juristic entity).

Signature fields: Signature, Date (Optional), Name, Title

NOTE: Signature - This form must be signed by the applicant in accordance with 37 CFR 1.33. See 37 CFR 1.4 for signature requirements and certifications. If more than one applicant, use multiple forms.

Total of forms are submitted.

This collection of information is required by 37 CFR 1.131, 1.32, and 1.33. The information is required to obtain or retain a benefit by the public which is to file (and by the USPTO to process) an application. Confidentiality is governed by 35 U.S.C. 122 and 37 CFR 1.11 and 1.14. This collection is estimated to take 3 minutes to complete, including gathering, preparing, and submitting the completed application form to the USPTO. Time will vary depending upon the individual case. Any comments on the amount of time you require to complete this form and/or suggestions for reducing this burden, should be sent to the Chief Information Officer, U.S. Patent and Trademark Office, U.S. Department of Commerce, P.O. Box 1450, Alexandria, VA 22313-1450. DO NOT SEND FEES OR COMPLETED FORMS TO THIS ADDRESS. SEND TO: Commissioner for Patents, P.O. Box 1460, Alexandria, VA 22313-1460.

If you need assistance in completing the form, call 1-800-PTO-9199 and select option 2.

CORRECTED APPLICATION DATA SHEET

Application Information

Application Number: 13/966,096
Filing Date: August 13, 2013
Title: PRODUCING ROUTING MESSAGES FOR VOICE
OVER IP COMMUNICATIONS
Attorney Docket Number: DIGIF.001C1

Correspondence Information

Correspondence Customer Number: 20995
Phone Number: (949) 760-0404
Fax Number: (949) 760-9502
E-Mail Address: efiling@knobbe.com

Representative Information

Representative Customer Number: 20995

Applicant Information

Applicant Name: * DIGIFONICA (INTERNATIONAL) LIMITED
VOIP-PAL.COM, INC.

Street: * 773 HORNBY STREET
10900 Northeast 4th Street, Suite 2300

City: * VANCOUVER
Bellevue

State or Province: * BC
WA

Country: * GA
US

Postal or Zip Code: * V6Z-1S4
98004

Dated: 6/22/16

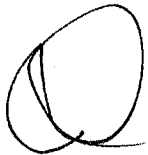
By: 

John M. Carson
Registration No. 34,303
Attorney of Record
Customer No. 20995
(858) 707-4000

23576756

Under the Paperwork Reduction Act of 1995, no persons are required to respond to a collection of information unless it displays a valid OMB control number.

STATEMENT UNDER 37 CFR 3.73(c)

Applicant/Patent Owner: VOIP-PAL.COM, INC.
Application No./Patent No.: 9,179,005 Filed/Issue Date: November 3, 2015
Titled: Producing Routing Messages for Voice Over IP Communications
VOIP-PAL.COM, INC., a corporation

(Name of Assignee) (Type of Assignee, e.g., corporation, partnership, university, government agency, etc.)

states that, for the patent application/patent identified above, it is (choose **one** of options 1, 2, 3 or 4 below):

- 1. The assignee of the entire right, title, and interest.
- 2. An assignee of less than the entire right, title, and interest (check applicable box):
 - The extent (by percentage) of its ownership interest is _____%. Additional Statement(s) by the owners holding the balance of the interest must be submitted to account for 100% of the ownership interest.
 - There are unspecified percentages of ownership. The other parties, including inventors, who together own the entire right, title and interest are:

Additional Statement(s) by the owner(s) holding the balance of the interest must be submitted to account for the entire right, title, and interest.

- 3. The assignee of an undivided interest in the entirety (a complete assignment from one of the joint inventors was made). The other parties, including inventors, who together own the entire right, title, and interest are:

Additional Statement(s) by the owner(s) holding the balance of the interest must be submitted to account for the entire right, title, and interest.

- 4. The recipient, via a court proceeding or the like (e.g., bankruptcy, probate), of an undivided interest in the entirety (a complete transfer of ownership interest was made). The certified document(s) showing the transfer is attached.

The interest identified in option 1, 2 or 3 above (not option 4) is evidenced by either (choose **one** of options A or B below):

- A. An assignment from the inventor(s) of the patent application/patent identified above. The assignment was recorded in the United States Patent and Trademark Office at Reel _____, Frame _____, or for which a copy thereof is attached.
- B. A chain of title from the inventor(s), of the patent application/patent identified above, to the current assignee as follows:

1. From: Clay Perreault; Steve Nicholson; Rod Thomson; Johan Emil Viktor Bjorsell; Fuad Arafat To: DIGIFONICA (INTERNATIONAL) LIMITED

The document was recorded in the United States Patent and Trademark Office at Reel 034122, Frame 0163, or for which a copy thereof is attached.

2. From: DIGIFONICA (INTERNATIONAL) LIMITED To: VOIP-PAL.COM, INC.

The document was recorded in the United States Patent and Trademark Office at Reel 038650, Frame 0887, or for which a copy thereof is attached.

This collection of information is required by 37 CFR 3.73(b). The information is required to obtain or retain a benefit by the public which is to file (and by the USPTO to process) an application. Confidentiality is governed by 35 U.S.C. 122 and 37 CFR 1.11 and 1.14. This collection is estimated to take 12 minutes to complete, including gathering, preparing, and submitting the completed application form to the USPTO. Time will vary depending upon the individual case. Any comments on the amount of time you require to complete this form and/or suggestions for reducing this burden, should be sent to the Chief Information Officer, U.S. Patent and Trademark Office, U.S. Department of Commerce, P.O. Box 1450, Alexandria, VA 22313-1450. DO NOT SEND FEES OR COMPLETED FORMS TO THIS ADDRESS. SEND TO: Commissioner for Patents, P.O. Box 1450, Alexandria, VA 22313-1450.

If you need assistance in completing the form, call 1-800-PTO-9199 and select option 2.

Under the Paperwork Reduction Act of 1995, no persons are required to respond to a collection of information unless it displays a valid OMB control number.

STATEMENT UNDER 37 CFR 3.73(c)

3. From: _____ To: _____

The document was recorded in the United States Patent and Trademark Office at
Reel _____, Frame _____, or for which a copy thereof is attached.

4. From: _____ To: _____

The document was recorded in the United States Patent and Trademark Office at
Reel _____, Frame _____, or for which a copy thereof is attached.

5. From: _____ To: _____

The document was recorded in the United States Patent and Trademark Office at
Reel _____, Frame _____, or for which a copy thereof is attached.

6. From: _____ To: _____

The document was recorded in the United States Patent and Trademark Office at
Reel _____, Frame _____, or for which a copy thereof is attached.

Additional documents in the chain of title are listed on a supplemental sheet(s).

As required by 37 CFR 3.73(c)(1)(i), the documentary evidence of the chain of title from the original owner to the assignee was, or concurrently is being, submitted for recordation pursuant to 37 CFR 3.11.

[NOTE: A separate copy (i.e., a true copy of the original assignment document(s)) must be submitted to Assignment Division in accordance with 37 CFR Part 3, to record the assignment in the records of the USPTO. See MPEP 302.08]

The undersigned (whose title is supplied below) is authorized to act on behalf of the assignee.

Signature

John Carson

Printed or Typed Name

Date

6/22/66

34,303

Title or Registration Number

Electronic Acknowledgement Receipt

EFS ID:	26142720
Application Number:	13966096
International Application Number:	
Confirmation Number:	8712
Title of Invention:	PRODUCING ROUTING MESSAGES FOR VOICE OVER IP COMMUNICATIONS
First Named Inventor/Applicant Name:	CLAY PERREAULT
Customer Number:	20995
Filer:	John M Carson/ThuyQuyen Nguyen
Filer Authorized By:	John M Carson
Attorney Docket Number:	DIGIF.001C1
Receipt Date:	22-JUN-2016
Filing Date:	13-AUG-2013
Time Stamp:	17:10:24
Application Type:	Utility under 35 USC 111(a)

Payment information:

Submitted with Payment	no
------------------------	----

File Listing:

Document Number	Document Description	File Name	File Size(Bytes)/ Message Digest	Multi Part /.zip	Pages (if appl.)
1		DIGIF_001C1_POA_ADS_373_8 pages.pdf	464633 189879c7923c7b58ed1a7eae02431aaaa60 349cc	yes	8

Multipart Description/PDF files in .zip description			
	Document Description	Start	End
	Transmittal Letter	1	2
	Power of Attorney	3	4
	Application Data Sheet	5	6
	Assignee showing of ownership per 37 CFR 3.73	7	8

Warnings:

Information:

Total Files Size (in bytes):	464633
-------------------------------------	--------

This Acknowledgement Receipt evidences receipt on the noted date by the USPTO of the indicated documents, characterized by the applicant, and including page counts, where applicable. It serves as evidence of receipt similar to a Post Card, as described in MPEP 503.

New Applications Under 35 U.S.C. 111

If a new application is being filed and the application includes the necessary components for a filing date (see 37 CFR 1.53(b)-(d) and MPEP 506), a Filing Receipt (37 CFR 1.54) will be issued in due course and the date shown on this Acknowledgement Receipt will establish the filing date of the application.

National Stage of an International Application under 35 U.S.C. 371

If a timely submission to enter the national stage of an international application is compliant with the conditions of 35 U.S.C. 371 and other applicable requirements a Form PCT/DO/EO/903 indicating acceptance of the application as a national stage submission under 35 U.S.C. 371 will be issued in addition to the Filing Receipt, in due course.

New International Application Filed with the USPTO as a Receiving Office

If a new international application is being filed and the international application includes the necessary components for an international filing date (see PCT Article 11 and MPEP 1810), a Notification of the International Application Number and of the International Filing Date (Form PCT/RO/105) will be issued in due course, subject to prescriptions concerning national security, and the date shown on this Acknowledgement Receipt will establish the international filing date of the application.

Please Direct All Correspondence to Customer Number 20995

REQUEST TO UPDATE APPLICANT FOR PATENT

Inventor	:	Clay Perreault
App. No	:	13/966,096
Filed	:	August 13, 2013
For	:	PRODUCING ROUTING MESSAGES FOR VOICE OVER IP COMMUNICATIONS
Examiner	:	Sing, Simon P.
Art Unit	:	2653

Commissioner for Patents
P.O. Box 1450
Alexandria, VA 22313-1450

Dear Sir:

This request to update the name of the Applicant is being made to update a Non-Inventor Applicant under 37 CFR 1.46. Accordingly pursuant to 37 CFR 1.46(c)(2), this Request is accompanied by:

1. An Application Data Sheet outlining changes being made to the designation of Applicant; and
2. Statement Under 3.73 identifying the complete chain of title to the current Non-Inventor Applicant.

Docket No.: DIGIF.001C1

June 20, 2016

App. No.: 13/966,096

Page 2 of 2

Please Direct All Correspondence to Customer Number 20995

No fee is believed to be due, however, the Commissioner is hereby authorized to charge any fee associated with this request, or credit overpayment to Deposit Account No. 11-1410.

Respectfully submitted,

KNOBBE MARTENS OLSON & BEAR LLP



Dated: 6/22/16

By: _____

John M. Carson
Registration No. 34,303
Attorney of Record
Customer No. 20995
(858) 707-4000

23573300



UNITED STATES PATENT AND TRADEMARK OFFICE

UNITED STATES DEPARTMENT OF COMMERCE
United States Patent and Trademark Office
Address: COMMISSIONER FOR PATENTS
P.O. Box 1450
Alexandria, Virginia 22313-1450
www.uspto.gov

APPLICATION NUMBER	FILING OR 371(C) DATE	FIRST NAMED APPLICANT	ATTY. DOCKET NO./TITLE
13/966,096	08/13/2013	CLAY PERREAULT	DIGIF.001C1

CONFIRMATION NO. 8712

POA ACCEPTANCE LETTER

20995
KNOBBE MARTENS OLSON & BEAR LLP
2040 MAIN STREET
FOURTEENTH FLOOR
IRVINE, CA 92614



Date Mailed: 07/11/2016

NOTICE OF ACCEPTANCE OF POWER OF ATTORNEY

This is in response to the Power of Attorney filed 06/22/2016.

The Power of Attorney in this application is accepted. Correspondence in this application will be mailed to the above address as provided by 37 CFR 1.33.

Questions about the contents of this notice and the requirements it sets forth should be directed to the Office of Data Management, Application Assistance Unit, at (571) 272-4000 or (571) 272-4200 or 1-888-786-0101.

/rmohamed/



UNITED STATES PATENT AND TRADEMARK OFFICE

UNITED STATES DEPARTMENT OF COMMERCE
United States Patent and Trademark Office
Address: COMMISSIONER FOR PATENTS
P.O. Box 1450
Alexandria, Virginia 22313-1450
www.uspto.gov

Table with 6 columns: APPLICATION NUMBER, FILING or 371(c) DATE, GRP ART UNIT, FIL FEE REC'D, ATTY. DOCKET NO, TOT CLAIMS, IND CLAIMS. Row 1: 13/966,096, 08/13/2013, 2653, 4590, DIGIF.001C1, 78, 6

CONFIRMATION NO. 8712
CORRECTED FILING RECEIPT

20995
KNOBBE MARTENS OLSON & BEAR LLP
2040 MAIN STREET
FOURTEENTH FLOOR
IRVINE, CA 92614



Date Mailed: 07/11/2016

Receipt is acknowledged of this non-provisional patent application. The application will be taken up for examination in due course. Applicant will be notified as to the results of the examination. Any correspondence concerning the application must include the following identification information: the U.S. APPLICATION NUMBER, FILING DATE, NAME OF APPLICANT, and TITLE OF INVENTION. Fees transmitted by check or draft are subject to collection. Please verify the accuracy of the data presented on this receipt. If an error is noted on this Filing Receipt, please submit a written request for a Filing Receipt Correction. Please provide a copy of this Filing Receipt with the changes noted thereon. If you received a "Notice to File Missing Parts" for this application, please submit any corrections to this Filing Receipt with your reply to the Notice. When the USPTO processes the reply to the Notice, the USPTO will generate another Filing Receipt incorporating the requested corrections

Inventor(s)

CLAY PERREAULT, Panama City, PANAMA;
STEVE NICHOLSON, Hamilton, NEW ZEALAND;
ROD THOMSON, North Vancouver, CANADA;
JOHAN EMIL VIKTOR BJÖRSELL, Vancouver, CANADA;
FUAD ARAFA, Vancouver, CANADA;

Applicant(s)

VOIP-PAL.COM, INC., Bellevue, WA;

Assignment For Published Patent Application

Digifonica (INTERNATIONAL) Limited, Vancouver, CANADA

Power of Attorney: The patent practitioners associated with Customer Number 20995

Domestic Priority data as claimed by applicant

This application is a CON of 12/513,147 03/01/2010 PAT 8542815
which is a 371 of PCT/CA07/01956 11/01/2007
which claims benefit of 60/856,212 11/02/2006

Foreign Applications for which priority is claimed (You may be eligible to benefit from the Patent Prosecution Highway program at the USPTO. Please see http://www.uspto.gov for more information.) - None.

Foreign application information must be provided in an Application Data Sheet in order to constitute a claim to foreign priority. See 37 CFR 1.55 and 1.76.

Permission to Access Application via Priority Document Exchange: Yes

Permission to Access Search Results: No

Applicant may provide or rescind an authorization for access using Form PTO/SB/39 or Form PTO/SB/69 as appropriate.

If Required, Foreign Filing License Granted: 08/28/2013

The country code and number of your priority application, to be used for filing abroad under the Paris Convention, is **US 13/966,096**

Projected Publication Date: Not Applicable

Non-Publication Request: No

Early Publication Request: No

**** SMALL ENTITY ****

Title

PRODUCING ROUTING MESSAGES FOR VOICE OVER IP COMMUNICATIONS

Preliminary Class

379

Statement under 37 CFR 1.55 or 1.78 for AIA (First Inventor to File) Transition Applications: No

PROTECTING YOUR INVENTION OUTSIDE THE UNITED STATES

Since the rights granted by a U.S. patent extend only throughout the territory of the United States and have no effect in a foreign country, an inventor who wishes patent protection in another country must apply for a patent in a specific country or in regional patent offices. Applicants may wish to consider the filing of an international application under the Patent Cooperation Treaty (PCT). An international (PCT) application generally has the same effect as a regular national patent application in each PCT-member country. The PCT process **simplifies** the filing of patent applications on the same invention in member countries, but **does not result** in a grant of "an international patent" and does not eliminate the need of applicants to file additional documents and fees in countries where patent protection is desired.

Almost every country has its own patent law, and a person desiring a patent in a particular country must make an application for patent in that country in accordance with its particular laws. Since the laws of many countries differ in various respects from the patent law of the United States, applicants are advised to seek guidance from specific foreign countries to ensure that patent rights are not lost prematurely.

Applicants also are advised that in the case of inventions made in the United States, the Director of the USPTO must issue a license before applicants can apply for a patent in a foreign country. The filing of a U.S. patent application serves as a request for a foreign filing license. The application's filing receipt contains further information and guidance as to the status of applicant's license for foreign filing.

Applicants may wish to consult the USPTO booklet, "General Information Concerning Patents" (specifically, the section entitled "Treaties and Foreign Patents") for more information on timeframes and deadlines for filing foreign patent applications. The guide is available either by contacting the USPTO Contact Center at 800-786-9199, or it can be viewed on the USPTO website at <http://www.uspto.gov/web/offices/pac/doc/general/index.html>.

For information on preventing theft of your intellectual property (patents, trademarks and copyrights), you may wish to consult the U.S. Government website, <http://www.stopfakes.gov>. Part of a Department of Commerce initiative, this website includes self-help "toolkits" giving innovators guidance on how to protect intellectual property in specific

countries such as China, Korea and Mexico. For questions regarding patent enforcement issues, applicants may call the U.S. Government hotline at 1-866-999-HALT (1-866-999-4258).

LICENSE FOR FOREIGN FILING UNDER
Title 35, United States Code, Section 184
Title 37, Code of Federal Regulations, 5.11 & 5.15

GRANTED

The applicant has been granted a license under 35 U.S.C. 184, if the phrase "IF REQUIRED, FOREIGN FILING LICENSE GRANTED" followed by a date appears on this form. Such licenses are issued in all applications where the conditions for issuance of a license have been met, regardless of whether or not a license may be required as set forth in 37 CFR 5.15. The scope and limitations of this license are set forth in 37 CFR 5.15(a) unless an earlier license has been issued under 37 CFR 5.15(b). The license is subject to revocation upon written notification. The date indicated is the effective date of the license, unless an earlier license of similar scope has been granted under 37 CFR 5.13 or 5.14.

This license is to be retained by the licensee and may be used at any time on or after the effective date thereof unless it is revoked. This license is automatically transferred to any related applications(s) filed under 37 CFR 1.53(d). This license is not retroactive.

The grant of a license does not in any way lessen the responsibility of a licensee for the security of the subject matter as imposed by any Government contract or the provisions of existing laws relating to espionage and the national security or the export of technical data. Licensees should apprise themselves of current regulations especially with respect to certain countries, of other agencies, particularly the Office of Defense Trade Controls, Department of State (with respect to Arms, Munitions and Implements of War (22 CFR 121-128)); the Bureau of Industry and Security, Department of Commerce (15 CFR parts 730-774); the Office of Foreign Assets Control, Department of Treasury (31 CFR Parts 500+) and the Department of Energy.

NOT GRANTED

No license under 35 U.S.C. 184 has been granted at this time, if the phrase "IF REQUIRED, FOREIGN FILING LICENSE GRANTED" DOES NOT appear on this form. Applicant may still petition for a license under 37 CFR 5.12, if a license is desired before the expiration of 6 months from the filing date of the application. If 6 months has lapsed from the filing date of this application and the licensee has not received any indication of a secrecy order under 35 U.S.C. 181, the licensee may foreign file the application pursuant to 37 CFR 5.15(b).

SelectUSA

The United States represents the largest, most dynamic marketplace in the world and is an unparalleled location for business investment, innovation, and commercialization of new technologies. The U.S. offers tremendous resources and advantages for those who invest and manufacture goods here. Through SelectUSA, our nation works to promote and facilitate business investment. SelectUSA provides information assistance to the international investor community; serves as an ombudsman for existing and potential investors; advocates on behalf of U.S. cities, states, and regions competing for global investment; and counsels U.S. economic development organizations on investment attraction best practices. To learn more about why the United States is the best country in the world to develop

technology, manufacture products, deliver services, and grow your business, visit <http://www.SelectUSA.gov> or call +1-202-482-6800.

UNITED STATES PATENT AND TRADEMARK OFFICE

BEFORE THE PATENT TRIAL AND APPEAL BOARD

APPLE INC.,
Petitioner,

v.

VOIP-PAL.COM INC.,
Patent Owner.

Case IPR2016-01198
Patent 9,179,005 B2

Before BARBARA A. BENOIT, LYNNE E. PETTIGREW, and
STACY B. MARGOLIES, *Administrative Patent Judges*.

MARGOLIES, *Administrative Patent Judge*.

DECISION
Institution of *Inter Partes* Review
37 C.F.R. § 42.108

I. INTRODUCTION

Apple Inc. (“Petitioner”) filed a Petition for *inter partes* review of claims 1, 24–26, 49, 50, 73–79, 83, 84, 88, 89, 92, 94–96, 98, and 99 of U.S. Patent No. 9,179,005 B2 (Ex. 1001, “the ’005 patent”). Paper 2 (“Pet.”). Voip-Pal.com, Inc. (“Patent Owner”) filed a Preliminary Response. Paper 5

(“Prelim. Resp.”). Institution of an *inter partes* review is authorized by statute when “the information presented in the petition . . . and any response . . . shows that there is a reasonable likelihood that the petitioner would prevail with respect to at least 1 of the claims challenged in the petition.” 35 U.S.C. § 314(a); *see* 37 C.F.R. § 42.108. Upon consideration of the Petition and the Preliminary Response, we conclude that the information presented shows that there is a reasonable likelihood that Petitioner would prevail in establishing the unpatentability of claims 1, 24–26, 49, 50, 73–79, 83, 84, 88, 89, 92, 94–96, 98, and 99 of the ’005 patent.

A. Related Matters

The parties identify the following district court proceedings in which the ’005 patent has been asserted: *Voip-Pal.com, Inc. v. Apple, Inc.*, Case No. 2-16-cv-00260 (D. Nev.); and *Voip-Pal.com, Inc. v. Verizon Wireless Services, LLC*, Case No. 2-16-cv-00271 (D. Nev.). *See* Pet. 60–61; Paper 4, 1.

Petitioner also has filed a petition for *inter partes* review of claims of U.S. Patent No. 8,542,815 (“the ’815 patent”) in IPR2016-001201. Another petitioner—Unified Patents Inc.—filed a petition for *inter partes* review of claims of the ’815 patent in IPR2016-01082. We did not institute a trial in that case.

B. The ’005 Patent

The ’005 patent is directed to classifying a call as a public network call or a private network call and producing a routing message based on that classification. Ex. 1001; Abstract. Figure 7 of the ’005 patent, shown below, illustrates a routing controller that facilitates communication between callers and callees:

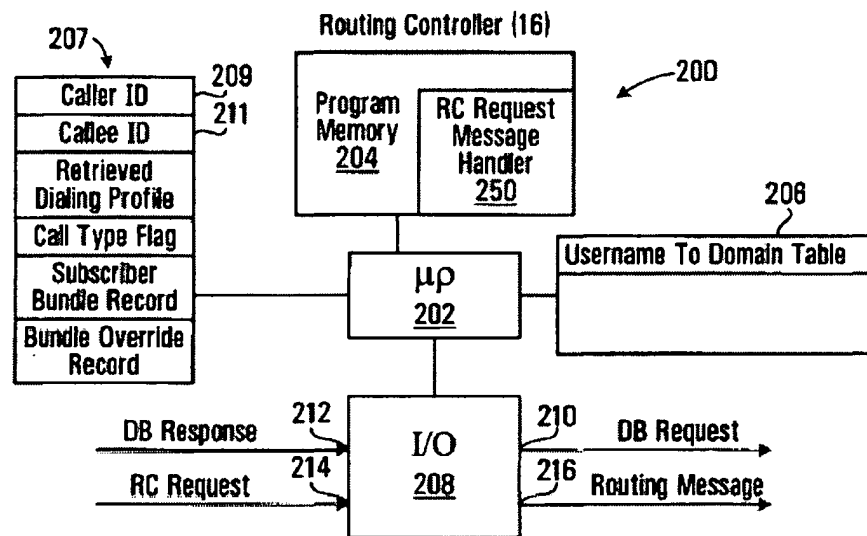

FIG. 7

Id. at Fig. 7, 14:32–33, 17:26–27. As shown in Figure 7, above, routing controller (RC) 16 includes RC processor circuit 200, which in turn includes processor 202, program memory 204, table memory 206, buffer memory 207, and I/O port 208. *Id.* at 17:28–31. Routing controller 16 queries database 18 (shown in Figure 1) to produce a routing message to connect caller and callee. *Id.* at 14:18–25, 14:32–42. Program memory 204 includes blocks of code for directing processor 202 to carry out various functions of the routing controller. *Id.* at 17:47–49. Those blocks of code include RC request message handler 250, which directs the routing controller to produce the routing message. *Id.* at 17:49–53.

According to the '005 patent, in response to a calling subscriber initiating a call, the routing controller:

receiv[es] a callee identifier from the calling subscriber, us[es] call classification criteria associated with the calling subscriber to classify the call as a public network call or a private network call[,] and produc[es] a routing message identifying an address

on the private network, associated with the callee[,] when the call is classified as a private network call and produc[es] a routing message identifying a gateway to the public network when the call is classified as a public network call.

Id. at 14:32–42.

Figures 8A through 8D of the '005 patent illustrate a flowchart of an RC request message handler executed by the RC processor circuit. *Id.* at 11:3–4. Figure 8B, shown below, illustrates steps for performing checks on the callee identifier:

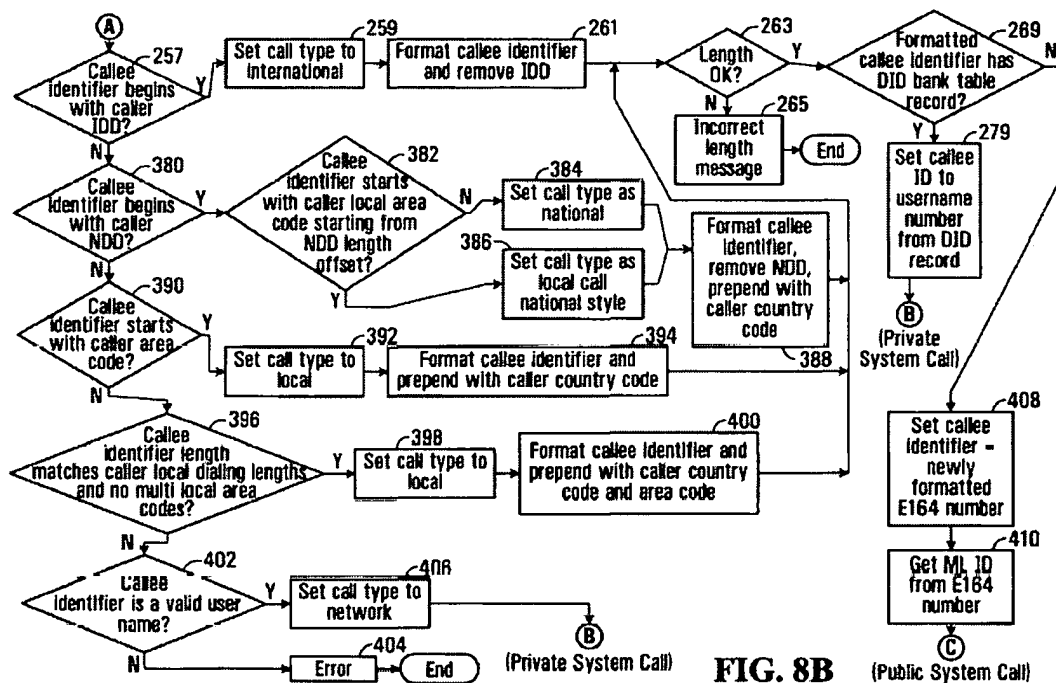

FIG. 8B

Id. at Fig. 8B, 19:53–57. Blocks 257, 380, 390, 396, 402 in Figure 8B above effectively “establish call classification criteria for classifying the call as a public network call or a private network call.” *Id.* at 22:58–61. For example, block 402 “directs the processor 202 of FIG. 7 to classify the call as a private network call when the callee identifier complies with a

predefined format, i.e. is a valid user name and identifies a subscriber to the private network” *Id.* at 22:61–23:3. Block 269 also classifies the call as public or private, depending on whether the callee is a subscriber to the system. *Id.* at 22:61–23:19, 20:23–33; *see also id.* at 18:63–19:30.

C. Illustrative Claim

Among the challenged claims, claims 1, 26, 50, 74, 94, and 99 are independent. Claims 1 and 74 are illustrative and read:

1. A process for producing a routing message for routing communications between a caller and a callee in a communication system, the process comprising:

using a caller identifier associated with the caller to locate a caller dialing profile comprising a plurality of calling attributes associated with the caller;

when at least one of said calling attributes and at least a portion of a callee identifier associated with the callee meet private network classification criteria, producing a private network routing message for receipt by a call controller, said private network routing message identifying an address, on the private network, associated with the callee; and

when at least one of said calling attributes and at least a portion of said callee identifier meet a public network classification criterion, producing a public network routing message for receipt by the call controller, said public network routing message identifying a gateway to the public network.

74. A method of routing communications in a packet switched network in which a first participant identifier is associated with a first participant and a second participant identifier is associated with a second participant in a communication, the method comprising:

after the first participant has accessed the packet switched network to initiate the communication, using the first participant identifier to locate a first participant profile comprising a plurality of attributes associated with the first participant;

when at least one of the first participant attributes and at least a portion of the second participant identifier meet a first network classification criterion, producing a first network routing message for receipt by a controller, the first network routing message identifying an address in a first portion of the packet switched network, the address being associated with the second participant, the first portion being controlled by an entity; and

when at least one of the first participant attributes and at least a portion of the second participant identifier meet a second network classification criterion, producing a second network routing message for receipt by the controller, the second network routing message identifying an address in a second portion of the packet switched network, the second portion not controlled by the entity.

Id. at 36:28–46, 43:41–65.

D. Asserted Grounds of Unpatentability

Petitioner contends that claims 1, 24–26, 49, 50, 73–79, 83, 84, 88, 89, 92, 94–96, 98, and 99 of the '005 patent are unpatentable based on the following specific grounds (Pet. 5, 10–60):

References	Basis	Challenged Claims
Chu '684 ¹ and Chu '366 ²	35 U.S.C. § 103(a)	1, 24–26, 49, 50, 73–79, 83, 84, 88, 89, 92, 94–96, 98, and 99.
Chu '684 and Chen ³	35 U.S.C. § 103(a)	1, 24–26, 49, 50, 73–79, 83, 84, 88, 89, 92, 94–96, 98, and 99

In its analysis, Petitioner relies on the declaration testimony of Dr. Henry H. Houh (Ex. 1009). *See, e.g.*, Pet. 19, 22, 27–30, 32, 36, 40–41, 48–51, 53, 60–61.

II. DISCUSSION

A. Claim Construction

In an *inter partes* review, we construe claim terms in an unexpired patent according to their broadest reasonable construction in light of the specification of the patent in which they appear. 37 C.F.R. § 42.100(b); *Cuozzo Speed Techs., LLC v. Lee*, 136 S. Ct. 2131, 2144–46 (2016) (upholding the use of the broadest reasonable interpretation standard). Consistent with the broadest reasonable construction, claim terms are presumed to have their ordinary and customary meaning as understood by a person of ordinary skill in the art in the context of the entire patent disclosure. *In re Translogic Tech., Inc.*, 504 F.3d 1249, 1257 (Fed. Cir. 2007). An inventor may provide a meaning for a term that is different from its ordinary meaning by defining the term in the specification with

¹ U.S. Patent No. 7,486,684 B2, filed Sept. 30, 2003 (Ex. 1006, “Chu ‘684”).

² U.S. Patent No. 8,036,366 B2, filed Aug. 4, 2006 (Ex. 1007, “Chu ‘366”).

³ U.S. Patent Application Publication No. 2007/0064919 A1, filed Sept. 14, 2005 (Ex. 1008, “Chen”).

reasonable clarity, deliberateness, and precision. *In re Paulsen*, 30 F.3d 1475, 1480 (Fed. Cir. 1994).

Petitioner proposes constructions for the means-plus-function limitations of claims 50 and 73. Pet. 6–9; *see* 37 C.F.R. § 42.104(b)(3) (requiring a petition to set forth, “[w]here the claim to be construed contains a means-plus-function or step-plus-function limitation as permitted under 35 U.S.C. 112(f), . . . the specific portions of the specification that describe the structure, material, or acts corresponding to each claimed function”). Patent Owner does not expressly propose any claim constructions. For purposes of this decision, we determine that the means-plus-function limitations require only identification of corresponding structure,⁴ as set forth below, and no other terms require express construction.

1. “*means for using*” (claim 50)

Claim 50 recites “means for using a caller identifier associated with the caller to locate a caller dialing profile comprising a plurality of calling attributes associated with the caller.” Petitioner proposes that the corresponding structure for this limitation is RC processor circuit 200 programmed to implement the algorithm illustrated in cell 254 of Figure 8A. Pet. 8. Patent Owner does not challenge Petitioner’s contention that this limitation is governed by 35 U.S.C. § 112 ¶ 6 or Petitioner’s identification of corresponding structure.

Based on the current record, we determine that this limitation is governed by section 112, paragraph 6. *See Williamson v. Citrix Online*,

⁴ A means-plus-function limitation is construed to cover the corresponding structure described in the specification and equivalents thereof. 35 U.S.C. § 112 ¶ 6.

LLC, 792 F.3d 1339, 1348 (Fed. Cir. 2015) (en banc) (“[T]he use of the word ‘means’ in a claim element creates a rebuttable presumption that § 112, para. 6 applies.”).

In applying section 112, paragraph 6, structure disclosed in the specification “is ‘corresponding’ structure only if the specification or prosecution history clearly links or associates that structure to the function recited in the claim.” *B. Braun Med., Inc. v. Abbott Labs.*, 124 F.3d 1419, 1424 (Fed. Cir. 1997). If “the disclosed structure is a computer, or microprocessor, programmed to carry out an algorithm, the disclosed structure is not the general purpose computer, but rather the special purpose computer programmed to perform the disclosed algorithm.” *WMS Gaming v. Int’l Game Tech.*, 184 F.3d 1339, 1349 (Fed. Cir. 1999).

Based on the current record, we determine that the corresponding structure for the “means for using” limitation is: RC processor circuit 200 programmed to implement the algorithm illustrated in block 254 of Figure 8A. *See* Ex. 1001, 11:3–4 (“FIGS. 8A-8D is a flowchart of [an] RC request message handler executed by the RC processor circuit shown in FIG. 7.”), 17:61–66, Figs. 7, 8A block 254 (“Use caller field to get dialing profile for caller from database”).

2. “*means for . . . producing a private network routing message*”
(*claim 50*)

Claim 50 recites “means for, when at least one of said calling attributes and at least a portion of a callee identifier associated with the callee meet private network classification criteria, producing a private network routing message for receipt by a call controller, said private network routing message identifying an address, on the private network,

associated with the callee.” Petitioner proposes that the corresponding structure for this limitation is: (i) processor 202 programmed to implement one or more branches of the algorithm illustrated Figure 8B; and (ii) processor 202 of RC processor circuit 200, programmed to implement the algorithm illustrated in cell 350 of Figure 8A or cell 644 of Figure 8C. Pet. 8. Patent Owner does not challenge Petitioner’s contention that this limitation is governed by 35 U.S.C. § 112 ¶ 6 or Petitioner’s identification of corresponding structure.

Based on the current record, we determine that this limitation is governed by section 112, paragraph 6, and that the corresponding structure is: processor 202 programmed to (i) implement one or more branches of the algorithm illustrated Figure 8B that leads to the end of block 406 or block 279, and (ii) implement the algorithm illustrated in block 350 of Figure 8A or block 644 of Figure 8C. *See Ex. 1001, 11:3–4, 17:47–53, 19:58–20:58, 21:23–23:3, 26:49–57, Figs. 7, 8A, 8B, 8C, 16, 32.*

3. *“means for . . . producing a public network routing message”
(claim 50)*

Claim 50 recites “means for, when at least one of said calling attributes and at least a portion of said callee identifier meet a public network classification criterion, producing a public network routing message for receipt by the call controller, said public network routing message identifying a gateway to the public network.” Petitioner proposes that the corresponding structure for this limitation includes at least processor 202 programmed to implement one or more branches of the algorithm illustrated Figure 8B. Pet. 7–8. Petitioner states that Figures 8A, 8C, and 8D “detail, among other functions, algorithms which produce network routing

messages.” *Id.* at 8. Petitioner adds that “because [Figure] 8D and the corresponding description do not illustrate the basic process of generating the claimed message, Petitioner identifies the claimed function as the disclosed algorithm.” *Id.* Specifically, Petitioner proposes that the corresponding structure for this limitation also includes processor 202 of RC processor circuit 200, programmed to implement the claimed function of “producing a public network routing message.” *Id.*

Patent Owner does not challenge Petitioner’s contention that the “means for . . . producing a public network routing message” limitation is governed by 35 U.S.C. § 112 ¶ 6 or Petitioner’s purported identification of corresponding structure.

Based on the current record, we determine that this limitation is governed by section 112, paragraph 6, and that the corresponding structure is: processor 202 programmed to (i) implement one or more branches of the algorithm illustrated Figure 8B that leads to the end of block 410, and (ii) implement the algorithm illustrated in Figure 8D. *See* Ex. 1001, 11:3–4, 17:47–53, 19:58–20:35, 21:27–23:3, 23:59–24:3 (“Referring to FIG. 21, a data structure for a supplier list record is shown. . . . [T]he specific route identifier field 546 holds an IP address of a gateway operated by the supplier indicated by the supplier ID field 540.”), 24:54–59 (“[R]eferring to FIG. 25, the routing message buffer holds a routing message identifying a plurality of different suppliers able to provide gateways to the public telephone network (i.e. specific routes) to establish at least part of a communication link through which the caller may contact the callee.”), 24:65–67 (“Referring back to FIG. 8D, block 568 directs the processor 202 of FIG. 7 to send the routing message shown in FIG. 25 to the call controller 14 in FIG. 1.”),

24:43–25:12, Figs. 7, 8B, 8D, 21–24, 25 (showing IP addresses of gateways).

4. “*means for causing*” (claim 73)

Claim 73 recites “means for causing the private network routing message or the public network routing message to be communicated to a call controller to effect routing of the call.” Petitioner proposes that the corresponding structure for this limitation is processor 202 of RC processor circuit 200, programmed to perform the algorithm illustrated in cell 381 of Figure 8A, cell 646 of Figure 8C, or cell 568 of Figure 8D. Pet. 8–9. Patent Owner does not challenge Petitioner’s contention that this limitation is governed by 35 U.S.C. § 112 ¶ 6 or Petitioner’s identification of corresponding structure.

Based on the current record, we determine that this limitation is governed by section 112, paragraph 6, and that the corresponding structure is: processor 202 of RC processor circuit 200, programmed to perform the algorithm illustrated in block 381 of Figure 8A, block 646 of Figure 8C, and block 568 of Figure 8D. *See* Ex. 1001, 20:37–58, 24:55–25:12, 26:52–53, Figs. 7, 8A, 8C, 8D.

B. Asserted Obviousness over Chu ’684 and Chu ’366

Petitioner contends that claims 1, 24–26, 49, 50, 73–79, 83, 84, 88, 89, 92, 94–96, 98, and 99 of the ’005 patent are unpatentable under 35 U.S.C. § 103(a) as obvious over Chu ’684 and Chu ’366. Pet. 1, 5, 10–36. Relying in part on the testimony of Dr. Henry H. Houh, Petitioner explains how the references allegedly teach or suggest the claim limitations and provides purported reasoning for combining the teachings of the references. *Id.* at 10–36.

1. Summary of Chu '684

Chu '684 discloses a communications system for managing calls in an Internet Protocol (IP) Virtual Private Network (VPN) and calls to the public switched telephone network (PSTN). Ex. 1006, Title, Abstract, 2:51–3:3, 4:13–14. Figure 2 of Chu '684, shown below, depicts a portion of the communications system:

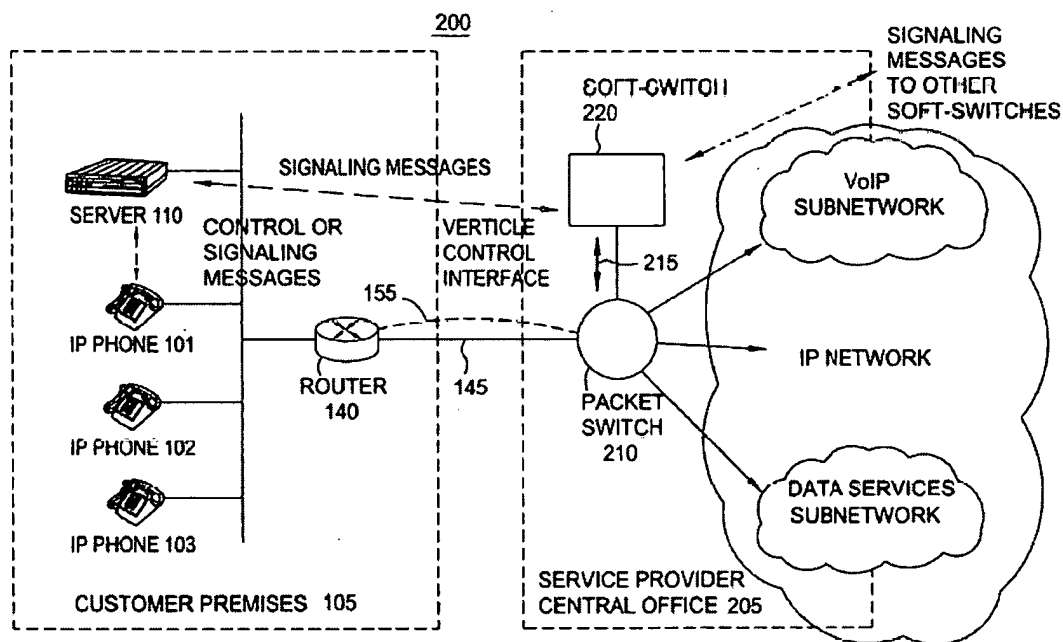

FIG. 2

Id. at 3:14–15. As shown above in Figure 2, communications system 200 includes customer premises 105 having IP phones 101, 102, and 103 and server 110 connected to a voice over IP (VoIP)-VPN Service Provider (SP) at SP central office 205. *Id.* at 4:24–28. Connection 145 between customer premises 205 and SP central office 205 is made via one or more routers 140. *Id.* at 4:28–30. Server 110 communicates with soft-switch 220 with an agreed-upon signaling protocol such as Session Invitation Protocol (SIP). *Id.* at 4:49–52. Soft-switch 220 sends appropriate commands to packet

switch 210. Packet switch 210 is a special media gateway that accepts voice packets from an incoming interface and switches these packets to an outgoing interface. *Id.* at 4:36–39. Soft-switch 220 “is the intelligence of the system For example, it keeps track of the VPN that a location belongs to, the dial plans of the subscribers, . . . and the like.” *Id.* at 4:59–63.

Chu ’684’s VoIP network carries both on-net (within the same VoIP VPN) and off-net (to PSTN) calls. *Id.* at 5:17–19. Chu ’684 discloses that an “On-Net Call” sequence begins when a user picks up the handset at IP phone 101. *Id.* at 8:39–40, 8:55–56. According to Chu ’684, IP phone 101 collects dialed digits from the user and sends them to server 110. *Id.* at 8:62–64. Chu ’684 discloses that “after receiving all the dialed digits from the phone 101, server 110 consults its dial plan to determine whether the call is local, to another on-net phone, or to a phone that is on the PSTN.” *Id.* at 8:65–9:1. In this on-net example, the call is another on-net phone in another location. According to Chu ’684, server 110 sends an SIP invite message to soft-switch 220 at central office 205. *Id.* at 9:2–4. Chu ’684 discloses that soft-switch 220 “consults the dial plan for this subscriber” based on the ID of server 110. *Id.* at 9:30–33. From the database associated with the dial plan, soft-switch 220 determines, among other things, the IP address of the egress packet switch. *Id.* at 9:34–38. Chu ’684 discloses that soft-switch 220 sends an SIP invite message to the next soft-switch, the SIP message including information such as that “the call is an on-net call for a particular VPN.” *Id.* at 9:50–58.

Figure 13 of Chu ’684 illustrates a configuration for establishing IP-VPN service to the PSTN. *Id.* at 13:1–3. According to Chu ’684, for an

outgoing call from IP phone 101, the operation is very similar to that of an intra-net call. *Id.* at 13:13–15. Chu '684 states: “From the dialed digits (of a destination phone that is being called, PSTN phone 1301), ingress soft-switch 220[] determines that this call is for the PSTN.” *Id.* at 13:15–18. From the same dialed digits, the soft-switch also determines egress PSTN gateway 1302 and its controlling soft-switch 1304. *Id.* at 13:18–20.

2. Summary of Chu '366

Chu '366 discloses a system for intelligent formatting of VoIP telephone numbers. Ex. 1007, Abstract. By way of background, Chu '366 explains that the International Telecommunication Union's E.164 protocol provides a uniform means for identifying any telephone number in the world to any telephony user in the world. *Id.* at 1:18–20. Chu '366 states that an E.164-formatted number has at most 15 digits, and contains an E.164 prefix (typically a + sign), a country code, and a subscriber telephone number. *Id.* at 1:29–31. Chu '366 explains that when making calls via a traditional PSTN, a subscriber is able to enter abbreviated numbers for local and national telephone calls. *Id.* at 1:35–37. For example, for a local call in the United States, a user may simply enter the seven digit telephone number without an E.164 prefix, the country code or the area code. *Id.* at 1:37–40. By contrast, Chu '366 states, “there is no such concept of local, long distance or national calls when making a call via Internet telephony” because even for a call between two local points, that call may be routed by servers located across the globe. *Id.* at 1:44–49.

According to Chu '366, then-existing global VoIP service providers required users to enter fully formatted E.164 telephone numbers. *Id.* at 1:49–51. Chu '366 describes a system that allows users to enter a phone

number that is not E.164-compliant, and transforms that number into one that is E.164-compliant using, for example, information from a call origin location profile. *Id.* at 1:67–2:4, 2:16–67.

3. Analysis

Petitioner generally contends that Chu '684 teaches call set up procedures in which a call processor analyzes attributes of the caller (e.g., the caller's dial plan) and information identifying the callee (e.g., dialed digits) to determine whether the call should be routed to a destination on the private packet network or the public PSTN, and that Chu '366 teaches using caller attributes such as country code and area code to reformat the dialed digits into a standard format before determining whether the call is public or private. Pet. 10–14. Petitioner contends that it would have been obvious to a skilled artisan to modify the system described in Chu '684 with the specific dialed digit reformatting teachings of Chu '366 and that a skilled artisan would have recognized that allowing users to place calls as if they were dialing from a standard PSTN phone would be desirable, creating a system capable of supporting a more intuitive and user friendly interface. Pet. 15–16 (citing Ex. 1009 (Houh Decl.) ¶¶ 35–39).

As to the limitations of claim 1, Petitioner contends that Chu '684 teaches the “using a caller identifier . . . to locate a caller dialing profile” limitation of claim 1 by teaching using a subscriber's identifying information (e.g., E.164 telephone number) to access a dial plan that includes attributes of the subscriber.” Pet. 17–18. For this same limitation, Petitioner also argues that Chu '366 teaches call origin profiles “that include calling attributes such as geographic location, country code, and area code.” *Id.* at 18.

As to the “producing a private network routing message” and “producing a public network routing message” limitations, Petitioner relies on teachings from Chu ’366 and Chu ’684. *Id.* at 18–20. Petitioner argues that Chu ’366 teaches reformatting dialed digits to generate an E.164-compliant callee identifier “when dialed digits ‘match’ caller attributes, e.g., when the dialed digits equal the national dialing length of the caller’s origin destination.” *Id.* at 18–19. Petitioner also argues that Chu ’684 teaches determining “whether the call ‘meets public network classification criteria’ or ‘private network classification criteria,’” citing the following passage from Chu ’684:

At step 608, after receiving all the dialed digits from the phone 101, server 110 consults its dial plan to determine whether the call is local, to another on-net phone, or to a phone that is on the PSTN.

Pet. 19–20 (citing Ex. 1006, 8:65–9:1).

Having reviewed the record, we determine that Petitioner has shown sufficiently for institution that the combination of Chu ’684 and Chu ’366 teaches the recited limitations of claim 1. *See id.* at 12–20; Ex. 1006, 8:65–9:1, 9:30–49, 4:52–56, 13:12–34; Ex. 1007, 2:38–67, 4:65–5:5, Fig. 6. Petitioner also has articulated sufficient reasoning with rational underpinning for combining the teachings of Chu ’684 and Chu ’366. Pet. 15–16. We address Patent Owner’s arguments made in its Preliminary Response below.

a. Claim 1: classification criteria

Patent Owner argues that Petitioner fails to make a sufficient showing regarding the “classification criteria” requirements of claim 1. Prelim. Resp. 16–25. Specifically, Patent Owner argues that Chu ’684’s classifying step

does not involve meeting classification criteria based on calling attributes, as recited in claim 1. *Id.* at 16–17. Patent Owner relies in part on Figure 6 of Chu '684, shown below:

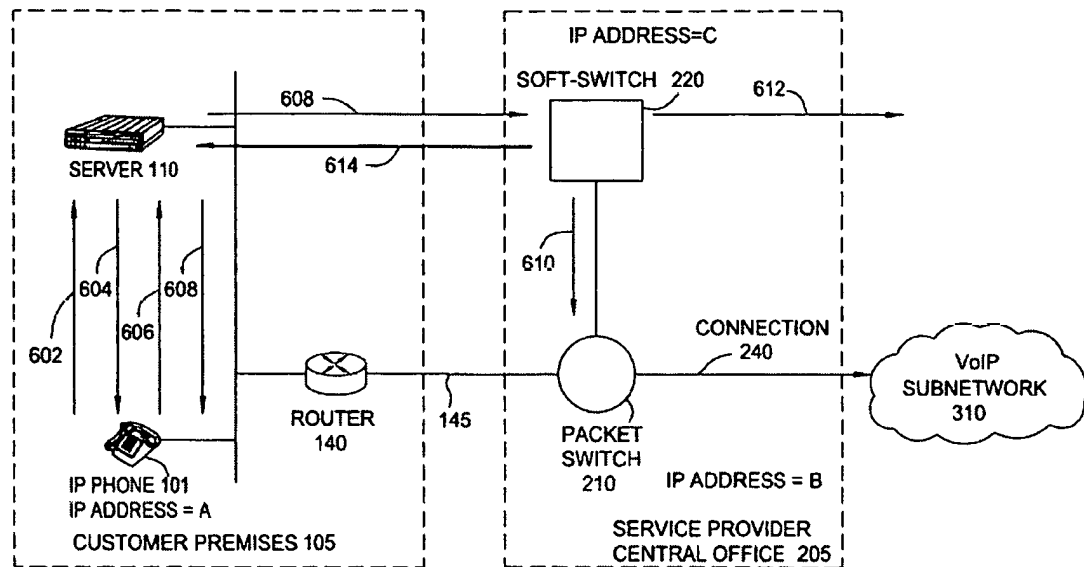

FIG. 6 200

Figure 6 of Chu '684, above, depicts a sequence for handling an on-net call. Ex. 1006, 8:39–40. According to Patent Owner, Petitioner relies on step 608, in which server 110 consults a dial plan to classify the call, for the “classification criteria” requirement, and improperly relies on subsequent step 610, in which soft-switch 220 uses a callee identifier to locate a dial plan, for the “using a caller identifier . . . to locate” step. Prelim. Resp. 17–19. Given the order of steps illustrated in Figure 6 above, Patent Owner argues that Chu '684's classifying step 608 “is distinct from” the claimed steps of “when at least one of said calling attributes and at least a portion of a callee identifier associated with the callee meet private network classification criteria, producing a private network routing message . . .” and “when at least one of said calling attributes and at least a portion of said

callee identifier meet a public network classification criterion, producing a public network routing message” *Id.* at 19.

We determine that Petitioner has made a sufficient showing at this stage. Petitioner does not rely exclusively on Chu ’684 for teaching the classification criteria limitations. Rather, Petitioner contends that Chu ’684’s disclosure of classifying the call based on a dial plan combined with Chu ’366’s teaching of reformatting dialed digits based on matching dialed digits to caller attributes teaches producing a private or a public network routing message when a calling attribute and a portion of a callee identifier associated with the callee meet private or public network classification criteria, respectively. Pet. 18–19. According to Chu ’684, at step 608, server 110 consults its dial plan to determine whether the call is to another on-net phone or to the PSTN. Ex. 1006, 8:65–9:1. Petitioner sufficiently shows for institution that Chu ’684 discloses the claimed classifying a call as a public network call based on public network classification criteria and classifying the call as a private network call based on private network classification criteria. *See* Pet. 19–20; Ex. 1006, 8:65–9:4. Petitioner also sufficiently shows for institution that Chu ’366 teaches reformatting dialed digits based on matching dialed digits to caller attributes such as the country code and/or area code for the location from which the caller is placing the call. Pet. 12–13, 17–19; Ex. 1007, 2:38–67, 4:65–5:5, Fig. 6. Petitioner also indicates that Chu’s reformatting is similar to the reformatting illustrated in Figure 8B of the ’005 patent. Pet. 11–13. Patent Owner addresses Chu ’684 and Chu ’366 individually, and does not consider the combined teachings of the references. *See* Prelim. Resp. 16–25; *see also In re Mouttet*, 686 F.3d 1322, 1333 (Fed. Cir. 2012) (citing *In re Keller*, 642 F.2d 413, 425 (CCPA

1981)) (“[T]he test for obviousness is what the combined teachings of the references would have suggested to those having ordinary skill in the art.”).

Patent Owner also argues that Chu ’366 does not disclose classification criteria as claimed because all calls in Chu ’366 are assumed to be destined for the PSTN. Prelim. Resp. 20. As explained above, Petitioner relies on the combined teachings of Chu ’684 and Chu ’366 for teaching the classification criteria claim limitations. Moreover, Petitioner does not rely on Chu ’366 for teaching private or public network classification criteria. Pet. 18–20.

Patent Owner further argues that the proposed combination “would not work.” Prelim Resp. 20. Specifically, Patent Owner argues that “Petitioner’s proposal to insert Chu ’366’s ‘reformatting’ prior to Chu ’684’s ‘classification’ of a call would render Chu ’684’s system unreliable.” *Id.* at 22. Patent Owner argues that Chu ’366’s reformatting is directed only to public telephone numbers, and that Chu ’684’s private numbering plan “is distinct from, and works in parallel with, the ‘public E.164 number plan’ used for placing calls using public telephone numbers.” *Id.* at 21. Patent Owner makes the unsupported statement at this preliminary stage that “[a] skilled person would understand that the purpose of using a ‘private numbering scheme’ within an organization is precisely to be free from the strictures of PSTN dialing conventions.” *Id.* at 22.

At this preliminary stage, Petitioner has sufficiently shown on the current record that combining the teachings of Chu ’684 and Chu ’366 in the manner proposed by Petitioner is simply the combination of familiar elements according to known methods to yield predictable results and thus would have been obvious to a person of ordinary skill in the art. *See* Pet. 19;

Ex. 1009 ¶ 38; *see also KSR Int'l Co. v. Teleflex Inc.*, 550 U.S. 398, 416 (2007).

We thus find based on the current record that Petitioner sufficiently shows that the combination of Chu '684 and Chu '366 teaches the claimed classification criteria limitations.

b. Claim 1: using a caller identifier . . . to locate a caller dialing profile

Patent Owner also argues that Chu '684 fails to disclose “using a caller identifier . . . to locate a caller dialing profile comprising a plurality of calling attributes associated with the caller,” as recited in claim 1 of the '005 patent. Prelim. Resp. 33–35. Patent Owner argues that Chu '684's dial plan “is not associated with any particular ‘caller’” and that Petitioner fails to establish that the dial plan includes any calling attributes associated with the caller. *Id.* at 33. Patent Owner also argues that the teachings of Chu '684 and Chu '366 are “incompatible” because “it is unclear how to combine a caller-specific call origin location profile [as taught by Chu '366] with an enterprise's IP-PBX network-specific ‘dial plan’ [as taught by Chu '684].” *Id.* at 35. Patent Owner maintains that the Petition does not explain how Chu '366's teaching of a user-specific profile could be applied to Chu '684's network-specific dial plan. *Id.* at 37.

We determine that Petitioner has made a sufficient showing at this stage. Claim 1 broadly recites that the caller dialing profile has a plurality of calling attributes “associated with the caller.” Petitioner has sufficiently shown at this preliminary stage that the combination of Chu '684 and Chu '366 teaches a caller dialing profile that includes calling attributes “associated with” a caller. *See* Pet. 11–13, 17; Ex. 1007, 4:65–5:5; Ex. 1006, 3:56–64; 9:23–25; Ex. 1009 ¶ 45. In addition, Petitioner sufficiently

explains for institution, and with support from its declarant, that a skilled artisan would have combined the teachings of the references by programming the Chu '684 system to analyze the dialed digits and reformat as necessary using caller attributes such as national code and area code. Pet. 16 (citing Ex. 1009 ¶ 38). We thus find that Petitioner sufficiently shows on the current record, and for the purpose of institution, that the combination of Chu '684 and Chu '366 teaches the claimed “using a caller identifier . . . to locate a caller dialing profile comprising a plurality of calling attributes associated with the caller.”

c. Motivation to combine

Patent Owner argues that Petitioner’s purported reason for combining the teachings of Chu '684 and Chu '366 is conclusory and insufficient. Prelim. Resp. 37–42. Patent Owner also identifies distinctions between the systems of the two references as support for additional reasons why one skilled in the art would not have made the proposed combination. *Id.* at 42–47.

We determine based on the current record for purposes of institution that Petitioner has articulated sufficient reasoning with rational underpinning for combining the teachings of Chu '684 and Chu '366. *See* Pet. 15–16; Ex. 1009 ¶¶ 36–39. For example, Petitioner argues with citations to the references that both Chu '684 and Chu '366 teach telecommunications systems in which VoIP subscribers can place calls to a callee on the PSTN. *See* Pet. 15; Ex. 1006, 8:65–9:1; Ex. 1007, 14:30–33. In addition, Petitioner cites evidence showing that (i) one of ordinary skill in the art would have recognized upon reading Chu '684 that allowing users to place calls as if they were dialing from a standard PSTN phone would have been desirable,

creating a system capable of supporting a more intuitive and user-friendly interface; and (ii) the infrastructure of the Chu '684 system would support dialed digit reformatting based on attributes of the caller as taught by Chu '366. *See* Pet. 19; Ex. 1009 ¶¶ 37, 38. A determination of obviousness based on teachings from multiple references does not require an actual, physical substitution of elements. *Mouffet*, 686 F.3d at 1332. Rather, the relevant inquiry is what the combined teachings of the references would have suggested to one having ordinary skill in the art. *Id.* at 1333.

d. Conclusion regarding claim 1

For the foregoing reasons, we determine that the information presented establishes a reasonable likelihood that Petitioner would prevail in showing that claim 1 is unpatentable under 35 U.S.C. § 103(a) as obvious over Chu '684 and Chu '366.

e. Claim 74

With respect to independent claim 74, the parties primarily rely on the same evidence and arguments that they rely on for claim 1. *See* Pet. 24–28; Prelim. Resp. 14–47. Claim 74 is different from claim 1 in that it recites, among other things, the following limitations:

when at least one of the first participant attributes and at least a portion of the second participant identifier meet a first network classification criterion, producing a first network routing message for receipt by a controller, *the first network routing message identifying an address in a first portion of the packet switched network*, the address being associated with the second participant, *the first portion being controlled by an entity*; and

when at least one of the first participant attributes and at least a portion of the second participant identifier meet a second network classification criterion, producing a second network routing message for receipt by the controller, *the second network routing message identifying an address in a second portion of the*

packet switched network, the second portion not controlled by the entity.

Ex. 1001, 43:51–65 (emphasis added).

Petitioner contends that the combination of Chu '684 and Chu '366 teaches the above-emphasized limitations by teaching that the reformatted callee identifier is used to determine (i) whether the callee is on the same packet-switched/soft-switch network serving the caller (“a first portion . . . controlled by an entity”) or (ii) if the callee is served by a different subscriber LAN than the caller (“a second portion not controlled by an entity”). Pet. 26; *see also id.* at 26–28. Patent Owner argues that “Petitioner assumes that a different ‘entity’ controls each ‘network’ (e.g., LAN) in Chu '684. But one ‘subscriber’ can control networks at multiple locations.”

Prelim. Resp. 24.

On the current record, Petitioner sufficiently shows for purposes of institution that Chu '684 teaches the disputed limitations. Petitioner sufficiently shows that Chu '684 teaches generating a private network routing message identifying an address on one LAN and generating a private network routing message identifying an address on a separate LAN. Pet. 26–28; Ex. 1006, 14:66–15:14, Fig. 14a. Petitioner relies on the embodiment illustrated in Figure 14a of Chu '684, shown below:

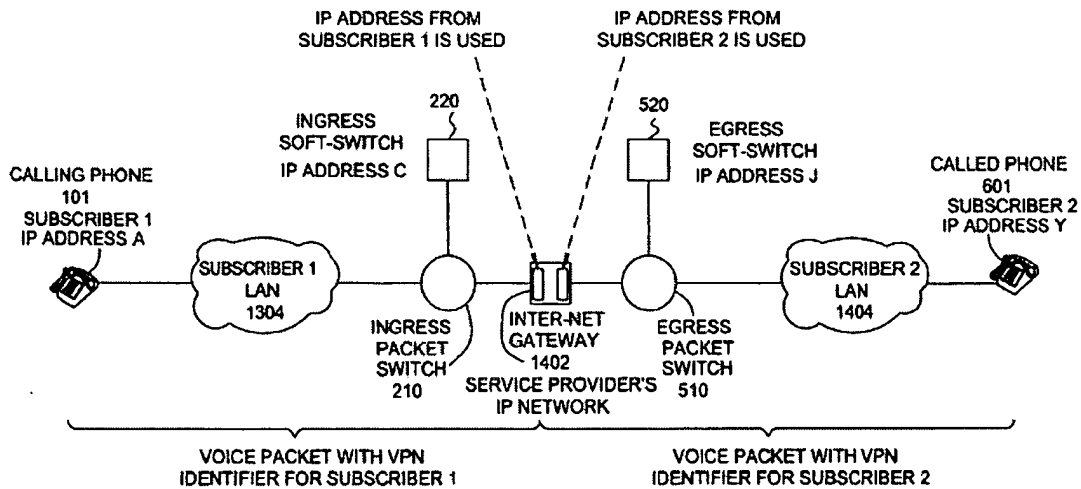

FIG. 14a

Petitioner sufficiently shows for purposes of institution that, as illustrated in Chu '684 Figure 14a above, LAN 1304 is for subscriber 1 and LAN 1404 is for subscriber 2. Ex. 1006, Fig. 14a; *see also id.* at 13:66–14:1 (“The configuration shown in FIG. 14a is for calls between IP phones of different subscribers’ networks (i.e. the first subscriber LAN 1304 and a second subscriber LAN 1404).”). Petitioner thus sufficiently shows that Chu '684 teaches that the separate LAN (LAN 1404) is not controlled by the subscriber that controls the first LAN (LAN 1304).

For the foregoing reasons, and for the reasons set forth above with respect to claim 1, we determine that the information presented establishes a reasonable likelihood that Petitioner would prevail in showing that independent claim 74 is unpatentable under 35 U.S.C. § 103(a) as obvious over Chu '684 and Chu '366.

f. Remaining claims

Petitioner and Patent Owner rely on the same evidence and arguments for challenged independent claims 26, 50, 94, and 99 that they rely on for

claim 1, and Petitioner presents additional declaration testimony from Dr. Houh regarding the means-plus-function limitations of claim 50. *See* Pet. 21–25, 31–36; Ex. 1009 ¶¶ 47, 48; Prelim. Resp. 14–47. For the foregoing reasons explained above in connection with claim 1, and because on the current record we are persuaded by the additional Dr. Houh testimony, we determine that the information presented establishes a reasonable likelihood that Petitioner would prevail in showing that independent claims 26, 50, 94, and 99 are unpatentable under 35 U.S.C. § 103(a) as obvious over Chu '684 and Chu '366.

We have reviewed the information presented in the Petition and supporting evidence with respect to challenged dependent claims 24, 25, 49, 73, 75–79, 83, 84, 88, 89, 92, 95, 96, and 98. *See* Pet. 20, 21, 23, 25, 28–31, 33–34; Ex. 1009 ¶¶ 49–52. Patent Owner does not raise any additional arguments specific to the dependent claims. *See, e.g.*, Prelim. Resp. 2–3, 14–47. We determine that the information presented establishes a reasonable likelihood that Petitioner would prevail in showing that independent claims 24, 25, 49, 73, 75–79, 83, 84, 88, 89, 92, 95, 96, and 98 are unpatentable under 35 U.S.C. § 103(a) as obvious over Chu '684 and Chu '366. *See, e.g.*, Ex. 1006, 4:52–56 (teaching sending routing messages to a soft-switch to effect routing), 13:4–9 (teaching that the packet switched network comprises the Internet); Ex. 1009 ¶¶ 49–52.

C. Asserted Obviousness over Chu '684 and Chen

Petitioner contends that claims 1, 24–26, 49, 50, 73–79, 83, 84, 88, 89, 92, 94–96, 98, and 99 of the '005 patent are unpatentable under 35 U.S.C. § 103(a) as obvious over Chu '684 and Chen. Pet. 1, 5, 36–60. Relying in part on the testimony of Dr. Henry H. Houh, Petitioner explains

how the references allegedly teach or suggest the claim limitations and provides purported reasoning for combining the teachings of the references. *Id.* at 36–60.

1. Summary of Chen

Chen discloses a method for translating between different dial plans “so that a user in any region or country may place phone calls in a familiar manner.” Ex. 1008 ¶¶ 2, 15. Chen explains that E.164 defines an international public telecommunication number plan and requires a format of +country code-area code-subscriber number. *Id.* ¶¶ 6, 11. Chen notes that a different numbering plan such as a regional or countrywide numbering plan defines the dial plan for local and long distance calls. *Id.* ¶ 12. Figures 6 and 7 of Chen disclose algorithms for translating between E.164 and regional numbering plans. *Id.* ¶¶ 35–47. Figure 6 is shown below:

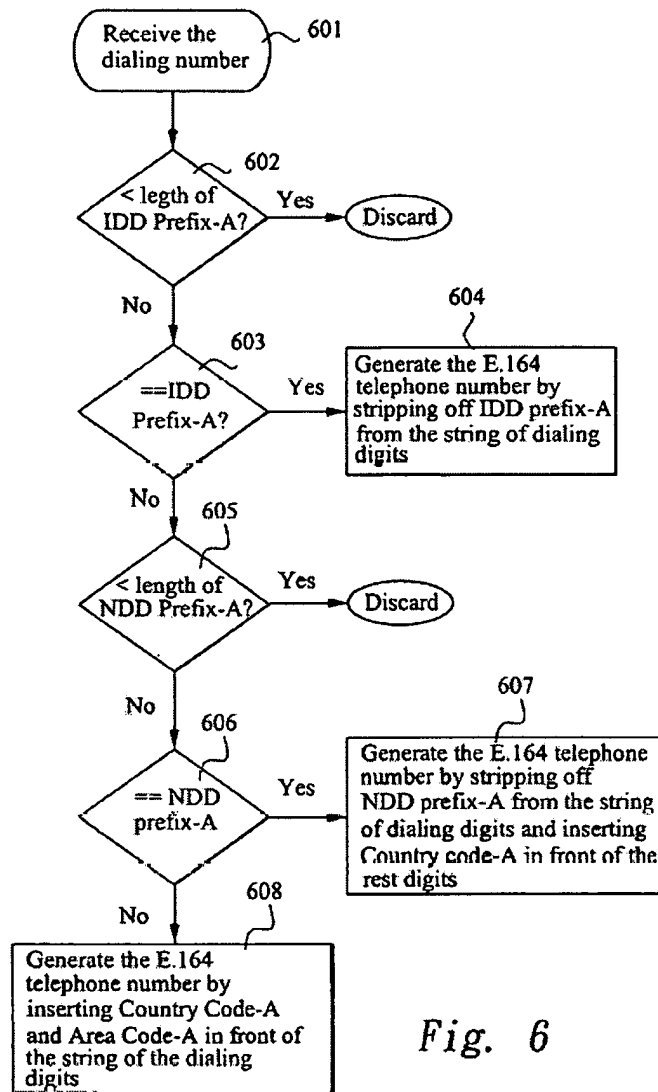

Fig. 6

Id. at Fig. 6. As illustrated in Figure 6 above, Chen discloses determining whether a dialed number has a particular format that contains an International Dialing Digit prefix (“+”) or a National Dialing Digits prefix (e.g., “1” for North America), and generating an E.164-compliant number by inserting the applicable country code and area code. *Id.* ¶¶ 33–40, Fig. 6. Figure 7 illustrates steps for translating an E.164-compliant number to the format of a different dial plan, such as that for a Session Initiation Protocol (SIP) phone. *Id.* ¶¶ 27, 41–48, 52, Fig. 7.

2. Analysis

Petitioner relies on essentially the same analysis to show that the subject matter of the challenged claims would have been obvious in view of Chu '684 and Chen as it does for the combination of Chu '684 and Chu '366. *Compare* Pet. 36–60, *with id.* at 10–36. Patent Owner likewise addresses both grounds essentially identically. *Compare* Prelim. Resp. 47–65, *with id.* at 16–47.

Having reviewed the record, we determine that Petitioner has shown sufficiently for institution that the combination of Chu '684 and Chen teaches the recited limitations of claim 1. *See* Pet. 36–60; Ex. 1006, 8:65–9:1, 9:30–49, 4:52–56, 13:12–34; Ex. 1007 ¶¶ 33–40, Fig. 6.

We determine that, based on the current record and for purposes of institution, Petitioner also has articulated sufficient reasoning with rational underpinning for combining the teachings of Chu '684 and Chen. Pet. 39–41.

For the foregoing reasons, we determine that the information presented establishes a reasonable likelihood that Petitioner would prevail in showing that claim 1 is unpatentable under 35 U.S.C. § 103(a) as obvious over Chu '684 and Chen. Petitioner and Patent Owner rely on the same evidence and arguments for challenged independent claims 26, 50, 74, 94, and 99 that they rely on for claim 1, except that Petitioner presents additional declaration testimony from Dr. Houh regarding the means-plus-function claim limitations of claim 50, and Patent Owner presents an additional argument regarding claim 74. *See* Pet. 36–60; Ex. 1009 ¶¶ 47–49; Prelim. Resp. 47–65. For the reasons explained above with respect to claims 1 and 74, and because on the current record we are persuaded by the

additional Dr. Houh testimony, we determine that the information presented establishes a reasonable likelihood that Petitioner would prevail in showing that independent claims 26, 50, 74, 94, and 99 are unpatentable under 35 U.S.C. § 103(a) as obvious over Chu '684 and Chen.

We also have reviewed the information presented in the Petition and supporting evidence with respect to challenged dependent claims 24, 25, 49, 73, 75–79, 83, 84, 88, 89, 92, 95, 96, and 98. *See* Pet. 45, 47, 49, 52–55, 57–58; Ex. 1009 ¶¶ 49–52. Patent Owner does not raise any additional arguments specific to the dependent claims. *See, e.g.*, Prelim. Resp. 2–3, 47–65. We determine that the information presented establishes a reasonable likelihood that Petitioner would prevail in showing that independent claims 24, 25, 49, 73, 75–79, 83, 84, 88, 89, 92, 95, 96, and 98 are unpatentable under 35 U.S.C. § 103(a) as obvious over Chu '684 and Chen. *See, e.g.*, Ex. 1006, 4:52–56 (teaching sending routing messages to a soft-switch to effect routing), 13:4–9 (teaching that the packet switched network comprises the Internet); Ex. 1009 ¶¶ 49–52.

III. CONCLUSION

For the above reasons, we determine that the information presented establishes a reasonable likelihood that Petitioner would prevail in showing that claims 1, 24–26, 49, 50, 73–79, 83, 84, 88, 89, 92, 94–96, 98, and 99 of the '005 patent are (i) unpatentable under 35 U.S.C. § 103(a) as obvious over Chu '684 and Chu '366, and (ii) unpatentable under 35 U.S.C. § 103(a) as obvious over Chu '684 and Chen. At this preliminary stage, the Board has not made a final determination with respect to the patentability of the challenged claims or any underlying factual and legal issues.

IV. ORDER

Accordingly, it is:

ORDERED that pursuant to 35 U.S.C. § 314(a), an *inter partes* review is instituted as to claims 1, 24–26, 49, 50, 73–79, 83, 84, 88, 89, 92, 94–96, 98, and 99 of the '005 patent on the grounds of (i) obviousness over Chu '684 and Chu '366, and (ii) obviousness over Chu '684 and Chen; and

FURTHER ORDERED that pursuant to 35 U.S.C. § 314(c) and 37 C.F.R. § 42.4, notice is hereby given of the institution of a trial, which commences on the entry date of this decision.

IPR2016-01198
Patent 9,179,005 B2

FOR PETITIONER:

Adam P. Seitz
Eric A. Buresh
Paul R. Hart
ERISE IP, P.A.
adam.seitz@eriseip.com
eric.buresh@eriseip.com
paul.hart@eriseip.com

FOR PATENT OWNER:

Kerry Taylor
John M. Carson
KNOBBE, MARTENS, OLSON & BEAR, LLP
2kst@knobbe.com
2jmc@knobbe.com
BoxDigifonica@knobbe.com