



US005795965A

# United States Patent [19]

[11] Patent Number: **5,795,965**

Tsuchiya et al.

[45] Date of Patent: **Aug. 18, 1998**

- [54] **RESHAPED HUMAN TO HUMAN INTERLEUKIN-6 RECEPTOR**
- [75] Inventors: **Masayuki Tsuchiya**; **Koh Sato**, both of Gotenba, Japan; **Mary Margaret Bendig**, West Hamsteaad; **Steven Tarran Jones**, Radlett; **José William Saldanha**, Endfield, all of Great Britain

9109967 7/1991 WIPO .

### OTHER PUBLICATIONS

- Oi et al. *Biotechniques*, vol. 4, No. 3, 1986 p. 214.
- Morrison Hospital Practice Oct. 15, 1989, 65.
- Kitani et al. *Clin. Exp. Immunol.* 88, 75-83 1992.
- Suzuki et al. *Immunology letters* 30(1991) 17-22.

- [73] Assignee: **Chugai Seiyaku Kabushiki Kaisha**, Tokyo, Japan

*Primary Examiner*—Lila Feisee  
*Assistant Examiner*—Geetha P. Bansal  
*Attorney, Agent, or Firm*—Foley & Lardner

- [21] Appl. No.: **137,117**
- [22] PCT Filed: **Apr. 24, 1992**
- [86] PCT No.: **PCT/JP92/00544**
- § 371 Date: **Dec. 20, 1993**
- § 102(e) Date: **Dec. 20, 1993**

### [57] ABSTRACT

A reshaped human antibody to the human IL-6R, comprising:

- [87] PCT Pub. No.: **WO92/19759**
- PCT Pub. Date: **Nov. 12, 1992**

- (A) an L chain comprising,
  - (1) a human L chain C region, and
  - (2) an L chain V region comprising human L chain framework regions (FRs), and mouse L chain complementary determination regions (CDRs) of a monoclonal antibody to the IL-6 receptor (IL-6R); and
- (B) an H chain comprising,
  - (1) a human H chain C region, and
  - (2) an H chain V region comprising human H chain FRs, and mouse H chain CDRs of a monoclonal antibody to the IL-6R.

- [30] **Foreign Application Priority Data**
- Apr. 25, 1991 [JP] Japan ..... 3-095476
- Feb. 19, 1992 [JP] Japan ..... 4-032084
- [51] **Int. Cl.<sup>6</sup>** ..... **C07K 16/00**
- [52] **U.S. Cl.** ..... **530/387.3; 530/388.24; 530/388.73**
- [58] **Field of Search** ..... **530/387.3, 388.22, 530/388.73**

Since major portion of the reshaped human antibody is derived from a human antibody and the mouse CDRs which are less immunogenic, the present reshaped human antibody is less immunogenic to human, and therefor is promised for therapeutic uses.

### [56] References Cited

#### FOREIGN PATENT DOCUMENTS

9007861 7/1990 WIPO .

**6 Claims, 24 Drawing Sheets**

Fig. 1

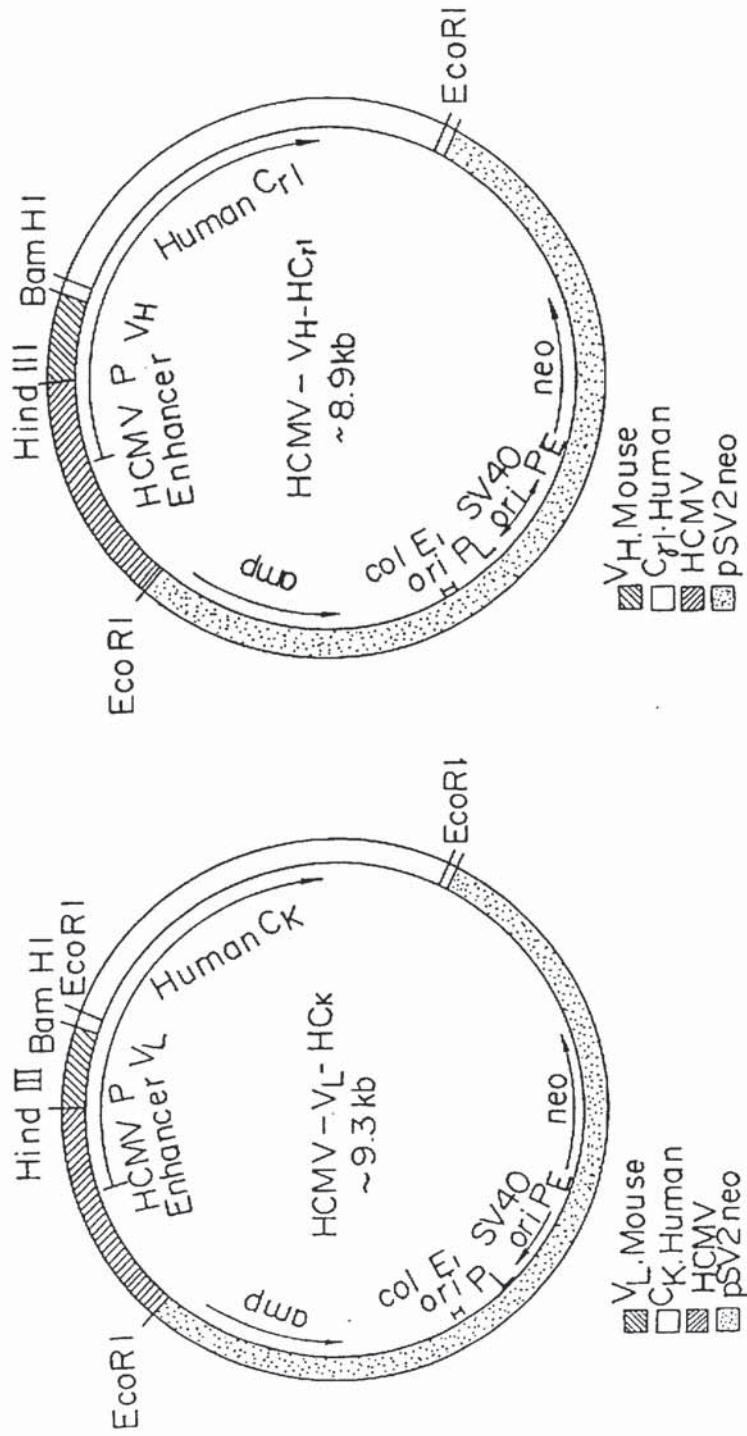

Fig. 2

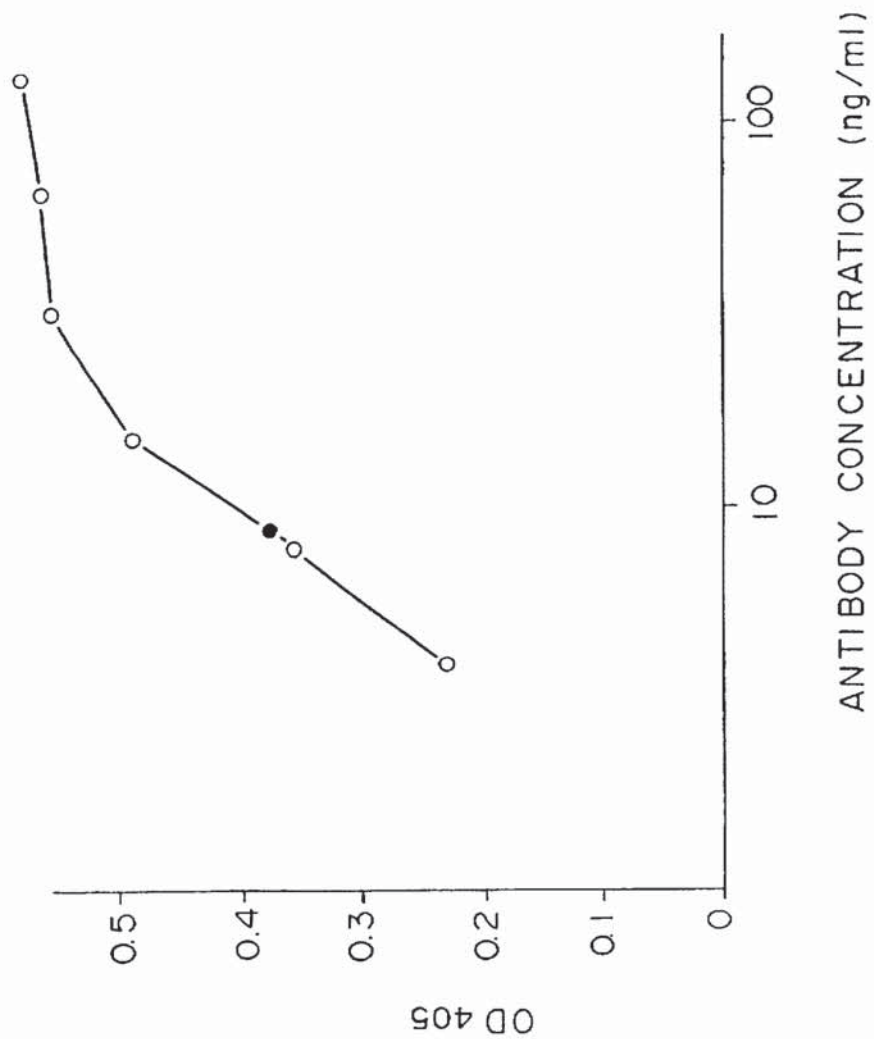

Fig. 3

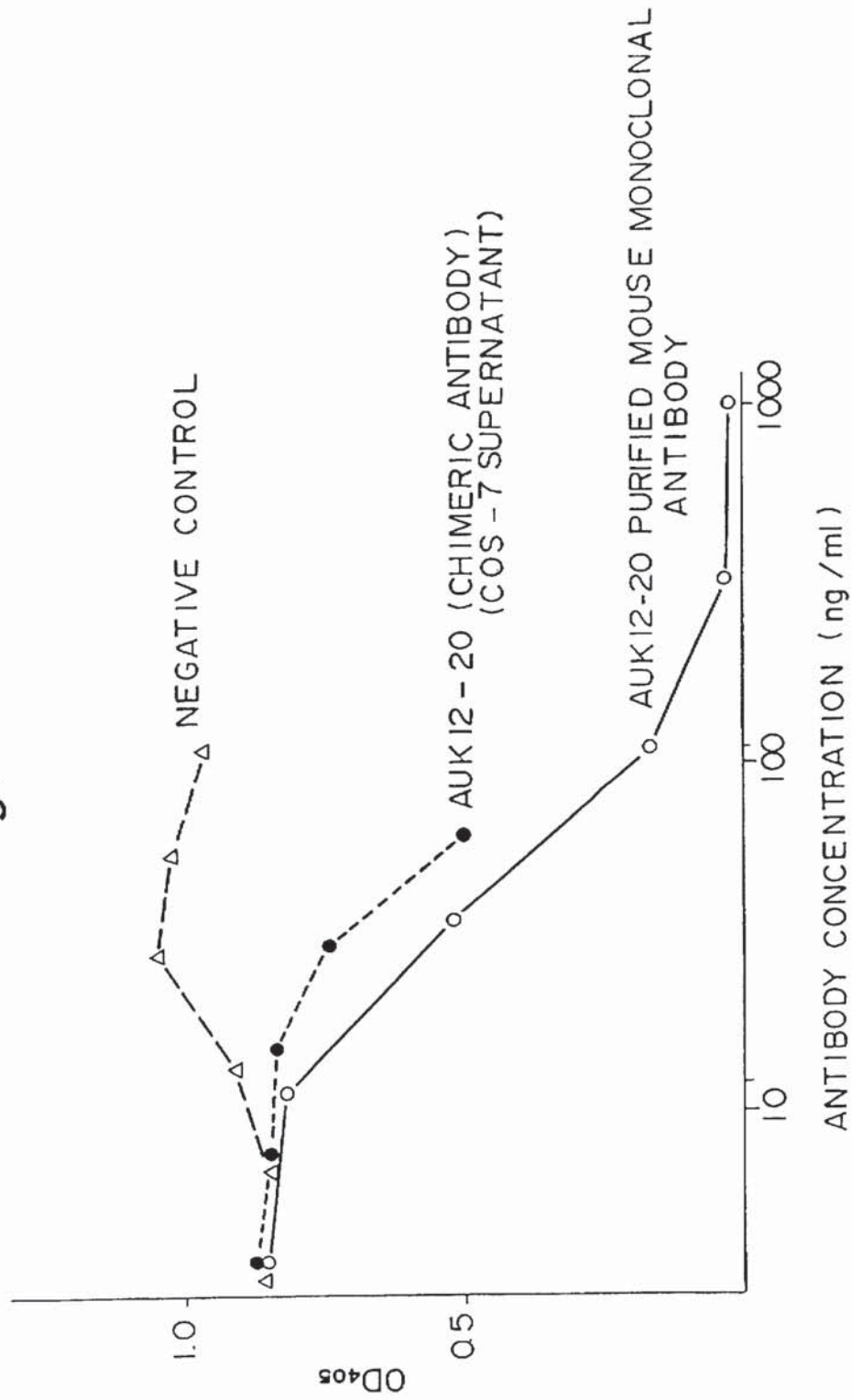

Fig. 4

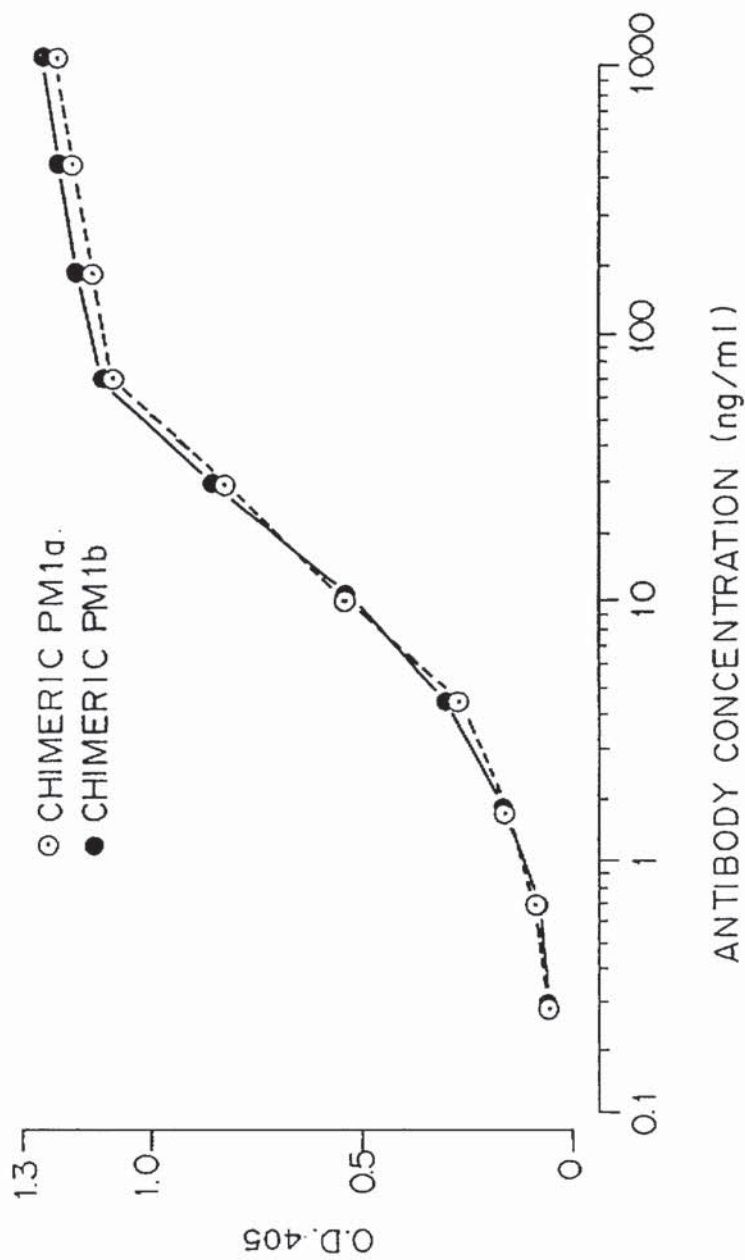

Fig. 5

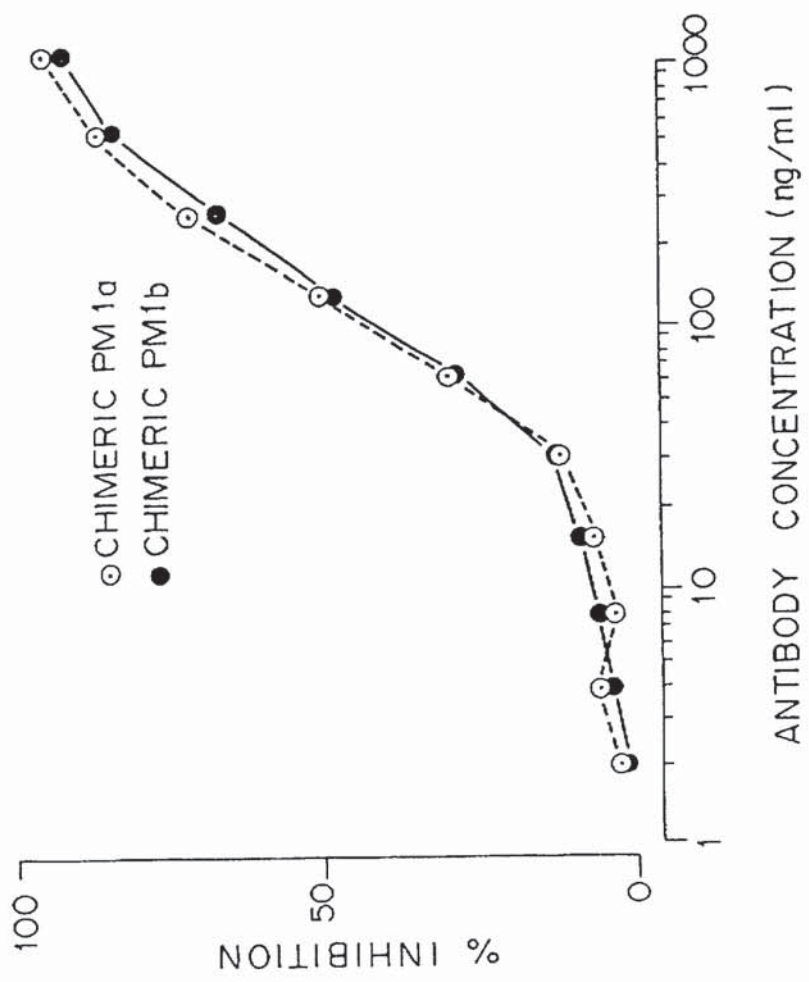

Fig. 6

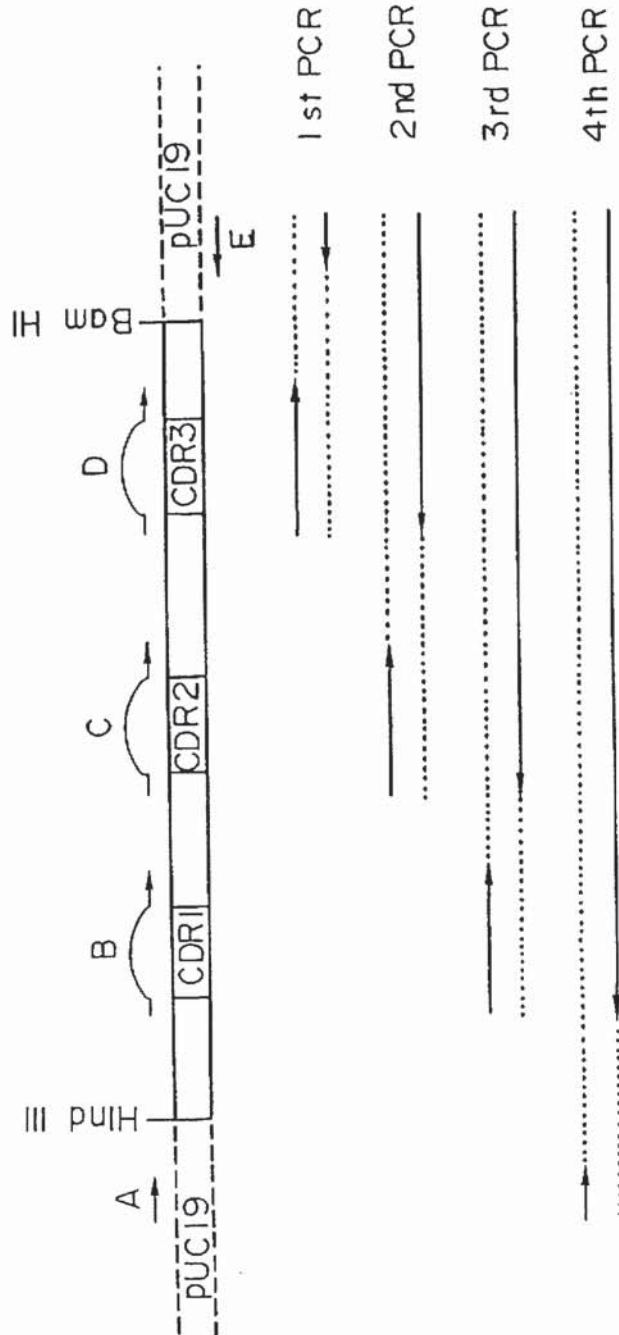

Fig. 7

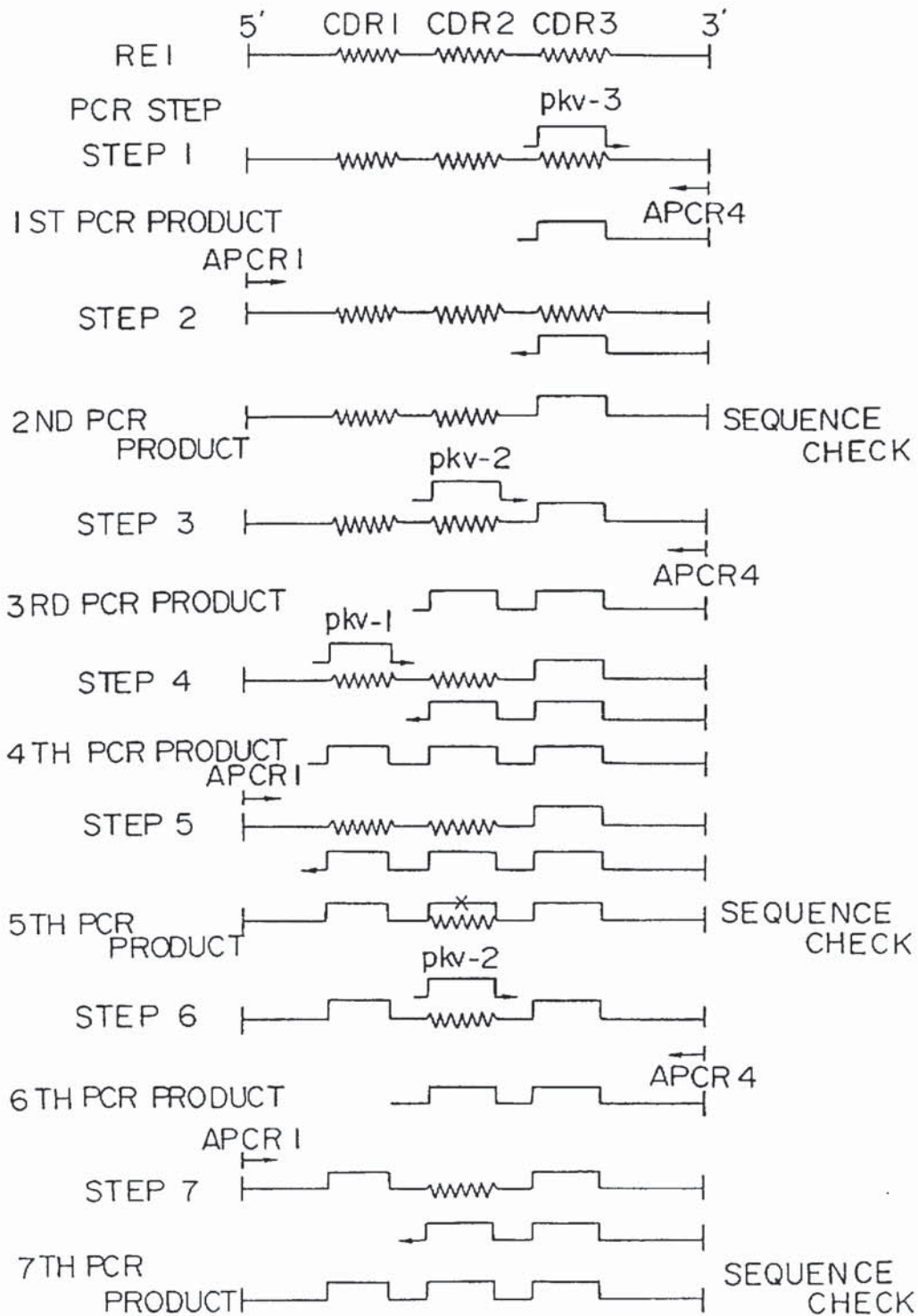



Fig. 8

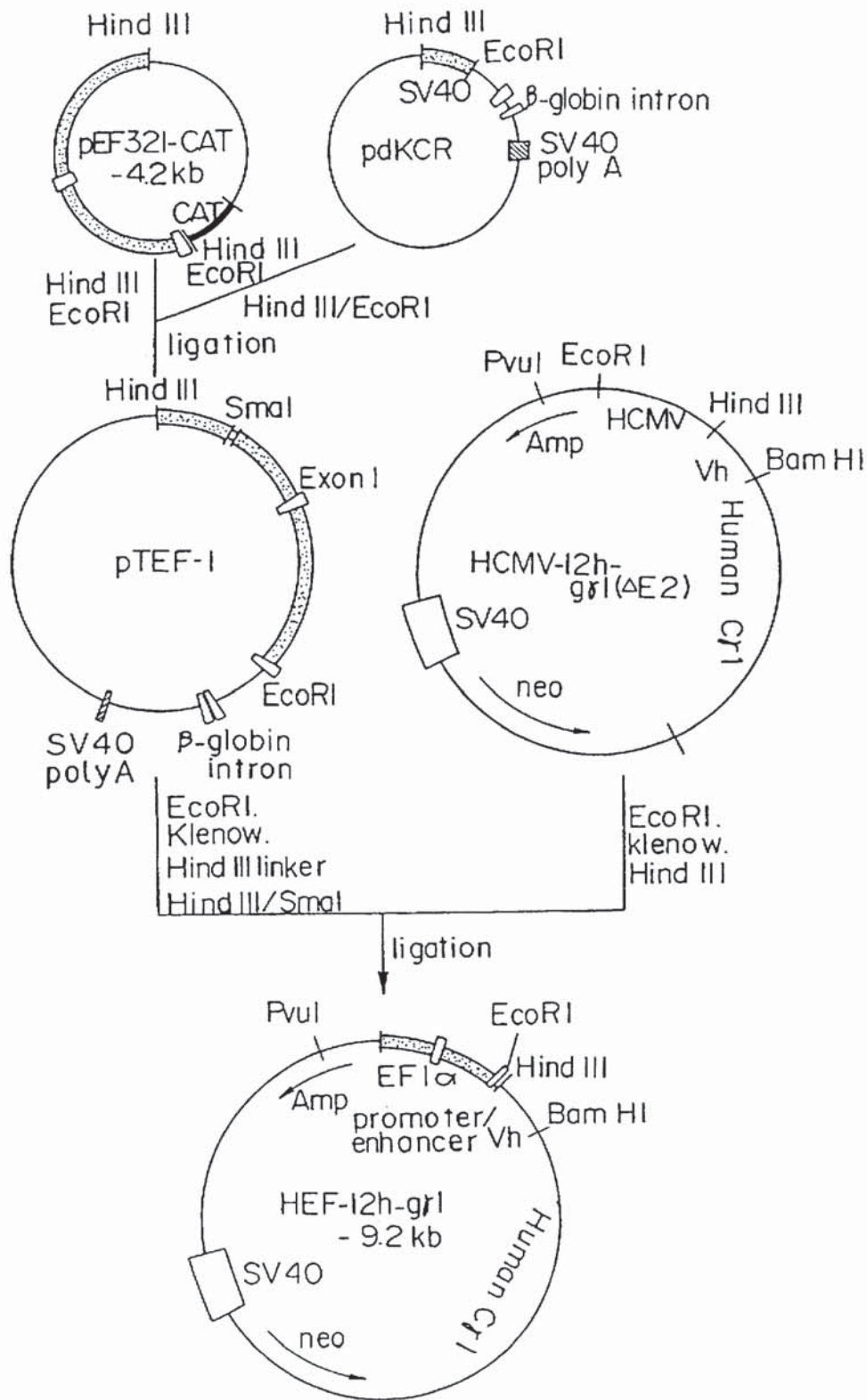

Fig. 9

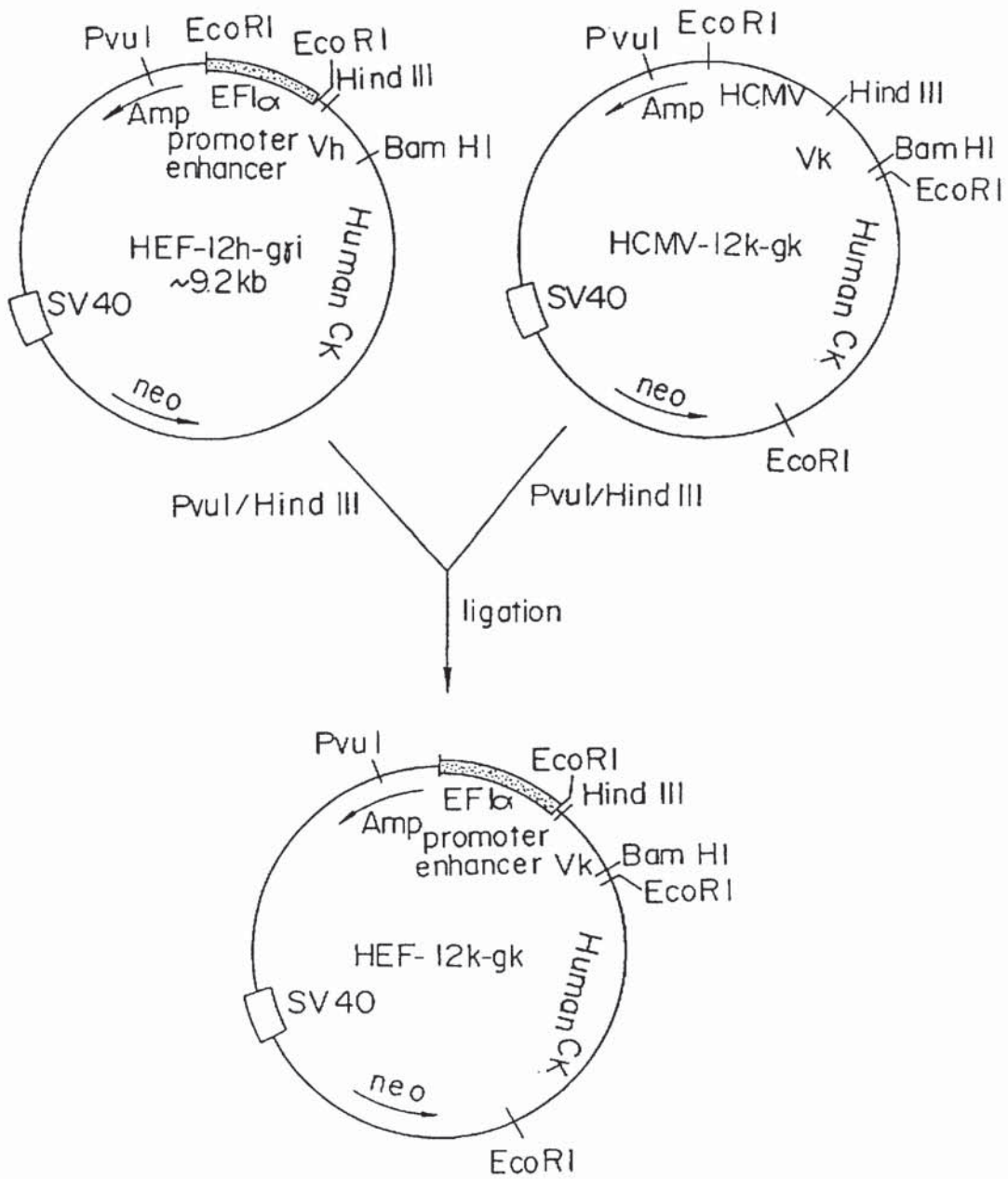

Fig. 10

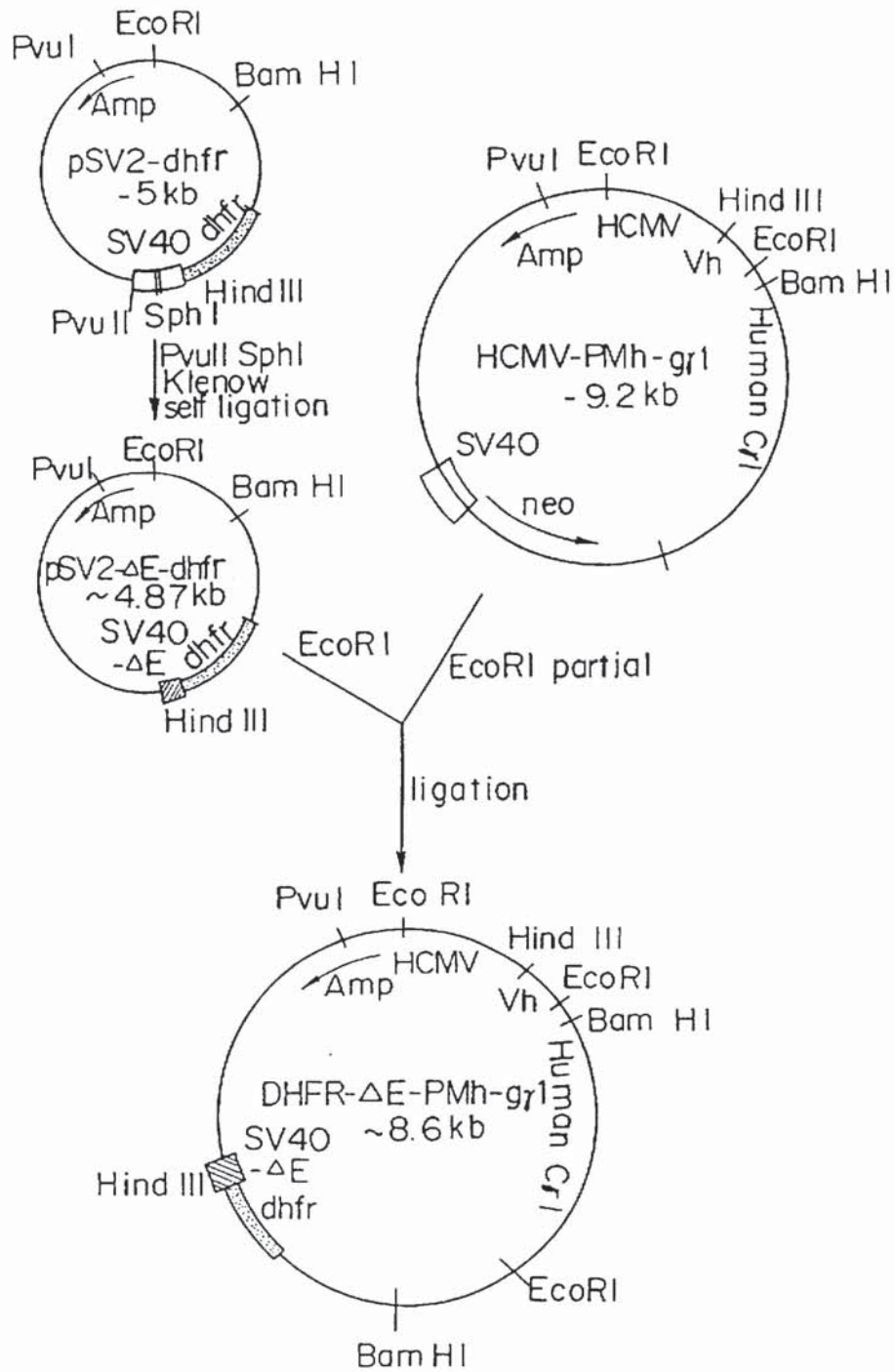

Fig. 11

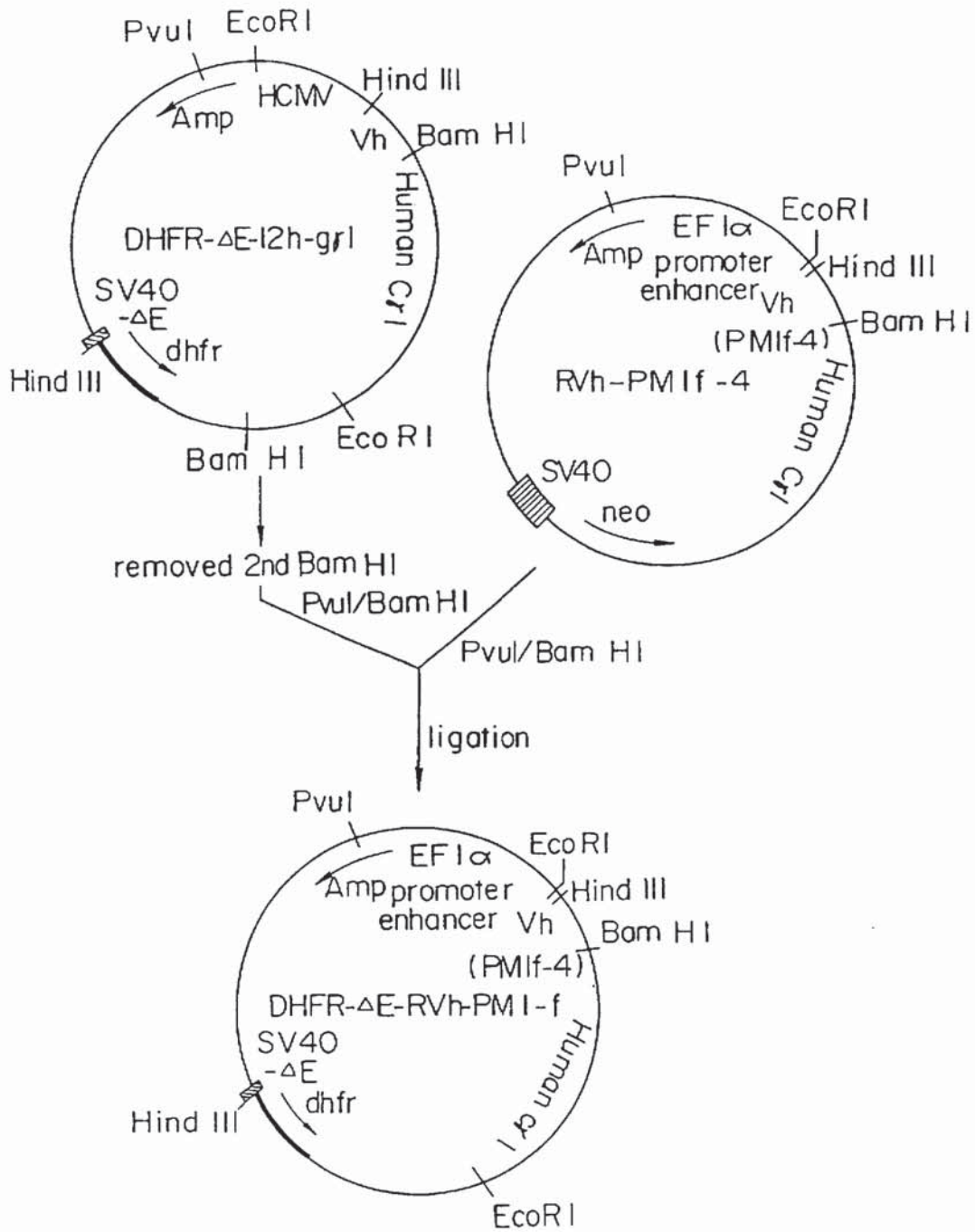

Fig. 12

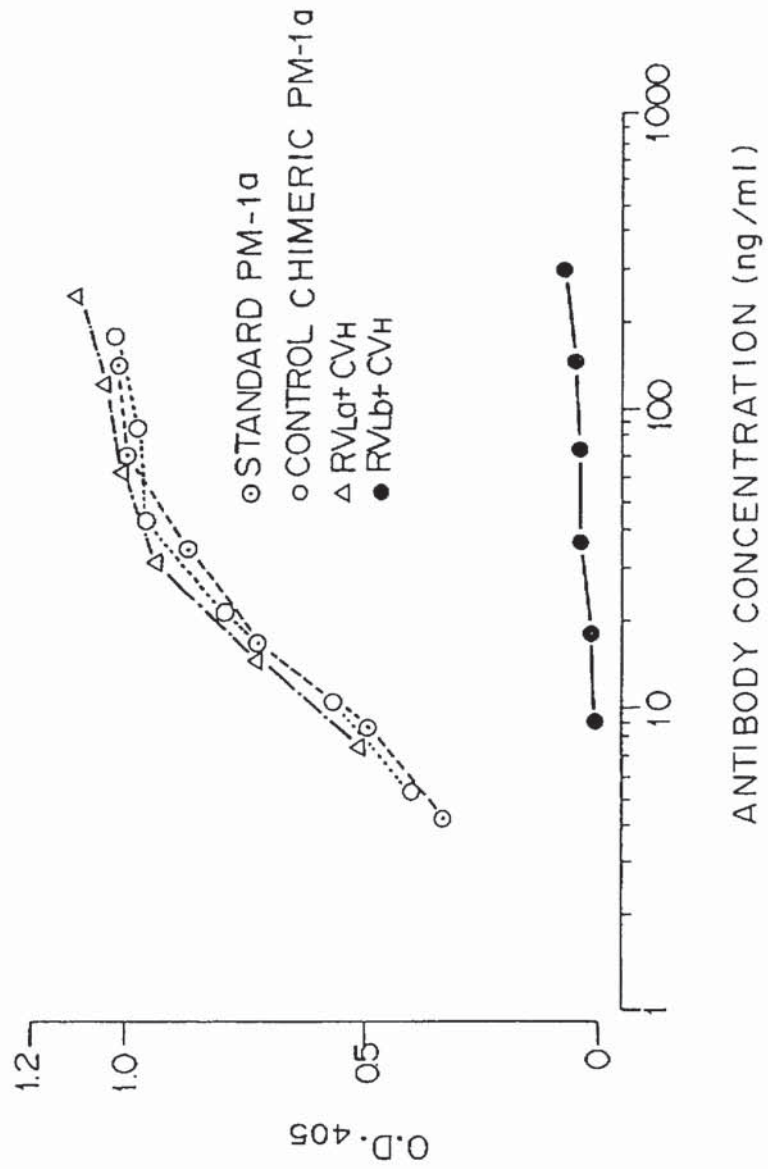

Fig. 13

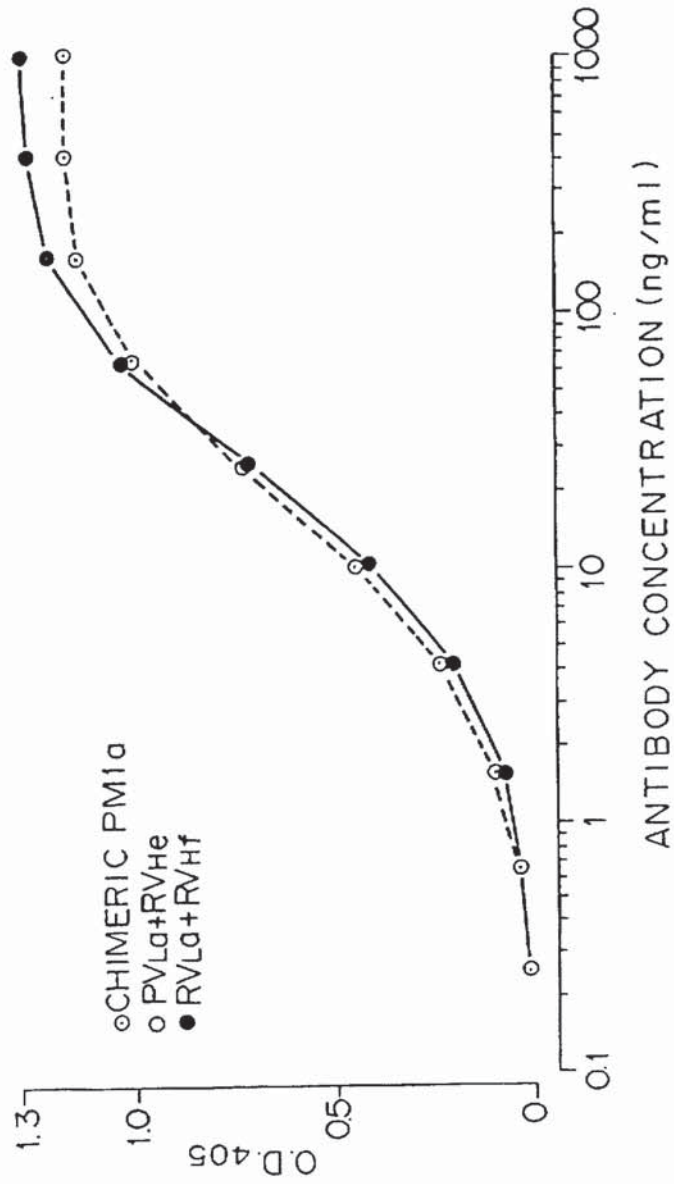

Fig. 14

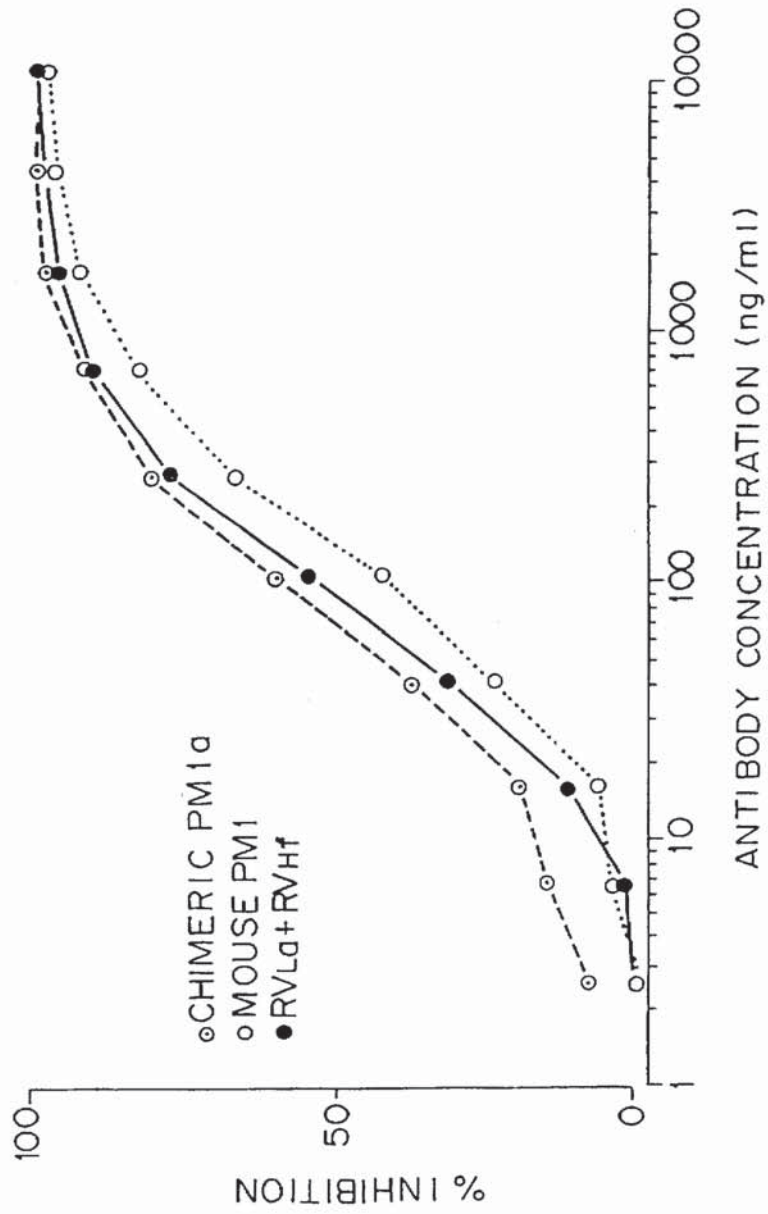

Fig. 15

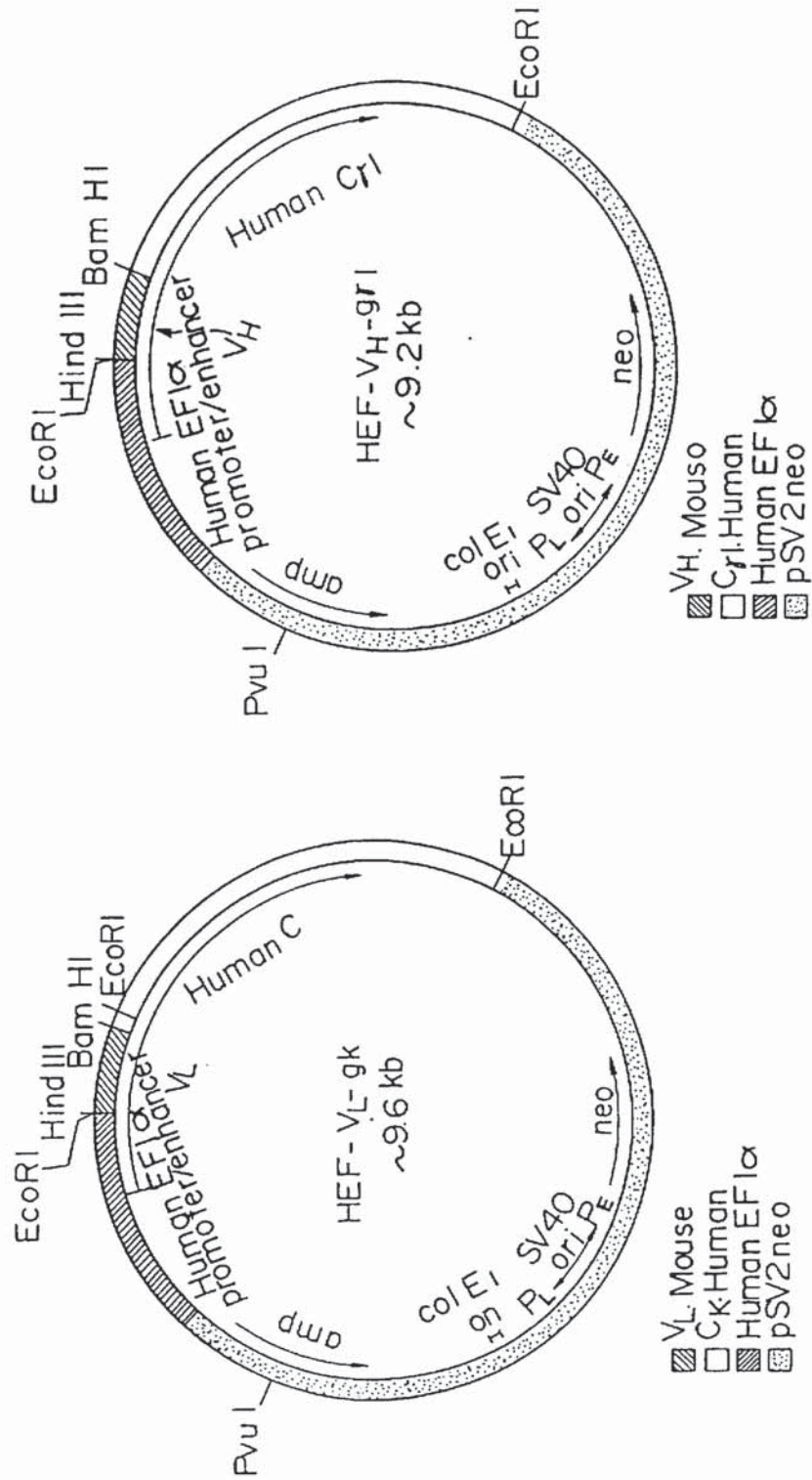



Fig.16

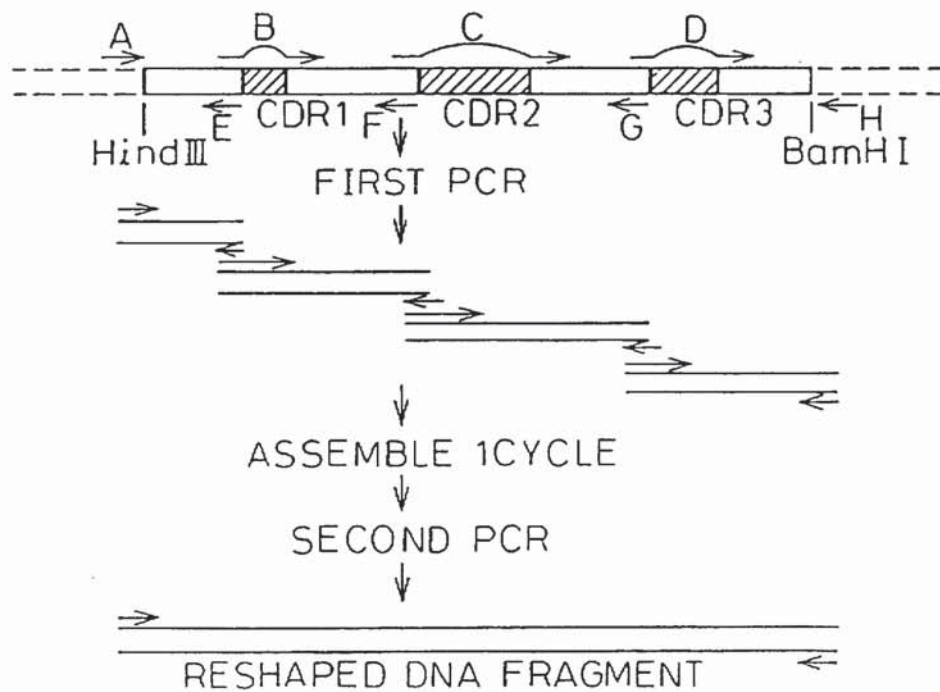

Fig.17

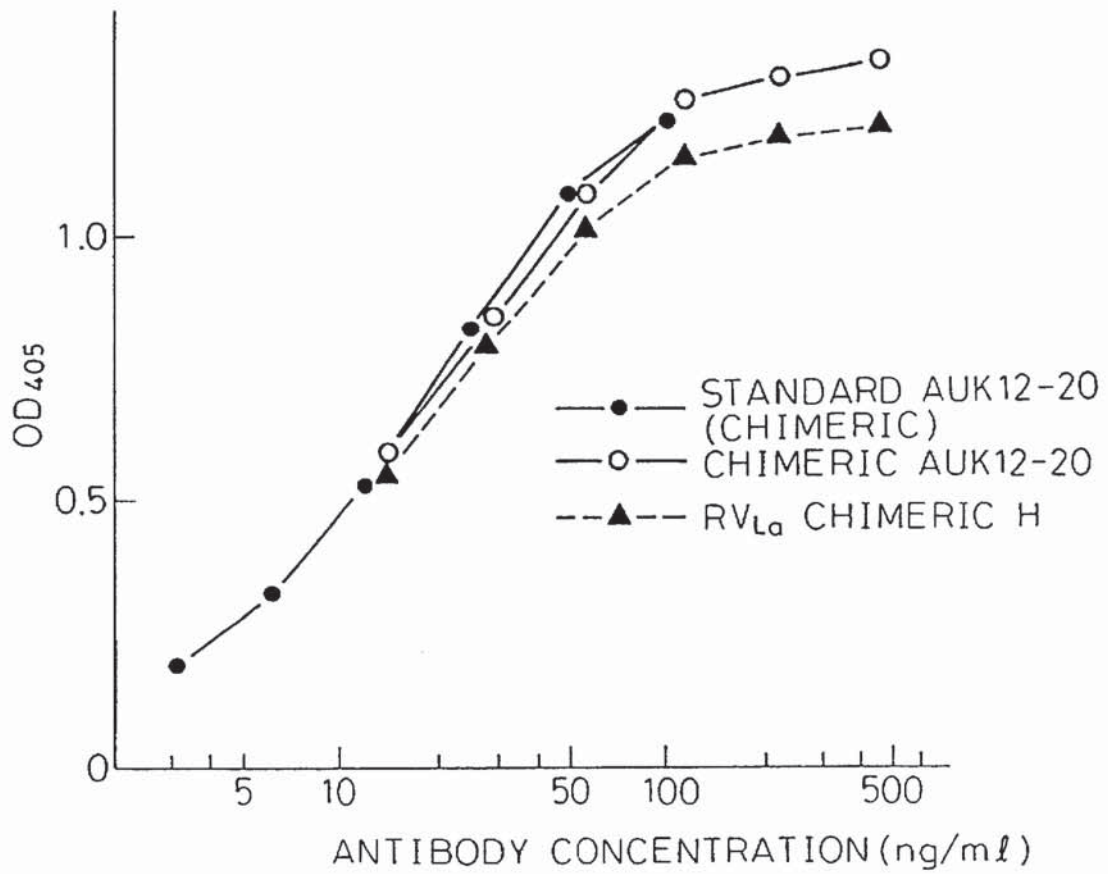

Fig.18

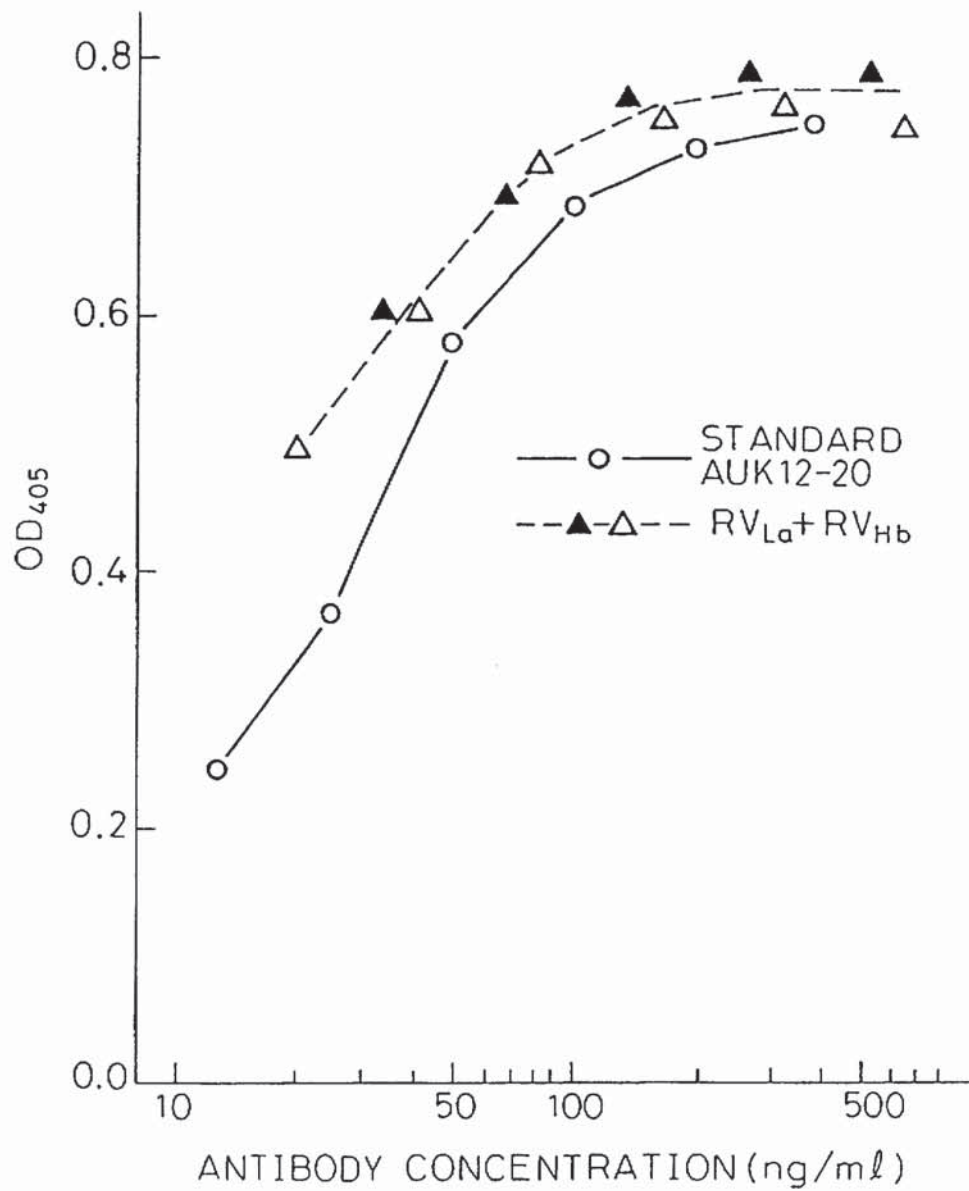

Fig.19

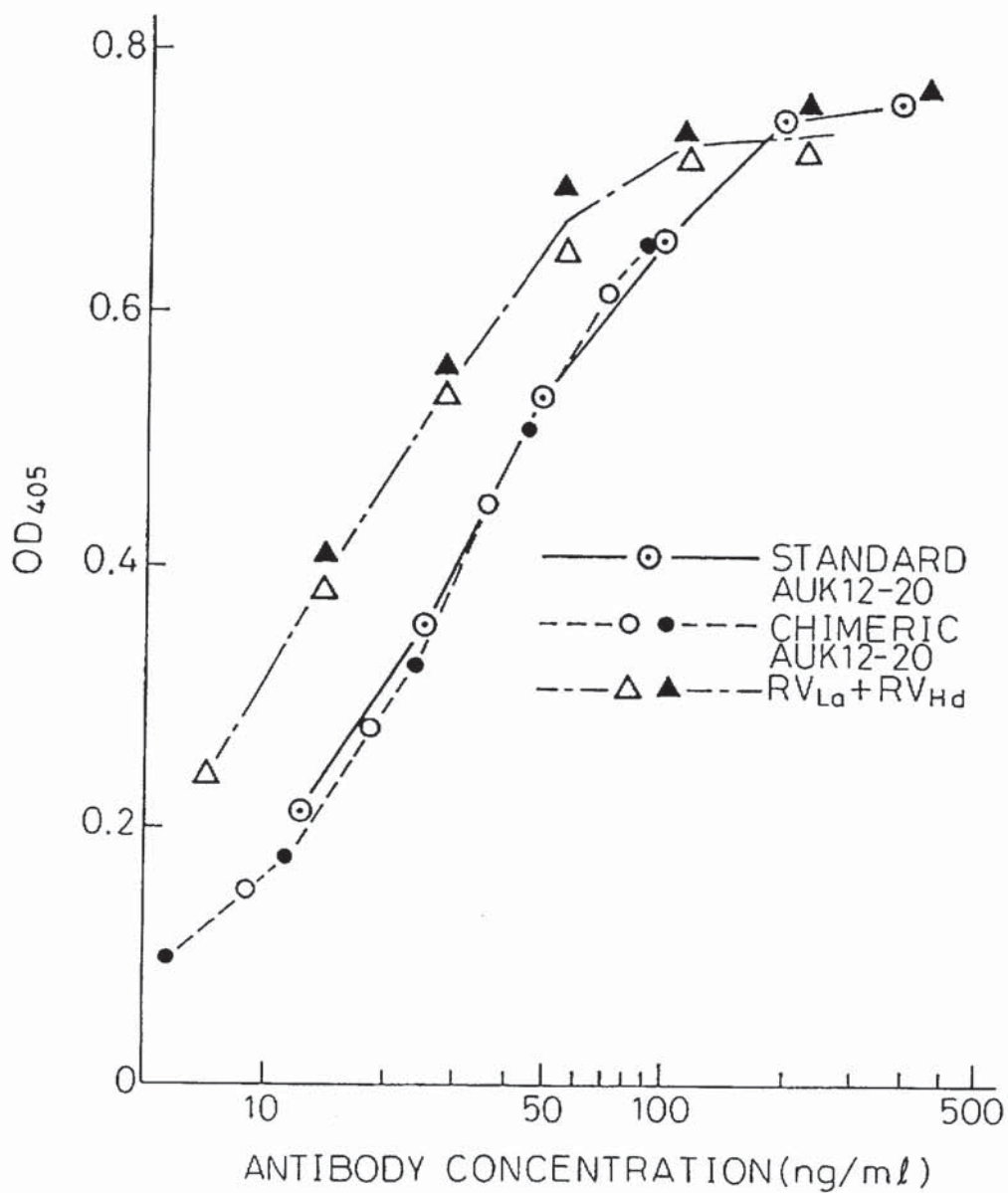

Fig.20

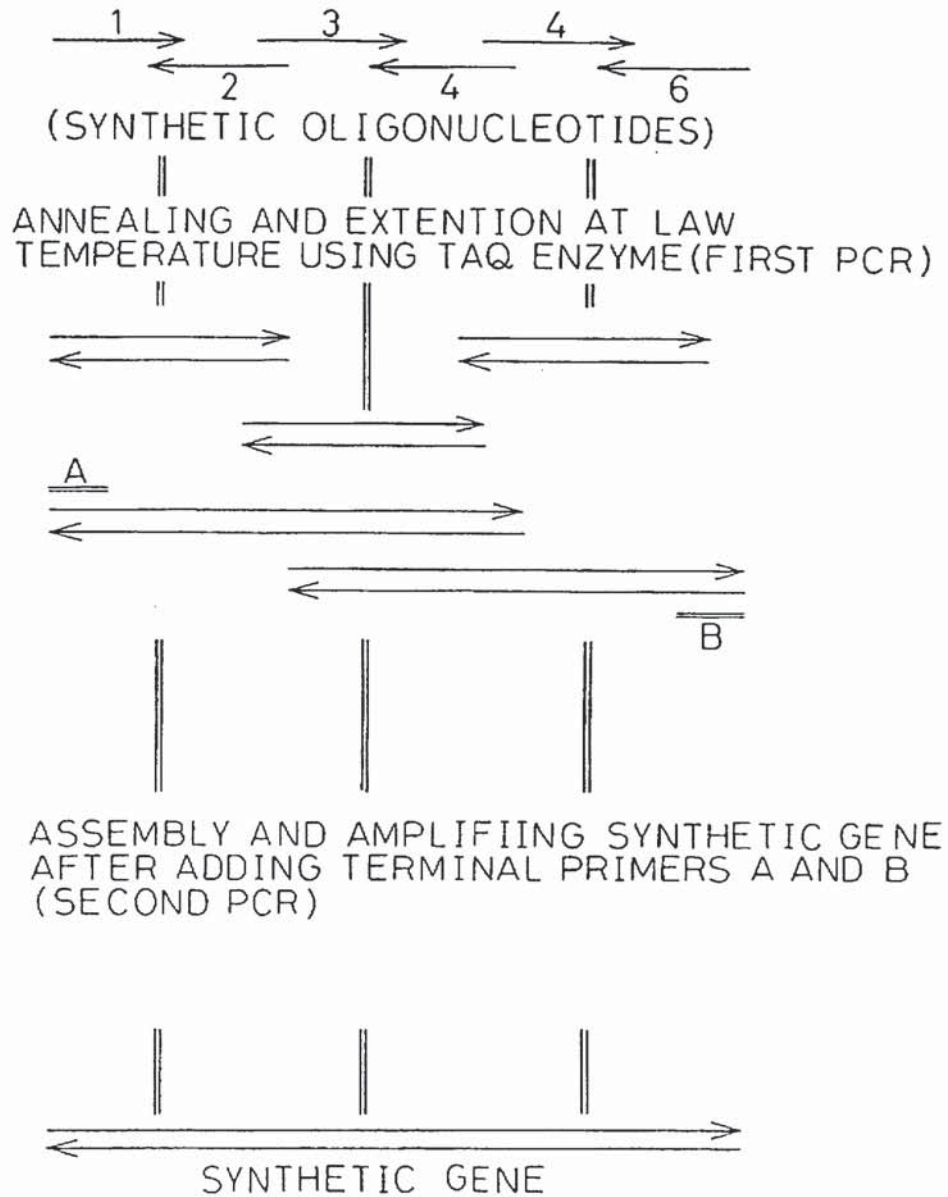

Fig.21

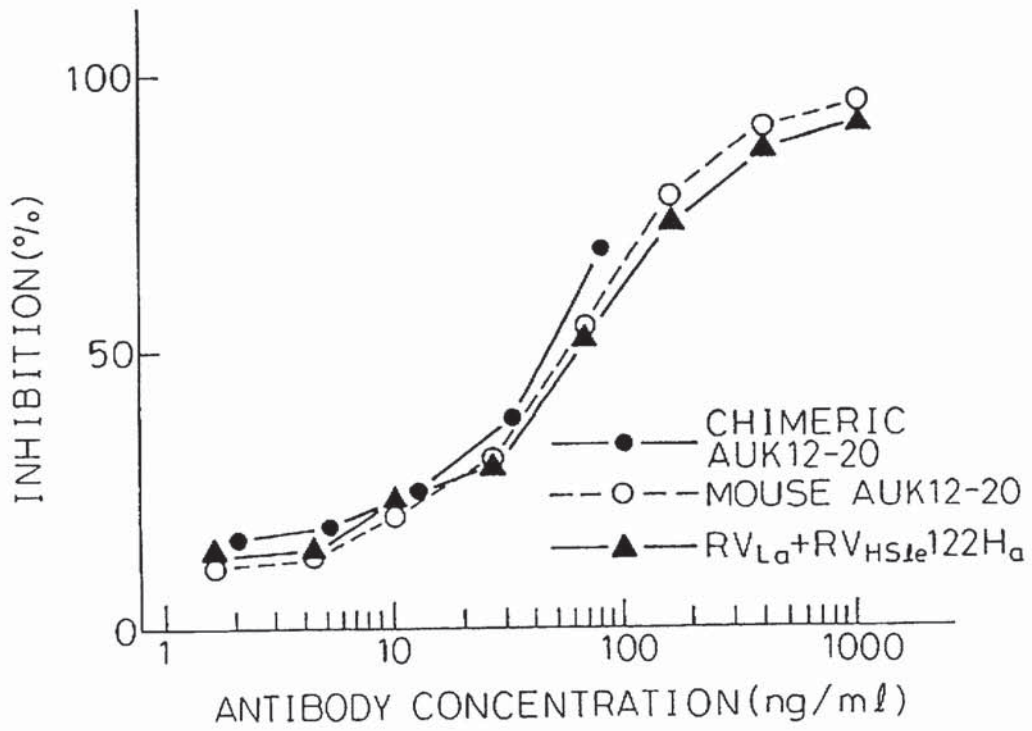

Fig.22

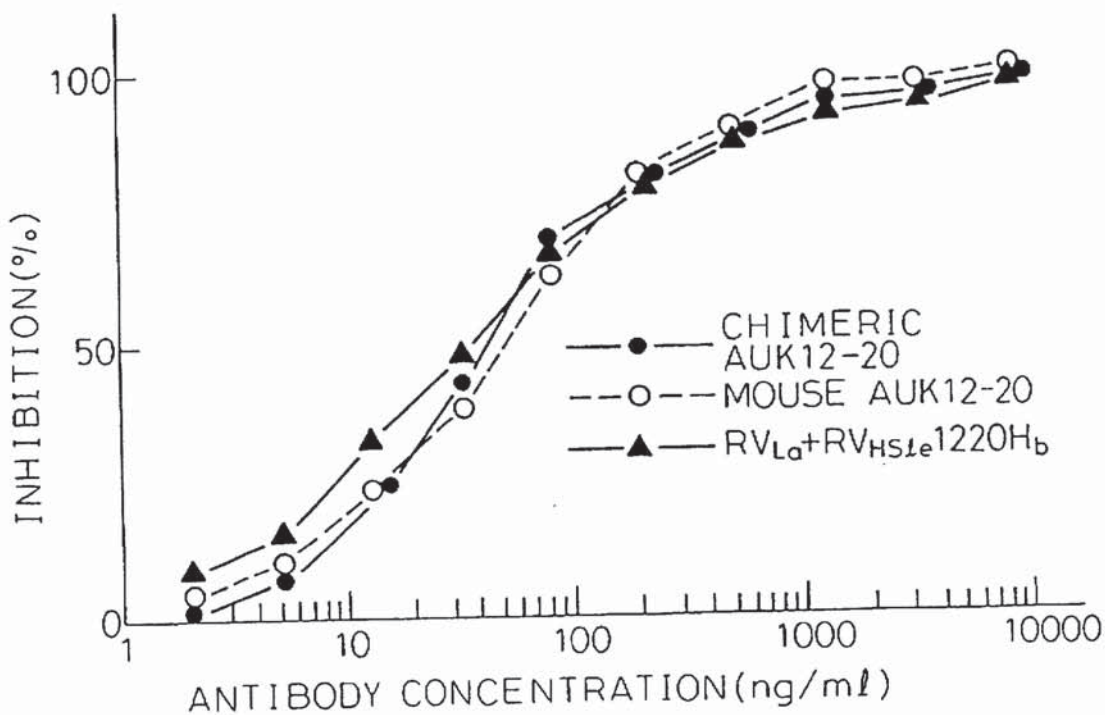

Fig.23

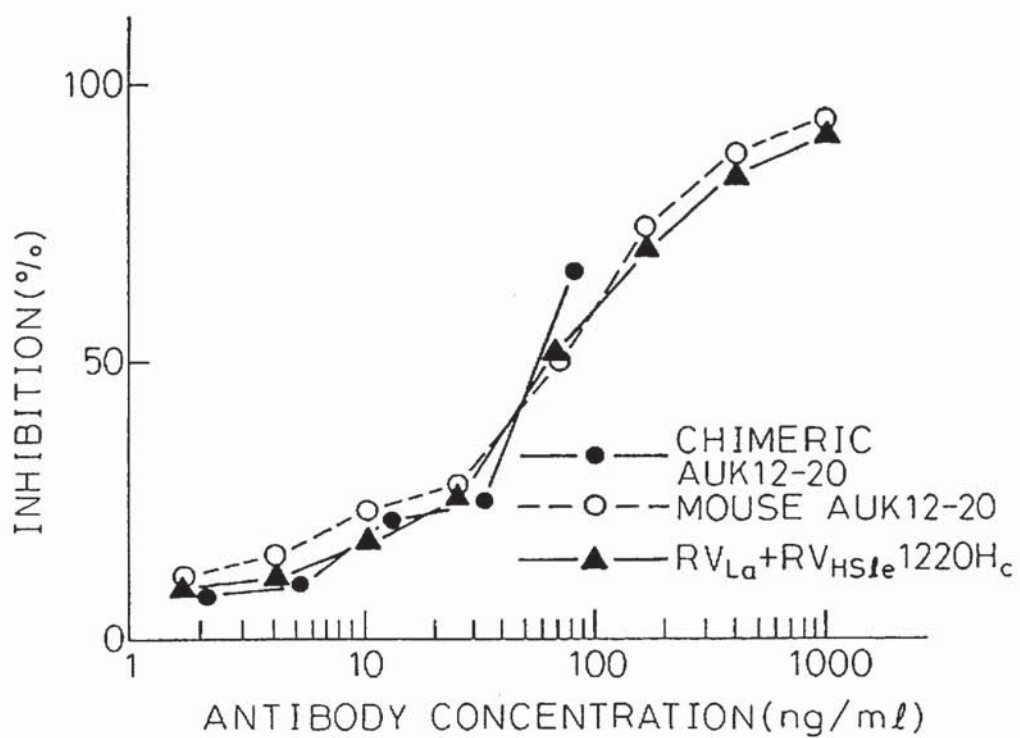
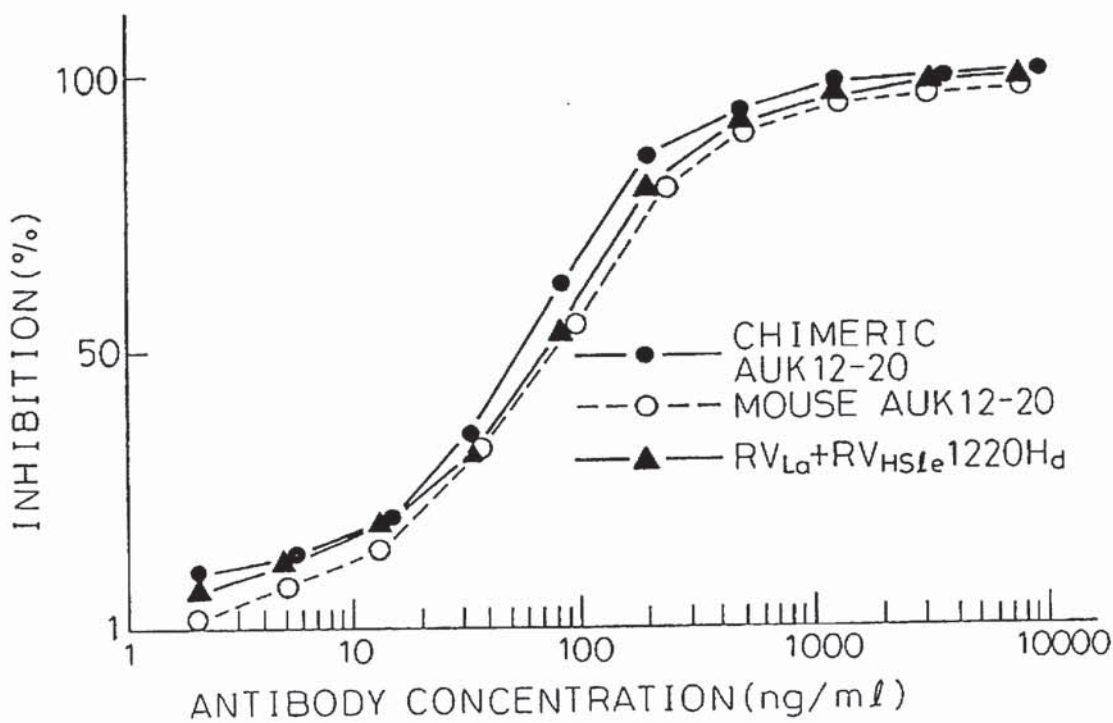



Fig.24



## RESHAPED HUMAN TO HUMAN INTERLEUKIN-6 RECEPTOR

### TECHNICAL FIELD

The present invention relates to variable regions (V region) of a mouse monoclonal antibody to the human interleukin-6 receptor (IL-6R), human/mouse chimeric antibody to the human IL-6R, and reshaped human antibody comprising a human antibody wherein the complementarity determining regions (CDRs) of the human light chain (L chain) V region and of the human heavy chain (H chain) V region are grafted with the CDRs of a mouse monoclonal antibody to the human IL-6R. Moreover, the present invention provides DNA coding for the above-mentioned antibodies or part thereof. The present invention further provides vectors, especially expression vectors comprising said DNA, and host cells transformed or transfected with said vector. The present invention still more provides a process for production of a chimeric antibody to the human IL-6R, and process for production of a reshaped human antibody to the human IL-6R.

### BACKGROUND ART

Interleukin-6 (IL-6) is a multi-function cytokine that is produced by a range of cells. It regulates immune responses, acute phase reactions, and hematopoiesis, and may play a central role in host defense mechanisms. It acts on a wide range of tissues, exerting growth-inducing, growth inhibitory, and differentiation-inducing effects, depending on the nature of the target cells. The specific receptor for IL-6 (IL-6R) is expressed on lymphoid as well as non-lymphoid cells in accordance with the multifunctional properties of IL-6. Abnormal expression of the IL-6 gene has been suggested to be involved in the pathogenesis of a variety of diseases, especially autoimmune diseases, mesangial proliferative glomerulonephritis, and plasmacytoma/myeloma (see review by Hirano et al., *Immunol. Today* 11, 443-449, 1990). Human myeloma cells are observed to produce IL-6 and express IL-6R. In experiments, antibody against IL-6 inhibited the in vitro growth of myeloma cells thus indicating that an autocrine regulatory loop is operating in oncogenesis of human myelomas (Kawano et al., *Nature*, 332, 83, 1988).

The IL-6R is present on the surface of various animal cells, and specifically binds to IL-6, and the number of IL-6R molecules on the cell surface has been reported (Taga et al., *J. Exp. Med.* 196, 967, 1987). Further, cDNA coding for a human IL-6R was cloned and a primary structure of the IL-6R was reported (Yamasaki et al., *Science*, 241, 825, 1988).

Mouse antibodies are highly immunogenic in humans and, for this reason, their therapeutic value in humans is limited. The half-life of mouse antibodies in vivo in human is relatively short. In addition, mouse antibodies can not be administered in multiple doses without generating an immune response which not only interferes with the planned efficacy but also risks an adverse allergic response in the patient.

To resolve these problems methods of producing humanized mouse antibodies were developed. Mouse antibodies can be humanized in two ways. The more simple method is to construct chimeric antibodies where the V regions are derived from the original mouse monoclonal antibody and the C regions are derived from suitable human antibodies. The resulting chimeric antibody contains the entire V domains of the original mouse antibody and can be expected

to bind antigen with the same specificity as the original mouse antibody. In addition, chimeric antibodies have a substantial reduction in the percent of the protein sequence derived from a non-human source and, therefore, are expected to be less immunogenic than the original mouse antibody. Although chimeric antibodies are predicted to bind antigen well and to be less immunogenic, an immune response to the mouse V regions can still occur (LoBuglio et al., *Proc. Natl. Acad. Sci. USA* 84, 4220-4224, 1989).

The second method for humanizing mouse antibodies is more complicated but more extensively reduces the potential immunogenicity of the mouse antibody. In this method, the complementarity determining regions (CDRs) from the V regions of the mouse antibody are grafted into human V regions to create "reshaped" human V regions. These reshaped human V regions are then joined to human C regions. The only portions of the final reshaped human antibody derived from non-human protein sequences are the CDRs. CDRs consist of highly variable protein sequences. They do not show species-specific sequences. For these reasons, a reshaped human antibody carrying murine CDRs should not be any more immunogenic than a natural human antibody containing human CDRs.

As seen from the above, it is supposed that reshaped human antibodies are useful for therapeutic purposes, but reshaped human antibodies to the human IL-6R are not known. Moreover, there is no process for construction of a reshaped human antibodies, universally applicable to any particular antibody. Therefore to construct a fully active reshaped human antibody to a particular antigen, various devices are necessary. Even though mouse monoclonal antibodies to the human IL-6R, i.e., PM1 and MT18, were prepared (Japanese Patent Application No. 2-189420), and the present inventors prepared mouse monoclonal antibodies to the human IL-6R, i.e., AUK12-20, AUK64-7 and AUK146-15, the present inventors are not aware of publications which suggest construction of reshaped human antibodies to the human IL-6R.

The present inventors also found that, when the mouse monoclonal antibodies to the human IL-6R were injected into nude mice transplanted with a human myeloma cell line, the growth of the tumor was remarkably inhibited. This suggests that the anti-human IL-6 receptor antibody is useful as a therapeutic agent for the treatment of myeloma.

### DISCLOSURE OF INVENTION

Therefore, the present invention is intended to provide a less immunogenic antibody to the human IL-6R. Accordingly, the present invention provides reshaped human antibodies to the human IL-6R. The present invention also provides human/mouse chimeric antibodies useful during the construction of the reshaped human antibody. The present invention further provides a part of reshaped human antibody, as well as the expression systems for production of the reshaped human antibody and a part thereof, and of the chimeric antibody.

More specifically, the present invention provides L chain V region of mouse monoclonal antibody to the human IL-6R; and H chain V region of a mouse monoclonal antibody to the human IL-6R.

The present invention also provides a chimeric antibody to the human IL-6R, comprising:

- (1) an L chain comprising a human L chain C region and an L chain V region of a mouse monoclonal antibody to the IL-6R; and
- (2) an H chain comprising a human H chain C region and an H chain V region of a mouse monoclonal antibody to the human IL-6R.

3

The present invention also provides CDR of an L chain V region of a mouse monoclonal antibody to the human IL-6R; and CDR of an H chain V region of a mouse monoclonal antibody to the human IL-6R.

The present invention moreover provides a reshaped human L chain V region of an antibody to the human IL-6R, comprising:

- (1) framework regions (FRs) of a human L chain V region, and
- (2) CDRs of an L chain V region of a mouse monoclonal antibody to the human IL-6R; and a reshaped human H chain V region of an antibody to the human IL-6R comprising:
  - (1) FRs of a human H chain V region, and
  - (2) CDRs of an H chain V region of a mouse monoclonal antibody to the human IL-6R.

The present invention also provides a reshaped human L chain of an antibody to the human IL-6R, comprising:

- (1) a human L chain C region; and
- (2) an L chain V region comprising human FRs, and CDRs of a mouse monoclonal antibody to the human IL-6R; and a reshaped human H chain of an antibody to the human IL-6R, comprising:
  - (1) a human H chain C region, and
  - (2) an H chain V region comprising a human FRs, and CDRs of a mouse monoclonal antibody to the human IL-6R.

The present invention still more provides a reshaped human antibody to the human IL-6R, comprising:

- (A) an L chain comprising,
  - (1) a human L chain C region, and
  - (2) an L chain V region comprising human L chain FRs, and L chain CDRs of a mouse monoclonal antibody to the human IL-6R; and
- (B) an H chain comprising,
  - (1) a human H chain C region, and
  - (2) an H chain V region comprising human H chain FRs, and H chain CDRs of a mouse monoclonal antibody to the human IL-6R.

The present invention further provides DNA coding for any one of the above-mentioned antibody polypeptides or parts thereof.

The present invention also provides vectors, for example, expression vectors comprising said DNA.

The present invention further provides host cells transformed or transfected with the said vector.

The present invention still more provide a process for production of a chimeric antibody to the human IL-6R, and a process for production of reshaped human antibody to the human IL-6R.

#### BRIEF DESCRIPTION OF DRAWINGS

FIG. 1 represents expression vectors comprising human cytomegalo virus (HCMV) promoter/enhancer system, useful for the expression of the present antibody peptide.

FIG. 2 is a graph showing a result of ELISA for confirmation of an ability of the present chimeric antibody AUK12-20 to bind to the human IL-6R.

FIG. 3 is a graph showing a result of measurement of an ability of the present chimeric antibody AUK12-20 to inhibit the binding of IL-6 to the human IL-6R.

FIG. 4 is a graph showing a result of ELISA for binding of the present chimeric antibodies PM1a and PM1b to human IL-6R.

4

FIG. 5 is a graph showing a result of ELISA testing the ability of the present chimeric antibodies PM1a and PM1b to inhibit IL-6 from binding to the human IL-6R.

FIG. 6 is a diagram of the construction of the first version of a reshaped human PM-1 H chain V region.

FIG. 7 is a diagram of the construction of the first version of a reshaped human PM-1 L chain V region.

FIG. 8 represents a process for construction of an expression plasmid HEF-12h-gyl comprising a human elongation factor 1 $\alpha$  (HEF-1 $\alpha$ ) promoter/enhancer, useful for the expression of an H chain.

FIG. 9 represents a process for construction of an expression plasmid HEF-12k-gk comprising the HEF-1 $\alpha$  promoter/enhancer system, useful for the expression of an L chain.

FIG. 10 represents a process for construction of an expression plasmid DHFR-PMh-gyl comprising HCMV promoter/enhancer and the dihydrofolate reductase (dhfr) gene linked to a defective SV40 promoter/enhancer sequence for amplification, useful for expression of an H chain.

FIG. 11 represents a process for the construction of an expression plasmid DHFR- $\Delta$ E-RVh-PM1-f comprising EF1 $\alpha$  promoter/enhancer and dhfr gene linked to a defective SV40 promoter/enhancer sequence for amplification, useful for expression of an H chain.

FIG. 12 is a graph showing an ability of version "a" and "b" of the reshaped human PM-1 L chain V region for binding to the human IL-6R.

FIG. 13 is a graph showing an ability of version "f" of the reshaped human PM-1 H chain V region plus version "a" of the reshaped PM-1 L chain L chain V region for binding to the human IL-6R.

FIG. 14 is a graph showing an ability of version "f" of the reshaped PM-1 H chain V region plus version "a" of the reshaped PM-1 L chain V region to inhibit the binding of IL-6 to the human IL-6R.

FIG. 15 represents expression plasmids HEF-V<sub>L</sub>-gk and HEF-V<sub>H</sub>-gyl comprising a human EF1- $\alpha$  promoter/enhancer, useful for expression of an L chain and H chain respectively.

FIG. 16 shows a process for construction of DNA coding for reshaped human AUK 12-20 antibody L chain V region.

FIG. 17 is a graph showing results of an ELISA for confirm of an ability of a reshaped human AUK 12-20 antibody L chain V region to bind to human IL-6R. In the Figure, "Standard AUK 12-20 (chimera) means a result for chimeric AUK 12-20 antibody produced by CHO cells and purified in a large amount.

FIG. 18 is a graph showing a result of an ELISA for an ability of a reshaped human AUK 12-20 antibody (L chain version "a"+H chain version "b") to bind to human IL-6R.

FIG. 19 is a graph showing a result of an ELISA for an ability of a reshaped human AUK 12-20 antibody (L chain version "a"+H chain version "d") to bind to the human IL-6R.

FIG. 20 shows a process for chemical synthesis of a reshaped human sle 1220 H antibody H chain V region.

FIG. 21 is a graph showing a result of an ELISA for an ability of a reshaped human sle 1220 antibody (L chain version "a"+H chain version "a") to inhibit the binding of IL-6 to the human IL-6R.

FIG. 22 is a graph showing a result of an ELISA for an ability of a reshaped human sle 1220 antibody (L chain

5

version "a"+H chain version "b") to inhibit the binding of IL-6 to the human IL-6R.

FIG. 23 is a graph showing a result of an ELISA for an ability of a reshaped human sle 1220 antibody (L chain version "a"+H chain version "c") to inhibit the binding of IL-6 to the human IL-6R.

FIG. 24 is a graph showing a result of an ELISA for an ability of a reshaped human sle 1220 antibody (L chain version "a"+H chain version "d") inhibit the binding of IL-6 to the human LI-6R.

#### Best Mode for Carrying Out the Invention Cloning of DNA coding for mouse V regions

More specifically, to clone DNA coding for V regions of a mouse monoclonal antibody to a human IL-6R, the construction of hybridoma, which produces a monoclonal antibody to the human IL-6R, is necessary as a gene source. As such a hybridoma, Japanese Patent Application No. 2-189420 describes a mouse hybridoma PM-1 which produces a monoclonal antibody PM1 and the properties thereof. Reference Examples 1 and 2 of the present specification describe the construction process of the hybridoma PM1. The present inventors have constructed hybridomas AUK12-20, AUK64-7, and AUK146-15, each producing a mouse monoclonal antibody to the human IL-6R. The construction process of these hybridomas is described in the Reference Examples 3 of this specification.

To clone desired DNAs coding for V regions, of a mouse monoclonal antibody, hybridoma cells are homogenized and a total RNA is obtained according to a conventional procedure described by Chirgwin et al., *Biochemistry* 18, 5294, 1977. Next, the total RNA is used to synthesize single-stranded cDNAs according to the method described by J. W. Larrick et al., *Biotechnology*, 7, 934, 1989.

Next, a specific amplification of a relevant portion of the cDNA is carried out by a polymerase chain reaction (PCR) method. For amplification of a  $\kappa$  L chain V region of a mouse monoclonal antibody, 11 groups of oligonucleotide primers (Mouse Kappa Variable; MKV) represented in SEQ ID NO: 1 to 11, and an oligonucleotide primer (Mouse Kappa Constant; MKC) represented in SEQ ID NO: 12 are used as 5'-terminal primers and a 3'-terminal primer respectively. The MKV primers hybridize with the DNA sequence coding for the mouse  $\kappa$  L chain leader sequence, and the MKC primer hybridizes with the DNA sequence coding for the mouse  $\kappa$  L chain constant region. For amplification of the H chain V region of a mouse monoclonal antibody, 10 groups of oligonucleotide primers (Mouse Heavy Variable; MHV) represented in SEQ ID NO: 13 to 22, and a oligonucleotide primer (Mouse Heavy Constant MHC) represented in SEQ ID NO: 23 are used as 5'-terminal primers and a 3'-terminal primer, respectively.

Note, the 5'-terminal primers contain the nucleotide sequence GTCGAC near the 5'-end thereof, which sequence provides a restriction enzyme Sal I cleavage site; and the 3'-terminal primer contains the nucleotide sequence CCCGGG near the 5'-end thereof, which sequence provides a restriction enzyme Xma I cleavage site. These restriction enzyme cleavage sites are used to subclone the DNA fragments coding for a variable region into cloning vectors.

Next, the amplification product is cleaved with restriction enzymes Sal I and Xma I to obtain a DNA fragment coding for a desired V region of a mouse monoclonal antibody. On the other hand, an appropriate cloning vector such as plasmid pUC19 is cleaved with the same restriction enzymes Sal I and Xma I and the above DNA fragment is ligated with the

6

cleaved pUC19 to obtain a plasmid incorporating a DNA fragment coding for a desired V region of a mouse monoclonal antibody.

The sequencing of the cloned DNA can be carried out by any conventional procedure.

The cloning of the desired DNA, and the sequencing thereof, are described in detail in Examples 1 to 3.

#### Complementarity Determining Regions (CDRs)

The present invention provides hypervariable or complementarity determining regions (CDRs) of each V region of the present invention. The V domains of each pair of L and H chains from the antigen binding site. The domains on the L and H chains have the same general structure and each domain comprises four framework regions (FRs), whose sequences are relatively conserved, connected by three CDRs (see Kabat, E. A., Wu, T. T., Bilofsky, H., Reid-Miller, M. and Perry, H., in "Sequences of Proteins of Immunological Interest", US Dept. Health and Human Services 1983). The four FRs largely adopt a  $\beta$ -sheet conformation and the CDRs form loops connecting FRs, and in some cases forming part of, the  $\beta$ -sheet structure. The CDRs are held in close proximity by FRs and, with the CDRs from the other domain, contribute to the formation of the antigen binding site. The CDRs are described in Example 4.

#### Construction of Chimeric Antibody

Prior to designing reshaped human V regions of an antibody to the human IL-6R, it is necessary to confirm that the CDRs to be used actually form an effective antigen binding region. For this purpose, chimeric antibodies were constructed. In addition the amino acid sequences of V regions of mouse anti human IL-6R antibodies predicted from the nucleotide sequences of cloned DNAs of the 4 mouse monoclonal antibodies described in Example 1 and 2 were compared to each other and to V regions from known mouse and human antibodies. For each of the 4 mouse monoclonal antibodies, a set of typical, functional mouse L and H chain V regions had been cloned. All four mouse anti-IL-6R antibodies, however, had relatively distinct V regions. The 4 antibodies were not simply minor variations of each other. Using the cloned mouse V regions, 4 chimeric anti-IL-6R antibodies were constructed.

The basic method for constructing chimeric antibodies comprises joining the mouse leader and V region sequences, as found in the PCR-cloned cDNAs, to human C regions-coding sequence already present in mammalian cell expression vectors. Among said 4 monoclonal antibodies, construction of a chimeric antibody from the monoclonal antibody AUK12-20 is described in Example 5.

Construction of a chimeric antibody from the monoclonal antibody PM-1 is described in Example 6. The cDNA coding for the mouse PM-1  $\kappa$  L chain leader and V region was PCR-subcloned into an expression vector containing a genomic DNA coding for the human kappa C region. The cDNA coding for the mouse PM-1 H chain leader and V regions was PCR-subcloned into an expression vector containing a genomic DNA coding for the human gamma-1 C region. Using specially designed PCR primers, the cDNA coding for the mouse PM-1 V region were adapted at their 5'- and 3'-ends (1) so that they would be easy to insert into the expression vectors and (2) so that they would function properly in these expression vectors. The PCR-modified mouse PM-1 V regions were then inserted into HCMV expression vectors already containing the desired human C regions (FIG. 1). These vectors are suitable for either

transient or stable expression of genetically-engineered antibodies in a variety of mammalian cell lines.

In addition to constructing a chimeric PM-1 antibody with V regions identical to the V regions present in mouse PM-1 antibody (version a), a second version of chimeric PM-1 antibody was constructed (version b). In chimeric PM-1 antibody (version b), the amino acid at position 107 in the L chain V region was changed from asparagine to lysine. In comparing the L chain V region from mouse PM-1 antibody to other mouse L chain V regions, it was noticed that the occurrence of an asparagine at position 107 was an unusual event. In mouse K L chain V regions, the most typical amino acid at position 107 is a lysine. In order to evaluate the importance of having the atypical amino acid asparagine at position 107 in the L chain V region of mouse PM-1 antibody, position 107 was changed to the typical amino acid lysine at this position. This change was achieved using a PCR-mutagenesis method (M. Kamman et al., Nucl. Acids Res. (1989) 17:5404) to make the necessary changes in the DNA sequences coding for the L chain V region.

The chimeric PM-1 antibody version (a) exhibited an activity to bind to the human IL-6R. The chimeric PM-1 antibody version (b) also binds to the human IL-6R as well as version (a). Similarly, from other 2 monoclonal antibodies AUK64-7 and AUK146-15, chimeric antibodies were constructed. All 4 chimeric antibodies bound well to the human IL-6R thus indicating in a functional assay that the correct mouse V regions had been cloned and sequenced.

From the 4 mouse anti-IL-6R antibodies, PM-1 antibody was selected as the first candidate for the design and construction of a reshaped human antibody to the human IL-6R. The selection of mouse PM-1 antibody was based largely on results obtained studying the effect of the mouse anti-IL-6R antibodies on human myeloma tumor cells transplanted into nude mice. Of the 4 mouse anti-IL-6R antibodies, PM-1 antibody showed the strongest anti-tumor cell activity.

#### Comparison of the V Regions from Mouse Monoclonal Antibody PM-1 to V Regions from known Mouse and Human Antibodies

To construct a reshaped human antibody wherein the CDRs of a mouse monoclonal antibody are grafted into a human monoclonal antibody, it is desired that there is high homology between FRs of the mouse monoclonal antibody and FRs of the human monoclonal antibody. Therefore, the amino acid sequences of the L and H chain V regions from mouse PM-1 antibody were compared to all known mouse and mouse V regions as found in the OWL (or Leeds) database of protein sequences.

With respect to V regions from mouse antibodies, the L chain V region of PM-1 antibody was most similar to the L chain V region of mouse antibody musigkcko (Chen, H. T. et al., J. Biol. Chem. (1987) 262:13579-13583) with a 93.5% identity. The H chain V region of PM-1 antibody was most similar to the H chain V region of mouse antibody musigvhr2 (F. J. Grant et al., Nucl. Acids Res. (1987) 15:5496) with a 84.0% identity. The mouse PM-1 V regions show high percents of identity to known mouse V regions thus indicating that the mouse PM-1 V regions are typical mouse V regions. This provides further indirect evidence that the cloned DNA sequences are correct. There is generally a higher percent identity between the L chain V regions than between the H chain V regions. This is probably due to the lower amount of diversity generally observed in L chain V regions as compared to H chain V regions.

With respect to V regions from human antibodies, the L chain V region of PM-1 antibody was most similar to the L chain V region of human antibody klhure, also referred to as REI (W. Palm et al., Physiol. Chem. (1975) 356:167-191) with a 72.2% identity. The H chain V region of PM-1 antibody was most similar to the H chain V region of human antibody humighvap (VAP) (H.W. Schroeder et al., Science (1987) 238:791-793) with a 71.8% identity. The comparisons to human V regions are most important for considering how to design reshaped human antibodies from mouse PM-1 antibody. The percent identities to human V regions are less than the percent identities to mouse V regions. This is indirect evidence that the mouse PM-1 V regions do look like mouse V regions and not like human V regions. This evidence also indicates that it will be best to humanize mouse PM-1 V regions in order to avoid problems of immunogenicity in human patients.

The V regions from mouse PM-1 antibody were also compared to the consensus sequences for the different subgroups of human V regions as defined by E. A. Kabat et al. ((1987) Sequences of Proteins of Immunological Interest, Fourth Edition, U.S. Department of Health and Human Services, U.S. Government Printing Office). The comparisons were made between the FRs of the V regions. The results are shown in Table 1.

TABLE 1

Percent identities between the FRs from the mouse PM-1 V regions and the FRs from the consensus sequences<sup>(1)</sup> for the different subgroups of human V regions.

#### A. FRs in the L chain V regions

HSGI	HSGII	HSGIII	HSGIV
70.1	53.3	60.7	59.8

#### B. FRs in the H chain V regions

HSGI	HSGII	HSGIII
44.1	52.9	49.2

<sup>(1)</sup>The consensus sequences were taken from the subgroups of human V regions as described in Kabat et al., (1987).

The FRs of mouse PM-1 L chain V region are most similar to the FRs from the consensus sequence for subgroup I (HSGI) of human L chain V regions with 70.1% identity. The FRs of mouse PM-1 H chain V region are most similar to the FRs from the consensus sequence for subgroup II (HSGII) of human H chain V regions with 52.9% identity. These results support the results obtained from the comparisons to known human antibodies. The L chain V region in human REI belongs to subgroup I of human L chain V regions and the H chain V region in human VAP belongs to subgroup II of human H chain V regions.

From these comparisons to the V regions in human antibodies, it is possible to select human V regions that will be the basis for the design of reshaped human PM-1 V regions. It would be best to use a human L chain V region that belongs to subgroup I (SGI) for the design of reshaped human PM-1 L chain V region and a human H chain V region that belongs to subgroup II (SGII) for the design of reshaped human PM-1 H chain V region.

#### Design of Reshaped Human PM-1 Variable Regions

The first step in designing the reshaped human PM-1 V regions was to select the human V regions that would be the

basis of the design. The FRs in the mouse PM-1 L chain V region were most similar to the FRs in human L chain V regions belonging to subgroup I (Table 1). As discussed above, in comparing the mouse PM-1 L chain V region to known human L chain V regions, it was most similar to the human L chain V region REI, a member of subgroup I of human L chain V regions. In designing reshaped human PM-1 L chain V regions, the FRs from REI were used. Moreover the REI FRs were used as starting material for the construction of reshaped human PM-1 L chain V region.

In these human FRs based on REI, there were five differences from the FRs in the original human REI (positions 39, 71, 104, 105, and 107 according to Kabat et al., 1987; see Table 2). The three changes in FR4 (positions 104, 105, and 107) were based on a J region from another human kappa L chain and, therefore, do not constitute a

amino acid at this position is predicted to directly influence the structure of the CDR1 loop of the L chain V region and, therefore, may well influence antigen binding. In the mouse PM-1 L chain V region, position 71 is a tyrosine. In the modified REI FRs used in the design of version "a" of reshaped human PM-1 L chain V region, position 71 was a phenylalanine. In version "b" of reshaped human PM-1 L chain V region, the phenylalanine at position 71 was changed to a tyrosine as found in mouse PM-1 L chain V region. Table 2 shows the amino acid sequences of mouse PM-1 L chain V region, the FRs of REI as modified for use in reshaped human CAMPATH-1H antibody (Riechmann et al., 1988), and the two versions of reshaped human PM-1 L chain V region.

Table 2

		Design of two different versions of reshaped human PM-1 L chain V region.																														
		FR1												CDR1																		
		1						2						3																		
		1	2	3	4	5	6	7	8	9	10	11	12	13	14	15	16	17	18	19	20	21	22	23	24	25	26	27	28			
V <sub>L</sub> PM-1	DI QMT QTT S S L S A S L G D R V T I S C													R A S Q D I S S Y L N																		
REI	DI QMT Q S P S S L S A S V G D R V T I T C													R A S Q D I S S Y L N																		
RV <sub>L</sub> a	DI QMT Q S P S S L S A S V G D R V T I T C													R A S Q D I S S Y L N																		
RV <sub>L</sub> b	-----													-----																		
		FR2									CDR2																					
		4			5																											
		5	6	7	8	9	0	1	2	3	4	5	6																			
V <sub>L</sub> PM-1	WY Q Q K P D G T I K L L I Y	Y T S R L H S																														
REI	WY Q Q K P G K A P K L L I Y	Y T S R L H S																														
RV <sub>L</sub> a	WY Q Q K P G K A P K L L I Y	Y T S R L H S																														
RV <sub>L</sub> b	-----	-----																														
		FR3												CDR3																		
		6						7						8						9												
		7	8	9	0	1	2	3	4	5	6	7	8	9	0	1	2	3	4	5	6	7	8	9	0	1	2	3	4	5	6	7
V <sub>L</sub> PM-1	G V P S R F S G S G S G T D Y S L T I N N L E Q E D I A T Y F C	Q Q G N T L P Y T																														
REI	G V P S R F S G S G S G T D F T F T I S S L Q P E D I A T Y Y C	Q Q G N T L P Y T																														
RV <sub>L</sub> a	G V P S R F S G S G S G T D F T F T I S S L Q P E D I A T Y Y C	Q Q G N T L P Y T																														
RV <sub>L</sub> b	-----	-----																														
		FR4																														
		10																														
		8	9	0	1	2	3	4	5	6	7																					
V <sub>L</sub> PM-1	F G G G T K L E I N																															
REI	F G Q G T K V E I K																															
RV <sub>L</sub> a	F G Q G T K V E I K																															
RV <sub>L</sub> b	-----	-----																														

## Note:

The FRs given for REI are those found in the reshaped human CAMPATH-1H antibody (Reichmann et al., 1988). The five underlined amino acid residues in the REI FRs are those that differ from the amino acid sequence of human REI (Palm et al., 1975; O. Epp et al., Biochemistry (1975) 14:4943-4952).

deviation from human (L. Riechmann et al., Nature (1988) 322:21-25). The two changes at positions 39 and 71 were changes back to the amino acids that occurred in the FRs of rat CAMPATH-1 L chain V region (Riechmann et al., 1988).

Two versions of reshaped human PM-1 L chain V region were designed. In the first version (version "a"), the human FRs were identical to the REI-based FRs present in reshaped human CAMPATH-1H (Riechmann et al., 1988) and the mouse CDRs were identical to the CDRs in mouse PM-1 L chain V region. The second version (version "b") was based on version "a" with only one amino acid change at position 71 in human FR3. Residue 71 is part of the canonical structure for CDR1 of the L chain V region as defined by C. Chothia et al., (J. Mol. Biol (1987) 196:901-917). The

The FRs in the mouse PM-1 H chain V region were most similar to the FRs in human H chain V regions belonging to subgroup II (Table 1). As discussed above, in comparing the mouse PM-1 H chain V region to known human H chain V regions, it was most similar to the human H chain V region VAP, a member of subgroup II of human H chain V regions. DNA sequences coding for the FRs in human H chain V region NEW, another member of subgroup II of human H chain V regions, were used as starting material for the construction of reshaped human PM-1 H chain V region, and as a base for designing the reshaped human PM-1 H chain V region.

Six versions of reshaped human PM-1 H chain V region were designed. In all six versions, the human FRs were

based on the NEW FRs present in reshaped human CAMPATH-1H (Riechmann et al., 1988) and the mouse CDRs were identical to the CDRs in mouse PM-1 H chain V region. Seven amino acid residues in the human FRs (positions 1, 27, 28, 29, 30, 48, and 71, see Table 3) were identified as having a possible adverse influence on antigen binding. In the model of mouse PM-1 V regions, residue 1

the overall structure of the V region and its antigen-binding site. Residue 71 is part of the canonical structure for CDR2 of the H chain V region as predicted by Chothia et al., (1989). The six versions of reshaped human PM-1 antibody incorporate different combinations of amino acid changes at these seven positions in the human NEW FRs (see Table 3).

TABLE 3

Design of six different versions of reshaped human PM-1 H chain V region.		
	FR1	CDR1
	1 2 3 4 5 6 7 8 9 0 1 2 3 4 5 6 7 8 9 0 1 2 3 4 5 6 7 8 9 0	
V <sub>H</sub> PM-1	DVQLQESG PVLVKPSQSLSLTCTVTGYSIT	SDHAW <sup>A</sup> S
NEW	QVQLQESG PGLVRPSTLSLTCTVSGSTFS	
RV <sub>Ha</sub>	QVQLQESG PGLVRPSTLSLTCTVSGYTFIT	SDHAW <sup>A</sup> S
RV <sub>Hb</sub>	-----	-----
RV <sub>Hc</sub>	D-----	-----
RV <sub>Hd</sub>	-----	-----
RV <sub>He</sub>	D-----	-----
RV <sub>Hf</sub>	-----	-----
	FR2	CDR2
	4 5 6 7 8 9 0 1 2 3 4 5 6 7 8 9	0 1 2 2 3 4 5 6 7 8 9 0 1 2 3 4 5
V <sub>H</sub> PM-1	WIRQFPGNKLEWVG	YIS <sup>A</sup> -YSGITTYNPSLKS
NEW	WVRQPPGRGLEWIG	
RV <sub>Ha</sub>	WVRQPPGRGLEWIG	YIS <sup>A</sup> -YSGITTYNPSLKS
RV <sub>Hb</sub>	-----	-----
RV <sub>Hc</sub>	-----	-----
RV <sub>Hd</sub>	-----M-	-----
RV <sub>He</sub>	-----M-	-----
RV <sub>Hf</sub>	-----	-----
	FR3	
	7 8 9 0 1 2 3 4 5 6 7 8 9 0 1 2 2 2 3 4 5 6 7 8 9 0 1 2 3 4	
V <sub>H</sub> PM-1	RI S I T R D T S K N Q F F L Q L N S V I T G D T S T Y Y C A R	
NEW	R V T M L V D T S K N Q F S L R L S S V I A A D T A V Y Y C A R	
RV <sub>Ha</sub>	R V T M L V D T S K N Q F S L R L S S V I A A D T A V Y Y C A R	
RV <sub>Hb</sub>	-----R-----	
RV <sub>Hc</sub>	-----R-----	
RV <sub>Hd</sub>	-----R-----	
RV <sub>He</sub>	-----R-----	
RV <sub>Hf</sub>	-----R-----	
	CDR3	FR4
	10 11	
	5 6 7 8 9 0 0 0 1 2	3 4 5 6 7 8 9 0 1 2 3
V <sub>H</sub> PM-1	SLARTTAMDY	WGQGTSVTVSS
NEW	SLARTTAMDY	WGQGSLVTVSS
RV <sub>Ha</sub>	SLARTTAMDY	WGQGSLVTVSS
RV <sub>Hb</sub>	-----	-----
RV <sub>Hc</sub>	-----	-----
RV <sub>He</sub>	-----	-----
RV <sub>Hf</sub>	-----	-----

Note:  
The FRs given for NEW are those found in the first version of reshaped human CAMPATH-1H antibody (Riechmann et al., 1988).

in the H chain V region is a surface residue that is located close to the CDR loops. Residues 27, 28, 29, and 30 are either part of the canonical structure for CDR1 of the H chain V region, as predicted by C. Chothia et al., Nature (1989) 34:877-883, and/or are observed in the model of the mouse PM-1 V regions to form part of the first structural loop of the H chain V region (Chothia, 1987). Residue 48 was observed in the model of the mouse PM-1 V regions to be a buried residue. Changes in a buried residue can disrupt

Construction of Reshaped Human PM-1 V Regions  
The first versions of the reshaped human PM-1 L and H chain V regions were each constructed using a novel PCR-based method. Essentially, a plasmid DNA coding for reshaped human V region that already contained suitable human FRs was modified using PCR primers to replace the CDRs present in the starting reshaped human V region with the CDRs from mouse PM-1 antibody. The starting material for the construction of the reshaped human PM-1 L chain V

region was a plasmid DNA containing the reshaped human D1.3 L chain V region. The reshaped human D1.3 L chain V region was constructed based on the FRs present in the human L chain V region of REI. The starting material for the construction of the reshaped human PM-1 H chain V region was a plasmid DNA containing the reshaped human D1.3 H chain V region. The reshaped human D1.3 H chain V region was constructed based on the FRs present in the human H chain V region of NEW (M. Verhoeyen et al., *Science* (1988) 239:1534-1536).

Once the starting plasmid DNAs containing the desired human FRs were selected, PCR primers were designed to enable the substitution of the mouse PM-1 CDRs in place of the mouse D1.3 CDRs. For each reshaped human PM-1 V region, three primers containing the DNA sequences coding for the mouse PM-1 CDRs and two primers flanking the entire DNA sequence coding for the reshaped human V region were designed and synthesized. Using the five PCR primers in a series of PCR reactions yielded a PCR product that consisted of the human FRs present in the starting reshaped human V region and the CDRs present in mouse PM-1 V region (see Example 7, and FIGS. 7 and 8). The PCR products were cloned and sequenced to ensure that the entire DNA sequence of version "a" of reshaped human PM-1 L and H chain V region coded for correct amino acid sequence (SEQ ID NO 55).

The remaining versions of the reshaped human PM-1 V regions were constructed using slight modifications of published PCR-mutagenesis techniques (Kamman et al., 1989). As described for the design of the reshaped human PM-1 V regions, one additional version (version "b") of the reshaped human PM-1 L chain V region was constructed and five additional versions (versions "b", "c", "d", "e", and "f") of the reshaped human PM-1 H chain V region were constructed. These additional versions contain a series of minor changes from the first versions. These minor changes in the amino acid sequences were achieved using PCR mutagenesis to make minor changes in the DNA sequences. PCR primers were designed that would introduce the necessary changes into the DNA sequence. Following a series of PCR reactions, a PCR product was cloned and sequenced to ensure that the changes in the DNA sequence had occurred as planned. Sequence of the reshaped human PM-1 antibody H chain V region version "f" is shown in SEQ ID NO 54).

Once the DNA sequences of the different versions of reshaped human PM-1 V regions were confirmed by sequencing, the reshaped human PM-1 V regions were subcloned into mammalian cell expression vectors already containing human C regions. Reshaped human PM-1 L chain V regions were joined to DNA sequences coding for human  $\kappa$  C region. Reshaped human PM-1 H chain V regions were joined to DNA sequences coding for human gamma-1 C region. In order to achieve higher levels of expression of the reshaped human PM-1 antibodies, the HCMV expression vectors, as shown in FIG. 1, were modified to replace the HCMV promoter-enhancer region with the human elongation factor (HEF-1 $\alpha$ ) promoter-enhancer (see FIG. 15).

Next, all combinations of the reshaped human L chain versions (a) and (b) with the H chain V region versions (a) to (f) were tested for binding to human IL-6R, and as a result, a reshaped human antibody comprising the L chain version (a) and the H chain version (f) exhibited an ability to bind to IL-6R at a same level as that of chimeric PM-1 (a) (FIG. 13) as described in detail in Example 11.

#### Modifications in the DNA Sequences Coding for the Reshaped Human PM-1 V Regions to Improve the Levels of Expression.

In reviewing the levels of reshaped human PM-1 antibodies being produced in cos cells, it became apparent that

the levels of expression of the reshaped human H chains were always approximately 10-fold lower than the levels of expression of the reshaped human L chains or of the chimeric L or H chains. It appeared that there was a problem in DNA coding for the reshaped human H chain V region that caused low levels of expression. In order to identify whether the lower levels of protein expression were the result of lower levels of transcription, RNA was prepared from cos cells co-transfected with vectors expressing reshaped human PM-1 L and H chains. First-strand cDNA was synthesized as described for the PCR cloning of the mouse PM-1 V regions. Using PCR primers designed to flank the ends of DNA coding for the reshaped human L or H chain V regions, PCR products were generated from the cDNAs that corresponded to reshaped human L chain V region or to reshaped human H chain V region.

For the reshaped human L chain V region, there were two PCR products, one 408 bp long, as expected, and a shorter PCR product 299 bp long. The correct size PCR product made up approximately 90% of the total yield of PCR product and the shorter PCR product made up approximately 10% of the total yield. For the reshaped human H chain V region, there were also two PCR products, one 444 bp long, as expected, and a shorter PCR product 370 bp long. In this case, however, the incorrect, shorter PCR product made up the majority of the total yield of PCR product, approximately 90%. The correct size PCR product made up only approximately 10% of the total yield of PCR product. These results indicated that some of the RNAs coding for the reshaped human V regions contained deletions.

In order to determine which sequences were being deleted, the shorter PCR products were cloned and sequenced. From the DNA sequences, it became clear that for both the L and H chain V regions specific sections of DNA were being deleted. Examination of the DNA sequences flanking the deleted sequences revealed that these sequences corresponded to the consensus sequences for splice donor-acceptor sequences (Breathnach, R. et al., *Ann. Rev. Biochem* (1981) 50:349-383). The explanation for the low levels of expression of the reshaped human H chains was that the design of the reshaped human H chain V regions had inadvertently created a rather efficient set of splice donor-acceptor sites. It also appeared that the design of the reshaped human L chain V regions had inadvertently created a rather inefficient set of splice donor-acceptor sites. In order to remove the splice donor-acceptor sites, minor modifications in the DNA sequences coding for versions "a" and "f", respectively, of the reshaped human PM-1 L and H chain V regions were made using the PCR-mutagenesis methods described earlier.

Another possible cause of reduced levels of expression was thought to be the presence of introns in the leader sequences in both the reshaped human L and H chain V regions (SEQ ID NOs: 54 and 55). These introns were originally derived from a mouse mu H chain leader sequence (M.S. Neuberger et al., *Nature* 1985 314:268-270) that was used in the construction of reshaped human D1.3 and V regions (Verhoeyen et al., 1988). Since the reshaped human D1.3 was expressed in a mammalian cell vector that employed a mouse immunoglobulin promoter, the presence of the mouse leader intron was important. The leader intron contains sequences that are important for expression from immunoglobulin promoters but not from viral promoters like HCMV (M. S. Neuberger et al., *Nucl. Acids Res.* (1988) 16:6713-6724). Where the reshaped human PM-1 L and H chains were being expressed in vectors employing non-immunoglobulin promoters, the introns in the leader



sequences were deleted by PCR cloning cDNAs coding for the reshaped human V regions (see Example 12).

Another possible cause of reduced levels of expression was thought to be the presence of a stretch of approximately 190 bp of non-functional DNA within the intron between the reshaped human PM-1 H chain V region and the human gamma-1 C region. The reshaped human PM-1 H chain V region was constructed from DNA sequences derived originally from reshaped human B1-8 H chain V region (P. T. Jones et al., *Nature* (1986) 321:522-525). This first reshaped human V region was constructed from the mouse NP H chain V region (M. S. Neuberger et al., *Nature* (1985); M. S. Neuberger et al., *EMBO J.* (1983) 2:1373-1378). This stretch of approximately 190 bp occurring in the intron between the reshaped human H chain V region and the BamHI site for joining of the reshaped human V regions to the expression vector was removed during the PCR cloning of cDNAs coding for the reshaped human V regions.

The DNA and amino acid sequences of the final versions of reshaped human PM-1 L and H chain V regions, as altered to improve expression levels, are shown in SEQ ID NOs: 57 and 56. These DNA sequences code for version "a" of the reshaped human PM-1 L chain V region as shown in Table 2 and version "f" of the reshaped human PM-1 H chain V region as shown in Table 3. When inserted into the HEF-1 $\alpha$  expression vectors (FIG. 15), these vectors transiently produce approximately 2  $\mu$ g/ml of antibody in transfected cos cells. In order to stably produce larger amounts of reshaped human PM-1 antibody, a new HEF-1 $\alpha$  expression vector incorporating the dhfr gene was constructed (see Example 10, FIG. 11). The "crippled" dhfr gene was introduced into the HEF-1 $\alpha$  vector expressing human gamma-1 H chains as was described for the HCMV vector expressing human gamma-1 H chains. The HEF-1 $\alpha$  vector expressing reshaped human PM-1 L chains and the HEF-1 $\alpha$ -dhfr vector expressing reshaped human P-1 H chains were co-transfected into CHO dhfr(-) cells. Stably transformed CHO cell lines were selected in Alpha-Minimum Essential Medium ( $\alpha$ -MEM) without nucleosides and with 10% FCS and 500  $\mu$ g/ml of G418. Prior to any gene amplification steps, CHO cell lines were observed that produced up to 10  $\mu$ g/10<sup>6</sup> cells/day of reshaped human PM-1 antibody.

#### Comparison of V Regions from Mouse Monoclonal Antibody AUK 12-20 to V Regions from Known Human Antibodies

The homology of FRs of  $\kappa$ L chain V region of the mouse monoclonal antibody AUK 12-20 with FRs of human  $\kappa$ L chain V region subgroup (HSG) I to IV, and the homology of FRs of H chain V region of the mouse monoclonal antibody AUK 12-20 with FRs of human H chain V regions subgroup (HSG) I to III are shown in Table 4.

TABLE 4

Percent identities between FRs from the mouse AUK 12-20 V regions and FRs from the consensus sequence for the different subgroups of human V regions			
FRs in the L chain V regions			
HSG1	HSG2	HSG3	HSG4
65.8	64.0	67.6	67.6
FRs in the H chain V regions			
HSGI	HSGII	HSGIII	
58.6	53.6	49.1	

As seen from Table 4, the  $\kappa$ L chain V region of the mouse monoclonal antibody AUK 12-20 is homologous in a similar extent (64 to 68%) with the human  $\kappa$ L chain V region subgroups (HSG) I to IV. In a search of the Data base "LEEDS" for protein, L chain V region of human antibody Len (M. Schneider et al., *Physiol. Chem.* (1975) 366:507-557) belonging to the HSG-IV exhibits the highest homology 68%. On the other hand, the human antibody REI, used for construction of a reshaped human antibody from the mouse monoclonal antibody PM-1 belongs to the HSG I, exhibits a 62% homology with L chain V region of the mouse monoclonal antibody AUK 12-20. In addition, the CDRs in the AUK 12-20 antibody L chain V region particularly CDR2, corresponded better to canonical structures of the CDRs in REI rather than those in LEN.

Considering the above, it is not necessary to choose a human antibody used for humanization of the mouse monoclonal antibody AUK 12-20 L chain V region from those antibodies belonging to the HSG IV. Therefore, as in the case of the humanization of the mouse monoclonal antibody PM-1 L chain V region, the FRs of REI are used for humanization of the mouse monoclonal antibody AUK 12-20 L chain V region.

As shown in Table 4, H chain V region of the antibody AUK 12-20 exhibits the highest homology with the HSG I. Moreover, in a search of Data base "LEEDS", human antibody HAX (Stollar, B. O. et al., *J. Immunol.* (1987) 139:2496-2501) also belonging to the HSG I exhibits an about 66% homology with the AUK 12-20 antibody H chain V region. Accordingly, to design reshaped human AUK 12-20 antibody H chain V region, the FRs of the human antibody HAX belonging to the HSG I and FRs of humanized 425 antibody H chain V region which has FRs consisting of HSGI consensus sequence (Ketteborough C. A. et al., *Protein Engineering* (1991) 4:773-783) are used. Note, the AUK 12-20 antibody H chain V region exhibits an about 64% homology with version "a" of the humanized 425 antibody H chain V region.

#### Design of Reshaped Human AUK 12-20 Antibody L Chain V Regions

According to the above reason, reshaped human AUK 12-20 antibody L chain V regions is designed as shown in Table 5 using FRs of the REI.



TABLE 6-continued

	FR3																															
	7					8			9																							
V <sub>H</sub> AUK 12-20	6	7	8	9	0	1	2	3	4	5	6	7	8	9	0	1	2	3	4													
SGI									A	B	C																					
RV <sub>H</sub> a	K	A	T	L	I	V	D	K	S	S	S	T	A	Y	M	H	L	S	S	L	T	S	E	D	S	A	V	Y	Y	C	A	R
RV <sub>H</sub> b	R	V	T	X	T	X	D	X	S	X	N	T	A	Y	M	E	L	S	S	L	R	S	E	D	T	A	V	Y	Y	C	A	R
RV <sub>H</sub> c	R	V	T	M	T	L	D	T	S	T	N	T	A	Y	M	E	L	S	S	L	R	S	E	D	T	A	V	Y	Y	C	A	R
RV <sub>H</sub> d	K	-	-	-	-	V	-	-	-	-	-	-	-	-	-	-	-	-	-	-	-	-	-	-	-	-	-	-	-	-	-	-
	K	-	-	-	-	V	-	-	-	-	-	-	-	-	-	-	-	-	-	-	-	-	-	-	-	-	-	-	-	-	-	-

	CDR3					FR4															
	10					11															
V <sub>H</sub> AUK 12-20	5	6	7	8	9	0	0	0	1	2	3	4	5	6	7	8	9	0	1	2	3
SGI																					
RV <sub>H</sub> a	G	G	N	-	R	F	-	-	A	Y	W	G	Q	G	T	L	V	T	V	S	A
RV <sub>H</sub> b	G	G	N	-	R	F	-	-	A	Y	W	G	Q	G	T	L	V	T	V	S	S
RV <sub>H</sub> c	G	G	N	-	R	F	-	-	A	Y	-	-	-	-	-	-	-	-	-	-	-
RV <sub>H</sub> d	-	-	-	-	-	-	-	-	-	-	-	-	-	-	-	-	-	-	-	-	-

Note:  
 The position where one common amino acid residue is not identified in the HSG I V<sub>H</sub> regions (SGI) is shown as "X". Two under lined amino acid residues are different from those in SGI consensus sequence. For RV<sub>H</sub>b, RV<sub>H</sub>c and RV<sub>H</sub>d, only amino acid residues different from those of RV<sub>H</sub>a are shown.

Moreover, version "a" to "d" of reshaped human AUK 12-20 antibody H chain V region are designed as shown in Table 7, using FRs of the human antibody HAX (J. Immunology (1987) 139:2496-2501; an antibody produced by

hybridoma 21/28 cells derived from B cells of a SLE patient; its amino acid sequence is described in FIG. 6 and nucleotide sequence of DNA coding for the amino acid sequence is shown in FIGS. 4 and 6, of this literature).

TABLE 7

	FR1																																			
	1					2					3																									
V <sub>H</sub> AUK 12-20	E	I	Q	L	Q	Q	S	G	P	E	L	M	K	P	G	A	S	V	K	I	S	C	K	A	S	G	Y	S	F	T	S	Y	Y	I	H	
SGI	Q	V	Q	L	V	Q	S	G	A	E	V	K	K	P	G	A	S	V	K	V	S	C	K	A	S	G	Y	T	F	T	-	-	-	-	-	
slc:																																				
1220Ha	Q	V	Q	L	V	Q	S	G	A	E	V	K	K	P	G	A	S	V	K	V	S	C	K	A	S	G	Y	S	F	T	S	Y	Y	I	H	
1220Hb	-	-	-	-	-	-	-	-	-	-	-	-	-	-	-	-	-	-	-	-	-	-	-	-	-	-	-	-	-	-	-	-	-	-	-	-
1220Hc	-	-	-	-	-	-	-	-	-	-	-	-	-	-	-	-	-	-	-	-	-	-	-	-	-	-	-	-	-	-	-	-	-	-	-	-
1220Hd	-	-	-	-	-	-	-	-	-	-	-	-	-	-	-	-	-	-	-	-	-	-	-	-	-	-	-	-	-	-	-	-	-	-	-	-

	FR2					CDR2																														
	4					5																														
V <sub>H</sub> AUK 12-20	W	V	K	Q	S	H	G	K	S	L	E	W	I	G	Y	I	D	P	-	-	F	N	G	G	T	S	Y	N	Q	K	F	K	G			
HAX	W	V	R	Q	A	P	G	Q	R	L	E	W	M	G	Y	I	D	P	-	-	F	N	G	G	T	S	Y	N	Q	K	F	K	G			
slc:																																				
1220Ha	W	V	R	Q	A	P	G	Q	R	L	E	W	M	G	Y	I	D	P	-	-	F	N	G	G	T	S	Y	N	Q	K	F	K	G			
1220Hb	-	-	-	-	-	-	-	-	-	-	-	-	-	-	I	-	-	-	-	-	-	-	-	-	-	-	-	-	-	-	-	-	-	-	-	-
1220Hc	-	-	-	-	-	-	-	-	-	-	-	-	-	-	-	-	-	-	-	-	-	-	-	-	-	-	-	-	-	-	-	-	-	-	-	-
1220Hd	-	-	-	-	-	-	-	-	-	-	-	-	-	-	I	-	-	-	-	-	-	-	-	-	-	-	-	-	-	-	-	-	-	-	-	-

	FR3																																			
	7					8			9																											
V <sub>H</sub> AUK 12-20	K	A	T	L	I	V	D	K	S	S	S	T	A	Y	M	H	L	S	S	L	T	S	E	D	S	A	V	Y	Y	C	A	R				
HAX	R	V	T	I	T	R	D	T	S	A	S	T	A	Y	M	E	L	S	S	L	R	S	E	D	T	A	V	Y	Y	C	A	R				
slc:																																				
1220Ha	R	V	T	I	T	V	D	T	S	A	S	T	A	Y	M	E	L	S	S	L	R	S	E	D	T	A	V	Y	Y	C	A	R				
1220Hb	-	-	-	-	-	V	-	-	-	-	-	-	-	-	-	-	-	-	-	-	-	-	-	-	-	-	-	-	-	-	-	-	-	-	-	-
1220Hc	K	-	-	-	-	V	-	-	-	-	-	-	-	-	-	-	-	-	-	-	-	-	-	-	-	-	-	-	-	-	-	-	-	-	-	-
1220Hd	K	-	-	-	-	V	-	-	-	-	-	-	-	-	-	-	-	-	-	-	-	-	-	-	-	-	-	-	-	-	-	-	-	-	-	-

TABLE 7-continued

	CDR3	FR4
	10	11
	5 7 8 9 0 0 0 1 2	3 4 5 6 7 8 9 0 1 2 3
	AB	
V <sub>H</sub> AUK 12-20	GGN-RF--AY	WGQGTLVTVSA
HAX	-----	WGQGTLVTVSS
sle:		
1220Ha	GGN-RF--AY	WGQGTLVTVSA
1220Hb	-----	-----
1220Hc	-----	-----
1220Hd	-----	-----

## Note:

The two underlined residues in sle1220Ha are changes from the HAX FRs. For sle1220Hb, sle1220Hc, and sle1220Hd, only the amino acids in the FRs that differ from those in the HAX FRs are shown.

For the production of the present chimeric or reshaped human antibodies to the human IL-6R, any expression system, including eucaryotic cells, for example, animal cells, such as established mammalian cell lines, fungal cells, and yeast cells, as well as procaryotic cells, for example, bacterial cells such as *E. coli* cells, may be used. Preferably the present chimeric or reshaped human antibodies are expressed in mammalian cells such as cos cells or CHO cells.

In such cases, a conventional promoter useful for the expression in mammalian cells can be used. For example, viral expression system such as human cytomegalovirus immediate early (HCMV) promoter is preferably used. Examples of the expression vector containing the HCMV promoter include HCMV-V<sub>H</sub>-HCγ1, HCMV-V<sub>L</sub>-HC<sub>K</sub>, HCMV-12h-gγ1, HCMV-12k-gk and the like derived from pSV2neo, as shown in FIG. 1.

Another embodiment of promoter useful for the present invention is the human elongation factor 1α (HEF-1α) promoter. Expression vectors containing this promoter include HEF-12h-gγ1 and HEF-12h-gk (FIGS. 8 and 9), as well as HEF-V<sub>H</sub>-gγ1 and HEF-V<sub>L</sub>-gk (FIG. 15).

For gene amplification dhfr in a host cell line, an expression vector may contain a dhfr gene. Expression vectors containing the dhfr gene, are for example, DHFR-ΔE-PMh-gγ1 (FIG. 10), DHFR-ΔE-RVh-PM1-f (FIG. 11) and the like.

In summary, the present invention first provides an L chain v region and an H chain V region of a mouse monoclonal antibody to the human IL-6R, as well as DNA coding for the L chain V region and DNA coding for the H chain V region. These are useful for the construction of a human/mouse chimeric antibody and reshaped human antibody to the human IL-6R. The monoclonal antibodies are, for example, AUK12-20, PM-1, AUK64-7 and AUK146-15. The L chain V region has an amino acid sequence shown in, for example, SEQ ID NOs: 24, 26, 28 or 30; and the H chain V region has an amino acid sequence shown in SEQ ID NOs: 25, 27, 29, or 31. These amino acid sequences are encoded by nucleotide sequences, for example, shown in SEQ ID NOs: 24 to 31 respectively.

The present invention also relates to a chimeric antibody to the human IL-6R, comprising:

- (1) an L chain comprising a human L chain C region and a mouse L chain V region; and
- (2) an H chain comprising a human H chain C region and a mouse H chain V region. The mouse L chain V region and the mouse H chain V region and DNA encoding them are as described above. The human L chain C region may be any human L chain C region, and for example, is human C<sub>K</sub>. The human H chain C region may be any human H chain C region, and for example human C<sub>γ1</sub>.

For the production of the chimeric antibody, two expression vectors, i.e., one comprising a DNA coding for a mouse L chain V region and a human L chain C region under the control of an expression control region such as an enhancer/promoter system, and another comprising a DNA coding for a mouse H chain V region and a human H chain C region under the expression control region such as an enhancer/promoter system, are constructed. Next, the expression vectors are co-transfected to host cells such as mammalian cells, and the transfected cells are cultured in vitro or in vivo to produce a chimeric antibody.

Alternatively, a DNA coding for a mouse L chain V region and a human L chain C region and a DNA coding for a mouse H chain V region and a human H chain C region are introduced into a single expression vector, and the vector is used to transfect host cells, which are then cultured in-vivo or in-vitro to produce a desired chimeric antibody.

The present invention further provides a reshaped antibody to the human IL-6R, comprising:

- (A) an L chain comprising,
  - (1) a human L chain C region, and
  - (2) an L chain V region comprising a human L chain FRs, and L chain CDRs of a mouse monoclonal antibody to the human IL-6R; and
- (B) an H chain comprising,
  - (1) a human H chain C region, and
  - (2) an H chain V region comprising human H chain FRs, and H chain CDRs of a mouse monoclonal antibody to the IL-6R.

In a preferred embodiment, the L chain CDRs have amino acid sequences shown in any one of SEQ ID NOs: 24, 26, 28 and 30 wherein the stretches of the amino acid sequences are defined in Table 9; the L chain CDRs have amino acid sequences shown in any one of SEQ ID NOs: 25, 27, 29 and 31 wherein the stretches of the amino acid sequences are defined in Table 9; human L chain FRs are derived from the REI; and human H chain FRs are derived from the NEW or HAX.

In the preferred embodiment, the L chain V region has an amino acid sequence shown in Table 2 as RV<sub>L</sub>a; and the H chain V region has an amino acid sequence shown in Table 3 as RV<sub>H</sub>a, RV<sub>H</sub>b, RV<sub>H</sub>c, RV<sub>H</sub>d, RV<sub>H</sub>e or RV<sub>H</sub>f. The amino acid sequence RV<sub>H</sub>f is most preferable.

For the production of the reshaped human antibody, two expression vectors, i.e., one comprising a DNA coding for the reshaped L chain as defined above under the control of an expression control region such as an enhancer/promoter system, and another comprising a DNA coding for the reshaped human H chain as defined above under the expression control region such as an enhancer/promoter system, are constructed. Next, the expression vectors are

co-transfected to host cells such as mammalian cells, and the transfected cells are cultured in vitro or in-vivo to produce a reshaped human antibody.

Alternatively, a DNA coding for the reshaped human L chain and a DNA coding for the reshaped H chain are introduced into a single expression vector, and the vector is used to transfect host cells, which are then cultured in vivo or in vitro to produce a desired reshaped human antibody.

A chimeric antibody of a reshaped human antibody thus produced can be isolated and purified by a conventional processes such as Protein A affinity chromatography, ion exchange chromatography, gel filtration and the like.

The present chimeric L chain or reshaped human L chain can be combined with an H chain to construct a whole antibody. Similarly, the present chimeric H chain or reshaped human H chain can be combined with an L chain to construct a whole antibody.

The present mouse L chain V region, reshaped human L chain V region, mouse H chain V region and reshaped human H chain V region are intrinsically a region which binds to an antigen, human IL-6R, and therefore considered to be useful as such or as a fused protein with other protein, for preparing pharmaceuticals or diagnostic agents.

Moreover, the present L chain V region CDRs and H chain V region CDRs are intrinsically regions which bind to an antigen, human IL-6R, and therefore considered to be useful as such or as a fused protein with other protein, for preparing pharmaceuticals or diagnostic agents.

DNA coding for a mouse L chain V region of the present invention is useful for construction of a DNA coding for a chimeric L chain or a DNA coding for a reshaped human L chain.

Similarly, DNA coding for a mouse H chain V region of the present invention is useful for construction of a DNA coding for a chimeric H chain or a DNA coding for a reshaped human H chain. Moreover, DNA coding for L chain V region CDR of the present invention is useful for construction of a DNA coding for a reshaped human L chain V region and a DNA coding for a reshaped human L chain. Similarly, DNA coding for H chain V region CDR of the present invention is useful for construction of a DNA coding for a reshaped human H chain V region and a DNA coding for a reshaped human H chain.

### EXAMPLES

The present invention will be further illustrated by, but is by no means limited to, the following Examples.

#### Example 1

Cloning of DNA coding for V region of mouse monoclonal antibody to human IL-6R (1)

A DNA coding for the V region of a mouse monoclonal antibody to a human IL-6R was cloned as follows.

##### 1. Preparation of total RNA

Total RNA from hybridoma AUK12-20 was prepared according to a procedure described by Chirgwin et al., *Biochemistry* 18, 5294 (1979). Namely,  $2.1 \times 10^8$  cells of the hybridoma AUK12-20 were completely homogenized in 20 ml of 4M guanidine thiocyanate (Fulka). The homogenate was layered over a 5.3M cesium chloride solution layer in a centrifuge tube, which was then centrifuged in a Beckman SW40 rotor at 31000 rpm at 20° C. for 24 hours to precipitate RNA. The RNA precipitate was washed with 80% ethanol and dissolved in 150  $\mu$ l of 10 mM Tris-HCl (pH 7.5) containing 1 mM EDTA and 0.5% SDS, and after adding Proteinase (Boehringer) thereon to 0.5 mg/ml, incubated at 37° C. for 20 minutes. The mixture was extracted

with phenol and chloroform, and RNA was precipitated with ethanol. Next, the RNA precipitate was dissolved in 200  $\mu$ l of 10 mM Tris-HCl (pH 7.5) containing 1 mM EDTA.

##### 2. Synthesis of single stranded cDNA

To synthesize single stranded cDNA according to a procedure described by J. W. Larrick et al., *Biotechnology*, 7, 934 (1989), about 5  $\mu$ g of the total RNA prepared as described above was dissolved in 10  $\mu$ l of 50 mM Tris-HCl (pH 8.3) buffer solution containing 40 mM KCl, 6 mM MgCl<sub>2</sub>, 10 mM dithiothreitol, 0.5 mM dATP, 0.5 mM dGTP, 0.5 mM dCTP, 0.5 mM dTTP, 35  $\mu$ M oligo dT primer (Amersham), 48 units of RAV-2 reverse transcriptase (RAV-2: Rous associated virus 2; Amersham) and 25 units of human placenta ribonuclease inhibitor (Amersham), and the reaction mixture was incubated at 37° C. for 60 minutes and directly used for the subsequent polymerase chain reaction (PCR) method.

##### 3. Amplification of cDNA coding for antibody V region by PCR method

The PCR method was carried out using a Thermal Cycler Model PHC-2 (Techne).

##### (1) Amplification of cDNA coding for mouse $\kappa$ light ( $\kappa$ L) chain variable region

The primers used for the PCR method were MKV (Mouse Kappa Variable) primers represented in SEQ ID NO: 1 to 11, which hybridize with a mouse  $\kappa$  L chain leader sequence (S. T. Jones et al., *Biotechnology*, 9, 88, 1991), and an MKC (Mouse Kappa Constant) primer represented in SEQ ID NO: 12, which hybridizes with a mouse  $\kappa$  L chain C region (S. T. Jones et al., *Biotechnology*, 9, 88, 1991).

First, 100  $\mu$ l of a PCR solution comprising 10 mM Tris-HCl (pH 8.3), 50 mM KCl, 0.1 mM dATP, 0.1 mM dGTP, 0.1 mM dCTP, 0.1 mM dTTP, 1.5 mM MgCl<sub>2</sub>, 2.5 units of DNA polymerase Ampli Taq (Perkin Elmer Cetus), 0.25  $\mu$ M of each group of MKV primer, 3  $\mu$ M MKC primer and 1  $\mu$ l of the reaction mixture of the single-stranded cDNA synthesis was heated at an initial temperature of 94° C. for 1.5 minutes, and then at 94° C. for 1 minute, 50° C. for 1 minute and 72° C. for 1 minute, in this order. After this temperature cycle was repeated 25 times, the reaction mixture was further incubated at 72° C. for 10 minutes.

##### (2) Amplification of cDNA coding for mouse H chain V region

As primers for the PCR, MHV (Mouse Heavy Variable) primers 1 to 10 represented in SEQ ID NO: 13 to 22 (S. T. Jones et al., *Biotechnology*, 9, 88, 1991), and an MHC (Mouse Heavy Constant) primer represented in SEQ ID NO: 23 (S. T. Jones et al., *Biotechnology*, 9, 88, 1991) were used. Amplification was carried out according to the same procedure as described for the amplification of the  $\kappa$  L chain V region gene in section 3. (1).

##### 4. Purification and Digestion of PCR Product

The DNA fragments amplified by the PCR as described above were purified using a QIAGEN PCR product purification kit (QIAGEN Inc. US), and digested with 10 units of restriction enzyme Sal I (GIBCO BRL) in 100 mM Tris-HCl (pH 7.6) containing 10 mM MgCl<sub>2</sub> and 150 mM NaCl, at 37° C. for three hours. The digestion mixture was extracted with phenol and chloroform, and the DNA was recovered by ethanol precipitation. Next, the DNA precipitate was digested with 10 units of restriction enzyme Xma I (New England Biolabs), at 37° C. for two hours, and resulting DNA fragments were separated by agarose gel electrophoresis using low melting agarose (FMC Bio Products USA).

An agarose piece containing DNA fragments of about 450 bp in length was excised and melted at 65° C. for 5 minutes, and an equal volume of 20 mM Tris-HCl (pH 7.5) containing

2 mM EDTA and 200 mM NaCl was added thereon. The mixture was extracted with phenol and chloroform, and the DNA fragment was recovered by ethanol precipitation and dissolved in 10  $\mu$ l of 10 mM Tris-HCl (pH 7.5) containing 1 mM EDTA. In this manner, a DNA fragment comprising a gene coding for a mouse  $\kappa$  L chain V region, and a DNA fragment comprising a gene coding for a mouse H chain V region were obtained. Both of the above DNA fragments had a Sal I cohesive end at the 5'-end thereof and an Xma I cohesive end at the 3'-end thereof.

#### 5. Ligation and Transformation

About 0.3  $\mu$ g of the Sal I - Xma I DNA fragment comprising a gene coding for a mouse  $\kappa$  L chain V region, prepared as described above, was ligated with about 0.1  $\mu$ g of a pUC19 vector prepared by digesting plasmid pUC19 by Sal I and Xma I, in a reaction mixture comprising 50 mM Tris-HCl (pH 7.4), 10 mM MgCl<sub>2</sub>, 10 mM dithiothreitol, 1 mM spermidine, 1 mM dATP, 0.1  $\mu$ g/ml of bovine serum albumin and 2 units of T4 DNA ligase (New England Biolabs), at 16° C. for 16 hours.

Next, 7  $\mu$ l of the above ligation mixture was added to 200  $\mu$ l of competent cells of *E. coli* DH5 $\alpha$ , and the cells were incubated for 30 minutes on ice, for one minute at 42° C., and again for one minute on ice. After adding 800  $\mu$ l of SOC medium (*Molecular Cloning: A Laboratory Manual*, Sambrook et al., Cold Spring Harbor Laboratory Press, 1989), the cell suspension was incubated at 37° C. for one hour, and inoculated onto an 2 $\times$ YT agar plate (*Molecular Cloning: A Laboratory Manual*, Sambrook et al., Cold Spring Harbor Laboratory Press, 1989), which was then incubated at 37° C. overnight to obtain an *E. coli* transformant. The transformant was cultured in 5 ml of 2 $\times$ YT medium containing 50  $\mu$ g/ml ampicillin, at 37° C. overnight, and a plasmid DNA was prepared from the culture according to an alkaline method (*Molecular Cloning: A Laboratory Manual*, Sambrook et al., Cold Spring Harbor Laboratory Press, 1989). The thus-obtained plasmid containing a gene coding for a mouse  $\kappa$  L chain V region derived from the hybridoma AUK12-20, was designated p12-k2.

According to the same procedure as described above, a plasmid containing a gene coding for a mouse H chain V region derived from the hybridoma AUK12-20 was constructed from the Sal I - Xma I DNA fragment, and designated p12-h2.

#### Example 2

Cloning of DNA coding for V region of mouse monoclonal antibody (2)

Substantially the same procedure as described in Example 1 was applied to the hybridoma PM1, AUK64-7, and AUK146-15, to obtain the following plasmids:

- a plasmid pPM-k3 containing a gene coding for a  $\kappa$  L chain V region derived from the hybridoma PM1;
- a plasmid pPM-h1 containing a gene coding for an H chain V region derived from the hybridoma PM1;
- a plasmid p64-k4 containing a gene coding for a  $\kappa$  L chain V region derived from the hybridoma AUK64-7;
- a plasmid p64-h2 containing a gene coding for an H chain V region derived from the hybridoma AUK64-7;
- a plasmid p146-k3 containing a gene coding for a  $\kappa$  L chain V region derived from the hybridoma AUK146-15; and
- a plasmid p146-h1 containing a gene coding for an H chain V region derived from the hybridoma AUK146-15.

Note *E. coli* strains containing the above-mentioned plasmid were deposited with the National Collections of Indus-

trial and Marine Bacteria Limited under the Budapest Treaty on Feb. 11, 1991, and were given the accession number shown in Table 8.

TABLE 8

Plasmid	SEQ ID NO	Accession No.
p12 - k2	24	NCIMB 40367
p12 - h2	25	NCIMB 40363
pPM - k3	26	NCIMB 40366
pPM - h1	27	NCIMB 40362
p64 - k4	28	NCIMB 40368
p64 - h2	29	NCIMB 40364
p146 - k3	30	NCIMB 40369
p146 - h1	31	NCIMB 40365

#### Example 3

Sequencing of DNA

Nucleotide sequences of a cDNA coding region in the above-mentioned plasmids were determined using a kit, Sequenase™ Version 2.0 (U.S. Biochemical Corp. USA).

First, about 3  $\mu$ g of plasmid DNA obtained as described above was denatured with 0.2N NaOH, annealed with a sequencing primer, and labeled with <sup>35</sup>S-dATP according to a protocol of the supplier. Next, the labeled DNA was applied to 6% polyacrylamide gel containing 8M urea, and, after electrophoresis, the gel was fixed with 10% methanol and 10% acetic acid, dried, and subjected to autoradiography to determine the nucleotide sequence.

The nucleotide sequence of cDNA coding region in each plasmid is shown in SEQ ID NOs 24 to 31.

#### Example 4

Determination of CDRs

General structures of L chain and H chain V regions are similar each other, wherein 4 frame works (FRs) are linked through 3 super variable regions, i.e., complementarity determining regions (CDRs). While amino acid sequences in the FRs are relatively well conserved, amino acid sequences in CDRs are very highly variable (Kabat, E. A. et al., "Sequences of Proteins of Immunological Interest", U.S. Dept. Health and Human Services 1983).

On the basis of the above-determined amino acid sequences of V regions of mouse monoclonal antibodies to human IL-6R, and according to Kabat, E. A. et al., "Sequences of Proteins of Immunological Interest", US Dept. Health and Human Services 1983, CDRs of each V region of mouse monoclonal antibodies to the human IL-6R were determined as shown in Table 9.

TABLE 9

plasmid	SEQ ID NO	CDR(1) (Amino acid No.)	CDR(2) (Amino acid No.)	CDR(3) (Amino acid No.)
p12-K2	24	24-38	54-60	93-101
p12-h2	25	31-35	50-66	99-105
pPM-k3	26	24-34	50-56	89-97
pPM-h1	27	31-36	51-66	99-108
p64-k4	28	24-38	54-60	93-101
p64-h2	29	31-35	50-66	99-109
p146-k3	30	24-34	50-56	89-97
p146-h1	31	31-35	50-66	99-106

#### Example 5

Confirmation of expression of cloned cDNA(1)  
(Construction of Chimeric AUK12-20 antibody)

Construction of Expression Plasmid

A chimeric L chain/H chain was constructed from PCR-cloned cDNAs coding for V regions  $\kappa$  L chain and H chain

of AUK12-20. In order to easily join a cDNA coding for the mouse AUK12-20 V region to a DNA coding for a human C region in a mammalian expression vector containing an enhancer and promoter of human cytomegalovirus (HCMV) expression vector, it is necessary to introduce convenient restriction enzyme cleavage sites to the 5'- and 3'- termini of the mouse cDNA.

This modification of the 5'- and 3'- termini was carried out by PCR method. Two sets of primers were designed and synthesized. An L chain V region backward primer (SEQ ID NO: 32) and H chain V region backward primer (SEQ ID NO: 33) were designed so that the primers hybridize with a DNA coding for the beginning of the leader sequence, maintain a DNA sequence essential for efficient translation (Kozak, M., *J. Mol. Biol.* 196: 947-950, 1987) and form a HindIII site for cloning into the HCMV expression vector. An L chain V region forward primer (SEQ ID NO: 34) and an H chain V region forward primer (SEQ ID NO: 35) were designed so that the primers hybridize with a DNA coding for the terminal portion of the J region, maintain a DNA sequence essential for splicing into the C region and form a Bam HI site for joining to the human C region in the HCMV expression vector.

Following the amplification by the PCR, the PCR product was digested with Hind III and BamHI, cloned into the HCMV vector containing the human  $\kappa$  and  $\gamma$  chain C regions DNA and sequenced to confirm that errors were not introduced during the PCR amplification. The resulting expression vectors are designated as HCMV-12k-gk and HCMV-12h-gyl.

The structures of the HCMV expression plasmids are shown in FIG. 1. In the plasmid HCMV-V<sub>L</sub>-HC<sub>K</sub>, V<sub>L</sub> region may be any mouse L chain V region. In this example, AUK12-20  $\kappa$ L chain V region was inserted to obtain the HCMV-12k. In the plasmid HCMV-V<sub>H</sub>-HC<sub>Y</sub>, V<sub>H</sub> region may be any mouse H chain V region. In this example, AUK12-20 H chain V region was inserted to obtain HCMV-12h-gyl.

#### Transient expression in COS cells

To observe transient expression of a chimeric AUK12-20 antibody in COS cells, the expression vectors constructed as described above were tested in the COS cells. The vector DNAs were introduced into COS cells by electroporation using a Gene Pulsar apparatus (Bio Rad). Namely, COS cells were suspended in phosphate-buffered saline (PBS) to a cell concentration of  $1 \times 10^7$  cells/ml, and to 0.8 ml aliquot of the suspension was added 10  $\mu$ g (per each plasmid) of DNA. Pulses were applied at 1,900 V and 25  $\mu$ F.

After recovery period of 10 minutes at a room temperature, the electroporated cells were added to 8 ml of DMEM (GIBCO) containing 10% fetal bovine serum. After incubation for 72 hours, a culture supernatant is collected, centrifuged to eliminate cell debris, and aseptically stored for a short period at 4° C. or for a long period at -20° C.

#### Quantification of chimeric antibody by ELISA

A culture supernatant of the transfected COS cells was assayed by ELISA to confirm the production of chimeric antibody. To detect the chimeric antibody, a plate was coated with goat anti-human IgG whole molecule (Sigma). The plate was blocked, and serially diluted supernatant from the COS cell culture was added to each well. After incubation and washing, alkaline phosphatase-linked goat anti-human IgG ( $\gamma$ -chain specific, Sigma) was added to each well. After incubation and washing, substrate buffer was added thereon. The reaction mixture was incubated, and after termination of the reaction, optical density at 405 nm was measured. As a standard, purified human IgG (Sigma) was used.

ELISA for confirmation of an ability to bind to human IL-6R

A culture supernatant of the transformed COS cells was assayed by ELISA to determine whether the produced antibody can bind to the antigen. To detect the binding to the antigen, a plate was coated with MT18 mouse monoclonal antibody (Reference Example 1), and after blocking with 1% bovine serum albumin (BSA) soluble recombinant human IL-6R (SR 344) was added thereon. After washing, a serially diluted culture supernatant from the COS cells was added to each well. After incubation and washing alkaline phosphatase-linked goat anti-human IgG was added. The reaction mixture was incubated, and after washing a substrate buffer was added. After incubation, the reaction was terminated, and optical density at 405 nm was measured.

A result is shown in FIG. 2. Transfection of gene coding for a chimeric antibody AUK12-20 into COS cells was twice repeated. Both the culture supernatant samples exhibited a strong binding to IL-6R, and optical density at 405 nm was changed in a sample dilution (monoclonal antibody concentration)—dependent manner as shown in FIG. 2 by open circles and closed circles revealing the presence of an antibody to IL-6R in the sample.

Determination of an ability to inhibit the binding to IL-6R with IL-6

To determine whether an antibody present in a medium inhibits the binding of IL-6R with IL-6, a plate was coated with MT18 monoclonal antibody (Reference Example 1). After blocking, soluble recombinant human IL-6R (SR 344) was added thereon. After washing, serially diluted sample from COS cell culture was added to each well with biotinylated IL-6.

After washing, alkaline phosphatase-linked streptavidin was added, and after incubation and washing, a substrate buffer was added. The reaction mixture was incubated, and after termination of the reaction, optical density at 405 nm was measured, purified mouse AUK12-20 monoclonal antibody was added as a positive control, and a culture medium from COS cells expressing a non-related antibody was used as a negative control.

A result is shown in FIG. 3. A culture supernatant of COS cells transfected with genes coding for chimeric antibody AUK 12-20 exhibited the binding of IL-6R with IL-6 at the highest and second highest concentrations. Namely, as shown by closed circles in FIG. 3, optical density at 405 nm changed in a sample dilution (antibody concentration) dependent manner, revealing the inhibition of the binding to IL-6R with IL-6 by an antibody in the sample. This is further confirmed by substantive conformity with antibody concentration dependent change of the positive control (open circles). Note, the negative control did not exhibit inhibition activity (open triangles).

#### Example 6

Confirmation of expression of cloned cDNA (2)  
(Construction of chimeric PM-1 antibody)  
(Construction of expression vectors)

In order to construct vectors expressing chimeric PM-1 antibody, the cDNA clones pPM-k3 and pPM-h1, coding for the mouse PM-1  $\kappa$ L chain and the H chain V regions, respectively, were modified by a PCR technique, and then introduced into the HCMV expression vectors (see FIG. 1). The backward primers pmk-s (SEQ NO: 38) for L chain V region and pmh-s (SEQ NO: 40) for H chain V region were designed to hybridize to the DNA sequences coding for the beginning of the leader sequences, and to have Kozak consensus sequence and a HindIII restriction site. The forward primers pmk-a (SEQ No: 36) for L chain V region

and pmh-a (SEQ No: 39) for H chain V region were designed to hybridize to the DNA sequences coding for the ends of the J regions, and to have a splice donor sequence and a BamHI restriction site.

For the kappa L chain V region, two forward primers were synthesized. Although in most kappa L chains lysine at position 107 is conserved, in mouse PM-1 kappa L chain position 107 is an asparagine. In order to investigate the effect of this change on the antigen-binding activity of the chimeric PM-1 antibody, the forward primer pmk-b (SEQ NO: 37) was designed to mutate position 107 from an asparagine to a lysine. Following the PCR reaction, the PCR products were purified, digested with HindIII and BamHI, and subcloned into a pUC19 vector (Yanische-Perron et al., *Gene* (1985) 33:103-109). After DNA sequencing, the HindIII-BamHI fragments were excised and cloned into the expression vector HCMV-V<sub>H</sub>-HC<sub>γ1</sub> to obtain HCMV-pmh-gyl for the chimeric H chain, and into the expression vector HCMV-V<sub>L</sub>-HC<sub>κ</sub> to obtain HCMV-pmka-gk and HCMV-pmkb-gk for the chimeric L chain.

#### Transfection of cos cells

The vectors were tested in cos cells to look for transient expression of chimeric human PM-1 antibodies. The HCMV-pmh-gyl, and either HCMV-pmka-gk or HCMV-pmkb-gk were co-transfected into the cos cells by electroporation using the Gene Pulsar apparatus (BioRad). DNA (10 μg of each plasmid) was added to a 0.8 ml aliquot of 1×10<sup>7</sup> cells/ml in PBS. A pulse was delivered at 1,900 volts, 25 microfarads capacitance. After a 10 min recovery period at a room temperature, the electroporated cells were added to 20 ml of Dulbecco's Modified Eagle Medium (DMEM) (GIBCO) containing 10% gamma-globulin-free fetal calf serum. After 72 h incubation, the medium was collected, centrifuged to remove cellular debris, and stored under sterile conditions at 4° C. for short periods of time, or at -20° C. for longer periods.

#### Expression and analysis of the chimeric PM-1 antibodies

After 3 days of transient expression, medium from the cos cells was collected and tested for chimeric PM-1 antibody. The medium was first analyzed by ELISA to determine if human-like antibody was being produced by the transfected cos cells. By using known amounts of purified human IgG as a standard in this assay, it is also possible to estimate an amount of human-like antibody (in this case, chimeric PM-1 antibody) present in the medium from the cos cells. For the detection of human antibody, plates were coated with goat anti-human IgG (whole molecule, Sigma). Following blocking, the samples from cos cells were serially diluted and added to each well. After incubation and washing, alkaline phosphatase-conjugated goat anti-human IgG (gamma chain specific, Sigma) was added. After incubation and washing, substrate buffer was added. After incubation, the reaction was stopped and the optical density at 405 nm measured. Purified human IgG (Sigma) was used as a standard.

The medium from the cos cells transfected with the vectors carrying the chimeric PM-1 genes was positive for the expression of a human-like antibody and the approximate amounts were quantified as described.

Next, the same medium from the cos cells transfected with the vectors carrying the chimeric PM-1 genes was assayed for an ability to bind to human IL-6R. For the detection of binding to the antigen, plates were coated with MT18 mouse monoclonal antibody (Reference Example 1), an antibody to the human IL-6R. Following blocking, soluble recombinant human IL-6R (SR344) was added. After washing, the samples were serially diluted and added

to each well. After incubation and washing, alkaline phosphatase-conjugated goat anti-human IgG (gamma chain specific sigma) was added. After incubation and washing, substrate buffer was added. After incubation, the reaction was stopped and the optical density at 405 nm measured. There was no standard available for this assay.

Two samples were from transfection with genes coding for a chimeric antibody with V regions identical to those found in mouse PM-1 antibody (chimeric PM-1a antibody, FIG. 4). One sample was from transfection with genes coding for a chimeric antibody with a single amino acid change at position 107 in the L chain V region as described above (chimeric PM-1b antibody, FIG. 4). All samples showed strong binding to IL-6R that decreased with dilution of the sample. Thus, the chimeric PM-1 antibody, as constructed, is functional and can bind well to its antigen. Most importantly, the demonstration of a functional chimeric PM-1 is direct evidence that the correct mouse PM-1 V regions have been cloned and sequenced. The chimeric PM-1 antibody, with either amino acid at position 107 in the L chain V region, bound well to its antigen, IL-6R. It appears that position 107 in the mouse PM-1 L chain V region is not very critical in antigen-binding and that either an asparagine or a lysine at this position will function satisfactorily. Since the mouse PM-1 antibody has an asparagine at this position in its L chain V region, all future work with chimeric PM-1 antibody was done with version a, the version that has V regions identical to those found in mouse PM-1 antibody.

In order to stably produce larger amounts of chimeric PM-1 antibody, a new HCMV expression vector incorporating the dhfr gene was constructed. The first step in achieving higher levels of expression of the chimeric PM-1 antibody was to modify the vector HCMV-V<sub>H</sub>-HC<sub>γ1</sub> (FIG. 1) so that this vector contained a dhfr gene being expressed by a "crippled" SV40 promoter-enhancer. The SV40 enhancer elements were deleted from the pSV2-dhfr vector (S. Subramani et al., *Mol. Cell. Biol.* (1981) 1:854-864) and the dhfr gene being expressed by the "crippled" SV40 promoter was inserted into the HCMV-V<sub>H</sub>-HC<sub>γ1</sub> vector in place of the neo gene being expressed by the SV40 promoter-enhancer. The mouse PM-1 V region was then inserted into this new HCMV-V<sub>H</sub>-HC<sub>γ1</sub>-dhfr vector. Construction of the improved expression vector is described in Example 10 in detail.

CHO dhfr(-) cells (G. Urlaub et al., *Proc. Natl. Acad. Sci. USA* (1980) 77:4216-4220) were co-transfected with two plasmid DNAs, the HCMV-V<sub>L</sub>-HC<sub>κ</sub> vector for expressing chimeric PM-1a L chain (HCMV-pmka-gk) and the HCMV-V<sub>H</sub>-HC<sub>γ1</sub>-dhfr vector for expressing chimeric PM-1 H chain (DHFR-ΔE PMh-gyl; Example 10). DNA (10 μg/ml of each plasmid) was added to a 0.8 ml aliquot of 1×10<sup>7</sup> cells/ml in PBS. A pulse was delivered at 1900 volts, 25 microfarads capacitance. After a 10 min recovery period at a room temperature, the electroporated cells were added to 10 ml of Alpha minimum essential medium (α-MEM) containing nucleosides and 10% FCS. After overnight incubation, the medium was changed to α-MEM without nucleosides and with 10% FCS and 500 μg/ml of G418 (GIBCO) for the selection of dhfr<sup>+</sup> and neo<sup>+</sup> transformed cells. After selection, the selected clones were used for gene amplification. After one round of amplification in 2×10<sup>-8</sup> M methotrexate (MTX), a cell line (PM1k3-7) was selected that produced approximately 3.9 μg/10<sup>6</sup> cells/day of chimeric PM-1a antibody.

ELISA assay for the ability of chimeric antibodies to inhibit IL-6 from binding to human IL-6R.

Antibodies produced in transfected cos cells or in stable CHO cell lines were assayed to determine whether the



antibodies could compete with biotinylated IL-6 for binding to IL-6R. Plates were coated with MT18 mouse monoclonal antibody. Following blocking, soluble recombinant human IL-6R (SR344) was added. After washing, the samples from the cos cells were serially diluted and added together with biotinylated IL-6 to each well. After washing, alkaline phosphatase-conjugated streptavidin was added. After incubation and washing, substrate buffer was added. After incubation, the reaction was stopped and the optical density at 405 nm measured. The Results are shown in FIG. 5.

#### Example 7

##### Construction of reshaped human PM-1 antibodies

In order to achieve CDR-grafting more rapidly and efficiently, a method for sequential CDR-grafting by PCR was developed. This method is based on PCR-mutagenesis methods (Kamman et al., 1989).

In order to prepare the template DNAs containing the selected human FRs for CDR-grafting, it was necessary to reclone suitable reshaped human V regions into convenient vectors. Plasmid DNAs alysl1 and F10 code for reshaped human D1.3 L and H chains and contain the FRs from human REI and NEW, respectively. An approximately 500 bp NcoI-BamHI fragment containing DNA sequence coding for the reshaped human D1.3 L chain V region was excised from alysl1 and subcloned into HindIII-BamHI cleaved-pBR327 to obtain a vector V1-lys-pBR327. HindIII-BamHI fragment from the V1-lys-pBR327 was inserted into HindIII-BamHI cleaved pUC19 to obtain a vector V1-lys-pUC19. An approximately 700 bp NcoI-BamHI fragment containing DNA sequence coding for the reshaped human D1.3 H chain V region was excised from F10 and subcloned into the HindIII-BamHI site of pBR327 vector, using a HindIII-NcoI adaptor, yielding Vh-lys-pBR327. A HindIII-BamHI fragment was then excised from this vector and subcloned into HindIII-BamHI cleaved pUC19 vector yielding Vh-lys-pUC19.

Note the construction of the plasmid alysl1 and the DNA sequence coding for the reshaped human D1.3 L chain V region used in a template is described. The DNA sequence coding for the reshaped human D1.3 H chain V region in the plasmid F10 used as a template is described in V. Verhoey et al., *Science* 237:1534-1536 (1988) FIG. 2.

FIG. 6 diagrams the primers and the PCR reactions used in the construction of the first version of reshaped human PM-1 H chain V region. A backward primer A (APCR1; SEQ NO: 41) and a forward primer E (APCR4; SEQ NO: 42) hybridize to DNA sequences on the vector. Although APCR1 and APCR4 were specifically designed for pUC19 vector, universal M13 sequence primers could be used.

The CDR1-grafting/mutagenic primer B (phv-1; SEQ NO: 43), CDR2-grafting primer C (phv-2; SEQ NO: 44) and CDR3-grafting primer D (phv-3; SEQ NO: 45) were 40-60 bp in length, consisting of DNA sequences coding for CDRs from the mouse PM-1 H chain V region and the human FRs in the template DNA that flank the CDR regions. In the first PCR reaction, the forward primer APCR4 and the backward primer D were used. The first PCR product, which contains the mouse PM-1 CDR3 sequence, was purified and used in the second PCR reaction as a forward primer with primer C as the backward primer. In the same manner, the second and third PCR products, which contain mouse PM-1 CDR2 and CDR3, and all three mouse PM-1 CDRs, respectively, were used as primers in the following PCR step. The fourth PCR product, which has the complete reshaped human PM-1 H chain V region, was purified, digested with HindIII and BamHI, and subcloned into a pUC19 vector for further analysis.

Three mutagenic primers phv-1, phv-2, and phv-3 were synthesized for the construction of reshaped human PM-1 H chain V region. They were purified on 12% polyacrylamide gels containing 8M urea. The mutagenic primer phv-1 was designed not only for mouse PM-1 CDR1-grafting but also for mutations at positions 27 and 30 in human FR1. Ser to Tyr and Ser to Thr, respectively. Each 100  $\mu$ l PCR reaction typically contained 10 mM Tris-HCl (pH 8.3), 50 mM KCl, 1.5 mM MgCl<sub>2</sub>, 250  $\mu$ M dNTPs, 50 ng of the template DNA (Vh-lys-pUC19), 2.5  $\mu$ l of AmpliTaq (Perkin Elmer Cetus) and the primers. The first PCR reaction containing 1  $\mu$ M of each of the phv-3 and APCR4 primers was carried out, after an initial denaturation at 94° C. for 1.5 min, for 30 cycles of 94° C. for 1 min, 37° C. for 1 min and 72° C. for 1 min were repeated. The ramp time between the annealing and synthesis steps was set for 2.5 min. The completion of the last cycle was followed by a final extension at 72° C. for 10 min. A 523 bp PCR product was purified using a 1.6% low melting temperature agarose gel and then used as a primer in the second PCR reaction.

In the second PCR reaction approximately 1  $\mu$ g of the purified first PCR product and 25 pmoles of the mutagenic primer phv-2 were used as primers. The PCR conditions were the same as described for the first PCR reaction. In the same manner, a 665 bp PCR product from the second PCR reaction and a 737 bp PCR product from the third reaction were used as primers in the third PCR reaction with the primer phv-1, and in the fourth PCR reaction with the primer APCR1, respectively. A 1.172 kb PCR product from the fourth PCR reaction was purified, digested with HindIII and BamHI, and then an approximately 700 bp fragment containing the reshaped human PM-1 H chain V region was subcloned into a pUC19 vector. Two of four clones sequenced had the DNA sequence coding for the correct amino acid sequence and were designated pUC-RVh-PM1a.

In order to construct other versions of reshaped PM-1 H chain V region, five mutagenic PCR primers were synthesized. Each PCR reaction was essentially carried out under the same condition as described above. For version "b", mutagenic primer phv-m4 (Val-71 to Arg-71; the number is according to Kabat et al; see Table 3) (SEQ ID NO: 46) and APCR4 were used in the first PCR reaction with template DNA, pUC-RVh-PM1a. The PCR product from this first PCR reaction was purified and was used as a forward primer in the second PCR reaction with the primer APCR1. The PCR product from the second PCR reaction was purified using a 1.6% low melting temperature agarose gel, digested with HindIII and BamHI, and subcloned into a pUC19 vector yielding pUC-RVh-PM1b. In the same manner, version "c" (pUC-RVh-PM1c) was obtained using a mutagenic primer phv-nm (Asp-1 to Gln-1) (SEQ ID NO: 47) and a template pUC-RVh-PM1b; version "d" (pUC-RVh-PM1d) was obtained using a mutagenic primer phv-m6 (Ile-48 to Met-48) (SEQ ID NO: 48) and a template pUC-RVh-PM1b; version "e" (pUC-RVh-PM1e) was obtained using the mutagenic primer phv-m6 and a template pUC-RVh-PM1c; and "version f" (pUC-RVh-PM1f) was obtained using a mutagenic primer phv-m7 (Thr-28 to Ser-28, and Phe-29 to Ile-29) (SEQ ID NO: 49) and a template pUC-RVh-PM1b. Amino acid sequence of the version "f" of the reshaped human H chain V region, and a nucleotide sequence codin therefor is shown in SEQ ID NO: 54.

FIG. 7 diagrams the primers and the PCR reactions used in the construction of the first version of reshaped human PM-1 L chain V region. For the construction of the first version of reshaped human PM-1 L chain V region, CDR1-grafting primer pkv-1 (SEQ ID NO: 50), CDR2-grafting

primer pkv-2 (SEQ ID NO: 51) and CDR3-grafting primer pkv-3 (SEQ ID NO: 52) were synthesized and purified on a 12% polyacrylamide gel containing 8M urea. PCR reactions were carried out as described above. The first PCR reaction contained 1  $\mu$ M of each of the pkv-3 and APCR4 primers. A 350 bp PCR product from the first PCR reaction was purified using a 1.5% low melting temperature agarose gel and used as a forward primer in the second PCR reaction. The PCR product from the second PCR reaction was purified, digested with BamHI and HindIII, and the 500 bp fragment containing the CDR3-grafted DNA was subcloned into a pUC19 vector for DNA sequencing. A plasmid DNA having the correct sequence was identified and used as the template DNA in the following PCR reaction. In the third PCR reaction, 25 pmoles of mutagenic primers pkv-2 and APCR4 were used. The PCR product from the third PCR reaction was purified and used as a primer, with the primer pkv-1, in the fourth PCR reaction. In the same manner, the PCR product from the fourth PCR reaction was used as a primer, with the APCR1 primer, in the fifth PCR reaction.

A 972 bp PCR product from the fifth PCR reaction was purified, digested with BamHI and HindIII, and subcloned into a pUC19 vector for DNA sequencing. A problem was identified in the CDR2 region. Two additional PCR reactions were necessary. In the sixth and seventh PCR reactions, the PCR product from the fifth PCR reaction, as cloned into pUC19 vector, was used as template DNA. In the sixth PCR reaction, the primers were pkv-2 and APCR4. The PCR product from the sixth PCR reaction was purified and used as a primer, with the APCR1 primer, in the seventh PCR reaction. The PCR product of the seventh PCR reaction was purified, digested with BamHI and HindIII, and a 500 bp DNA fragment was subcloned into a pUC19 vector for DNA sequencing. Two of five clones sequenced had the correct DNA sequence. The clone was designated pUC-RV1-PM1a. The sequence is shown in SEQ ID NO: 55.

For the construction of the other version of reshaped human PM-1 L chain V region, a mutagenic primer pvk-m1 (SEQ ID NO: 53) was synthesized. The PCR reactions were essentially as described above. In the first PCR reaction, the mutagenic primer pkv-m1 (Phe-71 to Tyr-71) and the APCR4 primer were used with the template DNA pUC-RV1-PM1a. The PCR product of the first PCR reaction was purified and used as a primer, with the APCR1 primer, in the second PCR reaction. The PCR product of the second PCR reaction was purified, digested with BamHI and HindIII, and subcloned into a pUC19 vector for DNA sequencing. The clone was designated pUC-RV1-PM1b.

#### Example 8

Construction of vectors that employ the human cytomegalovirus immediate early (HCMV) promoter to express genetically-engineered antibodies in mammalian cells (FIG. 1).

The DNA fragments coding for the chimeric PM-1 L and H chain V regions were initially inserted into HCMV vectors (HCMV-V<sub>L</sub>-HC<sub>x</sub> and HCMV-V<sub>H</sub>-HC<sub>y</sub>) designed to express either human kappa L chains or human gamma-1 H chains in mammalian cells (see FIG. 1). A detailed description of the construction of the HCMV expression vectors is published in Maeda et al., *Human Antibodies and Hybridomas* (1991) 2:124-134; C. A. Kettleborough et al., *Protein Engineering* (1991) 4:773-783. Both vectors are based on pSV2neo (P. J. Southern et al., *J. Mol. Appl. Genet.* (1982) 1:327-341) and contain the human cytomegalovirus (HCMV) promoter and enhancer (M. Boshart et al., *Cell* (1985) 41:521-530) for high level transcription of the immunoglobulin L and H chains. The L chain expression

vector contains genomic DNA coding for the human kappa C region (T. H. Rabbitts et al., *Curr. Top. Microbiol. Immunol.* (1984) 113:166-171) and the H chain expression vector contains genomic DNA coding for the human gamma-1 C region (N. Takahashi et al. *Cell* (1982) 29:671-679). The HCMV expression vectors are versatile and can be used for both transient and stable expression in a variety of mammalian cell types.

#### Example 9

Construction of vectors that employ the human elongation factor 1 $\alpha$  (HEF-1 $\alpha$ ) promoter to express genetically-engineered antibodies in mammalian cells (FIG. 8 and FIG. 9)

The human polypeptide chain elongation factor 1 $\alpha$  (HEF-1 $\alpha$ ) is one of the most abundant proteins. It is expressed in most cells. The transcriptional activity of the human EF-1 $\alpha$  promoter-enhancer is about 100-fold stronger than that of the SV40 early promoter-enhancer (D. W. Kim et al., *Gene* (1990) 91:217-223, and T. Uetsuki et al., *J. Biol. Chem.* (1989) 264:5791-5798). The 2.5 kb HEF-1 $\alpha$  promoter-enhancer region consists of approximately 1.5 kb of DNA flanking the 5'-end of the gene, 33 bp in the first exon, 943 bp in the first intron, and 10 bp of the first part of the 2nd exon. The approximately 2.5 kb HindIII-EcoRI fragment was excised from plasmid DNA pEF321-CAT (D. W. Kim et al., *Gene* (1990) 91:217-223, and T. Uetsuki et al., *J. Biol. Chem.* (1989) 264:5791-5798) and cloned into pDKCR vector DNA (M. Tsuchiya et al., *EMBO J.* (1987) 6:611-616) (K. O'Hare et al., *Proc. Natl. Acad. Sci USA* Vol. 78, No. 3, 1527-1531, 1981) to replace an approximately 300 bp HindIII-EcoRI fragment containing the SV40 early promoter-enhancer sequence thus yielding pTEF-1. pTEF-1 was digested with EcoRI, filled-in with the Klenow polymerase, and ligated to HindIII linkers. An approximately 1.6 kb HindIII-SmaI fragment was then excised from the modified pTEF-1 vector DNA.

Plasmid DNA HCMV-12h-gy1 ( $\Delta$ E2) was constructed from the HCMV-12h-gy1 constructed in Example 5 by partially digesting HCMV-12h-gy1 with EcoRI, filling-in with klenow polymerase, and self-ligating.

The plasmid HCMV-12h-gy1 ( $\Delta$ E2) was digested with EcoRI, filled-in with Klenow polymerase, and digested with HindIII. The resulting approximately 7 kb fragment containing the DNA sequence coding for human gamma-1 C region was ligated to the above-prepared 1.6 kb HindIII-SmaI fragment containing the HEF-1 $\alpha$  promoter-enhancer yielding HEF-12h-gy1. The HEF-1 $\alpha$  promoter-enhancer region in this vector was the same as that in pTEF-1 except for 380 bp of DNA flanking the 5'-region. The H chain V region, present as a HindIII-BamHI fragment, was easily interchangeable with other H chain V regions.

HindIII-BamHI DNA fragments containing the reshaped H chain V region were excised from the pUC-RVh-PM1a, pUC-RVh-PM1b, pUC-RVh-PM1c, pUC-RVh-PM1d, pUC-RVh-PM1e, and pUC-RVh-PM1f (Example 7), and inserted into the HindIII-BamHI portion of the HEF-12h-gy1 to obtain expression vectors RVh-PM1a, RVh-PM1b, RVh-PM1c, RVh-PM1d, RVh-PM1e and RVh-PM1f, respectively. The expression vectors RVh-PM1a, RVh-PM1b, RVh-PM1c, RVh-PM1d, RVh-PM1e and RVh-PM1f, as well as HEF-PMh-gy1 have the reshaped human PM-1 H chain V regions versions "a", "b", "c", "d", "e" and "f", as well as the mouse PM-1 H chain V region, respectively.

To construct the L chain expression vector, HEF-12k-gk, an approximately 3.0 kb PvuI-HindIII fragment containing the HEF-1 $\alpha$  promoter-enhancer region was excised from the HEF-12h-gy1 and ligated to an approximately 7.7 kb PvuI-

35

HindIII fragment from the HCMV L chain expression vector HCMV-12k-gk constructed in Example 5 to obtain HEF-12k-gk. As for the H chain expression vector HEF-12h-gyl, the L chain V region in HEF-12k-gk, present as a HindIII-BamHI fragment, is easily interchangeable with other L chain V regions.

HindIII-BamHI DNA fragments containing the reshaped human L chain V region were excised from the pUC-RV1-PM1a and pUC-RV1-PM1b (Example 7), and inserted into the HindIII-BamHI portion of the HEF-12k-gk to obtain expression vectors RV1-PM1a and RV1-PM1b, respectively. The expression vectors RV1-PM1a, RV1-PM1b, and HEF-PMk-gk have the reshaped human L chain V regions "a", "b", and the mouse PM-1 L chain V region, respectively.

#### Example 10

Construction of vectors that employ the dihydrofolate reductase (dhfr) gene linked to a defective SV40 promoter-enhancer sequence to achieve high levels of expression of genetically-engineered antibodies in CHO cells (FIG. 10 and FIG. 11).

In order to remove the enhancer sequence from the SV40 early promoter, the plasmid DNA pSV2-dhfr (S.Subramani et al., Mol. Cell. Biol. (1981) 1: 854-864) (ATCC 33694) was digested with SphI and PvuII, filled-in with Klenow polymerase, and self-ligated to yield pSV2-dhfr-ΔE (see FIG. 10). An approximately 3.7 kb EcoRI fragment containing the HCMV promoter, the H chain V region, and the human gamma-1 C region was excised from HCMV-PMh-gyl by partially digesting with EcoRI. This fragment was ligated to EcoRI-digested pSV2-dhfr-ΔE to yield DHFR-ΔE-PMh-gyl.

A similar vector was constructed based on the H chain expression vector that employs the HEF-1α promoter-enhancer (see FIG. 11). An approximately 3.7 kb EcoRI fragment derived from HCMV-12h-gyl was ligated with EcoRI-digested pSV2-dhfr-ΔE to yield DHFR-ΔE-12h-gyl. The BamHI site following the dhfr cDNA sequence in DHFR-ΔE-12h-gyl was removed by partially digesting with BamHI, filling-in with Klenow polymerase, and self-ligating. An approximately 4 kb PvuI-BamHI fragment containing the dhfr cDNA was excised from the modified DHFR-ΔE-12h-gyl DNA and ligated to an approximately 3 kb PvuI-BamHI fragment from RVh-PM1f-4 (constructed in Example 12) to yield DHFR-ΔE-RVh-PM1f.

The improved expression plasmids as prepared above can be used for the production of the reshaped human PH-1 antibodies of the present invention.

#### Example 11

Expression and analysis of different versions of reshaped human PM-1 antibody

The HEF-1α vectors expressing reshaped human PM-1 L and H chains were co-transfected into cos cells. As a standard control, HEF-1α vectors expressing chimeric PM-1 L and H chains were also co-transfected into cos cells. After 3 days the medium from the transfected cos cells was collected and analyzed by ELISA (1) for the amount of human IgG antibody present in the supernatant and (2) for the ability of that human IgG to bind to IL-6R. Later the same samples were also tested by ELISA for the ability of the antibody to inhibit human IL-6 from binding to human IL-6R.

Evaluation of the two versions of reshaped human PM-1 L chain V regions were conducted by co-transfecting cos cells with one of the two vectors expressing reshaped human PM-1 L chains (RV1-PM1a or RV1-PM1b) and the vector expressing chimeric PM-1 H chain (HCMV-PMh-gyl).

36

Cells were also co-transfected with vectors expressing chimeric PM-1 L and H chains (HCMV-PMka-gk and HCMV-PMh-gyl). Data using unpurified cos cell supernatants showed that version "a" of reshaped human PM-1 L chain was equivalent to chimeric PM-1 L chain in assays for binding to IL-6R. Version "b" of reshaped human PM-1 L chain, however, virtually abolished binding to IL-6R (FIG. 12). From these results, it was concluded that the change at position 71 in FR3 from phenylalanine (as present in the human REI as modified for CAMPATH-1H) to tyrosine (as present in natural human REI and in mouse PM-1) was very detrimental to the formation of a functional antigen-binding site.

Version "a" of the reshaped human PM-1 L chain V region was selected as the best version. In subsequent experiments evaluating the different versions of reshaped human PM-1 H chain V regions, version "a" of the reshaped human PM-1 L chain v region was always used.

Evaluation of the six versions of reshaped human PM-1 H chain V regions were conducted by co-transfecting cos cells with one of the six vectors expressing reshaped human PM-1 H chains (RVh-PM1a, RVh-PM1b, RVh-PM1c, RVh-PM1d, RVh-PM1e or RVh-PM1f) and the vector expressing version "a" of the reshaped human PM-1 L chain (RV1-PM1a). Cells were also co-transfected with vectors expressing chimeric PM-1 L and H chains (HEF-PMk-gk and HEF-PMh-gyl). Preliminary data using unpurified cos cell supernatants showed that version "a" of reshaped human PM-1 L chain and version "f" of reshaped human PM-1 H chain were equivalent to chimeric PM-1 L and H chains in assays for binding to IL-6R.

To confirm this preliminary data, chimeric and reshaped human PM-1 antibodies were concentrated and purified from cos cell supernatants using Protein A. Namely the media from cos cells was concentrated using a 100 kd cut-off ultrafiltration device (Amicon). The concentrated media was purified using Protein A agarose (Affi-Gel Protein A MAPSII kit, BioRad). Briefly, the concentrated media was applied to a Protein A agarose column that was equilibrated with five bed volumes of binding buffer. The column was washed with 15 bed volumes of the binding buffer, followed by 5 bed volumes of the elution buffer. The eluate was concentrated and the buffer changed to PBS using a microconcentrator (Centricon 10, Amicon). The purified antibodies were used for further analysis.

The analysis of purified samples of chimeric PM-1 antibody, and reshaped human PM-1 antibodies with version "a" of the L chain V region and versions "a", "b", "c", "d", "e", and "f" of the reshaped human H chain V region was carried out. Version "a" of the L chain plus version "f" of the H chain is clearly the best reshaped human PM-1 antibody. It binds to IL-6R as well as chimeric PM-1 antibody does (FIG. 13). It also inhibits human IL-6 from binding to the IL-6R as well as both the mouse and chimeric PM-1 antibodies do (FIG. 14).

#### Example 12

Reconstruction of the reshaped human PM-1 V regions to improve the levels of expression.

In order to remove the introns within the DNA sequences coding for the leader sequences of the reshaped human PM-1 L and H chain V regions (see SEQ ID Nos: 54 and 55), the cDNAs coding for the V regions were recloned using the PCR primers. The L and H chain expression vectors RV1-PM1a and RVh-PM1f were co-transfected into cos cells. After 48 hrs, total RNA was prepared (Chirgwin et al., Biochemistry (1979) 18:5294-5299) and 5 μg of total RNA was used for the first strand cDNA synthesis as described for

the PCR cloning of mouse antibody V regions. Three PCR primers were designed and synthesized. LEV-P1 (SEQ ID NO: 60) and HEV-P1 (SEQ ID NO: 58) contain the splice donor sequence and the BamHI site and were used as forward primers for the L and H chain V regions, respectively. HEV-P2 (SEQ ID NO: 59) contains the Kozak consensus sequence before the ATG initiation codon and the HindIII site and was used as a backward primer for both the L and H chain V regions. Each 100  $\mu$ l PCR reaction contained 20 mM Tris-HCl (pH 8.8), 10 mM KCl, 10 mM (NH<sub>4</sub>)<sub>2</sub>SO<sub>4</sub>, 2 mM MgSO<sub>4</sub>, 0.1% Triton X-100, 0.1  $\mu$ g BSA, 250  $\mu$ M dNTPs, 2.5  $\mu$ l of Vent DNA polymerase (BioLabs, U.K.), 50% of the first-strand cDNA synthesis reaction and 100 pmoles each of the forward and backward primers. Each PCR tube was overlaid with 50  $\mu$ l of mineral oil and then cycled, after an initial melt at 94° C. for 1.5 min, at 94° C. for 1 min, 50° C. for 1 min, and 72° C. for 1 min, and then at 72° C. for 10 min. The 408 bp PCR product containing the L chain V region and the 444 bp PCR product containing the H chain V region were purified using 2.0% low melting temperature agarose gels, digested with BamHI and HindIII, and subcloned into a pUC19 vector to obtain pUC-RV1-PM1a-3 and pUC-RVh-PM1f-3 respectively.

It was revealed that the DNA sequences of the reshaped human PM-1 L and H chain V regions contain inappropriate splice donor and acceptor sites (see SEQ ID NOs: 54 and 55). The sites within the L chain V region are not frequently used (approximately 10% of the mRNA), but the sites within the H chain V region are used frequently (approximately 90% of the mRNA). This aberrant splicing resulted in low levels of expression of the reshaped human PM-1 antibody. In order to avoid aberrant splicing in the V regions, the splice donor sites were removed using a PCR-based method. For the H chain V region, the backward primer NEW-SP1 (SEQ ID NO: 61) and the forward primer NEW-SP2 (SEQ ID NO: 62) were synthesized, changing the DNA sequence TGG GTG AGA to the DNA sequence TGG GTT CGC. The conditions for the PCR reactions were as described above for cDNA cloning except that the template DNA was 50 ng of pUC-RVh-PM1f-3 and the primers were either HEV-P2 and NEW-SP2, or HEV-P1 and NEW-SP1.

The PCR products from the two PCR reactions were purified using a 2.0% low melting temperature agarose gel and used in a PCR joining reaction. A 98  $\mu$ l PCR reaction containing 0.5  $\mu$ g of each of the first PCR products and 5  $\mu$ l of Vent DNA polymerase was incubated at 94° C. for 2 min, 50° C. for 2 min, and 72° C. for 5 min, and then 100 pmoles each of HEV-P1 and HEV-P2 primers were added. The PCR tube was overlaid with 30  $\mu$ l of mineral oil and subjected to 25 cycles of PCR, at 94° C. for 1 min, 50° C. for 1 min, and 72° C. for 1 min, and then incubated at 72° C. for 10 min.

In the same manner, the splice donor site in the reshaped human PM-1 L chain V region was removed using PCR primers REI-SP1 (SEQ ID NO: 63) and REI-SP2 (SEQ ID NO: 64) that changed the DNA sequence CAG GTA AGG to the DNA sequence CAG GAA AGG (see). Both PCR products, a 408 bp DNA fragment for the L chain V region and a 444 bp DNA fragment for the H chain V region, were purified using a 2.0% low melting temperature agarose gel, digested with HindIII and BamHI, and subcloned into a pUC19 vector to yield pUC-RV1-PM1a-4 and pUC-RVh-PM1f-4, respectively.

RVh-PM1f-4 was constructed by replacing the HindIII-BamHI fragment of RVh-PM1f with the HindIII-BamHI fragment excised from pUC-RVh-PM1f-4. Sequence of reshaped human PM-1 antibody L chain V region version

"a" wherein introns have been deleted is shown in SEQ ID NO: 57, and sequence of reshaped human PM-1 antibody H chain V region version "f" wherein have been deleted is shown in SEQ ID NO: 56.

#### Example 13

Construction of DNA coding for reshaped human AUK 12-20 antibody L chain V region

A process for construction of DNA coding for a reshaped human AUK 12-20 antibody L chain V region is shown in FIG. 16. A gene coding for a human antibody L chain V region is incorporated into pUC19 vector using restriction enzymes HindIII and BamHI. Eight PCR primers (A to H) are prepared, and in the first PCR 4 regions which form a gene coding for the V region are amplified. The primers A and H have homology to DNA sequences on the pUC19 vector. The primers B, C and D are primers of 40 to 60 bp length each having a gene sequence of CDR to be grafted, respectively. The primers E, F and G have homology to DNA sequence of 15 to 20 bp length of the 5'-terminus of the primers B, C and D, respectively. Four first PCR use pairs of primers A and E, B and F, C and G, as well as D and H, respectively.

The PCR product A-E encodes FR1, and the PCR product B-F encodes CDR1 and FR2. The 3'-terminal portion of the A-E fragment and the 5'-terminal portion of the B-F fragment have homology in their 15 to 20 bp length, allowing to join these fragments at latter stage. Similarly, the B-F fragment has a homology with the C-G fragment which encodes CDR2 and FR3. The C-G fragment further has a homology with the D-H fragment which encodes CDR3 and FR4. Thus, these 4 fragments can be joined by their mutual homology. After joining these 4 fragments in a PCR reaction mixture, primers A and H are added thereon in the second PCR to amplify a product formed by correct joining of the 4 fragment. The second PCR product thus obtained has three grafted CDRs, and after digestion with HindIII and BamHI, is subcloned into pUC19 vector.

More specifically, as a template, plasmid pUC-RV1-PM1a-4 constructed by inserting a DNA encoding reshaped human PM-1 antibody L chain V region version "a" into plasmid pUC19 was used.

The above-mentioned primers A to H have the following sequences.

Backward Primer	SEQ ID NO.	Forward primer	SEQ ID NO.
A. REVERSE	83	1220-L16	66
B. 1220-L1	65	1220-L2b	68
C. 1220-L2	67	1220L3b	70
D. 1220-L3	69	UNIVERSAL	82

The backward primers 1220-L1, 1220-L2 and 1220L3 for CDR grafting were purified with 12% polyacrylamide gel containing 8M area prior to using them.

A 100  $\mu$ l PCR reaction mixture contained 20 mM Tris-HCl (pH 8.8), 10 mM KCl, 10 mM (NH<sub>4</sub>)<sub>2</sub>SO<sub>4</sub>, 2 mM MgSO<sub>4</sub>, 0.1% Triton X-100, 1  $\mu$ g BSA, 250  $\mu$ M dNTPs, 5 units Vent DNA polymerase (BioLabs, U.K.), 50 ng pUC-RV1-PM1a-4 DNA, and 100 p moles each of the forward and backward primers. Each PCR tube was overlaid with 50  $\mu$ l of mineral oil, and after an initial denaturation at 94° C. for 1.5 minutes, 30 cycles of reaction at 94° C. for 1 minute, 50° C. for 1 minute and 72° C. for 1 minute was carried out, followed by an incubation at 72° C. for 10 minutes.

Each of the PCR products, 252 bp (A-E), 96 bp (B-F), 130 bp (C-G) and 123 bp (D-H) was purified with a 2.0% low

melting agarose (FMC, Bio. Products, USA). Namely, an agarose piece containing a DNA fragment was excised, melted at 65° C. for 5 minutes, and added to the same volume of 20 mM Tris-HCl (pH 7.5) containing 2 mM EDTA and 200 mM NaCl. The mixture was extracted with phenol and chloroform. The DNA fragment was recovered by an ethanol precipitation, dissolved in 10 mM Tris-HCl (pH 7.5) containing 1 mM EDTA, and used for PCR joining reaction.

Next, 98 µl of a PCR reaction mixture containing 0.2 µg each of the first PCR products and 5 units of Vent DNA polymerase was incubated at 94° C. for 2 minutes, 50° C. for 2 minutes and 72° C. for 5 minutes for a joining reaction. Next, 100 p moles each of the primers A (REVERSE) and H (UNIVERSAL) were added to the reaction mixture to make it to 100 µl volume, and the reaction mixture was overlaid with 50 µl of mineral oil and subjected to 30 cycles of a reaction at 94° C. for 1 minute, 50° C. for 1 minute and 72° C. for 1 minute, followed by an incubation at 72° C. for 10 minutes.

The second PCR product of 558 bp length containing an L chain V region into which CDRs of the mouse monoclonal antibody AUK 12-20 L chain had been grafted was purified by a 2.0% low melting agarose gel, and after digestion with BamHI and HindIII, subcloned into a pUC19 vector to obtain pUC-RL-1220a, and sequenced. A resulting amino acid sequence of the L chain V region and a nucleotide sequence encoding the amino acid sequence is shown in SEQ ID NO: 71.

Next, for construction of an L chain expression vector, a HindIII-BamHI DNA fragment containing a reshaped human AUK 12-20 antibody L chain V region was excised from the above-mentioned plasmid pUC-RV<sub>L</sub>-1220a, and inserted to HindIII-BamHI site of an L chain expression vector HEF-12k-gk to obtain an expression vector RV<sub>L</sub>-1220a for reshaped human AUK 12-20 antibody L chain V region version "a".

#### Example 14.

Expression and analysis of reshaped human AUK 12-20 antibody L chain

##### Transient expression in COS cells

The expression vector RV<sub>L</sub>-1220a for reshaped human AUK 12-20 antibody L chain and the expression vector HEF-12h-gy1 for chimeric 12-20 antibody H chain (Example 5) were cotransfected into COS cells to evaluate the reshaped human AUK 1220 antibody L chain version "a". Namely, COS cells were suspended in a phosphate-buffered saline (PBS) at a concentration of 1×10<sup>7</sup> cells 1 ml, and to 0.8 ml of the suspension were added the plasmid DNAs (10 µg for each plasmid). Pulses were applied to the suspension at an electric capacity of 1,900 V, 25 µF using a Gene Pulser apparatus (Bio Rad).

After restoration at a room temperature for 10 minutes, electroporated cells were added to 8 ml of DMEM medium (GIBCO) containing 10% bovine fetal serum. After incubation for 72 hours, supernatant was collected, centrifuged to eliminate cell debris, and stored in an aseptic condition at 4° C. for short period or at -20° C. for longer period.

##### Determination of human-like antibody by ELISA

A supernatant of the transfected COS cells was assayed by ELISA and the production of chimeric antibody was confirmed. To detect human-like antibody, a plate was coated with a goat anti-human IgG (whole molecule) (Sigma). After blocking, the supernatant from COS cells was sequentially diluted and added to each well.

The plate was incubated and washed, and an alkaline phosphatase-conjugated goat anti-human IgG (α-chain

specific, Sigma) was added thereon. After incubation and washing, a substrate solution was added. After further incubation, the reaction was terminated and an optical density at 405 nm was measured. As a standard, purified IgG (Sigma) was used.

ELISA for confirmation of an ability to bind to human IL-6R

A supernatant from the transfected COS cells was assayed by ELISA to determine whether the produced human-like antibody can bind to the antigen, human IL-6R. A plate was coated with a mouse monoclonal antibody MT18 (Reference Example 1). After blocking with 1% BSA, soluble recombinant human IL-6R (SR 344) was added to the plate. After washing the plate, supernatant from COS cells was sequentially diluted and added to each well of the plate. After inclusion and washing, alkaline phosphatase-conjugated goat anti-human IgG was added to the wells, and after further incubation and washing, a substrate solution was added thereon. After incubation, the reaction was terminated and optical density at 405 nm was measured.

A result is shown in FIG. 17. The human-like antibody comprising a combination of a reshaped human AUK 12-20 antibody L chain version "a" and a chimeric 12-20 antibody H chain exhibited a binding ability to IL-6R as strong as chimeric 12-20 antibody. Optical density at 405 nm changed in a dilution rate-dependent manner, confirming that the sample contains an antibody to IL-6R. In addition, this result shows that the reshaped human AUK 12-20 antibody L chain version "a" has an antigen binding ability as high as chimeric AUK 12-20 antibody L chain.

#### Example 15.

Construction of gene coding for reshaped human AUK 12-20 antibody H chain using HSGI consensus sequence

According to the same procedure as described in Example 13, CDRs of AUK 12-20 antibody H chain V region were grafted into the reshaped human V<sub>H</sub>a425 containing HSG I consensus sequences as its FRs (Kettleborough et al., Protein Engineering (1991) 4:773-783). First, a HindIII-BamHI DNA fragment encoding the reshaped human V<sub>H</sub>a425 (FIG. 3 in the literature) was excised from a plasmid HCMV-RV<sub>H</sub>a-425-γ1 and subcloned at HindIII-BamHI sites in pUC 19 vector to obtain pUC-RV<sub>H</sub>a-425a, which was then used as a template. 8 PCR primers (A1 to H1) were synthesized. The primer 1220-H1 was designed to graft CDR1 and to induce a mutation from T-28 to S-28, and the primer 1220-H3 was designed to graft CDR3 and to induce a mutation from S-94 to R-94. The primers 1220-H1, 1220-H2 and 1220-H3 were purified using a 12% polyacrylamide gel containing 8 M urea prior to using them. Nucleotide sequence of each primer was as follow.

Backward primer	SEQ ID NO.	Forward primer	SEQ ID NO.
A1. REVERSE	83	E1. 1220-H1b	73
B1. 1220-H1	72	E1. 1220-H2b	75
C1. 1220-H2	74	G1. 1220-H3b	77
D1. 1220-H3	76	H1. UNIVERSAL	82

Condition of PCR was the same as that described in Example 13, except that the pUC-RV<sub>H</sub>a-425a was used as a template DNA and the above-mentioned primers were used for grafting H chain CDRs. Primer pairs of A1 and E1, B1 and F1, C1 and G1, as well as D1 and H1 were used to carry out first PCR reactions, and the respective first PCR products, 186 bp (A1-E1), 75 bp (B1-F1), 173 bp (C1-G1) and 105 bp (D1-H1) were purified with 2.0% low melting

agarose gel, and used in subsequent second PCR joining reaction. According to the condition described in Example 13, 0.2 µg each of the first PCR products were used to carry out the second PCR reaction (including PCR joining reaction) to obtain a PCR product of 495 bp containing DNA coding for a human H chain V region into which mouse AUK 12-20 antibody H chain V region CDRs had been grafted, and the PCR product was purified using 2.5% low melting agarose gel. After digesting the PCR product with BamHI and HindIII, resulting BamHI-HindIII DNA fragment was subcloned into pUC19 and sequenced to obtain pUC-RV<sub>H</sub>-1220a.

It was revealed that DNA sequence coding for reshaped human AUK 12-20 antibody H chain V region contains a sequence well conforming to a splicing donor sequence, which may cause an abnormal splicing which was troublesome in the production of the reshaped human PM-1 antibody. Therefore, this DNA sequence was modified by PCR. Mutagenic primers, SGI-SP1 (SEQ ID NO: 97) and SGI-SP2 (SEQ ID NO: 98) were synthesized. These primers convert the DNA sequence AAG GTG AGC to the DNA sequence AAA GTC AGC. Condition of PCR reaction was same as described above, except that 50 ng of pUC-RV<sub>H</sub>-1220a was used as a template DNA, and the SGI-SP1 and UNIVERSAL (SEQ ID NO: 82), or the SGI-SP2 and REVERSE (SEQ ID NO: 83) were used as primers.

PCR products from two PCR reactions were purified by 2% low melting agarose gel and used in a PCR joining reaction. 98 µl of PCR reaction mixture containing 0.2 µg each of the first PCR products and 5 units of Vent DNA polymerase was incubated at 94° C. for 2 minutes, at 55° C. for 2 minutes and at 72° C. for 5 minutes for a joining reaction. Next, 100 pmoles each of UNIVERSAL and REVERSE primers were added to the reaction mixture, which was then overlaid with 50 µl of mineral oil and subjected to 30 cycles of second PCR reaction consisting of incubations at 94° C. for 1 minutes, at 50° C. for 1 minute and at 72° C. for 1 minute, followed by an incubations at 72° C. for 10 minutes. DNA fragment of 495 bp obtained in the second PCR was purified by a 2.0% low melting agarose gel, and subcloned into pUC19 vector and sequenced to obtain pUC-RV<sub>H</sub>-1220a-2.

Next, HindIII-BamHI DNA fragment containing DNA coding for reshaped human AUK 12-20 antibody H chain V region was excised from the pUC-RV<sub>H</sub>-1220a-2, and inserted at HindIII-BamHI sites of an H chain expression vector HEF-12h-gyl to obtain an expression vector RV<sub>H</sub>-1220a for the reshaped human AUK 12-20 antibody H chain version "a".

For construction of genes coding for reshaped human AUK 12-20 antibody H chain V region versions "b" to "d", two pairs of mutagenic primers were synthesized. Each PCR reaction was carried out under substantially the same condition as described above. For construction of version "b", in two first PCR reactions, either UNIVERSAL primer (SEQ ID NO: 82) and mutagenic primer 120H-ml (SEQ ID NO: 78), or REVERSE primer (SEQ ID NO: 83) and mutagenic primer 1220H-mlb (SEQ ID NO: 79), as well as pUC-RV<sub>H</sub>-1220a as a template were used. The first PCR products of 202 bp and 323 bp were purified by a 2.0% low melting agarose gel, and used in second PCR (including PCR joining reaction) under the same condition as described above to obtain a 495 bp product (version "b"). The product was digested with HindIII and BamHI, and subcloned into pUC19 vector to obtain pUC-RV<sub>H</sub>-1220b.

Similarly, mutagenic primer 1220H-m2 (SEQ ID NO: 80), 1220H-m2b (SEQ ID NO: 81) and a template pUC-

RV<sub>H</sub>-1220a were used in a PCR to obtain a PCR product (version "c"). The product was digested with HindIII-BamHI and inserted at HindIII-BamHI sites of pUC19 vector to obtain pUC-R<sub>H</sub>V-1220c. Moreover, mutagenic primers 1220H-mla (SEQ ID NO: 78), 1220H-mlb (SEQ ID NO: 79), and a template pUC-RV<sub>H</sub>-1220c were used to obtain a PCR Product (version "d"), which was then digested with HindIII and BamHI and inserted into HindIII-BamHI sites of pUC19 vector to obtain pUC-RV<sub>H</sub>-1220d.

Note, an amino acid sequence of the reshaped human AUK 12-20 antibody H chain V region version "b" and a nucleotide sequence coding therefor in the plasmid pUC-RV<sub>H</sub>-1220b is shown in SEQ No. 84; and an amino acid sequence of the reshaped human AUK 12-20 antibody H chain V region version "d" and a nucleotide sequence coding therefor in the plasmid pUC-RV<sub>H</sub>-1220d is shown in SEQ ID NO: 85.

Next, to construct the expression vectors, HindIII-BamHI fragments containing a reshaped human AUK 12-20 antibody H chain V region were excised from pUC-RV<sub>H</sub>-1220b, pUC-RV<sub>H</sub>-1220c and pUC-RV<sub>H</sub>-1220d and inserted into HindIII-BamHI sites of H chain expression vector HEF-12h-gyl to obtain RV<sub>H</sub>-1220b, RV<sub>H</sub>-1220c and RV<sub>H</sub>-1220d respectively.

#### Example 16.

Expression and analysis of various versions of reshaped human AUK 12-20 antibody.

COS cells were cotransfected with one of 4 expression vectors for reshaped human AUK 12-20 antibody H chain (RV<sub>H</sub>-1220a, RV<sub>H</sub>-1220b, RV<sub>H</sub>-1220c or RV<sub>H</sub>-1220d) and an expression vector VR<sub>H</sub>-1<sup>220</sup>a to evaluate 4 versions of the reshaped human AUK 12-20 antibody H chain V region. For reference, COS cells were cotransfected with expression vectors for chimeric 12-20 antibody L chain and H chain (HEF-12h-gyl and FEF-12-gk). In an assay for binding to the human IL-6R, a reshaped human AUK 12-20 antibody consisting of reshaped human AUK 12-20 antibody L chain and reshaped human AUK 12-20 antibody H chain version "b", and a reshaped human AUK 12-20 antibody consisting of reshaped human AUK 12-20 antibody L chain and reshaped human AUK 12-20 antibody H chain version "d" shows good binding as well as chimeric 12-20 antibody. These results are shown in FIGS. 18 and 19.

#### Example 17.

Construction of gene coding for reshaped human sle 1220 antibody H chain using human antibody HAX

A human antibody having the highest homology with the mouse monoclonal antibody AUK 12-20 H chain V region is HAX (J. Immunology (1987) 139:2496-2501; an antibody produced by hybridoma 21/28 derived from B cells of an SLE patient; its amino acid sequence is shown in FIG. 6, and nucleotide sequence therefor is shown in FIGS. 4 and 5 of this literature), according to a protein data base "Leeds". Reshaped human sle 1220H antibody H chain V region was constructed using FRs of the antibody HAX and CDRs of mouse monoclonal antibody AUK 12-20 H chain V region.

An entire DNA coding for a reshaped human sle 1220 H antibody H chain V region version "a" was chemically synthesized. DNA coding for sle 1220 H antibody H chain V region of an entire length 439 bp was designed by dividing the DNA into 6 oligonucleotides of 90 to 94 bp length overlapping each other by 21 bp (sle 1220 h 1 to 6; SEQ ID NOs: 86 to 91, respectively). In designing the oligonucleotides, secondary structure was tested and for sites having structural problems the third nucleotide in a codon was changed without change of amino acid encoded

thereby. The relationship of these oligonucleotides and a process for construction of double-stranded synthetic DNA are shown in FIG. 20.

The reaction shown in FIG. 20 is carried out using PCR technique. Namely, 6 synthetic oligonucleotides were added to a single PCR reaction tube to carry out the first PCR reaction, thereby two oligonucleotides are annealed and extended, and further 4 oligonucleotides or an entire oligonucleotide are obtained.

Next, terminal primers A (SEQ ID NO: 92) and B (SEQ ID NO: 93) are added to carry out the second PCR reaction, wherein only a correct oligonucleotide having an entire length can be amplified. The resulting product is digested with BamHI and HindIII, and subcloned into pUC19 vector, followed by sequencing.

More specifically, 98  $\mu$ l of a reaction mixture containing 100 mM tris-HCl (pH 8.5), 50 mM KCl, 0.1 mM dATP, 0.1 mM dGTP, 0.1 mM dCTP, 0.1 mM dTTP, 1.5 mM MgCl<sub>2</sub> and 2.5 U of DNA polymerase AmpliTaq (Perkin Elmer Cetus) as well as 5 pmoles each of the oligonucleotides was denatured at 94° C. for 1.5 minutes and subjected to 3 cycles of reaction by incubation at 92° C. for 3 minutes, 50° C. for 2 minutes and 72° C. for 5 minutes, followed by an incubation at 72° C. for 10 minutes. One  $\mu$ l each of 50 mM terminal primers A and B were added to the reaction mixture, which was then overlaid with 80  $\mu$ l of mineral oil, and after denaturation of 94° C. for 1.5 minutes, subjected to 30 cycles of reaction by incubation at 94° C. for 1 minute, 50° C. for 1 minute and at 72° C. for 1 minute, followed by an incubation at 72° C. for 10 minutes. The PCR product of 439 bp was purified by a 1.5% low melting agarose gel, digested with restriction enzymes BamHI HindIII, and subcloned into pUC19 vector, followed by confirmation of sequence. A clone thus obtained was designated pUC-RV<sub>H</sub>-sle 1220Ha. An amino acid sequence of reshaped human sle 1220H antibody H chain V region version "a" and a nucleotide coding therefor in the plasmid pUC-RV<sub>H</sub>-sle 1220Ha are shown in SEQ ID NO: 94.

Next, HindIII-BamHI DNA fragment containing a gene coding for reshaped human 12-20 (sle 1220H) antibody H chain V region was excised from the pUC-RV<sub>H</sub>-sle 1220Ha and inserted at HindIII-BamHI sites of an H chain expression vector HEF-12h-gyl to obtain RV<sub>H</sub>-sle 1220Ha.

For construction of version "b" to "d" of reshaped human sle 1220H antibody H chain V region, two mutagenic primers sle 1220Hm1 (SEQ ID NO 95) and sle 1220Hm2 (SEQ ID NO: 96) were synthesized. In each PCR, Vent DNA polymerase and reaction mixture composition described in Example 13 were used. In each PCR reaction, a reaction mixture containing pUC-RV<sub>H</sub>-sle 1220Ha as template, 50 pmoles of a mutagenic primer sle 1220Hm1 or sle 1220Hm2, and 50 pmoles of the terminal primer B was denatured at 94° C. for 1.5 minutes, and subjected to 30 cycles of reaction by incubation at 94° C. for 1 minute, at 50° C. for 1 minute and at 72° C. for 1 minute, followed by an incubation at 72° C. for 10 minutes. The product of 235 bp or 178 bp was purified by a 1.5% low melting agarose gel to use as a primer in the second PCR reaction. Namely the second PCR reaction was carried out using 50 pmoles of the terminal primer A, 0.2  $\mu$ g of the PCR product and pUC-RV<sub>H</sub>-sle 1220Ha as a template, and resulting product of 439 bp was purified by a 1.5% low melting agarose gel, digested with BamHI and HindIII, and subcloned into pUC19 vector to obtain pUC-RV<sub>H</sub>-sle 1220Hb or pUC-RVE-sle 1220Hc, which encodes reshaped human sle 1220 antibody H chain V region version "b" or "c", respectively.

A DNA coding for reshaped human sle 1220 H antibody H chain V region version "d" was constructed also follow.

As a template pUC-RV<sub>H</sub>-sle 1220Hb was used. 50 pmoles each of a mutagenic primer sle 1220Hm2 and the terminal primer B was used to carry out 30 cycles of the first PCR reaction. Resulting 176 bp PCR product was purified on a 1.6% low melting agarose gel to use as a primer in the second PCR. This primer and 50 pmoles of the terminal primer A was used in the second PCR to obtain a 439 bp DNA fragment. The PCR product thus obtained was purified, digested with BamHI and HindIII, and subcloned into pUC 19 vector to obtain pUC-RV<sub>H</sub>-sle 1220Hd.

Next, to construct expression vectors for various versions of reshaped human sle 1220H antibody H chain V region, BamHI-HindIII fragments containing a DNA encoding reshaped human sle 1220 antibody H chain V region were excised from pUC-RV<sub>H</sub>-sle 1220Hb, pUC-RV<sub>H</sub>-sle 1220Hc and pUC-RV<sub>H</sub>-sle 1220Hd, and inserted into HindIII-BamHI sites of the H chain expression vector HEF-12h-gyl to obtain expression vectors RV<sub>H</sub>-sle 1220Hb, RV<sub>H</sub>-sle 1220Hc and RV<sub>H</sub>-sle 1220Hd respectively.

Each of four vectors expressing reshaped human sle 1220H antibody H chain (RV<sub>H</sub>-sle 1220Ha, RV<sub>H</sub>-sle 1220Hb and RV<sub>H</sub>-sle 1220Hc or RV<sub>H</sub>-sle 1220Hd) and the vector RV<sub>L</sub>-1220a expressing reshaped human AUK 12-20 antibody L chain were cotransfected to COS cells to evaluate the four versions of the reshaped human sle 1220H antibody H chain V region for an ability to inhibit the binding of IL-6 to IL-6R. Results is shown in FIGS. 21 to 24. Note, these result were obtained after purifying the produced antibodies by protein A.

As seen from the above, according to the present invention, in a chimeric L chain or a reshaped human L chain, or a chimeric H chain or a reshaped human H chain, and especially in RF, one or more than one amino acid can be replaced with other amino acid maintaining an ability to bind to human IL-6R. Therefore, the present invention includes chimeric antibody and reshaped human antibody, chimeric L chain and reshaped human L chain, chimeric H chain and reshaped human H chain, reshaped L chain V region, and reshaped H chain V region, wherein one or more than one amino acid is replaced with other as well as DNA coding therefor, as far as they maintain their native property.

Starting hybridomas used in the present invention were constructed as follows.

#### Reference Example 1

##### Construction of Hybridoma MT18

To construct a hybridoma producing monoclonal antibody to human IL-6R, as an immunogen, a mouse T cell line expressing human IL-6R on the cell surface was constructed as follows. Namely, a plasmid pBSF2R.236 disclosed in Japanese Patent Application No. H1-9774 and pSV2neo was transfected into a mouse T cell line CTLL-2 (ATCC TIB214) according to a conventional procedure, and the resultant transformant was screened using G418 according to a conventional procedure to obtain a cell line expressing about 30,000 IL-6Rs per cell. This cell line was designated CTBC3.

The CTBC3 cells were cultured in RPMI 1640 according to a conventional procedure, the cultured cells were washed four times with PBS buffer, and 1 $\times$ 10<sup>7</sup> cells were intraperitoneally injected to C57BL/6 mice for immunization. The immunization was carried out once a week for 6 weeks.

Spleen cells were obtained from the immunized mice and fused with myeloma P3U1 cells using polyethylene glycol according to a conventional procedure, and the fused cells were screened as follows. The IL-6R negative human T cell line JURKAT (ATCC CRL 8163) was co-transfected with the plasmids pBSF2R.236 and pSV2neo, and transformed

cells were screened to obtain a cell line expressing about 100,000 IL-6Rs per cell. The cell line was designated NJBC8. A hybridoma cell clone producing an antibody which recognized NP40-lysed NJBC8 but did not recognize NP40-lysed JURKAT was cloned and designated MT18. The hybridoma MT18 was deposited with the Fermentation Research Institute Agency of Industrial Science and Technology (FRI), under the Budapest Treaty, as FERM BP-2999 on Jul. 10, 1990.

#### Reference Example 2

##### Construction of Hybridoma PM1

To construct a hybridoma producing monoclonal antibody to the IL-6R, as an antigen, human IL-6R was extracted as follows.  $3 \times 10^9$  human myeloma U266 cells (IL-6R-producing cells) were lysed in 1 ml of 1% digitonin, 10 mM triethanolamine buffer (pH 7.4), 0.15 M NaCl and 1 mM PMSF (phenylmethylsulfonyl fluoride; Wako Pure Chemicals). On the other hand, an MT18 antibody produced by the MT18 hybridoma prepared in Reference Example 1 was bonded to cyanogen bromide-activated Sepharose 4B (Pharmacia) according to a conventional procedure. This MT18 antibody-conjugated Sepharose 4B was mixed with the above-prepared cell lysate to bind the solubilized IL-6R to the MT18 antibody on Sepharose 4B. Substances non-specifically bonded to the Sepharose 4B were washed off, and the IL-6R bound to Sepharose 4B via the MT18 antibody was used as an immunogen.

BALB/c mice were intraperitoneally immunized with the above-prepared immunogen, once a week for 4 weeks. Next, spleen cells were obtained from the immunized mice, and fused with myeloma cells P3U1 using polyethylene glycol according to a conventional procedure. The fused cells were screened as follows. First, a culture supernatant and 0.01 ml of Protein G Sepharose (Pharmacia) were mixed to adsorb immunoglobulin in the supernatant to the Protein G Sepharose. On the other hand,  $10^7$  U266 cells internally labeled with  $^{35}\text{S}$ -methionine were lysed, and the IL-6R was affinity-purified using the MT18-conjugated Sepharose 4B. Next, the  $^{35}\text{S}$ -methionine-labeled IL-6R was immunoprecipitated with the above-prepared Protein G Sepharose on which an immunoglobulin had been bonded, and the precipitate was analyzed by SDS/PAGE. As a result, one hybridoma clone producing antibody which specifically bound to the IL-6R was isolated, and designated PM1. The hybridoma PM1 was deposited with the FRI under the Budapest Treaty as FERM BP-2998, on Jul. 10, 1990.

#### Reference Example 3

##### Construction of Hybridoma AUK12-20, AUK64-7 and AUK146-15

As an immunogen, a soluble IL-6R (SR 344) was prepared according to a procedure described by Yasukawa, K. et al., *J. Biochem.* 108, 673-676, 1990. Namely, a plasmid pCEdhfr 344 containing a cDNA coding for IL-6R wherein the 345th codon from the N-terminus had been replaced by a stop codon was transfected to CHO (5E27) cells, the transfected cells were cultured in a serum-free medium (SF-O medium, Sanko Junyaku), and a resulting supernatant was concentrated with an HF-Labl system (Tosoh), and purified by Blue-5PW column and Phenyl-5PW column. The purified soluble IL-6R showed a single band in an SDS-PAGE.

A female BALB/cAnNCrj mouse (Nippon CREA) was subcutaneously injected with 10  $\mu\text{g}$ /mouse of the immunogen in Freund's complete adjuvant (Bacto Adjuvant Complete H 37 Ra, Difco), followed by the second and third injections of the same amount of the immunogen in Freund's

incomplete adjuvant (Bacto Adjuvant Incomplete Freund, Difco) two and three weeks after the first injection, respectively. A final immunization (the fourth injection) was carried out without adjuvant into a tail vein one week after the third injection. A serum sample was prepared from the immunized mice, serially diluted with a dilution buffer, and assayed by ELISA according to a procedure described by Goldsmith, P. K., *Analytical Biochemistry*, 117, 53-60, 1981. Namely, an SR344 (0.1  $\mu\text{g}/\text{ml}$ )-coated plate was blocked with 1% BSA, and the diluted sample was added thereon. Mouse IgG bound to the SR344 was measured using goat anti-mouse IgG/alkaline phosphatase (A/P) (ZYMED) and a substrate for alkaline phosphatase (Sigma-104).

After confirming an increase of the anti-SR344 antibody in the serum, spleen cells were obtained from 5 BALB/c mice three days after the final immunization. The spleen cells and myeloma cells (P3U1) were mixed at a ratio of 25:1, fused using PEG1500, and cultured in 2000 wells at a cell concentration of 0.7 to  $1.1 \times 10^6$  cells/well. Supernatants from the wells were screened for their ability to bind SR344 (the first screening designated as R344 recognition assay), and for their ability to inhibit a binding of SR344 with an interleukin-6 by a IL-6/sIL-6R binding inhibition assay (RBIA). The first screening provided 240 positive wells, and the second screening provided 36 positive wells.

The above-mentioned R344 recognition assay was carried out as follows. Goat anti-mouse Ig (Cappel) (1  $\mu\text{g}/\text{ml}$ )-coated plate (MaxiSorp, Nunc) was blocked with 1% BSA, and 100  $\mu\text{l}$ /well of hybridoma culture supernatant was added thereon, followed by an incubation at room temperature for one hour. After washing the plate, 20  $\mu\text{g}/\text{ml}$  of SR344 was added to each well, and incubation was carried out at room temperature for one hour. The amount of SR344 captured by the immobilized antibody derived from the supernatant was determined by addition of rabbit anti-SR344 IgG (#2, 5  $\mu\text{g}/\text{ml}$ ), goat anti-rabbit IgG-alkaline phosphatase (A/P) (1:3000, Tago), and of a substrate (1 mg/ml, Sigma-104), followed by measurement of the optical density at 405-600 nm.

The above-mentioned RBIA was carried out as follows. MT18 antibody-coated plate was filled with 100  $\mu\text{g}/\text{ml}$  of SR344 (100  $\mu\text{l}$ /well), and incubation was carried out at a room temperature for one hour. After washing the plate, 50  $\mu\text{l}$ /well of hybridoma supernatant and 50  $\mu\text{g}/\text{ml}$  of biotin-interleukin-6 conjugate (20  $\mu\text{g}/\text{ml}$ ) were simultaneously added to each well, and the wells were incubated at room temperature for one hour. An amount of biotin-IL-6 bound to SR344 was measured by an addition of streptavidin-A/P (1:7000, PIERCE) and a corresponding substrate (Sigma-104), followed by a measurement of the optical density at 405-600 nm.

Finally, positive clones were purified by a twice-repeated limiting dilution method, and three hybridoma clones, i.e., AUK12-20, AUK145-15 and AUK64-7, which inhibit the binding of SR344 with the IL-6; and a hybridoma clone AUK181-6, which does not inhibit the binding of SR344 with the IL-6, were obtained.

##### Industrial Applicability

The present invention provides a reshaped human antibody to the human IL-6R, comprising a human antibody wherein the CDRs of the human V regions are replaced with the CDRs of a mouse monoclonal antibody to the human IL-6R. Since major portion of the reshaped human antibody is derived from a human antibody and the mouse CDRs which are less antigenic, the present reshaped human antibody is less immunogenic to human, and therefore is promised for therapeutic uses.



-continued

Reference to Deposited Microorganisms under Rule 13-2 of Budapest Treaty			Reference to Deposited Microorganisms under Rule 13-2 of Budapest Treaty		
Identification of Microorganism	Deposition No.	Deposition Date	Identification of Microorganism	Deposition No.	Deposition Date
Depository Authority: National Collections of Industrial and Marine Bacteria Limited Address: 23 St Macher Drive, Aberdeen AB2 1RY, UNITED KINGDOM			Depository Authority: Fermentation Research Institute, Agency of industrial Science and Technology Address: 103, Higashi 1-chome Tsukuba-shi Ibaraki Japan		
<i>E. Coli</i> DH5 $\alpha$ , pPM-h1	NCIMB 40362	Feb. 12, 1991	MT 18	FERM BP-2999	July 10, 1990
<i>E. Coli</i> DH5 $\alpha$ , p12-h2	NCIMB 40363	Feb. 12, 1991	PM 1	FERM BP-2998	July 10, 1990
<i>E. Coli</i> DH5 $\alpha$ , p64-h2	NCIMB 40364	Feb. 12, 1991			
<i>E. Coli</i> DH5 $\alpha$ , p146-h1	NCIMB 40365	Feb. 12, 1991			
<i>E. Coli</i> DH5 $\alpha$ , pPM-k3	MCIMB 40366	Feb. 12, 1991			
<i>E. Coli</i> DH5 $\alpha$ , p12-k2	NCIMB 40367	Feb. 12, 1991			
<i>E. Coli</i> DH5 $\alpha$ , p64-k4	NCIMB 40368	Feb. 12, 1991			
<i>E. Coli</i> DH5 $\alpha$ , p146-k3	NCIMB 40369	Feb. 12, 1991			

## SEQUENCE LISTING

## ( 1 ) GENERAL INFORMATION:

( i i i ) NUMBER OF SEQUENCES: 158

## ( 2 ) INFORMATION FOR SEQ ID NO:1:

## ( i ) SEQUENCE CHARACTERISTICS:

- ( A ) LENGTH: 40 base pairs
- ( B ) TYPE: nucleic acid
- ( C ) STRANDEDNESS: single
- ( D ) TOPOLOGY: linear

## ( x i ) SEQUENCE DESCRIPTION: SEQ ID NO:1:

ACTAGTCGAC ATGAAGTTGC CTGTTAGGCT GTTGGTGCTG 4 0

## ( 2 ) INFORMATION FOR SEQ ID NO:2:

## ( i ) SEQUENCE CHARACTERISTICS:

- ( A ) LENGTH: 39 base pairs
- ( B ) TYPE: nucleic acid
- ( C ) STRANDEDNESS: single
- ( D ) TOPOLOGY: linear

## ( x i ) SEQUENCE DESCRIPTION: SEQ ID NO:2:

ACTAGTCGAC ATGGAGWCAG ACACACTCCT GYTATGGGT 3 9

## ( 2 ) INFORMATION FOR SEQ ID NO:3:

## ( i ) SEQUENCE CHARACTERISTICS:

- ( A ) LENGTH: 40 base pairs
- ( B ) TYPE: nucleic acid
- ( C ) STRANDEDNESS: single
- ( D ) TOPOLOGY: linear

## ( x i ) SEQUENCE DESCRIPTION: SEQ ID NO:3:

ACTAGTCGAC ATGAGTGTGC TCACTCAGGT CCTGGSGTTG 4 0

## ( 2 ) INFORMATION FOR SEQ ID NO:4:

-continued

( i ) SEQUENCE CHARACTERISTICS:  
 ( A ) LENGTH: 43 base pairs  
 ( B ) TYPE: nucleic acid  
 ( C ) STRANDEDNESS: single  
 ( D ) TOPOLOGY: linear

( x i ) SEQUENCE DESCRIPTION: SEQ ID NO:4:

ACTAGTCGAC ATGAGGRCCC CTGCTCAGWT TYTTGGMWTC TTG 4 3

( 2 ) INFORMATION FOR SEQ ID NO:5:

( i ) SEQUENCE CHARACTERISTICS:  
 ( A ) LENGTH: 40 base pairs  
 ( B ) TYPE: nucleic acid  
 ( C ) STRANDEDNESS: single  
 ( D ) TOPOLOGY: linear

( x i ) SEQUENCE DESCRIPTION: SEQ ID NO:5:

ACTAGTCGAC ATGGATTTC AGGTGCAGAT TWCAGCTTC 4 0

( 2 ) INFORMATION FOR SEQ ID NO:6:

( i ) SEQUENCE CHARACTERISTICS:  
 ( A ) LENGTH: 37 base pairs  
 ( B ) TYPE: nucleic acid  
 ( C ) STRANDEDNESS: single  
 ( D ) TOPOLOGY: linear

( x i ) SEQUENCE DESCRIPTION: SEQ ID NO:6:

ACTAGTCGAC ATGAGGTKCY YTGYSAGYT YCTGRGG 3 7

( 2 ) INFORMATION FOR SEQ ID NO:7:

( i ) SEQUENCE CHARACTERISTICS:  
 ( A ) LENGTH: 41 base pairs  
 ( B ) TYPE: nucleic acid  
 ( C ) STRANDEDNESS: single  
 ( D ) TOPOLOGY: linear

( x i ) SEQUENCE DESCRIPTION: SEQ ID NO:7:

ACTAGTCGAC ATGGGCWTC A GATGGAGTC ACAKWYYCWG G 4 1

( 2 ) INFORMATION FOR SEQ ID NO:8:

( i ) SEQUENCE CHARACTERISTICS:  
 ( A ) LENGTH: 41 base pairs  
 ( B ) TYPE: nucleic acid  
 ( C ) STRANDEDNESS: single  
 ( D ) TOPOLOGY: linear

( x i ) SEQUENCE DESCRIPTION: SEQ ID NO:8:

ACTAGTCGAC ATGTGGGGAY CKTTTTYCM TTTTTCAATT G 4 1

( 2 ) INFORMATION FOR SEQ ID NO:9:

( i ) SEQUENCE CHARACTERISTICS:  
 ( A ) LENGTH: 35 base pairs  
 ( B ) TYPE: nucleic acid  
 ( C ) STRANDEDNESS: single  
 ( D ) TOPOLOGY: linear

( x i ) SEQUENCE DESCRIPTION: SEQ ID NO:9:

ACTAGTCGAC ATGGTRICCW CASCTCAGTT CCTTG 3 5

( 2 ) INFORMATION FOR SEQ ID NO:10:

( i ) SEQUENCE CHARACTERISTICS:  
 ( A ) LENGTH: 37 base pairs

-continued

- ( B ) TYPE: nucleic acid
- ( C ) STRANDEDNESS: single
- ( D ) TOPOLOGY: linear

( x i ) SEQUENCE DESCRIPTION: SEQ ID NO:10:

ACTAGTCGAC ATGTATATAT GTTTGTTGTC TATTICT 3 7

( 2 ) INFORMATION FOR SEQ ID NO:11:

- ( i ) SEQUENCE CHARACTERISTICS:
  - ( A ) LENGTH: 38 base pairs
  - ( B ) TYPE: nucleic acid
  - ( C ) STRANDEDNESS: single
  - ( D ) TOPOLOGY: linear

( x i ) SEQUENCE DESCRIPTION: SEQ ID NO:11:

ACTAGTCGAC ATGGAAGCCC CAGCTCAGCT TCTCTTCC 3 8

( 2 ) INFORMATION FOR SEQ ID NO:12:

- ( i ) SEQUENCE CHARACTERISTICS:
  - ( A ) LENGTH: 27 base pairs
  - ( B ) TYPE: nucleic acid
  - ( C ) STRANDEDNESS: single
  - ( D ) TOPOLOGY: linear

( x i ) SEQUENCE DESCRIPTION: SEQ ID NO:12:

GGATCCCGGG TGGATGGTGG GAAGATG 2 7

( 2 ) INFORMATION FOR SEQ ID NO:13:

- ( i ) SEQUENCE CHARACTERISTICS:
  - ( A ) LENGTH: 37 base pairs
  - ( B ) TYPE: nucleic acid
  - ( C ) STRANDEDNESS: single
  - ( D ) TOPOLOGY: linear

( x i ) SEQUENCE DESCRIPTION: SEQ ID NO:13:

ACTAGTCGAC ATGAAATGCA GCTGGGTCAT STTCTTC 3 7

( 2 ) INFORMATION FOR SEQ ID NO:14:

- ( i ) SEQUENCE CHARACTERISTICS:
  - ( A ) LENGTH: 36 base pairs
  - ( B ) TYPE: nucleic acid
  - ( C ) STRANDEDNESS: single
  - ( D ) TOPOLOGY: linear

( x i ) SEQUENCE DESCRIPTION: SEQ ID NO:14:

ACTAGTCGAC ATGGGATGGA GCTRTATCAT SYTCTT 3 6

( 2 ) INFORMATION FOR SEQ ID NO:15:

- ( i ) SEQUENCE CHARACTERISTICS:
  - ( A ) LENGTH: 37 base pairs
  - ( B ) TYPE: nucleic acid
  - ( C ) STRANDEDNESS: single
  - ( D ) TOPOLOGY: linear

( x i ) SEQUENCE DESCRIPTION: SEQ ID NO:15:

ACTAGTCGAC ATGGAAGWIGT GGTTAAACTG GGTTTTT 3 7

( 2 ) INFORMATION FOR SEQ ID NO:16:

- ( i ) SEQUENCE CHARACTERISTICS:
  - ( A ) LENGTH: 35 base pairs
  - ( B ) TYPE: nucleic acid
  - ( C ) STRANDEDNESS: single

-continued

( D ) TOPOLOGY: linear

( x i ) SEQUENCE DESCRIPTION: SEQ ID NO:16:  
ACTAGTCGAC ATGRACITITG GGYTCAGCTT GRITT 3 5

( 2 ) INFORMATION FOR SEQ ID NO:17:

( i ) SEQUENCE CHARACTERISTICS:  
( A ) LENGTH: 40 base pairs  
( B ) TYPE: nucleic acid  
( C ) STRANDEDNESS: single  
( D ) TOPOLOGY: linear

( x i ) SEQUENCE DESCRIPTION: SEQ ID NO:17:  
ACTAGTCGAC ATGGACTCCA GGCTCAATTT AGITTTICCTT 4 0

( 2 ) INFORMATION FOR SEQ ID NO:18:

( i ) SEQUENCE CHARACTERISTICS:  
( A ) LENGTH: 37 base pairs  
( B ) TYPE: nucleic acid  
( C ) STRANDEDNESS: single  
( D ) TOPOLOGY: linear

( x i ) SEQUENCE DESCRIPTION: SEQ ID NO:18:  
ACTAGTCGAC ATGGCTGTCY TRGSGCTRCT CITCTGC 3 7

( 2 ) INFORMATION FOR SEQ ID NO:19:

( i ) SEQUENCE CHARACTERISTICS:  
( A ) LENGTH: 36 base pairs  
( B ) TYPE: nucleic acid  
( C ) STRANDEDNESS: single  
( D ) TOPOLOGY: linear

( x i ) SEQUENCE DESCRIPTION: SEQ ID NO:19:  
ACTAGTCGAC ATGGRATGGA GCKGGRTCTT TMTCTT 3 6

( 2 ) INFORMATION FOR SEQ ID NO:20:

( i ) SEQUENCE CHARACTERISTICS:  
( A ) LENGTH: 33 base pairs  
( B ) TYPE: nucleic acid  
( C ) STRANDEDNESS: single  
( D ) TOPOLOGY: linear

( x i ) SEQUENCE DESCRIPTION: SEQ ID NO:20:  
ACTAGTCGAC ATGAGAGTGC TGATTCITTT GTG 3 3

( 2 ) INFORMATION FOR SEQ ID NO:21:

( i ) SEQUENCE CHARACTERISTICS:  
( A ) LENGTH: 40 base pairs  
( B ) TYPE: nucleic acid  
( C ) STRANDEDNESS: single  
( D ) TOPOLOGY: linear

( x i ) SEQUENCE DESCRIPTION: SEQ ID NO:21:  
ACTAGTCGAC ATGGMITGGG TGTGGAMCTT GCTATTCCTG 4 0

( 2 ) INFORMATION FOR SEQ ID NO:22:

( i ) SEQUENCE CHARACTERISTICS:  
( A ) LENGTH: 37 base pairs  
( B ) TYPE: nucleic acid  
( C ) STRANDEDNESS: single  
( D ) TOPOLOGY: linear

-continued

( x i ) SEQUENCE DESCRIPTION: SEQ ID NO:22:

ACTAGTCGAC ATGGGCAGAC TTACATTCTC ATTCTG

3 7

( 2 ) INFORMATION FOR SEQ ID NO:23:

( i ) SEQUENCE CHARACTERISTICS:

- ( A ) LENGTH: 28 base pairs
- ( B ) TYPE: nucleic acid
- ( C ) STRANDEDNESS: single
- ( D ) TOPOLOGY: linear

( x i ) SEQUENCE DESCRIPTION: SEQ ID NO:23:

GGATCCCGGG CCAGTGGATA GACAGATG

2 8

( 2 ) INFORMATION FOR SEQ ID NO:24:

( i ) SEQUENCE CHARACTERISTICS:

- ( A ) LENGTH: 393 base pairs
- ( B ) TYPE: nucleic acid
- ( C ) STRANDEDNESS: single
- ( D ) TOPOLOGY: linear

( i x ) FEATURE:

- ( A ) NAME/KEY: CDS
- ( B ) LOCATION: 1..393

( i x ) FEATURE:

- ( A ) NAME/KEY: mat\_peptide
- ( B ) LOCATION: 1..393

( x i ) SEQUENCE DESCRIPTION: SEQ ID NO:24:

ATG	GAG	TCA	GAC	ACA	CTC	CTG	CTA	IGG	GTA	CTG	CTG	CTC	TGG	GTT	CCA	4 8
Met	Glu	Ser	Asp	Thr	Leu	Leu	Leu	Trp	Val	Leu	Leu	Leu	Trp	Val	Pro	
1				5					10					15		
GGT	TCC	ACT	GGT	GAC	ATT	GTG	CTG	ACA	CAG	ICT	CCT	GCT	TCC	TTA	GGT	9 6
Gly	Ser	Thr	Gly	Asp	Ile	Val	Leu	Thr	Gln	Ser	Pro	Ala	Ser	Leu	Gly	
			20					25					30			
GTA	TCT	CTG	GGG	CAG	AGG	GCC	ACC	ATC	TCA	TGC	AGG	GCC	AGC	AAA	AGT	14 4
Val	Ser	Leu	Gly	Gln	Arg	Ala	Thr	Ile	Ser	Cys	Arg	Ala	Ser	Lys	Ser	
			35				40					45				
GTC	AGT	ACA	TCT	GGC	TAT	AGT	TAT	ATG	CAC	TGG	TAC	CAA	CAG	AAA	CCA	19 2
Val	Ser	Thr	Ser	Gly	Tyr	Ser	Tyr	Met	His	Trp	Tyr	Gln	Gln	Lys	Pro	
	50					55					60					
GGA	CAG	ACA	CCC	AAA	CTC	CTC	ATC	TAT	CTT	GCA	TCC	AAC	CTA	GAA	TCT	24 0
Gly	Gln	Thr	Pro	Lys	Leu	Leu	Ile	Tyr	Leu	Ala	Ser	Asn	Leu	Glu	Ser	
	65				70					75				80		
GGG	GTC	CCT	GCC	AGG	TTC	AGT	GGC	AGT	GGG	TCT	GGG	ACA	GAC	TTC	ACC	28 8
Gly	Val	Pro	Ala	Arg	Phe	Ser	Gly	Ser	Gly	Ser	Gly	Thr	Asp	Phe	Thr	
				85					90					95		
CTC	AAC	ATC	CAT	CCT	GTG	GAG	GAG	GAG	GAT	GCT	GCA	ACC	TAT	TAC	TGT	33 6
Leu	Asn	Ile	His	Pro	Val	Glu	Glu	Glu	Asp	Ala	Ala	Thr	Tyr	Tyr	Cys	
			100					105					110			
CAG	CAC	AGT	AGG	GAG	AAT	CCG	TAC	ACG	TTC	GGA	GGG	GGG	ACC	AAG	CTG	38 4
Gln	His	Ser	Arg	Glu	Asn	Pro	Tyr	Thr	Phe	Gly	Gly	Gly	Thr	Lys	Leu	
		115				120						125				
GAA	ATA	AAA														39 3
Glu	Ile	Lys														
	130															

( 2 ) INFORMATION FOR SEQ ID NO:25:

( i ) SEQUENCE CHARACTERISTICS:

- ( A ) LENGTH: 131 amino acids
- ( B ) TYPE: amino acid
- ( D ) TOPOLOGY: linear

-continued

( i i ) MOLECULE TYPE: protein

( x i ) SEQUENCE DESCRIPTION: SEQ ID NO:25:

```

Met  Glu  Ser  Asp  Thr  Leu  Leu  Leu  Trp  Val  Leu  Leu  Leu  Trp  Val  Pro
 1      5      10      15
Gly  Ser  Thr  Gly  Asp  Ile  Val  Leu  Thr  Gln  Ser  Pro  Ala  Ser  Leu  Gly
 20      25      30
Val  Ser  Leu  Gly  Gln  Arg  Ala  Thr  Ile  Ser  Cys  Arg  Ala  Ser  Lys  Ser
 35      40      45
Val  Ser  Thr  Ser  Gly  Tyr  Ser  Tyr  Met  His  Trp  Tyr  Gln  Gln  Lys  Pro
 50      55      60
Gly  Gln  Thr  Pro  Lys  Leu  Leu  Ile  Tyr  Leu  Ala  Ser  Asn  Leu  Glu  Ser
 65      70      75      80
Gly  Val  Pro  Ala  Arg  Phe  Ser  Gly  Ser  Gly  Ser  Gly  Thr  Asp  Phe  Thr
 85      90      95
Leu  Asn  Ile  His  Pro  Val  Glu  Glu  Glu  Asp  Ala  Ala  Thr  Tyr  Tyr  Cys
 100     105     110
Gln  His  Ser  Arg  Glu  Asn  Pro  Tyr  Thr  Phe  Gly  Gly  Gly  Thr  Lys  Leu
 115     120     125
Glu  Ile  Lys
 130
    
```

( 2 ) INFORMATION FOR SEQ ID NO:26:

( i ) SEQUENCE CHARACTERISTICS:

- ( A ) LENGTH: 405 base pairs
- ( B ) TYPE: nucleic acid
- ( C ) STRANDEDNESS: single
- ( D ) TOPOLOGY: linear

( i x ) FEATURE:

- ( A ) NAME/KEY: CDS
- ( B ) LOCATION: 1..405

( i x ) FEATURE:

- ( A ) NAME/KEY: mat\_peptide
- ( B ) LOCATION: 1..405

( x i ) SEQUENCE DESCRIPTION: SEQ ID NO:26:

```

ATG  GGA  TGG  AGC  GGG  ATC  TTT  CTC  TTC  CTT  CTG  TCA  GGA  ACT  GCA  GGT      48
Met  Gly  Trp  Ser  Gly  Ile  Phe  Leu  Phe  Leu  Leu  Ser  Gly  Thr  Ala  Gly
 1      5      10      15
GTC  CAC  TCT  GAG  ATC  CAG  CTG  CAG  CAG  TCT  GGA  CCT  GAG  CTG  ATG  AAG      96
Val  His  Ser  Glu  Ile  Gln  Leu  Gln  Gln  Ser  Gly  Pro  Glu  Leu  Met  Lys
 20      25      30
CCT  GGG  GCT  TCA  GTG  AAG  ATA  TCC  TGC  AAG  GCT  TCT  GGT  TAC  TCA  TTC      144
Pro  Gly  Ala  Ser  Val  Lys  Ile  Ser  Cys  Lys  Ala  Ser  Gly  Tyr  Ser  Phe
 35      40      45
ACT  AGC  TAT  TAC  ATA  CAC  TGG  GTG  AAG  CAG  AGC  CAT  GGA  AAG  AGC  CTT      192
Thr  Ser  Tyr  Tyr  Ile  His  Trp  Val  Lys  Gln  Ser  His  Gly  Lys  Ser  Leu
 50      55      60
GAG  TGG  ATT  GGA  TAT  ATT  GAT  CCT  TTC  AAT  GGT  GGT  ACT  AGC  TAC  AAC      240
Glu  Trp  Ile  Gly  Tyr  Ile  Asp  Pro  Phe  Asn  Gly  Gly  Thr  Ser  Tyr  Asn
 65      70      75      80
CAG  AAA  TTC  AAG  GGC  AAG  GCC  ACA  TTG  ACT  GTT  GAC  AAA  TCT  TCC  AGC      288
Gln  Lys  Phe  Lys  Gly  Lys  Ala  Thr  Leu  Thr  Val  Asp  Lys  Ser  Ser  Ser
 85      90      95
ACA  GCC  TAC  ATG  CAT  CTC  AGC  AGC  CTG  ACA  TCT  GAG  GAC  TCT  GCA  GTC      336
Thr  Ala  Tyr  Met  His  Leu  Ser  Ser  Leu  Thr  Ser  Glu  Asp  Ser  Ala  Val
 100     105     110
TAT  TAC  IGT  GCA  AGG  GGG  GGT  AAC  CGC  TTT  GCT  TAC  TGG  GGC  CAA  GGG      384
Tyr  Tyr  Cys  Ala  Arg  Gly  Gly  Asn  Arg  Phe  Ala  Tyr  Trp  Gly  Glu  Gly
    
```

-continued

115	120	125	405
ACT CTG GTC ACT GTC TCT GCA			
Thr Leu Val Thr Val Ser Ala			
130		135	

## ( 2 ) INFORMATION FOR SEQ ID NO:27:

- ( i ) SEQUENCE CHARACTERISTICS:  
 ( A ) LENGTH: 135 amino acids  
 ( B ) TYPE: amino acid  
 ( D ) TOPOLOGY: linear

( i i ) MOLECULE TYPE: protein

( x i ) SEQUENCE DESCRIPTION: SEQ ID NO:27:

Met	Gly	Trp	Ser	Gly	Ile	Phe	Leu	Phe	Leu	Leu	Ser	Gly	Thr	Ala	Gly	
1				5					10					15		
Val	His	Ser	Glu	Ile	Gln	Leu	Gln	Gln	Ser	Gly	Pro	Glu	Leu	Met	Lys	
			20					25					30			
Pro	Gly	Ala	Ser	Val	Lys	Ile	Ser	Cys	Lys	Ala	Ser	Gly	Tyr	Ser	Phe	
		35					40					45				
Thr	Ser	Tyr	Tyr	Ile	His	Trp	Val	Lys	Gln	Ser	His	Gly	Lys	Ser	Leu	
	50					55					60					
Glu	Trp	Ile	Gly	Tyr	Ile	Asp	Pro	Phe	Asn	Gly	Gly	Thr	Ser	Tyr	Asn	
65					70					75					80	
Gln	Lys	Phe	Lys	Gly	Lys	Ala	Thr	Leu	Thr	Val	Asp	Lys	Ser	Ser	Ser	
				85					90					95		
Thr	Ala	Tyr	Met	His	Leu	Ser	Ser	Leu	Thr	Ser	Glu	Asp	Ser	Ala	Val	
			100					105					110			
Tyr	Tyr	Cys	Ala	Arg	Gly	Gly	Asn	Arg	Phe	Ala	Tyr	Trp	Gly	Gln	Gly	
		115					120					125				
Thr	Leu	Val	Thr	Val	Ser	Ala										
	130					135										

## ( 2 ) INFORMATION FOR SEQ ID NO:28:

- ( i ) SEQUENCE CHARACTERISTICS:  
 ( A ) LENGTH: 381 base pairs  
 ( B ) TYPE: nucleic acid  
 ( C ) STRANDEDNESS: single  
 ( D ) TOPOLOGY: linear

( i x ) FEATURE:

- ( A ) NAME/KEY: CDS  
 ( B ) LOCATION: 1..381

( i x ) FEATURE:

- ( A ) NAME/KEY: mat\_peptide  
 ( B ) LOCATION: 1..381

( x i ) SEQUENCE DESCRIPTION: SEQ ID NO:28:

ATG	GTG	TCC	TCA	GCT	CAG	TTC	CTT	GGT	CTC	CTG	TTG	CTC	TGT	TTT	CAA	48
Met	Val	Ser	Ser	Ala	Gln	Phe	Leu	Gly	Leu	Leu	Leu	Leu	Cys	Phe	Gln	
1				5					10					15		
GGT	ACC	AGA	TGT	GAT	ATC	CAG	ATG	ACA	CAG	ACT	ACA	TCC	TCC	CTG	TCT	96
Gly	Thr	Arg	Cys	Asp	Ile	Gln	Met	Thr	Gln	Thr	Thr	Ser	Ser	Leu	Ser	
			20				25						30			
GCC	TCT	CTG	GGA	GAC	AGA	GTC	ACC	ATC	AGT	TGC	AGG	GCA	AGT	CAG	GAC	144
Ala	Ser	Leu	Gly	Asp	Arg	Val	Thr	Ile	Ser	Cys	Arg	Ala	Ser	Gln	Asp	
		35					40					45				
ATT	AGC	AGT	TAT	TTA	AAC	TGG	TAT	CAG	CAG	AAA	CCA	GAT	GGA	ACT	ATT	192
Ile	Ser	Ser	Tyr	Leu	Asn	Trp	Tyr	Gln	Gln	Lys	Pro	Asp	Gly	Thr	Ile	
	50					55					60					

-continued

AAA	CTC	CTG	ATC	TAC	TAC	ACA	TCA	AGA	TTA	CAC	TCA	GGA	GTC	CCA	TCA	240
Lys	Leu	Leu	Ile	Tyr	Tyr	Thr	Ser	Arg	Leu	His	Ser	Gly	Val	Pro	Ser	
65					70					75					80	
AGG	TTC	AGT	GGC	AGT	GGG	ICT	GGA	ACA	GAT	TAT	TCT	CTC	ACC	ATT	AAC	288
Arg	Phe	Ser	Gly	Ser	Gly	Ser	Gly	Thr	Asp	Tyr	Ser	Leu	Thr	Ile	Asn	
				85					90					95		
AAC	CTG	GAG	CAA	GAA	GAC	ATT	GCC	ACT	TAC	TTI	TGC	CAA	CAG	GGT	AAC	336
Asn	Leu	Glu	Gln	Glu	Asp	Ile	Ala	Thr	Tyr	Phe	Cys	Gln	Gln	Gly	Asn	
			100					105					110			
ACG	CTT	CCG	TAC	ACG	TTC	GGA	GGG	GGG	ACC	AAG	CTG	GAA	ATA	AAT		381
Thr	Leu	Pro	Tyr	Thr	Phe	Gly	Gly	Gly	Thr	Lys	Leu	Glu	Ile	Asn		
		115				120						125				

## ( 2 ) INFORMATION FOR SEQ ID NO:29:

## ( i ) SEQUENCE CHARACTERISTICS:

- ( A ) LENGTH: 127 amino acids
- ( B ) TYPE: amino acid
- ( D ) TOPOLOGY: linear

## ( i i ) MOLECULE TYPE: protein

## ( x i ) SEQUENCE DESCRIPTION: SEQ ID NO:29:

Met	Val	Ser	Ser	Ala	Gln	Phe	Leu	Gly	Leu	Leu	Leu	Leu	Cys	Phe	Gln	
1				5					10					15		
Gly	Thr	Arg	Cys	Asp	Ile	Gln	Met	Thr	Gln	Thr	Thr	Ser	Ser	Leu	Ser	
			20					25					30			
Ala	Ser	Leu	Gly	Asp	Arg	Val	Thr	Ile	Ser	Cys	Arg	Ala	Ser	Gln	Asp	
		35					40					45				
Ile	Ser	Ser	Tyr	Leu	Asn	Trp	Tyr	Gln	Gln	Lys	Pro	Asp	Gly	Thr	Ile	
	50					55					60					
Lys	Leu	Leu	Ile	Tyr	Tyr	Thr	Ser	Arg	Leu	His	Ser	Gly	Val	Pro	Ser	
65				70						75					80	
Arg	Phe	Ser	Gly	Ser	Gly	Ser	Gly	Thr	Asp	Tyr	Ser	Leu	Thr	Ile	Asn	
				85					90					95		
Asn	Leu	Glu	Gln	Glu	Asp	Ile	Ala	Thr	Tyr	Phe	Cys	Gln	Gln	Gly	Asn	
			100					105					110			
Thr	Leu	Pro	Tyr	Thr	Phe	Gly	Gly	Gly	Thr	Lys	Leu	Glu	Ile	Asn		
		115				120						125				

## ( 2 ) INFORMATION FOR SEQ ID NO:30:

## ( i ) SEQUENCE CHARACTERISTICS:

- ( A ) LENGTH: 411 base pairs
- ( B ) TYPE: nucleic acid
- ( C ) STRANDEDNESS: single
- ( D ) TOPOLOGY: linear

## ( i x ) FEATURE:

- ( A ) NAME/KEY: CDS
- ( B ) LOCATION: 1..411

## ( i x ) FEATURE:

- ( A ) NAME/KEY: mat\_peptide
- ( B ) LOCATION: 1..411

## ( x i ) SEQUENCE DESCRIPTION: SEQ ID NO:30:

ATG	AGA	GTG	CTG	ATT	CTT	TTG	TGG	CTG	TTC	ACA	GCC	TTT	CCT	GGT	ATC	48
Met	Arg	Val	Leu	Ile	Leu	Leu	Trp	Leu	Phe	Thr	Ala	Phe	Pro	Gly	Ile	
1				5					10					15		
CTG	TCT	GAT	GTG	CAG	CIT	CAG	GAG	TCG	GGA	CCT	GTC	CTG	GTG	AAG	CCT	96
Leu	Ser	Asp	Val	Gln	Leu	Gln	Glu	Ser	Gly	Pro	Val	Leu	Val	Lys	Pro	
			20					25					30			
TCT	CAG	TCT	CTG	TCC	CTC	ACC	TGC	ACT	GTC	ACT	GGC	TAC	TCA	ATC	ACC	144



-continued

Ser	Gln	Ser	Leu	Ser	Leu	Thr	Cys	Thr	Val	Thr	Gly	Tyr	Ser	Ile	Thr	
		35					40					45				
AGT	GAT	CAT	GCC	IGG	AGC	TGG	ATC	CGG	CAG	TTT	CCA	GGA	AAC	AAA	CTG	192
Ser	Asp	His	Ala	Trp	Ser	Trp	Ile	Arg	Gln	Phe	Pro	Gly	Asn	Lys	Leu	
	50					55					60					
GAG	TGG	ATG	GGC	TAC	ATA	AGT	TAC	AGT	GGT	ATC	ACT	ACC	TAC	AAC	CCA	240
Glu	Trp	Met	Gly	Tyr	Ile	Ser	Tyr	Ser	Gly	Ile	Thr	Thr	Tyr	Asn	Pro	
	65				70					75					80	
TCT	CTC	AAA	AGT	CGA	ATC	TCT	ATC	ACT	CGA	GAC	ACA	TCC	AAG	AAC	CAG	288
Ser	Leu	Lys	Ser	Arg	Ile	Ser	Ile	Thr	Arg	Asp	Thr	Ser	Lys	Asn	Gln	
				85					90					95		
TTC	TTC	CTA	CAG	TIG	AAAT	TCT	GTG	ACT	ACT	GGG	GAC	ACG	TCC	ACA	TAT	336
Phe	Phe	Leu	Gln	Leu	Asn	Ser	Val	Thr	Thr	Gly	Asp	Thr	Ser	Thr	Tyr	
			100					105					110			
TAC	TGT	GCA	AGA	TCC	CTA	GCT	CGG	ACT	ACG	GCT	ATG	GAC	TAC	TGG	GGT	384
Tyr	Cys	Ala	Arg	Ser	Leu	Ala	Arg	Thr	Thr	Ala	Met	Asp	Tyr	Trp	Gly	
		115					120					125				
CAA	GGA	ACC	TCA	GTC	ACC	GTC	TCC	TCA								411
Gln	Gly	Thr	Ser	Val	Thr	Val	Ser	Ser								
	130					135										

## ( 2 ) INFORMATION FOR SEQ ID NO:31:

## ( i ) SEQUENCE CHARACTERISTICS:

- ( A ) LENGTH: 137 amino acids
- ( B ) TYPE: amino acid
- ( D ) TOPOLOGY: linear

## ( ii ) MOLECULE TYPE: protein

## ( xi ) SEQUENCE DESCRIPTION: SEQ ID NO:31:

Met	Arg	Val	Leu	Ile	Leu	Leu	Trp	Leu	Phe	Thr	Ala	Phe	Pro	Gly	Ile	
1				5					10					15		
Leu	Ser	Asp	Val	Gln	Leu	Gln	Glu	Ser	Gly	Pro	Val	Leu	Val	Lys	Pro	
			20					25					30			
Ser	Gln	Ser	Leu	Ser	Leu	Thr	Cys	Thr	Val	Thr	Gly	Tyr	Ser	Ile	Thr	
			35				40					45				
Ser	Asp	His	Ala	Trp	Ser	Trp	Ile	Arg	Gln	Phe	Pro	Gly	Asn	Lys	Leu	
	50					55					60					
Glu	Trp	Met	Gly	Tyr	Ile	Ser	Tyr	Ser	Gly	Ile	Thr	Thr	Tyr	Asn	Pro	
	65				70					75					80	
Ser	Leu	Lys	Ser	Arg	Ile	Ser	Ile	Thr	Arg	Asp	Thr	Ser	Lys	Asn	Gln	
				85					90					95		
Phe	Phe	Leu	Gln	Leu	Asn	Ser	Val	Thr	Thr	Gly	Asp	Thr	Ser	Thr	Tyr	
			100					105					110			
Tyr	Cys	Ala	Arg	Ser	Leu	Ala	Arg	Thr	Thr	Ala	Met	Asp	Tyr	Trp	Gly	
		115					120					125				
Gln	Gly	Thr	Ser	Val	Thr	Val	Ser	Ser								
	130					135										

## ( 2 ) INFORMATION FOR SEQ ID NO:32:

## ( i ) SEQUENCE CHARACTERISTICS:

- ( A ) LENGTH: 393 base pairs
- ( B ) TYPE: nucleic acid
- ( C ) STRANDEDNESS: single
- ( D ) TOPOLOGY: linear

## ( ix ) FEATURE:

- ( A ) NAME/KEY: CDS
- ( B ) LOCATION: 1..393

## ( ix ) FEATURE:

-continued

( A ) NAME/KEY: mat\_peptide  
( B ) LOCATION: 1..393

( x i ) SEQUENCE DESCRIPTION: SEQ ID NO:32:

ATG	GAG	TCA	GAC	ACA	CTC	CTG	CTA	TGG	GTG	CTG	CTG	CTC	TGG	GTT	CCA	48
Met	Glu	Ser	Asp	Thr	Leu	Leu	Leu	Trp	Val	Leu	Leu	Leu	Trp	Val	Pro	
1				5					10					15		
GGT	TCC	ACA	GGT	GAC	ATT	GTG	TTG	ATC	CAA	TCT	CCA	GCT	TCT	TIG	GCT	96
Gly	Ser	Thr	Gly	Asp	Ile	Val	Leu	Ile	Gln	Ser	Pro	Ala	Ser	Leu	Ala	
			20					25					30			
GTG	TCT	CTA	GGG	CAG	AGG	GCC	ACC	ATA	TCC	TGC	AGA	GCC	AGT	GAA	AGT	144
Val	Ser	Leu	Gly	Gln	Arg	Ala	Thr	Ile	Ser	Cys	Arg	Ala	Ser	Glu	Ser	
			35				40					45				
GTT	GAT	AGT	TAT	GGC	AAT	AGT	TTT	ATG	CAC	TGG	TAC	CAG	CAG	AAA	CCA	192
Val	Asp	Ser	Tyr	Gly	Asn	Ser	Phe	Met	His	Trp	Tyr	Gln	Gln	Lys	Pro	
	50					55					60					
GGA	CAG	CCA	CCC	AAA	CTC	CTC	ATC	TAT	CGT	GCA	TCC	AAC	CTA	GAA	TCT	240
Gly	Gln	Pro	Pro	Lys	Leu	Leu	Ile	Tyr	Arg	Ala	Ser	Asn	Leu	Glu	Ser	
	65				70					75					80	
GGG	ATC	CCT	GCC	AGG	TTC	AGT	GGC	AGT	GGG	TCT	AGG	ACA	GAC	TTC	ACC	288
Gly	Ile	Pro	Ala	Arg	Phe	Ser	Gly	Ser	Gly	Ser	Arg	Thr	Asp	Phe	Thr	
				85					90					95		
CTC	ACC	ATT	AAT	CCT	GTG	GAG	GCT	GAT	GAT	GTT	GCA	ACC	TAT	TAC	TGT	336
Leu	Thr	Ile	Asn	Pro	Val	Glu	Ala	Asp	Asp	Val	Ala	Thr	Tyr	Tyr	Cys	
			100					105					110			
CAG	CAA	AGT	AAT	GAG	GAT	CCT	CCC	ACG	TTC	GGT	GCT	GGG	ACC	AAG	CTG	384
Gln	Gln	Ser	Asn	Glu	Asp	Pro	Pro	Thr	Phe	Gly	Ala	Gly	Thr	Lys	Leu	
			115				120					125				
GAG	CTG	AAA														393
Glu	Leu	Lys														
	130															

( 2 ) INFORMATION FOR SEQ ID NO:33:

( i ) SEQUENCE CHARACTERISTICS:

( A ) LENGTH: 131 amino acids  
( B ) TYPE: amino acid  
( D ) TOPOLOGY: linear

( i i ) MOLECULE TYPE: protein

( x i ) SEQUENCE DESCRIPTION: SEQ ID NO:33:

Met	Glu	Ser	Asp	Thr	Leu	Leu	Leu	Trp	Val	Leu	Leu	Leu	Trp	Val	Pro	
1				5					10					15		
Gly	Ser	Thr	Gly	Asp	Ile	Val	Leu	Ile	Gln	Ser	Pro	Ala	Ser	Leu	Ala	
			20					25					30			
Val	Ser	Leu	Gly	Gln	Arg	Ala	Thr	Ile	Ser	Cys	Arg	Ala	Ser	Glu	Ser	
			35				40					45				
Val	Asp	Ser	Tyr	Gly	Asn	Ser	Phe	Met	His	Trp	Tyr	Gln	Gln	Lys	Pro	
	50					55					60					
Gly	Gln	Pro	Pro	Lys	Leu	Leu	Ile	Tyr	Arg	Ala	Ser	Asn	Leu	Glu	Ser	
	65				70					75					80	
Gly	Ile	Pro	Ala	Arg	Phe	Ser	Gly	Ser	Gly	Ser	Arg	Thr	Asp	Phe	Thr	
				85					90					95		
Leu	Thr	Ile	Asn	Pro	Val	Glu	Ala	Asp	Asp	Val	Ala	Thr	Tyr	Tyr	Cys	
			100					105					110			
Gln	Gln	Ser	Asn	Glu	Asp	Pro	Pro	Thr	Phe	Gly	Ala	Gly	Thr	Lys	Leu	
		115					120					125				
Glu	Leu	Lys														
	130															

-continued

## ( 2 ) INFORMATION FOR SEQ ID NO:34:

( i ) SEQUENCE CHARACTERISTICS:  
 ( A ) LENGTH: 417 base pairs  
 ( B ) TYPE: nucleic acid  
 ( C ) STRANDEDNESS: single  
 ( D ) TOPOLOGY: linear

( i x ) FEATURE:  
 ( A ) NAME/KEY: CDS  
 ( B ) LOCATION: 1.417

( i x ) FEATURE:  
 ( A ) NAME/KEY: mat\_peptide  
 ( B ) LOCATION: 1.417

( x i ) SEQUENCE DESCRIPTION: SEQ ID NO:34:

ATG	GGA	TGG	AGC	GGG	GTC	TTT	ATC	TTC	CTC	CTG	TCA	GTA	ACT	GCA	GGT	48
Met	Gly	Trp	Ser	Gly	Val	Phe	Ile	Phe	Leu	Leu	Ser	Val	Thr	Ala	Gly	
1				5					10					15		
GTC	CAC	TCC	CAG	GTT	CAA	TTG	CAG	CAG	TCT	GGA	GCT	GAG	TTG	ATG	AAG	96
Val	His	Ser	Gln	Val	Gln	Leu	Gln	Gln	Ser	Gly	Ala	Glu	Leu	Met	Lys	
			20					25					30			
CCT	GGG	GCC	TCA	GTC	AAG	ATC	TCC	TGC	AAG	GCT	ACT	GGC	TAC	ACA	TTC	144
Pro	Gly	Ala	Ser	Val	Lys	Ile	Ser	Cys	Lys	Ala	Thr	Gly	Tyr	Thr	Phe	
		35					40					45				
AGT	AGT	TAT	TGG	ATA	GTG	TGG	ATA	AAG	CAG	AGG	CCT	GGA	CAT	GGC	CIT	192
Ser	Ser	Tyr	Trp	Ile	Val	Trp	Ile	Lys	Gln	Arg	Pro	Gly	His	Gly	Leu	
	50					55					60					
GAG	TGG	ATT	GGA	GAG	ATT	TTA	CCT	GGA	ACC	GGT	AGT	ACT	AAC	TAC	AAT	240
Glu	Trp	Ile	Gly	Glu	Ile	Leu	Pro	Gly	Thr	Gly	Ser	Thr	Asa	Tyr	Asn	
	65				70					75					80	
GAG	AAA	TTC	AAG	GGC	AAG	GCC	ACA	TTC	ACT	GCA	GAT	ACA	TCT	TCC	AAC	288
Glu	Lys	Phe	Lys	Gly	Lys	Ala	Thr	Phe	Thr	Ala	Asp	Thr	Ser	Ser	Asn	
				85					90					95		
ACA	GCC	TAC	ATG	CAA	CTC	AGC	AGC	CTG	ACA	TCT	GAG	GAC	TCT	GCC	GTC	336
Thr	Ala	Tyr	Met	Gln	Leu	Ser	Ser	Leu	Thr	Ser	Glu	Asp	Ser	Ala	Val	
			100					105					110			
TAT	TAC	TGT	GCA	AGT	CTA	GAC	AGC	TCG	GGC	TAC	TAT	GCT	ATG	GAC	TAT	384
Tyr	Tyr	Cys	Ala	Ser	Leu	Asp	Ser	Ser	Gly	Tyr	Tyr	Ala	Met	Asp	Tyr	
		115					120					125				
TGG	GGT	CAA	GGA	ACC	TCA	GTC	ACC	GTC	TCC	TCA						417
Trp	Gly	Gln	Gly	Thr	Ser	Val	Thr	Val	Ser	Ser						
	130					135										

## ( 2 ) INFORMATION FOR SEQ ID NO:35:

( i ) SEQUENCE CHARACTERISTICS:  
 ( A ) LENGTH: 139 amino acids  
 ( B ) TYPE: amino acid  
 ( D ) TOPOLOGY: linear

( i i ) MOLECULE TYPE: protein

( x i ) SEQUENCE DESCRIPTION: SEQ ID NO:35:

Met	Gly	Trp	Ser	Gly	Val	Phe	Ile	Phe	Leu	Leu	Ser	Val	Thr	Ala	Gly	
1				5					10					15		
Val	His	Ser	Gln	Val	Gln	Leu	Gln	Gln	Ser	Gly	Ala	Glu	Leu	Met	Lys	
			20					25					30			
Pro	Gly	Ala	Ser	Val	Lys	Ile	Ser	Cys	Lys	Ala	Thr	Gly	Tyr	Thr	Phe	
		35					40					45				
Ser	Ser	Tyr	Trp	Ile	Val	Trp	Ile	Lys	Gln	Arg	Pro	Gly	His	Gly	Leu	
	50					55					60					
Glu	Trp	Ile	Gly	Glu	Ile	Leu	Pro	Gly	Thr	Gly	Ser	Thr	Asn	Tyr	Asn	

-continued

---

65	70	75	80
Glu Lys Phe Lys Gly Lys Ala Thr Phe Thr Ala Asp Thr Ser Ser Asn	85	90	95
Thr Ala Tyr Met Gln Leu Ser Ser Leu Thr Ser Glu Asp Ser Ala Val	100	105	110
Tyr Tyr Cys Ala Ser Leu Asp Ser Ser Gly Tyr Tyr Ala Met Asp Tyr	115	120	125
Trp Gly Gln Gly Thr Ser Val Thr Val Ser Ser	130	135	

( 2 ) INFORMATION FOR SEQ ID NO:36:

- ( i ) SEQUENCE CHARACTERISTICS:
  - ( A ) LENGTH: 381 base pairs
  - ( B ) TYPE: nucleic acid
  - ( C ) STRANDEDNESS: single
  - ( D ) TOPOLOGY: linear

- ( i x ) FEATURE:
  - ( A ) NAME/KEY: CDS
  - ( B ) LOCATION: 1..381

- ( i x ) FEATURE:
  - ( A ) NAME/KEY: mat\_peptide
  - ( B ) LOCATION: 1..381

( x i ) SEQUENCE DESCRIPTION: SEQ ID NO:36:

ATG	GTG	TCC	ACA	CCT	CAG	TTC	CTT	GGT	CTC	CTG	TTG	ATC	TGT	TTT	CAA	48
Met	Val	Ser	Thr	Pro	Gln	Phe	Leu	Gly	Leu	Leu	Leu	Ile	Cys	Phe	Gln	
1				5					10					15		
GGT	ACC	AGA	TGT	GAT	ATC	CAG	ATG	ACA	CAG	ACT	ACA	TCC	TCC	CTG	ICT	96
Gly	Thr	Arg	Cys	Asp	Ile	Gln	Met	Thr	Gln	Thr	Thr	Ser	Ser	Leu	Ser	
			20				25						30			
GCC	TCT	CTG	GGA	GAC	AGA	GTC	ACC	ATC	AGT	TGC	AGG	GCA	AGT	CAG	GAC	144
Ala	Ser	Leu	Gly	Asp	Arg	Val	Thr	Ile	Ser	Cys	Arg	Ala	Ser	Gln	Asp	
		35				40						45				
ATT	AGT	AAT	TAT	TTA	AAC	TGG	TAT	CAA	CAG	AAA	CCA	GAT	GGA	ACT	GTT	192
Ile	Ser	Asn	Tyr	Leu	Asn	Trp	Tyr	Gln	Gln	Lys	Pro	Asp	Gly	Thr	Val	
	50					55					60					
AAA	CTC	CTG	ATC	TAC	TAT	ACA	TCA	AGA	TTA	CAC	TCA	GGA	GTC	CCA	TCA	240
Lys	Leu	Leu	Ile	Tyr	Tyr	Thr	Ser	Arg	Leu	His	Ser	Gly	Val	Pro	Ser	
	65				70				75					80		
AGG	ITC	AGT	GGC	AGT	GGG	TCT	GGA	ACA	GAT	TAT	TCT	CTC	ACC	ATT	AGC	288
Arg	Phe	Ser	Gly	Ser	Gly	Ser	Gly	Thr	Asp	Tyr	Ser	Leu	Thr	Ile	Ser	
			85				90						95			
AAC	CTG	GAG	CAA	GAA	GAT	ATT	GCC	AGT	TAC	TTT	TGC	CAA	CAG	GGT	TAT	336
Asn	Leu	Glu	Gln	Glu	Asp	Ile	Ala	Ser	Tyr	Phe	Cys	Gln	Gln	Gly	Tyr	
			100				105						110			
ACG	CCT	CCG	TGG	ACG	TTC	GGT	GGA	GGC	ACC	AAG	TIG	GAA	ATC	AAA		381
Thr	Pro	Pro	Trp	Thr	Phe	Gly	Gly	Gly	Thr	Lys	Leu	Glu	Ile	Lys		
		115				120						125				

( 2 ) INFORMATION FOR SEQ ID NO:37:

- ( i ) SEQUENCE CHARACTERISTICS:
  - ( A ) LENGTH: 127 amino acids
  - ( B ) TYPE: amino acid
  - ( D ) TOPOLOGY: linear

- ( i i ) MOLECULE TYPE: protein

( x i ) SEQUENCE DESCRIPTION: SEQ ID NO:37:

Met	Val	Ser	Thr	Pro	Gln	Phe	Leu	Gly	Leu	Leu	Leu	Ile	Cys	Phe	Gln
1				5				10						15	

-continued

---

Gly	Thr	Arg	Cys 20	Asp	Ile	Gln	Met	Thr 25	Gln	Thr	Thr	Ser	Ser 30	Leu	Ser
Ala	Ser	Leu 35	Gly	Asp	Arg	Val	Thr 40	Ile	Ser	Cys	Arg	Ala 45	Ser	Gln	Asp
Ile	Ser 50	Asn	Tyr	Leu	Asn	Trp 55	Tyr	Gln	Gln	Lys	Pro 60	Asp	Gly	Thr	Val
Lys 65	Leu	Leu	Ile	Tyr	Tyr 70	Thr	Ser	Arg	Leu	His 75	Ser	Gly	Val	Pro	Ser 80
Arg	Phe	Ser	Gly	Ser 85	Gly	Ser	Gly	Thr	Asp 90	Tyr	Ser	Leu	Thr	Ile	Ser 95
Asn	Leu	Glu 100	Gln	Glu	Asp	Ile	Ala	Ser 105	Tyr	Phe	Cys	Gln	Gln 110	Gly	Tyr
Thr	Pro 115	Pro	Trp	Thr	Phe	Gly	Gly 120	Gly	Thr	Lys	Leu	Glu 125	Ile	Lys	

( 2 ) INFORMATION FOR SEQ ID NO:38:

- ( i ) SEQUENCE CHARACTERISTICS:  
 ( A ) LENGTH: 402 base pairs  
 ( B ) TYPE: nucleic acid  
 ( C ) STRANDEDNESS: single  
 ( D ) TOPOLOGY: linear

- ( ix ) FEATURE:  
 ( A ) NAME/KEY: CDS  
 ( B ) LOCATION: 1..402

- ( ix ) FEATURE:  
 ( A ) NAME/KEY: mat\_peptide  
 ( B ) LOCATION: 1..402

( x i ) SEQUENCE DESCRIPTION: SEQ ID NO:38:

ATG	GAG	CIG	GAT	CIT	TAT	CTT	ATT	CTG	TCA	GTA	ACT	TCA	GGT	GTC	TAC	48
Met 1	Glu	Leu	Asp	Leu	Tyr	Leu	Ile	Leu	Ser	Val	Thr	Ser	Gly	Val	Tyr	
				5					10					15		
TCA	CAG	GTT	CAG	CTC	CAG	CAG	TCT	GGG	GCT	GAG	CTG	GCA	AGA	CCT	GGG	96
Ser	Gln	Val	Gln	Leu	Gln	Gln	Ser	Gly	Ala	Glu	Leu	Ala	Arg	Pro	Gly	
			20					25					30			
GCT	TCA	GTG	AAG	TTG	TCC	TGC	AAG	GCT	TCT	GGC	TAC	ACC	TTT	ACT	AAC	144
Ala	Ser	Val	Lys	Leu	Ser	Cys	Lys	Ala	Ser	Gly	Tyr	Thr	Phe	Thr	Asn	
		35				40					45					
TAC	TGG	GTG	CAG	TGG	GTA	AAA	CAG	AGG	CCT	GGA	CAG	GGT	CTG	GAA	TGG	192
Tyr	Trp	Val	Gln	Trp	Val	Lys	Gln	Arg	Pro	Gly	Gln	Gly	Leu	Glu	Trp	
	50				55					60						
ATT	GGG	TCT	ATT	TAT	CCT	GGA	GAT	GGT	GAT	ACT	AGG	AAC	ACT	CAG	AAG	240
Ile	Gly	Ser	Ile	Tyr	Pro	Gly	Asp	Gly	Asp	Thr	Arg	Asn	Thr	Gln	Lys	
	65			70				75							80	
TTC	AAG	GGC	AAG	GCC	ACA	TTG	ACT	GCA	GAT	AAA	TCC	TCC	ATC	ACA	GCC	288
Phe	Lys	Gly	Lys	Ala	Thr	Leu	Thr	Ala	Asp	Lys	Ser	Ser	Ile	Thr	Ala	
			85					90						95		
TAC	ATG	CAA	CTC	ACC	AGC	TTG	GCA	TCT	GAG	GAC	TCT	GCG	GTC	TAT	TAC	336
Tyr	Met	Gln	Leu	Thr	Ser	Leu	Ala	Ser	Glu	Asp	Ser	Ala	Val	Tyr	Tyr	
			100					105					110			
TGT	GCA	AGA	TCG	ACT	GGT	AAC	CAC	TTT	GAC	TAC	TGG	GGC	CAA	GGC	ACC	384
Cys	Ala	Arg	Ser	Thr	Gly	Asn	His	Phe	Asp	Tyr	Trp	Gly	Gln	Gly	Thr	
	115					120						125				
ACT	CTC	ACA	GTC	TCC	TCA											402
Thr	Leu	Thr	Val	Ser	Ser											
			130													

( 2 ) INFORMATION FOR SEQ ID NO:39:

- ( i ) SEQUENCE CHARACTERISTICS:

-continued

( A ) LENGTH: 134 amino acids  
 ( B ) TYPE: amino acid  
 ( D ) TOPOLOGY: linear

( i i ) MOLECULE TYPE: protein

( x i ) SEQUENCE DESCRIPTION: SEQ ID NO:39:

```

Met  Glu  Leu  Asp  Leu  Tyr  Leu  Ile  Leu  Ser  Val  Thr  Ser  Gly  Val  Tyr
 1      5      10      15
Ser  Gln  Val  Gln  Leu  Gln  Gln  Ser  Gly  Ala  Glu  Leu  Ala  Arg  Pro  Gly
 20      25      30
Ala  Ser  Val  Lys  Leu  Ser  Cys  Lys  Ala  Ser  Gly  Tyr  Thr  Phe  Thr  Asn
 35      40      45
Tyr  Trp  Val  Gln  Trp  Val  Lys  Gln  Arg  Pro  Gly  Gln  Gly  Leu  Glu  Trp
 50      55      60
Ile  Gly  Ser  Ile  Tyr  Pro  Gly  Asp  Gly  Asp  Thr  Arg  Asn  Thr  Gln  Lys
 65      70      75      80
Phe  Lys  Gly  Lys  Ala  Thr  Leu  Thr  Ala  Asp  Lys  Ser  Ser  Ile  Thr  Ala
 85      90      95
Tyr  Met  Gln  Leu  Thr  Ser  Leu  Ala  Ser  Glu  Asp  Ser  Ala  Val  Tyr  Tyr
 100     105     110
Cys  Ala  Arg  Ser  Thr  Gly  Asn  His  Phe  Asp  Tyr  Trp  Gly  Gln  Gly  Thr
 115     120     125
Thr  Leu  Thr  Val  Ser  Ser
 130

```

( 2 ) INFORMATION FOR SEQ ID NO:40:

( i ) SEQUENCE CHARACTERISTICS:

( A ) LENGTH: 35 base pairs  
 ( B ) TYPE: nucleic acid  
 ( C ) STRANDEDNESS: single  
 ( D ) TOPOLOGY: linear

( x i ) SEQUENCE DESCRIPTION: SEQ ID NO:40:

ACAAAGCTTC CACCATGGAG ICAGACACAC TCCTG 3 5

( 2 ) INFORMATION FOR SEQ ID NO:41:

( i ) SEQUENCE CHARACTERISTICS:

( A ) LENGTH: 36 base pairs  
 ( B ) TYPE: nucleic acid  
 ( C ) STRANDEDNESS: single  
 ( D ) TOPOLOGY: linear

( x i ) SEQUENCE DESCRIPTION: SEQ ID NO:41:

GGCTAAGCTT CCACCATGGG ATGGAGCGGG ATCTTT 3 6

( 2 ) INFORMATION FOR SEQ ID NO:42:

( i ) SEQUENCE CHARACTERISTICS:

( A ) LENGTH: 35 base pairs  
 ( B ) TYPE: nucleic acid  
 ( C ) STRANDEDNESS: single  
 ( D ) TOPOLOGY: linear

( x i ) SEQUENCE DESCRIPTION: SEQ ID NO:42:

CTTGATCCA CTCACGTTTT AITCCAGCT TGGTC 3 5

( 2 ) INFORMATION FOR SEQ ID NO:43:

( i ) SEQUENCE CHARACTERISTICS:

( A ) LENGTH: 36 base pairs  
 ( B ) TYPE: nucleic acid

-continued

---

( C ) STRANDEDNESS: single  
( D ) TOPOLOGY: linear

( x i ) SEQUENCE DESCRIPTION: SEQ ID NO:43:

GTTGGATCCA CTCACCTGCA GAGACAGTTA CCAGAG 3 6

( 2 ) INFORMATION FOR SEQ ID NO:44:

( i ) SEQUENCE CHARACTERISTICS:  
( A ) LENGTH: 35 base pairs  
( B ) TYPE: nucleic acid  
( C ) STRANDEDNESS: single  
( D ) TOPOLOGY: linear

( x i ) SEQUENCE DESCRIPTION: SEQ ID NO:44:

CTTGGATCCA CTCACGATTT ATTTCCAGCT TGGTC 3 5

( 2 ) INFORMATION FOR SEQ ID NO:45:

( i ) SEQUENCE CHARACTERISTICS:  
( A ) LENGTH: 35 base pairs  
( B ) TYPE: nucleic acid  
( C ) STRANDEDNESS: single  
( D ) TOPOLOGY: linear

( x i ) SEQUENCE DESCRIPTION: SEQ ID NO:45:

CTTGGATCCA CTCACGTTTT ATTTCCAGCT TGGTC 3 5

( 2 ) INFORMATION FOR SEQ ID NO:46:

( i ) SEQUENCE CHARACTERISTICS:  
( A ) LENGTH: 36 base pairs  
( B ) TYPE: nucleic acid  
( C ) STRANDEDNESS: single  
( D ) TOPOLOGY: linear

( x i ) SEQUENCE DESCRIPTION: SEQ ID NO:46:

ACAAAGCTTC CACCATGGTG TCCTCAGCTC AGTTCC 3 6

( 2 ) INFORMATION FOR SEQ ID NO:47:

( i ) SEQUENCE CHARACTERISTICS:  
( A ) LENGTH: 39 base pairs  
( B ) TYPE: nucleic acid  
( C ) STRANDEDNESS: single  
( D ) TOPOLOGY: linear

( x i ) SEQUENCE DESCRIPTION: SEQ ID NO:47:

TGTTAGATCT ACTCACCTGA GGAGACAGTG ACTGAGGTT 3 9

( 2 ) INFORMATION FOR SEQ ID NO:48:

( i ) SEQUENCE CHARACTERISTICS:  
( A ) LENGTH: 36 base pairs  
( B ) TYPE: nucleic acid  
( C ) STRANDEDNESS: single  
( D ) TOPOLOGY: linear

( x i ) SEQUENCE DESCRIPTION: SEQ ID NO:48:

GTCTAAGCTT CCACCATGAG AGTGCTGATT CTTTTG 3 6

( 2 ) INFORMATION FOR SEQ ID NO:49:

( i ) SEQUENCE CHARACTERISTICS:  
( A ) LENGTH: 17 base pairs  
( B ) TYPE: nucleic acid  
( C ) STRANDEDNESS: single  
( D ) TOPOLOGY: linear

-continued

( x i ) SEQUENCE DESCRIPTION: SEQ ID NO:49:  
T A C G C A A A C C G C C T C T C 1 7

( 2 ) INFORMATION FOR SEQ ID NO:50:  
( i ) SEQUENCE CHARACTERISTICS:  
( A ) LENGTH: 18 base pairs  
( B ) TYPE: nucleic acid  
( C ) STRANDEDNESS: single  
( D ) TOPOLOGY: linear  
( x i ) SEQUENCE DESCRIPTION: SEQ ID NO:50:  
G A G T G C A C C A T A T G C G G T 1 8

( 2 ) INFORMATION FOR SEQ ID NO:51:  
( i ) SEQUENCE CHARACTERISTICS:  
( A ) LENGTH: 55 base pairs  
( B ) TYPE: nucleic acid  
( C ) STRANDEDNESS: single  
( D ) TOPOLOGY: linear  
( x i ) SEQUENCE DESCRIPTION: SEQ ID NO:51:  
A C C G T G T C T G G C T A C A C C T C A C C A G C G A T C A T G C C T G G A G C T G G G T G A G A C A G C 5 5

( 2 ) INFORMATION FOR SEQ ID NO:52:  
( i ) SEQUENCE CHARACTERISTICS:  
( A ) LENGTH: 63 base pairs  
( B ) TYPE: nucleic acid  
( C ) STRANDEDNESS: single  
( D ) TOPOLOGY: linear  
( x i ) SEQUENCE DESCRIPTION: SEQ ID NO:52:  
T G A G T G G A T T G G A T A C A T T A G T A T A G T G G A A T C A C A A C C T A T A A T C C A T C T C T C A A A T C 6 0  
C A G 6 3

( 2 ) INFORMATION FOR SEQ ID NO:53:  
( i ) SEQUENCE CHARACTERISTICS:  
( A ) LENGTH: 54 base pairs  
( B ) TYPE: nucleic acid  
( C ) STRANDEDNESS: single  
( D ) TOPOLOGY: linear  
( x i ) SEQUENCE DESCRIPTION: SEQ ID NO:53:  
T A T T A T T G T G C A A G A T C C C T A G C T C G G A C T A C G G C T A T G G A C T A C T G G G G T C A A 5 4

( 2 ) INFORMATION FOR SEQ ID NO:54:  
( i ) SEQUENCE CHARACTERISTICS:  
( A ) LENGTH: 27 base pairs  
( B ) TYPE: nucleic acid  
( C ) STRANDEDNESS: single  
( D ) TOPOLOGY: linear  
( x i ) SEQUENCE DESCRIPTION: SEQ ID NO:54:  
G T G A C A A T G C T G A G A G A C A C C A G C A A G 2 7

( 2 ) INFORMATION FOR SEQ ID NO:55:  
( i ) SEQUENCE CHARACTERISTICS:  
( A ) LENGTH: 24 base pairs  
( B ) TYPE: nucleic acid  
( C ) STRANDEDNESS: single  
( D ) TOPOLOGY: linear



-continued

---

( x i ) SEQUENCE DESCRIPTION: SEQ ID NO:55:  
GGTGTCCACT CCGATGTCCA ACTG 2 4

( 2 ) INFORMATION FOR SEQ ID NO:56:  
( i ) SEQUENCE CHARACTERISTICS:  
( A ) LENGTH: 27 base pairs  
( B ) TYPE: nucleic acid  
( C ) STRANDEDNESS: single  
( D ) TOPOLOGY: linear  
( x i ) SEQUENCE DESCRIPTION: SEQ ID NO:56:  
GGTCTTGAGT GGATGGGATA CATTAGT 2 7

( 2 ) INFORMATION FOR SEQ ID NO:57:  
( i ) SEQUENCE CHARACTERISTICS:  
( A ) LENGTH: 29 base pairs  
( B ) TYPE: nucleic acid  
( C ) STRANDEDNESS: single  
( D ) TOPOLOGY: linear  
( x i ) SEQUENCE DESCRIPTION: SEQ ID NO:57:  
GTGTCCTGGCT ACTCAATTAC CAGCATCAT 2 9

( 2 ) INFORMATION FOR SEQ ID NO:58:  
( i ) SEQUENCE CHARACTERISTICS:  
( A ) LENGTH: 48 base pairs  
( B ) TYPE: nucleic acid  
( C ) STRANDEDNESS: single  
( D ) TOPOLOGY: linear  
( x i ) SEQUENCE DESCRIPTION: SEQ ID NO:58:  
TG TAGAGCCA GCCAGGACAT CAGCAGTTAC CTGAACTGGT ACCAGCAG 4 8

( 2 ) INFORMATION FOR SEQ ID NO:59:  
( i ) SEQUENCE CHARACTERISTICS:  
( A ) LENGTH: 42 base pairs  
( B ) TYPE: nucleic acid  
( C ) STRANDEDNESS: single  
( D ) TOPOLOGY: linear  
( x i ) SEQUENCE DESCRIPTION: SEQ ID NO:59:  
ATCTACTACA CCTCCAGACT GCACTCTGGT GTGCCAAGCA GA 4 2

( 2 ) INFORMATION FOR SEQ ID NO:60:  
( i ) SEQUENCE CHARACTERISTICS:  
( A ) LENGTH: 50 base pairs  
( B ) TYPE: nucleic acid  
( C ) STRANDEDNESS: single  
( D ) TOPOLOGY: linear  
( x i ) SEQUENCE DESCRIPTION: SEQ ID NO:60:  
ACCTACTACT GCCAACAGGG TAACACGCTT CCATACACGT TCGGCCAAGG 5 0

( 2 ) INFORMATION FOR SEQ ID NO:61:  
( i ) SEQUENCE CHARACTERISTICS:  
( A ) LENGTH: 27 base pairs  
( B ) TYPE: nucleic acid  
( C ) STRANDEDNESS: single  
( D ) TOPOLOGY: linear  
( x i ) SEQUENCE DESCRIPTION: SEQ ID NO:61:

-continued

AGCGGTACCG ACTACACCTT CACCATC

27

( 2 ) INFORMATION FOR SEQ ID NO:62:

( i ) SEQUENCE CHARACTERISTICS:  
 ( A ) LENGTH: 706 base pairs  
 ( B ) TYPE: nucleic acid  
 ( C ) STRANDEDNESS: single  
 ( D ) TOPOLOGY: linear

( i x ) FEATURE:  
 ( A ) NAME/KEY: CDS  
 ( B ) LOCATION: 8..52

( i x ) FEATURE:  
 ( A ) NAME/KEY: mat\_peptide  
 ( B ) LOCATION: 8..52

( i x ) FEATURE:  
 ( A ) NAME/KEY: CDS  
 ( B ) LOCATION: 135..503

( i x ) FEATURE:  
 ( A ) NAME/KEY: mat\_peptide  
 ( B ) LOCATION: 135..503

( x i ) SEQUENCE DESCRIPTION: SEQ ID NO:62:

AAGCTTC	ATG	GGA	TGG	AGC	TGT	ATC	ATC	CTC	TTC	ITG	GTA	GCA	ACA	GCT	49	
	Met	Gly	Trp	Ser	Cys	Ile	Ile	Leu	Phe	Leu	Val	Ala	Thr	Ala		
	1				5					10						
ACA	GGTAAAGGGGC	TCACAGTAGC	AGGCTTGAGG	TCTGGACATA	TATATGGGTG	102										
Thr						15										
ACAATGACAT	CCACTTTGCC	TTTCTCTCCA	CA	GGT	GTC	CAC	TCC	CAG	GTC	CAA	155					
				Gly	Val	His	Ser	Gln	Val	Gln						
				1				5								
CTG	CAG	GAG	AGC	GGT	CCA	GGT	CTT	GTG	AGA	CCT	AGC	CAG	ACC	CTG	AGC	203
Leu	Gln	Glu	Ser	Gly	Pro	Gly	Leu	Val	Arg	Pro	Ser	Gln	Thr	Leu	Ser	
		10				15						20				
CTG	ACC	TGC	ACC	GIG	TCT	GGC	TAC	TCA	ATT	ACC	AGC	GAT	CAT	GCC	TGG	251
Leu	Thr	Cys	Thr	Val	Ser	Gly	Tyr	Ser	Ile	Thr	Ser	Asp	His	Ala	Trp	
	25					30					35					
AGC	TGG	GTG	AGA	CAG	CCA	CCT	GGA	CGA	GGT	CTT	GAG	TGG	ATT	GGA	TAC	299
Ser	Trp	Val	Arg	Gln	Pro	Pro	Gly	Arg	Gly	Leu	Glu	Trp	Ile	Gly	Tyr	
	40				45					50				55		
ATT	AGT	TAT	AGT	GGA	ATC	ACA	ACC	TAT	AAT	CCA	TCT	CTC	AAA	TCC	AGA	347
Ile	Ser	Tyr	Ser	Gly	Ile	Thr	Thr	Tyr	Asn	Pro	Ser	Leu	Lys	Ser	Arg	
				60					65					70		
GTG	ACA	ATG	CTG	AGA	GAC	ACC	AGC	AAG	AAC	CAG	TTC	AGC	CTG	AGA	CTC	395
Val	Thr	Met	Leu	Arg	Asp	Thr	Ser	Lys	Asn	Gln	Phe	Ser	Leu	Arg	Leu	
			75					80					85			
AGC	AGC	GTG	ACA	GCC	GCC	GAC	ACC	GCG	GTT	TAT	TAT	TGT	GCA	AGA	TCC	443
Ser	Ser	Val	Thr	Ala	Ala	Asp	Thr	Ala	Val	Tyr	Tyr	Cys	Ala	Arg	Ser	
		90				95						100				
CTA	GCT	CGG	ACT	ACG	GCT	ATG	GAC	TAC	TGG	GGT	CAA	GGC	AGC	CTC	GTC	491
Leu	Ala	Arg	Thr	Thr	Ala	Met	Asp	Tyr	Trp	Gly	Gln	Gly	Ser	Leu	Val	
	105				110						115					
ACA	GTC	TCC	TCA	GGTGAGTCCT	TACAACCTCT	CTCTTCTATT	CAGCTTAAAT	543								
Thr	Val	Ser	Ser					120								
AGATTTTACT	GCAITTTGTTG	GGGGGAAAAT	GIGTGTATCT	GAATTTICAGG	TCATGAAGGA	603										
CTAGGGACAC	CTTGGGAGTC	AGAAAGGGTC	ATTGGGAGCC	CGGGCTGATG	CAGACAGACA	663										
TCCTCAGCTC	CCAGACTTCA	TGGCCAGAGA	TTTATAGGGA	TCC		706										

-continued

## ( 2 ) INFORMATION FOR SEQ ID NO:63:

- ( i ) SEQUENCE CHARACTERISTICS:  
 ( A ) LENGTH: 15 amino acids  
 ( B ) TYPE: amino acid  
 ( D ) TOPOLOGY: linear

( i i ) MOLECULE TYPE: protein

( x i ) SEQUENCE DESCRIPTION: SEQ ID NO:63:

Met Gly Trp Ser Cys Ile Ile Leu Phe Leu Val Ala Thr Ala Thr  
 1 5 10 15

## ( 2 ) INFORMATION FOR SEQ ID NO:64:

- ( i ) SEQUENCE CHARACTERISTICS:  
 ( A ) LENGTH: 123 amino acids  
 ( B ) TYPE: amino acid  
 ( D ) TOPOLOGY: linear

( i i ) MOLECULE TYPE: protein

( x i ) SEQUENCE DESCRIPTION: SEQ ID NO:64:

Gly Val His Ser Gln Val Gln Leu Gln Glu Ser Gly Pro Gly Leu Val  
 1 5 10 15  
 Arg Pro Ser Gln Thr Leu Ser Leu Thr Cys Thr Val Ser Gly Tyr Ser  
 20 25 30  
 Ile Thr Ser Asp His Ala Trp Ser Trp Val Arg Gln Pro Pro Gly Arg  
 35 40 45  
 Gly Leu Glu Trp Ile Gly Tyr Ile Ser Tyr Ser Gly Ile Thr Thr Tyr  
 50 55 60  
 Asn Pro Ser Leu Lys Ser Arg Val Thr Met Leu Arg Asp Thr Ser Lys  
 65 70 75 80  
 Asn Gln Phe Ser Leu Arg Leu Ser Ser Val Thr Ala Ala Asp Thr Ala  
 85 90 95  
 Val Tyr Tyr Cys Ala Arg Ser Leu Ala Arg Thr Thr Ala Met Asp Tyr  
 100 105 110  
 Trp Gly Gln Gly Ser Leu Val Thr Val Ser Ser  
 115 120

## ( 2 ) INFORMATION FOR SEQ ID NO:65:

- ( i ) SEQUENCE CHARACTERISTICS:  
 ( A ) LENGTH: 506 base pairs  
 ( B ) TYPE: nucleic acid  
 ( C ) STRANDEDNESS: single  
 ( D ) TOPOLOGY: linear

( i x ) FEATURE:

- ( A ) NAME/KEY: CDS  
 ( B ) LOCATION: 8..52

( i x ) FEATURE:

- ( A ) NAME/KEY: mat\_peptide  
 ( B ) LOCATION: 8..52

( i x ) FEATURE:

- ( A ) NAME/KEY: CDS  
 ( B ) LOCATION: 135..467

( i x ) FEATURE:

- ( A ) NAME/KEY: mat\_peptide  
 ( B ) LOCATION: 135..467

( x i ) SEQUENCE DESCRIPTION: SEQ ID NO:65:

AAGCTTC ATG GGA TGG AGC TGT ATC ATC CTC TTC TTG GTA GCA ACA GCT  
 Met Gly Trp Ser Cys Ile Ile Leu Phe Leu Val Ala Thr Ala

49

-continued

1	5	10	
ACA	GGTAAAGGGGC	TCACAGTAGC	AGGCTTIGAGG TCTGGACATA TATATGGGTG 102
Thr			
15			
ACA	ATGACAT	CCACTTTGCC	TTTCTCTCCA CA GGT GTC CAC TCC GAC ATC CAG 155
			Gly Val His Ser Asp Ile Gln
			1 5
ATG	ACC CAG	AGC CCA	AGC AGC CTG AGC GCC AGC GTG GGT GAC AGA GTG 203
Met	Thr Gln	Ser Pro	Ser Ser Leu Ser Ala Ser Val Gly Asp Arg Val
	10		15 20
ACC	ATC ACC	TGT AGA	GCC AGC CAG GAC ATC AGC AGT TAC CTG AAT TGG 251
Thr	Ile Thr	Cys Arg	Ala Ser Gln Asp Ile Ser Ser Tyr Leu Asn Trp
	25		30 35
TAC	CAG CAG	AAG CCA	GGT AAG GCT CCA AAG CTG CTG ATC TAC TAC ACC 299
Tyr	Gln Gln	Lys Pro	Gly Lys Ala Pro Lys Leu Ile Tyr Tyr Thr
	40		45 50 55
TCC	AGA CTG	CAC TCT	GGT GTG CCA AGC AGA TTC AGC GGT AGC GGT AGC 347
Ser	Arg Leu	His Ser	Gly Val Pro Ser Arg Phe Ser Gly Ser Gly Ser
			60 65 70
GGT	ACC GAC	TTC ACC	TTC ACC ATC AGC AGC CTC CAG CCA GAG GAC ATC 395
Gly	Thr Asp	Phe Thr	Phe Thr Ile Ser Ser Leu Gln Pro Glu Asp Ile
			75 80 85
GCT	ACC TAC	TAC TGC	CAA CAG GGT AAC ACG CTT CCA TAC ACG TTC GGC 443
Ala	Thr Tyr	Tyr Cys	Gln Gln Gly Asn Thr Leu Pro Tyr Thr Phe Gly
	90		95 100
CAA	GGG ACC	AAG GTG	GAA ATC AAA CGTGAGTAGA ATTTAAACTT TGCTTCCTCA 497
Gln	Gly Thr	Lys Val	Glu Ile Lys
	105		110
GT	GGATCC		
			506

( 2 ) INFORMATION FOR SEQ ID NO:66:

- ( i ) SEQUENCE CHARACTERISTICS:
  - ( A ) LENGTH: 15 amino acids
  - ( B ) TYPE: amino acid
  - ( D ) TOPOLOGY: linear

( ii ) MOLECULE TYPE: protein

( xi ) SEQUENCE DESCRIPTION: SEQ ID NO:66:

Met Gly Trp Ser Cys Ile Ile Leu Phe Leu Val Ala Thr Ala Thr  
 1 5 10 15

( 2 ) INFORMATION FOR SEQ ID NO:67:

- ( i ) SEQUENCE CHARACTERISTICS:
  - ( A ) LENGTH: 111 amino acids
  - ( B ) TYPE: amino acid
  - ( D ) TOPOLOGY: linear

( ii ) MOLECULE TYPE: protein

( xi ) SEQUENCE DESCRIPTION: SEQ ID NO:67:

Gly Val His Ser Asp Ile Gln Met Thr Gln Ser Pro Ser Ser Leu Ser  
 1 5 10 15

Ala Ser Val Gly Asp Arg Val Thr Ile Thr Cys Arg Ala Ser Gln Asp  
 20 25 30

Ile Ser Ser Tyr Leu Asn Trp Tyr Gln Gln Lys Pro Gly Lys Ala Pro  
 35 40 45

Lys Leu Leu Ile Tyr Tyr Thr Ser Arg Leu His Ser Gly Val Pro Ser  
 50 55 60

Arg Phe Ser Gly Ser Gly Thr Asp Phe Thr Phe Thr Ile Ser

-continued

65	70	75	80
Ser Leu Gln Pro Glu Asp Ile Ala Thr Tyr Tyr Cys Gln Gln Gly Asn	85	90	95
Thr Leu Pro Tyr Thr Phe Gly Gln Gly Thr Lys Val Glu Ile Lys	100	105	110

( 2 ) INFORMATION FOR SEQ ID NO:68:

- ( i ) SEQUENCE CHARACTERISTICS:
  - ( A ) LENGTH: 438 base pairs
  - ( B ) TYPE: nucleic acid
  - ( C ) STRANDEDNESS: single
  - ( D ) TOPOLOGY: linear

- ( i x ) FEATURE:
  - ( A ) NAME/KEY: CDS
  - ( B ) LOCATION: 12..425

- ( i x ) FEATURE:
  - ( A ) NAME/KEY: mat\_peptide
  - ( B ) LOCATION: 12..425

( x i ) SEQUENCE DESCRIPTION: SEQ ID NO:68:

AAGCTTCCAC C ATG GGA TGG AGC TGT ATC ATC CTC TTC TTG GTA GCA ACA	50
Met Gly Trp Ser Cys Ile Ile Leu Phe Leu Val Ala Thr	
1 5 10	
GCT ACA GGT GTC CAC TCC CAG GTC CAA CTG CAG GAG AGC GGT CCA GGT	98
Ala Thr Gly Val His Ser Gln Val Gln Leu Gln Glu Ser Gly Pro Gly	
15 20 25	
CTT GTG AGA CCT AGC CAG ACC CTG AGC CTG ACC TGC ACC GTG TCT GGC	146
Leu Val Arg Pro Ser Gln Thr Leu Ser Leu Thr Cys Thr Val Ser Gly	
30 35 40 45	
TAC TCA ATT ACC AGC GAT CAT GCC TGG AGC TGG GTT CGC CAG CCA CCT	194
Tyr Ser Ile Thr Ser Asp His Ala Trp Ser Trp Val Arg Gln Pro Pro	
50 55 60	
GGA CGA GGT CIT GAG TGG ATT GGA TAC ATT AGT TAT AGT GGA ATC ACA	242
Gly Arg Gly Leu Glu Trp Ile Gly Tyr Ile Ser Tyr Ser Gly Ile Thr	
65 70 75	
ACC TAT AAT CCA TCT CTC AAA TCC AGA GTG ACA ATG CTG AGA GAC ACC	290
Thr Tyr Asn Pro Ser Leu Lys Ser Arg Val Thr Met Leu Arg Asp Thr	
80 85 90	
AGC AAG AAC CAG TTC AGC CTG AGA CTC AGC AGC GTG ACA GCC GCC GAC	338
Ser Lys Asn Gln Phe Ser Leu Arg Leu Ser Ser Val Thr Ala Ala Asp	
95 100 105	
ACC GCG GTT TAT TAT TGT GCA AGA TCC CTA GCT CGG ACT ACG GCT ATG	386
Thr Ala Val Tyr Tyr Cys Ala Arg Ser Leu Ala Arg Thr Thr Ala Met	
110 115 120 125	
GAC TAC TGG GGT CAA GGC AGC CTC GTC ACA GTC TCC TCA GGTGAGTGGG	435
Asp Tyr Trp Gly Gln Gly Ser Leu Val Thr Val Ser Ser	
130 135	
TCC	438

( 2 ) INFORMATION FOR SEQ ID NO:69:

- ( i ) SEQUENCE CHARACTERISTICS:
  - ( A ) LENGTH: 138 amino acids
  - ( B ) TYPE: amino acid
  - ( D ) TOPOLOGY: linear

- ( i i ) MOLECULE TYPE: protein

( x i ) SEQUENCE DESCRIPTION: SEQ ID NO:69:

Met Gly Trp Ser Cys Ile Ile Leu Phe Leu Val Ala Thr Ala Thr Gly
1 5 10 15

-continued

Val	His	Ser	Gln	Val	Gln	Leu	Gln	Glu	Ser	Gly	Pro	Gly	Leu	Val	Arg
			20					25					30		
Pro	Ser	Gln	Thr	Leu	Ser	Leu	Thr	Cys	Thr	Val	Ser	Gly	Tyr	Ser	Ile
		35					40					45			
Thr	Ser	Asp	His	Ala	Trp	Ser	Trp	Val	Arg	Gln	Pro	Pro	Gly	Arg	Gly
	50					55					60				
Leu	Glu	Trp	Ile	Gly	Tyr	Ile	Ser	Tyr	Ser	Gly	Ile	Thr	Thr	Tyr	Asn
	65				70					75					80
Pro	Ser	Leu	Lys	Ser	Arg	Val	Thr	Met	Leu	Arg	Asp	Thr	Ser	Lys	Asn
				85					90					95	
Gln	Phe	Ser	Leu	Arg	Leu	Ser	Ser	Val	Thr	Ala	Ala	Asp	Thr	Ala	Val
			100					105					110		
Tyr	Tyr	Cys	Ala	Arg	Ser	Leu	Ala	Arg	Thr	Thr	Ala	Met	Asp	Tyr	Trp
		115					120					125			
Gly	Gln	Gly	Ser	Leu	Val	Thr	Val	Ser	Ser						
	130					135									

## ( 2 ) INFORMATION FOR SEQ ID NO:70:

( i ) SEQUENCE CHARACTERISTICS:  
 ( A ) LENGTH: 402 base pairs  
 ( B ) TYPE: nucleic acid  
 ( C ) STRANDEDNESS: single  
 ( D ) TOPOLOGY: linear

( i x ) FEATURE:  
 ( A ) NAME/KEY: CDS  
 ( B ) LOCATION: 12.389

( i x ) FEATURE:  
 ( A ) NAME/KEY: mat\_peptide  
 ( B ) LOCATION: 12.389

## ( x i ) SEQUENCE DESCRIPTION: SEQ ID NO:70:

AAGCTTCCAC	C	ATG	GGA	TGG	AGC	TGT	ATC	ATC	CTC	TTC	TTG	GTA	GCA	ACA	50	
		Met	Gly	Trp	Ser	Cys	Ile	Ile	Leu	Phe	Leu	Val	Ala	Thr		
		1				5					10					
GCT	ACA	GGT	GTC	CAC	TCC	GAC	ATC	CAG	ATG	ACC	CAG	AGC	CCA	AGC	AGC	98
Ala	Thr	Gly	Val	His	Ser	Asp	Ile	Gln	Met	Thr	Gln	Ser	Pro	Ser	Ser	
	15					20					25					
CTG	AGC	GCC	AGC	GTG	GGT	GAC	AGA	GTG	ACC	ATC	ACC	TGT	AGA	GCC	AGC	146
Leu	Ser	Ala	Ser	Val	Gly	Asp	Arg	Val	Thr	Ile	Thr	Cys	Arg	Ala	Ser	
	30				35					40					45	
CAG	GAC	ATC	AGC	AGT	TAC	CTG	AAT	TGG	TAC	CAG	CAG	AAG	CCA	GGA	AAG	194
Gln	Asp	Ile	Ser	Ser	Tyr	Leu	Asn	Trp	Tyr	Gln	Gln	Lys	Pro	Gly	Lys	
				50				55						60		
GCT	CCA	AAG	CTG	CTG	ATC	TAC	TAC	ACC	TCC	AGA	CTG	CAC	TCT	GGT	GTG	242
Ala	Pro	Lys	Leu	Leu	Ile	Tyr	Tyr	Thr	Ser	Arg	Leu	His	Ser	Gly	Val	
			65					70					75			
CCA	AGC	AGA	TTC	AGC	GGT	AGC	GGT	AGC	GGT	ACC	GAC	TTC	ACC	TTC	ACC	290
Pro	Ser	Arg	Phe	Ser	Gly	Ser	Gly	Ser	Gly	Thr	Asp	Phe	Thr	Phe	Thr	
		80					85					90				
ATC	AGC	AGC	CTC	CAG	CCA	GAG	GAC	ATC	GCT	ACC	TAC	TAC	TGC	CAA	CAG	338
Ile	Ser	Ser	Leu	Gln	Pro	Glu	Asp	Ile	Ala	Thr	Tyr	Tyr	Cys	Gln	Gln	
	95					100					105					
GGT	AAC	ACG	CTT	CCA	TAC	ACG	TTC	GGC	CAA	GGG	ACC	AAG	GTG	GAA	ATC	386
Gly	Asn	Thr	Leu	Pro	Tyr	Thr	Phe	Gly	Gln	Gly	Thr	Lys	Val	Glu	Ile	
	110				115					120					125	
AAA	CGTGAGTGGG	TCC														402
Lys																

## ( 2 ) INFORMATION FOR SEQ ID NO:71:

-continued

- ( i ) SEQUENCE CHARACTERISTICS:  
 ( A ) LENGTH: 126 amino acids  
 ( B ) TYPE: amino acid  
 ( D ) TOPOLOGY: linear

( i i ) MOLECULE TYPE: protein

( x i ) SEQUENCE DESCRIPTION: SEQ ID NO:71:

```

Met Gly Trp Ser Cys Ile Ile Leu Phe Leu Val Ala Thr Ala Thr Gly
 1      5      10      15
Val His Ser Asp Ile Gln Met Thr Gln Ser Pro Ser Ser Leu Ser Ala
 20      25      30
Ser Val Gly Asp Arg Val Thr Ile Thr Cys Arg Ala Ser Gln Asp Ile
 35      40      45
Ser Ser Tyr Leu Asn Trp Tyr Gln Gln Lys Pro Gly Lys Ala Pro Lys
 50      55      60
Leu Leu Ile Tyr Tyr Thr Ser Arg Leu His Ser Gly Val Pro Ser Arg
 65      70      75      80
Phe Ser Gly Ser Gly Ser Gly Thr Asp Phe Thr Phe Thr Ile Ser Ser
 85      90      95
Leu Gln Pro Glu Asp Ile Ala Thr Tyr Tyr Cys Gln Gln Gly Asn Thr
 100      105      110
Leu Pro Tyr Thr Phe Gly Gln Gly Thr Lys Val Glu Ile Lys
 115      120      125

```

( 2 ) INFORMATION FOR SEQ ID NO:72:

- ( i ) SEQUENCE CHARACTERISTICS:  
 ( A ) LENGTH: 36 base pairs  
 ( B ) TYPE: nucleic acid  
 ( C ) STRANDEDNESS: single  
 ( D ) TOPOLOGY: linear

( x i ) SEQUENCE DESCRIPTION: SEQ ID NO:72:

TAAGGATCCA CTCACCTGAG GAGACTGTGA CGAGGC 3 6

( 2 ) INFORMATION FOR SEQ ID NO:73:

- ( i ) SEQUENCE CHARACTERISTICS:  
 ( A ) LENGTH: 32 base pairs  
 ( B ) TYPE: nucleic acid  
 ( C ) STRANDEDNESS: single  
 ( D ) TOPOLOGY: linear

( x i ) SEQUENCE DESCRIPTION: SEQ ID NO:73:

ATCAAGCTTC CACCATGGGA TGGAGCTGTA TC 3 2

( 2 ) INFORMATION FOR SEQ ID NO:74:

- ( i ) SEQUENCE CHARACTERISTICS:  
 ( A ) LENGTH: 30 base pairs  
 ( B ) TYPE: nucleic acid  
 ( C ) STRANDEDNESS: single  
 ( D ) TOPOLOGY: linear

( x i ) SEQUENCE DESCRIPTION: SEQ ID NO:74:

AATGGATCCA CTCACGTTT G A T T T C C A C C T 3 0

( 2 ) INFORMATION FOR SEQ ID NO:75:

- ( i ) SEQUENCE CHARACTERISTICS:  
 ( A ) LENGTH: 33 base pairs  
 ( B ) TYPE: nucleic acid  
 ( C ) STRANDEDNESS: single

-continued

( D ) TOPOLOGY: linear

( x i ) SEQUENCE DESCRIPTION: SEQ ID NO:75:  
CATGCCTGGA GCTGGGTTCG CCAGCCACCT GGA 3 3

( 2 ) INFORMATION FOR SEQ ID NO:76:

( i ) SEQUENCE CHARACTERISTICS:  
( A ) LENGTH: 33 base pairs  
( B ) TYPE: nucleic acid  
( C ) STRANDEDNESS: single  
( D ) TOPOLOGY: linear

( x i ) SEQUENCE DESCRIPTION: SEQ ID NO:76:  
TCCAGGTGGC TGGCGAACC AGCTCCAGGC ATG 3 3

( 2 ) INFORMATION FOR SEQ ID NO:77:

( i ) SEQUENCE CHARACTERISTICS:  
( A ) LENGTH: 30 base pairs  
( B ) TYPE: nucleic acid  
( C ) STRANDEDNESS: single  
( D ) TOPOLOGY: linear

( x i ) SEQUENCE DESCRIPTION: SEQ ID NO:77:  
CAGCAGAAAGC CAGGAAAGGC TCCAAAGCTG 3 0

( 2 ) INFORMATION FOR SEQ ID NO:78:

( i ) SEQUENCE CHARACTERISTICS:  
( A ) LENGTH: 30 base pairs  
( B ) TYPE: nucleic acid  
( C ) STRANDEDNESS: single  
( D ) TOPOLOGY: linear

( x i ) SEQUENCE DESCRIPTION: SEQ ID NO:78:  
CAGCTTTGGA GCCTTTCCTG GCTTCTGCTG 3 0

( 2 ) INFORMATION FOR SEQ ID NO:79:

( i ) SEQUENCE CHARACTERISTICS:  
( A ) LENGTH: 66 base pairs  
( B ) TYPE: nucleic acid  
( C ) STRANDEDNESS: single  
( D ) TOPOLOGY: linear

( x i ) SEQUENCE DESCRIPTION: SEQ ID NO:79:  
ACCTGTAGAG CCAGCAAGAG TGITAGTACA TCTGGCTATA GTTATATGCA CTGGTACCAO 6 0  
CAGAAAG 6 6

( 2 ) INFORMATION FOR SEQ ID NO:80:

( i ) SEQUENCE CHARACTERISTICS:  
( A ) LENGTH: 15 base pairs  
( B ) TYPE: nucleic acid  
( C ) STRANDEDNESS: single  
( D ) TOPOLOGY: linear

( x i ) SEQUENCE DESCRIPTION: SEQ ID NO:80:  
GCTGGCTCTA CAGGT 1 5

( 2 ) INFORMATION FOR SEQ ID NO:81:

( i ) SEQUENCE CHARACTERISTICS:  
( A ) LENGTH: 48 base pairs  
( B ) TYPE: nucleic acid  
( C ) STRANDEDNESS: single



-continued

( D ) TOPOLOGY: linear

( x i ) SEQUENCE DESCRIPTION: SEQ ID NO:81:

AAGCTGCTGA TCTACCTTCC ATCCACCCTG GAATCTGGTG TGCCAAGC 4 8

( 2 ) INFORMATION FOR SEQ ID NO:82:

- ( i ) SEQUENCE CHARACTERISTICS:  
 ( A ) LENGTH: 15 base pairs  
 ( B ) TYPE: nucleic acid  
 ( C ) STRANDEDNESS: single  
 ( D ) TOPOLOGY: linear

( x i ) SEQUENCE DESCRIPTION: SEQ ID NO:82:

G TAGATCAGC AGCTT 1 5

( 2 ) INFORMATION FOR SEQ ID NO:83:

- ( i ) SEQUENCE CHARACTERISTICS:  
 ( A ) LENGTH: 48 base pairs  
 ( B ) TYPE: nucleic acid  
 ( C ) STRANDEDNESS: single  
 ( D ) TOPOLOGY: linear

( x i ) SEQUENCE DESCRIPTION: SEQ ID NO:83:

GCTACCTACT ACTGCCAGCA CAGTAGGGAG ACCCCATACA CGTTCGGC 4 8

( 2 ) INFORMATION FOR SEQ ID NO:84:

- ( i ) SEQUENCE CHARACTERISTICS:  
 ( A ) LENGTH: 15 base pairs  
 ( B ) TYPE: nucleic acid  
 ( C ) STRANDEDNESS: single  
 ( D ) TOPOLOGY: linear

( x i ) SEQUENCE DESCRIPTION: SEQ ID NO:84:

CTGGCAGTAG GTAGC 1 5

( 2 ) INFORMATION FOR SEQ ID NO:85:

- ( i ) SEQUENCE CHARACTERISTICS:  
 ( A ) LENGTH: 414 base pairs  
 ( B ) TYPE: nucleic acid  
 ( C ) STRANDEDNESS: single  
 ( D ) TOPOLOGY: linear

( i x ) FEATURE:

- ( A ) NAME/KEY: CDS  
 ( B ) LOCATION: 12..401

( i x ) FEATURE:

- ( A ) NAME/KEY: mat\_peptide  
 ( B ) LOCATION: 12..401

( x i ) SEQUENCE DESCRIPTION: SEQ ID NO:85:

AAGCTTCCAC C ATG GGA TGG AGC TGT ATC ATC CTC TTC TTG GTA GCA ACA 5 0  
 Met Gly Trp Ser Cys Ile Ile Leu Phe Leu Val Ala Thr  
 1 5 10

GCT ACA GGT GTC CAC TCC GAC ATC CAG ATG ACC CAG AGC CCA AGC AGC 9 8  
 Ala Thr Gly Val His Ser Asp Ile Gln Met Thr Gln Ser Pro Ser Ser  
 15 20 25

CTG AGC GCC AGC GTG GGT GAC AGA GTG ACC ATC ACC TGT AGA GCC AGC 14 6  
 Leu Ser Ala Ser Val Gly Asp Arg Val Thr Ile Thr Cys Arg Ala Ser  
 30 35 40 45

AAG AGT GTT AGT ACA TCT GGC TAT AGT TAT ATG CAC TGG TAC CAG CAG 19 4  
 Lys Ser Val Ser Thr Ser Gly Tyr Ser Tyr Met His Trp Tyr Gln Gln  
 50 55 60

-continued

AAG	CCA	GGA	AAG	GCT	CCA	AAG	CTG	CTG	ATC	TAC	CIT	GCA	TCC	AAC	CTG	242
Lys	Pro	Gly	Lys	Ala	Pro	Lys	Leu	Leu	Ile	Tyr	Leu	Ala	Ser	Asn	Leu	
			65					70					75			
GAA	TCT	GGT	GTG	CCA	AGC	AGA	TTC	AGC	GGT	AGC	GGT	AGC	GGT	ACC	GAC	290
Glu	Ser	Gly	Val	Pro	Ser	Arg	Phe	Ser	Gly	Ser	Gly	Ser	Gly	Thr	Asp	
		80					85					90				
TTC	ACC	TTC	ACC	ATC	AGC	AGC	CTC	CAG	CCA	GAG	GAC	ATC	GCT	ACC	TAC	338
Phe	Thr	Phe	Thr	Ile	Ser	Ser	Leu	Gln	Pro	Glu	Asp	Ile	Ala	Thr	Tyr	
	95					100					105					
TAC	TGC	CAG	CAC	AGT	AGG	GAG	AAC	CCA	TAC	ACG	TTC	GGC	CAA	GGG	ACC	386
Tyr	Cys	Gln	His	Ser	Arg	Glu	Asn	Pro	Tyr	Thr	Phe	Gly	Gln	Gly	Thr	
110					115					120					125	
AAG	GTG	GAA	ATC	AAA	CGT	GAG	TGGA	TCC								414
Lys	Val	Glu	Ile	Lys												
				130												

( 2 ) INFORMATION FOR SEQ ID NO:86:

- ( i ) SEQUENCE CHARACTERISTICS:
  - ( A ) LENGTH: 130 amino acids
  - ( B ) TYPE: amino acid
  - ( D ) TOPOLOGY: linear

( ii ) MOLECULE TYPE: protein

( xi ) SEQUENCE DESCRIPTION: SEQ ID NO:86:

Met	Gly	Trp	Ser	Cys	Ile	Ile	Leu	Phe	Leu	Val	Ala	Thr	Ala	Thr	Gly	
1				5					10						15	
Val	His	Ser	Asp	Ile	Gln	Met	Thr	Gln	Ser	Pro	Ser	Ser	Leu	Ser	Ala	
			20					25					30			
Ser	Val	Gly	Asp	Arg	Val	Thr	Ile	Thr	Cys	Arg	Ala	Ser	Lys	Ser	Val	
		35					40					45				
Ser	Thr	Ser	Gly	Tyr	Ser	Tyr	Met	His	Trp	Tyr	Gln	Gln	Lys	Pro	Gly	
	50					55					60					
Lys	Ala	Pro	Lys	Leu	Leu	Ile	Tyr	Leu	Ala	Ser	Asn	Leu	Glu	Ser	Gly	
65					70					75					80	
Val	Pro	Ser	Arg	Phe	Ser	Gly	Ser	Gly	Ser	Gly	Thr	Asp	Phe	Thr	Phe	
				85					90					95		
Thr	Ile	Ser	Ser	Leu	Gln	Pro	Glu	Asp	Ile	Ala	Thr	Tyr	Tyr	Cys	Gln	
			100					105					110			
His	Ser	Arg	Glu	Asn	Pro	Tyr	Thr	Phe	Gly	Gln	Gly	Thr	Lys	Val	Glu	
		115					120					125				
Ile	Lys															
	130															

( 2 ) INFORMATION FOR SEQ ID NO:87:

- ( i ) SEQUENCE CHARACTERISTICS:
  - ( A ) LENGTH: 45 base pairs
  - ( B ) TYPE: nucleic acid
  - ( C ) STRANDEDNESS: single
  - ( D ) TOPOLOGY: linear

( xi ) SEQUENCE DESCRIPTION: SEQ ID NO:87:

GGTTATTCAT TCACTAGTTA TTACATACAC TGGGTTAGAC AGGCC 45

( 2 ) INFORMATION FOR SEQ ID NO:88:

- ( i ) SEQUENCE CHARACTERISTICS:
  - ( A ) LENGTH: 27 base pairs
  - ( B ) TYPE: nucleic acid
  - ( C ) STRANDEDNESS: single
  - ( D ) TOPOLOGY: linear

-continued

---

( x i ) SEQUENCE DESCRIPTION: SEQ ID NO:88:  
AGTGAATGAA TAACCGCTAG CTTTACA 2 7

( 2 ) INFORMATION FOR SEQ ID NO:89:  
( i ) SEQUENCE CHARACTERISTICS:  
( A ) LENGTH: 69 base pairs  
( B ) TYPE: nucleic acid  
( C ) STRANDEDNESS: single  
( D ) TOPOLOGY: linear

( x i ) SEQUENCE DESCRIPTION: SEQ ID NO:89:  
GAGTGGGTGG GCTATATTGA TCCTTTCAAT GGTGGTACTA GCTATAATCA GAAGTTCAAAG 6 0  
GGCAGGGTT 6 9

( 2 ) INFORMATION FOR SEQ ID NO:90:  
( i ) SEQUENCE CHARACTERISTICS:  
( A ) LENGTH: 15 base pairs  
( B ) TYPE: nucleic acid  
( C ) STRANDEDNESS: single  
( D ) TOPOLOGY: linear

( x i ) SEQUENCE DESCRIPTION: SEQ ID NO:90:  
ATAGCCCACC CACTC 1 5

( 2 ) INFORMATION FOR SEQ ID NO:91:  
( i ) SEQUENCE CHARACTERISTICS:  
( A ) LENGTH: 36 base pairs  
( B ) TYPE: nucleic acid  
( C ) STRANDEDNESS: single  
( D ) TOPOLOGY: linear

( x i ) SEQUENCE DESCRIPTION: SEQ ID NO:91:  
GGGGGTAACC GCTTTGCTTA CTGGGGACAG GGTACC 3 6

( 2 ) INFORMATION FOR SEQ ID NO:92:  
( i ) SEQUENCE CHARACTERISTICS:  
( A ) LENGTH: 36 base pairs  
( B ) TYPE: nucleic acid  
( C ) STRANDEDNESS: single  
( D ) TOPOLOGY: linear

( x i ) SEQUENCE DESCRIPTION: SEQ ID NO:92:  
AGCAAAGCGG TTACCCCTC TGGCGCAGTA GTAGAC 3 6

( 2 ) INFORMATION FOR SEQ ID NO:93:  
( i ) SEQUENCE CHARACTERISTICS:  
( A ) LENGTH: 30 base pairs  
( B ) TYPE: nucleic acid  
( C ) STRANDEDNESS: single  
( D ) TOPOLOGY: linear

( x i ) SEQUENCE DESCRIPTION: SEQ ID NO:93:  
CAAGGTTACC ATGACCGTGG ACACCTCTAC 3 0

( 2 ) INFORMATION FOR SEQ ID NO:94:  
( i ) SEQUENCE CHARACTERISTICS:  
( A ) LENGTH: 30 base pairs  
( B ) TYPE: nucleic acid  
( C ) STRANDEDNESS: single  
( D ) TOPOLOGY: linear

-continued

( x i ) SEQUENCE DESCRIPTION: SEQ ID NO:94:  
CACGGTCATG GTAACCTTGC CTTGAACTT 3 0

( 2 ) INFORMATION FOR SEQ ID NO:95:  
( i ) SEQUENCE CHARACTERISTICS:  
( A ) LENGTH: 30 base pairs  
( B ) TYPE: nucleic acid  
( C ) STRANDEDNESS: single  
( D ) TOPOLOGY: linear  
( x i ) SEQUENCE DESCRIPTION: SEQ ID NO:95:  
GGGCTCGAAT GGATTGGCTA TATTGATCCT 3 0

( 2 ) INFORMATION FOR SEQ ID NO:96:  
( i ) SEQUENCE CHARACTERISTICS:  
( A ) LENGTH: 30 base pairs  
( B ) TYPE: nucleic acid  
( C ) STRANDEDNESS: single  
( D ) TOPOLOGY: linear  
( x i ) SEQUENCE DESCRIPTION: SEQ ID NO:96:  
AGGATCAATA TAGCCAATCC ATTGAGCCC 3 0

( 2 ) INFORMATION FOR SEQ ID NO:97:  
( i ) SEQUENCE CHARACTERISTICS:  
( A ) LENGTH: 16 base pairs  
( B ) TYPE: nucleic acid  
( C ) STRANDEDNESS: single  
( D ) TOPOLOGY: linear  
( x i ) SEQUENCE DESCRIPTION: SEQ ID NO:97:  
GTAAAACGAG GCCAGT 1 6

( 2 ) INFORMATION FOR SEQ ID NO:98:  
( i ) SEQUENCE CHARACTERISTICS:  
( A ) LENGTH: 17 base pairs  
( B ) TYPE: nucleic acid  
( C ) STRANDEDNESS: single  
( D ) TOPOLOGY: linear  
( x i ) SEQUENCE DESCRIPTION: SEQ ID NO:98:  
AACAGCTATG ACCATGA 1 7

( 2 ) INFORMATION FOR SEQ ID NO:99:  
( i ) SEQUENCE CHARACTERISTICS:  
( A ) LENGTH: 433 base pairs  
( B ) TYPE: nucleic acid  
( C ) STRANDEDNESS: single  
( D ) TOPOLOGY: linear  
( i x ) FEATURE:  
( A ) NAME/KEY: CDS  
( B ) LOCATION: 16.420  
( i x ) FEATURE:  
( A ) NAME/KEY: mat\_peptide  
( B ) LOCATION: 16.420  
( x i ) SEQUENCE DESCRIPTION: SEQ ID NO:99:  
AAGCTTGCCG CCACC ATG GAC TGG ACC TGG CGC GTG TTT TGC CTG CTC GCC 5 1  
Met Asp Trp Thr Trp Arg Val Phe Cys Leu Leu Ala  
1 5 10

-continued

GTG	GCT	CCT	GGG	GCC	CAC	AGC	CAG	GTG	CAA	CTA	GTG	CAG	TCC	GGC	GCC	99
Val	Ala	Pro	Gly	Ala	His	Ser	Gln	Val	Gln	Leu	Val	Gln	Ser	Gly	Ala	
		15					20					25				
GAA	GTG	AAG	AAA	CCC	GGT	GCT	TCC	GTG	AAA	GTC	AGC	TGT	AAA	GCT	AGC	147
Glu	Val	Lys	Lys	Pro	Gly	Ala	Ser	Val	Lys	Val	Ser	Cys	Lys	Ala	Ser	
	30					35					40					
GGT	TAT	TCA	TTC	ACT	AGT	TAT	TAC	ATA	CAC	TGG	GTT	AGA	CAG	GCC	CCA	195
Gly	Tyr	Ser	Phe	Thr	Ser	Tyr	Tyr	Ile	His	Trp	Val	Arg	Gln	Ala	Pro	
	45				50					55					60	
GGC	CAA	GGG	CTC	GAG	TGG	GTG	GGC	TAT	ATT	GAT	CCT	TTC	AAT	GGT	GGT	243
Gly	Gln	Gly	Leu	Glu	Trp	Val	Gly	Tyr	Ile	Asp	Pro	Phe	Asn	Gly	Gly	
				65					70					75		
ACT	AGC	TAT	AAT	CAG	AAG	TTC	AAG	GGC	AAG	GTT	ACC	ATG	ACC	GTG	GAC	291
Thr	Ser	Tyr	Asn	Gln	Lys	Phe	Lys	Gly	Lys	Val	Thr	Met	Thr	Val	Asp	
			80					85					90			
ACC	TCT	ACA	AAC	ACC	GCC	TAC	ATG	GAA	CTG	TCC	AGC	CTG	CGC	TCC	GAG	339
Thr	Ser	Thr	Asn	Thr	Ala	Tyr	Met	Glu	Leu	Ser	Ser	Leu	Arg	Ser	Glu	
		95					100					105				
GAC	ACT	GCA	TGC	TAC	TAC	TGC	GCC	AGA	GGG	GGT	AAC	CGC	TTT	GCT	TAC	387
Asp	Thr	Ala	Cys	Tyr	Tyr	Cys	Ala	Arg	Gly	Gly	Asn	Arg	Phe	Ala	Tyr	
	110					115					120					
TGG	GGA	CAG	GGT	ACC	CTT	GTC	ACC	GTC	AGT	TCA	GGT	GAG	TGGA	TCC		433
Trp	Gly	Gln	Gly	Thr	Leu	Val	Thr	Val	Ser	Ser						
	125				130					135						

( 2 ) INFORMATION FOR SEQ ID NO:100:

( i ) SEQUENCE CHARACTERISTICS:

( A ) LENGTH: 135 amino acids

( B ) TYPE: amino acid

( D ) TOPOLOGY: linear

( i i ) MOLECULE TYPE: protein

( x i ) SEQUENCE DESCRIPTION: SEQ ID NO:100:

Met	Asp	Trp	Thr	Trp	Arg	Val	Phe	Cys	Leu	Leu	Ala	Val	Ala	Pro	Gly	
1				5					10					15		
Ala	His	Ser	Gln	Val	Gln	Leu	Val	Gln	Ser	Gly	Ala	Glu	Val	Lys	Lys	
			20					25					30			
Pro	Gly	Ala	Ser	Val	Lys	Val	Ser	Cys	Lys	Ala	Ser	Gly	Tyr	Ser	Phe	
		35					40					45				
Thr	Ser	Tyr	Tyr	Ile	His	Trp	Val	Arg	Gln	Ala	Pro	Gly	Gln	Gly	Leu	
	50					55					60					
Glu	Trp	Val	Gly	Tyr	Ile	Asp	Pro	Phe	Asn	Gly	Gly	Thr	Ser	Tyr	Asn	
	65				70					75					80	
Gln	Lys	Phe	Lys	Gly	Lys	Val	Thr	Met	Thr	Val	Asp	Thr	Ser	Thr	Asn	
			85					90						95		
Thr	Ala	Tyr	Met	Glu	Leu	Ser	Ser	Leu	Arg	Ser	Glu	Asp	Thr	Ala	Cys	
			100					105					110			
Tyr	Tyr	Cys	Ala	Arg	Gly	Gly	Asn	Arg	Phe	Ala	Tyr	Trp	Gly	Gln	Gly	
		115					120					125				
Thr	Leu	Val	Thr	Val	Ser	Ser										
	130					135										

( 2 ) INFORMATION FOR SEQ ID NO:101:

( i ) SEQUENCE CHARACTERISTICS:

( A ) LENGTH: 433 base pairs

( B ) TYPE: nucleic acid

( C ) STRANDEDNESS: single

( D ) TOPOLOGY: linear

-continued

( i x ) FEATURE:  
 ( A ) NAME/KEY: CDS  
 ( B ) LOCATION: 16.420

( i x ) FEATURE:  
 ( A ) NAME/KEY: mat\_peptide  
 ( B ) LOCATION: 16.420

( x i ) SEQUENCE DESCRIPTION: SEQ ID NO:101:

```

AAGCTTGGCCG CCACC ATG GAC TGG ACC TGG CGC GTG TTT TGC CTG CTC GCC      51
      Met Asp Trp Thr Trp      Arg Val Phe Cys Leu Leu Ala
      1                               5                               10

GTG GCT CCT GGG GCC CAC AGC CAG GTG CAA CTA GTG CAG TCC GGC GCC      99
Val Ala Pro Gly Ala His Ser Gln Val Gln Leu Val Gln Ser Gly Ala
      15                               20                               25

GAA GTG AAG AAA CCC GGT GCT TCC GTG AAA GTC AGC TGT AAA GCT AGC     147
Glu Val Lys Lys Pro Gly Ala Ser Val Lys Val      Ser Cys Lys Ala Ser
      30                               35                               40

GGT TAT TCA TTC ACT AGT TAT TAC ATA CAC TGG GTT AGA CAG GCC CCA     195
Gly Tyr Ser Phe Thr Ser Tyr Tyr Ile His Trp Val Arg Gln Ala Pro
      45                               50                               55                               60

GGC CAA GGG CTC GAA TGG ATT GGC TAT ATT GAT CCT TTC AAT GGT GGT     243
Gly Gln Gly Leu Glu Trp Ile Gly Tyr Ile Asp Pro Phe Asn Gly Gly
      65                               70                               75

ACT AGC TAT AAT CAG AAG TTC AAG GGC AAG GTT ACC ATG ACC GTG GAC     291
Thr Ser Tyr Asn Gln Lys Phe Lys Gly Lys Val Thr Met Thr Val Asp
      80                               85                               90

ACC TCT ACA AAC ACC GCC TAC ATG GAA CTG TCC AGC CTG CGC TCC GAG     339
Thr Ser Thr Asn Thr Ala Tyr Met Glu Leu Ser Ser Leu Arg Ser Glu
      95                               100                               105

GAC ACT GCA GTC TAC TAC TGC GCC AGA GGG GGT AAC CGC TTT GCT TAC     387
Asp Thr Ala Val Tyr Tyr Cys Ala Arg Gly Gly Asn Arg Phe Ala Tyr
      110                               115                               120

TGG GGA CAG GGT ACC CTT GTC ACC GTC AGT TCA GGTGAGTGGG TCC         433
Trp Gly Gln Gly Thr Leu Val Thr Val Ser Ser
      125                               130                               135
    
```

( 2 ) INFORMATION FOR SEQ ID NO:102:

( i ) SEQUENCE CHARACTERISTICS:  
 ( A ) LENGTH: 135 amino acids  
 ( B ) TYPE: amino acid  
 ( D ) TOPOLOGY: linear

( i i ) MOLECULE TYPE: protein

( x i ) SEQUENCE DESCRIPTION: SEQ ID NO:102:

```

Met Asp Trp Thr Trp Arg Val Phe Cys Leu Leu Ala Val Ala Pro Gly
 1                               5                               10                               15

Ala His Ser Gln Val Gln Leu Val Gln Ser Gly Ala Glu Val Lys Lys
 20                               25                               30

Pro Gly Ala Ser Val Lys Val Ser Cys Lys Ala Ser Gly Tyr Ser Phe
 35                               40                               45

Thr Ser Tyr Tyr Ile His Trp Val Arg Gln Ala Pro Gly Gln Gly Leu
 50                               55                               60

Glu Trp Ile Gly Tyr Ile Asp Pro Phe Asn Gly Gly Thr Ser Tyr Asn
 65                               70                               75                               80

Gln Lys Phe Lys Gly Lys Val Thr Met Thr Val Asp Thr Ser Thr Asn
 85                               90                               95

Thr Ala Tyr Met Glu Leu Ser Ser Leu Arg Ser Glu Asp Thr Ala Val
100                               105                               110

Tyr Tyr Cys Ala Arg Gly Gly Asn Arg Phe Ala Tyr Trp Gly Gln Gly
    
```

-continued

1 1 5	1 2 0	1 2 5	
Thr Leu Val Thr Val Ser Ser			
1 3 0	1 3 5		
 ( 2 ) INFORMATION FOR SEQ ID NO:103:			
( i ) SEQUENCE CHARACTERISTICS:			
( A ) LENGTH: 90 base pairs			
( B ) TYPE: nucleic acid			
( C ) STRANDEDNESS: single			
( D ) TOPOLOGY: linear			
( x i ) SEQUENCE DESCRIPTION: SEQ ID NO:103:			
GATAAGCTTG CCGCCACCAT GGACTGGACC TGGAGGGTCT TCTTCTTGCT GGCTGTAGCT			6 0
CCAGGTGCTC ACTCCCAGGT GCAGCTTGTG			9 0
 ( 2 ) INFORMATION FOR SEQ ID NO:104:			
( i ) SEQUENCE CHARACTERISTICS:			
( A ) LENGTH: 90 base pairs			
( B ) TYPE: nucleic acid			
( C ) STRANDEDNESS: single			
( D ) TOPOLOGY: linear			
( x i ) SEQUENCE DESCRIPTION: SEQ ID NO:104:			
CACTCCAGG TGCAGCTTGT GCAGTCTGGA GCTGAGGTGA AGAAGCCTGG GGCCTCAGTG			6 0
AAGGTTTCCT GCAAGGCTTC TGGATACTCA			9 0
 ( 2 ) INFORMATION FOR SEQ ID NO:105:			
( i ) SEQUENCE CHARACTERISTICS:			
( A ) LENGTH: 90 base pairs			
( B ) TYPE: nucleic acid			
( C ) STRANDEDNESS: single			
( D ) TOPOLOGY: linear			
( x i ) SEQUENCE DESCRIPTION: SEQ ID NO:105:			
TGCAAGGCTT CTGGATACTC ATCAGTAGT TATTACATAC ACTGGGTGCG CCAGGCCCCC			6 0
GGACAAAGGC TTGAGTGGAT GGGATATATT			9 0
 ( 2 ) INFORMATION FOR SEQ ID NO:106:			
( i ) SEQUENCE CHARACTERISTICS:			
( A ) LENGTH: 90 base pairs			
( B ) TYPE: nucleic acid			
( C ) STRANDEDNESS: single			
( D ) TOPOLOGY: linear			
( x i ) SEQUENCE DESCRIPTION: SEQ ID NO:106:			
CTTGAGTGGG TGGGATATAT TGACCCTTTC AATGGTGGTA CTAGCTATAA TCAGAAAGTTC			6 0
AAGGGCAGAG TCACCATTAAC CGTAGACACA			9 0
 ( 2 ) INFORMATION FOR SEQ ID NO:107:			
( i ) SEQUENCE CHARACTERISTICS:			
( A ) LENGTH: 90 base pairs			
( B ) TYPE: nucleic acid			
( C ) STRANDEDNESS: single			
( D ) TOPOLOGY: linear			
( x i ) SEQUENCE DESCRIPTION: SEQ ID NO:107:			
GTCACCAITA CCGTAGACAC ATCCGCGAGC ACAGCCTACA TGGAGCTGAG CAGCCTGAGA			6 0
TCTGAAGACA CGGCTGTGTA TTA CTGTGCG			9 0

-continued

( 2 ) INFORMATION FOR SEQ ID NO:108:

- ( i ) SEQUENCE CHARACTERISTICS:
  - ( A ) LENGTH: 94 base pairs
  - ( B ) TYPE: nucleic acid
  - ( C ) STRANDEDNESS: single
  - ( D ) TOPOLOGY: linear

( x i ) SEQUENCE DESCRIPTION: SEQ ID NO:108:

```
ACGGCTGTGT ATTACTGTGC GAGAGGGGGT AACCGCTTTG CTTACTGGGG CCAGGGAACC      60
CTGGTCACCG TCTCCTCAGG TGAGTGGATC CGAC                                     94
```

( 2 ) INFORMATION FOR SEQ ID NO:109:

- ( i ) SEQUENCE CHARACTERISTICS:
  - ( A ) LENGTH: 15 base pairs
  - ( B ) TYPE: nucleic acid
  - ( C ) STRANDEDNESS: single
  - ( D ) TOPOLOGY: linear

( x i ) SEQUENCE DESCRIPTION: SEQ ID NO:109:

```
GATAAGCTTG CCGCC                                                         15
```

( 2 ) INFORMATION FOR SEQ ID NO:110:

- ( i ) SEQUENCE CHARACTERISTICS:
  - ( A ) LENGTH: 15 base pairs
  - ( B ) TYPE: nucleic acid
  - ( C ) STRANDEDNESS: single
  - ( D ) TOPOLOGY: linear

( x i ) SEQUENCE DESCRIPTION: SEQ ID NO:110:

```
GTCGGATCCA CTCAC                                                         15
```

( 2 ) INFORMATION FOR SEQ ID NO:111:

- ( i ) SEQUENCE CHARACTERISTICS:
  - ( A ) LENGTH: 433 base pairs
  - ( B ) TYPE: nucleic acid
  - ( C ) STRANDEDNESS: single
  - ( D ) TOPOLOGY: linear

( i x ) FEATURE:

- ( A ) NAME/KEY: CDS
- ( B ) LOCATION: 16..420

( i x ) FEATURE:

- ( A ) NAME/KEY: mat\_peptide
- ( B ) LOCATION: 16..420

( x i ) SEQUENCE DESCRIPTION: SEQ ID NO:111:

```
AAGCTTGCCG CCACC ATG GAC TGG ACC TGG AGG GTC TTC TTC TTG CTG GCT      51
      Met Asp Trp Thr Trp Arg Val Phe Phe Leu Leu Ala
      1                               5                               10

GTA GCT CCA GGT GCT CAC ICC CAG GTG CAG CTT GTG CAG TCT GGA GCT      99
Val Ala Pro Gly Ala His Ser Gln Val Gln Leu Val Gln Ser Gly Ala
      15                               20                               25

GAG GTG AAG AAG CCT GGG GCC TCA GTG AAG GTT TCC TGC AAG GCT ICT      147
Glu Val Lys Lys Pro Gly Ala Ser Val Lys Val Ser Cys Lys Ala Ser
      30                               35                               40

GGA TAC TCA TTC ACT AGT TAT TAC ATA CAC TGG GTG CGC CAG GCC CCC      195
Gly Tyr Ser Phe Thr Ser Tyr Tyr Ile His Trp Val Arg Gln Ala Pro
      45                               50                               55                               60

GGA CAA AGG CTT GAG TGG ATG GGA TAT ATT GAC CCT TTC AAT GGT GGT      243
Gly Gln Arg Leu Glu Trp Met Gly Tyr Ile Asp Pro Phe Asn Gly Gly
      65                               70                               75
```



-continued

ACT	AGC	TAT	AAT	CAG	AAG	TTC	AAG	GGC	AGA	GTC	ACC	ATT	ACC	GTA	GAC	291
Thr	Ser	Tyr	Asn	Gln	Lys	Phe	Lys	Gly	Arg	Val	Thr	Ile	Thr	Val	Asp	
			80					85					90			
ACA	TCC	GCG	AGC	ACA	GCC	TAC	ATG	GAG	CTG	AGC	AGT	CTG	AGA	TCT	GAA	339
Thr	Ser	Ala	Ser	Thr	Ala	Tyr	Met	Glu	Leu	Ser	Ser	Leu	Arg	Ser	Glu	
		95					100					105				
GAC	ACG	GCT	GIG	TAT	TAC	TGT	GCG	AGA	GGG	GGT	AAC	CGC	TTT	GCT	TAC	387
Asp	Thr	Ala	Val	Tyr	Tyr	Cys	Ala	Arg	Gly	Gly	Asn	Arg	Phe	Ala	Tyr	
		110				115					120					
TGG	GGC	CAG	GGA	ACC	CTG	GTC	ACC	GTC	TCC	TCA	GGTGAGTGGG	TCC				433
Trp	Gly	Gln	Gly	Thr	Leu	Val	Thr	Val	Ser	Ser						
					130					135						

## ( 2 ) INFORMATION FOR SEQ ID NO:112:

- ( i ) SEQUENCE CHARACTERISTICS:  
 ( A ) LENGTH: 135 amino acids  
 ( B ) TYPE: amino acid  
 ( D ) TOPOLOGY: linear

( i i ) MOLECULE TYPE: protein

( x i ) SEQUENCE DESCRIPTION: SEQ ID NO:112:

Met	Asp	Trp	Thr	Trp	Arg	Val	Phe	Phe	Leu	Leu	Ala	Val	Ala	Pro	Gly	
1				5					10					15		
Ala	His	Ser	Gln	Val	Gln	Leu	Val	Gln	Ser	Gly	Ala	Glu	Val	Lys	Lys	
			20					25					30			
Pro	Gly	Ala	Ser	Val	Lys	Val	Ser	Cys	Lys	Ala	Ser	Gly	Tyr	Ser	Phe	
		35					40					45				
Thr	Ser	Tyr	Tyr	Ile	His	Trp	Val	Arg	Gln	Ala	Pro	Gly	Gln	Arg	Leu	
	50					55					60					
Glu	Trp	Met	Gly	Tyr	Ile	Asp	Pro	Phe	Asn	Gly	Gly	Thr	Ser	Tyr	Asn	
	65				70					75					80	
Gln	Lys	Phe	Lys	Gly	Arg	Val	Thr	Ile	Thr	Val	Asp	Thr	Ser	Ala	Ser	
			85						90					95		
Thr	Ala	Tyr	Met	Glu	Leu	Ser	Ser	Leu	Arg	Ser	Glu	Asp	Thr	Ala	Val	
			100					105					110			
Tyr	Tyr	Cys	Ala	Arg	Gly	Gly	Asn	Arg	Phe	Ala	Tyr	Trp	Gly	Gln	Gly	
		115					120					125				
Thr	Leu	Val	Thr	Val	Ser	Ser										
	130					135										

## ( 2 ) INFORMATION FOR SEQ ID NO:113:

- ( i ) SEQUENCE CHARACTERISTICS:  
 ( A ) LENGTH: 27 base pairs  
 ( B ) TYPE: nucleic acid  
 ( C ) STRANDEDNESS: single  
 ( D ) TOPOLOGY: linear

( x i ) SEQUENCE DESCRIPTION: SEQ ID NO:113:

AGGCTTGAGT GGATTGGATA TATTGAC

27

## ( 2 ) INFORMATION FOR SEQ ID NO:114:

- ( i ) SEQUENCE CHARACTERISTICS:  
 ( A ) LENGTH: 27 base pairs  
 ( B ) TYPE: nucleic acid  
 ( C ) STRANDEDNESS: single  
 ( D ) TOPOLOGY: linear

( x i ) SEQUENCE DESCRIPTION: SEQ ID NO:114:

AAGTTC AAGG GCAAGGTCAC CATTACC

27

-continued

## ( 2 ) INFORMATION FOR SEQ ID NO:115:

- ( i ) SEQUENCE CHARACTERISTICS:  
 ( A ) LENGTH: 30 base pairs  
 ( B ) TYPE: nucleic acid  
 ( C ) STRANDEDNESS: single  
 ( D ) TOPOLOGY: linear

( x i ) SEQUENCE DESCRIPTION: SEQ ID NO:115:

GGTGCTTCCG TGAAAGTCAG CTGTAAAGCT

3 0

## ( 2 ) INFORMATION FOR SEQ ID NO:116:

- ( i ) SEQUENCE CHARACTERISTICS:  
 ( A ) LENGTH: 30 base pairs  
 ( B ) TYPE: nucleic acid  
 ( C ) STRANDEDNESS: single  
 ( D ) TOPOLOGY: linear

( x i ) SEQUENCE DESCRIPTION: SEQ ID NO:116:

AGCTTTACAG CTGACTTCA CGGAAGCACC

3 0

## ( 2 ) INFORMATION FOR SEQ ID NO:117:

- ( i ) SEQUENCE CHARACTERISTICS:  
 ( A ) LENGTH: 11 amino acids  
 ( B ) TYPE: amino acid  
 ( C ) STRANDEDNESS: single  
 ( D ) TOPOLOGY: linear

( x i ) SEQUENCE DESCRIPTION: SEQ ID NO:117:

Arg	Ala	Ser	Gln	Asp	Ile	Ser	Ser	Tyr	Leu	Asn
1				5					10	

## ( 2 ) INFORMATION FOR SEQ ID NO:118:

- ( i ) SEQUENCE CHARACTERISTICS:  
 ( A ) LENGTH: 7 amino acids  
 ( B ) TYPE: amino acid  
 ( C ) STRANDEDNESS: single  
 ( D ) TOPOLOGY: linear

( x i ) SEQUENCE DESCRIPTION: SEQ ID NO:118:

Tyr	Thr	Ser	Arg	Leu	His	Ser
1				5		

## ( 2 ) INFORMATION FOR SEQ ID NO:119:

- ( i ) SEQUENCE CHARACTERISTICS:  
 ( A ) LENGTH: 9 amino acids  
 ( B ) TYPE: amino acid  
 ( C ) STRANDEDNESS: single  
 ( D ) TOPOLOGY: linear

( x i ) SEQUENCE DESCRIPTION: SEQ ID NO:119:

Gln	Gln	Gly	Asn	Thr	Leu	Pro	Tyr	Thr
1				5				

## ( 2 ) INFORMATION FOR SEQ ID NO:120:

- ( i ) SEQUENCE CHARACTERISTICS:  
 ( A ) LENGTH: 23 amino acids  
 ( B ) TYPE: amino acid  
 ( C ) STRANDEDNESS: single  
 ( D ) TOPOLOGY: linear

( x i ) SEQUENCE DESCRIPTION: SEQ ID NO:120:

-continued

Asp Ile Gln Met Thr Gln Ser Pro Ser Ser Leu Ser Ala Ser Val Gly  
 1 5 10 15

Asp Arg Val Thr Ile Thr Cys  
 20

## ( 2 ) INFORMATION FOR SEQ ID NO:121:

( i ) SEQUENCE CHARACTERISTICS:  
 ( A ) LENGTH: 15 amino acids  
 ( B ) TYPE: amino acid  
 ( C ) STRANDEDNESS: single  
 ( D ) TOPOLOGY: linear

## ( x i ) SEQUENCE DESCRIPTION: SEQ ID NO:121:

Trp Tyr Gln Gln Lys Pro Gly Lys Ala Pro Lys Leu Leu Ile Tyr  
 1 5 10 15

## ( 2 ) INFORMATION FOR SEQ ID NO:122:

( i ) SEQUENCE CHARACTERISTICS:  
 ( A ) LENGTH: 32 amino acids  
 ( B ) TYPE: amino acid  
 ( C ) STRANDEDNESS: single  
 ( D ) TOPOLOGY: linear

## ( x i ) SEQUENCE DESCRIPTION: SEQ ID NO:122:

Gly Val Pro Ser Arg Phe Ser Gly Ser Gly Ser Gly Thr Asp Phe Thr  
 1 5 10 15  
 Phe Thr Ile Ser Ser Leu Gln Pro Glu Asp Ile Ala Thr Tyr Tyr Cys  
 20 25 30

## ( 2 ) INFORMATION FOR SEQ ID NO:123:

( i ) SEQUENCE CHARACTERISTICS:  
 ( A ) LENGTH: 10 amino acids  
 ( B ) TYPE: amino acid  
 ( C ) STRANDEDNESS: single  
 ( D ) TOPOLOGY: linear

## ( x i ) SEQUENCE DESCRIPTION: SEQ ID NO:123:

Phe Gly Gln Gly Thr Lys Val Glu Ile Lys  
 1 5 10

## ( 2 ) INFORMATION FOR SEQ ID NO:124:

( i ) SEQUENCE CHARACTERISTICS:  
 ( A ) LENGTH: 32 amino acids  
 ( B ) TYPE: amino acid  
 ( C ) STRANDEDNESS: single  
 ( D ) TOPOLOGY: linear

## ( x i ) SEQUENCE DESCRIPTION: SEQ ID NO:124:

Gly Val Pro Ser Arg Phe Ser Gly Ser Gly Ser Gly Thr Asp Tyr Thr  
 1 5 10 15  
 Phe Thr Ile Ser Ser Leu Gln Pro Glu Asp Ile Ala Thr Tyr Tyr Cys  
 20 25 30

## ( 2 ) INFORMATION FOR SEQ ID NO:125:

( i ) SEQUENCE CHARACTERISTICS:  
 ( A ) LENGTH: 6 amino acids  
 ( B ) TYPE: amino acid  
 ( C ) STRANDEDNESS: single  
 ( D ) TOPOLOGY: linear

## ( x i ) SEQUENCE DESCRIPTION: SEQ ID NO:125:

Ser Asp His Ala Trp Ser

-continued

- 1 5
- ( 2 ) INFORMATION FOR SEQ ID NO:126:
- ( i ) SEQUENCE CHARACTERISTICS:  
 ( A ) LENGTH: 16 amino acids  
 ( B ) TYPE: amino acid  
 ( C ) STRANDEDNESS: single  
 ( D ) TOPOLOGY: linear
- ( x i ) SEQUENCE DESCRIPTION: SEQ ID NO:126:
- Tyr Ile Ser Tyr Ser Gly Ile Thr Thr Tyr Asn Pro Ser Leu Lys Ser  
 1 5 10 15
- ( 2 ) INFORMATION FOR SEQ ID NO:127:
- ( i ) SEQUENCE CHARACTERISTICS:  
 ( A ) LENGTH: 10 amino acids  
 ( B ) TYPE: amino acid  
 ( C ) STRANDEDNESS: single  
 ( D ) TOPOLOGY: linear
- ( x i ) SEQUENCE DESCRIPTION: SEQ ID NO:127:
- Ser Leu Ala Arg Thr Thr Ala Met Asp Tyr  
 1 5 10
- ( 2 ) INFORMATION FOR SEQ ID NO:128:
- ( i ) SEQUENCE CHARACTERISTICS:  
 ( A ) LENGTH: 30 amino acids  
 ( B ) TYPE: amino acid  
 ( C ) STRANDEDNESS: single  
 ( D ) TOPOLOGY: linear
- ( x i ) SEQUENCE DESCRIPTION: SEQ ID NO:128:
- Gln Val Gln Leu Gln Glu Ser Gly Pro Gly Leu Val Arg Pro Ser Gln  
 1 5 10 15
- Thr Leu Ser Leu Thr Cys Thr Val Ser Gly Tyr Thr Phe Thr  
 20 25 30
- ( 2 ) INFORMATION FOR SEQ ID NO:129:
- ( i ) SEQUENCE CHARACTERISTICS:  
 ( A ) LENGTH: 14 amino acids  
 ( B ) TYPE: amino acid  
 ( C ) STRANDEDNESS: single  
 ( D ) TOPOLOGY: linear
- ( x i ) SEQUENCE DESCRIPTION: SEQ ID NO:129:
- Trp Val Arg Gln Pro Pro Gly Arg Gly Leu Glu Trp Ile Gly  
 1 5 10
- ( 2 ) INFORMATION FOR SEQ ID NO:130:
- ( i ) SEQUENCE CHARACTERISTICS:  
 ( A ) LENGTH: 32 amino acids  
 ( B ) TYPE: amino acid  
 ( C ) STRANDEDNESS: single  
 ( D ) TOPOLOGY: linear
- ( x i ) SEQUENCE DESCRIPTION: SEQ ID NO:130:
- Arg Val Thr Met Leu Val Asp Thr Ser Lys Asn Gln Phe Ser Leu Arg  
 1 5 10 15
- Leu Ser Ser Val Thr Ala Ala Asp Thr Ala Val Tyr Tyr Cys Ala Arg  
 20 25 30
- ( 2 ) INFORMATION FOR SEQ ID NO:131:

-continued

( i ) SEQUENCE CHARACTERISTICS:  
 ( A ) LENGTH: 11 amino acids  
 ( B ) TYPE: amino acid  
 ( C ) STRANDEDNESS: single  
 ( D ) TOPOLOGY: linear

( x i ) SEQUENCE DESCRIPTION: SEQ ID NO:131:

Trp Gly Gln Gly Ser Leu Val Thr Val Ser Ser  
 1 5 10

( 2 ) INFORMATION FOR SEQ ID NO:132:

( i ) SEQUENCE CHARACTERISTICS:  
 ( A ) LENGTH: 32 amino acids  
 ( B ) TYPE: amino acid  
 ( C ) STRANDEDNESS: single  
 ( D ) TOPOLOGY: linear

( x i ) SEQUENCE DESCRIPTION: SEQ ID NO:132:

Arg Val Thr Met Leu Arg Asp Thr Ser Lys Asn Gln Phe Ser Leu Arg  
 1 5 10 15  
 Leu Ser Ser Val Thr Ala Ala Asp Thr Ala Val Tyr Tyr Cys Ala Arg  
 20 25 30

( 2 ) INFORMATION FOR SEQ ID NO:133:

( i ) SEQUENCE CHARACTERISTICS:  
 ( A ) LENGTH: 30 amino acids  
 ( B ) TYPE: amino acid  
 ( C ) STRANDEDNESS: single  
 ( D ) TOPOLOGY: linear

( x i ) SEQUENCE DESCRIPTION: SEQ ID NO:133:

Asp Val Gln Leu Gln Glu Ser Gly Pro Gly Leu Val Arg Pro Ser Gln  
 1 5 10 15  
 Thr Leu Ser Leu Thr Cys Thr Val Ser Gly Tyr Thr Phe Thr  
 20 25 30

( 2 ) INFORMATION FOR SEQ ID NO:134:

( i ) SEQUENCE CHARACTERISTICS:  
 ( A ) LENGTH: 14 amino acids  
 ( B ) TYPE: amino acid  
 ( C ) STRANDEDNESS: single  
 ( D ) TOPOLOGY: linear

( x i ) SEQUENCE DESCRIPTION: SEQ ID NO:134:

Trp Val Arg Gln Pro Pro Gly Arg Gly Leu Glu Trp Met Gly  
 1 5 10

( 2 ) INFORMATION FOR SEQ ID NO:135:

( i ) SEQUENCE CHARACTERISTICS:  
 ( A ) LENGTH: 30 amino acids  
 ( B ) TYPE: amino acid  
 ( C ) STRANDEDNESS: single  
 ( D ) TOPOLOGY: linear

( x i ) SEQUENCE DESCRIPTION: SEQ ID NO:135:

Gln Val Gln Leu Gln Glu Ser Gly Pro Gly Leu Val Arg Pro Ser Gln  
 1 5 10 15  
 Thr Leu Ser Leu Thr Cys Thr Val Ser Gly Tyr Ser Ile Thr  
 20 25 30

( 2 ) INFORMATION FOR SEQ ID NO:136:

-continued

( i ) SEQUENCE CHARACTERISTICS:  
 ( A ) LENGTH: 15 amino acids  
 ( B ) TYPE: amino acid  
 ( C ) STRANDEDNESS: single  
 ( D ) TOPOLOGY: linear

( x i ) SEQUENCE DESCRIPTION: SEQ ID NO:136:

Arg Ala Ser Lys Ser Val Ser Thr Ser Gly Tyr Ser Tyr Met His  
 1 5 10 15

( 2 ) INFORMATION FOR SEQ ID NO:137:

( i ) SEQUENCE CHARACTERISTICS:  
 ( A ) LENGTH: 6 amino acids  
 ( B ) TYPE: amino acid  
 ( C ) STRANDEDNESS: single  
 ( D ) TOPOLOGY: linear

( x i ) SEQUENCE DESCRIPTION: SEQ ID NO:137:

Ala Ser Asn Leu Glu Ser  
 1 5

( 2 ) INFORMATION FOR SEQ ID NO:138:

( i ) SEQUENCE CHARACTERISTICS:  
 ( A ) LENGTH: 9 amino acids  
 ( B ) TYPE: amino acid  
 ( C ) STRANDEDNESS: single  
 ( D ) TOPOLOGY: linear

( x i ) SEQUENCE DESCRIPTION: SEQ ID NO:138:

Gln His Ser Arg Glu Asn Pro Tyr Thr  
 1 5

( 2 ) INFORMATION FOR SEQ ID NO:139:

( i ) SEQUENCE CHARACTERISTICS:  
 ( A ) LENGTH: 23 amino acids  
 ( B ) TYPE: amino acid  
 ( C ) STRANDEDNESS: single  
 ( D ) TOPOLOGY: linear

( x i ) SEQUENCE DESCRIPTION: SEQ ID NO:139:

Asp Ile Gln Met Thr Gln Ser Pro Ser Ser Leu Ser Ala Ser Val Gly  
 1 5 10 15  
 Asp Arg Val Thr Ile Thr Cys  
 20

( 2 ) INFORMATION FOR SEQ ID NO:140:

( i ) SEQUENCE CHARACTERISTICS:  
 ( A ) LENGTH: 15 amino acids  
 ( B ) TYPE: amino acid  
 ( C ) STRANDEDNESS: single  
 ( D ) TOPOLOGY: linear

( x i ) SEQUENCE DESCRIPTION: SEQ ID NO:140:

Trp Tyr Gln Gln Lys Pro Gly Lys Ala Pro Lys Leu Leu Ile Tyr  
 1 5 10 15

( 2 ) INFORMATION FOR SEQ ID NO:141:

( i ) SEQUENCE CHARACTERISTICS:  
 ( A ) LENGTH: 32 amino acids  
 ( B ) TYPE: amino acid  
 ( C ) STRANDEDNESS: single  
 ( D ) TOPOLOGY: linear

( x i ) SEQUENCE DESCRIPTION: SEQ ID NO:141:

-continued

```

Gly Val Pro Ser Arg Phe Ser Gly Ser Gly Ser Gly Thr Asp Phe Thr
1           5           10
Phe Thr Ile Ser Ser Leu Gln Pro Glu Asp Ile Ala Thr Tyr Tyr Cys
          20           25           30

```

## ( 2 ) INFORMATION FOR SEQ ID NO:142:

```

( i ) SEQUENCE CHARACTERISTICS:
      ( A ) LENGTH: 10 amino acids
      ( B ) TYPE: amino acid
      ( C ) STRANDEDNESS: single
      ( D ) TOPOLOGY: linear

```

## ( x i ) SEQUENCE DESCRIPTION: SEQ ID NO:142:

```

Phe Gly Gln Gly Thr Lys Val Glu Ile Lys
1           5           10

```

## ( 2 ) INFORMATION FOR SEQ ID NO:143:

```

( i ) SEQUENCE CHARACTERISTICS:
      ( A ) LENGTH: 5 amino acids
      ( B ) TYPE: amino acid
      ( C ) STRANDEDNESS: single
      ( D ) TOPOLOGY: linear

```

## ( x i ) SEQUENCE DESCRIPTION: SEQ ID NO:143:

```

Ser Tyr Tyr Ile His
1           5

```

## ( 2 ) INFORMATION FOR SEQ ID NO:144:

```

( i ) SEQUENCE CHARACTERISTICS:
      ( A ) LENGTH: 17 amino acids
      ( B ) TYPE: amino acid
      ( C ) STRANDEDNESS: single
      ( D ) TOPOLOGY: linear

```

## ( x i ) SEQUENCE DESCRIPTION: SEQ ID NO:144:

```

Tyr Ile Asp Pro Phe Asn Gly Gly Thr Ser Tyr Asn Gln Lys Phe Lys
1           5           10           15
Gly

```

## ( 2 ) INFORMATION FOR SEQ ID NO:145:

```

( i ) SEQUENCE CHARACTERISTICS:
      ( A ) LENGTH: 7 amino acids
      ( B ) TYPE: amino acid
      ( C ) STRANDEDNESS: single
      ( D ) TOPOLOGY: linear

```

## ( x i ) SEQUENCE DESCRIPTION: SEQ ID NO:145:

```

Gly Gly Asn Arg Phe Ala Tyr
1           5

```

## ( 2 ) INFORMATION FOR SEQ ID NO:146:

```

( i ) SEQUENCE CHARACTERISTICS:
      ( A ) LENGTH: 30 amino acids
      ( B ) TYPE: amino acid
      ( C ) STRANDEDNESS: single
      ( D ) TOPOLOGY: linear

```

## ( x i ) SEQUENCE DESCRIPTION: SEQ ID NO:146:

```

Gln Val Gln Leu Val Gln Ser Gly Ala Glu Val Lys Lys Pro Gly Ala
1           5           10           15
Ser Val Lys Val Ser Cys Lys Ala Ser Gly Tyr Ser Phe Thr

```

-continued

2 0

2 5

3 0

## ( 2 ) INFORMATION FOR SEQ ID NO:147:

- ( i ) SEQUENCE CHARACTERISTICS:  
 ( A ) LENGTH: 14 amino acids  
 ( B ) TYPE: amino acid  
 ( C ) STRANDEDNESS: single  
 ( D ) TOPOLOGY: linear

## ( x i ) SEQUENCE DESCRIPTION: SEQ ID NO:147:

Trp Val Arg Gln Ala Pro Gly Gln Gly Leu Glu Trp Val Gly  
 1 5 10

## ( 2 ) INFORMATION FOR SEQ ID NO:148:

- ( i ) SEQUENCE CHARACTERISTICS:  
 ( A ) LENGTH: 32 amino acids  
 ( B ) TYPE: amino acid  
 ( C ) STRANDEDNESS: single  
 ( D ) TOPOLOGY: linear

## ( x i ) SEQUENCE DESCRIPTION: SEQ ID NO:148:

Arg Val Thr Met Thr Leu Asp Thr Ser Thr Asn Thr Ala Tyr Met Glu  
 1 5 10 15  
 Leu Ser Ser Leu Arg Ser Glu Asp Thr Ala Val Tyr Tyr Cys Ala Arg  
 20 25 30

## ( 2 ) INFORMATION FOR SEQ ID NO:149:

- ( i ) SEQUENCE CHARACTERISTICS:  
 ( A ) LENGTH: 11 amino acids  
 ( B ) TYPE: amino acid  
 ( C ) STRANDEDNESS: single  
 ( D ) TOPOLOGY: linear

## ( x i ) SEQUENCE DESCRIPTION: SEQ ID NO:149:

Trp Gly Gln Gly Thr Leu Val Thr Val Ser Ser  
 1 5 10

## ( 2 ) INFORMATION FOR SEQ ID NO:150:

- ( i ) SEQUENCE CHARACTERISTICS:  
 ( A ) LENGTH: 32 amino acids  
 ( B ) TYPE: amino acid  
 ( C ) STRANDEDNESS: single  
 ( D ) TOPOLOGY: linear

## ( x i ) SEQUENCE DESCRIPTION: SEQ ID NO:150:

Lys Val Thr Met Thr Val Asp Thr Ser Thr Asn Thr Ala Tyr Met Glu  
 1 5 10 15  
 Leu Ser Ser Leu Arg Ser Glu Asp Thr Ala Val Tyr Tyr Cys Ala Arg  
 20 25 30

## ( 2 ) INFORMATION FOR SEQ ID NO:151:

- ( i ) SEQUENCE CHARACTERISTICS:  
 ( A ) LENGTH: 14 amino acids  
 ( B ) TYPE: amino acid  
 ( C ) STRANDEDNESS: single  
 ( D ) TOPOLOGY: linear

## ( x i ) SEQUENCE DESCRIPTION: SEQ ID NO:151:

Trp Val Arg Gln Ala Pro Gly Gln Gly Leu Glu Trp Ile Gly  
 1 5 10

## ( 2 ) INFORMATION FOR SEQ ID NO:152:



-continued

( i ) SEQUENCE CHARACTERISTICS:  
 ( A ) LENGTH: 30 amino acids  
 ( B ) TYPE: amino acid  
 ( C ) STRANDEDNESS: single  
 ( D ) TOPOLOGY: linear

( x i ) SEQUENCE DESCRIPTION: SEQ ID NO:152:

Gln Val Gln Leu Val Gln Ser Gly Ala Glu Val Lys Lys Pro Gly Ala  
 1 5 10 15  
 Ser Val Lys Val Ser Cys Lys Ala Ser Gly Tyr Ser Phe Thr  
 20 25 30

( 2 ) INFORMATION FOR SEQ ID NO:153:

( i ) SEQUENCE CHARACTERISTICS:  
 ( A ) LENGTH: 14 amino acids  
 ( B ) TYPE: amino acid  
 ( C ) STRANDEDNESS: single  
 ( D ) TOPOLOGY: linear

( x i ) SEQUENCE DESCRIPTION: SEQ ID NO:153:

Trp Val Arg Gln Ala Pro Gly Gln Arg Leu Glu Trp Met Gly  
 1 5 10

( 2 ) INFORMATION FOR SEQ ID NO:154:

( i ) SEQUENCE CHARACTERISTICS:  
 ( A ) LENGTH: 32 amino acids  
 ( B ) TYPE: amino acid  
 ( C ) STRANDEDNESS: single  
 ( D ) TOPOLOGY: linear

( x i ) SEQUENCE DESCRIPTION: SEQ ID NO:154:

Arg Val Thr Ile Thr Val Asp Thr Ser Ala Ser Thr Ala Tyr Met Glu  
 1 5 10 15  
 Leu Ser Ser Leu Arg Ser Glu Asp Thr Ala Val Tyr Tyr Cys Ala Arg  
 20 25 30

( 2 ) INFORMATION FOR SEQ ID NO:155:

( i ) SEQUENCE CHARACTERISTICS:  
 ( A ) LENGTH: 14 amino acids  
 ( B ) TYPE: amino acid  
 ( C ) STRANDEDNESS: single  
 ( D ) TOPOLOGY: linear

( x i ) SEQUENCE DESCRIPTION: SEQ ID NO:155:

Trp Val Arg Gln Ala Pro Gly Gln Arg Leu Glu Trp Ile Gly  
 1 5 10

( 2 ) INFORMATION FOR SEQ ID NO:156:

( i ) SEQUENCE CHARACTERISTICS:  
 ( A ) LENGTH: 32 amino acids  
 ( B ) TYPE: amino acid  
 ( C ) STRANDEDNESS: single  
 ( D ) TOPOLOGY: linear

( x i ) SEQUENCE DESCRIPTION: SEQ ID NO:156:

Lys Val Thr Ile Thr Val Asp Thr Ser Ala Ser Thr Ala Tyr Met Glu  
 1 5 10 15  
 Leu Ser Ser Leu Arg Ser Glu Asp Thr Ala Val Tyr Tyr Cys Ala Arg  
 20 25 30

( 2 ) INFORMATION FOR SEQ ID NO:157:

-continued

( i ) SEQUENCE CHARACTERISTICS:  
 ( A ) LENGTH: 30 amino acids  
 ( B ) TYPE: amino acid  
 ( C ) STRANDEDNESS: single  
 ( D ) TOPOLOGY: linear

( x i ) SEQUENCE DESCRIPTION: SEQ ID NO:157:

Gln Val Gln Leu Val Gln Ser Gly Ala Glu Val Lys Lys Pro Gly Ala  
 1 5 10 15  
 Ser Val Lys Val Ser Cys Lys Ala Ser Gly Tyr Ser Phe Thr  
 20 25 30

( 2 ) INFORMATION FOR SEQ ID NO:158:

( i ) SEQUENCE CHARACTERISTICS:  
 ( A ) LENGTH: 14 amino acids  
 ( B ) TYPE: amino acid  
 ( C ) STRANDEDNESS: single  
 ( D ) TOPOLOGY: linear

( x i ) SEQUENCE DESCRIPTION: SEQ ID NO:158:

Trp Val Arg Gln Ala Pro Gly Gln Arg Leu Glu Trp Ile Gly  
 1 5 10

We claim:

1. A variable (V) region of a heavy (H) chain of an antibody to the human IL-6 receptor having the following structure:

FR1<sup>2</sup>-CDR1<sup>2</sup>-FR2<sup>2</sup>-CDR2<sup>2</sup>-FR3<sup>2</sup>-CDR3<sup>2</sup>-FR4<sup>2</sup>  
 wherein CDR1<sup>2</sup>, CDR2<sup>2</sup> and CDR3<sup>2</sup> represent a set of three complementarity determining regions comprising a set of the following amino acid sequences shown by:

SEQ ID No. 125 CDR1 <sup>2</sup>	Ser	Asp	His	Ala	Trp	Ser				
SEQ ID No. 126 CDR2 <sup>2</sup>	Tyr	Ile	Ser	Tyr	Ser	Gly	Ile	Thr	Thr	
SEQ ID No. 127 CDR3 <sup>2</sup>	Tyr	Asn	Pro	Ser	Leu	Lys	Ser			
	Ser	Leu	Ala	Arg	Thr	Thr	Ala	Met	Asp	
	Tyr									

and  
 40 FR1<sup>2</sup>, FR2<sup>2</sup>, FR3<sup>2</sup> and FR4<sup>2</sup> comprise a set of the following amino acid sequences:

SEQ ID No. 135 FR1 <sup>2</sup>	Gln	Val	Gln	Leu	Gln	Glu	Ser	Gly	Pro	Gly
	Leu	Val	Arg	Pro	Ser	Gln	Thr	Leu	Ser	Leu
	Thr	Cys	Thr	Val	Ser	Gly	Tyr	Ser	Ile	Thr
SEQ ID No. 129 FR2 <sup>2</sup>	Trp	Val	Arg	Gln	Pro	Pro	Gly	Arg	Gly	Leu
	Glu	Trp	Ile	Gly						
SEQ ID No. 132 FR3 <sup>2</sup>	Arg	Val	Thr	Met	Leu	Arg	Asp	Thr	Ser	Lys
	Asn	Gln	Phe	Ser	Leu	Arg	Leu	Ser	Ser	Val
	Thr	Ala	Ala	Asp	Thr	Ala	Val	Tyr	Tyr	Cys
	Ala	Arg								
SEQ ID No. 131 FR4 <sup>2</sup>	Trp	Gly	Gln	Gly	Ser	Leu	Val	Thr	Val	Ser
	Ser									

55

2. An H chain of an antibody to the human IL-6 receptor, comprising:

(1) a V region of a heavy chain of an antibody to the human IL-6 receptor having the following structure:

60 FR1<sup>2</sup>-CDR1<sup>2</sup>-FR2<sup>2</sup>-CDR2<sup>2</sup>-FR3<sup>2</sup>-CDR3<sup>2</sup>-FR4<sup>2</sup>  
 wherein CDR1<sup>2</sup>, CDR2<sup>2</sup> and CDR3<sup>2</sup> represent a set of three complementarity determining regions comprising a set of the following amino acid sequences:

SEQ ID No. 125 CDR1 <sup>2</sup>	Ser	Asp	His	Ala	Trp	Ser				
SEQ ID No. 126 CDR2 <sup>2</sup>	Tyr	Ile	Ser	Tyr	Ser	Gly	Ile	Thr	Thr	Tyr
SEQ ID No. 127 CDR3 <sup>2</sup>	Ser	Leu	Ala	Arg	Thr	Thr	Ala	Met	Asp	
		Tyr;								

and FR1<sup>2</sup>, FR2<sup>2</sup>, FR3<sup>2</sup> and FR4<sup>2</sup> comprise a set of the following amino acid sequences:

SEQ ID No. 135 FR1 <sup>2</sup>	Gln	Val	Gln	Leu	Gln	Glu	Ser	Gly	Pro	Gly
	Leu	Val	Arg	Pro	Ser	Gln	Thr	Leu	Ser	Leu
	Thr	Cys	Thr	Val	Ser	Gly	Tyr	Ser	Ile	Thr
SEQ ID No. 129 FR2 <sup>2</sup>	Trp	Val	Arg	Gln	Pro	Pro	Gly	Arg	Gly	Leu
	Glu	Trp	Ile	Gly						
SEQ ID No. 132 FR3 <sup>2</sup>	Arg	Val	Thr	Met	Leu	Arg	Asp	Thr	Ser	Lys
	Asn	Gln	Phe	Ser	Leu	Arg	Leu	Ser	Ser	Val
	Thr	Ala	Ala	Asp	Thr	Ala	Val	Tyr	Tyr	Cys
	Ala	Arg								
SEQ ID No. 131 FR4 <sup>2</sup>	Trp	Gly	Gln	Gly	Ser	Leu	Val	Thr	Val	Ser
	Ser;									

and

(2) a C region of an H chain of a human antibody Cy.

3. A reshaped human antibody to the human IL-6 receptor, comprising

(A) L chains of an antibody to said human IL-6 receptor, each comprising:

(1) a variable (V) region of a light (L) chain of an antibody to the human IL-6 receptor having the following structure:

FR1<sup>1</sup>-CDR1<sup>1</sup>-FR2<sup>1</sup>-CDR2<sup>1</sup>-FR3<sup>1</sup>-CDR3<sup>1</sup>-FR4<sup>1</sup>

wherein CDR1<sup>1</sup>, CDR2<sup>1</sup> and CDR3<sup>1</sup> represent a set of three complementarity determining regions comprising a set of the following amino acid sequences:

SEQ ID No. 117 CDR1<sup>1</sup> Arg Ala Ser Gln Asp Ile Ser Ser Tyr Leu Asn

SEQ ID No. 118 CDR2<sup>1</sup> Tyr Thr Ser Arg Leu His Ser

SEQ ID No. 119 CDR3<sup>1</sup> Gln Gln Gly Asn Thr Leu Pro Tyr Thr;

and

the FR1<sup>1</sup>, FR2<sup>1</sup>, FR3<sup>1</sup> and FR4<sup>1</sup> comprise a set of the following amino acid sequences:

SEQ ID No. 120 FR1<sup>1</sup> Asp Ile Gln Met Thr Gln Ser Pro Ser Ser  
Leu Ser Ala Ser Val Gly Asp Arg Val Thr  
Ile Thr Cys

SEQ ID No. 121 FR2<sup>1</sup> Trp Tyr Gln Gln Lys Pro Gly Lys Ala Pro  
Lys Leu Leu Ile Tyr

SEQ ID No. 122 FR3<sup>1</sup> Gly Val Pro Ser Arg Phe Ser Gly Ser Gly  
Ser Gly Thr Asp Phe Thr Phe Thr Ile Ser  
Ser Leu Gln Pro Glu Asp Ile Ala Thr Tyr  
Tyr Cys

SEQ ID No. 123 FR4<sup>1</sup> Phe Gly Gln Gly Thr Lys Val Glu Ile Lys;

or

SEQ ID No. 120 FR1<sup>1</sup> Asp Ile Gln Met Thr Gln Ser Pro Ser Ser  
Leu Ser Ala Ser Val Gly Asp Arg Val Thr  
Ile Thr Cys

SEQ ID No. 121 FR2<sup>1</sup> Trp Tyr Gln Gln Lys Pro Gly Lys Ala Pro  
Lys Leu Leu Ile Tyr

25

SEQ ID No. 124 FR3<sup>1</sup> -continued  
Gly Val Pro Ser Arg Phe Ser Gly Ser Gly  
Ser Gly Thr Asp Tyr Thr Phe Thr Ile Ser  
Ser Leu Gln Pro Glu Asp Ile Ala Thr Tyr  
Tyr Cys

30

SEQ ID No. 123 FR4<sup>1</sup> Phe Gly Gln Gly Thr Lys Val Glu Ile Lys;

and

(2) a C region of an L chain of a human antibody Ck;  
and N

(B) H chains of an antibody to the human IL-6 receptor, each comprising:

(1) a V region of a heavy (H) chain of an antibody to the human IL-6 receptor having the following structure:

FR1<sup>2</sup>-CDR1<sup>2</sup>-FR2<sup>2</sup>-CDR2<sup>2</sup>-FR3<sup>2</sup>-CDR3<sup>2</sup>-FR4<sup>2</sup>

wherein CDR1<sup>2</sup>, CDR2<sup>2</sup> and CDR3<sup>2</sup> represent a set of three complementarity determining regions comprising a set of the amino acid sequences shown by:

SEQ ID No. 125 CDR1<sup>2</sup> Ser Asp His Ala Trp Ser

SEQ ID No. 126 CDR2<sup>2</sup> Tyr Ile Ser Tyr Ser Gly Ile Thr Thr Tyr Asn  
Pro Ser Leu Lys Ser

SEQ ID No. 127 CDR3<sup>2</sup> Ser Leu Ala Arg Thr Thr Ala Met Asp Tyr;

50

and

the FR1<sup>2</sup>, FR2<sup>2</sup>, FR3<sup>2</sup> and FR4<sup>2</sup> comprise a set of the following amino acid sequences:

SEQ ID No. 135 FR1<sup>2</sup> Gln Val Gln Leu Gln Glu Ser Gly Pro Gly  
Leu Val Arg Pro Ser Gln Thr Leu Ser Leu  
Thr Cys Thr Val Ser Gly Tyr Ser Ile Thr

SEQ ID No. 129 FR2<sup>2</sup> Trp Val Arg Gln Pro Pro Gly Arg Gly Leu  
Glu Trp Ile Gly

SEQ ID No. 132 FR3<sup>2</sup> Arg Val Thr Met Leu Arg Asp Thr Ser Lys  
Asn Gln Phe Ser Leu Arg Leu Ser Ser Val  
Thr Ala Ala Asp Thr Ala Val Tyr Tyr Cys  
Ala Arg

SEQ ID No. 131 FR4<sup>2</sup> Trp Gly Gln Gly Ser Leu Val Thr Val Ser  
Ser;

65

and

(2) a C region of an H chain of a human antibody Cy.

4. A V region of a heavy (H) chain of an antibody to the human IL-6 receptor having the following structure:

FR1<sup>4</sup>-CDR1<sup>4</sup>-FR2<sup>4</sup>-CDR2<sup>4</sup>-FR3<sup>4</sup>-CDR3<sup>4</sup>-FR4<sup>4</sup>

wherein CDR1<sup>4</sup>, CDR2<sup>4</sup> and CDR3<sup>4</sup>, represent a set of three complementarity determining regions comprising a set of the following amino acid sequences:

SEQ ID No. 143 CDR1 <sup>4</sup>	Ser	Tyr	Tyr	Ile	His						
SEQ ID No. 144 CDR2 <sup>4</sup>	Tyr	Ile	Asp	Pro	Phe	Asn	Gly	Gly	Thr	Ser	
	Tyr	Asn	Gln	Lys	Phe	Lys	Gly				
SEQ ID No. 145 CDR3 <sup>4</sup>	Gly	Gly	Asn	Arg	Phe	Ala	Tyr;				

and

the FR1<sup>4</sup>, FR2<sup>4</sup>, FR3<sup>4</sup> and FR4<sup>4</sup> comprise a set of the following amino acid sequences:

SEQ ID No. 146 FR1 <sup>4</sup>	Gln	Val	Gln	Leu	Val	Gln	Ser	Gly	Ala	Glu
	Val	Lys	Lys	Pro	Gly	Ala	Ser	Val	Lys	Val
	Ser	Cys	Lys	Ala	Ser	Gly	Tyr	Ser	Phe	Thr
SEQ ID No. 147 FR2 <sup>4</sup>	Trp	Val	Arg	Gln	Ala	Pro	Gly	Gln	Gly	Leu
	Glu	Trp	Val	Gly						
SEQ ID No. 150 FR3 <sup>4</sup>	Lys	Val	Thr	Met	Thr	Val	Asp	Thr	Ser	Thr
	Asn	Thr	Ala	Tyr	Met	Glu	Leu	Ser	Ser	Leu
	Arg	Ser	Gly	Asp	Thr	Ala	Val	Tyr	Ser	Cys
	Ala	Arg								
SEQ ID No. 149 FR4 <sup>4</sup>	Trp	Gly	Gln	Gly	Thr	Leu	Val	Thr	Val	Ser
	Ser;									
SEQ ID No. 146 FR1 <sup>4</sup>	Gln	Val	Gln	Leu	Val	Gln	Ser	Gly	Ala	Glu
	Val	Lys	Lys	Pro	Gly	Ala	Ser	Val	Lys	Val
	Ser	Cys	Lys	Ala	Ser	Gly	Tyr	Ser	Phe	Thr
SEQ ID No. 151 FR2 <sup>4</sup>	Trp	Val	Arg	Gln	Ala	Pro	Gly	Gln	Gly	Leu
	Glu	Trp	Ile	Gly						
SEQ ID No. 150 FR3 <sup>4</sup>	Lys	Val	Thr	Met	Thr	Val	Asp	Thr	Ser	Thr
	Asn	Thr	Ala	Tyr	Met	Glu	Leu	Ser	Ser	Leu
	Arg	Ser	Glu	Asp	Thr	Ala	Val	Tyr	Tyr	Cys
	Ala	Arg								
SEQ ID No. 149 FR4 <sup>4</sup>	Trp	Gly	Gln	Gly	Thr	Leu	Val	Thr	Val	Ser
	Ser;									
SEQ ID No. 152 FR1 <sup>4</sup>	Trp	Val	Arg	Gln	Ala	Pro	Gly	Gln	Arg	Leu
	Glu	Trp	Ile	Gly						
SEQ ID No. 155 FR2 <sup>4</sup>	Trp	Val	Arg	Gln	Ala	Pro	Gly	Gln	Arg	Leu
	Glu	Trp	Ile	Gly						
SEQ ID No. 154 FR3 <sup>4</sup>	Arg	Val	Thr	Ile	Thr	Val	Asp	Thr	Ser	Ala
	Ser	Thr	Ala	Tyr	Met	Glu	Leu	Ser	Ser	Leu
	Arg	Ser	Glu	Asp	Thr	Ala	Val	Tyr	Tyr	Cys
	Ala	Arg								
SEQ ID No. 149 FR4 <sup>4</sup>	Trp	Gly	Gln	Gly	Thr	Leu	Val	Thr	Val	Ser
	Ser;									
or										
SEQ ID No. 152 FR1 <sup>4</sup>	Gln	Val	Gln	Leu	Val	Gln	Ser	Gly	Ala	Glu
	Val	Lys	Lys	Pro	Gly	Ala	Ser	Val	Lys	Val
	Ser	Cys	Lys	Ala	Ser	Gly	Tyr	Ser	Phe	Thr
SEQ ID No. 155 FR2 <sup>4</sup>	Trp	Val	Arg	Gln	Ala	Pro	Gly	Gln	Arg	Leu
	Glu	Trp	Ile	Gly						
SEQ ID No. 156 FR3 <sup>4</sup>	Lys	Val	Thr	Ile	Thr	Val	Asp	Thr	Ser	Ala
	Ser	Thr	Ala	Tyr	Met	Glu	Leu	Ser	Ser	Leu
	Arg	Ser	Glu	Asp	Thr	Ala	Val	Tyr	Tyr	Cys
	Ala	Arg								
SEQ ID No. 149 FR4 <sup>4</sup>	Trp	Gly	Gln	Gly	Thr	Leu	Val	Thr	Val	Ser
	Ser;									

5. An H chain of an antibody to the human IL-6 receptor, comprising:

(1) a V region of heavy (H) chain of an antibody to the human IL-6 receptor having the following structure:

FR1<sup>4</sup>-CDR1<sup>4</sup>-FR2<sup>4</sup>-CDR2<sup>4</sup>-FR3<sup>4</sup>-CDR3<sup>4</sup>-FR4<sup>4</sup> 5  
 where CDR1<sup>4</sup>, CDR2<sup>4</sup>, and CDR3<sup>4</sup> represent a set of three complementarity determining regions comprising a set of the following sequences shown by:

SEQ ID No. 143 CDR1 <sup>4</sup>	Ser	Tyr	Tyr	Ile	His						
SEQ ID No. 144 CDR2 <sup>4</sup>	Tyr	Ile	Asp	Pro	Phe	Asn	Gly	Gly	Thr	Ser	
SEQ ID No. 145 CDR3 <sup>4</sup>	Tyr	Asn	Gln	Lys	Phe	Lys	Gly				
	Gly	Gly	Asn	Arg	Phe	Ala	Tyr;				

and

the FR1<sup>4</sup>, FR2<sup>4</sup>, FR3<sup>4</sup>, and FR4<sup>4</sup> comprise a set of the following amino acid sequences:

SEQ ID No. 146 FR1 <sup>4</sup>	Gln	Val	Gln	Leu	Val	Gln	Ser	Gly	Ala	Glu
	Val	Lys	Lys	Pro	Gly	Ala	Ser	Val	Lys	Val
SEQ ID No. 147 FR2 <sup>4</sup>	Ser	Cys	Lys	Ala	Ser	Gly	Tyr	Ser	Phe	Thr
	Trp	Val	Arg	Gln	Ala	Pro	Gly	Gln	Gly	Leu
SEQ ID No. 150 FR3 <sup>4</sup>	Glu	Trp	Val	Gly						
	Lys	Val	Thr	Met	Thr	Val	Asp	Thr	Ser	Thr
	Asn	Thr	Ala	Tyr	Met	Glu	Leu	Ser	Ser	Leu
	Arg	Ser	Glu	Asp	Thr	Ala	Val	Tyr	Tyr	Cys
	Ala	Arg								
SEQ ID No. 149 FR4 <sup>4</sup>	Trp	Gly	Gln	Gly	Thr	Leu	Val	Thr	Val	Ser
	Ser;									
SEQ ID No. 146 FR1 <sup>4</sup>	Gln	Val	Gln	Leu	Val	Gln	Ser	Gly	Ala	Glu
	Val	Lys	Lys	Pro	Gly	Ala	Ser	Val	Lys	Val
SEQ ID No. 151 FR2 <sup>4</sup>	Ser	Cys	Lys	Ala	Ser	Gly	Tyr	Ser	Phe	Thr
	Trp	Val	Arg	Gln	Ala	Pro	Gly	Gln	Gly	Leu
SEQ ID No. 150 FR3 <sup>4</sup>	Glu	Trp	Ile	Gly						
	Lys	Val	Thr	Met	Thr	Val	Asp	Thr	Ser	Thr
	Asn	Thr	Ala	Tyr	Met	Glu	Leu	Ser	Ser	Leu
	Arg	Ser	Glu	Asp	Thr	Ala	Val	Tyr	Tyr	Cys
	Ala	Arg								
SEQ ID No. 149 FR4 <sup>4</sup>	Trp	Gly	Gln	Gly	Thr	Leu	Val	Thr	Val	Ser
	Ser;									
SEQ ID No. 157 FR1 <sup>4</sup>	Gln	Val	Gln	Leu	Val	Gln	Ser	Gly	Ala	Glu
	Val	Lys	Lys	Pro	Gly	Ala	Ser	Val	Lys	Val
SEQ ID No. 158 FR2 <sup>4</sup>	Ser	Cys	Lys	Ala	Ser	Gly	Tyr	Ser	Phe	Thr
	Trp	Val	Arg	Gln	Ala	Pro	Gly	Gln	Arg	Leu
SEQ ID No. 154 FR3 <sup>4</sup>	Glu	Trp	Ile	Gly						
	Arg	Val	Thr	Ile	Thr	Val	Asp	Thr	Ser	Ala
	Ser	Thr	Ala	Tyr	Met	Glu	Leu	Ser	Ser	Leu
	Arg	Ser	Glu	Asp	Thr	Ala	Val	Tyr	Tyr	Cys
	Ala	Arg								
SEQ ID No. 149 FR4 <sup>4</sup>	Trp	Gly	Gln	Gly	Thr	Leu	Val	Thr	Val	Ser
	Ser;									
SEQ ID No. 152 FR1 <sup>4</sup>	Gln	Val	Gln	Leu	Val	Gln	Ser	Gly	Ala	Glu
	Val	Lys	Lys	Pro	Gly	Ala	Ser	Val	Lys	Val
SEQ ID No. 153 FR2 <sup>4</sup>	Ser	Cys	Lys	Ala	Ser	Gly	Tyr	Ser	Phe	Thr
	Trp	Val	Arg	Gln	Ala	Pro	Gly	Gln	Arg	Leu
SEQ ID No. 156 FR3 <sup>4</sup>	Glu	Trp	Met	Gly						
	Lys	Val	Thr	Ile	Thr	Val	Asp	Thr	Ser	Ala
	Ser	Thr	Ala	Tyr	Met	Glu	Leu	Ser	Ser	Leu
	Arg	Ser	Glu	Asp	Thr	Ala	Val	Tyr	Tyr	Cys
	Ala	Arg								
SEQ ID No. 149 FR4 <sup>4</sup>	Trp	Gly	Gln	Gly	Thr	Leu	Val	Thr	Val	Ser
	Ser;									
or										
SEQ ID No. 152 FR1 <sup>4</sup>	Gln	Val	Gln	Leu	Val	Gln	Ser	Gly	Ala	Glu
	Val	Lys	Lys	Pro	Gly	Ala	Ser	Val	Lys	Val
SEQ ID No. 155 FR2 <sup>4</sup>	Ser	Cys	Lys	Ala	Ser	Gly	Tyr	Ser	Phe	Thr
	Trp	Val	Arg	Gln	Ala	Pro	Gly	Gln	Arg	Leu
SEQ ID No. 156 FR3 <sup>4</sup>	Glu	Trp	Ile	Gly						
	Lys	Val	Thr	Ile	Thr	Val	Asp	Thr	Ser	Ala
	Ser	Thr	Ala	Tyr	Met	Glu	Leu	Ser	Ser	Leu
	Arg	Ser	Glu	Asp	Thr	Ala	Val	Tyr	Tyr	Cys
	Ala	Arg								

-continued

SEQ ID No. 149 FR4 <sup>4</sup>	Trp	Gly	Gln	Gly	Thr	Leu	Val	Thr	Val	Ser
---------------------------------	-----	-----	-----	-----	-----	-----	-----	-----	-----	-----

and

(2) a C region of an H chain of a human antibody C $\gamma$ .  
 6. A reshaped human antibody to the human IL-6 receptor,  
 comprising:

(A) L chains of an antibody to the human IL-6 receptor,  
 each comprising:

(1) a variable (V) region of a light (L) chain of an  
 antibody to the human IL-6 receptor having the  
 following structure:

FR1<sup>3</sup>-CDR1<sup>3</sup>-FR2<sup>3</sup>-CDR2<sup>3</sup>-FR3<sup>3</sup>-CDR3<sup>3</sup>-FR4<sup>3</sup>  
 wherein CDR1<sup>3</sup>, CDR2<sup>3</sup> and CDR3<sup>3</sup> represent a set  
 of three complementarity determining regions comprising a set of the following amino acid sequences:

SEQ ID No. 136 CDR1 <sup>3</sup>	Arg Ala Ser Lys Ser Val Ser Thr Ser Gly Tyr
SEQ ID No. 137 CDR2 <sup>3</sup>	Ser Tyr Met His
SEQ ID No. 138 CDR3 <sup>3</sup>	Ala Ser Asn Leu Glu Ser
	Gln His Ser Arg Glu Asn Pro Tyr Thr;

and

FR1<sup>3</sup>, FR2<sup>3</sup>, FR3<sup>3</sup> and FR4<sup>3</sup> comprise a set of the  
 following amino acid sequences:

SEQ ID No. 139 FR1 <sup>3</sup>	Asp Ile Gln Met Thr Gln Ser Pro Ser Ser
	Leu Ser Ala Ser Val Gly Asp Arg Val Thr
	Ile Thr Cys

SEQ ID No. 140 FR2 <sup>3</sup>	Trp Tyr Gln Gln Lys Pro Gly Lys Ala Pro
	Lys Leu Leu Ile Tyr

SEQ ID No. 141 FR3 <sup>3</sup>	Gly Val Pro Ser Arg Phe Ser Gly Ser Gly
	Ser Gly Thr Asp Phe Thr Phe Thr Ile Ser
	Ser Leu Gln Pro Glu Asp Ile Ala Thr Tyr
	Tyr Cys

SEQ ID No. 142 FR4 <sup>3</sup>	Phe Gly Gln Gly Thr Lys Val Glu Ile Lys;
---------------------------------	--

and

(2) a C region of an L chain of a human antibody C $\kappa$ ;  
 and

(B) H chains of an antibody to the human IL-6 receptor,  
 each comprising:

(1) a V region of a heavy (H) chain of an antibody to  
 the human IL-6 receptor having the following structure:

FR1<sup>4</sup>-CDR1<sup>4</sup>-FR2<sup>4</sup>-CDR2<sup>4</sup>-FR3<sup>4</sup>-CDR3<sup>4</sup>-FR4<sup>4</sup>  
 wherein CDR1<sup>4</sup>, CDR2<sup>4</sup> and CDR3<sup>4</sup> represent a set  
 of three complementarity determining regions comprising a set of the following amino acid sequences:

SEQ ID No. 143 CDR1 <sup>4</sup>	Ser Tyr Tyr Ile His
----------------------------------	---------------------

SEQ ID No. 144 CDR2 <sup>4</sup>	Tyr Ile Asp Pro Phe Asn Gly Gly Thr Ser Tyr
----------------------------------	---

SEQ ID No. 145 CDR3 <sup>4</sup>	Asn Gly Lys Phe Lys Gly
	Gly Gly Asn Arg Phe Ala Tyr;

and

FR1<sup>4</sup>, FR2<sup>4</sup>, FR3<sup>4</sup> and FR4<sup>4</sup> comprise a set of the  
 following amino acid sequences:

SEQ ID No. 146 FR1 <sup>4</sup>	Gln Val Gln Leu Val Gln Ser Gly Ala Glu
	Val Lys Lys Pro Gly Ala Ser Val Lys Val
	Ser Cys Lys Ala Ser Gly Tyr Ser Phe Thr

SEQ ID No. 147 FR2 <sup>4</sup>	Trp Val Arg Gln Ala Pro Gly Gln Gly Leu
	Glu Trp Val Gly

-continued

SEQ ID No. 150 FR3 <sup>4</sup>	Lys Val Thr Met Thr Val Asp Thr Ser Thr
	Asn Thr Ala Tyr Met Glu Leu Ser Ser Leu
	Arg Ser Glu Asp Thr Ala Val Tyr Tyr Cys
	Ala Arg

SEQ ID No. 149 FR4 <sup>4</sup>	Trp Gly Gln Gly Thr Leu Val Thr Val Ser
	Ser;

SEQ ID No. 146 FR1 <sup>4</sup>	Gln Val Gln Leu Val Gln Ser Gly Ala Glu
	Val Lys Lys Pro Gly Ala Ser Val Lys Val
	Ser Cys Lys Ala Ser Gly Tyr Ser Phe Thr

SEQ ID No. 151 FR2 <sup>4</sup>	Trp Val Arg Gln Ala Pro Gly Gln Gly Leu
	Glu Trp Ile Gly

SEQ ID No. 150 FR3 <sup>4</sup>	Lys Val Thr Met Thr Val Asp Thr Ser Thr
	Asn Thr Asn Thr Ala Tyr Met Glu Leu Ser
	Ser Leu Arg Ser Glu Asp Thr Ala Val Tyr
	Tyr Cys Ala Arg

SEQ ID No. 149 FR4 <sup>4</sup>	Trp Gly Gln Gly Thr Leu Val Thr Val Ser
	Ser;

SEQ ID No. 152 FR1 <sup>4</sup>	Gln Val Gln Leu Val Gln Ser Gly Ala Glu
	Val Lys Lys Pro Gly Ala Ser Val Lys Val
	Ser Cys Lys Ala Ser Gly Tyr Ser Phe Thr

SEQ ID No. 155 FR2 <sup>4</sup>	Trp Val Arg Gln Ala Pro Gly Gln Arg Leu
	Glu Trp Ile Gly

SEQ ID No. 154 FR3 <sup>4</sup>	Arg Val Thr Ile Thr Val Asp Thr Ser Ala
	Ser Thr Ala Tyr Met Glu Leu Ser Ser Leu
	Arg Ser Glu Asp Thr Ala Val Tyr Tyr Cys
	Ala Arg

SEQ ID No. 149 FR4 <sup>4</sup>	Trp Gly Gln Gly Thr Leu Val Thr Val Ser
	Ser;

SEQ ID No. 152 FR1 <sup>4</sup>	Gln Val Gln Leu Val Gln Ser Gly Ala Glu
	Val Lys Lys Pro Gly Ala Ser Val Lys Val
	Ser Cys Lys Ala Ser Gly Tyr Ser Phe Thr

SEQ ID No. 153 FR2 <sup>4</sup>	Trp Val Arg Gln Ala Pro Gly Gln Arg Leu
	Glu Trp Met Gly

SEQ ID No. 156 FR3 <sup>4</sup>	Lys Val Thr Ile Thr Val Asp Thr Ser Ala
	Ser Thr Ala Tyr Met Glu Leu Ser Ser Leu
	Arg Ser Glu Asp Thr Ala Val Tyr Tyr Cys
	Ala Arg

SEQ ID No. 149 FR4 <sup>4</sup>	Trp Gly Gln Gly Thr Leu Val Thr Val Ser
	Ser;
	or

SEQ ID No. 152 FR1 <sup>4</sup>	Gln Val Gln Leu Val Gln Ser Gly Ala Glu
	Val Lys Lys Pro Gly Ala Ser Val Lys Val
	Ser Cys Lys Ala Ser Gly Tyr Ser Phe Thr

SEQ ID No. 155 FR2 <sup>4</sup>	Trp Val Arg Gln Ala Pro Gly Gln Arg Leu
	Glu Trp Ile Gly

SEQ ID No. 156 FR3 <sup>4</sup>	Lys Val Thr Ile Thr Val Asp Thr Ser Ala
	Ser Thr Ala Tyr Met Glu Leu Ser Ser Leu
	Arg Ser Glu Asp Thr Ala Val Tyr Tyr Cys
	Ala Arg

SEQ ID No. 149 FR4 <sup>4</sup>	Trp Gly Gln Gly Thr Leu Val Thr Val Ser
	Ser;

and

(2) a C region of an H chain of a human antibody C $\gamma$ .

\* \* \* \* \*

UNITED STATES PATENT AND TRADEMARK OFFICE  
**CERTIFICATE OF CORRECTION**

PATENT NO. : 5,795,965  
APPLICATION NO. : 08/137117  
DATED : August 18, 1998  
INVENTOR(S) : Masayuki et al.

Page 1 of 1

It is certified that error appears in the above-identified patent and that said Letters Patent is hereby corrected as shown below:

Col. 132, claim 3, line 33, "and N" should read --and--.

Signed and Sealed this

Fifteenth Day of September, 2009

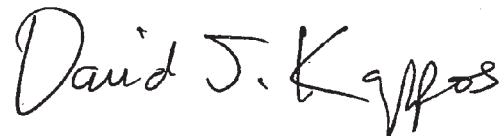
A handwritten signature in black ink that reads "David J. Kappos". The signature is written in a cursive style with a large initial 'D' and a stylized 'K'.

David J. Kappos  
*Director of the United States Patent and Trademark Office*