

Ex. 1012

US Patent No. 5,905,860 (“Olsen”)



- [54] **FAULT TOLERANT ELECTRONIC LICENSING SYSTEM**
- [75] Inventors: **James E. Olsen**, Park City; **Adam L. Bringham**, Provo, both of Utah
- [73] Assignee: **Novell, Inc.**, Provo, Utah
- [21] Appl. No.: **08/804,936**
- [22] Filed: **Feb. 24, 1997**

Related U.S. Application Data

- [63] Continuation-in-part of application No. 08/620,319, Mar. 15, 1996, Pat. No. 5,758,069.

- [51] **Int. Cl.⁶** **H04L 9/00**
- [52] **U.S. Cl.** **395/187.01; 395/186; 395/200.57; 380/4**
- [58] **Field of Search** **395/187.01, 186, 395/200.57; 380/3, 4**

References Cited

U.S. PATENT DOCUMENTS

4,870,568	9/1989	Kahle et al.	707/5
4,924,378	5/1990	Hershey	395/187.01
4,937,863	6/1990	Robert et al.	380/4
4,941,175	7/1990	Enescu et al.	380/4
5,023,907	6/1991	Johnson et al.	380/4
5,047,928	9/1991	Wiedemer	380/4
5,097,533	3/1992	Burger et al.	395/500
5,103,476	4/1992	Waite et al.	380/4
5,138,712	8/1992	Corbin	395/186
5,157,663	10/1992	Major et al.	380/25
5,182,770	1/1993	Medveczky et al.	380/4
5,187,770	2/1993	Mishima et al.	385/145
5,201,046	4/1993	Goldberg et al.	707/100
5,201,048	4/1993	Coulter et al.	707/3
5,204,897	4/1993	Wyman	380/4

5,222,134	6/1993	Waite et al.	380/4
5,260,999	11/1993	Wyman	380/4
5,265,065	11/1993	Turtle	707/4
5,278,980	1/1994	Pederson et al.	707/4
5,287,408	2/1994	Samson	380/25
5,319,705	6/1994	Halter et al.	380/4
5,343,526	8/1994	Lassers	380/4
5,343,527	8/1994	Moore	380/4
5,349,642	9/1994	Kingdon	380/25
5,371,792	12/1994	Asai et al.	380/3
5,375,206	12/1994	Hunter et al.	395/712
5,386,369	1/1995	Christiano	705/400
5,438,508	8/1995	Wyman	705/8
5,553,143	9/1996	Ross	380/25
5,675,782	10/1997	Montague et al.	395/609
5,689,638	11/1997	Sadovsky	395/188.01

FOREIGN PATENT DOCUMENTS

A-38209/93	4/1993	Australia .
A-48113/93	3/1994	Australia .
WO 89/04520	5/1989	WIPO .
WO 92/20021	11/1992	WIPO .

Primary Examiner—Ly Hua
Attorney, Agent, or Firm—Dinsmore & Shohl LLP

[57] **ABSTRACT**

A licensing system provides enhanced flexibility for licensing applications in a network. The licensing system includes a directory services database which stores all license information. The directory services database is accessed by providing a request to a license service provider associated with a server. The license service provider generates an executable entity based on the request parameters, which searches the database and, if the appropriate units are available, assembles a license. The license and the application are then transmitted to the requesting client. All aspects of the transaction are also stored in a database organized according to a transaction's relation to a particular license.

22 Claims, 5 Drawing Sheets

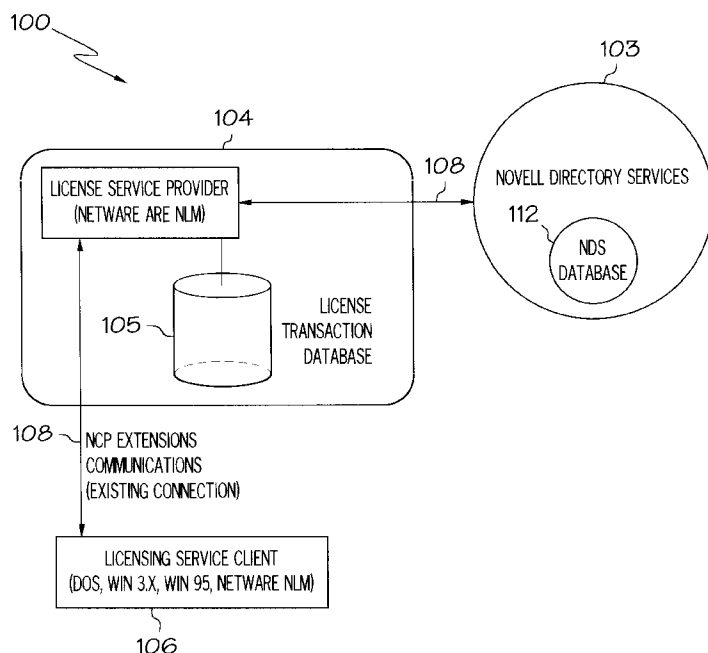

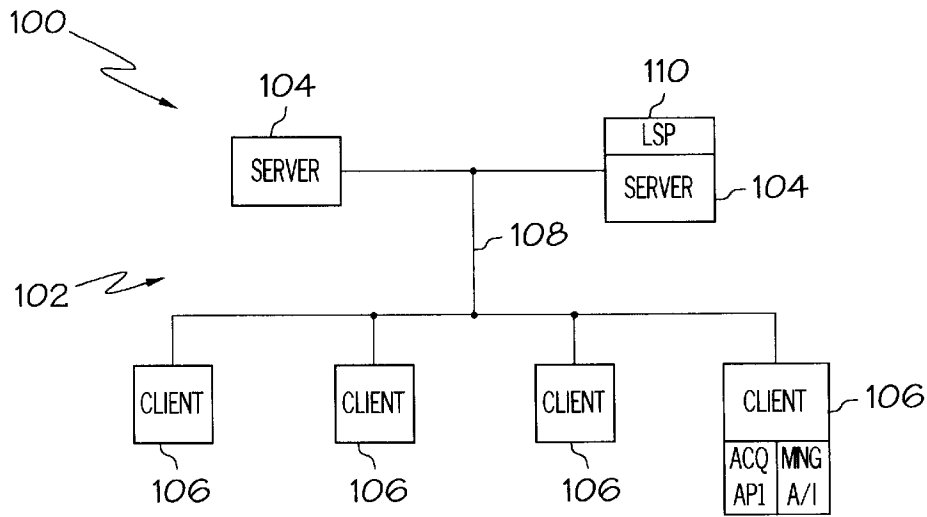

FIG. 1A

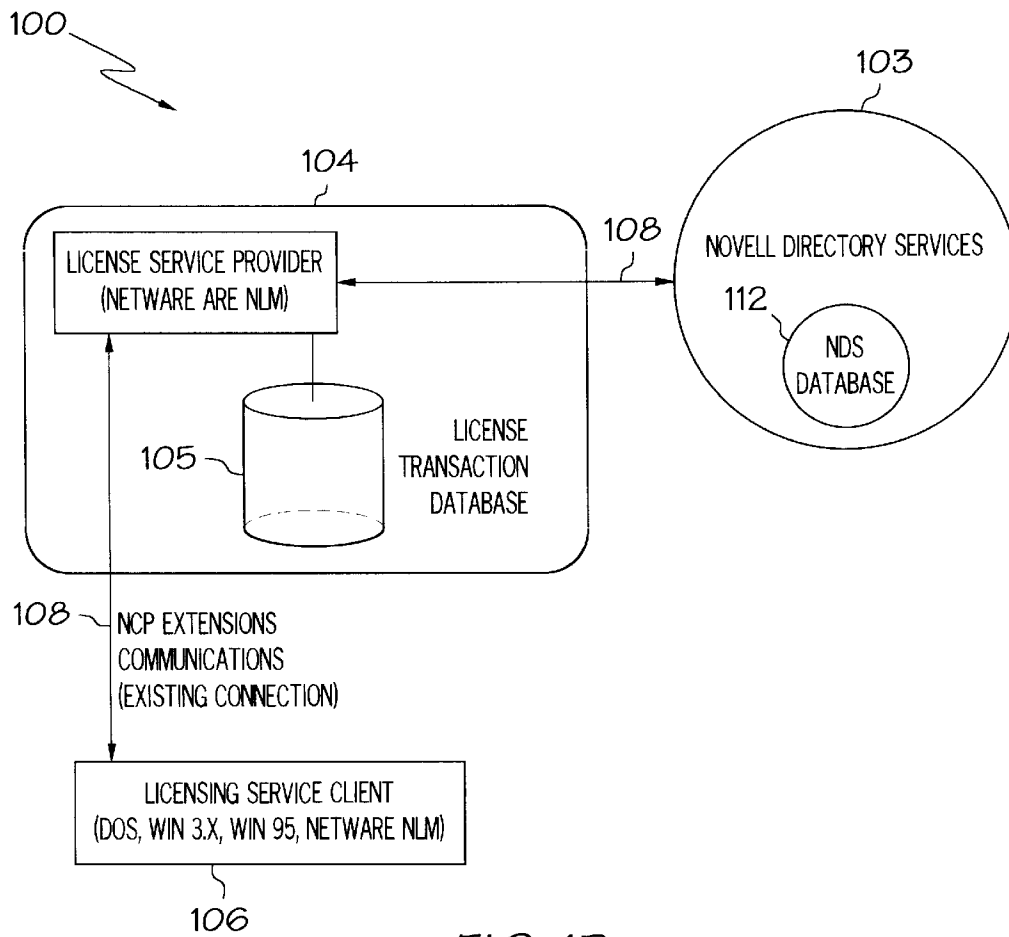

FIG. 1B

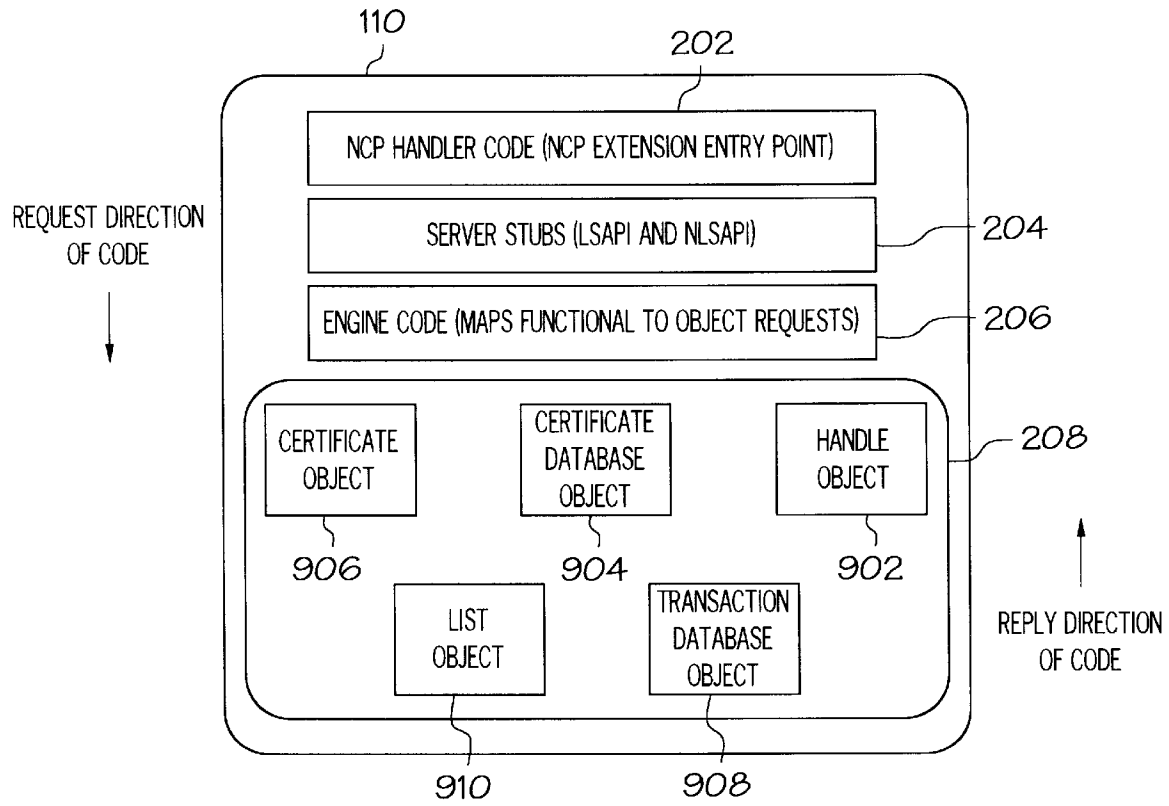

FIG. 2

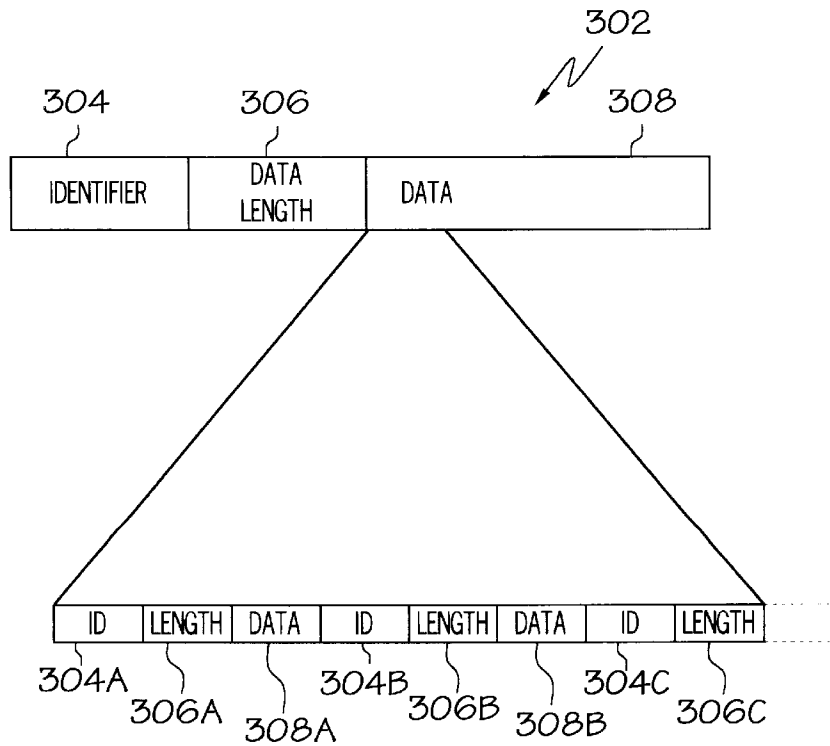

FIG. 3

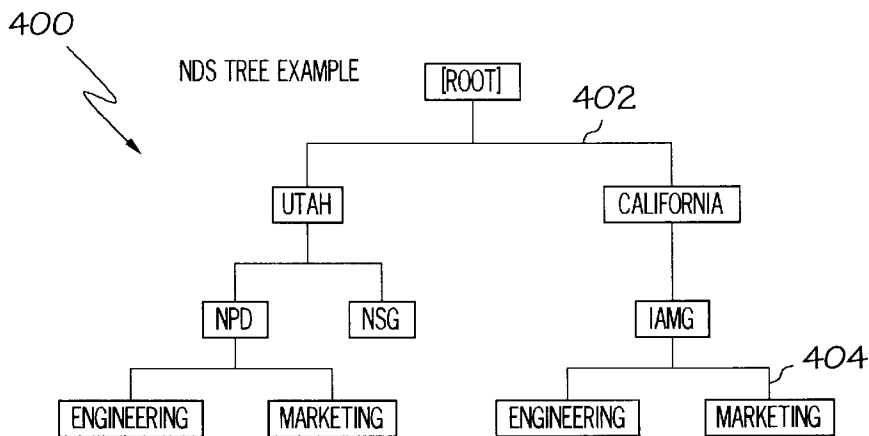

FIG. 4

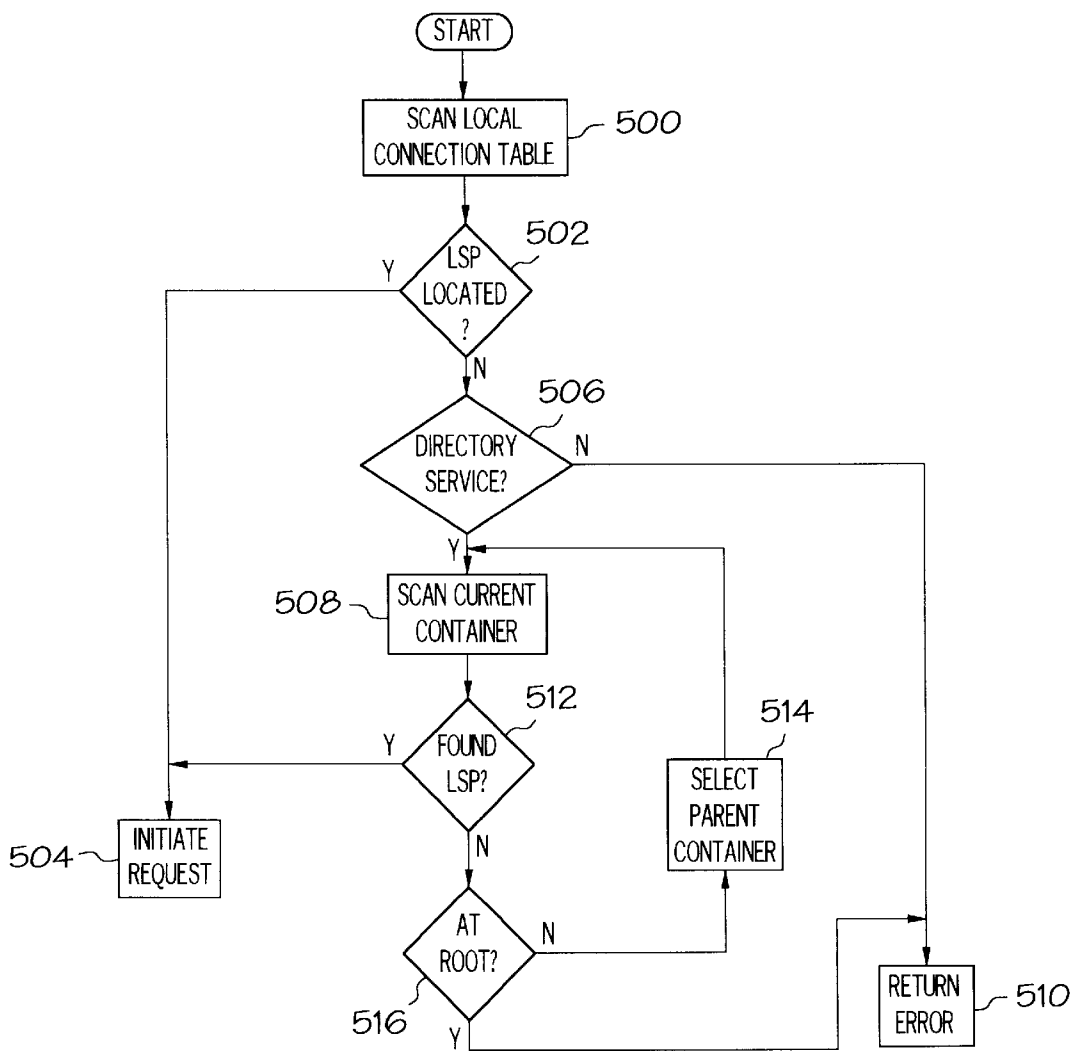

FIG. 5

Explore Litigation Insights

Docket Alarm provides insights to develop a more informed litigation strategy and the peace of mind of knowing you're on top of things.

Real-Time Litigation Alerts



Keep your litigation team up-to-date with **real-time alerts** and advanced team management tools built for the enterprise, all while greatly reducing PACER spend.

Our comprehensive service means we can handle Federal, State, and Administrative courts across the country.

Advanced Docket Research



With over 230 million records, Docket Alarm's cloud-native docket research platform finds what other services can't. Coverage includes Federal, State, plus PTAB, TTAB, ITC and NLRB decisions, all in one place.

Identify arguments that have been successful in the past with full text, pinpoint searching. Link to case law cited within any court document via Fastcase.

Analytics At Your Fingertips



Learn what happened the last time a particular judge, opposing counsel or company faced cases similar to yours.

Advanced out-of-the-box PTAB and TTAB analytics are always at your fingertips.

API

Docket Alarm offers a powerful API (application programming interface) to developers that want to integrate case filings into their apps.

LAW FIRMS

Build custom dashboards for your attorneys and clients with live data direct from the court.

Automate many repetitive legal tasks like conflict checks, document management, and marketing.

FINANCIAL INSTITUTIONS

Litigation and bankruptcy checks for companies and debtors.

E-DISCOVERY AND LEGAL VENDORS

Sync your system to PACER to automate legal marketing.