



US008983134B2

(12) **United States Patent**
Pirim

(10) **Patent No.:** **US 8,983,134 B2**
(45) **Date of Patent:** ***Mar. 17, 2015**

(54) **IMAGE PROCESSING METHOD**
(71) Applicant: **Image Processing Technologies LLC**,
Suffern, NY (US)
(72) Inventor: **Patrick Pirim**, Paris (FR)
(*) Notice: Subject to any disclaimer, the term of this
patent is extended or adjusted under 35
U.S.C. 154(b) by 0 days.

This patent is subject to a terminal dis-
claimer.

(21) Appl. No.: **14/215,358**
(22) Filed: **Mar. 17, 2014**
(65) **Prior Publication Data**
US 2014/0198952 A1 Jul. 17, 2014

Related U.S. Application Data
(60) Continuation of application No. 12/620,092, filed on
Nov. 17, 2009, now Pat. No. 8,805,001, which is a
(Continued)

(30) **Foreign Application Priority Data**
Jul. 26, 1996 (FR) 96 09420

(51) **Int. Cl.**
G06K 9/00 (2006.01)
G06T 7/20 (2006.01)
G06K 9/62 (2006.01)

(52) **U.S. Cl.**
CPC **G06T 7/2033** (2013.01); **G06K 9/6212**
(2013.01)
USPC **382/103**; 382/128; 382/168

(58) **Field of Classification Search**
CPC G06T 2207/30221; G06T 2207/30236;
G06T 7/0083; G06T 7/208; G06T 11/001;
G06T 2207/20144; G06T 7/20; G06T 7/2093;
G06T 2207/30232; G06K 2209/23; G06K
9/6202; G06K 9/00771; G06K 2209/09;
G06K 9/00201; G06K 2009/3291; G06K
9/00342; G06K 9/00362; G06K 9/00664;
G06K 9/00791; H04N 7/368; B60R 2300/802;
B60R 2300/804; B60R 2300/806
See application file for complete search history.

(56) **References Cited**
U.S. PATENT DOCUMENTS
4,706,120 A 11/1987 Slaughter et al.
4,719,584 A * 1/1988 Rue et al. 348/171
(Continued)

FOREIGN PATENT DOCUMENTS
EP 0046110 A1 2/1982
EP 2611063 A1 8/1988
(Continued)

OTHER PUBLICATIONS
Stephane G. Mallat, "A Theory for Multiresolution Signal Decom-
position: The Wavelet Representation", IEEE Transactions on Pat-
tern Analysis and Machine Intelligence, Vol. 11, No. 7, Jul. 1989, pp.
674-693.
(Continued)

Primary Examiner — Manav Seth
(74) *Attorney, Agent, or Firm* — Novak Druce Connolly
Bove + Quigg
(57)

ABSTRACT
A method and apparatus for localizing an area in relative
movement and for determining the speed and direction
thereof in real time is disclosed. Each pixel of an image is
smoothed using its own time constant. A binary value corre-
sponding to the existence of a significant variation in the
amplitude of the smoothed pixel from the prior frame, and the
amplitude of the variation, are determined, and the time con-
stant for the pixel is updated. For each particular pixel, two
matrices are formed that include a subset of the pixels spa-
tially related to the particular pixel. The first matrix contains
the binary values of the subset of pixels. The second matrix
contains the amplitude of the variation of the subset of pixels.
In the first matrix, it is determined whether the pixels along an
oriented direction relative to the particular pixel have binary
values representative of significant variation, and, for such
pixels, it is determined in the second matrix whether the
amplitude of these pixels varies in a known manner indicating
movement in the oriented direction. In each of several
domains, histogram of the values in the first and second
matrices falling in such domain is formed. Using the histo-
grams, it is determined whether there is an area having the
characteristics of the particular domain. The domains include
luminance, hue, saturation, speed (V), oriented direction
(D1), time constant (CO), first axis (x(m)), and second axis
(y(m)).

6 Claims, 13 Drawing Sheets

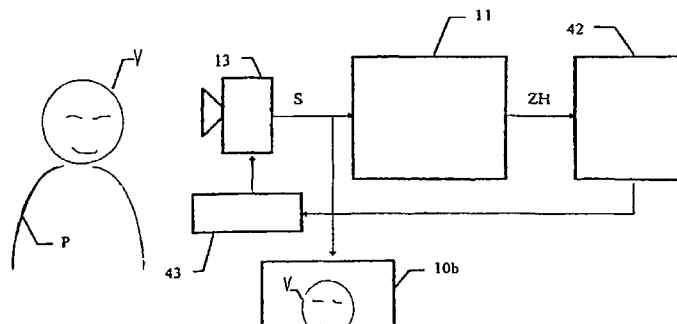

Related U.S. Application Data

continuation of application No. 11/676,926, filed on Feb. 20, 2007, now Pat. No. 7,650,015, which is a division of application No. 09/792,294, filed on Feb. 23, 2001, now Pat. No. 7,181,047, which is a continuation-in-part of application No. 09/230,502, filed as application No. PCT/FR97/01354 on Jul. 22, 1997, now Pat. No. 6,486,909, and a continuation-in-part of application No. PCT/EP98/05383, filed on Aug. 25, 1998.

FOREIGN PATENT DOCUMENTS

EP	0380659	A	8/1990
EP	0394959	A2	10/1990
EP	0574831		12/1993
EP	2751772	A1	1/1998
JP	06-205780		7/1994
WO	98/05002		2/1998
WO	99/36694		7/1999
WO	99/36893		7/1999
WO	00/11639	A1	3/2000
WO	01/11610	A1	3/2000
WO	01/63557	A2	8/2001

(56)

References Cited

U.S. PATENT DOCUMENTS

4,783,828	A	11/1988	Sadjadi	
5,008,946	A	4/1991	Ando	
5,088,488	A	2/1992	Markowitz et al.	
5,109,425	A	4/1992	Lawton	
5,123,055	A	6/1992	Kasdan	
5,163,095	A	11/1992	Kosaka	
5,263,098	A	11/1993	Horikami	
5,278,921	A	1/1994	Nakamura et al.	
5,359,533	A	10/1994	Ricka et al.	
5,360,968	A *	11/1994	Scott	235/454
5,384,865	A	1/1995	Loveridge	
5,430,809	A	7/1995	Tomitaka	
5,473,369	A	12/1995	Abe	
5,488,430	A	1/1996	Hong	
5,521,843	A	5/1996	Hashima et al.	
5,546,475	A	8/1996	Bolle et al.	
5,565,920	A	10/1996	Lee et al.	
5,592,226	A	1/1997	Lee et al.	
5,592,237	A	1/1997	Greenway et al.	
5,608,820	A	3/1997	Vaidyanathan	
5,610,653	A	3/1997	Abecassis	
5,625,717	A	4/1997	Hashimoto et al.	
5,630,037	A	5/1997	Schindler	
5,694,495	A	12/1997	Hara et al.	
5,712,729	A	1/1998	Hashimoto	
5,774,581	A	6/1998	Fassnacht et al.	
5,793,888	A	8/1998	Delanoy	
5,912,980	A	6/1999	Hunke	
5,982,944	A	11/1999	Vaidyanathan et al.	
6,226,388	B1	5/2001	Qian et al.	
6,256,608	B1	7/2001	Malvar	
6,263,089	B1 *	7/2001	Otsuka et al.	382/107
6,304,187	B1	10/2001	Pirim	
6,312,385	B1	11/2001	Mo et al.	
6,486,909	B1	11/2002	Pirim	
6,597,738	B1	7/2003	Park et al.	
6,717,518	B1	4/2004	Pirim et al.	
7,181,047	B2	2/2007	Pirim	
7,650,015	B2	1/2010	Pirim	
8,116,527	B2	2/2012	Sabol et al.	
8,805,001	B2	8/2014	Pirim	
2002/0101432	A1	8/2002	Ohara et al.	
2002/0120594	A1	8/2002	Pirim	
2002/0156753	A1	10/2002	Pirim	
2002/0169732	A1	11/2002	Pirim	
2003/0067978	A1	4/2003	Pirim	
2003/0152267	A1	8/2003	Pirim	
2007/0140526	A1	6/2007	Pirim	

OTHER PUBLICATIONS

John G. Daugman, "Complete Discrete 2-D Gabor Transforms by Neural Networks for Image Analysis and Compression", IEEE Transaction on Acoustics, Speech and Signal Processing, vol. 36, No. 7, Jul. 1988, pp. 1169-14179.

Alberto Tomita, Jr. et al., "Hand Shape Extraction from a Sequence of Digitized Gray-Scale Images", IECON '94, 20th International Conference on Industrial Electronics, Control and Instrumentation, vol. 3 of 3, Special Sessions, Signal Processing and Control, pp. 1925-1930.

Giacomo Indiveri et al., "System Implementations of Analog VLSI Velocity Sensor", 1996 IEEE Proceedings of MicroNeuro '96, pp. 15-22.

VePierre-Francois Rüedi, "Motion Detection Silicon Retina Based on Event Correlations", 1996 IEEE Proceedings of MicroNeuro '96, pp. 23-29.

Revue Trimestrielle <<Techniques de Lingenieur>>, "Instantané Technique" Techniques De ingénieur, Mar. 1997—No. 5 (40F), ISSN 0994-0758.

Es Professionnels de L'informatique En Entreprise Magazine, "Objectif Securite Des Reseaux", No. 24, Jan. 1997.

Electronique International Hebdo, Dec. 5, 1996—No. 245, "Premier . . . oeil", Françoise Gru svelte (with translation).

Nabeel Al Adsani, "for Immediate Release the Generic Visual Perception Processor", Oct. 10, 1997, p. 1.

Colin Johnson, "Vision Chip's Circuitry Has Its Eye Out for You", <http://192.215.107.74/wire/news/1997/09/09013vision.html>, pp. 1-3.

The Japan Times, "British firm has eye on the future", Business & Technology, Tuesday, Nov. 18, 1997, 4th Edition.

Inside the Pentagon's, Inside Missile Defense, an exclusive biweekly report on U.S. missile defense programs, procurement and policymaking, "Missile Technology" vol. 3, No. 16—Aug. 13, 1997, p. 5.

Electronique, "Le Mechanisme de la Vision Humaine Dans Le Silicium", Electronique Le Mensuel Des Ingenieurs De Conception, No. 68, Mar. 1997, ISSN 1157-1151 (with translation).

"Un Processor de Perception Visuelle", Lehaut Parleur, 25F Des solutions électroniques pour tous, No. 1856, Jan. 15, 1997.

"Realiser un Decodeur Pour TV Numerique", Electronique, Le Mensuel Des Ingenieurs De Conception, No. 66, Jan. 1997.

Kenichi Yamada, et al., "Image Understanding Based on Edge Halogram Method for Rear-End Collision Avoidance System", Vehicle Navigation & Information Systems Conference Proceedings; (1994), pp. 445-450 published Aug. 31, 1994; XP 000641348.

* cited by examiner

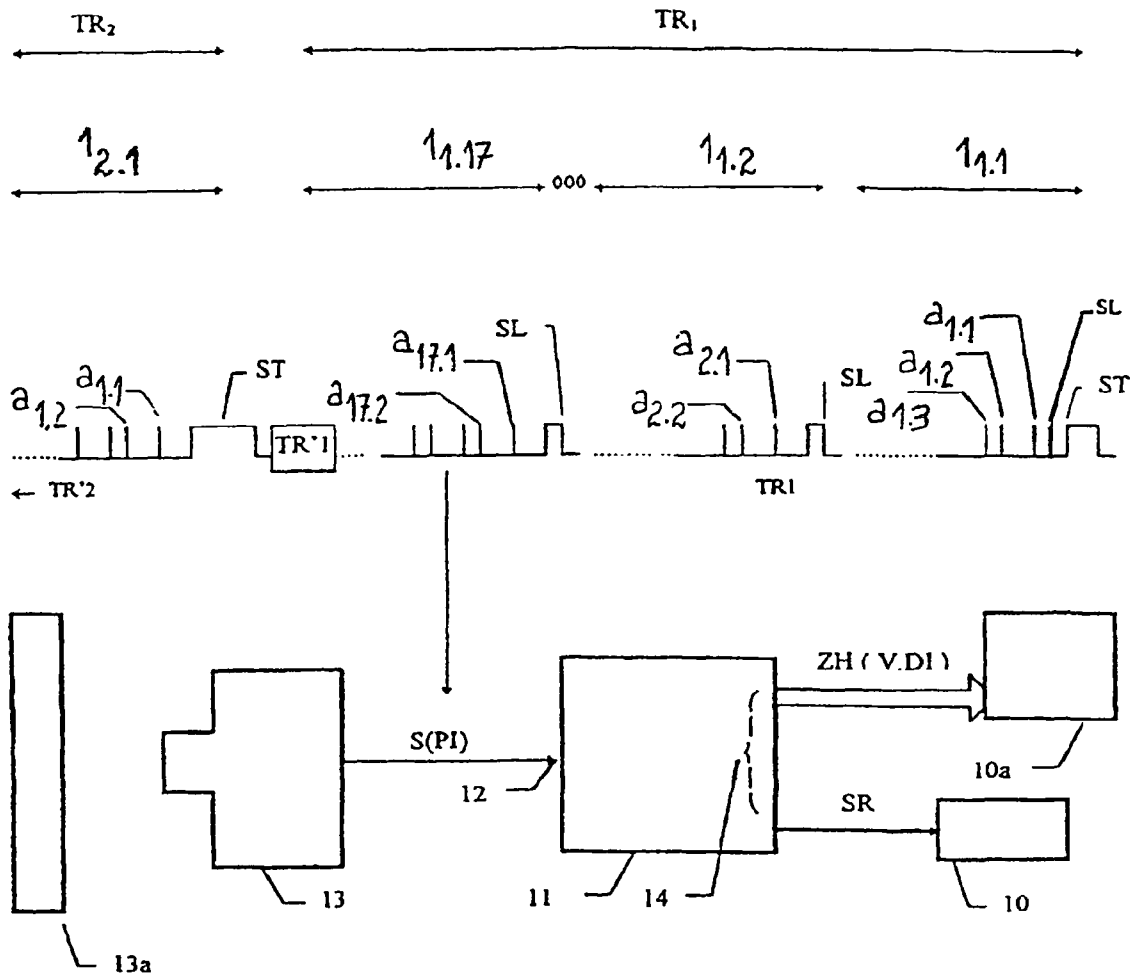

FIG. 1

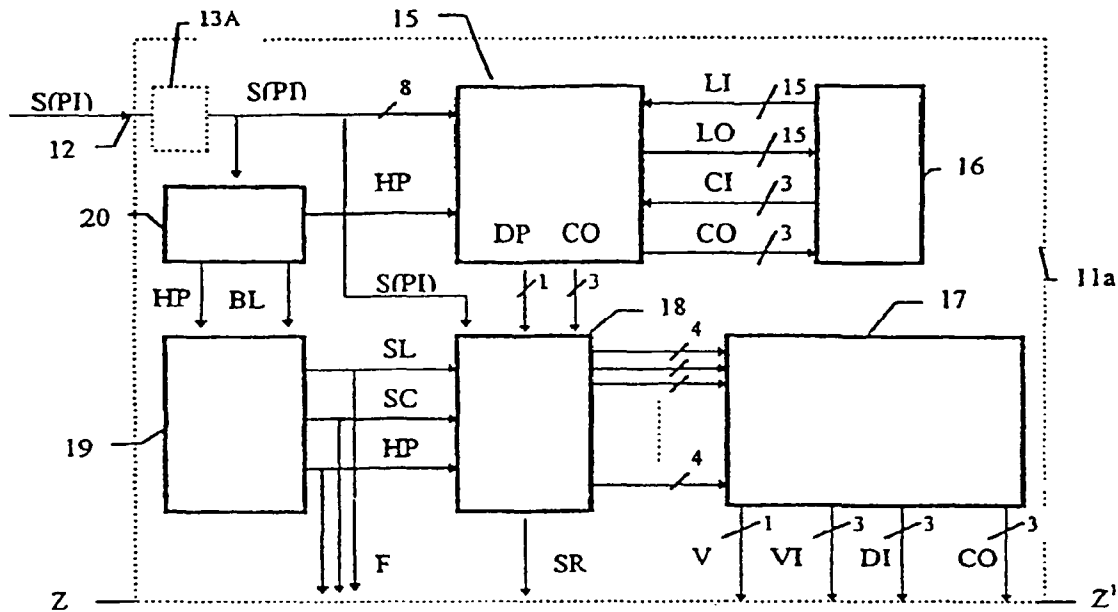

FIG. 2

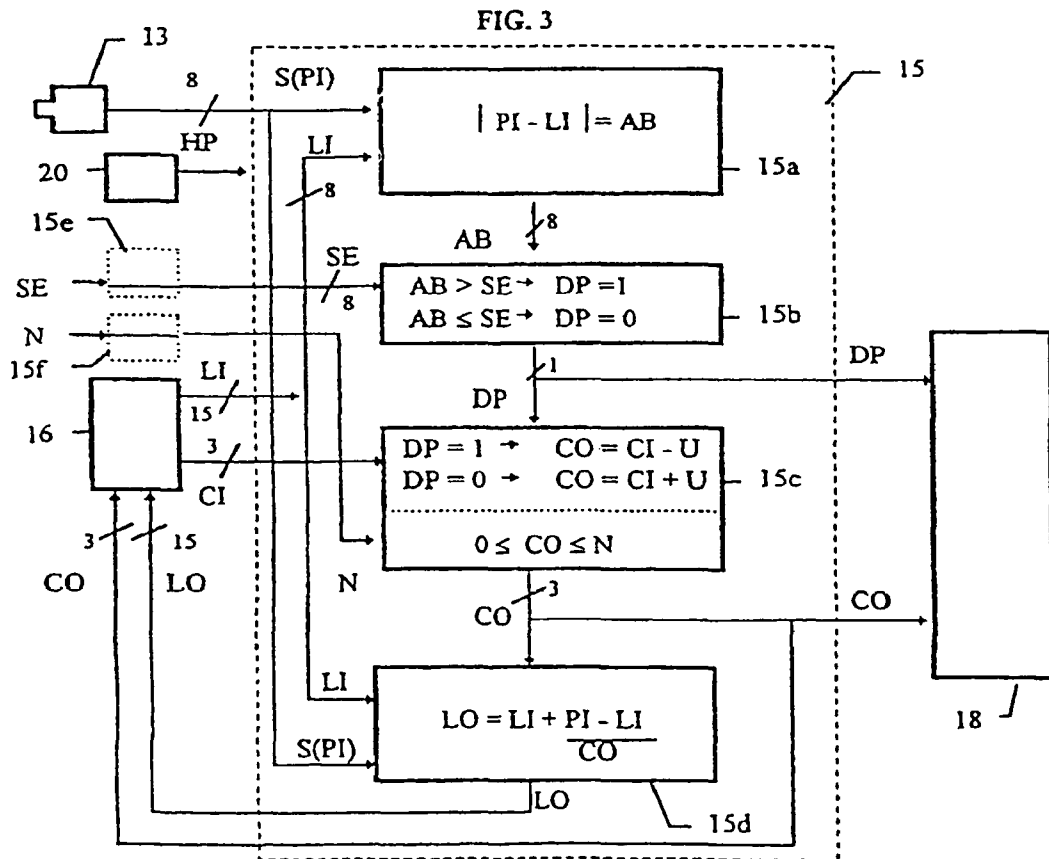

FIG. 3

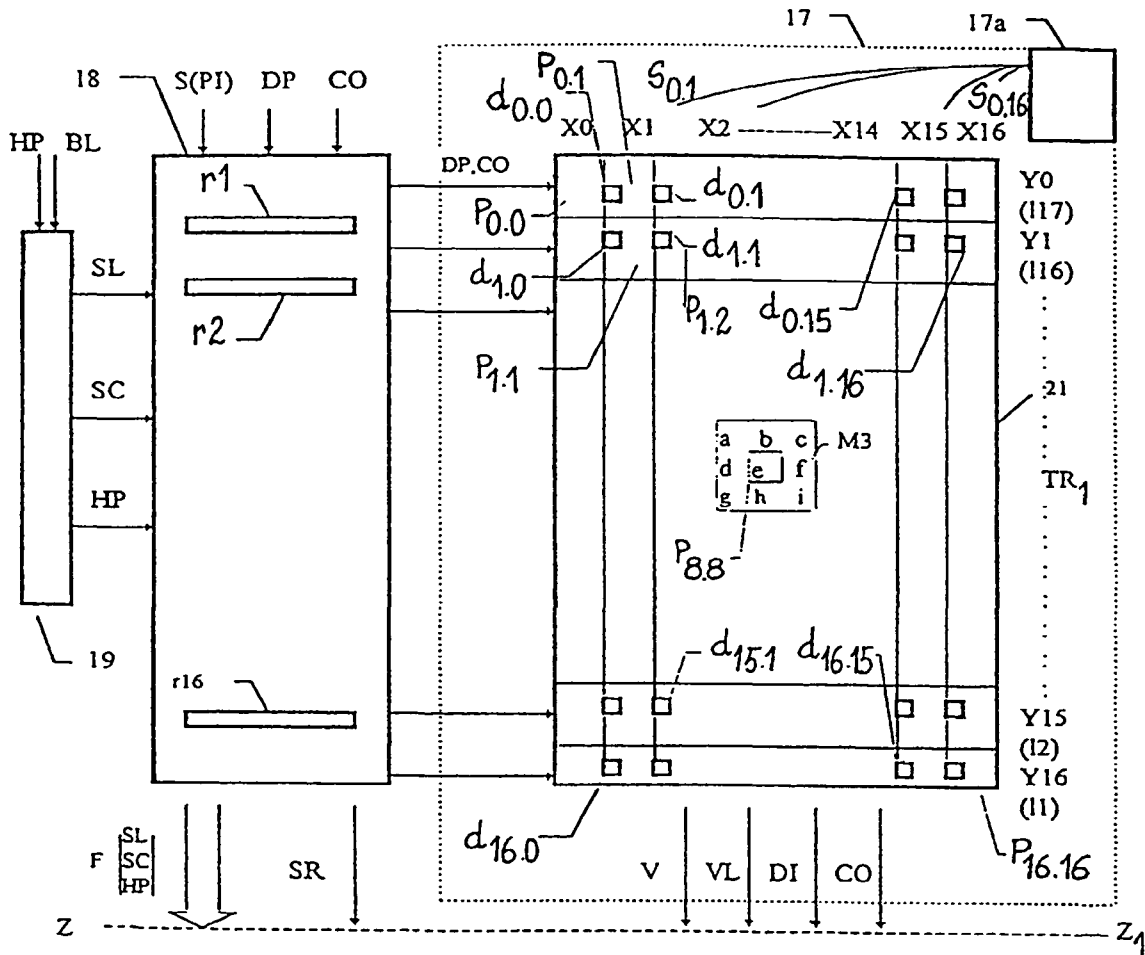

FIG. 4

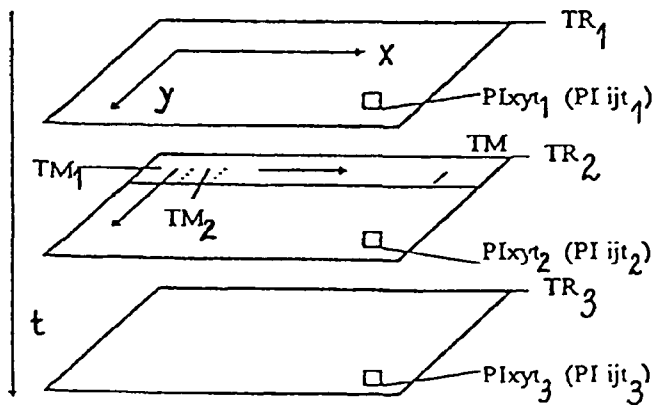

FIG. 5

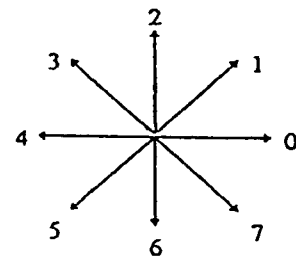

FIG. 6

Explore Litigation Insights

Docket Alarm provides insights to develop a more informed litigation strategy and the peace of mind of knowing you're on top of things.

Real-Time Litigation Alerts



Keep your litigation team up-to-date with **real-time alerts** and advanced team management tools built for the enterprise, all while greatly reducing PACER spend.

Our comprehensive service means we can handle Federal, State, and Administrative courts across the country.

Advanced Docket Research



With over 230 million records, Docket Alarm's cloud-native docket research platform finds what other services can't. Coverage includes Federal, State, plus PTAB, TTAB, ITC and NLRB decisions, all in one place.

Identify arguments that have been successful in the past with full text, pinpoint searching. Link to case law cited within any court document via Fastcase.

Analytics At Your Fingertips



Learn what happened the last time a particular judge, opposing counsel or company faced cases similar to yours.

Advanced out-of-the-box PTAB and TTAB analytics are always at your fingertips.

API

Docket Alarm offers a powerful API (application programming interface) to developers that want to integrate case filings into their apps.

LAW FIRMS

Build custom dashboards for your attorneys and clients with live data direct from the court.

Automate many repetitive legal tasks like conflict checks, document management, and marketing.

FINANCIAL INSTITUTIONS

Litigation and bankruptcy checks for companies and debtors.

E-DISCOVERY AND LEGAL VENDORS

Sync your system to PACER to automate legal marketing.