

- [54] **EYE TRACKING APPARATUS AND METHOD EMPLOYING GRAYSCALE THRESHOLD VALUES**
- [75] Inventors: **Lester A. Gerhardt**, Clifton Park, N.Y.;  
**Ross M. Sabolcik**, Austin, Tex.
- [73] Assignee: **Rensselaer Polytechnic Institute**, Troy, N.Y.
- [21] Appl. No.: **204,008**
- [22] Filed: **Mar. 1, 1994**
- [51] Int. Cl.<sup>6</sup> ..... **G06K 9/00**
- [52] U.S. Cl. .... **382/103; 382/171; 382/291; 345/158; 364/709.11**
- [58] **Field of Search** ..... **382/1, 9, 48, 100, 382/103, 117, 171, 173, 291; 348/78; 345/8, 157, 158; 364/709.1, 709.11; 351/206, 209, 210, 245**

[56] **References Cited**

**U.S. PATENT DOCUMENTS**

3,236,578	2/1966	Mackworth et al.	351/7
3,542,457	11/1970	Balding et al.	351/7
4,102,564	7/1978	Michael	351/7
4,595,990	6/1986	Garwin et al.	364/518
4,625,329	11/1986	Ishikawa et al.	382/1
4,648,052	3/1987	Friedman et al.	364/550
4,748,502	5/1988	Friedman et al.	358/93
4,815,839	3/1989	Waldorf	351/210
4,836,670	6/1989	Hutchinson	351/210
4,852,988	8/1989	Velez et al.	351/210
4,988,183	1/1991	Kasahara et al.	351/210
5,002,385	3/1991	Kasahara et al.	351/210

(List continued on next page.)

**FOREIGN PATENT DOCUMENTS**

0456166	11/1991	European Pat. Off.	351/209
1090333	5/1985	U.S.S.R.	A61B 3/14

**OTHER PUBLICATIONS**

- Cunningham, R., "Segmenting Binary Images", *Robotic Age*, Jul./Aug. 1981, pp. 4-19.
- Kitter, J., Illingworth, J., & Föglein, J., "Threshold Selection Based on a Simple Image Statistic", *Computer Vision, Graphics, and Image Processing*, 1985, vol. 30, pp. 125-147.
- Haralick, R. M. & Shapiro, L. G., "Survey: Image Segmentation Techniques", *Computer Vision, Graphics and Image Processing*, 1985, vol. 29, pp. 100-132.
- "The Eyegaze Computer System", LC Technologies, Inc., Product Brochure, Aug. 1991, (13 pages).
- Haralick, R. M., Sternberg, S. R. & Zhuang, X., "Image Analysis Using Mathematical Morphology", *IEEE Transactions on Pattern Analysis and Machine Intelligence*, vol. PAMI-9, No. 4, Jul. 1987, pp. 532-550.

*Primary Examiner*—Leo H. Boudreau  
*Assistant Examiner*—Andrew W. Johns  
*Attorney, Agent, or Firm*—Heslin & Rothenberg

[57] **ABSTRACT**

An eye-tracking system determines the position of a user's pupil and maps this position into a point of regard of the user on an interface device, such as a display screen, or other real-world object by a system comprising a camera for acquiring a video image of the pupil; a frame grabber coupled to the camera for accepting and converting analog video data from the camera to digital pixel data; a computer coupled to the frame grabber for processing the digital pixel data to substantially determine the position of the pupil; a display screen coupled to the computer; and a support connected to the camera and display screen for fixing the relative physical positions thereof relative to the user's pupil. The processing performed by the computer may include the selection of a first pixel intensity threshold for the segmentation of the digital pixel data into first and second groups, where the total pixel area of the first group is selected to be substantially equal to a pre-determined value expected to correspond to the area of a user's pupil. The system may be calibrated by the user's following a cursor on the display screen while the system measures the pupil position for known locations of the cursor.

**35 Claims, 16 Drawing Sheets**

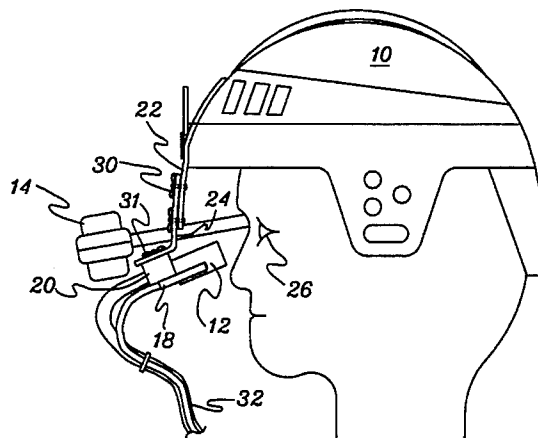

---

U.S. PATENT DOCUMENTS						
			5,093,567	3/1992	Staveley .....	250/221
5,016,282	5/1991	Tomono et al. ....	5,094,521	3/1992	Jolson et al. ....	351/210
5,034,618	7/1991	Akeel et al. ....	5,109,425	4/1992	Lawton .....	382/1
5,049,147	9/1991	Danon .....	5,189,512	2/1993	Cameron et al. ....	358/93
5,070,883	12/1991	Kasahara .....	5,325,133	6/1994	Adachi .....	351/209

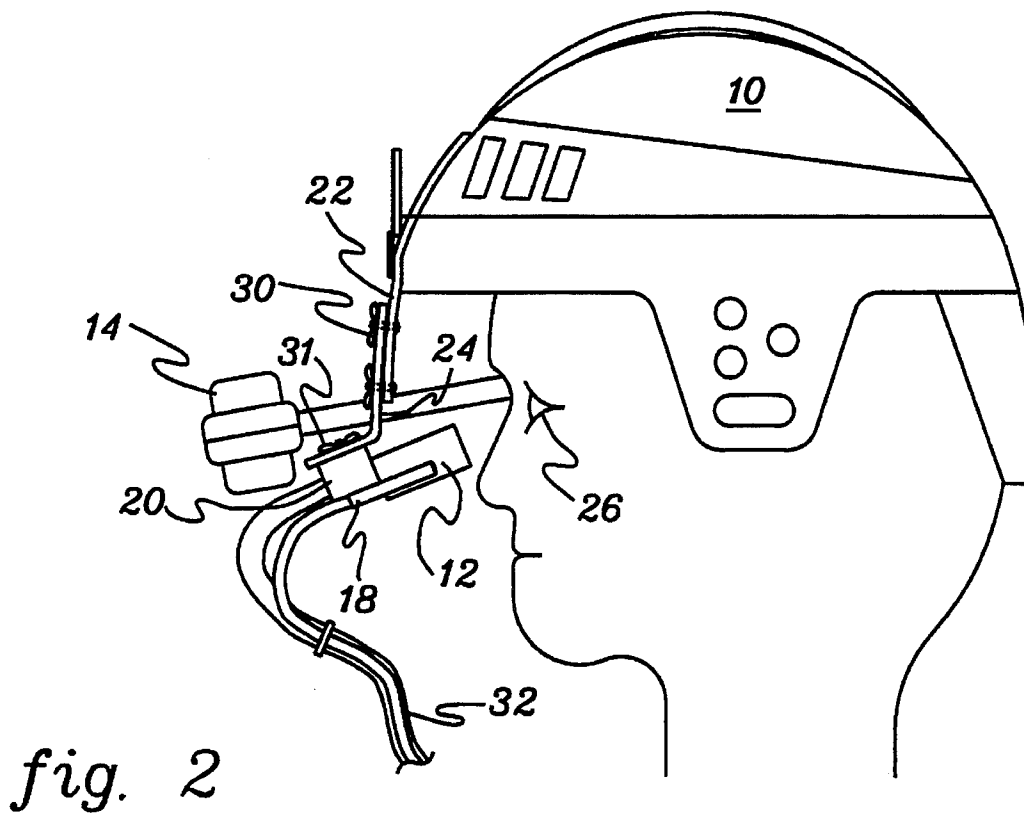
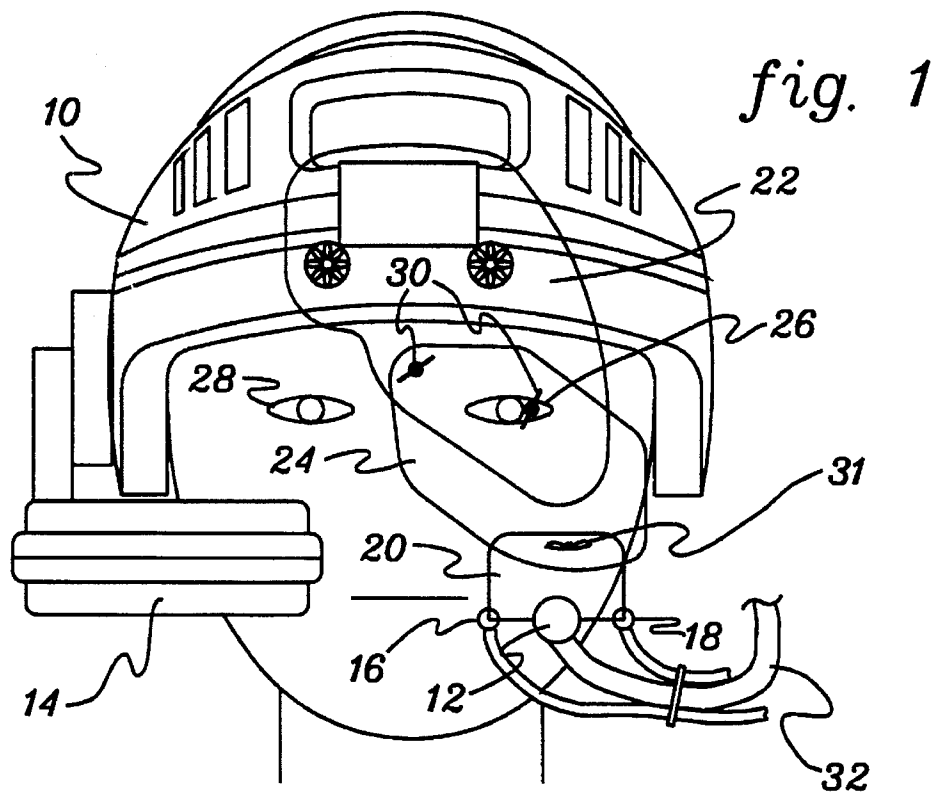

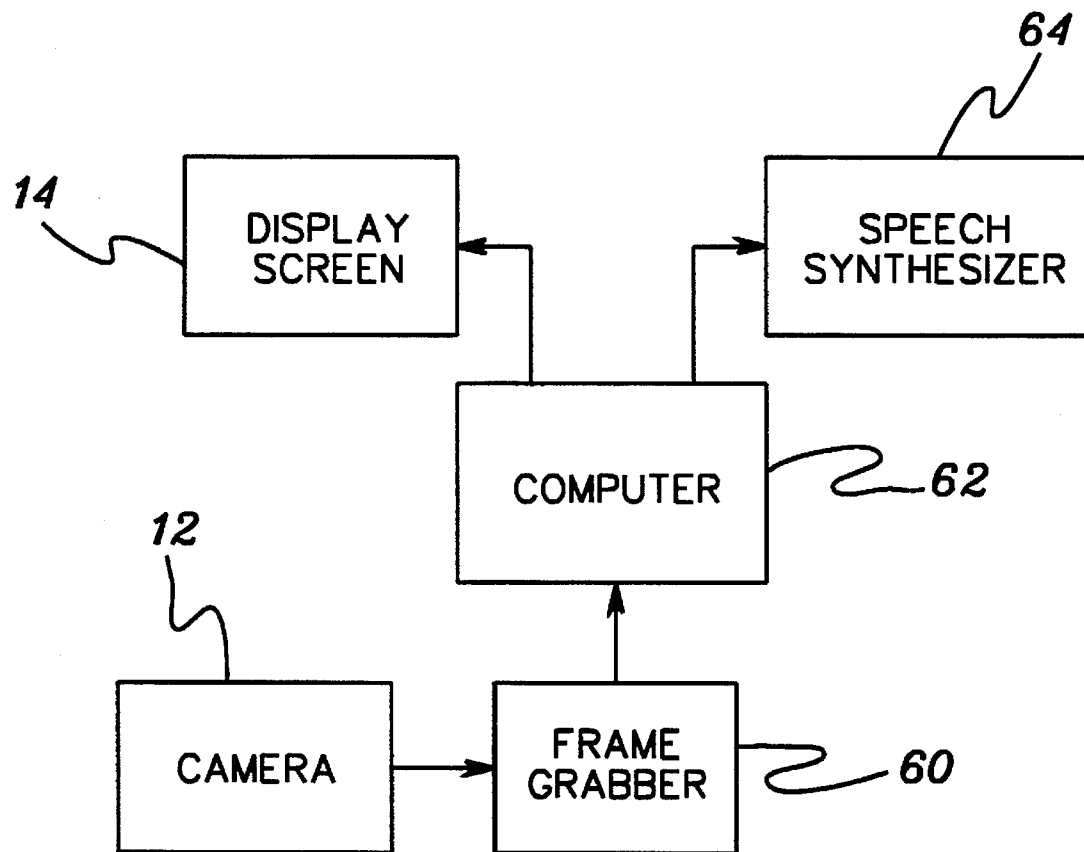

*fig. 3*

fig. 4

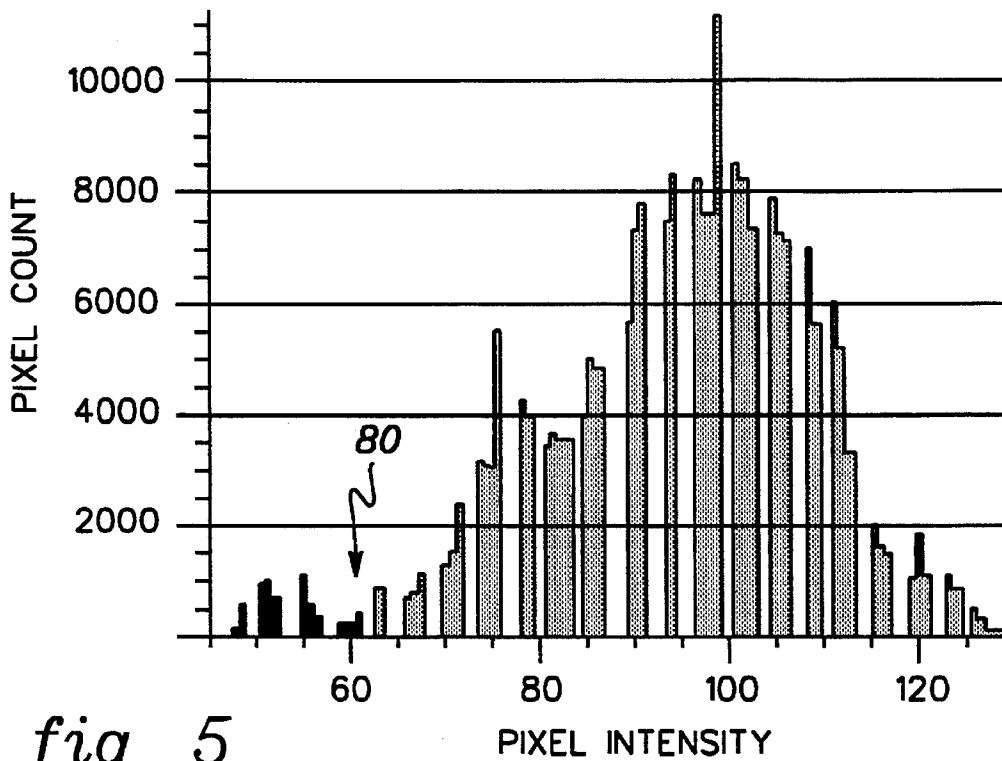
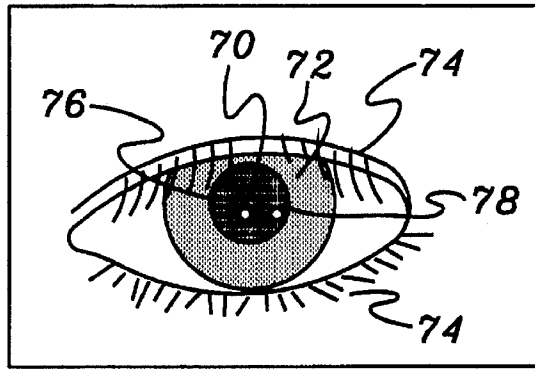
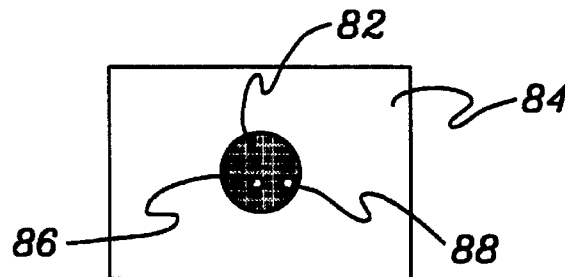

fig. 5

fig. 6



# Explore Litigation Insights

Docket Alarm provides insights to develop a more informed litigation strategy and the peace of mind of knowing you're on top of things.

## Real-Time Litigation Alerts



Keep your litigation team up-to-date with **real-time alerts** and advanced team management tools built for the enterprise, all while greatly reducing PACER spend.

Our comprehensive service means we can handle Federal, State, and Administrative courts across the country.

## Advanced Docket Research



With over 230 million records, Docket Alarm's cloud-native docket research platform finds what other services can't. Coverage includes Federal, State, plus PTAB, TTAB, ITC and NLRB decisions, all in one place.

Identify arguments that have been successful in the past with full text, pinpoint searching. Link to case law cited within any court document via Fastcase.

## Analytics At Your Fingertips



Learn what happened the last time a particular judge, opposing counsel or company faced cases similar to yours.

Advanced out-of-the-box PTAB and TTAB analytics are always at your fingertips.

## API

Docket Alarm offers a powerful API (application programming interface) to developers that want to integrate case filings into their apps.

## LAW FIRMS

Build custom dashboards for your attorneys and clients with live data direct from the court.

Automate many repetitive legal tasks like conflict checks, document management, and marketing.

## FINANCIAL INSTITUTIONS

Litigation and bankruptcy checks for companies and debtors.

## E-DISCOVERY AND LEGAL VENDORS

Sync your system to PACER to automate legal marketing.