



Electronics America, Inc., Samsung Telecommunications America LLC, ZTE Corporation, ZTE USA Inc., and ZTE Solutions, Inc. (collectively, the “Defendants”) for infringement of U.S. Patent No. 8,457,022 (“the ’022 patent”), U.S. Patent No. 8,570,957 (“the ’957 patent”), and U.S. Patent No. 8,867,472 (“the ’472 patent”).

## **INTRODUCTION**

AT&T proclaims that its 4G LTE cellular network covers over 300 million people. AT&T competes intensely with other national carriers to win subscribers and requires advanced LTE capabilities and features to do so. AT&T boasts that its network has the strongest LTE signal, is the most reliable LTE network, and has the fewest dropped calls. (*See* [www.att.com/network/en/index.html](http://www.att.com/network/en/index.html), as of April 30, 2015.) The technology of the CCE patents asserted in this Complaint underlies critical features of AT&T’s LTE network and allows AT&T to make most efficient use of its extremely valuable wireless spectrum. This is necessary to compete for customers in a highly competitive market and support as many users as possible while offering them the best possible LTE cellular experience. AT&T’s ability to do so is a direct result of AT&T’s infringement of the CCE patents.

AT&T relies upon its suppliers of mobile devices and network equipment, such as those named as defendants in this Complaint, to provide the LTE user equipment and base stations that are specifically designed by AT&T and its suppliers to operate as efficiently as possible using various features of the LTE wireless standards. In providing, testing, and/or operating the hardware that AT&T utilizes or sells to customers to offer 4G LTE cellular communications, each of its suppliers, including Alcatel-Lucent, Ericsson, Apple, HTC, LG, Samsung, and ZTE, also infringe the CCE patents that are the subject of this Complaint.

**THE PARTIES**

1. Cellular Communications Equipment LLC is a Texas limited liability company with its principal place of business in Plano, Texas.

2. AT&T Inc. is a Delaware corporation with its principal place of business in Dallas, Texas. This Defendant may be served with process through its agent, The Corporation Trust Company, Corporation Trust Center, 1209 Orange Street, Wilmington, Delaware 19801. This Defendant does business in the State of Texas and in the Eastern District of Texas.

3. AT&T Mobility LLC (with AT&T Inc., collectively “AT&T”) is a Delaware limited liability company with its principal place of business in Atlanta, Georgia. This Defendant may be served with process through its agent, The Corporation Trust Company, Corporation Trust Center, 1209 Orange Street, Wilmington, Delaware 19801. This Defendant does business in the State of Texas and in the Eastern District of Texas.

4. Alcatel-Lucent S.A. is a corporation organized under the laws of France with its principal place of business in Boulogne-Billancourt, France. On information and belief, this Defendant may be served with process at its principal place of business at 148/152 route de la Reine 92100 Boulogne-Billancourt, France. This Defendant does business in the State of Texas and in the Eastern District of Texas.

5. Alcatel-Lucent USA, Inc. (with Alcatel-Lucent S.A., collectively “Alcatel”) is a Delaware corporation with its principal place of business in Murray Hill, New Jersey. This Defendant may be served with process through its agent, The Corporation Service Company, 2711 Centerville Rd. Suite 400, Wilmington, Delaware 19808. This Defendant does business in the State of Texas and in the Eastern District of Texas.

6. Ericsson Inc. is a Delaware corporation with its headquarters and principal place of business in Plano, Texas. This Defendant may be served with process through its agent, Capitol Corporate Services, Inc., 800 Brazos, Suite 400, Austin, Texas 78701. This Defendant does business in the State of Texas and in the Eastern District of Texas.

7. Telefonaktiebolaget LM Ericsson (with Ericsson Inc., collectively “Ericsson”) is a company organized under the laws of Sweden with its principal place of business in Stockholm, Sweden. On information and belief, this Defendant may be served with process at its principal place of business at Torshamnsgatan 21, Kista, 164 83 Stockholm, Sweden. This Defendant does business in the State of Texas and in the Eastern District of Texas.

8. Apple Inc. (“Apple”) is a California corporation with its principal place of business in Cupertino, California. This Defendant may be served with process through its agent in Texas, CT Corporation System, 1999 Bryan Street, Ste. 900; Dallas, TX 75201-3136. This Defendant does business in the State of Texas and in the Eastern District of Texas.

9. HTC Corporation is incorporated under the laws of Taiwan with its principal place of business at 23 Xinghau Road, Taoyuan City, Taoyuan 330, Taiwan, R.O.C. On information and belief, this Defendant may be served with process at its principal place of business at 23 Xinghau Road, Taoyuan City, Taoyuan 330, Taiwan, R.O.C. This Defendant does business in the State of Texas and in the Eastern District of Texas.

10. HTC America, Inc. is a Washington corporation with its principal place of business at 13920 SE Eastgate Way, Suite 400, Bellevue, Washington 98005. This Defendant may be served with process through its agent in Texas, National Registered Agents, Inc., 1021 Main Street, Suite 1150, Houston, TX 77002. This Defendant does business in the State of Texas and in the Eastern District of Texas.



11. LG Electronics, Inc. is incorporated under the laws of South Korea with its principal place of business at LG Twin Towers 20, Yeouido-dong, Yeongdeunspo-gu, Seoul 150-721, South Korea. On information and belief, this Defendant may be served with process at its principal place of business at LG Twin Towers 20, Yeouido-dong, Yeongdeunspo-gu, Seoul 150-721, South Korea. This Defendant does business in the State of Texas and in the Eastern District of Texas.

12. LG Electronics USA, Inc. (with LG Electronics, Inc., collectively “LG”) is a Delaware corporation with its principal place of business in Englewood Cliffs, New Jersey. This Defendant may be served with process through its agent, United States Corporation Company, 2711 Centerville Road, Suite 400, Wilmington, Delaware 19808. This Defendant does business in the State of Texas and in the Eastern District of Texas.

13. Samsung Electronics Co., Ltd. is a corporation organized under the laws of South Korea with its principal place of business located at Samsung Main Building, 250, Taepyeongno 2-ga, Jung-gu, Seoul 100-742, Republic of Korea. On information and belief, this Defendant may be served with process at its principal place of business at Samsung Main Building, 250, Taepyeongno 2-ga, Jung-gu, Seoul 100-742, Republic of Korea. This Defendant does business in the State of Texas and in the Eastern District of Texas.

14. Samsung Electronics America, Inc. is a New York corporation with its principal place of business in Ridgefield Park, New Jersey. This Defendant may be served with process through its agent, CT Corporation System, 1999 Bryan Street, Suite 900, Dallas, Texas 75201. This Defendant does business in the State of Texas and in the Eastern District of Texas.

15. Samsung Telecommunications America, LLC (with Samsung Electronics Co., Ltd. and Samsung Electronics America, Inc., collectively “Samsung”) is a Delaware limited liability corporation with its principal place of business in Richardson, Texas. This Defendant may be

served with process through its agent, Corporation Service Company, 211 E. 7th Street, Suite 620, Austin, Texas 78701. This Defendant does business in the State of Texas and in the Eastern District of Texas.

16. ZTE Corporation is a corporation organized and existing under the laws of the People's Republic of China with its principal place of business in ZTE Plaza, Keji Road South, Hi-Tech Industrial Park, Nanshan District, Shenzhen, Guangdong Province, P.R. China 518057. On information and belief, this Defendant may be served with process at its principal place of business at ZTE Plaza, Keji Road South, Hi-Tech Industrial Park, Nanshan District, Shenzhen, Guangdong Province, P.R. China 518057. This Defendant does business in the State of Texas and in the Eastern District of Texas.

17. ZTE USA Inc. is a New Jersey corporation with its principal place of business in Richardson, Texas. This Defendant may be served with process through its agent, Li Mo, 4585 Spencer Drive, Plano, Texas 75024. This Defendant does business in the State of Texas and in the Eastern District of Texas.

18. ZTE Solutions Inc. (with ZTE Corp. and ZTE USA Inc., collectively "ZTE") is a Delaware corporation with its principal place of business in Richardson, Texas. This Defendant may be served with process through its agent, Corporation Service Company, 2711 Centerville Road, Suite 400, Wilmington, Delaware 19808. This Defendant does business in the State of Texas and in the Eastern District of Texas.

#### **JURISDICTION AND VENUE**

19. This action arises under the patent laws of the United States, namely 35 U.S.C. §§ 271, 281, and 284-285, among others.

20. This Court has subject matter jurisdiction pursuant to 28 U.S.C. §§ 1331 and 1338(a), and 1367.

21. Venue is proper in this judicial district pursuant to 28 U.S.C. §§ 1391(b) and (c), and 1400(b). On information and belief, each Defendant is deemed to reside in this judicial district, has committed acts of infringement in this judicial district, has purposely transacted business in this judicial district, and/or has regular and established places of business in this judicial district.

22. On information and belief, each Defendant is subject to this Court's specific and general personal jurisdiction pursuant to due process and/or the Texas Long Arm Statute, due at least to their substantial business in this State and judicial district, including: (A) at least part of their infringing activities alleged herein; and (B) regularly doing or soliciting business, engaging in other persistent conduct, and/or deriving substantial revenue from goods sold and services provided to Texas residents.

### **COUNT I**

(INFRINGEMENT OF U.S. PATENT NO. 8,457,022)

23. CCE incorporates paragraphs 1 through 22 herein by reference.

24. CCE is the assignee of the '022 patent, entitled "Method and Apparatus for Providing Signaling of Redundancy Versions," with ownership of all substantial rights in the '022 patent, including the right to exclude others and to enforce, sue, and recover damages for past and future infringements. A true and correct copy of the '022 patent is attached as Exhibit A.

25. The '022 patent is valid, enforceable, and was duly issued in full compliance with Title 35 of the United States Code.

26. Defendants AT&T, Alcatel, Ericsson, Apple, HTC, LG, Samsung, and ZTE have and continue to directly and/or indirectly infringe (by inducing infringement and/or contributing to infringement) one or more claims of the '022 patent in this judicial district and elsewhere in Texas and the United States without the consent or authorization of CCE, by or through their making, having made, offering for sale, selling, importing, and/or using user equipment for AT&T's LTE network—supplied by Apple, HTC, LG, Samsung, and ZTE—and AT&T's base station equipment—supplied by Alcatel and Ericsson—including, for example: the Apple iPhone 5, Apple iPhone 5c, Apple iPhone 5s, Apple iPhone 6, Apple iPhone 6 Plus, Apple iPad Air, Apple iPad Air 2, Apple iPad Mini, Apple iPad Mini 3, Apple iPad Mini with Retina Display, Apple iPad with Retina Display (iPad 4), HTC Desire 610, HTC Desire EYE, HTC First, HTC One (M7), HTC One (M8), HTC One (M8) Windows, HTC One M9, HTC One mini, HTC One VX, HTC One X, HTC One X+ (HTC Era 42), HTC Titan II, HTC Windows Phone 8X, HTC Jetstream (Puccini), LG Escape P870, LG G Flex, LG G Flex 2, LG G Vista, LG G2, LG G3, LG G3 Vigor, LG Optimus G, LG G Pad 7.0 LTE, Samsung ATIV S Neo, Samsung Focus 2, Samsung Galaxy Alpha, Samsung Galaxy Exhilarate, Samsung Galaxy Express, Samsung Galaxy Mega, Samsung Galaxy Mega 2, Samsung Galaxy Note 3, Samsung Galaxy Note 4, Samsung Galaxy Note Edge, Samsung Galaxy Note II, Samsung Galaxy Rugby Pro, Samsung Galaxy S3, Samsung Galaxy S3 mini, Samsung Galaxy S4, Samsung Galaxy S4 Active, Samsung Galaxy S4 mini, Samsung Galaxy S4 Zoom, Samsung Galaxy S5, Samsung Galaxy S5 mini, Samsung Galaxy S6, Samsung Galaxy S6 Edge, Samsung Rugby Smart, Samsung ATIV smart PC 4G LTE 700TC (XE700T1C-HA1US), Samsung GALAXY Note 8.0, Samsung Galaxy Note PRO 12.2, Samsung Galaxy Tab 2 10.1, Samsung Galaxy Tab 3 7.0, Samsung Galaxy Tab 4 (8.0), Samsung Galaxy Tab 4 10.1, Samsung Galaxy Tab 8.9, Samsung Galaxy Tab S 10.5, Samsung Galaxy Tab S 8.4, ZTE Compel,

ZTE Overture (Z995), and ZTE Z998 GoPhone (ZTE Unico LTE), compatible with the AT&T LTE cellular network and made, used, sold, offered for sale, imported or otherwise distributed by or through AT&T and/or its suppliers for use on AT&T's LTE network (the "AT&T User Equipment"); and the Alcatel-Lucent 9768, Alcatel-Lucent 9100 Multi-Standard Base Station, Alcatel-Lucent 9412 eNodeB Compact, Alcatel-Lucent lightRadio 9711, Alcatel-Lucent lightRadio 9712, Alcatel-Lucent 9768, Alcatel-Lucent Evercore LTE 400 PMR, Alcatel-Lucent Multi-Carrier Remote Radio Head, and Ericsson RBS 6000 series, compatible with the AT&T LTE cellular network and made, used, sold, offered for sale, imported, and/or operated by or through AT&T and/or its suppliers for use in AT&T's LTE network (the "AT&T Base Stations"). These devices are collectively referred to as the "AT&T LTE User Equipment and Network Equipment."

27. Defendants directly infringe the apparatus claims of the '022 patent by making, using, offering to sell, selling, and/or importing the AT&T LTE User Equipment and Network Equipment. Defendants also directly infringe the '022 patent by making, using, selling, offering for sale, and/or importing the AT&T LTE User Equipment and Network Equipment to practice the claimed methods. Defendants are thereby liable for direct infringement.

28. Additionally, Defendants are liable for indirect infringement of the '022 patent because they induce and/or contribute to the direct infringement of the patent by their customers (including AT&T by its suppliers) and other end users who use the AT&T LTE User Equipment and Network Equipment to practice the claimed methods. On information and belief, Defendants had knowledge of the '022 patent at least as early as December 2012. And since that time, Defendants have specifically intended and continue to specifically intend for persons who acquire and use the AT&T LTE User Equipment and Network Equipment, including Defendants'

customers (e.g., mobile device users, AT&T, etc.), to use such devices in a manner that infringes the '022 patent.

29. On information and belief, each Defendant, or an affiliated entity, is a 3rd Generation Partnership Project (or "3GPP") member organization, or is affiliated with a 3GPP member organization. 3GPP solicits identification of standard essential patents, and, through 3GPP, Defendants received actual notice of the standard essential patents at issue here. The '022 patent is one such patent, and Defendants have known of the '022 patent at least as early as December 2012, when it was disclosed to 3GPP via the European Telecommunications Standards Institute ("ETSI," an organizational member of 3GPP).

30. Despite having knowledge of the '022 patent, Defendants named in this Count have specifically intended and continue to specifically intend for persons who acquire and use the AT&T LTE User Equipment and Network Equipment, including Defendants' customers (e.g., mobile device users, AT&T, etc.), to use such devices in a manner that infringes one or more claims of the '022 patent. This is evident when Defendants encourage and instruct customers and other end users in the use and operation of the AT&T LTE User Equipment and Network Equipment via advertisement and instructional materials.

31. In particular, despite having knowledge of the '022 patent, Defendants have provided, and continue to provide, instructional materials, such as user guides, owner manuals, and similar online resources (available for example, via <http://www.att.com/esupport>, <http://support.apple.com/manuals/>, <http://www.htc.com/us/support/>, <http://www.lg.com/us/support/mobile-support>, <http://www.samsung.com/us/support/downloads>, [http://www.zteusa.com/support\\_page](http://www.zteusa.com/support_page), and other instructional materials and documentation provided or made available by Defendants to customers after purchase) that specifically teach the

customers and other end users to use the AT&T LTE User Equipment and Network Equipment in an infringing manner. By providing such instructions, Defendants know (and have known), or should know (and should have known), that their actions have, and continue to, actively induce infringement.

32. Additionally, Defendants named in this Count know, and have known, that the AT&T LTE User Equipment and Network Equipment include proprietary hardware components and software instructions that work in concert to perform specific, intended functions. Such specific, intended functions, carried out by these hardware and software combinations, are a material part of the inventions of the '022 patent and are not staple articles of commerce suitable for substantial non-infringing use.

33. On information and belief, AT&T along with its suppliers, Alcatel, Ericsson, Apple, HTC, LG, Samsung, and ZTE, test, make, use, offer for sale, sell, and/or import the AT&T LTE User Equipment and Network Equipment described in this Count, pursuant to one or more contractual agreements between them relating to, at least, the distribution, sale, and operation of such devices. Accordingly, AT&T, Alcatel, Ericsson, Apple, HTC, LG, Samsung, and ZTE are jointly, severally, or alternatively liable for infringements described in this Count.

34. CCE has been damaged as a result of Defendants' infringing conduct described in this Count. Defendants are, thus, liable to CCE in an amount that adequately compensates CCE for Defendants' infringements, which, by law, cannot be less than a reasonable royalty, together with interest and costs as fixed by this Court under 35 U.S.C. § 284.

## **COUNT II**

(INFRINGEMENT OF U.S. PATENT NO. 8,570,957)

35. CCE incorporates paragraphs 1 through 22 herein by reference.

36. CCE is the assignee of the '957 patent, entitled "Extension of Power Headroom Reporting and Trigger Conditions," with ownership of all substantial rights in the '957 patent, including the right to exclude others and to enforce, sue, and recover damages for past and future infringements. A true and correct copy of the '957 patent is attached as Exhibit B.

37. The '957 patent is valid, enforceable, and was duly issued in full compliance with Title 35 of the United States Code.

38. Defendants AT&T, Alcatel, Ericsson, Apple, HTC, LG, Samsung, and ZTE have and continue to directly and/or indirectly infringe (by inducing infringement and/or contributing to infringement) one or more claims of the '957 patent in this judicial district and elsewhere in Texas and the United States without the consent or authorization of CCE, by or through their making, having made, offering for sale, selling, importing, and/or using user equipment for AT&T's LTE network—supplied by Apple, HTC, LG, Samsung, and ZTE—and AT&T's base station equipment—supplied by Alcatel and Ericsson—including, for example: the Apple iPhone 5, Apple iPhone 5c, Apple iPhone 5s, Apple iPhone 6, Apple iPhone 6 Plus, Apple iPad Air, Apple iPad Air 2, Apple iPad Mini, Apple iPad Mini 3, Apple iPad Mini with Retina Display, Apple iPad with Retina Display (iPad 4), HTC Desire 610, HTC Desire EYE, HTC First, HTC One (M7), HTC One (M8), HTC One (M8) Windows, HTC One M9, HTC One mini, HTC One VX, HTC One X, HTC One X+ (HTC Era 42), HTC Titan II, HTC Windows Phone 8X, HTC Jetstream (Puccini), LG Escape P870, LG G Flex, LG G Flex 2, LG G Vista, LG G2, LG G3, LG G3 Vigor, LG Optimus G, LG G Pad 7.0 LTE, Samsung ATIV S Neo, Samsung Focus 2, Samsung Galaxy Alpha, Samsung Galaxy Exhilarate, Samsung Galaxy Express, Samsung Galaxy Mega, Samsung Galaxy Mega 2, Samsung Galaxy Note 3, Samsung Galaxy Note 4, Samsung Galaxy Note Edge, Samsung Galaxy Note II, Samsung Galaxy Rugby Pro, Samsung Galaxy S3, Samsung Galaxy S3



mini, Samsung Galaxy S4, Samsung Galaxy S4 Active, Samsung Galaxy S4 mini, Samsung Galaxy S4 Zoom, Samsung Galaxy S5, Samsung Galaxy S5 mini, Samsung Galaxy S6, Samsung Galaxy S6 Edge, Samsung Rugby Smart, Samsung ATIV smart PC 4G LTE 700TC (XE700T1C-HA1US), Samsung GALAXY Note 8.0, Samsung Galaxy Note PRO 12.2, Samsung Galaxy Tab 2 10.1, Samsung Galaxy Tab 3 7.0, Samsung Galaxy Tab 4 (8.0), Samsung Galaxy Tab 4 10.1, Samsung Galaxy Tab 8.9, Samsung Galaxy Tab S 10.5, Samsung Galaxy Tab S 8.4, ZTE Compel, ZTE Overture (Z995), and ZTE Z998 GoPhone (ZTE Unico LTE), compatible with the AT&T LTE cellular network and made, used, sold, offered for sale, imported or otherwise distributed by or through AT&T and/or its suppliers for use on AT&T's LTE network (the "AT&T User Equipment"); and the Alcatel-Lucent 9768, Alcatel-Lucent 9100 Multi-Standard Base Station, Alcatel-Lucent 9412 eNodeB Compact, Alcatel-Lucent lightRadio 9711, Alcatel-Lucent lightRadio 9712, Alcatel-Lucent 9768, Alcatel-Lucent Evercore LTE 400 PMR, Alcatel-Lucent Multi-Carrier Remote Radio Head, and Ericsson RBS 6000 series, compatible with the AT&T LTE cellular network and made, used, sold, offered for sale, imported, and/or operated by or through AT&T and/or its suppliers for use in AT&T's LTE network (the "AT&T Base Stations"). These devices are collectively referred to as the "AT&T LTE User Equipment and Network Equipment."

39. Defendants directly infringe the apparatus claims of the '957 patent by making, using, offering to sell, selling, and/or importing the AT&T LTE User Equipment and Network Equipment. Defendants also directly infringe the '957 patent by making, using, selling, offering for sale, and/or importing the AT&T LTE User Equipment and Network Equipment to practice the claimed methods. Defendants are thereby liable for direct infringement.

40. Additionally, Defendants are liable for indirect infringement of the '957 patent because they induce and/or contribute to the direct infringement of the patent by their customers (including AT&T by its suppliers) and other end users who use the AT&T LTE User Equipment and Network Equipment to practice the claimed methods. Defendants have specifically intended and continue to specifically intend for persons who acquire and use the AT&T LTE User Equipment and Network Equipment, including Defendants' customers (e.g., mobile device users, AT&T, etc.), to use such devices in a manner that infringes the '957 patent.

41. Each Defendant has had knowledge of the '957 patent, at least as early as service of this Complaint. *See, e.g., Patent Harbor, LLC v. Dreamworks Animation SKG, Inc.*, No. 6:11-cv-229, 2012 U.S. Dist. LEXIS 114199, at \*17 (E.D. Tex. Jul. 27, 2012).

42. Despite having knowledge of the '957 patent, Defendants named in this Count have specifically intended and continue to specifically intend for persons who acquire and use the AT&T LTE User Equipment and Network Equipment, including Defendants' customers (e.g., mobile device users, AT&T, etc.), to use such devices in a manner that infringes one or more claims of the '957 patent. This is evident when Defendants encourage and instruct customers and other end users in the use and operation of the AT&T LTE User Equipment and Network Equipment via advertisement and instructional materials.

43. In particular, despite having knowledge of the '957 patent, Defendants have provided, and continue to provide, instructional materials, such as user guides, owner manuals, and similar online resources (available for example, via <http://www.att.com/esupport>, <http://support.apple.com/manuals/>, <http://www.htc.com/us/support/>, <http://www.lg.com/us/support/mobile-support>, <http://www.samsung.com/us/support/downloads>, [http://www.zteusa.com/support\\_page](http://www.zteusa.com/support_page), and other instructional materials and documentation

provided or made available by Defendants to customers after purchase) that specifically teach the customers and other end users to use the AT&T LTE User Equipment and Network Equipment in an infringing manner. By providing such instructions, Defendants know (and have known), or should know (and should have known), that their actions have, and continue to, actively induce infringement.

44. Additionally, Defendants named in this Count know, and have known, that the AT&T LTE User Equipment and Network Equipment include proprietary hardware components and software instructions that work in concert to perform specific, intended functions. Such specific, intended functions, carried out by these hardware and software combinations, are a material part of the inventions of the '957 patent and are not staple articles of commerce suitable for substantial non-infringing use.

45. On information and belief, AT&T along with its suppliers, Alcatel, Ericsson, Apple, HTC, LG, Samsung, and ZTE, test, make, use, offer for sale, sell, and/or import the AT&T LTE User Equipment and Network Equipment described in this Count, pursuant to one or more contractual agreements between them relating to, at least, the distribution, sale, and operation of such devices. Accordingly, AT&T, Alcatel, Ericsson, Apple, HTC, LG, Samsung, and ZTE are jointly, severally, or alternatively liable for infringements described in this Count.

46. CCE has been damaged as a result of Defendants' infringing conduct described in this Count. Defendants are, thus, liable to CCE in an amount that adequately compensates CCE for Defendants' infringements, which, by law, cannot be less than a reasonable royalty, together with interest and costs as fixed by this Court under 35 U.S.C. § 284.

### **COUNT III**

(INFRINGEMENT OF U.S. PATENT NO. 8,867,472)

47. CCE incorporates paragraphs 1 through 22 herein by reference.

48. CCE is the assignee of the '472 patent, entitled "Signalling of Channel Information," with ownership of all substantial rights in the '472 patent, including the right to exclude others and to enforce, sue, and recover damages for past and future infringements. A true and correct copy of the '472 patent is attached as Exhibit C.

49. The '472 patent is valid, enforceable, and was duly issued in full compliance with Title 35 of the United States Code.

50. Defendants AT&T, Alcatel, Ericsson, Apple, HTC, LG, Samsung, and ZTE have and continue to directly and/or indirectly infringe (by inducing infringement and/or contributing to infringement) one or more claims of the '472 patent in this judicial district and elsewhere in Texas and the United States without the consent or authorization of CCE, by or through their making, having made, offering for sale, selling, importing, and/or using user equipment for AT&T's LTE network—supplied by Apple, HTC, LG, Samsung, and ZTE—and AT&T's base station equipment—supplied by Alcatel and Ericsson—including, for example: the Apple iPhone 5, Apple iPhone 5c, Apple iPhone 5s, Apple iPhone 6, Apple iPhone 6 Plus, Apple iPad Air, Apple iPad Air 2, Apple iPad Mini, Apple iPad Mini 3, Apple iPad Mini with Retina Display, Apple iPad with Retina Display (iPad 4), HTC Desire 610, HTC Desire EYE, HTC First, HTC One (M7), HTC One (M8), HTC One (M8) Windows, HTC One M9, HTC One mini, HTC One VX, HTC One X, HTC One X+ (HTC Era 42), HTC Titan II, HTC Windows Phone 8X, HTC Jetstream (Puccini), LG Escape P870, LG G Flex, LG G Flex 2, LG G Vista, LG G2, LG G3, LG G3 Vigor, LG Optimus G, LG G Pad 7.0 LTE, Samsung ATIV S Neo, Samsung Focus 2, Samsung Galaxy Alpha, Samsung Galaxy Exhilarate, Samsung Galaxy Express, Samsung Galaxy Mega, Samsung Galaxy Mega 2, Samsung Galaxy Note 3, Samsung Galaxy Note 4, Samsung Galaxy Note Edge, Samsung Galaxy Note II, Samsung Galaxy Rugby Pro, Samsung Galaxy S3, Samsung Galaxy S3

mini, Samsung Galaxy S4, Samsung Galaxy S4 Active, Samsung Galaxy S4 mini, Samsung Galaxy S4 Zoom, Samsung Galaxy S5, Samsung Galaxy S5 mini, Samsung Galaxy S6, Samsung Galaxy S6 Edge, Samsung Rugby Smart, Samsung ATIV smart PC 4G LTE 700TC (XE700T1C-HA1US), Samsung GALAXY Note 8.0, Samsung Galaxy Note PRO 12.2, Samsung Galaxy Tab 2 10.1, Samsung Galaxy Tab 3 7.0, Samsung Galaxy Tab 4 (8.0), Samsung Galaxy Tab 4 10.1, Samsung Galaxy Tab 8.9, Samsung Galaxy Tab S 10.5, Samsung Galaxy Tab S 8.4, ZTE Compel, ZTE Overture (Z995), and ZTE Z998 GoPhone (ZTE Unico LTE), compatible with the AT&T LTE cellular network and made, used, sold, offered for sale, imported or otherwise distributed by or through AT&T and/or its suppliers for use on AT&T's LTE network (the "AT&T User Equipment"); and the Alcatel-Lucent 9768, Alcatel-Lucent 9100 Multi-Standard Base Station, Alcatel-Lucent 9412 eNodeB Compact, Alcatel-Lucent lightRadio 9711, Alcatel-Lucent lightRadio 9712, Alcatel-Lucent 9768, Alcatel-Lucent Evercore LTE 400 PMR, Alcatel-Lucent Multi-Carrier Remote Radio Head, and Ericsson RBS 6000 series, compatible with the AT&T LTE cellular network and made, used, sold, offered for sale, imported, and/or operated by or through AT&T and/or its suppliers for use in AT&T's LTE network (the "AT&T Base Stations"). These devices are collectively referred to as the "AT&T LTE User Equipment and Network Equipment."

51. Defendants directly infringe the apparatus claims of the '472 patent by making, using, offering to sell, selling, and/or importing the AT&T LTE User Equipment and Network Equipment. Defendants also directly infringe the '472 patent by making, using, selling, offering for sale, and/or importing the AT&T LTE User Equipment and Network Equipment to practice the claimed methods. Defendants are thereby liable for direct infringement.

52. Additionally, Defendants are liable for indirect infringement of the '472 patent because they induce and/or contribute to the direct infringement of the patent by their customers (including AT&T by its suppliers) and other end users who use the AT&T LTE User Equipment and Network Equipment to practice the claimed methods. Defendants have specifically intended and continue to specifically intend for persons who acquire and use the AT&T LTE User Equipment and Network Equipment, including Defendants' customers (e.g., mobile device users, AT&T, etc.), to use such devices in a manner that infringes the '472 patent.

53. Each Defendant has had knowledge of the '472 patent, at least as early as service of this Complaint. *See, e.g., Patent Harbor, LLC v. Dreamworks Animation SKG, Inc.*, No. 6:11-cv-229, 2012 U.S. Dist. LEXIS 114199, at \*17 (E.D. Tex. Jul. 27, 2012).

54. Despite having knowledge of the '472 patent, Defendants named in this Count have specifically intended and continue to specifically intend for persons who acquire and use the AT&T LTE User Equipment and Network Equipment, including Defendants' customers (e.g., mobile device users, AT&T, etc.), to use such devices in a manner that infringes one or more claims of the '472 patent. This is evident when Defendants encourage and instruct customers and other end users in the use and operation of the AT&T LTE User Equipment and Network Equipment via advertisement and instructional materials.

55. In particular, despite having knowledge of the '472 patent, Defendants have provided, and continue to provide, instructional materials, such as user guides, owner manuals, and similar online resources (available for example, via <http://www.att.com/esupport>, <http://support.apple.com/manuals/>, <http://www.htc.com/us/support/>, <http://www.lg.com/us/support/mobile-support>, <http://www.samsung.com/us/support/downloads>, [http://www.zteusa.com/support\\_page](http://www.zteusa.com/support_page), and other instructional materials and documentation

provided or made available by Defendants to customers after purchase) that specifically teach the customers and other end users to use the AT&T LTE User Equipment and Network Equipment in an infringing manner. By providing such instructions, Defendants know (and have known), or should know (and should have known), that their actions have, and continue to, actively induce infringement.

56. Additionally, Defendants named in this Count know, and have known, that the AT&T LTE User Equipment and Network Equipment include proprietary hardware components and software instructions that work in concert to perform specific, intended functions. Such specific, intended functions, carried out by these hardware and software combinations, are a material part of the inventions of the '472 patent and are not staple articles of commerce suitable for substantial non-infringing use.

57. On information and belief, AT&T along with its suppliers, Alcatel, Ericsson, Apple, HTC, LG, Samsung, and ZTE, test, make, use, offer for sale, sell, and/or import the AT&T LTE User Equipment and Network Equipment described in this Count, pursuant to one or more contractual agreements between them relating to, at least, the distribution, sale, and operation of such devices. Accordingly, AT&T, Alcatel, Ericsson, Apple, HTC, LG, Samsung, and ZTE are jointly, severally, or alternatively liable for infringements described in this Count.

58. CCE has been damaged as a result of Defendants' infringing conduct described in this Count. Defendants are, thus, liable to CCE in an amount that adequately compensates CCE for Defendants' infringements, which, by law, cannot be less than a reasonable royalty, together with interest and costs as fixed by this Court under 35 U.S.C. § 284.

#### **JOINDER OF PARTIES**

59. CCE incorporates paragraphs 1 through 58 herein by reference.

60. On information and belief, AT&T has purchased or otherwise acquired from Alcatel, Ericsson, Apple, HTC, LG, Samsung, and ZTE certain mobile devices and/or base station equipment for sale, resale, distribution to their customers (and other end users), and/or use in their cellular communications networks for the benefit of their customers (and other end users), that are the subject of Counts I through III (or some subset thereof). Thus, for these Counts, the right to relief against Alcatel, Ericsson, Apple, HTC, LG, Samsung, and ZTE is asserted jointly and severally with AT&T.

61. The alleged infringements set forth in Counts I through III arise out of the same transaction, occurrence, or series of transactions or occurrences relating to the testing, making, using, offering for sale, selling, and/or importing of the AT&T devices and equipment made the subject of Counts I through III.

62. Questions of fact common to all Defendants will arise in this action including, for example, infringement by, or through use of, AT&T devices and equipment.

63. Thus, joinder of AT&T, Alcatel, Ericsson, Apple, HTC, LG, Samsung, and ZTE is proper in this litigation pursuant to 35 U.S.C. § 299(a).

### **JURY DEMAND**

CCE hereby requests a trial by jury pursuant to Rule 38 of the Federal Rules of Civil Procedure.

### **PRAYER FOR RELIEF**

CCE requests that the Court find in its favor and against Defendants, and that the Court grant CCE the following relief:

- a. Judgment that one or more claims of the '022, '957, and '472 patents have been infringed, either literally and/or under the doctrine of equivalents, by Defendants and/or by others whose infringements have been induced by Defendants and/or by others to whose infringements Defendants have



contributed;

- b. Judgment that Defendants account for and pay to CCE all damages to and costs incurred by CCE because of Defendants' infringing activities and other conduct complained of herein;
- c. Judgment that Defendants account for and pay to CCE a reasonable, ongoing, post-judgment royalty because of Defendants' infringing activities and other conduct complained of herein;
- d. That CCE be granted pre-judgment and post-judgment interest on the damages caused by Defendants' infringing activities and other conduct complained of herein; and
- e. That CCE be granted such other and further relief as the Court may deem just and proper under the circumstances.

Dated: April 30, 2015

Respectfully submitted,

/s/ Jeffrey R. Bragalone  
Jeffrey R. Bragalone (lead attorney)  
Texas Bar No. 02855775  
Monte Bond  
Texas Bar No. 02585625  
Terry A. Saad  
Texas Bar No. 24066015

**Bragalone Conroy PC**  
2200 Ross Avenue  
Suite 4500W  
Dallas, TX 75201  
Tel: (214) 785-6670  
Fax: (214) 785-6680  
[jbragalone@bcpc-law.com](mailto:jbragalone@bcpc-law.com)  
[mbond@bcpc-law.com](mailto:mbond@bcpc-law.com)  
[tsaad@bcpc-law.com](mailto:tsaad@bcpc-law.com)

Edward R. Nelson, III  
[ed@nelbum.com](mailto:ed@nelbum.com)  
Texas Bar No. 00797142  
S. Brannon Latimer  
[brannon@nelbum.com](mailto:brannon@nelbum.com)  
Texas Bar No. 24060137  
Thomas C. Cecil  
[tom@nelbum.com](mailto:tom@nelbum.com)  
Texas Bar No. 24069489  
NELSON BUMGARDNER, P.C.  
3131 West 7<sup>th</sup> Street, Suite 300  
Fort Worth, Texas 76107  
Phone: (817) 377-9111  
Fax: (817) 377-3485

Attorneys for Plaintiff  
**CELLULAR COMMUNICATIONS  
EQUIPMENT LLC**

CIVIL COVER SHEET

The JS 44 civil cover sheet and the information contained herein neither replace nor supplement the filing and service of pleadings or other papers as required by law, except as provided by local rules of court. This form, approved by the Judicial Conference of the United States in September 1974, is required for the use of the Clerk of Court for the purpose of initiating the civil docket sheet. (SEE INSTRUCTIONS ON NEXT PAGE OF THIS FORM.)

I. (a) PLAINTIFFS

CELLULAR COMMUNICATIONS EQUIPMENT LLC

(b) County of Residence of First Listed Plaintiff Collin (EXCEPT IN U.S. PLAINTIFF CASES)

(c) Attorneys (Firm Name, Address, and Telephone Number) Jeffrey R. Bragalone, Bragalone Conroy PC 2200 Ross Avenue, Suite 4500W Dallas, TX 75201 214-785-6670

DEFENDANTS

AT&T INC., AT&T MOBILITY LLC, ET AL.

County of Residence of First Listed Defendant (IN U.S. PLAINTIFF CASES ONLY)

NOTE: IN LAND CONDEMNATION CASES, USE THE LOCATION OF THE TRACT OF LAND INVOLVED.

Attorneys (If Known)

II. BASIS OF JURISDICTION (Place an "X" in One Box Only)

- 1 U.S. Government Plaintiff, 2 U.S. Government Defendant, 3 Federal Question (U.S. Government Not a Party), 4 Diversity (Indicate Citizenship of Parties in Item III)

III. CITIZENSHIP OF PRINCIPAL PARTIES (Place an "X" in One Box for Plaintiff and One Box for Defendant)

Table with columns for Plaintiff (PTF) and Defendant (DEF) citizenship: Citizen of This State, Citizen of Another State, Citizen or Subject of a Foreign Country, Incorporated or Principal Place of Business In This State, Incorporated and Principal Place of Business In Another State, Foreign Nation.

IV. NATURE OF SUIT (Place an "X" in One Box Only)

Large table with categories: CONTRACT, REAL PROPERTY, TORTS, CIVIL RIGHTS, PRISONER PETITIONS, FORFEITURE/PENALTY, LABOR, IMMIGRATION, BANKRUPTCY, SOCIAL SECURITY, FEDERAL TAX SUITS, OTHER STATUTES.

V. ORIGIN (Place an "X" in One Box Only)

- 1 Original Proceeding, 2 Removed from State Court, 3 Remanded from Appellate Court, 4 Reinstated or Reopened, 5 Transferred from Another District, 6 Multidistrict Litigation

VI. CAUSE OF ACTION

Cite the U.S. Civil Statute under which you are filing (Do not cite jurisdictional statutes unless diversity): 35 U.S.C. § 1, et seq., including 35 U.S.C. §§ 271, 281, 284, and 285. Brief description of cause: Infringement of U.S. Patent No. 8,457,022, No. 8,570,957, and No. 8,867,472

VII. REQUESTED IN COMPLAINT:

CHECK IF THIS IS A CLASS ACTION UNDER RULE 23, F.R.Cv.P. DEMAND \$ CHECK YES only if demanded in complaint: JURY DEMAND: Yes No

VIII. RELATED CASE(S) IF ANY

(See instructions): JUDGE DOCKET NUMBER

DATE 04/30/2015 SIGNATURE OF ATTORNEY OF RECORD /s/ Jeffrey R. Bragalone

FOR OFFICE USE ONLY

---

**EXHIBIT A**

---

(12) **United States Patent**  
**Lindh et al.**

(10) **Patent No.:** **US 8,457,022 B2**  
 (45) **Date of Patent:** **Jun. 4, 2013**

(54) **METHOD AND APPARATUS FOR PROVIDING SIGNALING OF REDUNDANCY VERSIONS**

(75) Inventors: **Lars Lindh**, Helsingfors (FI); **Mieszko Chmiel**, San Diego, CA (US); **Frank Frederiksen**, Klarup (DK)

(73) Assignee: **Nokia Siemens Networks GmbH & Co. KG**, Munich (DE)

(\* ) Notice: Subject to any disclaimer, the term of this patent is extended or adjusted under 35 U.S.C. 154(b) by 212 days.

(21) Appl. No.: **12/564,536**

(22) Filed: **Sep. 22, 2009**

(65) **Prior Publication Data**

US 2010/0080152 A1 Apr. 1, 2010

**Related U.S. Application Data**

(60) Provisional application No. 61/099,049, filed on Sep. 22, 2008.

(51) **Int. Cl.**  
**H04L 29/02** (2006.01)  
**H04L 12/28** (2006.01)

(52) **U.S. Cl.**  
 USPC ..... **370/280**

(58) **Field of Classification Search**  
 USPC ..... 370/276, 277, 280, 310, 312, 431, 370/474

See application file for complete search history.

(56) **References Cited**

**U.S. PATENT DOCUMENTS**

7,823,040 B2 \* 10/2010 Cheng ..... 714/751  
 7,881,236 B2 \* 2/2011 Park et al. .... 370/278  
 7,925,953 B2 \* 4/2011 Malkamaki et al. .... 714/748

2005/0076283 A1 4/2005 Malkamaki et al.  
 2005/0250454 A1 \* 11/2005 Sebire et al. .... 455/67.11  
 2007/0042782 A1 \* 2/2007 Lee et al. .... 455/450  
 2008/0090517 A1 \* 4/2008 Cheng ..... 455/39  
 2009/0028129 A1 \* 1/2009 Pi et al. .... 370/351  
 2009/0098876 A1 \* 4/2009 Khan et al. .... 455/445  
 2009/0100309 A1 \* 4/2009 Zheng ..... 714/748  
 2009/0125774 A1 \* 5/2009 Kim et al. .... 714/748  
 2009/0279460 A1 \* 11/2009 Sarkar ..... 370/280  
 2009/0300456 A1 \* 12/2009 Pelletier et al. .... 714/749  
 2009/0327828 A1 \* 12/2009 Ojala et al. .... 714/749  
 2010/0023830 A1 \* 1/2010 Wengert et al. .... 714/748  
 2010/0027460 A1 \* 2/2010 Kim et al. .... 370/315

(Continued)

**FOREIGN PATENT DOCUMENTS**

CN 101257372 A 9/2008  
 WO WO 2006/030019 A2 3/2006  
 WO WO 2007/083555 A1 7/2007

**OTHER PUBLICATIONS**

3GPP TR 08.008 V0.0.1, "Technical Report 3rd Generation Partnership Project; Technical Specification Group, Overview of 3GPP Release 8; Summary of all Release 8 Features (Release 8)", Aug. 2008, 187 pages.

(Continued)

*Primary Examiner* — Chi Pham  
*Assistant Examiner* — Robert Lopata  
 (74) *Attorney, Agent, or Firm* — Dithavong, Mori & Steiner, P.C.

(57) **ABSTRACT**

An approach is provided for efficient signaling of redundancy version information. A redundancy version signaling module detects the start of a system information radio transmission window and assigns a redundancy version sequence at the start of the transmission window.

**13 Claims, 15 Drawing Sheets**

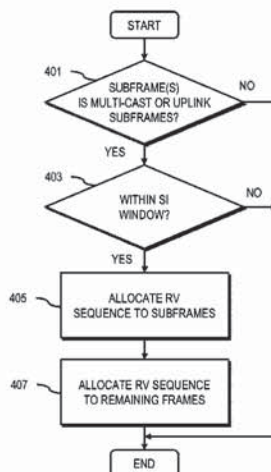

**US 8,457,022 B2**

U.S. PATENT DOCUMENTS

2010/0034139	A1*	2/2010	Love et al. ....	370/328
2010/0284490	A1*	11/2010	Kim et al. ....	375/298
2010/0309870	A1*	12/2010	Wengert et al. ....	370/329
2011/0122825	A1*	5/2011	Lee et al. ....	370/328
2011/0246846	A1*	10/2011	Ojala et al. ....	714/748

OTHER PUBLICATIONS

3GPP TR 23.882 V1.15.0, "3rd Generation Partnership Project; Technical Specification Group Services and System Aspects; 3GPP System Architecture Evolution: Report on Technical Options and Conclusions (Release 7)", Feb. 2008, 262 pages.

3GPP TR 25.813 V7.1.0, "3rd Generation Partnership Project; Technical Specification Group Radio Access Network; Evolved Universal Terrestrial Radio Access (E-UTRA) and Evolved Universal Terrestrial Radio Access Network (E-UTRAN); Radio interface protocol aspects (Release 7)", Sep. 2006, 41 pages.

3GPP TR 25.814 V1.5.0, "Physical Layer Aspects for Evolved UTRA (Release 7)", May 2006, 125 pages.

3GPP TS 36.211 V8.3.0, "Evolved Universal Terrestrial Radio Access (E-UTRA); Physical Channels and Modulation (Release 8)", May 2008, 77 pages.

3GPP TS 36.300 V8.5.0, "3rd Generation Partnership Project; Technical Specification Group Radio Access Network; Evolved Universal

Terrestrial Radio Access (E-UTRA) and Evolved Universal Terrestrial Radio Access Network (E-UTRAN); Overall description; Stage 2 (Release 8)", May 2008, 134 pages.

3GPP TS 36.321 V8.2.0, "Evolved Universal Terrestrial Radio Access (E-UTRA) Medium Access Control (MAC) protocol specification (Release 8)", May 2008, 33 pages.

3GPP TS 36.331 V8.2.0, "Evolved Universal Terrestrial Radio Access (E-UTRA), Radio Resource Control (RRC), Protocol specification (Release 8)", May 2008, 151 pages.

3GPP TSG RAN 1 #54, R1-083207, "DCI Format 1C with implicit RV and TBS", Jeju, Korea, Aug. 2008, 5 pages.

3GPP TSG RAN WG 1 #52, R1-081009, "RV Selection for uplink HARQ", Sorrento, Italy, Feb. 2008, 4 pages.

3GPP TSG RAN WG1 Meeting #49bis, R1-073200, "An RV definition scheme with variable starting Positions", LG Electronics, Orlando, USA, Jun. 25-29, 2007, XP050106834, 5 pages.

3GPP TSG-RAN Working Group 1 #52, R1-080945, "Simulation results on RV usage for uplink HARQ", Sorrento, Italy, Feb. 2008, 2 pages.

International Search Report and Written Opinion for the corresponding PCT App. No. PCT/EP2009/062255 dated Mar. 9, 2010, pp. 1-17.

\* cited by examiner



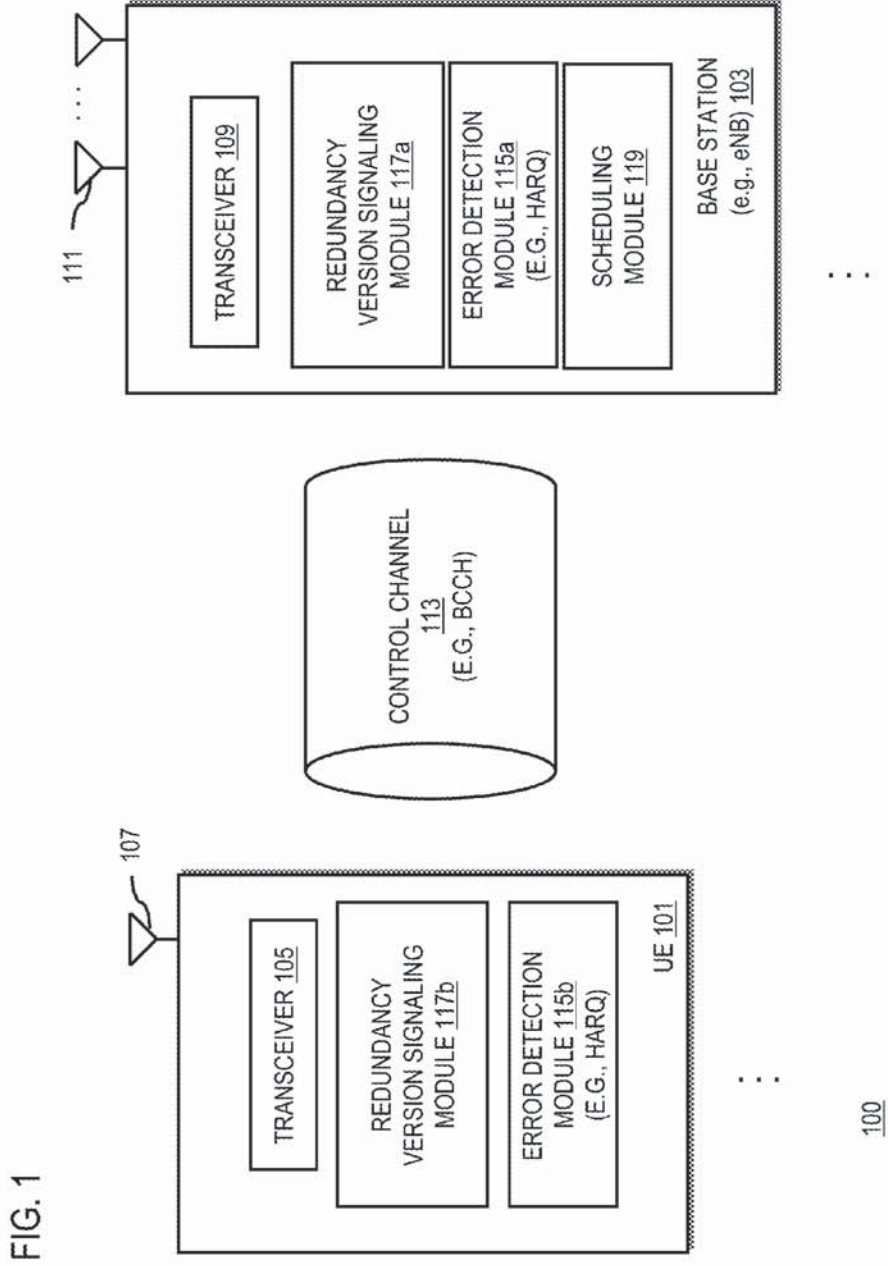

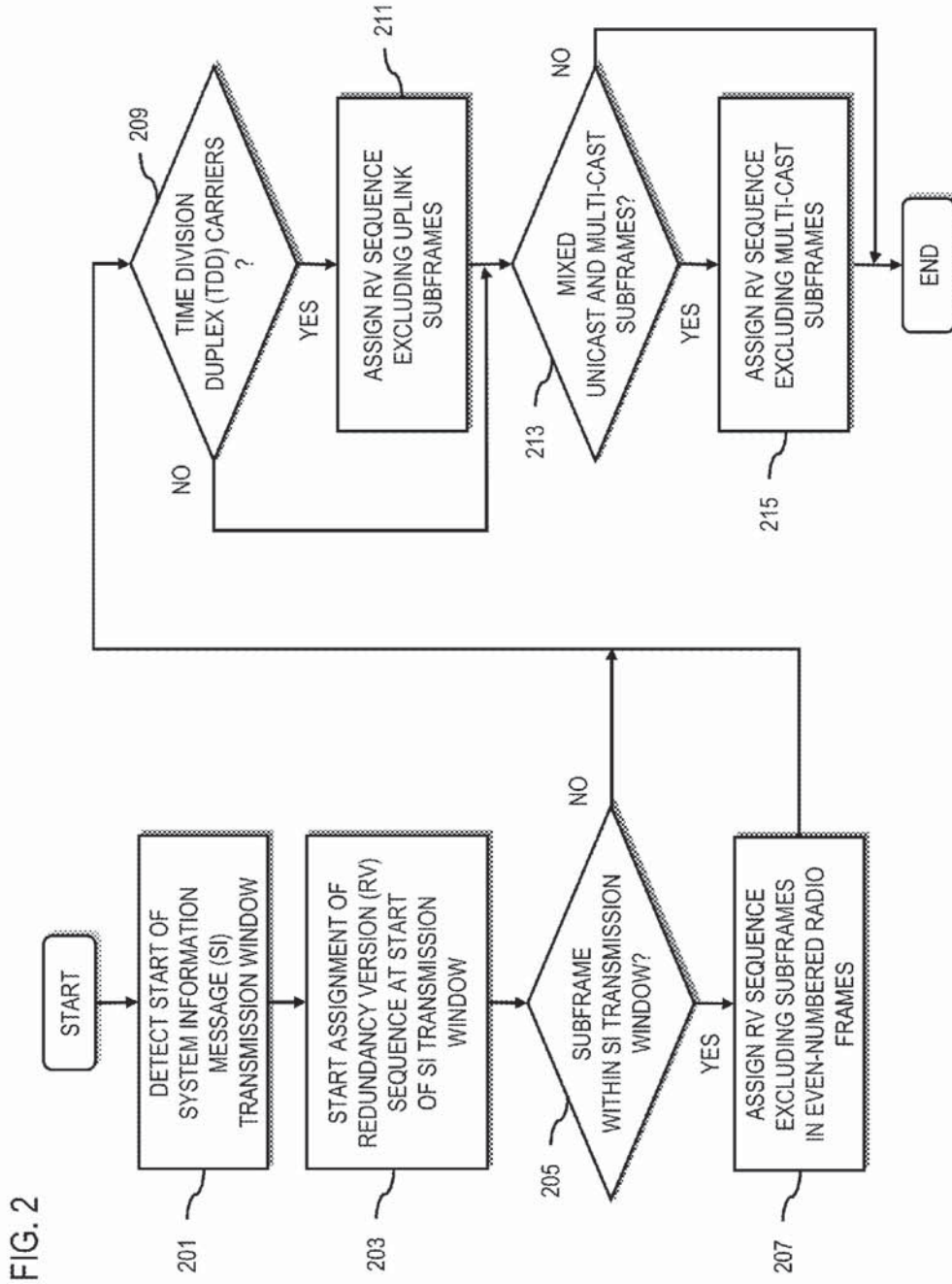



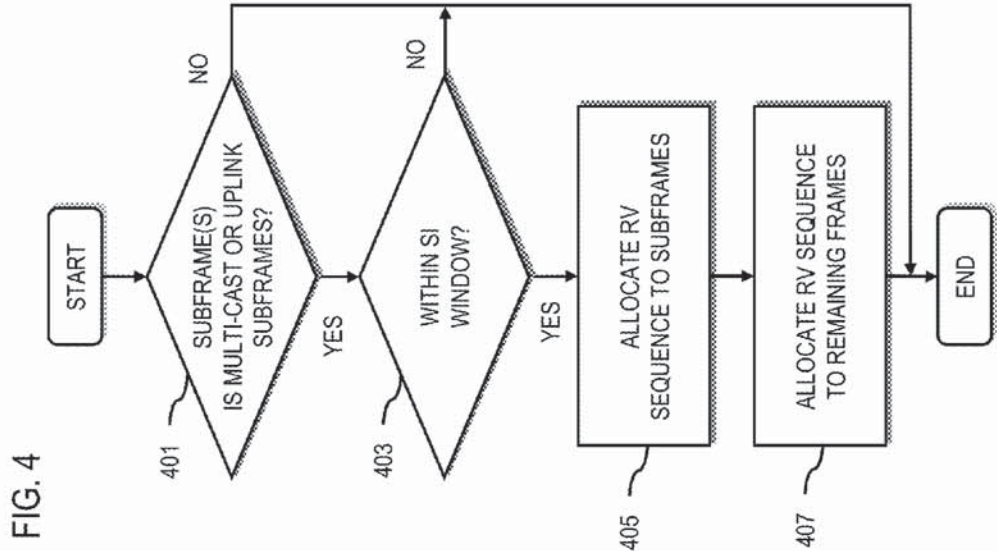

FIG. 4

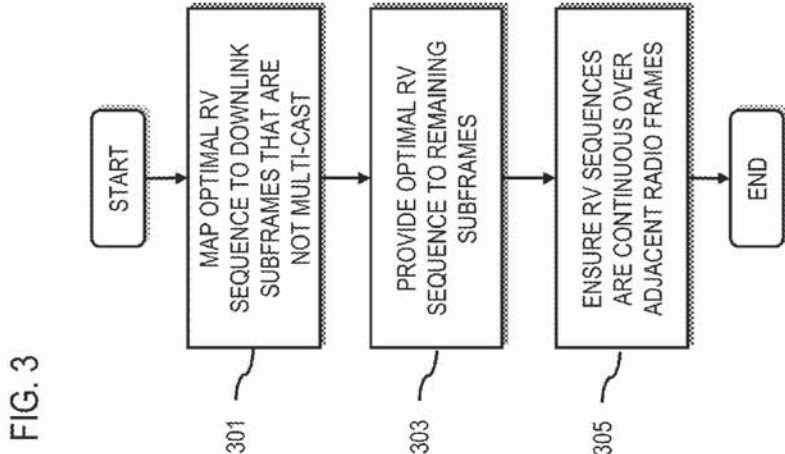

FIG. 3

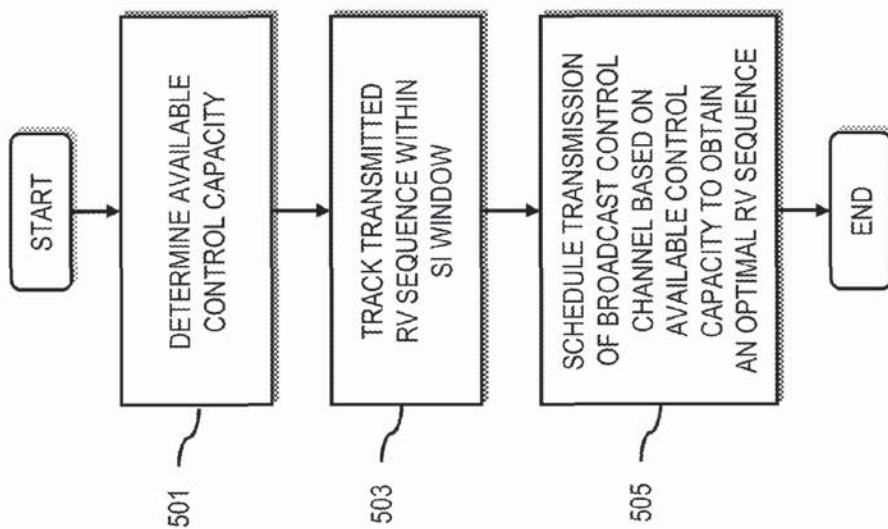

FIG. 5

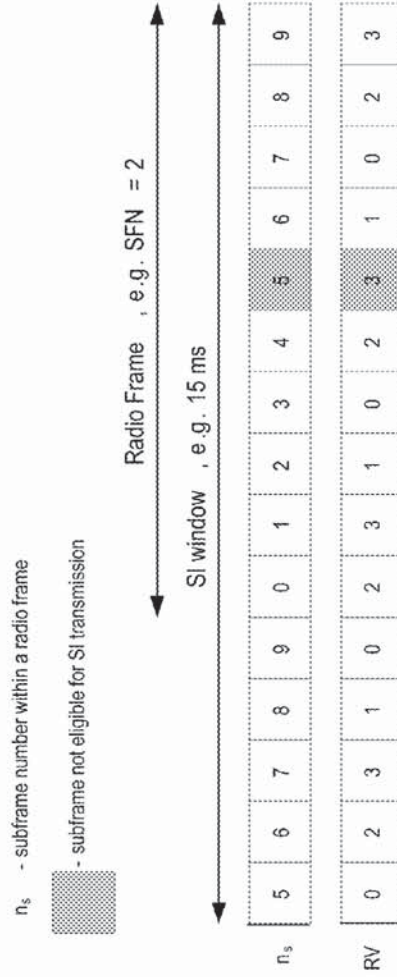
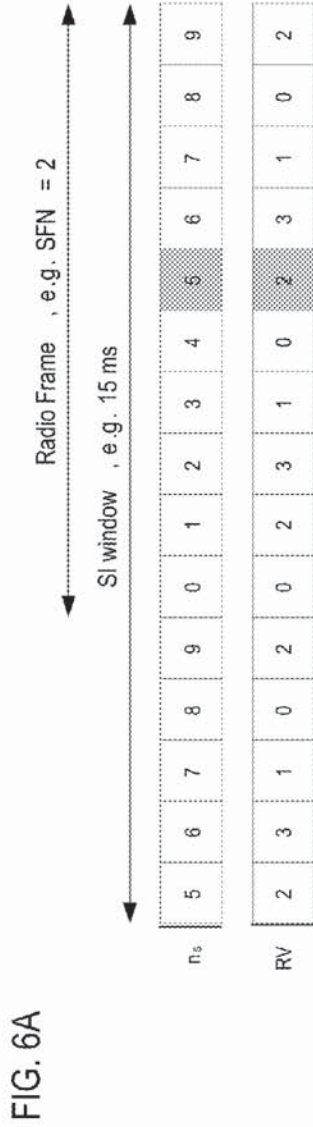
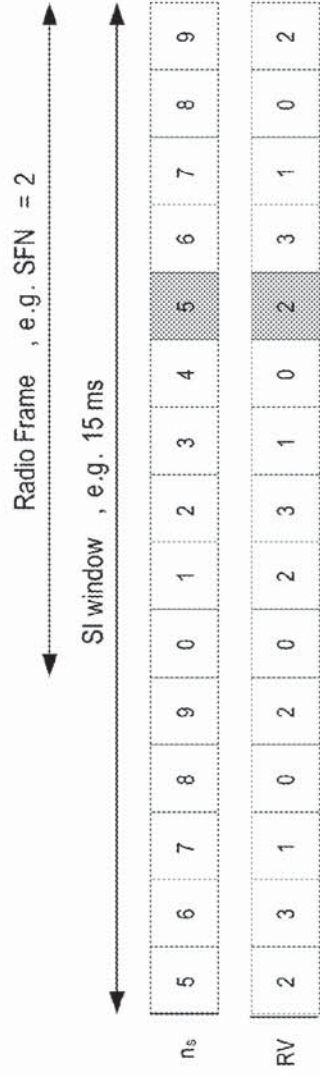

FIG. 6B

FIG. 7A



$n_s$  - subframe number within a radio frame

- subframe not eligible for SI transmission



FIG. 7B

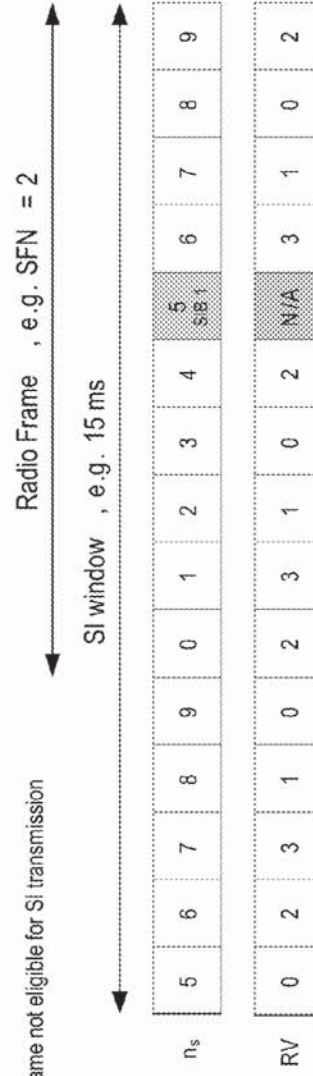
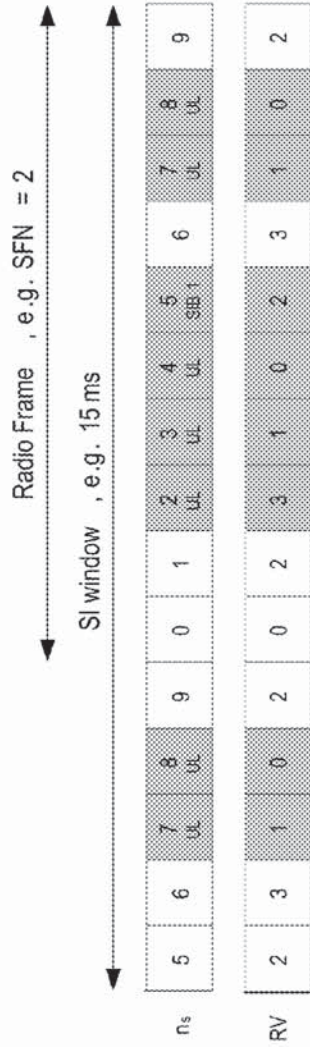

FIG. 8A



$n_s$  - subframe number within a radio frame  
 - subframe not eligible for SI transmission

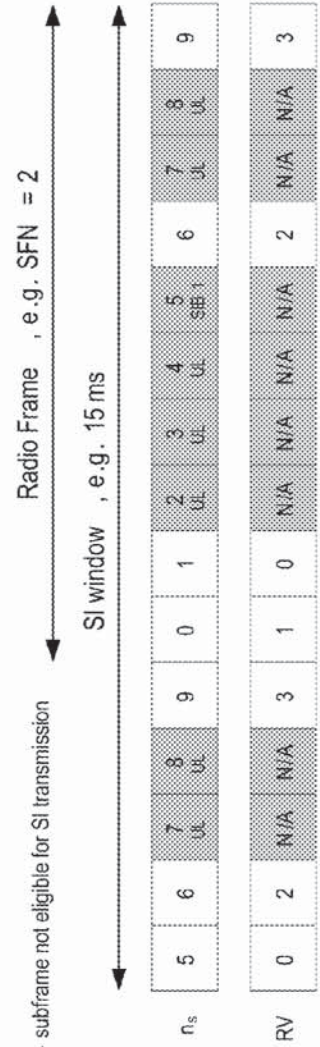

FIG. 8B



FIG. 9A

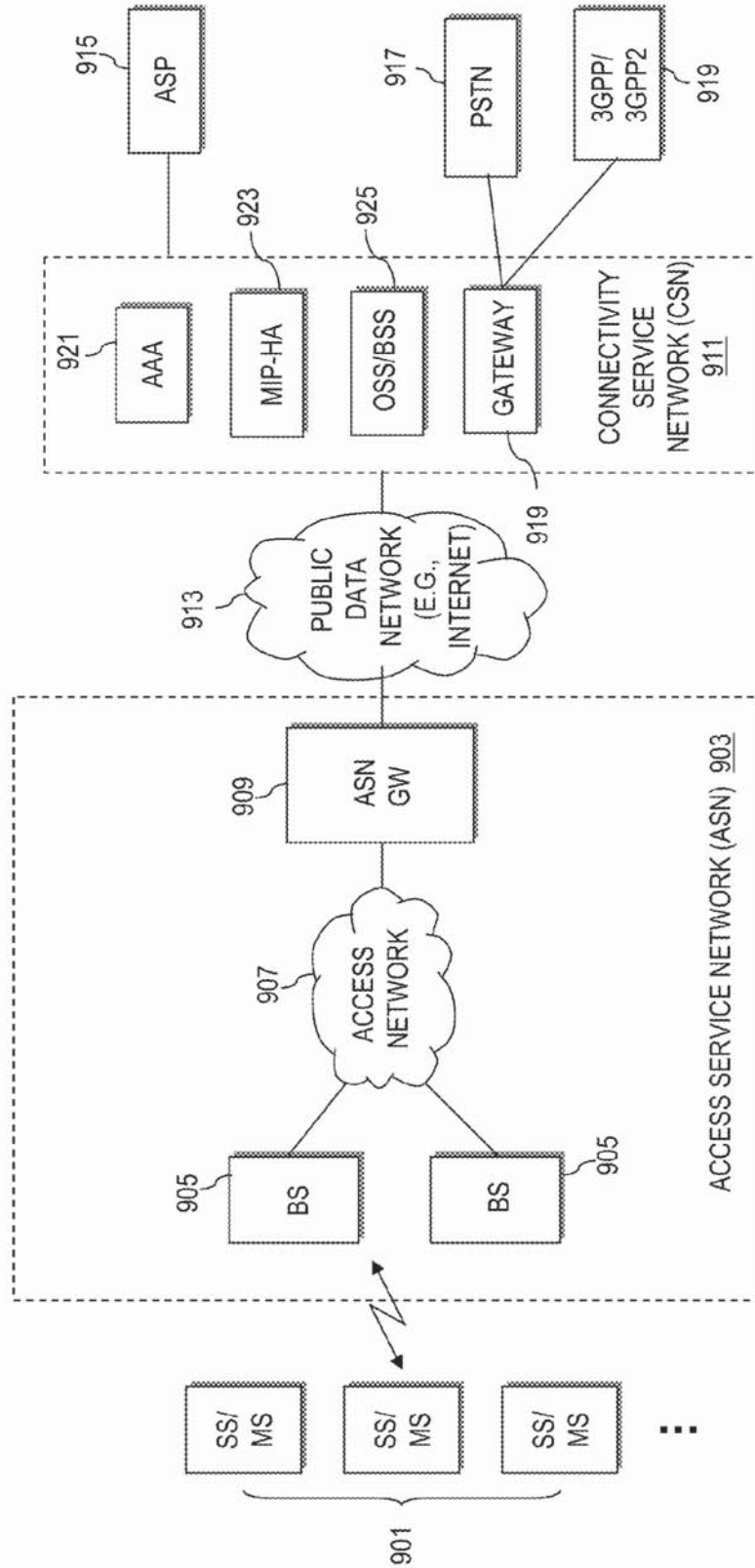
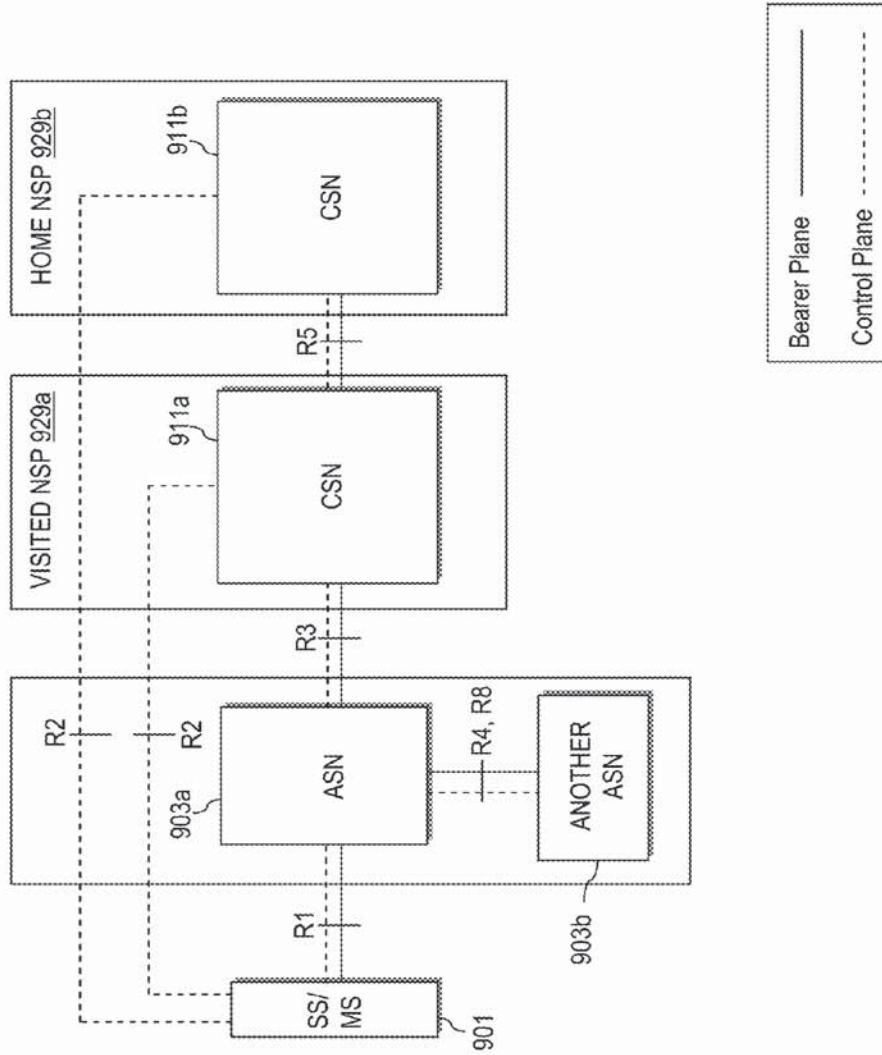

FIG. 9B



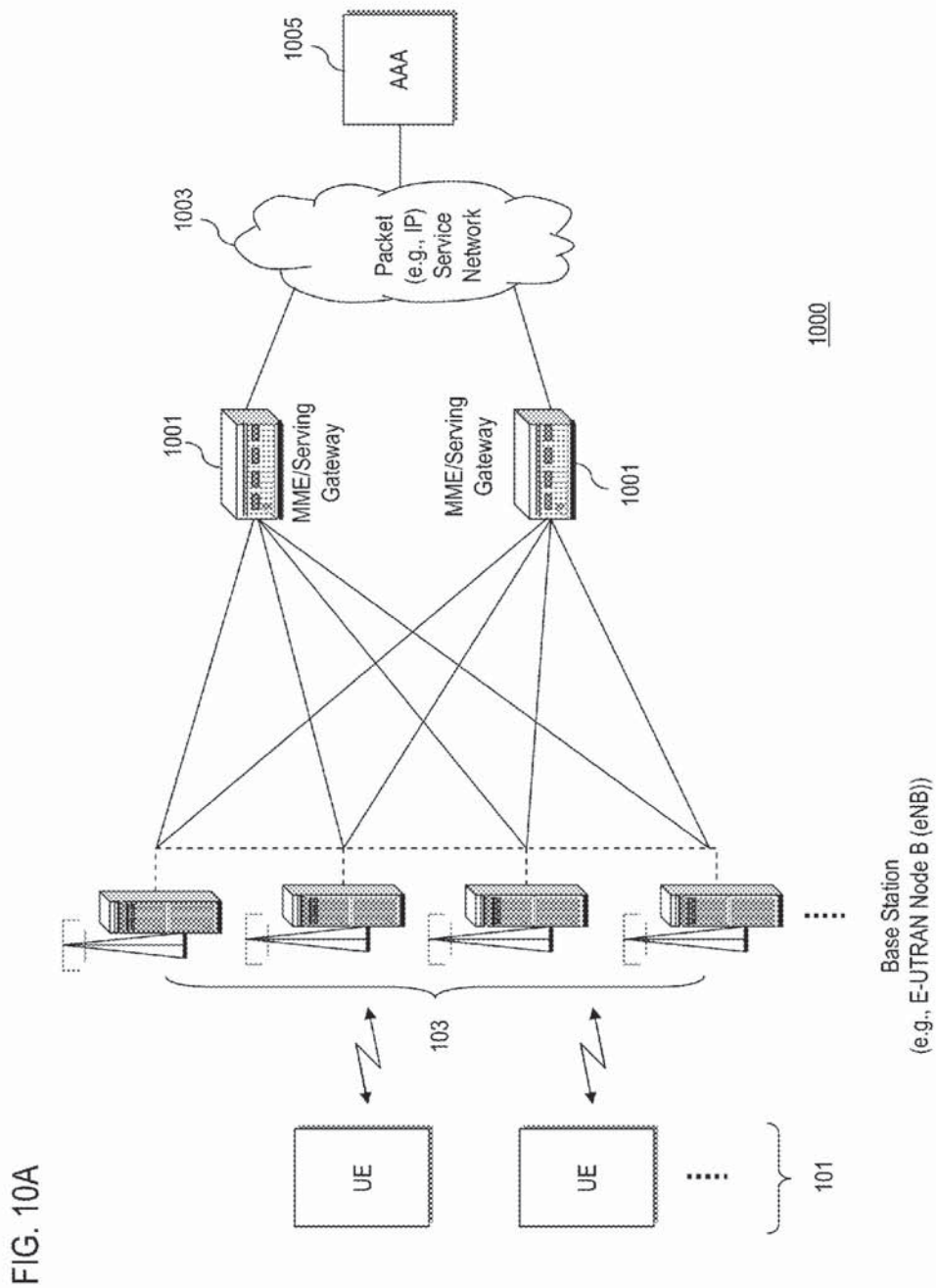



FIG. 10B

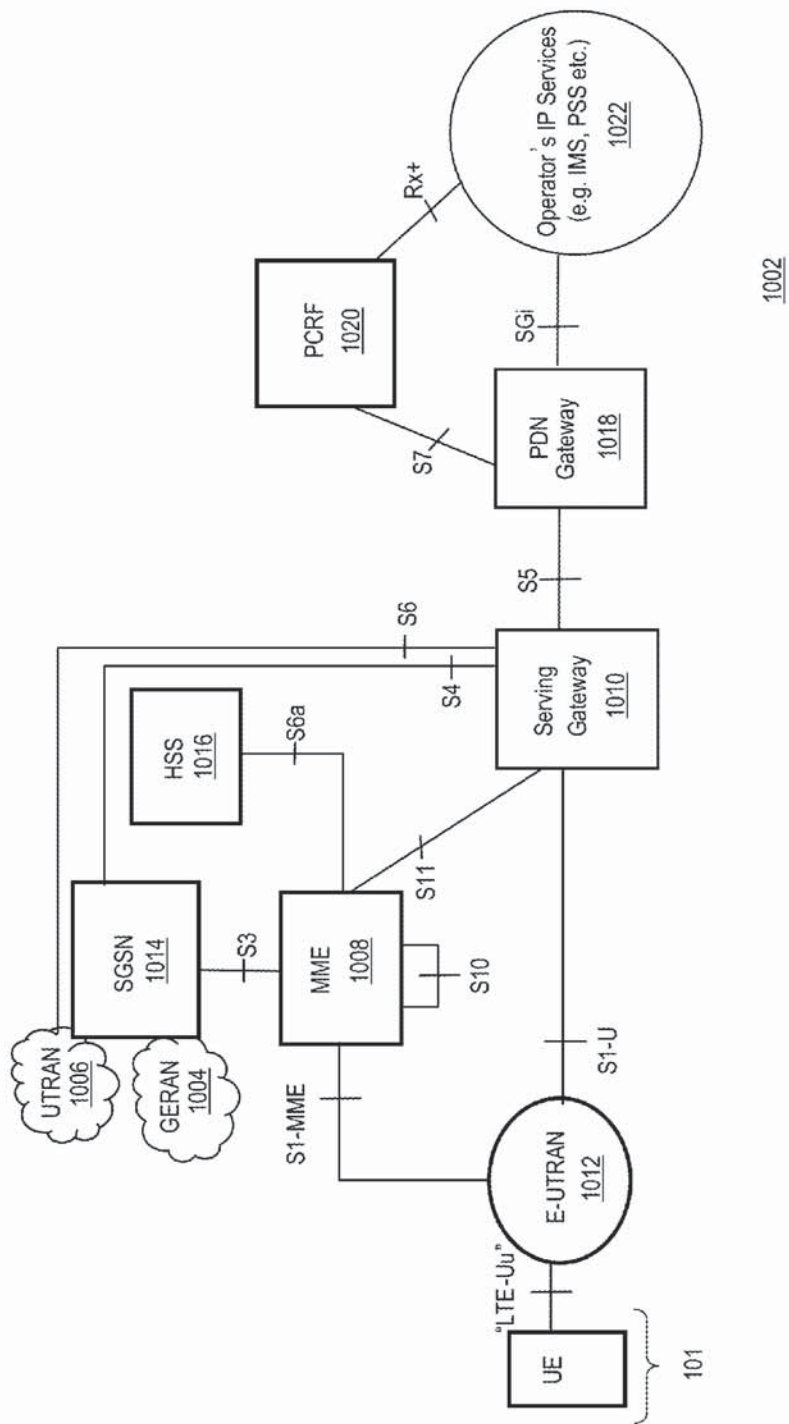

FIG. 10C

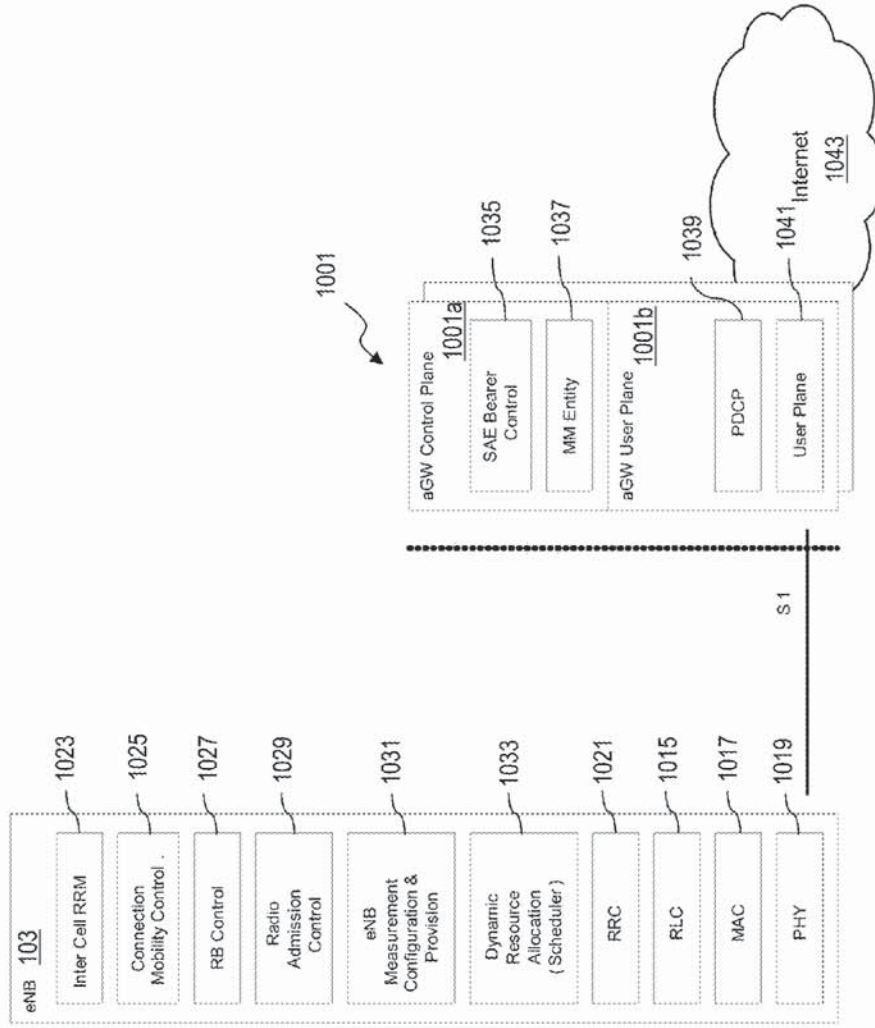
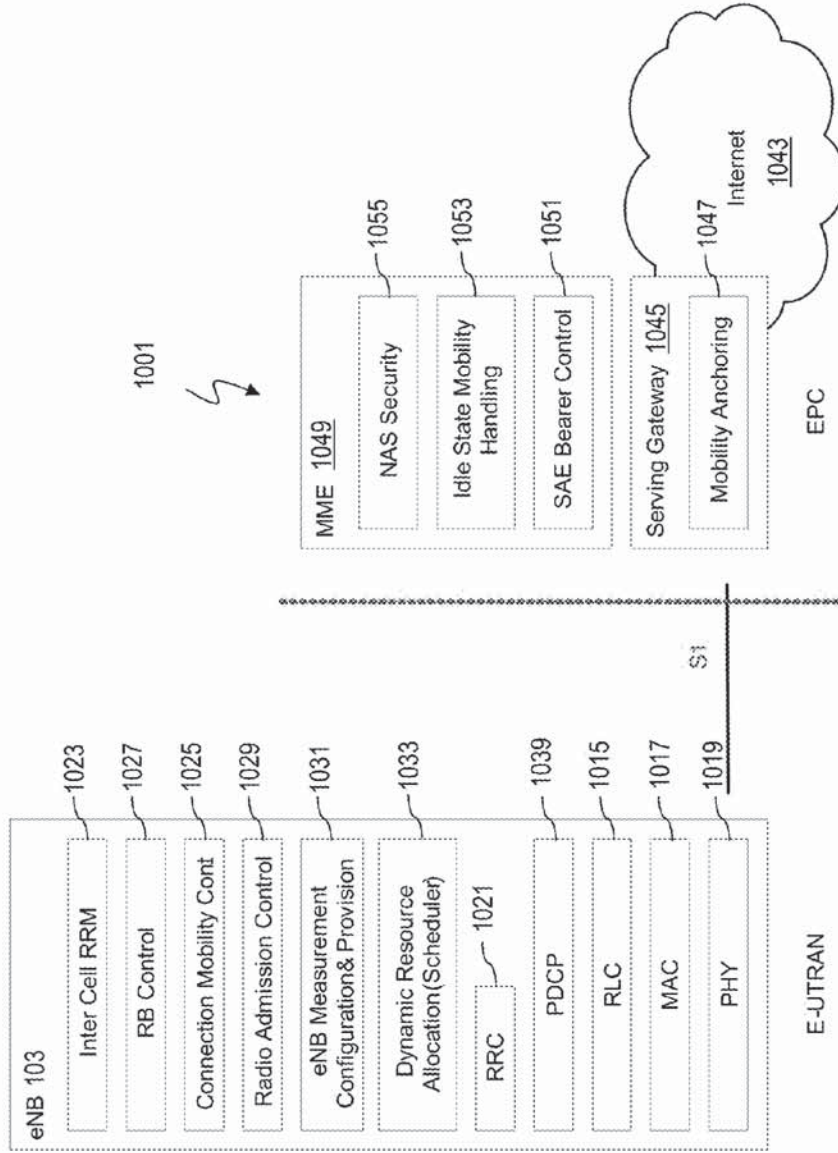

FIG. 10D



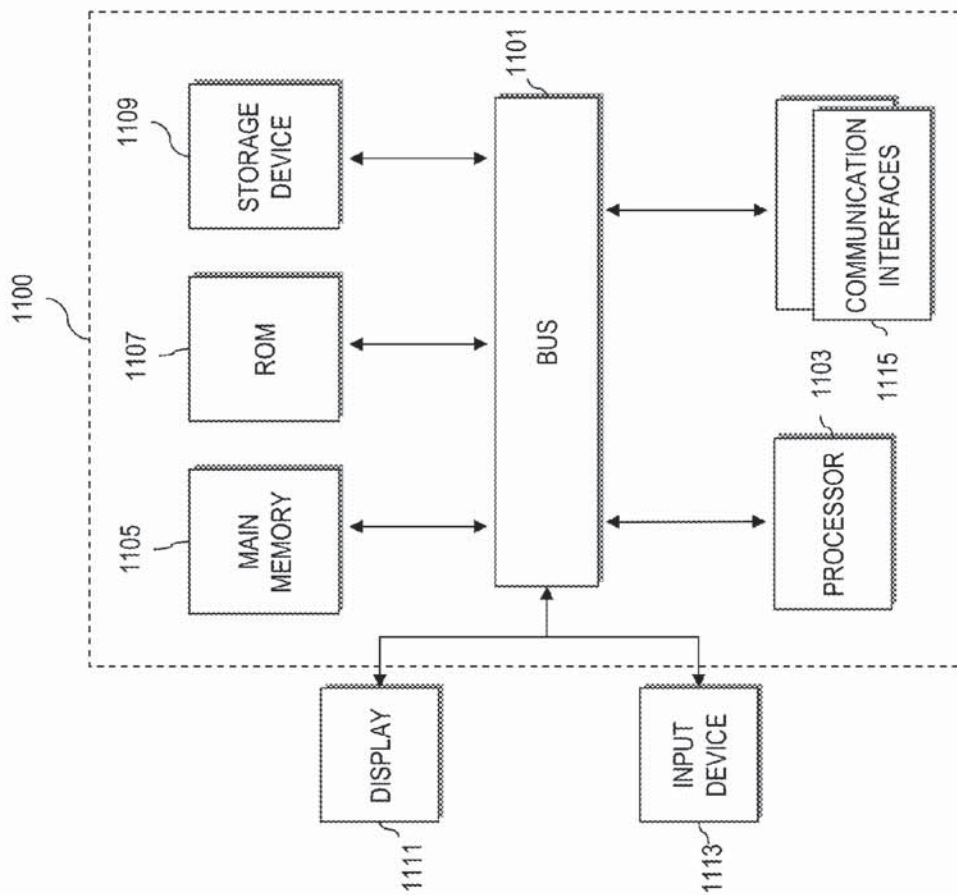
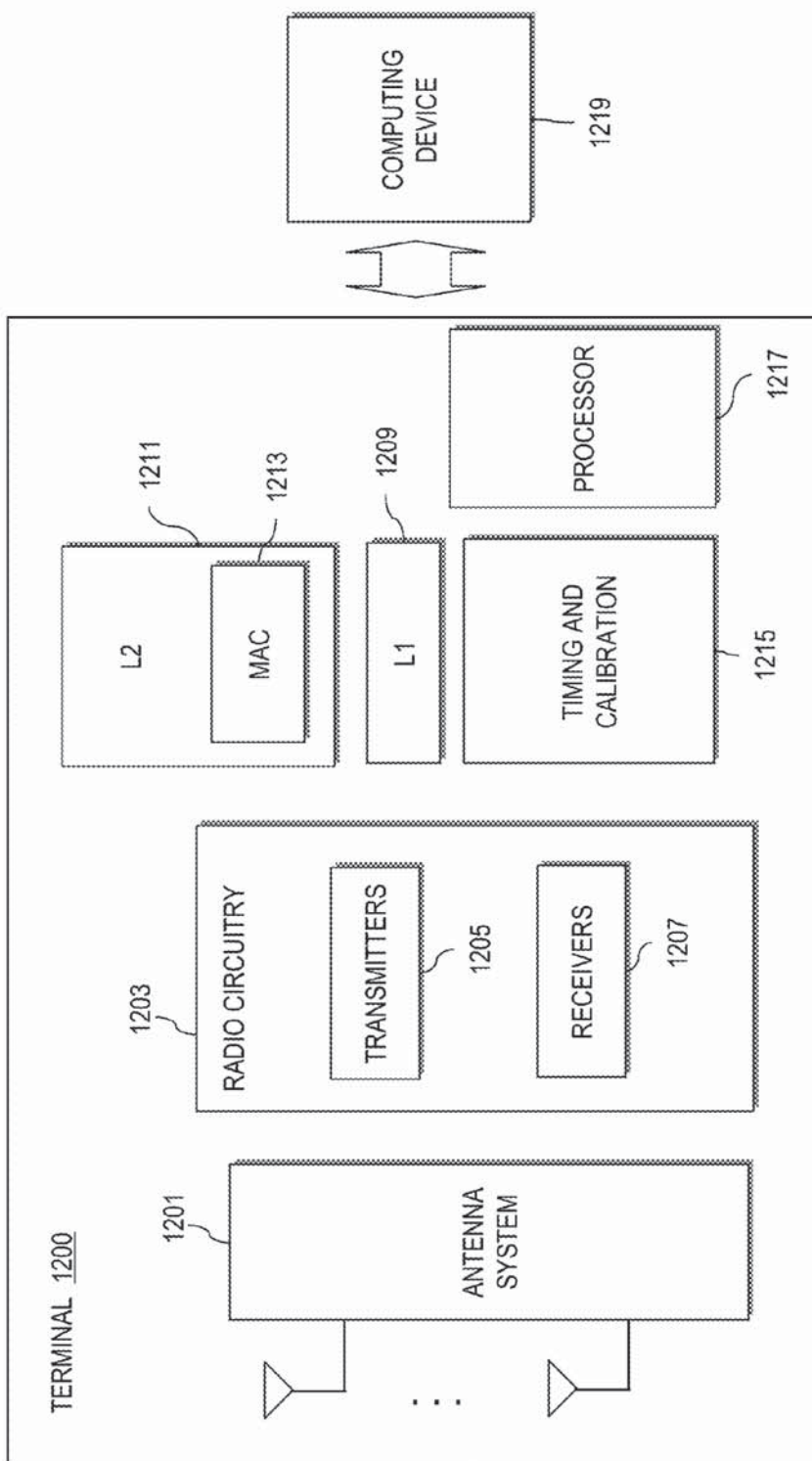

FIG. 11

FIG. 12





US 8,457,022 B2

1

## METHOD AND APPARATUS FOR PROVIDING SIGNALING OF REDUNDANCY VERSIONS

### RELATED APPLICATIONS

This application claims the benefit of the earlier filing date under 35 U.S.C. §119(e) of U.S. Provisional Application Ser. No. 61/099,049 filed Sep. 22, 2008, entitled "Method and Apparatus for Providing Signaling of Redundancy Versions," the entirety of which is incorporated herein by reference.

### BACKGROUND

Radio communication systems, such as a wireless data networks (e.g., Third Generation Partnership Project (3GPP) Long Term Evolution (LTE) systems, spread spectrum systems (such as Code Division Multiple Access (CDMA) networks), Time Division Multiple Access (TDMA) networks, WiMAX (Worldwide Interoperability for Microwave Access), etc.), provide users with the convenience of mobility along with a rich set of services and features. This convenience has spawned significant adoption by an ever growing number of consumers as an accepted mode of communication for business and personal uses. To promote greater adoption, the telecommunication industry, from manufacturers to service providers, has agreed at great expense and effort to develop standards for communication protocols that underlie the various services and features. One area of effort involves acknowledgment signaling, whereby transmissions can be implicitly or explicitly acknowledged to convey successful transmission of data. An inefficient acknowledgement scheme can unnecessarily consume network resources.

Therefore, there is a need for an approach for providing efficient signaling, which can co-exist with already developed standards and protocols.

### SOME EXAMPLE EMBODIMENTS

According to one embodiment, a method comprises detecting start of a system information message transmission window. The method also comprises assigning a redundancy version sequence at the start of the transmission window.

According to another embodiment, a computer-readable storage medium carrying on or more sequences of one or more instructions which, when executed by one or more processors, cause an apparatus to detect start of a system information message transmission window. The apparatus is also caused to assign a redundancy version sequence at the start of the transmission window.

According to another embodiment, an apparatus comprises a redundancy version signaling module configured to detect start of a system information message transmission window and to assign a redundancy version sequence at the start of the transmission window.

According to another embodiment, an apparatus comprises means for detecting start of a system information message transmission window. The apparatus also comprises means for assigning a redundancy version sequence at the start of the transmission window.

According to another embodiment, a method comprises assigning a redundancy version sequence at a start of the transmission window by allocating the sequence to non-multicast subframes within a system information message transmission window, and by allocating the sequence to remaining subframes within the system information message transmission window.

2

According to another embodiment, a computer-readable storage medium carrying on or more sequences of one or more instructions which, when executed by one or more processors, cause an apparatus to assign a redundancy version sequence at a start of the transmission window by allocating the sequence to non-multicast subframes within a system information message transmission window, and by allocating the sequence to remaining subframes within the system information message transmission window.

According to another embodiment, an apparatus comprises a redundancy version signaling module configured to assign a redundancy version sequence at a start of the transmission window by allocating the sequence to non-multicast subframes within a system information message transmission window, and by allocating the sequence to remaining subframes within the system information message transmission window.

According to yet another embodiment, an apparatus comprises means for assigning a redundancy version sequence at a start of the transmission window by allocating the sequence to non-multicast subframes within a system information message transmission window, and by allocating the sequence to remaining subframes within the system information message transmission window.

Still other aspects, features, and advantages of the invention are readily apparent from the following detailed description, simply by illustrating a number of particular embodiments and implementations, including the best mode contemplated for carrying out the invention. The invention is also capable of other and different embodiments, and its several details can be modified in various obvious respects, all without departing from the spirit and scope of the invention. Accordingly, the drawings and description are to be regarded as illustrative in nature, and not as restrictive.

### BRIEF DESCRIPTION OF THE DRAWINGS

The embodiments of the invention are illustrated by way of example, and not by way of limitation, in the figures of the accompanying drawings:

FIG. 1 is a diagram of a communication system capable of providing signaling of redundancy versions, according to an exemplary embodiment;

FIGS. 2-5 are flowcharts of processes for signaling of redundancy versions, according to various exemplary embodiments;

FIGS. 6A and 6B are diagrams, respectively, of a conventional redundancy version mapping scheme, and of a redundancy version mapping scheme according to an exemplary embodiment, each scheme pertaining to an exemplary system information message window length of 15 ms;

FIGS. 7A and 7B are diagrams, respectively, of a conventional redundancy version mapping scheme, and of a redundancy version mapping scheme according to an exemplary embodiment, each scheme pertaining to an exemplary system information message window length of 15 ms for Frequency Division Duplex (FDD);

FIGS. 8A and 8B are diagrams, respectively, of a conventional redundancy version mapping scheme, and of a redundancy version mapping scheme according to an exemplary embodiment, each scheme pertaining to an exemplary system information message window length of 15 ms for Time Division Duplex (TDD);

FIGS. 9A and 9B are diagrams of an exemplary WiMAX (Worldwide Interoperability for Microwave Access) architecture, in which the system of FIG. 1 can operate, according to various exemplary embodiments of the invention;



US 8,457,022 B2

3

FIGS. 10A-10D are diagrams of communication systems having exemplary long-term evolution (LTE) architectures, in which the user equipment (UE) and the base station of FIG. 1 can operate, according to various exemplary embodiments of the invention;

FIG. 11 is a diagram of hardware that can be used to implement an embodiment of the invention; and

FIG. 12 is a diagram of exemplary components of a user terminal configured to operate in the systems of FIGS. 9 and 10, according to an embodiment of the invention.

#### DESCRIPTION OF SOME EMBODIMENTS

An apparatus, method, and software for implicitly signaling redundancy version information are disclosed. In the following description, for the purposes of explanation, numerous specific details are set forth in order to provide a thorough understanding of the embodiments of the invention. It is apparent, however, to one skilled in the art that the embodiments of the invention may be practiced without these specific details or with an equivalent arrangement. In other instances, well-known structures and devices are shown in block diagram form in order to avoid unnecessarily obscuring the embodiments of the invention.

Although the embodiments of the invention are discussed with respect to a wireless network compliant with the Third Generation Partnership Project (3GPP) Long Term Evolution (LTE) architecture, it is recognized by one of ordinary skill in the art that the embodiments of the inventions have applicability to any type of communication system and equivalent functional capabilities.

FIG. 1 is a diagram of a communication system capable of providing signaling of redundancy version, according to an exemplary embodiment. As shown in FIG. 1, a communication system 100 includes one or more user equipment (UEs) 101 communicating with a base station 103, which is part of an access network (e.g., 3GPP LTE or E-UTRAN, etc.) (not shown). Under the 3GPP LTE architecture (as shown in FIGS. 10A-10D), the base station 103 is denoted as an enhanced Node B (eNB). The UE 101 can be any type of mobile stations, such as handsets, terminals, stations, units, devices, multimedia tablets, Internet nodes, communicators, Personal Digital Assistants (PDAs) or any type of interface to the user (such as “wearable” circuitry, etc.). The UE 101 includes a transceiver 105 and an antenna system 107 that couples to the transceiver 105 to receive or transmit signals to the base station 103. The antenna system 107 can include one or more antennas. For the purposes of illustration, the time division duplex (TDD) mode of 3GPP is described herein; however, it is recognized that other modes can be supported, e.g., frequency division duplex (FDD).

As with the UE 101, the base station 103 employs a transceiver 109, which transmits information to the UE 101. Also, the base station 103 can employ one or more antennas 111 for transmitting and receiving electromagnetic signals. For instance, the Node B 103 may utilize a Multiple Input Multiple Output (MIMO) antenna system, whereby the Node B 103 can support multiple antenna transmit and receive capabilities. This arrangement can support the parallel transmission of independent data streams to achieve high data rates between the UE 101 and Node B 103. The base station 103, in an exemplary embodiment, uses OFDM (Orthogonal Frequency Division Multiplexing) as a downlink (DL) transmission scheme and a single-carrier transmission (e.g., SC-FDMA (Single Carrier-Frequency Division Multiple Access)) with cyclic prefix for the uplink (UL) transmission scheme. SC-FDMA can also be realized using a DFT-S-

4

OFDM principle, which is detailed in 3GPP TR 25.814, entitled “Physical Layer Aspects for Evolved UTRA,” v.1.5.0, May 2006 (which is incorporated herein by reference in its entirety). SC-FDMA, also referred to as Multi-User-SC-FDMA, allows multiple users to transmit simultaneously on different sub-bands.

In one embodiment, the system of FIG. 1 provides MBMS (Multimedia Broadcast Multicast Services) services in a MBSFN (Multimedia Broadcast Single Frequency Network). An MBSFN typically has other neighboring MBSFNs or unicast networks operating at the same frequency.

Communications between the UE 101 and the base station 103 (and thus, the network) is governed, in part, by control information exchanged between the two entities. Such control information, in an exemplary embodiment, is transported over a control channel 113 on, for example, the downlink from the base station 103 to the UE 101. By way of example, a number of communication channels are defined for use in the system 100. The channel types include: physical channels, transport channels, and logical channels. For instance in LTE system, the physical channels include, among others, a Physical Downlink Shared channel (PDSCH), Physical Downlink Control Channel (PDCCH), Physical Uplink Shared Channel (PUSCH), and Physical Uplink Control Channel (PUCCH). The transport channels can be defined by how they transfer data over the radio interface and the characteristics of the data. In LTE downlink, the transport channels include, among others, a broadcast channel (BCH), paging channel (PCH), and Down Link Shared Channel (DL-SCH). In LTE uplink, the exemplary transport channels are a Random Access Channel (RACH) and Uplink Shared Channel (UL-SCH). Each transport channel is mapped to one or more physical channels according to its physical characteristics.

Each logical channel can be defined by the type and required Quality of Service (QoS) of information that it carries. In LTE system, the associated logical channels include, for example, a broadcast control channel (BCCH), a paging control channel (PCCH), Dedicated Control Channel (DCCH), Common Control Channel (CCCH), Dedicated Traffic Channel (DTCH), etc.

In LTE system, the BCCH (Broadcast Control Channel) can be mapped onto both BCH and DL-SCH. As such, this is mapped to the PDSCH; the time-frequency resource can be dynamically allocated by using L1/L2 control channel (PDCCH). In this case, BCCH (Broadcast Control Channel)-RNTI (Radio Network Temporary Identifier) is used to identify the resource allocation information.

To ensure accurate delivery of information between the eNB 103 and the UE 101, the system 100 utilizes error detection modules 115a and 115b, respectively, in exchanging information, e.g., Hybrid ARQ (HARQ). HARQ is a concatenation of Forward Error Correction (FEC) coding and an Automatic Repeat Request (ARQ) protocol. In one embodiment, the error detection modules 115a-115b work in conjunction with the scheduling module 119 of the eNB 103 to schedule the transmissions of error control signalling. Automatic Repeat Request (ARQ) is an error recovery mechanism used on the link layer. As such, this error recovery scheme is used in conjunction with error detection schemes (e.g., CRC (cyclic redundancy check)), and is handled with the assistance of error detection modules and within the eNB 103 and UE 101, respectively. The HARQ mechanism permits the receiver (e.g., UE 101) to indicate to the transmitter (e.g., eNB 103) that a packet or sub-packet has been received incorrectly, and thus, requests the transmitter to resend the particular packet(s).



5

The HARQ functionality employs redundancy information (e.g., redundancy version (RV) parameters) to control the transmissions. Accordingly, the eNB 103 and UE 101 possess, in an exemplary embodiment, redundancy version signaling modules 117a and 117b, respectively. For example, the UE 101 can be configured to use the same incremental redundancy version for all transmissions. Accordingly, an RV sequence specifies the RV parameters associated with a block of transmissions.

It should be noted that for the transmission of SI-x information on the PDSCH, HARQ in its normal form is not used, as there is no UL channel for carrying this information. However, the RV properties of HARQ during the transmission of the different sub-parts of the encoded packet can be exploited.

In one embodiment, the eNB 103 transmits to terminals (e.g., UE 101) using common control channels (e.g. the Broadcast Control Channel (BCCH)) with variable redundancy versions (RV), but without the corresponding explicit redundancy version signaling. Determination of the RVs at the UE 101 (and at the eNB 103) for the transmission of the BCCH (carried over the DL-SCH and PDSCH) can be problematic.

It is observed that the transmission of the BCCH over DL-SCH/PDSCH has the following characteristics. First,

6

As used herein, downlink (DL) refers to communication in the direction of the eNB 103 (or network) to the UE 101, while uplink (UL) relates to communication in the direction of the UE 101 to the eNB 103 (or network).

In view of the above, implicit RV signaling has received significant attention. For example, one traditional approach provides that the redundancy version sequence of 0,2,3,1 . . . is optimal among all possible (permutations of) RV sequences; and this offers performance close to the optimal IR performance of so called pure circular buffer.

In another approach, this RV sequence is used for LTE UL non-adaptive, synchronous HARQ retransmissions. However, in such a case, the eNode B knows the exact time instances where it can expect the retransmissions. On the contrary, for BCCH transmissions the eNode B has the flexibility to select the subframes in which retransmissions will take place so the UE 101 does not have the full knowledge about time instances of retransmission.

In another approach, the BCCH's RVs are linked to subframe number ( $n_s, n_s=0,1, \dots, 9$ ) and/or to radio frame number (SFN, SFN=0,1, . . . , 1023). This is illustrated in Table 1 for SIB1 and SI-x.

TABLE 1

SIB1 - the RV linked to the radio frame number (SFN)																
SFN mod8																
	0	1	2	3	4	5	6	7	0	1	2	3	4	5	6	7
RV	0	N/A	2	N/A	3	N/A	1	N/A	0	N/A	2	N/A	3	N/A	1	N/A
SI-x ( $x > 1$ ) - the RV linked to the subframe number ( $n_s$ )																
Subframe number ( $n_s$ )																
	0	1	2	3	4	5	6	7	8	9						
RV	0	2	3	1	0	2	3	1	0	2						

multiple system information blocks can be carried on the BCCH, each with its own transmission time interval (TTI), denoted as  $T_x$  (e.g., System Information Block Type 1 (SIB1) has the TTI of 80 ms, for SI-2 the TTI can be 160 ms, etc. for SI-x,  $x=2, \dots, 8$ ).

Second, SI-x transmission can have multiple instances within a TTI; and those multiple transmissions can be soft-combined at the UE 101 within a window. The window size is configurable; and the same for all SI-x within one cell, it is one of  $w \in \{1,2,5,10,15,20,40\}$ ms (see 3GPP TS 36.331 v8.2.0, "Evolved Universal Terrestrial Radio Access (E-UTRA); Radio Resource Control (RRC); Protocol specification"; which is incorporated herein by reference in its entirety). The exact position and the number of SI-x transmission instances within the window  $w$  is eNB 103 implementation-specific.

Third, multiple SI-x transmission instances can have different redundancy versions in order to obtain incremental redundancy (IR) gains during the above mentioned soft combining approach at the UE 101.

Fourth, the BCCH transmission over the PDSCH is scheduled with a special downlink (DL) control channel (PDCCH) referred to as Downlink Control Information (DCI) format 1C, which compared to other DCI formats does not, for example, contain the 2 explicit bits for RV signaling in order to reduce the overhead and increase coverage.

The first approach cannot be reused directly for the BCCH RV determination because the time instances for BCCH retransmissions are not fully specified (i.e., the eNB has the full flexibility to select the number and positions of SI-x transmissions within the respective window). In the second approach, for SI-x's RV selection, it is observed that it is not guaranteed that each SI-x window position will be aligned with the start of subframe numbering ( $n_s$  or  $n_s \bmod 4$ ). In these cases the RV sequence may be suboptimal if the eNB 103 decides to schedule the SI-x transmission instances consecutively within the corresponding window. Moreover, for certain window sizes (e.g., 20 ms and 40 ms), and also for certain window positions, the probability of occurrence of each RV is not equal. Additionally, this approach does not take into account possible UL subframes (in case of TDD carriers) and possible MBSFN subframes, which might further escalate the above problems of unequal probabilities of RV occurrence and suboptimal RV sequences.

The above traditional approaches for implicit signaling are further described in the following (all of which are incorporated herein by reference in their entireties): R1-080945, "Simulation results on RV usage for uplink HARQ", Nokia Siemens Networks, Nokia; R1-081009, "RV selection for uplink HARQ", LG Electronics; 3GPP TS 36.321v8.2.0, "Evolved Universal Terrestrial Radio Access (E-UTRA); Medium Access Control (MAC) protocol specification";



US 8,457,022 B2

7

R1-083207, "DCI Format 1C with implicit RV and TBS", Motorola; and 3GPP TS 36.211 v8.3.0, "Evolved Universal Terrestrial Radio Access (E-UTRA); Physical channels and modulation."

To mitigate the above problems and drawbacks, processes for implicit redundancy version assignment are proposed, as detailed in FIGS. 2-5.

FIGS. 2-5 are flowcharts of processes for signaling of redundancy versions, according to various exemplary embodiments. In one embodiment, the processes of FIGS. 2-5 are performed by the RV signaling module 117. As shown in FIG. 2 (denoted as Method 1), the RV signaling module 117 detects the start of system information (SI) transmission window (step 201). Next, the assignment of the RV sequence of 02310231 . . . can be started at the beginning of a corresponding SI transmission window (step 203); this method can be further optimized by one or a combination of the enhancements. For example, the process assigns the RV sequence excluding subframes #5 in even-numbered radio frames (when SFN mod 2=0) if such a subframe(s) fall within the SI window (subframes #5 in even-numbered radio frames cannot be used for SI-x, x>1 transmission as they are reserved for SIB1 transmission) (steps 205 and 207). Also, the process assigns the RV sequence excluding UL subframes in case of TDD carriers (UL subframes cannot be used for SI transmission) (steps 209 and 211). This can be considered for all SI-x transmissions as the UL/DL configurations are conveyed by means of SIB1. Although particular subframes are described (e.g., subframe #5), it is contemplated that any predetermined subframe can be utilized.

Further, the process can assign the RV sequence excluding MBSFN (e.g., multi-cast subframes) subframes in case of mixed unicast/MBSFN sub-frames (steps 213 and 215). For instance, this can be considered only for SI-x, where x>2 as the unicast/MBSFN subframe allocations is conveyed by means of SI-2.

FIG. 3 shows another process (Method 2) for implicit signaling of redundancy version information. For example, in one embodiment, FDD subframes #0, 4, 5 and 9 cannot be used for MBSFN. One starting point for the implicit mapping of the redundancy versions is then to have mapping of the subframe number to the RV, which ensures that the transmission works well also in the case of maximal or optimal MBSFN usage—i.e., all subframes except 0, 4, 5 and 9 are used for MBSFN (step 301). In TDD, the subframes that are not MBSFN can be different (e.g., 0, 1, 5, 6). However, the principle would be the same: first map the optimal RV sequence to DL subframes that are never MBSFN, and then map the optimal RV sequence to the remaining subframes (step 303). Additionally, the RV signaling module 117 can ensure that the RV sequences are mapped so that the sequences are continuous over adjacent radio frames (step 305).

A third approach (Method 3), as shown in the process of FIG. 4, process combines the above Methods 1 and 2, according to an exemplary embodiment. Specifically, the process assigns the optimal RV sequence of 02310231 . . . to subframes in an SI transmission window in the following way. The process of FIG. 4 allocates the RV sequence to the subframes that are guaranteed not to be MBSFN/UL subframes within the SI window by first determining whether the subframes are multi-cast or uplink subframes (step 401) and then whether the subframes are within the SI windows (step 403). If both conditions are met, the RV signaling module 117 allocates the RV sequence to the subframes (step 405).

8

Next, the process allocates the RV sequence to the remaining (e.g., non-UL—i.e. DL) subframes within the SI window (step 407).

FIG. 5 shows an optional procedure involving the scheduling module 119 of FIG. 1, according to an exemplary embodiment. In one embodiment, the eNB 103 provides a scheduling functionality (via scheduling module 119), which will keep track of the already transmitted BCCH redundancy versions within the SI window. In step 501, the scheduling module 119 determines available control capacity. For example, determining available control capacity includes determining the number and types of control channels 113 that are available to the scheduling module 119. The module 119 then tracks the RV sequences that have been transmitted within the SI window (step 503). Based on the available control capacity and/or the tracked RV sequences, the scheduling module 119 can schedule transmission of a BCCH to obtain an optimal RV sequence (step 505). For instance, the scheduling module 119 can elect to postpone (or advance) the transmission of a BCCH for a few subframes to get the optimum RV sequence.

It is contemplated that the steps of the described processes of FIGS. 2-5 may be performed in any suitable order or combined in any suitable manner.

For the purposes of illustration, the above Method 1 is explained with respect to an exemplary RV mapping (which is contrasted to conventional approaches).

FIGS. 6A and 6B are diagrams, respectively, of a conventional redundancy version mapping scheme, and of a redundancy version mapping scheme according to an exemplary embodiment, each scheme pertaining to an information message window length of, e.g., 15 ms.

As shown, the number of subframes within the SI window is denoted  $n_s^w$ , the RV for a possible BCCH transmission in subframe  $i$ ,  $i=0,1, \dots, n_s^w-1$  within the window is given by:

$$RV_k = \left\lceil \frac{3}{2}k \right\rceil \bmod 4,$$

where

$$k = i \bmod 4,$$

$$i = 0, 1, \dots, n_s^w - 1.$$

In further optimizations the RV sequences are assigned in the same way with the exception that the number of subframes within the window  $n_s^{w'}$  does not include subframes #5 in even-numbered radio frames (i.e., when SFN mod 2=0) and/or UL subframes within the window so  $i=0,1, \dots, n_s^{w'}-1$  and consequently an RV only exists for subframes other than #5 (in even-numbered radio frames) and/or for non-UL subframes, this is illustrated in FIGS. 7A and 7B for FDD and in FIGS. 8A and 8B for TDD.

Regarding Method 2 (FIG. 3), the process for the mapping of RV values to subframes can then be formulated as follows. The RV values are mapped in optimal order to the subframes that are guaranteed to be non-MBSFN: RVs 0,2,3,1->(are mapped to subframes #) 0,4,5,9. Also, the process provides optimal RV sequences in remaining subframes. Further, the optimal RV sequences are made continuous over adjacent radio frames. The process results in an RV to subframe mapping, as shown in Table 2.



TABLE 2

Subframe # ( $n_s$ )	RV
0	0
1	2
2	3
3	1
4	2
5	3
6	0
7	2
8	3
9	1

As for Method 3 (FIG. 4), the number of DL subframes that are guaranteed to be non-MBSFN subframes (assuming a maximum MBSFN allocation) within the SI window is denoted as  $n_s^{non-MBSFN,non-UL}$ , where the RV for a possible BCCH transmission in subframe  $i$  (DL subframe that is guaranteed to be non-MBSFN),  $i=0,1, \dots, n_s^{non-MBSFN,non-UL}-1$  within the window is given by:

$$RV_k = \left\lfloor \frac{3}{2}k \right\rfloor \bmod 4,$$

where

$$k = i \bmod 4,$$

$$i = 0, 1, \dots, n_s^{non-MBSFN,non-UL} - 1.$$

The number of remaining DL subframes (not assigned an RV in the previous step) within the window is denoted as  $n_s^{remain}$ ; the RV for a possible BCCH transmission in these subframes in the SI window is given by:

$$RV_k = \left\lfloor \frac{3}{2}k \right\rfloor \bmod 4,$$

where

$$k = i \bmod 4,$$

$$i = 0, 1, \dots, n_s^{remain} - 1.$$

As mentioned, the described processes may be implemented in any number of radio networks.

The approaches of FIGS. 6B, 7B, and 8B provide, according to certain embodiments, a number of advantages over the approaches of FIGS. 6A, 7A, and 7B. Under Method 1, the optimal RV sequence is ensured at the beginning of an SI window. This is especially important in case of consecutive BCCH scheduling and/or in case of multiple retransmissions within short SI windows; the optimal RVs will either reduce the Signal-to-Noise (SNR) required to correctly receive the BCCH or enable quicker BCCH acquisition and UE 101 battery saving. Also, probabilities of occurrence of different RVs within a window are equalized; this is especially important for sparse BCCH scheduling. Further, the order (0231 . . .) of the optimal RVS is not disturbed. Method 1 also allows two types of implementation: on-the-fly RV calculation according to the above equations or via a stored look-up table linking the subframe numbers within a window with the RVs; it is contemplated that other embodiments are possible.

According to certain embodiments, the process of FIG. 3 (Method 2) likewise provides a number of advantages. The approach advantageously can provide a very simple mapping from the subframe number to the RV, which is independent of

the system frame number (SFN). Such an approach can also enable two strategies for sending the system information: minimum time (consecutive) and time diversity (sparse). In the exemplary case in which subframe #5 (in even radio frames) is reserved for SIB1 and cannot be used for other information blocks, Method 2 can compensate for by having a transmit opportunity for RV=3 three times in each system frame.

Moreover, certain embodiments of Method 3 can provide the following advantages. The optimal RVS is ensured at the beginning of an SI window. In addition, the RVS is ensured to support the maximum MBSFN allocation.

The processes for implicit signaling of redundancy information can be performed over a variety of networks; two exemplary systems are described with respect to FIGS. 9 and 10.

FIGS. 9A and 9B are diagrams of an exemplary WiMAX architecture, in which the system of FIG. 1, according to various exemplary embodiments of the invention. The architecture shown in FIGS. 9A and 9B can support fixed, nomadic, and mobile deployments and be based on an Internet Protocol (IP) service model. Subscriber or mobile stations 901 can communicate with an access service network (ASN) 903, which includes one or more base stations (BS) 905. In this exemplary system, the BS 905, in addition to providing the air interface to the mobile stations 901, possesses such management functions as handoff triggering and tunnel establishment, radio resource management, quality of service (QoS) policy enforcement, traffic classification, DHCP (Dynamic Host Control Protocol) proxy, key management, session management, and multicast group management.

The base station 905 has connectivity to an access network 907. The access network 907 utilizes an ASN gateway 909 to access a connectivity service network (CSN) 911 over, for example, a data network 913. By way of example, the network 913 can be a public data network, such as the global Internet.

The ASN gateway 909 provides a Layer 2 traffic aggregation point within the ASN 903. The ASN gateway 909 can additionally provide intra-ASN location management and paging, radio resource management and admission control, caching of subscriber profiles and encryption keys, AAA client functionality, establishment and management of mobility tunnel with base stations, QoS and policy enforcement, foreign agent functionality for mobile IP, and routing to the selected CSN 911.

The CSN 911 interfaces with various systems, such as application service provider (ASP) 915, a public switched telephone network (PSTN) 917, and a Third Generation Partnership Project (3GPP)/3GPP2 system 919, and enterprise networks (not shown).

The CSN 911 can include the following components: Access, Authorization and Accounting system (AAA) 921, a mobile IP-Home Agent (MIP-HA) 923, an operation support system (OSS)/business support system (BSS) 925, and a gateway 927. The AAA system 921, which can be implemented as one or more servers, provide support authentication for the devices, users, and specific services. The CSN 911 also provides per user policy management of QoS and security, as well as IP address management, support for roaming between different network service providers (NSPs), location management among ASNs.

FIG. 9B shows a reference architecture that defines interfaces (i.e., reference points) between functional entities capable of supporting various embodiments of the invention. The WiMAX network reference model defines reference points: R1, R2, R3, R4, and R5. R1 is defined between the



US 8,457,022 B2

11

SS/MS **901** and the ASN **903a**; this interface, in addition to the air interface, includes protocols in the management plane. **R2** is provided between the SS/MS **901** and a CSN (e.g., CSN **911a** and **911b**) for authentication, service authorization, IP configuration, and mobility management. The ASN **903a** and CSN **911a** communicate over **R3**, which supports policy enforcement and mobility management.

**R4** is defined between ASNs **903a** and **903b** to support inter-ASN mobility. **R5** is defined to support roaming across multiple NSPs (e.g., visited NSP **929a** and home NSP **929b**).

As mentioned, other wireless systems can be utilized, such as 3GPP LTE, as next explained.

FIGS. **10A-10D** are diagrams of communication systems having exemplary long-term evolution (LTE) architectures, in which the user equipment (UE) and the base station of FIG. **1** can operate, according to various exemplary embodiments of the invention. By way of example (shown in FIG. **10A**), a base station (e.g., destination node) and a user equipment (UE) (e.g., source node) can communicate in system **1000** using any access scheme, such as Time Division Multiple Access (TDMA), Code Division Multiple Access (CDMA), Wideband Code Division Multiple Access (WCDMA), Orthogonal Frequency Division Multiple Access (OFDMA) or Single Carrier Frequency Division Multiple Access (FDMA) (SC-FDMA) or a combination of thereof. In an exemplary embodiment, both uplink and downlink can utilize WCDMA. In another exemplary embodiment, uplink utilizes SC-FDMA, while downlink utilizes OFDMA.

The communication system **1000** is compliant with 3GPP LTE, entitled "Long Term Evolution of the 3GPP Radio Technology" (which is incorporated herein by reference in its entirety). As shown in FIG. **10A**, one or more user equipment (UEs) communicate with a network equipment, such as a base station **103**, which is part of an access network (e.g., WiMAX (Worldwide Interoperability for Microwave Access), 3GPP LTE (or E-UTRAN), etc.). Under the 3GPP LTE architecture, base station **103** is denoted as an enhanced Node B (eNB).

MME (Mobile Management Entity)/Serving Gateways **1001** are connected to the eNBs **103** in a full or partial mesh configuration using tunneling over a packet transport network (e.g., Internet Protocol (IP) network) **1003**. Exemplary functions of the MME/Serving GW **1001** include distribution of paging messages to the eNBs **103**, termination of U-plane packets for paging reasons, and switching of U-plane for support of UE mobility. Since the GWs **1001** serve as a gateway to external networks, e.g., the Internet or private networks **1003**, the GWs **1001** include an Access, Authorization and Accounting system (AAA) **1005** to securely determine the identity and privileges of a user and to track each user's activities. Namely, the MME Serving Gateway **1001** is the key control-node for the LTE access-network and is responsible for idle mode UE tracking and paging procedure including retransmissions. Also, the MME **1001** is involved in the bearer activation/deactivation process and is responsible for selecting the SGW (Serving Gateway) for a UE at the initial attach and at time of intra-LTE handover involving Core Network (CN) node relocation.

A more detailed description of the LTE interface is provided in 3GPP TR 25.813, entitled "E-UTRA and E-UTRAN: Radio Interface Protocol Aspects," which is incorporated herein by reference in its entirety.

In FIG. **10B**, a communication system **1002** supports GERAN (GSM/EDGE radio access) **1004**, and UTRAN **1006** based access networks, E-UTRAN **1012** and non-3GPP (not shown) based access networks, and is more fully described in TR 23.882, which is incorporated herein by reference in its entirety. A key feature of this system is the

12

separation of the network entity that performs control-plane functionality (MME **1008**) from the network entity that performs bearer-plane functionality (Serving Gateway **1010**) with a well defined open interface between them **S11**. Since E-UTRAN **1012** provides higher bandwidths to enable new services as well as to improve existing ones, separation of MME **1008** from Serving Gateway **1010** implies that Serving Gateway **1010** can be based on a platform optimized for signaling transactions. This scheme enables selection of more cost-effective platforms for, as well as independent scaling of, each of these two elements. Service providers can also select optimized topological locations of Serving Gateways **1010** within the network independent of the locations of MMEs **1008** in order to reduce optimized bandwidth latencies and avoid concentrated points of failure.

As seen in FIG. **10B**, the E-UTRAN (e.g., eNB) **1012** interfaces with UE **101** via LTE-Uu. The E-UTRAN **1012** supports LTE air interface and includes functions for radio resource control (RRC) functionality corresponding to the control plane MME **1008**. The E-UTRAN **1012** also performs a variety of functions including radio resource management, admission control, scheduling, enforcement of negotiated uplink (UL) QoS (Quality of Service), cell information broadcast, ciphering/deciphering of user, compression/decompression of downlink and uplink user plane packet headers and Packet Data Convergence Protocol (PDCP).

The MME **1008**, as a key control node, is responsible for managing mobility UE identifies and security parameters and paging procedure including retransmissions. The MME **1008** is involved in the bearer activation/deactivation process and is also responsible for choosing Serving Gateway **1010** for the UE **101**. MME **1008** functions include Non Access Stratum (NAS) signaling and related security. MME **1008** checks the authorization of the UE **101** to camp on the service provider's Public Land Mobile Network (PLMN) and enforces UE **101** roaming restrictions. The MME **1008** also provides the control plane function for mobility between LTE and 2G/3G access networks with the **S3** interface terminating at the MME **1008** from the SGSN (Serving GPRS Support Node) **1014**.

The SGSN **1014** is responsible for the delivery of data packets from and to the mobile stations within its geographical service area. Its tasks include packet routing and transfer, mobility management, logical link management, and authentication and charging functions. The **S6a** interface enables transfer of subscription and authentication data for authenticating/authorizing user access to the evolved system (AAA interface) between MME **1008** and HSS (Home Subscriber Server) **1016**. The **S10** interface between MMEs **1008** provides MME relocation and MME **1008** to MME **1008** information transfer. The Serving Gateway **1010** is the node that terminates the interface towards the E-UTRAN **1012** via **S1-U**.

The **S1-U** interface provides a per bearer user plane tunneling between the E-UTRAN **1012** and Serving Gateway **1010**. It contains support for path switching during handover between eNBs **103**. The **S4** interface provides the user plane with related control and mobility support between SGSN **1014** and the 3GPP Anchor function of Serving Gateway **1010**.

The **S12** is an interface between UTRAN **1006** and Serving Gateway **1010**. Packet Data Network (PDN) Gateway **1018** provides connectivity to the UE **101** to external packet data networks by being the point of exit and entry of traffic for the UE **101**. The PDN Gateway **1018** performs policy enforcement, packet filtering for each user, charging support, lawful interception and packet screening. Another role of the PDN



US 8,457,022 B2

13

Gateway **1018** is to act as the anchor for mobility between 3GPP and non-3GPP technologies such as WiMax and 3GPP2 (CDMA 1X and EvDO (Evolution Data Only)).

The S7 interface provides transfer of QoS policy and charging rules from PCRF (Policy and Charging Role Function) **1020** to Policy and Charging Enforcement Function (PCEF) in the PDN Gateway **1018**. The SGi interface is the interface between the PDN Gateway and the operator's IP services including packet data network **1022**. Packet data network **1022** may be an operator external public or private packet data network or an intra operator packet data network, e.g., for provision of IMS (IP Multimedia Subsystem) services. Rx+ is the interface between the PCRF and the packet data network **1022**.

As seen in FIG. **10C**, the eNB **103** utilizes an E-UTRA (Evolved Universal Terrestrial Radio Access) (user plane, e.g., RLC (Radio Link Control) **1015**, MAC (Media Access Control) **1017**, and PHY (Physical) **1019**, as well as a control plane (e.g., RRC **1021**)). The eNB **103** also includes the following functions: Inter Cell RRM (Radio Resource Management) **1023**, Connection Mobility Control **1025**, RB (Radio Bearer) Control **1027**, Radio Admission Control **1029**, eNB Measurement Configuration and Provision **1031**, and Dynamic Resource Allocation (Scheduler) **1033**.

The eNB **103** communicates with the aGW **1001** (Access Gateway) via an S1 interface. The aGW **1001** includes a User Plane **1001a** and a Control plane **1001b**. The control plane **1001b** provides the following components: SAE (System Architecture Evolution) Bearer Control **1035** and MM (Mobile Management) Entity **1037**. The user plane **1001b** includes a PDCP (Packet Data Convergence Protocol) **1039** and a user plane functions **1041**. It is noted that the functionality of the aGW **1001** can also be provided by a combination of a serving gateway (SGW) and a packet data network (PDN) GW. The aGW **1001** can also interface with a packet network, such as the Internet **1043**.

In an alternative embodiment, as shown in FIG. **10D**, the PDCP (Packet Data Convergence Protocol) functionality can reside in the eNB **103** rather than the GW **1001**. Other than this PDCP capability, the eNB functions of FIG. **10C** are also provided in this architecture.

In the system of FIG. **10D**, a functional split between E-UTRAN and EPC (Evolved Packet Core) is provided. In this example, radio protocol architecture of E-UTRAN is provided for the user plane and the control plane. A more detailed description of the architecture is provided in 3GPP TS 86.300.

The eNB **103** interfaces via the S1 to the Serving Gateway **1045**, which includes a Mobility Anchoring function **1047**. According to this architecture, the MME (Mobility Management Entity) **1049** provides SAE (System Architecture Evolution) Bearer Control **1051**, Idle State Mobility Handling **1053**, and NAS (Non-Access Stratum) Security **1055**.

One of ordinary skill in the art would recognize that the processes for implicitly signaling redundancy version information (or parameter) may be implemented via software, hardware (e.g., general processor, Digital Signal Processing (DSP) chip, an Application Specific Integrated Circuit (ASIC), Field Programmable Gate Arrays (FPGAs), etc.), firmware, or a combination thereof. Such exemplary hardware for performing the described functions is detailed below.

FIG. **11** illustrates exemplary hardware upon which various embodiments of the invention can be implemented. A computing system **1100** includes a bus **1101** or other communication mechanism for communicating information and a processor **1103** coupled to the bus **1101** for processing infor-

14

mation. The computing system **1100** also includes main memory **1105**, such as a random access memory (RAM) or other dynamic storage device, coupled to the bus **1101** for storing information and instructions to be executed by the processor **1103**. Main memory **1105** can also be used for storing temporary variables or other intermediate information during execution of instructions by the processor **1103**. The computing system **1100** may further include a read only memory (ROM) **1107** or other static storage device coupled to the bus **1101** for storing static information and instructions for the processor **1103**. A storage device **1109**, such as a magnetic disk or optical disk, is coupled to the bus **1101** for persistently storing information and instructions.

The computing system **1100** may be coupled via the bus **1101** to a display **1111**, such as a liquid crystal display, or active matrix display, for displaying information to a user. An input device **1113**, such as a keyboard including alphanumeric and other keys, may be coupled to the bus **1101** for communicating information and command selections to the processor **1103**. The input device **1113** can include a cursor control, such as a mouse, a trackball, or cursor direction keys, for communicating direction information and command selections to the processor **1103** and for controlling cursor movement on the display **1111**.

According to various embodiments of the invention, the processes described herein can be provided by the computing system **1100** in response to the processor **1103** executing an arrangement of instructions contained in main memory **1105**. Such instructions can be read into main memory **1105** from another computer-readable medium, such as the storage device **1109**. Execution of the arrangement of instructions contained in main memory **1105** causes the processor **1103** to perform the process steps described herein. One or more processors in a multi-processing arrangement may also be employed to execute the instructions contained in main memory **1105**. In alternative embodiments, hard-wired circuitry may be used in place of or in combination with software instructions to implement the embodiment of the invention. In another example, reconfigurable hardware such as Field Programmable Gate Arrays (FPGAs) can be used, in which the functionality and connection topology of its logic gates are customizable at run-time, typically by programming memory look up tables. Thus, embodiments of the invention are not limited to any specific combination of hardware circuitry and software.

The computing system **1100** also includes at least one communication interface **1115** coupled to bus **1101**. The communication interface **1115** provides a two-way data communication coupling to a network link (not shown). The communication interface **1115** sends and receives electrical, electromagnetic, or optical signals that carry digital data streams representing various types of information. Further, the communication interface **1115** can include peripheral interface devices, such as a Universal Serial Bus (USB) interface, a PCMCIA (Personal Computer Memory Card International Association) interface, etc.

The processor **1103** may execute the transmitted code while being received and/or store the code in the storage device **1109**, or other non-volatile storage for later execution. In this manner, the computing system **1100** may obtain application code in the form of a carrier wave.

The term "computer-readable medium" as used herein refers to any medium that participates in providing instructions to the processor **1103** for execution. Such a medium may take many forms, including but not limited to non-volatile media, volatile media, and transmission media. Non-volatile media include, for example, optical or magnetic disks, such as



US 8,457,022 B2

15

the storage device 1109. Volatile media include dynamic memory, such as main memory 1105. Transmission media include coaxial cables, copper wire and fiber optics, including the wires that comprise the bus 1101. Transmission media can also take the form of acoustic, optical, or electromagnetic waves, such as those generated during radio frequency (RF) and infrared (IR) data communications. Common forms of computer-readable media include, for example, a floppy disk, a flexible disk, hard disk, magnetic tape, any other magnetic medium, a CD-ROM, CDRW, DVD, any other optical medium, punch cards, paper tape, optical mark sheets, any other physical medium with patterns of holes or other optically recognizable indicia, a RAM, a PROM, and EPROM, a FLASH-EPROM, any other memory chip or cartridge, a carrier wave, or any other medium from which a computer can read.

Various forms of computer-readable media may be involved in providing instructions to a processor for execution. For example, the instructions for carrying out at least part of the invention may initially be borne on a magnetic disk of a remote computer. In such a scenario, the remote computer loads the instructions into main memory and sends the instructions over a telephone line using a modem. A modem of a local system receives the data on the telephone line and uses an infrared transmitter to convert the data to an infrared signal and transmit the infrared signal to a portable computing device, such as a personal digital assistant (PDA) or a laptop. An infrared detector on the portable computing device receives the information and instructions borne by the infrared signal and places the data on a bus. The bus conveys the data to main memory, from which a processor retrieves and executes the instructions. The instructions received by main memory can optionally be stored on storage device either before or after execution by processor.

FIG. 12 is a diagram of exemplary components of a user terminal configured to operate in the systems of FIGS. 5 and 6, according to an embodiment of the invention. A user terminal 1200 includes an antenna system 1201 (which can utilize multiple antennas) to receive and transmit signals. The antenna system 1201 is coupled to radio circuitry 1203, which includes multiple transmitters 1205 and receivers 1207. The radio circuitry encompasses all of the Radio Frequency (RF) circuitry as well as base-band processing circuitry. As shown, layer-1 (L1) and layer-2 (L2) processing are provided by units 1209 and 1211, respectively. Optionally, layer-3 functions can be provided (not shown). L2 unit 1211 can include module 1213, which executes all Medium Access Control (MAC) layer functions. A timing and calibration module 1215 maintains proper timing by interfacing, for example, an external timing reference (not shown). Additionally, a processor 1217 is included. Under this scenario, the user terminal 1200 communicates with a computing device 1219, which can be a personal computer, work station, a Personal Digital Assistant (PDA), web appliance, cellular phone, etc.

While the invention has been described in connection with a number of embodiments and implementations, the invention is not so limited but covers various obvious modifications and equivalent arrangements, which fall within the purview of the claims. Although features of the invention are expressed in certain combinations among the claims, it is contemplated that these features can be arranged in any combination and order.

What is claimed is:

1. A method comprising:
  - detecting start of a system information message transmission window; and

16

assigning a redundancy version sequence at the start of the transmission window,

wherein the assignment includes excluding one or more of the predetermined subframes in even-numbered radio frames if the subframes are within the transmission window, and

wherein the assignment includes excluding uplink subframes and multi-cast subframes, and

wherein the assignment ensures the redundancy version sequence is continuous over adjacent radio frames, and wherein the redundancy version sequence is calculated according to

$$RV_k = \left\lceil \frac{3}{2}k \right\rceil \bmod 4,$$

where  $RV_k$  is the redundancy version sequence,  $k=i \bmod 4$ ,  $i=0,1, \dots, n_s^w-1$ , and  $n_s^w$  denotes a number of subframes within the system information message transmission window.

2. The method of claim 1, further comprising:
  - determining whether the subframes are a mixture of multi-cast subframes and unicast subframes.

3. The method of claim 1, further comprising:
  - determining available control capacity;
  - tracking the redundancy version sequence with a system information message transmission window; and
  - scheduling transmission of a broadcast control channel signal based on the available control capacity to obtain an optimal redundancy version sequence.

4. The method of claim 3, wherein the optimal redundancy version sequence is obtained at the start of the system information message transmission window, and the optimal redundancy version sequence either reduces a signal-to-noise ratio, enables quicker acquisition of the broadcast control channel signal, reduces power consumption, or a combination thereof.

5. The method of claim 1, wherein the subframes are a part of radio frames that utilize either time division duplex (TDD) carriers or frequency division duplex (FDD) carriers.

6. An apparatus comprising:

- a redundancy version signaling module configured to detect start of a system information message transmission window and to assign a redundancy version sequence at the start of the transmission window, wherein the assignment includes excluding one or more of the predetermined subframes in even-numbered radio frames if the subframes are within the transmission window, and wherein the assignment includes excluding uplink subframes and multi-cast subframes,

wherein the assignment ensures the redundancy version sequence is continuous over adjacent radio frames, and wherein the redundancy version sequence is calculated according to

$$RV_k = \left\lceil \frac{3}{2}k \right\rceil \bmod 4,$$

where  $RV_k$  is the redundancy version sequence  $k=i \bmod 4$ ,  $i=0,1, \dots, i=0,1, \dots, n_s^w-1$ , and  $n_s^w$  denotes a number of subframes within the system information message transmission window.

7. The apparatus of claim 6, wherein the redundancy version signaling module is further configured to:



US 8,457,022 B2

17

determine whether the subframes are a mixture of multi-cast subframes and unicast subframes.

8. The apparatus of claim 6, wherein the redundancy version signaling module is further configured to:  
 determine available control capacity;  
 track transmitted redundancy version sequence with a system information message transmission window; and  
 schedule transmission of a broadcast control channel signal based on the available control capacity to obtain an optimal redundancy version sequence.

9. The apparatus of claim 8, wherein the optimal redundancy version sequence is obtained at the start of the system information message transmission window, and the optimal redundancy version sequence either reduces a-signal-to-noise ratio, enables quicker acquisition of the broadcast control channel signal, reduces power consumption, or a combination thereof.

10. The apparatus of claim 6, wherein the subframes are a part of radio frames that utilize either time division duplex (TDD) carriers or frequency division duplex (FDD) carriers.

11. A non-transitory computer-readable storage medium carrying one or more sequences of one or more instructions which, when executed by one or more processors, cause an apparatus to perform:

- detecting start of a system information message transmission window; and
  - assigning a redundancy version sequence at the start of the transmission window,
- wherein the assignment includes excluding one or more predetermined subframes in even-numbered radio

18

frames if the subframes are within the transmission window and excluding uplink subframes, and wherein the redundancy version sequence is calculated according to

$$RV_k = \left\lceil \frac{3}{2}k \right\rceil \bmod 4,$$

where  $RV_k$  is the redundancy version sequence,  $k=i \bmod 4$ ,  $i=0,1, \dots, n_s^w-1$ , and  $n_s^w$  denotes a number of subframes within the system information message transmission window.

12. The non-transitory computer-readable storage medium of claim 11, wherein the apparatus is caused to further perform:

- determining whether the subframes are a mixture of multi-cast subframes and unicast subframes, wherein the assignment includes excluding the multi-cast subframes.

13. The non-transitory computer-readable storage medium of claim 11, wherein the apparatus is caused to further perform:

- determining available control capacity;
- tracking the redundancy version sequence with a system information message transmission window; and
- scheduling transmission of a broadcast control channel signal based on the available control capacity to obtain an optimal redundancy version sequence.

\* \* \* \* \*



---

**EXHIBIT B**

---

(12) **United States Patent**  
**Ball et al.**

(10) **Patent No.:** **US 8,570,957 B2**  
 (45) **Date of Patent:** **Oct. 29, 2013**

(54) **EXTENSION OF POWER HEADROOM REPORTING AND TRIGGER CONDITIONS**

(75) Inventors: **Carsten Ball**, München (DE); **Jari Lindholm**, Palojoki (FI); **Robert Müllner**, München (DE); **Claudio Rosa**, Randers (DE)

(73) Assignee: **Nokia Siemens Networks Oy**, Espoo (FI)

(\* ) Notice: Subject to any disclaimer, the term of this patent is extended or adjusted under 35 U.S.C. 154(b) by 1003 days.

(21) Appl. No.: **12/382,920**

(22) Filed: **Mar. 26, 2009**

(65) **Prior Publication Data**

US 2009/0245191 A1 Oct. 1, 2009

**Related U.S. Application Data**

(60) Provisional application No. 61/039,707, filed on Mar. 26, 2008.

(51) **Int. Cl.**  
**H04L 1/00** (2006.01)  
**H04B 7/00** (2006.01)

(52) **U.S. Cl.**  
 USPC ..... **370/329; 455/522**

(58) **Field of Classification Search**  
 USPC ..... 370/329  
 See application file for complete search history.

(56) **References Cited**

**U.S. PATENT DOCUMENTS**

5,491,837 A \* 2/1996 Haartsen ..... 455/62  
 5,551,057 A \* 8/1996 Mitra ..... 455/522  
 5,991,618 A \* 11/1999 Hall ..... 455/425  
 6,075,974 A 6/2000 Saints et al.

6,374,085 B1 \* 4/2002 Saints et al. .... 455/69  
 6,975,609 B1 \* 12/2005 Khaleghi et al. .... 370/335  
 7,428,426 B2 \* 9/2008 Kiran et al. .... 455/522  
 7,860,052 B2 \* 12/2010 Lohr et al. .... 370/329  
 7,894,444 B2 2/2011 Lohr et al.  
 8,457,676 B2 \* 6/2013 Michel et al. .... 455/522  
 2004/0252658 A1 \* 12/2004 Hosein et al. .... 370/328  
 2007/0297360 A1 \* 12/2007 Joachim et al. .... 370/329  
 2008/0037413 A1 \* 2/2008 Gu et al. .... 370/210

(Continued)

**FOREIGN PATENT DOCUMENTS**

CN 101009933 A 8/2007  
 RU 2236757 C2 9/2004  
 WO 2004/056009 A1 7/2004

**OTHER PUBLICATIONS**

3GPP TSG-RAN4 Meeting #44bis, R4-071574, "Requirements for the UE Transmission Power Headroom (UPH)"Oct. 8-12, 2007, pp. 1-3.

(Continued)

*Primary Examiner* — Guang Li

(74) *Attorney, Agent, or Firm* — Squire Sanders (US) LLP

(57) **ABSTRACT**

A method can include determining a power headroom report, and transmitting the headroom report. The power headroom report can provide both positive and negative values of power headroom according to the determination, in which negative values indicate the missing power in dB to fulfill requirements, such as those given by current resource allocation and modulation and coding scheme. This method can be implemented by encoding instructions for performing this method on a computer-readable medium, such that the instructions when execute cause the computer to execute the method as a computer process. The method can further include receiving a power headroom report. The method can additionally include allocating radio network resources based on the power headroom report.

**16 Claims, 4 Drawing Sheets**

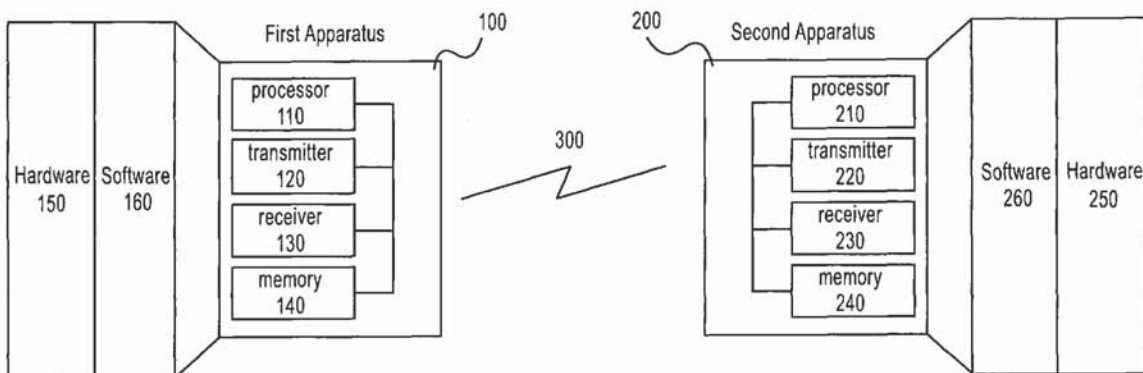

**US 8,570,957 B2**

Page 2

(56)

**References Cited**

U.S. PATENT DOCUMENTS

2008/0072079	A1 *	3/2008	Bieswanger et al. ....	713/300
2008/0175185	A1 *	7/2008	Ji et al. ....	370/318
2008/0254819	A1 *	10/2008	Niwano et al. ....	455/522
2009/0125650	A1 *	5/2009	Sebire .....	710/57
2009/0175187	A1 *	7/2009	Jersenius et al. ....	370/252
2009/0191910	A1 *	7/2009	Athalye et al. ....	455/522
2010/0173665	A1 *	7/2010	Michel et al. ....	455/522

OTHER PUBLICATIONS

3GPP TS 36.331 V8.0.0, "3rd Generation Partnership Project; Technical Specification Group Radio Access Network; Evolved Universal Terrestrial Radio Access (E-UTRA) Radio Resource Control (RRC); Protocol Specification (Release 8)", Dec. 2007, pp. 1-56.

3GPP TS 36.101 V8.0.0, "3rd Generation Partnership Project; Technical Specification Group Radio Access Network; Evolved Universal Terrestrial Radio Access (E-UTRA); User Equipment (UE) Radio Transmission and Reception (Release 8)", Dec. 2007, pp. 1-45.

International Search Report international application No. PCT/EP2009/053556 dated Sep. 28, 2009.

3GPP TS 36.213, v8.3.0, "3rd Generation Partnership Project; Technical Specification Group Radio Access Network; Evolved Universal Terrestrial Radio Access (E-UTRA); Physical Layer Procedures", Release 8, pp. 1-45, (May 2008).

WORU Notice of Allowance issued Sep. 14, 2012 in corresponding Application No. RU 201043473/08 (062617).

WOCN Office Action dated Dec. 4, 2012 in corresponding Application No. CN 200980119369.1.

\* cited by examiner

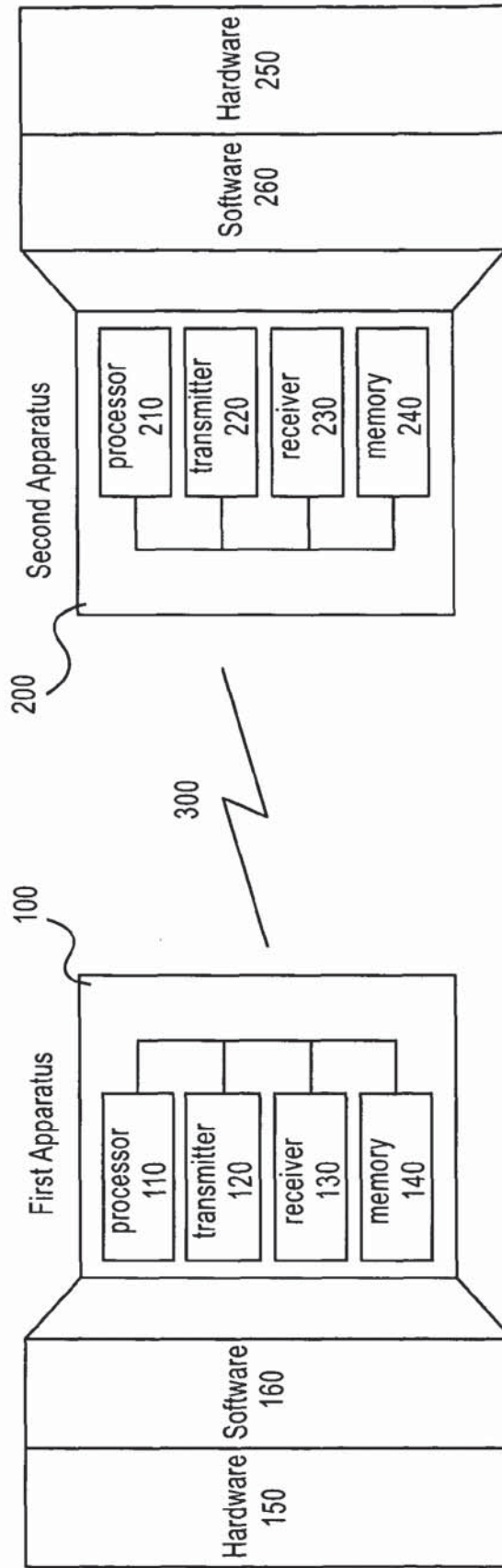

FIG.1

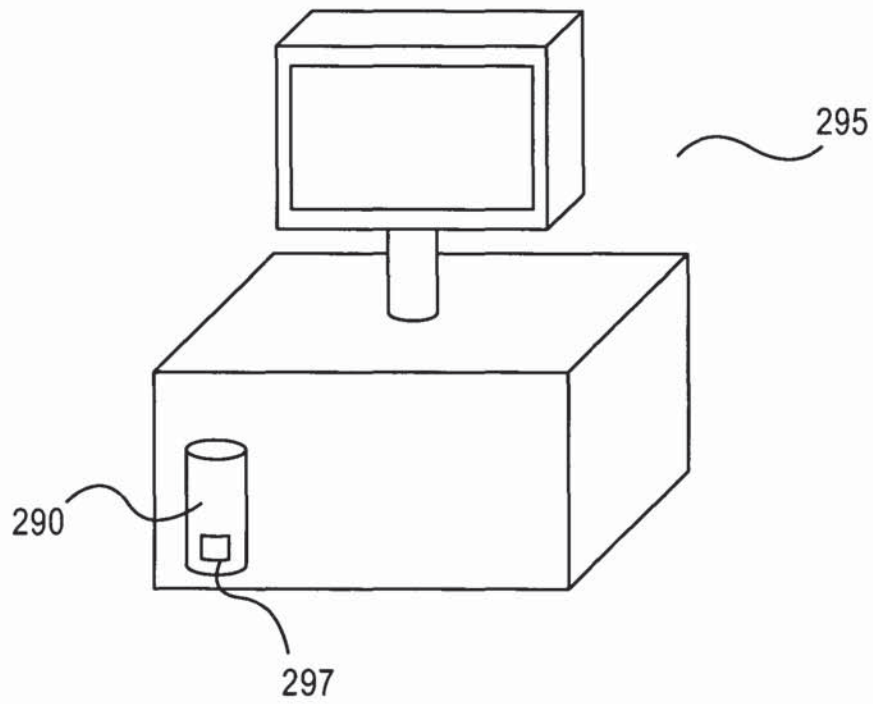

FIG. 2

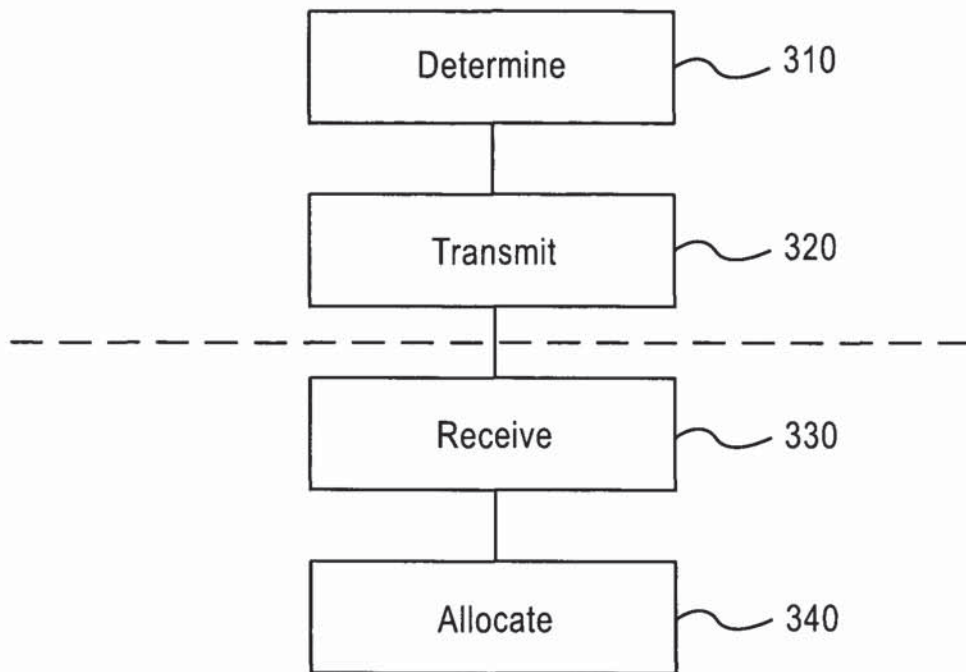

FIG.3

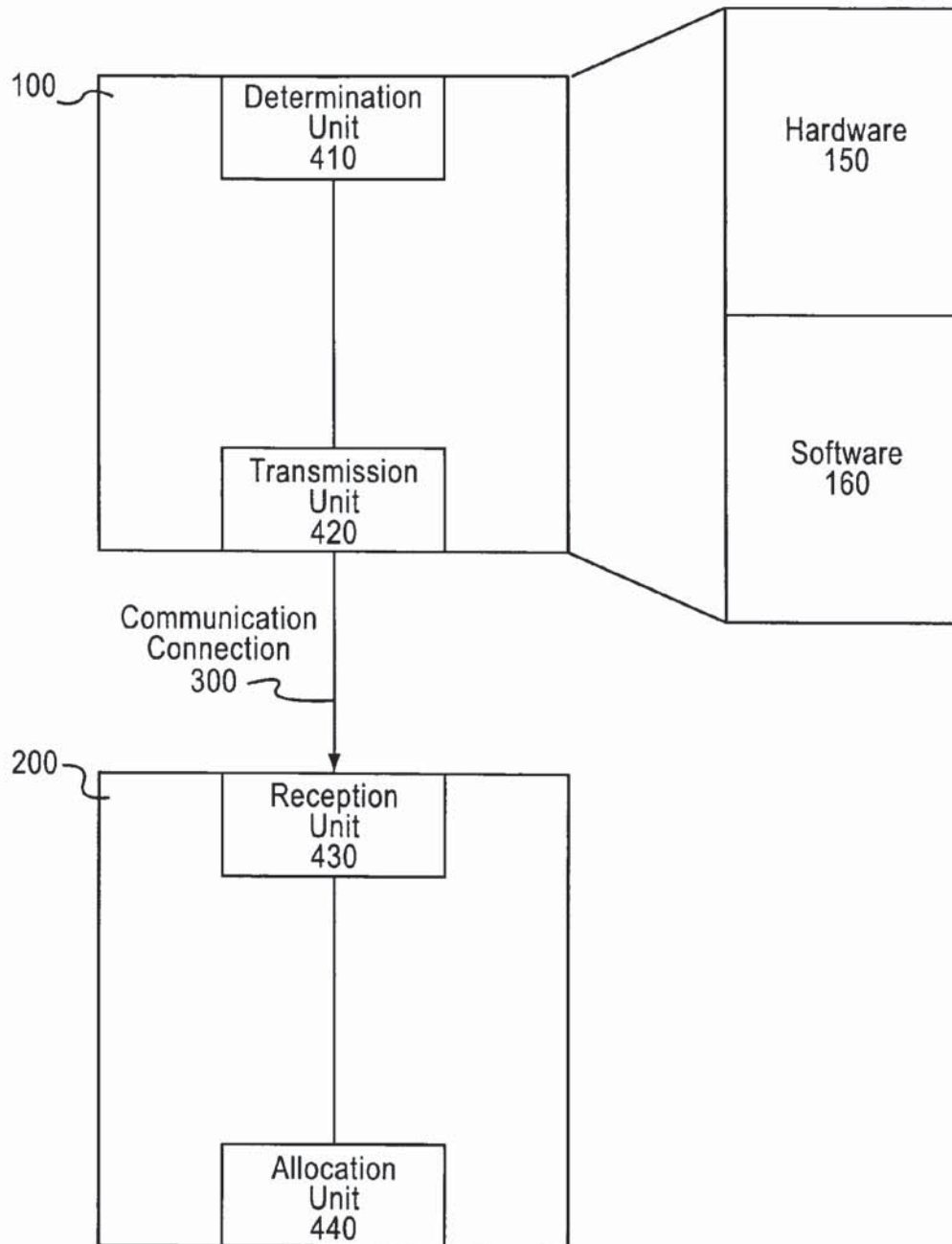

FIG.4



US 8,570,957 B2

1

## EXTENSION OF POWER HEADROOM REPORTING AND TRIGGER CONDITIONS

### CROSS REFERENCE TO RELATED APPLICATIONS

This application claims priority under 35 U.S.C. §119(e) of U.S. Provisional Patent Application Ser. No. 61/039,707, filed on Mar. 26, 2008. The subject matter of the earlier filed application is hereby incorporated by reference.

### BACKGROUND OF THE INVENTION

#### 1. Field of the Invention

Certain embodiments of the present invention generally relate to communication technologies. For example, certain embodiments of the present invention can be used in wireless communications, and particular in the Long Term Evolution (LTE) of Third Generation Partnership Project (3GPP) and Evolved UMTS (Universal Mobile Telecommunication System) Terrestrial Radio Access Network (Evolved UTRAN or simply EUTRAN). More particularly certain embodiments of the present invention provide an extension of power headroom reporting to be used by each and every user equipment (UE) to allow for a more efficient resource allocation by an evolved Node B (eNodeB).

#### 2. Description of the Related Art

Third Generation Partnership Project (3GPP) Long Term Evolution (LTE), which is a project within the 3GPP to improve the UMTS standard with respect to efficiency, services, costs, new spectrum opportunities and better integration with other open standards. LTE may result in a new evolved Release 8 of the 3GPP standard including extensions and modifications of the UMTS system. The architecture is called EPS (Evolved Packet System) and comprehends E-UTRAN (Evolved UTRAN) on the access side and EPC (Evolved Packet Core) on the core side.

3GPP Release 8 is expected to be developed further. Much of the standard is expected to be oriented around upgrading UMTS to the fourth generation mobile communications technology, essentially a wireless broadband Internet system with voice and other services, such as data services, built on top.

In 3GPP standardization the specification for power headroom reporting for LTE has started and is expected to be defined. Power headroom reporting is currently topic of 3GPP standardization and the described problem has not yet been solved.

### SUMMARY OF THE INVENTION

One embodiment of the present invention is an apparatus. The apparatus includes a processor configured to determine a power headroom report. The apparatus also includes a transmitter configured to transmit the headroom report. The processor is configured to determine the power headroom report with both positive and negative values of power headroom, as applicable, in which negative values indicate the missing power in dB to fulfill transmission requirements.

Another embodiment of the present invention is also an apparatus. The apparatus includes a receiver configured to receive a power headroom report. The apparatus further includes a processor configured to allocate radio network resources based on the power headroom report. The processor is configured to obtain both positive and negative values of power headroom from the power headroom report, as applicable, in which negative values indicate the missing power in dB to fulfill transmission requirements.

2

A further embodiment of the present invention is a method. The method includes determining a power headroom report. The method also includes transmitting the headroom report. The determining includes determining the power headroom report with both positive and negative values of power headroom, as applicable, in which negative values indicate the missing power in dB to fulfill transmission requirements.

An additional embodiment of the present invention is also a method. The method includes receiving a power headroom report. The method also includes allocating radio network resources based on the power headroom report. The allocating includes obtaining, from the power headroom report, both positive and negative values of power headroom, as applicable, in which negative values indicate the missing power in dB to fulfill transmission requirements.

Another embodiment of the present invention is a computer-readable storage medium encoded with instructions configured to control a computer to execute a process. The process includes determining a power headroom report. The process also includes transmitting the headroom report. The determining includes determining the power headroom report with both positive and negative values of power headroom, as applicable, in which negative values indicate the missing power in dB to fulfill transmission requirements.

A further embodiment of the present invention is a computer-readable storage medium encoded with instructions configured to control a computer to execute a process. The process includes receiving a power headroom report. The process also includes allocating radio network resources based on the power headroom report. The allocating includes obtaining, from the power headroom report, both positive and negative values of power headroom, as applicable, in which negative values indicate the missing power in dB to fulfill transmission requirements.

Another embodiment of the present invention is an apparatus. The apparatus includes determining means for determining a power headroom report. The apparatus also includes transmitting means for transmitting the headroom report. The determining means is configured to determine the power headroom report with both positive and negative values of power headroom, as applicable, in which negative values indicate the missing power in dB to fulfill transmission requirements.

An additional embodiment of the present invention is also an apparatus. The apparatus includes receiving means for receiving a power headroom report. The apparatus also includes allocating means for allocating radio network resources based on the power headroom report. The processor is configured to obtain both positive and negative values of power headroom from the power headroom report, as applicable, in which negative values indicate the missing power in dB to fulfill transmission requirements.

### BRIEF DESCRIPTION OF THE DRAWINGS

For proper understanding of the invention, reference should be made to the accompanying drawings, wherein:

FIG. 1 illustrates a system according to an embodiment of the present invention;

FIG. 2 illustrates a computer-readable medium according to an embodiment of the present invention; and

FIG. 3 illustrates a method according to an embodiment of the present invention.

FIG. 4 illustrates a system according to another embodiment of the present invention.



## DETAILED DESCRIPTION OF THE PREFERRED EMBODIMENT(S)

Certain embodiments of the present invention relate to an extension of power headroom reporting to be used by each and every User Equipment (UE) to allow for a more economic resource allocation by an evolved Node B (eNodeB).

In such embodiments, the UE can report in a power headroom report the difference between the nominal maximum power and the power at the UE, e.g. the power that the UE would use if it did not apply maximum power limitations. This power headroom report describes only the positive difference between nominal maximum transmission power and the currently used power. Hence, with the current standardization assumption, the eNodeB will not have knowledge about the “missing” power at the UE. As a result resources on the air interface are somehow wasted since the scheduler is not aware of how much the UE power budget is exceeded.

Power headroom reporting can be performed in both directions, e.g. reporting (a) positive headroom if the current transmit power is lower than the nominal maximum transmission power and (b) negative headroom if the required transmit power according to the allocation scheme in terms of number of resource blocks, broadcasted and dedicated offset parameters, path loss estimates, as well as selected modulation and coding scheme and closed-loop power correction values requires higher power than the nominal maximum transmit power. It should be noted that the power headroom report is negative if the right part of the min-function in Equation 1 for Physical Uplink Shared Channel (discussed below) exceeds  $P_{max}$ . This part includes further terms (offset parameters, path loss estimates, and closed-loop power corrections). Example: The right part of the min-function requests a transmission power of 26 dBm.  $P_{max}$  is set to 23 dBm. The reported power headroom is 23 dBm-26 dBm=-3 dB.

The extension of power headroom reporting to negative values can be used by the UE to inform the eNodeB about the amount of missing power in dB; eNodeB scheduler to reduce the number of allocated RBs to an optimum bandwidth and/or Adaptive Modulation and Coding (AMC) to adapt the modulation and coding scheme (MCS downgrade) in case of slow AMC, or outer loop link adaptation offset in case of fast AMC; adaptation of the UpLink (UL) power control; reconfiguration of UL sounding channel—if applicable; reconfiguration of signaling resources and power—if applicable; and resealing of previous measurements—if applicable.

The currently proposed uplink in LTE uses Single Carrier Frequency Division Multiple Access (SC-FDMA) multiplexing and Quadrature Phase Shift Keying (QPSK) or 16 Quadrature Amplitude Modulation (QAM) (64 QAM optional) modulation. Power control can be an efficient means to improve the cell edge behavior, to relax the requirements on the intra-cell orthogonality, and to reduce inter-cell interference and power consumption. Basically, the Power Spectral Density (PSD) can be determined by an open loop power control component calculated at the User Equipment (UE) and a closed loop power control correction transmitted by the eNodeB. PSD can be defined as “transmission power per resource block,” where a resource block (RB) is the smallest time/frequency unit that can be assigned by the scheduler. The setting of the UE transmit power according to 3GPP TS 36.213 (which is hereby incorporated by reference in its entirety) is based on broadcasted and dedicated parameters as well as path loss estimates. The maximum uplink transmit power is limited by a maximum value  $P_{max}$  signaled from the network to the UE and by the capability of the UE according to its UE class.

The eNodeB can be configured to know at which PSD level the different UEs are operating. The PSD can be calculated from the total UE transmission power and the number of assigned physical resources. This information can be important for performing correct radio resource management and link quality control decisions at the eNodeB, especially for the adaptation of the modulation and coding scheme, UpLink (UL) power control and resource assignment. An imprecise knowledge of the PSD used by a specific UE could e.g. cause the allocation of an excessively high transmission bandwidth, thus resulting in a lower Signal to Interference plus Noise Ratio (SINR) than expected. Information on the PSD used at the UE is expected to be obtained from the power control headroom reports, which are current topics in 3GPP standardization.

The power control headroom is the difference between the nominal maximum transmission power and the power at the UE, e.g. the power that the UE would use if it did not apply maximum power limitations. The power control headroom is calculated per Transmission Time Interval (TTI) and it is expected that the UE sends power headroom reports after a closed loop power control commands, if the change of the path loss exceeds a specific threshold since the last power headroom report, if the UE is close to maximum power or if the timer started at previous report has elapsed. Periodic sending of power headroom report is also possible.

3GPP TS 36.213 defines the UE transmit power for the Physical Uplink Shared Channel (PUSCH)  $P_{PUSCH}$  transmission in subframe  $i$  by the following equation:

Equation 1 for Physical Uplink Shared Channel (PUSCH)

$$P_{PUSCH}(i) = \min\{P_{MAX}, 10 \log_{10}(M_{PUSCH}(i)) + P_{O_{PUSCH}(j)} + \alpha \cdot PL + \Delta_{TF}(TF(i)) + f(i)\} \text{ [dBm]}$$

where

$P_{MAX}$  can be the maximum allowed power configured by higher layers;

$M_{PUSCH}$  can be the size of the PUSCH resource assignment expressed in number of resource blocks valid for subframe  $i$ ;

$P_{O_{PUSCH}}$  can be an offset parameter defined by Operation and Maintenance (O&M) or additionally influenced by internal calculations;

$\alpha$  can be a path loss compensation factor adjustable by O&M;

PL can be the downlink Path Loss (PL) estimate calculated in the UE;

$\Delta_{TF}$  can be a Transport Format (TF) dependent offset; and  $f(i)$  can represent reporting of closed loop power correction values using accumulation or absolute values, respectively.

An alternative to Equation 1 is the following:

$$P_{PUSCH}(i) = \min\{P_{MAX}, 10 \log_{10}(M_{PUSCH}(i)) + P_{O_{PUSCH}(j)} + \alpha(j) \cdot PL + \Delta_{TF}(i) + f(i)\}$$

where the terms are defined as in Equation 1. Further changes are possible, for example, in which  $P_{MAX}$  is defined by  $PCMAX = \min(P_{EMAX}, P_{UMAX})$ , where  $P_{EMAX}$  is the maximum allowed power configured by higher layers and defined in 3GPP TS 36.331 and  $P_{UMAX}$  is the maximum UE power for the UE power class specified in 3GPP TS 36.101.

The UE can report in the power headroom report, the difference between  $P_{MAX}$  and the second term of the minimum function in equation 1. This power headroom report (in the conventional implementation) describes only the positive difference between nominal maximum transmission power and the currently used power. Using maximum transmit power results in a power headroom of 0 dB but also requiring



US 8,570,957 B2

5

more power for maintaining the PSD at given allocation would result in a power headroom report of 0 dB. In other words, if more power than  $P_{max}$  is required according to the right part of the min-function in equation 1, the power headroom without extension to negative values would also report the value 0 and the network does not obtain knowledge whether the uplink power is exactly sufficient (the right part of the min-function is equal to  $P_{max}$ ) or if power is missing, i.e. the right part of the min-function is higher than  $P_{max}$ . Hence with the current standardization assumption the eNodeB is not expected to have knowledge about the “missing” power at the UE. As a result resources on the air interface may be wasted, since the scheduler is not aware of how much the UE power budget is exceeded.

In certain embodiments of the present invention, the power headroom reporting is extended to both directions, e.g. reporting (a) positive headroom if the current transmit power is lower than the nominal maximum transmission power and (b) negative headroom if the required transmit power according to the allocation scheme in terms of number of RBs as well as selected modulation and coding scheme requires higher power than the nominal maximum transmit power.

The extension of power headroom reporting to negative values can be used by

- (a) the UE to inform the eNodeB about the amount of missing power in dB;
- (b) an eNodeB scheduler to reduce the number of allocated RBs to an optimum bandwidth (ATB=adaptive transmission bandwidth) and/or adaptive modulation and coding (AMC) to adapt the modulation and coding scheme (MCS downgrade) in case of slow AMC, or outer loop link adaptation offset in case of fast AMC;
- (c) adaptation of the UL power control;
- (d) reconfiguration of UL sounding channel—if applicable;
- (e) reconfiguration of signaling resources and power—if applicable; and
- (f) rescaling of previous measurements—if applicable.

There can also be an emergency trigger condition, whenever the UE power is exceeded. The UE can send immediately a Power Headroom Report. The UE can, optionally, also be allowed to use only a limited number of resources for submission and can indicate this (or be told of this by, for example, an eNodeB). This may enhance high coverage.

There are also some further options. For example, if the UE runs out of power (required power according to allocation scheme exceeds  $P_{MAX}$ ) it can reduce the number of RBs for uplink transmission, i.e. the UE can transmit on fewer RBs than scheduled. The eNodeB can be informed about this action. This option can be enabled or disabled by the network via broadcast message or dedicated signaling. For another example, if the UE runs out of power (required power according to allocation scheme exceeds  $P_{MAX}$ ) and different  $\Delta_{TF}$  values are used for different transport formats, the UE can use another, e.g. more robust modulation and coding scheme with lower  $\Delta_{TF}$  and can signal this to the eNodeB. Enabling or disabling of this option can also be controlled by the network.

The extension of the reported range can lead to a more efficient utilization of the available resources. Without this solution, the PSD requirements from power control algorithm (according to 3GPP TS 36.213) at given resource allocation might not be maintained because an indicated power headroom of 0 dB does not provide information whether (or which) additional power is required. As a consequence, the quality requirements in terms of signal to interference and noise ratio (SINR) cannot be maintained, and a more robust

6

modulation and coding scheme (MCS) would be expected to be selected by AMC, while the number of allocated RBs is still maintained.

At least some of the solutions described in present application allow the scheduler to reduce the resource allocation on the appropriate number of RBs, in a targeted, accurate way. Hence, radio resource management may have all necessary information to determine in advance the number of RBs to be reduced. The assignment of the gained RBs to other connections may become possible immediately, and the performance of LTE can be increased in terms of quality and capacity.

Certain embodiments of the present invention may result in a shift of the range covered by headroom reporting. The power control range in LTE is assumed to be 40 dB. With 6 bits used for signaling 64 power headroom, levels can be defined ranging from +40 dB to -23 dB in steps of 1 dB. This range can be extended, in terms of the lower limit of the range, from currently 0 dB to negative values. An extension to 3 dB can permit Adaptive Transmission Bandwidth (ATB) to reduce the bandwidth by 50%. Larger steps in bandwidth reduction can be provided by extending the range to e.g. -10 dB or -23 dB. This extension for the information of negative power headroom can be used by radio resource management to adapt the modulation scheme e.g. from 16 QAM to QPSK or from 64 QAM to 16 QAM (mapping on link level curves). A larger negative range can also allow for a higher granularity in each mixture of joint ATB and AMC measures. This is expected to provide sufficient range given by 6 bits for signaling. A shift of the range towards negative values could be similarly handled in case of a reduction of the signaling bits to e.g. 5.

Certain embodiments of the present invention extend the power headroom report from positive only to positive and negative values, where negative power headroom represents the following situation: the reported negative value indicates the missing power in dB to fulfill the requirements given by current resource allocation and modulation and coding scheme. This knowledge can allow an exact reassignment of the allocated resources and a more economic resource utilization.

FIG. 1 illustrates a system according to an embodiment of the present invention. The system includes a first apparatus 100 and a second apparatus 200. The first apparatus 100 and the second apparatus 200 can be configured to communicate over a communication link 300, which is illustrated as a direct wireless communication link, though there is no requirement that any connection between the first apparatus 100 and second apparatus 200 be either direct or wireless.

The first apparatus 100 can include a processor 110, a transmitter 120, a receiver 130, and optionally a memory 140. The first apparatus 100 can be, for example, a UE, such as a personal digital assistant, a handheld computer, a cellular telephone, or other communication device. The first apparatus can be implemented as a combination of hardware 150 and software 160. The hardware 150 can be, for example, a general purpose computer or an Application Specific Integrated Circuit (ASIC). The optional memory 140 can be any conventional memory, such as flash Random Access Memory (RAM), a Compact Disk (CD), or a hard drive.

The processor 110 can be configured to determine a power headroom report. The transmitter 120 can be configured to transmit the headroom report. The power headroom report itself can be configured to provide both positive and negative values of power headroom according to the determination of the processor, in which negative values indicate the missing power in dB to fulfill transmission requirements such as, for



example, the requirements given by at least one of resource allocation, modulation scheme, coding scheme, offset parameters, path loss estimates, or closed-loop power correction values. By “both . . . and . . . according to the determination,” it should be understood that in certain embodiments of the present invention, this is implemented by providing a positive value (only) if the determination yields a positive value and a negative value (only) if the determination yields a negative value. It is not necessarily required that both a positive value and a negative value be simultaneously present in a given power report.

The second apparatus 200 can include a processor 210, a transmitter 220, a receiver 230, and optionally a memory 240. The second apparatus 200 can be, for example, a base station, access point, router, or evolved Node B. The second apparatus can be implemented as a combination of hardware 250 and software 260. The hardware 250 can be, for example, a general purpose computer or an Application Specific Integrated Circuit (ASIC). The optional memory 240 can be any conventional memory, such as flash Random Access Memory (RAM), a Compact Disk (CD), or a hard drive.

The receiver 230 can be configured to receive a power headroom report. The processor 210 can be configured to allocate radio network resources based on the power headroom report. The power headroom report itself can be configured to provide both positive and negative values of power headroom according to the determination of the processor, in which negative values indicate the missing power in dB to fulfill transmission requirements such as, for example, requirements given by at least one of resource allocation, modulation scheme, coding scheme, offset parameters, path loss estimates, or closed-loop power correction values.

FIG. 2 illustrates a computer-readable medium according to an embodiment of the present invention. A computer-readable medium 290 (such as a hard disk drive, CD-Read Only Memory (CD-ROM), or Electronically Programmable ROM (EPROM)—other forms of computer readable media are not excluded) can be encoded with instructions that cause a computer 295 to execute a process when the instructions are executed. The instructions can include a power headroom report 297 in which a power headroom on a range that includes negative and positive power headroom is expressible. The power headroom report 297 can include a value that is either positive or negative. Whether the value is positive or negative can be determined by processor of, for example, a user equipment. The value provided in the power headroom report 297 can instruct the processor of, for example, an eNodeB, to allocate resources in a particular way.

FIG. 3 illustrates a method according to an embodiment of the present invention. The method can include determining 310 a power headroom report. The method can also include transmitting 320 the headroom report. The power headroom report can provide both positive and negative values of power headroom according to the determination, in which negative values indicate the missing power in dB to fulfill transmission requirements such as, for example, requirements given by at least one of resource allocation, modulation scheme, coding scheme, offset parameters, path loss estimates, or closed-loop power correction values. This method can be implemented by encoding instructions for performing this method on a computer-readable medium, such that the instructions when execute cause the computer to execute the method as a computer process.

The method can further include receiving 330 a power headroom report. The method can additionally include allocating 340 radio network resources based on the power headroom report.

The present invention has been described mainly in terms of a user equipment (UE) interacting with an evolved Node B (eNodeB). It should be understood, however, that this implementation is merely an example. Other implementations could be made, such as by substituting personal computers (PCs) for both the UE and the eNodeB. Additionally, though in some places the system is described as containing only a single UE and only a single eNodeB, it should be understood that the system could be implemented with either multiple UEs or multiple eNodeBs or both.

FIG. 4 illustrates a system according to an embodiment of the present invention. The system includes a first apparatus 100 and a second apparatus 200. The first apparatus 100 and the second apparatus 200 can be configured to communicate over a communication link 300, which is illustrated as a direct communication link, though there is no requirement that any connection between the first apparatus 100 and second apparatus 200 be a direct connection.

The first apparatus 100 can be implemented as a combination of hardware 150 and software 160. The hardware 150 can be, for example, a general purpose computer or an Application Specific Integrated Circuit (ASIC). Likewise, the second apparatus 200 can be similar constructed.

The first apparatus 100 can include a determination unit 410 configured to determine a power headroom report. The first apparatus can also include a transmission unit 420 configured to transmit the headroom report. The power headroom report itself can be configured to provide both positive and negative values of power headroom according to the determination of the determination unit 410, in which negative values indicate the missing power in dB to fulfill transmission requirements such as, for example, requirements given by at least one of resource allocation, modulation scheme, coding scheme, offset parameters, path loss estimates, or closed-loop power correction values. By “both . . . and . . . according to the determination,” it should be understood that in certain embodiments of the present invention, this is implemented by providing a positive value (only) if the determination yields a positive value and a negative value (only) if the determination yields a negative value. It is not necessarily required that both a positive value and a negative value be simultaneously present in a given power report.

The second apparatus 200 can include a reception unit 430 configured to receive a power headroom report. The second apparatus 200 can also include an allocation unit 440 configured to allocate radio network resources based on the power headroom report. The power headroom report itself can be configured to provide both positive and negative values of power headroom according to the determination of the processor, in which negative values indicate the missing power in dB to fulfill transmission requirements such as, for example, requirements given by at least one of resource allocation, modulation scheme, coding scheme, offset parameters, path loss estimates, or closed-loop power correction values.

The various units (410, 420, 430, and 440) of the first apparatus 100 and the second apparatus 200 can be implemented in hardware, optionally together with software. Thus, for example, a general purpose processor can be configured to serve as an allocation unit 440 when it is performing allocation, and the same general purpose processor can serve as a reception unit 430 when it is receiving a signal that includes a power headroom report. Alternatively, two or more processors or other devices can be configured to serve as the various units (410, 420, 430, and 440), in particular implementations.

One having ordinary skill in the art will readily understand that the invention as discussed above may be practiced with steps in a different order, and/or with hardware elements in



US 8,570,957 B2

9

configurations which are different than those which are disclosed. Therefore, although the invention has been described based upon these preferred embodiments, it would be apparent to those of skill in the art that certain modifications, variations, and alternative constructions would be apparent, while remaining within the spirit and scope of the invention, which is defined by the appended claims.

We claim:

1. An apparatus, comprising:
  - a processor configured to determine a power headroom report; and
  - a transmitter configured to transmit the headroom report, wherein the processor is configured to determine the power headroom report with both positive and negative values of power headroom, as applicable, in which negative values indicate the missing power in dB to fulfill transmission requirements, and
  - wherein the processor is configured to determine the power headroom by subtracting the nominal maximum transmission power and the power that the apparatus would use if it did not apply maximum power limitations, wherein the result of said subtracting is not limited to zero and positive values.
2. The apparatus of claim 1, wherein the apparatus comprises a user equipment.
3. The apparatus of claim 1, wherein the processor is configured to determine the power headroom report comprising a 6 bit report configured to identify a level selected from a range of +40 to -23 dB, in 1 dB steps.
4. An apparatus, comprising:
  - a receiver configured to receive a power headroom report; a processor configured to allocate radio network resources based on the power headroom report,
  - wherein the processor is configured to obtain both positive and negative values of power headroom from the power headroom report, as applicable, in which negative values indicate the missing power in dB to fulfill transmission requirements,
  - wherein the processor is configured to allocate additional radio network resources to a user equipment when the power headroom indicates positive headroom, when applicable, and to allocate fewer radio network resources to the user equipment when the power headroom report indicates negative headroom.
5. The apparatus of claim 4, wherein the apparatus comprises an enhanced node B.
6. The apparatus of claim 4, wherein the processor is configured to obtain, from the power headroom report, a 6 bit report configured to identify a level selected from a range of +40 to -23 dB, in 1 dB steps.
7. A method, comprising:
  - determining a power headroom report; and
  - transmitting the headroom report,
  - wherein the determining comprises determining the power headroom report with both positive and negative values of power headroom, as applicable, in which negative values indicate the missing power in dB to fulfill transmission requirements, and
  - wherein the determining comprises determining the power headroom by subtracting the nominal maximum transmission power and the power that the apparatus would use if it did not apply maximum power limitations, wherein the result of said subtracting is not limited to zero and positive values.
8. The method of claim 7, wherein the method is performed by a user equipment.

10

9. The method of claim 7, further comprising: configuring the power headroom report as a 6 bit report configured to identify a level selected from a range of +40 to -23 dB, in 1 dB steps.

10. A method, comprising:
 

- receiving a power headroom report;
- allocating radio network resources based on the power headroom report,
- wherein the allocating comprises obtaining, from the power headroom report, both positive and negative values of power headroom, as applicable, in which negative values indicate the missing power in dB to fulfill transmission requirements,
- wherein the allocating radio resources comprises allocating additional radio network resources to a user equipment when the power headroom indicates positive headroom, when applicable, and to allocate fewer radio network resources to the user equipment when the power headroom report indicates negative headroom.

11. The method of claim 10, wherein the method is performed by an enhanced node B.

12. The method of claim 10, further comprising: obtaining, from the power headroom report, a 6 bit report configured to identify a level selected from a range of +40 to -23 dB, in 1 dB steps.

13. A non-transitory computer-readable storage medium encoded with instructions configured to control a computer to execute a process, the process including:

- determining a power headroom report; and
- transmitting the headroom report,
- wherein the determining comprises determining the power headroom report with both positive and negative values of power headroom, as applicable, in which negative values indicate the missing power in dB to fulfill transmission requirements, and
- wherein the determining comprises determining the power headroom by subtracting the nominal maximum transmission power and the power that the apparatus would use if it did not apply maximum power limitations, wherein the result of said subtracting is not limited to zero and positive values.

14. A non-transitory computer-readable storage medium encoded with instructions configured to control a computer to execute a process, the process including:

- receiving a power headroom report;
- allocating radio network resources based on the power headroom report,
- wherein the allocating comprises obtaining, from the power headroom report, both positive and negative values of power headroom, as applicable, in which negative values indicate the missing power in dB to fulfill transmission requirements,
- wherein the allocating radio resources comprises allocating additional radio network resources to a user equipment when the power headroom indicates positive headroom, when applicable, and to allocate fewer radio network resources to the user equipment when the power headroom report indicates negative headroom.

15. An apparatus, comprising:
 

- determining means for determining a power headroom report; and
- transmitting means for transmitting the headroom report, wherein the determining means is configured to determine the power headroom report with both positive and negative values of power headroom, as applicable, in which negative values indicate the missing power in dB to fulfill transmission requirements, and

US 8,570,957 B2

11

12

wherein the determining means is configured to determine the power headroom by subtracting the nominal maximum transmission power and the power that the apparatus would use if it did not apply maximum power limitations, wherein the result of said subtracting is not limited to zero and positive values. 5

16. An apparatus, comprising:

receiving means for receiving a power headroom report; allocating means for allocating radio network resources based on the power headroom report, 10

wherein the allocating means is configured to obtain both positive and negative values of power headroom from the power headroom report, as applicable, in which negative values indicate the missing power in dB to fulfill transmission requirements, 15

wherein the allocating means is configured to allocate additional radio network resources to a user equipment when the power headroom indicates positive headroom, when applicable, and to allocate fewer radio network resources to the user equipment when the power headroom report indicates negative headroom. 20

\* \* \* \* \*

---

**EXHIBIT C**

---



(12) **United States Patent**  
**Lunttila et al.**

(10) **Patent No.:** **US 8,867,472 B2**  
 (45) **Date of Patent:** **Oct. 21, 2014**

(54) **SIGNALLING OF CHANNEL INFORMATION**

(75) Inventors: **Timo Erkki Lunttila**, Espoo (FI); **Klaus Ingemann Pedersen**, Aalborg (DK); **Frank Frederiksen**, Klarup (DK)

(73) Assignee: **Cellular Communications Equipment LLC**, Plano, TX (US)

(\*) Notice: Subject to any disclaimer, the term of this patent is extended or adjusted under 35 U.S.C. 154(b) by 192 days.

(21) Appl. No.: **13/637,222**

(22) PCT Filed: **Mar. 25, 2010**

(86) PCT No.: **PCT/EP2010/053919**  
 § 371 (c)(1),  
 (2), (4) Date: **Nov. 14, 2012**

(87) PCT Pub. No.: **WO2011/116823**  
 PCT Pub. Date: **Sep. 29, 2011**

(65) **Prior Publication Data**  
 US 2013/0089043 A1 Apr. 11, 2013

(51) **Int. Cl.**  
**H04W 4/00** (2009.01)  
**H04W 72/04** (2009.01)  
**H04L 1/00** (2006.01)  
**H04W 72/00** (2009.01)

(52) **U.S. Cl.**  
 CPC ..... **H04W 72/042** (2013.01); **H04L 1/0027** (2013.01); **H04L 1/0026** (2013.01)  
 USPC ..... **370/329**; 455/450

(58) **Field of Classification Search**  
 None  
 See application file for complete search history.

(56) **References Cited**

U.S. PATENT DOCUMENTS

2009/0257385	A1 *	10/2009	Meylan et al. ....	370/329
2010/0098012	A1 *	4/2010	Bala et al. ....	370/329
2010/0113078	A1 *	5/2010	Farajidana et al. ....	455/507
2010/0246561	A1 *	9/2010	Shin et al. ....	370/345
2011/0317652	A1 *	12/2011	Kim et al. ....	370/329
2012/0106495	A1 *	5/2012	Yang et al. ....	370/329
2012/0120838	A1 *	5/2012	Farajidana et al. ....	370/252
2012/0269153	A1 *	10/2012	Seo et al. ....	370/329
2013/0010740	A1 *	1/2013	Kim et al. ....	370/329

FOREIGN PATENT DOCUMENTS

WO	WO 2009/088225	A2	7/2009
WO	WO 2011/015331		2/2011

OTHER PUBLICATIONS

3GPP TS 36.212 V9.0.0 (Dec. 2009); 3rd Generation Partnership Project; Technical Specification Group Radio Access Network; Evolved Universal Terrestrial Radio Access (E-UTRA); Multiplexing and channel coding (Release 9) (61 pages).  
 RP-080137; 3GPP TSG RAN #39; NTT DoCoMo; "Proposed SID on LTE-Advanced"; Mar. 4-7, 2008; Puerto Vallarta, Mexico (5 pages).

(Continued)

*Primary Examiner* — Clemence Han  
 (74) *Attorney, Agent, or Firm* — Martin & Ferraro, LLP

(57) **ABSTRACT**

An apparatus and a method are described by which a request for providing aperiodic channel information with respect to a selected downlink component carrier of a plurality of component carriers is received, the selected downlink component carrier is determined, channel information with respect to the selected downlink component carrier is established, and the channel information with respect to the selected downlink component carrier is sent.

**56 Claims, 2 Drawing Sheets**

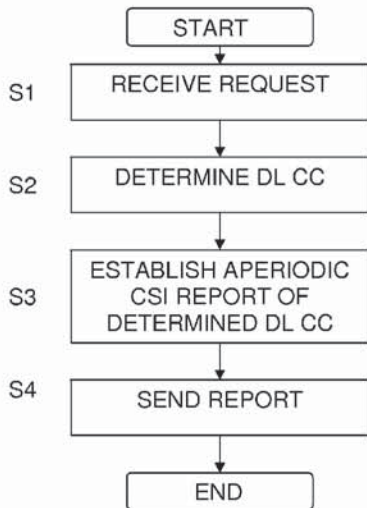

**US 8,867,472 B2**

Page 2

---

(56)

**References Cited**

OTHER PUBLICATIONS

R1-100014, "CQI feedback for LTE-A", 3GPP TSG RAN WG1 Meeting #59bis, Valencia, Spain, Jan. 18-22, 2010, CATT, 7 pgs.  
R1-100372, "Aperiodic CQI Reporting for Carrier Aggregation" 3GPP TSG-RAN WG1 Meeting 59bis, Jan. 18-22, 2010, Panasonic, HTC Corp., 2 pgs.

R1-101478, "CQI Feedback for Multicarrier Operation", 3GPP TSQ RAN WG1 #60, Feb. 22-26, 2010, San Francisco, USA, Qualcomm Inc., 3 pgs.

Abstract only, "Downlink PDCCH Signaling and CQI Measurement for LTE-A Bandwidth Extension" © 2009 Nokia Siemens Networks, 1 pg.

\* cited by examiner

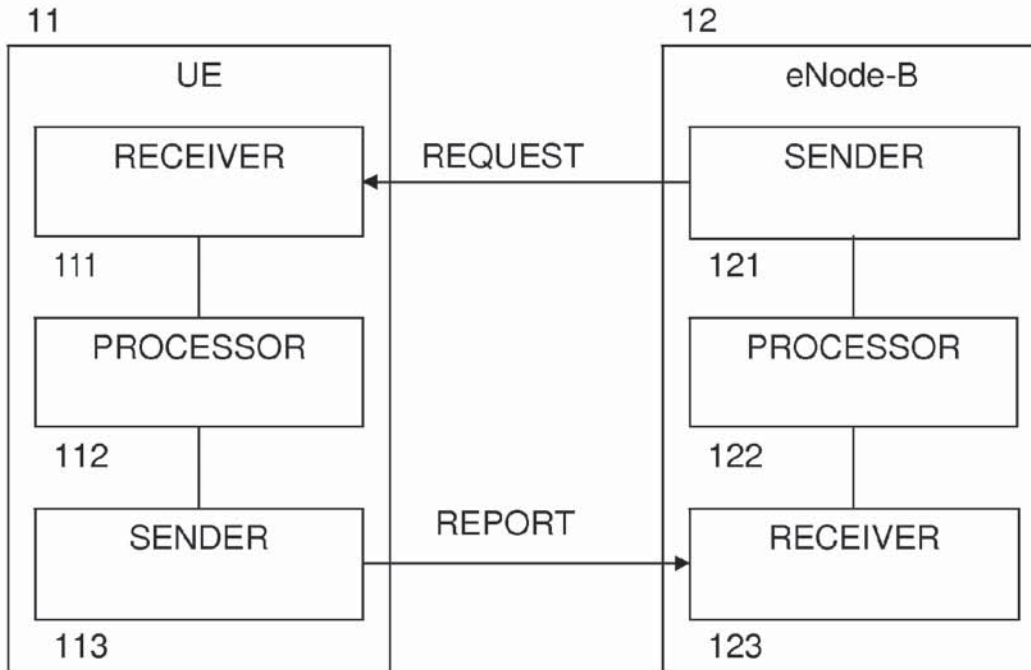

Fig. 1

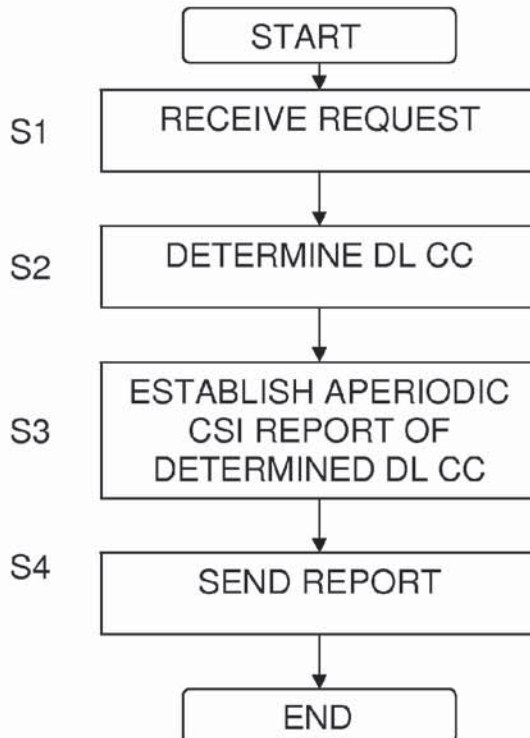

Fig. 2A

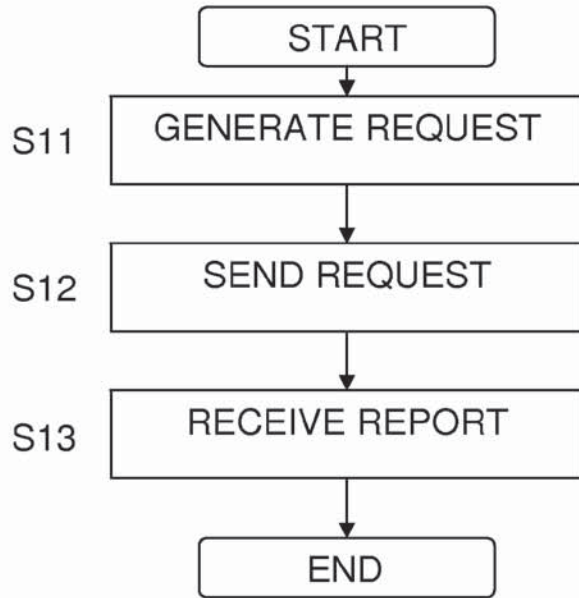

Fig. 2B

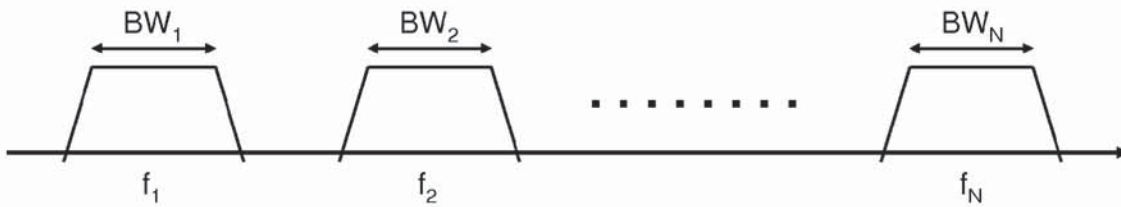

Fig. 3



US 8,867,472 B2

1

**SIGNALLING OF CHANNEL INFORMATION**

## FIELD OF THE INVENTION

The present invention relates to an apparatus, method and computer program product for aperiodic channel quality indication for carrier aggregation.

## RELATED BACKGROUND ART

The following meanings for the abbreviations used in this specification apply:

3GPP 3<sup>rd</sup> generation partnership project  
 CA Carrier Aggregation  
 CC Component carrier  
 CIF Carrier Indicator Field  
 CQI Channel quality indicator  
 CRC Cyclic Redundancy Check  
 CSI Channel State information (includes e.g. CQI, PMI and RI)  
 DCI Downlink Control Information  
 DL Downlink  
 DRX/DTX Discontinuous transmission/detection  
 eNode-B LTE base station (also referred to as eNB)  
 FDPS Frequency Domain Packet Scheduling  
 LTE Long term evolution  
 LTE-A LTE-Advanced  
 MAC Medium Access Control  
 MCS Modulation and Coding Scheme  
 MIMO Multiple Input Multiple Output  
 NDI New Data Indicator  
 PDCCH Physical Downlink Control Channel  
 PMI Precoding Matrix Indicator  
 PRB Physical resource block  
 PUCCH Physical Uplink Control Channel  
 PUSCH Physical Uplink Shared Channel  
 RI Rank Indicator  
 RRC Radio Resource Control  
 SU-MIMO Single User Multiple Input Multiple Output  
 UE User equipment  
 UL Uplink

Some embodiments of the present invention relate, for example, to LTE-Advanced system which will most likely be part of 3GPP LTE Rel-10. More specifically, the focus is on Channel State Information (CSI) feedback signalling with carrier aggregation. It is, however, noted that the embodiments may be applied to other systems and releases as well.

LTE-Advanced will be an evolution of LTE Rel-8 system fulfilling the ITU-R requirements for IMT-Advanced. 3GPP approved a new Study Item on LTE-Advanced in RAN#39 (March 2008). Carrier aggregation will be one key technology component required to meet the bandwidth and peak data rate requirements set for the new system.

As described above, embodiments of the present invention relate to component carrier aggregation (or channel bonding), where the total system bandwidth consists of set of component carriers as illustrated in FIG. 3. FIG. 3 shows an example of carrier aggregation with non-contiguous bands, in which the total system bandwidth contains a set of component carriers  $BW_1, BW_2, \dots, BW_N$  having carrier frequencies  $f_1, f_2, \dots, f_N$ .

The ongoing standardization of LTE-Advanced in 3GPP (currently in the study item phase) assumes carrier aggregation to form bandwidths of up to 100 MHz by having aggregation of up to 5 component carriers of 20 MHz each. Different transport blocks with different modulation and coding schemes (MCS) can be transmitted on the different compo-

2

nent carriers, although transmitted to the same user. In order to facilitate such schemes with efficient frequency domain link adaptation scheduling, the UEs must provide frequency selective channel state information (CSI) feedback. CSI may include channel quality indicators (CQI), Precoding Matrix Indicators (PMI), Rank Indicators (RI) and/or channel frequency or impulse response and/or channel covariance matrix. Additionally the CSI report may include an indication of the component carrier or the sub-band the report refers to.

In order to achieve gains from frequency dependent packet scheduling (FDPS) it is necessary to obtain accurate information about the frequency domain behaviour of the propagation channel. To enable FDPS, several frequency selective CSI reporting modes were added into the LTE Rel-8 specifications. The size of the CSI reports depends on the reporting mode, system bandwidth and rank. The maximum size of the CSI report in LTE Rel-8 is 64 bits (mode 3-1, 20 MHz BW, rank>1) excluding CRC bits.

When using multiple component carriers, this would lead to large reports. Hence, the size of the reports should be reduced.

## SUMMARY OF THE INVENTION

Thus, it is an object of the present invention to overcome the above problem of the prior art.

According to several embodiments of the present invention, an apparatus and a method are provided by which a request for providing aperiodic channel information with respect to a selected downlink component carrier of a plurality of component carriers is received, the selected downlink component carrier is determined, channel information with respect to the selected downlink component carrier is established, and the channel information with respect to the selected downlink component carrier is sent.

According to several embodiments of the present invention, an apparatus and a method are provided, by which a request for providing aperiodic channel information with respect to a selected downlink component carrier of a plurality of component carriers is generated, and the request is sent.

## BRIEF DESCRIPTION OF THE DRAWINGS

These and other objects, features, details and advantages will become more fully apparent from the following detailed description of embodiments of the present invention which is to be taken in conjunction with the appended drawings, in which:

FIG. 1 a structure of a user equipment (UE) and an eNode-B according to some embodiments of the present invention;

FIG. 2A and 2B show processes carried out by a user equipment (UE) and an eNode-B according to some embodiments of the present invention; and

FIG. 3 shows an example of carrier aggregation.

## DETAILED DESCRIPTION OF EMBODIMENTS

In the following, description will be made to embodiments of the present invention. It is to be understood, however, that the description is given by way of example only, and that the described embodiments are by no means to be understood as limiting the present invention thereto.

As mentioned in the introductory part of the present application, the size of channel state information (CSI) or channel



US 8,867,472 B2

3

quality indicators (CQI) reports should be reduced in connection with carrier aggregation, in which a plurality of component carriers (CC) is used.

It has been specified in the 3GPP RAN WG#1 that in LTE Rel-8 and Rel-9, the eNodeB can in any subframe (excluding the ones when the UE in configured to DRX/DTX) force the UE to send an aperiodic CSI report on PUSCH. That is, in contrast to a periodic CSI report, an aperiodic CSI report is sent by the UE when it is triggered to do so.

The aperiodic CSI request is triggered with one specific bit in the uplink grant (using DCI format 0, as specified in 36.212). Furthermore, it is possible to ask for the aperiodic CSI transmission without any simultaneous UL data transmission, i.e. aperiodic CSI only. Each UE is always semi-statically configured via RRC signalling to use one aperiodic CSI reporting mode (before explicit configuration is sent, a default mode is assumed depending on the transmission mode).

With carrier aggregation the need for elaborate CSI remains. LTE-Advanced (Rel-10) will support at most 5 DL CCs. Hence the straightforward expansion of Rel-8 reporting for multiple CCs would result in very large reports (e.g. 5\*64 bits=320 bits). This is not desirable from the Uplink signalling point of view. Firstly, such high overhead limits uplink capacity considerably. Secondly, in many cases it is not possible to guarantee sufficient UL coverage for such large payloads. Hence it's clear some compression methods need to be considered to reduce the UL signalling burden.

Thus, in order to make efficient use of aggregated spectrum, aperiodic CSI reporting needs to be tailored for the support of multiple Component Carriers (CC). Embodiments of the present invention report focus on the related DL signalling aspects.

According to embodiments of the present invention, an approach is taken according to which it is possible to request for a detailed, aperiodic channel information (e.g., CSI) report for some specific DL CC (plus potentially some coarse wideband CSI for other CCs). Embodiments describe DL control signalling mechanisms for how to realize this.

In the following, some embodiments are described with respect to FIG. 1. In particular, FIG. 1 shows structures of the network elements as used in some of the embodiments described in the following.

Reference number 11 shows an user equipment (UE) as an example for an apparatus carrying out processes according to the embodiments. In particular, the UE comprises a receiver (receiving means) 111 which is configured to receive a request (e.g., an aperiodic CQI or CSI trigger as described in the following) for providing aperiodic channel information with respect to a selected downlink component carrier of a plurality of component carriers. The UE further comprises a processor (processing means) 112 which is configured to determine the selected downlink component carrier and to establish channel information with respect to the selected downlink component carrier. That is, the processor determines the component carrier to be monitored or evaluated, for example based on information as will be described in the following. Then, the processor monitors the channel in order to detect the channel quality of the component carriers or the like. Moreover, the UE comprises a sender (sending means) 113 which is configured to send the channel information (e.g., aperiodic CSI report or feedback).

It is noted that the sender 111, the processor 112 and/or the sender 113 may be provided as one unit, e.g., such that the processor 112 receives and/or sends the corresponding messages, requests etc. to/from a transmitting unit of the UE or

4

the like. Moreover, the processor 112 can be part of a central processor of the UE, and/or can be configured to carry out further functions.

Reference number 12 shows an eNode-B as an example for a network control element or an apparatus which sends the request for providing aperiodic channel information described above. The eNode-B 12 comprises a processor (processing means) 122 configured to generate a request (e.g., an aperiodic CQI or CSI trigger as described in the following) for providing aperiodic channel information with respect to a selected downlink component carrier of a plurality of component carriers. Moreover, a sender (sending means) 121 is configured to send the request. Furthermore, the eNode-B 12 may comprise a receiver (receiving means) 123 configured to receive aperiodic channel information sent in response to the request for providing aperiodic channel information.

Thus, the sender 121 of the eNodeB sends a request or trigger (as indicated in FIG. 1 by the upper arrow), the processor 112 detects the channel state and/or channel quality on the selected component carrier, and the sender 113 of the UE 12 sends the corresponding report to the receiver 123 of the eNode-B (a indicated by the lower arrow in FIG. 1).

It is noted that, similar as in case of the UE 11, the sender 121, the processor 122 and/or the receiver 123 may be provided as one unit, e.g., such that the processor 122 receives and/or sends the corresponding messages, requests etc. to/from a transmitting unit of the eNode-B or the like. Moreover, the processor 122 can be part of a central processor of the eNode-B, and/or can be configured to carry out further functions.

FIGS. 2A and 2B show methods according to embodiments of the present invention.

FIG. 2A shows a process carried out on by an apparatus such as an user equipment, for example. In step S1, a request (e.g., an aperiodic CQI or CSI trigger as described in the following) for providing aperiodic channel information with respect to a selected downlink component carrier of a plurality of component carriers is received. In step S2, the selected downlink component carrier is determined. In step S3, channel information with respect to the selected downlink component carrier is established, and in step S4, the channel information with respect to the selected downlink component carrier is sent (e.g., to network control element such as an eNode-B).

FIG. 2B shows a process carried out by a network control element such as an eNode-B, for example. In step S11, a request for providing aperiodic channel information with respect to a selected downlink component carrier of a plurality of component carriers is generated, and in step S12, the request is sent.

Moreover, the method may comprise a step S13, in which aperiodic channel information sent in response to the request for providing aperiodic channel information is received.

Thus, according to embodiments of the present invention, signalling for Aperiodic CSI feedback with carrier aggregation is achieved.

Hence, according to embodiments of the present invention, DL signalling mechanisms and rules are defined which are required for aperiodic CSI report triggering with Carrier Aggregation. A few alternative/complementary options are listed below with respect to certain embodiments. The common nominator for all the alternatives is that they provide a way to indicate for which DL CC the detailed frequency selective CSI report is derived. Additionally wideband reports for other DL CC in the DL CC monitoring set can be reported simultaneously.



US 8,867,472 B2

5

The selected downlink component carrier described above may be the primary component carrier in a CC set, or an arbitrary selected one of the set. That is, for example, any one of the component carriers  $BW_1$  to  $BW_N$  shown in FIG. 3 can be predetermined and indicated to the UE as the selected downlink component carrier by the different measures as described below.

It is noted that the channel information described above may comprise CSI or CQI, as mentioned above. However, the embodiments are not limited to the specific definitions of CSI and CQI.

It is noted that according to the embodiments described below, an aperiodic CSI trigger (as an example for the request for providing aperiodic channel information) is sent within an uplink (UL) grant. However, the embodiments are not limited to this, and the request (or trigger) may be sent in other suitable ways.

Moreover, in the first to sixth embodiments described in the following, the basic structure and functions as described above are applied. Hence, only the different aspects of the embodiments are described.

According to the first embodiment, the detailed frequency selective aperiodic CSI report is derived from the DL CC that carried the UL grant with the aperiodic CSI trigger.

That is, when the UE 11 receives UL grant on which the trigger (request for providing aperiodic channel information) on a particular component carrier, it knows that it has to detect the channel state or quality information on this particular component carrier.

Thus, the indication which particular component carrier is selected is provided by sending the request, in this case the UL grant including the request, on this particular component carrier.

According to the second embodiment, in the UL grant used for triggering the aperiodic CSI report there is provided an indicator pointing out for which CC the frequency selective report should be calculated. For example, the indicator may comprise 1-3 bit, so that, e.g., five component carriers as specified by LTE-A may be indicated.

In particular, this indicator may be similar to the carrier indicator field (CIF) used for scheduling data across CCs.

Alternatively, some unused fields in the UL grant may be used. For instance, Rel'8 DCI format 0 will have a single padding bit, which could potentially be used for indicating whether the primary component carrier should be reported, or whether one of the secondary CCs should be reported. For example, the secondary CCs could be indicated by using a hopping pattern.

For example, a hopping pattern as described in document "Downlink PDCCH signaling and CQI measurement for LTE-A bandwidth extension", No. IPCOM000178173D published on ww.IP.com. In detail, a secondary component carrier to be monitored is indicated by  $C_n$  . . . , and for M component carriers  $C_0, C_1$  . . .  $C_M$ , the value of n can be calculated as follows:

$$n = (\text{SFN} + \text{UE ID}) \bmod M$$

where SFN is the system frame number and UE ID is a UE identification number (usually 16 Bit). Then  $C_n$  is the selected/used secondary component carrier. In LTE 10, M could be 4, when all available CCs (5) are used (i.e., one primary CC and four secondary CCs).

Thus, summarizing, according to the second embodiment, a particular indicator is used for specifying the component carrier on which the channel state should be detected.

According to the third embodiment, whenever the UE receives an UL grant with request to send Aperiodic CSI, it

6

shall send the configured CSI report for the primary DL CC. That is, in this case the component carrier for which the CSI report is to be established predetermined, namely the primary component carrier.

Here the configured CSI report (configured via RRC) may be frequency selective.

In addition, the UE could send also wideband CSI for other configured and activated CCs.

According to the fourth embodiment, a combined indication of the scheduled UL CC and the DL CC for which to derive the frequency selective CSI report is included into the UL grant. That is, according to the fourth embodiment a possibility to simultaneously indicate also the DL CC to report is taken into account in the UL grant CIF design.

This could, for instance, happen during the design of the potential new UL resource grant that is considered for SU-MIMO (single-user multiple input multiple output). This grant will have a completely new design, and would potentially leave room for more advanced indications of the CSI (or CQI) reporting mode.

According to the fifth embodiment, the DL CC for which the frequency selective Aperiodic CSI report is derived is configured semi-statically using higher layer signalling (e.g. RRC or MAC). That is, similar as according to the third embodiment, the component carrier for which the report is to be established is predetermined or preconfigured, so that the UE 12 knows which component carrier is to be evaluated when it receives the aperiodic trigger.

According to the sixth embodiment, unused portions of the UL grant are used in order to indicate the selected component carrier.

Namely, in the case when an aperiodic CSI report is requested to be transmitted without simultaneous UL data there will be some unused signalling bits/states in the UL grant (e.g. MCS, NDI and resource allocation signalling). Those can be utilized to indicate the DL CC for which the frequency selective CSI is measured and reported, so that the information for indicating the DL CC can be included in such unused signalling bits or states, or the some of the signalling bits or states can be reinterpreted with this information.

Thus, the following advantages are achieved by the embodiments as described above:

For the eNode-B the ability to request for a detailed Aperiodic CSI report for a desired CC is useful to complement efficient scheduling and link adaptation decisions. Examples include cases where the eNode-B only have data for a particular UE to be send on a single CC. For such cases it would be useful for the eNode-B to request CSI for the desired CC where the scheduling is about to happen.

Currently there is not a mechanism available to realize this—hence one needs to be standardized.

The solution as described above requires only minimized standardization effort since there is no need to define new CA specific reporting formats.

It is noted that some embodiments as described above are directed to LTE-A. However, LTE-A is only an example, and embodiments of the present invention may be applied on any radio access technology in which a system bandwidth is divided in sub-bands and component carriers are monitored with respect to channel quality.

According to a first aspect of several embodiments of the invention, an apparatus is provided which comprises

a receiver configured to receive a request for providing aperiodic channel information with respect to a selected downlink component carrier of a plurality of component carriers,



US 8,867,472 B2

7

a processor configured to determine the selected downlink component carrier and to establish channel information with respect to the selected downlink component carrier, and

a sender configured to send the channel information with respect to the selected downlink component carrier.

The first aspect may be modified as follows:

The processor may be configured to determine the selected downlink component carrier based on which component carrier carried the request for providing the aperiodic channel information.

The processor may be configured to determine the selected downlink component carrier based on an indicator sent with the request for providing aperiodic channel information.

The request for providing aperiodic channel information and the indicator may be included in an uplink grant.

The selected downlink component carrier may be a predetermined downlink component carrier, and the processor may be configured to establish channel information with respect to the predetermined downlink component carrier when the request for providing aperiodic channel state information is received.

The predetermined downlink component carrier may be a primary downlink component carrier.

The predetermined downlink component carrier may be configured using control signalling.

The predetermined downlink component carrier may be configured by a network control element.

The request for providing aperiodic channel information may be included in an uplink grant, wherein the uplink grant comprises a combined indication of a scheduled uplink component carrier and the selected downlink component carrier.

The combined indication may be included in a carrier indicator field.

The request for providing aperiodic channel information may be included an uplink grant, and wherein, when the aperiodic channel information is requested to be transmitted without simultaneous uplink data, the request for providing aperiodic channel information may be included in unused signalling bits or states, or some of the signalling bits or states are reinterpreted with the request for providing aperiodic channel information.

The processor may be configured to provide channel information for at least one of the other component carriers than the selected component carrier, and the sender may be configured to send the channel information for the at least one of the other component carriers.

The channel information for the at least one of the other component carriers may be a wideband channel information.

The at least one of the other component carriers may be configured using control signalling.

The at least one of the other component carriers may be configured using control signalling by a network control element.

The control signalling may be radio resource control signalling or medium access control signalling.

Information regarding the at least one of the other component carriers may be included in the request for providing aperiodic channel information.

The request for providing aperiodic channel information may be included in an uplink grant.

The sender may be configured to send the channel information to a network control element.

The network control element may be an eNode-B, a relay node or a home eNode-B.

8

The channel information may comprise channel state information and/or a channel quality indicator.

The apparatus may be or may be part of a user equipment.

According to a second aspect of several embodiments of the invention, an apparatus is provided which comprises

a processor configured to generate a request for providing aperiodic channel information with respect to a selected downlink component carrier of a plurality of component carriers, and

a sender configured to send the request.

The second aspect may be modified as follows:

The apparatus may further comprise a receiver configured to receive aperiodic channel information sent in response to the request for providing aperiodic channel information.

The sender may be configured to send the request for providing the aperiodic channel information on the component carrier for which the aperiodic channel information is to be provided.

The processor may be configured to generate an indicator for determining the selected downlink component carrier, and the sender may be configured to send the indicator with the request for providing aperiodic channel information.

The request for providing aperiodic channel information and the indicator may be included in an uplink grant.

The selected downlink component carrier may be a predetermined downlink component carrier.

The predetermined downlink component carrier may be a primary downlink component carrier.

The predetermined downlink component carrier may be configured using control signalling.

The control signalling may be radio resource control signalling or medium access control signalling.

The processor may be configured to include the request for providing aperiodic channel information in an uplink grant, wherein the uplink grant may comprise a combined indication of a scheduled uplink component carrier and the selected downlink component carrier.

The processor may be configured to include the combined indication in a carrier indicator field.

The processor may be configured to include the request for providing aperiodic channel information in an uplink grant, and to include, when the aperiodic channel information is requested to be transmitted without simultaneous uplink data, the request for providing aperiodic channel information in unused signalling bits or states, or some of the signalling bits or states may be reinterpreted with the request for providing aperiodic channel information.

The processor may be configured to generate a request for providing channel information for at least one of the other component carriers than the selected component carrier.

The channel information for the at least one of the other component carriers may be a wideband channel information.

The receiver may be configured to receive the aperiodic channel information from a user equipment.

The processor may be configured to include the request for providing aperiodic channel information in an uplink grant.

The apparatus may be a network control element or may be part of a network control element. The network control element may be an eNode-B.

The channel information may comprise channel state information and/or a channel quality indicator.

According to a third aspect of several embodiments of the invention, a method is provided which comprises

receiving a request for providing aperiodic channel information with respect to a selected downlink component carrier of a plurality of component carriers, determining the selected downlink component carrier,



US 8,867,472 B2

9

establishing channel information with respect to the selected downlink component carrier, and sending the channel information with respect to the selected downlink component carrier.

The third aspect may be modified as follows:

The selected downlink component carrier may be determined based on which component carrier carried the request for providing the aperiodic channel information.

The selected downlink component carrier may be determined based on an indicator sent with the request for providing aperiodic channel information.

The request for providing aperiodic channel information and the indicator may be included in an uplink grant.

The selected downlink component carrier may be a predetermined downlink component carrier, and the channel information may be established with respect to the predetermined downlink component carrier when the request for providing aperiodic channel information is received.

The predetermined downlink component carrier may be a primary downlink component carrier.

The predetermined downlink component carrier may be configured using control signalling.

The predetermined downlink component carrier may be configured by a network control element.

The request for providing aperiodic channel information may be included in an uplink grant, wherein the uplink grant may comprise a combined indication of a scheduled uplink component carrier and the selected downlink component carrier.

The combined indication may be included in a carrier indicator field.

The request for providing aperiodic channel information may be included an uplink grant, and wherein, when the aperiodic channel information is requested to be transmitted without simultaneous uplink data, the request for providing aperiodic channel information may be included in unused signalling bits or states, or some of the signalling bits or states may be reinterpreted with the request for providing aperiodic channel information.

The method may further comprise

providing channel information for at least one of the other component carriers than the selected component carrier, and

sending the channel information for the at least one of the other component carriers.

The channel information for the at least one of the other component carriers may be a wideband channel information.

The at least one of the other component carriers may be configured using control signalling.

The at least one of the other component carriers may be configured by a network control element.

The control signalling may be radio resource control signalling or medium access control signalling.

Information regarding the at least one of the other component carriers may be included in the request for providing aperiodic channel information.

The channel information may be sent to a network control element.

The network control element may be an eNode-B, a relay node or a home eNode-B.

The request for providing aperiodic channel information may be included in an uplink grant.

The method may be carried out by a user equipment or a part thereof.

The channel information may comprise channel state information and/or a channel quality indicator.

10

According to a fourth aspect of several embodiments of the invention, a method is provided which comprises generating a request for providing aperiodic channel information with respect to a selected downlink component carrier of a plurality of component carriers, and sending the request.

The fourth aspect may be modified as follows:

The method may further comprise receiving aperiodic channel information sent in response to the request for providing aperiodic channel information.

The request for providing the aperiodic channel information may be sent on the component carrier for which the aperiodic channel information is to be provided.

The method may further comprise

generating an indicator for determining the selected downlink component carrier, wherein the indicator is sent with the request for providing aperiodic channel information.

The request for providing aperiodic channel information and the indicator may be included in an uplink grant.

The selected downlink component carrier may be a predetermined downlink component carrier.

The predetermined downlink component carrier may be a primary downlink component carrier.

The predetermined downlink component carrier may be configured using control signalling.

The control signalling may be radio resource control signalling or medium access control signalling.

The method may further comprise

including the request for providing aperiodic channel information included in an uplink grant, wherein the uplink grant comprises a combined indication of a scheduled uplink component carrier and the selected downlink component carrier.

The combined indication may be included in a carrier indicator field.

The method may further comprise

including the request for providing aperiodic channel information in an uplink grant, and,

including the request for providing aperiodic channel information in unused signalling bits or states or some of the signalling bits or states are reinterpreted with the request for providing aperiodic channel information, when the aperiodic channel information is requested to be transmitted without simultaneous uplink data.

The method may further comprise

generating a request for providing channel information for at least one of the other component carriers than the selected component carrier.

The channel information for the at least one of the other component carriers may be a wideband channel information.

The aperiodic channel information may be received from a user equipment.

The request for providing aperiodic channel information may be included in an uplink grant.

The method may be carried out by a network control element or a part thereof, wherein the network control element may be an eNode-B.

The channel information may comprise channel state information and/or a channel quality indicator.

According to a fifth aspect of several embodiments of the present invention, a computer program product is provided which comprises code means for performing a method according to any one of the third and fourth aspects and their modifications when run on a computer.

The computer program product is embodied on a computer-readable medium.



US 8,867,472 B2

11

The computer program product may be directly loadable into an internal memory of the computer.

According to a sixth aspect of several embodiments of the invention, an apparatus is provided which comprises means for receiving a request for providing aperiodic channel information with respect to a selected downlink component carrier of a plurality of component carriers, means for determining the selected downlink component carrier and to establish channel information with respect to the selected downlink component carrier, and means for sending the channel information with respect to the selected downlink component carrier.

The sixth aspect may be modified as follows:

The apparatus may comprise means for determining the selected downlink component carrier based on which component carrier carried the request for providing the aperiodic channel information.

The apparatus may comprise means for determining the selected downlink component carrier based on an indicator sent with the request for providing aperiodic channel information.

The apparatus may comprise means for providing channel information for at least one of the other component carriers than the selected component carrier, and means for sending the channel information for the at least one of the other component carriers.

According to a seventh aspect of several embodiments of the invention, an apparatus is provided which comprises means for generating a request for providing aperiodic channel information with respect to a selected downlink component carrier of a plurality of component carriers, and means for sending the request.

The seventh aspect may be modified as follows:

The apparatus may further comprise means for receiving aperiodic channel information sent in response to the request for providing aperiodic channel information.

The apparatus may comprise means for sending the request for providing the aperiodic channel information on the component carrier for which the aperiodic channel information is to be provided.

The apparatus may comprise means for generating an indicator for determining the selected downlink component carrier, and means for sending the indicator with the request for providing aperiodic channel information.

The apparatus may comprise means for including the request for providing aperiodic channel information in an uplink grant, wherein the uplink grant may comprise a combined indication of a scheduled uplink component carrier and the selected downlink component carrier.

The apparatus may comprise means for including the combined indication in a carrier indicator field.

The apparatus may comprise means for including the request for providing aperiodic channel information in an uplink grant, and for including, when the aperiodic channel information is requested to be transmitted without simultaneous uplink data, the request for providing aperiodic channel information in unused signalling bits or states, or some of the signalling bits or states may be reinterpreted with the request for providing aperiodic channel information.

The apparatus may comprise means for generating a request for providing channel information for at least one of the other component carriers than the selected component carrier.

The apparatus may comprise means for receiving the aperiodic channel information from a user equipment.

12

The apparatus may comprise means for including the request for providing aperiodic channel information in an uplink grant.

It is to be understood that any of the above modifications can be applied singly or in combination to the respective aspects and/or embodiments to which they refer, unless they are explicitly stated as excluding alternatives.

For the purpose of the present invention as described herein above, it should be noted that

method steps likely to be implemented as software code portions and being run using a processor at a network element or terminal (as examples of devices, apparatuses and/or modules thereof, or as examples of entities including apparatuses and/or modules therefore), are software code independent and can be specified using any known or future developed programming language as long as the functionality defined by the method steps is preserved;

generally, any method step is suitable to be implemented as software or by hardware without changing the idea of the invention in terms of the functionality implemented;

method steps and/or devices, units or means likely to be implemented as hardware components at the above-defined apparatuses, or any module(s) thereof, (e.g., devices carrying out the functions of the apparatuses according to the embodiments as described above, UE, eNode-B etc. as described above) are hardware independent and can be implemented using any known or future developed hardware technology or any hybrids of these, such as MOS (Metal Oxide Semiconductor), CMOS (Complementary MOS), BiMOS (Bipolar MOS), BiCMOS (Bipolar CMOS), ECL (Emitter Coupled Logic), TTL (Transistor-Transistor Logic), etc., using for example ASIC (Application Specific IC (Integrated Circuit)) components, FPGA (Field-programmable Gate Arrays) components, CPLD (Complex Programmable Logic Device) components or DSP (Digital Signal Processor) components;

devices, units or means (e.g. the above-defined apparatuses, or any one of their respective means) can be implemented as individual devices, units or means, but this does not exclude that they are implemented in a distributed fashion throughout the system, as long as the functionality of the device, unit or means is preserved;

an apparatus may be represented by a semiconductor chip, a chipset, or a (hardware) module comprising such chip or chipset; this, however, does not exclude the possibility that a functionality of an apparatus or module, instead of being hardware implemented, be implemented as software in a (software) module such as a computer program or a computer program product comprising executable software code portions for execution/being run on a processor;

a device may be regarded as an apparatus or as an assembly of more than one apparatus, whether functionally in cooperation with each other or functionally independently of each other but in a same device housing, for example.

It is noted that the embodiments and examples described above are provided for illustrative purposes only and are in no way intended that the present invention is restricted thereto. Rather, it is the intention that all variations and modifications be included which fall within the spirit and scope of the appended claims.



US 8,867,472 B2

13

The invention claimed is:

1. An apparatus comprising:

a receiver configured to receive a request for providing aperiodic channel information with respect to a selected downlink component carrier of a plurality of component carriers;

a processor configured to:

determine the selected downlink component carrier based on which component carrier of the plurality of component carriers carried the request for providing the aperiodic channel information; and

establish channel information with respect to the selected downlink component carrier; and

a sender configured to send the channel information with respect to the selected downlink component carrier.

2. The apparatus according to claim 1, wherein the processor is configured to also determine the selected downlink component carrier based on an indicator sent with the request for providing the aperiodic channel information.

3. The apparatus according to claim 2, wherein the request for providing the aperiodic channel information and the indicator are included in an uplink grant.

4. The apparatus according to claim 1, wherein the selected downlink component carrier is a predetermined downlink component carrier, and the processor is configured to establish channel information with respect to the predetermined downlink component carrier when the request for providing the aperiodic channel information is received.

5. The apparatus according to claim 4, wherein the predetermined downlink component carrier is a primary downlink component carrier.

6. The apparatus according to claim 4, wherein the predetermined downlink component carrier is configured by a network control element.

7. The apparatus according to claim 1, wherein the request for providing the aperiodic channel information is included in an uplink grant, wherein the uplink grant comprises a combined indication of a scheduled uplink component carrier and the selected downlink component carrier.

8. The apparatus according to claim 7, wherein the combined indication is included in a carrier indicator field.

9. The apparatus according to claim 1, wherein the request for providing the aperiodic channel information is included in an uplink grant, and wherein, when the aperiodic channel information is requested to be transmitted without simultaneous uplink data, the request for providing the aperiodic channel information is included in at least one of unused signalling bits and states of the uplink grant, or when the aperiodic channel information is requested to be transmitted without simultaneous uplink data, the at least one of the unused signalling bits and the states of the uplink grant are reinterpreted with the request for providing the aperiodic channel information.

10. The apparatus according to claim 1, wherein the processor is configured to provide channel information for at least one of the other component carriers of the plurality of component carriers other than the selected downlink component carrier, and the sender is configured to send the channel information for the at least one of the other component carriers.

11. The apparatus according to claim 10, wherein the channel information for the at least one of the other component carriers is a wideband channel information.

12. The apparatus according to claim 11, wherein information regarding the at least one of the other component carriers is included in the request for providing the aperiodic channel information.

14

13. The apparatus according to claim 10, wherein the at least one of the other component carriers are configured by a network control element.

14. The apparatus according to claim 1, wherein the request for providing the aperiodic channel information is included in an uplink grant.

15. An apparatus comprising:

a processor configured to generate a request for providing aperiodic channel information with respect to a selected downlink component carrier of a plurality of component carriers; and

a sender configured to send the request for providing the aperiodic channel information on a component carrier for which the aperiodic channel information is provided.

16. The apparatus according to claim 15, further comprising a receiver configured to receive the aperiodic channel information sent in response to the request for providing the aperiodic channel information.

17. The apparatus according to claim 15, wherein the processor is configured to generate an indicator for determining the selected downlink component carrier, and the sender is configured to send the indicator with the request for providing the aperiodic channel information.

18. The apparatus according to claim 17, wherein the request for providing the aperiodic channel information and the indicator are included in an uplink grant.

19. The apparatus according to claim 15, wherein the selected downlink component carrier is a predetermined downlink component carrier.

20. The apparatus according to claim 19, wherein the predetermined downlink component carrier is a primary downlink component carrier.

21. The apparatus according to claim 19, wherein the predetermined downlink component carrier is configured using control signalling.

22. The apparatus according to claim 15, wherein the processor is configured to include the request for providing the aperiodic channel information in an uplink grant, wherein the uplink grant comprises a combined indication of a scheduled uplink component carrier and the selected downlink component carrier.

23. The apparatus according to claim 22, wherein the processor is configured to include the combined indication in a carrier indicator field.

24. The apparatus according to claim 15, wherein the processor is configured to include the request for providing the aperiodic channel information in an uplink grant, and to include, when the aperiodic channel information is requested to be transmitted without simultaneous uplink data, the request for providing the aperiodic channel information included in at least one of unused signalling bits and states of the uplink grant, or when the aperiodic channel information is requested to be transmitted without simultaneous uplink data, the at least one of the unused signalling bits and the states of the uplink grant are reinterpreted with the request for providing the aperiodic channel information.

25. The apparatus according to claim 15, wherein the processor is configured to generate a request for providing channel information for at least one of the other component carriers of the plurality of component carriers other than the selected component carrier.

26. The apparatus according to claim 25, wherein the channel information for the at least one of the other component carriers is a wideband channel information.

27. The apparatus according to claim 15, wherein the processor is configured to include the request for providing the aperiodic channel information in an uplink grant.



US 8,867,472 B2

15

28. A method comprising:  
 receiving a request for providing aperiodic channel information with respect to a selected downlink component carrier of a plurality of component carriers;  
 determining the selected downlink component carrier based on which component carrier of the plurality of component carriers carried the request for providing the aperiodic channel information;  
 establishing channel information with respect to the selected downlink component carrier; and  
 sending the channel information with respect to the selected downlink component carrier.

29. The method according to claim 28, wherein the selected downlink component carrier is also determined based on an indicator sent with the request for providing the aperiodic channel information.

30. The method according to claim 29, wherein the request for providing the aperiodic channel information and the indicator are included in an uplink grant.

31. The method according to claim 28, wherein the selected downlink component carrier is a predetermined downlink component carrier, and the channel information is established with respect to the predetermined downlink component carrier when the request for providing the aperiodic channel information is received.

32. The method according to claim 31, wherein the predetermined downlink component carrier is a primary downlink component carrier.

33. The method according to claim 31, wherein the predetermined downlink component carrier is configured by a network control element.

34. The method according to claim 28, wherein the request for providing the aperiodic channel information is included in an uplink grant, wherein the uplink grant comprises a combined indication of a scheduled uplink component carrier and the selected downlink component carrier.

35. The method according to claim 34, wherein the combined indication is included in a carrier indicator field.

36. The method according to claim 28, wherein the request for providing the aperiodic channel information is included in an uplink grant, and wherein, when the aperiodic channel information is requested to be transmitted without simultaneous uplink data, the request for providing the aperiodic channel information is included in at least one of unused signalling bits and states of the uplink grant, or when the aperiodic channel information is requested to be transmitted without simultaneous uplink data, the at least one of the unused signalling bits and the states of the uplink grant are reinterpreted with the request for providing the aperiodic channel information.

37. The method according to claim 28, further comprising:  
 providing channel information for at least one of the other component carriers of the plurality of component carriers other than the selected component carrier of the plurality of component carriers; and  
 sending the channel information for the at least one of the other component carriers.

38. The method according to claim 37, wherein the channel information for the at least one of the other component carriers is a wideband channel information.

39. The method according to claim 37, wherein the at least one of the other component carriers are configured by a network control element.

40. The method according to claim 37, wherein information regarding the at least one of the other component carriers is included in the request for providing the aperiodic channel information.

16

41. The method according to claim 28, wherein the request for providing the aperiodic channel information is included in an uplink grant.

42. A non-transitory computer program product comprising code means for performing a method according to claim 28 when run on a processing means or module.

43. The non-transitory computer program product according to claim 42, wherein the computer program product is embodied on a computer-readable medium.

44. A method comprising:  
 generating a request for providing aperiodic channel information with respect to a selected downlink component carrier of a plurality of component carriers; and  
 sending the request for providing the aperiodic channel information on a component carrier for which the aperiodic channel information is provided.

45. The method according to claim 44, further comprising receiving the aperiodic channel information sent in response to the request for providing the aperiodic channel information.

46. The method according to claim 44, further comprising generating an indicator for determining the selected downlink component carrier, wherein the indicator is sent with the request for providing the aperiodic channel information.

47. The method according to claim 46, wherein the request for providing the aperiodic channel information and the indicator are included in an uplink grant.

48. The method according to claim 44, wherein the selected downlink component carrier is a predetermined downlink component carrier.

49. The method according to claim 48, wherein the predetermined downlink component carrier is a primary downlink component carrier.

50. The method according to claim 48, wherein the predetermined downlink component carrier is configured using control signalling.

51. The method according to claim 44, further comprising including the request for providing the aperiodic channel information in an uplink grant, wherein the uplink grant comprises a combined indication of a scheduled uplink component carrier and the selected downlink component carrier.

52. The method according to claim 51, wherein the combined indication is included in a carrier indicator field.

53. The method according to claim 44, further comprising:  
 including the request for providing the aperiodic channel information in an uplink grant; and  
 including the request for providing the aperiodic channel information in at least one of unused signalling bits and states of the uplink grant or reinterpreting the at least one of the unused signalling bits and the states of the uplink grant with the request for providing the aperiodic channel information, when the aperiodic channel information is requested to be transmitted without simultaneous uplink data.

54. The method according to claim 44, further comprising generating a request for providing channel information for at least one of the other component carriers of the plurality of component carriers other than the selected component carrier.

55. The method according to claim 54, wherein the channel information for the at least one of the other component carriers is a wideband channel information.

56. The method according to claim 44, wherein the request for providing the aperiodic channel information is included in an uplink grant.

\* \* \* \* \*