



US005635423A

# United States Patent [19]

[11] Patent Number: **5,635,423**

Huang et al.

[45] Date of Patent: **Jun. 3, 1997**

[54] **SIMPLIFIED DUAL DAMASCENE PROCESS FOR MULTI-LEVEL METALLIZATION AND INTERCONNECTION STRUCTURE**

0 435 187 7/1991 European Pat. Off. .  
0 463 972 1/1992 European Pat. Off. .

### OTHER PUBLICATIONS

[75] Inventors: **Richard J. Huang; Angela Hui**, both of Milpitas; **Robin Cheung**, Cupertino; **Mark Chang**, Los Altos; **Ming-Ren Lin**, Cupertino, all of Calif.

Kikuta et al., "Al-Gr Reflow Sputtering For Submicron-Contact-Hole Filling", Microelectronics Research Laboratories, NEC Corporation, IEEE VMIC Conference, Jun. 11-12, 1991, pp. 5.2.1-5.2.4.

[73] Assignee: **Advanced Micro Devices, Inc.**, Sunnyvale, Calif.

IBM Technical Disclosure Bulletin, vol. 30, No. 8, Jan 1988, New York, US, pp. 252-253, XP 000097503 Anonymous "Methods of forming small contact holes".

[21] Appl. No.: **320,516**

Proceedings of the 8th International IEEE VLSI Multilevel Interconnection Conference, Santa Clara, CA, USA, Jun. 11-12, 1991, pp. 144-152, Kaanta et al., "Dual damascene: a ULSI wiring technology".

[22] Filed: **Oct. 11, 1994**

[51] Int. Cl.<sup>6</sup> ..... **H01L 21/44**

Joshi, "A New Damascene Structure for Submicrometer Interconnect Wiring," IEEE Electron Letters, vol. 14, No. 3, Mar. 1993, pp. 129-132.

[52] U.S. Cl. .... **437/195; 437/190; 437/203; 156/652.1; 156/653.1**

Kaanta et al., "Dual Damascene: A ULSI Wiring Technology," Jun. 11-12, 1991, VMIC Conference, IEEE, pp. 144-152.

[58] Field of Search ..... **437/195, 190, 437/182, 203; 156/DIG. 652.1, DIG. 653.1**

Kenny et al., "A Buried-Plate Trench Cell for a 64-Mb DRAM," 1992 Symposium on VLSI Technology Digest of Technical Papers, IEEE, pp. 14 and 15.

### [56] References Cited

#### U.S. PATENT DOCUMENTS

3,844,831	10/1974	Cass et al. ....	437/195
3,961,414	6/1976	Humphreys .....	437/195
4,472,240	9/1984	Kameyama .	
4,536,951	8/1985	Rhodes et al. ....	437/195
4,764,484	8/1988	Mo .....	437/195
4,801,350	1/1989	Mattox et al. .	
4,933,303	6/1990	Mo .....	437/190
4,948,755	8/1990	Mo .....	437/195
4,996,167	2/1991	Chen .	
5,055,423	10/1991	Smith et al. ....	437/195
5,093,279	3/1992	Andreshak et al. .	
5,262,354	11/1993	Cote et al. .	
5,354,711	10/1994	Heitzmann et al. ....	437/182
5,470,788	11/1995	Biery et al. ....	437/190

#### FOREIGN PATENT DOCUMENTS

0 224 013	6/1987	European Pat. Off. .
0 425 787	5/1991	European Pat. Off. .

*Primary Examiner*—Charles L. Bowers, Jr.

*Assistant Examiner*—Lynne A. Gurley

### [57] ABSTRACT

A semiconductor device containing an interconnection structure having a reduced interwiring spacing is produced by a modified dual damascene process. In one embodiment, an opening for a via is initially formed in a second insulative layer above a first insulative layer with an etch stop layer therebetween. A larger opening for a trench is then formed in the second insulative layer while simultaneously extending the via opening through the etch stop layer and first insulative layer. The trench and via are then simultaneously filled with conductive material.

**13 Claims, 8 Drawing Sheets**

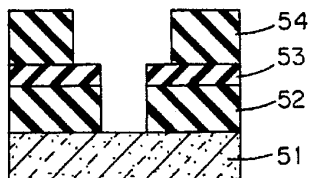
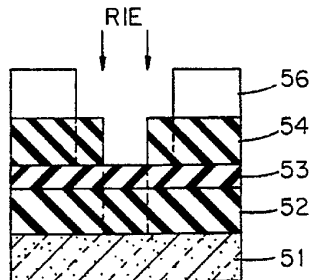

FIG. 1(a) PRIOR ART

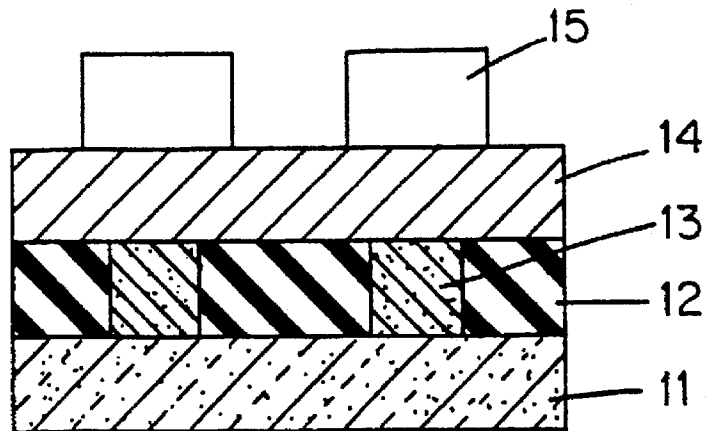

FIG. 1(b) PRIOR ART

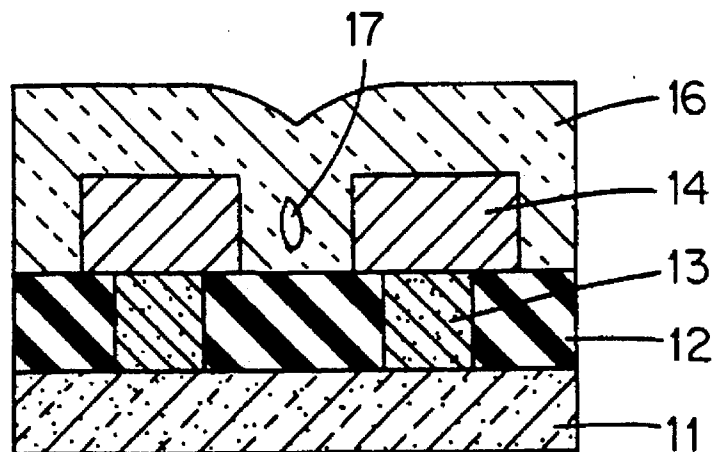

FIG. 2(a)  
PRIOR ART

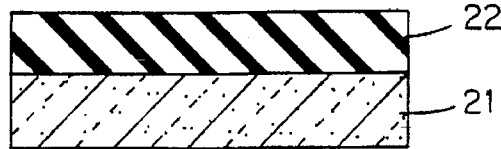

FIG. 2(b)  
PRIOR ART

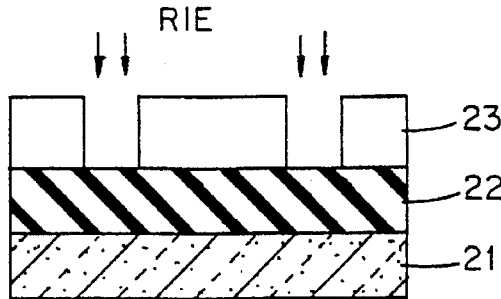

FIG. 2(c)  
PRIOR ART

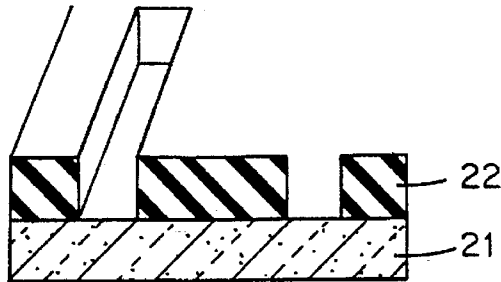

FIG. 2(d)  
PRIOR ART

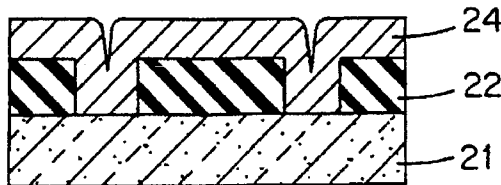

FIG. 2(e)  
PRIOR ART

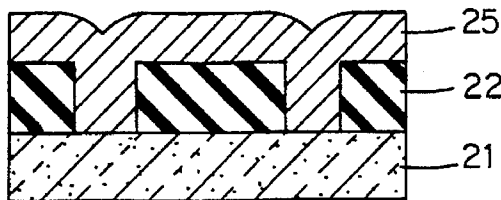

FIG. 3  
PRIOR ART

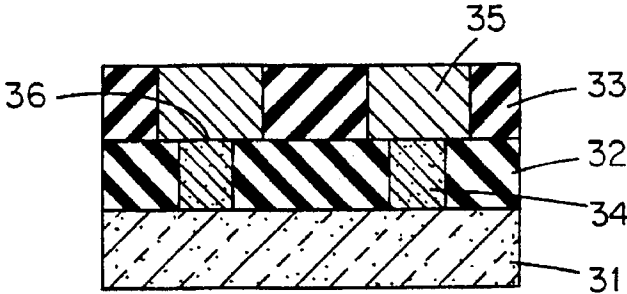

FIG. 4(a)  
PRIOR ART

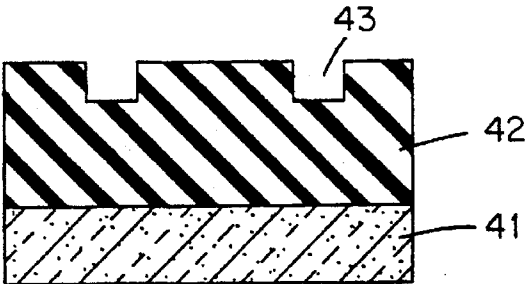

FIG. 4(b)  
PRIOR ART

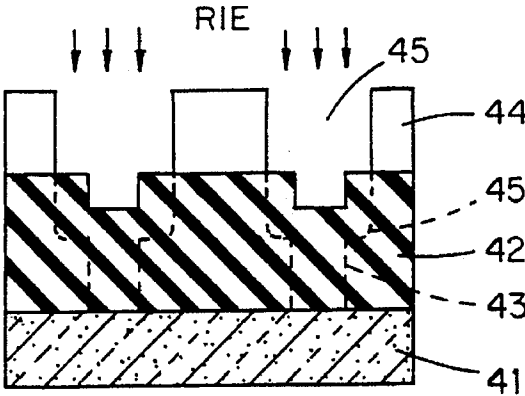

FIG. 4(c)  
PRIOR ART

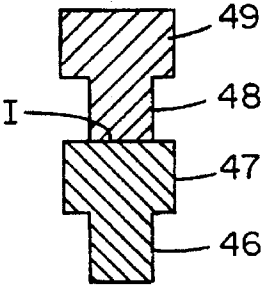

FIG. 5(a)

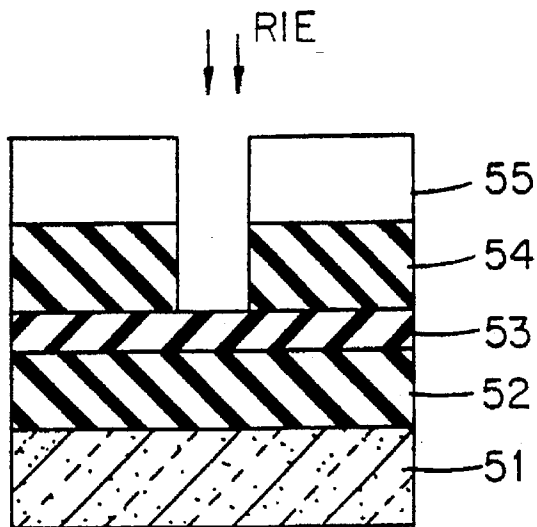

FIG. 5(b)

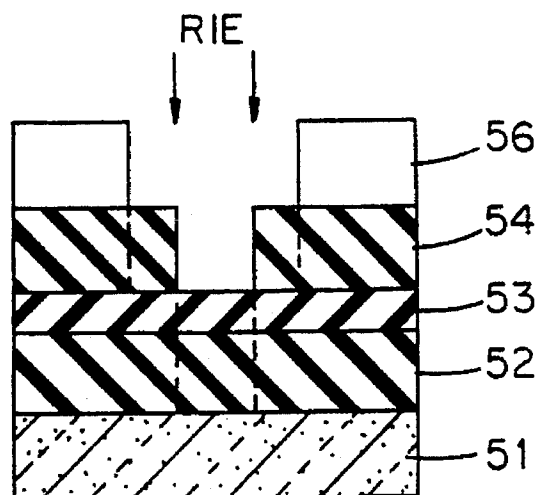
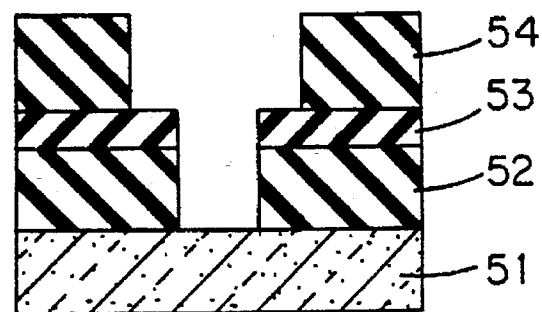

FIG. 5(c)



# Explore Litigation Insights

Docket Alarm provides insights to develop a more informed litigation strategy and the peace of mind of knowing you're on top of things.

## Real-Time Litigation Alerts



Keep your litigation team up-to-date with **real-time alerts** and advanced team management tools built for the enterprise, all while greatly reducing PACER spend.

Our comprehensive service means we can handle Federal, State, and Administrative courts across the country.

## Advanced Docket Research



With over 230 million records, Docket Alarm's cloud-native docket research platform finds what other services can't. Coverage includes Federal, State, plus PTAB, TTAB, ITC and NLRB decisions, all in one place.

Identify arguments that have been successful in the past with full text, pinpoint searching. Link to case law cited within any court document via Fastcase.

## Analytics At Your Fingertips



Learn what happened the last time a particular judge, opposing counsel or company faced cases similar to yours.

Advanced out-of-the-box PTAB and TTAB analytics are always at your fingertips.

## API

Docket Alarm offers a powerful API (application programming interface) to developers that want to integrate case filings into their apps.

## LAW FIRMS

Build custom dashboards for your attorneys and clients with live data direct from the court.

Automate many repetitive legal tasks like conflict checks, document management, and marketing.

## FINANCIAL INSTITUTIONS

Litigation and bankruptcy checks for companies and debtors.

## E-DISCOVERY AND LEGAL VENDORS

Sync your system to PACER to automate legal marketing.