



US005521422A

United States Patent [19]

[11] Patent Number: **5,521,422**

Mandelman et al.

[45] Date of Patent: **May 28, 1996**

[54] **CORNER PROTECTED SHALLOW TRENCH ISOLATION DEVICE**

4-56279 2/1992 Japan 257/622

OTHER PUBLICATIONS

[75] Inventors: **Jack A. Mandelman**, Stormville, N.Y.; **Brian J. Machesney**, Burlington, Vt.; **Hing Wong**, Norwalk, Conn.; **Michael D. Armacost**, Wallkill, N.Y.; **Pai-Hung Pan**, Boise, Id.

T. Furukawa et al., "Process and Device Simulation of Trench Isolation Corner Parasitic Device", Proceedings of the Electrochemical Society Meeting, Oct. 9-14, 1988, pp. 1-2.

A. Bryant et al., "The Current-Carrying Corner Inherent to Trench Isolation", IEEE Electron Device Letters, vol. 14, No. 8, Aug. 1993, pp. 412-414.

D. Foty et al., "Behavior of an NMOS Trench-Isolated Corner Parasitic Device at Low Temperature", Proceedings of the Electrochemical Society Meeting, Oct. 1989, pp. 1-2.

T. Ishijima et al., "A Deep-Submicron Isolation Technology with T-shaped Oxide (TSO) Structure", Proceedings of the IEDM, 1990, pp. 257-260.

P. C. Fazan et al., "A Highly Manufacturable Trench Isolation Process for Deep Submicron DRAMs", Proceedings of the IEDM, 1993, pp. 57-60.

J. F. Shepard, "Method to Reduce Loss of Isolation Trench Insulation", IBM Technical Disclosure Bulletin, vol. 33, No. 10A, pp. 298-299, Mar. 1991.

C. W. Kaanta et al., "Use of Easily Removable Sacrificial Layer to Suppress Chemical-Mechanical Overpolish Damage", IBM Technical Disclosure Bulletin, vol. 34, No. 4B, pp. 343-344, Sep. 1991.

[73] Assignee: **International Business Machines Corporation**, Armonk, N.Y.

[21] Appl. No.: **348,709**

[22] Filed: **Dec. 2, 1994**

[51] Int. Cl.⁶ **H01L 29/00**

[52] U.S. Cl. **257/510; 257/513; 257/622; 257/623; 257/626**

[58] Field of Search **257/301, 302, 257/303, 304, 305, 905, 510, 513, 524, 622, 623, 626, 647**

[56] References Cited

U.S. PATENT DOCUMENTS

4,389,294	6/1983	Anantha et al.	204/192
4,502,913	3/1985	Lechaton et al.	257/513
4,506,434	3/1985	Tetsuya et al.	29/571
4,814,840	3/1989	Kameda	257/301
4,836,885	6/1989	Breiten et al.	156/643
4,873,203	10/1989	Kagu et al.	437/67
4,966,870	10/1990	Barber et al.	437/228
4,988,637	1/1991	Dhong et al.	437/52
4,998,161	3/1991	Kimura et al.	357/23.4
5,064,777	11/1991	Dhong et al.	437/52
5,160,988	11/1992	Higuchi et al.	257/301
5,173,439	12/1992	Dash et al.	437/67
5,250,831	10/1993	Ishii	257/305
5,260,588	11/1993	Ohta et al.	257/623
5,275,965	1/1994	Manning	437/67
5,292,670	3/1994	Sundaresan	437/21
5,298,434	3/1994	Strater et al.	437/21

FOREIGN PATENT DOCUMENTS

401537 12/1990 European Pat. Off. 257/301

Primary Examiner—Sara W. Crane
Assistant Examiner—Alice W. Tang
Attorney, Agent, or Firm—James M. Leas

[57] ABSTRACT

A semiconductor structure to prevent gate wrap-around and corner parasitic leakage comprising a semiconductor substrate having a planar surface. A trench is located in the substrate, the trench having a sidewall. An intersection of the trench and the surface forms a corner. A dielectric lines the sidewall of the trench. And, a corner dielectric co-aligned with the corner extends a subminimum dimension distance over the substrate from the corner.

10 Claims, 5 Drawing Sheets

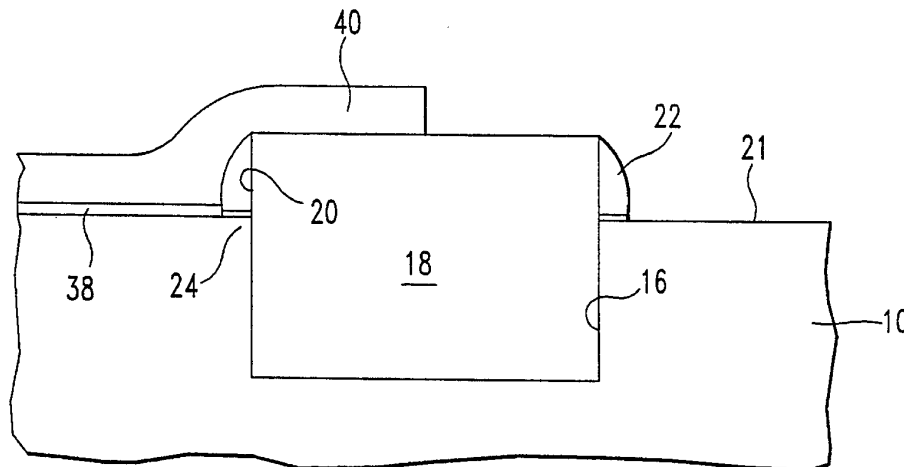

FIG. 1a

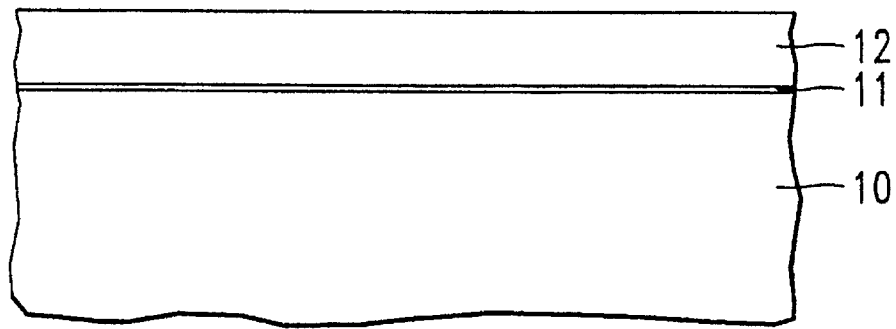

FIG. 1b

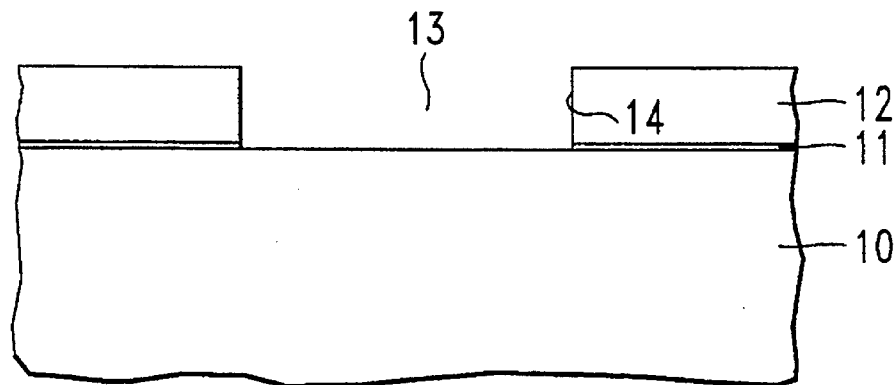
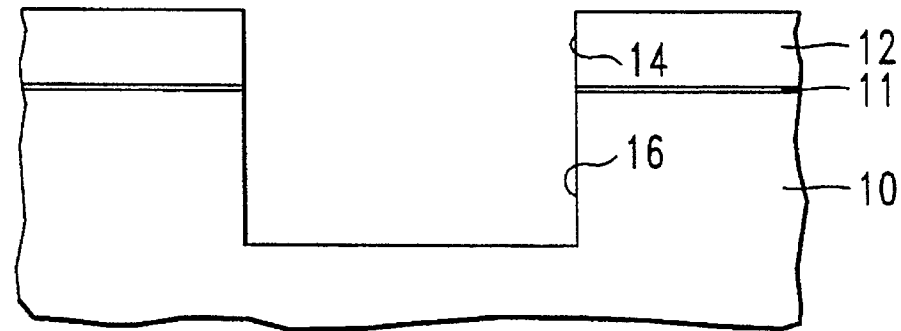

FIG. 1c



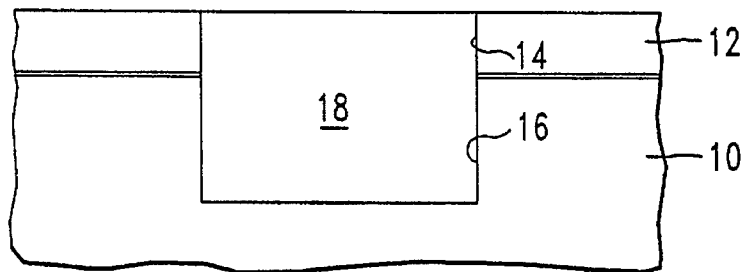

FIG. 1d

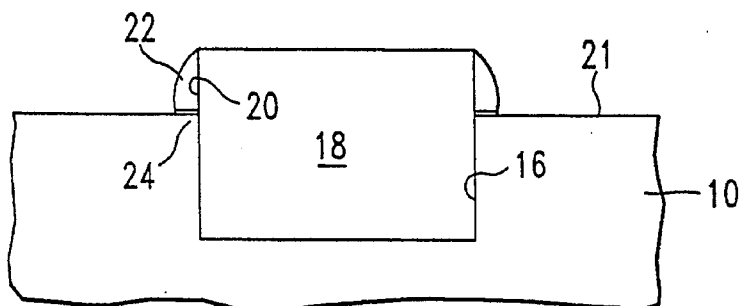

FIG. 1e

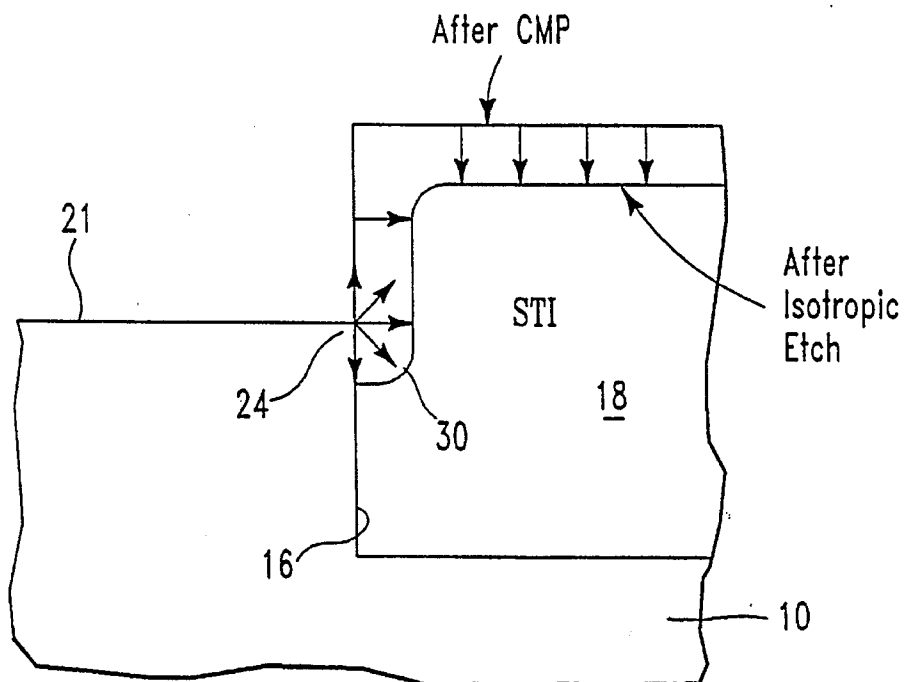
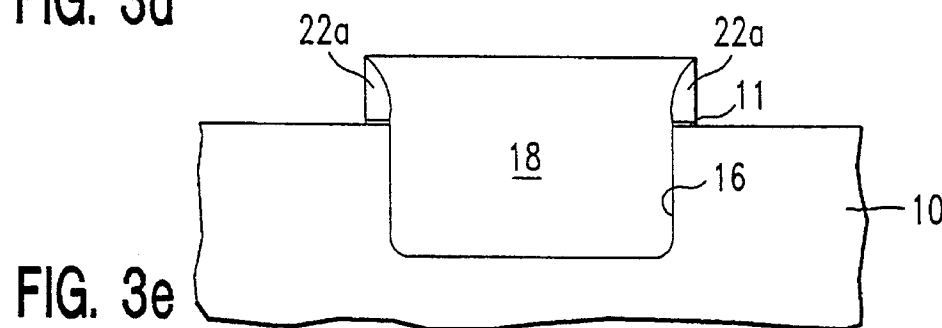
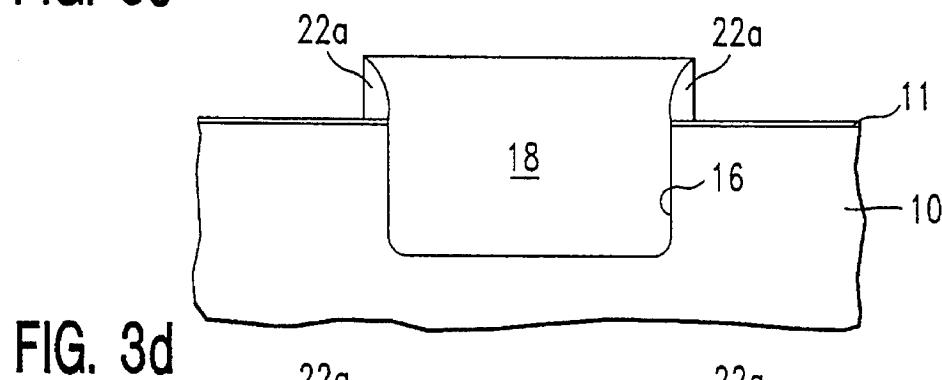
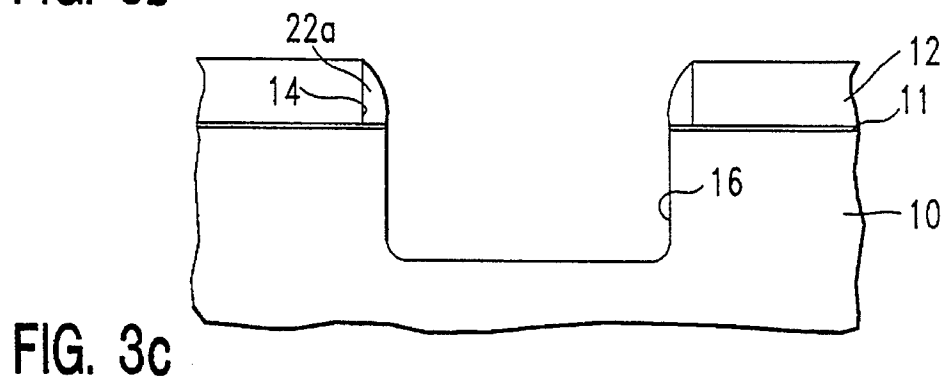
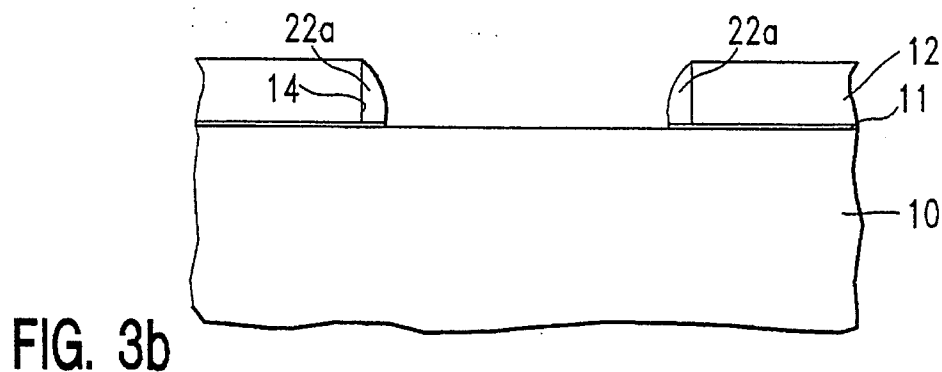
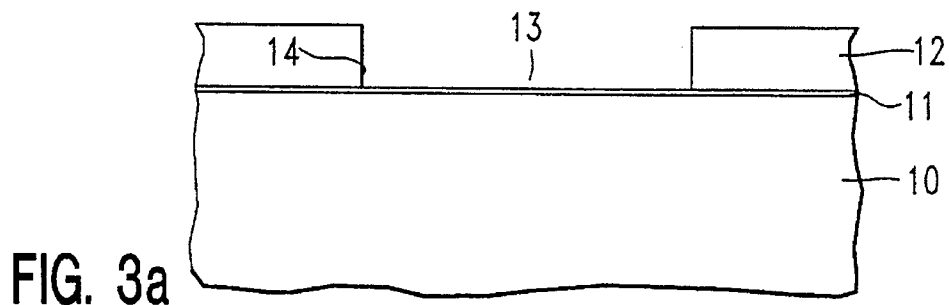

FIG. 2
PRIOR ART



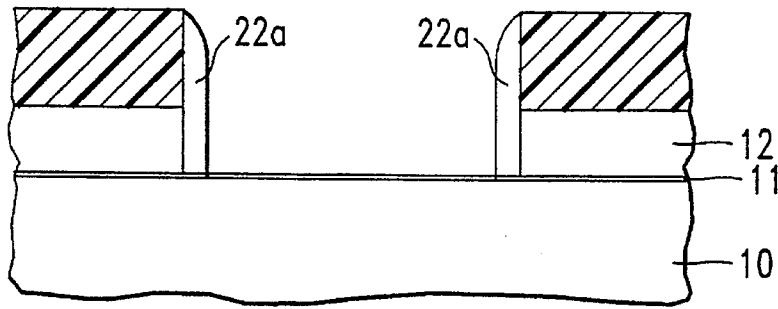

FIG. 4a

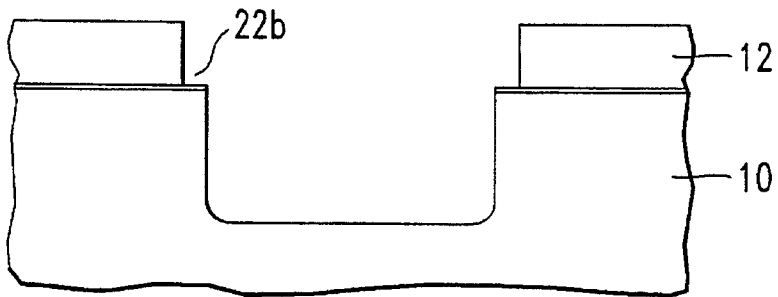

FIG. 4b

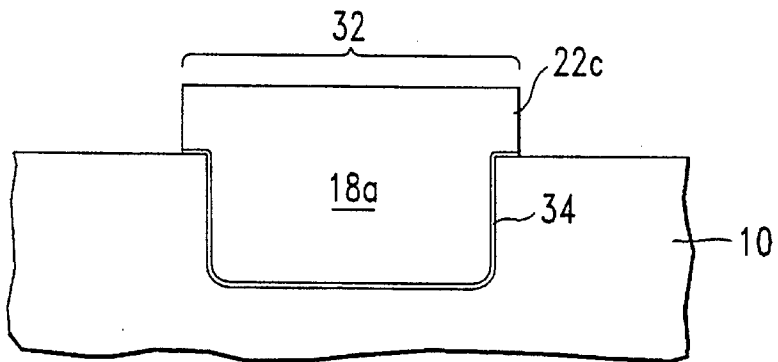

FIG. 4c

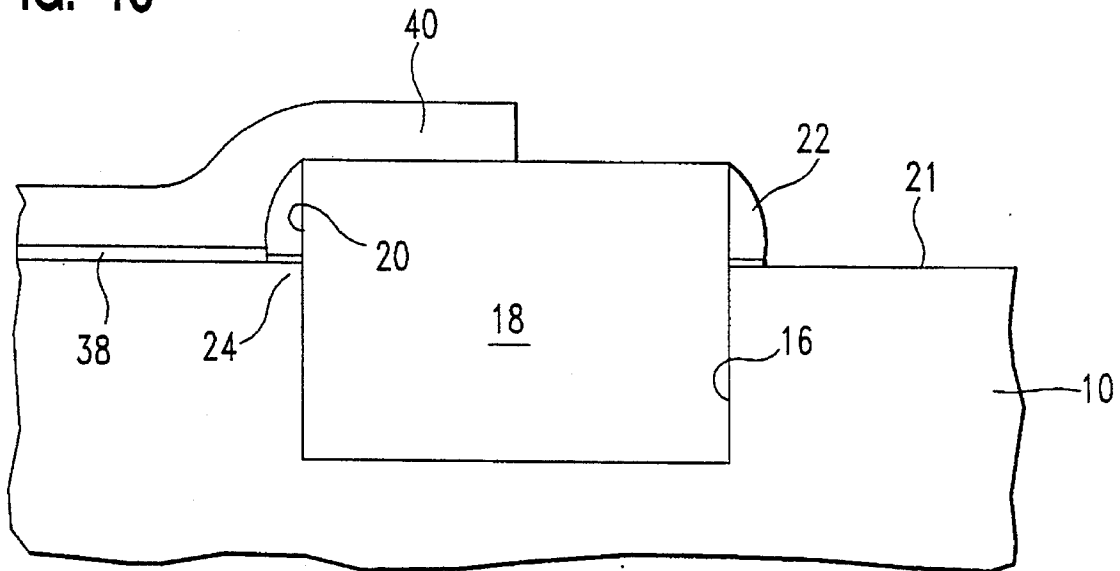

FIG. 5

Explore Litigation Insights

Docket Alarm provides insights to develop a more informed litigation strategy and the peace of mind of knowing you're on top of things.

Real-Time Litigation Alerts



Keep your litigation team up-to-date with **real-time alerts** and advanced team management tools built for the enterprise, all while greatly reducing PACER spend.

Our comprehensive service means we can handle Federal, State, and Administrative courts across the country.

Advanced Docket Research



With over 230 million records, Docket Alarm's cloud-native docket research platform finds what other services can't. Coverage includes Federal, State, plus PTAB, TTAB, ITC and NLRB decisions, all in one place.

Identify arguments that have been successful in the past with full text, pinpoint searching. Link to case law cited within any court document via Fastcase.

Analytics At Your Fingertips



Learn what happened the last time a particular judge, opposing counsel or company faced cases similar to yours.

Advanced out-of-the-box PTAB and TTAB analytics are always at your fingertips.

API

Docket Alarm offers a powerful API (application programming interface) to developers that want to integrate case filings into their apps.

LAW FIRMS

Build custom dashboards for your attorneys and clients with live data direct from the court.

Automate many repetitive legal tasks like conflict checks, document management, and marketing.

FINANCIAL INSTITUTIONS

Litigation and bankruptcy checks for companies and debtors.

E-DISCOVERY AND LEGAL VENDORS

Sync your system to PACER to automate legal marketing.