



US006625656B2

(12) **United States Patent**
Goldhor et al.

(10) **Patent No.:** **US 6,625,656 B2**
(45) **Date of Patent:** **Sep. 23, 2003**

(54) **METHOD AND APPARATUS FOR CONTINUOUS PLAYBACK OR DISTRIBUTION OF INFORMATION INCLUDING AUDIO-VISUAL STREAMED MULTIMEDIA**

(75) Inventors: **Richard S. Goldhor**, Belmont, MA (US); **Donald J. Hejna, Jr.**, Los Altos, CA (US)

(73) Assignee: **Enounce, Incorporated**, Palo Alto, CA (US)

(*) Notice: Subject to any disclaimer, the term of this patent is extended or adjusted under 35 U.S.C. 154(b) by 0 days.

(21) Appl. No.: **09/519,487**

(22) Filed: **Mar. 6, 2000**

(65) **Prior Publication Data**

US 2002/0052967 A1 May 2, 2002

Related U.S. Application Data

(63) Continuation-in-part of application No. 09/304,761, filed on May 4, 1999.

(51) **Int. Cl.**⁷ **G06F 15/16**

(52) **U.S. Cl.** **709/231; 709/232; 709/233**

(58) **Field of Search** **709/217, 219, 709/218, 231, 232, 233, 234, 235; 348/6, 7, 513, 516, 518; 725/101, 92, 93, 94, 95, 96, 88, 89, 90, 134, 142**

(56) **References Cited**

U.S. PATENT DOCUMENTS

5,544,324 A * 8/1996 Edem et al. 709/231
5,630,013 A * 5/1997 Suzuki et al. 704/216
5,649,050 A * 7/1997 Hardwick et al. 704/203

5,652,627 A * 7/1997 Allen 348/497
5,692,213 A * 11/1997 Goldberg et al. 345/302
5,694,521 A * 12/1997 Shlomot et al. 704/262
5,749,064 A * 5/1998 Pawate et al. 704/213
5,758,076 A * 5/1998 Wu et al. 709/231
5,767,863 A * 6/1998 Kimura 345/531
5,793,980 A * 8/1998 Glaser et al. 709/231
5,806,023 A * 9/1998 Satyamurti 704/211
5,808,662 A * 9/1998 Kinney et al. 348/15
5,818,436 A * 10/1998 Imai et al. 345/302
5,822,537 A * 10/1998 Katseff et al. 709/231
5,842,172 A * 11/1998 Wilson 704/503
5,864,678 A * 1/1999 Riddle 709/235
5,864,682 A * 1/1999 Porter et al. 709/247
5,893,062 A * 4/1999 Bhadkamkar et al. 704/270
5,953,506 A * 9/1999 Kalra et al. 709/231
5,973,255 A * 10/1999 Tanji 84/636
6,018,359 A * 1/2000 Kermodé et al. 725/101
6,086,537 A * 7/2000 Urbano et al. 600/443
6,123,548 A * 9/2000 Tallal et al. 434/185
6,124,878 A * 9/2000 Adams et al. 725/118
6,169,843 B1 * 1/2001 Lenihan et al. 386/46
6,357,047 B1 * 3/2002 Kurtze et al. 725/151
6,397,251 B1 * 5/2002 Graf 709/225
6,415,326 B1 * 7/2002 Gupta et al. 709/231
6,449,653 B2 * 9/2002 Klemets et al. 709/231

* cited by examiner

Primary Examiner—Mark R. Powell

Assistant Examiner—William C. Vaughn, Jr.

(74) *Attorney, Agent, or Firm*—Michael B. Einschlag

(57) **ABSTRACT**

An embodiment of the present invention is an apparatus for preparing media for playback which comprises: (a) a buffer which stores data corresponding to the media; (b) a time-scale modification system that time-scale modifies data output from the buffer at a playback rate; and (c) a rate determiner that determines the playback rate over an interval to control the amount of data in the buffer.

2 Claims, 16 Drawing Sheets

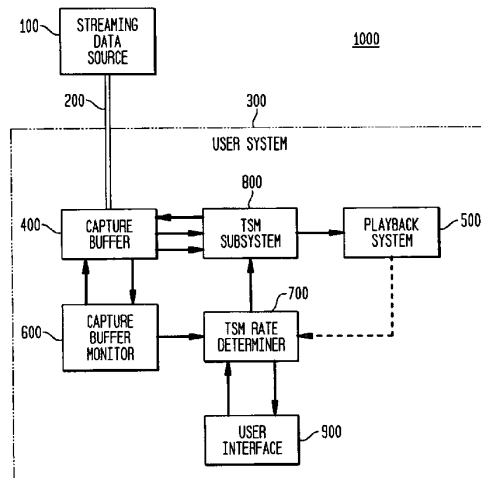

FIG. 1

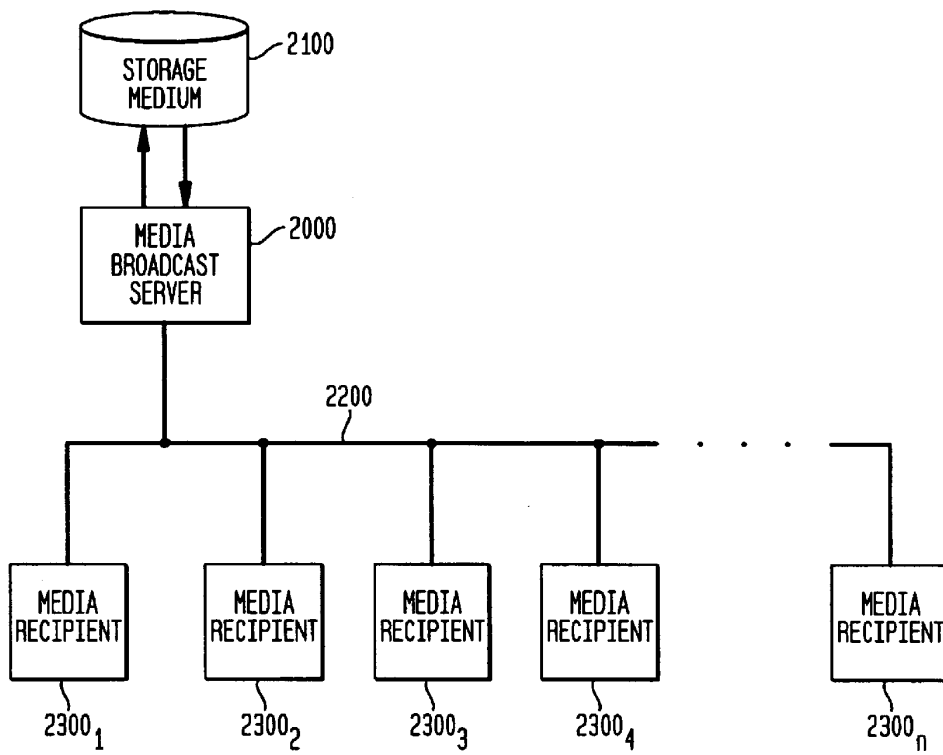

FIG. 2

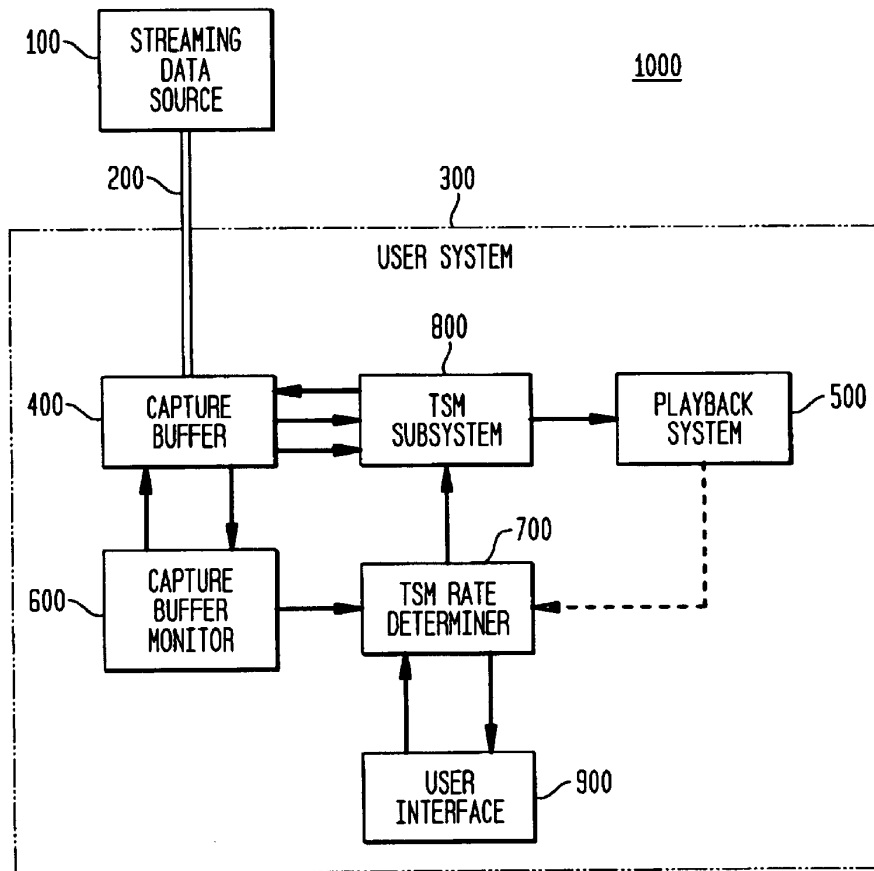

FIG. 3

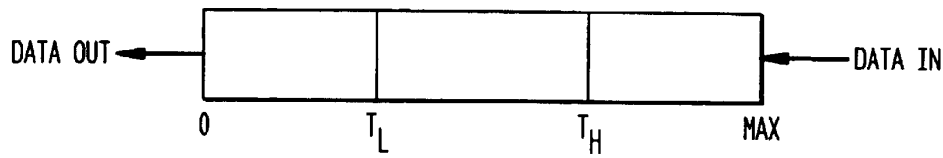
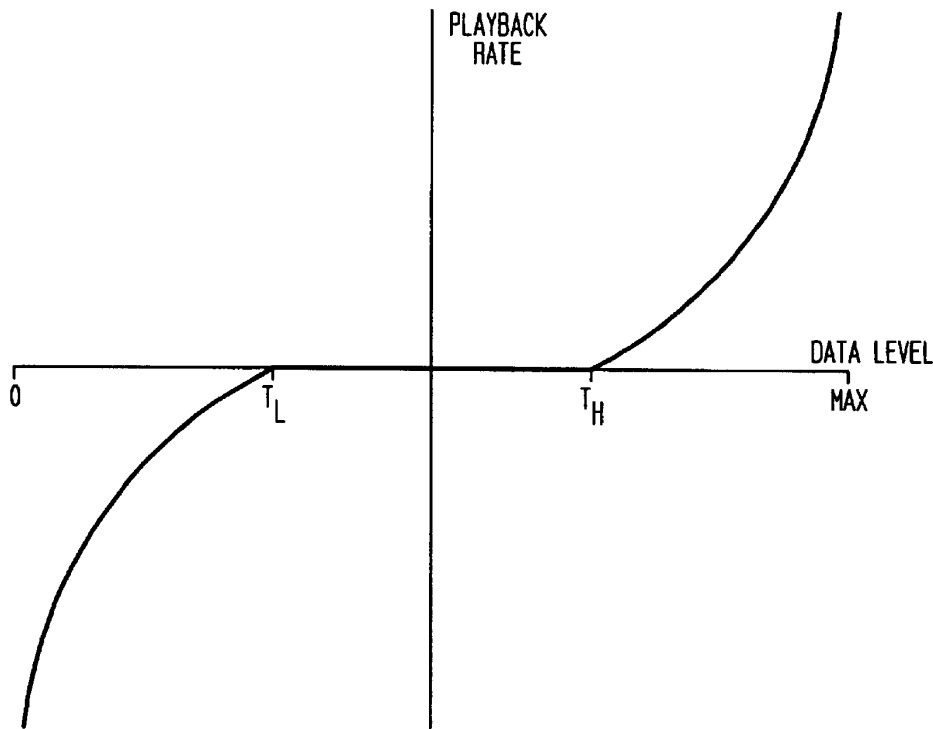

FIG. 4



$0 \leq x \leq T_L$	PLAYBACK RATE = (SCALE) $\tanh^{-1}((X-T_L)/(T_L))$
$T_L < x < T_H$	PLAYBACK RATE = 1.0
$T_H \leq x \leq MAX$	PLAYBACK RATE = (SCALE) $\tanh^{-1}((X-T_H)/(MAX-T_H))$

FIG. 5

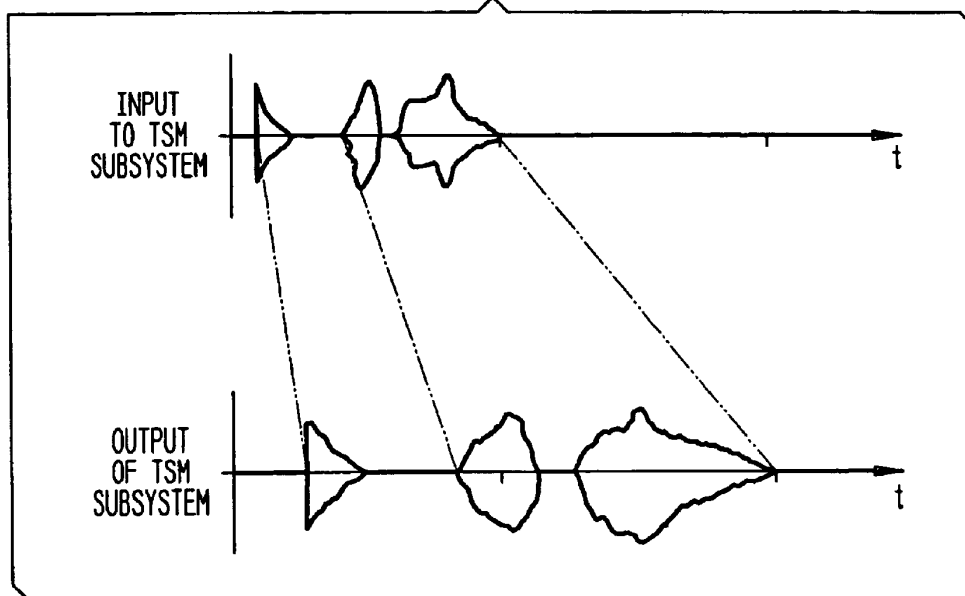
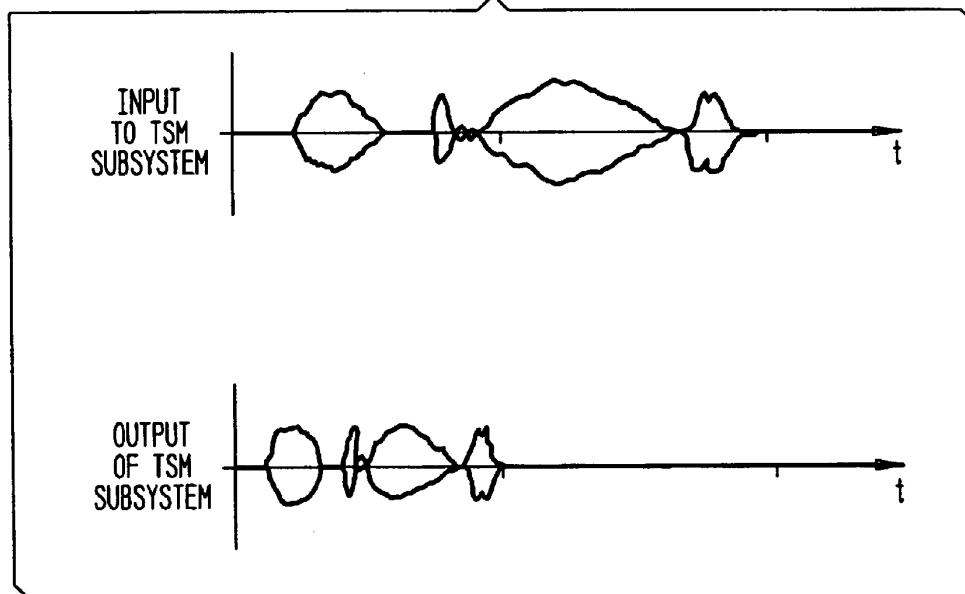

FIG. 6



Explore Litigation Insights

Docket Alarm provides insights to develop a more informed litigation strategy and the peace of mind of knowing you're on top of things.

Real-Time Litigation Alerts



Keep your litigation team up-to-date with **real-time alerts** and advanced team management tools built for the enterprise, all while greatly reducing PACER spend.

Our comprehensive service means we can handle Federal, State, and Administrative courts across the country.

Advanced Docket Research



With over 230 million records, Docket Alarm's cloud-native docket research platform finds what other services can't. Coverage includes Federal, State, plus PTAB, TTAB, ITC and NLRB decisions, all in one place.

Identify arguments that have been successful in the past with full text, pinpoint searching. Link to case law cited within any court document via Fastcase.

Analytics At Your Fingertips



Learn what happened the last time a particular judge, opposing counsel or company faced cases similar to yours.

Advanced out-of-the-box PTAB and TTAB analytics are always at your fingertips.

API

Docket Alarm offers a powerful API (application programming interface) to developers that want to integrate case filings into their apps.

LAW FIRMS

Build custom dashboards for your attorneys and clients with live data direct from the court.

Automate many repetitive legal tasks like conflict checks, document management, and marketing.

FINANCIAL INSTITUTIONS

Litigation and bankruptcy checks for companies and debtors.

E-DISCOVERY AND LEGAL VENDORS

Sync your system to PACER to automate legal marketing.