

FILE HISTORY

US 6,538,324

PATENT: 6,538,324

INVENTORS: Tagami, Masayoshi  
Hayashi, Yoshihiro

TITLE: Multi-layered wiring layer and method of  
fabricating the same

APPLICATION  
NO: US2000596415A

FILED: 19 JUN 2000

ISSUED: 25 MAR 2003

COMPILED: 22 MAY 2015

257	751	ISSUE CLASSIFICATION
Class	Subclass	

PATENT NUMBER
<b>6538324</b>

6538324

U.S. UTILITY Patent Application

SCANNED <i>AM</i> O.I.P.E. Q.A. <i>DMW</i>	PATENT DATE MAR 25 2002
--	----------------------------

APPLICATION NO. 09/596415	CONT/PRIOR F	CLASS 257	SUBCLASS 751	ART UNIT 2811	EXAMINER <i>H. Vu</i>
------------------------------	-----------------	--------------	-----------------	------------------	--------------------------

APPLICANTS  
Masayoshi Tagami  
Yoshihiro Hayashi

TITLE  
Multi-layered wiring layer and method of fabricating the same

PTO-2040  
12/99

ISSUING CLASSIFICATION							
ORIGINAL		CROSS REFERENCE(S)					
CLASS	SUBCLASS	CLASS	SUBCLASS (ONE SUBCLASS PER BLOCK)				
257	751	257	762				
INTERNATIONAL CLASSIFICATION							
# 01 L	23/48						
# 01 L	23/52						

Continued on Issue Slip Inside File Jacket

<input type="checkbox"/> <b>TERMINAL DISCLAIMER</b>	<b>DRAWINGS</b>			<b>CLAIMS ALLOWED</b>	
	Sheets Drwg. <i>18/20</i>	Figs. Drwg. 34	Print Fig. 4D	Total Claims 10	Print Claim for O.G. 1
<input type="checkbox"/> The term of this patent subsequent to _____ (date) has been disclaimed.	<i>HUNG KIM VU</i> (Assistant Examiner)			<b>NOTICE OF ALLOWANCE MAILED</b> <i>9-10-02</i>	
	<b>TOM THOMAS</b> SUPERVISORY PATENT EXAMINER TECHNOLOGY CENTER 2800 <i>T. Thomas</i> (Primary Examiner)			<b>ISSUE FEE</b> Amount Due <i>\$1280</i>	
<input type="checkbox"/> The term of this patent shall not extend beyond the expiration date of U.S. Patent. No. _____	<i>9-9-02</i> (Date)			Date Paid <i>12-16-02</i>	
	<input type="checkbox"/> The terminal _____ months of this patent have been disclaimed.			<b>ISSUE BATCH NUMBER</b>	
<i>Surles 9/15/02</i> (Legal Instruments Examiner)					
<b>WARNING:</b> The information disclosed herein may be restricted. Unauthorized disclosure may be prohibited by the United States Code Title 35, Sections 122, 181 and 368. Possession outside the U.S. Patent & Trademark Office is restricted to authorized employees and contractors only.					

Form PTO-436A  
(Rev. 6/99)

FILED WITH:  DISK (CRF)  FICHE  CD-ROM  
(Attached in pocket on right inside flap)

**ISSUE FEE IN FULL**

(FACE)

6,538,324

**MULTI-LAYERED WIRING LAYER AND METHOD OF FABRICATING THE SAME**

**Transaction History**

<b>Date</b>	<b>Transaction Description</b>
6/19/2000	Information Disclosure Statement (IDS) Filed
6/19/2000	Information Disclosure Statement (IDS) Filed
6/19/2000	Request for Foreign Priority (Priority Papers May Be Included)
6/19/2000	Initial Exam Team nn
7/10/2000	IFW Scan & PACR Auto Security Review
8/16/2000	Application Dispatched from OIPE
8/16/2000	Correspondence Address Change
9/13/2000	Case Docketed to Examiner in GAU
4/29/2001	Case Docketed to Examiner in GAU
6/4/2001	Restriction/Election Requirement
6/5/2001	Mail Restriction Requirement
7/9/2001	Response to Election / Restriction Filed
7/14/2001	Date Forwarded to Examiner
9/24/2001	Non-Final Rejection
9/25/2001	Mail Non-Final Rejection
1/28/2002	Response after Non-Final Action
2/2/2002	Date Forwarded to Examiner
4/3/2002	Final Rejection
4/4/2002	Mail Final Rejection (PTOL - 326)
6/11/2002	Amendment after Final Rejection
6/25/2002	Date Forwarded to Examiner
7/1/2002	Advisory Action (PTOL-303)
7/2/2002	Mail Advisory Action (PTOL - 303)
8/9/2002	Request for Continued Examination (RCE)
8/9/2002	Request for Extension of Time - Granted
8/9/2002	Workflow - Request for RCE - Begin
8/20/2002	Date Forwarded to Examiner
8/20/2002	Date Forwarded to Examiner
8/20/2002	Disposal for a RCE / CPA / R129

9/9/2002	Notice of Allowance Data Verification Completed
9/9/2002	Case Docketed to Examiner in GAU
9/10/2002	Mail Notice of Allowance
9/13/2002	Information Disclosure Statement (IDS) Filed
9/13/2002	Information Disclosure Statement (IDS) Filed
9/13/2002	Workflow - Informational Disclosure Statement - Finish
9/13/2002	Workflow - Informational Disclosure Statement - Begin
9/15/2002	Dispatch to Publications
9/17/2002	Receipt into Pubs
9/18/2002	Workflow - File Sent to Contractor
10/11/2002	Receipt into Pubs
11/20/2002	Mail Miscellaneous Communication to Applicant
11/20/2002	Miscellaneous Communication to Applicant - No Action Count
11/21/2002	Receipt into Pubs
12/16/2002	Issue Fee Payment Verified
12/16/2002	Workflow - Drawings Finished
12/16/2002	Workflow - Drawings Matched with File at Contractor
12/16/2002	Workflow - Drawings Received at Contractor
12/16/2002	Workflow - Drawings Sent to Contractor
12/16/2002	Issue Fee Payment Received
12/30/2002	Application Is Considered Ready for Issue
1/2/2003	Receipt into Pubs
1/14/2003	Request for Refund
1/21/2003	Workflow - Drawings Finished
1/21/2003	Workflow - Drawings Matched with File at Contractor
1/27/2003	Receipt into Pubs
3/6/2003	Issue Notification Mailed
3/25/2003	Recordation of Patent Grant Mailed
3/25/2003	Patent Issue Date Used in PTA Calculation

PATENT APPLICATION



09596415

Jc511 U.S. PTO

09/528415



06/19/00

INITIALS

JUN 28 00 20

CONTENTS

Date Received  
(Incl. C. of M.)  
or  
Date Mailed

Date Received  
(Incl. C. of M.)  
or  
Date Mailed

1. Application 18 sheets papers.		42.	
2. Priority Paper	6-19-00	43.	
3. IDS	6-19-00	44.	
4. Restriction	6/5/01	45.	
5. ELECTION form	7/9/01	46.	
6. Rejection	9.25.01		
7. Amdt A	1-28-02	47.	
8. Final Rejection	4/4/02	49.	
9. response (AF)	6-11-02	50.	
10. PTO-303	7/2/02	51.	
11. Req Ext (1)	8-9-02	52.	
12. Req RCE	8-9-02	53.	
13. Amdt B	8-9-02	54.	
14. PTO-37/c	9/10/02	55.	
15. Prior Art	9-13-02	56.	
16. PTO-90c	11/20/02	57.	
<b>18. QUERY</b> 1/2/03 NC 1/2/03		59.	
<b>2. Original Drawings (20 sheets)</b> 1-21-03		60.	
20. Req for refund	01-14-03	61.	
21.		62.	
22.		63.	
23.		64.	
24.		65.	
25.		66.	
26.		67.	
27.		68.	
28.		69.	
29.		70.	
30.		71.	
31.		72.	
32.		73.	
33.		74.	
34.		75.	
35.		76.	
36.		77.	
37.		78.	
38.		79.	
39.		80.	
40.		81.	
41.		82.	

(LEFT OUTSIDE)

ISSUE SLIP STAPLE AREA (for additional cross references)

POSITION	INITIALS	ID NO.	DATE
FEE DETERMINATION	<i>jsd</i>	7533	
O.I.P.E. CLASSIFIER		8	6-28-00
FORMALITY REVIEW			
RESPONSE FORMALITY REVIEW		71471	8/16

INDEX OF CLAIMS

- ✓ ..... Rejected
- = ..... Allowed
- (Through numeral)... Canceled
- ± ..... Restricted
- N ..... Non-elected
- I ..... Interference
- A ..... Appeal
- O ..... Objected

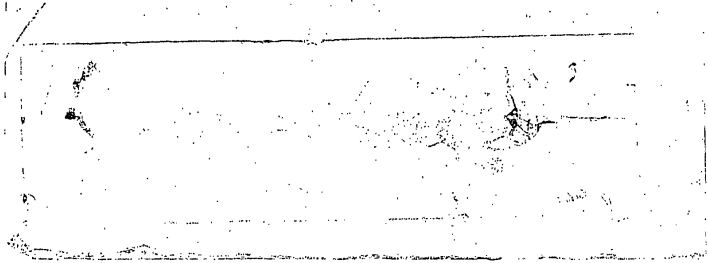
Claim	Final	Original	Date
1	✓	5/01	
2	✓	9/01	
3	✓	3/02	
4	✓	9/02	
5	✓		
6	✓		
7	✓		
8	✓		
9	✓		
10	✓		
11	✓		
12			
13			
14			
15			
16			
17	✓		
18			
19			
20			
21			
22			
23	✓		
24			
25			
26			
27			
28			
29			
30	✓		
31			
32			
33			
34			
35			
36	±	2	2
37	A	0	11
38	IO	0	11
39			
40			
41			
42			
43			
44			
45			
46			
47			
48			
49			
50			

Claim	Final	Original	Date
51			
52			
53			
54			
55			
56			
57			
58			
59			
60			
61			
62			
63			
64			
65			
66			
67			
68			
69			
70			
71			
72			
73			
74			
75			
76			
77			
78			
79			
80			
81			
82			
83			
84			
85			
86			
87			
88			
89			
90			
91			
92			
93			
94			
95			
96			
97			
98			
99			
100			

Claim	Final	Original	Date
101			
102			
103			
104			
105			
106			
107			
108			
109			
110			
111			
112			
113			
114			
115			
116			
117			
118			
119			
120			
121			
122			
123			
124			
125			
126			
127			
128			
129			
130			
131			
132			
133			
134			
135			
136			
137			
138			
139			
140			
141			
142			
143			
144			
145			
146			
147			
148			
149			
150			

If more than 150 claims or 10 actions  
staple additional sheet here

(LEFT INSIDE)



SEARCHED			
Class	Sub.	Date	Exmr.
257	751	09/11/01	<u>Vu</u>
	752		
	753		
	758		
	762		
	773		
438	626		
	627		
	628		
	643		
	644		
	645		
Above	Update	03/24/02	<u>Vu</u>
All	Above	08/31/02	<u>Vu</u>

SEARCH NOTES (INCLUDING SEARCH STRATEGY)		
	Date	Exmr.
EAST	09/11/01	<u>Vu</u>
EAST	05/26/02	<u>Vu</u>
EAST	08/31/02	<u>Vu</u>
Library Search	08/29/02	<u>Vu</u>

INTERFERENCE SEARCHED			
Class	Sub.	Date	Exmr.
257	751	09/06/02	<u>Vu</u>
	762		

(RIGHT OUTSIDE)

	Type	Hits	Search Text
1	BRS	949	(amorphous and crystal\$5) with nitride
2	BRS	235	((amorphous and crystal\$5) with nitride) and (barrier or barriers)
3	BRS	633	(amorphous and crystal\$5) with nitride
4	BRS	63	((amorphous and crystal\$5) with nitride) and (barrier or barriers)
5	IS&R	3509	((257/751,752,753,753,762,773) or (438/626,627,628,643,644,645)).CCLS.
6	BRS	237	(amorphous and crystal\$5) and ((257/751,752,753,753,762,773) or (438/626,627,628,643,644,645)).CCLS.)

09/03/2002, EAST Version: 1.03.0002



	DBs	Time Stamp	Comments	Error Definition
1	USPAT	2002/08/31 13:15		
2	USPAT	2002/08/31 12:40		
3	US-PGPUB; EPO; JPO; DERWENT; IBM TDB	2002/08/31 13:03		
4	US-PGPUB; EPO; JPO; DERWENT; IBM TDB	2002/08/31 13:14		
5	USPAT	2002/08/31 13:15		
6	USPAT	2002/09/03 07:36		

09/03/2002, EAST Version: 1.03.0002

09/596,415 9/6/02

FILE 'INPADOC, HCAPLUS, WPIX, J...IO' ENTERED AT 13:00:21 ON 06 SEP 2002.

L1 4 S JP99-0214110/PRN,AP  
SET SMARTSELECT ON  
L2 SEL PLU=ON L1 1- IC MC RN : 12 TERMS  
L3 492715 S L2  
L4 4 S L1 AND L3

FILE 'REGISTRY' ENTERED AT 13:11:56 ON 06 SEP 2002

L5 4730 S N TI/ELF OR N TA/ELF OR N W/ELF OR N NB/ELF OR MO N/ELF OR N ZR/ELF OR HF N/ELF OR AL N/ELF OR N  
V/ELF OR CR N/ELF  
L6 945 S N.TI/MF OR N.TA/MF OR N.W/MF OR N.NB/MF OR MO.N/MF OR N.ZR/MF OR HF.N/MF OR AL.N/MF OR N.V/MF  
OR CR.N/MF

FILE 'CAPLUS' ENTERED AT 13:16:22 ON 06 SEP 2002

L7 1265 S (L5 OR L6)(L)CRYST#####  
L8 274 S (L5 OR L6)(L)(NONCRYST##### OR NON CRYST##### OR AMORPHOUS)  
L9 51227 S (L5 OR L6)  
L10 17596 S METAL#####(1A)(NITROGEN OR NITRID#### OR "N")  
L11 82137 S (CONC OR CONCN OR CONCENTRATION OR PPM OR WT OR PERCENT OR RATIO OR  
ATOMIC)(2A)(NITROGEN OR NITRID##### OR "N")  
L12 65189 S (L9 OR L10)  
L13 2417 S L12 AND L11  
L14 26597 S (SMALLER OR LARGER OR MORE OR LESS OR RELATIVE##)(2A)(NITROGEN OR NITRID#### OR "N")  
L15 429 S L12 AND L14  
L16 18153 S (AMOUNT)(2A)(NITROGEN OR NITRID#### OR "N")  
L17 20847 S L13 OR L15 OR L16  
L18 32 S L7 AND L8  
S 7440-50-8/REG#

FILE 'REGISTRY' ENTERED AT 13:23:51 ON 06 SEP 2002

L19 1 S 7440-50-8/RN

FILE 'CAPLUS' ENTERED AT 13:23:51 ON 06 SEP 2002

L20 364227 S L19  
L21 601448 S DIFFUSION OR BARRIER  
L22 2910 S L17 AND (FILM OR LAYER#### OR MULTILAYER###  
##)  
L23 689 S L17 AND L21  
L24 343 S L22 AND L23  
L25 86 S L24 AND (SECOND OR TOP OR BOTTOM OR UNDER  
OR OVER)  
L26 93 S (L7 OR L8) AND L17  
L27 3 S L20 AND L26  
L28 8 S L21 AND L26  
L29 49 S L22 AND L26  
L30 9 S (L27 OR L28)  
S (NITROGEN/CN OR N/MF)(L)CONCENTRATION

FILE 'REGISTRY' ENTERED AT 13:31:01 ON 06 SEP 2002

L31 40 S N/MF

FILE 'CAPLUS' ENTERED AT 13:31:02 ON 06 SEP 2002

L32 28692 S L31

FILE 'REGISTRY' ENTERED AT 13:31:03 ON 06 SEP 2002

L33 1 S NITROGEN/CN

FILE 'CAPLUS' ENTERED AT 13:31:03 ON 06 SEP 2002

L34 199098 S L33  
L35 2397 S (L34 OR L32)(L)CONCENTRATION  
L36 0 S (L7 OR L8) AND L35  
L37 45 S L12 AND L35  
L38 8 S L37 AND (SECOND OR TOP OR BOTTOM OR UNDER OR OVER)  
L39 9 S L37 AND (FILM OR LAYER#### OR MULTILAYER#####)  
L40 3 S L37 AND (L20 OR L21)  
L41 17 S (L38 OR L39 OR L40) NOT L30  
L42 17231 S L20 AND L21  
L43 1108 S L9 AND L42

L44 18 S (L7 OR L8) AND L43  
L45 16 S L44 NOT ((L38 OR L39 OR L40) OR L30)  
L46 125 S (L18 OR L29 OR L37)  
L47 99 S L46 NOT (L44 OR (L38 OR L39 OR L40) OR L30)  
L48 90744 S (SECOND OR TOP OR BOTTOM OR UNDER OR OVER)(3A)(FILM OR LAYER####)  
L49 5 S L47 AND L48  
L50 121888 S (L18 OR L35 OR L16 OR L14 OR L11)  
L51 99 S L47 AND L50  
L52 71 S L51 AND (L7 OR L8)  
L53 30 S L51 AND L7 AND L8  
L54 0 S (L51 AND (H01L021-28 OR H01L021-3205 OR H01L021-768)/IC) NOT L53  
L55 124 S (L7 OR L8) AND L50  
L56 75 S L53 OR L49 OR (L44 OR (L38 OR L39 OR L40) OR L30)  
L57 80 S L55 NOT L56  
L58 0 S L57 AND (SECOND OR TOP OR BOTTOM)(2A)(FILM OR LAYER####)  
L59 38 S L57 AND (FILM OR LAYER####)  
L60 0 S L35 AND (L7 OR L8)  
L61 31 S L35 AND (L5 OR L6)  
L62 0 S L61 AND (NONCRYST? OR NON CRYST##### OR AMORPHOUS)  
L63 5 S L61 AND CRYST#####  
L64 31751 S (NITROGEN OR "N")(2A)(FILM OR LAYER####)  
L65 79 S (L7 OR L8) AND L64  
L66 6 S L48 AND L65  
L67 12725 S (NITROGEN OR "N")(2A)DIFFERENT  
L68 2315 S L50 AND L67  
L69 43 S (L5 OR L6) AND L68  
L70 49 S L59 OR L66 OR L63  
L71 121 S L70 OR L53 OR L49 OR (L44 OR (L38 OR L39 OR L40) OR L30)  
L72 41 S L69 NOT L71  
L73 1 S L48 AND L72  
L74 40 S L72 NOT L73  
L75 30750 S DOUBLE(2W)LAYER###  
L76 291 S L12 AND L75  
L77 10 S L76 AND AMORPHOUS(1A)(FILM OR LAYER###)  
L78 6 S L76 AND CRYST#####(1A)(FILM OR LAYER###)  
L79 0 S L76 AND NONCRYST#####(1A)(FILM OR LAYER###)  
L80 16 S (L77 OR L78)  
L81 9 S NITRIDE NITRIDE(W)(MULTILAYER OR LAYER OR FILM OR MULTIPLE)  
L82 SEL PLU=ON L81 1- RN: 69 TERMS  
L83 2457130 S L82  
L84 9 S L81 AND L83  
L85 0 S CRYSTAL##### AMORPHOUS DOUBLE LAYER  
L86 0 S CRYSTAL#####(3A)AMORPHOUS DOUBLE(2W)LAYER  
L87 72 S CRYSTAL#####(3A)AMORPHOUS AND DOUBLE(2W)LAYER  
L88 4 S L12 AND L87  
L89 266 S (TAGAMI MASAYOSHI OR HAYASHI YOSHIHIRO)/IN,AU  
L90 81642 S (TWO OR DUAL OR DOUBLE OR BI)(W)LAYER OR BILAYER?  
L91 1 S L89 AND L90  
L92 686 S L12 AND L90  
L93 43 S (AMORPHOUS OR NONCRYST? OR NON CRYST?) AND L92  
L94 19 S L93 AND CRYST?  
L95 SEL PLU=ON L94 1- RN: 67 TERMS  
L96 1859308 S L95  
L97 19 S L94 AND L96  
L98 1 S DOUBLE NITRIDE LAYER  
L99 4 S TWO NITRIDE LAYERS

	Type	L #	Hits	Search Text	DBs	Time Stamp
1	BRS	L1	215	((amorphous and crystal\$5) with nitride) and barrier\$1	USPAT	2002/03/26 17:04
2	BRS	L2	44	((amorphous and crystal\$5) with nitride) and barrier\$1	US-PGP UB; EPO; JPO; DERWEN T; IBM TDB	2002/03/26 17:03
3	BRS	L3	19	((amorphous and crystal\$5) with (TiN or WN or TaN)) and barrier\$1	US-PGP UB; EPO; JPO; DERWEN T; IBM TDB	2002/03/26 17:00
4	BRS	L4	87	((amorphous and crystal\$5) with (TiN or WN or TaN)) and barrier\$1	USPAT	2002/03/26 17:04

03/26/2002, EAST Version: 1.02.0008

	Type	Hits	Search Text
1	BRS	3325	amorphous with nitride
2	BRS	4431	crystal\$5 with nitride
3	BRS	841	(amorphous with nitride) and (crystal\$5 with nitride)
4	BRS	142798	barrier\$1
5	BRS	193	((amorphous with nitride) and (crystal\$5 with nitride)) and barrier\$1

09/14/2001, EAST Version: 1.02.0008

	DBs	Time Stamp	Comments	Error Definition
1	USPAT	2001/09/11 08:53		
2	USPAT	2001/09/11 08:54		
3	USPAT	2001/09/11 09:01		
4	USPAT	2001/09/11 09:01		
5	USPAT	2001/09/11 09:01		

09/14/2001, EAST Version: 1.02.0008



US006538324B1

(12) **United States Patent**  
Tagami et al.

(10) **Patent No.:** US 6,538,324 B1  
(45) **Date of Patent:** Mar. 25, 2003

(54) **MULTI-LAYERED WIRING LAYER AND METHOD OF FABRICATING THE SAME**

(75) Inventors: **Masayoshi Tagami**, Tokyo (JP);  
**Yoshihiro Hayashi**, Tokyo (JP)

(73) Assignee: **NEC Corporation**, Tokyo (JP)

(\*) Notice: Subject to any disclaimer, the term of this patent is extended or adjusted under 35 U.S.C. 154(b) by 0 days.

(21) Appl. No.: **09/596,415**

(22) Filed: **Jun. 19, 2000**

(30) **Foreign Application Priority Data**

Jun. 24, 1999 (JP) ..... 11-214110

(51) **Int. Cl.**<sup>7</sup> ..... **H01L 23/48; H01L 23/52**

(52) **U.S. Cl.** ..... **257/751; 257/762**

(58) **Field of Search** ..... **257/751, 752, 257/753, 758, 762, 773; 438/626, 627, 628, 643, 644, 645**

(56) **References Cited**

**U.S. PATENT DOCUMENTS**

5,668,411 A \* 9/1997 Hong et al. .... 257/751  
5,858,873 A \* 1/1999 Vitkavage et al. .... 438/626

**FOREIGN PATENT DOCUMENTS**

JP 8-139092 5/1996  
JP 8-274098 10/1996  
JP 9-64044 3/1997  
JP 9-293690 \* 11/1997  
JP 10-256256 9/1998

**OTHER PUBLICATIONS**

Semiconductor World Nobuyoshi Aways, Feb. 1998, pp. 91-96.

Kee-Won Kwon et al., "Characteristics of Ta As An Underlayer for Cu Interconnects", Advanced Metallization and Interconnect Systems for ULSI Applications in 1997, 1998, pp. 711-716.

M. T. Wang, et al., "Barrier Properties of Very Thin Ta and TaN Layers Against Copper Diffusion", Journal Electrochemical Society, Jul. 1998, pp. 2538-2545.

D. Denning, et al., An Inlaid CVD Cu Based Integration for Sub 0.25µm Technology, 1998 Symposium on VLSI Technology Digest of Technical Papers, 1998, pp. 22-23.

\* cited by examiner

*Primary Examiner*—Tom Thomas

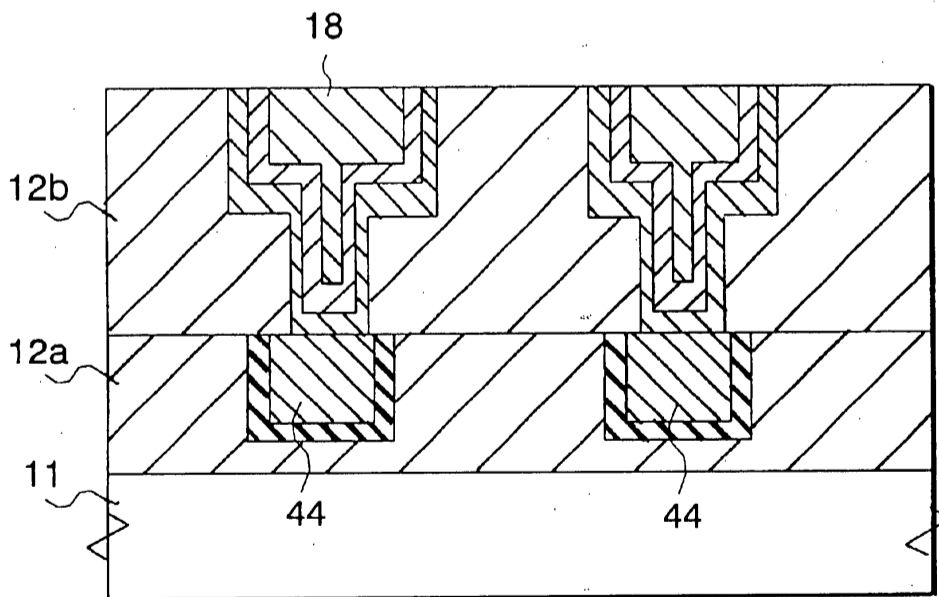
*Assistant Examiner*—Hung Kim Vu

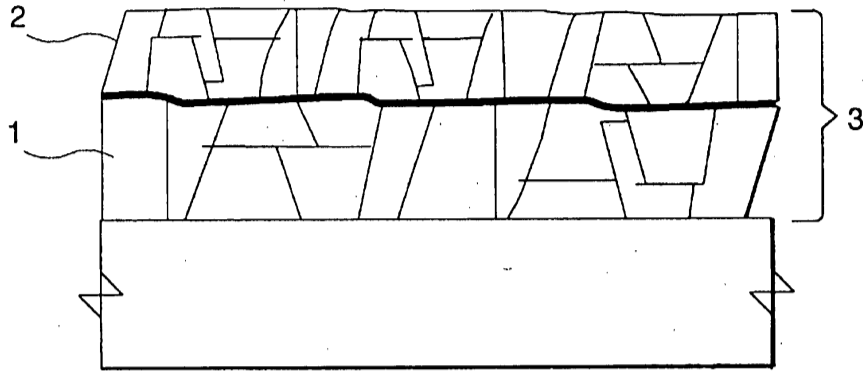
(74) *Attorney, Agent, or Firm*—Scully, Scott, Murphy & Presser

(57) **ABSTRACT**

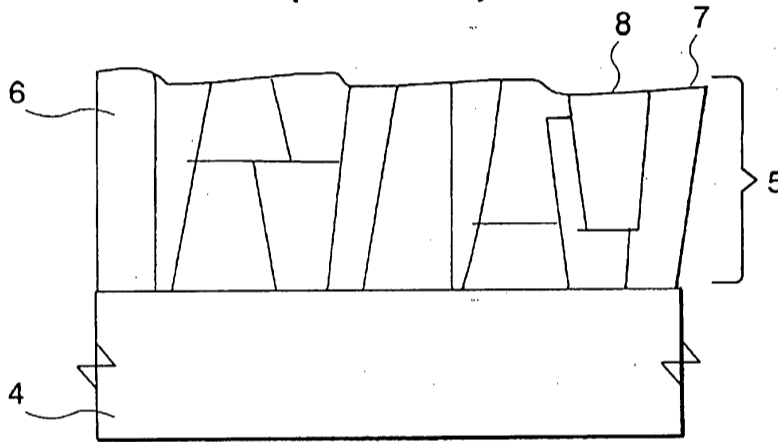
There is provided a barrier film preventing diffusion of copper from a copper wiring layer formed on a semiconductor substrate. The barrier film has a multi-layered structure of first and second films wherein the first film is composed of crystalline metal containing nitrogen therein, and the second film is composed of amorphous metal nitride. The barrier film is constituted of common metal atomic species. The barrier film prevents copper diffusion from a copper wiring layer into a semiconductor device, and has sufficient adhesion characteristic to both a copper film and an interlayer insulating film.

**10 Claims, 20 Drawing Sheets**

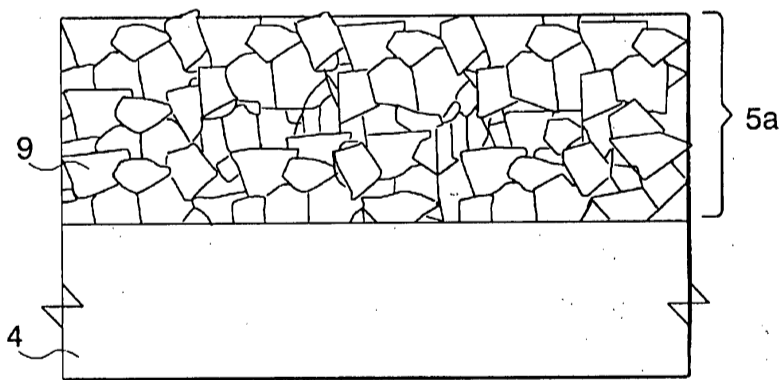




**FIG. 1**  
*(Prior Art)*



**FIG. 2**  
*(Prior Art)*



**FIG. 3**  
*(Prior Art)*



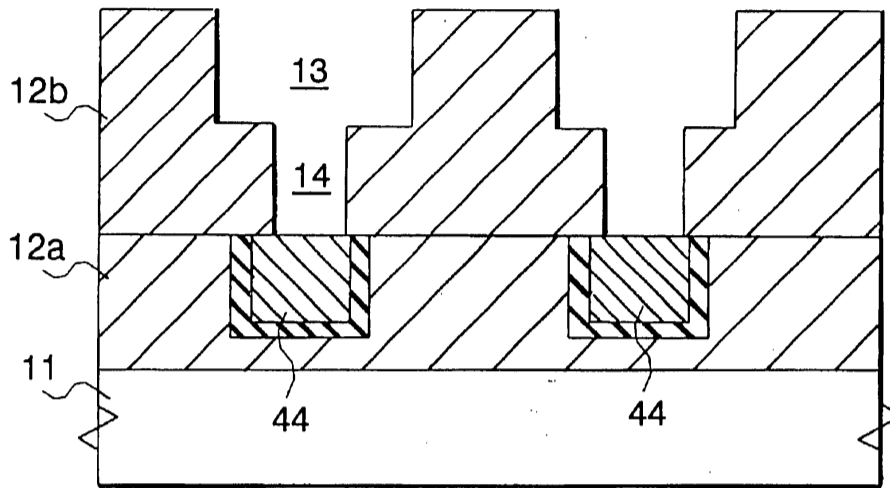


FIG. 4A

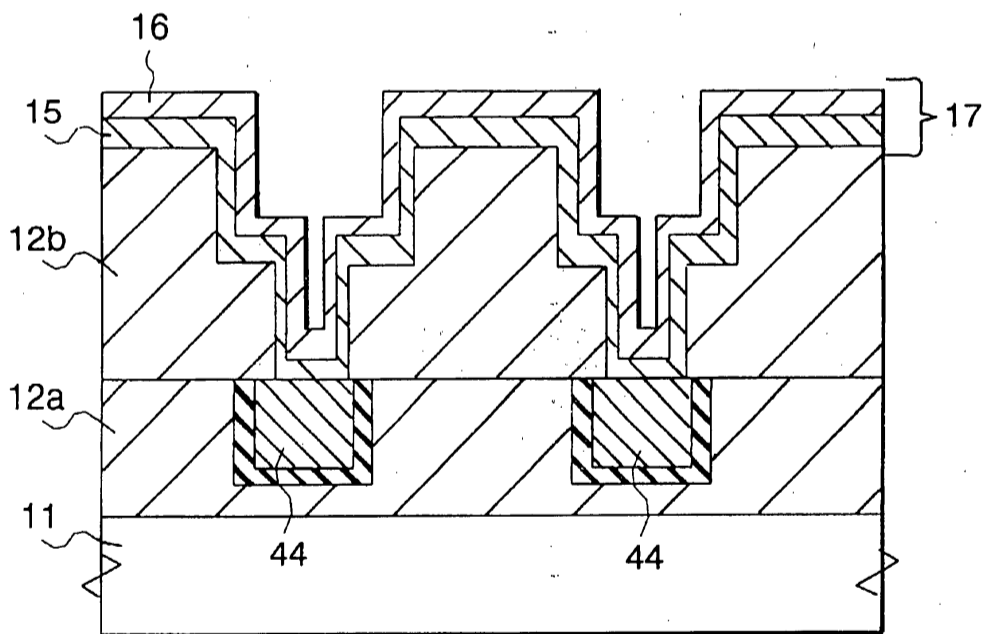


FIG. 4B

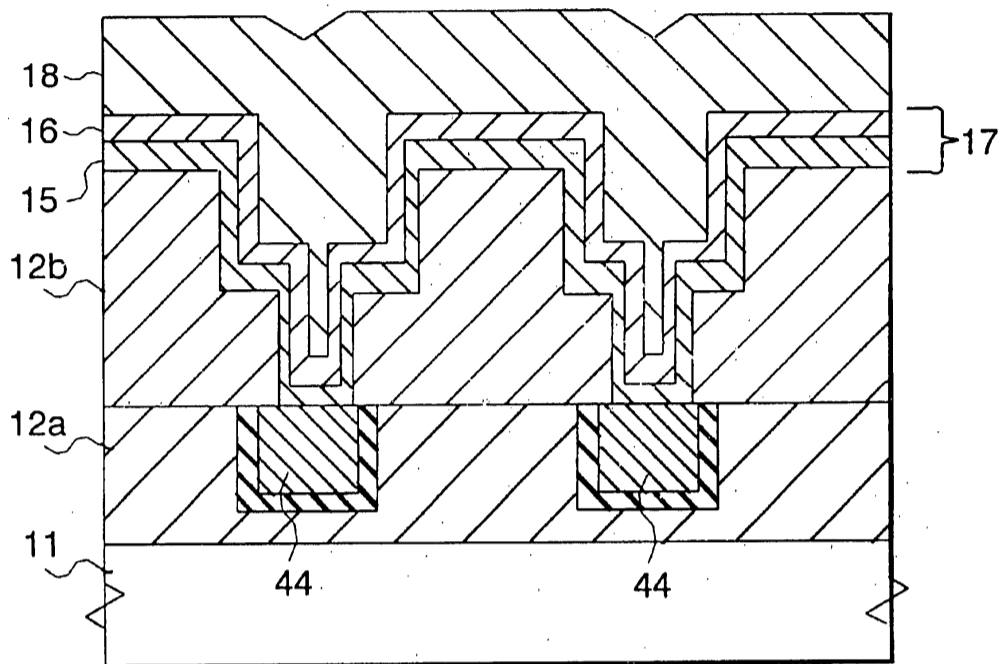


FIG. 4C

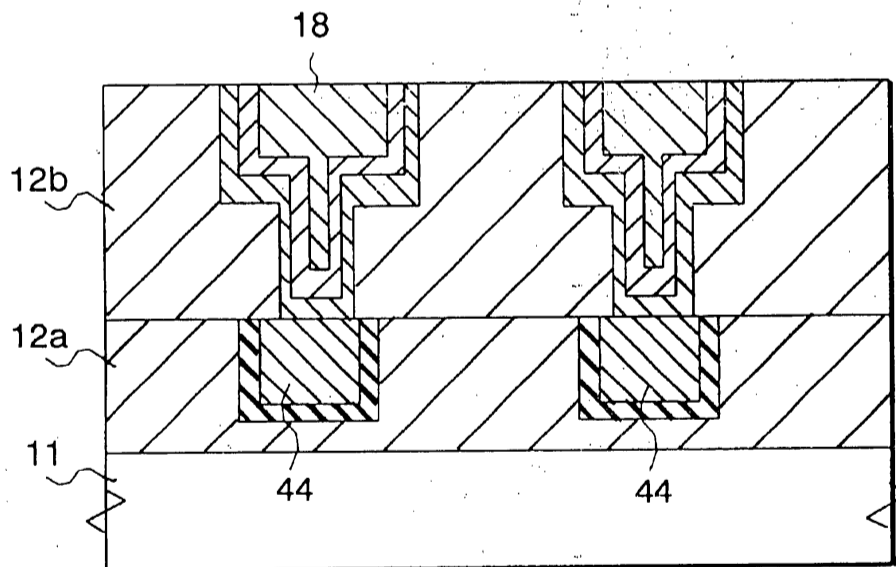
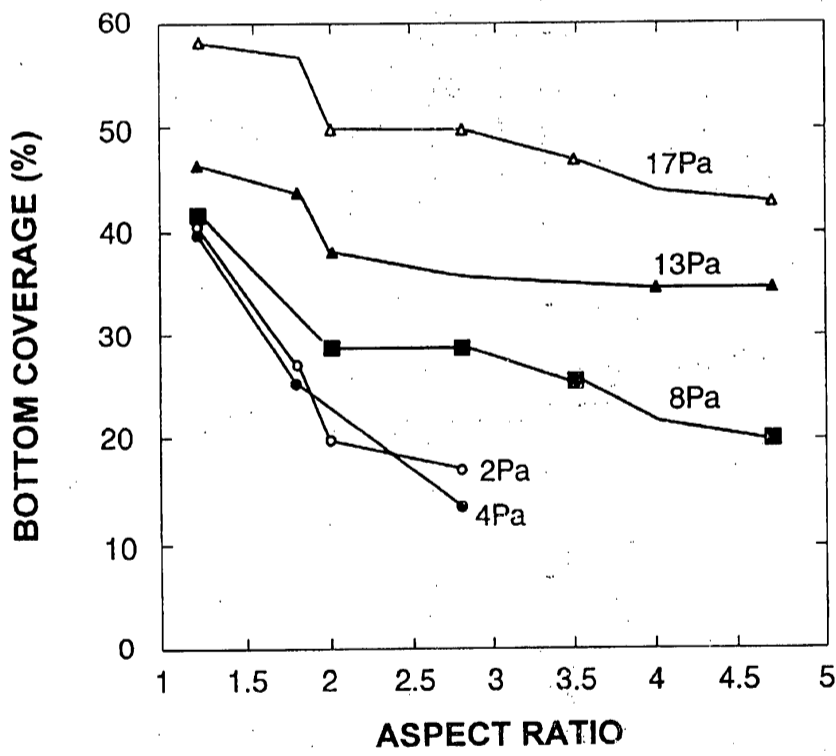
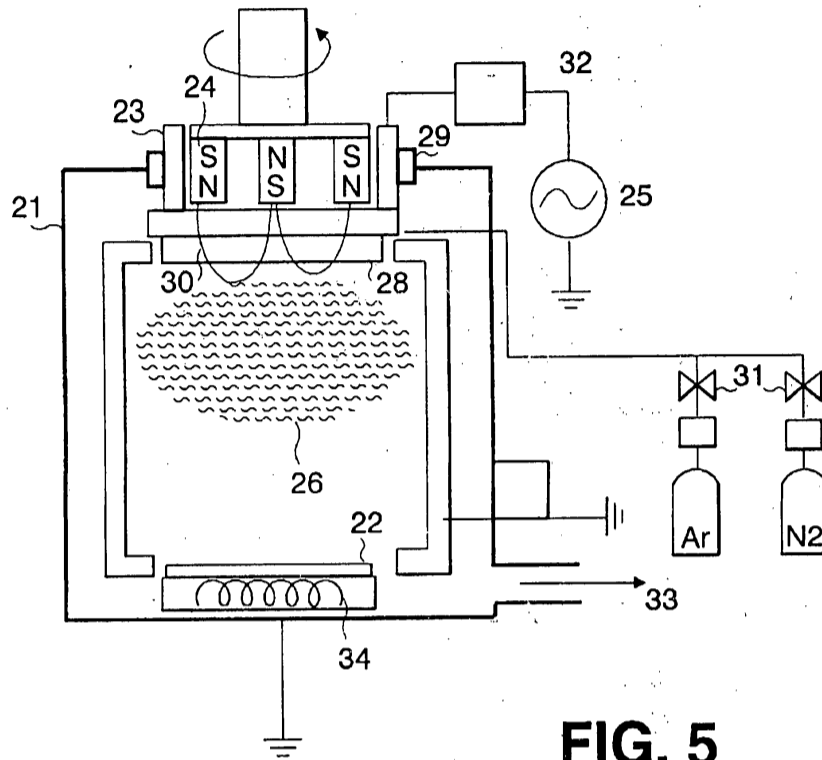


FIG. 4D



**FIG. 6**

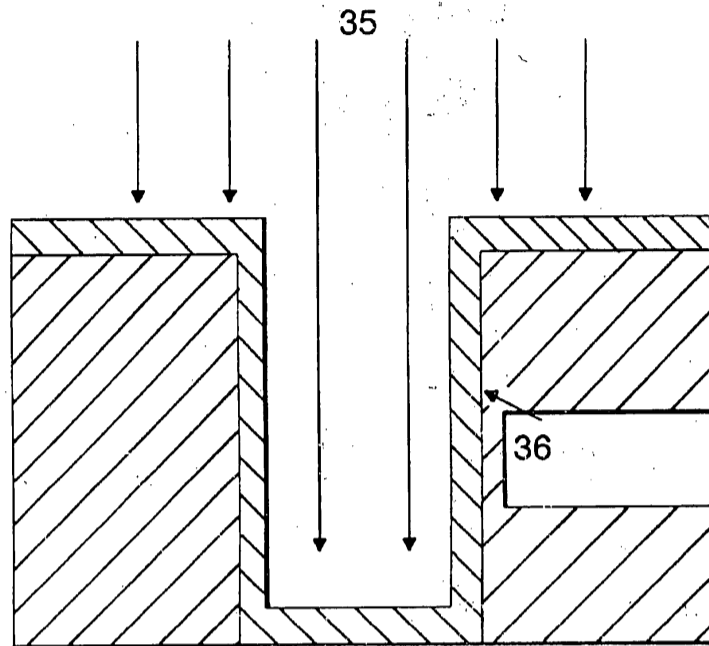


FIG. 7

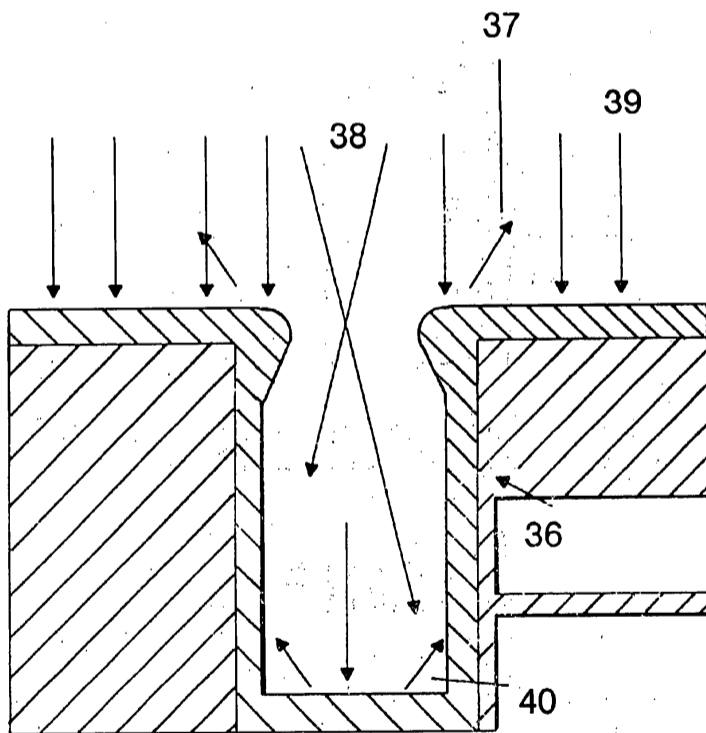


FIG. 8

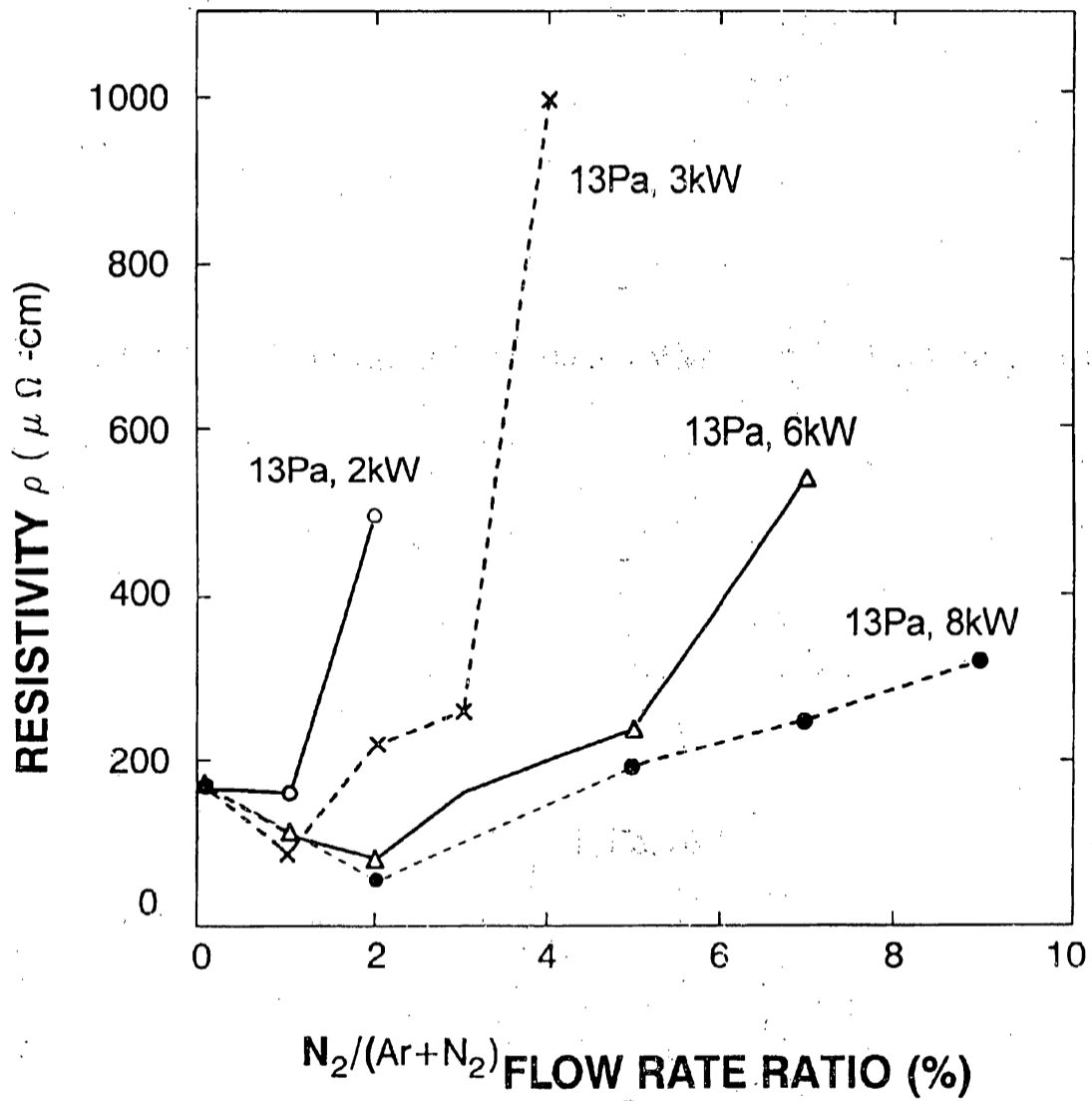


FIG. 9

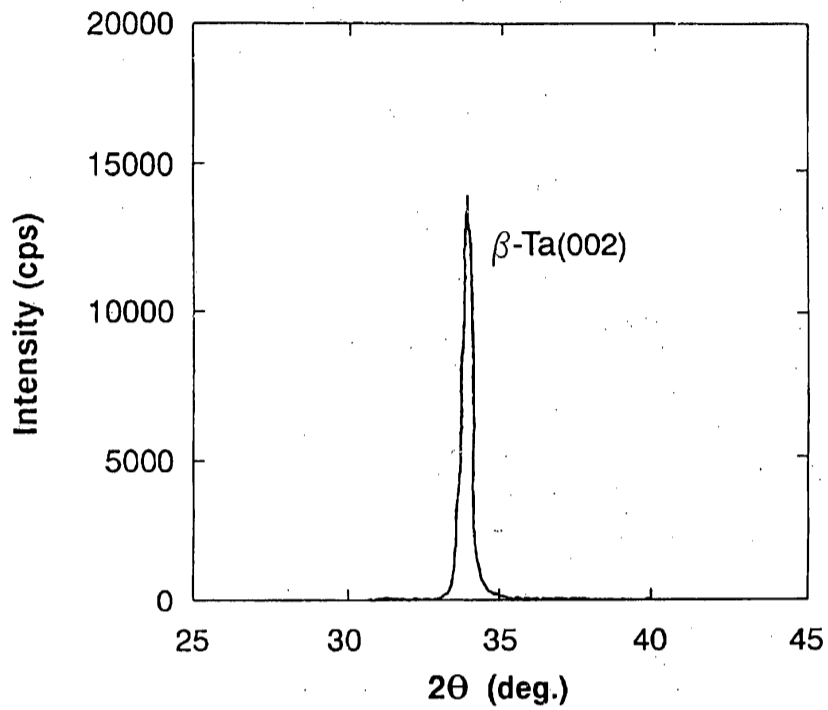


FIG. 10

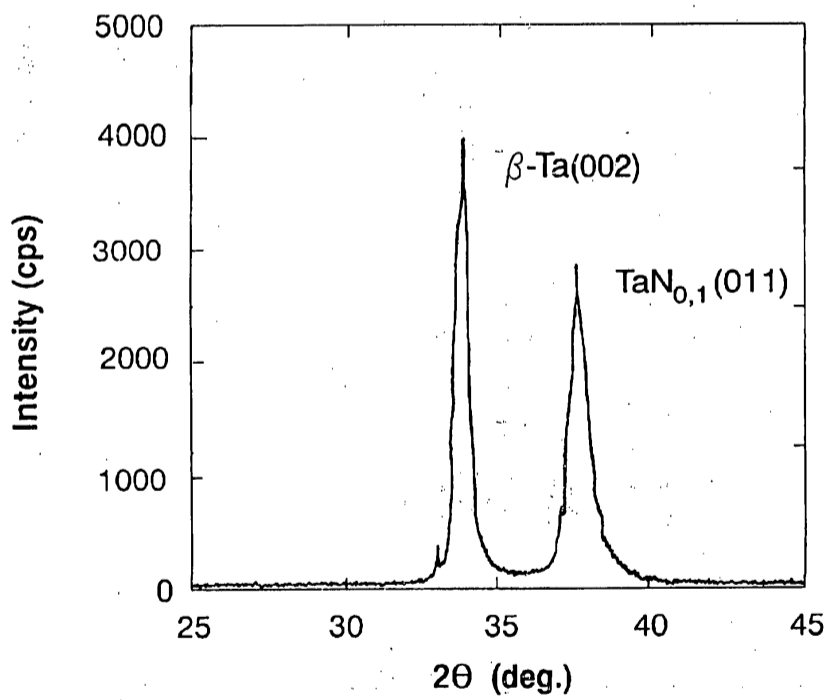


FIG. 11

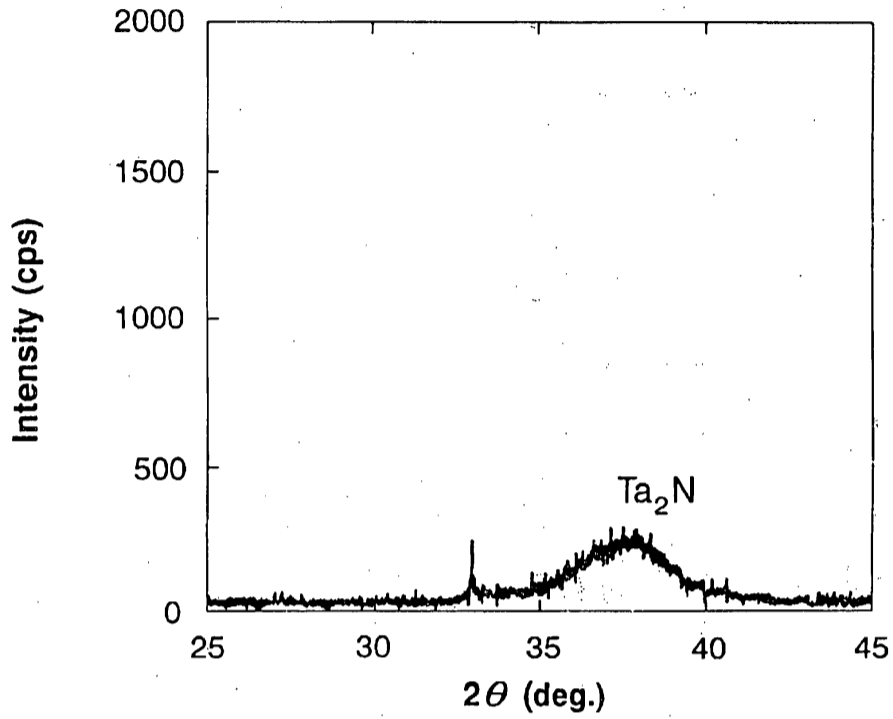


FIG. 12

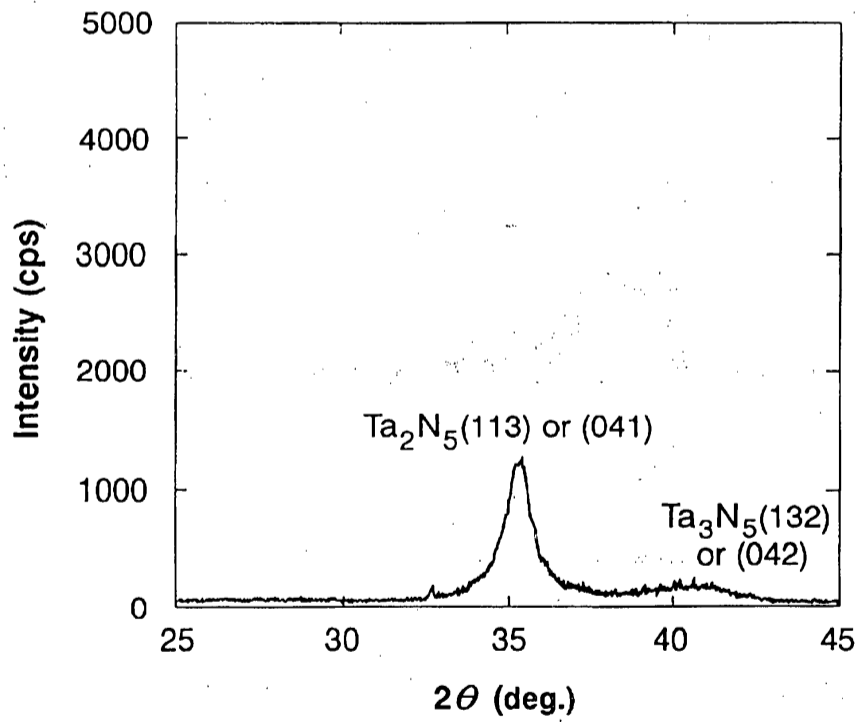


FIG. 13

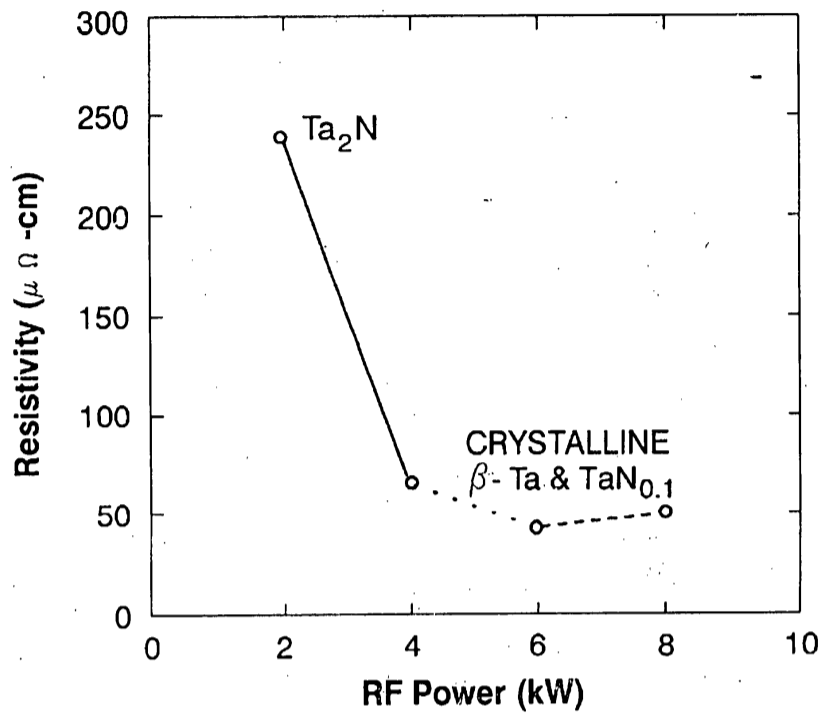


FIG. 14

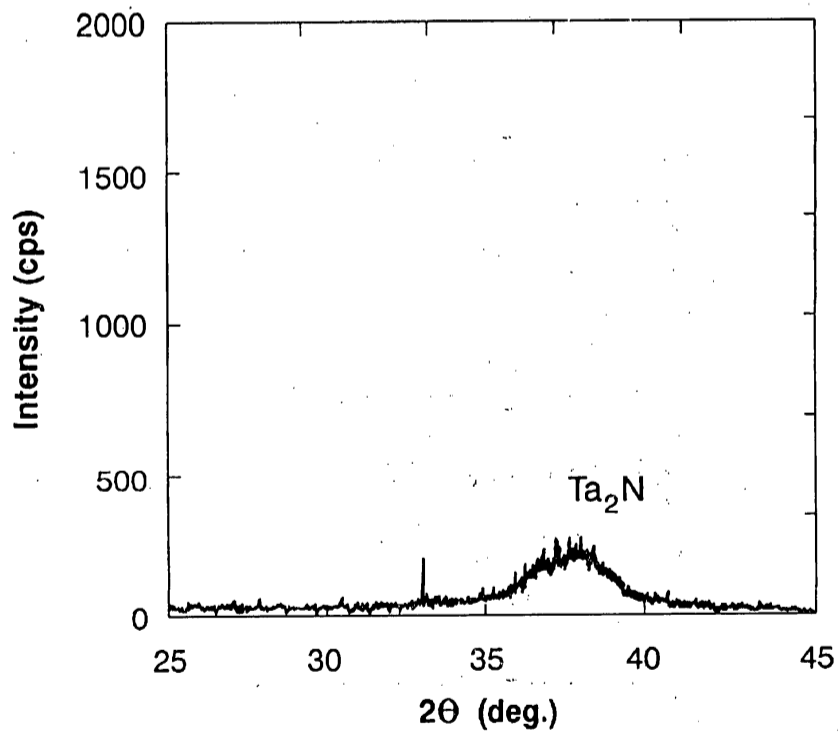


FIG. 15



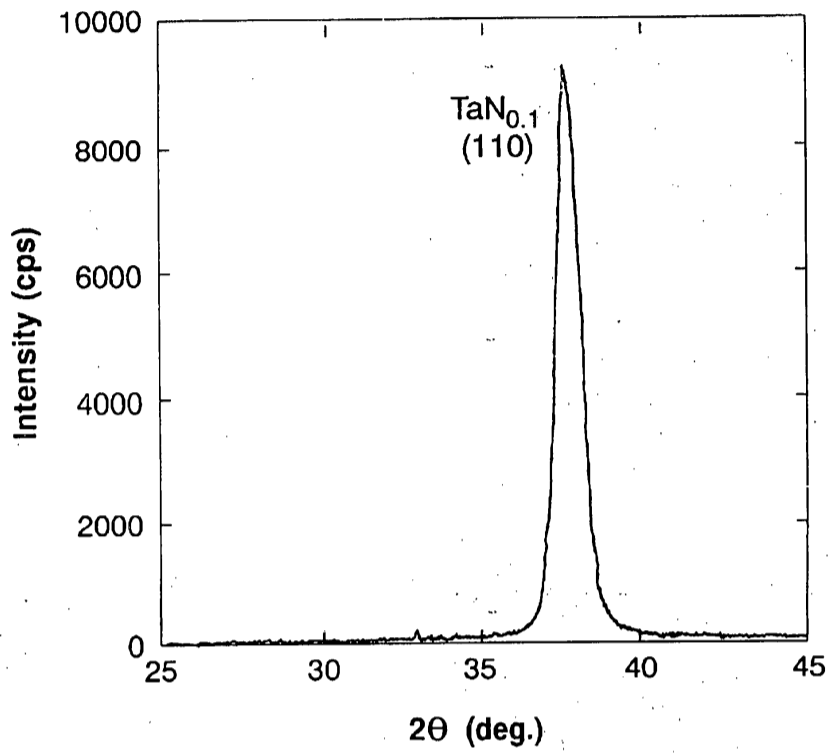


FIG. 16

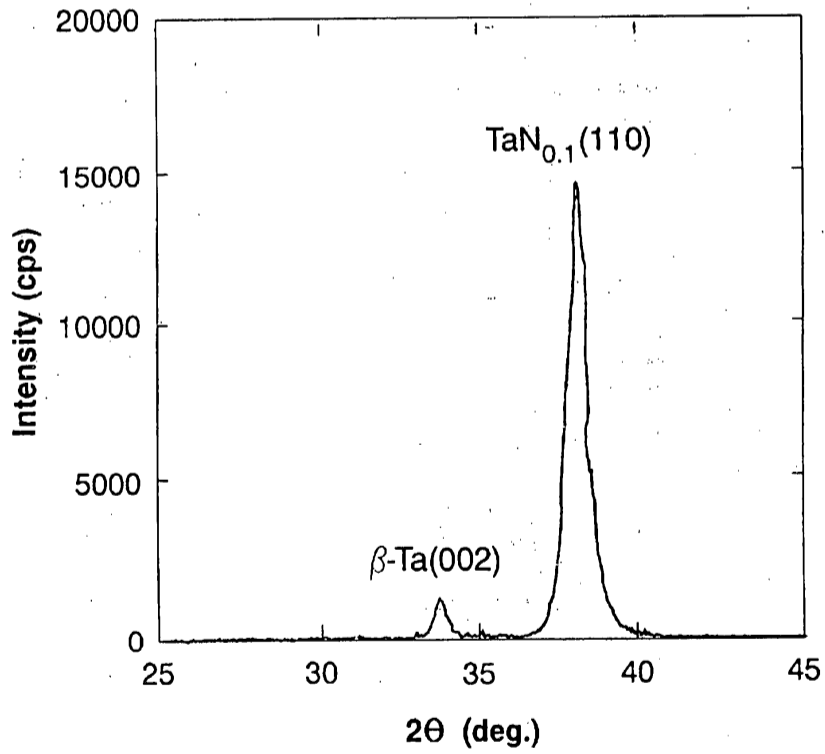


FIG. 17

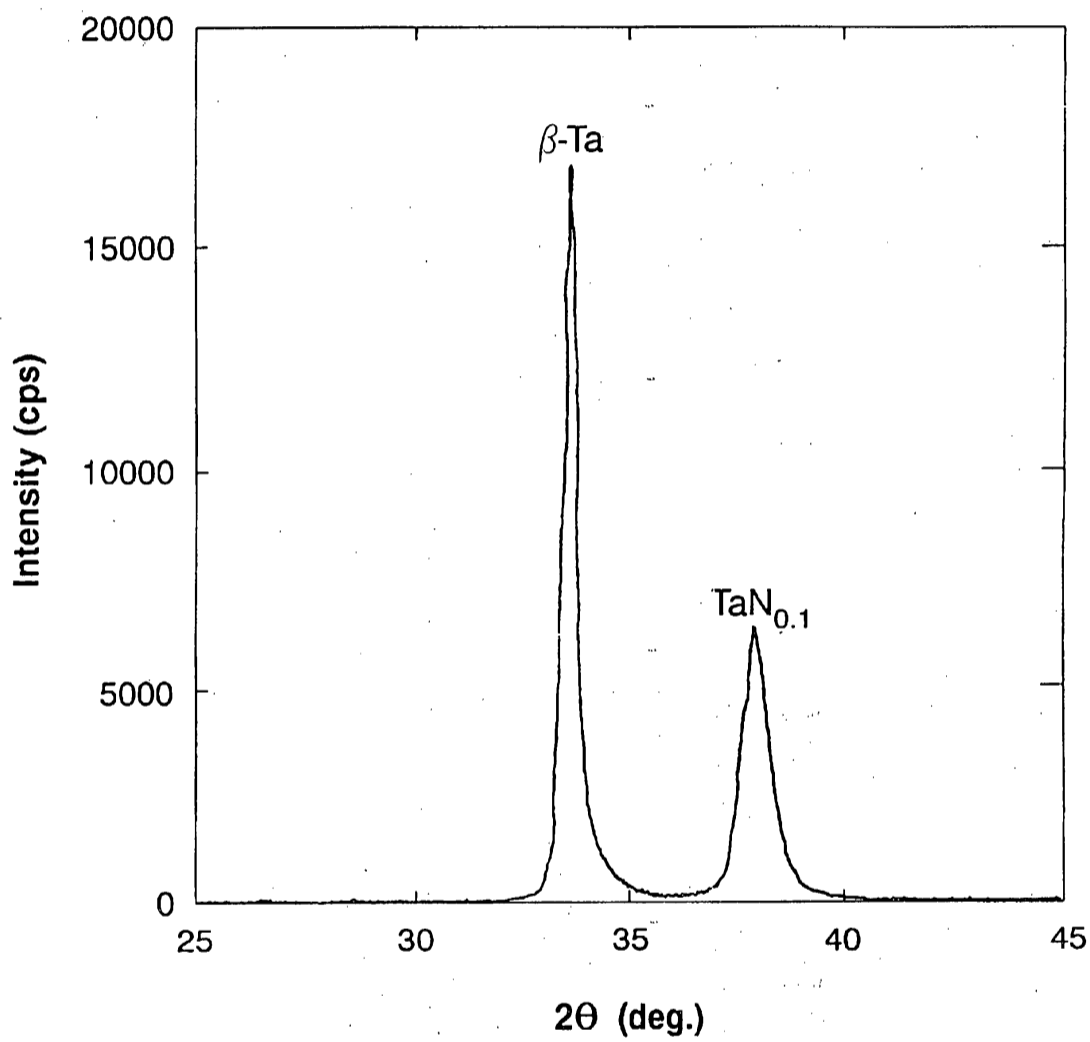
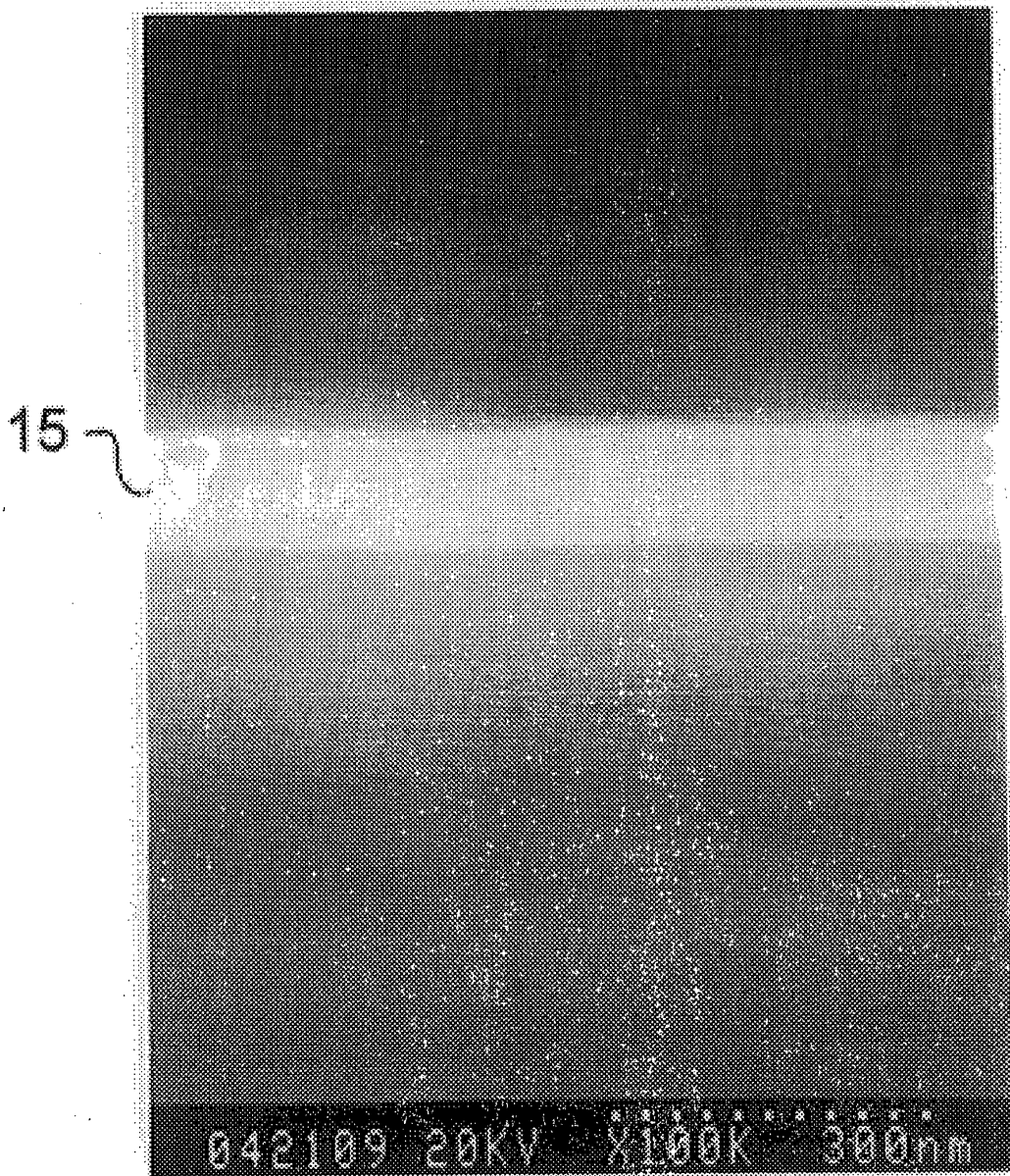
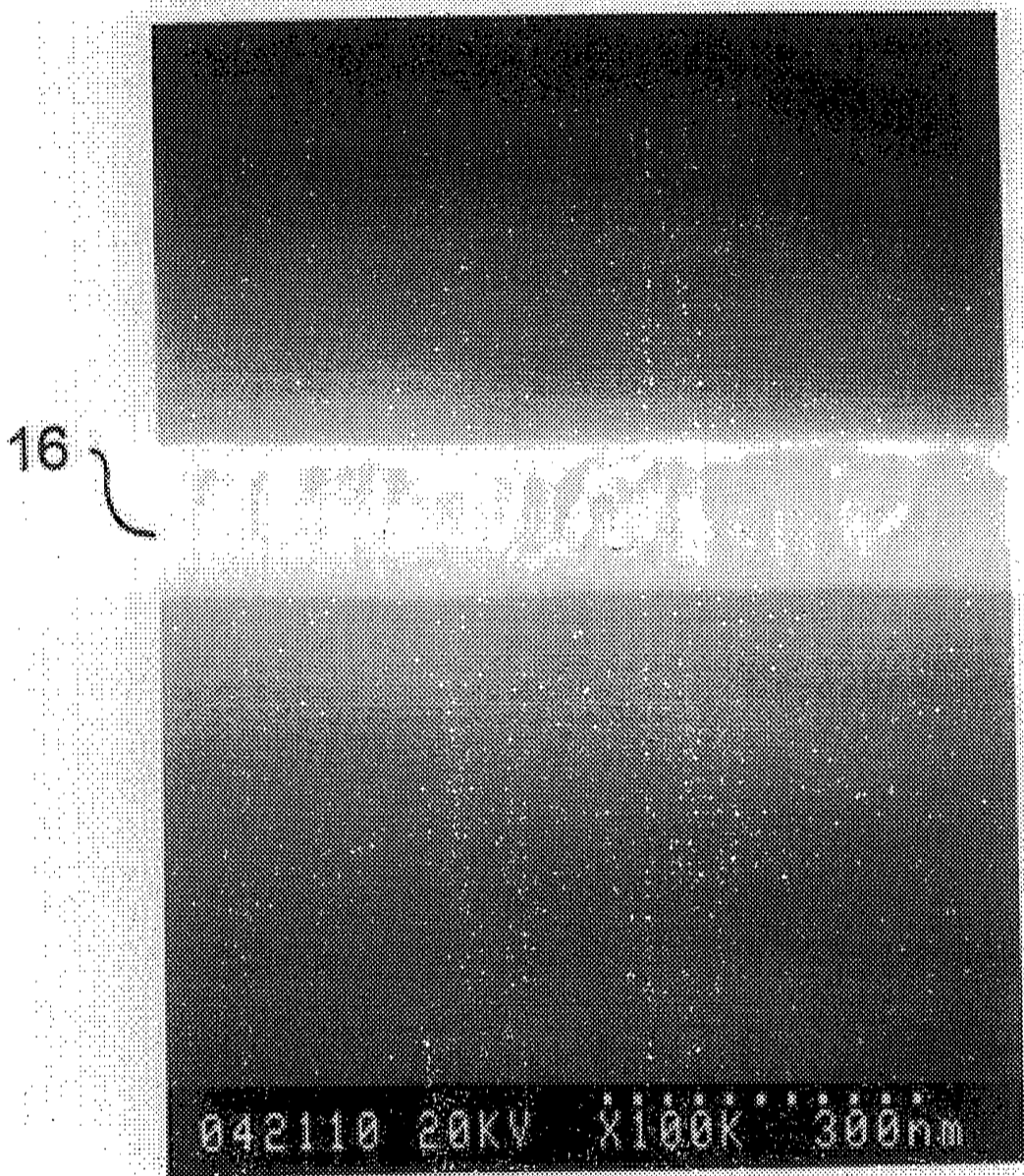


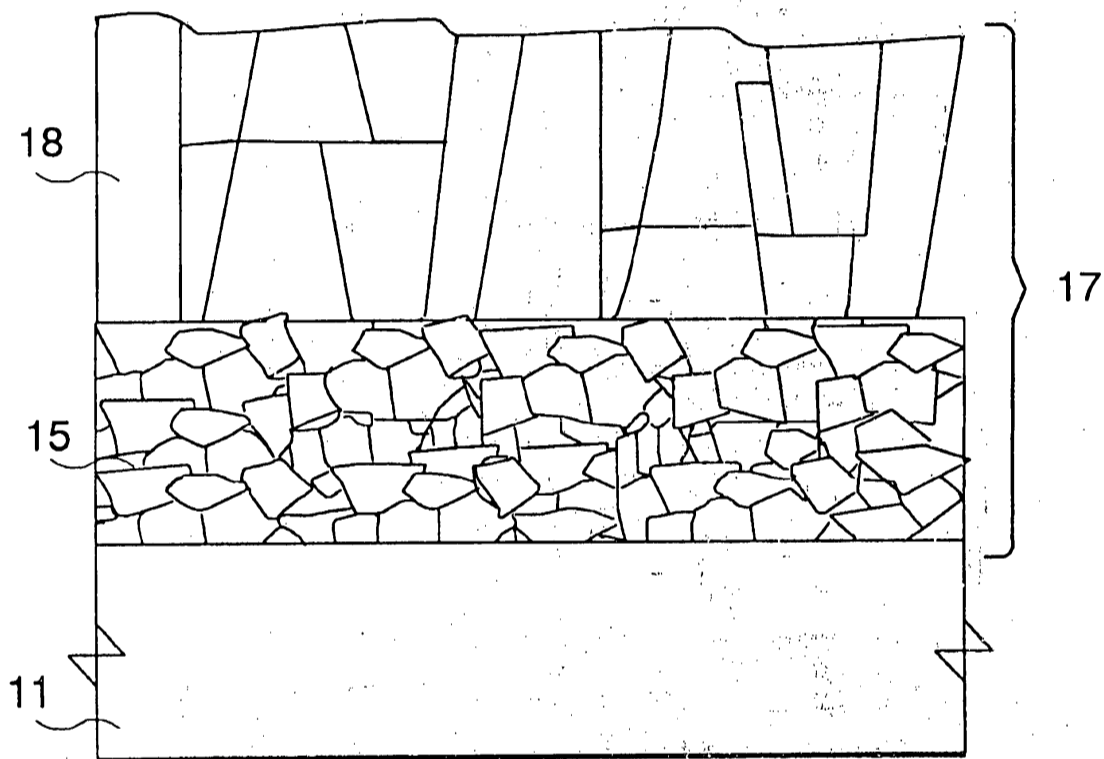
FIG. 18



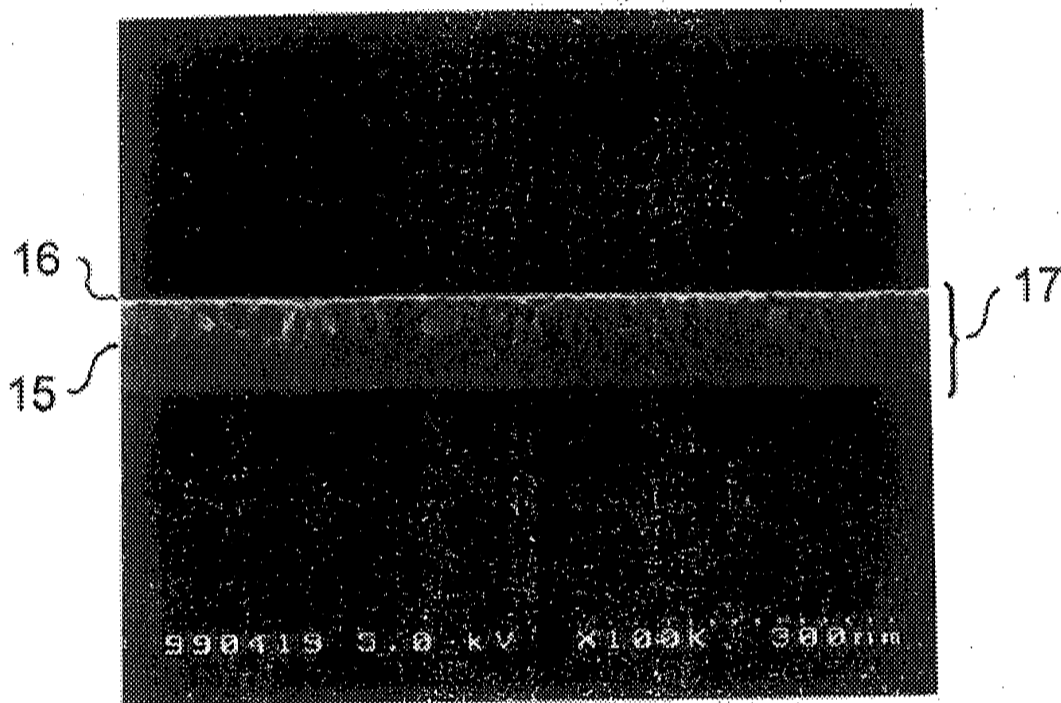
**FIG. 19**



**FIG. 20**



**FIG. 21**



**FIG. 22**

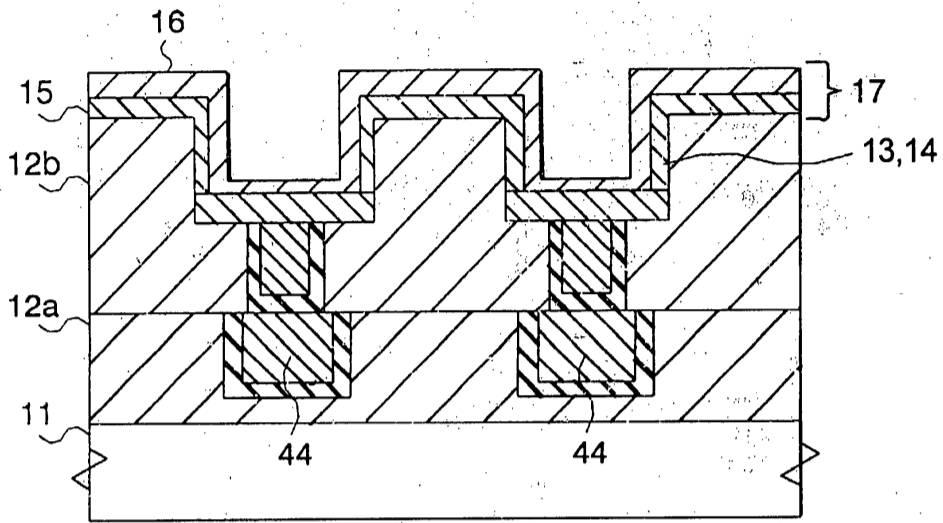


FIG. 23

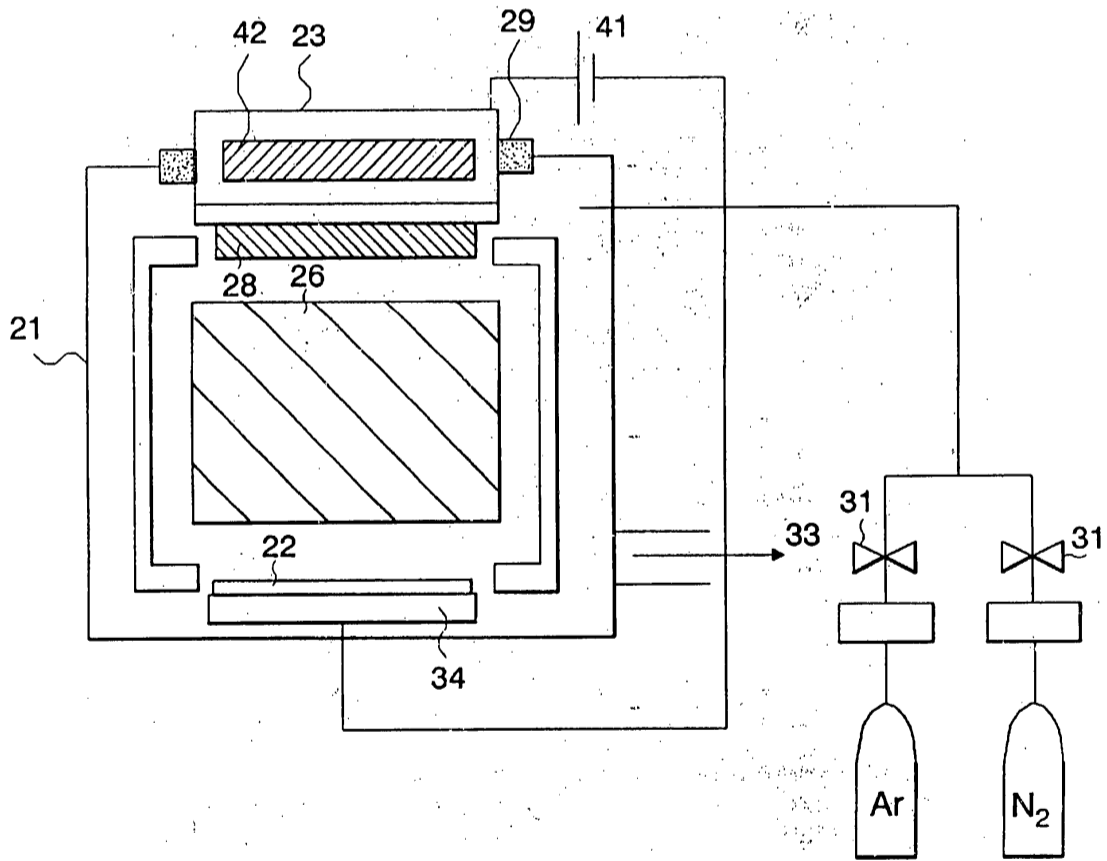


FIG. 24

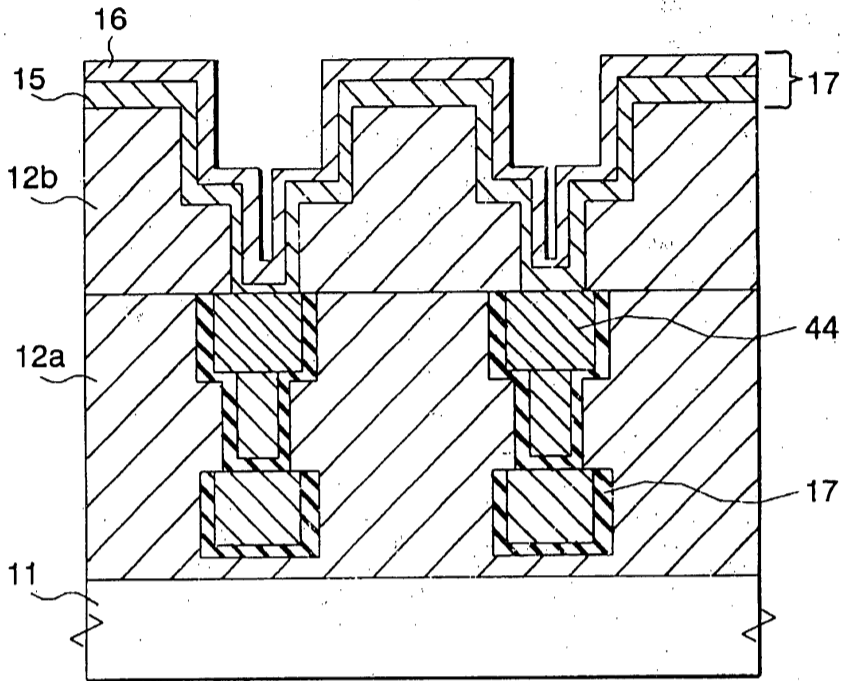


FIG. 25

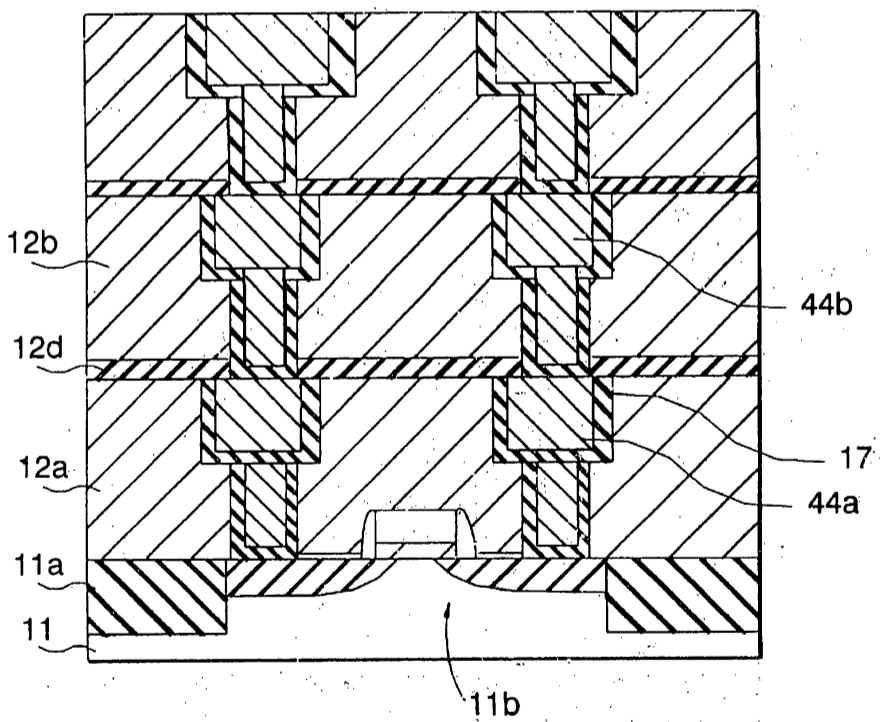
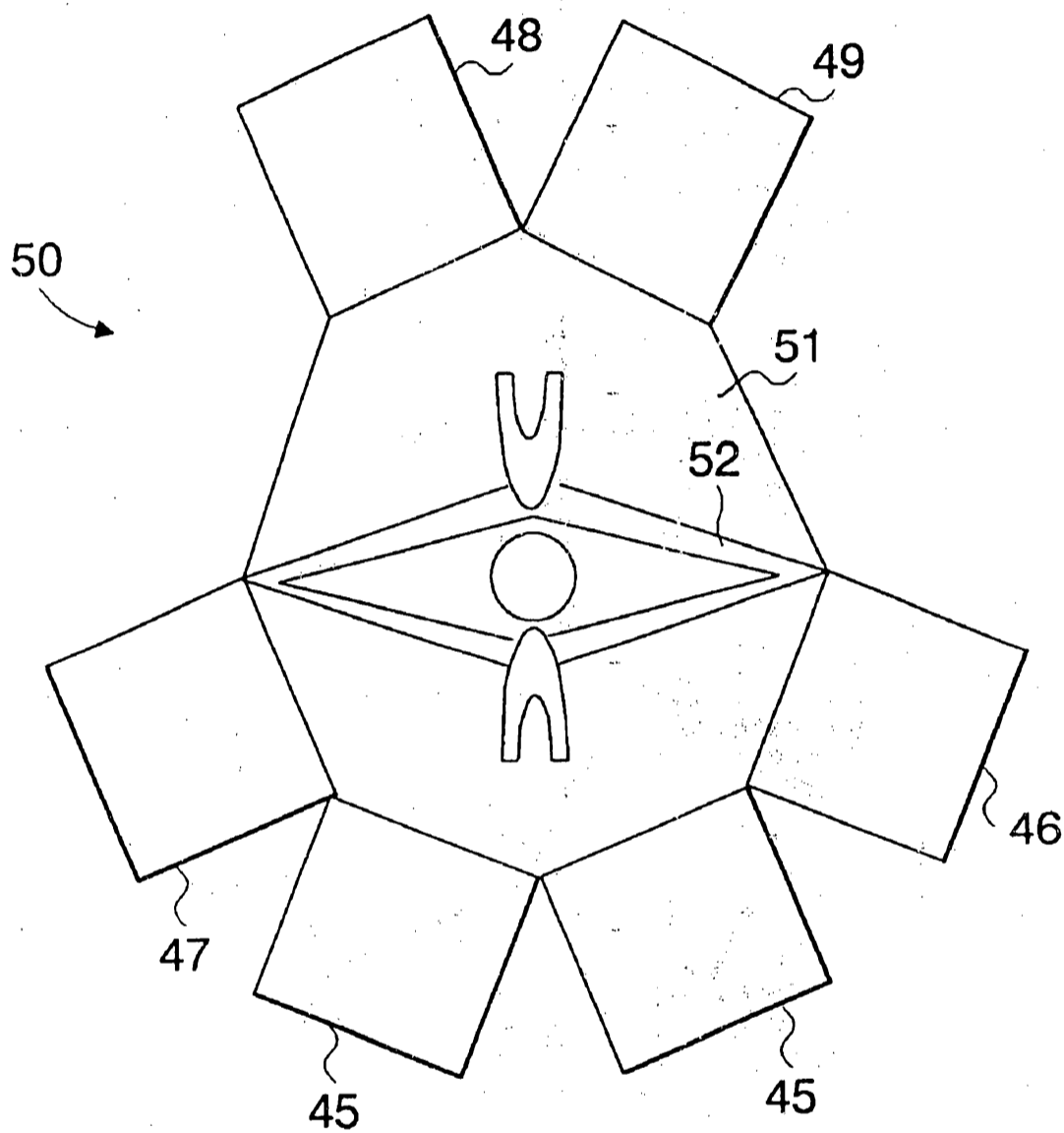


FIG. 26





**FIG. 27**

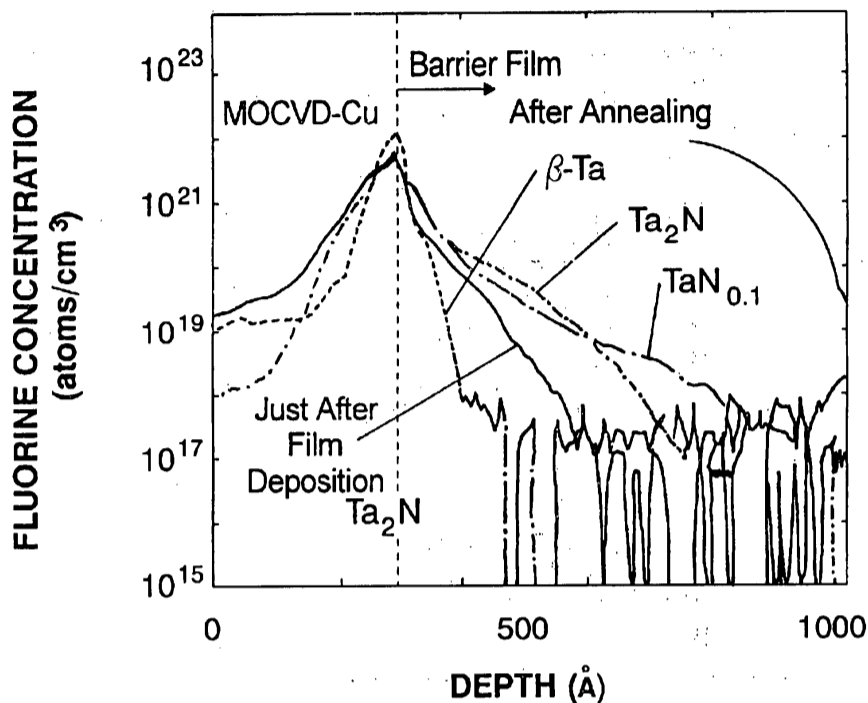


FIG. 28

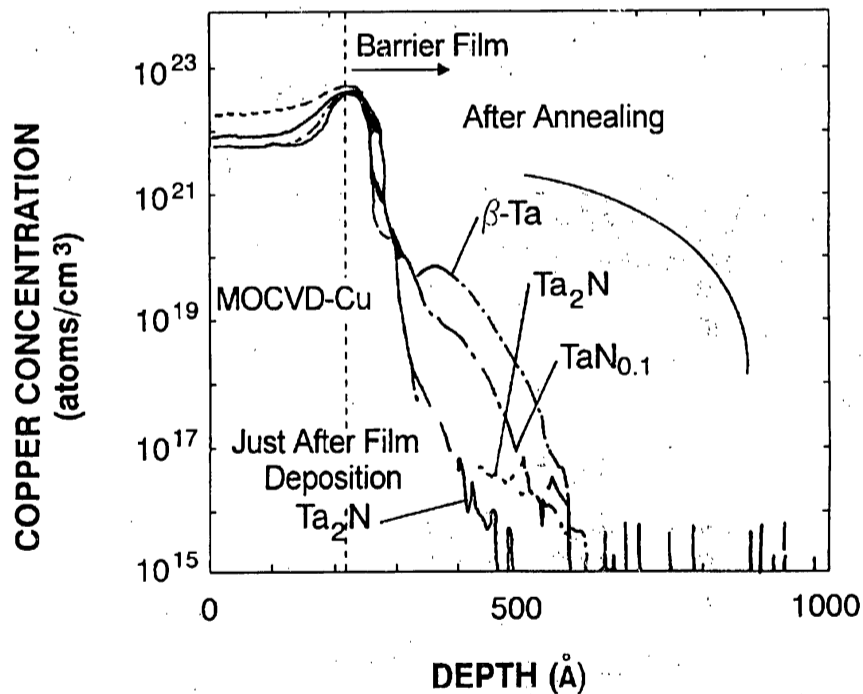


FIG. 29

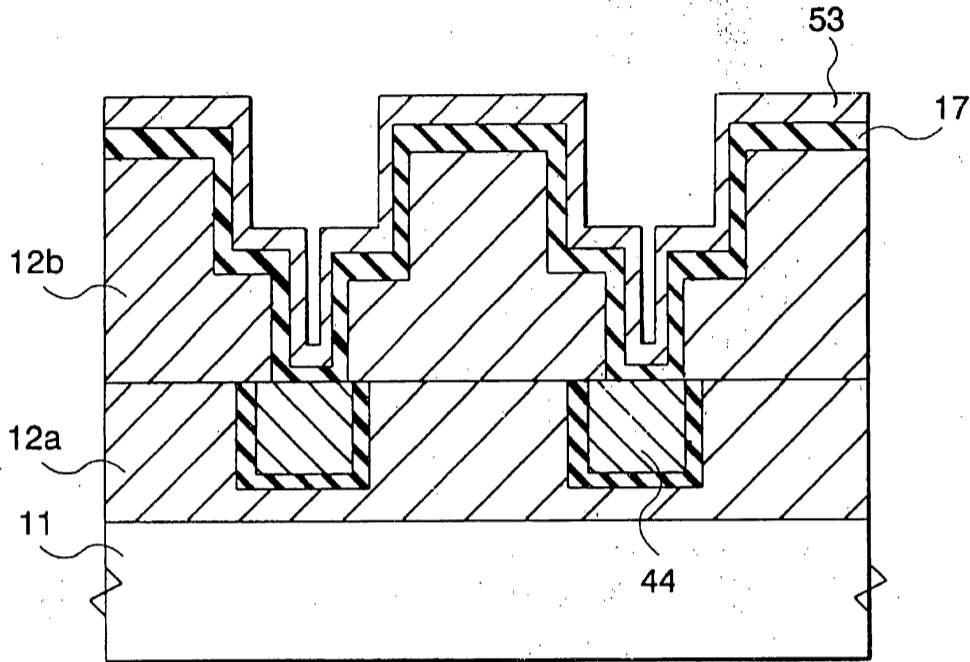


FIG. 30

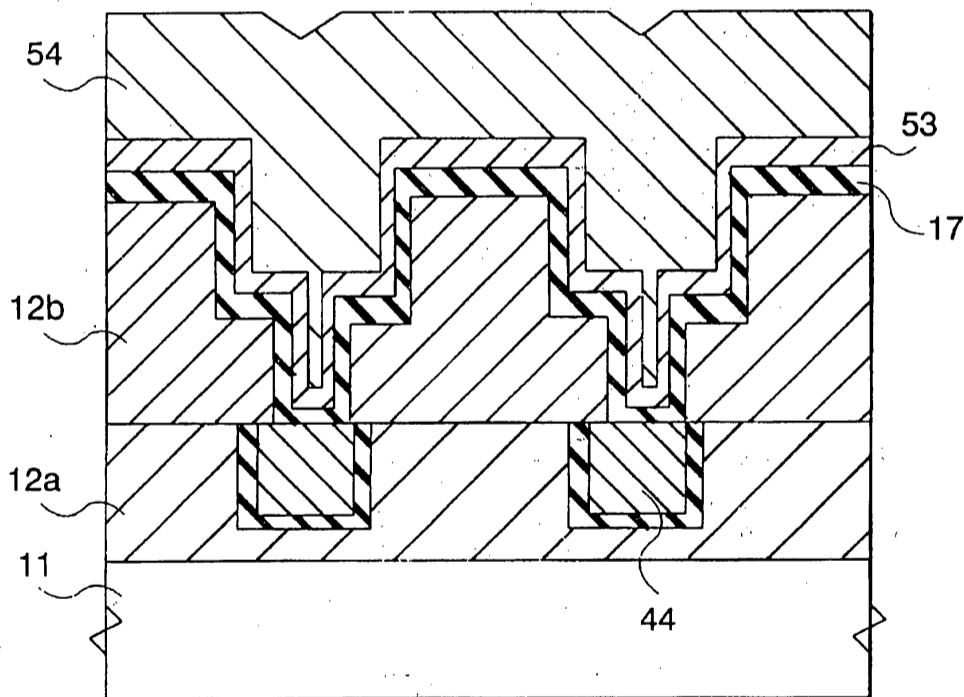


FIG. 31

1

**MULTI-LAYERED WIRING LAYER AND  
METHOD OF FABRICATING THE SAME**

BACKGROUND OF THE INVENTION

1. Field of the Invention

The invention relates to a semiconductor integrated circuit including a copper wiring layer, and more particularly to a barrier film which prevents copper diffusion from such a copper wiring layer.

2. Description of the Related Art

As a semiconductor device has been designed to be smaller and smaller in size, wiring delay exerts greater influence on a silicon ULSI device. As a result, though a wiring layer has been composed of aluminum, it is necessary to compose a wiring layer of copper in place of aluminum.

Resistivity of copper is equal to about 70% of resistivity of aluminum. However, since copper does not form passive state composed of an oxide film, at a surface thereof, unlike aluminum, copper is more corrosive than aluminum.

In addition, since copper has a high diffusion rate in both silicon (Si) and silicon dioxide (SiO<sub>2</sub>), if copper enters MOSFET formed on a silicon substrate, copper would induce reduction in carrier lifetime.

Hence, it is absolutely necessary for a semiconductor device having a copper wiring layer to have a diffusion-barrier film for preventing diffusion of copper into an interlayer insulating film formed between copper wiring layers. In addition, since such a diffusion-barrier film has to have high adhesion characteristic to both an interlayer insulating film and a copper wiring layer in order to keep reliability in wiring.

Thus, there have been made many suggestions about a structure of a barrier metal layer and a method of fabricating the same, in order to prevent copper diffusion from a copper wiring layer.

For instance, a structure of a barrier metal layer is suggested in the following articles:

- (a) Semiconductor World, Nobuyoshi Awaya, February 1998, pp. 91-96 (hereinafter, referred to as Prior Art 1);
- (b) Advanced Metallization and Interconnect Systems for ULSI Applications in 1997, Kee-Won Kwon et al., 1998, pp. 711-716 (hereinafter, referred to as Prior Art 2);
- (c) Journal Electrochemical Society, M. T. Wang et al., July 1998, pp. 2538-2545 (hereinafter, referred to as Prior Art 3); and
- (d) 1998 Symposium on VLSI Technology Digest of Technical Papers, D. Denning et al., 1998, pp. 22-23.

In addition, a structure of a barrier metal layer and a method of fabricating the same both for preventing copper diffusion is suggested also in Japanese Unexamined Patent Publications 8-139092, 8-274098, 9-64044 and 10-256256, and Japanese Patent Application No. 10-330938. Herein, Japanese Patent Application No. 10-330938 is not published yet, and hence does not constitute prior art to the present invention. However, it is explained in the specification only for better understanding of the present invention. The applicant does not admit that Japanese Patent Application No. 10-330938 constitutes prior art to the present invention.

It is quite difficult to dry-etch copper, and hence, a copper wiring layer is formed generally by chemical mechanical polishing (CMP).

Specifically, a copper wiring layer is formed as follows.

An insulating film is formed on an underlying copper wiring layer. Then, the insulating film is formed with a

2

recess and a through-hole reaching the underlying copper wiring layer. Then, a thin diffusion-barrier film is formed on surfaces of the recess and the through-hole therewith such that the recess and the through-hole is completely covered at surfaces thereof with the diffusion-barrier film in order to prevent copper diffusion from uncovered region.

Thereafter, a copper film is deposited filling the recess and the through-hole therewith by CVD or sputtering. Then, the copper film and the diffusion-barrier film are removed in selected regions by CMP. Thus, a copper wiring layer is completed.

As will be obvious to those skilled in the art, the diffusion-barrier film is required to have high coverage as well as capability of preventing copper diffusion and adhesion to copper.

The diffusion-barrier film is composed, for instance, of refractive metal such as tungsten (W), tantalum (Ta) or titanium (Ti), or nitride of such refractive metal such as tungsten nitride (WN), titanium nitride (TiN) or tantalum nitride (TaN).

As explained in Prior Art 2, for instance, a tantalum (Ta) barrier film has high adhesion with a copper film formed on the tantalum barrier film by sputtering, ensuring improvement in crystallinity of the copper film. However, since copper is diffused into the tantalum film, it would be necessary for the tantalum barrier film formed below the copper film, to have a thickness of 50 nm or greater.

Prior Art 4 reports that if a copper film is formed on a tantalum film by CVD, fluorine (F) segregates at an interface between the copper film and TaN, resulting in degradation in adhesion therebetween.

Prior Art 3 reports that a crystalline TaN barrier film oriented in directions of (200) and (111) can prevent copper diffusion more highly than a crystalline Ta barrier film.

As an solution to enhance a characteristic of preventing copper diffusion and adhesion to copper, a multi-layered structure of a metal film and a metal nitride film has been suggested.

For instance, the above-mentioned Japanese Patent Application No. 10-330938 has suggested a method of fabricating a multi-layered barrier film including a titanium film and formed by sputtering.

As illustrated in FIG. 1, in accordance with the suggested method, only an argon gas is introduced into a sputter chamber to thereby form a titanium film 1. Then, a nitrogen gas is introduced into the sputter chamber, and a thin titanium nitride film 2 is formed on the titanium film 1 auxiliarily making use of reaction between titanium and nitrogen. Thus, there is formed a multi-layered barrier structure 3 comprised of the titanium film 1 and the thin titanium nitride film 2.

In the method, a metal oxide film formed on an underlying wiring film is removed by argon plasma prior to carrying out sputtering.

However, the conventional barrier film for preventing copper diffusion is accompanied with the following problems.

The first problem is that it is quite difficult to make a diffusion-barrier film have both a characteristic of preventing copper diffusion and a sufficient adhesive force with copper.

As illustrated in FIG. 2, it is now assumed to form a metal film 5 having a crystallized pillar structure, on a semiconductor substrate 4. In the metal film 5, a lot of grains each comprised of individual crystals, and grain boundaries 7 each defining an interface between the grains 6 exist throughout the metal film 5, that is, from an upper surface to

3

a bottom of the metal film 5. The grain boundaries 7 define paths 8 through which copper is diffused. As a result, the metal film 5 has low barrier characteristic of preventing copper diffusion.

As illustrated in FIG. 3, it is now assumed to form a metal film 5a on a semiconductor substrate 4. If the metal film 5a is composed of metals having small resistivity, such as tungsten (W), titanium (Ti) or tantalum (Ta), the metal film 5 would have a polycrystal structure. As a result, the metal film 5a would have a pillar-like structure similarly to the metal film 5 illustrated in FIG. 2, and accordingly, the metal film 5a would have small barrier characteristic of preventing copper diffusion.

However, it should be noted that if a copper film is formed on a crystalline metal film, such as a  $\beta$ -Ta (002) film as obtained in sputtering of a tantalum film, by sputtering, the copper film would have high adhesion and rich crystal orientation, though a barrier characteristic of preventing copper diffusion would be deteriorated. As a result, the copper film would enhance reliability in copper wiring.

In contrast, the metal film 5a illustrated in FIG. 3, which is composed of particles 9 such as amorphous TaN and formed on the semiconductor substrate 4, has small resistivity, specifically in the range of about 200 to 250  $\mu\Omega\text{cm}$ , and does not have the paths through which copper is diffused unlike the crystalline metal film 5 illustrated in FIG. 2. As a result, the metal film 5a would have high barrier characteristic of preventing copper diffusion.

However, since a surface of the metal film 5a is amorphous and hence crystal lattice is not uniformly arranged, if a copper film is formed on the amorphous metal film 5a by CVD or sputtering, copper crystallinity and adhesion to copper are degraded.

As mentioned so far, it is quite difficult to form a diffusion-barrier film having a single-layered structure comprised only of a crystalline metal film or an amorphous metal nitride film, and further having high barrier characteristic of preventing copper diffusion and high adhesion to copper.

The second problem is caused when a diffusion-barrier film is designed to have a multi-layered structure in order to avoid the above-mentioned problem of the single-layered diffusion-barrier film.

For instance, if a diffusion-barrier film is designed to have a multi-layered structure comprised of a crystalline metal film having high adhesion to copper and an amorphous metal nitride film having high barrier characteristic, such as TaN, there would be obtained a diffusion-barrier film having high barrier characteristic of preventing copper diffusion and high adhesion to copper.

However, since it was not possible in a conventional method to successively form a crystalline metal film and an amorphous metal nitride film by sputtering, the crystalline metal film and the amorphous metal nitride film had to be separately formed in the same sputtering chamber or be formed in separate sputtering chambers.

For instance, the above-mentioned Japanese Patent Application No. 10-330938 has suggested a method including the steps of introducing an argon gas into a sputtering chamber to thereby form a titanium film, and introducing a nitrogen gas into the sputtering chamber to thereby form a titanium nitride film on the titanium film.

However, in accordance with this method, the titanium nitride film cannot be formed until partial pressures of argon and nitrogen become stable by varying a mixture ratio of argon and nitrogen. Hence, it is impossible to enhance a fabrication yield of fabricating a diffusion-barrier film having a multi-layered structure.

4

The third problem relates to coverage of a film formed by sputtering.

In general, when a metal film or a metal nitride film is formed by sputtering, a metal target is sputtered by argon plasma generated by virtue of rotational magnetic field and application of DC bias, and resultingly, a metal film or a metal nitride film is deposited on a substrate located in facing relation to the metal target.

In sputtering, a pressure at which a metal target is sputtered is low, specifically, equal to 1 Pa or smaller. Since metal particles sputtered by argon plasma are radiated randomly to a surface of a substrate, for instance, if the substrate is formed at a surface thereof with a deep recess or hole, it would almost impossible to deposit a metal film such that such a recess or hole is completely covered with the metal film.

In addition, since a sputtering pressure is low, argon plasma could have a low plasma density, and hence, there cannot be expected re-sputtering effect in which a metal film deposited onto a surface of a substrate is sputtered by argon plasma.

In order to enhance coverage of a metal film, there has been suggested collimate sputtering in which a metal plate formed with a lot of through-holes is located between a sputtering target and a substrate, and metal particles are caused to pass through the through-holes to thereby uniform direction of metal particles. In accordance with the collimate sputtering, it is possible to deposit a metal film on a bottom of a recess formed at a surface of a substrate, but it is not possible to deposit a metal film onto an inner sidewall of the recess.

The fourth problem is that a crystalline metal film having high adhesion with a copper film tends to react with atmosphere to thereby a reaction layer at a surface thereof.

Such a reaction layer would much deteriorate adhesion of a metal film with a copper film.

The fifth problem is a copper oxide film is adhered again to a recess or hole.

An oxide film formed on a surface of an underlying wiring metal film is removed by argon plasma prior to deposition of a diffusion-barrier film by sputtering. When an underlying wiring layer is composed of copper, a copper oxide film is scattered by argon sputtering, and as a result, the thus scattered copper oxide is adhered again to a recess or hole formed at a surface of an insulating film.

The sixth problem is that when a copper film is formed on a tantalum film and an amorphous TaN film by CVD, adhesion between the copper film and a diffusion-barrier film is deteriorated.

#### SUMMARY OF THE INVENTION

In view of the above-mentioned problems in a conventional diffusion-barrier film, it is an object of the present invention to provide a diffusion-barrier film having both a diffusion-barrier characteristic of preventing copper from being diffused into a semiconductor device and high adhesion between a copper film and an interlayer insulating film.

It is also an object of the present invention to provide a multi-layered wiring structure including the above-mentioned diffusion-barrier film.

Another object of the present invention is to provide a method of fabricating such the above-mentioned diffusion-barrier film.

A further object of the present invention is to provide a method of fabricating a multi-layered copper wiring layer in which copper is buried above the above-mentioned diffusion-barrier film.

5

In one aspect of the present invention, there is provided a barrier film preventing diffusion of copper from a copper wiring layer formed on a semiconductor substrate, including a multi-layered structure of first and second films, the first film being composed of crystalline metal containing nitrogen therein, the second film being composed of amorphous metal nitride, the barrier film being constituted of common metal atomic species.

It is preferable that the first film is formed on the second film.

It is preferable that the second film has a thickness in the range of 80 angstroms to 150 angstroms both inclusive.

It is preferable that the first film has a thickness in the range of 60 angstroms to 300 angstroms both inclusive.

In another aspect of the present invention, there is provided a multi-layered wiring structure including a barrier film which prevents diffusion of copper from a copper wiring layer formed on a semiconductor substrate, the barrier film having a multi-layered structure of first and second films, the first film being composed of crystalline metal containing nitrogen therein, the second film being composed of amorphous metal nitride, the barrier film being constituted of common metal atomic species.

It is preferable that the barrier film covers a recess and a hole formed throughout an insulating film formed on an underlying wiring layer.

It is preferable that the multi-layered wiring structure further includes a copper film formed on the first film.

In still another aspect of the present invention, there is provided a method of forming a diffusion-barrier film by sputtering, including the steps of (a) preparing gas containing nitrogen therein, and (b) varying only power of an electric power source for generating plasma to thereby successively form a diffusion-barrier film having a multi-layered structure of first and second films, the first film being composed of crystalline metal containing nitrogen therein, the second film being composed of amorphous metal nitride, the barrier film being constituted of metal atomic species of sputter target.

It is preferable that the gas containing nitrogen therein has a pressure equal to or greater than 5 Pa.

It is preferable that the gas contains nitrogen at 10 volume % or smaller.

It is preferable that the metal atomic species of sputter target is one of tantalum, tungsten, titanium, molybdenum and niobium alone or in combination.

It is preferable that the second film has a thickness in the range of 80 angstroms to 150 angstroms both inclusive.

It is preferable that the first film has a thickness in the range of 60 angstroms to 300 angstroms both inclusive.

There is further provided a method of forming a diffusion-barrier film by RF magnetron sputtering making use of rotational magnetic field and RF power, including the steps of (a) preparing gas containing nitrogen therein, and (b) varying the RF power to thereby successively form a diffusion-barrier film having a multi-layered structure of first and second films, the first film being composed of crystalline metal containing nitrogen therein, the second film being composed of amorphous metal nitride, the barrier film being constituted of metal atomic species of sputter target.

There is still further provided a method of forming a diffusion-barrier film by RF magnetron sputtering, including the steps of (a) setting an electric power source for generation plasma to generate power having a first value, to thereby form a first film, with a concentration of nitrogen in plasma gas

6

being kept at a constant, and (b) setting the electric power source to generate power having a second value greater than the first value at the moment when the first film is formed by a predetermined thickness, to thereby form a second film on the first film.

It is preferable that the first film is composed of amorphous metal nitride, and the second film is composed of crystalline metal containing nitrogen therein.

There is yet further provided a method of forming a copper wiring film, including the steps of (a) radiating plasma of argon containing hydrogen therein, to a recess or hole formed at an insulating film formed on a semiconductor substrate, (b) forming a diffusion-barrier film to cover the recess or hole therewith without exposing to atmosphere, the diffusion-barrier film having a multi-layered structure of first and second films, the first film being composed of crystalline metal containing nitrogen therein, the second film being composed of amorphous metal nitride, and (c) forming a copper film on the diffusion-barrier film without exposing to atmosphere.

It is preferable that the diffusion-barrier film is formed by sputtering.

It is preferable that the copper film is formed in vacuum.

It is preferable that the copper film is formed by thermal chemical vapor deposition in which thermal dismutation in a complex of organic metal is utilized.

It is preferable that the copper film is formed by sputtering in which copper target is used.

The advantages obtained by the aforementioned present invention will be described hereinbelow.

In the diffusion-barrier film in accordance with the present invention, a copper film makes direct contact with a crystalline metal film containing nitrogen therein, ensuring high adhesion therebetween and high crystallinity of a copper film.

In addition, since the metal film contains nitrogen therein, copper diffusion into a semiconductor device can be prevented more effectively than a metal film having pure crystals.

In the diffusion-barrier film in accordance with the present invention, an amorphous metal film containing nitrogen therein lies under a crystalline metal film containing nitrogen therein. Hence, it is possible to effectively prevent copper diffusion, and to ensure high adhesion with an underlying insulating film such as a silicon dioxide film. That is, by forming a copper wiring layer on the diffusion-barrier film in accordance with the present invention, it is possible to not only ensure high crystallinity and high adhesion of a copper wiring layer, but also to prevent copper diffusion.

The method in accordance with the present invention makes it possible to successively form a diffusion-barrier film having a multi-layered structure of first and second films, by varying only power of an electric power source for generating plasma in sputtering in which gas containing nitrogen therein is employed. Herein, the first film is composed of crystalline metal containing nitrogen therein, and the second film is composed of amorphous metal nitride. The barrier film is constituted of metal atomic species of sputter target.

Specifically, an electric power source for generating plasma is first set to generate relatively low power with a concentration of nitrogen in plasma gas being kept constant. A film is formed in such a condition. Target metal makes sufficient reaction with nitrogen, and resultingly, an amor-

phous metal nitride film is formed. Immediately after the formation of the amorphous metal nitride film, the electric power source is set to generate relatively high power to thereby form a film without allowing sufficient time for reaction between nitrogen and target metal. As a result, there is obtained a crystalline metal film containing nitrogen therein.

Thus, it is possible to successively form a diffusion-barrier film in the same chamber, wherein the diffusion-barrier film has a multi-layered structure including a crystalline metal film containing nitrogen therein and an amorphous metal nitride film.

The method of fabricating a diffusion-barrier film employs RF magnetron sputtering in which rotational magnetic field and RF power are utilized. Since the method makes it possible to carry out sputtering where a nitrogen-containing gas has a pressure equal to or greater than 5 Pa, plasma density of argon which is a main constituent of sputtering gas can be enhanced, and thus, there can be obtained coverage for entirely covering a recess or hole formed at a surface of a substrate, with the diffusion-barrier film.

The method of fabricating a diffusion-barrier film, in accordance with the present invention, includes the step of radiating plasma of argon containing hydrogen therein, to a recess or hole formed at an insulating film formed on a semiconductor substrate. This step reduces a copper oxide film formed on a surface of an underlying copper wiring layer, to thereby turn copper oxide back to copper, ensuring remarkable reduction in re-sputtering of a copper oxide film to a surface of a recess or hole formed at a surface of an insulating film.

Then, a diffusion-barrier film is formed to cover the recess or hole therewith without exposing to atmosphere, wherein the diffusion-barrier film has a multi-layered structure of first and second films, the first film being composed of crystalline metal containing nitrogen therein, the second film being composed of amorphous metal nitride. Then, a thin copper film is formed on the diffusion-barrier film in vacuum. As a result, there is obtained a multi-layered structure comprised of the diffusion-barrier film and the copper wiring film without a metal oxide layer being sandwiched therebetween.

The above and other objects and advantageous features of the present invention will be made apparent from the following description made with reference to the accompanying drawings, in which like reference characters designate the same or similar parts throughout the drawings.

#### BRIEF DESCRIPTION OF THE DRAWINGS

FIG. 1 is a cross-sectional view of a conventional copper wiring structure.

FIG. 2 is a cross-sectional view of another conventional copper wiring structure.

FIG. 3 is a cross-sectional view of still another conventional copper wiring structure.

FIG. 4A is a cross-sectional view of a diffusion-barrier film in accordance with the first embodiment of the present invention, illustrating the first step of a method of fabricating the same.

FIG. 4B is a cross-sectional view of a diffusion-barrier film in accordance with the first embodiment of the present invention, illustrating the second step of a method of fabricating the same.

FIG. 4C is a cross-sectional view of a diffusion-barrier film in accordance with the first embodiment of the present

invention, illustrating the third step of a method of fabricating the same.

FIG. 4D is a cross-sectional view of a diffusion-barrier film in accordance with the first embodiment of the present invention, illustrating the fourth step of a method of fabricating the same.

FIG. 5 illustrates a high-pressure RF magnetron sputtering apparatus used in the first embodiment.

FIG. 6 is a graph showing coverage characteristic of a tantalum film in high-pressure RF magnetron sputtering.

FIGS. 7 and 8 are cross-sectional views of a recess covered with a tantalum film in high-pressure RF magnetron sputtering.

FIG. 9 is a graph showing a relation among a ratio of a nitrogen gas in a mixture gas introduced into a chamber, RF power, and resistivity of a film formed by sputtering.

FIGS. 10 to 18 are graphs each showing film quality and characteristics of TaN and Ta films in high-pressure RF magnetron sputtering.

FIGS. 19 and 20 are photographs of a film formed by high-pressure RF magnetron sputtering which photograph is taken by means of a scanning electron microscopy (SEM).

FIG. 21 is a cross-sectional view of a diffusion-barrier film formed by high-pressure RF magnetron sputtering which barrier-diffusion film is comprised of a crystalline Ta film containing nitrogen in solid solution and an amorphous metal TaN film.

FIG. 22 is a photograph of a film formed by high-pressure RF magnetron sputtering which photograph is taken by means of a scanning electron microscopy (SEM).

FIG. 23 is a cross-sectional view of a diffusion-barrier film covering a recess therewith.

FIG. 24 illustrates a DC magnetron sputtering apparatus used in the fourth embodiment.

FIG. 25 is a cross-sectional view of a diffusion-barrier film covering a recess formed at a surface of an insulating film formed above a lower wiring layer.

FIG. 26 is a cross-sectional view of a diffusion-barrier film covering a recess formed at a surface of an insulating film formed above lower wiring layers.

FIG. 27 is a plan view of a cluster apparatus used for forming a copper wiring layer.

FIG. 28 is a graph showing a diffusion profile of fluorine into a diffusion-barrier film.

FIG. 29 is a graph showing a diffusion profile of copper into a diffusion-barrier film.

FIG. 30 is a cross-sectional view of a copper wiring structure in accordance with the seventh embodiment.

FIG. 31 is a cross-sectional view of a copper wiring structure in accordance with the seventh embodiment.

#### DESCRIPTION OF THE PREFERRED EMBODIMENTS

Preferred embodiments in accordance with the present invention will be explained hereinbelow with reference to drawings.

A method of fabricating a diffusion-barrier film in accordance with the preferred embodiment is explained hereinbelow with reference to FIGS. 4A to 4D.

As illustrated in FIG. 4A, a first insulating film 12a is formed on a semiconductor substrate 11, and a second insulating film 12b is formed on the first insulating film 12a. A copper wiring layer 44 is buried in the first insulating film

12a. The second insulating film 12b is formed at a surface thereof with recesses 13 in each of which a wiring is to be formed. Holes 14 reach the first insulating film 12a from a bottom of each of the recesses 13.

First, the semiconductor substrate 11 is exposed to argon plasma containing hydrogen therein, in a first chamber.

Then, the semiconductor substrate 11 is transferred in vacuum to a second chamber, and a film is formed on the semiconductor substrate 11 in a nitrogen-containing gas by sputtering in which a sputtering target is composed of refractive metal.

First, an electric power source for generating plasma is set to generate relatively low power with a concentration of nitrogen in plasma gas being kept constant. As a result, the target metal makes sufficient reaction with nitrogen, and an amorphous metal nitride film 15 is deposited over a surface of the second insulating film 12b, as illustrated in FIG. 4B.

Then, immediately after the formation of the amorphous metal nitride film 15, the electric power source is set to generate relatively high power to thereby form a film without allowing sufficient time for reaction between nitrogen and the target metal. As a result, a crystalline metal film 16 containing nitrogen therein is formed on the amorphous metal nitride film 15.

Thus, as illustrated in FIG. 4B, it is possible to successively and effectively fabricate the diffusion-barrier film 17 having a multi-layered structure, on both an inner sidewall and a bottom of the recesses 13 and the holes 14 in the same chamber. By setting a sputtering pressure sufficiently high while deposition of the diffusion-barrier film 17 by sputtering, it would be possible to enhance coverage of the diffusion-barrier film 17.

Thereafter, the semiconductor substrate 11 is transferred into a third chamber in vacuum. Then, a copper film 18 is deposited over the diffusion-barrier film 17 in vacuum in the third chamber to thereby completely fill the recesses 13 and the holes 14 with the copper film 18, as illustrated in FIG. 4C. Since the crystal metal film 16 containing nitrogen therein is exposed outside and the semiconductor substrate 11 is transferred in vacuum, an oxide film is not formed at a surface of the crystal metal film 16.

Then, as illustrated in FIG. 4D, the diffusion-barrier film 17 and the copper film 18 are removed by CMP until the second insulating film 12b appears. Thus, there is obtained a copper wiring structure having high reliability.

The reason of enhancement in barrier characteristic of preventing copper diffusion is to introduce nitrogen into the metal film 16. In addition, the metal film 16 containing nitrogen ensures high adhesion with copper. The amorphous metal nitride film 15 also has a characteristic of preventing copper diffusion, and further enhances adhesion with the second insulating film 12b. Thus, it is possible to ensure high adhesion between the copper film 18 and the diffusion-barrier film 17, and to prevent copper from being diffused from the copper film 18 into the second insulating film 12b.

Hereinbelow are explained detailed examples of the above-mentioned embodiment.

#### FIRST EXAMPLE

In the first example, hereinbelow is explained sputtering for fabricating a multi-layered structure comprised of a crystalline metal film containing nitrogen therein and an amorphous metal nitride film.

The sputtering in the first example is carried out in a RF magnetron sputtering apparatus illustrated in FIG. 5.

In the illustrated RF magnetron sputtering apparatus, a chamber 21 is kept to be in vacuum, specifically, to have an internal pressure of about  $1 \times 10^{-7}$  Pa to about  $1 \times 10^{-6}$  Pa by means of a pump 33 such as a dry pump, a cryosorption pump or a turbo pump. In the chamber 21 is placed a heater 34 which can heat a semiconductor substrate 22 introduced into the chamber 21, up to about 20 to 300 degrees centigrade. A metal target 28 or the semiconductor substrate 22 is designed to be able to raise or lower, and hence, a distance between the metal target 28 and the semiconductor substrate 22 can be varied in the range of 102 mm to 134 mm.

Argon and nitrogen gases are adjusted with respect to a flow rate by means of mass flow controllers 31, and then, introduced into the chamber 21. When the argon and nitrogen gases are introduced into the chamber 21, the chamber 21 has an internal pressure of about 2 Pa to about 17 Pa.

The metal target 28 has a diameter, for instance, in the range of about 300 mm to about 320 mm. The metal target 28 is fixed to the chamber 21 through a target holder 27, a cathode 23 and insulators 29. In the cathodes 23 are rotatably arranged a plurality of permanent magnets 24. By rotating the permanent magnets 24, magnetic field 30 in the chamber 21 is uniformized, and erosion at a surface of the metal target 28 is also uniformized. As a result, it is possible to enhance uniformity of a film to be formed on the semiconductor substrate 22.

A RF electric power source 25 for introducing RF power into the chamber 21 is in electrical connection with the cathode 23 through a matching box 32 carrying out impedance matching. The RF electric power source 25 applies radio frequency (RF) having a frequency of 13.56 MHz to the metal target 28 having a diameter of 300 mm, at 0 to 10 kW.

Turning the RF electric power source 25 on to thereby introduce RF into the chamber 21, there is generated argon plasma containing nitrogen therein. The target metal 28 is sputtered by argon ions generated in the argon plasma 26. As a result, metal particles of the target metal 28 fly into the semiconductor substrate 22, and thus, the crystalline metal film 16 containing nitrogen therein or the amorphous metal nitride film 15 is formed.

The inventor actually formed a tantalum film covering therewith the hole 14 (see FIG. 4A) formed through the second insulating film 12b by means of the above-mentioned RF magnetron sputtering apparatus. The coverage characteristic of the tantalum film is shown in FIG. 6.

The hole 14 had a diameter in the range of 0.3  $\mu\text{m}$  to 1.5  $\mu\text{m}$ . The second insulating film 12b had a thickness of about 1.5  $\mu\text{m}$  where the hole 14 was formed.

As is obvious in view of FIG. 6, as a sputtering pressure is increased from 2 Pa to 17 Pa, bottom coverage is enhanced. Herein, bottom coverage is defined as a ratio of a thickness of the tantalum film at a bottom of the hole 14 to a thickness of the tantalum film at a surface of the second insulating film 12b. Specifically, when a sputtering pressure is over 5 Pa, sufficient coverage can be obtained to a hole having a great aspect ratio.

A thickness of the tantalum film at an inner sidewall of the hole 14 is equal to about a half of a thickness of the tantalum film at a bottom of the hole 14. As a sputtering pressure is increased, the tantalum film covers an inner sidewall of the hole 14 therewith to a greater degree.

The reason of this phenomenon is considered as follows.

The first reason is an increase in the number of Ta ions in plasma gas, as illustrated in FIG. 7.



As a sputtering pressure is increased, tantalum atomics increasingly make collision with excited argon atomics, resulting in that argon atomics are facilitated to be ionized. The resultant tantalum ions are attracted to negative self-bias generated at the semiconductor substrate 22. As a result, an incident angle at which tantalum ion flux 35 is radiated to the semiconductor substrate 22 becomes nearly 90 degrees. Thus, overhanging which occurs in the vicinity of an edge of recess or hole in conventional sputtering is suppressed, ensuring tantalum atomics to reach a bottom of the hole 14 or recess 13. As a result, a tantalum film 36 entirely covers an inner sidewall of the hole 14.

The second reason is that the deposited tantalum film 36 is re-sputtered by argon ions 39, as illustrated in FIG. 8.

The argon ions 39 which are primary constituents of plasma gas are accelerated by electric field and reach not only a target but also the semiconductor substrate 22 which is in a condition of negative self-bias. This means that the tantalum film 36 having been deposited onto the semiconductor substrate 22 is re-sputtered. Since the tantalum film deposited in the vicinity of an edge of the hole 14 or recess 13 and causing overhanging is re-sputtered by the argon ions 39, as indicated with an arrow 37, tantalum atomics 38 directing to a bottom of the hole 14 or recess 13 are not interfered at the edge of the hole 14 or recess 13. Accordingly, it is ensured that a tantalum film is deposited on a bottom and an inner sidewall of the hole 14 or recess 13.

In addition, since the tantalum film 36 deposited on a bottom of the hole 14 or recess 13 is re-sputtered by the argon ions 39, tantalum atomics generated by re-sputtering are deposited again on an inner sidewall 40 of the hole 14 or recess 13, ensuring enhancement in coverage at the sidewall 40 of the hole 14 or recess 13.

It is not possible to determine which is a main reason for enhancement in coverage among the above-mentioned first and second reasons. However, since mean free path of plasma ion is just a few millimeters under a pressure over 5 Pa, it is considered that almost 90 degrees of an incident angle of the tantalum ion flux 35 does not contribute to enhancement in coverage so much. The main reason why the coverage is enhanced is considered that argon ions are generated in a sufficient density by virtue of a high pressure, and a tantalum film having been deposited are re-sputtered by the argon ions.

In accordance with the experiments the inventor had conducted, it was confirmed that coverage was enhanced in sputtering of a tantalum nitride film, carried out under a high pressure over 5 Pa.

As mentioned so far, it is preferable that a sputtering pressure is set equal to or greater than 5 Pa in RF magnetron sputtering.

## SECOND EXAMPLE

FIG. 9 shows a relation between a flow rate ratio and resistivity of a film formed by high-pressure RF magnetron sputtering having been explained in the first example, for various RF powers. Herein, the flow rate ratio is defined as a ratio of a volume of argon gas to be introduced into the chamber 21 to a volume of nitrogen gas to be introduced into the chamber 21 ( $N_2/(Ar+N_2)$ ).

The relation shown in FIG. 9 was observed when the chamber 21 had a pressure of 13 Pa, the semiconductor substrate 22 was heated at 200 degrees centigrade, the permanent magnets 24 were rotated at 10 r.p.m., and the distance between the metal target 28 and the semiconductor substrate 22 was 134 mm.

As a ratio of  $N_2$  gas in the flow rate ratio  $N_2/(Ar+N_2)$  is increased, the resistivity is once reduced, and thereafter, increased again, regardless the RF power. However, an increase rate of the  $N_2$  gas ratio is dependent on the RF power. The resistivity increases at a lower rate at the greater RF power.

FIGS. 10 to 13 show how X-ray diffraction (XRD) patterns vary as the  $N_2$  gas ratio is varied when RF power of 6 kW ( $8.5 \text{ W/cm}^2$ ) is applied to the tantalum target having a diameter of 300 mm.

Specifically, FIGS. 10 to 13 shows XRD patterns when the  $N_2$  gas ratio is equal to 0%, 1%, 5%, and 7% respectively. Hereinbelow are explained FIGS. 10 to 13 in comparison with FIG. 9.

When the  $N_2$  gas ratio is equal to 0%, there is obtained a  $\beta$ -Ta(002)-oriented crystalline tantalum film which has resistivity in the range of about 160 to 200  $\mu\Omega\text{-cm}$ , as illustrated in FIG. 10.

When the  $N_2$  gas ratio is equal to 1%, there is obtained a crystalline metal film (herein, a tantalum film) containing nitrogen therein, which includes  $\beta$ -Ta and  $TaN_{0.1}$  in mixture and which has resistivity in the range of about 100  $\mu\Omega\text{-cm}$ , as illustrated in FIG. 11.

When the  $N_2$  gas ratio is equal to 5%, it is understood in view of FIG. 12 that XRD pattern strength is reduced, and hence, there is formed an amorphous metal nitride film, which has resistivity in the range of about 200 to 250  $\mu\Omega\text{-cm}$ .

When the  $N_2$  gas ratio is equal to 7%, a crystalline metal nitride film ( $Ta_3N_5$ ) is formed, and resistivity is further increased, as illustrated in FIG. 13.

As mentioned above, when the tantalum target is selected, a crystalline structure, composition and resistivity of a film to be formed by sputtering vary in dependence on both a concentration of nitrogen gas in sputtering gas and RF power. Conversely speaking, this means that it is possible to control characteristics of a film to be formed by sputtering, by controlling both a concentration of nitrogen gas in sputtering gas and RF power. The present invention is based on this discovery.

However, it is difficult to vary a flow rate of sputtering gas (that is, a pressure of sputtering gas) and  $N_2$  composition ratio in sputtering. Accordingly, it is necessary in practical use to keep both a flow rate of sputtering gas (that is, a pressure of sputtering gas) and  $N_2$  composition ratio constant, and to vary only RF power, to thereby control a crystalline structure, composition and resistivity of a film to be formed by sputtering.

FIG. 14 shows how resistivity varies when only RF power is varied while a  $N_2$  gas ratio is kept fixed at 2%. As is obvious in view of FIG. 14, it is understood that it is possible to control film quality and resistivity of a film to be formed by sputtering, even when only RF power is varied. In FIG. 14, resistivity is varied when a gas pressure is equal to 10 Pa, the permanent magnets are rotated at 10 r.p.m., and the substrate was heated at 200 degrees centigrade.

FIGS. 15 to 18 show XRD characteristics relative to RF power. FIGS. 15 to 18 show XRD characteristics observed when RF power is equal to 2 kW, 3 kW, 6 kW and 8 kW, respectively.

Specifically, when RF power is equal to 2 kW, there is obtained amorphous  $Ta_2N$ , as illustrated in FIG. 15. By increasing RF power, there is obtained crystalline  $TaN_{0.1}$ . When RF power is equal to 8 kW, there is obtained a crystalline metal film containing nitrogen therein, which includes a  $\beta$ -Ta film and  $TaN_{0.1}$  in mixture.

13

FIGS. 19 and 20 are SEM (Scanning Electron Microscopy) photographs of films obtained when RF power is set equal to 2 kW and 8 kW, respectively.

When RF power is set equal to 2 kW, as is obvious in view of XRD illustrated in FIG. 15, there is not observed grain boundary, because a deposited film has an amorphous structure. In contrast, when RF power is set equal to 8 kW, as is obvious in view of XRD illustrated in FIG. 18, there is obtained a crystalline film including a  $\beta$ -Ta film and  $Ta_{0.1}N_{0.1}$  in mixture, and having a pillar-like structure.

That is, if  $Ta_2N$ , which is an amorphous metal nitride film, is deposited at 2 kW of RF power, and RF power is increased up to 8 kW immediately when the film has acquired a desired thickness, the film is turned into a crystalline metal film containing nitrogen therein. As a result, as illustrated in FIG. 21, a diffusion-barrier film 17 is formed on a semiconductor substrate 11 where the diffusion-barrier film 17 has a multi-layered structure comprised of an amorphous metal nitride film 15 and a crystalline metal film 16 containing nitrogen therein. Specifically, the amorphous metal nitride film 15 is an amorphous  $Ta_2N$  film, and the crystalline metal film 16 is composed of crystalline  $\beta$ -Ta and crystalline  $Ta_{0.1}N_{0.1}$  in mixture.

FIG. 22 is a SEM photograph of a cross-section of the diffusion-barrier film 17 which is formed by changing sputtering power from 2 kW to 8 kW while a TaN film is being deposited, to thereby successively deposit the crystalline metal film 16 and the amorphous metal nitride film 15 each by a thickness of about 500 angstroms. It is confirmed in FIG. 22 that the amorphous  $Ta_2N$  film 15 and the crystalline metal film 16 containing nitrogen therein form a multi-layered structure.

The reason of this phenomenon is considered as follows.

When sputtering power is set equal to 2 kW, since a sputtering rate caused by argon ions is relatively low, there is sufficient time for a tantalum target to be nitrided by  $N_2$  at a surface thereof. Hence, the tantalum target is nitrided at a surface thereof, and turned into  $Ta_2N$ . Since the thus produced  $Ta_2N$  is sputtered by argon ions, a  $Ta_2N$  film is deposited. However, when sputtering power is set equal to 8 kW, the tantalum target is sputtered by argon ions before a surface of the tantalum target is sufficiently nitrided. As a result, there is obtained a tantalum film slightly containing nitrogen.

By utilizing the above-mentioned phenomenon, it is possible to form the diffusion-barrier film 17 having a multi-layered structure and covering therewith the recess 13 or the hole 14 formed at the second insulating film 12b formed on the semiconductor substrate 11, as illustrated in FIG. 23.

The lower film or amorphous metal nitride ( $Ta_2N$ ) film 15 is required to have such a thickness that barrier characteristic of preventing copper diffusion is ensured and adhesion with the underlying insulating film 12b is also ensured. A desired thickness of the amorphous metal nitride ( $Ta_2N$ ) film 15 is in the range of about 80 angstroms to about 150 angstroms.

On the other hand, the crystalline nitrogen-containing metal film 16 composed of crystalline  $\beta$ -Ta and crystalline  $Ta_{0.1}N_{0.1}$  in mixture is required to have such a thickness that barrier characteristic of preventing copper diffusion is ensured and adhesion with copper is also ensured. A desired thickness of the crystalline metal film 16 is in the range of about 60 angstroms to about 300 angstroms.

#### THIRD EXAMPLE

The RF magnetron sputtering having been explained in the first example makes it possible to enhance coverage

14

characteristic of a deposited film for covering a recess or hole therewith, by introducing a gas having a higher pressure than usual, specifically, a pressure equal to or greater than 5 Pa, into a chamber. That is, it is possible to form the multi-layered barrier film 17 under desired coverage characteristic by switching RF power with a sputtering pressure being kept equal to or greater than 5 Pa, even when there is carried out dual-damassin process in which the recess 13 and the hole 14 formed at a surface of the second insulating film 12b formed on the semiconductor substrate 11 are concurrently filled with the diffusion-barrier film 17.

#### FOURTH EXAMPLE

In the above-mentioned first and second examples, the process in which a multi-layered barrier film is successively formed by switching RF power while the film is being formed is applied to RF magnetron sputtering. This process may be applied to DC magnetron sputtering, as illustrated in FIG. 24, though a  $N_2$  gas ratio and RF power are different from those in the first and second examples.

FIG. 24 illustrates a DC magnetron sputtering apparatus. The apparatus is comprised of a chamber 21, a heater 34 fixed on a bottom of the chamber 21 for heating a semiconductor substrate 22, a target metal 28 fixed to a top of the chamber 21 by means of insulators 29 and a cathode 23, a pump 33 for exhausting air from the chamber 21 such that a pressure in the chamber 21 is in the range of about  $1 \times 10^{-7}$  Pa to about  $1 \times 10^{-6}$  Pa, a magnet 42 positioned above the target metal 28, mass flow controllers 31 for adjusting flow rates of argon gas and nitrogen gas, and allowing the gases to enter the chamber 21, and a DC electric power source 41 for applying a DC voltage to both the cathode 23 and the heater 34.

Turning the DC electric power source 41 on, argon plasma containing nitrogen therein is generated in the chamber 21.

#### FIFTH EXAMPLE

In the first and second examples, there is formed only one via-hole and wiring. However, it should be noted that the present invention may be applied to a copper wiring structure including two or more via-holes and wirings.

In the fifth example, as illustrated in FIG. 25, a first insulating film 12a is formed on a semiconductor substrate 11. The first insulating film 12a is formed with via-holes which is filled with a copper wiring layer 44 with a diffusion-barrier film 17 being sandwiched between an inner surface of each of the via-holes and the copper wiring layer 44. A second insulating film 12b is formed on the first insulating film 12a. The second insulating film 12b is also formed with recesses and via-holes which is filled with a copper wiring (not illustrated) with a diffusion-barrier film 17 being sandwiched between inner surfaces of the recesses and the via-holes, and the copper wiring.

Thus, recesses and/or holes formed throughout each of multi-layered insulating films are covered with the diffusion-barrier film 17, and then, the recesses and/or holes may be filled with a copper wiring layer.

An example of the multi-layered structure is illustrated in FIG. 26. The illustrated multi-layered structure is comprised of three insulating layers. Each of the insulating layers is formed with recesses and via-holes, which are covered at their surfaces with a diffusion-barrier layer 17, and filled with copper wiring layers 44a and 44b.

Hereinbelow is explained a method of fabricating the multi-layered structure illustrated in FIG. 26.

A semiconductor substrate **11** is formed at a surface thereof with oxide layers **11a**. A semiconductor device **11b** is formed on the semiconductor substrate **11** between the oxide layers **11a**.

A first insulating film **12a** is formed on the semiconductor substrate **11**. The first insulating film **12a** is comprised of, for instance, a silicon dioxide film. The first insulating film **12a** is formed with recess and holes reaching the semiconductor device **11b**. The recesses and holes are covered at their inner surfaces with the diffusion-barrier film **17**. The diffusion-barrier film **17** has a multi-layered structure comprised of a crystalline nitrogen-containing metal film and an amorphous metal nitride film, and has sufficient coverage to cover recesses and holes therewith. The diffusion-barrier film **17** may be formed by such high-pressure RF magnetron sputtering as mentioned in the first example.

Then, the recesses and holes are filled with copper in vacuum. Then, the copper film and the diffusion-barrier film **17** are removed by CMP until the first insulating film **12a** appears. Thus, there is fabricated the copper wiring layer **44a**.

Since copper does not form passive state at a surface, the copper wiring layer **44a** may be oxidized. In order to prevent oxidation of the copper wiring layer **44a**, a silicon nitride film **12d** is formed over the first insulating film **12a**.

Then, a second insulating film **12b** is formed on the first insulating film **12a**. The second insulating film **12b** is formed with recesses and holes reaching the copper wiring layer **44a** formed in the first insulating film **12a**. Then, the recesses and holes formed in the second insulating film **12b** are covered with the diffusion-barrier film **17**, and the recesses and holes are filled with the copper wiring layer **44b**. By repeating the above-mentioned steps by the desired number, there can be fabricated a semiconductor device having such a multi-layered copper wiring structure as illustrated in FIG. 26.

#### SIXTH EXAMPLE

The sixth example relates to an apparatus and a method of successively forming both a diffusion-barrier film having a multi-layered structure and copper wiring layer.

FIG. 27 is a top plan view of an apparatus of forming a copper wiring layer, in accordance with the sixth example.

The apparatus includes a cluster chamber **51** including a separation chamber **51** at a center. The separation chamber **51** is equipped therein with a robot **52** for transferring a semiconductor substrate.

The cluster chamber **51** is comprised further of two lord lock chambers **45**, a chamber **46** used for heating a semiconductor substrate, an etching chamber **47** used for cleaning recesses and holes, a sputter chamber **48** used for fabricating a diffusion-barrier film, and a chamber **49** used for forming a copper wiring layer, arranged around the separation chamber **51**.

It is possible to form a copper wiring layer without exposure of a semiconductor substrate to atmosphere through the use of the cluster chamber **50**.

Hereinbelow are explained steps of fabricating a copper wiring layer.

First, a semiconductor substrate is introduced into one of the lord lock chambers **45**. An insulating film is formed in advance on the semiconductor substrate, and the insulating film is formed in advance with a recess and/or hole.

Then, the lord lock chamber **45** is evacuated of air by means of a dry pump and a turbo pump for about five

minutes. As a result, the lord lock chamber **45** has a vacuum degree of  $7 \times 10^{-3}$  Pa to  $8 \times 10^{-3}$  Pa.

Then, a gate valve between the lord lock chamber **45** and the separation chamber **51** is made open. The separation chamber **51** is in advance kept in a vacuum degree of about  $5 \times 10^{-5}$  Pa to  $1 \times 10^{-5}$  Pa by means of a dry pump and a turbo pump. Hence, the semiconductor substrate is transferred into the separation chamber **52** by the robot **52** without being exposed to atmosphere.

Then, the semiconductor substrate is transferred into the chamber **46** which is in advance kept in a vacuum degree of about  $6 \times 10^{31.5}$  Pa by means of a dry pump and a turbo pump. The semiconductor substrate is heated at about 50 to about 200 degrees centigrade in the chamber **46** to thereby remove moisture existing at a surface of the semiconductor substrate and clean a surface of the semiconductor substrate.

Then, the semiconductor substrate is transferred into the etching chamber **47** from the chamber **46** through the separation chamber **51**. The etching chamber **47** is kept in a vacuum degree of about  $5 \times 10^{-6}$  Pa by means of a cryosorption pump, dry pump and a turbo pump.

After introducing the semiconductor substrate into the etching chamber **47**, the semiconductor substrate is plasma-etched in argon gas or argon gas diluted with hydrogen gas ( $H_2/Ar=3\%$ ). By carrying out plasma-etching, a surface of the semiconductor substrate and inner surfaces of a recess and a hole are reduced and cleaned.

The plasma-etching has an advantage that edges of a recess and a hole are ground by the plasma-etching, and accordingly, an opening area of the recess and hole is broadened, ensuring enhancement in coverage characteristic.

Then, the semiconductor substrate is transferred into the sputter chamber **48** from the etching chamber **47** by means of the robot **52**. The sputter chamber **48** is kept in a vacuum degree of about  $4 \times 10^{-6}$  Pa by means of a cryosorption pump, dry pump and a turbo pump. The high-pressure RF magnetron sputtering as having been explained in the first example is carried out in the sputter chamber **48**.

In the sputter chamber **48**, a crystalline nitrogen-containing metal film (a film composed of crystalline  $\beta$ -Ta and crystalline  $TaN_{0.1}$  in mixture) and an amorphous metal nitride film (a  $Ta_2N$  film) are deposited on the semiconductor substrate by the method having been explained in the first and second examples, wherein RF power is instantaneously switched. In this example, a gas pressure is kept at 10 Pa, a substrate temperature is kept at 200 degrees centigrade, a  $N_2$  gas ratio is kept at 2%, and RF power is switched from 2 kW to 8 kW. As a result, there is obtained a diffusion-barrier film having a multi-layered structure and also having enhanced coverage characteristic under the characteristics illustrated in FIG. 6.

Then, the semiconductor substrate is transferred in vacuum to the chamber **49** from the sputter chamber **48**. The chamber **49** is kept in a vacuum degree of about  $4 \times 10^{-4}$  Pa by means of a dry pump and a turbo pump. Since the semiconductor substrate is transferred in vacuum, the crystalline nitrogen-containing metal film in the diffusion-barrier film is kept clean at a surface thereof. A copper film is deposited on the crystalline nitrogen-containing metal film by chemical vapor deposition (CVD) such that the recess and hole is filled with copper, as follows.

The semiconductor substrate is kept at about 170 to about 200 degrees centigrade. A source including Cu (hfac) tmvs (trimethylvinylsilyl hexafluoroacetylacetonate copper (I)) as a main constituent is introduced into a carburetor at 1 to 2

17

grams per minute through a liquid transfer system. The source gasified in the carburetor is introduced into the chamber 49 together with nitrogen carrier gas, resulting in that the chamber 49 is kept at about 1 kPa.

The gas introduced into the chamber 49 makes chemical reaction on the semiconductor substrate, and is turned into copper, and then, deposited on the semiconductor substrate. Herein, copper is deposited by such a thickness that a recess and/or hole is sufficiently filled with copper, for instance, a thickness in the range of about 8000 angstroms to about 15000 angstroms.

In particular, when a copper film is formed by CVD, segregation of fluorine at a surface of the diffusion-barrier film, diffusion of fluorine into the diffusion-barrier film, and diffusion of copper into the diffusion-barrier film exert a great influence on the adhesion, which fluorine is contained in Cu (hfac) tmvs which is a source for carrying out CVD.

FIGS. 28 and 29 illustrate diffusion profiles of fluorine and copper into the diffusion-barrier film, respectively, which profiles were measured by SIMS (secondary ion mass spectroscopy).

In a  $\beta$ -Ta film obtained by sputtering carried out in argon atmosphere, since fluorine segregates at an interface between copper and tantalum, the  $\beta$ -Ta film would have poor adhesion. With respect to a  $Ta_2N$  film, though fluorine is diffused into the  $Ta_2N$  film, copper is scarcely diffused in the  $Ta_2N$  film. As a result, atomics are coupled with each other with a poor force, and hence, the  $Ta_2N$  film would have poor adhesion. In contrast, with respect to a  $TaN_{0.1}$  film, since copper and fluorine are allowed to be diffused into the  $TaN_{0.1}$  film, atomics are coupled with each other with a strong force, and as a result, the  $TaN_{0.1}$  film would have high adhesion.

Thus, it is understood that if copper is deposited by CVD, the diffusion-barrier film having a multi-layered structure comprised of a crystalline  $TaN_{0.1}$  film and an amorphous  $Ta_2N$  film would have enhanced adhesion and barrier characteristic of preventing copper diffusion.

In accordance with the sixth example, a copper wiring layer can be formed on a semiconductor substrate without the semiconductor substrate being exposed to atmosphere. Accordingly, the diffusion-barrier film is kept clean at a surface, and hence, film quality of a copper film formed by CVD is likely to be reflected to a crystalline structure of a tantalum film of the diffusion-barrier film. Thus, it is possible to enhance crystal orientation of copper and adhesion between copper and a diffusion-barrier film.

#### SEVENTH EXAMPLE

The seventh example relates to the cluster chamber 50 illustrated in FIG. 27. In the seventh example, the sputter chamber 48 is positioned in a region where a copper wiring layer is to be formed, which region corresponds to the chamber 49 in which a copper wiring layer is formed. Since the diffusion-barrier film includes a  $TaN_{0.1}$  film containing crystalline  $\beta$ -Ta therein, at a surface, adhesion between the diffusion-barrier film and a copper film formed by sputtering is kept the same as adhesion between the diffusion-barrier film and a copper film formed by CVD.

#### EIGHTH EXAMPLE

In the eighth example, the semiconductor substrate is taken out of the cluster chamber 50 illustrated in FIG. 27. The semiconductor substrate has such a copper wiring structure as illustrated in FIG. 30. Specifically, recesses and

18

holes formed in the second insulating film 12b are covered with the diffusion-barrier film 17, and a copper film 53 is formed covering the diffusion-barrier film 17 therewith.

A second copper film 54 is deposited over the copper film 53 by plating such that the recesses and holes are filled with the second copper film 54. As a result, as illustrated in FIG. 31, it is possible to fabricate a structure comprised of the multi-layered barrier layer 17, the copper film 53 formed by CVD or sputtering, and the second copper film 54 formed by plating. Thereafter, as illustrated in FIG. 4D, for instance, the second copper film 54, the copper film 53 and the diffusion-barrier film 17 are removed by CMP. Thus, there is obtained a copper wiring structure.

While the present invention has been described in connection with the preferred embodiments, the present invention provides the following advantages.

The first advantage is that it is possible to have a diffusion-barrier film having sufficient barrier characteristic of preventing copper diffusion and high adhesion with a copper film. This is because the diffusion-barrier film is designed to have a multi-layered structure comprised of an amorphous metal nitride film having a high barrier characteristic of preventing copper diffusion and a crystalline nitrogen-containing metal film having high adhesion with copper.

The second advantage is that it is possible to successively fabricate the diffusion-barrier film in a common chamber. This ensures reduction in apparatus cost and reduction in time for fabricating the diffusion-barrier film.

This is because that it is possible to successively form an amorphous metal nitride film and a crystalline nitrogen-containing metal film by instantaneously changing only RF power with a volume ratio of a nitrogen gas to a process gas introduced into a chamber, being kept constant. In accordance with this method, an upper metal film in the diffusion-barrier film inevitably contains nitrogen therein.

The third advantage is that a copper film can be formed with a surface of the diffusion-barrier film being kept clean, through the use of an apparatus of transferring a semiconductor substrate in vacuum. As a result, reliability in a copper wiring layer can be enhanced.

While the present invention has been described in connection with certain preferred embodiments, it is to be understood that the subject matter encompassed by way of the present invention is not to be limited to those specific embodiments. On the contrary, it is intended for the subject matter of the invention to include all alternatives, modifications and equivalents as can be included within the spirit and scope of the following claims.

The entire disclosure of Japanese Patent Application No. 11-214110 filed on Jun. 24, 1999 including specification, claims, drawings and summary is incorporated herein by reference in its entirety.

What is claimed is:

1. A barrier film preventing diffusion of copper from a copper wiring layer formed on a semiconductor substrate, comprising a multi-layered structure of first and second films,
  - a) said first film being composed of crystalline metal containing nitrogen therein,
  - b) said second film being composed of amorphous metal nitride,
  - c) said barrier film being constituted of common metal atomic species,
  - d) said first film being formed on said second film,

19

said first film in direct contact with said second film,  
said first film containing nitrogen in a smaller content than  
that of said second film.

2. The barrier film as set forth in claim 1, wherein said  
second film has a thickness in the range of 80 angstroms to  
150 angstroms both inclusive. 5

3. The barrier film as set forth in claim 1, wherein said first  
film has a thickness in the range of 60 angstroms to 300  
angstroms both inclusive.

4. The barrier film as set forth in claim 1, wherein said first  
film is composed of  $\beta$ -Ta and  $TaN_{0.1}$ , and said second film  
is composed of  $Ta_2N$ . 10

5. A multi-layered wiring structure comprising a barrier  
film which prevents diffusion of copper from a copper  
wiring layer formed on a semiconductor substrate, 15

said barrier film having a multi-layered structure of first  
and second films,

said first film being composed of crystalline metal con-  
taining nitrogen therein, 20

said second film being composed of amorphous metal  
nitride,

said barrier film being constituted of common metal  
atomic species,

20

said first film being formed on said second film,  
said first film in direct contact with said second film,  
said first film containing nitrogen in a smaller content than  
that of said second film.

6. The multi-layered wiring structure as set forth in claim  
5, wherein said second film has a thickness in the range of  
80 angstroms to 150 angstroms both inclusive.

7. The multi-layered wiring structure as set forth in claim  
5, wherein said first film has a thickness in the range of 60  
angstroms to 300 angstroms both inclusive.

8. The multi-layered wiring structure as set forth in claim  
5; wherein said barrier film covers a recess and a hole  
formed throughout an insulating film formed on an under-  
lying wiring layer.

9. The multi-layered wiring structure as set forth in claim  
5, further comprising a copper film formed on said first film.

10. The multi-layered wiring structure as set forth in claim  
5, wherein said first film is composed of  $\beta$ -Ta and  $TaN_{0.1}$ ,  
and said second film is composed of  $Ta_2N$ .

\* \* \* \* \*



Bib Data Sheet



**UNITED STATES DEPARTMENT OF COMMERCE  
Patent and Trademark Office**

Address: COMMISSIONER OF PATENTS AND TRADEMARKS  
Washington, D.C. 20231

<b>SERIAL NUMBER</b> 09/596,415	<b>FILING DATE</b> 06/19/2000 <b>RULE</b> -	<b>CLASS</b> 257	<b>GROUP ART UNIT</b> 2811	<b>ATTORNEY DOCKET NO.</b> 13715
<b>APPLICANTS</b> Masayoshi Tagami, Tokyo, JAPAN; Yoshihiro Hayashi, Tokyo, JAPAN;				
<b>** CONTINUING DATA *****</b>				
<b>** FOREIGN APPLICATIONS *****</b> JAPAN 11-214110 06/24/1999				
<b>IF REQUIRED, FOREIGN FILING LICENSE GRANTED</b> <b>** 08/16/2000</b>				
Foreign Priority claimed <input checked="" type="checkbox"/> yes <input type="checkbox"/> no		<b>STATE OR COUNTRY</b> JAPAN	<b>SHEETS DRAWING</b> 18	<b>TOTAL CLAIMS</b> 36
35 USC 119 (a-d) conditions met <input checked="" type="checkbox"/> yes <input type="checkbox"/> no <input type="checkbox"/> Met after Allowance				<b>INDEPENDENT CLAIMS</b> 6
Verified and Acknowledged	Examiner's Signature _____ Initials _____			
<b>ADDRESS</b> Paul J Esatto Jr Scully Scott Murphy & Presser 400 Garden City Plaza Garden City ,NY 11530				
<b>TITLE</b> Multi-layered wiring layer and method of fabricating the same				
<b>FILING FEE RECEIVED</b> 1212	FEES: Authority has been given in Paper No. _____ to charge/credit DEPOSIT ACCOUNT No. _____ for following:		<input type="checkbox"/> All Fees <input type="checkbox"/> 1.16 Fees ( Filing ) <input type="checkbox"/> 1.17 Fees ( Processing Ext. of time ) <input type="checkbox"/> 1.18 Fees ( Issue ) <input type="checkbox"/> Other _____ <input type="checkbox"/> Credit	

PATENT APPLICATION SERIAL NO. \_\_\_\_\_

U.S. DEPARTMENT OF COMMERCE  
PATENT AND TRADEMARK OFFICE  
FEE RECORD SHEET

06/26/2000 JWASHING 00000067 09596415

01 FC:101	690.00 OP
02 FC:102	234.00 OP
03 FC:103	288.00 OP

PTO-1556  
(5/87)

\*U.S. GPO: 1999-459-082/13144

06-20-00

A

Express Mail Label No. EE692181515

06/19/00  
3511 U.S. PTO  
09/596415

# UTILITY PATENT APPLICATION TRANSMITTAL (Large Entity)

(Only for new nonprovisional applications under 37 CFR 1.53(b))

Docket No:  
13715

Total Pages in this Submission

## TO THE ASSISTANT COMMISSIONER FOR PATENTS

Box Patent Application  
Washington, D.C. 20231

Transmitted herewith for filing under 35 U.S.C. 111(a) and 37 C.F.R. 1.53(b) is a new utility patent application for an invention entitled:

**MULTI-LAYERED WIRING LAYER AND METHOD OF FABRICATING THE SAME**

and invented by:

Masayoshi Tagami, et al.

3511 U.S. PTO  
09/596415  
06/19/00

If a CONTINUATION APPLICATION, check appropriate box and supply the requisite information:

Continuation  Divisional  Continuation-in-part (CIP) of prior application No.: \_\_\_\_\_

Which is a:

Continuation  Divisional  Continuation-in-part (CIP) of prior application No.: \_\_\_\_\_

Which is a:

Continuation  Divisional  Continuation-in-part (CIP) of prior application No.: \_\_\_\_\_

Enclosed are:

### Application Elements

1.  Filing fee as calculated and transmitted as described below
2.  Specification having 39 pages and including the following:
  - a.  Descriptive Title of the Invention
  - b.  Cross References to Related Applications (if applicable)
  - c.  Statement Regarding Federally-sponsored Research/Development (if applicable)
  - d.  Reference to Microfiche Appendix (if applicable)
  - e.  Background of the Invention
  - f.  Brief Summary of the Invention
  - g.  Brief Description of the Drawings (if drawings filed)
  - h.  Detailed Description
  - i.  Claim(s) as Classified Below
  - j.  Abstract of the Disclosure



**UTILITY PATENT APPLICATION TRANSMITTAL  
(Large Entity)**

*(Only for new nonprovisional applications under 37 CFR 1.53(b))*

Docket No.  
13715

Total Pages in this Submission

**Application Elements (Continued)**

3.  Drawing(s) *(when necessary as prescribed by 35 USC 113)*
- a.  Formal                      Number of Sheets                      18
- b.  Informal                      Number of Sheets                      \_\_\_\_\_
4.  Oath or Declaration
- a.  Newly executed *(original or copy)*                       Unexecuted
- b.  Copy from a prior application (37 CFR 1.63(d)) *(for continuation/divisional application only)*
- c.  With Power of Attorney                       Without Power of Attorney
- d.  DELETION OF INVENTOR(S)  
Signed statement attached deleting inventor(s) named in the prior application,  
see 37 C.F.R. 1.63(d)(2) and 1.33(b).
5.  Incorporation By Reference *(usable if Box 4b is checked)*  
The entire disclosure of the prior application, from which a copy of the oath or declaration is supplied  
under Box 4b, is considered as being part of the disclosure of the accompanying application and is hereby  
incorporated by reference therein.
6.  Computer Program in Microfiche *(Appendix)*
7.  Nucleotide and/or Amino Acid Sequence Submission *(if applicable, all must be included)*
- a.  Paper Copy
- b.  Computer Readable Copy *(identical to computer copy)*
- c.  Statement Verifying Identical Paper and Computer Readable Copy

**Accompanying Application Parts**

8.  Assignment Papers *(cover sheet & document(s))*
9.  37 CFR 3.73(B) Statement *(when there is an assignee)*
10.  English Translation Document *(if applicable)*
11.  Information Disclosure Statement/PTO-1449                       Copies of IDS Citations
12.  Preliminary Amendment
13.  Acknowledgment postcard
14.  Certificate of Mailing
- First Class                       Express Mail *(Specify Label No.):* EE692181515US

**UTILITY PATENT APPLICATION TRANSMITTAL  
(Large Entity)**

*(Only for new nonprovisional applications under 37 CFR 1.53(b))*

Docket No.  
13715

Total Pages in this Submission

**Accompanying Application Parts (Continued)**

15.  Certified Copy of Priority Document(s) *(if foreign priority is claimed)*

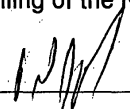
16.  Additional Enclosures *(please identify below):*

**Fee Calculation and Transmittal**

**CLAIMS AS FILED**

For	#Filed	#Allowed	#Extra	Rate	Fee
<b>Total Claims</b>	36	- 20 =	16	x \$18.00	\$288.00
<b>Indep. Claims</b>	6	- 3 =	3	x \$78.00	\$234.00
<b>Multiple Dependent Claims (check if applicable)</b> <input type="checkbox"/>					\$0.00
<b>BASIC FEE</b>					\$690.00
<b>OTHER FEE (specify purpose)</b>					\$0.00
<b>TOTAL FILING FEE</b>					\$1,212.00

- A check in the amount of **\$1,212.00** to cover the filing fee is enclosed.
- The Commissioner is hereby authorized to charge and credit Deposit Account No. 19-1013/SSMP as described below. A duplicate copy of this sheet is enclosed.
  - Charge the amount of \_\_\_\_\_ as filing fee.
  - Credit any overpayment.
  - Charge any additional filing fees required under 37 C.F.R. 1.16 and 1.17.
  - Charge the issue fee set in 37 C.F.R. 1.18 at the mailing of the Notice of Allowance, pursuant to 37 C.F.R. 1.311(b).

  
 \_\_\_\_\_  
*Signature*  
**Paul J. Esatto, Jr.**  
 Registration No. 30, 749

Dated: June 19, 2000

**Scully, Scott, Murphy & Presser**  
 400 Garden City Plaza  
 Garden City, NY 11530  
 (516) 742-4343

cc:

**UTILITY PATENT APPLICATION TRANSMITTAL  
(Large Entity)**

*(Only for new nonprovisional applications under 37 CFR 1.53(b))*

Docket No.  
13715

Total Pages in this Submission

**TO THE ASSISTANT COMMISSIONER FOR PATENTS**

Box Patent Application  
Washington, D.C. 20231

Transmitted herewith for filing under 35 U.S.C. 111(a) and 37 C.F.R. 1.53(b) is a new utility patent application for an invention entitled:

**MULTI-LAYERED WIRING LAYER AND METHOD OF FABRICATING THE SAME**

and invented by:

**Masayoshi Tagami, et al.**

If a **CONTINUATION APPLICATION**, check appropriate box and supply the requisite information:

Continuation  Divisional  Continuation-in-part (CIP) of prior application No.: \_\_\_\_\_

Which is a:

Continuation  Divisional  Continuation-in-part (CIP) of prior application No.: \_\_\_\_\_

Which is a:

Continuation  Divisional  Continuation-in-part (CIP) of prior application No.: \_\_\_\_\_

Enclosed are:

**Application Elements**

1.  Filing fee as calculated and transmitted as described below
2.  Specification having 39 pages and including the following:
  - a.  Descriptive Title of the Invention
  - b.  Cross References to Related Applications (if applicable)
  - c.  Statement Regarding Federally-sponsored Research/Development (if applicable)
  - d.  Reference to Microfiche Appendix (if applicable)
  - e.  Background of the Invention
  - f.  Brief Summary of the Invention
  - g.  Brief Description of the Drawings (if drawings filed)
  - h.  Detailed Description
  - i.  Claim(s) as Classified Below
  - j.  Abstract of the Disclosure

**UTILITY PATENT APPLICATION TRANSMITTAL  
(Large Entity)**

*(Only for new nonprovisional applications under 37 CFR 1.53(b))*

Docket No.  
13715

Total Pages in this Submission

**Application Elements (Continued)**

3.  Drawing(s) *(when necessary as prescribed by 35 USC 113)*
- a.  Formal                      Number of Sheets                      18
- b.  Informal                      Number of Sheets                      \_\_\_\_\_
4.  Oath or Declaration
- a.  Newly executed *(original or copy)*                       Unexecuted
- b.  Copy from a prior application (37 CFR 1.63(d)) *(for continuation/divisional application only)*
- c.  With Power of Attorney                       Without Power of Attorney
- d.  DELETION OF INVENTOR(S)  
Signed statement attached deleting inventor(s) named in the prior application,  
see 37 C.F.R. 1.63(d)(2) and 1.33(b).
5.  Incorporation By Reference *(usable if Box 4b is checked)*  
The entire disclosure of the prior application, from which a copy of the oath or declaration is supplied  
under Box 4b, is considered as being part of the disclosure of the accompanying application and is hereby  
incorporated by reference therein.
6.  Computer Program in Microfiche *(Appendix)*
7.  Nucleotide and/or Amino Acid Sequence Submission *(if applicable, all must be included)*
- a.  Paper Copy
- b.  Computer Readable Copy *(identical to computer copy)*
- c.  Statement Verifying Identical Paper and Computer Readable Copy

JCS11 U.S. PTO  
09/596415  
06/19/00

**Accompanying Application Parts**

8.  Assignment Papers *(cover sheet & document(s))*
9.  37 CFR 3.73(B) Statement *(when there is an assignee)*
10.  English Translation Document *(if applicable)*
11.  Information Disclosure Statement/PTO-1449                       Copies of IDS Citations
12.  Preliminary Amendment
13.  Acknowledgment postcard
14.  Certificate of Mailing
- First Class                       Express Mail *(Specify Label No.):* EE692181515US

**UTILITY PATENT APPLICATION TRANSMITTAL  
(Large Entity)**

*(Only for new nonprovisional applications under 37 CFR 1.53(b))*

Docket No.  
13715

Total Pages in this Submission

**Accompanying Application Parts (Continued)**

15.  Certified Copy of Priority Document(s) *(if foreign priority is claimed)*

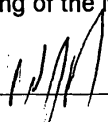
16.  Additional Enclosures *(please identify below):*

**Fee Calculation and Transmittal**

**CLAIMS AS FILED**

For	#Filed	#Allowed	#Extra	Rate	Fee
Total Claims	36	- 20 =	16	x \$18.00	\$288.00
Indep. Claims	6	- 3 =	3	x \$78.00	\$234.00
Multiple Dependent Claims (check if applicable) <input type="checkbox"/>					\$0.00
<b>BASIC FEE</b>					\$690.00
<b>OTHER FEE (specify purpose)</b>					\$0.00
<b>TOTAL FILING FEE</b>					\$1,212.00

- A check in the amount of **\$1,212.00** to cover the filing fee is enclosed.
- The Commissioner is hereby authorized to charge and credit Deposit Account No. **19-1013/SSMP** as described below. A duplicate copy of this sheet is enclosed.
  - Charge the amount of \_\_\_\_\_ as filing fee.
  - Credit any overpayment.
  - Charge any additional filing fees required under 37 C.F.R. 1.16 and 1.17.
  - Charge the issue fee set in 37 C.F.R. 1.18 at the mailing of the Notice of Allowance, pursuant to 37 C.F.R. 1.311(b).

  
 \_\_\_\_\_  
*Signature*  
**Paul J. Esatto, Jr.**  
 Registration No. 30, 749

Dated: June 19, 2000

**Scully, Scott, Murphy & Presser**  
 400 Garden City Plaza  
 Garden City, NY 11530  
 (516) 742-4343

cc:

MULTI-LAYERED WIRING LAYER  
AND  
METHOD OF FABRICATING THE SAME

5 BACKGROUND OF THE INVENTION

FIELD OF THE INVENTION

The invention relates to a semiconductor integrated circuit including a copper wiring layer, and more particularly to a barrier film which prevents copper diffusion from such a copper wiring layer.

10

DESCRIPTION OF THE RELATED ART

As a semiconductor device has been designed to be smaller and smaller in size, wiring delay exerts greater influence on a silicon ULSI device. As a result, though a wiring layer has been composed of aluminum, it is necessary to  
15 compose a wiring layer of copper in place of aluminum.

Resistivity of copper is equal to about 70% of resistivity of aluminum. However, since copper does not form passive state composed of an oxide film, at a surface thereof, unlike aluminum, copper is more corrosive than aluminum.

In addition, since copper has a high diffusion rate in both silicon (Si)  
20 and silicon dioxide ( $\text{SiO}_2$ ), if copper enters MOSFET formed on a silicon substrate, copper would induce reduction in carrier lifetime.

Hence, it is absolutely necessary for a semiconductor device having a copper wiring layer to have a diffusion-barrier film for preventing diffusion of copper into an interlayer insulating film formed between copper wiring layers.

25 In addition, since such a diffusion-barrier film has to have high adhesion characteristic to both an interlayer insulating film and a copper wiring layer in order to keep reliability in wiring.

Thus, there have been made many suggestions about a structure of a barrier metal layer and a method of fabricating the same, in order to prevent

copper diffusion form a copper wiring layer.

For instance, a structure of a barrier metal layer is suggested in the following articles:

(a) Semiconductor World, Nobuyoshi Awaya, February 1998, pp. 91-96  
5 (hereinafter, referred to as Prior Art 1);

(b) Advanced Metallization and Interconnect Systems for ULSI Applications in 1997, Kee-Won Kwon et al., 1998, pp. 711-716 (hereinafter, referred to Prior Art 2);

(c) Journal Electrochemical Society, M. T. Wang et al., July 1998, pp. 2538-  
10 2545 (hereinafter, referred to as Prior Art 3); and

(d) 1998 Symposium on VLSI Technology Digest of Technical Papers, D. Denning et al., 1998, pp. 22-23.

In addition, a structure of a barrier metal layer and a method of fabricating the same both for preventing copper diffusion is suggested also in  
15 Japanese Unexamined Patent Publications 8-139092, 8-274098, 9-64044 and 10-256256, and Japanese Patent Application No. 10-330938. Herein, Japanese Patent Application No. 10-330938 is not published yet, and hence does not constitute prior art to the present invention. However, it is explained in the specification only for better understanding of the present invention. The  
20 applicant does not admit that Japanese Patent Application No. 10-330938 constitutes prior art to the present invention.

It is quite difficult to dry-etch copper, and hence, a copper wiring layer is formed generally by chemical mechanical polishing (CMP).

Specifically, a copper wiring layer is formed as follows.

25 An insulating film is formed on an underlying copper wiring layer. Then, the insulating film is formed with a recess and a through-hole reaching the underlying copper wiring layer. Then, a thin diffusion-barrier film is formed on surfaces of the recess and the through-hole therewith such that the recess and the through-hole is completely covered at surfaces thereof with the diffusion-barrier

film in order to prevent copper diffusion from uncovered region.

Thereafter, a copper film is deposited filling the recess and the through-hole therewith by CVD or sputtering. Then, the copper film and the diffusion-barrier film are removed in selected regions by CMP. Thus, a copper wiring layer is completed.

As will be obvious to those skilled in the art, the diffusion-barrier film is required to have high coverage as well as capability of preventing copper diffusion and adhesion to copper.

The diffusion-barrier film is composed, for instance, of refractive metal such as tungsten (W), tantalum (Ta) or titanium (Ti), or nitride of such refractive metal such as tungsten nitride (WN), titanium nitride (TiN) or tantalum nitride (TaN).

As explained in Prior Art 2, for instance, a tantalum (Ta) barrier film has high adhesion with a copper film formed on the tantalum barrier film by sputtering, ensuring improvement in crystallinity of the copper film. However, since copper is diffused into the tantalum film, it would be necessary for the tantalum barrier film formed below the copper film, to have a thickness of 50 nm or greater.

Prior Art 4 reports that if a copper film is formed on a tantalum film by CVD, fluorine (F) segregates at an interface between the copper film and TaN, resulting in degradation in adhesion therebetween.

Prior Art 3 reports that a crystalline TaN barrier film oriented in directions of (200) and (111) can prevent copper diffusion more highly than a crystalline Ta barrier film.

As an solution to enhance a characteristic of preventing copper diffusion and adhesion to copper, a multi-layered structure of a metal film and a metal nitride film has been suggested.

For instance, the above-mentioned Japanese Patent Application No. 10-330938 has suggested a method of fabricating a multi-layered barrier film



including a titanium film and formed by sputtering.

As illustrated in Fig. 1, in accordance with the suggested method, only an argon gas is introduced into a sputter chamber to thereby form a titanium film 1. Then, a nitrogen gas is introduced into the sputter chamber, and a thin titanium nitride film 2 is formed on the titanium film 1 auxiliarily making use of reaction between titanium and nitrogen. Thus, there is formed a multi-layered barrier structure 3 comprised of the titanium film 1 and the thin titanium nitride film 2.

In the method, a metal oxide film formed on an underlying wiring film is removed by argon plasma prior to carrying out sputtering.

However, the conventional barrier film for preventing copper diffusion is accompanied with the following problems.

The first problem is that it is quite difficult to make a diffusion-barrier film have both a characteristic of preventing copper diffusion and a sufficient adhesive force with copper.

As illustrated in Fig. 2, it is now assumed to form a metal film 5 having a crystallized pillar structure, on a semiconductor substrate 4. In the metal film 5, a lot of grains each comprised of individual crystals, and grain boundaries 7 each defining an interface between the grains 6 exist throughout the metal film 5, that is, from an upper surface to a bottom of the metal film 5. The grain boundaries 7 define paths 8 through which copper is diffused. As a result, the metal film 5 has low barrier characteristic of preventing copper diffusion.

As illustrated in Fig. 3, it is now assumed to form a metal film 5a on a semiconductor substrate 4. If the metal film 5a is composed of metals having small resistivity, such as tungsten (W), titanium (Ti) or tantalum (Ta), the metal film 5 would have a polycrystal structure. As a result, the metal film 5a would have a pillar-like structure similarly to the metal film 5 illustrated in Fig. 2, and accordingly, the metal film 5a would have small barrier characteristic of preventing copper diffusion.

However, it should be noted that if a copper film is formed on a crystalline metal film, such as a  $\beta$ -Ta (002) film as obtained in sputtering of a tantalum film, by sputtering, the copper film would have high adhesion and rich crystal orientation, though a barrier characteristic of preventing copper diffusion would be deteriorated. As a result, the copper film would enhance reliability in copper wiring.

In contrast, the metal film 5a illustrated in Fig. 3, which is composed of particles 9 such as amorphous TaN and formed on the semiconductor substrate 4, has small resistivity, specifically in the range of about 200 to 250  $\mu\Omega$  cm, and does not have the paths through which copper is diffused unlike the crystalline metal film 5 illustrated in Fig. 2. As a result, the metal film 5a would have high barrier characteristic of preventing copper diffusion.

However, since a surface of the metal film 5a is amorphous and hence crystal lattice is not uniformly arranged, if a copper film is formed on the amorphous metal film 5a by CVD or sputtering, copper crystallinity and adhesion to copper are degraded.

As mentioned so far, it is quite difficult to form a diffusion-barrier film having a single-layered structure comprised only of a crystalline metal film or an amorphous metal nitride film, and further having high barrier characteristic of preventing copper diffusion and high adhesion to copper.

The second problem is caused when a diffusion-barrier film is designed to have a multi-layered structure in order to avoid the above-mentioned problem of the single-layered diffusion-barrier film.

For instance, if a diffusion-barrier film is designed to have a multi-layered structure comprised of a crystalline metal film having high adhesion to copper and an amorphous metal nitride film having high barrier characteristic, such as TaN, there would be obtained a diffusion-barrier film having high barrier characteristic of preventing copper diffusion and high adhesion to copper.

However, since it was not possible in a conventional method to

successively form a crystalline metal film and an amorphous metal nitride film by sputtering, the crystalline metal film and the amorphous metal nitride film had to be separately formed in the same sputtering chamber or be formed in separate sputtering chambers.

5           For instance, the above-mentioned Japanese Patent Application No. 10-330938 has suggested a method including the steps of introducing an argon gas into a sputtering chamber to thereby form a titanium film, and introducing a nitrogen gas into the sputtering chamber to thereby form a titanium nitride film on the titanium film.

10           However, in accordance with this method, the titanium nitride film cannot be formed until partial pressures of argon and nitrogen become stable by varying a mixture ratio of argon and nitrogen. Hence, it is impossible to enhance a fabrication yield of fabricating a diffusion-barrier film having a multi-layered structure.

15           The third problem relates to coverage of a film formed by sputtering.

In general, when a metal film or a metal nitride film is formed by sputtering, a metal target is sputtered by argon plasma generated by virtue of rotational magnetic field and application of DC bias, and resultingly, a metal film or a metal nitride film is deposited on a substrate located in facing relation to the  
20 metal target.

In sputtering, a pressure at which a metal target is sputtered is low, specifically, equal to 1 Pa or smaller. Since metal particles sputtered by argon plasma are radiated randomly to a surface of a substrate, for instance, if the substrate is formed at a surface thereof with a deep recess or hole, it would almost  
25 impossible to deposit a metal film such that such a recess or hole is completely covered with the metal film.

In addition, since a sputtering pressure is low, argon plasma could have a low plasma density, and hence, there cannot be expected re-sputtering effect in which a metal film deposited onto a surface of a substrate is sputtered by argon

plasma.

In order to enhance coverage of a metal film, there has been suggested collimate sputtering in which a metal plate formed with a lot of through-holes is located between a sputtering target and a substrate, and metal particles are caused to pass through the through-holes to thereby uniform direction of metal particles. In accordance with the collimate sputtering, it is possible to deposit a metal film on a bottom of a recess formed at a surface of a substrate, but it is not possible to deposit a metal film onto an inner sidewall of the recess.

The fourth problem is that a crystalline metal film having high adhesion with a copper film tends to react with atmosphere to thereby a reaction layer at a surface thereof.

Such a reaction layer would much deteriorate adhesion of a metal film with a copper film.

The fifth problem is a copper oxide film is adhered again to a recess or hole.

An oxide film formed on a surface of an underlying wiring metal film is removed by argon plasma prior to deposition of a diffusion-barrier film by sputtering. When an underlying wiring layer is composed of copper, a copper oxide film is scattered by argon sputtering, and as a result, the thus scattered copper oxide is adhered again to a recess or hole formed at a surface of an insulating film.

The sixth problem is that when a copper film is formed on a tantalum film and an amorphous TaN film by CVD, adhesion between the copper film and a diffusion-barrier film is deteriorated.

## SUMMARY OF THE INVENTION

In view of the above-mentioned problems in a conventional diffusion-barrier film, it is an object of the present invention to provide a diffusion-barrier film having both a diffusion-barrier characteristic of preventing copper from being

diffused into a semiconductor device and high adhesion between a copper film and an interlayer insulating film.

It is also an object of the present invention to provide a multi-layered wiring structure including the above-mentioned diffusion-barrier film.

5 Another object of the present invention is to provide a method of fabricating such the above-mentioned diffusion-barrier film.

A further object of the present invention is to provide a method of fabricating a multi-layered copper wiring layer in which copper is buried above the above-mentioned diffusion-barrier film.

10 In one aspect of the present invention, there is provided a barrier film preventing diffusion of copper from a copper wiring layer formed on a semiconductor substrate, including a multi-layered structure of first and second films, the first film being composed of crystalline metal containing nitrogen therein, the second film being composed of amorphous metal nitride, the barrier  
15 film being constituted of common metal atomic species.

It is preferable that the first film is formed on the second film.

It is preferable that the second film has a thickness in the range of 80 angstroms to 150 angstroms both inclusive.

It is preferable that the first film has a thickness in the range of 60  
20 angstroms to 300 angstroms both inclusive.

In another aspect of the present invention, there is provided a multi-layered wiring structure including a barrier film which prevents diffusion of copper from a copper wiring layer formed on a semiconductor substrate, the barrier film having a multi-layered structure of first and second films, the first  
25 film being composed of crystalline metal containing nitrogen therein, the second film being composed of amorphous metal nitride, the barrier film being constituted of common metal atomic species.

It is preferable that the barrier film covers a recess and a hole formed throughout an insulating film formed on an underlying wiring layer.

It is preferable that the multi-layered wiring structure further includes a copper film formed on the first film.

In still another aspect of the present invention, there is provided a method of forming a diffusion-barrier film by sputtering, including the steps of (a) preparing gas containing nitrogen therein, and (b) varying only power of an electric power source for generating plasma to thereby successively form a diffusion-barrier film having a multi-layered structure of first and second films, the first film being composed of crystalline metal containing nitrogen therein, the second film being composed of amorphous metal nitride, the barrier film being constituted of metal atomic species of sputter target.

It is preferable that the gas containing nitrogen therein has a pressure equal to or greater than 5 Pa.

It is preferable that the gas contains nitrogen at 10 volume % or smaller.

It is preferable that the metal atomic species of sputter target is one of tantalum, tungsten, titanium, molybdenum and niobium alone or in combination.

It is preferable that the second film has a thickness in the range of 80 angstroms to 150 angstroms both inclusive.

It is preferable that the first film has a thickness in the range of 60 angstroms to 300 angstroms both inclusive.

There is further provided a method of forming a diffusion-barrier film by RF magnetron sputtering making use of rotational magnetic field and RF power, including the steps of (a) preparing gas containing nitrogen therein, and (b) varying the RF power to thereby successively form a diffusion-barrier film having a multi-layered structure of first and second films, the first film being composed of crystalline metal containing nitrogen therein, the second film being composed of amorphous metal nitride, the barrier film being constituted of metal atomic species of sputter target.

There is still further provided a method of forming a diffusion-barrier

film by RF magnetron sputtering, including the steps of (a) setting an electric power source for generation plasma to generate power having a first value, to thereby a first film, with a concentration of nitrogen in plasma gas being kept at a constant, and (b) setting the electric power source to generate power having a  
5 second value greater than the first value at the moment when the first film is formed by a predetermined thickness, to thereby form a second film on the first film.

It is preferable that the first film is composed of amorphous metal nitride, and the second film is composed of crystalline metal containing nitrogen  
10 therein.

There is yet further provided a method of forming a copper wiring film, including the steps of (a) radiating plasma of argon containing hydrogen therein, to a recess or hole formed at an insulating film formed on a semiconductor substrate, (b) forming a diffusion-barrier film to cover the recess or hole therewith  
15 without exposing to atmosphere, the diffusion-barrier film having a multi-layered structure of first and second films, the first film being composed of crystalline metal containing nitrogen therein, the second film being composed of amorphous metal nitride, and (c) forming a copper film on the diffusion-barrier film without exposing to atmosphere.

20 It is preferable that the diffusion-barrier film is formed by sputtering.

It is preferable that the copper film is formed in vacuum.

It is preferable that the copper film is formed by thermal chemical vapor deposition in which thermal dismutation in a complex of organic metal is utilized.

25 It is preferable that the copper film is formed by sputtering in which copper target is used.

The advantages obtained by the aforementioned present invention will be described hereinbelow.

In the diffusion-barrier film in accordance with the present invention, a

copper film makes direct contact with a crystalline metal film containing nitrogen therein, ensuring high adhesion therebetween and high crystallinity of a copper film.

In addition, since the metal film contains nitrogen therein, copper  
5 diffusion into a semiconductor device can be prevented more effectively than a metal film having pure crystals.

In the diffusion-barrier film in accordance with the present invention, an amorphous metal film containing nitrogen therein lies under a crystalline metal film containing nitrogen therein. Hence, it is possible to effectively  
10 prevent copper diffusion, and to ensure high adhesion with an underlying insulating film such as a silicon dioxide film. That is, by forming a copper wiring layer on the diffusion-barrier film in accordance with the present invention, it is possible to not only ensure high crystallinity and high adhesion of a copper wiring layer, but also to prevent copper diffusion.

The method in accordance with the present invention makes it possible  
15 to successively form a diffusion-barrier film having a multi-layered structure of first and second films, by varying only power of an electric power source for generating plasma in sputtering in which gas containing nitrogen therein is employed. Herein, the first film is composed of crystalline metal containing  
20 nitrogen therein, and the second film is composed of amorphous metal nitride. The barrier film is constituted of metal atomic species of sputter target.

Specifically, an electric power source for generating plasma is first set to generate relatively low power with a concentration of nitrogen in plasma gas being kept constant. A film is formed in such a condition. Target metal makes  
25 sufficient reaction with nitrogen, and resultingly, an amorphous metal nitride film is formed. Immediately after the formation of the amorphous metal nitride film, the electric power source is set to generate relatively high power to thereby form a film without allowing sufficient time for reaction between nitrogen and target metal. As a result, there is obtained a crystalline metal film containing nitrogen



therein.

Thus, it is possible to successively form a diffusion-barrier film in the same chamber, wherein the diffusion-barrier film has a multi-layered structure including a crystalline metal film containing nitrogen therein and an amorphous metal nitride film.

The method of fabricating a diffusion-barrier film employs RF magnetron sputtering in which rotational magnetic field and RF power are utilized. Since the method makes it possible to carry out sputtering where a nitrogen-containing gas has a pressure equal to or greater than 5 Pa, plasma density of argon which is a main constituent of sputtering gas can be enhanced, and thus, there can be obtained coverage for entirely covering a recess or hole formed at a surface of a substrate, with the diffusion-barrier film.

The method of fabricating a diffusion-barrier film, in accordance with the present invention, includes the step of radiating plasma of argon containing hydrogen therein, to a recess or hole formed at an insulating film formed on a semiconductor substrate. This step reduces a copper oxide film formed on a surface of an underlying copper wiring layer, to thereby turn copper oxide back to copper, ensuring remarkable reduction in re-sputtering of a copper oxide film to a surface of a recess or hole formed at a surface of an insulating film.

Then, a diffusion-barrier film is formed to cover the recess or hole therewith without exposing to atmosphere, wherein the diffusion-barrier film has a multi-layered structure of first and second films, the first film being composed of crystalline metal containing nitrogen therein, the second film being composed of amorphous metal nitride. Then, a thin copper film is formed on the diffusion-barrier film in vacuum. As a result, there is obtained a multi-layered structure comprised of the diffusion-barrier film and the copper wiring film without a metal oxide layer being sandwiched therebetween.

The above and other objects and advantageous features of the present invention will be made apparent from the following description made with

reference to the accompanying drawings, in which like reference characters designate the same or similar parts throughout the drawings.

#### BRIEF DESCRIPTION OF THE DRAWINGS

5            Fig. 1 is a cross-sectional view of a conventional copper wiring structure.

             Fig. 2 is a cross-sectional view of another conventional copper wiring structure.

10           Fig. 3 is a cross-sectional view of still another conventional copper wiring structure.

             Fig. 4A is a cross-sectional view of a diffusion-barrier film in accordance with the first embodiment of the present invention, illustrating the first step of a method of fabricating the same.

15           Fig. 4B is a cross-sectional view of a diffusion-barrier film in accordance with the first embodiment of the present invention, illustrating the second step of a method of fabricating the same.

             Fig. 4C is a cross-sectional view of a diffusion-barrier film in accordance with the first embodiment of the present invention, illustrating the third step of a method of fabricating the same.

20           Fig. 4D is a cross-sectional view of a diffusion-barrier film in accordance with the first embodiment of the present invention, illustrating the fourth step of a method of fabricating the same.

             Fig. 5 illustrates a high-pressure RF magnetron sputtering apparatus used in the first embodiment.

25           Fig. 6 is a graph showing coverage characteristic of a tantalum film in high-pressure RF magnetron sputtering.

             Figs. 7 and 8 are cross-sectional views of a recess covered with a tantalum film in high-pressure RF magnetron sputtering.

             Fig. 9 is a graph showing a relation among a ratio of a nitrogen gas in a

mixture gas introduced into a chamber, RF power, and resistivity of a film formed by sputtering.

Figs. 10 to 18 are graphs each showing film quality and characteristics of TaN and Ta films in high-pressure RF magnetron sputtering.

5 Figs. 19 and 20 are photographs of a film formed by high-pressure RF magnetron sputtering which photograph is taken by means of a scanning electron microscopy (SEM).

10 Fig. 21 is a cross-sectional view of a diffusion-barrier film formed by high-pressure RF magnetron sputtering which barrier-diffusion film is comprised of a crystalline Ta film containing nitrogen in solid solution and an amorphous metal TaN film.

Fig. 22 is a photograph of a film formed by high-pressure RF magnetron sputtering which photograph is taken by means of a scanning electron microscopy (SEM).

15 Fig. 23 is a cross-sectional view of a diffusion-barrier film covering a recess therewith.

Fig. 24 illustrates a DC magnetron sputtering apparatus used in the fourth embodiment.

20 Fig. 25 is a cross-sectional view of a diffusion-barrier film covering a recess formed at a surface of an insulating film formed above a lower wiring layer.

Fig. 26 is a cross-sectional view of a diffusion-barrier film covering a recess formed at a surface of an insulating film formed above lower wiring layers.

Fig. 27 is a plan view of a cluster apparatus used for forming a copper wiring layer.

25 Fig. 28 is a graph showing a diffusion profile of fluorine into a diffusion-barrier film.

Fig. 29 is a graph showing a diffusion profile of copper into a diffusion-barrier film.

Fig. 30 is a cross-sectional view of a copper wiring structure in

accordance with the seventh embodiment.

Fig. 31 is a cross-sectional view of a copper wiring structure in accordance with the seventh embodiment.

## 5 DESCRIPTION OF THE PREFERRED EMBODIMENTS

Preferred embodiments in accordance with the present invention will be explained hereinbelow with reference to drawings.

A method of fabricating a diffusion-barrier film in accordance with the preferred embodiment is explained hereinbelow with reference to Figs. 4A to 4D.

10 As illustrated in Fig. 4A, a first insulating film 12a is formed on a semiconductor substrate 11, and a second insulating film 12b is formed on the first insulating film 12a. A copper wiring layer 44 is buried in the first insulating film 12a. The second insulating film 12b is formed at a surface thereof with recesses 13 in each of which a wiring is to be formed. Holes 14 reach the first  
15 insulating film 12a from a bottom of each of the recesses 13.

First, the semiconductor substrate 11 is exposed to argon plasma containing hydrogen therein, in a first chamber.

Then, the semiconductor substrate 11 is transferred in vacuum to a second chamber, and a film is formed on the semiconductor substrate 11 in a  
20 nitrogen-containing gas by sputtering in which a sputtering target is composed of refractive metal.

First, an electric power source for generating plasma is set to generate relatively low power with a concentration of nitrogen in plasma gas being kept constant. As a result, the target metal makes sufficient reaction with nitrogen,  
25 and an amorphous metal nitride film 15 is deposited over a surface of the second insulating film 12b, as illustrated in Fig. 4B.

Then, immediately after the formation of the amorphous metal nitride film 15, the electric power source is set to generate relatively high power to thereby form a film without allowing sufficient time for reaction between nitrogen

and the target metal. As a result, a crystalline metal film 16 containing nitrogen therein is formed on the amorphous metal nitride film 15.

Thus, as illustrated in Fig. 4B, it is possible to successively and effectively fabricate the diffusion-barrier film 17 having a multi-layered structure, on both an inner sidewall and a bottom of the recesses 13 and the holes 14 in the same chamber. By setting a sputtering pressure sufficiently high while deposition of the diffusion-barrier film 17 by sputtering, it would be possible to enhance coverage of the diffusion-barrier film 17.

Thereafter, the semiconductor substrate 11 is transferred into a third chamber in vacuum. Then, a copper film 18 is deposited over the diffusion-barrier film 17 in vacuum in the third chamber to thereby completely fill the recesses 13 and the holes 14 with the copper film 18, as illustrated in Fig. 4C. Since the crystal metal film 16 containing nitrogen therein is exposed outside and the semiconductor substrate 11 is transferred in vacuum, an oxide film is not formed at a surface of the crystal metal film 16.

Then, as illustrated in Fig. 4D, the diffusion-barrier film 17 and the copper film 18 are removed by CMP until the second insulating film 12b appears. Thus, there is obtained a copper wiring structure having high reliability.

The reason of enhancement in barrier characteristic of preventing copper diffusion is to introduce nitrogen into the metal film 16. In addition, the metal film 16 containing nitrogen ensures high adhesion with copper. The amorphous metal nitride film 15 also has a characteristic of preventing copper diffusion, and further enhances adhesion with the second insulating film 12b. Thus, it is possible to ensure high adhesion between the copper film 18 and the diffusion-barrier film 17, and to prevent copper from being diffused from the copper film 18 into the second insulating film 12b.

Hereinbelow are explained detailed examples of the above-mentioned embodiment.

[First Example]

In the first example, hereinbelow is explained sputtering for fabricating a multi-layered structure comprised of a crystalline metal film containing nitrogen therein and an amorphous metal nitride film.

5 The sputtering in the first example is carried out in a RF magnetron sputtering apparatus illustrated in Fig. 5.

In the illustrated RF magnetron sputtering apparatus, a chamber 21 is kept to be in vacuum, specifically, to have an internal pressure of about  $1 \times 10^{-7}$  Pa to about  $1 \times 10^{-6}$  Pa by means of a pump 33 such as a dry pump, a cryosorption pump or a turbo pump. In the chamber 21 is placed a heater 34 which can heat a  
10 semiconductor substrate 22 introduced into the chamber 21, up to about 20 to 300 degrees centigrade. A metal target 28 or the semiconductor substrate 22 is designed to be able to raise or lower, and hence, a distance between the metal target 28 and the semiconductor substrate 22 can be varied in the range of 102 mm to 134 mm.

15 Argon and nitrogen gases are adjusted with respect to a flow rate by means of mass flow controllers 31, and then, introduced into the chamber 21. When the argon and nitrogen gases are introduced into the chamber 21, the chamber 21 has an internal pressure of about 2 Pa to about 17 Pa.

The metal target 28 has a diameter, for instance, in the range of about  
20 300 mm to about 320 mm. The metal target 28 is fixed to the chamber 21 through a target holder 27, a cathode 23 and insulators 29. In the cathodes 23 are rotatably arranged a plurality of permanent magnets 24. By rotating the permanent magnets 24, magnetic field 30 in the chamber 21 is uniformized, and erosion at a surface of the metal target 28 is also uniformized. As a result, it is  
25 possible to enhance uniformity of a film to be formed on the semiconductor substrate 22.

A RF electric power source 25 for introducing RF power into the chamber 21 is in electrical connection with the cathode 23 through a matching box 32 carrying out impedance matching. The RF electric power source 25 applies

radio frequency (RF) having a frequency of 13.56 MHz to the metal target 28 having a diameter of 300 mm, at 0 to 10 kW.

Turning the RF electric power source 25 on to thereby introduce RF into the chamber 21, there is generated argon plasma containing nitrogen therein.  
5 The target metal 28 is sputtered by argon ions generated in the argon plasma 26. As a result, metal particles of the target metal 28 fly into the semiconductor substrate 22, and thus, the crystalline metal film 16 containing nitrogen therein or the amorphous metal nitride film 15 is formed.

The inventor actually formed a tantalum film covering therewith the  
10 hole 14 (see Fig. 4A) formed through the second insulating film 12b by means of the above-mentioned RF magnetron sputtering apparatus. The coverage characteristic of the tantalum film is shown in Fig. 6.

The hole 14 had a diameter in the range of  $0.3\ \mu\text{m}$  to  $1.5\ \mu\text{m}$ . The second insulating film 12b had a thickness of about  $1.5\ \mu\text{m}$  where the hole 14 was  
15 formed.

As is obvious in view of Fig. 6, as a sputtering pressure is increased from 2 Pa to 17 Pa, bottom coverage is enhanced. Herein, bottom coverage is defined as a ratio of a thickness of the tantalum film at a bottom of the hole 14 to a thickness of the tantalum film at a surface of the second insulating film 12b.  
20 Specifically, when a sputtering pressure is over 5 Pa, sufficient coverage can be obtained to a hole having a great aspect ratio.

A thickness of the tantalum film at an inner sidewall of the hole 14 is equal to about a half of a thickness of the tantalum film at a bottom of the hole 14. As a sputtering pressure is increased, the tantalum film covers an inner sidewall  
25 of the hole 14 therewith to a greater degree.

The reason of this phenomenon is considered as follows.

The first reason is an increase in the number of Ta ions in plasma gas, as illustrated in Fig. 7.

As a sputtering pressure is increased, tantalum atoms increasingly

make collision with excited argon atomics, resulting in that argon atomics are facilitated to be ionized. The resultant tantalum ions are attracted to negative self-bias generated at the semiconductor substrate 22. As a result, an incident angle at which tantalum ion flux 35 is radiated to the semiconductor substrate 22 becomes nearly 90 degrees. Thus, overhanging which occurs in the vicinity of an edge of recess or hole in conventional sputtering is suppressed, ensuring tantalum atomics to reach a bottom of the hole 14 or recess 13. As a result, a tantalum film 36 entirely covers an inner sidewall of the hole 14.

The second reason is that the deposited tantalum film 36 is re-sputtered by argon ions 39, as illustrated in Fig. 8.

The argon ions 39 which are primary constituents of plasma gas are accelerated by electric field and reach not only a target but also the semiconductor substrate 22 which is in a condition of negative self-bias. This means that the tantalum film 36 having been deposited onto the semiconductor substrate 22 is re-sputtered. Since the tantalum film deposited in the vicinity of an edge of the hole 14 or recess 13 and causing overhanging is re-sputtered by the argon ions 39, as indicated with an arrow 37, tantalum atomics 38 directing to a bottom of the hole 14 or recess 13 are not interfered at the edge of the hole 14 or recess 13. Accordingly, it is ensured that a tantalum film is deposited on a bottom and an inner sidewall of the hole 14 or recess 13.

In addition, since the tantalum film 36 deposited on a bottom of the hole 14 or recess 13 is re-sputtered by the argon ions 39, tantalum atomics generated by re-sputtering are deposited again on an inner sidewall 40 of the hole 14 or recess 13, ensuring enhancement in coverage at the sidewall 40 of the hole 14 or recess 13.

It is not possible to determine which is a main reason for enhancement in coverage among the above-mentioned first and second reasons. However, since mean free path of plasma ion is just a few millimeters under a pressure over 5 Pa, it is considered that almost 90 degrees of an incident angle of the tantalum



ion flux 35 does not contribute to enhancement in coverage so much. The main reason why the coverage is enhanced is considered that argon ions are generated in a sufficient density by virtue of a high pressure, and a tantalum film having been deposited are re-sputtered by the argon ions.

5 In accordance with the experiments the inventor had conducted, it was confirmed that coverage was enhanced in sputtering of a tantalum nitride film, carried out under a high pressure over 5 Pa.

As mentioned so far, it is preferable that a sputtering pressure is set equal to or greater than 5 Pa in RF magnetron sputtering.

10 [Second Example]

Fig. 9 shows a relation between a flow rate ratio and resistivity of a film formed by high-pressure RF magnetron sputtering having been explained in the first example, for various RF powers. Herein, the flow rate ratio is defined as a ratio of a volume of argon gas to be introduced into the chamber 21 to a volume of  
15 nitrogen gas to be introduced into the chamber 21 ( $N_2 / (Ar + N_2)$ ).

The relation shown in Fig. 9 was observed when the chamber 21 had a pressure of 13 Pa, the semiconductor substrate 22 was heated at 200 degrees centigrade, the permanent magnets 24 were rotated at 10 r.p.m., and the distance between the metal target 28 and the semiconductor substrate 22 was 134 mm.

20 As a ratio of  $N_2$  gas in the flow rate ratio  $N_2 / (Ar + N_2)$  is increased, the resistivity is once reduced, and thereafter, increased again, regardless the RF power. However, an increase rate of the  $N_2$  gas ratio is dependent on the RF power. The resistivity increases at a lower rate at the greater RF power.

Figs. 10 to 13 show how X-ray diffraction (XRD) patterns vary as the  $N_2$   
25 gas ratio is varied when RF power of 6 kW ( $8.5 \text{ W/cm}^2$ ) is applied to the tantalum target having a diameter of 300 mm.

Specifically, Figs. 10 to 13 shows XRD patterns when the  $N_2$  gas ratio is equal to 0%, 1%, 5%, and 7% respectively. Hereinbelow are explained Figs. 10 to 13 in comparison with Fig. 9.

When the  $N_2$  gas ratio is equal to 0%, there is obtained a  $\beta$ -Ta (002)-oriented crystalline tantalum film which has resistivity in the range of about 160 to 200  $\mu\Omega$ -cm, as illustrated in Fig. 10.

When the  $N_2$  gas ratio is equal to 1%, there is obtained a crystalline metal film (herein, a tantalum film) containing nitrogen therein, which includes  $\beta$ -Ta and  $TaN_{0.1}$  in mixture and which has resistivity in the range of about 100  $\mu\Omega$ -cm, as illustrated in Fig. 11.

When the  $N_2$  gas ratio is equal to 5%, it is understood in view of Fig. 12 that XRD pattern strength is reduced, and hence, there is formed an amorphous metal nitride film, which has resistivity in the range of about 200 to 250  $\mu\Omega$ -cm.

When the  $N_2$  gas ratio is equal to 7%, a crystalline metal nitride film ( $Ta_3N_5$ ) is formed, and resistivity is further increased, as illustrated in Fig. 13.

As mentioned above, when the tantalum target is selected, a crystalline structure, composition and resistivity of a film to be formed by sputtering vary in dependence on both a concentration of nitrogen gas in sputtering gas and RF power. Conversely speaking, this means that it is possible to control characteristics of a film to be formed by sputtering, by controlling both a concentration of nitrogen gas in sputtering gas and RF power. The present invention is based on this discovery.

However, it is difficult to vary a flow rate of sputtering gas (that is, a pressure of sputtering gas) and  $N_2$  composition ratio in sputtering. Accordingly, it is necessary in practical use to keep both a flow rate of sputtering gas (that is, a pressure of sputtering gas) and  $N_2$  composition ratio constant, and to vary only RF power, to thereby control a crystalline structure, composition and resistivity of a film to be formed by sputtering.

Fig. 14 shows how resistivity varies when only RF power is varied while a  $N_2$  gas ratio is kept fixed at 2%. As is obvious in view of Fig. 14, it is understood that it is possible to control film quality and resistivity of a film to be formed by sputtering, even when only RF power is varied. In Fig. 14, resistivity is varied

when a gas pressure is equal to 10 Pa, the permanent magnets are rotated at 10 r.p.m., and the substrate was heated at 200 degrees centigrade.

Figs. 15 to 18 show XRD characteristics relative to RF power. Figs. 15 to 18 show XRD characteristics observed when RF power is equal to 2 kW, 3 kW, 6 kW and 8 kW, respectively.

Specifically, when RF power is equal to 2 kW, there is obtained amorphous  $Ta_2N$ , as illustrated in Fig. 15. By increasing RF power, there is obtained crystalline  $TaN_{0.1}$ . When RF power is equal to 8 kW, there is obtained a crystalline metal film containing nitrogen therein, which includes a  $\beta$ -Ta film and  $TaN_{0.1}$  in mixture.

Figs. 19 and 20 are SEM (Scanning Electron Microscopy) photographs of films obtained when RF power is set equal to 2 kW and 8 kW, respectively.

When RF power is set equal to 2 kW, as is obvious in view of XRD illustrated in Fig. 15, there is not observed grain boundary, because a deposited film has an amorphous structure. In contrast, when RF power is set equal to 8 kW, as is obvious in view of XRD illustrated in Fig. 18, there is obtained a crystalline film including a  $\beta$ -Ta film and  $TaN_{0.1}$  in mixture, and having a pillar-like structure.

That is, if  $Ta_2N$ , which is an amorphous metal nitride film, is deposited at 2 kW of RF power, and RF power is increased up to 8 kW immediately when the film has acquired a desired thickness, the film is turned into a crystalline metal film containing nitrogen therein. As a result, as illustrated in Fig. 21, a diffusion-barrier film 17 is formed on a semiconductor substrate 11 where the diffusion-barrier film 17 has a multi-layered structure comprised of an amorphous metal nitride film 15 and a crystalline metal film 16 containing nitrogen therein. Specifically, the amorphous metal nitride film 15 is an amorphous  $Ta_2N$  film, and the crystalline metal film 16 is composed of crystalline  $\beta$ -Ta and crystalline  $TaN_{0.1}$  in mixture.

Fig. 22 is a SEM photograph of a cross-section of the diffusion-barrier

film 17 which is formed by changing sputtering power from 2 kW to 8 kW while a TaN film is being deposited, to thereby successively deposit the crystalline metal film 16 and the amorphous metal nitride film 15 each by a thickness of about 500 angstroms. It is confirmed in Fig. 22 that the amorphous Ta<sub>2</sub>N film 15 and the  
5 crystalline metal film 16 containing nitrogen therein form a multi-layered structure.

The reason of this phenomenon is considered as follows.

When sputtering power is set equal to 2 kW, since a sputtering rate caused by argon ions is relatively low, there is sufficient time for a tantalum  
10 target to be nitrated by N<sub>2</sub> at a surface thereof. Hence, the tantalum target is nitrated at a surface thereof, and turned into Ta<sub>2</sub>N. Since the thus produced Ta<sub>2</sub>N is sputtered by argon ions, a Ta<sub>2</sub>N film is deposited. However, when sputtering power is set equal to 8 kW, the tantalum target is sputtered by argon ions before a surface of the tantalum target is sufficiently nitrated. As a result,  
15 there is obtained a tantalum film slightly containing nitrogen.

By utilizing the above-mentioned phenomenon, it is possible to form the diffusion-barrier film 17 having a multi-layered structure and covering therewith the recess 13 or the hole 14 formed at the second insulating film 12b formed on the semiconductor substrate 11, as illustrated in Fig. 23.

20 The lower film or amorphous metal nitride (Ta<sub>2</sub>N) film 15 is required to have such a thickness that barrier characteristic of preventing copper diffusion is ensured and adhesion with the underlying insulating film 12b is also ensured. A desired thickness of the amorphous metal nitride (Ta<sub>2</sub>N) film 15 is in the range of about 80 angstroms to about 150 angstroms.

25 On the other hand, the crystalline nitrogen-containing metal film 16 composed of crystalline β-Ta and crystalline TaN<sub>0.1</sub> in mixture is required to have such a thickness that barrier characteristic of preventing copper diffusion is ensured and adhesion with copper is also ensured. A desired thickness of the crystalline metal film 16 is in the range of about 60 angstroms to about 300

angstroms.

[Third Example]

The RF magnetron sputtering having been explained in the first example makes it possible to enhance coverage characteristic of a deposited film  
5 for covering a recess or hole therewith, by introducing a gas having a higher pressure than usual, specifically, a pressure equal to or greater than 5 Pa, into a chamber. That is, it is possible to form the multi-layered barrier film 17 under desired coverage characteristic by switching RF power with a sputtering pressure being kept equal to or greater than 5 Pa, even when there is carried out dual-  
10 damassin process in which the recess 13 and the hole 14 formed at a surface of the second insulating film 12b formed on the semiconductor substrate 11 are concurrently filled with the diffusion-barrier film 17.

[Fourth Example]

In the above-mentioned first and second examples, the process in which  
15 a multi-layered barrier film is successively formed by switching RF power while the film is being formed is applied to RF magnetron sputtering. This process may be applied to DC magnetron sputtering, as illustrated in Fig. 24, though a N<sub>2</sub> gas ratio and RF power are different from those in the first and second examples.

Fig. 24 illustrates a DC magnetron sputtering apparatus. The  
20 apparatus is comprised of a chamber 21, a heater 34 fixed on a bottom of the chamber 21 for heating a semiconductor substrate 22, a target metal 28 fixed to a top of the chamber 21 by means of insulators 29 and a cathode 23, a pump 33 for exhausting air from the chamber 21 such that a pressure in the chamber 21 is in the range of about  $1 \times 10^{-7}$  Pa to about  $1 \times 10^{-6}$  Pa, a magnet 42 positioned above  
25 the target metal 28, mass flow controllers 31 for adjusting flow rates of argon gas and nitrogen gas, and allowing the gases to enter the chamber 21, and a DC electric power source 41 for applying a DC voltage to both the cathode 23 and the heater 34.

Turning the DC electric power source 41 on, argon plasma containing

nitrogen therein is generated in the chamber 21.

[Fifth Example]

In the first and second examples, there is formed only one via-hole and wiring. However, it should be noted that the present invention may be applied to  
5 a copper wiring structure including two or more via-holes and wirings.

In the fifth example, as illustrated in Fig. 25, a first insulating film 12a is formed on a semiconductor substrate 11. The first insulating film 12a is formed with via-holes which is filled with a copper wiring layer 44 with a diffusion-barrier film 17 being sandwiched between an inner surface of each of the  
10 via-holes and the copper wiring layer 44. A second insulating film 12b is formed on the first insulating film 12a. The second insulating film 12b is also formed with recesses and via-holes which is filled with a copper wiring (not illustrated) with a diffusion-barrier film 17 being sandwiched between inner surfaces of the recesses and the via-holes, and the copper wiring.

15 Thus, recesses and/or holes formed throughout each of multi-layered insulating films are covered with the diffusion-barrier film 17, and then, the recesses and/or holes may be filled with a copper wiring layer.

An example of the multi-layered structure is illustrated in Fig. 26. The illustrated multi-layered structure is comprised of three insulating layers.  
20 Each of the insulating layers is formed with recesses and via-holes, which are covered at their surfaces with a diffusion-barrier layer 17, and filled with copper wiring layers 44a and 44b.

Hereinbelow is explained a method of fabricating the multi-layered structure illustrated in Fig. 26.

25 A semiconductor substrate 11 is formed at a surface thereof with oxide layers 11a. A semiconductor device 11b is formed on the semiconductor substrate 11 between the oxide layers 11a.

A first insulating film 12a is formed on the semiconductor substrate 11. The first insulating film 12a is comprised of, for instance, a silicon dioxide film.

The first insulating film 12a is formed with recess and holes reaching the semiconductor device 11b. The recesses and holes are covered at their inner surfaces with the diffusion-barrier film 17. The diffusion-barrier film 17 has a multi-layered structure comprised of a crystalline nitrogen-containing metal film  
5 and an amorphous metal nitride film, and has sufficient coverage to cover recesses and holes therewith. The diffusion-barrier film 17 may be formed by such high-pressure RF magnetron sputtering as mentioned in the first example.

Then, the recesses and holes are filled with copper in vacuum. Then, the copper film and the diffusion-barrier film 17 are removed by CMP until the  
10 first insulating film 12a appears. Thus, there is fabricated the copper wiring layer 44a.

Since copper does not form passive state at a surface, the copper wiring layer 44a may be oxidized. In order to prevent oxidation of the copper wiring layer 44a, a silicon nitride film 12d is formed over the first insulating film 12a.

Then, a second insulating film 12b is formed on the first insulating film  
15 12a. The second insulating film 12b is formed with recesses and holes reaching the copper wiring layer 44a formed in the first insulating film 12a. Then, the recesses and holes formed in the second insulating film 12b are covered with the diffusion-barrier film 17, and the recesses and holes are filled with the copper  
20 wiring layer 44b. By repeating the above-mentioned steps by the desired number, there can be fabricated a semiconductor device having such a multi-layered copper wiring structure as illustrated in Fig. 26.

[Sixth Example]

The sixth example relates to an apparatus and a method of successively  
25 forming both a diffusion-barrier film having a multi-layered structure and copper wiring layer.

Fig. 27 is a top plan view of an apparatus of forming a copper wiring layer, in accordance with the sixth example.

The apparatus includes a cluster chamber 51 including a separation

chamber 51 at a center. The separation chamber 51 is equipped therein with a robot 52 for transferring a semiconductor substrate.

The cluster chamber 51 is comprised further of two lord lock chambers 45, a chamber 46 used for heating a semiconductor substrate, an etching chamber 47 used for cleaning recesses and holes, a sputter chamber 48 used for fabricating a diffusion-barrier film, and a chamber 49 used for forming a copper wiring layer, arranged around the separation chamber 51.

It is possible to form a copper wiring layer without exposure of a semiconductor substrate to atmosphere through the use of the cluster chamber 50.

10 Hereinbelow are explained steps of fabricating a copper wiring layer.

First, a semiconductor substrate is introduced into one of the lord lock chambers 45. An insulating film is formed in advance on the semiconductor substrate, and the insulating film is formed in advance with a recess and/or hole.

15 Then, the lord lock chamber 45 is evacuated of air by means of a dry pump and a turbo pump for about five minutes. As a result, the lord lock chamber 45 has a vacuum degree of  $7 \times 10^{-3}$  Pa to  $8 \times 10^{-3}$  Pa.

Then, a gate valve between the lord lock chamber 45 and the separation chamber 51 is made open. The separation chamber 51 is in advance kept in a vacuum degree of about  $5 \times 10^{-5}$  Pa to  $1 \times 10^{-5}$  Pa by means of a dry pump and a turbo pump. Hence, the semiconductor substrate is transferred into the separation chamber 52 by the robot 52 without being exposed to atmosphere.

25 Then, the semiconductor substrate is transferred into the chamber 46 which is in advance kept in a vacuum degree of about  $6 \times 10^{-5}$  Pa by means of a dry pump and a turbo pump. The semiconductor substrate is heated at about 50 to about 200 degrees centigrade in the chamber 46 to thereby remove moisture existing at a surface of the semiconductor substrate and clean a surface of the semiconductor substrate.

Then, the semiconductor substrate is transferred into the etching chamber 47 from the chamber 46 through the separation chamber 51. The



etching chamber 47 is kept in a vacuum degree of about  $5 \times 10^{-6}$  Pa by means of a cryosorption pump, dry pump and a turbo pump.

After introducing the semiconductor substrate into the etching chamber 47, the semiconductor substrate is plasma-etched in argon gas or argon gas diluted with hydrogen gas ( $H_2/Ar = 3\%$ ). By carrying out plasma-etching, a surface of the semiconductor substrate and inner surfaces of a recess and a hole are reduced and cleaned.

The plasma-etching has an advantage that edges of a recess and a hole are ground by the plasma-etching, and accordingly, an opening area of the recess and hole is broadened, ensuring enhancement in coverage characteristic.

Then, the semiconductor substrate is transferred into the sputter chamber 48 from the etching chamber 47 by means of the robot 52. The sputter chamber 48 is kept in a vacuum degree of about  $4 \times 10^{-6}$  Pa by means of a cryosorption pump, dry pump and a turbo pump. The high-pressure RF magnetron sputtering as having been explained in the first example is carried out in the sputter chamber 48.

In the sputter chamber 48, a crystalline nitrogen-containing metal film (a film composed of crystalline  $\beta$ -Ta and crystalline  $TaN_{0.1}$  in mixture) and an amorphous metal nitride film (a  $Ta_2N$  film) are deposited on the semiconductor substrate by the method having been explained in the first and second examples, wherein RF power is instantaneously switched. In this example, a gas pressure is kept at 10 Pa, a substrate temperature is kept at 200 degrees centigrade, a  $N_2$  gas ratio is kept at 2%, and RF power is switched from 2 kW to 8 kW. As a result, there is obtained a diffusion-barrier film having a multi-layered structure and also having enhanced coverage characteristic under the characteristics illustrated in Fig. 6.

Then, the semiconductor substrate is transferred in vacuum to the chamber 49 from the sputter chamber 48. The chamber 49 is kept in a vacuum degree of about  $4 \times 10^{-4}$  Pa by means of a dry pump and a turbo pump. Since the

semiconductor substrate is transferred in vacuum, the crystalline nitrogen-containing metal film in the diffusion-barrier film is kept clean at a surface thereof. A copper film is deposited on the crystalline nitrogen-containing metal film by chemical vapor deposition (CVD) such that the recess and hole is filled  
5 with copper, as follows.

The semiconductor substrate is kept at about 170 to about 200 degrees centigrade. A source including Cu (hfac) tmvs (trimethylvinylsilyl hexafluoroacetylacetonate copper (I) ) as a main constituent is introduced into a carburetor at 1 to 2 grams per minute through a liquid transfer system. The  
10 source gasified in the carburetor is introduced into the chamber 49 together with nitrogen carrier gas, resulting in that the chamber 49 is kept at about 1 kPa.

The gas introduced into the chamber 49 makes chemical reaction on the semiconductor substrate, and is turned into copper, and then, deposited on the semiconductor substrate. Herein, copper is deposited by such a thickness that a  
15 recess and/or hole is sufficiently filled with copper, for instance, a thickness in the range of about 8000 angstroms to about 15000 angstroms.

In particular, when a copper film is formed by CVD, segregation of fluorine at a surface of the diffusion-barrier film, diffusion of fluorine into the diffusion-barrier film, and diffusion of copper into the diffusion-barrier film exert  
20 a great influence on the adhesion, which fluorine is contained in Cu (hfac) tmvs which is a source for carrying out CVD.

Figs. 28 and 29 illustrate diffusion profiles of fluorine and copper into the diffusion-barrier film, respectively, which profiles were measured by SIMS (secondary ion mass spectroscopy).

25 In a  $\beta$  - Ta film obtained by sputtering carried out in argon atmosphere, since fluorine segregates at an interface between copper and tantalum, the  $\beta$  - Ta film would have poor adhesion. With respect to a Ta<sub>2</sub>N film, though fluorine is diffused into the Ta<sub>2</sub>N film, copper is scarcely diffused in the Ta<sub>2</sub>N film. As a result, atomics are coupled with each other with a poor force,

and hence, the  $Ta_2N$  film would have poor adhesion. In contrast, with respect to a  $TaN_{0.1}$  film, since copper and fluorine are allowed to be diffused into the  $TaN_{0.1}$  film, atoms are coupled with each other with a strong force, and as a result, the  $TaN_{0.1}$  film would have high adhesion.

5            Thus, it is understood that if copper is deposited by CVD, the diffusion-barrier film having a multi-layered structure comprised of a crystalline  $TaN_{0.1}$  film and an amorphous  $Ta_2N$  film would have enhanced adhesion and barrier characteristic of preventing copper diffusion.

10            In accordance with the sixth example, a copper wiring layer can be formed on a semiconductor substrate without the semiconductor substrate being exposed to atmosphere. Accordingly, the diffusion-barrier film is kept clean at a surface, and hence, film quality of a copper film formed by CVD is likely to be reflected to a crystalline structure of a tantalum film of the diffusion-barrier film. Thus, it is possible to enhance crystal orientation of copper and adhesion between  
15            copper and a diffusion-barrier film.

[Seventh Example]

20            The seventh example relates to the cluster chamber 50 illustrated in Fig. 27. In the seventh example, the sputter chamber 48 is positioned in a region where a copper wiring layer is to be formed, which region corresponds to the chamber 49 in which a copper wiring layer is formed. Since the diffusion-barrier film includes a  $TaN_{0.1}$  film containing crystalline  $\beta-Ta$  therein, at a surface, adhesion between the diffusion-barrier film and a copper film formed by sputtering is kept the same as adhesion between the diffusion-barrier film and a copper film formed by CVD.

25            [Eighth Example]

              In the eighth example, the semiconductor substrate is taken out of the cluster chamber 50 illustrated in Fig. 27. The semiconductor substrate has such a copper wiring structure as illustrated in Fig. 30. Specifically, recesses and holes formed in the second insulating film 12b are covered with the diffusion-

barrier film 17, and a copper film 53 is formed covering the diffusion-barrier film 17 therewith.

A second copper film 54 is deposited over the copper film 53 by plating such that the recesses and holes are filled with the second copper film 54. As a result, as illustrated in Fig. 31, it is possible to fabricate a structure comprised of the multi-layered barrier layer 17, the copper film 53 formed by CVD or sputtering, and the second copper film 54 formed by plating. Thereafter, as illustrated in Fig. 4D, for instance, the second copper film 54, the copper film 53 and the diffusion-barrier film 17 are removed by CMP. Thus, there is obtained a copper wiring structure.

While the present invention has been described in connection with the preferred embodiments, the present invention provides the following advantages.

The first advantage is that it is possible to have a diffusion-barrier film having sufficient barrier characteristic of preventing copper diffusion and high adhesion with a copper film. This is because the diffusion-barrier film is designed to have a multi-layered structure comprised of an amorphous metal nitride film having a high barrier characteristic of preventing copper diffusion and a crystalline nitrogen-containing metal film having high adhesion with copper.

The second advantage is that it is possible to successively fabricate the diffusion-barrier film in a common chamber. This ensures reduction in apparatus cost and reduction in time for fabricating the diffusion-barrier film.

This is because that it is possible to successively form an amorphous metal nitride film and a crystalline nitrogen-containing metal film by instantaneously changing only RF power with a volume ratio of a nitrogen gas to a process gas introduced into a chamber, being kept constant. In accordance with this method, an upper metal film in the diffusion-barrier film inevitably contains nitrogen therein.

The third advantage is that a copper film can be formed with a surface

of the diffusion-barrier film being kept clean, through the use of an apparatus of transferring a semiconductor substrate in vacuum. As a result, reliability in a copper wiring layer can be enhanced.

5 While the present invention has been described in connection with certain preferred embodiments, it is to be understood that the subject matter encompassed by way of the present invention is not to be limited to those specific embodiments. On the contrary, it is intended for the subject matter of the invention to include all alternatives, modifications and equivalents as can be included within the spirit and scope of the following claims.

10 The entire disclosure of Japanese Patent Application No. 11-214110 filed on June 24, 1999 including specification, claims, drawings and summary is incorporated herein by reference in its entirety.

WHAT IS CLAIMED IS:

Sub  
a11

1. A barrier film preventing diffusion of copper from a copper wiring layer formed on a semiconductor substrate, comprising a multi-layered structure of first and second films,  
5 said first film being composed of crystalline metal containing nitrogen therein,  
said second film being composed of amorphous metal nitride,  
said barrier film being constituted of common metal atomic species.

10

2. The barrier film as set forth in claim 1, wherein said first film is formed on said second film.

2  
3. The barrier film as set forth in claim 1, wherein said second film has a  
15 thickness in the range of 80 angstroms to 150 angstroms both inclusive.

3  
4. The barrier film as set forth in claim 1, wherein said first film has a thickness in the range of 60 angstroms to 300 angstroms both inclusive.

Sub  
a2

5. A multi-layered wiring structure comprising a barrier film which prevents diffusion of copper from a copper wiring layer formed on a semiconductor substrate,  
said barrier film having a multi-layered structure of first and second films,  
said first film being composed of crystalline metal containing nitrogen  
25 therein,  
said second film being composed of amorphous metal nitride,  
said barrier film being constituted of common metal atomic species.

6. The multi-layered wiring structure as set forth in claim 5, wherein said

first film is formed on said second film.

~~6~~  
7. The multi-layered wiring structure as set forth in claim 5, wherein said second film has a thickness in the range of 80 angstroms to 150 angstroms both inclusive.

~~7~~  
8. The multi-layered wiring structure as set forth in claim 5, wherein said first film has a thickness in the range of 60 angstroms to 300 angstroms both inclusive.

~~8~~  
9. The multi-layered wiring structure as set forth in claim 5, wherein said barrier film covers a recess and a hole formed throughout an insulating film formed on an underlying wiring layer.

~~9~~  
10. The multi-layered wiring structure as set forth in claim 5, further comprising a copper film formed on said first film.

11. A method of forming a diffusion-barrier film by sputtering, comprising the steps of:

- (a) preparing gas containing nitrogen therein; and
- (b) varying only power of an electric power source for generating plasma to thereby successively form a diffusion-barrier film having a multi-layered structure of first and second films, said first film being composed of crystalline metal containing nitrogen therein, said second film being composed of amorphous metal nitride, said barrier film being constituted of metal atomic species of sputter target.

12. The method as set forth in claim 11, wherein said gas containing nitrogen therein has a pressure equal to or greater than 5 Pa.

13. The method as set forth in claim 11, wherein said gas contains nitrogen at 10 volume % or smaller.

5 14. The method as set forth in claim 11, wherein said metal atomic species of sputter target is one of tantalum, tungsten, titanium, molybdenum and niobium alone or in combination.

15 15. The method as set forth in claim 11, wherein said second film has a thickness in the range of 80 angstroms to 150 angstroms both inclusive.

16. The method as set forth in claim 11, wherein said first film has a thickness in the range of 60 angstroms to 300 angstroms both inclusive.

15 17. A method of forming a diffusion-barrier film by RF magnetron sputtering making use of rotational magnetic field and RF power, comprising the steps of:

(a) preparing gas containing nitrogen therein; and

(b) varying said RF power to thereby successively form a diffusion-barrier film having a multi-layered structure of first and second films, said first film  
20 being composed of crystalline metal containing nitrogen therein, said second film being composed of amorphous metal nitride, said barrier film being constituted of metal atomic species of sputter target.

18. The method as set forth in claim 17, wherein said gas containing nitrogen  
25 therein has a pressure equal to or greater than 5 Pa.

19. The method as set forth in claim 17, wherein said gas contains nitrogen at 10 volume % or smaller.



20. The method as set forth in claim 17, wherein said metal atomic species of sputter target is one of tantalum, tungsten, titanium, molybdenum and niobium alone or in combination.

5 21. The method as set forth in claim 17, wherein said second film has a thickness in the range of 80 angstroms to 150 angstroms both inclusive.

22. The method as set forth in claim 17, wherein said first film has a thickness in the range of 60 angstroms to 300 angstroms both inclusive.

10

23. A method of forming a diffusion-barrier film by RF magnetron sputtering, comprising the steps of:

(a) setting an electric power source for generation plasma to generate power having a first value, to thereby a first film, with a concentration of nitrogen in plasma gas being kept at a constant; and

15

(b) setting said electric power source to generate power having a second value greater than said first value at the moment when said first film is formed by a predetermined thickness, to thereby form a second film on said first film.

20

24. The method as set forth in claim 23, wherein said first film is composed of amorphous metal nitride, and said second film is composed of crystalline metal containing nitrogen therein.

25. The method as set forth in claim 23, wherein said plasma gas contains nitrogen gas at a pressure equal to or greater than 5 Pa.

25

26. The method as set forth in claim 23, wherein said plasma gas contains nitrogen gas at 10 volume % or smaller.

27. The method as set forth in claim 23, wherein metal atomic species of sputter target is one of tantalum, tungsten, titanium, molybdenum and niobium alone or in combination.

5 28. The method as set forth in claim 23, wherein said first film has a thickness in the range of 80 angstroms to 150 angstroms both inclusive.

29. The method as set forth in claim 23, wherein said second film has a thickness in the range of 60 angstroms to 300 angstroms both inclusive.

10

30. A method of forming a copper wiring film, comprising the steps of:

(a) radiating plasma of argon containing hydrogen therein, to a recess or hole formed at an insulating film formed on a semiconductor substrate;

15

(b) forming a diffusion-barrier film to cover said recess or hole therewith without exposing to atmosphere, said diffusion-barrier film having a multi-layered structure of first and second films, said first film being composed of crystalline metal containing nitrogen therein, said second film being composed of amorphous metal nitride; and

20

(c) forming a copper film on said diffusion-barrier film without exposing to atmosphere.

31. The method as set forth in claim 30, wherein said diffusion-barrier film is formed by sputtering.

25

32. The method as set forth in claim 30, wherein said copper film is formed in vacuum.

33. The method as set forth in claim 32, wherein said copper film is formed by thermal chemical vapor deposition in which thermal dismutation in a complex

of organic metal is utilized.

34. The method as set forth in claim 32, wherein said copper film is formed by sputtering in which copper target is used.

5

35. The method as set forth in claim 30, wherein said first film has a thickness in the range of 60 angstroms to 300 angstroms both inclusive.

36. The method as set forth in claim 30, wherein said second film has a  
10 thickness in the range of 80 angstroms to 150 angstroms both inclusive.

*Add  
a3*

ABSTRACT OF THE DISCLOSURE

09/596415

5 There is provided a barrier film preventing diffusion of copper from a copper wiring layer formed on a semiconductor substrate. The barrier film has a multi-layered structure of first and second films wherein the first film is composed of crystalline metal containing nitrogen therein, and the second film is composed of amorphous metal nitride. The barrier film is constituted of common metal atomic species. The barrier film prevents copper diffusion from a copper wiring layer into a semiconductor device, and has sufficient adhesion characteristic to  
10 both a copper film and an interlayer insulating film.

FIG. 1  
PRIOR ART

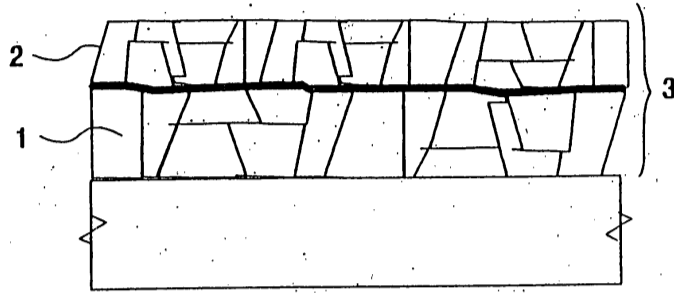


FIG. 2  
PRIOR ART

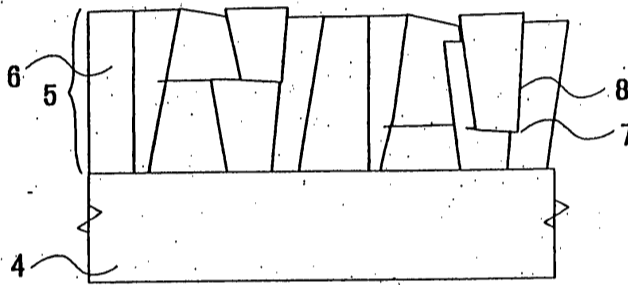
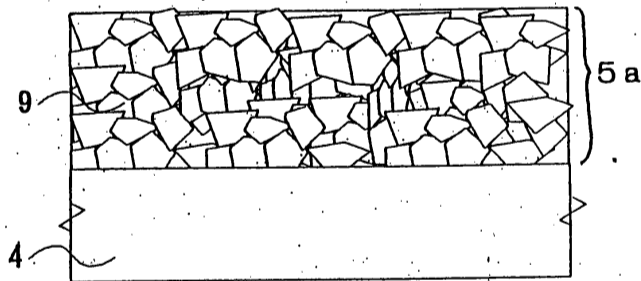


FIG. 3  
PRIOR ART



24

FIG. 4A

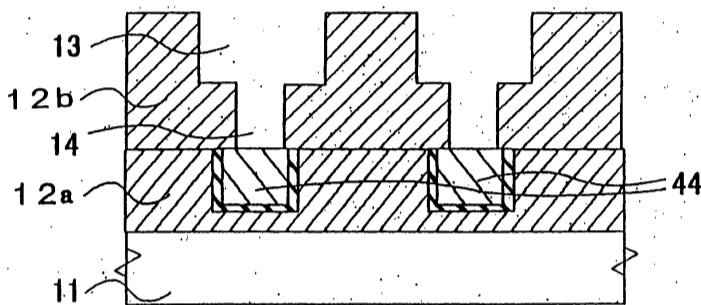


FIG. 4B

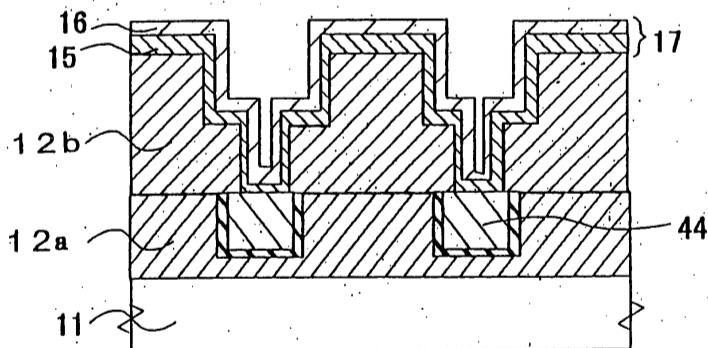


FIG. 4C

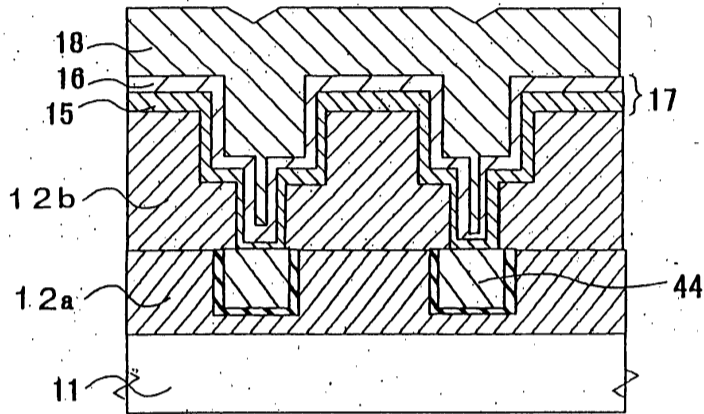


FIG. 4D

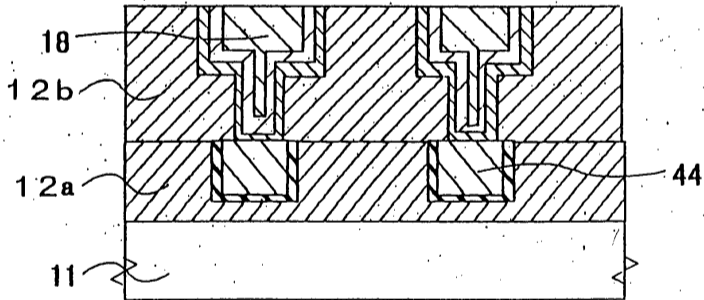


FIG. 5

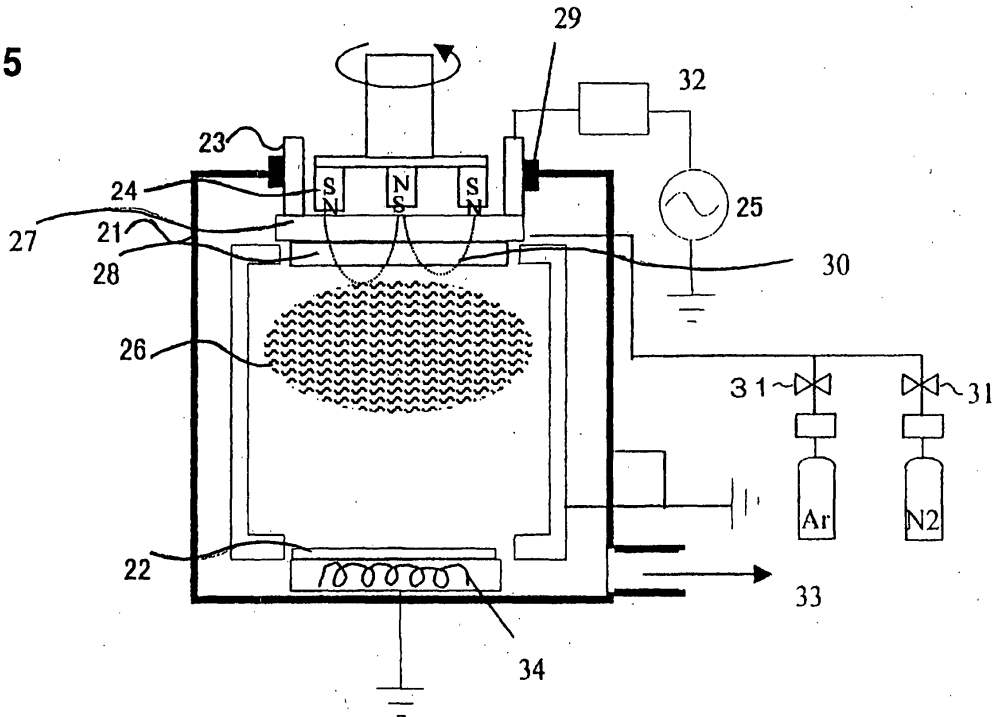


FIG. 6

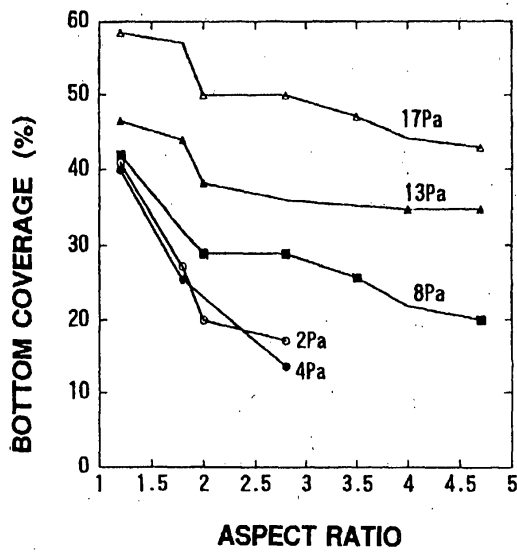




FIG. 7

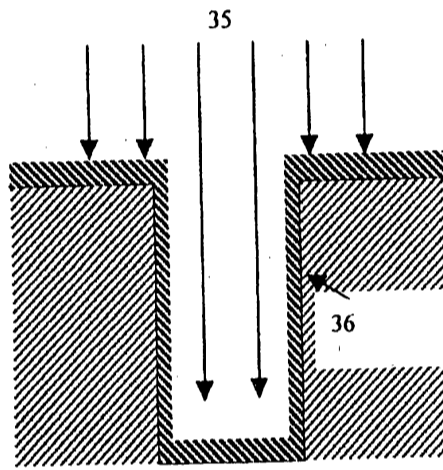


FIG. 8

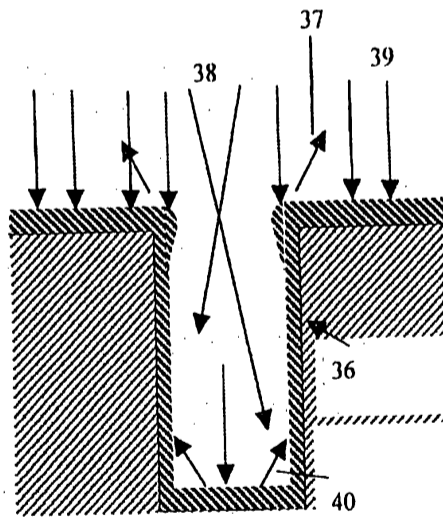


FIG. 9

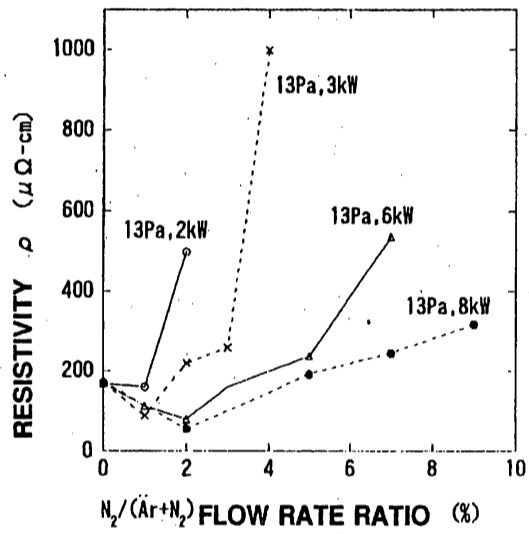


FIG. 10

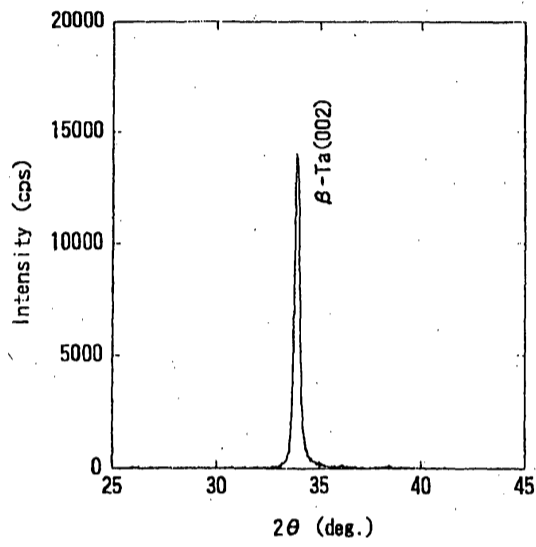
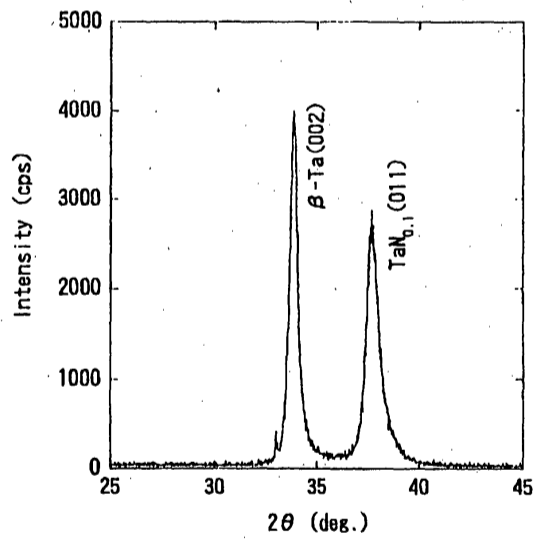


FIG. 11



8/18

FIG. 12

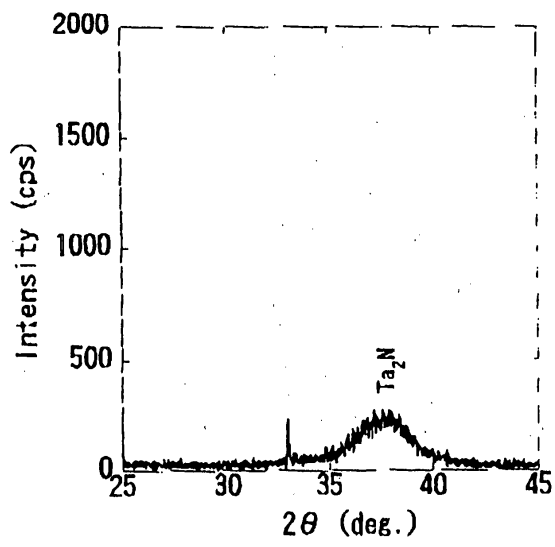
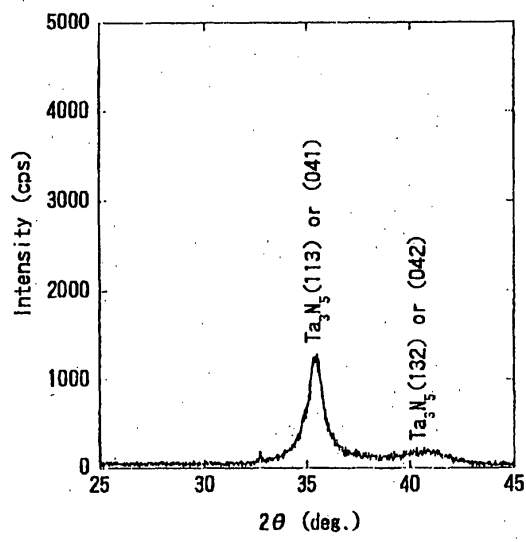


FIG. 13



9/18

FIG. 14

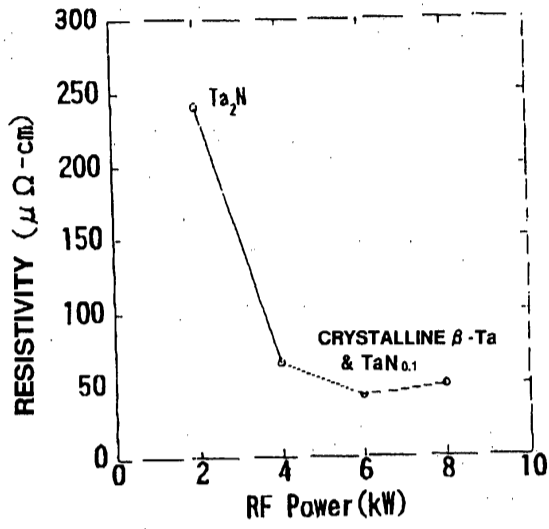


FIG. 15

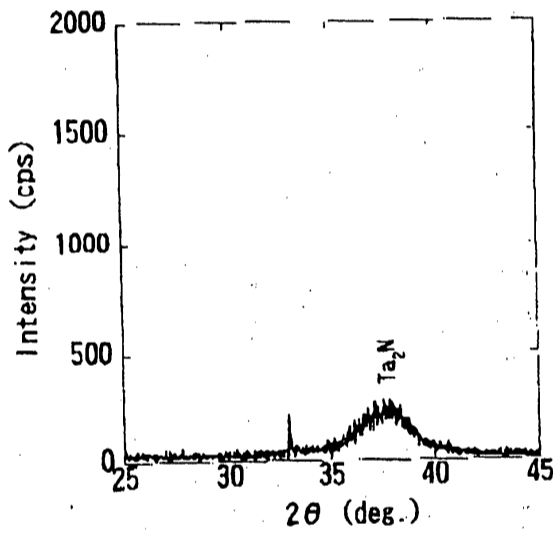
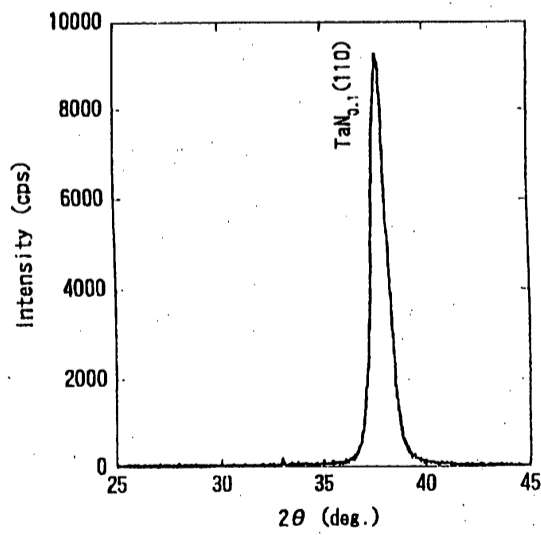


FIG. 16



10/18

FIG. 17

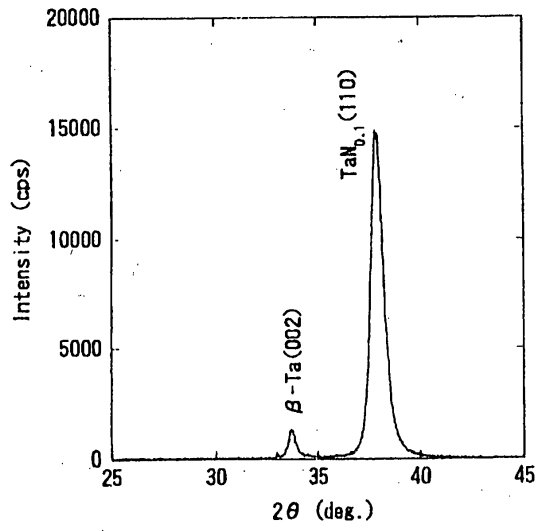
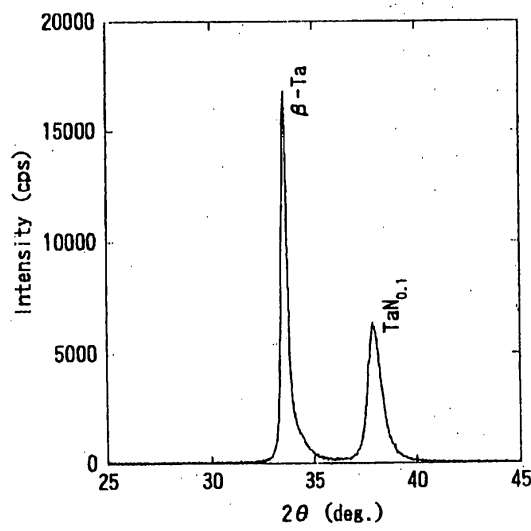
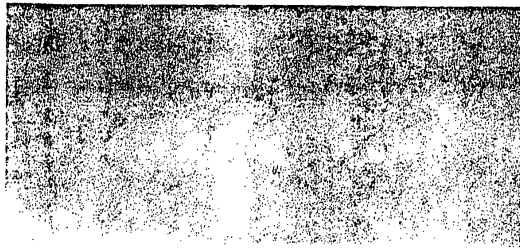


FIG. 18

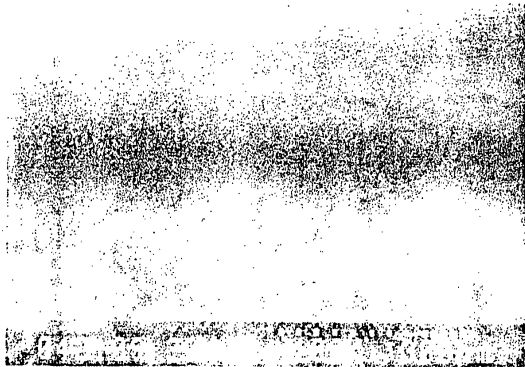


11/18

FIG. 19



15 ~

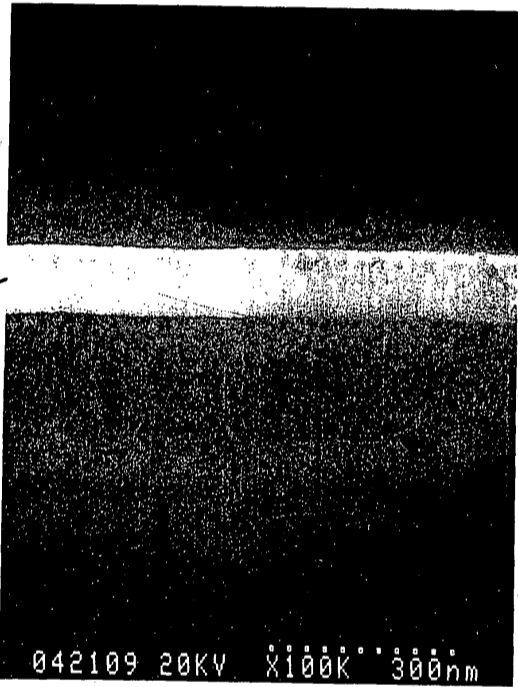


11/18

11/18

FIG. 19

15 ~~~~~

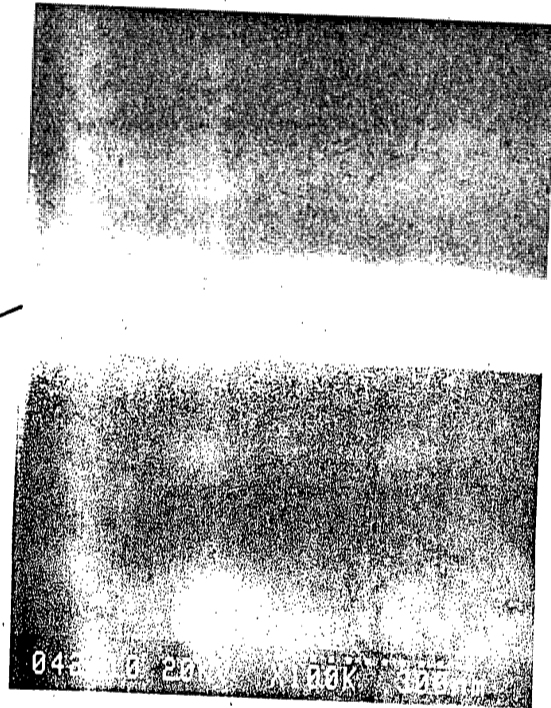




12/18

FIG. 20

16 ~

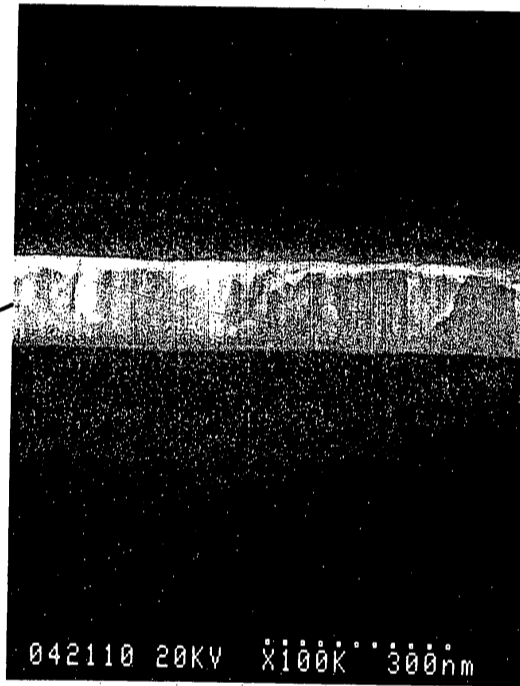


12/18

FIG. 20

SEM

16 ~



13/18

FIG. 21

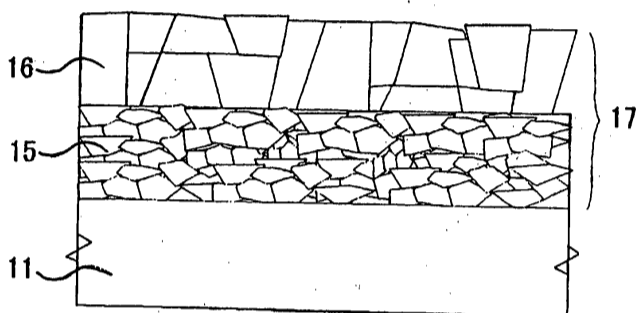
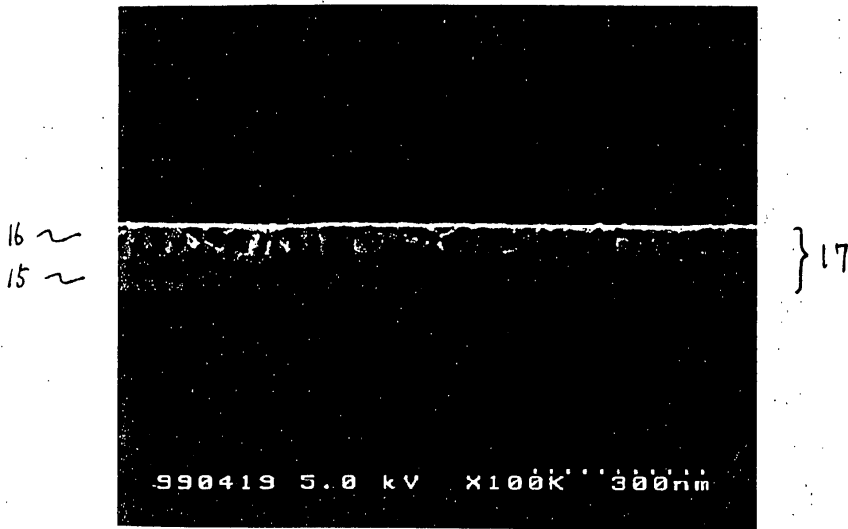


FIG. 22

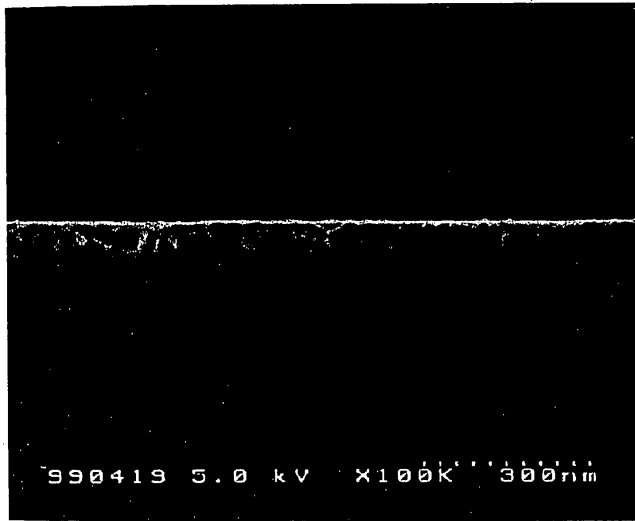


14/18

FIG. 22

16  
15

~  
~



} 17

58

15/18

FIG. 23

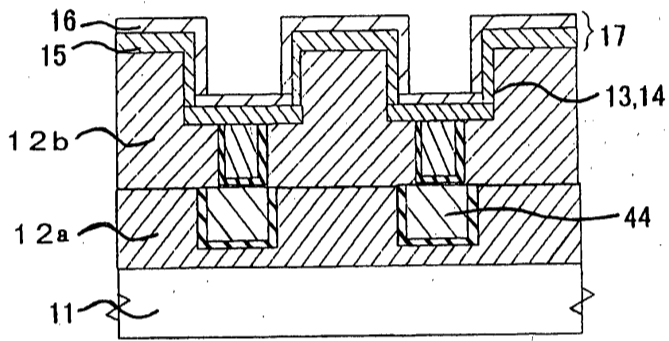
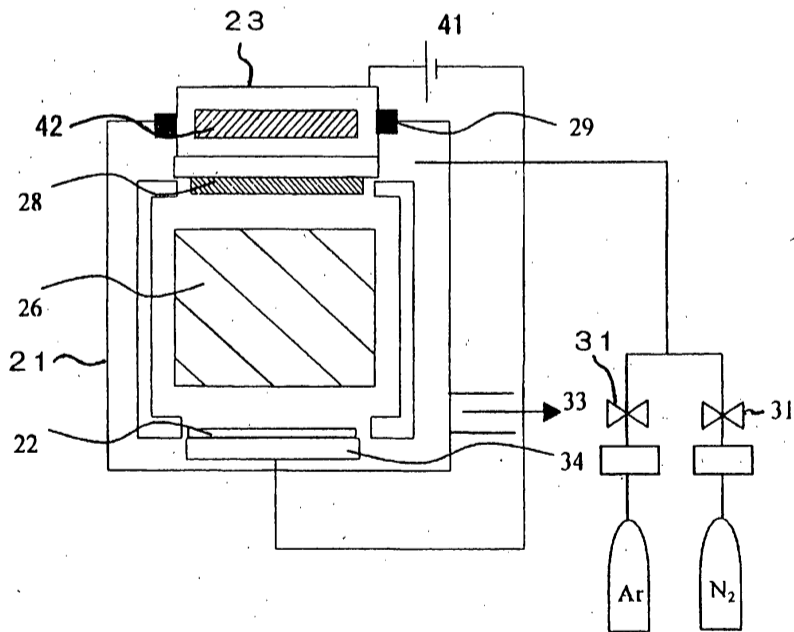


FIG. 24



16/18

FIG. 25

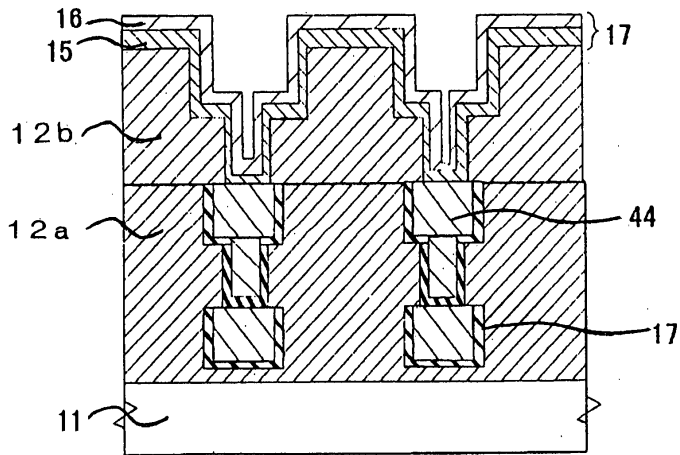


FIG. 26

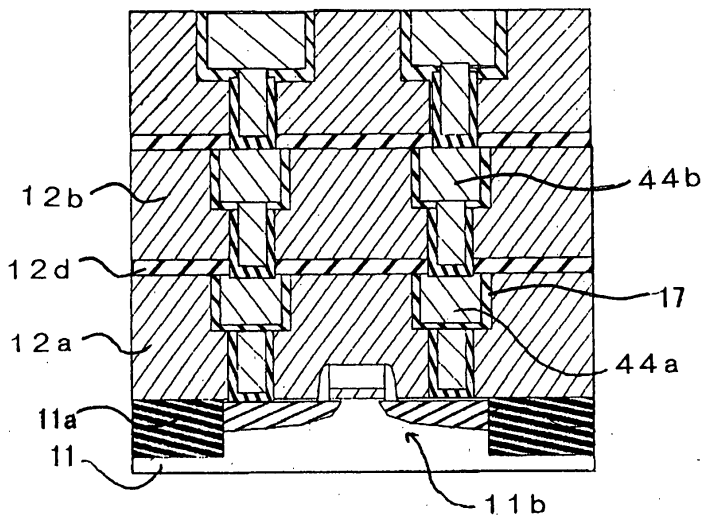


FIG. 27

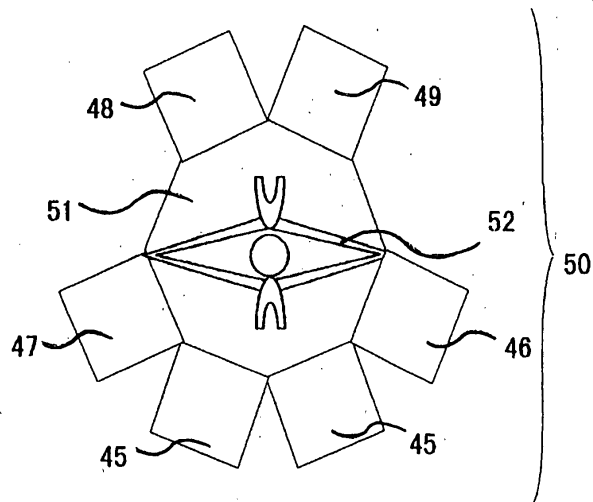


FIG. 28

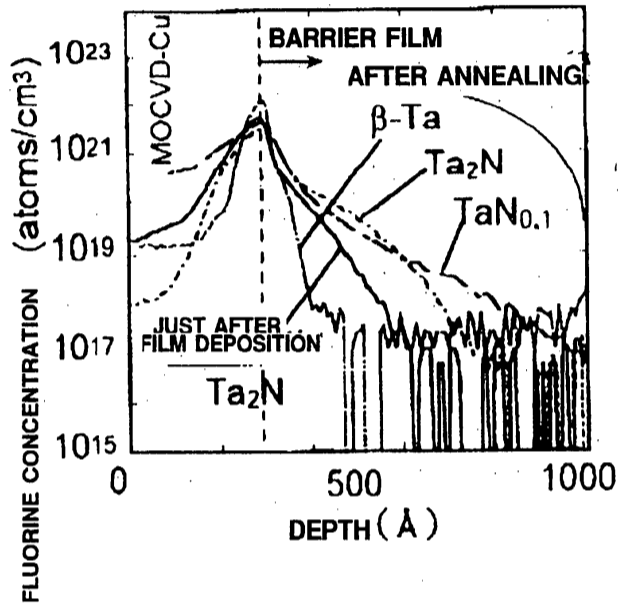


FIG. 29

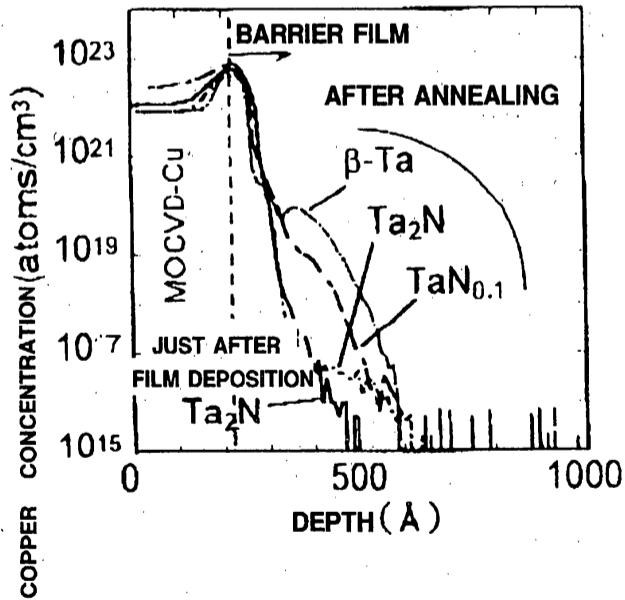




FIG. 30

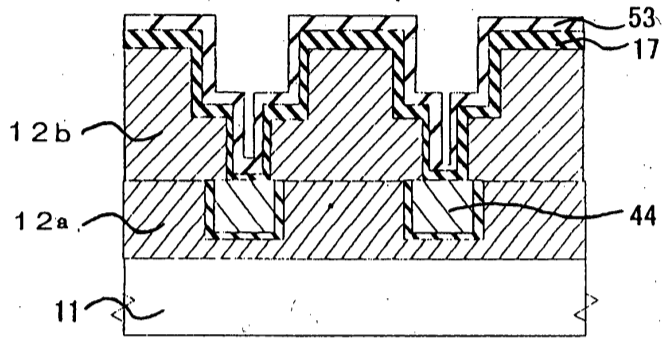
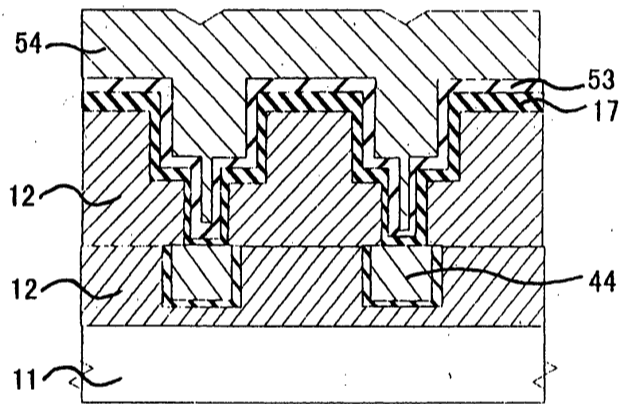


FIG. 31



257  
758  
Thomas  
2811

FIG. 1  
PRIOR ART

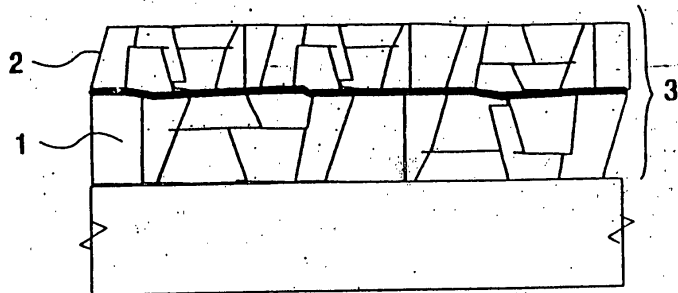


FIG. 2  
PRIOR ART

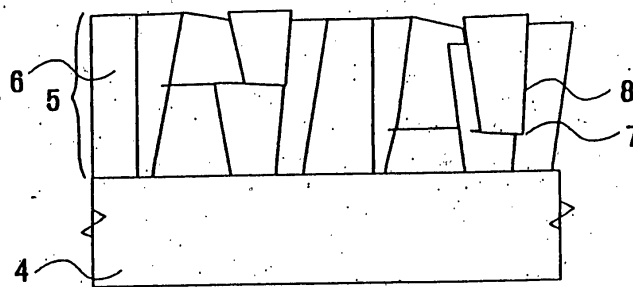


FIG. 3  
PRIOR ART

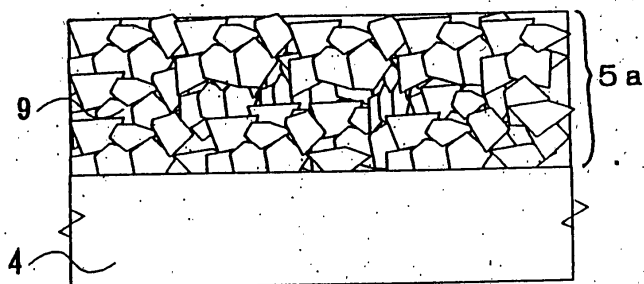


FIG. 4C

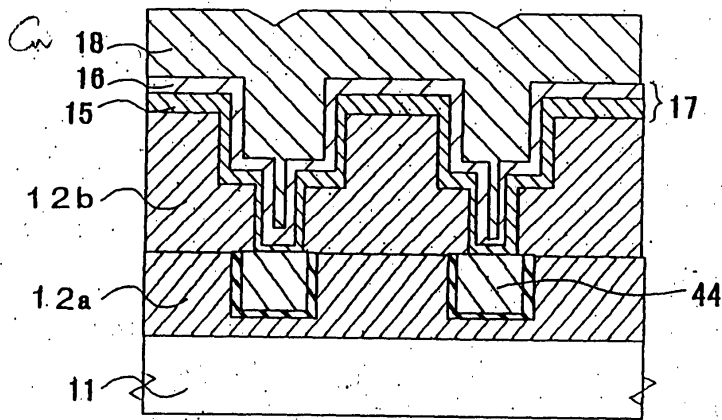


FIG. 4D

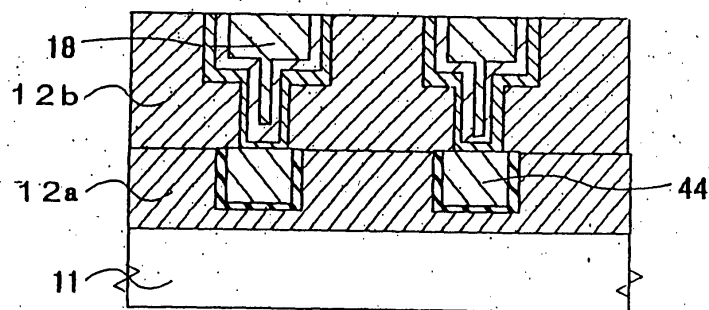


FIG. 5

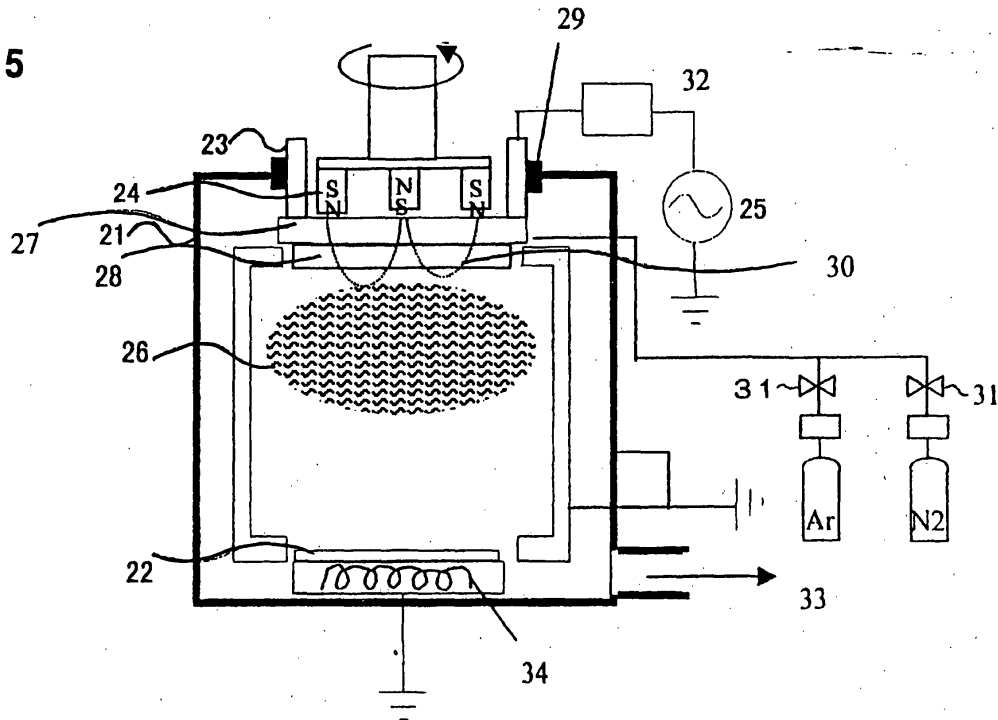
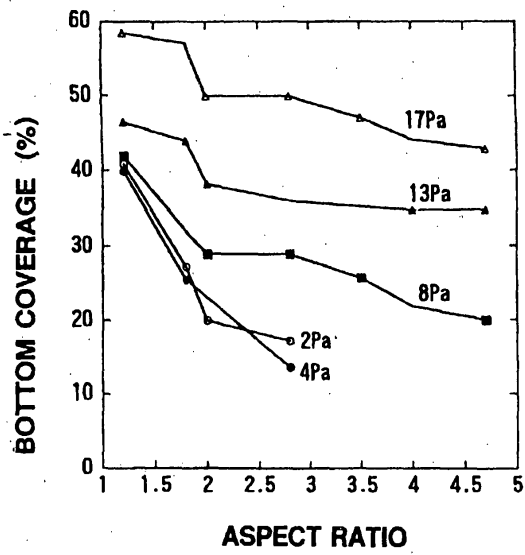


FIG. 6



5/18

FIG. 7

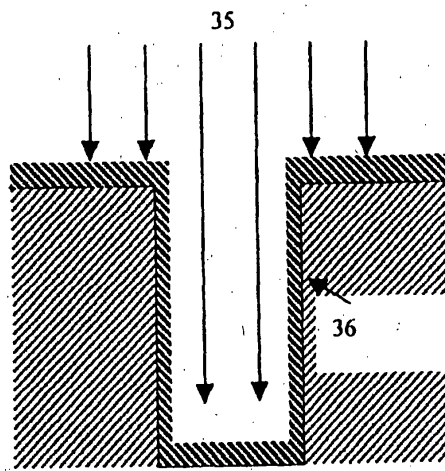
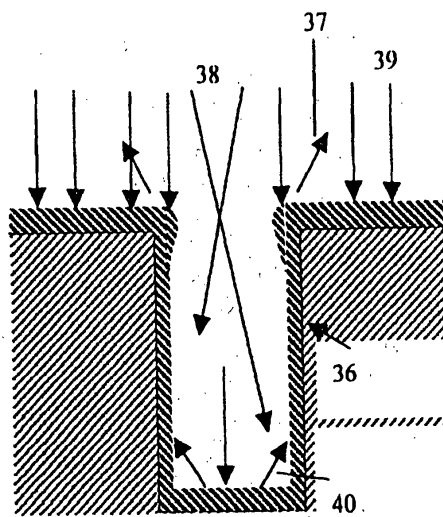
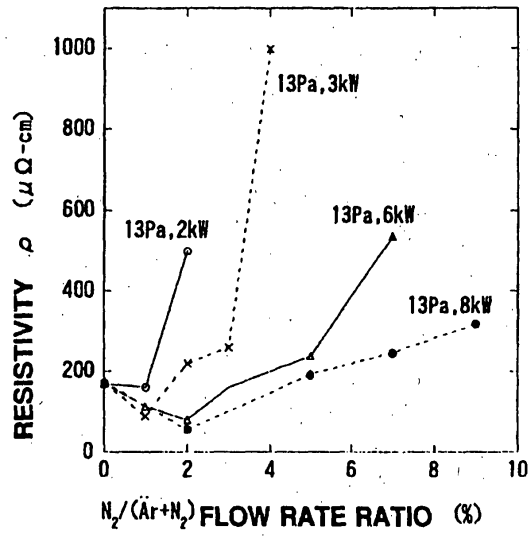


FIG. 8



6/18

FIG. 9



7/18

FIG. 10

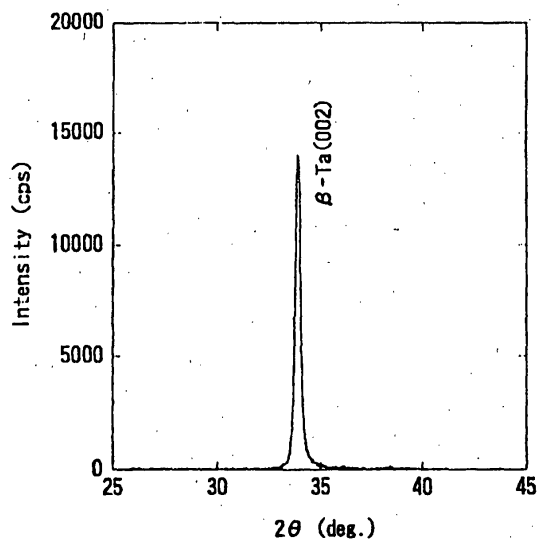
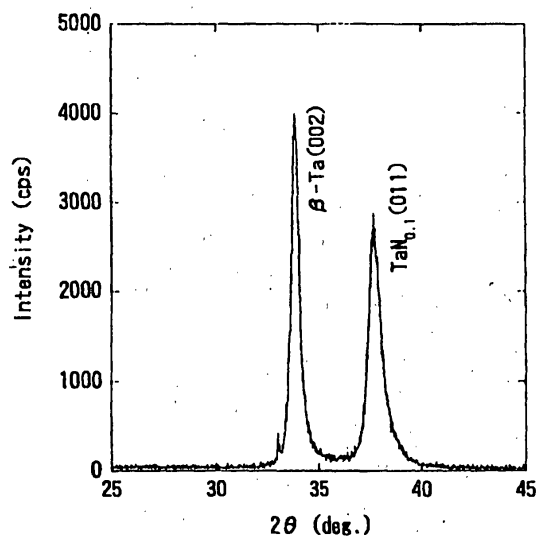


FIG. 11



8/18

FIG. 12

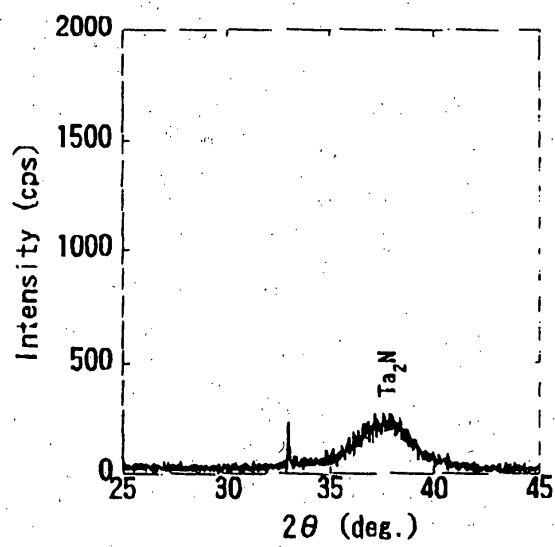


FIG. 13

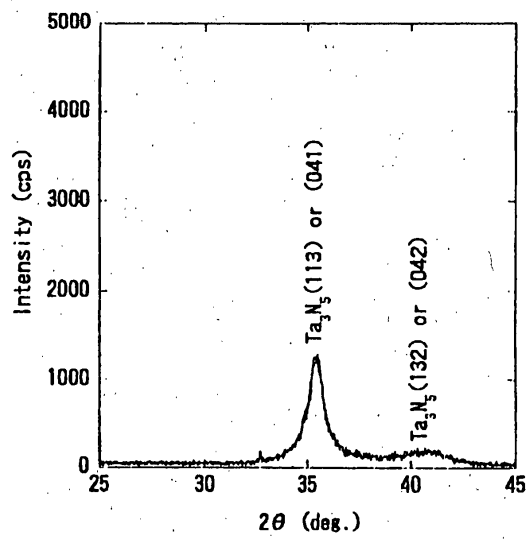




FIG. 14

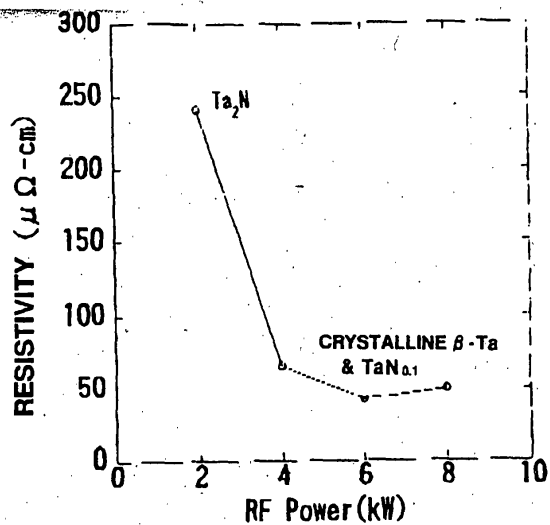


FIG. 15

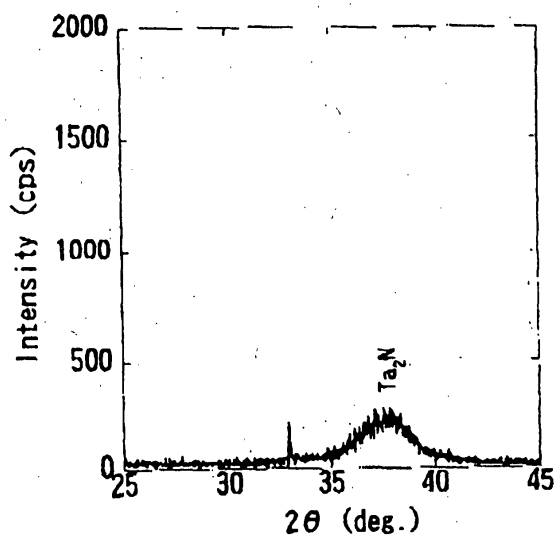


FIG. 16

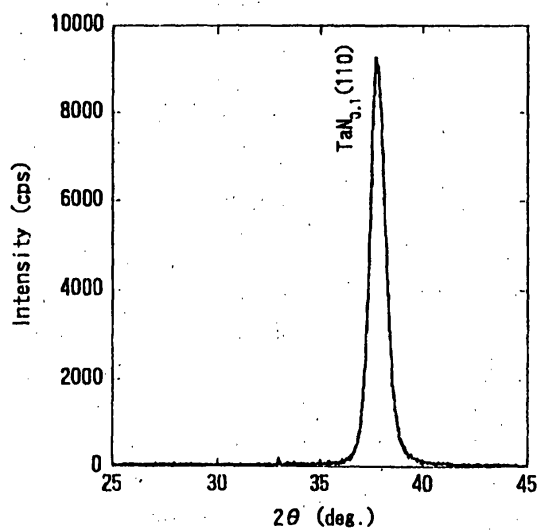


FIG. 17

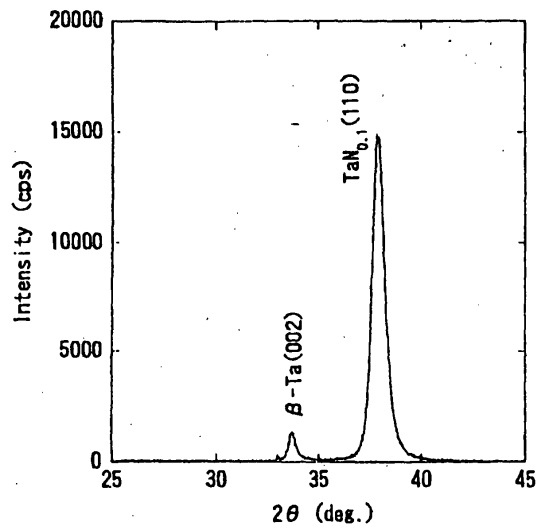
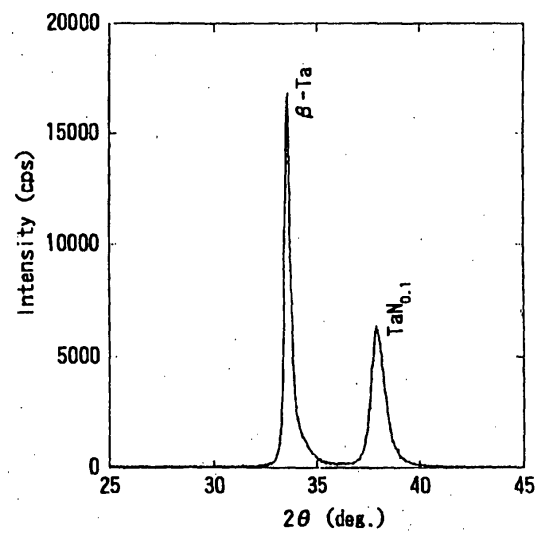
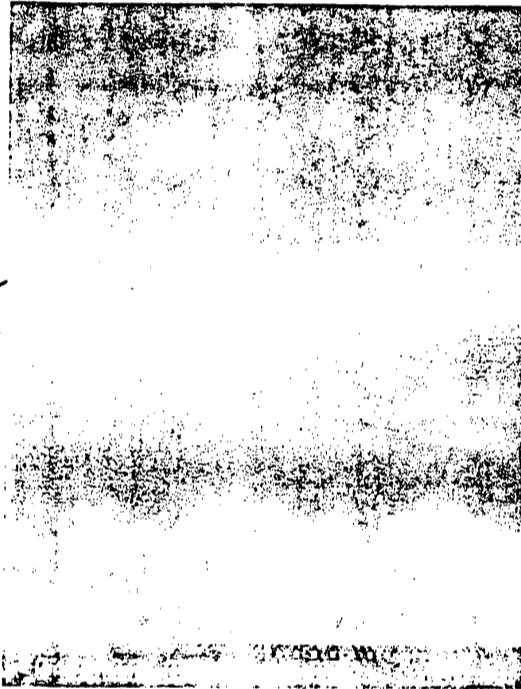


FIG. 18



11/18

FIG. 19



15 ~~~~~

2025 RELEASE

PRINT OF DRAWINGS  
AS ORIGINALLY FILED

12/18

FIG. 20

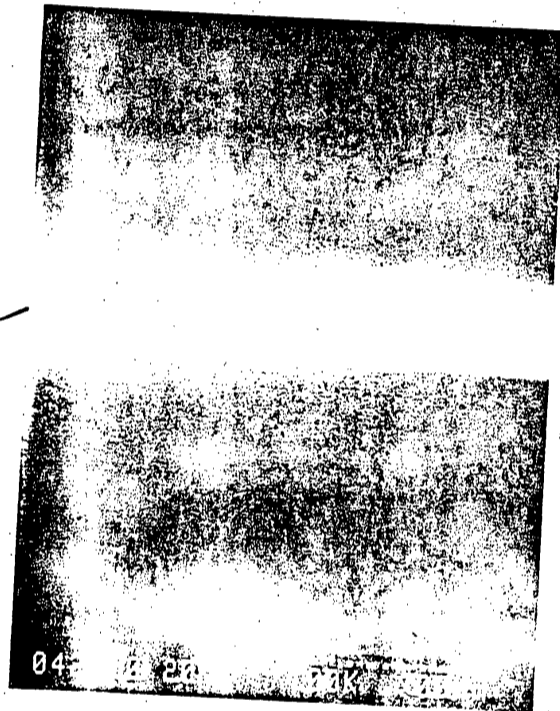


FIG. 21

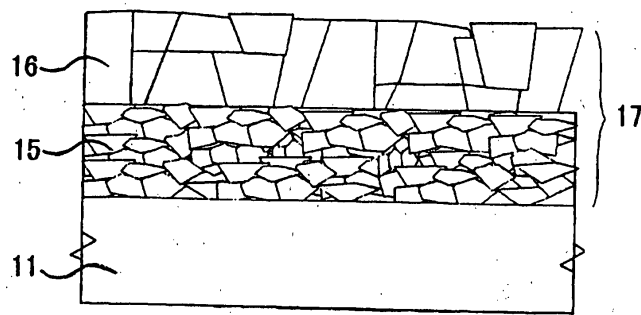
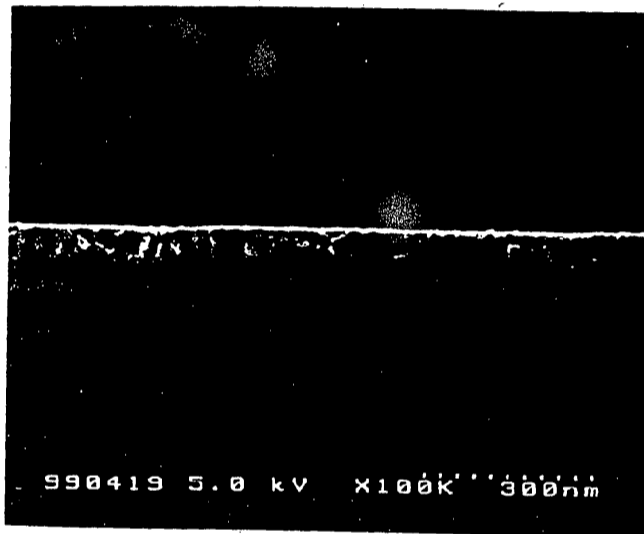


FIG. 22



998419 5.0 kV X100k 300um

FIG. 23

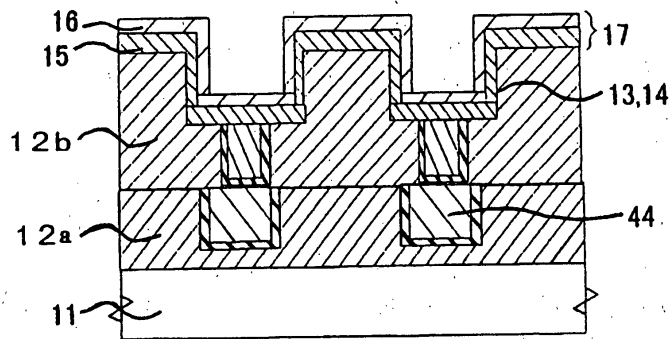


FIG. 24

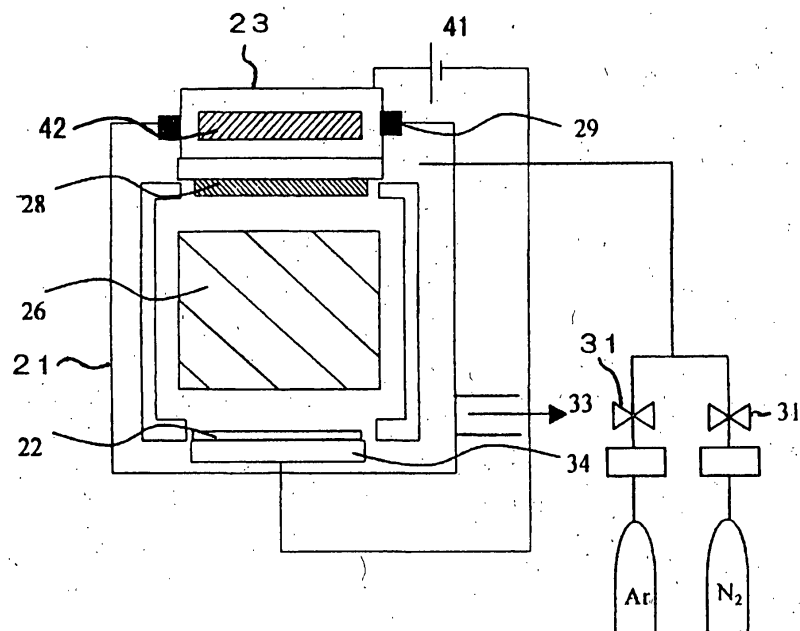


FIG. 25

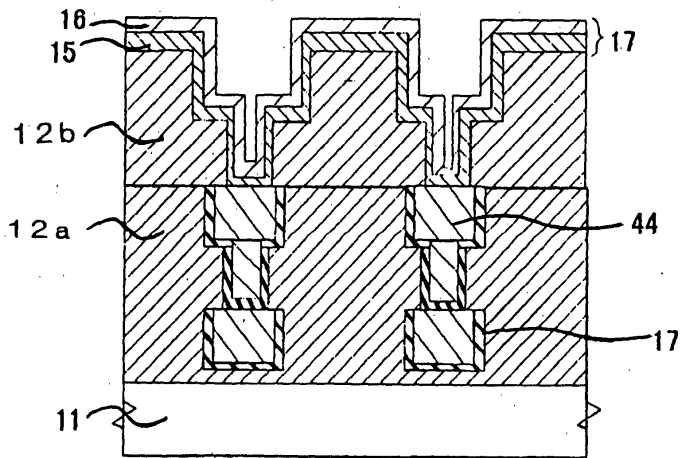


FIG. 26

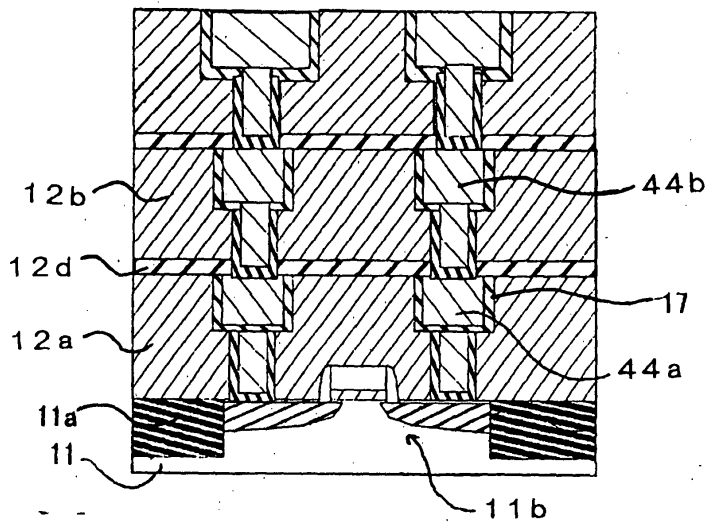
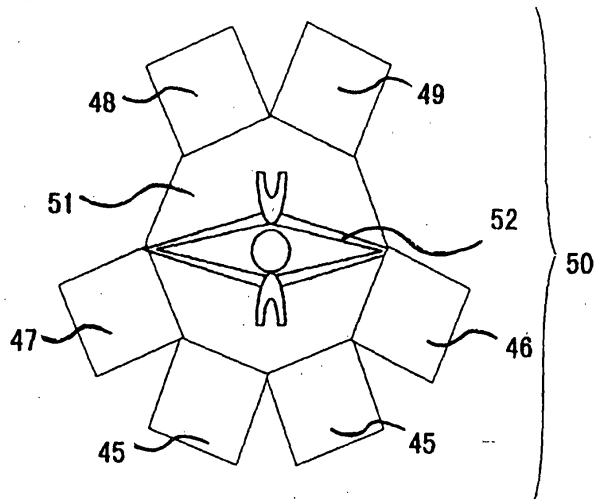


FIG. 27





17/18

FIG. 28

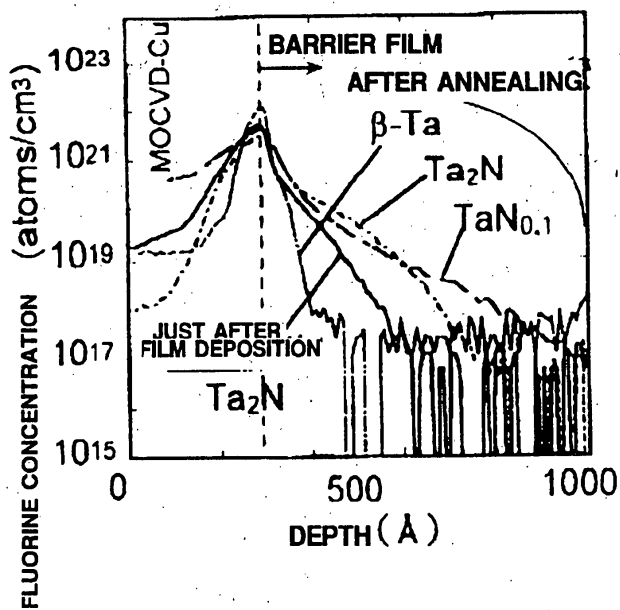


FIG. 29

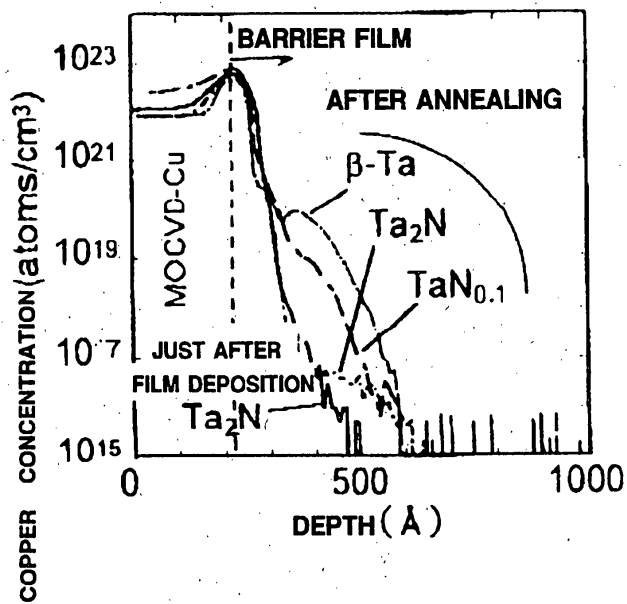


FIG. 30

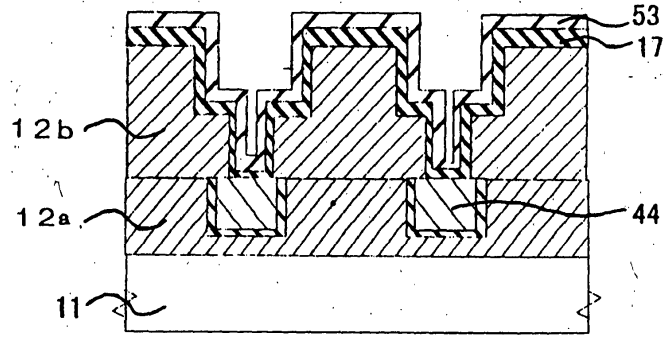
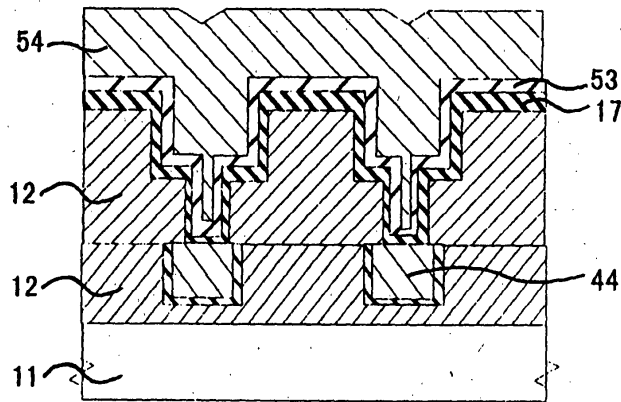


FIG. 31



11-214110  
天野 A224

Express Mail Label No.

Page 1 of

13715 Docket No.

## Declaration and Power of Attorney For Patent Application English Language Declaration

As a below named inventor, I hereby declare that:

My residence, post office address and citizenship are as stated below next to my name,

I believe I am the original, first and sole inventor (if only one name is listed below) or an original, first and joint inventor (if plural names are listed below) of the subject matter which is claimed and for which a patent is sought on the invention entitled

MULTI-LAYERED WIRING LAYER AND METHOD OF FABRICATING THE SAME

the specification of which

(check one)

is attached hereto.

was filed on \_\_\_\_\_ as United States Application No. or PCT International Application Number \_\_\_\_\_ and was amended on \_\_\_\_\_

(if applicable)

I hereby state that I have reviewed and understand the contents of the above identified specification, including the claims, as amended by any amendment referred to above.

I acknowledge the duty to disclose to the United States Patent and Trademark Office all information known to me to be material to patentability as defined in Title 37, Code of Federal Regulations, Section 1.56.

I hereby claim foreign priority benefits under Title 35, United States Code, Section 119(a)-(d) or Section 365(b) of any foreign application(s) for patent or inventor's certificate, or Section 365(a) of any PCT International application which designated at least one country other than the United States, listed below and have also identified below, by checking the box, any foreign application for patent or inventor's certificate or PCT International application having a filing date before that of the application on which priority is claimed.

Prior Foreign Application(s)			Priority Not Claimed
<u>11-214110</u> (Number)	<u>Japan</u> (Country)	<u>24/6/1999</u> (Day/Month/Year Filed)	<input type="checkbox"/>
<u>                    </u> (Number)	<u>                    </u> (Country)	<u>                    </u> (Day/Month/Year Filed)	<input type="checkbox"/>
<u>                    </u> (Number)	<u>                    </u> (Country)	<u>                    </u> (Day/Month/Year Filed)	<input type="checkbox"/>

11-214110  
天野 A224

I hereby claim the benefit under 35 U.S.C. Section 119(e) of any United States provisional application(s) listed below:

(Application Serial No.)	(Filing Date)
(Application Serial No.)	(Filing Date)
(Application Serial No.)	(Filing Date)

I hereby claim the benefit under 35 U. S. C. Section 120 of any United States application(s), or Section 365(c) of any PCT International application designating the United States, listed below and, insofar as the subject matter of each of the claims of this application is not disclosed in the prior United States or PCT International application in the manner provided by the first paragraph of 35 U.S.C. Section 112, I acknowledge the duty to disclose to the United States Patent and Trademark Office all information known to me to be material to patentability as defined in Title 37, C. F. R., Section 1.56 which became available between the filing date of the prior application and the national or PCT International filing date of this application:

(Application Serial No.)	(Filing Date)	(Status) (patented, pending, abandoned)
(Application Serial No.)	(Filing Date)	(Status) (patented, pending, abandoned)
(Application Serial No.)	(Filing Date)	(Status) (patented, pending, abandoned)

I hereby declare that all statements made herein of my own knowledge are true and that all statements made on information and belief are believed to be true; and further that these statements were made with the knowledge that willful false statements and the like so made are punishable by fine or imprisonment, or both, under Section 1001 of Title 18 of the United States Code and that such willful false statements may jeopardize the validity of the application or any patent issued thereon.


11-214110  
野 A 224

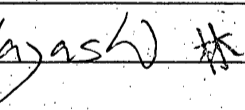
POWER OF ATTORNEY: As a named inventor, I hereby appoint the following attorney(s) and/or agent(s) to prosecute this application and transact all business in the Patent and Trademark Office connected therewith. *(list name and registration number)*

- Stephen D. Murphy, Reg. No.: 22,002
- Paul J. Esatto, Reg. No.: 30,749
- William C. Roch, Reg. No.: 24,972
- Mark J. Cohen, Reg. No.: 32,211
- Frank S. DiGiglio, Reg. No.: 31,346
- Donald T. Black, Reg. No.: 27,999

Send Correspondence to: Paul J. Esatto, Jr.  
Scully, Scott, Murphy & Presser  
400 Garden City Plaza  
Garden City, New York 11530

Direct Telephone Calls to: *(name and telephone number)*  
Paul J. Esatto, Jr. (516) 742-4343

Full name of sole or first inventor	MASAYOSHI TAGAMI
Sole or first inventor's signature	Masayoshi Tagami 
	Date June 9, 2000
Residence	Tokyo, Japan
Citizenship	Japan
Post Office Address	c/o NEC Corporation, 7-1, Shiba 5-chome, Minato-ku, Tokyo, Japan

Full name of second inventor, if any	YOSHIHIRO HAYASHI
Second inventor's signature	Yoshihiro Hayashi 
	Date June 9, 2000
Residence	Tokyo, Japan
Citizenship	Japan
Post Office Address	c/o NEC Corporation, 7-1, Shiba 5-chome, Minato-ku, Tokyo, Japan

## Application Assignment Record

According to the application transmittal letter, an assignment recording ownership was filed with this application; however, a copy of this record was not located in the original file history record obtained from the United States Patent and Trademark Office. Upon your request, we will attempt to obtain the assignment documents from the Assignment Recordation Branch of the United States Patent and Trademark Office or from a related application case (if applicable). Please note that additional charges will apply for this service.

This page is not part of the official USPTO record. It has been determined that content identified on this document is missing from the original file history record.

#3 | 185  
9-13-00  
R. N. [unclear]

**IN THE UNITED STATES PATENT AND TRADEMARK OFFICE**

**PATENT**  
PTO  
098596815  
06/19/00

**Applicant:** Masayoshi Tagami, et al.      **Examiner:** Unassigned  
**Serial No.** Unassigned      **Art Unit:** Unassigned  
**Filed:** Herewith      **Docket:** 13715  
**For:** MULTI-LAYERED WIRING LAYER      **Dated:** June 19, 2000  
AND METHOD OF FABRICATING THE SAME

Assistant Commissioner for Patents  
Washington, D.C. 20231

**INFORMATION DISCLOSURE STATEMENT**

Sir:

In accordance with 37 C.F.R. §§ 1.97 and 1.98, it is requested that the following references, which are also listed on the attached Form PTO-1449, be made of record in the above-identified case.

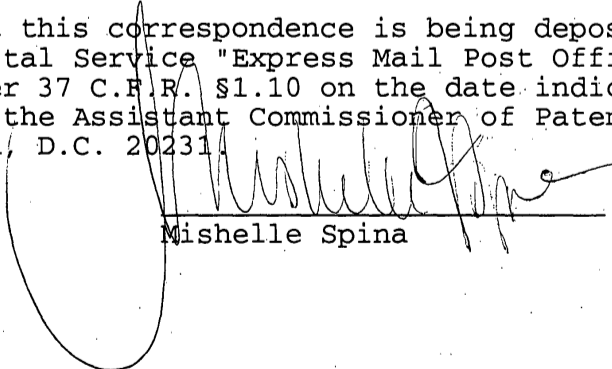
1. Semiconductor World, Nobuyoshi Awaya, February 1998, pp. 91-96;
2. Kee-Won Kwon et al., "Characteristics of Ta As An Underlayer for Cu Interconnects", Advanced Metallization and Interconnect Systems for ULSI Applications in 1997, 1998, pp.711-716;
3. M.T. Wang, et al., "Barrier Properties of Very Thin Ta and TaN Layers Against Copper Diffusion", Journal Electrochemical Society, July 1998, pp.2538-2545;

**CERTIFICATE OF MAILING BY "EXPRESS MAIL"**

"Express Mail" Mailing Label Number: EE692181515US  
Date of Deposit: June 19, 2000

I hereby certify that this correspondence is being deposited with the United States Postal Service "Express Mail Post Office to Addressee" service under 37 C.F.R. §1.10 on the date indicated above and is addressed to the Assistant Commissioner of Patents and Trademarks, Washington, D.C. 20231.

Dated: June 19, 2000

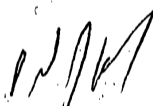
  
Mishelle Spina

4. D. Denning, et al., "An Inlaid CVD Cu Based Integration for Sub 0.25 $\mu$ m Technology, 1998 Symposium on VLSI Technology Digest of Technical Papers, 1998, pp. 22-23;
5. Japanese Unexamined Patent Publication No. 8-139092, dated May 31, 1996;
6. Japanese Unexamined Patent Publication No. 8-274098, dated October 18, 1996;
7. Japanese Unexamined Patent Publication No. 9-64044, dated March 7, 1997;
8. Japanese Unexamined Patent Publication No. 10-256256, dated September 25, 1998.

Applicants are submitting copies of the above-cited references. The relevance of the references has been described in the specification. Therefore, translations are not required.

Inasmuch as this Information Disclosure Statement is being submitted in accordance with the schedule set out in 37 C.F.R. § 1.97(b), no petition, certification or fee is required.

Respectfully submitted,



Paul J. Esatto, Jr.  
Registration No. 30,749

Scully, Scott, Murphy & Presser  
400 Garden City Plaza  
Garden City, New York 11530  
(516) 742-4343

PJE/am



<b>INFORMATION DISCLOSURE CITATION</b> <i>(Use several sheets if necessary)</i>				ATTY DOCKET NO. 13715		SERIAL NO. <u>09/596,415</u> <del>To be assigned</del>					
				APPLICANT(S) <b>Masayoshi Tagami, et al.</b>				FILING DATE <u>06/19/00</u> <del>Herewith</del>		GROUP <u>2811</u> <del>Unassigned</del>	
				<b>U.S. PATENT DOCUMENTS</b>							
EXAMINER INITIAL	DOCUMENT NUMBER	DATE	NAME	CLASS	SUBCLASS	FILING DATE IF APPROPRIATE					
/											
<b>FOREIGN PATENT DOCUMENTS</b>											
	DOCUMENT NUMBER	DATE	COUNTRY	CLASS	SUBCLASS	TRANSLATION					
						YES	NO				
<u>Vu</u>	8-139092	5/31/96	Japan	-	-		✓				
<u>Vu</u>	8-274098	10/18/96	Japan	-	-		✓				
<u>Vu</u>	9-64044	3/7/97	Japan	-	-		✓				
<u>Vu</u>	10-256256	9/25/98	Japan	-	-		✓				
<b>OTHER DOCUMENTS (Including Author, Title, Date, Pertinent Pages, Etc.)</b>											
<u>Vu</u>	Semiconductor World Nobuyoshi Aways, February 1998, pp.91-96										
<u>Vu</u>	Kee-Won Kwon et al., "Characteristics of Ta As An Underlayer for Cu Interconnects", Advanced Metallization and Interconnect Systems for ULSI Applications in 1997, 1998, pp.711-716										
EXAMINER: <u>HUNG K. JU</u>				DATE CONSIDERED: <u>09/11/01</u>							
<small>*EXAMINER: Initial if reference considered, whether or not citation is in conformance with MPEP 609; Draw line through citation if not in conformance and not considered. Include copy of this form with next communication to applicant.</small>											



**INFORMATION DISCLOSURE CITATION**  
(Use several sheets if necessary)

ATTY DOCKET NO. 13715 SERIAL NO. 09/596,415  
To be assigned  
APPLICANT(S) Masayoshi Tagami, et al.  
FILING DATE 06/19/00 GROUP 2811  
Herewith Unassigned

**U.S. PATENT DOCUMENTS**

*EXAMINER INITIAL	DOCUMENT NUMBER	DATE	NAME	CLASS	SUBCLASS	FILING DATE IF APPROPRIATE

**FOREIGN PATENT DOCUMENTS**

	DOCUMENT NUMBER	DATE	COUNTRY	CLASS	SUBCLASS	TRANSLATION	
						YES	NO
Vu	8-139092	5/31/96	Japan	-	-		✓
Vu	8-274098	10/18/96	Japan	-	-		✓
Vu	9-64044	3/7/97	Japan	-	-		✓
Vu	10-256256	9/25/98	Japan	-	-		✓

**OTHER DOCUMENTS (Including Author, Title, Date, Pertinent Pages, Etc.)**

Vu		Semiconductor World Nobuyoshi Awaya, February 1998, pp.91-96
Vu		Kee-Won Kwon et al., "Characteristics of Ta As An Underlayer for Cu Interconnects", Advanced Metallization and Interconnect Systems for ULSI Applications in 1997, 1998, pp.711-716

EXAMINER HUNG K. JU DATE CONSIDERED 09/11/01

\*EXAMINER: Initial if reference considered, whether or not citation is in conformance with MPEP 609; Draw line through citation if not in conformance and not considered. Include copy of this form with next communication to applicant.

**INFORMATION DISCLOSURE CITATION**  
(Use several sheets if necessary)

ATTY DOCKET NO. 13715

SERIAL NO. 09/596,415  
~~To be assigned~~

APPLICANT(S)  
Masayoshi Tagami, et al.

FILING DATE 06/19/00  
~~Herewith~~

GROUP  
~~Unassigned~~ 2811

**U.S. PATENT DOCUMENTS**

*EXAMINER INITIAL	DOCUMENT NUMBER	DATE	NAME	CLASS	SUBCLASS	FILING DATE IF APPROPRIATE

**FOREIGN PATENT DOCUMENTS**

	DOCUMENT NUMBER	DATE	COUNTRY	CLASS	SUBCLASS	TRANSLATION	
						YES	NO

**OTHER DOCUMENTS (Including Author, Title, Date, Pertinent Pages, Etc.)**

✓		M. T. Wang, et al., "Barrier Properties of Very Thin Ta and TaN Layers Against Copper Diffusion", Journal Electrochemical Society, July 1998, pp.2538-2545
✓		D. Denning, et al., "An Inlaid CVD Cu Based Integration for Sub 0.25µm Technology, 1998 Symposium on VLSI Technology Digest of Technical Papers, 1998, pp. 22-23

EXAMINER HUNG K. VU DATE CONSIDERED 09/11/01

\*EXAMINER: Initial if reference considered, whether or not citation is in conformance with MPEP 609; Draw line through citation if not in conformance and not considered. Include copy of this form with next communication to applicant.

**CERTIFICATE OF MAILING BY "EXPRESS MAIL" (37 CFR 1.10)**

Applicant(s): Masayoshi Tagami, et al.

Docket No.

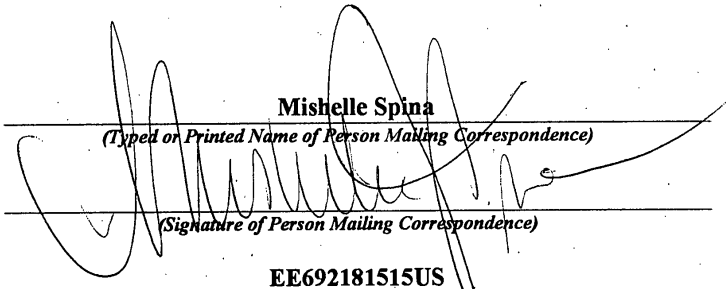
13715

Serial No. To be assigned	Filing Date Herewith	Examiner Unassigned	Group Art Unit Unassigned
------------------------------	-------------------------	------------------------	------------------------------

Invention: **MULTI-LAYERED WIRING LAYER AND METHOD OF FABRICATING THE SAME**



I hereby certify that this New Patent Application  
*(Identify type of correspondence)*  
is being deposited with the United States Postal Service "Express Mail Post Office to Addressee" service under  
37 CFR 1.10 in an envelope addressed to: The Assistant Commissioner for Patents, Washington, D.C. 20231  
on June 19, 2000  
*(Date)*

Mishelle Spina  
*(Typed or Printed Name of Person Mailing Correspondence)*  
  
*(Signature of Person Mailing Correspondence)*  
EE692181515US  
*("Express Mail" Mailing Label Number)*

**Note: Each paper must have its own certificate of mailing.**

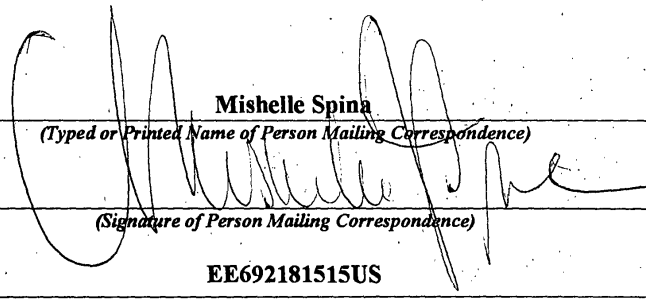
<b>CERTIFICATE OF MAILING BY "EXPRESS MAIL" (37 CFR 1.10)</b> Applicant(s): Masayoshi Tagami, et al.	Docket No. 13715
---	---------------------

Serial No. To be assigned	Filing Date Herewith	Examiner Unassigned	Group Art Unit Unassigned
------------------------------	-------------------------	------------------------	------------------------------

Invention: **MULTI-LAYERED WIRING LAYER AND METHOD OF FABRICATING THE SAME**



I hereby certify that this New Patent Application  
*(Identify type of correspondence)*  
 is being deposited with the United States Postal Service "Express Mail Post Office to Addressee" service under  
 37 CFR 1.10 in an envelope addressed to: The Assistant Commissioner for Patents, Washington, D.C. 20231  
 on June 19, 2000  
*(Date)*

Mishelle Spina  
*(Typed or Printed Name of Person Mailing Correspondence)*  
  
*(Signature of Person Mailing Correspondence)*  
EE692181515US  
*("Express Mail" Mailing Label Number)*

**Note: Each paper must have its own certificate of mailing.**

#2 | Priority  
Paper  
9-13-00  
P. States  
PATENTS

IN THE UNITED STATES PATENT AND TRADEMARK OFFICE

**Applicant:** Masayoshi Tagami, et al.      **Docket:** 13715  
**Serial No.:** To be assigned                      **Dated:** June 19, 2000  
**Filed:** Herewith  
**For:** MULTI-LAYERED WIRING LAYER AND  
METHOD OF FABRICATING THE SAME

Assistant Commissioner for Patents  
Washington, DC 20231

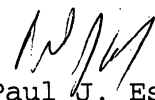
10511 U.S. PTO  
09/596415  
06/19/00

CLAIM OF PRIORITY

Sir:

Applicants in the above-identified application hereby claim the right of priority in connection with Title 35 U.S.C. § 119 and in support thereof, herewith submit a certified copy of Japanese Patent Application 11-214110 filed on June 24, 1999.

Respectfully submitted,

  
Paul J. Esatto, Jr.  
Registration No. 30,749

Scully, Scott, Murphy & Presser  
400 Garden City Plaza  
Garden City, NY 11530  
(516) 742-4343

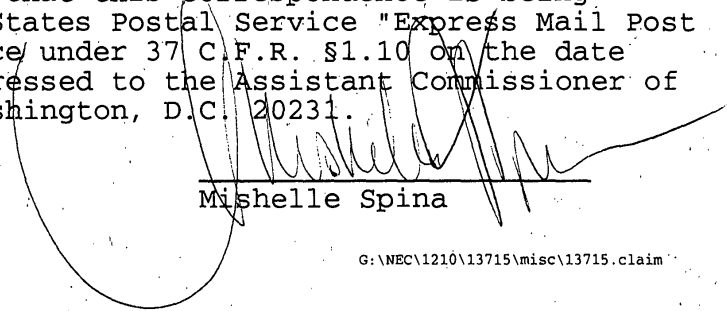
PJE/am

CERTIFICATE OF MAILING BY "EXPRESS MAIL"

"Express Mail" Mailing Label Number: EE692181515US  
Date of Deposit: June 19, 2000

I hereby certify that this correspondence is being deposited with the United States Postal Service "Express Mail Post Office to Addressee" service under 37 C.F.R. §1.10 on the date indicated above and is addressed to the Assistant Commissioner of Patents and Trademarks, Washington, D.C. 20231.

Dated: June 19, 2000

  
Michelle Spina

G:\NEC\1210\13715\misc\13715.claim

日 本 国 特 許 庁  
PATENT OFFICE  
JAPANESE GOVERNMENT

JCS11 U.S. PTO

09/596415



別紙添付の書類に記載されている事項は下記の出願書類に記載されて  
る事項と同一であることを証明する。

This is to certify that the annexed is a true copy of the following application as filed  
with this Office.

出 願 年 月 日  
Date of Application:

1999年 6月24日

願 番 号  
Application Number:

平成11年特許願第214110号

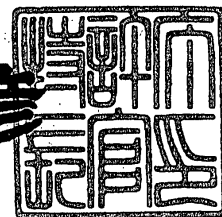
願 人  
Applicant(s):

日本電気株式会社

2000年 2月18日

特許庁長官  
Commissioner,  
Patent Office

近藤隆彦



出証番号 出証特2000-3008346



特平 11-214110

【書類名】 特許願

【整理番号】 34001979

【提出日】 平成11年 6月24日

【あて先】 特許庁長官殿

【国際特許分類】 H01L 21/3205  
21/2 8

【請求項の数】 27

【発明者】

【住所又は居所】 東京都港区芝五丁目7番1号 日本電気株式会社内

【氏名】 田上 政由

【発明者】

【住所又は居所】 東京都港区芝五丁目7番1号 日本電気株式会社内

【氏名】 林 喜宏

【特許出願人】

【識別番号】 000004237

【住所又は居所】 東京都港区芝五丁目7番1号

【氏名又は名称】 日本電気株式会社

【代理人】

【識別番号】 100096105

【弁理士】

【氏名又は名称】 天野 広

【電話番号】 03(5484)2241

【手数料の表示】

【予納台帳番号】 038830

【納付金額】 21,000円

【提出物件の目録】

【物件名】 明細書 1

【物件名】 図面 1

【物件名】 要約書 1

特平11-214110

【包括委任状番号】 9715826

【プールの要否】 要

【書類名】 明細書

【発明の名称】 多層配線の構造及びその製造方法

【特許請求の範囲】

【請求項 1】 半導体基板上に形成された銅配線からの銅拡散を防止する拡散バリア膜において、

前記拡散バリア膜は、結晶質の窒素含有金属膜と非晶質の金属窒化膜とからなる積層構造を有し、

前記拡散バリア膜を構成する金属原子種は同一であることを特徴とする拡散バリア膜。

【請求項 2】 前記非晶質金属窒化膜の膜厚は 80 乃至 150 オングストロームであることを特徴とする請求項 1 に記載の拡散バリア膜。

【請求項 3】 前記結晶質窒素含有金属膜の膜厚は 60 乃至 300 オングストロームであることを特徴とする請求項 1 又は 2 に記載の拡散バリア膜。

【請求項 4】 半導体基板上に形成された銅配線からの銅拡散を防止する拡散バリア膜を有する多層配線の構造において、

前記拡散バリア膜は、結晶質の窒素含有金属膜と非晶質の金属窒化膜とからなる積層構造を有し、

前記拡散バリア膜を構成する金属原子種は同一であることを特徴とする多層配線の構造。

【請求項 5】 前記拡散バリア膜は、下地配線層上の絶縁膜に形成された配線溝及び孔の表面を覆うように形成されていることを特徴とする請求項 4 に記載の多層配線の構造。

【請求項 6】 前記窒素含有金属膜上に銅膜が形成されていることを特徴とする請求項 4 又は 5 に記載の多層配線の構造。

【請求項 7】 前記非晶質金属窒化膜の膜厚は 80 乃至 150 オングストロームであることを特徴とする請求項 4 乃至 6 の何れか一項に記載の拡散バリア膜。

【請求項 8】 前記結晶質窒素含有金属膜の膜厚は 60 乃至 300 オングストロームであることを特徴とする請求項 4 乃至 7 の何れか一項に記載の拡散バリア膜。

ア膜。

【請求項 9】 スパッタ法による拡散バリア膜の製造方法において、

窒素含有ガスを用い、プラズマを発生させる電源のパワーのみを変化させ、スパッタターゲットの金属原子種を成分とする結晶質の窒素含有金属膜と非晶質の金属窒化膜とからなる積層構造の拡散バリア膜を連続的に形成することを特徴とする拡散バリア膜の製造方法。

【請求項 10】 回転磁場と RF パワーとを利用する RF マグネトロンスパッタ方式による拡散バリア膜の製造方法であって、

窒素含有ガスを用い、前記 RF パワーを変化させ、スパッタターゲットの金属原子種を成分とする結晶質の窒素含有金属膜と非晶質の金属窒化膜とからなる積層構造の拡散バリア膜を連続的に形成することを特徴とする拡散バリア膜の製造方法。

【請求項 11】 前記窒素含有ガスの圧力は 5 Pa 以上であることを特徴とする請求項 9 又は 10 に記載の拡散バリア膜の製造方法。

【請求項 12】 前記窒素含有ガスの窒素ガス濃度が 10% 以下であることを特徴とする請求項 9 乃至 11 の何れか一項に記載の拡散バリア膜の製造方法。

【請求項 13】 前記スパッタターゲットの金属原子種がタンタル、タングステン、チタン、モリブデン、ニオブあるいはこれらの混合物であることを特徴とする請求項 9 乃至 12 の何れか一項に記載の拡散バリア膜の製造方法。

【請求項 14】 RF マグネトロンスパッタ方式による拡散バリア膜の製造方法であって、

プラズマガス中の窒素濃度を一定値に維持した状態において、プラズマ発生電源を第一の値のパワーに設定し、第一の膜を成膜する過程と、

所望の膜厚が得られた瞬間に前記プラズマ発生電源を前記第一の値よりも大きい第二の値のパワーに設定し、前記第一の膜上に第二の膜を成膜する過程と、

を備えることを特徴とする拡散バリア膜の製造方法。

【請求項 15】 前記第一の膜は非晶質の金属窒化膜であり、前記第二の膜は結晶質の窒素含有金属膜であることを特徴とする請求項 14 に記載の拡散バリア膜の製造方法。

【請求項 16】 前記プラズマガス中の窒素ガスの圧力は 5 Pa 以上であることを特徴とする請求項 14 に記載の拡散バリア膜の製造方法。

【請求項 17】 前記窒素ガスの濃度が 10% 以下であることを特徴とする請求項 14 乃至 16 の何れか一項に記載の拡散バリア膜の製造方法。

【請求項 18】 スパッタターゲットの金属原子種がタンタル、タングステン、チタン、モリブデン、ニオブあるいはこれらの混合物であることを特徴とする請求項 14 乃至 17 の何れか一項に記載の拡散バリア膜の製造方法。

【請求項 19】 前記非晶質金属窒化膜の膜厚は 80 乃至 150 オングストロームであることを特徴とする請求項 9 乃至 18 の何れか一項に記載の拡散バリア膜の製造方法。

【請求項 20】 前記結晶質窒素含有金属膜の膜厚は 60 乃至 300 オングストロームであることを特徴とする請求項 9 乃至 19 の何れか一項に記載の拡散バリア膜の製造方法。

【請求項 21】 半導体基板上の絶縁膜に形成された配線溝あるいは孔に対して水素含有アルゴンのプラズマを照射処理する工程と、

大気に曝すことなく、前記配線溝あるいは孔の表面層を覆うように、結晶質の窒素含有金属膜と非晶質の金属窒化膜からなる積層構造の拡散バリア膜を形成する工程と、

大気に曝すことなく、前記拡散バリア膜上に銅薄膜を成長する工程と、  
を備える銅配線膜の製造方法。

【請求項 22】 前記拡散バリア膜はスパッタ法により形成されるものであることを特徴とする請求項 21 に記載の銅配線膜の製造方法。

【請求項 23】 前記銅薄膜は真空成膜法により形成されるものであることを特徴とする請求項 21 に記載の銅配線膜の製造方法。

【請求項 24】 前記真空成膜法は有機金属錯体の熱不均化反応を用いる熱化学気相堆積法（熱 CVD 法）であることを特徴とする請求項 23 に記載の銅配線膜の製造方法。

【請求項 25】 前記真空成膜法は銅ターゲットを用いたスパッタ法であることを特徴とする請求項 23 に記載の銅配線膜の製造方法。

【請求項 26】 前記非晶質金属窒化膜の膜厚は 80 乃至 150 オングストロームであることを特徴とする請求項 21 乃至 25 の何れか一項に記載の銅配線膜の製造方法。

【請求項 27】 前記結晶質窒素含有金属膜の膜厚は 60 乃至 300 オングストロームであることを特徴とする請求項 21 乃至 26 の何れか一項に記載の銅配線膜の製造方法。

【発明の詳細な説明】

【0001】

【発明の属する技術分野】

本発明は、配線材料として銅 (Cu) を用いた半導体集積回路の構造及びその製造方法に関するものであり、特に、銅配線膜からの銅の拡散を防止する拡散バリア膜に関する。

【0002】

【従来の技術】

半導体装置の微細化の進展に伴い、配線遅延がシリコン ULSI デバイスの性能に及ぼす影響が増大し、従来のアルミニウム配線材を銅に置きかえることが必要となってきている。銅の比抵抗はアルミニウムの比抵抗の 70% 程度であるが、銅は、アルミニウムと異なり、その表面層に酸化膜不動態を形成しないため、腐食しやすい。

【0003】

また、銅は珪素 (シリコン: Si) 及び二酸化珪素 (二酸化シリコン: SiO<sub>2</sub>) 中を非常に大きい速度で拡散するため、シリコン基板に形成される MOSFET 中に浸入すると、キャリアライフタイムの劣化を引き起こす。

【0004】

このため、銅配線を用いた半導体装置においては、銅の配線層間絶縁膜への銅拡散を防止するための拡散防止膜 (拡散バリア膜) を設けることが必要となる。さらに、拡散バリア膜は、配線信頼性を保持するために、層間絶縁膜及び銅との密着性が高くてはならない。

【0005】

特平11-214110

このため、これまでに、半導体集積回路における銅配線膜からの銅の拡散を防止するためのバリアメタル層の構造及びその製造方法について、多くの提案がなされている。

【0006】

例えば、「Semiconductor World」(1998年2月発行、筆者粟屋信義)の91-94頁(以下、「従来例1」と呼ぶ)、「Advanced Metallization and Interconnect Systems for ULSI Applications in 1997」(1998年発行、筆者 キーウオン・クウォン(Kee-Won Kwon))の712頁17行-713頁10行及び図3-5(以下、「従来例2」と呼ぶ)、「Journal Electrochemical Society」(1998年7月発行、筆者 エム・ティー・ワン(M. T. Wang))の2538-2545頁(以下、「従来例3」と呼ぶ)、「1998 Symposium on VLSI Technology Digest of Technical Papers」(1998年発行、筆者 ティー・デニング(D. Denning)他)の22-23頁(以下、「従来例4」と呼ぶ)にバリアメタル層についての考察がなされている。

【0007】

また、特開平8-139092号公報、特開平8-274098号公報、特開平9-64044号公報、特開平10-256256号公報及び特願平10-330938号には、銅拡散を防止するためのバリアメタル層の構造及びその製造方法が提案されている。

【0008】

一般に、銅はドライエッチングを行うことが困難であることから、化学機械研磨法(CMP:Chemical Mechanical Polishing)を利用して銅配線を形成する。

【0009】

具体的には、下地銅配線上に絶縁膜を形成し、この絶縁膜に配線溝と、下地配線層に至る孔とを形成する。次に、配線溝と孔の表面層に薄い拡散バリア膜を形

成する。この際、配線溝と孔の表面層が完全に拡散バリア膜で覆われているようにする。未覆領域からの銅の拡散を防止するためである。その後、電解メッキ法、CVD法あるいはスパッタ法によって、拡散バリア膜で覆われた配線溝と孔とを埋め込みながら銅膜を成長し、CMP法によって、絶縁膜表面に形成された銅膜と拡散バリア膜とを選択的に除去する。

【0010】

このように、拡散バリア膜には、先に述べた銅の拡散防止性と銅に対する密着性に加えて、高い被覆性が要求される。

【0011】

このような銅配線に対する拡散バリア膜の材質としては、従来例1に記載されているように、高融点金属（タングステン（W）、タンタル（Ta）など）やその窒化物（窒化タングステン（WN）、チタン（Ti）、窒化チタン（TiN）、窒化タンタル（Ta<sub>3</sub>N<sub>5</sub>）など）が検討されている。

【0012】

例えば、従来例2に記載されているように、Taバリア膜はその上にスパッタ法により形成される銅膜との密着性が良く、銅膜の結晶性を改善することができる。しかしながら、銅はTa膜中へも拡散するため、銅膜の下に形成されるTaバリア膜は50nm以上の膜厚を有することが必要となる。

【0013】

しかしながら、従来例4には、Ta膜上にCVD法により銅膜を成膜した場合、銅とTa<sub>3</sub>N<sub>5</sub>との界面にフッ素（F）が偏析し、密着性が劣化することが報告されている。

【0014】

また、従来例3に記載されているように、（200）及び（111）方向に配向した結晶質Ta<sub>3</sub>N<sub>5</sub>バリア膜は、結晶質Taバリア膜と比較して、銅拡散阻止の機能に富むことが報告されている。

【0015】

また、銅の拡散防止機能と銅に対する密着性を改善する方策として、金属膜と金属窒化膜とを積層する試みもなされている。



特平11-214110

【0016】

例えば、上記の特願平10-330938号には、チタンを金属膜として用いた、スパッタ法による積層バリア膜の製造方法が記載されている。図32に示すように、この製造方法においては、まず、Arガスのみをスパッタチャンバー内に導入し、チタン膜1を成膜する。その後、窒素ガスを導入することにより、チタンと窒素の反応を補助的に利用しながら、チタン膜1上に窒化チタン薄膜2を形成する。このようにして、チタン膜1と窒化チタン薄膜2とからなる積層バリア構造3が形成される。この製造方法においては、スパッタ前処理として下地配線膜表面の金属酸化膜を除去するために、アルゴンプラズマ処理が行われる。

【0017】

【発明が解決しようとする課題】

以上のような従来の銅の拡散バリア膜は、以下に述べるような技術的課題を有するものであった。

【0018】

第1の技術的課題は、銅に対する拡散防止性能と銅との密着性を兼ね備えた拡散バリア膜を作ることが難しいことである。

【0019】

図33に示すように、半導体基板4上に結晶化した柱状構造の金属膜5を成膜した場合を想定する。この金属膜5においては、一個の結晶の集まりであるグレイン6と、グレイン6の界面となる粒界7とが金属膜5の表面から底部に至るまで存在するため、この粒界7が銅の拡散する経路8となる。このため、金属膜5の銅拡散のバリア性は低いものとなる。

【0020】

また、図34に示すように、タングステン(W)、チタン(Ti)、タンタル(Ta)などの比抵抗が小さい金属を用いて、半導体基板4上に金属膜5aを形成すると、金属膜5aは多結晶構造となる。このため、この金属膜5aは、図33に示した金属膜5と同様の柱状構造となってしまう、銅拡散に対するバリア性が低いものとなる。

【0021】

ただし、通常のTa膜のスパッタにおいて得られるような $\beta$ -Ta(002)膜などの結晶化した金属膜上にスパッタ法により銅を成膜した場合には、銅の拡散防止性は劣るものの密着性に優れ、結晶配向性に富んだ銅膜を形成することができることから、銅配線の信頼性は向上する。

【0022】

一方、図34に示すような半導体基板4上に成膜された非晶質（アモルファス）のTa<sub>2</sub>N<sub>5</sub>のような微粒子9からなる金属膜5aにおいては、比抵抗も約200-250 $\mu\Omega$ -cmと低く、図33に示したような結晶化した金属膜5と異なり、銅の拡散経路8も存在しないため、銅拡散に対するバリア性は非常に高いものとなる。

【0023】

しかしながら、金属膜5aの表面はアモルファス状で結晶格子が均等に配列されていないため、この非晶質（アモルファス）状膜上にCVD法又はスパッタ法により銅を成膜すると、銅の結晶性と銅に対する密着性が劣化する。

【0024】

このように、結晶質の金属膜あるいは非晶質の金属窒化膜のみからなる単層構造膜においては、銅の拡散防止性と密着性に富んだ拡散バリア膜を得ることは困難である。

第2の技術的課題は、単層構造の拡散バリア膜の欠点を回避することを目的として、拡散バリア膜を多層構造膜とする際に発生するものである。

【0025】

例えば、銅との密着性が高い結晶質の金属膜とTa<sub>2</sub>N<sub>5</sub>のような拡散バリア性の高い非晶質の金属窒化膜との積層構造として拡散バリア膜を形成すると、銅の拡散防止性と密着性に富んだ拡散バリア膜を得ることができる。

【0026】

しかしながら、従来は、結晶質の金属膜と非晶質の金属窒化膜とを連続的にスパッタ成膜することが不可能であったため、結晶質の金属膜と非晶質の金属窒化膜とをそれぞれ別個に、すなわち、2回に分けて成膜を行うか、あるいは、異なる2つ以上のスパッタ成膜チャンバーを用いる必要があった。

【0027】

例えば、上記の特願平10-330938号においては、スパッタ成膜チャンパーにArガスを導入してチタン膜を成膜した後、窒素ガスを導入して窒化チタンを成膜している。しかしながら、この方法によれば、チタン膜を成膜してから窒化チタンの成膜を行うまでの間においては、導入ガスの混合比を変化させることによりチャンパー内のArと窒素の分圧が安定するまで、窒化チタンの成膜を行うことはできないため、生産性が時間的に非効率なものとならざるを得ない。

【0028】

第3の技術的課題は、スパッタ膜の被覆性に関するものである。

【0029】

一般に、金属膜及びその金属窒化膜をスパッタ成膜する場合、回転磁場と直流バイアス印加によって発生するArプラズマで金属ターゲットを叩き、対極に設置されている基板に金属膜あるいはその窒化膜を成長させる。

【0030】

この場合、スパッタ圧力は1Pa以下の低圧力である。Arプラズマで叩かれた金属粒子は基板表面に対してランダムに照射されるため、例えば、基板表面に深い配線溝や孔が存在した場合、これらの開口部を完全に覆うように金属膜を成長することは困難であった。また、スパッタ圧力が低いため、Arプラズマ密度が低く、基板表面に被着した金属膜をArプラズマ粒子で叩くという再スパッタ効果を期待することはできない。

【0031】

被覆性を向上させるためにスパッタターゲットと基板との間に多数の孔を形成した金属板を設置して、この孔を通過させることにより、スパッタ金属粒子の方向性を揃えるコリメートスパッタ法が提案されている。このコリメートスパッタ法によれば、基板表面に形成された開口部の底面に金属膜を成長することは可能であるが、開口部の側面に金属膜を付着させることは困難であった。

【0032】

第4の技術的課題は、銅膜との間で良好な密着性を有する結晶性の金属膜は大気中と容易に反応して表面反応層を形成する点である。

このような表面反応層は銅膜との密着性を著しく劣化させてしまう。

【0033】

第5の技術的課題は、銅酸化膜の再付着の問題である。

拡散バリア膜のスパッタ成長前に下地配線金属膜表面の酸化膜を除去するため、Arプラズマ処理が行われる。下地配線が銅の場合、銅酸化膜がArスパッタにより飛散し、絶縁膜に形成された孔の表面に銅酸化膜が再付着してしまうという問題があった。

【0034】

第6の技術的課題は、CVD法により、Ta膜及び非晶質のTa<sub>2</sub>N膜上に銅膜を成膜した場合、銅と拡散バリア層との間の密着性が悪くなる点である。

【0035】

本発明は、以上のような従来技術における問題点に鑑みてなされたものであり、銅配線を用いた半導体装置において、銅の半導体装置中への拡散を防止する拡散バリア性能と、銅及び配線層間膜の間の密着性能とを兼ね備えた拡散バリア膜、そのような拡散バリア膜を有する多層配線構造、及び、そのような拡散バリア膜の製造方法を提供することを目的とする。

【0036】

さらには、本発明は、上記のような拡散バリア膜上に銅を埋め込んだ銅多層配線の製造方法を提供することを目的とする。

【0037】

【課題を解決するための手段】

この目的を達成するため、本発明の請求項1は、半導体基板上に形成された銅配線からの銅拡散を防止する拡散バリア膜において、拡散バリア膜は、結晶質の窒素含有金属膜と非晶質の金属窒化膜とからなる積層構造を有し、拡散バリア膜を構成する金属原子種は同一であることを特徴とする拡散バリア膜を提供する。

【0038】

また、請求項4は、半導体基板上に形成された銅配線からの銅拡散を防止する拡散バリア膜を有する多層配線の構造において、拡散バリア膜は、結晶質の窒素

含有金属膜と非晶質の金属窒化膜とからなる積層構造を有し、拡散バリア膜を構成する金属原子種は同一であることを特徴とする多層配線の構造を提供する。

【0039】

この多層配線の構造においては、請求項5に記載されているように、拡散バリア膜は、下地配線層上の絶縁膜に形成された配線溝及び孔の表面を覆うように形成されていることが好ましい。

【0040】

また、請求項6に記載されているように、窒素含有金属膜上には銅膜を形成することができる。

【0041】

請求項9は、スパッタ法による拡散バリア膜の製造方法において、窒素含有ガスを用い、プラズマを発生させる電源のパワーのみを変化させ、スパッタターゲットの金属原子種を成分とする結晶質の窒素含有金属膜と非晶質の金属窒化膜とからなる積層構造の拡散バリア膜を連続的に形成することを特徴とする拡散バリア膜の製造方法を提供する。

【0042】

また、請求項10は、回転磁場とRFパワーとを利用するRFマグネトロンスパッタ方式による拡散バリア膜の製造方法であって、窒素含有ガスを用い、RFパワーを変化させ、スパッタターゲットの金属原子種を成分とする結晶質の窒素含有金属膜と非晶質の金属窒化膜とからなる積層構造の拡散バリア膜を連続的に形成することを特徴とする拡散バリア膜の製造方法を提供する。

【0043】

請求項11に記載されているように、窒素含有ガスの圧力は5Pa以上であることが好ましい。

【0044】

また、請求項12に記載されているように、窒素含有ガスの窒素ガス濃度は10%以下であることが好ましい。

【0045】

請求項13に記載されているように、スパッタターゲットの金属原子種として

は、タンタル、タングステン、チタン、モリブデン、ニオブあるいはこれらの混合物から選択することができる。

【0046】

請求項14は、RFマグネトロンスパッタ方式による拡散バリア膜の製造方法であって、プラズマガス中の窒素濃度を一定値に維持した状態において、プラズマ発生電源を第一の値のパワーに設定し、第一の膜を成膜する過程と、所望の膜厚が得られた瞬間にプラズマ発生電源を第一の値よりも大きい第二の値のパワーに設定し、第一の膜上に第二の膜を成膜する過程と、を備えることを特徴とする拡散バリア膜の製造方法を提供する。

【0047】

この拡散バリア膜の製造方法においては、請求項15に記載されているように、第一の膜としては、例えば、非晶質の金属窒化膜を、第二の膜としては、例えば、結晶質の窒素含有金属膜を選択することができる。

【0048】

請求項21は、半導体基板上の絶縁膜に形成された配線溝あるいは孔に対して水素含有アルゴンのプラズマを照射処理する工程と、大気に曝すことなく、配線溝あるいは孔の表面層を覆うように、結晶質の窒素含有金属膜と非晶質の金属窒化膜からなる積層構造の拡散バリア膜を形成する工程と、大気に曝すことなく、拡散バリア膜上に銅薄膜を成長する工程と、を備える銅配線膜の製造方法を提供する。

【0049】

拡散バリア膜は、請求項22に記載されているように、例えば、スパッタ法により形成することができる。

【0050】

また、銅薄膜は、請求項23に記載されているように、例えば、真空成膜法により形成することができる。

【0051】

真空成膜法としては、請求項24に記載されているように、例えば、有機金属錯体の熱不均化反応を用いる熱化学気相堆積法（熱CVD法）を用いることがで

特平11-214110

きる。あるいは、請求項25に記載されているように、銅ターゲットを用いたスパッタ法を用いることができる。

【0052】

請求項2、7、19、26に記載されているように、非晶質金属窒化膜の膜厚は80乃至150オングストロームであることが好ましい。

【0053】

請求項3、8、20、27に記載されているように、結晶質窒素含有金属膜の膜厚は60乃至300オングストロームであることが好ましい。

【0054】

【作用】

本発明に係る拡散バリア膜によれば、銅膜と直接的に接する膜は結晶質の窒素含有金属膜であるため、密着性と銅膜の高い結晶性を確保することができる。

【0055】

また、金属結晶中に窒素を含有させたことにより、純粋な金属結晶膜と比較して、銅の拡散を抑制させることができる。

【0056】

さらには、本発明に係る拡散バリア膜によれば、結晶質の窒素含有金属膜の下に非晶質の金属窒化膜が存在するため、銅の拡散を防止することができるとともに、下地絶縁膜（ここでは、シリコン酸化膜）との密着性をも確保することができる。すなわち、本発明に係る拡散バリア膜上に銅配線膜を形成することにより、銅配線膜の高結晶性と密着性とを確保することができると同時に、銅拡散を防止することができるという効果を発揮する。

【0057】

また、本発明に係る拡散バリア膜の製造方法によれば、窒素含有ガスを用いるスパッタ法におけるプラズマ発生電源パワーのみを変化させることによって、スパッタターゲットの金属原子種を成分とする結晶質の窒素含有金属膜と非晶質の金属窒化膜とからなる積層構造を連続的に形成することが可能になる。

【0058】

具体的には、プラズマガス中の窒素濃度を一定に保った状態で、まず、プラズ

マ発生電源を低パワーとして成膜を行うと、ターゲット金属と窒素との十分な反応により、非晶質の金属窒化膜が成長する。その直後に、プラズマ発生電源を高パワーに変化させ、窒素とターゲット金属との間の十分な反応時間を与えることなく膜成長させることにより、結晶質の窒素含有金属膜が得られる。その結果、同一チャンバー内において、結晶質の窒素含有金属膜と非晶質の金属窒化膜とからなる積層構造の拡散バリア膜を連続的に効率良く成膜することができるという効果を発揮する。

## 【0059】

また、本発明に係る拡散バリア膜の製造方法によれば、回転磁場とRFパワーとを導入したRFマグネトロンスパッタ方式を採用し、窒素含有ガスの圧力が5 Pa以上であるようなスパッタを実現することを可能にしているため、スパッタガスの主成分であるArプラズマ密度を向上させて基板開口部の全面に渡る被覆性を確保できるという効果を得ることができる。

## 【0060】

また、本発明による拡散バリア膜の製造方法は、半導体基板上の絶縁膜に形成された配線溝あるいは孔に対して水素含有アルゴンのプラズマを照射処理する工程を含む。この工程により、下地銅配線層の表面に形成されていた銅酸化膜を還元して金属銅に戻すことができ、ひいては、絶縁膜に形成された孔の表面への銅酸化膜の再スパッタ被着を大幅に減らすことができる。

## 【0061】

さらに、その後、大気に曝すことなく、配線溝あるいは孔の表面層を覆うように結晶質の窒素含有金属膜と非晶質の金属窒化膜とからなる積層構造の拡散バリア膜を形成する工程と真空成膜法により銅薄膜を成長する工程とにより、金属酸化膜層を界面に介在させずに、拡散バリア膜／銅配線膜からなる構造を得ることができるという効果を発揮する。

## 【0062】

## 【発明の実施の形態】

次に、図1乃至図4を参照して、本発明の第一の実施の形態に係る拡散バリア膜の製造方法を説明する。



【0063】

図1に示すように、半導体基板11上には、第一の絶縁膜12aが形成され、この第一の絶縁膜12aには銅配線44が形成されている。第一の絶縁膜12a上には、第二の絶縁膜12bが形成されており、この第二の絶縁膜12bの表面には配線溝13が形成され、配線溝13の底面には、第一の絶縁膜12aに達する孔14が配線溝13と連続して形成されている。

【0064】

先ず、第1のチャンバーにおいて、半導体基板11を水素含有アルゴンプラズマに曝し、下地銅配線44の表面に形成された銅酸化膜を還元除去する。次いで、かかる半導体基板11を真空搬送し、第2のチャンバーにおいて、窒素含有ガスを用いて、高融点金属ターゲットからのスパッタ成膜を行う。

【0065】

この際、プラズマガス中の窒素濃度を一定に保った状態で、まず、プラズマ発生電源を低パワーにして成膜を行うと、ターゲット金属と窒素との十分な反応により、図2に示すように、非晶質の金属窒化膜15が成長する。その後、プラズマ発生電源を瞬時に高パワーに変化させ、窒素とターゲット金属との十分な反応時間を与えることなく、膜成長を行うことにより、非晶質の金属窒化膜15上に結晶質の窒素含有金属膜16を得る。

【0066】

その結果、図2に示すように、積層構造を有する拡散バリア膜17を配線溝13及び孔14の側壁部及び底部において同一チャンバー内で連続的に効率良く成膜することができる。この拡散バリア膜17のスパッタ成長の際、スパッタ圧力を十分に高くすることにより、拡散バリア膜17の被覆性を向上させることができる。

【0067】

その後、半導体基板11を真空搬送し、第3のチャンバーにおいて、図3に示すように、拡散バリア膜17上に銅膜18を真空成膜し、配線溝13及び孔14を銅膜18で埋め込む。この際、拡散バリア膜17の表面は結晶質の窒素含有金属膜16であり、かつ、半導体基板11の真空搬送により、窒素含有金属膜16

の表面には酸化膜が形成されていない。

【0068】

最後に、図4に示すように、CMP法で第二の絶縁膜12bの表面に形成されている拡散バリア膜17と銅膜18とを選択的に除去することにより、信頼性の高い銅配線を得ることができる。

【0069】

銅の拡散バリア性の向上の原因は金属膜16に窒素を含有させたことである。また、この窒素含有金属膜16は銅との密着性を確保することに大きな効果を有する。非晶質金属窒化膜15も銅拡散防止に効力を発揮する他、下地層間絶縁膜12bとの密着性の向上に大きく寄与する。その結果、銅膜18と拡散バリア膜17との間の密着性を確保することができ、また、銅膜18から第二の絶縁膜12bへの銅の拡散も防止することができる。

【0070】

【実施例】

以下、上記の第一の実施形態の各実施例について説明する。

【0071】

【第一の実施例】

第一の実施例においては、結晶性の窒素含有金属と非晶質の金属窒化膜とからなる積層構造を形成するスパッタ法について説明する。

【0072】

第一の実施例におけるスパッタ法は、図5に示すRFマグネトロンスパッタ装置において実行される。

【0073】

図5に示すRFマグネトロンスパッタ装置においては、ドライポンプ、クライオポンプ及びターボポンプなどの排気ポンプ33により、チャンバー21は、その内部圧力が約 $1 \times 10^{-7}$  Pa乃至約 $1 \times 10^{-6}$  Paの真空状態になるように、排気されている。チャンバー21には基板加熱ヒーター34が設置されており、チャンバー21内に導入された半導体基板22を約20乃至300℃に加熱することができるようになっている。また、金属ターゲット28と半導体基板2

2との間の距離は102mm乃至134mmの範囲内において変化させることが可能である。

【0074】

また、アルゴン(Ar)ガスと窒素(N<sub>2</sub>)ガスとがそれぞれマスフローコントローラ31を介して流量が調整された状態でチャンバー21内に導入されるようになっている。これらのガスをチャンバー21に導入したときのチャンバー21内の圧力は2Pa乃至17Paである。

【0075】

金属ターゲット28の直径は、例えば、300乃至320mm程度であり、金属ターゲット28は金属製のターゲットホルダ27とカソード23と絶縁体29とを介してスパッタチャンバー21に取り付けられている。カソード23の内部には永久磁石24が回転可能に配置されており、永久磁石24を回転させることにより、チャンバー21内部の磁場30を均一にして、金属ターゲット28の表面の削れ(エロージョン)が一定になるようにしている。これにより、半導体基板22上に成膜される膜の均一性を高めることができる。

【0076】

また、チャンバー21内にRFを導入するためのRF電源25は、インピーダンスマッチングを行うための整合器(マッチングボックス)32を介して、カソード23に接続されており、300mmφの金属ターゲット28に対して13.56MHzの高周波を0乃至10kWのパワーで印加することが可能である。

【0077】

RF電源25をONにしてRFをチャンバー21内に導入すると、窒素を含むArプラズマ26が発生する。このArプラズマ26で発生するArイオンにより、ターゲット金属28がスパッタされ、半導体基板22に到達し、結晶質の窒素含有金属16あるいは非晶質の金属窒化膜15が堆積される。

【0078】

上述のようなRFマグネトロンスパッタ方式を用いて、半導体基板22上の絶縁膜12b(図1参照)内に形成された孔14(図1参照)に対してTa成膜を行った。その埋め込み特性の結果を図6に示す。

【0079】

孔14の直径は0.3  $\mu\text{m}$ 乃至1.5  $\mu\text{m}$ であり、孔14が開口されている箇所における絶縁膜12bの厚さは約1.5  $\mu\text{m}$ であった。図6から明らかであるように、スパッタ圧力を増加させていくにつれて(2→4→8→13→17 Pa)、ボトムカバレッジ(孔14の底における堆積膜厚/絶縁膜12bの表面での堆積膜厚の比)が向上していくことが分かる。具体的には、スパッタ圧力が5 Paを超えると、アスペクト比の大きな孔に対しても十分な被覆性を示していることがわかる。

【0080】

なお、孔14の側面におけるTa堆積膜厚は孔14の底部における堆積膜厚の半分程度であり、スパッタ圧力の増加に伴い、孔14の内壁面全体を被覆するTa膜が形成された。

【0081】

この現象の原因としては次のような2つの点が考えられる。

まず、第1の原因として考えられることは、図7に示すように、プラズマガス中のTaイオン数の増加である。

【0082】

スパッタ圧力が増加することにより、Ta原子と励起Ar原子との衝突が増加し、Ta原子のイオン化が促進される。その結果として生じたTaイオンが、半導体基板22に発生する負のセルフバイアスに引っ張られる結果、半導体基板面に対するTaイオン流束35の入射角の垂直性が向上する。このため、通常のスパッタで起こるような開口部付近におけるオーバーハングが抑制され、孔14や配線溝13の底部までTaが到達しやすくなる。その結果、孔14の内壁面全体を被覆するTa膜36が形成される。

【0083】

第2の原因としては、図8に示すようなArイオン39による堆積Ta膜36の再スパッタが考えられる。

【0084】

スパッタプラズマガスの主成分であるArイオン39はターゲットに対しての

みでなく、負のセルフバイアス状態にある半導体基板22に対しても、電界により加速された状態で到達する。すなわち、半導体基板22上に堆積したTa膜も再びスパッタされることになる。このArイオン39により、孔14や配線溝13の開口部付近に堆積してオーバーハングを起こす原因となるTa膜が矢印37で示されるように再スパッタされるため、孔14や配線溝13の底部に向かうTa原子38が開口部付近で妨げられにくくなる。このため、孔14の底部や側面におけるTaの堆積が行われやすくなる。

【0085】

さらに、孔14や配線溝13の底部におけるTa膜36もArイオン39により再スパッタされるため、再スパッタされた底部のTa原子が孔14や配線溝13の側面40に再堆積し、孔14の側面40におけるカバレッジが向上するものと考えられる。

【0086】

現時点においては、上記のどちらの効果が主因となって埋め込み被覆性が向上するのか断定はできない。ただし、5Paを超える高圧力の下におけるプラズマイオンの平均自由行程は数mmであることから、Taイオン流束35の入射角の垂直性の向上による効果はそれほど大きくはないものと考えられる。高圧力により十分な密度のArイオンが発生し、このArイオンによるTa堆積膜の再スパッタが主因となって、被覆性が向上するものと推定される。

【0087】

なお、タンタル窒化膜のスパッタ成膜についても、同様に、5Paを超える高圧スパッタにおいて良好な被覆性が認められた。

【0088】

以上述べたように、RFマグネトロンスパッタ方式においては、スパッタ圧力を5Pa以上の高圧力とすることが望ましい。

【0089】

【第二の実施例】

図9に、第一の実施例で挙げた高圧RFマグネトロンスパッタ方式を用いて、チャンバー21内に導入するアルゴンガス(Ar)の量に対する窒素ガス(N<sub>2</sub>)

)の量の比( $N_2 / (Ar + N_2)$ )を変化させた場合のRFパワーとスパッタ成長膜の比抵抗の変化との間の関係を示す。

【0090】

この時のチャンパー21内の圧力は13Pa、半導体基板22の加熱温度は200℃、マグネット24の回転速度は10rpm、金属ターゲット28と半導体基板22との間の距離は134mmである。

【0091】

RFパワーに関わらず、 $N_2 / (Ar + N_2)$ における $N_2$ 割合の増加に伴って、一旦、比抵抗が減少し、その後、再び増加して行く傾向が見られる。ただし、その増加率はRFパワーに依存し、RFパワーが大きいほど比抵抗の増加率は低減する。

【0092】

図10から図13に、300mmφのTaターゲットに対してRFパワー=6kW(8.5W/cm<sup>2</sup>)を投入した時の $N_2$ 比の変化によるX線回折パターン(XRD)の変化を示す。

【0093】

具体的には、図10は $N_2$ 比=0%、図11は $N_2$ 比=1%、図12は $N_2$ 比=5%、図13に $N_2$ 比=7%の場合のXRDパターンを示す。以下、図10乃至図13と比抵抗を示す図9とを対応させながら説明する。

【0094】

$N_2$ 比=0%の場合には、図10に示すように、β-Ta(002)配向した結晶質のTa金属膜が得られ、その比抵抗は160乃至200μΩ-cmである。

【0095】

$N_2$ 比=1%の場合には、図11に示すように、β-TaとTa<sub>0.1</sub>N<sub>0.1</sub>とが混在した結晶性の窒素含有金属膜(ここでは、Ta膜)が得られ、その比抵抗の値は約100μΩ-cm程度に減少する。

【0096】

$N_2$ 比=5%の場合には、図12に示すように、XRDパターン強度が低下し

ており、非晶質の金属窒化膜が形成されていることがわかる。その比抵抗は約200乃至250  $\mu\Omega\text{-cm}$ 程度であった。

【0097】

更に $N_2$ 比を増加させていくと、図13に示すように、 $N_2$ 比=7%の場合には、 $Ta_3N_5$ の結晶性の金属窒化膜が成長し、比抵抗は更に上昇する。

【0098】

このように、Taターゲットを用いた場合、スパッタガス中の $N_2$ 濃度とRFパワー値とに依存して、成長する膜の結晶構造、組成及び比抵抗が変化する。このことは、逆に見れば、スパッタガス中の $N_2$ 濃度とRFパワー値を制御することによって、成長膜の特性を制御することができることを意味している。本発明はこのような見地に基づくものである。

【0099】

しかしながら、スパッタ法の場合、スパッタガスの流量（ガス圧力）や $N_2$ 組成比を変化させることは容易ではない。従って、実用的には、スパッタガスの流量（ガス圧力）や $N_2$ 組成比を一定値に維持し、RFパワーのみを変化させることにより、スパッタ成長した膜の結晶構造、組成及び比抵抗を制御することが必要となる。

【0100】

そこで、 $N_2$ 比を2%に固定してRFパワーのみを変化させた場合の比抵抗の変化を図14に示す。図14から明らかであるように、RFパワーのみを変化させた場合においても、スパッタ膜質及び比抵抗を制御できることがわかる。図14に示す比抵抗の変化におけるガス圧力は10Pa、マグネット回転速度は10rpm、基板温度は200℃である。

【0101】

また、各RFパワーに対するXRDの特性を図15乃至図18に示す。図15はRFパワー=2kW、図16はRFパワー=3kW、図17はRFパワー=6kW、図18はRFパワー=8kWの場合のXRDの特性である。

【0102】

具体的には、RFパワー=2kWの場合には、図15に示すように、非晶質の

Ta<sub>2</sub>Nが得られ、RFパワーを増加させるにつれて結晶質のTa<sub>0.1</sub>Nが得られ、さらに、RFパワー=8kWの場合においては、図18に示すように、β-Ta膜とTa<sub>0.1</sub>Nとが混合した結晶質の窒素含有金属膜へと変化している。

【0103】

図19と図20に、それぞれRFパワー=2kWとRFパワー=8kWの場合に得られた膜の断面走査型電子顕微鏡(Scanning Electron Microscopy: SEM)写真を示す。

【0104】

RFパワー=2kWの場合には、図15に示すXRDからも明らかであるように、成長膜は非晶質構造を持つため、結晶粒界は認められない。一方、RFパワー=8kWの場合には、図18に示すXRDからも分かるように、β-Ta膜とTa<sub>0.1</sub>Nとが混合したような結晶膜が得られており、膜も柱状構造を有していることが分かる。

【0105】

すなわち、非晶質の金属窒化膜であるTa<sub>2</sub>Nを2kWのRFパワーで成膜し、所望の膜厚が得られた瞬間にスパッタパワーを8kWに変化させることにより、結晶性の窒素含有金属膜に膜質を変化させると、図21に示すように、半導体基板11上に、非晶質の金属窒化膜15(非晶質のTa<sub>2</sub>N)と、結晶質の窒素含有金属膜16(結晶質のβ-Taと結晶質のTa<sub>0.1</sub>Nとからなる混合膜)とからなる積層構造の拡散バリア膜17が成膜される。

【0106】

実際に、Ta<sub>2</sub>N成膜中にスパッタパワーを2kWから8kWに変化させ、結晶質の窒素含有金属膜16と非晶質の金属窒化膜15とをそれぞれ約500Åずつ連続的に成長した膜の断面のSEM写真を図22に示す。非晶質のTa<sub>2</sub>N膜15と柱状結晶質の窒素含有金属膜(Ta<sub>2</sub>N膜)16とが連続的に積層構造を構成して成膜されていることが確認できる。

【0107】

この現象の原理は以下のように考えられる。スパッタパワーが2kWの場合に



は、Arイオンによるスパッタ率が低いために、Taターゲットの表面が $N_2$ により十分に窒化される時間が存在する。このため、Taターゲットの表面が窒化され、 $Ta_2N$ に変化する。このように窒化された $Ta_2N$ がArイオンによりスパッタされるために $Ta_2N$ が堆積される。しかしながら、スパッタパワーが8kWになると、Taターゲットの表面が十分に窒化される時間が与えられる前にArイオンによりスパッタされるため、スパッタされるTa膜に窒素が微量のみ含まれるような窒素含有の金属膜が得られやすくなるものと推定される。

## 【0108】

この現象を利用することにより、図23に示すように、半導体基板11上に成膜された絶縁膜12b内に形成された配線溝13またはビア孔14を覆うようにして、積層構造の拡散バリア膜17を成膜することが可能となる。下層に位置する非晶質の金属窒化膜( $Ta_2N$ )15は、銅の拡散バリア性を確保することができ、かつ、下地絶縁膜12bとの密着性を保持できる程度の膜厚を有することが必要である。そのような膜厚としては、約80Å乃至150Åが好ましい。一方、結晶質の窒素含有金属膜(結晶質の $\beta$ -Taと結晶質の $TaN_{0.1}$ とからなる混合膜)16は銅の拡散バリア性を保持でき、かつ、銅との密着性を確保することができれば良く、窒素含有金属膜16の膜厚としては、60Å乃至300Å程度が最適である。

## 【0109】

## 【第三の実施例】

第一実施例において述べたRFマグネトロンスパッタ方式においては、チャンパー内に導入する圧力を通常のスパッタよりも高圧にすることにより、すなわち、5Pa以上とすることにより、配線溝又は孔への埋め込み性能を向上させることが可能になる。すなわち、この領域の圧力の下で成膜中にパワーを切り替えることにより、図1に示したように、半導体基板11上に成膜された絶縁膜12b中に形成された配線溝13と孔14とを同時に埋め込むようなデュアルダマシンプロセスを用いる際にも、良好な埋め込み特性の下で積層バリア膜17を得ることが可能になる。

## 【0110】

【第四の実施例】

上述の第一及び第二の実施例においては、スパッタパワーを切り替えることにより連続的に積層バリア膜を作製するプロセスをRFマグネトロンスパッタ形式に適用した場合について述べた。このプロセスは、 $N_2$ 比や成膜パワーは異なる条件になるが、図24に示すようなDCマグネトロンスパッタ方式にも適用することができる。

【0111】

図24に示すDCマグネトロンスパッタ装置は、チャンバー21と、チャンバー21の底面に設置され、半導体基板22を加熱する基板加熱ヒーター34と、絶縁体29とカソード23とを介してチャンバー21の内部の上方に配置されたターゲット金属28と、チャンバー21の内部圧力が約 $1 \times 10^{-7}$  Pa乃至約 $1 \times 10^{-6}$  Paの真空状態になるように排気を行う排気ポンプ33と、ターゲット金属28の上方に配置されたマグネット42と、絶縁体29を介してチャンバー21と、アルゴンガスと窒素ガスの流量を調整してチャンバー21内に送り込むマスフローコントローラ31と、カソード23と基板加熱ヒーター34に直流電圧を印加するDC電源41と、からなっている。

【0112】

DC電源41をオンにすることにより、窒素を含むアルゴンプラズマ26がチャンバー21内に発生する。

【0113】

【第五の実施例】

第一及び第二の実施例においては、一つのビア及び配線が形成されている例を挙げたが、本発明を適用することができる構造は、一つのビア及び配線が形成されている構造には限定されない。

【0114】

図25に示すように、半導体基板11上に第一の絶縁膜12aが形成され、この第一の絶縁膜12aにはビア孔の内部に拡散バリア膜17を介して銅配線44が形成され、さらに、第一の絶縁膜12a上には第二の絶縁膜12b形成されている。第二の絶縁膜12b内に形成された配線溝及びビア孔の表面にも拡散バリア

ア膜17が形成されており、配線溝及びビア孔は拡散バリア膜17を介して銅配線（図示せず）で埋め込まれる。

【0115】

このように、積層された複数の絶縁膜のそれぞれに形成された配線溝及びビア孔の表面を拡散バリア膜17で覆い、次いで、銅配線層で配線溝及びビア孔を埋め込むことが可能である。

【0116】

その一例を図26に示す。図26に示す積層構造は、3層の絶縁膜からなり、各絶縁膜には配線溝及びビア孔が形成され、それらの配線溝及びビア孔の表面は拡散バリア層17で覆われ、さらに、銅配線44が埋め込まれている。

【0117】

以下、図26に示す積層構造の製造方法を説明する。

半導体基板11には、素子分離層11aにより分離された半導体素子11bが形成されている。その半導体基板11上に成膜されたシリコン酸化膜等の第一の絶縁膜12aには、半導体素子11bとコンタクトを取るための配線溝及び孔が形成されており、これらの配線溝及び孔の表面には、第一の実施例において述べたような高圧RFマグネトロンスパッタ法により、良好な埋め込み性の下に結晶質の窒素含有金属膜と非晶質の金属窒化膜とからなる積層構造を有する拡散バリア膜17が形成されている。

【0118】

その後、真空成膜法により銅膜を配線溝及び孔に埋め込んで形成し、化学的機械的研磨法（CMP法）により、第一の絶縁膜12a上の余剰の銅膜及び拡散バリア膜17を選択的に研磨し、銅配線44aを形成する。

【0119】

銅は表面に不動体を作らないため、銅膜44a中への酸化が進行する恐れがある。このため、銅配線44aの酸化を防止するためのシリコン窒化膜12dを第一の絶縁膜12a上に形成する。

【0120】

さらに、第一の絶縁膜12a上に第二の絶縁膜12bを形成し、下層の銅配線

44aと接触するような配線溝及び孔を第二の絶縁膜12b中に形成する。次いで、その配線溝及び孔に拡散バリア膜17を形成し、さらに、銅膜44bで配線溝及び孔を埋め込むような製造過程を所望の回数だけ繰り返すことにより、図26に示すような銅多層配線構造を有する半導体装置を製作することができる。

【0121】

【第六の実施例】

第六の実施例においては、積層構造の拡散バリア膜と銅配線膜とを連続して形成するための装置及びその製造工程について述べる。

【0122】

図27は、本実施例に係る銅配線膜形成装置を上方から見たときの平面図である。

【0123】

銅配線膜形成装置は中心部にセパレーションチャンバー51を備えており、このセパレーションチャンバー51の内部には、搬送用ロボット52が保持されている。セパレーションチャンバー51の周囲には、さらに、2個のロードロックチャンバー45、基板加熱ガス出しチャンバー46、配線溝及び孔クリーニング用エッチングチャンバー47、積層構造の拡散バリア膜形成用のスパッタチャンバー48、銅配線成膜チャンバー49が付設されている。このような構成のクラスチャンバー50を用いることにより、半導体基板を大気に曝すことなく、銅配線金属を成膜することが可能である。

【0124】

銅配線金属膜の具体的な製造工程を以下に述べる。

まず、半導体基板をロードロックチャンバー45に導入する。半導体基板には絶縁膜が形成され、この絶縁膜には配線溝又は孔が形成されているものとする。次いで、ドライポンプ及びターボポンプを用いて、ロードロックチャンバー45を排気する。排気時間は約5分程度であり、排気後の真空度は $7 \times 10^{-3}$ 乃至 $8 \times 10^{-3}$  Paである。

【0125】

その後、ロードロックチャンバー45とセパレーションチャンバー51との間

のゲートバルブを開ける。この時、セパレーションチャンバー51は、クライオポンプ及びドライポンプ及びターボポンプによって、 $5 \times 10^{-5}$ 乃至 $1 \times 10^{-5}$  Pa程度の真空度に保たれており、半導体基板は、真空を破ることなく、搬送用ロボット52によってセパレーションチャンバー51の内部に搬送される。

## 【0126】

その後、先ず、半導体基板表面上の水分を飛ばし、アライニングを行うために、半導体基板を基板加熱ガス出しチャンバー46に搬送する。この時、基板加熱ガス出しチャンバー46は、ドライポンプ及びターボポンプによって、 $6 \times 10^{-5}$  Pa程度の真空度に保たれている。基板加熱ガス出しチャンバー46の内部において、半導体基板を $150^{\circ}\text{C}$ 乃至 $200^{\circ}\text{C}$ 程度に加熱し、半導体基板表面の水分を飛ばし、半導体基板の表面を清浄化する。

## 【0127】

次に、半導体基板を基板加熱ガス出しチャンバー46からセパレーションチャンバー51を経由してクリーニング用エッチングチャンバー47に搬送する。クリーニング用エッチングチャンバー47は、クライオポンプ、ターボポンプ及びドライポンプによって、 $5 \times 10^{-6}$  Pa程度の真空度に保たれている。

## 【0128】

半導体基板をクリーニング用エッチングチャンバー47の内部に搬入した後、アルゴン(Ar)ガスまたは水素希釈Arガス( $\text{H}_2/\text{Ar}=3\%$ )を用いて、半導体基板のプラズマエッチングを行うことにより、半導体基板の表面、配線溝の内部及び孔の内部を還元清浄化する。

## 【0129】

また、このプラズマエッチングには、孔及び配線溝の形状の角を削って、開口部を擬似的に広げ、埋め込み特性を向上させる効果もある。

## 【0130】

次に、搬送用ロボット52によって、半導体基板をクリーニング用エッチングチャンバー47からスパッタチャンバー48に搬送する。スパッタチャンバー48においては、第一の実施例で挙げた高圧RFマグネトロンスパッタ法によるスパッタが実施される。スパッタチャンバー48の内部は、ドライポンプ、クライ

オポンプ及びターボポンプによって、 $4 \times 10^{-6}$  Pa程度の真空度に保たれている。

【0131】

スパッタチャンバー48に導入された半導体基板は、第一及び第二の実施例において説明したようなRFパワーを瞬間的に切り替える方法によって、結晶性の窒素含有金属膜（結晶質の $\beta$ -Taと結晶質の $TaN_{0.1}$ とからなる混合膜）と非晶質の金属窒化膜（ $Ta_2N$ ）とを堆積させる。ここでは、ガス圧力10 Pa、基板温度200℃、 $N_2$ 分圧比=2%とし、パワーを2 kWから8 kWに切り替えることにより、図6に示したような特性の下で、良好な埋め込み性の下に積層構造の拡散バリア膜を得ることができる。

【0132】

最後に、半導体基板をスパッタチャンバー48から銅配線成膜チャンバー49に真空搬送する。真空搬送を行うため、拡散バリア膜の上層に位置する結晶性の窒素含有金属膜の表面は清浄に保たれる。この結晶性の窒素含有金属膜上に、化学気相堆積法（CVD法）により、配線溝及び孔を埋め込みながら銅を成膜する。銅配線成膜チャンバー49内はドライポンプ及びターボポンプにより $4 \times 10^{-4}$  Pa程度の真空度に排気されている。

【0133】

先ず、半導体基板の温度を170乃至200℃程度に維持し、 $Cu(hfac)tmvs$ （トリメチルビニルシリルヘキサフルオロアセチルアセトネート銅：trimethylvinylsilyl hexafluoroacetylacetonate copper (I)）を主とする原料1乃至2 g/分を液体輸送方式により気化器に導入する。気化器で気化された原料は窒素キャリアガスにより銅配線成膜チャンバー49内に導入され、その結果、銅配線成膜チャンバー49内の圧力は約1 kPa程度に保たれる。

【0134】

導入された原料ガスは半導体基板上で化学反応を起こし、銅膜となって半導体基板上に堆積される。ここでは、配線溝及び孔を十分に埋設するような膜厚、例えば、8000乃至15000 Å程度の膜厚になるように堆積する。

## 【0135】

特に、CVD法を用いて銅の成膜を行う場合、CVD原料であるトリメチルビニルシリルヘキサフルオロアセチルアセトネート銅 (*trimethylvinylsilyl hexafluoroacetylacetonate copper* ( $\text{Cu}(\text{hfac})\text{tmvs}$ )) の中に含まれているフッ素 (F) の拡散バリア膜の表面への偏析及び膜中への拡散並びに銅の拡散が密着性に大きな影響を及ぼす。

## 【0136】

図28及び図29にSIMS法 (*Secondary Ion Mass Spectroscopy*) により測定した拡散バリア膜中へのフッ素及び銅の拡散プロファイルをそれぞれ示す。

## 【0137】

Ar 雰囲気のスパッタにより得られる  $\beta$ -Ta では、フッ素が銅と Ta との界面に偏析するため、密着性は悪くなる。一方、 $\text{Ta}_2\text{N}$  では、フッ素が膜中に拡散するものの、銅をほとんど膜中に拡散させないため、原子間の結びつきが悪く、密着性は悪くなる。 $\text{TaN}_{0.1}$  では、銅及びフッ素を膜中に拡散させるため、原子間の結びつきが向上し、密着性が良好となる。

## 【0138】

すなわち、CVD法によって銅を堆積する場合には、結晶質  $\text{TaN}_{0.1}$  / 非晶質  $\text{Ta}_2\text{N}$  の積層バリア構造が密着性及び拡散バリア性を極めて向上させるものであることがわかる。

## 【0139】

以上のような過程を経ることにより、銅配線形成時に、半導体基板を大気に曝すことなく、銅配線膜を成膜できることから、拡散バリア膜の表面を清浄な状態に保つことが可能となり、CVD法で作製される銅の膜質が拡散バリア膜の表面の Ta 膜の結晶構造に反映しやすくなるため、銅の結晶配向性及び拡散バリア膜との密着性を向上させることが可能である。

## 【0140】

## 【第七の実施例】

本実施例においては、図 27 に示したクラスタチャンバー 50 の銅配線成膜部（銅配線成膜チャンバー 49 に対応する領域）にスパッタチャンバー 48 が取り付けられている。拡散バリア膜の表面には、結晶性の  $\beta$ -Ta を含んだ  $TaNO_1$  が存在するため、スパッタ法により成膜された銅膜との密着性は、CVD 法により成膜された銅膜との密着性と同様に、保持される。

【0141】

## 【第八の実施例】

本実施例においては、先ず、図 27 に示したクラスタチャンバー 50 から半導体基板を取り出す。この半導体基板は図 30 に示すような構造を有している。すなわち、第二の絶縁膜 12b に形成されている配線溝及び孔の表面には拡散バリア膜 17 が形成され、拡散バリア膜 17 上には銅下地膜 53 が形成されている。

【0142】

この半導体基板に対して、メッキ法により、銅膜 54 を配線溝及び孔が埋め込まれるように成膜する。この結果、図 31 に示すように、積層バリア構造 17、CVD 法またはスパッタ法により形成された銅下地膜 53、メッキ法により形成された埋め込み銅構造 54 を作製することが可能となる。この後、例えば、図 4 に示したように、銅膜 54、銅下地膜 53、拡散バリア膜 17 を CMP 法により選択的に除去することにより、銅配線構造を得ることができる。

【0143】

## 【発明の効果】

本発明により、以下のような効果を得ることができる。

第 1 の効果は、銅に対する拡散バリア性及び密着性を兼ね備えた拡散バリア膜を得ることが可能になることである。これは、拡散バリア膜を、銅の拡散バリア性能の高い非晶質の金属窒化膜と密着性の高い結晶化した窒素含有金属膜とからなる積層構造として構成するためである。

【0144】

第 2 の効果は、拡散バリア膜を同一チャンバーで連続的に成膜することが可能であることである。このため、装置コスト及び時間的コストを低減することが可能となる。



【0145】

この理由は、スパッタ時にチャンバー内に導入するガスの窒素比を固定した状態で、スパッタパワーのみを瞬間的に変化させることにより、連続的に非晶質の金属窒化膜と結晶質の窒素含有金属膜とを成膜することが可能であるためである。この方法の場合、上層の金属膜には必然的に窒素が含有されることとなる。

【0146】

第3の効果は、例えば、半導体基板を真空搬送する装置を用いることにより、拡散バリア膜の表面を清浄に保った状態で銅膜を成長させることが可能になり、銅配線の信頼性を向上させることができる。

【図面の簡単な説明】

【図1】

本発明の第一の実施の形態に係る拡散バリア膜の製造方法における第一の工程を示す断面図である。

【図2】

本発明の第一の実施の形態に係る拡散バリア膜の製造方法における第二の工程を示す断面図である。

【図3】

本発明の第一の実施の形態に係る拡散バリア膜の製造方法における第三の工程を示す断面図である。

【図4】

本発明の第一の実施の形態に係る拡散バリア膜の製造方法における第四の工程を示す断面図である。

【図5】

第一の実施例における高圧RFマグネトロンスパッタ装置の構成を示す概略図である。

【図6】

高圧RFマグネトロンスパッタ方式におけるTa膜の埋め込み特性を示すグラフである。

【図7】

高圧RFマグネトロンスパッタ方式においてTa膜の埋め込み特性が向上する理由を説明するための断面図である。

【図8】

高圧RFマグネトロンスパッタ方式においてTa膜の埋め込み特性が向上する理由を説明するための断面図である。

【図9】

高圧RFマグネトロンスパッタ方式において、チャンバーに導入する窒素ガスの比率を変化させた場合のRFパワーとスパッタ成長膜の比抵抗の変化との間の関係を示すグラフである。

【図10】

高圧RFマグネトロンスパッタ方式におけるTa<sub>2</sub>N<sub>5</sub>及びTa膜の成膜膜質特性を示すグラフである。

【図11】

高圧RFマグネトロンスパッタ方式におけるTa<sub>2</sub>N<sub>5</sub>及びTa膜の成膜膜質特性を示すグラフである。

【図12】

高圧RFマグネトロンスパッタ方式におけるTa<sub>2</sub>N<sub>5</sub>及びTa膜の成膜膜質特性を示すグラフである。

【図13】

高圧RFマグネトロンスパッタ方式におけるTa<sub>2</sub>N<sub>5</sub>及びTa膜の成膜膜質特性を示すグラフである。

【図14】

高圧RFマグネトロンスパッタ方式におけるTa<sub>2</sub>N<sub>5</sub>及びTa膜の成膜膜質特性を示すグラフである。

【図15】

高圧RFマグネトロンスパッタ方式におけるTa<sub>2</sub>N<sub>5</sub>及びTa膜の成膜膜質特性を示すグラフである。

【図16】

高圧RFマグネトロンスパッタ方式におけるTa<sub>2</sub>N<sub>5</sub>及びTa膜の成膜膜質特性

を示すグラフである。

【図17】

高圧RFマグネトロンスパッタ方式におけるTa<sub>2</sub>N及びTa膜の成膜膜質特性を示すグラフである。

【図18】

高圧RFマグネトロンスパッタ方式におけるTa<sub>2</sub>N及びTa膜の成膜膜質特性を示すグラフである。

【図19】

高圧RFマグネトロンスパッタ方式における成長膜の断面走査型電子顕微鏡写真である。

【図20】

高圧RFマグネトロンスパッタ方式における成長膜の断面走査型電子顕微鏡写真である。

【図21】

高圧RFマグネトロンスパッタ方式により形成された結晶性窒素固溶Ta膜及びアモルファス金属Ta<sub>2</sub>N膜とからなる拡散バリア膜の断面図である。

【図22】

高圧RFマグネトロンスパッタ方式により形成された拡散バリア膜の断面走査型電子顕微鏡写真である。

【図23】

配線溝または孔に埋め込まれた拡散バリア膜の断面図である。

【図24】

第四の実施例におけるDCマグネトロンスパッタ装置の概略図である。

【図25】

下層配線及びビア孔を有する構造上に形成された配線溝及び孔を示した断面図である。

【図26】

複数の下層配線及びビア孔を有する構造上に形成された配線溝及び孔を示した断面図である。

【図 27】

銅配線形成用クラスタ装置の平面図である。

【図 28】

拡散バリア膜中へのフッ素の拡散プロファイルを示すグラフである。

【図 29】

拡散バリア膜中への銅の拡散プロファイルを示すグラフである。

【図 30】

第七の実施例における銅配線構造の断面図である。

【図 31】

第七の実施例における銅配線構造の断面図である。

【図 32】

従来の銅配線構造の断面図である。

【図 33】

従来の銅配線構造の断面図である。

【図 34】

従来の銅配線構造の断面図である。

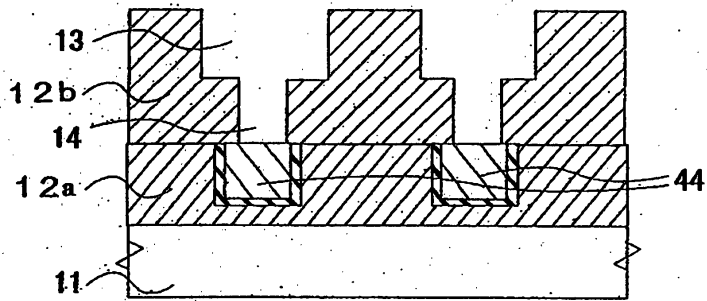
【符号の説明】

- 1 1 半導体基板
- 1 2 a 第一の絶縁膜
- 1 2 b 第二の絶縁膜
- 1 3 配線溝
- 1 4 孔
- 1 5 非晶質の金属窒化膜
- 1 6 結晶質の窒素含有金属膜
- 1 7 拡散バリア膜
- 1 8 銅膜
- 2 1 チャンバー
- 2 2 半導体基板
- 2 3 カソード

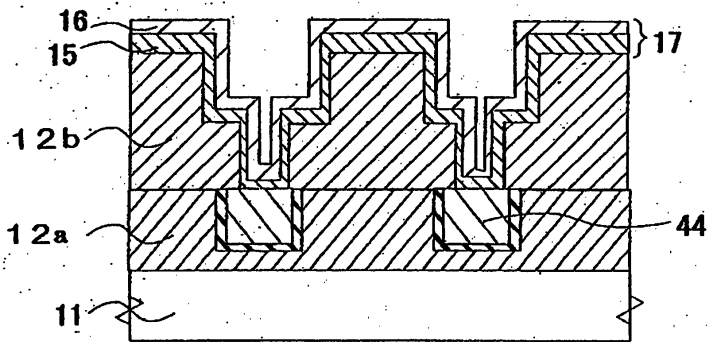
- 24 マグネット
- 25 RF電源
- 26 Arプラズマ
- 27 ターゲットホルダ
- 28 ターゲット金属
- 29 絶縁体
- 30 磁場
- 31 マスフローコントローラ
- 32 整合器
- 33 排気ポンプ
- 34 基板加熱ヒータ
- 41 DC電源
- 42 マグネット
- 44 銅配線
- 45 ロードロックチャンバー
- 46 基板加熱ガス出しチャンバー
- 47 クリーニング用エッチングチャンバー
- 48 スパッタチャンバー
- 49 銅配線成膜チャンバー
- 50 クラスタチャンバー
- 51 セパレーションチャンバー
- 52 搬送用ロボット

【書類名】 図面

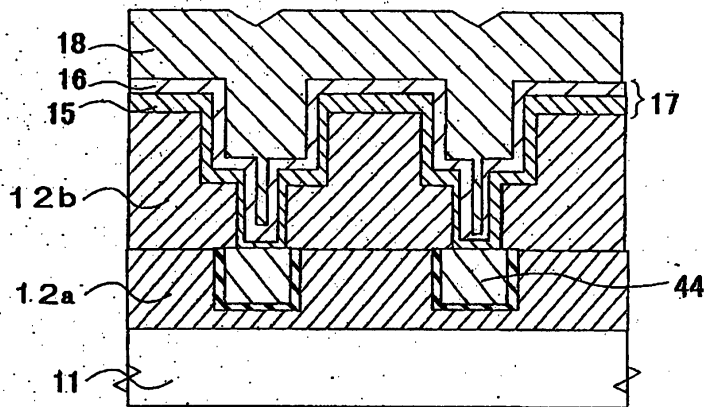
【図1】



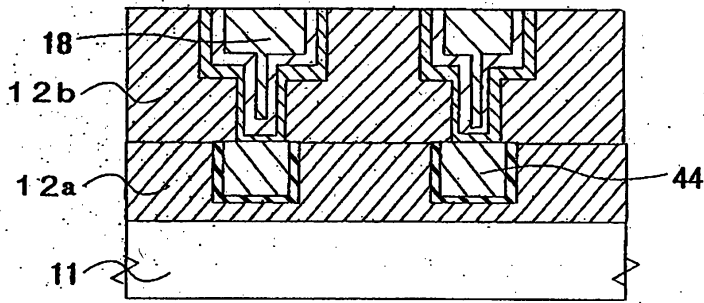
【図2】



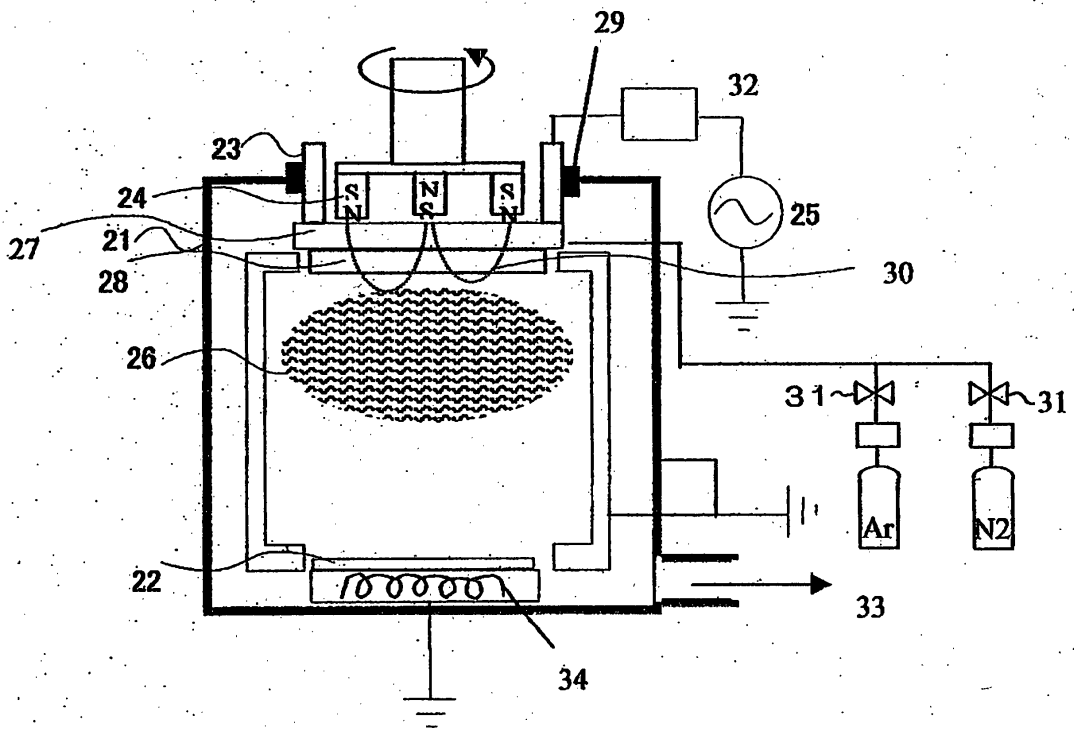
【図3】



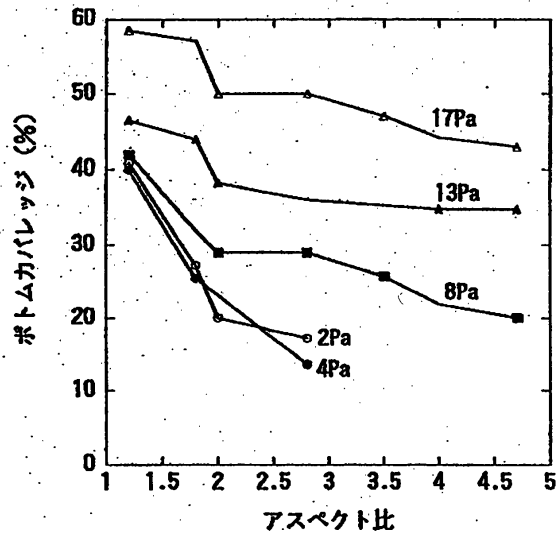
【图 4】



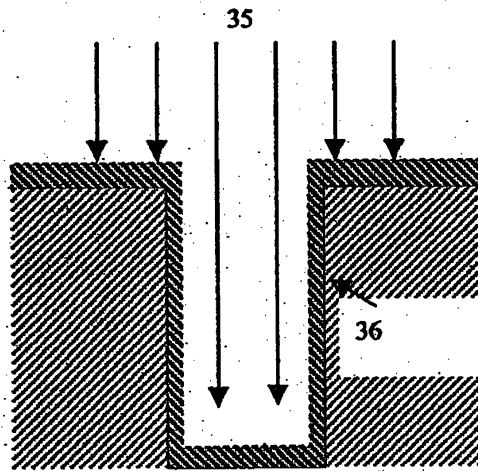
【图 5】



【図6】

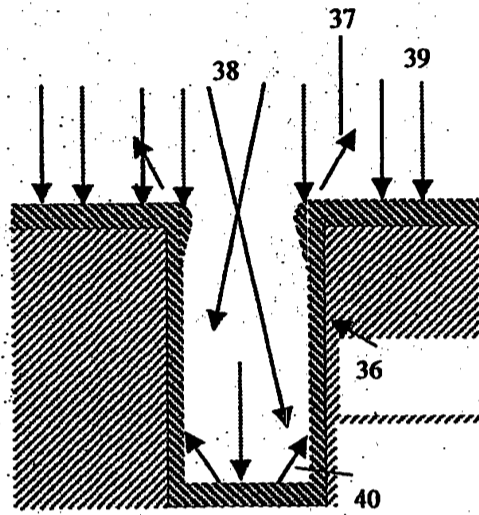


【図7】

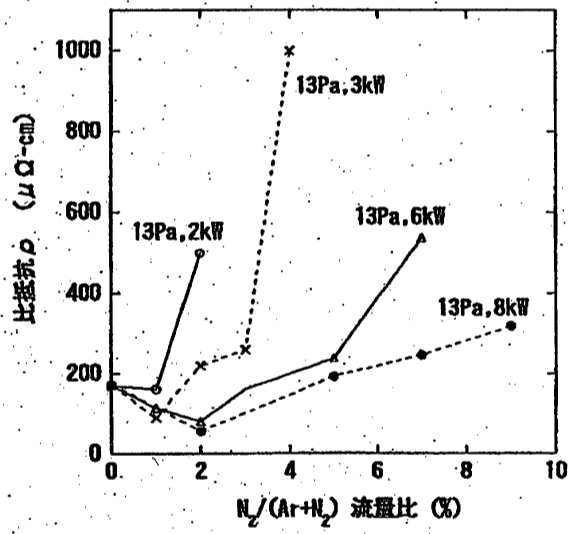




【图 8】

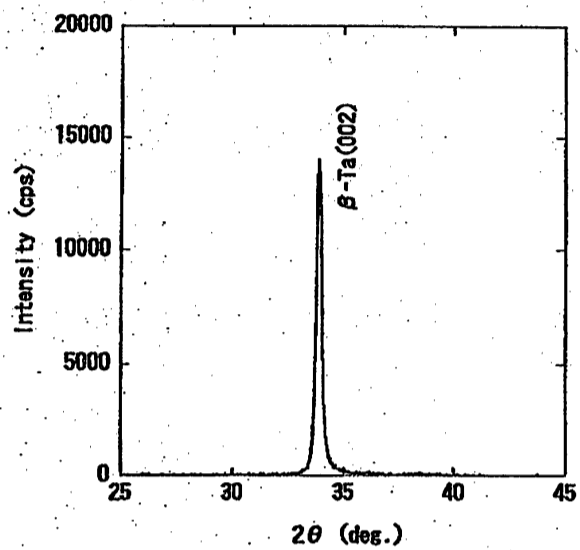


【图 9】

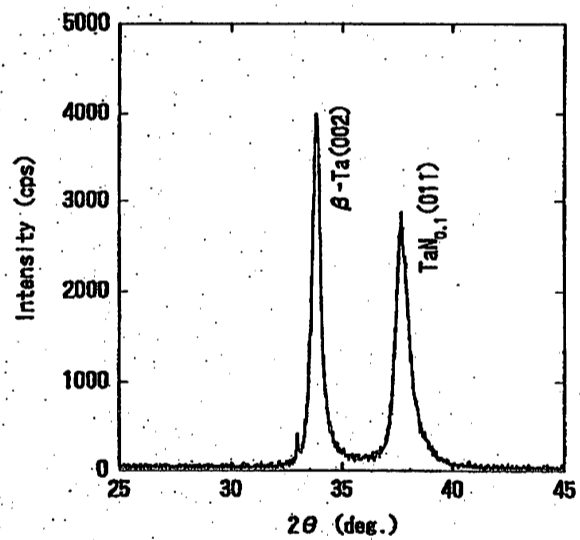


特平11-214110

【図10】

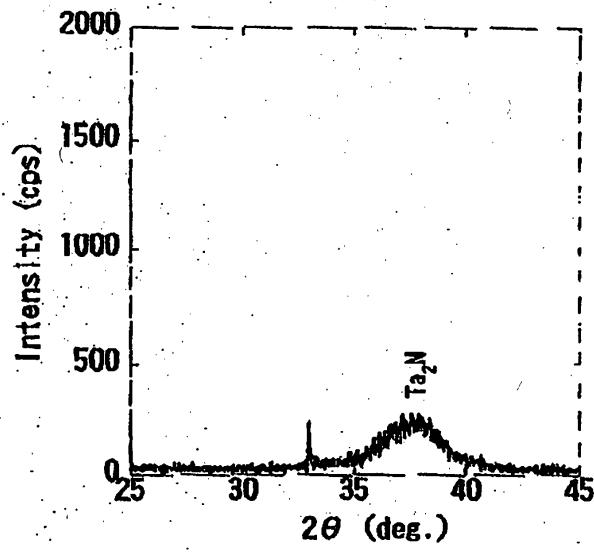


【図11】

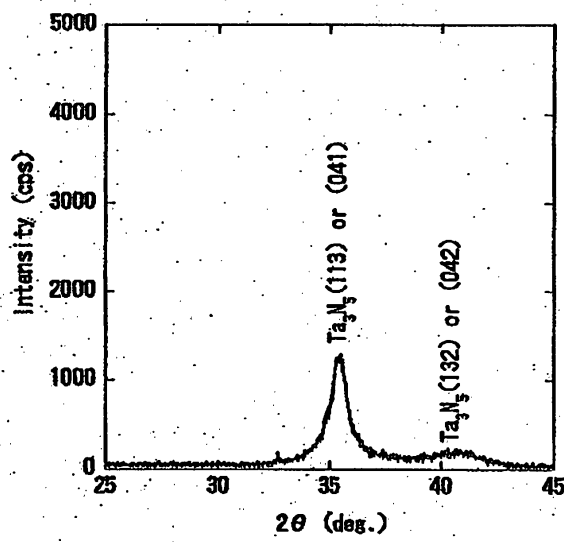


特平 11-214110

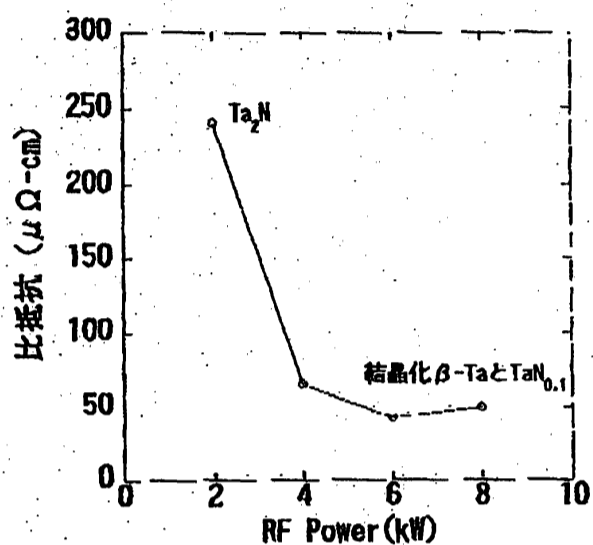
【図 1 2】



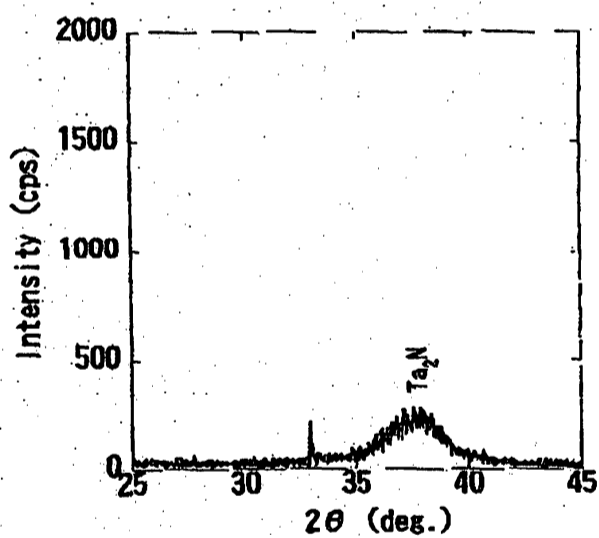
【図 1 3】



【图14】

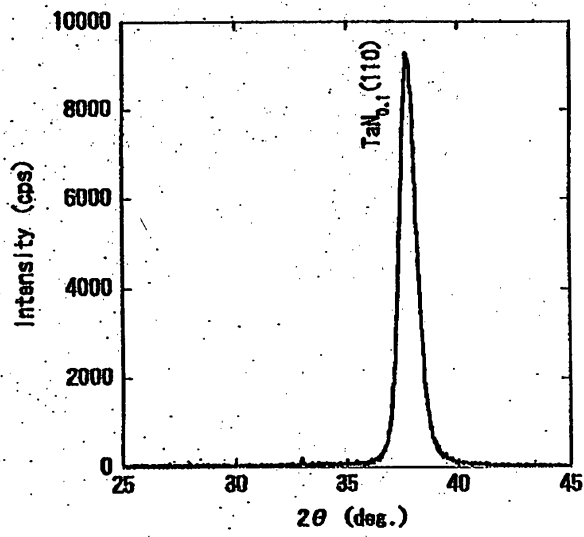


【图15】

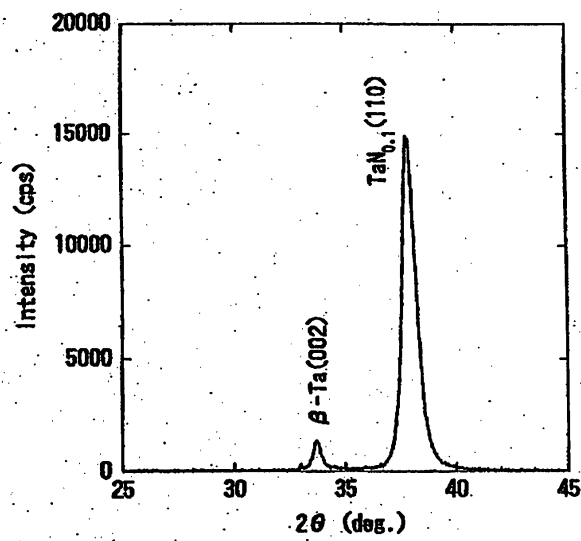


特平 11-214110

【図 16】

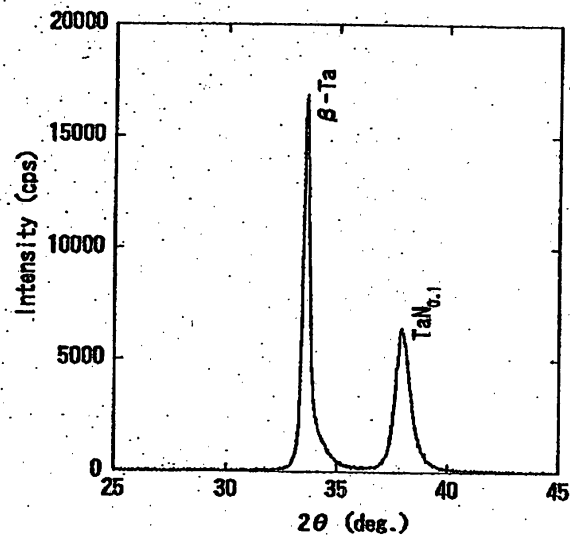


【図 17】



特平 11-214110

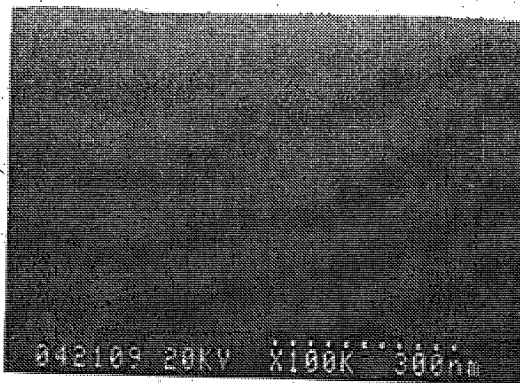
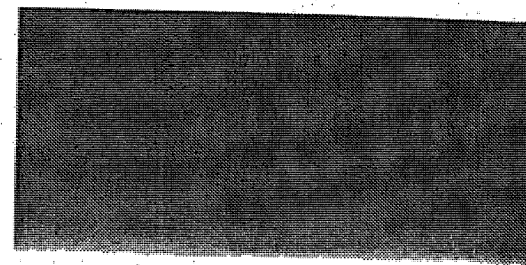
【図 18】



【図 19】

図面代用写真

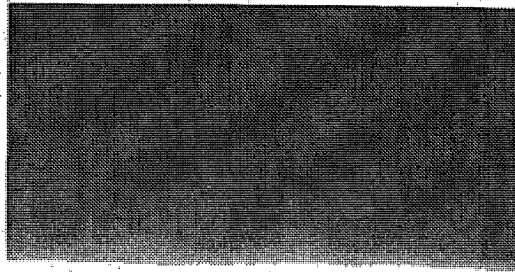
15 ~



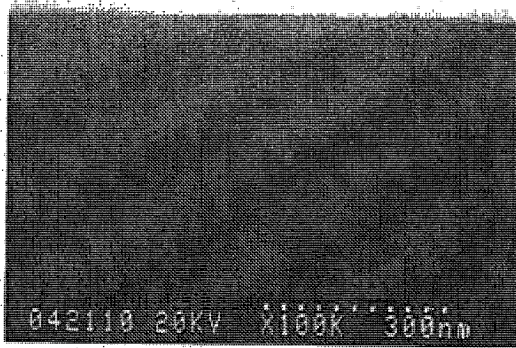
特平 11-214110

【图 20】

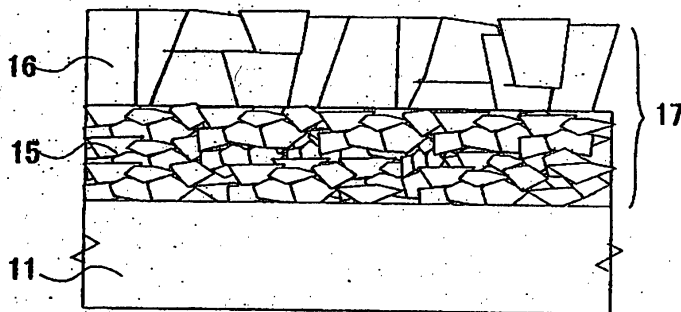
図面代用写真



16a



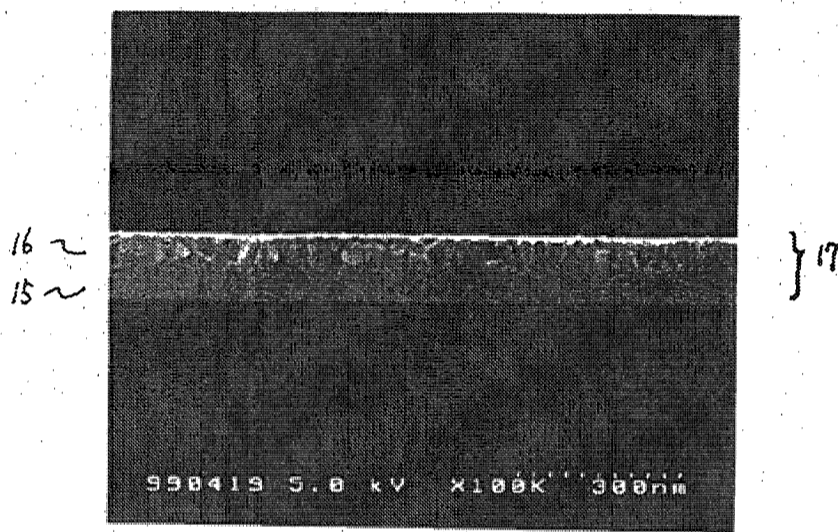
【图 21】



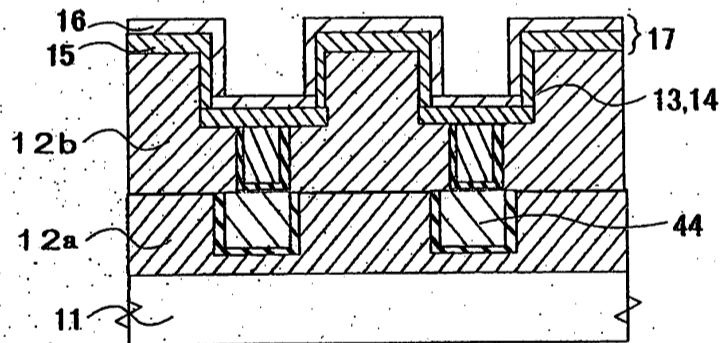
特平 11-214110

【図 22】

図面代用写真

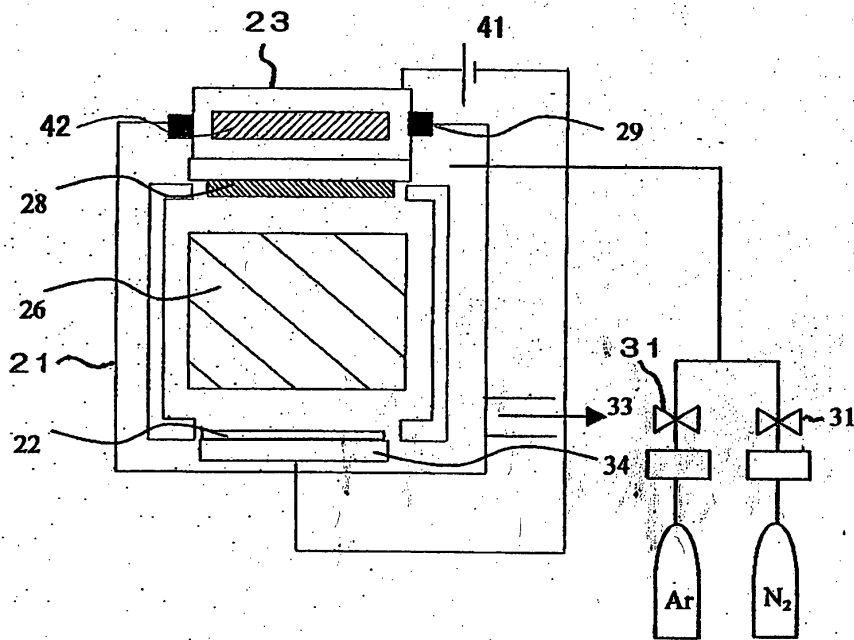


【図 23】

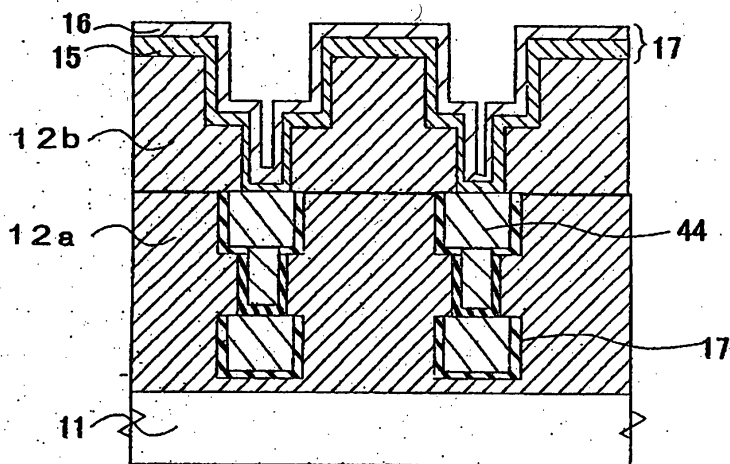




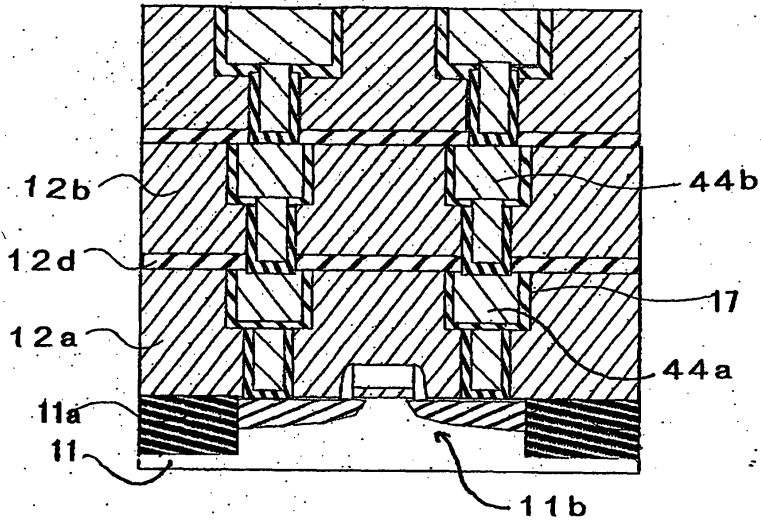
【図 24】



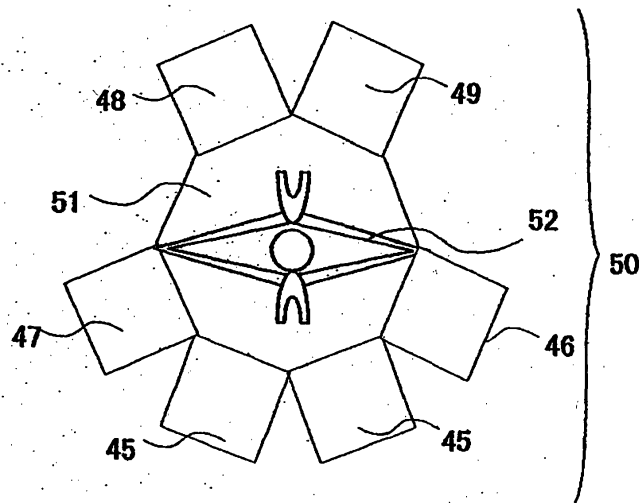
【図 25】



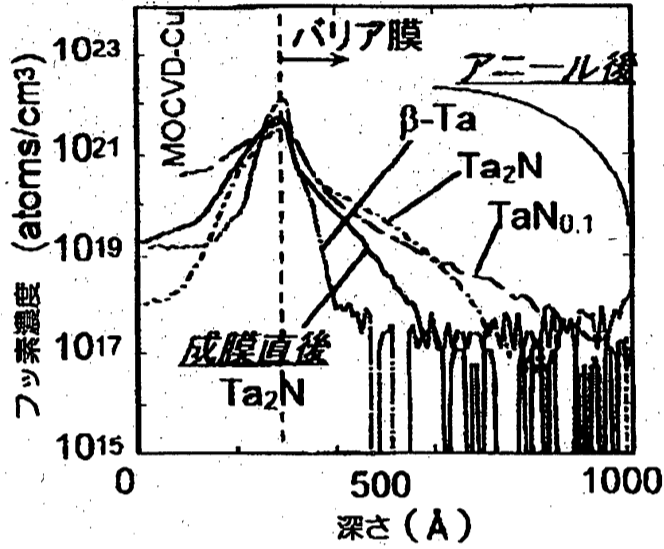
【図 26】



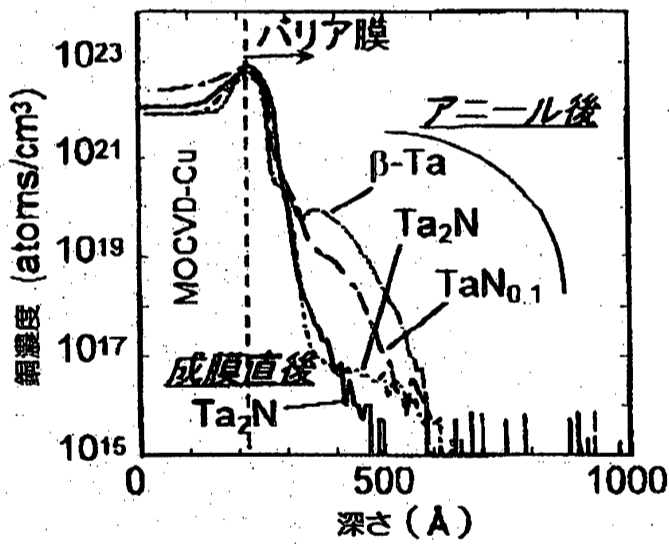
【図 27】



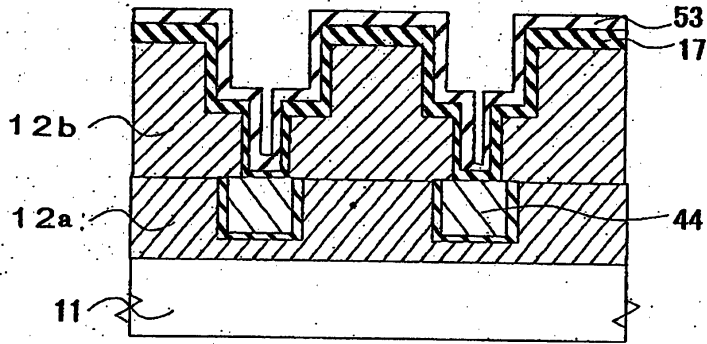
【図28】



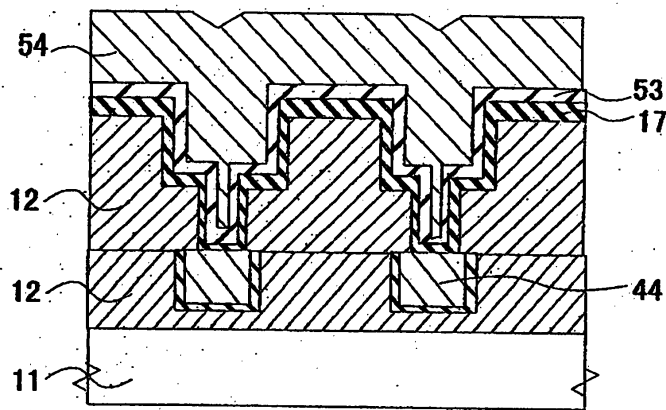
【図29】



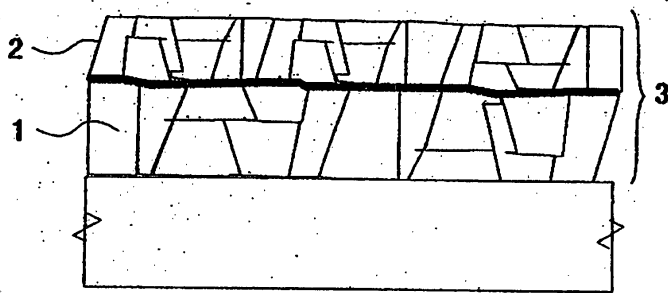
【図30】



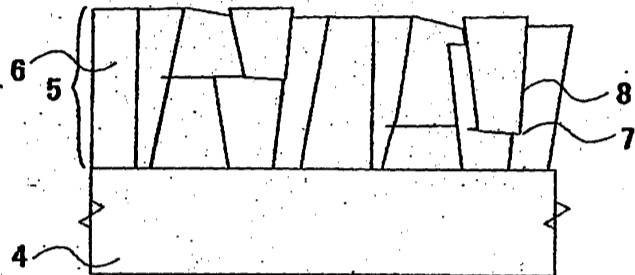
【図31】



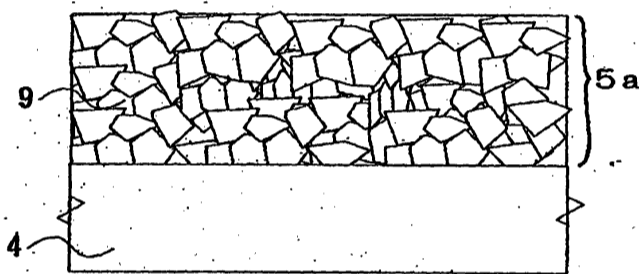
【図32】



【図33】



【図34】



特平 11-214110

【書類名】 要約書

【要約】

【課題】銅の拡散を防止するためのバリア膜は、バリア性と共に銅との密着性も要求されるが、これまでの金属及び金属窒化膜バリア膜ではバリア性と密着性を両立したものを得ることは難しかった。

【解決手段】バリア性に優れた非晶質金属窒化膜 15 と密着性に優れた結晶性金属膜 16 とを積層構造とすることにより、密着性とバリア性を両立した積層バリア膜 17 が得られる。例えば、半導体基板 11 上の絶縁膜 12 b に形成された配線溝または孔に埋め込み積層バリア膜 17 を成膜し、拡散バリア膜 17 上に銅膜 18 を形成することにより、良好な密着性と拡散がない銅配線を得ることが可能となる。

【選択図】 図 3

特平11-214110

出願人履歴情報

識別番号 [000004237]

1. 変更年月日 1990年 8月29日  
[変更理由] 新規登録  
住 所 東京都港区芝五丁目7番1号  
氏 名 日本電気株式会社



**UNITED STATES DEPARTMENT OF COMMERCE  
United States Patent and Trademark Office**

Address: COMMISSIONER OF PATENTS AND TRADEMARKS  
Washington, D.C. 20231

*Handwritten initials and scribbles*

APPLICATION NO.	FILING DATE	FIRST NAMED INVENTOR	ATTORNEY DOCKET NO.
-----------------	-------------	----------------------	---------------------

09/596,415	06/19/00	TAGAMI	M 13715
------------	----------	--------	---------

EXAMINER

MM21/0605

PAUL J ESATTO JR  
SCULLY SCOTT MURPHY & PRESSER  
400 GARDEN CITY PLAZA  
GARDEN CITY NY 11530

ART UNIT	PAPER NUMBER
----------	--------------

VII, H

2811

DATE MAILED: 06/05/01

Please find below and/or attached an Office communication concerning this application or proceeding.

Commissioner of Patents and Trademarks



<b>Office Action Summary</b>	<b>Application No.</b> 09/596,415	<b>Applicant(s)</b> TAGAMI ET AL.	
	<b>Examiner</b> Hung K. Vu	<b>Art Unit</b> 2811	

**-- The MAILING DATE of this communication appears on the cover sheet with the correspondence address --**

**Period for Reply**

A SHORTENED STATUTORY PERIOD FOR REPLY IS SET TO EXPIRE 1 MONTH(S) FROM THE MAILING DATE OF THIS COMMUNICATION.

- Extensions of time may be available under the provisions of 37 CFR 1.136 (a). In no event, however, may a reply be timely filed after SIX (6) MONTHS from the mailing date of this communication.
- If the period for reply specified above is less than thirty (30) days, a reply within the statutory minimum of thirty (30) days will be considered timely.
- If NO period for reply is specified above, the maximum statutory period will apply and will expire SIX (6) MONTHS from the mailing date of this communication.
- Failure to reply within the set or extended period for reply will, by statute, cause the application to become ABANDONED (35 U.S.C. § 133).
- Any reply received by the Office later than three months after the mailing date of this communication, even if timely filed, may reduce any earned patent term adjustment. See 37 CFR 1.704(b).

**Status**

1)  Responsive to communication(s) filed on 19 June 2000.

2a)  This action is FINAL.                      2b)  This action is non-final.

3)  Since this application is in condition for allowance except for formal matters, prosecution as to the merits is closed in accordance with the practice under *Ex parte Quayle*, 1935 C.D. 11, 453 O.G. 213.

**Disposition of Claims**

4)  Claim(s) 1-36 is/are pending in the application.

    4a) Of the above claim(s) \_\_\_\_\_ is/are withdrawn from consideration.

5)  Claim(s) \_\_\_\_\_ is/are allowed.

6)  Claim(s) \_\_\_\_\_ is/are rejected.

7)  Claim(s) \_\_\_\_\_ is/are objected to.

8)  Claims 1-36 are subject to restriction and/or election requirement.

**Application Papers**

9)  The specification is objected to by the Examiner.

10)  The drawing(s) filed on \_\_\_\_\_ is/are objected to by the Examiner.

11)  The proposed drawing correction filed on \_\_\_\_\_ is: a)  approved b)  disapproved.

12)  The oath or declaration is objected to by the Examiner.

**Priority under 35 U.S.C. § 119**

13)  Acknowledgment is made of a claim for foreign priority under 35 U.S.C. § 119(a)-(d) or (f).

    a)  All    b)  Some \*    c)  None of:

        1.  Certified copies of the priority documents have been received.

        2.  Certified copies of the priority documents have been received in Application No. \_\_\_\_\_.

        3.  Copies of the certified copies of the priority documents have been received in this National Stage application from the International Bureau (PCT Rule 17.2(a)).

    \* See the attached detailed Office action for a list of the certified copies not received.

14)  Acknowledgement is made of a claim for domestic priority under 35 U.S.C. § 119(e).

**Attachment(s)**

15) <input type="checkbox"/> Notice of References Cited (PTO-892)	18) <input type="checkbox"/> Interview Summary (PTO-413) Paper No(s) _____
16) <input type="checkbox"/> Notice of Draftsperson's Patent Drawing Review (PTO-948)	19) <input type="checkbox"/> Notice of Informal Patent Application (PTO-152)
17) <input type="checkbox"/> Information Disclosure Statement(s) (PTO-1449) Paper No(s) _____	20) <input type="checkbox"/> Other:

**DETAILED ACTION**

*Election/Restrictions*

Restriction to one of the following inventions is required under 35 U.S.C. 121:

- I. Claims 1-10, drawn to a semiconductor device, classified in class 257, subclass 758.
- II. Claims 11-36, drawn to a method of making a semiconductor device, classified in class 438, subclass 22+.

The inventions are distinct, each from the other because of the following reasons:

Inventions II and I are related as process of making and product made. The inventions are distinct if either or both of the following can be shown: (1) that the process as claimed can be used to make other and materially different product or (2) that the product as claimed can be made by another and materially different process (MPEP § 806.05(f)). In the instant case unpatentability of the Group I invention would not necessarily imply unpatentability of the Group II invention, since the device of the Group I invention could be made by processes materially different from those of the Group II invention, for example, forming a diffusion barrier film by CVD method or PVD method instead of sputtering method.

Because these inventions are distinct for the reasons given above and have acquired a separate status in the art as shown by their different classification, restriction for examination purposes as indicated is proper.

Application/Control Number: 09/596,415  
Art Unit: 2811

Page 3

Applicant is advised that the reply to this requirement to be complete must include an election of the invention to be examined even though the requirement be traversed (37 CFR 1.143).

Applicant is reminded that upon the cancellation of claims to a non-elected invention, the inventorship must be amended in compliance with 37 CFR 1.48(b) if one or more of the currently named inventors is no longer an inventor of at least one claim remaining in the application. Any amendment of inventorship must be accompanied by a petition under 37 CFR 1.48(b) and by the fee required under 37 CFR 1.17(i).

Any inquiry concerning this communication or earlier communications from the examiner should be directed to Hung K. Vu whose telephone number is (703) 308-4079. The examiner can normally be reached on Mon-Thurs 7:00-5:30, Eastern Time.

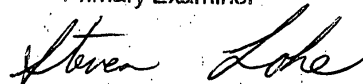
If attempts to reach the examiner by telephone are unsuccessful, the examiner's supervisor, Tom Thomas can be reached on (703) 308-2772. The fax phone numbers for the organization where this application or proceeding is assigned are (703) 308-7722 for regular communications and (703) 308-7722 for After Final communications.

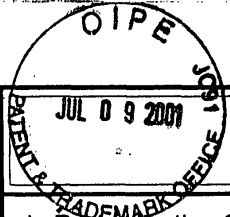
Any inquiry of a general nature or relating to the status of this application or proceeding should be directed to the receptionist whose telephone number is (703) 308-0956.

Vu

May 26, 2001

Steven Loke  
Primary Examiner





GP 281

<b>TRANSMITTAL LETTER (General - Patent Pending)</b>	Docket No. 13715
--	---------------------

In Re Application Of: **Masayoshi Tagami, et al.**

Serial No. 09/596,415	Filing Date June 19, 2000	Examiner Hung K. Vu	Group Art Unit 2811
--------------------------	------------------------------	------------------------	------------------------

Title: **MULTI-LAYERED WIRING LAYER AND METHOD OF FABRICATING THE SAME**

TO THE ASSISTANT COMMISSIONER FOR PATENTS:

Transmitted herewith is:

**RESPONSE TO REQUIREMENT FOR RESTRICTION**

in the above identified application.

- No additional fee is required.
- A check in the amount of \_\_\_\_\_ is attached.
- The Assistant Commissioner is hereby authorized to charge and credit Deposit Account No. **19-1013SSMP** as described below. A duplicate copy of this sheet is enclosed.
  - Charge the amount of \_\_\_\_\_
  - Credit any overpayment.
  - Charge any additional fee required.

RECEIVED  
JUL 11 2001  
TC 2800 MAIL ROOM

*Signature*

**Paul J. Esatto, Jr., Reg. No. 30,749  
Scully, Scott, Murphy & Presser  
400 Garden City Plaza  
Garden City, New York 11530  
(516) 742-4343**

Dated: **July 5, 2001**

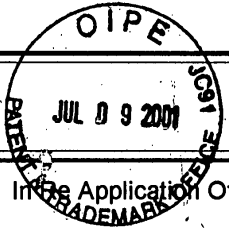
I certify that this document and fee is being deposited on 7/5/01 with the U.S. Postal Service as first class mail under 37 C.F.R. 1.8 and is addressed to the Assistant Commissioner for Patents, Washington, D.C. 20231.

*Janet Grossman*  
*Signature of Person Mailing Correspondence*

**Janet Grossman**

*Typed or Printed Name of Person Mailing Correspondence*

CC:



**TRANSMITTAL LETTER  
(General - Patent Pending)**

Docket No.  
13715

In Re Application Of: **Masayoshi Tagami, et al.**

Serial No.  
09/596,415

Filing Date  
June 19, 2000

Examiner  
Hung K. Vu

Group Art Unit  
2811

Title: **MULTI-LAYERED WIRING LAYER AND METHOD OF FABRICATING THE SAME**

TO THE ASSISTANT COMMISSIONER FOR PATENTS:

Transmitted herewith is:

**RESPONSE TO REQUIREMENT FOR RESTRICTION**

in the above identified application.

- No additional fee is required.
- A check in the amount of \_\_\_\_\_ is attached.
- The Assistant Commissioner is hereby authorized to charge and credit Deposit Account No. **19-1013SSMP** as described below. A duplicate copy of this sheet is enclosed.
  - Charge the amount of \_\_\_\_\_
  - Credit any overpayment.
  - Charge any additional fee required.

RECEIVED  
JUL 11 2001  
TC 2800 MAIL ROOM

*Signature*

Dated: **July 5, 2001**

**Paul J. Esatto, Jr., Reg. No. 30,749  
Scully, Scott, Murphy & Presser  
400 Garden City Plaza  
Garden City, New York 11530  
(516) 742-4343**

I certify that this document and fee is being deposited on 7/5/01 with the U.S. Postal Service as first class mail under 37 C.F.R. 1.8 and is addressed to the Assistant Commissioner for Patents, Washington, D.C. 20231.

*Signature of Person Mailing Correspondence*

**Janet Grossman**

*Typed or Printed Name of Person Mailing Correspondence*

CC:



PATENT

#5/ELE  
7/14/01  
Sunder

IN THE UNITED STATES PATENT AND TRADEMARK OFFICE

**Applicants:** Masayoshi Tagami, et al.      **Examiner:** Hung K. Vu  
**Serial No.:** 09/596,415      **Group Art Unit:** 2811  
**Filed:** June 19, 2000      **Docket:** 13715  
**For:** MULTI-LAYERED WIRING LAYER      **Dated:** July 5, 2001  
AND METHOD OF FABRICATING THE SAME

Assistant Commissioner for Patents  
Washington, DC 20231

RESPONSE TO REQUIREMENT FOR RESTRICTION

Sir:

Pursuant to the Restriction Requirement imposed in the Official Action dated June 5, 2001, Applicant provisionally elects the claims of Group I, i.e., Claims 1-10 for continued prosecution herein.

Claims 1-36 are present in the above-captioned application and have been subjected to restriction under 35 U.S.C. §121. Specifically, the Official Action avers that the following inventions are present in the claims:

RECEIVED  
JUL 11 2001  
DC 200 MAIL ROOM

CERTIFICATE OF MAILING UNDER 37 C.F.R. § 1.8(a)

I hereby certify that this correspondence is being deposited with the United States Postal Service as first class mail in an envelope addressed to: Assistant Commissioner for Patents, Washington, DC 20231 on July 5, 2001.

Dated: July 5, 2001

Janet Grossman  
Janet Grossman

G:\NEC\1210\13715\amend\13715.am1

Group I, Claims 1-10 drawn to a semiconductor device, classified in class 257, subclass 758, and


Group II, Claims 11-36, drawn to a method of making a semiconductor device, classified in class 438, subclass 22+.

It is the Examiner's position that the inventions listed as Groups I and II are distinct from each other.

In response to the Examiner's requirement for restriction, Applicant provisionally elects to prosecute the subject matter of Group I, Claims 1-10. However, Applicant reserves the right under 35 U.S.C. § 121 to file one or more divisional applications directed to the non-elected claims in this application.

In view of the foregoing, an examination on the merits of the elected claims, at an early date, is earnestly solicited.

Respectfully submitted,

  
Paul J. Esatto, Jr.  
Registration No. 30,749

SCULLY, SCOTT, MURPHY & PRESSER  
400 Garden City Plaza  
Garden City, New York 11530  
(516) 742-4343

PJE:ae

G:\NEC\1210\13715\amend\13715.am1



**UNITED STATES DEPARTMENT OF COMMERCE  
Patent and Trademark Office**

Address: COMMISSIONER OF PATENTS AND TRADEMARKS  
Washington, D.C. 20231

*RC*

APPLICATION NO. 09/596,415	FILING DATE 06/19/00	FIRST NAMED INVENTOR TAGAMI	M	ATTORNEY DOCKET NO. 13715
-------------------------------	-------------------------	--------------------------------	---	------------------------------

*an*

MMC2/0925

PAUL J ESATTO JR.  
SCULLY SCOTT MURPHY & PRESSER  
400 GARDEN CITY PLAZA  
GARDEN CITY NY 11530

EXAMINER  
VJ,H

ART UNIT 2811	PAPER NUMBER
------------------	--------------

DATE MAILED: 09/25/01

Please find below and/or attached an Office communication concerning this application or proceeding.

Commissioner of Patents and Trademarks



<b>Office Action Summary</b>	<b>Application No.</b> 09/596,415	<b>Applicant(s)</b> TAGAMI ET AL.	
	<b>Examiner</b> Hung K. Vu	<b>Art Unit</b> 2811	

**-- The MAILING DATE of this communication appears on the cover sheet with the correspondence address --**

**Period for Reply**

A SHORTENED STATUTORY PERIOD FOR REPLY IS SET TO EXPIRE 3 MONTH(S) FROM THE MAILING DATE OF THIS COMMUNICATION.

- Extensions of time may be available under the provisions of 37 CFR 1.136(a). In no event, however, may a reply be timely filed after SIX (6) MONTHS from the mailing date of this communication.
- If the period for reply specified above is less than thirty (30) days, a reply within the statutory minimum of thirty (30) days will be considered timely.
- If NO period for reply is specified above, the maximum statutory period will apply and will expire SIX (6) MONTHS from the mailing date of this communication.
- Failure to reply within the set or extended period for reply will, by statute, cause the application to become ABANDONED (35 U.S.C. § 133).
- Any reply received by the Office later than three months after the mailing date of this communication, even if timely filed, may reduce any earned patent term adjustment. See 37 CFR 1.704(b).

**Status**

1)  Responsive to communication(s) filed on 09 July 2001.

2a)  This action is FINAL.                      2b)  This action is non-final.

3)  Since this application is in condition for allowance except for formal matters, prosecution as to the merits is closed in accordance with the practice under *Ex parte Quayle*, 1935 C.D. 11, 453 O.G. 213.

**Disposition of Claims**

4)  Claim(s) 1-36 is/are pending in the application.

4a) Of the above claim(s) 11-36 is/are withdrawn from consideration.

5)  Claim(s) \_\_\_\_\_ is/are allowed.

6)  Claim(s) 1-10 is/are rejected.

7)  Claim(s) \_\_\_\_\_ is/are objected to.

8)  Claim(s) \_\_\_\_\_ are subject to restriction and/or election requirement.

**Application Papers**

9)  The specification is objected to by the Examiner.

10)  The drawing(s) filed on \_\_\_\_\_ is/are: a)  accepted or b)  objected to by the Examiner.  
Applicant may not request that any objection to the drawing(s) be held in abeyance. See 37 CFR 1.85(a).

11)  The proposed drawing correction filed on \_\_\_\_\_ is: a)  approved b)  disapproved by the Examiner.  
If approved, corrected drawings are required in reply to this Office action.

12)  The oath or declaration is objected to by the Examiner.

**Priority under 35 U.S.C. §§ 119 and 120**

13)  Acknowledgment is made of a claim for foreign priority under 35 U.S.C. § 119(a)-(d) or (f).

a)  All   b)  Some \*   c)  None of:

1.  Certified copies of the priority documents have been received.

2.  Certified copies of the priority documents have been received in Application No. \_\_\_\_\_.

3.  Copies of the certified copies of the priority documents have been received in this National Stage application from the International Bureau (PCT Rule 17.2(a)).

\* See the attached detailed Office action for a list of the certified copies not received.

14)  Acknowledgment is made of a claim for domestic priority under 35 U.S.C. § 119(e) (to a provisional application).

a)  The translation of the foreign language provisional application has been received.

15)  Acknowledgment is made of a claim for domestic priority under 35 U.S.C. §§ 120 and/or 121.

**Attachment(s)**

1) <input checked="" type="checkbox"/> Notice of References Cited (PTO-892) 2) <input type="checkbox"/> Notice of Draftsperson's Patent Drawing Review (PTO-948) 3) <input checked="" type="checkbox"/> Information Disclosure Statement(s) (PTO-1449) Paper No(s) <u>3</u> .	4) <input type="checkbox"/> Interview Summary (PTO-413) Paper No(s) _____ 5) <input type="checkbox"/> Notice of Informal Patent Application (PTO-152) 6) <input type="checkbox"/> Other:
---	--

**DETAILED ACTION**

*Election/Restrictions*

1. Applicant's election of Invention of Group I, Claims 1-10, in Paper No. 5 is acknowledged. Because applicant did not distinctly and specifically point out the supposed errors in the restriction requirement, the election has been treated as an election without traverse (MPEP § 818.03(a)).

Applicant's election without traverse of Invention of Group I, Claims 1-10, in Paper No. 5 is acknowledged.

Claims 11-36 are withdrawn from further consideration pursuant to 37 CFR 1.142(b) as being drawn to a nonelected Invention, there being no allowable generic or linking claim.

Election was made **without** traverse in Paper No. 5.

*Claim Rejections - 35 USC § 102*

2. The following is a quotation of the appropriate paragraphs of 35 U.S.C. 102 that form the basis for the rejections under this section made in this Office action:

A person shall be entitled to a patent unless –

(b) the invention was patented or described in a printed publication in this or a foreign country or in public use or on sale in this country, more than one year prior to the date of application for patent in the United States.

Claims 1-3, 5-7, and 10 are rejected under 35 U.S.C. 102(b) as being anticipated by Vitkavage et al. (PN 5,858,873).

Vitkavage et al. discloses a barrier film preventing diffusion of copper from a copper wiring layer formed on a semiconductor substrate (2), comprising a multi-layered structure of first and second films,

A first film (14) being composed of crystalline metal containing nitrogen therein,

The second film (12) being composed of amorphous metal nitride,

The barrier film being constituted of common metal atomic species. Note Figures 1-4 of

Vitkavage et al..

With regard to claims 2 and 6, Vitkavage et al. discloses wherein the first film is formed on the second film.

With regard to claims 3 and 7, Vitkavage et al. discloses wherein the second film has a thickness in the range of 60 angstroms to 300 angstroms both inclusive.

With regard to claim 10, Vitkavage et al. discloses a copper film (18) formed on the first film.

*Claim Rejections - 35 USC § 103*

3. The following is a quotation of 35 U.S.C. 103(a) which forms the basis for all obviousness rejections set forth in this Office action:

(a) A patent may not be obtained though the invention is not identically disclosed or described as set forth in section 102 of this title, if the differences between the subject matter sought to be patented and the prior art are such that the subject matter as a whole would have been obvious at the time the invention was made to a person having ordinary skill in the art to which said subject matter pertains. Patentability shall not be negated by the manner in which the invention was made.

Claims 4, 8, and 9 are rejected under 35 U.S.C. 103(a) as being unpatentable over Vitkavage et al. (PN 5,858,873).

With regard to claims 4 and 8, Vitkavage et al. discloses all of the claimed limitations except the thickness of the first film. However, it would have been obvious to one of ordinary skill in the

Art Unit: 2811

art to form Vitkavage et al.'s first film having a thickness as claimed range because the thickness of the first film is variable of importance subject to routine experimentation and optimization. Also, the thickness differences are considered obvious design choices and are not patentable unless unobvious or unexpected results are obtained from these changes. It appears that these changes produce no functional differences and therefore would have been obvious. See *In re Woodruff*, 919 F.2d 1575, 1578, 16 USPQ2d 1934, 1936 (Fed. Cir. 1990).

With regard to claim 9, Vitkavage et al. discloses wherein the barrier film covers a recess and a hole (10) formed throughout an insulating film (8) formed on an underlying region (4).

Vitkavage et al. discloses the underlying region is a diffusion region. Vitkavage et al. does not disclose the underlying region is a wiring layer. However, it would have been obvious to one of ordinary skill in the art at the time the invention was made to form the underlying region of Vitkavage et al. as the wiring layer in order to connect to other parts of the circuit to perform additional functions.

#### *Conclusion*

4. Any inquiry concerning this communication or earlier communications from the examiner should be directed to Hung K. Vu whose telephone number is (703) 308-4079. The examiner can normally be reached on Mon-Thurs 7:00-5:30, Eastern Time.

If attempts to reach the examiner by telephone are unsuccessful, the examiner's supervisor, Tom Thomas can be reached on (703) 308-2772. The fax phone numbers for the

Application/Control Number: 09/596,415

Page 5

Art Unit: 2811

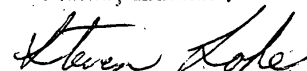
organization where this application or proceeding is assigned are (703) 308-7722 for regular communications and (703) 308-7722 for After Final communications.

Any inquiry of a general nature or relating to the status of this application or proceeding should be directed to the receptionist whose telephone number is (703) 308-0956.

Vu

September 19, 2001

Steven Loke  
Primary Examiner



<b>Notice of References Cited</b>	Application/Control No. 09/596,415	Applicant(s)/Patent Under Reexamination TAGAMI ET AL.	
	Examiner Hung K. Vu	Art Unit 2811	Page 1 of 1

**U.S. PATENT DOCUMENTS**

*		Document Number	Date	Name	Classification	
		Country Code-Number-Kind Code	MM-YYYY			
	A	US-5,858,873	01-1999	VITKAVAGE ET AL.	438	626
	B	US-				
	C	US-				
	D	US-				
	E	US-				
	F	US-				
	G	US-				
	H	US-				
	I	US-				
	J	US-				
	K	US-				
	L	US-				
	M	US-				

**FOREIGN PATENT DOCUMENTS**

*		Document Number	Date	Country	Name	Classification	
		Country Code-Number-Kind Code	MM-YYYY				
	N						
	O						
	P						
	Q						
	R						
	S						
	T						

**NON-PATENT DOCUMENTS**

*		Include as applicable: Author, Title Date, Publisher, Edition or Volume, Pertinent Pages)
	U	
	V	
	W	
	X	

\*A copy of this reference is not being furnished with this Office action. (See MPEP § 707.05(a).)  
 Dates in MM-YYYY format are publication dates. Classifications may be US or foreign.

2011

<b>AMENDMENT TRANSMITTAL LETTER (Large Entity)</b>	Docket No. 13715
Applicant(s): Masayoshi Tagami, et al.	

Serial No. 09/596,415	Filing Date June 19, 2000	Examiner H. Vu	Group Art Unit 2811
--------------------------	------------------------------	-------------------	------------------------

Invention: **MULTI-LAYERED WIRING LAYER AND METHOD OF FABRICATING THE SAME**

TO THE ASSISTANT COMMISSIONER FOR PATENTS:

Transmitted herewith is an amendment in the above-identified application.  
The fee has been calculated and is transmitted as shown below.

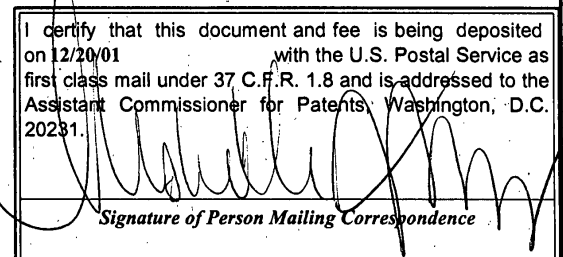
CLAIMS AS AMENDED						
	CLAIMS REMAINING AFTER AMENDMENT	HIGHEST # PREV. PAID FOR	NUMBER EXTRA CLAIMS PRESENT	RATE	ADDITIONAL FEE	
TOTAL CLAIMS	36	36	0	x \$18.00	\$0.00	
INDEP. CLAIMS	6	6	0	x \$84.00	\$0.00	
Multiple Dependent Claims (check if applicable) <input type="checkbox"/>						\$0.00
<b>TOTAL ADDITIONAL FEE FOR THIS AMENDMENT</b>						<b>\$0.00</b>

- No additional fee is required for amendment.
- Please charge Deposit Account No. \_\_\_\_\_ in the amount of \_\_\_\_\_  
A duplicate copy of this sheet is enclosed.
- A check in the amount of \_\_\_\_\_ to cover the filing fee is enclosed.
- The Commissioner is hereby authorized to charge payment of the following fees associated with this communication or credit any overpayment to Deposit Account No. 19-1013/SSMP  
A duplicate copy of this sheet is enclosed.
  - Any additional filing fees required under 37 C.F.R. 1.16.
  - Any patent application processing fees under 37 CFR 1.17.


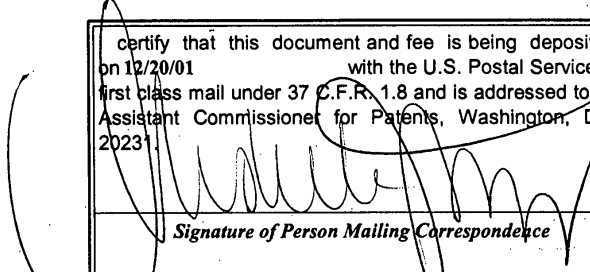
*Anthony N. Fresco*  
\_\_\_\_\_  
Signature

Dated: December 20, 2001

**Anthony N. Fresco**  
Registration No.: 45,784  
  
**Scully, Scott, Murphy & Presser**  
400 Garden City Plaza  
Garden City, New York 11530  
(516) 742-4343

I certify that this document and fee is being deposited on 12/20/01 with the U.S. Postal Service as first class mail under 37 C.F.R. 1.8 and is addressed to the Assistant Commissioner for Patents, Washington, D.C. 20231.	
<i>Signature of Person Mailing Correspondence</i>	
<b>Mishelle Mustafa</b>	
<i>Typed or Printed Name of Person Mailing Correspondence</i>	

cc:

<b>AMENDMENT TRANSMITTAL LETTER (Large Entity)</b>			Docket No. <b>13715</b>
Applicant(s): <b>Masayoshi Tagami, et al.</b>			Group/Art Unit <b>2811/31</b>
Serial No. <b>09/596,415</b>	Filing Date <b>June 19, 2000</b>	Examiner <b>H. Vu</b>	RECEIVED MAIL ROOM JAN 28 2002
Invention: <b>MULTI-LAYERED WIRING LAYER AND METHOD OF FABRICATING THE SAME</b>			
<u>TO THE ASSISTANT COMMISSIONER FOR PATENTS:</u>			
Transmitted herewith is an amendment in the above-identified application. The fee has been calculated and is transmitted as shown below.			
<b>CLAIMS AS AMENDED</b>			
	CLAIMS REMAINING AFTER AMENDMENT	HIGHEST # PREV. PAID FOR	NUMBER EXTRA CLAIMS PRESENT
TOTAL CLAIMS	36 -	36 =	0 x
INDEP. CLAIMS	6 -	6 =	0 x
Multiple Dependent Claims (check if applicable) <input type="checkbox"/>			RATE
			\$18.00
			\$84.00
<b>TOTAL ADDITIONAL FEE FOR THIS AMENDMENT</b>			<b>\$0.00</b>
<input checked="" type="checkbox"/> No additional fee is required for amendment. <input type="checkbox"/> Please charge Deposit Account No. _____ in the amount of _____ A duplicate copy of this sheet is enclosed. <input type="checkbox"/> A check in the amount of _____ to cover the filing fee is enclosed. <input checked="" type="checkbox"/> The Commissioner is hereby authorized to charge payment of the following fees associated with this communication or credit any overpayment to Deposit Account No. <b>19-1013/SSMP</b> A duplicate copy of this sheet is enclosed. <input type="checkbox"/> Any additional filing fees required under 37 C.F.R. 1.16. <input type="checkbox"/> Any patent application processing fees under 37 CFR 1.17.			
 Signature		Dated: <b>December 20, 2001</b>	
<b>Anthony N. Fresco</b> Registration No.: 45,784  <b>Scully, Scott, Murphy &amp; Presser</b> 400 Garden City Plaza Garden City, New York 11530 (516) 742-4343		certify that this document and fee is being deposited on <b>12/20/01</b> with the U.S. Postal Service as first class mail under 37 C.F.R. 1.8 and is addressed to the Assistant Commissioner for Patents, Washington, D.C. 20231.  Signature of Person Mailing Correspondence <b>Mishelle Mustafa</b> Typed or Printed Name of Person Mailing Correspondence	
CC:			

P11LARGE/REV06





PATENTS

**IN THE UNITED STATES PATENT AND TRADEMARK OFFICE**

<b>Applicants:</b>	Masayoshi Tagami, et al.	<b>Examiner:</b>	H. Vu
<b>Serial No:</b>	09/596,415	<b>Art Unit:</b>	2811
<b>Filed:</b>	June 19, 2000	<b>Docket:</b>	13715
<b>For:</b>	MULTI-LAYERED WIRING LAYER AND METHOD OF FABRICATING THE SAME	<b>Dated:</b>	December 20, 2001

# 7/a  
2-2-02  
Payton  
RECEIVED  
JAN 31 2002  
TO 2800 MAIL ROOM

Assistant Commissioner for Patents  
United States Patent and Trademark Office  
Washington, D.C. 20231

**RESPONSE UNDER 37 C.F.R. § 1.111**

Sir:

In response to the official Office Action dated September 25, 2001, the applicant respectfully presents the following Amendment and Remarks as set forth herein below.

**IN THE CLAIMS:**

Please cancel claims 2 and 6.

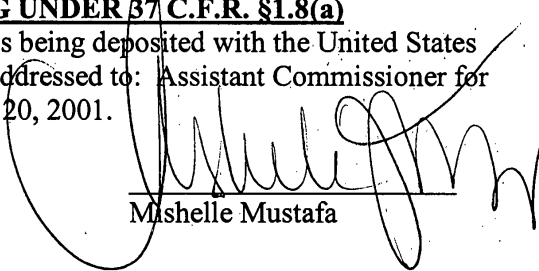
Please amend claim 1 to read as follows:

1. (Amended) A barrier film preventing diffusion of copper from a copper wiring layer formed on a semiconductor substrate, comprising a multi-layered structure of first and second films,

**CERTIFICATE OF MAILING UNDER 37 C.F.R. § 1.8(a)**

I hereby certify that this correspondence is being deposited with the United States Postal Service as first class mail in an envelope addressed to: Assistant Commissioner for Patents, Washington, D.C. 20231, on December 20, 2001.

Dated: December 20, 2001

  
Mishelle Mustafa

g\nec\1210\13715\amend\13715.am2.doc

09/596,415

A1  
Concl'd

said first film being composed of crystalline metal containing nitrogen therein,  
said second film being composed of amorphous metal nitride,  
said barrier film being constituted of common metal atomic species,  
said first film being formed on said second film,  
said first film containing nitrogen in a smaller content than that of said second  
film.

Subt B2

Please amend claim 5 to read as follows:

5. (Amended) A multi-layered wiring structure comprising a barrier film  
which prevents diffusion of copper from a copper wiring layer formed on a semiconductor  
substrate,

A2

said barrier film having a multi-layered structure of first and second films,  
said first film being composed of crystalline metal containing nitrogen therein,  
said second film being composed of amorphous metal nitride,  
said barrier film being constituted of common metal atomic species,  
said first film being formed on said second film,  
said first film containing nitrogen in a smaller content than that of said second

film.

Please add the following new claims 37 and 38.

A3

~~37~~<sup>4</sup> (New) The barrier film as set forth in claim 1, wherein said first film is  
composed of  $\beta$ -Ta and  $TaN_{0.1}$ , and said second film is composed of  $Ta_2N$ .

~~38~~<sup>10</sup> (New) The multi-layered wiring structure as set forth in claim 5, wherein  
said first film is composed of  $\beta$ -Ta and  $TaN_{0.1}$ , and said second film is composed of  $Ta_2N$ .

09/596,415

**REMARKS**

Reconsideration of this application based on the foregoing Amendment and the following Remarks is respectfully requested.

The Examiner has acknowledged the applicant's election of Group I, claims 1-10, in the applicant's Response to a Requirement for Restriction of July 5, 2001. Claims 11-36 are withdrawn from consideration pursuant to 37 C.F.R. § 1.142(b) as being drawn to a nonelected invention, there being no allowable generic or linking claim. The Examiner has treated the election as an election without traverse, in that the election was made without traverse in the applicant's July 5, 2001 response.

Claims 1-3, 5-7 and 10 stand rejected under 35 U.S.C. § 102(b) as being anticipated by Vitkavage et al. (U.S. 5,858,873) and claims 4, 8 and 9 stand rejected under 35 U.S.C. § 103(a) as being unpatentable over Vitkavage et al.

In response, the applicants have amended claims 1 and 5 to recite that the first film is formed on the second film, the first film containing nitrogen in a smaller content than that of the second film. The applicants have added new claims 37 and 38 which recite that the first film is composed of  $\beta$ -Ta and  $TaN_{0.1}$  and the second film is composed of  $Ta_2N$ . Support for the amendment to claims 1 and 5 and the addition of new claims 37 and 38 is provided in the specification on page 23, line 20, to page 30, line 1, of the application. No new matter has been added.

Vitkavage et al. discloses in column 4, lines 1-12, that the first layer 14 is comprised of a refractory material such as refractory nitride, carbide or boronide. For instance, the first layer 14 is comprised of TiN, TiC or TiB. The adhesion or second layer 12 is comprised of a metal such as Ti, Ta, Zr, Hf or W. The first layer 14 is formed on the

09/596,415

second layer 12. In a typical case in the cited reference, the first layer 14 is composed of TiN is formed on the second layer 12 composed of Ti. Herein, the first layer 14 contains nitrogen in a *higher* content than that of the second layer 12.

In contrast, in the present invention, claims 1 and 5, as amended, and the corresponding new dependent claims 37 and 38, recite that the first film 16 in the present invention is comprised of a crystalline metal film containing nitrogen therein. For instance, the first film 16 is composed of  $TaN_{0.1}$  which is called nitrogen-containing  $\alpha$ -Ta, or a combination of  $TaN_{0.1}$  and  $\beta$ -Ta. The second film 15 in the present invention is comprised of an amorphous metal nitride film. For instance, the second film 15 is composed of  $Ta_2N$ . That is, the first film 16 is composed of crystalline metal containing nitrogen at 10% or smaller, and the second film 15 is composed of amorphous metal nitride containing nitrogen at about 30%. The first layer 16 contains nitrogen in a *smaller content* than that of the second film 15, which is structurally different from the cited reference.

In addition, in the present invention of amended claims 1 and 5, the copper film 18 makes contact with the first film 16 beneath which the second film 16 is formed. As illustrated in Fig. 9, the first film 16 composed of nitrogen-containing crystalline metal has a smaller resistivity than that of a Ta film containing no nitrogen. Hence, the first film is formed of not a pure-metal film, but a nitrogen-containing crystalline metal film.

Therefore, the applicants respectfully maintain that the present invention of amended claims 1 and 5, and new claims 37 and 38 patentably distinguish over Vitkavage et al and that the claims are not anticipated by Vitkavage et al. under 35 U.S.C. § 102(b). Claim 3 stands together with claim 1 and claims 7 and 10 stand together with claim 5.

09/596,415

With regard to the rejections of claims 4, 8 and 9 under 35 U.S.C. § 103(a), the applicants respectfully maintain that claim 4 stands together with claim 1, as amended, and claims 8 and 9 stand together with claim 5, as amended.

The foregoing Amendment and Remarks establish the patentable nature of all of the claims under consideration in the application, i.e., claims 1, 3-5, and 7-10. Claims 2 and 6 have been cancelled. No new matter has been added, wherefore, early and favorable reconsideration of the present application and issuance of a Notice of Allowability are respectfully requested.

Respectfully submitted,

*Anthony N. Fresco*

Anthony N. Fresco

Registration No.: 45,784

Scully, Scott, Murphy & Presser  
400 Garden City Plaza  
Garden City, New York 11530  
(516) 742-4343

ANF:cm

Encl. (Version with Markings to Show Changes Made)

09/596,415

**VERSION WITH MARKINGS TO SHOW CHANGES MADE**

**In the Claims:**

**Claims 2 and 6 have been cancelled.**

**Claim 1 has been amended as follows:**

1. (Amended) A barrier film preventing diffusion of copper from a copper wiring layer formed on a semiconductor substrate, comprising a multi-layered structure of first and second films,

said first film being composed of crystalline metal containing nitrogen therein,

said second film being composed of amorphous metal nitride,

said barrier film being constituted of common metal atomic species,

said first film being formed on said second film,

said first film containing nitrogen in a smaller content than that of said second

film.

**Claim 5 has been amended as follows:**

5. (Amended) A multi-layered wiring structure comprising a barrier film which prevents diffusion of copper from a copper wiring layer formed on a semiconductor substrate,

said barrier film having a multi-layered structure of first and second films,

said first film being composed of crystalline metal containing nitrogen therein,

said second film being composed of amorphous metal nitride,

said barrier film being constituted of common metal atomic species,

said first film being formed on said second film,

09/596,415

said first film containing nitrogen in a smaller content than that of said second film.

**New claims 37 and 38 have been added as follows:**

37. (New) The barrier film as set forth in claim 1, wherein said first film is composed of  $\beta$ -Ta and  $\text{TaN}_{0.1}$ , and said second film is composed of  $\text{Ta}_2\text{N}$ .

38. (New) The multi-layered wiring structure as set forth in claim 5, wherein said first film is composed of  $\beta$ -Ta and  $\text{TaN}_{0.1}$ , and said second film is composed of  $\text{Ta}_2\text{N}$ .



UNITED STATES PATENT AND TRADEMARK OFFICE

UNITED STATES DEPARTMENT OF COMMERCE  
United States Patent and Trademark Office  
Address: COMMISSIONER OF PATENTS AND TRADEMARKS  
Washington, D.C. 20231  
www.uspto.gov

MP

APPLICATION NO.	FILING DATE	FIRST NAMED INVENTOR	ATTORNEY DOCKET NO.	CONFIRMATION NO.
09/596,415	06/19/2000	Masayoshi Tagami	13715	3425

7590 04/04/2002

Paul J Esatto Jr  
Scully Scott Murphy & Presser  
400 Garden City Plaza  
Garden City, NY 11530

EXAMINER

VU, HUNG K

ART UNIT PAPER NUMBER

2811

DATE MAILED: 04/04/2002

Please find below and/or attached an Office communication concerning this application or proceeding.



<b>Office Action Summary</b>	<b>Application No.</b>	<b>Applicant(s)</b>	
	09/596,415	TAGAMI ET AL.	
	<b>Examiner</b>	<b>Art Unit</b>	
	Hung K. Vu	2811	

-- The MAILING DATE of this communication appears on the cover sheet with the correspondence address --

**Period for Reply**

A SHORTENED STATUTORY PERIOD FOR REPLY IS SET TO EXPIRE 3 MONTH(S) FROM THE MAILING DATE OF THIS COMMUNICATION.

- Extensions of time may be available under the provisions of 37 CFR 1.136(a). In no event, however, may a reply be timely filed after SIX (6) MONTHS from the mailing date of this communication.
- If the period for reply specified above is less than thirty (30) days, a reply within the statutory minimum of thirty (30) days will be considered timely.
- If NO period for reply is specified above, the maximum statutory period will apply and will expire SIX (6) MONTHS from the mailing date of this communication.
- Failure to reply within the set or extended period for reply will, by statute, cause the application to become ABANDONED (35 U.S.C. § 133).
- Any reply received by the Office later than three months after the mailing date of this communication, even if timely filed, may reduce any earned patent term adjustment. See 37 CFR 1.704(b).

**Status**

- 1)  Responsive to communication(s) filed on 20 December 2001.
- 2a)  This action is **FINAL**.                      2b)  This action is non-final.
- 3)  Since this application is in condition for allowance except for formal matters, prosecution as to the merits is closed in accordance with the practice under *Ex parte Quayle*, 1935 C.D. 11, 453 O.G. 213.

**Disposition of Claims**

- 4)  Claim(s) 1,3-5 and 7-38 is/are pending in the application.
- 4a) Of the above claim(s) 11-36 is/are withdrawn from consideration.
- 5)  Claim(s) \_\_\_\_\_ is/are allowed.
- 6)  Claim(s) 1,3-5, 7-10 is/are rejected.
- 7)  Claim(s) 37 and 38 is/are objected to.
- 8)  Claim(s) \_\_\_\_\_ are subject to restriction and/or election requirement.

**Application Papers**

- 9)  The specification is objected to by the Examiner.
- 10)  The drawing(s) filed on \_\_\_\_\_ is/are: a)  accepted or b)  objected to by the Examiner.  
    Applicant may not request that any objection to the drawing(s) be held in abeyance. See 37 CFR 1.85(a).
- 11)  The proposed drawing correction filed on \_\_\_\_\_ is: a)  approved b)  disapproved by the Examiner.  
    If approved, corrected drawings are required in reply to this Office action.
- 12)  The oath or declaration is objected to by the Examiner.

**Priority under 35 U.S.C. §§ 119 and 120**

- 13)  Acknowledgment is made of a claim for foreign priority under 35 U.S.C. § 119(a)-(d) or (f):  
    a)  All    b)  Some \*    c)  None of:  
    1.  Certified copies of the priority documents have been received.  
    2.  Certified copies of the priority documents have been received in Application No. \_\_\_\_\_  
    3.  Copies of the certified copies of the priority documents have been received in this National Stage application from the International Bureau (PCT Rule 17.2(a)).  
    \* See the attached detailed Office action for a list of the certified copies not received.
- 14)  Acknowledgment is made of a claim for domestic priority under 35 U.S.C. § 119(e) (to a provisional application).  
    a)  The translation of the foreign language provisional application has been received.
- 15)  Acknowledgment is made of a claim for domestic priority under 35 U.S.C. §§ 120 and/or 121.

**Attachment(s)**

- |   |   |
|---|---|
| 1) <input checked="" type="checkbox"/> Notice of References Cited (PTO-892)                   | 4) <input type="checkbox"/> Interview Summary (PTO-413) Paper No(s). _____  |
| 2) <input type="checkbox"/> Notice of Draftsperson's Patent Drawing Review (PTO-948)          | 5) <input type="checkbox"/> Notice of Informal Patent Application (PTO-152) |
| 3) <input type="checkbox"/> Information Disclosure Statement(s) (PTO-1449) Paper No(s). _____ | 6) <input type="checkbox"/> Other:  |

**DETAILED ACTION**

***Claim Rejections - 35 USC § 102***

1. The following is a quotation of the appropriate paragraphs of 35 U.S.C. 102 that form the basis for the rejections under this section made in this Office action:

A person shall be entitled to a patent unless –

(b) the invention was patented or described in a printed publication in this or a foreign country or in public use or on sale in this country, more than one year prior to the date of application for patent in the United States:

Claims 1, 3-5, 7-10 are rejected under 35 U.S.C. 102(b) as being anticipated by Hong et al. (PN 5,668,411). Note Figures 7-10 and Table 1 of Hong et al..

Hong et al. discloses a barrier film preventing diffusion of copper from a copper wiring layer formed on a semiconductor substrate (22), comprising a multi-layered structure of first and second films,

A first film (48) being composed of crystalline metal containing nitrogen therein,

The second film (44) being composed of amorphous metal nitride,

The barrier film being constituted of common metal atomic species (Ti, Ta, W),

The first film being formed on the second film,

The first film containing nitrogen (TiWN, TiAlN, TiSiN, TaSiN) in a smaller content than that of the second film (TiN, TaN).

With regard to claims 3 and 7, Hong et al. discloses wherein the second film has a thickness 100-6000 angstroms (within the range of 80 angstroms to 150 angstroms both inclusive).

Art Unit: 2811

With regard to claims 4 and 8, Hong et al. discloses wherein the first film has a thickness 100-1000 angstroms (within the range of 60 angstroms to 300 angstroms both inclusive).

With regard to claim 9, Hong et al. discloses wherein the barrier film covers a recess and a hole formed throughout an insulating film (30) formed on an underlying wiring layer (22).

With regard to claim 10, Hong et al. discloses a copper film (26) formed on the first film.

*Response to Arguments*

2. Applicant's arguments with respect to claims 1 and 5 have been considered but are moot in view of the new ground(s) of rejection.

*Allowable Subject Matter*

3. Claims 37 and 38 are objected to as being dependent upon a rejected base claim, but would be allowable if rewritten in independent form including all of the limitations of the base claim and any intervening claims.

4. The following is an examiner's statement of reasons for allowance:

Applicants' claims 37 and 38 are allowable over the references of record because none of these references disclose or can be combined to yield the claimed invention such as the first film is composed of  $\beta$ -Ta and  $TaN_{0.1}$ , and the second film is composed of  $Ta_2N$ .

*Conclusion*

5. Applicant's amendment necessitated the new ground(s) of rejection presented in this Office action. Accordingly, **THIS ACTION IS MADE FINAL**. See MPEP § 706.07(a). Applicant is reminded of the extension of time policy as set forth in 37 CFR 1.136(a).

A shortened statutory period for reply to this final action is set to expire **THREE MONTHS** from the mailing date of this action. In the event a first reply is filed within **TWO MONTHS** of the mailing date of this final action and the advisory action is not mailed until after the end of the **THREE-MONTH** shortened statutory period, then the shortened statutory period will expire on the date the advisory action is mailed, and any extension fee pursuant to 37 CFR 1.136(a) will be calculated from the mailing date of the advisory action. In no event, however, will the statutory period for reply expire later than **SIX MONTHS** from the date of this final action.

Any inquiry concerning this communication or earlier communications from the examiner should be directed to Hung K. Vu whose telephone number is (703) 308-4079. The examiner can normally be reached on Mon-Thurs 7:00-5:30, Eastern Time.

If attempts to reach the examiner by telephone are unsuccessful, the examiner's supervisor, Tom Thomas can be reached on (703) 308-2772. The fax phone numbers for the organization where this application or proceeding is assigned are (703) 308-7722 for regular communications and (703) 308-7722 for After Final communications.

Any inquiry of a general nature or relating to the status of this application or proceeding should be directed to the receptionist whose telephone number is (703) 308-0956.

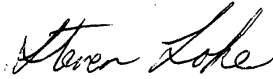
Application/Control Number: 09/596,415  
Art Unit: 2811

Page 5

Vu

March 29, 2002

Steven Loke  
Priority Examiner



<b>Notice of References Cited</b>	Application/Control No. 09/596,415	Applicant(s)/Patent Under Reexamination TAGAMI ET AL.	
	Examiner Hung K. Vu	Art Unit 2811	Page 1 of 1

**U.S. PATENT DOCUMENTS**

*	Document Number Country Code-Number-Kind Code	Date MM-YYYY	Name	Classification
A	US-5,668,411	09-1997	HONG ET AL.	257/751
B	US-			
C	US-			
D	US-			
E	US-			
F	US-			
G	US-			
H	US-			
I	US-			
J	US-			
K	US-			
L	US-			
M	US-			

**FOREIGN PATENT DOCUMENTS**

*	Document Number Country Code-Number-Kind Code	Date MM-YYYY	Country	Name	Classification
N					
O					
P					
Q					
R					
S					
T					

**NON-PATENT DOCUMENTS**

*	Include as applicable: Author, Title Date, Publisher, Edition or Volume, Pertinent Pages)
U	
V	
W	
X	

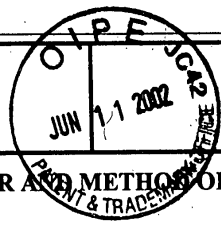
\*A copy of this reference is not being furnished with this Office action. (See MPEP § 707.05(a).)  
Dates in MM-YYYY format are publication dates. Classifications may be US or foreign.

COPY OF P RS  
ORIGINALLY FILED

AF  
4800

<b>AMENDMENT TRANSMITTAL LETTER (Large Entity)</b> Applicant(s): Masayoshi Tagami, et al.	Docket No. 13715
--	---------------------

Serial No. 09/596,415	Filing Date June 19, 2000	Examiner H. Vu	Group Art Unit 2811
--------------------------	------------------------------	-------------------	------------------------



Invention: MULTI-LAYERED WIRING LAYER AND METHOD OF FABRICATING THE SAME  
Corres. and Mail  
**BOX AF**

TO THE ASSISTANT COMMISSIONER FOR PATENTS:  
Transmitted herewith is an amendment in the above-identified application.  
The fee has been calculated and is transmitted as shown below.

CLAIMS AS AMENDED					
	CLAIMS REMAINING AFTER AMENDMENT	HIGHEST # PREV. PAID FOR	NUMBER EXTRA CLAIMS PRESENT	RATE	ADDITIONAL FEE
TOTAL CLAIMS	36 -	36 =	0 x	\$18.00	\$0.00
INDEP. CLAIMS	6 -	6 =	0 x	\$84.00	\$0.00
Multiple Dependent Claims (check if applicable)					\$0.00
TOTAL ADDITIONAL FEE FOR THIS AMENDMENT					\$0.00

- No additional fee is required for amendment.
- Please charge Deposit Account No. \_\_\_\_\_ in the amount of \_\_\_\_\_  
A duplicate copy of this sheet is enclosed.
- A check in the amount of \_\_\_\_\_ to cover the filing fee is enclosed.
- The Commissioner is hereby authorized to charge payment of the following fees associated with this communication or credit any overpayment to Deposit Account No. 19-1013/SSMP  
A duplicate copy of this sheet is enclosed.
  - Any additional filing fees required under 37 C.F.R. 1.16.
  - Any patent application processing fees under 37 CFR 1.17.

*Anthony N. Fresco*  
Signature

Dated: June 4, 2002

Anthony N. Fresco  
Registration No. 45,784

**SCULLY, SCOTT, MURPHY & PRESSER**  
400 Garden City Plaza  
Garden City, New York 11530  
(516) 742-4343

ANF:yp  
cc:

I certify that this document and fee is being deposited on June 4, 2002 with the U.S. Postal Service as first class mail under 37 C.F.R. 1.8 and is addressed to the Assistant Commissioner for Patents, Washington, D.C. 20231
<i>Mishelle Mustafa</i> Signature of Person Mailing Correspondence
<b>Mishelle Mustafa</b> Typed or Printed Name of Person Mailing Correspondence

P11LARGE/REV06

COPY OF PAPERS  
ORIGINALLY FILED

**AMENDMENT TRANSMITTAL LETTER (Large Entity)**  
 Applicant(s): Masayoshi Tagami, et al. Docket No. 13715

Serial No. 09/596,415	Filing Date June 19, 2000	Examiner H. Vu	Group Art Unit 2811
--------------------------	------------------------------	-------------------	------------------------



Invention: **MULTI-LAYERED WIRING LAYER AND METHOD OF FABRICATING THE SAME**

RECEIVED  
JUN 21 2002  
TECHNOLOGY CENTER 2800

TO THE ASSISTANT COMMISSIONER FOR PATENTS:

Transmitted herewith is an amendment in the above-identified application.  
 The fee has been calculated and is transmitted as shown below.

CLAIMS AS AMENDED					
	CLAIMS REMAINING AFTER AMENDMENT	HIGHEST # PREV. PAID FOR	NUMBER EXTRA CLAIMS PRESENT	RATE	ADDITIONAL FEE
TOTAL CLAIMS	36 -	36 =	0 x	\$18.00	\$0.00
INDEP. CLAIMS	6 -	6 =	0 x	\$84.00	\$0.00
Multiple Dependent Claims (check if applicable) <input type="checkbox"/>					\$0.00
<b>TOTAL ADDITIONAL FEE FOR THIS AMENDMENT</b>					<b>\$0.00</b>

- No additional fee is required for amendment.
- Please charge Deposit Account No. \_\_\_\_\_ in the amount of \_\_\_\_\_  
A duplicate copy of this sheet is enclosed.
- A check in the amount of \_\_\_\_\_ to cover the filing fee is enclosed.
- The Commissioner is hereby authorized to charge payment of the following fees associated with this communication or credit any overpayment to Deposit Account No. 19-1013/SSMP  
A duplicate copy of this sheet is enclosed.
  - Any additional filing fees required under 37 C.F.R. 1.16.
  - Any patent application processing fees under 37 CFR 1.17.

*Anthony N. Fresco*  
Signature

Dated: June 4, 2002

Anthony N. Fresco  
Registration No. 45,784

**SCULLY, SCOTT, MURPHY & PRESSER**  
 400 Garden City Plaza  
 Garden City, New York 11530  
 (516) 742-4343

ANF:yp  
cc:

I certify that this document and fee is being deposited on June 4, 2002 with the U.S. Postal Service as first class mail under 37 C.F.R. 1.8 and is addressed to the Assistant Commissioner for Patents, Washington, D.C. 20231.	
<i>Mishelle Mustafa</i> Signature of Person Mailing Correspondence	
<b>Mishelle Mustafa</b> Typed or Printed Name of Person Mailing Correspondence	



#9/response  
6-25-02  
JD



COPY OF PAPERS  
ORIGINALLY FILED

RESPONSE UNDER 37 C.F.R. § 1.116  
EXPEDITED PROCEDURE  
EXAMINING GROUP 2811

PATENTS

**IN THE UNITED STATES PATENT AND TRADEMARK OFFICE**

<b>Applicant(s):</b> Masayoshi Tagami, et al.	<b>Examiner:</b> H. Vu
<b>Serial No.:</b> 09/596,415	<b>Art Unit:</b> 2811
<b>Filed:</b> June 19, 2000	<b>Docket:</b> 13715
<b>For:</b> MULTI-LAYERED WIRING LAYER AND METHOD OF FABRICATING THE SAME	<b>Dated:</b> June 4, 2002

RECEIVED  
JUN 21 2002  
TECHNOLOGY CENTER 2800

Assistant Commissioner for Patents  
United States Patent and Trademark Office  
Washington, D.C. 20231

**RESPONSE AFTER FINAL REJECTION UNDER 37 C.F.R. § 1.116**

Sir:

In response to the Final Office Action dated April 4, 2002, the applicant respectfully requests consideration of the following Remarks in the above-identified case:

**CERTIFICATE OF MAILING UNDER 37 C.F.R. § 1.8(a)**

I hereby certify that this correspondence is being deposited with the United States Postal Service as first class mail in an envelope addressed to: Assistant Commissioner for Patents, Washington, D.C. 20231, on June 4, 2002.

**Dated:** June 4, 2002

Michelle Mustafa

### REMARKS

This response is submitted in response to the Final Office Action dated April 4, 2002 and respectfully requests that the Examiner reconsider the rejection of the claims as set forth therein.

The Examiner objects to claims 37 and 38 as being dependent upon a rejected base claim but would be allowable if rewritten in independent form including all of the limitations of the base claim and any intervening claims.

The Examiner has considered the applicants' arguments with respect to claims 1 and 5 but the Examiner considers the arguments moot in view of new grounds of rejection.

The Examiner has rejected claims 1, 3-5 and 7-10 under 35 U.S.C. 102(b) as being anticipated by Hong et al. (U.S. 5,668,411 – filed July 23, 1996 – issued September 16, 1997).

Hong et al is a new reference cited by the Examiner. In the first Office Action, the Examiner cited Vitkavage et al. (U.S. 5,858,873 – filed March 12, 1997 – issued January 12, 1999). The Examiner now asserts that FIGS. 7-10 and Table 1 of Hong et al disclose the limitations of claim 1 of a barrier film preventing diffusion of copper from a copper wiring structure comprising a barrier film which prevents diffusion of copper from a copper wiring layer formed on a semiconductor substrate.

In response, the applicants respectfully maintain with respect to claims 1 and 5 that Hong et al does not disclose the first film being formed on the second film, as recited by claims 1 and 5. Instead, Hong et al, FIGS. 7 and 10 discloses

that there is a seed layer 46 of the diffusion barrier film positioned between the top layer 48 and the bottom layer 44.

Furthermore, the top layer 48 of Hong et al, which corresponds to the first film of the present invention, contains TiN or TiWN. The bottom layer 44 of Hong et al, which corresponds to the second film of the present invention, contains TiN, TiAlN, or TiSiN. Therefore, contrary to the Examiner's assertion, Hong et al does not disclose that the first film contains nitrogen in a smaller content than that of the second film. Instead, in Hong et al, preferably, both the first and second films can be TiN, or both can be TiWN.

Although tungsten has an atomic weight of 183.84 which is greater than the atomic weight of either aluminum or silicon, and the compound TiWN suggested by Hong et al for the top layer or first film does contain nitrogen in a smaller content than that of the bottom layer or second film, Hong et al does not specify that the first layer must contain nitrogen in a smaller content than that of the second layer, as recited by claims 1 and 5.

Therefore, claims 1 and 5, by reciting that the first film is formed on the second film, patentably distinguish over Hong et al. Furthermore, in the best mode described by Hong et al, the nitrogen content of the first and second films are equivalent, being comprised of TiN. Furthermore, Hong et al does not teach or suggest any particular advantage of the first film being comprised of TiWN while the second film is comprised of TiN or TiAlN.

With regard to claims 3-4 and 7-10, in view of the applicants' arguments in favor of claims 1 and 5 as patentably distinguishing over Hong et al, the applicants

respectfully maintain that claims 3-4 and 7-10 also patentably distinguish over Hong et al.

The applicant respectfully requests that the Examiner consider the foregoing Remarks. The foregoing Remarks establish the patentable nature of all of the claims currently in the application, i.e. claims 1, 3-5, and 7-10. Claims 2 and 6 were previously cancelled. Claims 37 and 38 are objected to as being dependent upon a rejection base claim but would be allowable if rewritten in independent form to include all of the limitations of the base claims and any intervening claims. No new issues have been raised, wherefore, early and favorable reconsideration and issuance of a Notice of Allowance are respectfully solicited.

Respectfully submitted,



Anthony N. Fresco  
Registration No.: 45,784

SCULLY, SCOTT, MURPHY & PRESSER  
400 Garden City Plaza  
Garden City, New York 11530  
(516) 742-4343/4366 FAX

ANF:yp



UNITED STATES PATENT AND TRADEMARK OFFICE

UNITED STATES DEPARTMENT OF COMMERCE  
United States Patent and Trademark Office  
Address: COMMISSIONER OF PATENTS AND TRADEMARKS  
Washington, D.C. 20231  
www.uspto.gov

APPLICATION NO.	FILING DATE	FIRST NAMED INVENTOR	ATTORNEY DOCKET NO.	CONFIRMATION NO.
09/596,415	06/19/2000	Masayoshi Tagami	13715	3425

7590 07/02/2002

Paul J Esatto Jr  
Scully Scott Murphy & Presser  
400 Garden City Plaza  
Garden City, NY 11530

EXAMINER

VU, HUNG K

ART UNIT PAPER NUMBER

2811

DATE MAILED: 07/02/2002

Please find below and/or attached an Office communication concerning this application or proceeding.

<b>Advisory Action</b>	<b>Application No.</b> 09/596,415	<b>Applicant(s)</b> TAGAMI ET AL.	
	<b>Examiner</b> Hung K. Vu	<b>Art Unit</b> 2811	

--The MAILING DATE of this communication appears on the cover sheet with the correspondence address --

THE REPLY FILED 11 June 2002 FAILS TO PLACE THIS APPLICATION IN CONDITION FOR ALLOWANCE. Therefore, further action by the applicant is required to avoid abandonment of this application. A proper reply to a final rejection under 37 CFR 1.113 may only be either: (1) a timely filed amendment which places the application in condition for allowance; (2) a timely filed Notice of Appeal (with appeal fee); or (3) a timely filed Request for Continued Examination (RCE) in compliance with 37 CFR 1.114.

**PERIOD FOR REPLY** [check either a) or b)]

- a)  The period for reply expires 3 months from the mailing date of the final rejection.  
b)  The period for reply expires on: (1) the mailing date of this Advisory Action, or (2) the date set forth in the final rejection, whichever is later. In no event, however, will the statutory period for reply expire later than SIX MONTHS from the mailing date of the final rejection. ONLY CHECK THIS BOX WHEN THE FIRST REPLY WAS FILED WITHIN TWO MONTHS OF THE FINAL REJECTION. See MPEP 706.07(f).

Extensions of time may be obtained under 37 CFR 1.136(a). The date on which the petition under 37 CFR 1.136(a) and the appropriate extension fee have been filed is the date for purposes of determining the period of extension and the corresponding amount of the fee. The appropriate extension fee under 37 CFR 1.17(a) is calculated from: (1) the expiration date of the shortened statutory period for reply originally set in the final Office action; or (2) as set forth in (b) above, if checked. Any reply received by the Office later than three months after the mailing date of the final rejection, even if timely filed, may reduce any earned patent term adjustment. See 37 CFR 1.704(b).

1.  A Notice of Appeal was filed on \_\_\_\_\_. Appellant's Brief must be filed within the period set forth in 37 CFR 1.192(a), or any extension thereof (37 CFR 1.191(d)), to avoid dismissal of the appeal.  
2.  The proposed amendment(s) will not be entered because:  
(a)  they raise new issues that would require further consideration and/or search (see NOTE below);  
(b)  they raise the issue of new matter (see Note below);  
(c)  they are not deemed to place the application in better form for appeal by materially reducing or simplifying the issues for appeal; and/or  
(d)  they present additional claims without canceling a corresponding number of finally rejected claims.

NOTE: \_\_\_\_\_

3.  Applicant's reply has overcome the following rejection(s): \_\_\_\_\_  
4.  Newly proposed or amended claim(s) \_\_\_\_\_ would be allowable if submitted in a separate, timely filed amendment canceling the non-allowable claim(s).  
5.  The a)  affidavit, b)  exhibit, or c)  request for reconsideration has been considered but does NOT place the application in condition for allowance because: See Continuation Sheet.  
6.  The affidavit or exhibit will NOT be considered because it is not directed SOLELY to issues which were newly raised by the Examiner in the final rejection.  
7.  For purposes of Appeal, the proposed amendment(s) a)  will not be entered or b)  will be entered and an explanation of how the new or amended claims would be rejected is provided below or appended.

The status of the claim(s) is (or will be) as follows:

Claim(s) allowed: \_\_\_\_\_

Claim(s) objected to: 37 and 38

Claim(s) rejected: 1, 3-5 and 7-10

Claim(s) withdrawn from consideration: 11-36

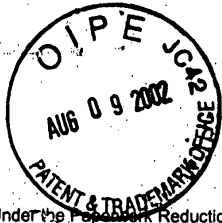
8.  The proposed drawing correction filed on \_\_\_\_\_ is a)  approved or b)  disapproved by the Examiner.  
9.  Note the attached Information Disclosure Statement(s) (PTO-1449) Paper No(s). \_\_\_\_\_  
10.  Other: \_\_\_\_\_

TOM THOMAS  
SUPERVISORY PATENT EXAMINER

Continuation Sheet (PTO-303)  
09/596,415

Application No.

Continuation of 5. does NOT place the application in condition for allowance because: Hong et al. discloses forming a first film (48) containing nitrogen (TiWN, TiAlN, TiSiN or TaSiN) in a smaller content than that of the second film (44) which is TiN or TaN. Further, Hong et al. also discloses forming the first film (48) on the second film (44). Note that the claimed language does not state whether the first film is formed on and in directly contact with the second film. Therefore, Applicant's claims 1 and 5 do not distinguish over the Hong et al. reference.



COPY OF PAPERS  
ORIGINALLY FILED

Rec  
2800

PTO/SB/30 (10/2001)

Approved for use through 10/31/2002 OMB 0651-0081

U.S. Patent and Trademark Office: U.S. DEPARTMENT OF COMMERCE

Under the Paperwork Reduction Act of 1995, no persons are required to respond to a collection of information unless it displays a valid OMB control number.



### REQUEST FOR CONTINUED EXAMINATION (RCE) TRANSMITTAL

Address to:  
Commissioner for Patents  
Box RCE  
Washington, DC 20231

Application Number	09/596,415
Filing Date	June 19, 2000
First Named Inventor	Masayoshi Tagami, et al.
Art Unit	2811
Examiner Name	H. Vu
Attorney Docket Number	13715

H/2  
Req  
RCE  
FJ  
8-20-02

This is a Request for Continued Examination (RCE) under 37 CFR 1.114 of the above-identified application. Request for Continued Examination (RCE) practice under 37 CFR 1.114 does not apply to any utility or plant application filed prior to June 8, 1995.

#### 1. Submission required under 37 CFR §1.114

- a.  Previously submitted
  - i.  Consider the amendment(s)/reply under 37 CFR §1.116 previously filed on \_\_\_\_\_  
(Any unentered amendment(s) referred to above will be entered).
  - ii.  Consider the arguments in the Appeal Brief or Reply Brief previously filed on \_\_\_\_\_
  - iii.  Other \_\_\_\_\_
- b.  Enclosed
  - i.  Amendment/Reply
  - ii.  Affidavit(s)/Declaration(s)
  - iii.  Information Disclosure Statement (IDS)
  - iv.  Other Petition for Extension of Time

RECEIVED  
AUG 20 2002  
TECHNOLOGY CENTER

#### 2. Miscellaneous

- a.  Suspension of action on the above-identified application is requested under 37 CFR §1.103(c) for a period of \_\_\_\_\_ months (Period of suspension shall not exceed 3 months; Fee under 37 CFR §1.17(f) required)
- b.  Other \_\_\_\_\_

#### 3. Fees

- The RCE fee under 37 CFR §1.17(e) is required by 37 CFR §1.114 when the RCE is filed.
- a.  The Director is hereby authorized to charge the following fees, or credit any overpayments, to Deposit Account No. 19-1013/SSMP
  - i.  RCE fee required under 37 CFR §1.17(e) 08/12/2002 AWDNAF1 00000024 09596415
  - ii.  Extension of time fee (37 CFR §§1.136 and 1.17) 01 FC:179 740.00 DP
  - iii.  Other \_\_\_\_\_
- b.  Check in the amount of \$ 740.00/110.00 enclosed
- c.  Payment by credit card (Form PTO-2038 enclosed)

**WARNING: Information on this form may become public. Credit card information should not be included on this form. Provide credit card information and authorization on PTO-2038.**

#### SIGNATURE OF APPLICANT, ATTORNEY, OR AGENT REQUIRED

Name (Print / Type)	Paul J. Esatto, Jr.	Registration No. (Attorney / Agent)	30,749
Signature		Date	August 5, 2002

#### CERTIFICATE OF MAILING OR TRANSMISSION

I hereby certify that this correspondence is being deposited with the United States Postal Service with sufficient postage as first class mail in an envelope addressed to: Commissioner For Patents, Boc RCE, Washington, DC 20231, or facsimile transmitted to the U.S. Patent and Trademark Office.

Name (Print / Type)	Mishelle Mustafa	Date	August 5, 2002
Signature			

Burden Hour Statement: This form is estimated to take 0.2 hours to complete. Time will vary depending upon the needs of the individual case. Any comments on the amount of time you are required to complete this form should be sent to the Chief Information Officer, U.S. Patent and Trademark Office, Washington, DC 20231. DO NOT SEND FEES OR COMPLETED FORMS TO THIS ADDRESS. SEND Fees and Completed Forms to the following address: Assistant Commissioner for Patents, Box RCE, Washington, DC 20231.



COPY OF PAPERS  
ORIGINAL FILED



PTO/SB/30 (10/2001)  
Approved for use through 10/31/2002 OMB 0651-0031  
U.S. Patent and Trademark Office: U.S. DEPARTMENT OF COMMERCE  
Under the Paperwork Reduction Act of 1995, no persons are required to respond to a collection of information unless it displays a valid OMB control number.

<b>REQUEST FOR CONTINUED EXAMINATION (RCE) TRANSMITTAL</b>  Address to: Commissioner for Patents Box RCE Washington, DC 20231	Application Number	09/596,415
	Filing Date	June 19, 2000
	First Named Inventor	Masayoshi Tagami, et al.
	Art Unit	2811
	Examiner Name	H. Vu
	Attorney Docket Number	13715

This is a Request for Continued Examination (RCE) under 37 CFR 1.114 of the above-identified application. Request for Continued Examination (RCE) practice under 37 CFR 1.114 does not apply to any utility or plant application filed prior to June 8, 2002.

1.  Submission required under 37 CFR §1.114

a.  Previously submitted

i.  Consider the amendment(s)/reply under 37 CFR §1.116 previously filed on \_\_\_\_\_  
(Any unentered amendment(s) referred to above will be entered).

ii.  Consider the arguments in the Appeal Brief or Reply Brief previously filed on \_\_\_\_\_

iii.  Other \_\_\_\_\_

b.  Enclosed

i.  Amendment/Reply

ii.  Affidavit(s)/Declaration(s)

iii.  Information Disclosure Statement (IDS)

iv.  Other Petition for Extension of Time

2.  Miscellaneous

a.  Suspension of action on the above-identified application is requested under 37 CFR §1.103(c) for a period of \_\_\_\_\_ months (Period of suspension shall not exceed 3 months; Fee under 37 CFR §1.17(i) required)

b.  Other \_\_\_\_\_

3.  Fees The RCE fee under 37 CFR §1.17(e) is required by 37 CFR §1.114 when the RCE is filed.

a.  The Director is hereby authorized to charge the following fees, or credit any overpayments, to Deposit Account No. 19-1013/SSMP

i.  RCE fee required under 37 CFR §1.17(e)

ii.  Extension of time fee (37 CFR §§1.136 and 1.17)

iii.  Other \_\_\_\_\_

b.  Check in the amount of \$ 740.00/110.00 enclosed

c.  Payment by credit card (Form PTO-2038 enclosed)

**WARNING: Information on this form may become public. Credit card information should not be included on this form. Provide credit card information and authorization on PTO-2038.**

RECEIVED  
AUG 20 2002  
TECHNOLOGY CENTER 2800

**SIGNATURE OF APPLICANT, ATTORNEY, OR AGENT REQUIRED**

Name (Print / Type)	Paul J. Esatto, Jr.	Registration No. (Attorney / Agent)	30,749
Signature		Date	August 5, 2002

**CERTIFICATE OF MAILING OR TRANSMISSION**

I hereby certify that this correspondence is being deposited with the United States Postal Service with sufficient postage as first class mail in an envelope addressed to: Commissioner For Patents, Boc RCE, Washington, DC 20231, or facsimile transmitted to the U.S. Patent and Trademark

Name (Print / Type)	Mishelle Mustafa
Signature	
Date	August 5, 2002

Burden Hour Statement: This form is estimated to take 0.2 hours to complete. Time will vary depending upon the needs of the individual case. Any comments on the amount of time you are required to complete this form should be sent to the Chief Information Officer, U.S. Patent and Trademark Office, Washington, DC 20231. DO NOT SEND FEES OR COMPLETED FORMS TO THIS ADDRESS. SEND Fees and Completed Forms to the following address: Assistant Commissioner for Patents, Box RCE, Washington, DC 20231.

09/577,702



PATENTS

**IN THE UNITED STATES PATENT AND TRADEMARK OFFICE**

<b>Applicant(s):</b> Masayoshi Tagami, et al.	<b>Examiner:</b> H. Vu
<b>Serial No.:</b> 09/596,415	<b>Art Unit:</b> 2811
<b>Filed:</b> June 19, 2000	<b>Docket:</b> 13715
<b>For:</b> MULTI-LAYERED WIRING LAYER AND METHOD OF FABRICATING THE SAME	<b>Dated:</b> August 5, 2002

13/B  
FJONES  
8-20-02

Assistant Commissioner for Patents  
United States Patent and Trademark Office  
Washington, D.C. 20231

**PRELIMINARY AMENDMENT UNDER 37 C.F.R. § 1.115**

Sir:

In response to the Final Office Action dated April 4, 2002, and the Advisory Action of July 2, 2002 issued in response to the applicants' Response After Final Rejection Under 37 CFR 1.116 of June 4, 2002 and the telephonic interview with the applicants' representative, Anthony N. Fresco, on July 29, 2002, the applicants respectfully submit the following Preliminary Amendment in conjunction with the concurrently-filed request for continued examination (RCE):

COPY OF PAPERS  
ORIGINALLY FILED  
RECEIVED  
AUG 20 2002  
TECHNOLOGY CENTER 2800

**CERTIFICATE OF MAILING UNDER 37 C.F.R. § 1.8(a)**

I hereby certify that this correspondence is being deposited with the United States Postal Service as first class mail in an envelope addressed to: Assistant Commissioner for Patents, Washington, D.C. 20231, on August 5, 2002.

**Dated:** August 5, 2002

**Mishelle Mustafa**

09/577,702

**IN THE CLAIMS:**

**Please amend claim 1 to read as follows:**

---

**1. (Twice Amended)** A barrier film preventing diffusion of copper from a copper wiring layer formed on a semiconductor substrate, comprising a multi-layered structure of first and second films,

said first film being composed of crystalline metal containing nitrogen therein,

said second film being composed of amorphous metal nitride,

said barrier film being constituted of common metal atomic species,

said first film being formed on said second film,

said first film in direct contact with said second film,

said first film containing nitrogen in a smaller content than that of

said second film.

---

**Please amend claim 5 to read as follows:**

---

**5. (Twice Amended)** A multi-layered wiring structure comprising a barrier film which prevents diffusion of copper from a copper wiring layer formed on a semiconductor substrate,

said barrier film having a multi-layered structure of first and second films,

said first film being composed of crystalline metal containing nitrogen therein,

said second film being composed of amorphous metal nitride,

09/577,702

B<sub>2</sub>  
cont

said barrier film being constituted of common metal atomic species,  
said first film being formed on said second film,  
said first film in direct contact with said second film,  
said first film containing nitrogen in a smaller content than that of  
said second film.

**REMARKS**

This Preliminary Amendment and the concurrently filed RCE are submitted in response to the Final Office Action dated April 4, 2002 and respectfully requests that the Examiner reconsider the rejection of the claims as set forth therein.

The Examiner objects to claims 37 and 38 as being dependent upon a rejected base claim but would be allowable if rewritten in independent form including all of the limitations of the base claim and any intervening claims.

The Examiner has considered the applicants' arguments with respect to claims 1 and 5 but the Examiner considers the arguments moot in view of new grounds of rejection.

The Examiner has rejected claims 1, 3-5 and 7-10 under 35 U.S.C. 102(b) as being anticipated by Hong et al. (U.S. 5,668,411 – filed July 23, 1996 – issued September 16, 1997).

Hong et al is a new reference cited by the Examiner. In the first Office Action, the Examiner cited Vitkavage et al. (U.S. 5,858,873 – filed March 12, 1997 – issued January 12, 1999). The Examiner now asserts that FIGS. 7-10 and Table 1

38

B

09/577,702

of Hong et al disclose the limitations of claim 1 of a barrier film preventing diffusion of copper from a copper wiring structure comprising a barrier film which prevents diffusion of copper from a copper wiring layer formed on a semiconductor substrate.

In the applicants' June 4, 2002 Response After Final Rejection Under 37 CFR 1.116, the applicants respectfully maintained with respect to claims 1 and 5 that Hong et al does not disclose the first film being formed on the second film, as recited by claims 1 and 5. Instead, Hong et al, FIGS. 7 and 10 discloses that there is a seed layer 46 of the diffusion barrier film positioned between the top layer 48 and the bottom layer 44.

Furthermore, the applicants also argued that the top layer 48 of Hong et al, which corresponds to the first film of the present invention, contains TiN or TiWN. The bottom layer 44 of Hong et al, which corresponds to the second film of the present invention, contains TiN, TiAlN, or TiSiN. Therefore, contrary to the Examiner's assertion, Hong et al does not disclose that the first film contains nitrogen in a smaller content than that of the second film. Instead, in Hong et al, preferably, both the first and second films can be TiN, or both can be TiWN.

Although tungsten has an atomic weight of 183.84 which is greater than the atomic weight of either aluminum or silicon, and the compound TiWN suggested by Hong et al for the top layer or first film does contain nitrogen in a smaller content than that of the bottom layer or second film, Hong et al does not specify that the first layer must contain nitrogen in a smaller content than that of the second layer, as recited by claims 1 and 5.

09/577,702

The applicants argued that, therefore, claims 1 and 5, by reciting that the first film is formed on the second film, patentably distinguish over Hong et al. Furthermore, in the best mode described by Hong et al, the nitrogen content of the first and second films are equivalent, being comprised of TiN. Furthermore, Hong et al does not teach or suggest any particular advantage of the first film being comprised of TiWN while the second film is comprised of TiN or TiAlN.

In the Advisory Action of July 2, 2002, the Examiner rejected the foregoing arguments, asserting that Hong et al discloses forming a first film (48) containing nitrogen (TiWN, TiAlN, TiSiN or TaSiN) in a smaller content than that of the second film (44) which is TiN or TaN. The Examiner's position further is that Hong et al also discloses forming the first film (48) on the second film (44). The Examiner noted however that the claimed language does not state whether the first film is formed on and in direct contact with the second film.

In response, in a facsimile sent on July 25, 2002 to the Examiner, the applicants proposed amendments to claims 1 and 5 to recite "said first film in direct contact with said second film.".

In a telephonic interview with the Examiner on July 29, 2002, based on the proposed amendments to claims 1 and 5 sent by facsimile, the Examiner indicated to the applicants' representative, Anthony N. Fresco, that the proposed amendment to claims 1 and 5 requires further search and consideration, and that a RCE would be required. Therefore, the applicants are herein submitting this Preliminary Amendment Under 37 CFR 1.115 in conjunction with the

09/577,702

**VERSION WITH MARKINGS TO SHOW CHANGES MADE**

**In the Claims:**

**Claim 1 has been amended as follows:**

1. (Twice Amended) A barrier film preventing diffusion of copper from a copper wiring layer formed on a semiconductor substrate, comprising a multi-layered structure of first and second films,

said first film being composed of crystalline metal containing nitrogen therein,

said second film being composed of amorphous metal nitride,

said barrier film being constituted of common metal atomic species,

said first film being formed on said second film,

said first film in direct contact with said second film,

said first film containing nitrogen in a smaller content than that of said second film.

**Claim 5 has been amended as follows:**

5. (Twice Amended) A multi-layered wiring structure comprising a barrier film which prevents diffusion of copper from a copper wiring layer formed on a semiconductor substrate,

said barrier film having a multi-layered structure of first and second films,

said first film being composed of crystalline metal containing nitrogen therein,

said second film being composed of amorphous metal nitride,

09/577,702

concurrently filed RCE to enter the amendments to claims 1 and 5 to recite "said first film in direct contact with said second film". No new matter has been added.

With regard to claims 3-4 and 7-10, in view of the applicants' amendments to claims 1 and 5, which the applicants respectfully maintain establish claims 1 and 5 as patentably distinguishing over Hong et al, the applicants maintain that claims 3-4 and 7-10 also patentably distinguish over Hong et al.

The foregoing Remarks establish the patentable nature of all of the claims currently in the application, i.e. claims 1, 3-5, and 7-10 and 37-38. Claims 2 and 6 were previously cancelled. Claims 37 and 38 are objected to as being dependent upon a rejection base claim but would be allowable if rewritten in independent form to include all of the limitations of the base claims and any intervening claims. No matter has been added and no new issues have been raised, wherefore, early and favorable reconsideration and issuance of a Notice of Allowance are respectfully solicited.

Respectfully submitted,

*Anthony N. Fresco*

Anthony N. Fresco

Registration No.: 45,784

SCULLY, SCOTT, MURPHY & PRESSER  
400 Garden City Plaza  
Garden City, New York 11530  
(516) 742-4343/4366 FAX

ANF:yd

Enclosure: Version with Markings to Show Changes Made



09/577,702

said barrier film being constituted of common metal atomic species,

said first film being formed on said second film,

said first film in direct contact with said second film,

said first film containing nitrogen in a smaller content than that of

said second film.

PETITION FOR EXTENSION OF TIME UNDER 37 CFR 1.136(a)  
(Large Entity) Docket No. 13715

In Re Application Of: Masayoshi Tagami, et al.

Serial No. 09/596,415 Filing Date June 19, 2000 Examiner H. Vu Group Art Unit 2811

Invention: MULTI-LAYERED WIRING LAYER AND METHOD OF FABRICATING THE SAME  
COPY OF PAPER  
ORIGINALLY FILED  
18 11  
Request  
JONES  
8-20-02

TO THE ASSISTANT COMMISSIONER FOR PATENTS:

This is a request under the provisions of 37 CFR 1.136(a) to extend the period for filing a response to the Office Action of April 4, 2002 above-identified application.

The requested extension is as follows (check time period desired):

One month Two months Three months Four months Five months  
from: July 4, 2002 until: August 4, 2002

The fee for the extension of time is \$110 and is to be paid as follows:

- A check in the amount of the fee is enclosed.
The Commissioner is hereby authorized to charge any fees which may be required, or credit any overpayment, to Deposit Account No. 19-1013/SSMP
A duplicate copy of this sheet is enclosed.
If an additional extension of time is required, please consider this a petition therefor and charge any additional fees which may be required to Deposit Account No. 19-1013/SSMP
A duplicate copy of this sheet is enclosed.

Anthony N. Fresco Signature

Dated: August 5, 2002



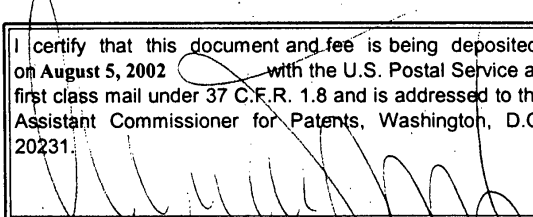
Anthony N. Fresco
Registration No. 45,784

SCULLY, SCOTT, MURPHY & PRESSER
400 Garden City Plaza
Garden City, New York 11530
(516) 742-4343

08/12/2002 AWONDAF1 00000024 09596415
02 FC:115 110.00 OP

ANF:yd
cc:

I certify that this document and fee is being deposited on August 5, 2002 with the U.S. Postal Service as first class mail under 37 C.F.R. 1.8 and is addressed to the Assistant Commissioner for Patents, Washington, D.C. 20231.
Signature of Person Mailing Correspondence
Mishelle Mustafa
Typed or Printed Name of Person Mailing Correspondence

<b>PETITION FOR EXTENSION OF TIME UNDER 37 CFR 1.136(a)</b> (Large Entity)			Docket No. 13715	
In Re Application Of: Masayoshi Tagami, et al.				
Serial No. 09/596,415	Filing Date June 19, 2000		Examiner H. Vu	Group Art Unit 2811
Invention: MULTI-LAYERED WIRING LAYER AND METHOD OF FABRICATING THE SAME				
COPY OF PAPERS ORIGINALLY FILED				
<u>TO THE ASSISTANT COMMISSIONER FOR PATENTS:</u>				
This is a request under the provisions of 37 CFR 1.136(a) to extend the period for filing a response to the Office Action of <u>April 4, 2002</u> above-identified application. <i>Date</i>				
The requested extension is as follows (check time period desired):				
<input checked="" type="checkbox"/> One month <input type="checkbox"/> Two months <input type="checkbox"/> Three months <input type="checkbox"/> Four months <input type="checkbox"/> Five months				
from: <u>July 4, 2002</u> until: <u>August 4, 2002</u> <i>Date</i> <span style="float: right;"><i>Date</i></span>				
The fee for the extension of time is \$110 and is to be paid as follows:				
<input checked="" type="checkbox"/> A check in the amount of the fee is enclosed. <input checked="" type="checkbox"/> The Commissioner is hereby authorized to charge any fees which may be required, or credit any overpayment, to Deposit Account No. 19-1013/SSMP A duplicate copy of this sheet is enclosed. <input type="checkbox"/> If an additional extension of time is required, please consider this a petition therefor and charge any additional fees which may be required to Deposit Account No. 19-1013/SSMP A duplicate copy of this sheet is enclosed.				
 <i>Signature</i>			Dated: August 5, 2002	
Anthony N. Fresco Registration No. 45,784  <b>SCULLY, SCOTT, MURPHY &amp; PRESSER</b> 400 Garden City Plaza Garden City, New York 11530 (516) 742-4343			<div style="border: 1px solid black; padding: 5px; width: fit-content; margin: auto;">         I certify that this document and fee is being deposited on August 5, 2002 with the U.S. Postal Service as first class mail under 37 C.F.R. 1.8 and is addressed to the Assistant Commissioner for Patents, Washington, D.C. 20231.    <i>Signature of Person Mailing Correspondence</i>  <b>Mishelle Mustafa</b>          Typed or Printed Name of Person Mailing Correspondence       </div>	
ANF:yd cc:				

 RECEIVED  
 AUG 20 2002  
 TECHNOLOGY CENTER 2800

<b>Notice of Allowability</b>	<b>Application No.</b>	<b>Applicant(s)</b>	
	09/596,415	TAGAMI ET AL.	
	<b>Examiner</b>	<b>Art Unit</b>	
	Hung K. Vu	2811	

**-- The MAILING DATE of this communication appears on the cover sheet with the correspondence address--**  
 All claims being allowable, PROSECUTION ON THE MERITS IS (OR REMAINS) CLOSED in this application. If not included herewith (or previously mailed), a Notice of Allowance (PTOL-85) or other appropriate communication will be mailed in due course. **THIS NOTICE OF ALLOWABILITY IS NOT A GRANT OF PATENT RIGHTS.** This application is subject to withdrawal from issue at the initiative of the Office or upon petition by the applicant. See 37 CFR 1.313 and MPEP 1308.

1.  This communication is responsive to 8/5/02.
2.  The allowed claim(s) is/are 1,3-5,7-10,37 and 38.
3.  The drawings filed on \_\_\_\_\_ are accepted by the Examiner.
4.  Acknowledgment is made of a claim for foreign priority under 35 U.S.C. § 119(a)-(d) or (f).
  - a)  All    b)  Some\*    c)  None    of the:
    1.  Certified copies of the priority documents have been received.
    2.  Certified copies of the priority documents have been received in Application No. \_\_\_\_\_.
    3.  Copies of the certified copies of the priority documents have been received in this national stage application from the International Bureau (PCT Rule.17.2(a)).

\* Certified copies not received: \_\_\_\_\_.
5.  Acknowledgment is made of a claim for domestic priority under 35 U.S.C. § 119(e) (to a provisional application).
  - (a)  The translation of the foreign language provisional application has been received.
6.  Acknowledgment is made of a claim for domestic priority under 35 U.S.C. §§ 120 and/or 121.

Applicant has THREE MONTHS FROM THE "MAILING DATE" of this communication to file a reply complying with the requirements noted below. Failure to timely comply will result in ABANDONMENT of this application. **THIS THREE-MONTH PERIOD IS NOT EXTENDABLE.**

7.  A SUBSTITUTE OATH OR DECLARATION must be submitted. Note the attached EXAMINER'S AMENDMENT or NOTICE OF INFORMAL PATENT APPLICATION (PTO-152) which gives reason(s) why the oath or declaration is deficient.
8.  CORRECTED DRAWINGS must be submitted.
  - (a)  including changes required by the Notice of Draftsperson's Patent Drawing Review ( PTO-948) attached
    - 1)  hereto or 2)  to Paper No. \_\_\_\_\_.
  - (b)  including changes required by the proposed drawing correction filed \_\_\_\_\_, which has been approved by the Examiner.
  - (c)  including changes required by the attached Examiner's Amendment / Comment or in the Office action of Paper No. \_\_\_\_\_.

Identifying indicia such as the application number (see 37 CFR 1.84(c)) should be written on the drawings in the top margin (not the back) of each sheet. The drawings should be filed as a separate paper with a transmittal letter addressed to the Official Draftsperson.

9.  DEPOSIT OF and/or INFORMATION about the deposit of BIOLOGICAL MATERIAL must be submitted. Note the attached Examiner's comment regarding REQUIREMENT FOR THE DEPOSIT OF BIOLOGICAL MATERIAL.

**Attachment(s).**

- |  |   |
|--|---|
| 1 <input checked="" type="checkbox"/> Notice of References Cited (PTO-892)                             | 2 <input type="checkbox"/> Notice of Informal Patent Application (PTO-152)          |
| 3 <input checked="" type="checkbox"/> Notice of Draftsperson's Patent Drawing Review (PTO-948)         | 4 <input type="checkbox"/> Interview Summary (PTO-413), Paper No. _____             |
| 5 <input type="checkbox"/> Information Disclosure Statements (PTO-1449), Paper No. _____               | 6 <input checked="" type="checkbox"/> Examiner's Amendment/Comment                  |
| 7 <input type="checkbox"/> Examiner's Comment Regarding Requirement for Deposit of Biological Material | 8 <input checked="" type="checkbox"/> Examiner's Statement of Reasons for Allowance |
|  | 9 <input type="checkbox"/> Other  |

*Tom Thomas*  
**TOM THOMAS**  
 SUPERVISORY PATENT EXAMINER  
 TECHNOLOGY CENTER 2800

10

***Examiner's Amendment***

1. This application is in condition for allowance except for the presence of claims 11-39 to invention non-elected without traverse. Accordingly, claims 11-36 have been cancelled.

***Allowable Subject Matter***

2. The following is an examiner's statement of reasons for allowance:

Applicants' claims 1, 3-5, 7-10 and 37-38 are allowable over the references of record because none of these references disclose or can be combined to yield the claimed invention such as the barrier film preventing diffusion of copper from a copper wiring layer formed on a semiconductor substrate comprising, a multi-layered structure of first and second films, the first film being composed of crystalline metal containing nitrogen therein the second film being composed of amorphous metal nitride, the barrier film being constituted of common metal atomic species, the first film being formed on the second film, the first film in direct contact with the second film, the first film containing nitrogen in a smaller content than that of the second film.

Any comments considered necessary by applicant must be submitted no later than the payment of the issue fee and, to avoid processing delays, should preferably accompany the issue fee. Such submissions should be clearly labeled "Comments on Statement of Reasons for Allowance."

Art Unit: 2811

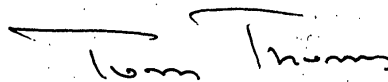
**Conclusion**

3. Papers related to this application may be submitted to Technology Center (TC) 2800 by facsimile transmission. Papers should be faxed to TC 2800 via the TC 2800 Fax center located in Crystal Plaza 4, room 4-C23. The faxing of such papers must conform with the notice published in the Official Gazette, 1096 OG 30 (November 15, 1989). The Group 2811 Fax Center number is (703) 308-7722 and 308-7724. The Group 2811 Fax Center is to be used only for papers related to Group 2811 applications.

Any inquiry concerning this communication or any earlier communication from the Examiner should be directed to **Hung Vu** whose telephone number is (703) 308-4079. The Examiner is in the Office generally between the hours of 7:00 AM to 5:30 PM (Eastern Standard Time) Monday through Thursday.

If attempts to reach the examiner by telephone are unsuccessful, the examiner's supervisor, **Tom Thomas**, can be reached on (703) 308-2772.

Any inquiry of a general nature or relating to the status of this application should be directed to the **Technology Center Receptionists** whose telephone number is (703) 308-0956.



TOM THOMAS  
SUPERVISORY PATENT EXAMINER  
TECHNOLOGY CENTER 2800

Vu

September 6, 2002

<b>Notice of References Cited</b>	Application/Control No. 09/596,415	Applicant(s)/Patent Under Reexamination TAGAMI ET AL.	
	Examiner Hung K. Vu	Art Unit 2811	Page 1 of 1

**U.S. PATENT DOCUMENTS**

*	Document Number Country Code-Number-Kind Code	Date MM-YYYY	Name	Classification
	A US-			
	B US-			
	C US-			
	D US-			
	E US-			
	F US-			
	G US-			
	H US-			
	I US-			
	J US-			
	K US-			
	L US-			
	M US-			

**FOREIGN PATENT DOCUMENTS**

*	Document Number Country Code-Number-Kind Code	Date MM-YYYY	Country	Name	Classification
	N JP9-293690	11-1997	JAPAN		
	O				
	P				
	Q				
	R				
	S				
	T				

**NON-PATENT DOCUMENTS**

*	Include as applicable: Author, Title Date, Publisher, Edition or Volume, Pertinent Pages)
	U
	V
	W
	X

\*A copy of this reference is not being furnished with this Office action. (See MPEP § 707.05(a).)  
Dates in MM-YYYY format are publication dates. Classifications may be US or foreign.

9/596415

NOTICE OF DRAFTSPERSON'S PATENT DRAWING REVIEW

The drawing(s) filed (insert date) 6/19/02 are:

- A. [ ] approved by the Draftsperson under 37 CFR 1.84 or 1.152.
B. [X] objected to by the Draftsperson under 37 CFR 1.84 or 1.152 for the reasons indicated below. The Examiner will require submission of new, corrected drawings when necessary.

1. DRAWINGS. 37 CFR 1.84(a): Acceptable categories of drawings: Black ink. Color.
2. PHOTOGRAPHS. 37 CFR 1.84(b)
3. TYPE OF PAPER. 37 CFR 1.84(e)
4. SIZE OF PAPER. 37 CFR 1.84(f): Acceptable sizes:
5. MARGINS. 37 CFR 1.84(g): Acceptable margins:
6. VIEWS. 37 CFR 1.84(h)
7. SECTIONAL VIEWS. 37 CFR 1.84 (h)(3)
8. ARRANGEMENT OF VIEWS. 37 CFR 1.84(i)
9. SCALE. 37 CFR 1.84(k)
10. CHARACTER OF LINES, NUMBERS, & LETTERS. 37 CFR 1.84(j)
11. SHADING. 37 CFR 1.84(m)
12. NUMBERS, LETTERS, & REFERENCE CHARACTERS. 37 CFR 1.84(p)
13. LEAD LINES. 37 CFR 1.84(q)
14. NUMBERING OF SHEETS OF DRAWINGS. 37 CFR 1.84(t)
15. NUMBERING OF VIEWS. 37 CFR 1.84(u)
16. CORRECTIONS. 37 CFR 1.84(w)
17. DESIGN DRAWINGS. 37 CFR 1.152

COMMENTS Fig 19, 20 need to be reproduced for sharpness & clarity

REVIEWER wf DATE 9/5/02 TELEPHONE NO. 7055028404
ATTACHMENT TO PAPER NO.



**Attachment for PTO-948 (Rev. 03/01, or earlier)  
6/18/01**

**The below text replaces the pre-printed text under the heading, "Information on How to Effect Drawing Changes," on the back of the PTO-948 (Rev. 03/01, or earlier) form.**

**INFORMATION ON HOW TO EFFECT DRAWING CHANGES**

**1. Correction of Informalities -- 37 CFR 1.85**

New corrected drawings must be filed with the changes incorporated therein. Identifying indicia, if provided, should include the title of the invention, inventor's name, and application number, or docket number (if any) if an application number has not been assigned to the application. If this information is provided, it must be placed on the front of each sheet and centered within the top margin. If corrected drawings are required in a Notice of Allowability (PTOL-37), the new drawings **MUST** be filed within the **THREE MONTH** shortened statutory period set for reply in the Notice of Allowability. Extensions of time may **NOT** be obtained under the provisions of 37 CFR 1.136(a) or (b) for filing the corrected drawings after the mailing of a Notice of Allowability. The drawings should be filed as a separate paper with a transmittal letter addressed to the Official Draftsperson.

**2. Corrections other than Informalities Noted by Draftsperson on form PTO-948.**

All changes to the drawings, other than informalities noted by the Draftsperson, **MUST** be made in the same manner as above except that, normally, a highlighted (preferably red ink) sketch of the changes to be incorporated into the new drawings **MUST** be approved by the examiner before the application will be allowed. No changes will be permitted to be made, other than correction of informalities, unless the examiner has approved the proposed changes.

**Timing of Corrections**

Applicant is required to submit the drawing corrections within the time period set in the attached Office communication. See 37 CFR 1.85(a).

Failure to take corrective action within the set period will result in **ABANDONMENT** of the application.

06/01/01



UNITED STATES PATENT AND TRADEMARK OFFICE

UNITED STATES DEPARTMENT OF COMMERCE
United States Patent and Trademark Office
Address: COMMISSIONER OF PATENTS AND TRADEMARKS
Washington, D.C. 20231
www.uspto.gov

NOTICE OF ALLOWANCE AND FEE(S) DUE

7590 09/10/2002
Paul J Esatto Jr
Scully Scott Murphy & Presser
400 Garden City Plaza
Garden City, NY 11530

EXAMINER

VU, HUNG K

ART UNIT CLASS-SUBCLASS

2811

257-751000

DATE MAILED: 09/10/2002

Table with 5 columns: APPLICATION NO., FILING DATE, FIRST NAMED INVENTOR, ATTORNEY DOCKET NO., CONFIRMATION NO. Values: 09/596,415, 06/19/2000, Masayoshi Tagami, 13715, 3425

TITLE OF INVENTION: MULTI-LAYERED WIRING LAYER AND METHOD OF FABRICATING THE SAME

Table with 6 columns: APPLN. TYPE, SMALL ENTITY, ISSUE FEE, PUBLICATION FEE, TOTAL FEE(S) DUE, DATE DUE. Values: nonprovisional, NO, \$1280, \$0, \$1280, 12/10/2002

THE APPLICATION IDENTIFIED ABOVE HAS BEEN EXAMINED AND IS ALLOWED FOR ISSUANCE AS A PATENT. PROSECUTION ON THE MERITS IS CLOSED. THIS NOTICE OF ALLOWANCE IS NOT A GRANT OF PATENT RIGHTS. THIS APPLICATION IS SUBJECT TO WITHDRAWAL FROM ISSUE AT THE INITIATIVE OF THE OFFICE OR UPON PETITION BY THE APPLICANT. SEE 37 CFR 1.313 AND MPEP 1308.

THE ISSUE FEE AND PUBLICATION FEE (IF REQUIRED) MUST BE PAID WITHIN THREE MONTHS FROM THE MAILING DATE OF THIS NOTICE OR THIS APPLICATION SHALL BE REGARDED AS ABANDONED. THIS STATUTORY PERIOD CANNOT BE EXTENDED. SEE 35 U.S.C. 151. THE ISSUE FEE DUE INDICATED ABOVE REFLECTS A CREDIT FOR ANY PREVIOUSLY PAID ISSUE FEE APPLIED IN THIS APPLICATION. THE PTOL-85B (OR AN EQUIVALENT) MUST BE RETURNED WITHIN THIS PERIOD EVEN IF NO-FEE IS DUE OR THE APPLICATION WILL BE REGARDED AS ABANDONED.

HOW TO REPLY TO THIS NOTICE:

I. Review the SMALL ENTITY status shown above.

If the SMALL ENTITY is shown as YES, verify your current SMALL ENTITY status:

A. If the status is the same, pay the TOTAL FEE(S) DUE shown above.

B. If the status is changed, pay the PUBLICATION FEE (if required) and twice the amount of the ISSUE FEE shown above and notify the United States Patent and Trademark Office of the change in status, or

If the SMALL ENTITY is shown as NO:

A. Pay TOTAL FEE(S) DUE shown above, or

B. If applicant claimed SMALL ENTITY status before, or is now claiming SMALL ENTITY status, check the box below and enclose the PUBLICATION FEE and 1/2 the ISSUE FEE shown above.

[ ] Applicant claims SMALL ENTITY status. See 37 CFR 1.27.

II. PART B - FEE(S) TRANSMITTAL should be completed and returned to the United States Patent and Trademark Office (USPTO) with your ISSUE FEE and PUBLICATION FEE (if required). Even if the fee(s) have already been paid, Part B - Fee(s) Transmittal should be completed and returned. If you are charging the fee(s) to your deposit account, section "4b" of Part B - Fee(s) Transmittal should be completed and an extra copy of the form should be submitted.

III. All communications regarding this application must give the application number. Please direct all communications prior to issuance to Box ISSUE FEE unless advised to the contrary.

IMPORTANT REMINDER: Utility patents issuing on applications filed on or after Dec. 12, 1980 may require payment of maintenance fees. It is patentee's responsibility to ensure timely payment of maintenance fees when due.

**PART B - FEE(S) TRANSMITTAL**

**Complete and send this form, together with applicable fee(s), to: Mail Box ISSUE FEE  
 Commissioner for Patents  
 Washington, D.C. 20231  
Fax (703)746-4000**

**INSTRUCTIONS:** This form should be used for transmitting the ISSUE FEE and PUBLICATION FEE (if required). Blocks 1 through 4 should be completed where appropriate. All further correspondence including the Patent, advance orders and notification of maintenance fees will be mailed to the current correspondence address as indicated unless corrected below or directed otherwise in Block 1, by (a) specifying a new correspondence address; and/or (b) indicating a separate "FEE ADDRESS" for maintenance fee notifications.

CURRENT CORRESPONDENCE ADDRESS (Note: Legibly mark-up with any corrections or use Block 1)  
 7590 09/10/2002

Paul J Esatto Jr  
 Scully Scott Murphy & Presser  
 400 Garden City Plaza  
 Garden City, NY 11530

Note: A certificate of mailing can only be used for domestic mailings of the Fee(s) Transmittal. This certificate cannot be used for any other accompanying papers. Each additional paper, such as an assignment or formal drawing, must have its own certificate of mailing or transmission.

**Certificate of Mailing or Transmission**  
 I hereby certify that this Fee(s) Transmittal is being deposited with the United States Postal Service with sufficient postage for first class mail in an envelope addressed to the Box Issue Fee address above, or being facsimile-transmitted to the USPTO, on the date indicated below.

(Depositor's name)
(Signature)
(Date)

APPLICATION NO.	FILING DATE	FIRST NAMED INVENTOR	ATTORNEY DOCKET NO.	CONFIRMATION NO.
09/596,415	06/19/2000	Masayoshi Tagami	13715	3425

TITLE OF INVENTION: MULTI-LAYERED WIRING LAYER AND METHOD OF FABRICATING THE SAME

APPLN. TYPE	SMALL ENTITY	ISSUE FEE	PUBLICATION FEE	TOTAL FEE(S) DUE	DATE DUE
nonprovisional	NO	\$1280	\$0	\$1280	12/10/2002

EXAMINER	ART UNIT	CLASS-SUBCLASS
VU, HUNG K	2811	257-751000

1. Change of correspondence address or indication of "Fee Address" (37 CFR 1.363).

- Change of correspondence address (or Change of Correspondence Address form PTO/SB/122) attached.  
 "Fee Address" indication (or "Fee Address" Indication form PTO/SB/47; Rev 03-02 or more recent) attached. Use of a Customer Number is required.

2. For printing on the patent front page, list (1) the names of up to 3 registered patent attorneys or agents OR, alternatively, (2) the name of a single firm (having as a member a registered attorney or agent) and the names of up to 2 registered patent attorneys or agents. If no name is listed, no name will be printed.

- 1 \_\_\_\_\_  
 2 \_\_\_\_\_  
 3 \_\_\_\_\_

**3. ASSIGNEE NAME AND RESIDENCE DATA TO BE PRINTED ON THE PATENT (print or type)**

PLEASE NOTE: Unless an assignee is identified below, no assignee data will appear on the patent. Inclusion of assignee data is only appropriate when an assignment has been previously submitted to the USPTO or is being submitted under separate cover. Completion of this form is NOT a substitute for filing an assignment.

(A) NAME OF ASSIGNEE (B) RESIDENCE: (CITY and STATE OR COUNTRY)

Please check the appropriate assignee category or categories (will not be printed on the patent)  individual  corporation or other private group entity  government

**4a. The following fee(s) are enclosed:**

- Issue Fee  
 Publication Fee  
 Advance Order - # of Copies \_\_\_\_\_

**4b. Payment of Fee(s):**

- A check in the amount of the fee(s) is enclosed.  
 Payment by credit card. Form PTO-2038 is attached.  
 The Commissioner is hereby authorized by charge the required fee(s), or credit any overpayment, to Deposit Account Number \_\_\_\_\_ (enclose an extra copy of this form).

Commissioner for Patents is requested to apply the Issue Fee and Publication Fee (if any) or to re-apply any previously paid issue fee to the application identified above.

(Authorized Signature) (Date)

NOTE: The Issue Fee and Publication Fee (if required) will not be accepted from anyone other than the applicant; a registered attorney or agent; or the assignee or other party in interest as shown by the records of the United States Patent and Trademark Office.

This collection of information is required by 37 CFR 1.311. The information is required to obtain or retain a benefit by the public which is to file (and by the USPTO to process) an application. Confidentiality is governed by 35 U.S.C. 122 and 37 CFR 1.14. This collection is estimated to take 12 minutes to complete, including gathering, preparing, and submitting the completed application form to the USPTO. Time will vary depending upon the individual case. Any comments on the amount of time you require to complete this form and/or suggestions for reducing this burden, should be sent to the Chief Information Officer, U.S. Patent and Trademark Office, U.S. Department of Commerce, Washington, D.C. 20231. DO NOT SEND FEES OR COMPLETED FORMS TO THIS ADDRESS. SEND TO: Commissioner for Patents, Washington, DC 20231.

Under the Paperwork Reduction Act of 1995, no persons are required to respond to a collection of information unless it displays a valid OMB control number.

TRANSMIT THIS FORM WITH FEE(S)

PTOL-85 (REV. 04-02) Approved for use through 01/31/2004. OMB 0651-0033

U.S. Patent and Trademark Office; U.S. DEPARTMENT OF COMMERCE



UNITED STATES PATENT AND TRADEMARK OFFICE

UNITED STATES DEPARTMENT OF COMMERCE  
United States Patent and Trademark Office  
Address: COMMISSIONER OF PATENTS AND TRADEMARKS  
Washington, D.C. 20231  
www.uspto.gov

APPLICATION NO.	FILING DATE	FIRST NAMED INVENTOR	ATTORNEY DOCKET NO.	CONFIRMATION NO.
09/596,415	06/19/2000	Masayoshi Tagami	13715	3425

EXAMINER

VU, HUNG K

ART UNIT	PAPER NUMBER
2811	

2811

DATE MAILED: 09/10/2002

7590 09/10/2002  
Paul J Esatto Jr  
Scully Scott Murphy & Presser  
400 Garden City Plaza  
Garden City, NY 11530

**Determination of Patent Term Adjustment under 35 U.S.C. 154 (b)**  
(application filed on or after May 29, 2000)

The patent term adjustment to date is 0 days. If the issue fee is paid on the date that is three months after the mailing date of this notice and the patent issues on the Tuesday before the date that is 28 weeks (six and a half months) after the mailing date of this notice, the term adjustment will be 0 days.

If a continued prosecution application (CPA) was filed in the above-identified application, the filing date that determines patent term adjustment is the filing date of the most recent CPA.

Applicant will be able to obtain more detailed information by accessing the Patent Application Information Retrieval (PAIR) system. (<http://pair.uspto.gov>)



UNITED STATES PATENT AND TRADEMARK OFFICE

UNITED STATES DEPARTMENT OF COMMERCE  
United States Patent and Trademark Office  
Address: COMMISSIONER OF PATENTS AND TRADEMARKS  
Washington, D.C. 20231  
www.uspto.gov

APPLICATION NO.	FILING DATE	FIRST NAMED INVENTOR	ATTORNEY DOCKET NO.	CONFIRMATION NO.
09/596,415	06/19/2000	Masayoshi Tagami	13715	3425

7590 09/10/2002

Paul J Esatto Jr  
Scully Scott Murphy & Presser  
400 Garden City Plaza  
Garden City, NY 11530  
UNITED STATES

EXAMINER

VU, HUNG K

ART UNIT	PAPER NUMBER
2811	

2811

DATE MAILED: 09/10/2002

**Notice of Possible Fee Increase on October 1, 2002**

If a reply to a "Notice of Allowance and Fee(s) Due" is filed in the Office on or after October 1, 2002, then the amount due may be higher than that set forth in the "Notice of Allowance and Fee(s) Due" since there may be an increase in fees effective on October 1, 2002. See Revision of Patent and Trademark Fees for Fiscal Year 2003: Notice of Proposed Rulemaking, 67 Fed. Reg. 30634, 30636 (May 7, 2002). Although a change to the amount of the publication fee is not currently proposed for October 2002, if the issue fee or publication fee is to be paid on or after October 1, 2002, applicant should check the USPTO web site for the current fees before submitting the payment. The USPTO Internet address for the fee schedule is: <http://www.uspto.gov/main/howtofees.htm>.

If the issue fee paid is the amount shown on the "Notice of Allowance and Fee(s) Due," but not the correct amount in view of any fee increase, a "Notice to Pay Balance of Issue Fee" will be mailed to applicant. In order to avoid processing delays associated with mailing of a "Notice to Pay Balance of Issue Fee," if the response to the Notice of Allowance and Fee(s) due form is to be filed on or after October 1, 2002 (or mailed with a certificate of mailing on or after October 1, 2002), the issue fee paid should be the fee that is required at the time the fee is paid. If the issue fee was previously paid, and the response to the "Notice of Allowance and Fee(s) Due" includes a request to apply a previously-paid issue fee to the issue fee now due, then the difference between the issue fee amount at the time the response is filed and the previously paid issue fee should be paid. See Manual of Patent Examining Procedure, Section 1308.01 (Eighth Edition, August 2001).

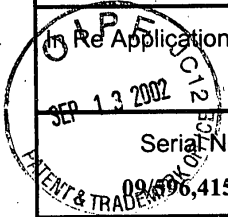
Questions relating to issue and publication fee payments should be directed to the Customer Service Center of the Office of Patent Publication at (703) 305-8283.

2811

**TRANSMITTAL OF INFORMATION DISCLOSURE STATEMENT  
(Under 37 CFR 1.97(b) or 1.97(c))**

Docket No.  
13715

Re Application Of: Masayoshi Tagami, et al.



Serial No.  
09/06,415

Filing Date  
June 19, 2000

Examiner  
H. Vu

Group Art Unit  
2811

Title: MULTI-LAYERED WIRING LAYER AND METHOD OF FABRICATING THE SAME

RECEIVED  
SEP 15 2002  
TECHNOLOGY CENTER 2000

Address to:  
Assistant Commissioner for Patents  
Washington, D.C. 20231

**37 CFR 1.97(b)**

- 1.  The Information Disclosure Statement submitted herewith is being filed within three months of the filing of a national application other than a continued prosecution application under 37 CFR 1.53(d); within three months of the date of entry of the national stage as set forth in 37 CFR 1.491 in an international application; before the mailing of a first Office Action on the merits, or before the mailing of a first Office Action after the filing of a request for continued examination under 37 CFR 1.114.

**37 CFR 1.97(c)**

- 2.  The Information Disclosure Statement submitted herewith is being filed after the period specified in 37 CFR 1.97(b), provided that the Information Disclosure Statement is filed before the mailing date of a Final Action under 37 CFR 1.113, a Notice of Allowance under 37 CFR 1.311, or an Action that otherwise closes prosecution in the application, and is accompanied by one of:
  - the statement specified in 37 CFR 1.97(e);

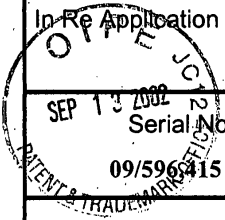
OR

  - the fee set forth in 37 CFR 1.17(p).

**TRANSMITTAL OF INFORMATION DISCLOSURE STATEMENT  
(Under 37 CFR 1.97(b) or 1.97(c))**

Docket No.  
13715

In Re Application Of: **Masayoshi Tagami, et al.**



Serial No.  
09/596415

Filing Date  
June 19, 2000

Examiner  
H. Vu

Group Art Unit  
2811

Title: **MULTI-LAYERED WIRING LAYER AND METHOD OF FABRICATING THE SAME**

Address to:  
**Assistant Commissioner for Patents  
Washington, D.C. 20231**

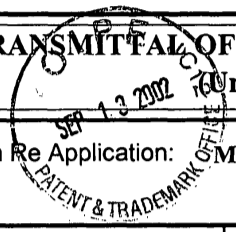
**37 CFR 1.97(b)**

1.  The Information Disclosure Statement submitted herewith is being filed within three months of the filing of a national application other than a continued prosecution application under 37 CFR 1.53(d); within three months of the date of entry of the national stage as set forth in 37 CFR 1.491 in an international application; before the mailing of a first Office Action on the merits, or before the mailing of a first Office Action after the filing of a request for continued examination under 37 CFR 1.114.

**37 CFR 1.97(c)**

2.  The Information Disclosure Statement submitted herewith is being filed after the period specified in 37 CFR 1.97(b), provided that the Information Disclosure Statement is filed before the mailing date of a Final Action under 37 CFR 1.113, a Notice of Allowance under 37 CFR 1.311, or an Action that otherwise closes prosecution in the application, and is accompanied by one of:
- the statement specified in 37 CFR 1.97(e);
- OR**
- the fee set forth in 37 CFR 1.17(p).

RECEIVED  
SEP 16 2002  
TECHNOLOGY CENTER 2800



<b>TRANSMITTAL OF INFORMATION DISCLOSURE STATEMENT</b> Under 37 CFR 1.97(b) or 1.97(c)	Docket No. 13715
---	---------------------

In Re Application: **Masayoshi Tagami, et al.**

Serial No. <b>09/596,415</b>	Filing Date <b>June 19, 2000</b>	Examiner <b>H. Vu</b>	Group Art Unit <b>2811</b>
---------------------------------	-------------------------------------	--------------------------	-------------------------------

**MULTI-LAYERED WIRING LAYER AND METHOD OF FABRICATING THE SAME**

**Payment of Fee**

(Only complete if Applicant elects to pay the fee set forth in 37 CFR 1.17(p))

- A check in the amount of \_\_\_\_\_ is attached.
- The Assistant Commissioner is hereby authorized to charge and credit Deposit Account No. **19-1013/SSMP** as described below. A duplicate copy of this sheet is enclosed.
  - Charge the amount of \_\_\_\_\_
  - Credit any overpayment.
  - Charge any additional fee required.

**Certificate of Transmission by Facsimile\***

I certify that this document and authorization to charge deposit account is being facsimile transmitted to the United States Patent and Trademark Office (F
_____ (Date)
_____ Signature
_____ Typed or Printed Name of Person Signing Certificate

**Certificate of Mailing by First Class Mail**

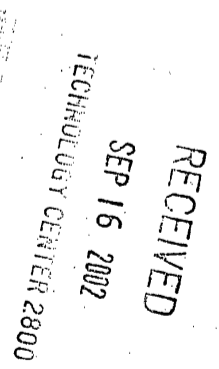
I certify that this document and fee is being deposited on <b>September 9, 2002</b> with the U.S. Postal Service as first class mail under 37 C.F.R. 1.8 and is addressed to the Assistant Commissioner for Patents, Washington, D.C. 20231.
_____ Signature of Person Mailing Correspondence
<b>Mishelle Mustafa</b> Typed or Printed Name of Person Mailing Certificate

\*This certificate may only be used if paying by deposit account.

*Anthony N. Fresco*  
\_\_\_\_\_  
Signature  
**Anthony N. Fresco**  
Registration No.: 45,784

Dated: **September 9, 2002**

**SCULLY, SCOTT, MURPHY & PRESSER**  
400 Garden City Plaza  
Garden City, New York 11530  
(516) 742-4343/4366 Fax  
ANF:yd  
cc:







09/596,415

PATENT

**IN THE UNITED STATES PATENT AND TRADEMARK OFFICE**

<b>Applicant(s):</b> Masayoshi Tagami, et al.	<b>Examiner:</b> H. Vu
<b>Serial No.:</b> 09/596,415	<b>Art Unit:</b> 2811
<b>Filed:</b> June 19, 2000	<b>Docket:</b> 13715
<b>For:</b> MULTI-LAYERED WIRING LAYER AND METHOD OF FABRICATING THE SAME	<b>Dated:</b> September 9, 2002

Assistant Commissioner for Patents  
United States Patent and Trademark Office  
Washington, D.C. 20231

**STATEMENT PURSUANT  
TO 37 C.F.R. § 1.97(c)(1) and (e)(1)**

Sir:

I hereby state that each item of information contained in this Information Disclosure Statement was first cited in any communication from a foreign patent office in a counterpart foreign application not more than three months prior to the filing of this Information Disclosure Statement.

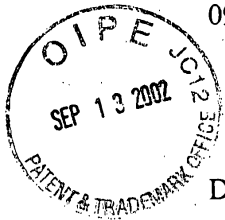
**CERTIFICATE OF MAILING UNDER 37 C.F.R. §1.8(a)**

I hereby certify that this correspondence is being deposited with the United States Postal Service as first class mail in an envelope addressed to: Assistant Commissioner for Patents, Washington, D.C. 20231 on September 9, 2002.

**Dated:** September 9, 2002

  
**Mishelle Mustafa**

G:\nec\1210\13715\amend\13715.statement



09/596,415

Accordingly, it is respectfully requested that the accompanying Information Disclosure Statement be considered with respect to the above-identified application.

Respectfully submitted,

*Anthony N. Fresco*

Anthony N. Fresco

Registration No.: 45,784

SCULLY, SCOTT, MURPHY & PRESSER  
400 Garden City Plaza  
Garden City, New York 11530  
(516) 742-4343/4366 Fax

ANF:yd

G:\nec\1210\13715\amend\13715.statement



09/596,415

PATENT

**IN THE UNITED STATES PATENT AND TRADEMARK OFFICE**

**Applicant(s):** Masayoshi Tagami, et al.

**Examiner:** H. Vu

**Serial No.:** 09/596,415

**Art Unit:** 2811

**Filed:** June 19, 2000

**Docket:** 13715

**For:** MULTI-LAYERED WIRING LAYER AND METHOD OF FABRICATING THE SAME

**Dated:** September 2002

#15  
Prior Art  
FJONE  
10-30-02

TECHNOLOGY CENTER 2800  
SEP 16 2002  
RECEIVED

Assistant Commissioner for Patents  
United States Patent and Trademark Office  
Washington, D.C. 20231

**INFORMATION DISCLOSURE STATEMENT**

Sir:

In accordance with 37 C.F.R. §§ 1.97 and 1.98, it is requested that the following references, which are also listed on the attached Form PTO-1449, be made of record in the above-identified case.

1. Japanese Laid-Open Patent Application No. 8-250596 dated September 27, 1996;
2. Japanese Laid-Open Patent Application No. 10-125627 dated May 15, 1998;
3. Japanese Laid-Open Patent Application No. 11-67686 dated March 9, 1999.

10/30/2002 SSURLES 00000006 191013 09596415  
01 FC:1460 -130.00 CH

**CERTIFICATE OF MAILING UNDER 37 C.F.R. §1.8(a)**

I hereby certify that this correspondence is being deposited with the United States Postal Service as first class mail in an envelope addressed to: Assistant Commissioner for Patents, Washington, D.C. 20231 on September 9, 2002.

**Dated:** September 9, 2002

**Mishelle Mustafa**

Adjustment date: 03/31/2003 EKKUDAY1  
10/30/2002 SSURLES 00000006 191013 09596415  
01 FC:1460 130.00 CH

09/596,415



The references were cited in an Official Action dated July 5, 2002 received from the Japanese Patent Office. Applicants are submitting copies of the above-cited references, together with a translation of the Examiner's comments regarding the references from the Official Action. The relevance of the references is described in the Official Action.

In compliance with the requirements of 37 C.F.R. § 1.98(a)(3), as a concise statement of relevance, as it is presently understood by the individual designated in 37 C.F.R. § 1.56(c) most knowledgeable about the content of the information, the undersigned submits a translation of portions of an official action by a foreign examiner in which the references were cited. The relevance to the pending U.S. patent application is that the references were cited in a foreign patent application on the same subject matter. However, no independent analysis of the references, the accuracy of the statement of the foreign examiner or the claims of the foreign application under the laws of that country or the United States relative to the subject matter claimed in the present application has been made; the present understanding of the contents thereof by the undersigned being based on the translation of the foreign examiner's comments submitted herewith.



09/596,415

Inasmuch as this Information Disclosure Statement is being submitted in accordance with the schedule set out in 37 C.F.R. § 1.97(b), a statement is enclosed.

Respectfully submitted,

*Anthony N. Fresco*

Anthony N. Fresco  
Registration No.: 45,784

SCULLY, SCOTT, MURPHY & PRESSER  
400 Garden City Plaza  
Garden City, New York 11530  
(516) 742-4343/4366 Fax

ANF:yd

**INFORMATION DISCLOSURE CITATION**  
(Use several sheets if necessary)

Docket Number (Optional) <b>13715</b>	Application Number <b>09/596,415</b>
Applicant(s) <b>Masayoshi Tagami, et al.</b>	
Filing Date <b>June 19, 2000</b>	Group Art Unit <b>2811</b>

**U.S. PATENT DOCUMENTS**

*EXAMINER INITIAL	REF	DOCUMENT NUMBER	DATE	NAME	CLASS	SUBCLASS	FILING DATE IF APPROPRIATE

**FOREIGN PATENT DOCUMENTS**

	REF	DOCUMENT NUMBER	DATE	COUNTRY	CLASS	SUBCLASS	Translation	
							YES	NO
<input checked="" type="checkbox"/>		8-250596	9/27/1996	Japan	-	-		<input checked="" type="checkbox"/>
<input checked="" type="checkbox"/>		10-125627	5/15/1998	Japan	-	-		<input checked="" type="checkbox"/>
<input checked="" type="checkbox"/>		11-67686	3/9/1999	Japan	-	-		<input checked="" type="checkbox"/>

**OTHER DOCUMENTS** (Including Author, Title, Date, Pertinent Pages, Etc.)


EXAMINER <b>HONG K. JU</b>	DATE CONSIDERED <b>11/19/02</b>
-------------------------------	------------------------------------

EXAMINER: Initial if citation considered, whether or not citation is in conformance with MPEP Section 609; Draw line through citation if not in conformance and not considered. Include copy of this form with next communication to applicant.

**INFORMATION DISCLOSURE CITATION**  
(Use several sheets if necessary)

Docket Number (Optional) <b>13715</b>	Application Number <b>09/596,415</b>
Applicant(s) <b>Masayoshi Tagami, et al.</b>	
Filing Date <b>June 19, 2000</b>	Group Art Unit <b>2811</b>

**U.S. PATENT DOCUMENTS**

*EXAMINER INITIAL	REF	DOCUMENT NUMBER	DATE	NAME	CLASS	SUBCLASS	FILING DATE IF APPROPRIATE

**FOREIGN PATENT DOCUMENTS**

	REF	DOCUMENT NUMBER	DATE	COUNTRY	CLASS	SUBCLASS	Translation	
							YES	NO
✓		8-250596	9/27/1996	Japan	-	-		✓
✓		10-125627	5/15/1998	Japan	-	-		✓
✓		11-67686	3/9/1999	Japan	-	-		✓

**OTHER DOCUMENTS** (Including Author, Title, Date, Pertinent Pages, Etc.)


EXAMINER <b>HUNG K. JU</b>	DATE CONSIDERED <b>11/19/02</b>
-------------------------------	------------------------------------

EXAMINER: Initial if citation considered, whether or not citation is in conformance with MPEP Section 609; Draw line through citation if not in conformance and not considered. Include copy of this form with next communication to applicant.

#18 Pat Rev

**\*RETURN TO FMF - LOCATION 7540**

QUERY CONTROL FORM		RTIS USE ONLY	
Application No. <u>09/396,415</u>	Prepared by <u>BAB</u>	<del>Tracking Number</del>	
Examiner-GAU <u>Vu 2811</u>	Date <u>1/10/03</u>	<del>Week Date</del>	
	No. of queries <u>1</u>		

JACKET			
a. Serial No.	f. Foreign Priority	k. Print Claim(s)	p. PTO-1449
b. Applicant(s)	g. Disclaimer	l. Print Fig.	q. PTOL-85b
c. Continuing Data	h. Microfiche Appendix	m. Searched Column	r. Abstract
d. PCT	i. Title	n. PTO-270/328	s. Sheets/Figs
e. Domestic Priority	j. Claims Allowed	o. PTO-892	t. Other

SPECIFICATION	MESSAGE
a. Page Missing	<p><u>10 sheets/fig -</u>  <u>Drawings damaged due</u>  <u>to irradiation. Please</u>  <u>reconcile.</u></p>
b. Text Continuity	
c. Holes through Data	
d. Other Missing Text	
e. Illegible Text	
f. Duplicate Text	
g. Brief Description	
h. Sequence Listing	
i. Appendix	
j. Amendments	
k. Other	
<b>CLAIMS</b>	
a. Claim(s) Missing	<p><i>Thanks</i></p> <p>initials <u>BAB</u></p>
b. Improper Dependency	
c. Duplicate Numbers	
d. Incorrect Numbering	
e. Index Disagrees	
f. Punctuation	
g. Amendments	
h. Bracketing	
i. Missing Text	
j. Duplicate Text	
k. Other	
<b>RESPONSE</b>	
	initials <u>NC</u>





UNITED STATES PATENT AND TRADEMARK OFFICE

UNITED STATES DEPARTMENT OF COMMERCE  
United States Patent and Trademark Office  
Address: COMMISSIONER OF PATENTS AND TRADEMARKS  
Washington, D.C. 20231  
www.uspto.gov

APPLICATION NO.	FILING DATE	FIRST NAMED INVENTOR	ATTORNEY DOCKET NO.	CONFIRMATION NO.
09/596,415	06/19/2000	Masayoshi Tagami	13715	3425

23389 7590 11/20/2002

SCULLY SCOTT MURPHY & PRESSER, PC  
400 GARDEN CITY PLAZA  
GARDEN CITY, NY 11530

EXAMINER

VU, HUNG K

ART UNIT PAPER NUMBER

2811

DATE MAILED: 11/20/2002

Please find below and/or attached an Office communication concerning this application or proceeding.



UNITED STATES DEPARTMENT OF COMMERCE  
Patent and Trade Mark Office

Address: ASSISTANT COMMISSIONER FOR PATENTS  
Washington, D.C. 20231

09/ 596415

*[Handwritten mark]*

APPLICATION NO. / CONTROL NO.	FILING DATE	FIRST NAMED INVENTOR / PATENT IN REEXAMINATION	ATTORNEY DOCKET NO.
----------------------------------	-------------	---	---------------------

EXAMINER

ART UNIT	PAPER
----------	-------

16

DATE MAILED:

Please find below and/or attached an Office communication concerning this application or proceeding.

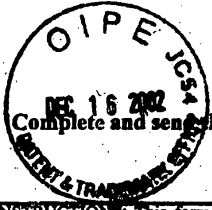
Commissioner of Patents and Trademarks

The IDS filed 09/09/02 had been entered and considered by the examiner..

*Tom Thomas*

TOM THOMAS  
SUPERVISORY PATENT EXAMINER  
TECHNOLOGY CENTER 2800

BEST COPY



PART B - FEE(S) TRANSMITTAL

Complete and send this form, together with applicable fee(s), to: Mail Box ISSUE FEE  
Commissioner for Patents  
Washington, D.C. 20231  
Fax (703)746-4000

INSTRUCTIONS: This form should be used for transmitting the ISSUE FEE and PUBLICATION FEE (if required). Blocks 1 through 4 should be completed where appropriate. All further correspondence including the Patent, advance orders and notification of maintenance fees will be mailed to the current correspondence address as indicated unless corrected below or directed otherwise in Block 1, by (a) specifying a new correspondence address; and/or (b) indicating a separate "FEE ADDRESS" for maintenance fee notifications.

CURRENT CORRESPONDENCE ADDRESS (Note: Legibly mark-up with any corrections or use block 1)  
7590 09/10/2002

Paul J Esatto Jr  
Scully Scott Murphy & Presser  
400 Garden City Plaza  
Garden City, NY 11530

Note: A certificate of mailing can only be used for domestic mailings of the Fee(s) Transmittal. This certificate cannot be used for any other accompanying paper. Each additional paper, such as an assignment or formal drawing, must have its own certificate of mailing or transmission.

Certificate of Mailing or Transmission  
I hereby certify that this Fee(s) Transmittal is being deposited with the United States Postal Service with sufficient postage for first class mail in an envelope addressed to the Box Issue Fee address above, or being facsimile transmitted to the USPTO, on the date indicated below.  
Michelle Mustafa (Depositor's name)  
(Signature)  
December 10, 2002 (Date)

APPLICATION NO.	FILING DATE	FIRST NAMED INVENTOR	ATTORNEY DOCKET NO.	CONFIRMATION NO.
09/596,413	06/19/2000	Masayoshi Tagami	13715	3425

TITLE OF INVENTION: MULTI-LAYERED WIRING LAYER AND METHOD OF FABRICATING THE SAME

APPLN. TYPE	SMALL ENTITY	ISSUE FEE	PUBLICATION FEE	TOTAL FEE(S) DUE	DATE DUE
nonprovisional	NO	\$1280	\$0	\$1280	12/10/2002

EXAMINER	ART UNIT	CLASS-SUBCLASS
VU, HUNG K	2811	257-751000

1. Change of correspondence address or indication of "Fee Address" (37 CFR 1.363).
- Change of correspondence address (or Change of Correspondence Address form PTO/SB/122) attached.
- "Fee Address" indication (or "Fee Address" Indication form PTO/SB/47; Rev 03-02 or more recent) attached. Use of a Customer Number is required.
2. For printing on the patent front page, list (1) the names of up to 3 registered patent attorneys or agents OR, alternatively, (2) the name of a single firm (having as a member a registered attorney or agent) and the names of up to 2 registered patent attorneys or agents. If no name is listed, no name will be printed.
- Scully, Scott, Murphy & Presser

3. ASSIGNEE NAME AND RESIDENCE DATA TO BE PRINTED ON THE PATENT (print or type)
- PLEASE NOTE: Unless an assignee is identified below, no assignee data will appear on the patent. Inclusion of assignee data is only appropriate when an assignment has been previously submitted to the USPTO or is being submitted under separate cover. Completion of this form is NOT a substitute for filing an assignment.
- (A) NAME OF ASSIGNEE: NEC Corporation
- (B) RESIDENCE: (CITY and STATE OR COUNTRY): Tokyo, Japan

Please check the appropriate assignee category or categories (will not be printed on the patent)  individual  corporation or other private group entity  government

- 4a. The following fee(s) are enclosed:
- Issue Fee
- Publication Fee
- Advance Order - # of Copies 1
- 4b. Payment of Fee(s):
- A check in the amount of the fee(s) is enclosed.
- Payment by credit card. Form PTO-2038 is attached.
- The Commissioner is hereby authorized by charge the required fee(s), or credit any overpayment, to Deposit Account Number 9-1013/SB/00 (enclose an extra copy of this form).

Commissioner for Patents is requested to apply the Issue Fee and Publication Fee (if any) or to re-apply any previously paid issue fee to the application identified above.

(Authorized Signature) Paul J. Esatto, Jr. Reg. No. 30,749 (Date) December 10, 2002

NOTE: The Issue Fee and Publication Fee (if required) will not be accepted from anyone other than the applicant, a registered attorney or agent, or the assignee or other party in interest as shown by the records of the United States Patent and Trademark Office.

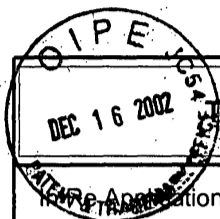
This collection of information is required by 37 CFR 1.311. The information is required to obtain or retain a benefit by the public which is to file (and by the USPTO to process) an application. Confidentiality is governed by 35 U.S.C. 122 and 37 CFR 1.14. This collection is estimated to take 12 minutes to complete, including gathering, preparing, and submitting the completed application form to the USPTO. Time will vary depending upon the individual case. Any comments on the amount of time you require to complete this form and/or suggestions for reducing this burden, should be sent to the Chief Information Officer, U.S. Patent and Trademark Office, U.S. Department of Commerce, Washington, D.C. 20231. DO NOT SEND FEES OR COMPLETED FORMS TO THIS ADDRESS. SEND TO: Commissioner for Patents, Washington, DC 20231.

Under the Paperwork Reduction Act of 1995, no persons are required to respond to a collection of information unless it displays a valid OMB control number.

12/17/2002 BNGUYEN 00000241 09596415

01 FC:1501 1280.00 00  
02 FC:8001 3.00 00

TRANSMIT THIS FORM WITH FEE(S)



**TRANSMITTAL OF FORMAL DRAWINGS**

Docket No.  
13715

# 17000

Invention Of: Masayoshi Tagami

Serial No.	Filing Date	Batch No.	Examiner	Art Unit
09/596,415	June 19, 2000		Hung K. VU	2811

Invention: **MULTI-LAYERED WIRING LAYER AND METHOD OF FABRICATING THE SAME**

Address to:  
Assistant Commissioner for Patents  
Washington, D.C. 20231

Transmitted herewith are:

20 sheets of formal drawing(s) for this application.

Each sheet of drawing indicates the identifying indicia suggested in 37 CFR Section 1.84(c).

*Anthony N. Fresco*  
Signature

Dated: December 10, 2002

Anthony N. Fresco  
Registration No.: 45,784

SCULLY, SCOTT, MURPHY & PRESSER  
400 Garden City Plaza  
Garden City, New York 11530  
(516) 742-4343/4366 Fax  
ANF:yd

I certify that this document and attached formal drawings are being deposited on 12/10/2002 with the U.S. Postal Service as first class mail under 37 C.F.R. 1.8 and addressed to the Assistant Commissioner for Patents, Washington, D.C. 20231.

*Mishelle Mustafa*  
Signature of Person Mailing Correspondence

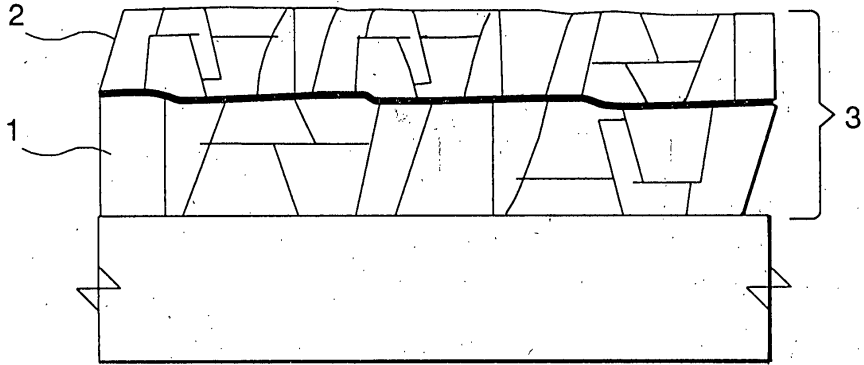
Mishelle Mustafa  
Typed or Printed Name of Person Mailing Correspondence

09/02

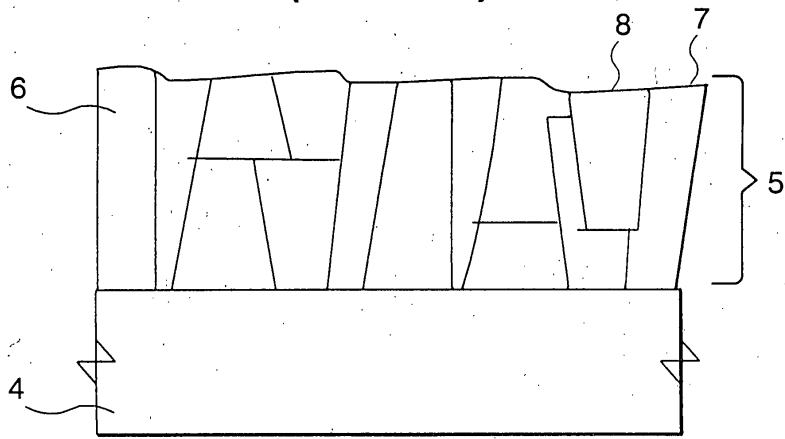
P23B/REV01



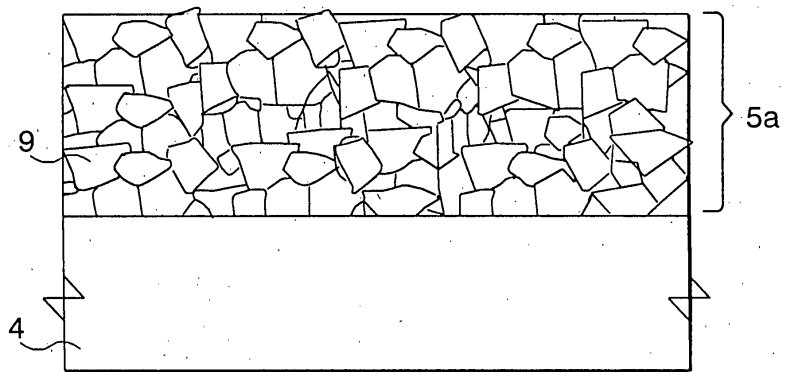
1/20



**FIG. 1**  
*(Prior Art)*



**FIG. 2**  
*(Prior Art)*



**FIG. 3**  
*(Prior Art)*



2/20

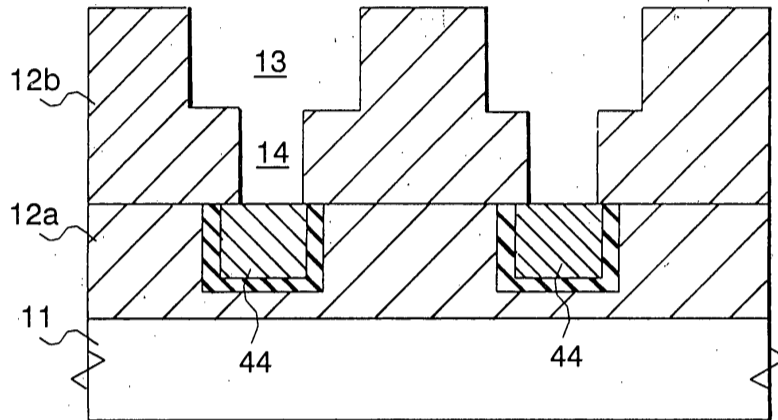


FIG. 4A

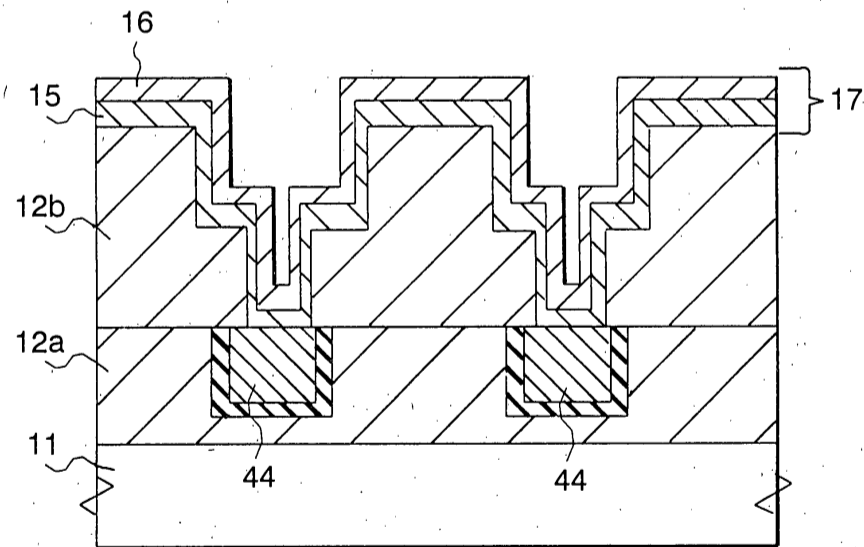


FIG. 4B



3/20

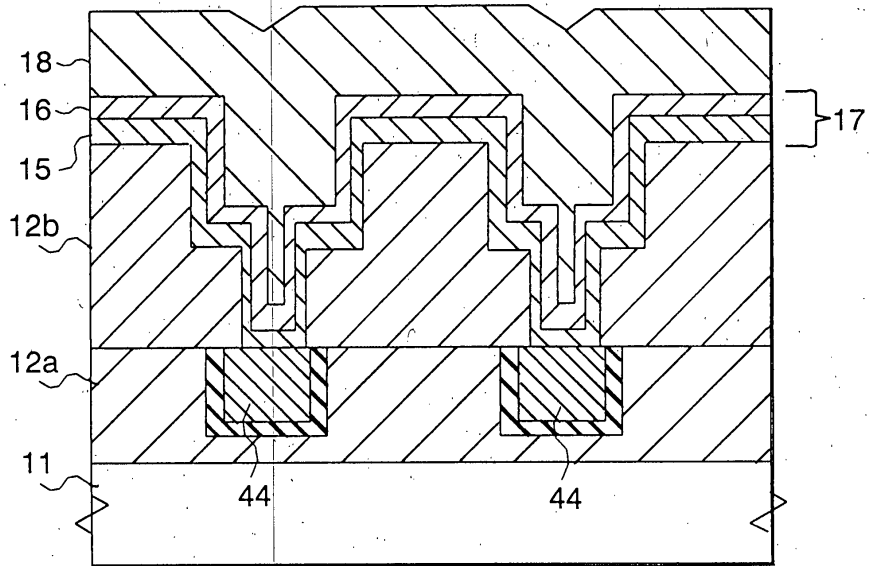


FIG. 4C

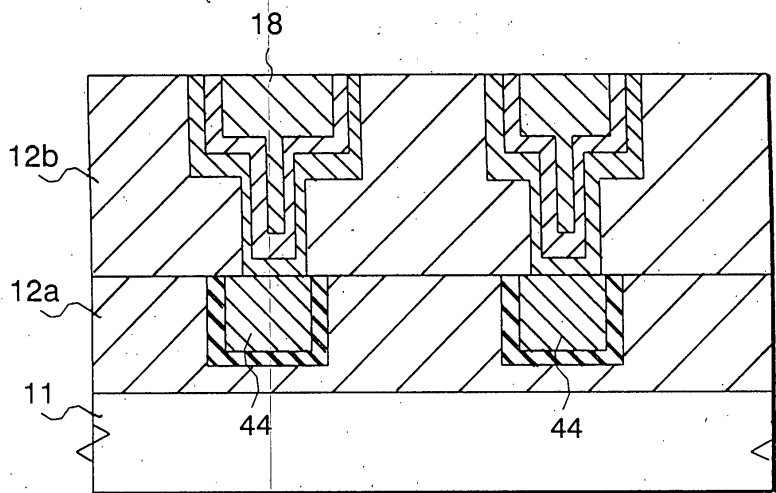


FIG. 4D



4/20

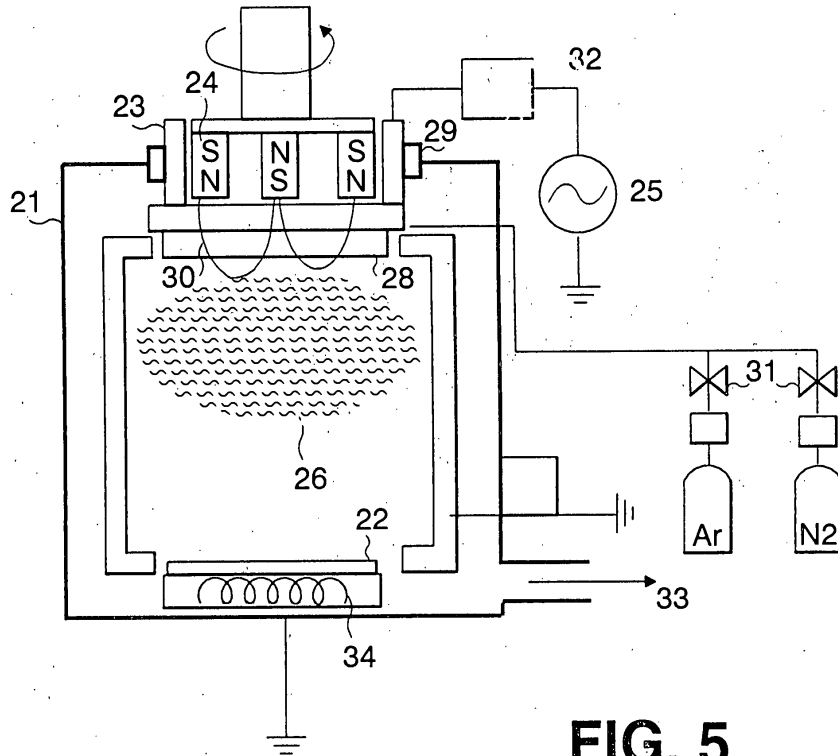


FIG. 5

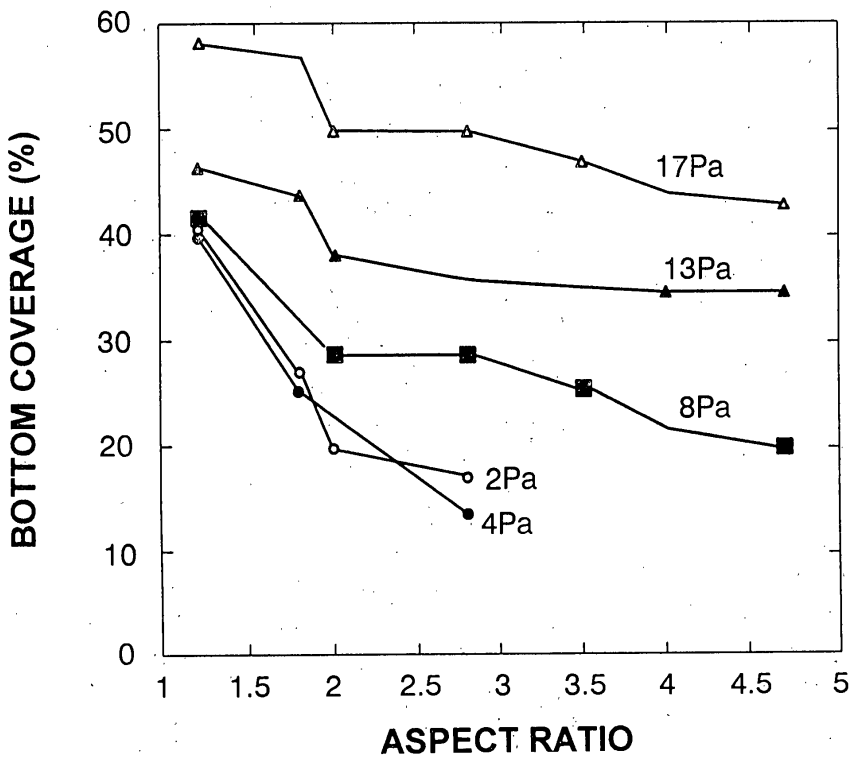


FIG. 6





5/20

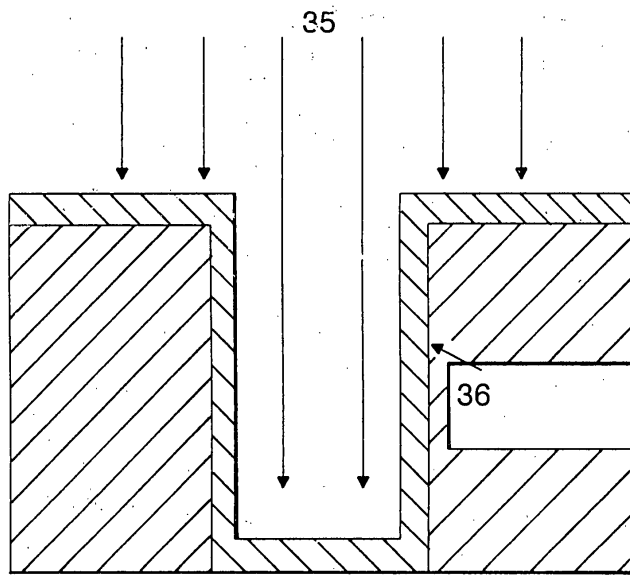


FIG. 7

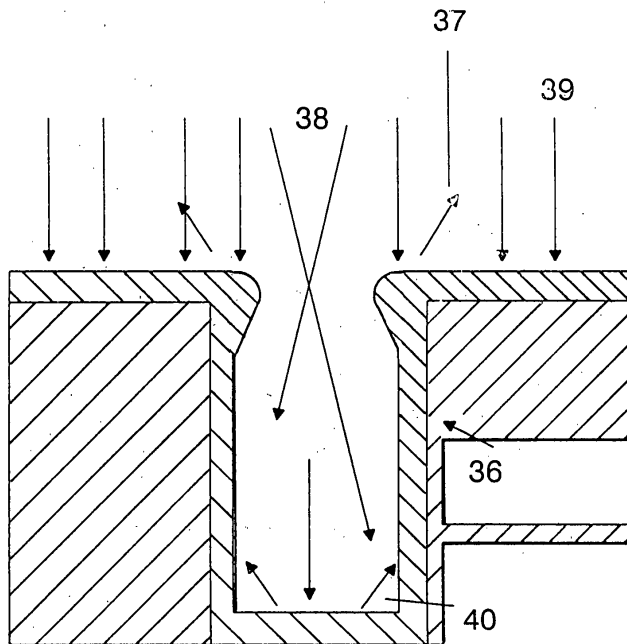


FIG. 8



6/20

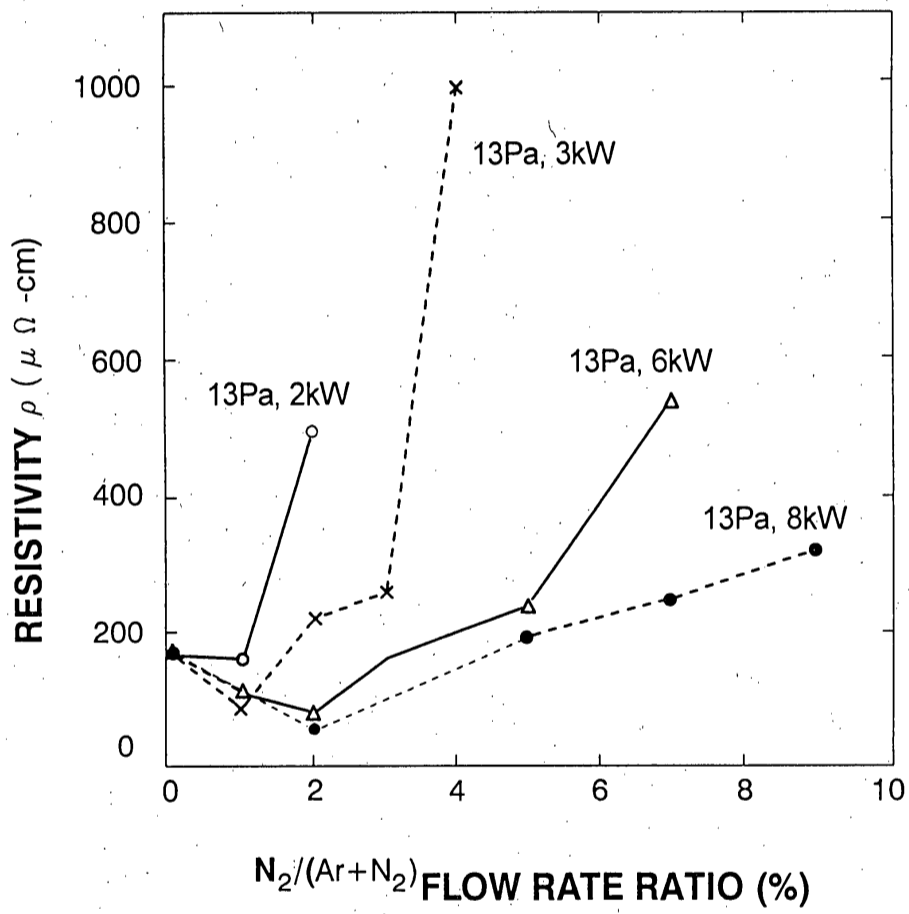


FIG. 9



7/20

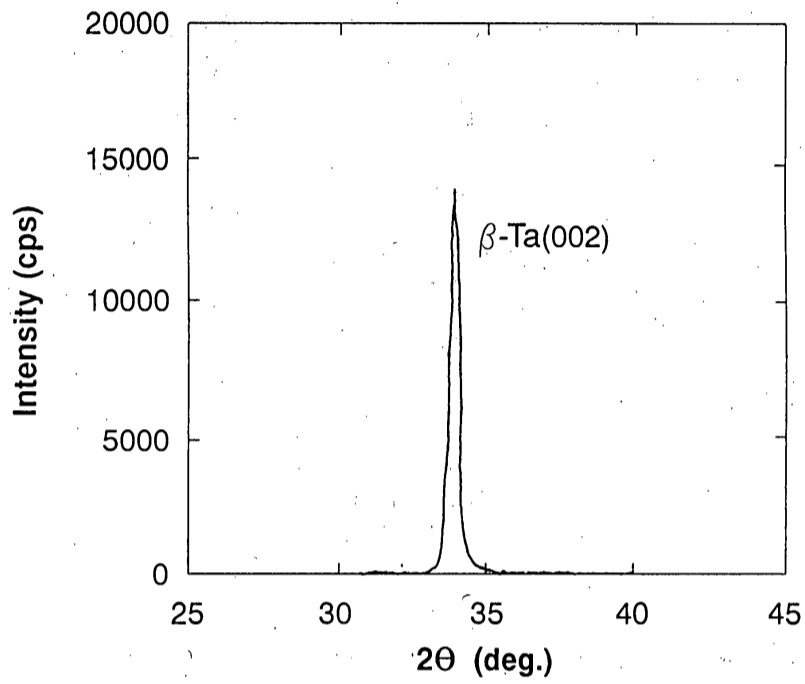


FIG. 10

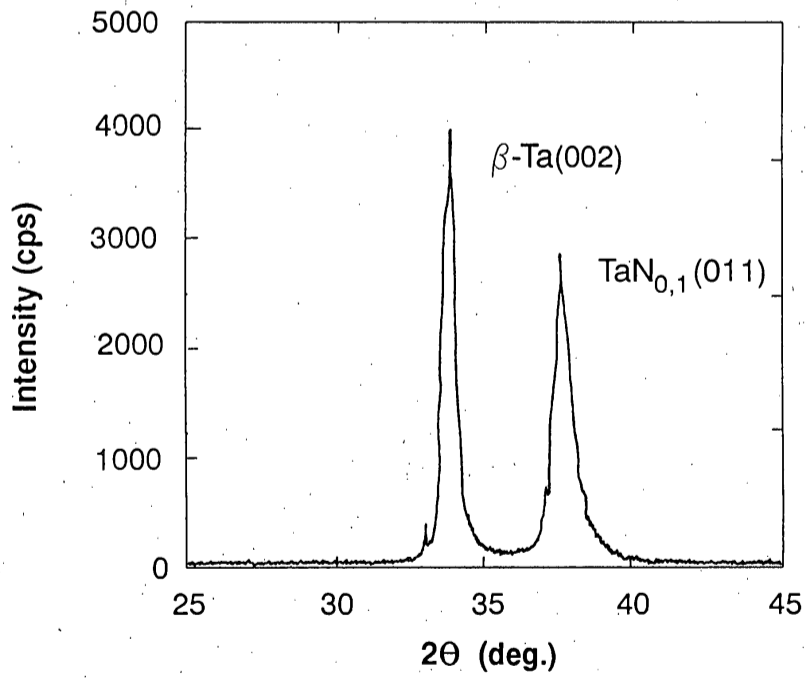


FIG. 11



8/20

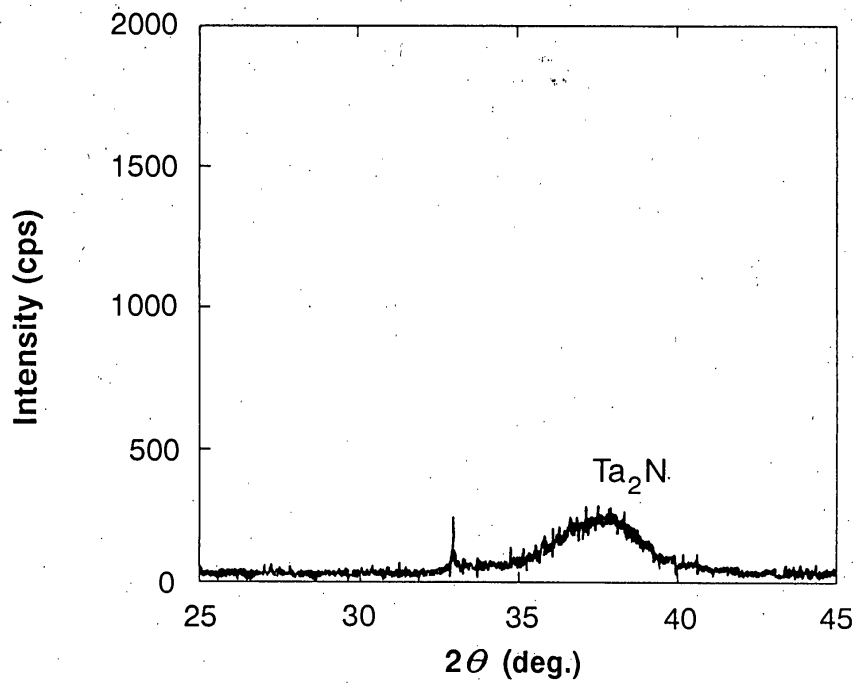


FIG. 12

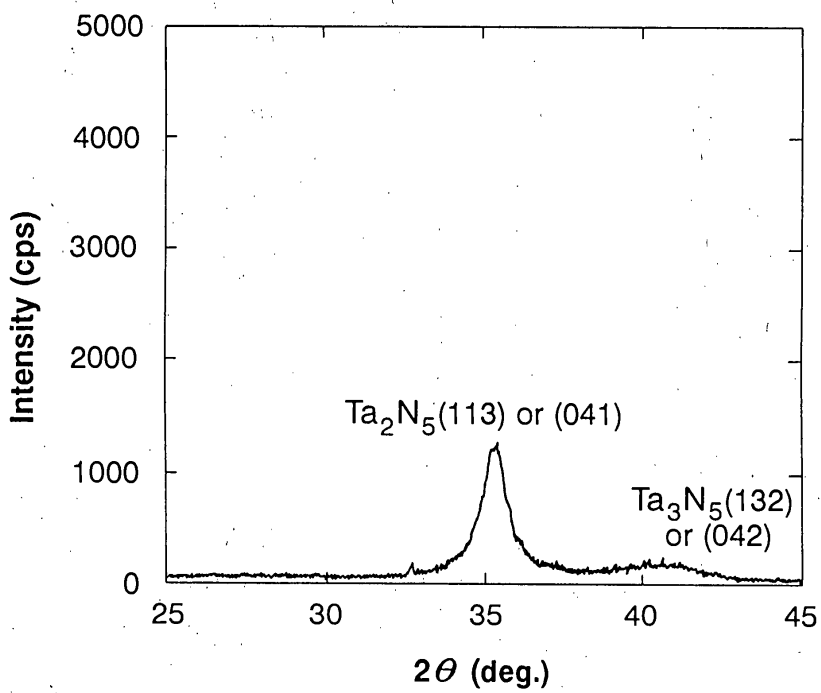
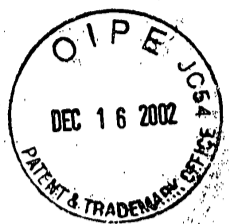


FIG. 13



9/20

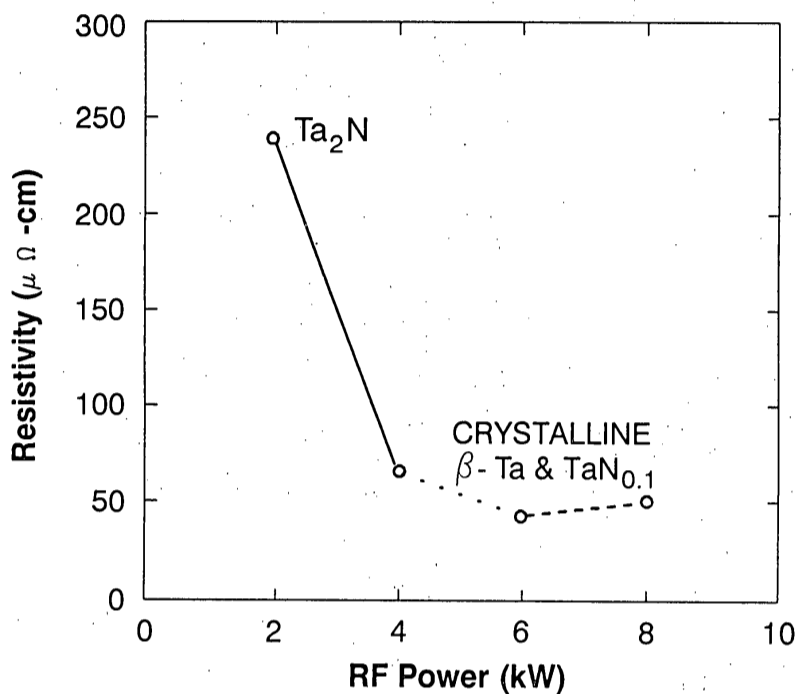


FIG. 14

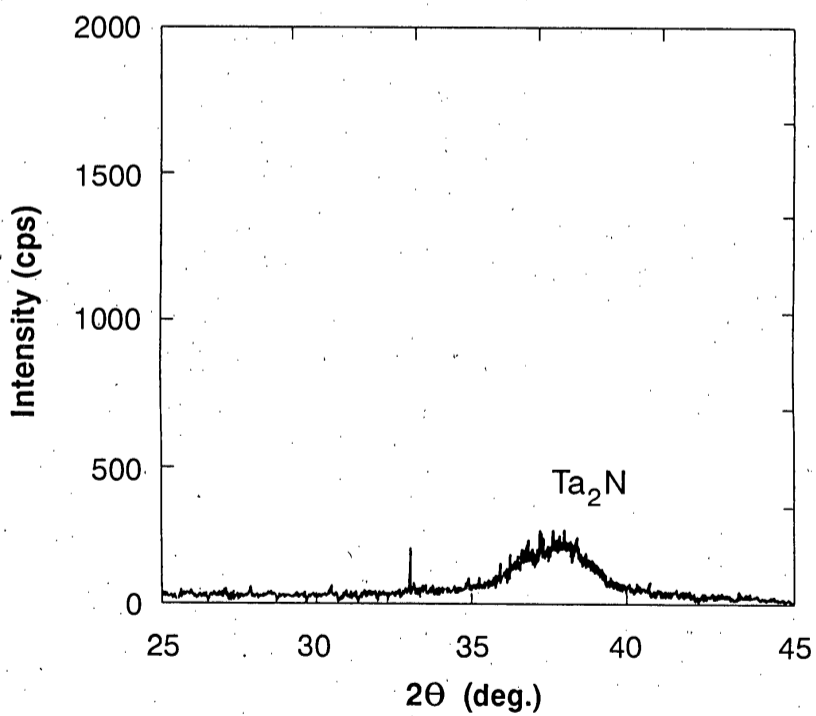


FIG. 15



10/20

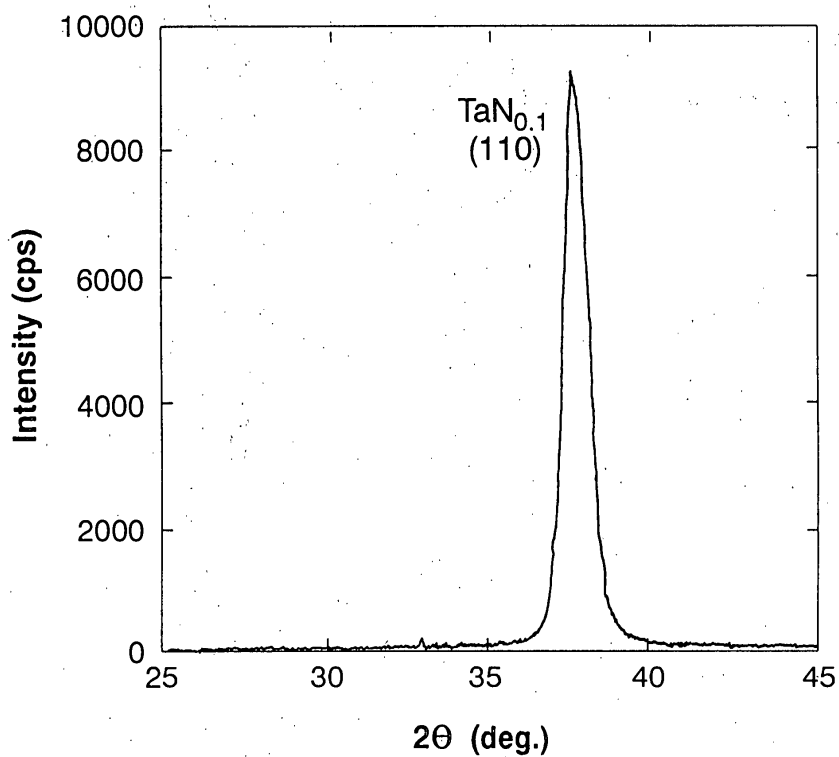


FIG. 16

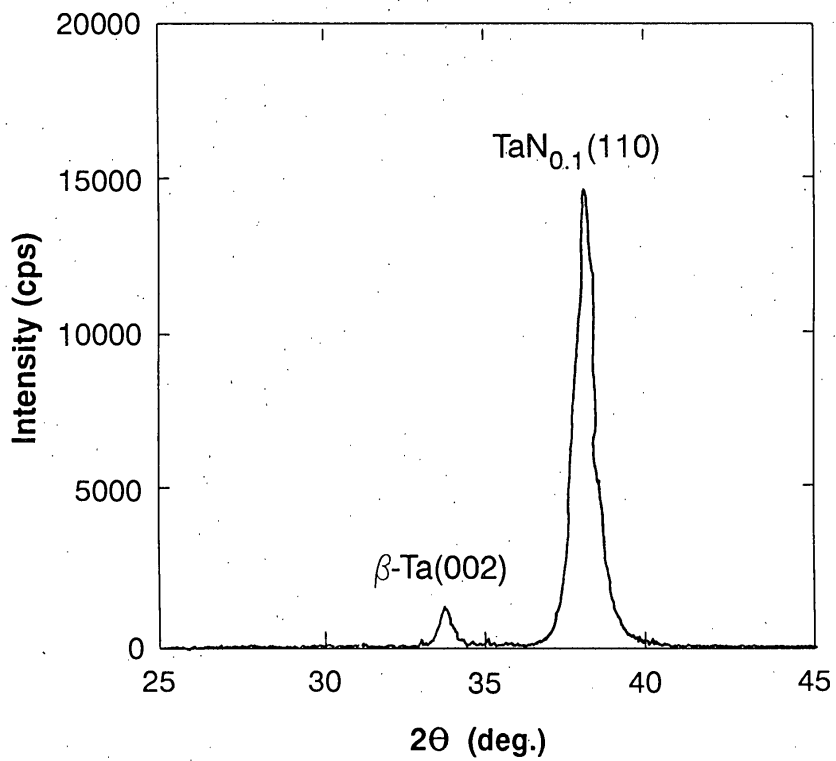
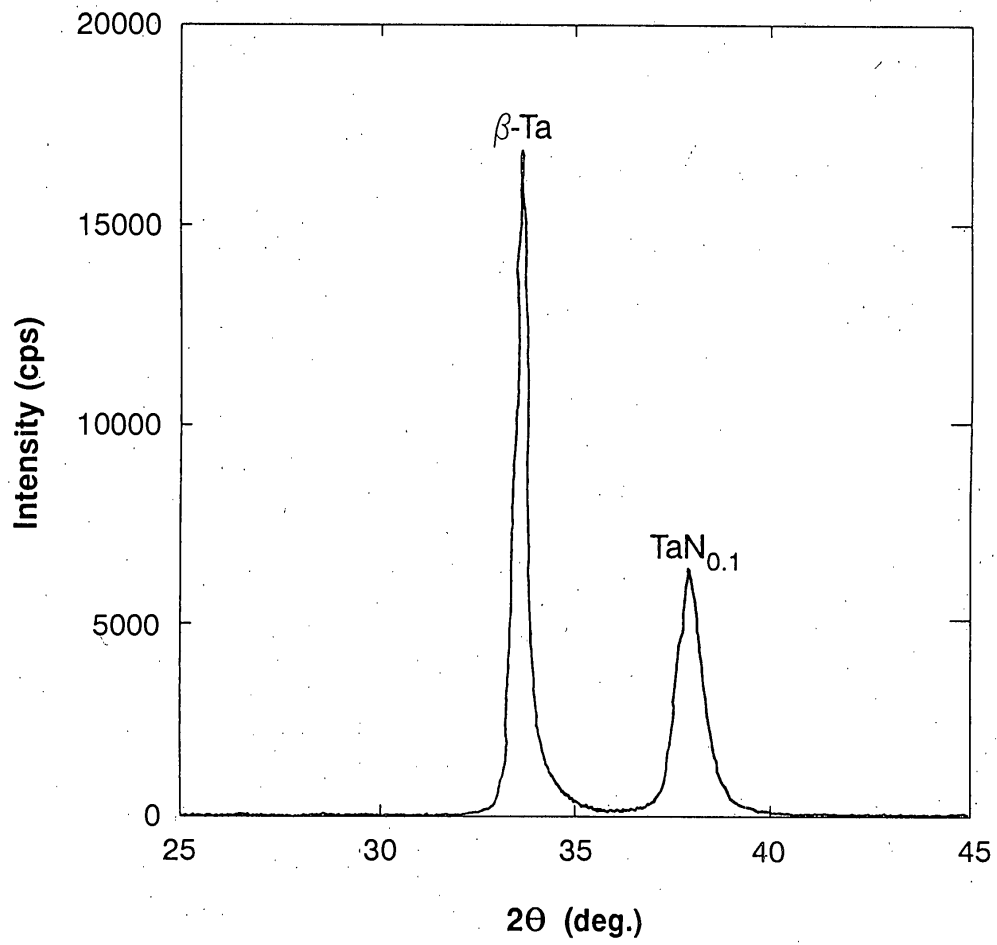


FIG. 17



11/20



**FIG. 18**

J1135 U.S. PTO



12/16/02

12/20

15



**FIG. 19**



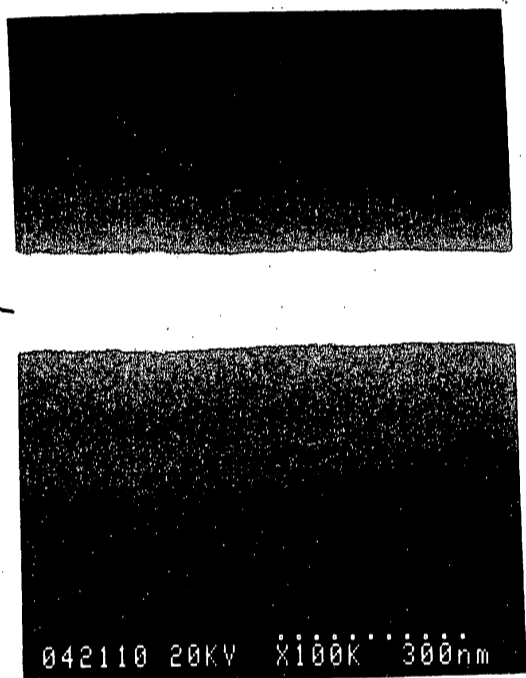
J1135 U.S. PTO



12/16/02

13/20

16



**FIG. 20**



14/20

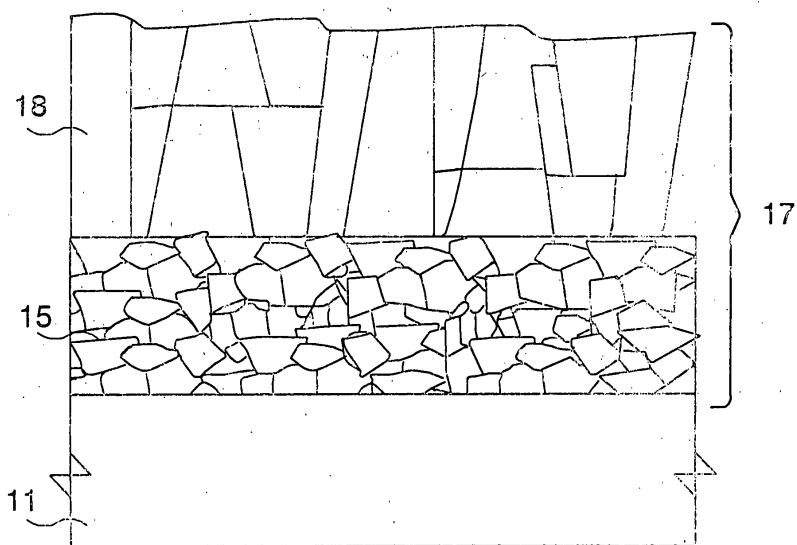
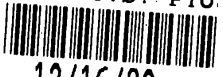


FIG. 21

J1135 U.S. PTO.



12/16/02

15/20

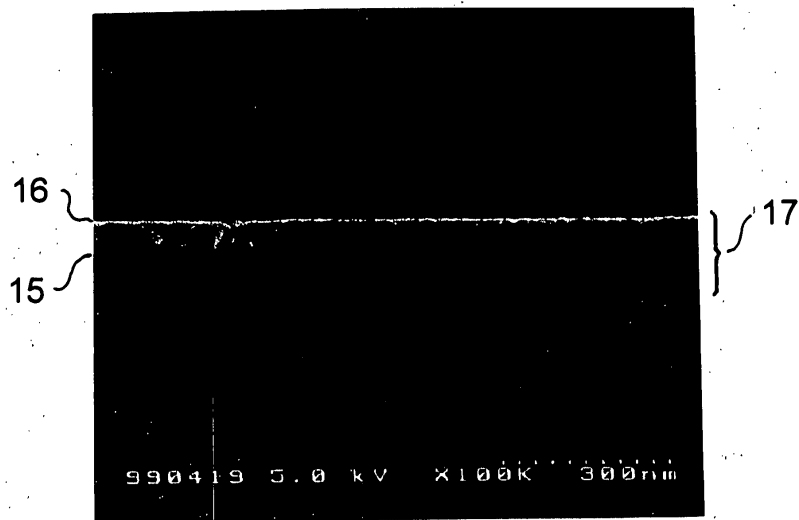


FIG. 22



16/20

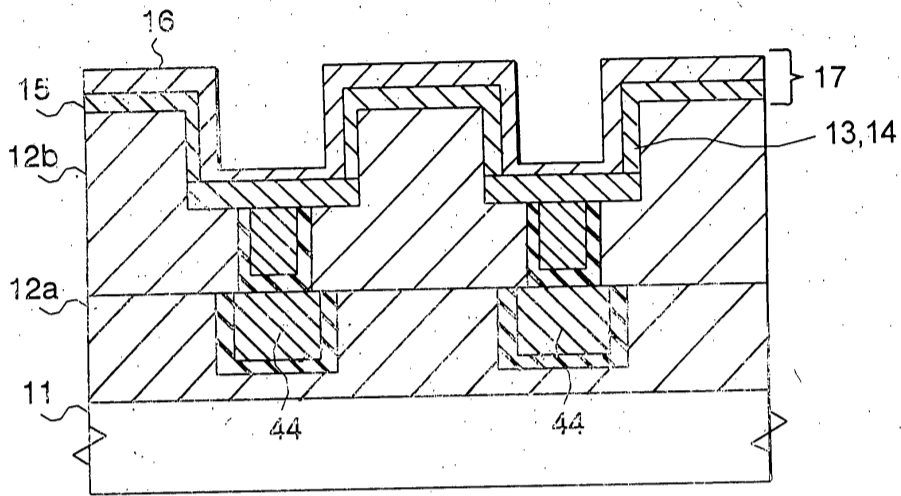


FIG. 23

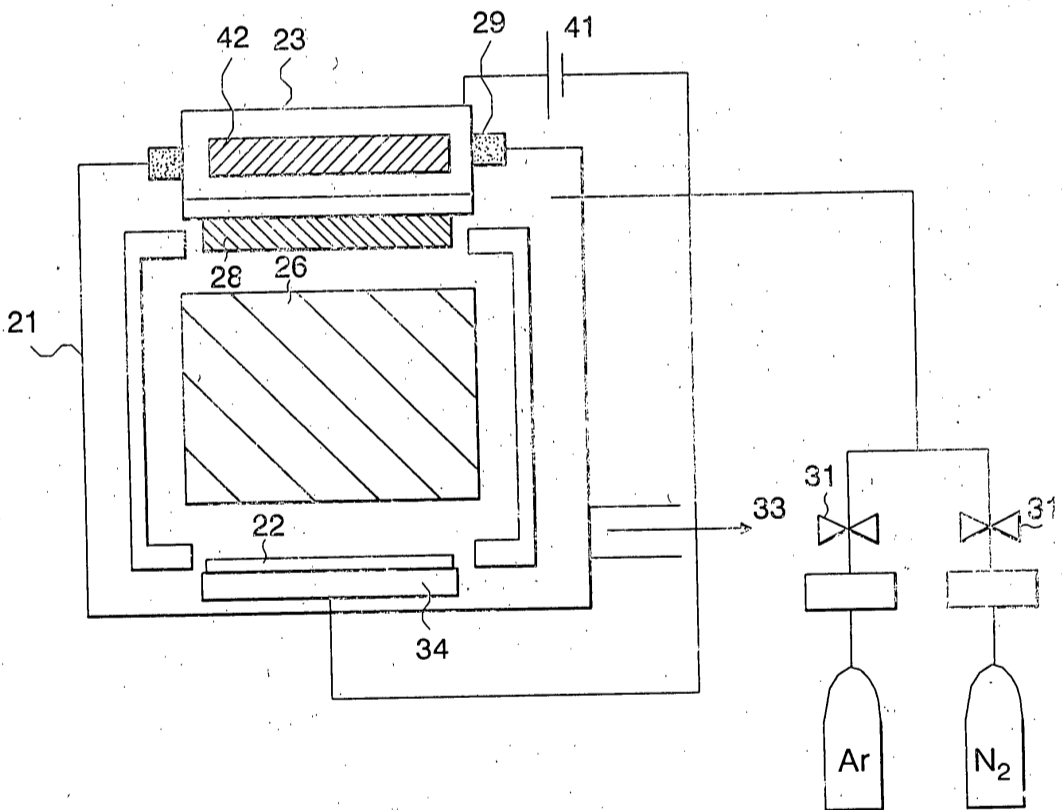


FIG. 24



17/20

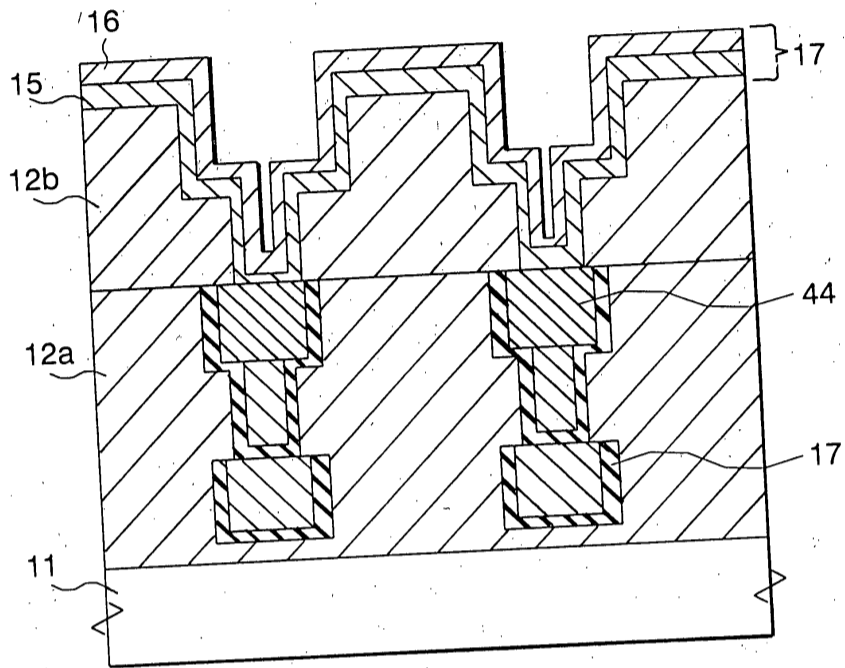


FIG. 25

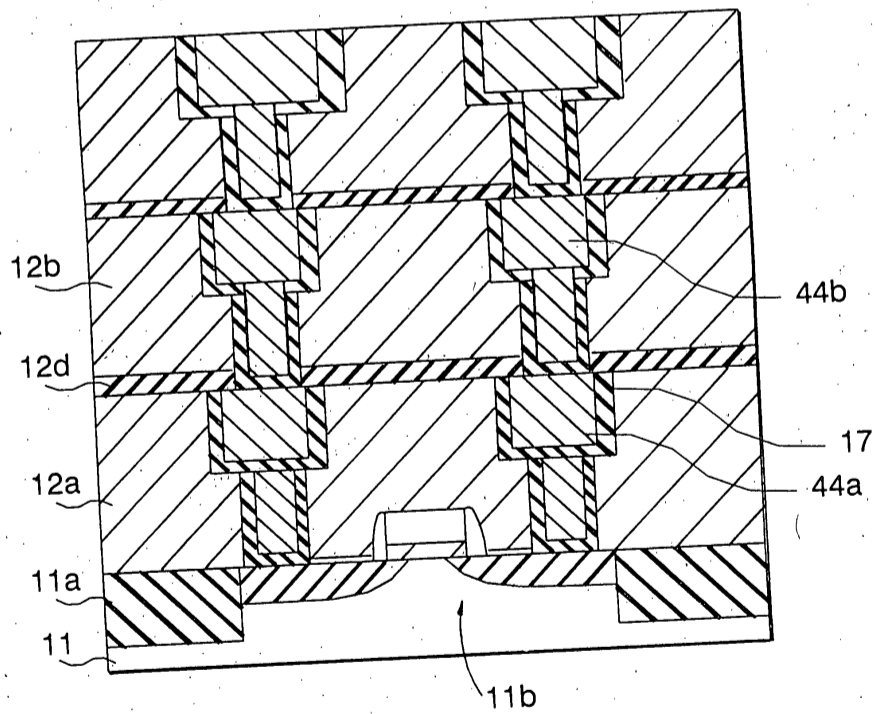


FIG. 26



18/20

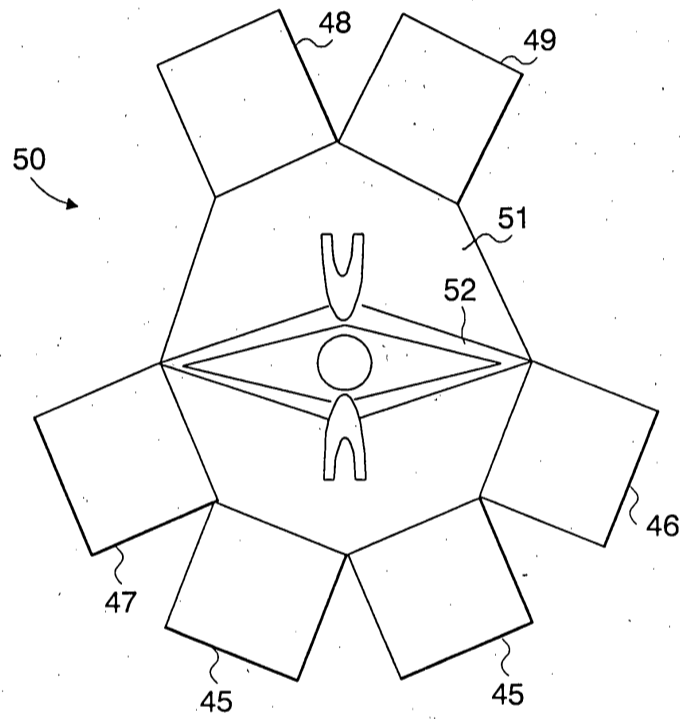


FIG. 27



19/20

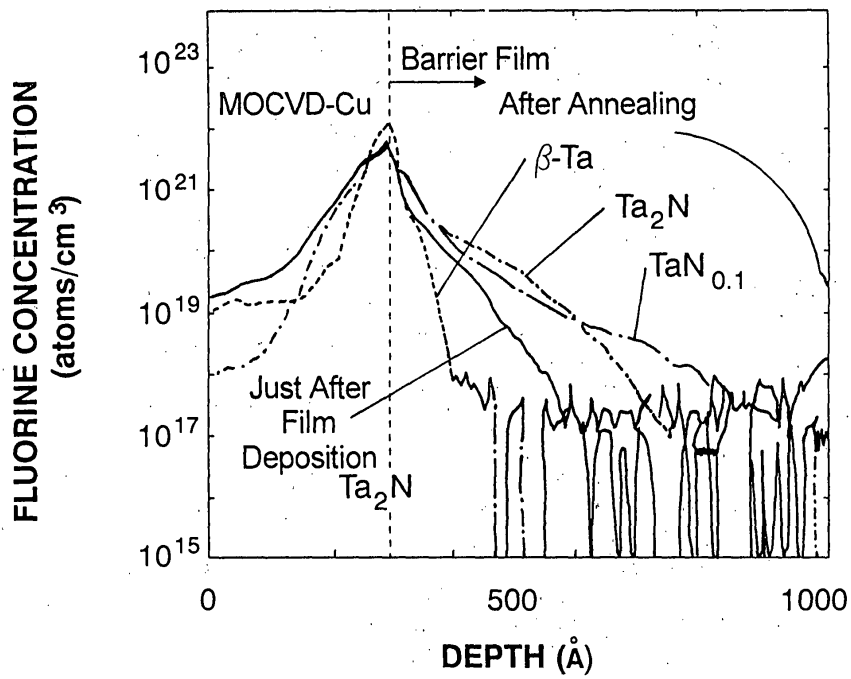


FIG. 28

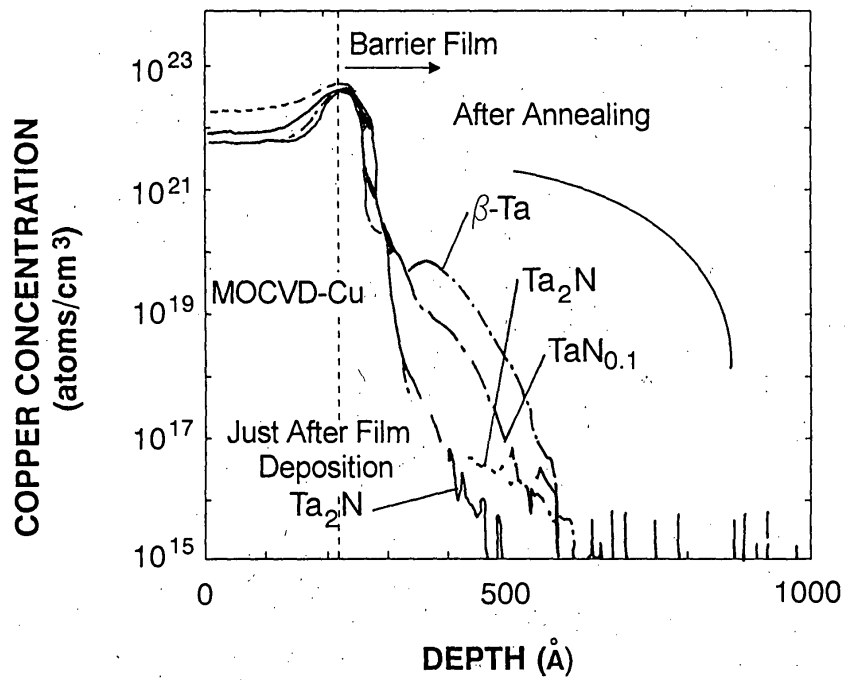


FIG. 29



20/20

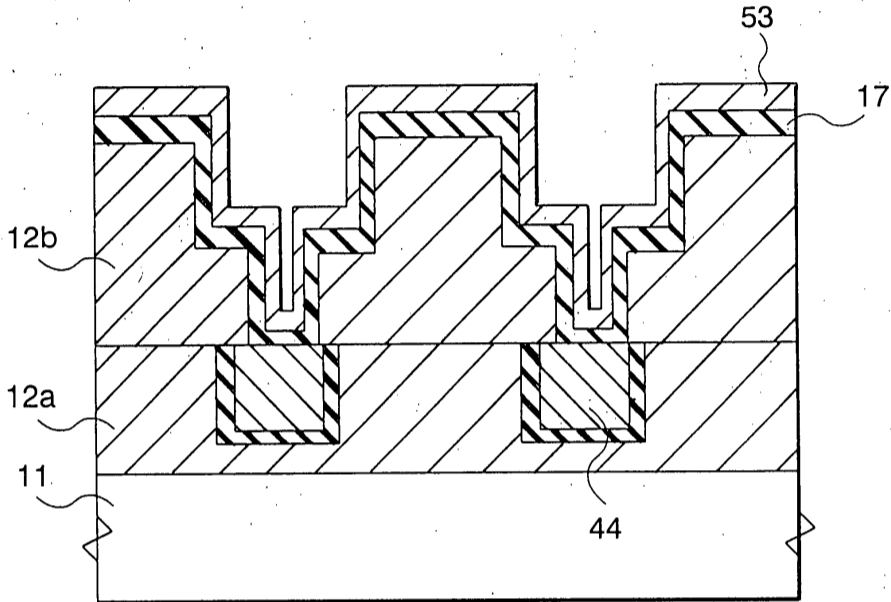


FIG. 30

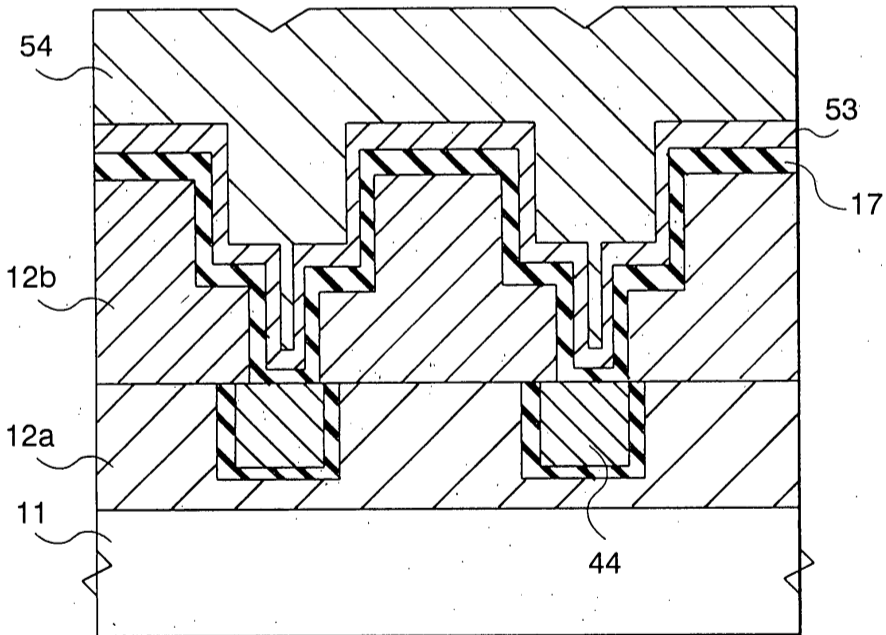


FIG. 31



400 Garden City Plaza  
Garden City, New York 11530  
(516) 742-4343 - Telephone  
(516) 742-4366 - Facsimile  
e.mail: Intprop@ssmp.com

**SCULLY, SCOTT, MURPHY  
& PRESSER**

# Fax

**To:** US Patent & Trademark Office  
Refund Section, Accounting Division  
Office of Finance

**From:** Linda Hagemeyer\Office Manager

---

**Fax:** 703-308-5077 **Pages:** 4

---

**Docket** 13715 **Date:** January 14, 2003

---

**Re:** Deposit Account No. 19-1013 **Attn:** Refund Section, Office of Finance

---

**Urgent**     **For Review**     **Please Comment**     **Please Reply**     **Please Recycle**

---

Attached is another Request for Refund.  
Please credit our account in the amount of \$130.00 as soon as possible.

CONFIDENTIALITY: The documents accompanying this facsimile transmission may contain information which is either confidential or legally privileged and is intended only for the authorized use of the individual or entity named above without right or publication or republication, dissemination or disclosure except as expressly set forth or established by course of dealing. All rights are reserved. If you are not the intended recipient, you are hereby notified that any disclosure, copying, distribution or use of the contents of this facsimile is prohibited. If you received this transmission in error, please notify us immediately by telephone to arrange for return of the documents.

If you have any problems concerning this facsimile, please call (516) 742-4343 and ask for Linda.

# 201 Reg for Refund  
03-31-03

IN THE UNITED STATES PATENT AND TRADEMARK OFFICE

Applicant(s): Masayoshi Tagami

Serial No: 09/596,415

Filing Date: June 19, 2000

Docket No.: 13715

Attention: Refund Section, Accounting Division  
Office of Finance

REQUEST FOR REFUND

Sir/Madam:

For the reason set forth below, Applicant(s) representatives request that they be refunded \$130.00 by crediting this amount to Deposit Account No. 19-1013. This amount is the official fee for a Petition which was charged to Deposit Account No. 19-1013 on October 30, 2002, Seq. No. 6 (Copy of deposit account attached).

There was no Petition filed in this case, nor was one requested for any reason, therefore, it is respectfully requested that Deposit Account No. 19-1013 be credited in the amount of \$130.00.

*Linda Hagemeyer*  
Linda Hagemeyer  
Office Manager

Scully, Scott, Murphy & Presser  
400 Garden City Plaza  
Garden City, New York 11530  
(516) 742-4343  
Dated: January 14, 2003

Deposit Account Statement

<https://rampsdev.uspto.gov/ram26/Controller.jsessionid=kirodv1xm2>



Return To:  
 USPTO  
 Home  
 Page  
 Finance  
 Home  
 Page

**Deposit Account Statement**

Requested Statement Month: October 2002  
 Deposit Account Number: 191013  
 Name: SCULLY, SCOTT, MURPHY & PRESSER  
 Attention: DEBORAH SHEEHAN  
 Address: A PROFESSIONAL CORPORATION  
 City: GARDEN CITY  
 State: NY  
 Zip: 11530-0299

DATE	SEQ	POSTING REF TXT	ATTORNEY DOCKET NBR	FEE CODE	AMT	BAL
10/01	9	10255362		9204	-\$18.00	\$17,302.88
10/01	203	09436164	13164	1801	\$740.00	\$16,562.88
10/01	204	09436164	13164	1251	\$110.00	\$16,452.88
10/03	115	09349352	12801	1801	\$740.00	\$15,712.88
10/03	128	10261434	15896	2203	\$22.00	\$15,690.88
10/07	7	09212094	12119	1801	\$740.00	\$14,950.88
10/07	9	09853105		9204	-\$130.00	\$15,080.88
10/07	16	09181384	11825	1252	-\$390.00	\$15,470.88
10/08	1	09441333	13175	1251	\$110.00	\$15,360.88
10/08	1	09947006	12364Z	1814	\$110.00	\$15,250.88
10/08	2	09441333	13175	1201	\$168.00	\$15,082.88
10/09	1	09840207	NL000238	1201	\$84.00	\$14,998.88
10/09	2	09840207	NL000238	1202	\$54.00	\$14,944.88
10/09	29	08931055	10861	1401	\$320.00	\$14,624.88
10/09	487	75809389		6004	\$300.00	\$14,324.88
10/10	77	09801356	10309	1201	\$84.00	\$14,240.88
10/10	177	PCT/US02/31732	14927	1707	\$40.00	\$14,200.88
10/10	179	PCT/US02/31732	14927	8006	\$15.00	\$14,185.88
10/10	482	75476510		6004	\$150.00	\$14,035.88
10/10	516	75642058		6004	\$150.00	\$13,885.88
10/10	537	75577131		6004	\$150.00	\$13,735.88
10/11	2	09745967	14184	1806	\$180.00	\$13,555.88
10/11	150	78173150		6001	\$325.00	\$13,230.88
10/11	197	78173180		6001	\$325.00	\$12,905.88

Deposit Account Statement

<https://rampsdev.uspto.gov/ram26/Controller.js?sessionId=kirodv1xm2>

10/25	274	PCT/US02/33855	15967	1707	\$40.00	\$29,680.88
10/25	276	PCT/US02/33855	15967	8006	\$15.00	\$29,665.88
10/25	585	78178372		7001	\$325.00	\$29,340.88
10/25	628	78178404		7001	\$325.00	\$29,015.88
10/28	1	09406662	13024	1253	\$920.00	\$28,095.88
10/28	549	PCT/US02/10275	15441	1705	\$9.00	\$28,086.88
10/30	3	29147933		2251	\$55.00	\$28,031.88
10/30	4	09736037	FRSHP003	1814	\$110.00	\$27,921.88
10/30	6	09596415	13715	1460	\$130.00	\$27,791.88
10/30	15	10163645	15602	1251	\$110.00	\$27,681.88

START BALANCE	SUM OF CHARGES	SUM OF REPLENISH	END BALANCE
\$17,284.88	\$8,988.00	\$19,385.00	\$27,681.88

[Need Help?](#) | [Return to USPTO Home Page](#) | [Return to Office of Finance Home Page](#)

# 19

JLG

SCULLY, SCOTT, MURPHY & PRESSER  
A PROFESSIONAL CORPORATION  
ATTORNEYS AT LAW  
400 GARDEN CITY PLAZA  
GARDEN CITY, NEW YORK 11530-0299

LEOPOLD PRESSER  
KENNETH L. KING  
FRANK S. DIGIGLIO  
PAUL J. ESATTO, JR.  
JOHN S. SENSNY  
MARK J. COHEN  
RICHARD L. CATANIA  
EDWARD W. GROLZ  
STEVEN FISCHMAN  
PETER I. BERNSTEIN  
WILLIAM C. ROCH

T. DAVID BOMZER  
PHILIP BRAGINSKY  
JOHN L. BRECKENRIDGE\*  
MARVIN BRESSLER  
ERIC P. HALBER\*  
THOMAS SPINELLI  
ALEXANDER G. VODOVOZOV  
PATRICIA A. WILCZYNSKI

\*CO BAR ONLY  
\*D.C. BAR ONLY

ANTHONY N. FRESCO  
LESLIE S. SZIVOS, PH.D.  
DAVID J. TORRENTE

PATENT AGENTS

XIAOCHUN ZHU, PH.D.  
TECHNICAL CONSULTANT

ALLEN R. MORGANSTERN  
STEPHEN A. YOUNG  
COUNSEL

JOHN F. SCULLY  
STEPHEN D. MURPHY  
RETIRED

ANTHONY C. SCOTT (1931-1994)  
WILLIAM E. MCNULTY (1927-1993)

TELEPHONE: (516) 742-4343  
FACSIMILE: (516) 742-4366  
E-MAIL: Intprop@ssmp.com

January 17, 2003  
FEDERAL EXPRESS

US Patent and Trademark Office  
c/o RTIS  
3443 Carlin Spring Road  
Falls Church, VA 22041

Attention: Toni Hood/Nadine Clark

Re: U.S. Patent Application No.: 09/596,415  
Our Docket: 13715

RECEIVED  
JAN 21 2003  
OFFICE OF PATENT TRIAL AND APPEALS  
DIRECTOR'S OFFICE

Dear Examiner Clark:

As per our phone conversation of January 16, 2003 you indicated that the twenty (20) sheets of drawings (Figs. 1-31) which we filed on December 16, 2002 with payment of the issue fee were damaged due to irradiation by the US Postal Service.

Therefore, as per your request, we are hereby enclosing a replacement set of drawings via Federal Express to avoid the irradiation process.

Please let us know if there are any further questions.

Sincerely yours,

*Anthony N. Fresco*

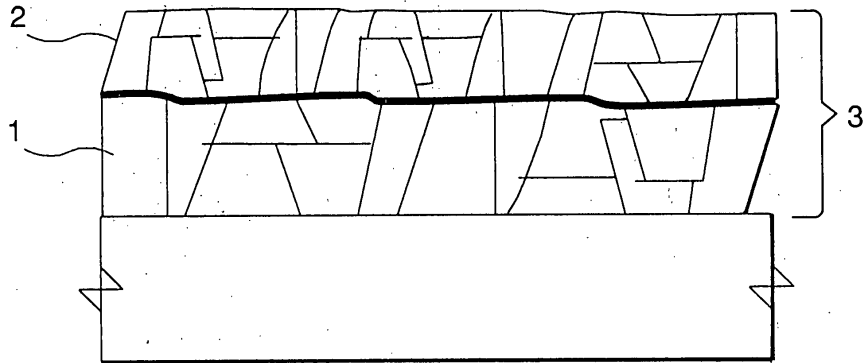
Anthony N. Fresco

ANF:yd  
Enclosures

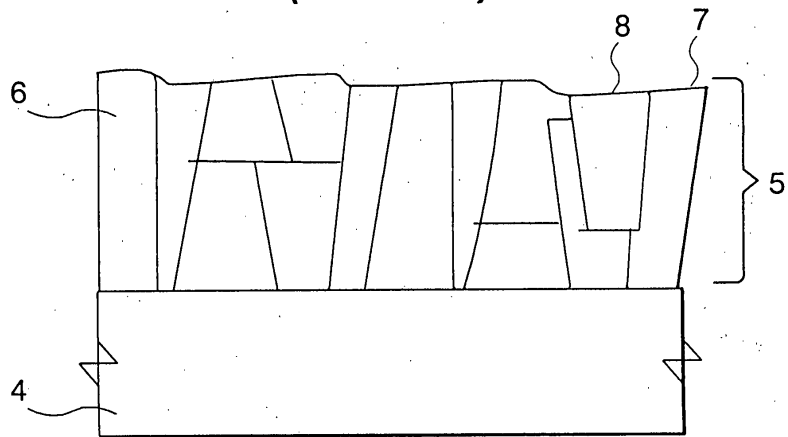
g:\nec\1210\13715\ltr\13715.L18

6538324

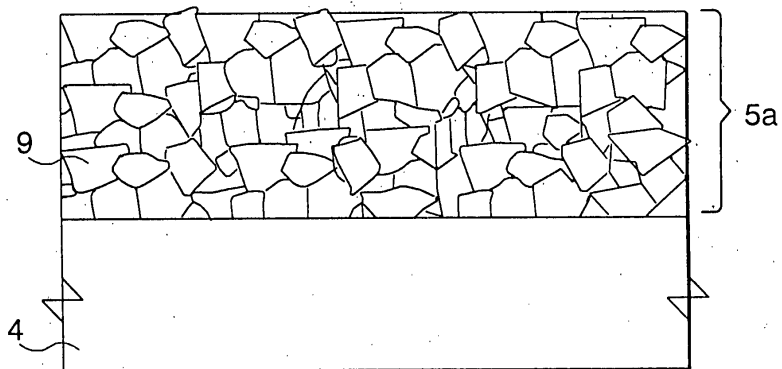
1/20



**FIG. 1**  
*(Prior Art)*



**FIG. 2**  
*(Prior Art)*



**FIG. 3**  
*(Prior Art)*

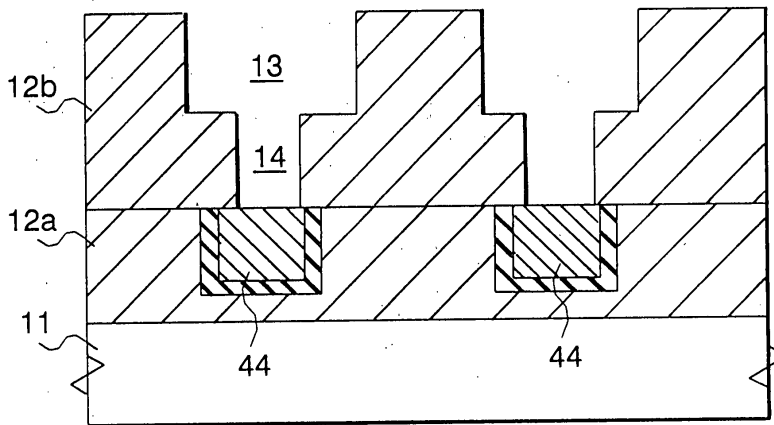


FIG. 4A

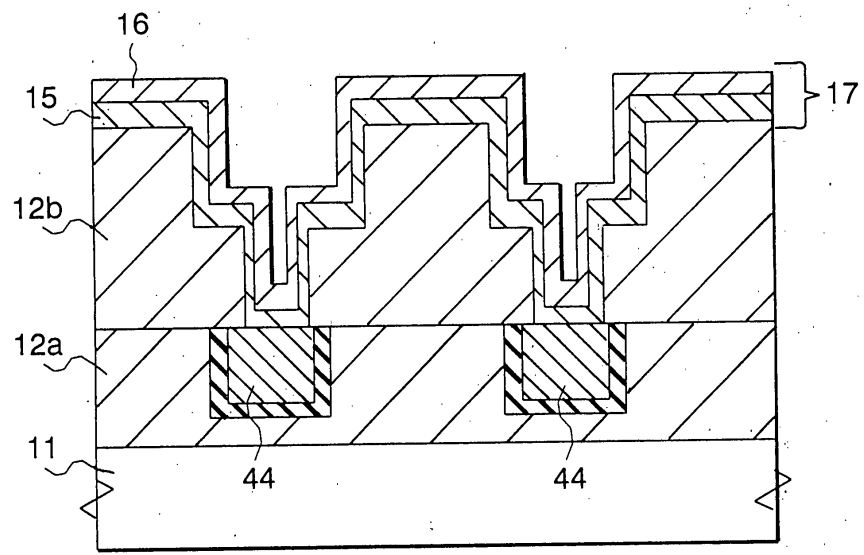


FIG. 4B

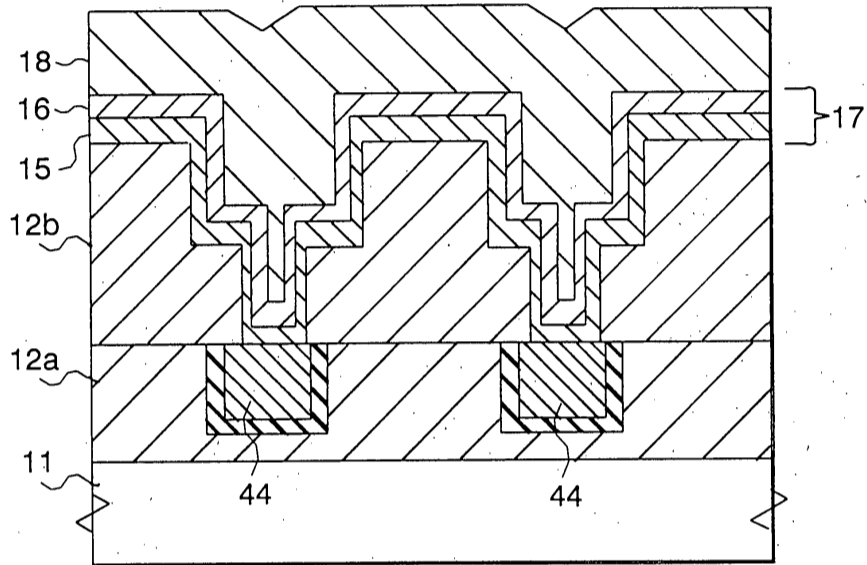


FIG. 4C

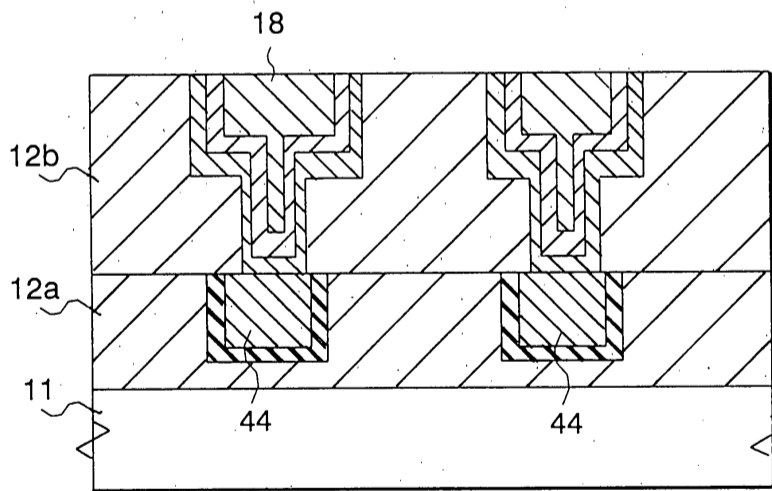
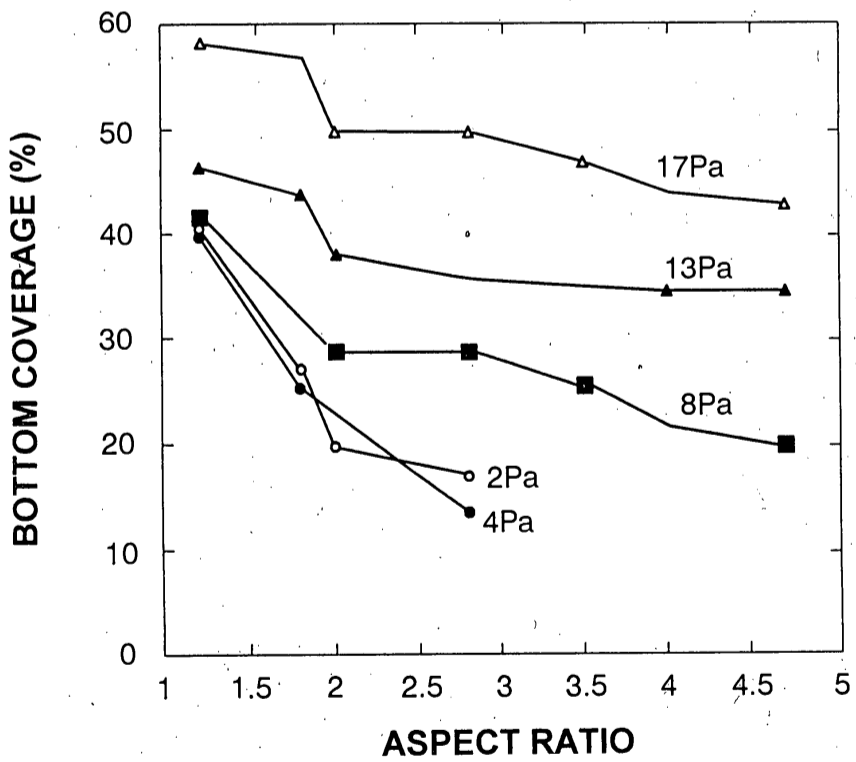
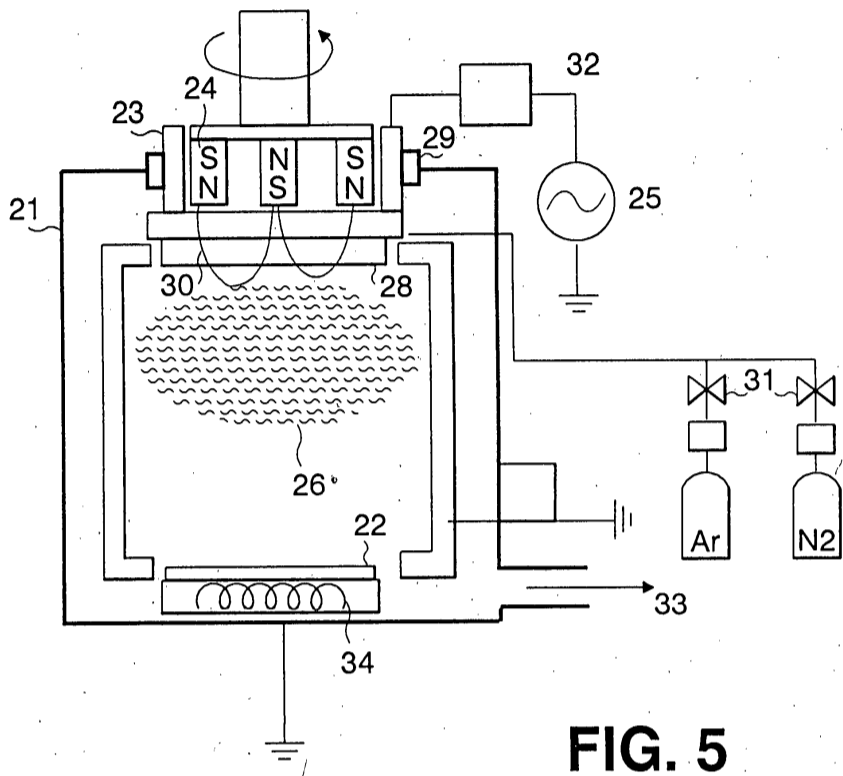


FIG. 4D



4/20



5/20

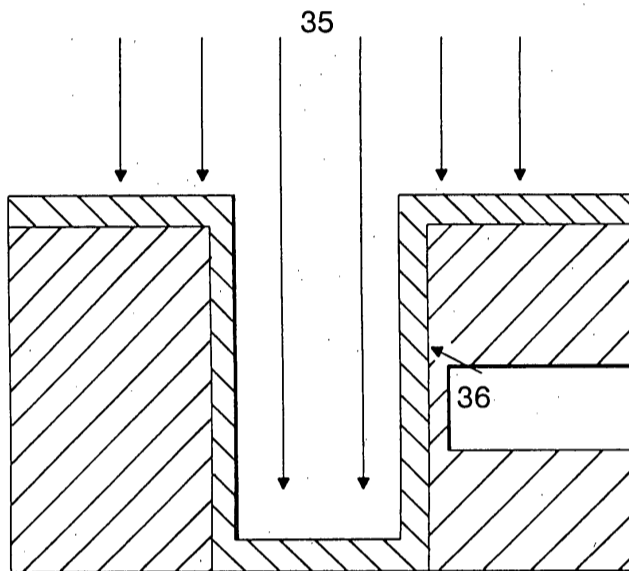


FIG. 7

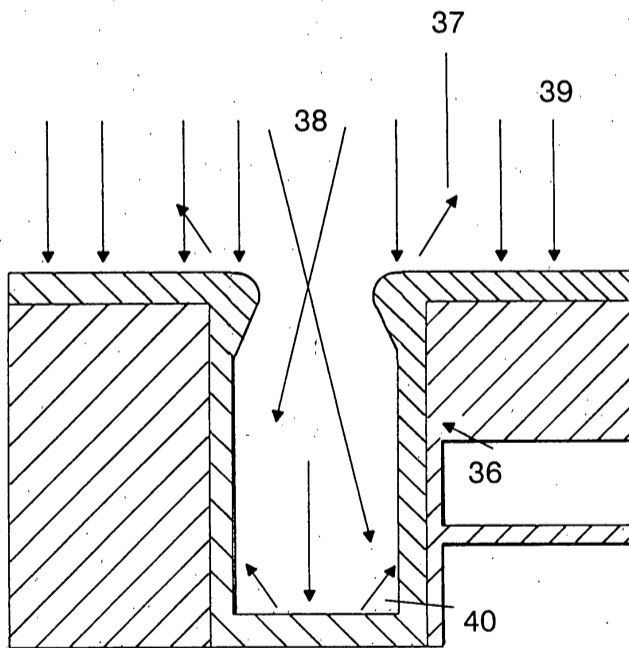


FIG. 8

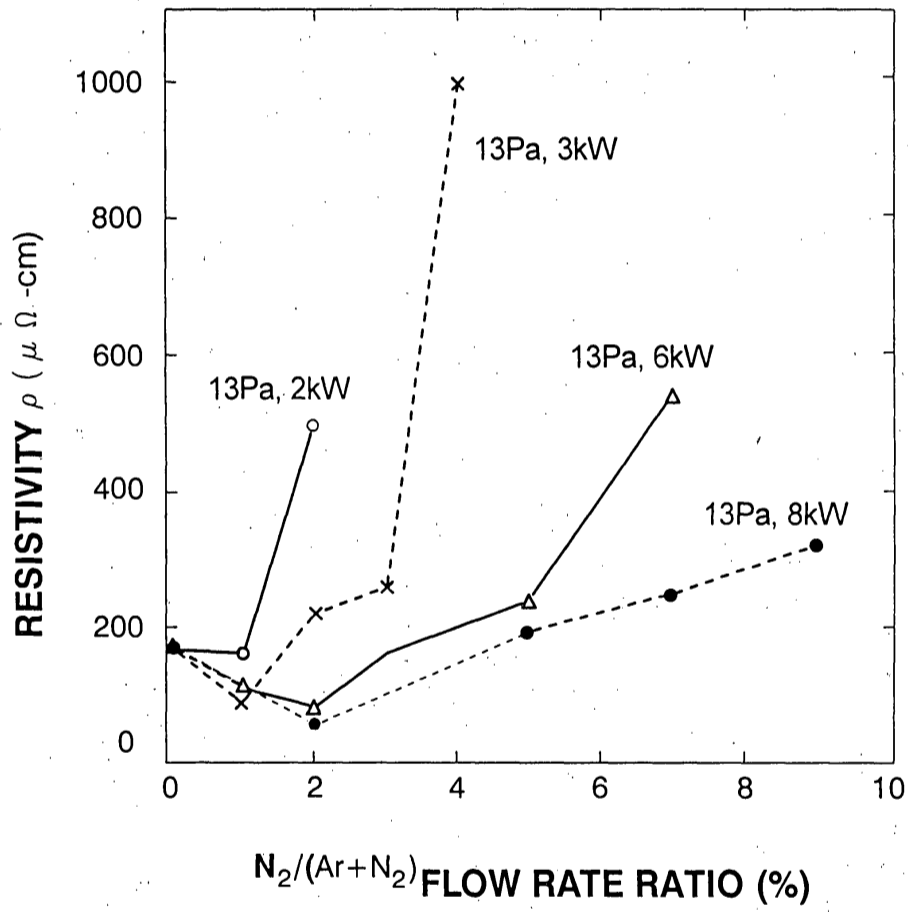


FIG. 9

7/20

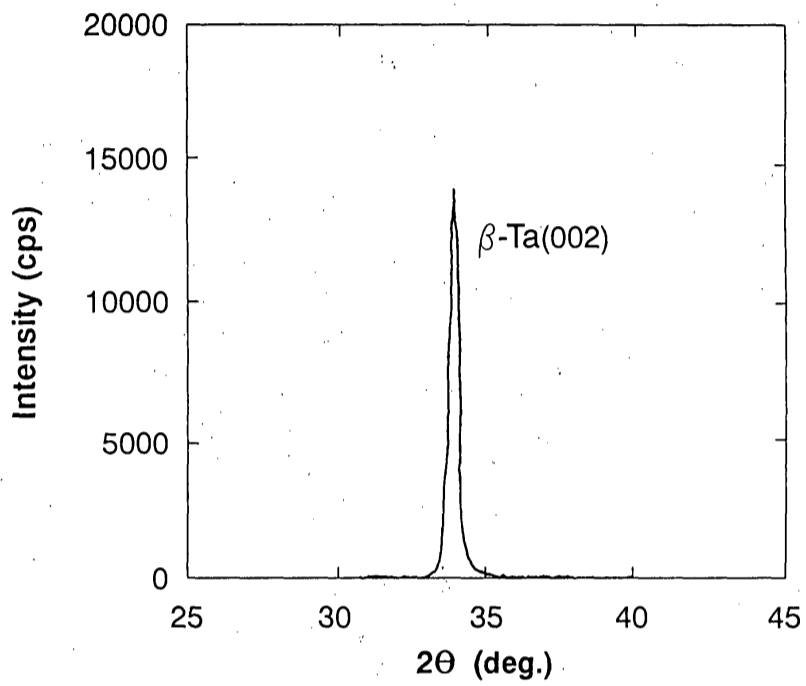


FIG. 10

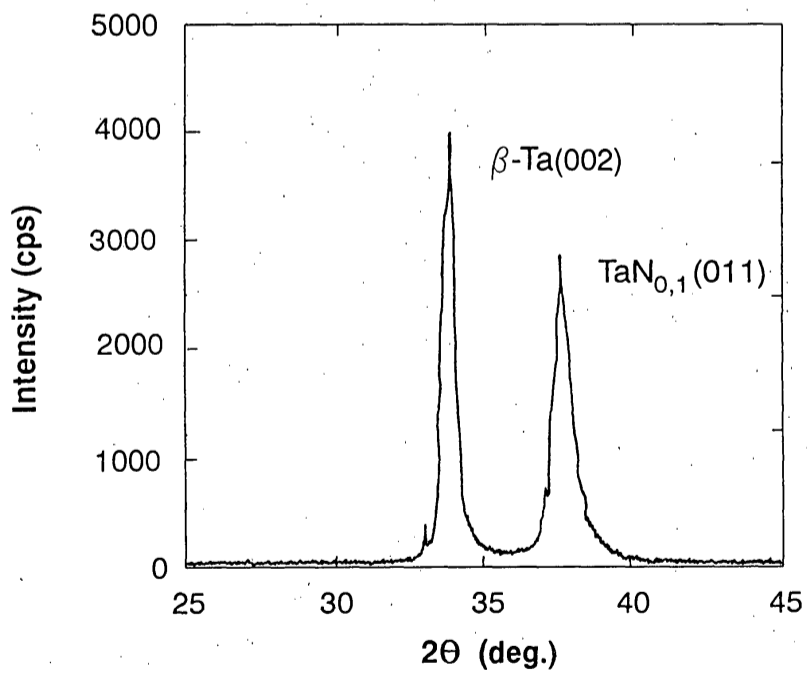
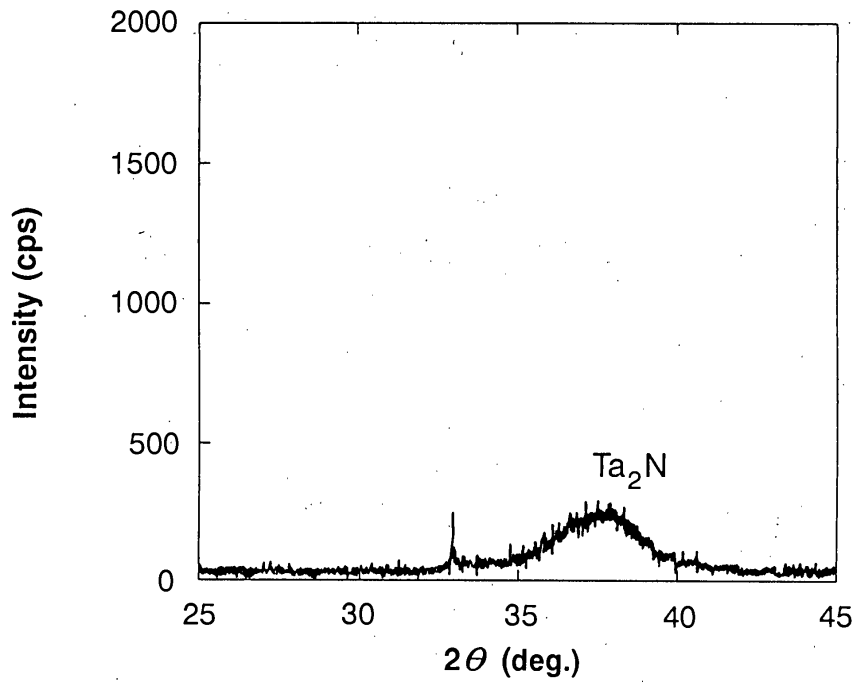
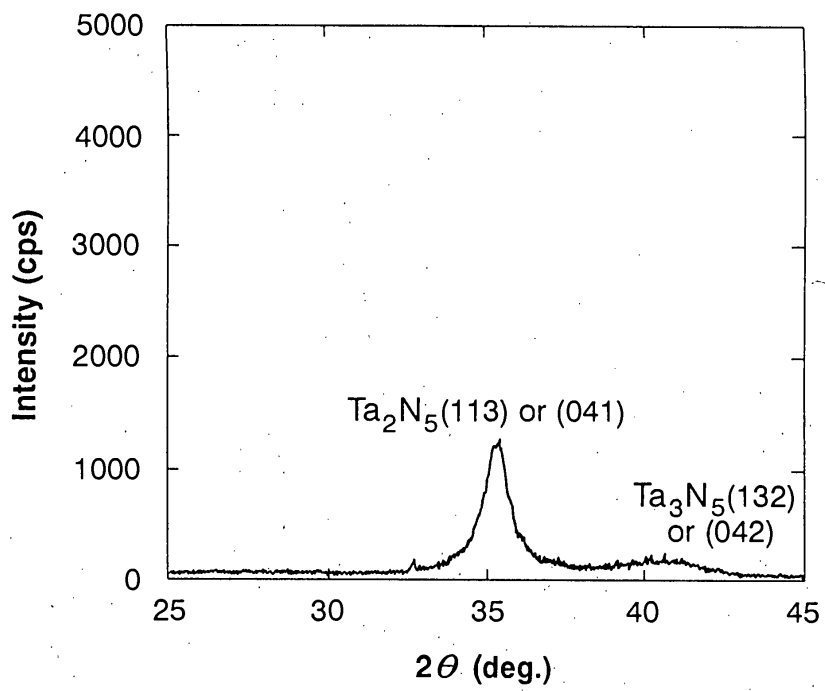


FIG. 11

8/20



**FIG. 12**



**FIG. 13**

9/20

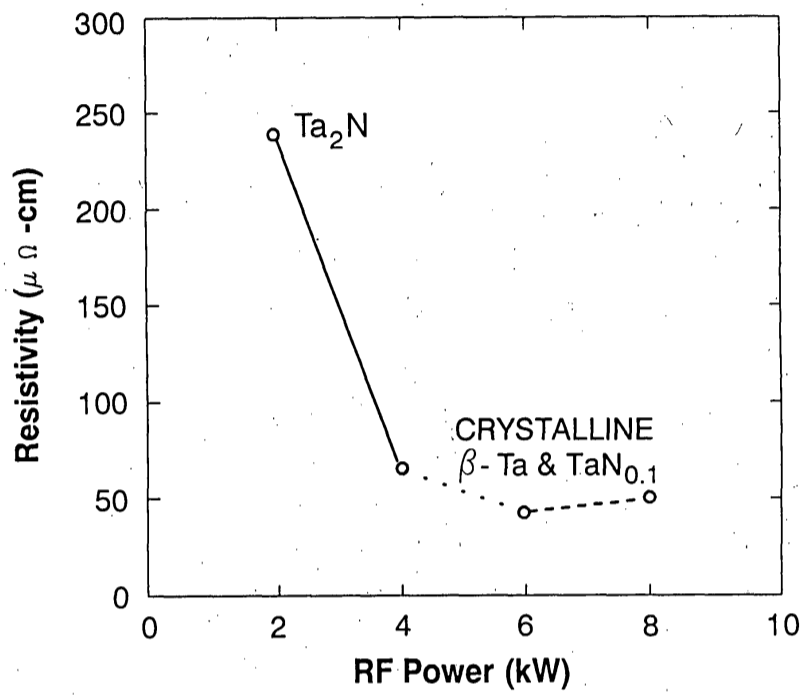


FIG. 14

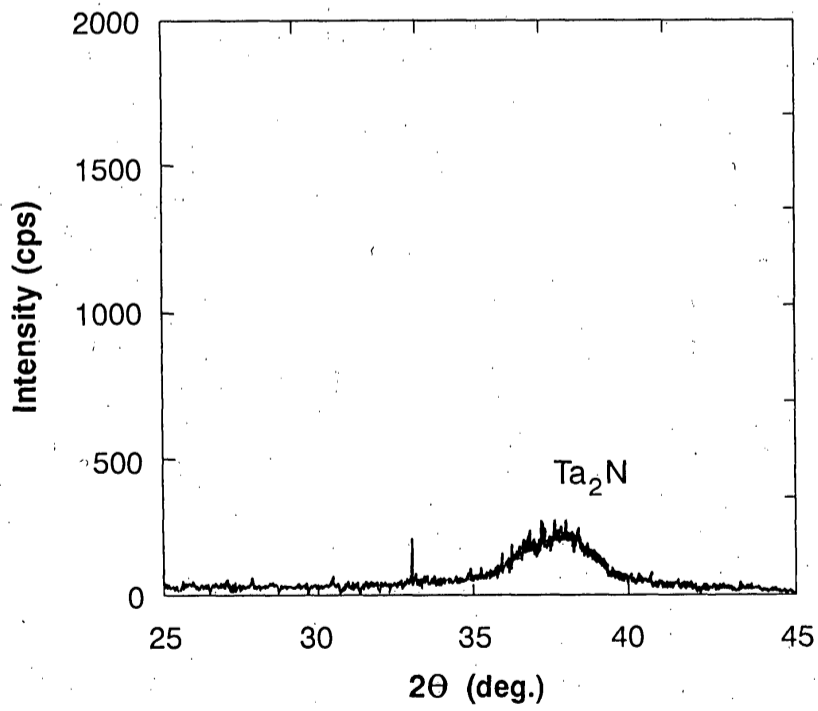
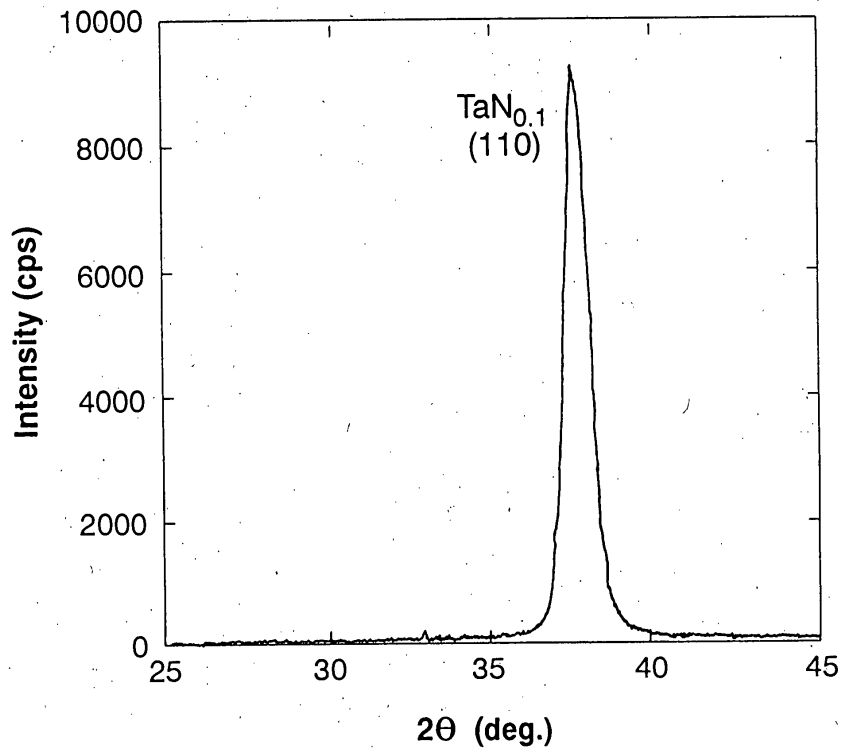
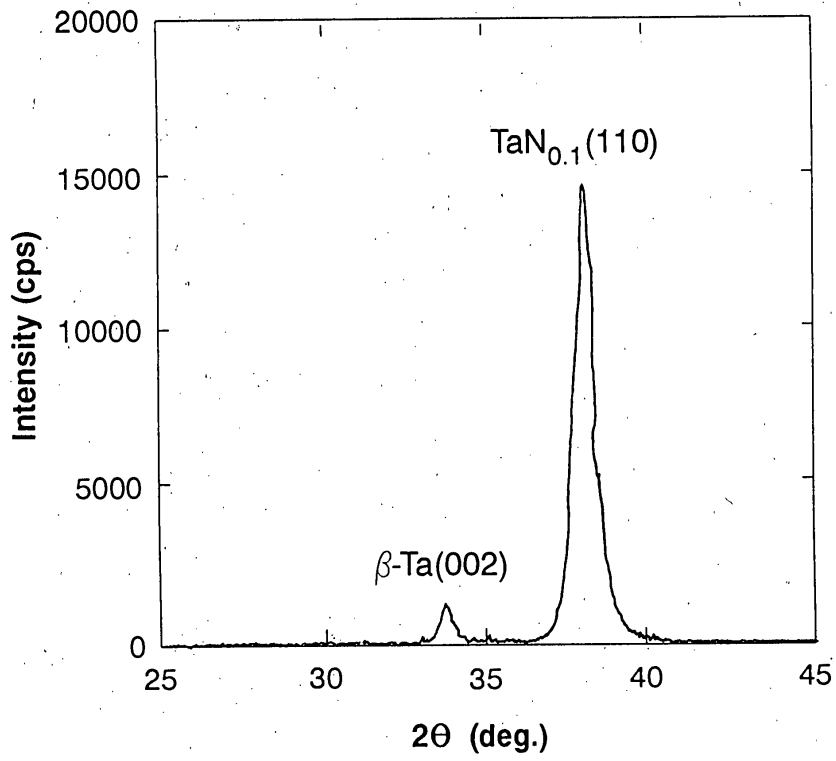


FIG. 15

10/20



**FIG. 16**



**FIG. 17**

11/20

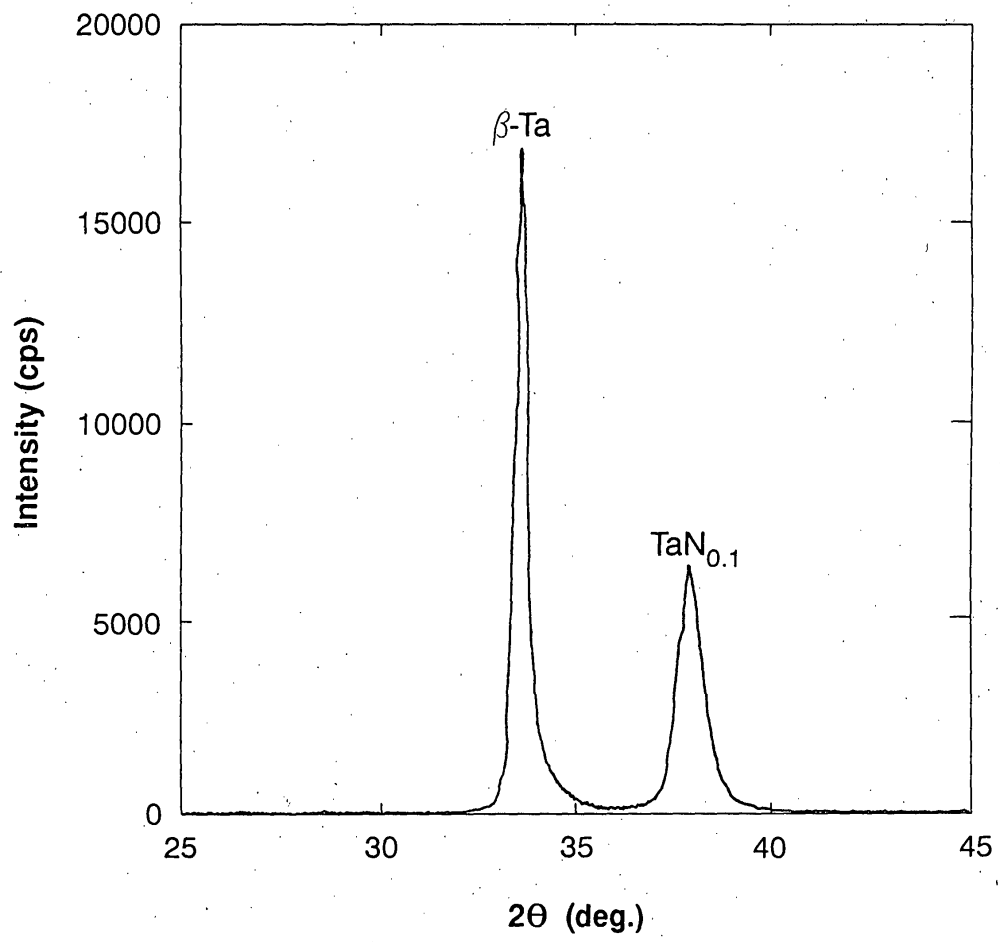
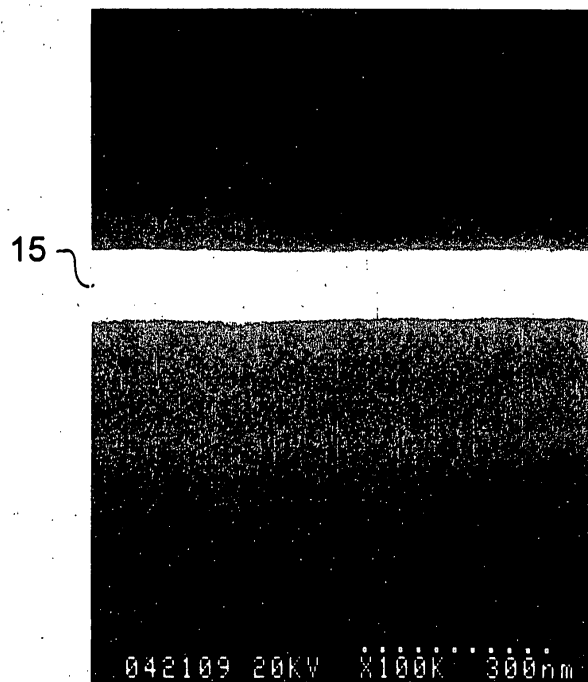


FIG. 18



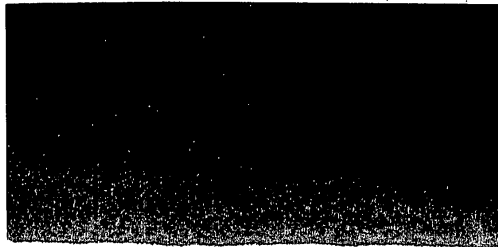
12/20



**FIG. 19**

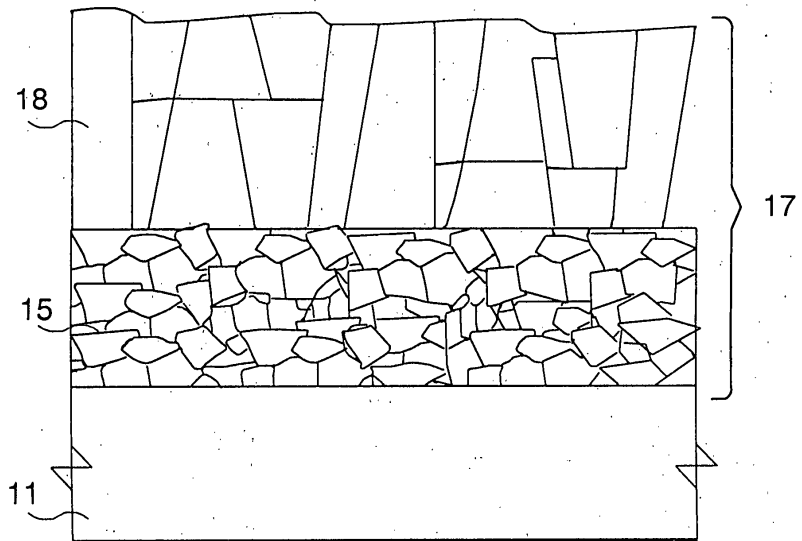
13/20

16



**FIG. 20**

14/20



**FIG. 21**

15/20

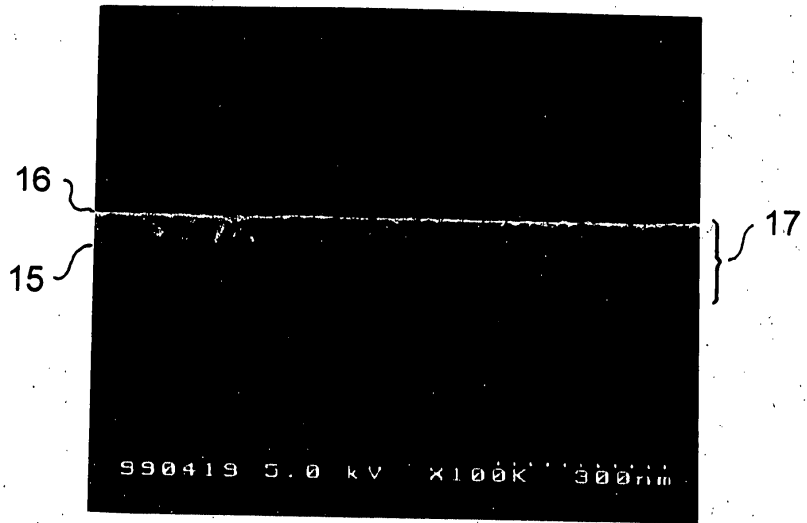


FIG. 22

16/20

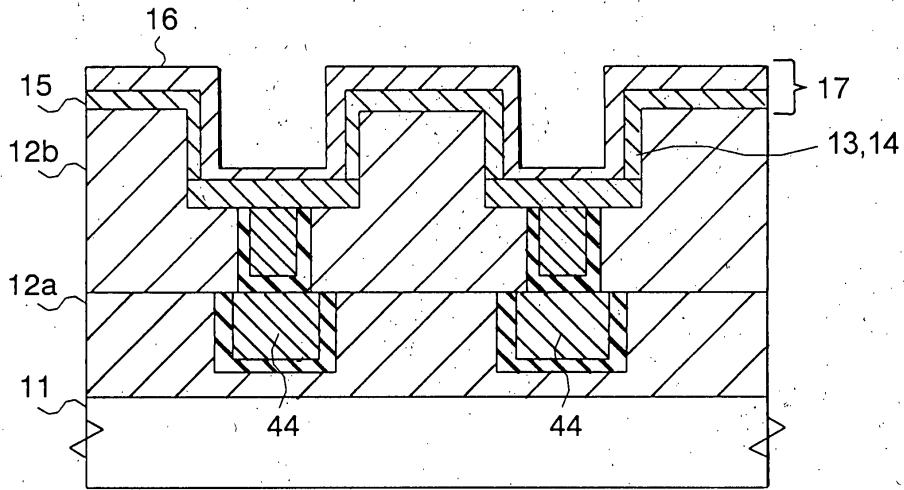


FIG. 23

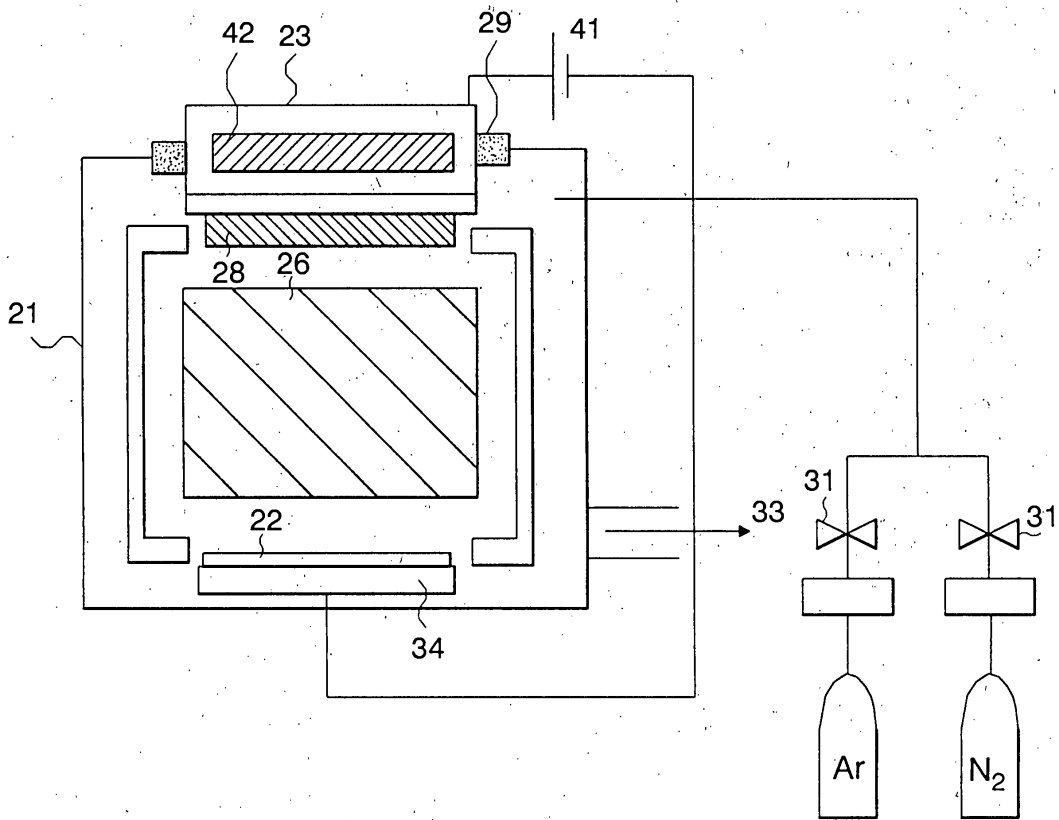


FIG. 24

17/20

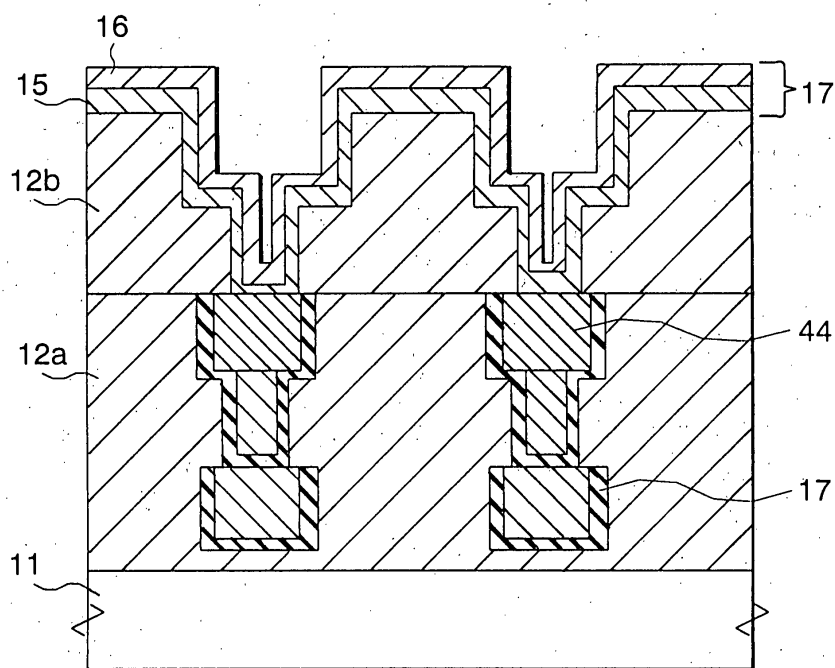


FIG. 25

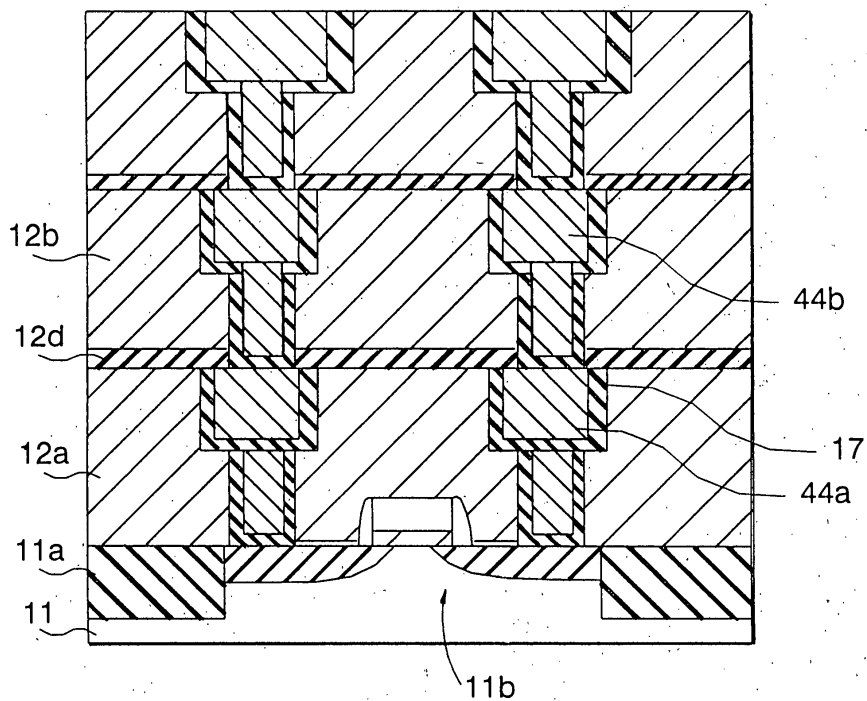
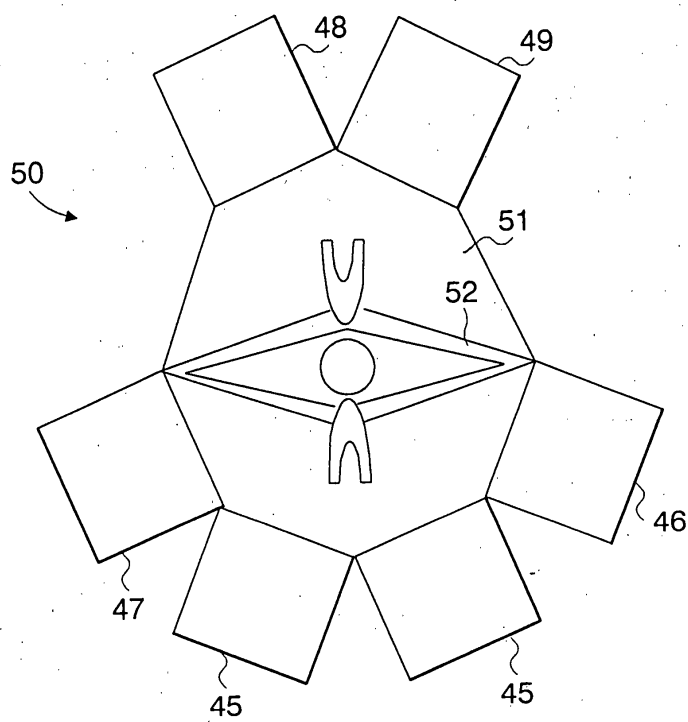


FIG. 26



**FIG. 27**

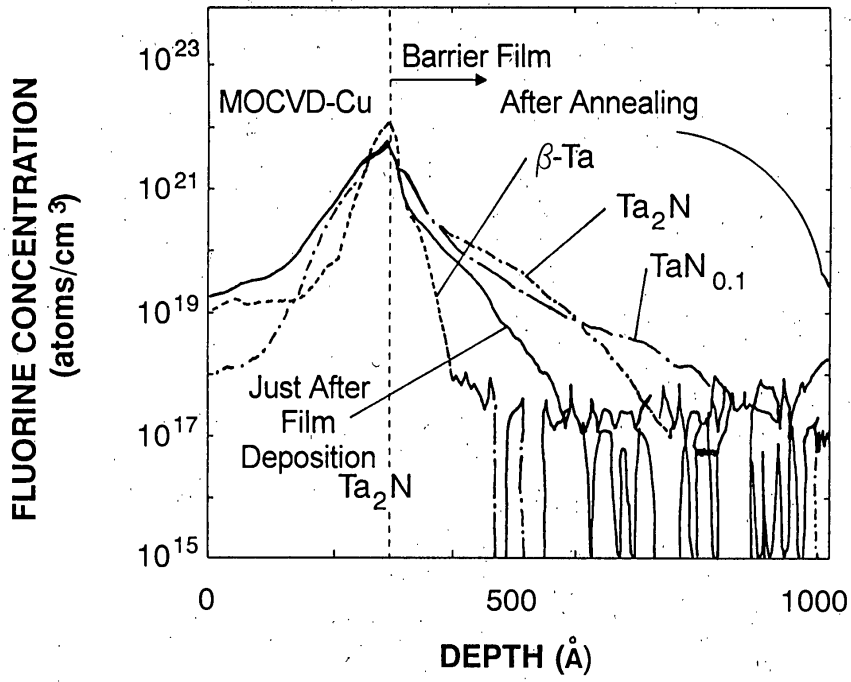


FIG. 28

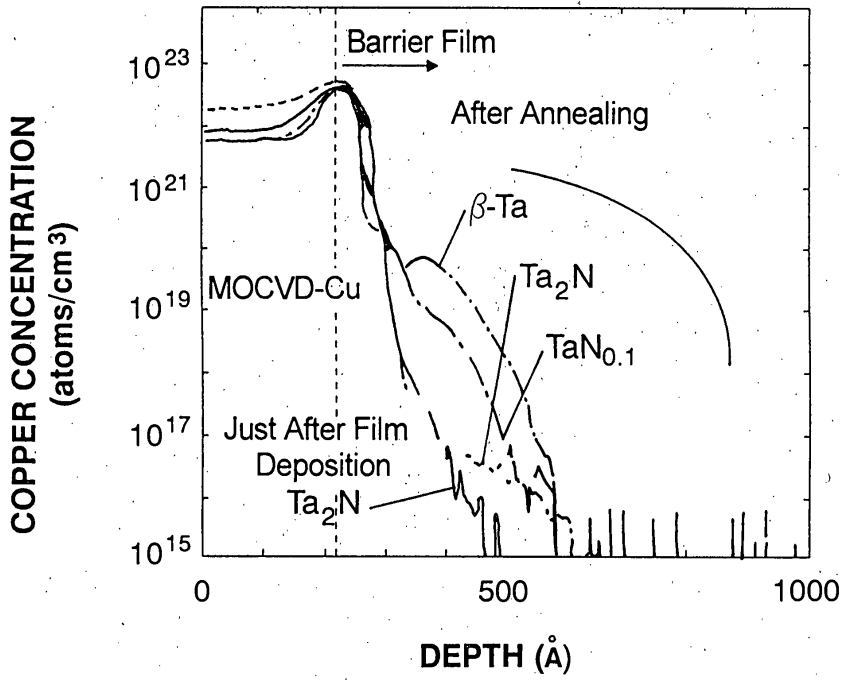


FIG. 29



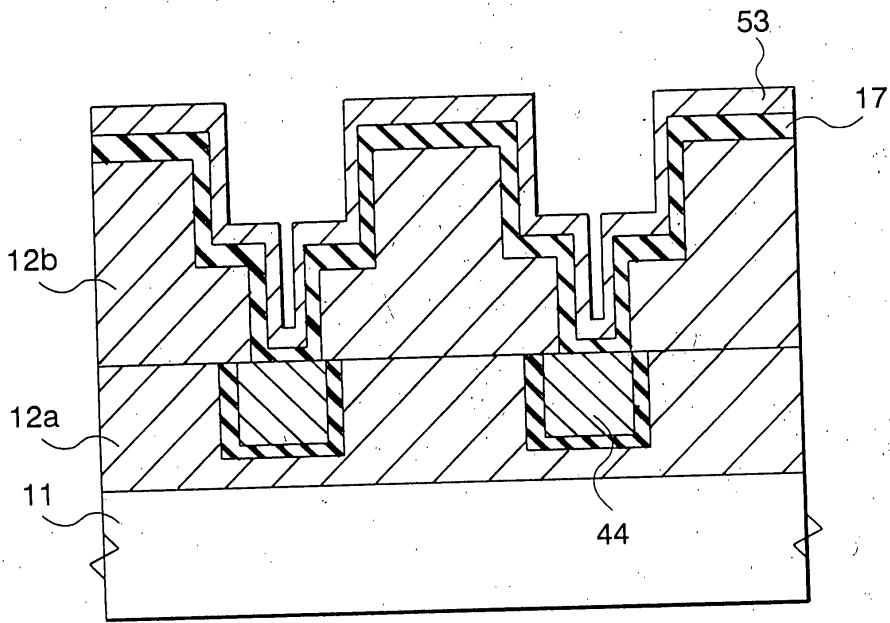


FIG. 30

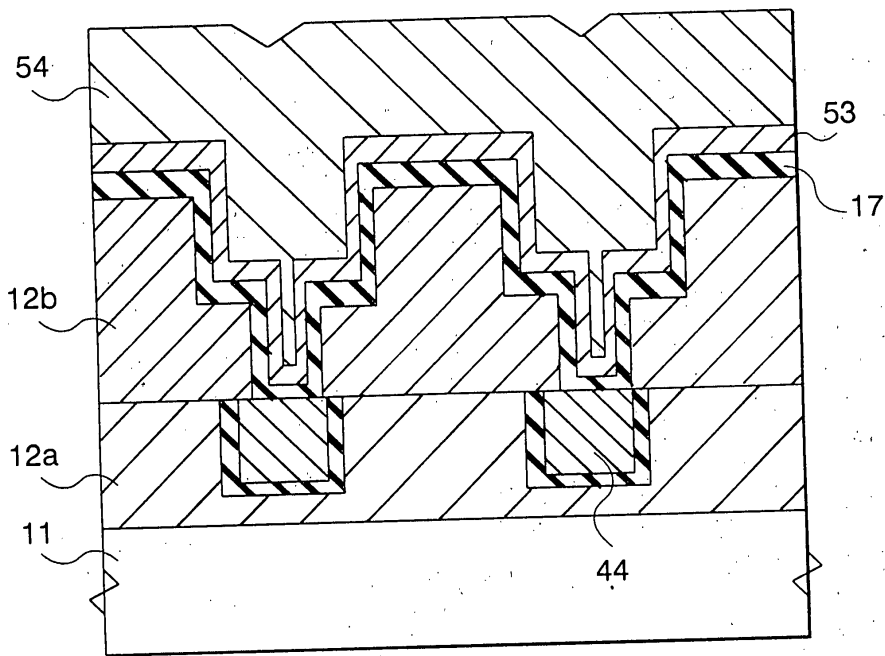


FIG. 31

**PATENT APPLICATION FEE DETERMINATION RECORD**  
Effective October 1, 2001

Application or Docket Number

09/596415

**CLAIMS AS FILED - PART I**

	(Column 1)	(Column 2)
TOTAL CLAIMS		
FOR	NUMBER FILED	NUMBER EXTRA
TOTAL CHARGEABLE CLAIMS	minus 20= *	
INDEPENDENT CLAIMS	minus 3 = *	
MULTIPLE DEPENDENT CLAIM PRESENT <input type="checkbox"/>		

\* If the difference in column 1 is less than zero, enter "0" in column 2

SMALL ENTITY TYPE

OR OTHER THAN SMALL ENTITY

RATE	FEE	OR	RATE	FEE
BASIC FEE	370.00	OR	BASIC FEE	740.00
X\$ 9=		OR	X\$18=	
X42=		OR	X84=	
+140=		OR	+280=	
TOTAL		OR	TOTAL	

**CLAIMS AS AMENDED - PART II**

	(Column 1)	(Column 2)	(Column 3)
AMENDMENT A	CLAIMS REMAINING AFTER AMENDMENT	HIGHEST NUMBER PREVIOUSLY PAID FOR	PRESENT EXTRA
	Total * 36	Minus ** 36	= -
	Independent * 6	Minus *** 6	= -
FIRST PRESENTATION OF MULTIPLE DEPENDENT CLAIM <input type="checkbox"/>			

SMALL ENTITY OR OTHER THAN SMALL ENTITY

RATE	ADDITIONAL FEE	OR	RATE	ADDITIONAL FEE
X\$ 9=		OR	X\$18=	
X42=		OR	X84=	
+140=		OR	+280=	
TOTAL ADDIT. FEE		OR	TOTAL ADDIT. FEE	

	(Column 1)	(Column 2)	(Column 3)
AMENDMENT B	CLAIMS REMAINING AFTER AMENDMENT	HIGHEST NUMBER PREVIOUSLY PAID FOR	PRESENT EXTRA
	Total * 36	Minus ** 34	= -
	Independent * 6	Minus *** 6	= -
FIRST PRESENTATION OF MULTIPLE DEPENDENT CLAIM <input type="checkbox"/>			

RATE	ADDITIONAL FEE	OR	RATE	ADDITIONAL FEE
X\$ 9=		OR	X\$18=	
X42=		OR	X84=	
+140=		OR	+280=	
TOTAL ADDIT. FEE		OR	TOTAL ADDIT. FEE	

	(Column 1)	(Column 2)	(Column 3)
AMENDMENT C	CLAIMS REMAINING AFTER AMENDMENT	HIGHEST NUMBER PREVIOUSLY PAID FOR	PRESENT EXTRA
	Total * 10	Minus ** 36	= -
	Independent * 2	Minus *** 6	= -
FIRST PRESENTATION OF MULTIPLE DEPENDENT CLAIM <input type="checkbox"/>			

RATE	ADDITIONAL FEE	OR	RATE	ADDITIONAL FEE
X\$ 9=		OR	X\$18=	
X42=		OR	X84=	
+140=		OR	+280=	
TOTAL ADDIT. FEE		OR	TOTAL ADDIT. FEE	

\* If the entry in column 1 is less than the entry in column 2, write "0" in column 3.  
 \*\* If the "Highest Number Previously Paid For" IN THIS SPACE is less than 20, enter "20."  
 \*\*\* If the "Highest Number Previously Paid For" IN THIS SPACE is less than 3, enter "3."  
 The "Highest Number Previously Paid For" (Total or Independent) is the highest number found in the appropriate box in column 1.

**PATENT APPLICATION FEE DETERMINATION RECORD**  
Effective December 29, 1999

Application or Docket Number

596415

**CLAIMS AS FILED - PART I**

FOR	(Column 1) NUMBER FILED	(Column 2) NUMBER EXTRA
BASIC FEE		
TOTAL CLAIMS	36 minus 20 = *	16
INDEPENDENT CLAIMS	6 minus 3 = *	3
MULTIPLE DEPENDENT CLAIM PRESENT		

\* If the difference in column 1 is less than zero, enter "0" in column 2

**CLAIMS AS AMENDED - PART II**

AMENDMENT A	(Column 1)	(Column 2)	(Column 3)
	CLAIMS REMAINING AFTER AMENDMENT	HIGHEST NUMBER PREVIOUSLY PAID FOR	PRESENT EXTRA
Total	*	Minus	** =
Independent	*	Minus	*** =
FIRST PRESENTATION OF MULTIPLE DEPENDENT CLAIM			

AMENDMENT B	(Column 1)	(Column 2)	(Column 3)
	CLAIMS REMAINING AFTER AMENDMENT	HIGHEST NUMBER PREVIOUSLY PAID FOR	PRESENT EXTRA
Total	*	Minus	** =
Independent	*	Minus	*** =
FIRST PRESENTATION OF MULTIPLE DEPENDENT CLAIM			

AMENDMENT C	(Column 1)	(Column 2)	(Column 3)
	CLAIMS REMAINING AFTER AMENDMENT	HIGHEST NUMBER PREVIOUSLY PAID FOR	PRESENT EXTRA
Total	*	Minus	** =
Independent	*	Minus	*** =
FIRST PRESENTATION OF MULTIPLE DEPENDENT CLAIM			

\* If the entry in column 1 is less than the entry in column 2, write "0" in column 3.  
 \*\* If the "Highest Number Previously Paid For" IN THIS SPACE is less than 20, enter "20."  
 \*\*\* If the "Highest Number Previously Paid For" IN THIS SPACE is less than 3, enter "3."  
 The "Highest Number Previously Paid For" (Total or Independent) is the highest number found in the appropriate box in column 1.

SMALL ENTITY TYPE  OR

OTHER THAN SMALL ENTITY

RATE	FEE	OR	RATE	FEE
	345.00			690.00
X\$ 9=			X\$18=	288. <sup>00</sup>
X39=			X78=	274. <sup>00</sup>
+130=			+260=	
TOTAL			TOTAL	1212. <sup>00</sup>

SMALL ENTITY OR

OTHER THAN SMALL ENTITY

RATE	ADDITIONAL FEE	OR	RATE	ADDITIONAL FEE
X\$ 9=			X\$18=	
X39=			X78=	
+130=			+260=	
TOTAL ADDIT. FEE			TOTAL ADDIT. FEE	

RATE	ADDITIONAL FEE	OR	RATE	ADDITIONAL FEE
X\$ 9=			X\$18=	
X39=			X78=	
+130=			+260=	
TOTAL ADDIT. FEE			TOTAL ADDIT. FEE	

RATE	ADDITIONAL FEE	OR	RATE	ADDITIONAL FEE
X\$ 9=			X\$18=	
X39=			X78=	
+130=			+260=	
TOTAL ADDIT. FEE			TOTAL ADDIT. FEE	

Table of Contents

---

1. US6538324B1 Multi-layered wiring layer and method of fabricating the same
-

**Family 1/1**

3 record(s) per family, collapsed by 2 record(s)

**Record 1/2** US6538324B1 Multi-layered wiring layer and method of fabricating the same

**Publication Number:**

US6538324B1 20030325

**Title:**

Multi-layered wiring layer and method of fabricating the same

**Title - DWPI:**

Diffusion barrier film for semiconductor integrated circuit, comprises of laminated nitrogen-containing crystalline metal film, amorphous metal nitride film, and same kind of metal atoms

**Priority Number:**

JP1999214110A

**Priority Date:**

1999-06-24

**Application Number:**

US2000596415A

**Application Date:**

2000-06-19

**Publication Date:**

2003-03-25

**IPC Class Table:**

IPC	Section	Class	Subclass	Class Group	Subgroup
H01L002128	H	H01	H01L	H01L0021	H01L002128
H01L0021285	H	H01	H01L	H01L0021	H01L0021285
H01L00213205	H	H01	H01L	H01L0021	H01L00213205
H01L0021768	H	H01	H01L	H01L0021	H01L0021768
H01L002352	H	H01	H01L	H01L0023	H01L002352
H01L0023522	H	H01	H01L	H01L0023	H01L0023522

H01L0023532	H	H01	H01L	H01L0023	H01L0023532
-------------	---	-----	------	----------	-------------

**IPC Class Table - DWPI:**

IPC - DWPI	Section - DWPI	Class - DWPI	Subclass - DWPI	Class Group - DWPI	Subgroup - DWPI
H01L0021768	H	H01	H01L	H01L0021	H01L0021768
H01L002348	H	H01	H01L	H01L0023	H01L002348
H01L002128	H	H01	H01L	H01L0021	H01L002128
H01L00213205	H	H01	H01L	H01L0021	H01L00213205
H01L002352	H	H01	H01L	H01L0023	H01L002352

**Assignee/Applicant:**

NEC Corporation, Tokyo, JP

**JP F Terms:**

**JP FI Codes:**

**Assignee - Original:**

NEC Corporation

**Any CPC Table:**

Type	Invention	Additional	Version	Office
Current	H01L 21/76846	H01L 2924/0002	20130101	EP
Current	H01L 21/2855	H01L 2924/3011	20130101	EP
Current	H01L 21/76862		20130101	EP
Current	H01L 21/76865		20130101	EP
Current	H01L 23/5226		20130101	EP
Current	H01L 23/53238		20130101	EP

**ECLA:**

H01L0021768C3B4 | H01L0021285B4F | H01L0021768C3D4B | H01L0021768C3D6 |  
H01L0023522E | H01L0023532M1C4 | T01L092430110

**Abstract:**

There is provided a barrier film preventing diffusion of copper from a copper wiring layer formed on a semiconductor substrate. The barrier film has a multi-layered structure of first and second films wherein the first film is composed of crystalline metal containing nitrogen therein, and the second film is composed of amorphous metal nitride. The barrier film is constituted of common metal atomic species. The barrier film prevents copper diffusion from a copper wiring layer into a semiconductor device, and has sufficient adhesion characteristic to both a copper film and an interlayer insulating film.

**Language of Publication:**

EN

**INPADOC Legal Status Table:**

Gazette Date	Code	INPADOC Legal Status Impact
2015-01-28	AS	-
<b>Description:</b> ASSIGNMENT GODO KAISHA IP BRIDGE 1, JAPAN ASSIGNMENT OF ASSIGNORS INTEREST; ASSIGNOR:NEC CORPORATION; REEL/FRAME:034834/0806 2014-11-01		
2014-08-27	FPAY	+
<b>Description:</b> FEE PAYMENT		
2010-08-26	FPAY	+
<b>Description:</b> FEE PAYMENT		
2006-09-01	FPAY	+
<b>Description:</b> FEE PAYMENT		
2000-06-19	AS	-
<b>Description:</b> ASSIGNMENT NEC CORPORATION, JAPAN ASSIGNMENT OF ASSIGNORS INTEREST; ASSIGNORS:TAGAMI, MASAYOSHI; HAYASHI, YOSHIHIRO; REEL/FRAME:010911/0893 2000-06-09		

**Post-Issuance (US):**

**Reassignment (US) Table:**

Assignee	Assignor	Date Signed	Reel/Frame	Date
GODO KAISHA IP BRIDGE 1,TOKYO,JP	NEC CORPORATION	2014-11-01	034834/0806	2015-01-28
<b>Conveyance:</b> ASSIGNMENT OF ASSIGNORS INTEREST (SEE DOCUMENT FOR DETAILS).				
<b>Corresponent:</b> CPA GLOBAL LIMITED LIBERATION HOUSE CASTLE STREET ST HELIER, JE1 1BL JERSEY				
NEC CORPORATION,TOKYO,JP	TAGAMI, MASAYOSHI	2000-06-09	010911/0893	2000-06-19
	HAYASHI, YOSHIHIRO	2000-06-09		
<b>Conveyance:</b> ASSIGNMENT OF ASSIGNORS INTEREST (SEE DOCUMENT FOR DETAILS).				
<b>Corresponent:</b> SCULLY, SCOTT ET AL PAUL J. ESATTO, JR. 400 GARDEN CITY PLAZA GARDEN CITY, NY 11530				

**Maintenance Status (US):**

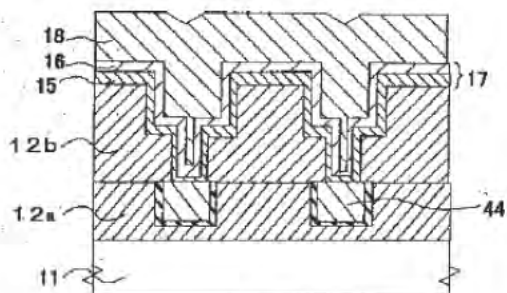
**Litigation (US):**

**Opposition (EP):**

**License (EP):**

**EPO Procedural Status:**

**Front Page Drawing:**





**Record 2/2** JP03562628B2 A diffusion barrier film|membrane, a multilayer interconnection structure, and a method of producing the same

**Publication Number:**

JP03562628B2 20040908  
JP2001007204A 20010112

**Title:**

A diffusion barrier film|membrane, a multilayer interconnection structure, and a method of producing the same

**Title - DWPI:**

Diffusion barrier film for semiconductor integrated circuit, comprises of laminated nitrogen-containing crystalline metal film, amorphous metal nitride film, and same kind of metal atoms

**Priority Number:**

JP1999214110A

**Priority Date:**

1999-06-24

**Application Number:**

JP1999214110A

**Application Date:**

1999-06-24

**Publication Date:**

2004-09-08

**IPC Class Table:**

IPC	Section	Class	Subclass	Class Group	Subgroup
H01L002128	H	H01	H01L	H01L0021	H01L002128
H01L0021285	H	H01	H01L	H01L0021	H01L0021285
H01L00213205	H	H01	H01L	H01L0021	H01L00213205
H01L0021768	H	H01	H01L	H01L0021	H01L0021768
H01L002352	H	H01	H01L	H01L0023	H01L002352
H01L0023522	H	H01	H01L	H01L0023	H01L0023522
H01L0023532	H	H01	H01L	H01L0023	H01L0023532

**IPC Class Table - DWPI:**

IPC - DWPI	Section - DWPI	Class - DWPI	Subclass - DWPI	Class Group - DWPI	Subgroup - DWPI
H01L0021768	H	H01	H01L	H01L0021	H01L0021768

H01L002348	H	H01	H01L	H01L0023	H01L002348
H01L002128	H	H01	H01L	H01L0021	H01L002128
H01L00213205	H	H01	H01L	H01L0021	H01L00213205
H01L002352	H	H01	H01L	H01L0023	H01L002352

**Assignee/Applicant:**

**JP F Terms:**

| 4M104BB04 | 4M104BB29 | 4M104BB30 | 4M104BB31 | 4M104BB32 | 4M104BB33 | 4M104BB37 | 4M104CC01 | 4M104DD16 | 4M104DD17 | 4M104DD23 | 4M104DD37 | 4M104DD42 | 4M104DD43 | 4M104DD52 | 4M104DD53 | 4M104FF18 | 4M104FF22 | 4M104HH08 | 4M104HH13 | 4M104HH20 | 5F033HH11 | 5F033HH32 | 5F033HH33 | 5F033HH34 | 5F033JJ11 | 5F033JJ32 | 5F033JJ33 | 5F033JJ34 | 5F033KK11 | 5F033KK32 | 5F033KK33 | 5F033KK34 | 5F033LL06 | 5F033MM01 | 5F033MM02 | 5F033MM12 | 5F033MM13 | 5F033NN06 | 5F033NN07 | 5F033PP06 | 5F033PP15 | 5F033PP16 | 5F033PP27 | 5F033PP28 | 5F033PP33 | 5F033QQ00 | 5F033QQ12 | 5F033QQ48 | 5F033QQ92 | 5F033QQ94 | 5F033QQ98 | 5F033RR04 | 5F033RR06 | 5F033TT02 | 5F033WW02 | 5F033WW04 | 5F033WW05 | 5F033WW07 | 5F033WW10 | 5F033XX02 | 5F033XX13 | 5F033XX20 | 5F033XX28

**JP FI Codes:**

| H01L002128-301R | H01L002188-M | H01L002188-R | H01L002190-A

**Assignee - Original:**

**Any CPC Table:**

Type	Invention	Additional	Version	Office
Current	H01L 21/76846	H01L 2924/0002	20130101	EP
Current	H01L 21/2855	H01L 2924/3011	20130101	EP
Current	H01L 21/76862		20130101	EP
Current	H01L 21/76865		20130101	EP
Current	H01L 23/5226		20130101	EP
Current	H01L 23/53238		20130101	EP

**ECLA:**

H01L0021768C3B4 | H01L0021285B4F | H01L0021768C3D4B | H01L0021768C3D6 | H01L0023522E | H01L0023532M1C4 | T01L092430110

**Abstract:**

**Language of Publication:**

JA

**INPADOC Legal Status Table:**

Gazette Date	Code	INPADOC Legal Status Impact

2015-01-15	R350	-
<b>Description:</b> WRITTEN NOTIFICATION OF REGISTRATION OF TRANSFER JAPANESE INTERMEDIATE CODE: R350		
2015-01-06	S111	-
<b>Description:</b> REQUEST FOR CHANGE OF OWNERSHIP OR PART OF OWNERSHIP JAPANESE INTERMEDIATE CODE: R313113		
2012-06-05	FPAY	+
<b>Description:</b> RENEWAL FEE PAYMENT (PRS DATE IS RENEWAL DATE OF DATABASE) PAYMENT UNTIL: 20130611		
2012-05-31	FPAY	+
<b>Description:</b> RENEWAL FEE PAYMENT (PRS DATE IS RENEWAL DATE OF DATABASE) PAYMENT UNTIL: 20120611		
2011-10-18	FPAY	+
<b>Description:</b> RENEWAL FEE PAYMENT (PRS DATE IS RENEWAL DATE OF DATABASE) PAYMENT UNTIL: 20120611		
2011-05-26	FPAY	+
<b>Description:</b> RENEWAL FEE PAYMENT (PRS DATE IS RENEWAL DATE OF DATABASE) PAYMENT UNTIL: 20110611		
2010-06-01	FPAY	+
<b>Description:</b> RENEWAL FEE PAYMENT (PRS DATE IS RENEWAL DATE OF DATABASE) PAYMENT UNTIL: 20110611		
2010-05-27	FPAY	+
<b>Description:</b> RENEWAL FEE PAYMENT (PRS DATE IS RENEWAL DATE OF DATABASE) PAYMENT UNTIL: 20100611		
2009-06-02	FPAY	+
<b>Description:</b> RENEWAL FEE PAYMENT (PRS DATE IS RENEWAL DATE OF DATABASE) PAYMENT UNTIL: 20100611		
2008-06-10	FPAY	+
<b>Description:</b> RENEWAL FEE PAYMENT (PRS DATE IS RENEWAL DATE OF DATABASE) PAYMENT UNTIL: 20090611		
2008-06-05	FPAY	+
<b>Description:</b> RENEWAL FEE PAYMENT (PRS DATE IS RENEWAL DATE OF DATABASE) PAYMENT UNTIL: 20080611		
2004-06-11	R150	+
<b>Description:</b> CERTIFICATE OF PATENT (=GRANT) OR REGISTRATION OF UTILITY MODEL JAPANESE INTERMEDIATE CODE: R150		

2004-06-10	A61	+
Description: FIRST PAYMENT OF ANNUAL FEES (DURING GRANT PROCEDURE) JAPANESE INTERMEDIATE CODE: A61 2004-05-26		
2004-05-14	A01	+
Description: WRITTEN DECISION TO GRANT A PATENT OR TO GRANT A REGISTRATION (UTILITY MODEL) JAPANESE INTERMEDIATE CODE: A01 2004-05-13		
2004-05-11	TRDD	+
Description: DECISION OF GRANT OR REJECTION WRITTEN		

**Post-Issuance (US):**

**Reassignment (US) Table:**

**Maintenance Status (US):**

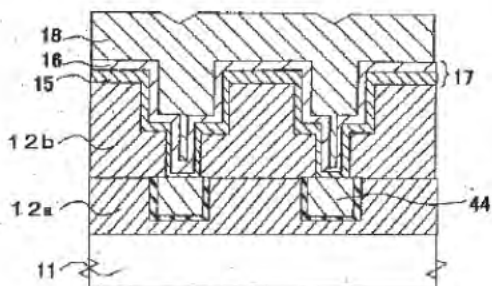
**Litigation (US):**

**Opposition (EP):**

**License (EP):**

**EPO Procedural Status:**

**Front Page Drawing:**



THOMSON REUTERS

Copyright 2007-2015 THOMSON REUTERS

## USPTO Maintenance Report

Patent Bibliographic Data			05/22/2015 04:06 PM		
Patent Number:	6538324	Application Number:	09596415		
Issue Date:	03/25/2003	Filing Date:	06/19/2000		
Title:	MULTI-LAYERED WIRING LAYER AND METHOD OF FABRICATING THE SAME				
Status:	4th, 8th and 12th year fees paid		Entity:	LARGE	
Window Opens:	N/A	Surcharge Date:	N/A	Expiration:	N/A
Fee Amt Due:	Window not open	Surchg Amt Due:	Window not open	Total Amt Due:	Window not open
Fee Code:					
Surcharge Fee Code:					
Most recent events (up to 7):	08/27/2014 08/26/2010 09/01/2006 09/24/2003 09/24/2003	Payment of Maintenance Fee, 12th Year, Large Entity. Payment of Maintenance Fee, 8th Year, Large Entity. Payment of Maintenance Fee, 4th Year, Large Entity. Payor Number Assigned. Payer Number De-assigned. --- End of Maintenance History ---			
Address for fee purposes:	CPA GLOBL LIMITED 2318 Mill Road 12th Floor ALEXANDRIA VA 22314				