

US 8536134	B2	20130917		
US 20080009436	A1	20080110	US 2007-857223	20070918
US 8211855	B2	20120703		
US 20080070834	A1	20080320	US 2007-940652	20071115
US 20120270805	A1	20121025	US 2012-13536479	20120628

PRIORITY APPLN. INFO.:

			US 2005-181178	A2 20050713
			US 2005-181187	A2 20050713
			US 2005-181409	A2 20050713
			US 2005-181428	A2 20050713
			US 2005-181509	A2 20050713
			US 2005-255821	A3 20051019
			US 2007-857223	A1 20070918

ASSIGNMENT HISTORY FOR US PATENT AVAILABLE IN LSUS DISPLAY FORMAT

AB A composition is disclosed herein comprising from about 0.001% to about 0.4% cyclosporin A, castor oil, and a surfactant selected from the group consisting of alc. ethoxylated, alcs., alkyl glycosides, alkyl polyglycosides, alkylphenol ethoxylates, amine oxides, block polymers, carboxylated alc. or alkylphenol ethoxylates, carboxylic adds/fatty acids, cellulose derivs., ethoxylated alcs., ethoxylated alkylphenols, ethoxylated aryl phenols, ethoxylated fatty acids, ethoxylated fatty acids, ethoxylated fatty esters and oils, fatty alcs., fatty esters, glycol esters, lanolin-based derivs., lecithin and lecithin derivs., lignin and lignin derivs., Me esters, monoglycerides and derivs., phospholipids, polyacrylic acids, polyethylene glycols, polyethylene oxide-polypropylene oxide copolymers, polyethylene oxides, polymeric surfactants, polypropylene oxides, propoxylated alcs., propoxylated alkyl phenols, propoxylated fatty acids, protein-based surfactants, sarcosine derivs., silicone-based surfactants, sorbitan derivs., stearates, sucrose and glucose esters and derivs., and combinations thereof. For example, emulsion was prepared containing cyclosporin A 0.1%, castor oil 1%, clove oil 0.7%, Polysorbate-80 1%, diglycerol 0.7%, glycerin 2%, CM-cellulose 0.5%, sodium hydroxide to adjust pH (7.2) and water as needed.

OS.CITING REF COUNT: 1 THERE ARE 1 CAPLUS RECORDS THAT CITE THIS RECORD (2 CITINGS)

REFERENCE COUNT: 89 THERE ARE 89 CITED REFERENCES AVAILABLE FOR THIS RECORD. ALL CITATIONS AVAILABLE IN THE RE FORMAT

L1 ANSWER 5 OF 5 CAPLUS COPYRIGHT 2013 ACS on STN

ACCESSION NUMBER: 2007:58577 CAPLUS
DOCUMENT NUMBER: 146:149007
TITLE: Composition comprising cyclosporin A
INVENTOR(S): Chang, James N.; Olejnik, Orest; Firestone, Bruce A.
PATENT ASSIGNEE(S): Allergan, Inc., USA
SOURCE: PCT Int. Appl., 32 pp.
CODEN: PIXXD2

DOCUMENT TYPE: Patent
LANGUAGE: English
FAMILY ACC. NUM. COUNT: 3

PATENT INFORMATION:

PATENT NO.	KIND	DATE	APPLICATION NO.	DATE
-----	---	-----	-----	-----
WO 2007008894	A2	20070118	WO 2006-US26881	20060712
WO 2007008894	A3	20070628		

W: AE, AG, AL, AM, AT, AU, AZ, BA, BB, BG, BR, BW, BY, BZ, CA, CH, CN, CO, CR, CU, CZ, DE, DK, DM, DZ, EC, EE, EG, ES, FI, GB, GD, GE, GH, GM, HN, HR, HU, ID, IL, IN, IS, JP, KE, KG, KM, KN, KP, KR, KZ, LA, LC, LK, LR, LS, LT, LU, LV, LY, MA, MD, MG, MK, MN, MW, MX, MZ, NA, NG, NI, NO, NZ, OM, PG, PH, PL, PT, RO, RS, RU, SC, SD, SE, SG, SK, SL, SM, SY, TJ, TM, TN, TR, TT, TZ, UA, UG, US, UZ, VC, VN, ZA, ZM, ZW

RW: AT, BE, BG, CH, CY, CZ, DE, DK, EE, ES, FI, FR, GB, GR, HU, IE, IS, IT, LT, LU, LV, MC, NL, PL, PT, RO, SE, SI, SK, TR, BF, BJ, CF, CG, CI, CM, GA, GN, GQ, GW, ML, MR, NE, SN, TD, TG, BW, GH, GM, KE, LS, MW, MZ, NA, SD, SL, SZ, TZ, UG, ZM, ZW, AM, AZ, BY, KG, KZ, MD, RU, TJ, TM, AP, EA, EP, OA

US 20070015690	A1	20070118	US 2005-181178	20050713
US 7297679	B2	20071120		
US 20070015710	A1	20070118	US 2005-181187	20050713
US 7276476	B2	20071002		
US 20070015691	A1	20070118	US 2005-181409	20050713
US 20070015692	A1	20070118	US 2005-181428	20050713
US 7202209	B2	20070410		
US 20070015693	A1	20070118	US 2005-181509	20050713
AU 2006268264	A1	20070118	AU 2006-268264	20060712
CA 2602452	A1	20070118	CA 2006-2602452	20060712
EP 1901711	A2	20080326	EP 2006-786892	20060712
R: AT, BE, BG, CH, CY, CZ, DE, DK, EE, ES, FI, FR, GB, GR, HU, IE, IS, IT, LI, LT, LU, LV, MC, NL, PL, PT, RO, SE, SI, SK, TR				
JP 2009501228	T	20090115	JP 2008-521528	20060712
BR 2006013533	A2	20110118	BR 2006-13533	20060712
US 20070149447	A1	20070628	US 2007-679934	20070228
US 8536134	B2	20130917		
US 20080070834	A1	20080320	US 2007-940652	20071115
US 20080207494	A1	20080828	US 2007-917448	20071213
US 8288348	B2	20121016		

PRIORITY APPLN. INFO.:

US 2005-181178	A	20050713
US 2005-181187	A	20050713
US 2005-181409	A	20050713
US 2005-181428	A	20050713
US 2005-181509	A	20050713
WO 2006-US26881	W	20060712

ASSIGNMENT HISTORY FOR US PATENT AVAILABLE IN LSUS DISPLAY FORMAT

AB Cyclosporin A compns. are disclosed herein comprising an oil and a surfactant. These are useful in the treatment of dry eye disease. Thus, composition was prepared containing cyclosporin A 0.1, castor oil 1, clove oil 0.7, polysorbate-80 1, diglycerol 0.7, glycerin 2, CM-cellulose 0.5 and water as needed.

OS.CITING REF COUNT: 6 THERE ARE 6 CAPLUS RECORDS THAT CITE THIS RECORD (6 CITINGS)

=> d his

(FILE 'HOME' ENTERED AT 23:44:39 ON 01 OCT 2013)

FILE 'CAPLUS, MEDLINE, EMBASE, BIOSIS' ENTERED AT 23:44:57 ON 01 OCT 2013
L1 5 CYCLOSPORIN AND CASTOR AND POLYSORBATE AND PEMULEN AND (GLYCERI

=> logoff h

COST IN U.S. DOLLARS	SINCE FILE	TOTAL
	ENTRY	SESSION
FULL ESTIMATED COST	37.83	38.07

SESSION WILL BE HELD FOR 120 MINUTES
STN INTERNATIONAL SESSION SUSPENDED AT 23:48:15 ON 01 OCT 2013

Search Notes 	Application/Control No. 13967163	Applicant(s)/Patent Under Reexamination ACHEAMPONG ET AL.
	Examiner MARCELA M CORDERO GARCIA	Art Unit 1658

CPC- SEARCHED		
Symbol	Date	Examiner

CPC COMBINATION SETS - SEARCHED		
Symbol	Date	Examiner

US CLASSIFICATION SEARCHED			
Class	Subclass	Date	Examiner
none	none	10/2/2013	MMCG

SEARCH NOTES		
Search Notes	Date	Examiner
STN search (attached)	10/3/2013	MMCG
EAST updated (attached)	10/2/2013	MMCG
also ran PALM inventor search	10/2/2013	MMCG

INTERFERENCE SEARCH			
US Class/ CPC Symbol	US Subclass / CPC Group	Date	Examiner

--	--

INFORMATION DISCLOSURE STATEMENT BY APPLICANT (Not for submission under 37 CFR 1.99)	Application Number		13967163
	Filing Date		2013-08-14
	First Named Inventor	ACHEAMPONG, ANDREW	
	Art Unit		1653
	Examiner Name	TBD	
	Attorney Docket Number		17618-US-BCON6-AP

ALL REFERENCES CONSIDERED EXCEPT WHERE LINED THROUGH. /M.M.C.G./

U.S.PATENTS						
Examiner Initial*	Cite No	Patent Number	Kind Code ¹	Issue Date	Name of Patentee or Applicant of cited Document	Pages,Columns,Lines where Relevant Passages or Relevant Figures Appear
	1	3278447		1966-10-11	Thomas McNicholas	
	2	4388229		1983-06-14	Cherng-Chyi Fu	
	3	4388307		1983-06-14	Thomas Cavanak	
	4	4614736		1986-09-30	Devallee et al	
	5	4649047		1987-03-10	Renee Kaswan	
	6	4764503		1988-08-16	Roland Wenger	
	7	4814323		1989-03-21	Andrieu et al	
	8	4839342		1989-06-13	Renee Kaswan	

INFORMATION DISCLOSURE STATEMENT BY APPLICANT (Not for submission under 37 CFR 1.99)	Application Number		13967163	13967163 - GAU: 1658
	Filing Date		2013-08-14	
	First Named Inventor	ACHEAMPONG, ANDREW		
	Art Unit	1653		
	Examiner Name	TBD		
	Attorney Docket Number	17618-US-BCON6-AP		

ALL REFERENCES CONSIDERED EXCEPT WHERE LINED THROUGH. /M.M.C.G./

9	4970076		1990-11-13	David Horrobin	
10	4990337		1991-02-05	Kurihara et al	
11	4996193		1991-02-26	Hewitt et al	
12	5047396		1991-09-10	Orban et al	
13	5051402		1991-09-24	Kurihara et al	
14	5053000		1991-10-01	Booth et al	
15	5286730		1994-02-15	Caufield et al	
16	5286731		1994-02-15	Caufield et al	
17	5294604		1994-03-15	Nussenblatt et al	
18	5296158		1994-03-22	MacGilp et al	
19	5342625		1994-08-30	Hauer et al	

Receipt date: 09/12/2013 INFORMATION DISCLOSURE STATEMENT BY APPLICANT (Not for submission under 37 CFR 1.99)	Application Number		13967163	13967163 - GAU: 1658	
	Filing Date		2013-08-14		
	First Named Inventor		ACHEAMPONG, ANDREW		
	Art Unit		1653		
	Examiner Name		TBD		
	Attorney Docket Number		17618-US-BCON6-AP		

ALL REFERENCES CONSIDERED EXCEPT WHERE LINED THROUGH. /M.M.C.G./

	20	5368854		1994-11-29	Donna Rennick	
	21	5411952		1995-05-02	Renee Kaswan	
	22	5424078		1995-06-13	Anthony Dziabo	
	23	5474919		1995-12-12	Chartrain et al	
	24	5474979		1995-12-12	Ding et al	U.S. Application No. 08/243,279 and its entire prosecution history**
	25	5504068		1996-04-02	Komiya et al	
	26	5540931		1996-07-30	Hewitt et al	
	27	5543393		1996-08-06	Kim et al	
	28	5589455		1996-12-31	Jong Woo	
	29	5591971		1997-01-07	Shahar et al	
	30	5614491		1997-03-25	Walch et al	

Receipt date: 09/12/2013 INFORMATION DISCLOSURE STATEMENT BY APPLICANT (Not for submission under 37 CFR 1.99)	Application Number		13967163	13967163 - GAU: 1658
	Filing Date		2013-08-14	
	First Named Inventor	ACHEAMPONG, ANDREW		
	Art Unit		1653	
	Examiner Name	TBD		
	Attorney Docket Number		17618-US-BCON6-AP	

ALL REFERENCES CONSIDERED EXCEPT WHERE LINED THROUGH. /M.M.C.G./

	31	5639724		1997-06-17	Thomas Cavanak	
	32	5652212		1997-07-29	Cavanak et al	
	33	5719123		1998-02-17	Morley et al	
	34	5739105		1998-04-14	Kim et al	
	35	5753166		1998-05-19	Dalton et al	
	36	5766629		1998-06-16	Cho et al	
	37	5798333		1998-08-25	Bernard Sherman	
	38	5807820		1998-09-15	Elias et al	
	39	5827822		1998-10-27	Floch'h et al	
	40	5827862		1998-10-27	Yoshitaka Yamamura	
	41	5834017		1998-11-10	Cho et al	

Receipt date: 09/12/2013 INFORMATION DISCLOSURE STATEMENT BY APPLICANT (Not for submission under 37 CFR 1.99)	Application Number		13967163	13967163 - GAU: 1658
	Filing Date		2013-08-14	
	First Named Inventor	ACHEAMPONG, ANDREW		
	Art Unit		1653	
	Examiner Name	TBD		
	Attorney Docket Number		17618-US-BCON6-AP	

ALL REFERENCES CONSIDERED EXCEPT WHERE LINED THROUGH. /M.M.C.G./

	42	5843452		1998-12-01	Wiedmann et al	
	43	5843891		1998-12-01	Bernard Sherman	
	44	5858401		1999-01-12	Bhalani et al	
	45	5866159		1999-02-02	Hauer et al	
	46	5891846		1999-04-06	Ishida et al	
	47	5916589		1999-06-29	Hauer et al	
	48	5929030		1999-07-27	Hamied et al	
	49	5951971		1999-09-14	Kawashima et al	
	50	5962014		1999-10-05	Hauer et al	
	51	5962017		1999-10-05	Hauer et al	
	52	5962019		1999-10-05	Cho et al	

Receipt date: 09/12/2013 INFORMATION DISCLOSURE STATEMENT BY APPLICANT (Not for submission under 37 CFR 1.99)	Application Number		13967163	13967163 - GAU: 1658
	Filing Date		2013-08-14	
	First Named Inventor	ACHEAMPONG, ANDREW		
	Art Unit		1653	
	Examiner Name	TBD		
	Attorney Docket Number		17618-US-BCON6-AP	

ALL REFERENCES CONSIDERED EXCEPT WHERE LINED THROUGH. /M.M.C.G./

	53	5977066		1999-11-02	Thomas Cavanak	
	54	5981479		1999-11-09	Ko et al	
	55	5981607		1999-11-09	Ding et al	U.S. Application No. 09/008,924 and its entire prosecution history**
	56	5998365		1999-12-07	Bernard Sherman	
	57	6004566		1999-12-21	Friedman et al	
	58	6007840		1999-12-28	Hauer et al	
	59	6008191		1999-12-28	Amarjit Singh	
	60	6008192		1999-12-28	Al-Razzak et al	
	61	6022852		2000-02-08	Klokkers et al	
	62	6024978		2000-02-15	Hauer et al	
	63	6046163		2000-04-04	Stuchlik et al	

Receipt date: 09/12/2013 INFORMATION DISCLOSURE STATEMENT BY APPLICANT (Not for submission under 37 CFR 1.99)	Application Number	13967163	13967163 - GAU: 1658
	Filing Date	2013-08-14	
	First Named Inventor	ACHEAMPONG, ANDREW	
	Art Unit	1653	
	Examiner Name	TBD	
	Attorney Docket Number	17618-US-BCON6-AP	

ALL REFERENCES CONSIDERED EXCEPT WHERE LINED THROUGH. /M.M.C.G./

	64	6057289		2000-05-02	Nirmal Mulye	
	65	6159933		2000-12-12	Bernard Sherman	
	66	6197335		2001-03-06	Bernard Sherman	
	67	6254860		2001-07-03	Michael Garst	
	68	6254885		2001-07-03	Cho et al	
	69	6267985		2001-07-31	Chen et al	
	70	6284268		2001-09-04	Mishra et al	
	71	6294192		2001-09-25	Patel et al	
	72	6306825		2001-10-23	Thomas Cavanak	
	73	6323204		2001-11-27	James Burke	
	74	6346511		2002-02-12	Singh et al	

Receipt date: 09/12/2013 INFORMATION DISCLOSURE STATEMENT BY APPLICANT (Not for submission under 37 CFR 1.99)	Application Number	13967163	13967163 - GAU: 1658
	Filing Date	2013-08-14	
	First Named Inventor	ACHEAMPONG, ANDREW	
	Art Unit	1653	
	Examiner Name	TBD	
	Attorney Docket Number	17618-US-BCON6-AP	

ALL REFERENCES CONSIDERED EXCEPT WHERE LINED THROUGH. /M.M.C.G./

	75	6350442		2002-02-26	Michael Garst	
	76	6413547		2002-07-02	Bennett et al	
	77	6420355		2002-07-16	Richter et al	
	78	6468968		2002-10-22	Cavanak et al	
	79	6475519		2002-11-05	Meinzer et al	
	80	6486124		2002-11-26	Olbrich et al	
	81	6544953		2003-04-08	Tsuzuki et al	
	82	6555526		2003-04-29	Toshihiko Matsuo	
	83	6562873		2003-05-13	Olejniak et al	
	84	6569463		2003-03-27	Patel et al	
	85	6582718		2003-06-24	Yoichi Kawashima	

Receipt date: 09/12/2013 INFORMATION DISCLOSURE STATEMENT BY APPLICANT (Not for submission under 37 CFR 1.99)	Application Number		13967163	13967163 - GAU: 1658	
	Filing Date		2013-08-14		
	First Named Inventor		ACHEAMPONG, ANDREW		
	Art Unit		1653		
	Examiner Name		TBD		
	Attorney Docket Number		17618-US-BCON6-AP		

ALL REFERENCES CONSIDERED EXCEPT WHERE LINED THROUGH. /M.M.C.G./

	86	6656460		2003-12-02	Benita et al	
	87	6872705		2005-03-29	Robert Lyons	
	88	7202209		2007-04-10	James N. Chang	U.S. Application No. 11/181,428 and its entire prosecution history**
	89	7276476		2007-10-02	Chang et al	U.S. Application No. 11/181,187 and its entire prosecution history**
	90	7288520		2007-10-30	Chang et al	U.S. Application No. 11/255,821 and its entire prosecution history**
	91	7297679		2007-11-20	James Chang	U.S. Application No. 11/181,178 and its entire prosecution history**
	92	7501393		2009-03-10	Tien et al	U.S. Application No. 11/161,218 and its entire prosecution history**
	93	8211855		2012-07-03	Chang et al	U.S. Application No. 11/857,223 and its entire prosecution history**
	94	8288348		2012-10-16	Chang et al	U.S. Application No. 11/917,448 and its entire prosecution history**

If you wish to add additional U.S. Patent citation information please click the Add button.

U.S.PATENT APPLICATION PUBLICATIONS

Examiner Initial*	Cite No	Publication Number	Kind Code ¹	Publication Date	Name of Patentee or Applicant of cited Document	Pages, Columns, Lines where Relevant Passages or Relevant Figures Appear
-------------------	---------	--------------------	------------------------	------------------	---	--

Receipt date: 09/12/2013 INFORMATION DISCLOSURE STATEMENT BY APPLICANT (Not for submission under 37 CFR 1.99)	Application Number		13967163	13967163 - GAU: 1658	
	Filing Date		2013-08-14		
	First Named Inventor		ACHEAMPONG, ANDREW		
	Art Unit		1653		
	Examiner Name		TBD		
	Attorney Docket Number		17618-US-BCON6-AP		

ALL REFERENCES CONSIDERED EXCEPT WHERE LINED THROUGH. /M.M.C.G./

1	20010003589		2001-06-14	Neuer et al	
2	20010014665		2001-08-16	Fischer et al	
3	20010036449		2001-11-01	Michael Garst	
4	20020012680		2002-01-31	Patel et al	
5	20020013272		2002-01-31	Cavanak et al	
6	20020016290		2002-02-07	Floc'h et al	
7	20020016292		2002-02-07	Richter et al	
8	20020025927		2002-02-28	Olbrich et al	
9	20020045601		2002-04-18	Yoichi Kawashima	
10	20020107183		2002-08-08	Petszulat et al	
11	20020119190		2002-08-29	Meinzer et al	

Receipt date: 09/12/2013 INFORMATION DISCLOSURE STATEMENT BY APPLICANT (Not for submission under 37 CFR 1.99)	Application Number	13967163	13967163 - GAU: 1658
	Filing Date	2013-08-14	
	First Named Inventor	ACHEAMPONG, ANDREW	
	Art Unit	1653	
	Examiner Name	TBD	
	Attorney Docket Number	17618-US-BCON6-AP	

ALL REFERENCES CONSIDERED EXCEPT WHERE LINED THROUGH. /M.M.C.G./

12	20020165134		2002-11-07	Richter et al	
13	20030021816		2003-01-30	Kang et al	
14	20030044452		2003-03-06	Ryuji Ueno	
15	20030055028		2003-03-20	Stergiopoulos et al	
16	20030059470		2003-03-27	Rainer Muller	
17	20030060402		2003-03-27	Cavanak et al	
18	20030087813		2003-05-08	Or et al	
19	20030104992		2003-06-05	Or et al	
20	20030108626		2003-06-12	Benita et al	
21	20030109425		2003-06-12	Or et al	
22	20030109426		2003-06-12	Or et al	

Receipt date: 09/12/2013 INFORMATION DISCLOSURE STATEMENT BY APPLICANT (Not for submission under 37 CFR 1.99)	Application Number	13967163	13967163 - GAU: 1658
	Filing Date	2013-08-14	
	First Named Inventor	ACHEAMPONG, ANDREW	
	Art Unit	1653	
	Examiner Name	TBD	
	Attorney Docket Number	17618-US-BCON6-AP	

ALL REFERENCES CONSIDERED EXCEPT WHERE LINED THROUGH. /M.M.C.G./

	23	20030133984		2003-07-17	Ambuhl et al	
	24	20030143250		2003-07-31	Hauer et al	
	25	20030147954		2003-08-07	Yang et al	
	26	20030166517		2003-09-04	Fricker et al	
	27	20050014691		2005-01-20	Bakhit et al	
	28	20050059583		2005-03-17	Andrew Acheampong	U.S. Application No. 10/927,857 and its entire prosecution history**
	29	20070015691		2007-01-18	James Chang	U.S. Application No. 11/181,409 and its entire prosecution history**
	30	20070027072		2007-02-01	Tien et al	
	31	20070087962		2007-04-19	Tien et al	
	32	20070149447		2007-06-28	Chang et al	U.S. Application No. 11/679,934 and its entire prosecution history**
	33	20070299004		2007-12-27	Acheampong et al	U.S. Application No. 11/897,177 and its entire prosecution history**

Receipt date: 09/12/2013 INFORMATION DISCLOSURE STATEMENT BY APPLICANT (Not for submission under 37 CFR 1.99)	Application Number	13967163	13967163 - GAU: 1658
	Filing Date	2013-08-14	
	First Named Inventor	ACHEAMPONG, ANDREW	
	Art Unit	1653	
	Examiner Name	TBD	
	Attorney Docket Number	17618-US-BCON6-AP	

ALL REFERENCES CONSIDERED EXCEPT WHERE LINED THROUGH. /M.M.C.G./

34	20080039378		2008-02-14	Graham et al	U.S. Application No. 11/781,095 and its entire prosecution history**
35	20080070834		2008-03-20	Chang et al	U.S. Application No. 11/940,652 and its entire prosecution history**
36	20080146497		2008-06-19	Graham et al	U.S. Application No. 11/858,200 and its entire prosecution history**
37	20080207495		2008-08-28	Graham et al	U.S. Application No. 12/035,698 and its entire prosecution history**
38	20090131307		2009-05-21	Tien et al	U.S. Application No. 12/361,335 and its entire prosecution history**
39	20100279951		2010-11-04	Morgan et al	U.S. Application No. 12/771,952 and its entire prosecution history**
40	20110009339		2011-01-13	Rhett Schiffman	U.S. Application No. 12/759,431 and its entire prosecution history**
41	20110294744		2011-12-01	Morgan et al	U.S. Application No. 13/115,764 and its entire prosecution history**
42	20120270805		2012-10-25	Chang et al	U.S. Application No. 13/536,479 and its entire prosecution history**
43	20130059796		2013-03-07	Chang et al	U.S. Application No. 13/649,287 and its entire prosecution history**

If you wish to add additional U.S. Published Application citation information please click the Add button.

FOREIGN PATENT DOCUMENTS

Receipt date: 09/12/2013 INFORMATION DISCLOSURE STATEMENT BY APPLICANT (Not for submission under 37 CFR 1.99)	Application Number		13967163	13967163 - GAU: 1658
	Filing Date		2013-08-14	
	First Named Inventor	ACHEAMPONG, ANDREW		
	Art Unit		1653	
	Examiner Name	TBD		
	Attorney Docket Number		17618-US-BCON6-AP	

ALL REFERENCES CONSIDERED EXCEPT WHERE LINED THROUGH. /M.M.C.G./

Examiner Initial*	Cite No	Foreign Document Number ³	Country Code ²	Kind Code ⁴	Publication Date	Name of Patentee or Applicant of cited Document	Pages, Columns, Lines where Relevant Passages or Relevant Figures Appear	T ⁵
	1	19810655	DE		1999-09-16	Eberhard-Karis- Universitat Tubingen Universitatskl		<input type="checkbox"/>
	2	0471293	EP		1992-02-19	ABBOTT LABORATORIES		<input type="checkbox"/>
	3	0547229	EP		1993-01-07	LLT Institute Co., Ltd.		<input type="checkbox"/>
	4	0760237	EP		1997-03-05	Cipla Limited		<input type="checkbox"/>
	5	1995-031211	WO		1995-11-23	Allergan Inc.		<input type="checkbox"/>
	6	2000-000179	WO		2000-01-06	Won Jin Biopharma Co., Ltd		<input type="checkbox"/>
	7	2001-032142	WO		2001-05-10	Cipla Limited		<input type="checkbox"/>
	8	2001-041671	WO		2001-06-14	Transneuronix, Inc.		<input type="checkbox"/>
	9	2002-009667	WO		2002-02-07	Pharmasol GMBH		<input type="checkbox"/>
	10	2002-049603	WO		2002-06-27	LG Household & Health Care Ltd.		<input type="checkbox"/>

Receipt date: 09/12/2013 INFORMATION DISCLOSURE STATEMENT BY APPLICANT (Not for submission under 37 CFR 1.99)	Application Number	13967163	13967163 - GAU: 1658
	Filing Date	2013-08-14	
	First Named Inventor	ACHEAMPONG, ANDREW	
	Art Unit	1653	
	Examiner Name	TBD	
	Attorney Docket Number	17618-US-BCON6-AP	

ALL REFERENCES CONSIDERED EXCEPT WHERE LINED THROUGH. /M.M.C.G./

11	2003-030834	WO		2003-04-17	Enanta Pharmaceuticals, Inc.	<input type="checkbox"/>
12	2003-053405	WO		2003-07-03	Yissum Research Development Company of the Hebrew	<input type="checkbox"/>

If you wish to add additional Foreign Patent Document citation information please click the Add button

NON-PATENT LITERATURE DOCUMENTS

Examiner Initials*	Cite No	Include name of the author (in CAPITAL LETTERS), title of the article (when appropriate), title of the item (book, magazine, journal, serial, symposium, catalog, etc), date, pages(s), volume-issue number(s), publisher, city and/or country where published.	T ⁵
	1	ABDULRAZIK, M. ET AL, Ocular Delivery of Cyclosporin A II. Effect of Submicron Emulsion's Surface Charge on Ocular Distribution of Topical Cyclosporin A, S.T.P. Pharma Sciences, Dec. 2001, 427-432, 11(6)	<input type="checkbox"/>
	2	ACHEAMPONG, ANDREW ET AL, Cyclosporine Distribution into the Conjunctiva, Cornea, Lacrimal Gland and Systemic Blood Following Topical Dosing of Cyclosporine to Rabbit, Dog and Human eyes, 1996, 179	<input type="checkbox"/>
	3	ACHEAMPONG, ANDREW ET AL, Cyclosporine Distribution Into The Conjunctiva, Cornea, Lacrimal Gland, and Systemic Blood Following Topical Dosing of Cyclosporine to Rabbit, Dog, and Human Eyes, Adv. Exp. Med. Biol., 1998, 1001-1004, 438	<input type="checkbox"/>
	4	ACHEAMPONG, ANDREW ET AL, Distribution of Cyclosporin A in Ocular Tissues After Topical Administration to Albino Rabbits and Beagle Dogs, Current Eye Research, 1999, 91-103, 18(2)	<input type="checkbox"/>
	5	AKPEK, ESEN KARAMURSEL ET AL, A Randomized Trial of Topical Cyclosporin 0.05% in Topical Steroid-Resistant Atopic Keratoconjunctivitis, Ophthalmology, 2004, 476-482, 111	<input type="checkbox"/>
	6	ANGELOV, O. ET AL, Preclinical Safety Studies of Cyclosporine Ophthalmic Emulsion, Adv Exp Med Biol, 1998, 991-995, 438	<input type="checkbox"/>
	7	ANGELOV, O. ET AL, Safety Assessment of Cyclosporine Ophthalmic Emulsion in Rabbits and Dogs, XIth Congress of the European Society of Ophthalmology, 1997, 25-28, 1-5, Soc. Ophthalmol Eur., HU	<input type="checkbox"/>

Receipt date: 09/12/2013 INFORMATION DISCLOSURE STATEMENT BY APPLICANT (Not for submission under 37 CFR 1.99)	Application Number	13967163	13967163 - GAU: 1658
	Filing Date	2013-08-14	
	First Named Inventor	ACHEAMPONG, ANDREW	
	Art Unit	1653	
	Examiner Name	TBD	
	Attorney Docket Number	17618-US-BCON6-AP	

ALL REFERENCES CONSIDERED EXCEPT WHERE LINED THROUGH. /M.M.C.G./

8	ARDIZZONE, SANDRO ET AL, A Practical Guide to the Management of Distal Ulcerative Colitis, Drugs, 1998, 519-542, 55(4)	<input type="checkbox"/>
9	BANIC, MARKO ET AL, Effect of Cyclosporine in a Murine Model of Experimental Colitis, Digestive Diseases and Sciences, June 2002, 1362-1368, 47(6)	<input type="checkbox"/>
10	BONINI, S. ET AL, Vernal Keratoconjunctivitis, Eye, 2004, 345-351, 18	<input type="checkbox"/>
11	BREWSTER, MARCUS ET AL, Enhanced Delivery of Ganciclovir to the Brain Through the Use of Redox Targeting, Antimicrobial Agents and Chemotherapy, Apr 1994, 817-823, 38(4)	<input type="checkbox"/>
12	BREWSTER, MARCUS ET AL, Intravenous and Oral Pharmacokinetic Evaluation of a 2-Hydroxypropyl- β -cyclodextrin-Based Formulation of Carbamazepine in the Dog: Comparison with Commercially Available Tablets and Suspensions, Journal of Pharmaceutical Sciences, March 1997, 335-339, 86(3)	<input type="checkbox"/>
13	BREWSTER, MARCUS ET AL, Preparation, Characterization, and Anesthetic Properties of 2-Hydroxypropyl- β -cyclodextrin Complexes of Pregnanolone and Pregnenolone in Rat and Mouse, Journal of Pharmaceutical Sciences, October 1995, 1154-1159, 84(10)	<input type="checkbox"/>
14	BRINKMEIER, THOMAS ET AL, Pyodermatitis-Pyostomatitis Vegetans: A Clinical Course of Two Decades with Response to Cyclosporine and Low-Dose Prednisolone, Acta Derm Venereol, 2001, 134-136, 81	<input type="checkbox"/>
15	CASTILLO, JOSE M. BENITEZ DEL ET AL, Influence of Topical Cyclosporine A and Dissolvent on Corneal Epithelium Permeability of Fluorescein, Documenta Ophthalmologica, 1995, 49-55, 91	<input type="checkbox"/>
16	CHEEKS, LISA ET AL, Influence of Vehicle and Anterior Chamber Protein Concentration on Cyclosporine Penetration Through the Isolated Rabbit Cornea, Current Eye Research, 1992, 641-649, 11(7)	<input type="checkbox"/>
17	Database WPI Week 200044, Derwent Pub. Ltd., London, GB; An 2000-492678 & JP2000/143542, 2000, 2 Pages	<input type="checkbox"/>
18	DING, SHULIN ET AL, Cyclosporine Ophthalmic O/W emulsion: Formulation and Emulsion Characterization, Pharm Res, 1997, 1 page, 14 (11)	<input type="checkbox"/>

Receipt date: 09/12/2013 INFORMATION DISCLOSURE STATEMENT BY APPLICANT (Not for submission under 37 CFR 1.99)	Application Number	13967163	13967163 - GAU: 1658
	Filing Date	2013-08-14	
	First Named Inventor	ACHEAMPONG, ANDREW	
	Art Unit	1653	
	Examiner Name	TBD	
	Attorney Docket Number	17618-US-BCON6-AP	

ALL REFERENCES CONSIDERED EXCEPT WHERE LINED THROUGH. /M.M.C.G./

19	DONNENFELD, ERIC D., The Economics Of Using Restasis, Ophthalmology Management, 10/2003, 3 pages, US	<input type="checkbox"/>
20	DROSOS, A. A. ET AL, Efficacy and Safety of Cyclosporine-A Therapy for Primary Sjogren's Syndrome, Ter. Arkh., 1998, 77-80, 60(4)	<input type="checkbox"/>
21	DROSOS, A.A. ET AL, Cyclosporin A Therapy in Patients with Primary Sjogren's Syndrome: Results at One Year, Scand J Rheumatology, 1986, 246-249, 61	<input type="checkbox"/>
22	EISEN, DRORE ET AL, Topical Cyclosporine for Oral Mucosal Disorders, J Am Acad Dermatol, Dec. 1990, 1259-1264, 23	<input type="checkbox"/>
23	EPSTEIN, JOEL ET AL, Topical Cyclosporine in a Bioadhesive for Treatment of Oral Lichenoid Muscosal Reactions, Oral Surg Oral Med Oral Pathol Oral, 1996, 532-536, 82	<input type="checkbox"/>
24	ERDMANN, S. ET AL, Pemphigus Vulgaris Der Mund- Und Kehlkopfschleimhaut Pemphigus Vulgaris of the Oral Mucosa and the Larynx, H+G Zeitschrift Fuer Hautkrankheiten, 1997, 283-286, 72(4)	<input type="checkbox"/>
25	FDA Concludes Restasis (Cyclosporine) Not Effective for Dry Eye (6/18/1999). Accessed online at http://www.dryeyeinfo.org/Restasis_Cyclosporine.htm on 8/14/09. 1 Page	<input type="checkbox"/>
26	GAETA, G.M. ET AL, Cyclosporin Bioadhesive Gel in the Topical Treatment of Erosive Oral Lichen Planus, International Journal of Immunopathology and Pharmacology, 1994, 125-132, 7(2)	<input type="checkbox"/>
27	GIPSON, ILENE ET AL, Character of Ocular Surface Mucins and Their Alteration in Dry Eye Disease, The Ocular Surface, April 2004, 131-148, 2(2)	<input type="checkbox"/>
28	GREMSE, DAVID ET AL, Ulcerative Colitis in Children, Pediatr Drugs, 2002, 807-815, 4(12)	<input type="checkbox"/>
29	GUNDUZ, KAAAN ET AL, Topical Cyclosporin Treatment of Keratoconjunctivitis Sicca in Secondary Sjogren's Syndrome, Acta Ophthalmologica, 1994, 438-442, 72	<input type="checkbox"/>

Receipt date: 09/12/2013 INFORMATION DISCLOSURE STATEMENT BY APPLICANT (Not for submission under 37 CFR 1.99)	Application Number	13967163	13967163 - GAU: 1658
	Filing Date	2013-08-14	
	First Named Inventor	ACHEAMPONG, ANDREW	
	Art Unit	1653	
	Examiner Name	TBD	
	Attorney Docket Number	17618-US-BCON6-AP	

ALL REFERENCES CONSIDERED EXCEPT WHERE LINED THROUGH. /M.M.C.G./

30	http://web.archive.org/web/2001030625323/http://www.surfactant.co.kr/surfactants/pegester.html , 2001, 6 Pages, retrieved on 7/05/2008	<input type="checkbox"/>
31	HUNTER, P.A. ET AL, Cyclosporin A Applied Topically to the Recipient Eye Inhibits Corneal Graft Rejection, Clin Exp Immunol, 1981, 173-177, 45	<input type="checkbox"/>
32	JUMAA, MUHANNAD ET AL, Physicochemical Properties and Hemolytic Effect of Different Lipid Emulsion Formulations Using a Mixture of Emulsifiers, Pharmaceutica Acta Helvetiae, 1999, 293-301, 73	<input type="checkbox"/>
33	KANAI, A. ET AL, The Effect on the Cornea of Alpha Cyclodextrin Vehicle for Eye Drops, Transplantation Proceedings, Febraury 1989, 3150-3152, Vol. 21	<input type="checkbox"/>
34	KANPOLAT, AYFER ET AL, Penetration of Cyclosporin A into the Rabbit Cornea and Aqueous Humor after Topical Drop and Collagen Shield Administration, Cornea/External Disease, April 1994, 119-122, 20(2)	<input type="checkbox"/>
35	KAUR, RABINDER ET AL, Solid Dispersions of Drugs in Polyocetylhlene 40 Stearate: Dissolution Rates and Physico-Chemical Interactions, Journal of Pharmacy and Pharmacology, December 1979, 48P	<input type="checkbox"/>
36	KUWANO, MITSUAKI ET AL, Cyclosporine A Formulation Affects Its Ocular Distribution in Rabbits, Pharmaceutical Research, January 2002, 108-111, 19(1)	<input type="checkbox"/>
37	Lambert Technologies Corp. Material Safety Data Sheet for LUMULSE™ POE-40 MS KP, last revision 8/22/2003. 3 pages	<input type="checkbox"/>
38	LEIBOVITZ, Z. ET AL., Our Experience In Processing Maize (Corn) Germ Oil, Journal Of The American Oil Chemists Society, 02/1983, 395-399, 80 (2), US	<input type="checkbox"/>
39	LIXIN, XIE ET AL, Effect Of Cyclosporine A Delivery System in Corneal Transplantation, Chinese Medical Journal, 2002, 110-113, 115 (1), US	<input type="checkbox"/>
40	LOPATIN, D.E., Chemical Compositions and Functions of Saliva, 8/24/2001, 31 Pages	<input type="checkbox"/>

Receipt date: 09/12/2013 INFORMATION DISCLOSURE STATEMENT BY APPLICANT (Not for submission under 37 CFR 1.99)	Application Number	13967163	13967163 - GAU: 1658
	Filing Date	2013-08-14	
	First Named Inventor	ACHEAMPONG, ANDREW	
	Art Unit	1653	
	Examiner Name	TBD	
	Attorney Docket Number	17618-US-BCON6-AP	

ALL REFERENCES CONSIDERED EXCEPT WHERE LINED THROUGH. /M.M.C.G./

41	LYONS, R.T. ET AL, Influence of Three Emulsion Formulation Parameters on the Ocular Bioavailability of Cyclosporine A in Albino Rabbits, Am Assoc Pharm Sci, 2000, 1 Page, 2(4)	<input type="checkbox"/>
42	PEDERSEN, ANNE MARIE ET AL, Primary Sjogren's Syndrome: Oral Aspects on Pathogenesis, Diagnostic Criteria, Clinical Features and Approaches for Therapy, Expert Opin Pharma, 2001, 1415-1436, 2(9)	<input type="checkbox"/>
43	PHILLIPS, THOMAS ET AL, Cyclosporine Has a Direct Effect on the Differentiation of a Mucin-Secreting Cell Line, Journal of Cellular Physiology, 2000, 400-408, 184	<input type="checkbox"/>
44	PRESENT, D.H. ET AL, Cyclosporine and Other Immunosuppressive Agents: Current and Future Role in the Treatment of Inflammatory Bowel Disease, American Journal of Gastroenterology, 1993, 627-630, 88(5)	<input type="checkbox"/>
45	Restasis ® Product Information Sheet, Allergan, Inc., 2009, 5 Pages	<input type="checkbox"/>
46	Restasis® Increasing Tear Production, Retrieved on 08/14/2009, http://www.restasisprofessional.com/_clinical/clinical_increasing.htm 3 pages	<input type="checkbox"/>
47	ROBINSON, N.A. ET AL, Desquamative Gingivitis: A Sign of Mucocutaneous Disorders - a Review, Australian Dental Journal, 2003, 205-211, 48(4)	<input type="checkbox"/>
48	RUDINGER, J., Characteristics of the Amino Acids as Components of a Peptide Hormone Sequence, Peptide Hormones, 1976, 1-7	<input type="checkbox"/>
49	SALL, KENNETH ET AL, Two Multicenter, Randomized Studies of the Efficacy and Safety of Cyclosporine Ophthalmic Emulsion in Moderate to Severe Dry Eye Disease, Ophthalmology, 2000, 631-639, 107	<input type="checkbox"/>
50	SANDBORN, WILLIAM ET AL, A Placebo-Controlled Trial of Cyclosporine Enemas for Mildly to Moderately Active Left-Sided Ulcerative Colitis, Gastroenterology, 1994, 1429-1435, 106	<input type="checkbox"/>
51	SANDBORN, WILLIAM ET AL, Cyclosporine Enemas for Treatment-Resistant, Mildly to Moderately Active, Left-Sided Ulcerative Colitis, American Journal of Gastroenterology, 1993, 640-645, 88(5)	<input type="checkbox"/>

Receipt date: 09/12/2013 INFORMATION DISCLOSURE STATEMENT BY APPLICANT (Not for submission under 37 CFR 1.99)	Application Number	13967163	13967163 - GAU: 1658
	Filing Date	2013-08-14	
	First Named Inventor	ACHEAMPONG, ANDREW	
	Art Unit	1653	
	Examiner Name	TBD	
	Attorney Docket Number	17618-US-BCON6-AP	

ALL REFERENCES CONSIDERED EXCEPT WHERE LINED THROUGH. /M.M.C.G./

52	SCHWAB, MATTHIAS ET AL, Pharmacokinetic Considerations in the Treatment of Inflammatory Bowel Disease, Clin Pharm, 2001, 723-751, 60(10)	<input type="checkbox"/>
53	SECCHI, ANTONIO ET AL, Topical Use of Cyclosporine in the Treatment of Vernal Keratoconjunctivitis, American Journal of Ophthalmology, December 1990, 641-645, 110	<input type="checkbox"/>
54	SMALL, DAVE ET AL, The Ocular Pharmacokinetics of Cyclosporine in Albino Rabbits and Beagle Dogs, Ocular Drug Delivery and Metabolism, 1999, 54	<input type="checkbox"/>
55	SMALL, DAVID ET AL, Blood Concentrations of Cyclosporin A During Long-Term Treatment With Cyclosporin A ophthalmic Emulsions in Patients with Moderate to Severe Dry Eye Disease, Journal of Ocular Pharmacology and Therapeutics, 2002, 411-418, 18(5)	<input type="checkbox"/>
56	SMILEK, DAWN ET AL, A Single Amino Acid Change in a Myelin Basic Protein Peptide Confers the Capacity to Prevent Rather Than Induce Experimental Autoimmune Encephalomyelitis, Proc. Natl. Acad. Sci., Nov 1991, 9633-9637, 88	<input type="checkbox"/>
57	STEPHENSON, MICHELLE, The Latest Uses Of Restasis, Review Of Ophthalmology, 12/30/2005, 7 Pages, US	<input type="checkbox"/>
58	STEVENSON, DARA ET AL, Efficacy and Safety of Cyclosporin A ophthalmic Emulsion in the Treatment of Moderate-to-Severe Dry Eye Disease, Ophthalmology, 2000, 967-974, 107	<input type="checkbox"/>
59	TESAVIBUL, N. ET AL, Topical Cyclosporine A (CsA) for Ocular Surface Abnormalities in Graft Versus Host Disease Patients, Invest Ophthalmol Vis Sci, Feb 1996, S1026, 37(3)	<input type="checkbox"/>
60	The Online Medical Dictionary, Derivative, Analog, Analogue, Xerostomia, accessed 7/7/2005 and 7/13/2005, 6 Pages	<input type="checkbox"/>
61	TIBELL, A. ET AL., Cyclosporin A In Fat Emulsion Carriers: Experimental Studies On Pharmacokinetics And Tissue Distribution, Pharmacology & Toxicology, 1995, 115-121, 76, US	<input type="checkbox"/>
62	TSUBOTA, KAZUO ET AL, Use of Topical Cyclosporin A in a Primary Sjogren's Syndrome Mouse Model, Invest Ophthalmol Vis Sci, Aug. 1998, 1551-1559, 39(9)	<input type="checkbox"/>

Receipt date: 09/12/2013 INFORMATION DISCLOSURE STATEMENT BY APPLICANT (Not for submission under 37 CFR 1.99)	Application Number	13967163	13967163 - GAU: 1658
	Filing Date	2013-08-14	
	First Named Inventor	ACHEAMPONG, ANDREW	
	Art Unit	1653	
	Examiner Name	TBD	
	Attorney Docket Number	17618-US-BCON6-AP	

ALL REFERENCES CONSIDERED EXCEPT WHERE LINED THROUGH. /M.M.C.G./

63	VAN DER REIJDEN, WILLY ET AL, Treatment of Oral Dryness Related Complaints (Xerostomia) in Sjogren's Syndrome, Ann Rheum Dis, 1999, 465-473, 58	<input type="checkbox"/>
64	WINTER, T.A. ET AL, Cyclosporin A Retention Enemas in Refractory Distal Ulcerative Colitis and 'Pouchitis', Scand J Gastroenterol, 1993, 701-704, 28	<input type="checkbox"/>
65	U.S. Pending Application: 13/967,189 Filed on August 14, 2013	<input type="checkbox"/>
66	U.S. Pending Application: 13/976,179 Filed on August 14, 2013	<input type="checkbox"/>
67	U.S. Pending Application: 13/961,818 Filed on August 07, 2013	<input type="checkbox"/>
68	U.S. Pending Application: 13/961,835 Filed on August 07, 2013	<input type="checkbox"/>
69	U.S. Pending Application: 13/961,808 Filed on August 07, 2013	<input type="checkbox"/>
70	U.S. Pending Application: 13/961,828 Filed on August 07, 2013	<input type="checkbox"/>
71	U.S. Pending Application: 13/967,168 Filed on August 14, 2013	<input type="checkbox"/>
72	U.S. Re-Examination Application: 90/009,944 Filed on August, 27, 2011	<input type="checkbox"/>

If you wish to add additional non-patent literature document citation information please click the Add button

Receipt date: 09/12/2013 INFORMATION DISCLOSURE STATEMENT BY APPLICANT (Not for submission under 37 CFR 1.99)	Application Number	13967163	13967163 - GAU: 1658
	Filing Date	2013-08-14	
	First Named Inventor	ACHEAMPONG, ANDREW	
	Art Unit	1653	
	Examiner Name	TBD	
	Attorney Docket Number	17618-US-BCON6-AP	

ALL REFERENCES CONSIDERED EXCEPT WHERE LINED THROUGH. /M.M.C.G./

EXAMINER SIGNATURE			
Examiner Signature	<i>/Marcela Cordero Garcia/</i>	Date Considered	<i>09/27/2013</i>
<p>*EXAMINER: Initial if reference considered, whether or not citation is in conformance with MPEP 609. Draw line through a citation if not in conformance and not considered. Include copy of this form with next communication to applicant.</p>			
<p>¹ See Kind Codes of USPTO Patent Documents at www.USPTO.GOV or MPEP 901.04. ² Enter office that issued the document, by the two-letter code (WIPO Standard ST.3). ³ For Japanese patent documents, the indication of the year of the reign of the Emperor must precede the serial number of the patent document. ⁴ Kind of document by the appropriate symbols as indicated on the document under WIPO Standard ST.16 if possible. ⁵ Applicant is to place a check mark here if English language translation is attached.</p>			

Receipt date: 09/12/2013 INFORMATION DISCLOSURE STATEMENT BY APPLICANT (Not for submission under 37 CFR 1.99)	Application Number	13967163	13967163 - GAU: 1658
	Filing Date	2013-08-14	
	First Named Inventor	ACHEAMPONG, ANDREW	
	Art Unit	1653	
	Examiner Name	TBD	
	Attorney Docket Number	17618-US-BCON6-AP	

CERTIFICATION STATEMENT

Please see 37 CFR 1.97 and 1.98 to make the appropriate selection(s):

That each item of information contained in the information disclosure statement was first cited in any communication from a foreign patent office in a counterpart foreign application not more than three months prior to the filing of the information disclosure statement. See 37 CFR 1.97(e)(1).

OR

That no item of information contained in the information disclosure statement was cited in a communication from a foreign patent office in a counterpart foreign application, and, to the knowledge of the person signing the certification after making reasonable inquiry, no item of information contained in the information disclosure statement was known to any individual designated in 37 CFR 1.56(c) more than three months prior to the filing of the information disclosure statement. See 37 CFR 1.97(e)(2).

** Signature indicates consideration of publication and file history. The Examiner has access to these materials through the PTO computer systems. If additional copies are desired, please notify the Applicants through their attorneys.

- See attached certification statement.
- Fee set forth in 37 CFR 1.17 (p) has been submitted herewith.
- None

SIGNATURE

A signature of the applicant or representative is required in accordance with CFR 1.33, 10.18. Please see CFR 1.4(d) for the form of the signature.

Signature	/Laura L. Wine/	Date (YYYY-MM-DD)	2013-09-12
Name/Print	Laura L. Wine	Registration Number	68,681

This collection of information is required by 37 CFR 1.97 and 1.98. The information is required to obtain or retain a benefit by the public which is to file (and by the USPTO to process) an application. Confidentiality is governed by 35 U.S.C. 122 and 37 CFR 1.14. This collection is estimated to take 1 hour to complete, including gathering, preparing and submitting the completed application form to the USPTO. Time will vary depending upon the individual case. Any comments on the amount of time you require to complete this form and/or suggestions for reducing this burden, should be sent to the Chief Information Officer, U.S. Patent and Trademark Office, U.S. Department of Commerce, P.O. Box 1450, Alexandria, VA 22313-1450. **DO NOT SEND FEES OR COMPLETED FORMS TO THIS ADDRESS. SEND TO: Commissioner for Patents, P.O. Box 1450, Alexandria, VA 22313-1450.**

Privacy Act Statement

The Privacy Act of 1974 (P.L. 93-579) requires that you be given certain information in connection with your submission of the attached form related to a patent application or patent. Accordingly, pursuant to the requirements of the Act, please be advised that: (1) the general authority for the collection of this information is 35 U.S.C. 2(b)(2); (2) furnishing of the information solicited is voluntary; and (3) the principal purpose for which the information is used by the U.S. Patent and Trademark Office is to process and/or examine your submission related to a patent application or patent. If you do not furnish the requested information, the U.S. Patent and Trademark Office may not be able to process and/or examine your submission, which may result in termination of proceedings or abandonment of the application or expiration of the patent.

The information provided by you in this form will be subject to the following routine uses:

1. The information on this form will be treated confidentially to the extent allowed under the Freedom of Information Act (5 U.S.C. 552) and the Privacy Act (5 U.S.C. 552a). Records from this system of records may be disclosed to the Department of Justice to determine whether the Freedom of Information Act requires disclosure of these records.
2. A record from this system of records may be disclosed, as a routine use, in the course of presenting evidence to a court, magistrate, or administrative tribunal, including disclosures to opposing counsel in the course of settlement negotiations.
3. A record in this system of records may be disclosed, as a routine use, to a Member of Congress submitting a request involving an individual, to whom the record pertains, when the individual has requested assistance from the Member with respect to the subject matter of the record.
4. A record in this system of records may be disclosed, as a routine use, to a contractor of the Agency having need for the information in order to perform a contract. Recipients of information shall be required to comply with the requirements of the Privacy Act of 1974, as amended, pursuant to 5 U.S.C. 552a(m).
5. A record related to an International Application filed under the Patent Cooperation Treaty in this system of records may be disclosed, as a routine use, to the International Bureau of the World Intellectual Property Organization, pursuant to the Patent Cooperation Treaty.
6. A record in this system of records may be disclosed, as a routine use, to another federal agency for purposes of National Security review (35 U.S.C. 181) and for review pursuant to the Atomic Energy Act (42 U.S.C. 218(c)).
7. A record from this system of records may be disclosed, as a routine use, to the Administrator, General Services, or his/her designee, during an inspection of records conducted by GSA as part of that agency's responsibility to recommend improvements in records management practices and programs, under authority of 44 U.S.C. 2904 and 2906. Such disclosure shall be made in accordance with the GSA regulations governing inspection of records for this purpose, and any other relevant (i.e., GSA or Commerce) directive. Such disclosure shall not be used to make determinations about individuals.
8. A record from this system of records may be disclosed, as a routine use, to the public after either publication of the application pursuant to 35 U.S.C. 122(b) or issuance of a patent pursuant to 35 U.S.C. 151. Further, a record may be disclosed, subject to the limitations of 37 CFR 1.14, as a routine use, to the public if the record was filed in an application which became abandoned or in which the proceedings were terminated and which application is referenced by either a published application, an application open to public inspections or an issued patent.
9. A record from this system of records may be disclosed, as a routine use, to a Federal, State, or local law enforcement agency, if the USPTO becomes aware of a violation or potential violation of law or regulation.

IN THE UNITED STATES PATENT AND TRADEMARK OFFICE

Applicant: Acheampong, *et al.*

Serial No.: 13/967,163

Filed: August 14, 2013

For: METHODS OF PROVIDING
THERAPEUTIC EFFECTS USING
CYCLOSPORIN COMPONENTS

Examiner: Marcela M Cordero Garcia

Group Art Unit: 1658

Confirmation No. 4274

Customer No.: 51957

RESPONSE TO NON FINAL OFFICE ACTION DATED OCTOBER 17, 2013

Commissioner for Patents
P.O. Box 1450
Alexandria, VA 22313-1450

Dear Sir:

These papers are filed in reply to the Office Action mailed October 17, 2013

Amendments to the Claims begin at page 2;

Summary of the Interview begins at page 6;

Remarks follow on page 7.

AMENDMENTS TO THE CLAIMS

The following claims replace all prior versions of claims submitted in this application.

Only those claims being amended herein show their changes in highlighted form, where insertions appear as underlined text (e.g., insertions) while deletions appear as strikethrough or surrounded by double brackets (e.g. deletions or [[deletions]]).

1– 36. (Canceled)

37. **(Currently Amended)** A topical ophthalmic emulsion for treating an eye of a human ~~having KCS, wherein the topical ophthalmic emulsion comprises~~ comprising cyclosporin A in an amount of about 0.05% by weight, polysorbate 80, ~~Permulen~~ acrylate/C10-30 alkyl acrylate cross-polymer, water, and castor oil in an amount of about 1.25% by weight; ~~and~~ ~~—wherein the topical ophthalmic emulsion is therapeutically effective in treating KCS.~~

38. (Previously Presented) The topical ophthalmic emulsion of Claim 37, wherein the topical ophthalmic emulsion further comprises a tonicity agent or a demulcent component.

39. (Previously Presented) The topical ophthalmic emulsion of Claim 38, wherein the tonicity agent or the demulcent component is glycerine.

40. (Previously Presented) The topical ophthalmic emulsion of Claim 37, wherein the topical ophthalmic emulsion further comprises a buffer.

41. (Previously Presented) The topical ophthalmic emulsion of Claim 40, wherein the buffer is sodium hydroxide.

42. (Previously Presented) The topical ophthalmic emulsion of Claim 37, wherein the topical ophthalmic emulsion further comprises glycerine and a buffer.

43. (Previously Presented) The topical ophthalmic emulsion of Claim 37, wherein the topical ophthalmic emulsion comprises polysorbate 80 in an amount of about 1.0% by weight.

44. (**Currently Amended**) The topical ophthalmic emulsion of Claim 37, wherein the topical ophthalmic emulsion comprises ~~Penulen~~ acrylate/C10-30 alkyl acrylate cross-polymer in an amount of about 0.05% by weight.

45. (Previously Presented) The topical ophthalmic emulsion of Claim 37, wherein the topical ophthalmic emulsion further comprises glycerine in an amount of about 2.2% by weight, water, and a buffer.

46. (Previously Presented) The topical ophthalmic emulsion of Claim 45, wherein the buffer is sodium hydroxide.

47. (**Currently Amended**) The topical ophthalmic emulsion of Claim 37, wherein, when the topical ophthalmic emulsion is administered to an eye of a human ~~in an effective amount in treating KCS~~, the blood of the human has substantially no detectable concentration of cyclosporin A.

48. (Previously Presented) The topical ophthalmic emulsion of Claim 42, wherein the topical ophthalmic emulsion has a pH in the range of about 7.2 to about 7.6.

49– 53. (Canceled)

54. (**Currently Amended**) A topical ophthalmic emulsion for treating an eye of a human, ~~wherein the topical ophthalmic emulsion increases tear production in the eye of a human, and~~ wherein the topical ophthalmic emulsion comprises:

cyclosporin A in an amount of about 0.05% by weight;

castor oil in an amount of about 1.25% by weight;

polysorbate 80 in an amount of about 1.0% by weight;

~~Penulen~~ acrylate/C10-30 alkyl acrylate cross-polymer in an amount of about 0.05% by weight;
a tonicity component or a demulcent component in an amount of about 2.2% by weight;
a buffer; and
water;
wherein the topical ophthalmic emulsion has a pH in the range of about 7.2 to about 7.6.

55. (Previously Presented) The topical ophthalmic emulsion of Claim 54, wherein the buffer is sodium hydroxide.

56. (Previously Presented) The topical ophthalmic emulsion of Claim 54, wherein the tonicity component or the demulcent component is glycerine.

57. (**Currently Amended**) The topical ophthalmic emulsion of Claim 54, wherein, when the topical ophthalmic emulsion is administered to an eye of a human ~~in an effective amount to increase tear production~~, the blood of the human has substantially no detectable concentration of the cyclosporin A.

58. (Canceled)

59. (**Currently Amended**) The topical ophthalmic emulsion of Claim 54, wherein the topical ophthalmic emulsion is effective in treating keratoconjunctivitis sicca~~KCS~~.

60. (**Currently Amended**) A topical ophthalmic emulsion for treating an eye of a human, the topical ophthalmic emulsion comprising:

cyclosporin A in an amount of about 0.05% by weight;
castor oil in an amount of about 1.25% by weight;
polysorbate 80 in an amount of about 1.0% by weight;
~~Penulen~~ acrylate/C10-30 alkyl acrylate cross-polymer in an amount of about 0.05% by weight;
glycerine in an amount of about 2.2% by weight;

sodium hydroxide; and

water;

~~wherein the emulsion is effective in treating KCS.~~

61. (Previously Presented) The topical ophthalmic emulsion of Claim 60, wherein the topical ophthalmic emulsion has a pH in the range of about 7.2 to about 7.6.

62. (New) The topical ophthalmic emulsion of Claim 37, wherein the topical ophthalmic emulsion is therapeutically effective in treating dry eye.

63. (New) The topical ophthalmic emulsion of Claim 37, wherein the topical ophthalmic emulsion is therapeutically effective in treating keratoconjunctivitis sicca.

64. (New) The topical ophthalmic emulsion of Claim 37, wherein the topical ophthalmic emulsion is therapeutically effective in increasing tear production.

65. (New) The topical ophthalmic emulsion of Claim 54, wherein the topical ophthalmic emulsion is therapeutically effective in treating dry eye.

66. (New) The topical ophthalmic emulsion of Claim 54, wherein the topical ophthalmic emulsion is therapeutically effective in increasing tear production.

67. (New) The topical ophthalmic emulsion of Claim 60, wherein the topical ophthalmic emulsion is therapeutically effective in treating dry eye.

68. (New) The topical ophthalmic emulsion of Claim 60, wherein the topical ophthalmic emulsion is therapeutically effective in treating keratoconjunctivitis sicca.

69. (New) The topical ophthalmic emulsion of Claim 60, wherein the topical ophthalmic emulsion is therapeutically effective in increasing tear production.

SUMMARY OF INTERVIEW

Attendees, Date and Type of Interview

An in-person interview was conducted on October 3, 2013 at the USPTO and was attended by Examiner Cordero Garcia, Laura L. Wine, Dr. Rhett Schiffman, Dr. Mayssa Attar, and Debra Condino.

Exhibits and/or Demonstrations

Data demonstrating unexpected results and commercial success of the claimed formulation were presented. Data and information regarding the claimed formulation's satisfaction of a long felt need were also presented.

Identification of Claims Discussed

The Claims were discussed, focusing on Claims 37 and 54.

Identification of Prior Art Discussed

The prior art of record was discussed, focusing on Ding (U.S. Patent No. 5,474,979).

Proposed Amendments

It was proposed to amend Claims 54 to recite a range of pH of the claimed formulation.

Principal Arguments and Other Matters

The Applicants presented data demonstrating unexpected results, commercial success, and satisfaction of a long felt need of the claimed formulation. While the Applicants do not acquiesce to any *prima facie* case of obviousness, the evidence of non-obviousness presented at the interview overcomes the *prima facie* obviousness rejection.

Results of Interview

It was agreed that the evidence of non-obviousness presented rendered the claims allowable and overcame the prior art of record. It was agreed that the Applicants would file a response, presenting arguments and data discussed at the interview.

REMARKS

This Reply responds to the Office Action sent October 17, 2013 , in which the Office Action rejected Claims 37-61. Claims 49-53 and 58 are newly cancelled. Claims 37, 44, 47, 54, 57, and 59-60 have been amended. Claims 62-69 are new. Thus, Claims 37-48, 54-57 and 59-69 are currently pending. No new matter has been added by this amendment, and all amendments to the claims are fully supported by the originally filed application. The Applicants respectfully submit that the claims are in condition for allowance.

Claim Rejections

35 U.S.C. § 112, second paragraph

Claims 37-61 were rejected under 35 U.S.C. § 112, second paragraph as being indefinite for failing to particularly point out and distinctly claim the subject matter which Applicants regard as the invention. The Applicants submit that the amendments to the claims submitted herewith render the rejection under 35 U.S.C. § 112, second paragraph moot. Thus, the Applicants respectfully request that the claim rejections under 35 U.S.C. § 112, second paragraph be withdrawn.

35 U.S.C. 103(a)

The Office Action rejected Claims 37-61 under 35 U.S.C. 103(a) as being unpatentable as obvious in view of U.S. Patent No. 5,474,979 to Ding et al. (“Ding”).

The Applicants submit that the *prima facie* case of obviousness has not been properly established against the pending claims. However, the Applicants submit that the unexpected results, commercial success, and satisfaction of long felt need obtained with the claimed formulations and failure of others overcome the *prima facie* obviousness rejection asserted in the Office Action.

The Federal Circuit has held that objective evidence of nonobviousness must always be taken into account before a conclusion on obviousness is reached. Similarly, M.P.E.P. 716.01(a) states that “[a]ffidavits or declarations, when timely presented, containing evidence of criticality or unexpected results, commercial success, long-left but unsolved needs, failure of others, skepticism of experts, etc., must be considered by the Patent Office in determining the issue of obviousness of claims for patentability under 35 U.S.C. 103.” Thus, the *Graham* factors,

including the use of objective evidence of secondary considerations to rebut a *prima facie* case of obviousness, remains the framework to be followed for a determination of obviousness. The Federal Circuit has even stated that “evidence of secondary considerations may often be the most probative and cogent evidence in the record. It may often establish that an invention appearing to have been obvious in light of the prior art was not.” *See, Stratoflex Inc. v. Aeroquip Corp.*, 713 F.2d 1530, 1538 (Fed. Cir. 1983).

The Claimed Formulations Provide Surprising and Unexpected Results

As discussed in the interview with the Examiner, the claimed formulations provide surprising and unexpected results in view of the prior art (e.g. Ding). According to MPEP § 2144.05 (III), the Applicants can rebut a presumption of obviousness based on a claimed invention that falls within a prior art range by showing “(1) [t]hat the prior art taught away from the claimed invention...or (2) **that there are new and unexpected results relative to the prior art.**” *Iron Grip Barbell Co., Inc. v. USA Sports, Inc.*, 392 F.3d 1317, 1322, 73 USPQ2d 1225, 1228 (Fed. Cir. 2004).

In support of this position, the Applicants submit herewith as Exhibit 1 a Declaration of Dr. Rhett M. Schiffman under 37 C.F.R. § 1.132 (hereinafter, “Schiffman Declaration 1”), Chief Medical Officer at Neurotech, with over 12 years of experience as a clinician in the eye care field. The Applicants also submit herewith as Exhibit 2, a Declaration of Dr. Mayssa Attar under 37 C.F.R. § 1.132 (hereinafter, “Attar Declaration”), Research Investigator at Allergan, Inc., the assignee of record of the present application, with about 15 years of experience in the pharmacokinetics field.

As described by Dr. Schiffman and Dr. Attar in their respective declarations, supported by examples and experiments, the claimed formulations provided unexpected results compared to the prior art with regards to two key objective testing parameters for dry eye or keratoconjunctivis sicca: Schirmer Tear Testing and decrease in corneal staining, and with regards to reduction in blurred vision and decreased use of artificial tears. Specifically, the claimed formulations provided unexpected results compared to formulations 1E and 1D disclosed in Ding, which included 0.05% by weight cyclosporin A and 0.625% by weight castor oil and 0.10% by weight cyclosporin A and 1.25% by weight castor oil, respectively. *See* Ding, col. 4, lines 34-43.

As described by Dr. Schiffman in paragraphs 17-20 of Schiffman Declaration 1 and as seen in Exhibits E and F to Schiffman Declaration 1, surprisingly, the claimed formulation demonstrated an 8-fold increase in relative efficacy for the Schirmer Tear Test score in the first study of Allergan’s Phase 3 trials compared to the relative efficacy for the 0.05% by weight cyclosporin A/0.625% by weight castor oil formulation disclosed in Example 1E of Ding, tested in Phase 2 trials. The data presented herewith represents the subpopulation of Phase 2 patients with the same reductions in tear production (≤ 5 mm/5 min) as those enrolled in the Phase 3 studies. Schiffman Declaration 1 at ¶ 8. Exhibits E and F also illustrate that the claimed formulations also demonstrated a 4-fold improvement in the relative efficacy for the Schirmer Tear Test score for the second study of Phase 3 and a 4-fold increase in relative efficacy for decrease in corneal staining score in both of the Phase 3 studies compared to the 0.05% by weight cyclosporin A/0.625% by weight castor oil formulation tested in Phase 2 and disclosed in Ding (Ding 1E). This was clearly a very surprising and unexpected result.

Exhibit E of Schiffman Declaration 1

	Phase 2 001	Phase 3 (1 st study)	Phase 3 (2 nd study)
	0.05% CsA in 0.625% CO	0.05% CsA in 1.25% CO	0.05% CsA in 1.25% CO
	Compared with 0.1% CsA in 1.25% CO		
Improvement in STT	0.25	2 (8-Fold Improvement*)	1 (4-Fold Improvement*)
Decrease in Corneal Staining	0.25	1 (4-Fold Improvement*)	1 (4-Fold Improvement*)

*Compared to the 0.05% CsA/0.625% CO Phase 2 formulation (disclosed in Ding)

Exhibit F of Schiffman Declaration 1

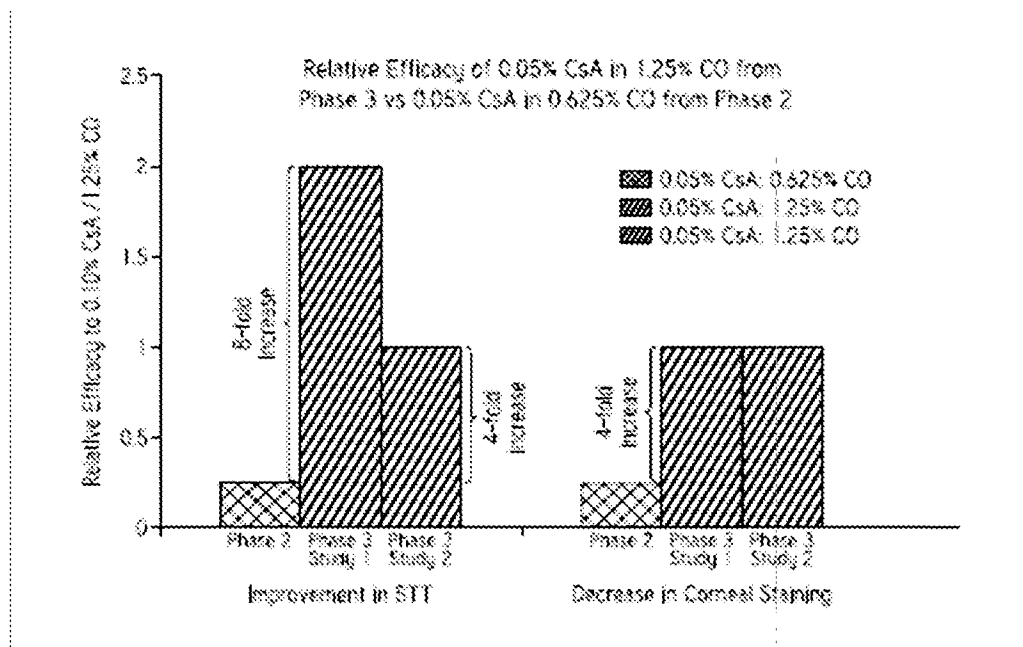

This dramatic increase in relative efficacy between the claimed formulation and the formulation disclosed in Examples 1E and 1D of Ding was especially unexpected in view of pharmacokinetic data. As described by Dr. Attar in paragraph 7 of the Attar Declaration, pharmacokinetic studies were performed on animal eyes, which compared the pharmacokinetic properties of several cyclosporin A-containing formulations, including formulations containing 0.05% by weight cyclosporin A and 0.625% by weight castor oil, formulations containing 0.05% by weight cyclosporin A and 1.25% by weight castor oil, and formulations containing 0.1% by weight cyclosporin A and 1.25% by weight castor oil. This data was compiled and organized in Exhibit B to the Attar Declaration, reproduced below:

Exhibit B to Attar Declaration

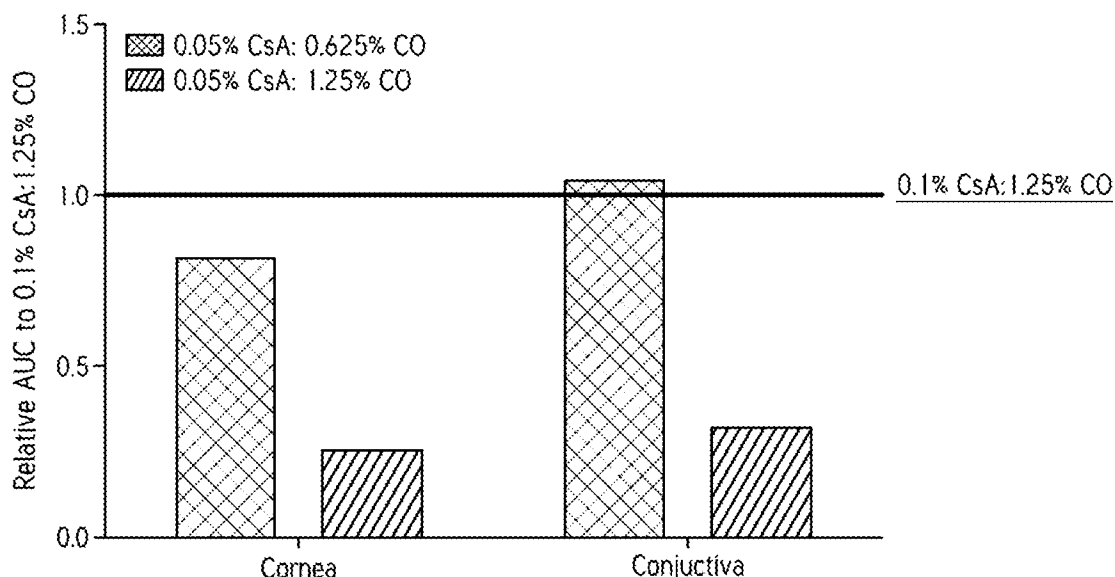

As described in paragraph 7 of the Attar Declaration, this chart shows that the amount of cyclosporin A that reaches the cornea and conjunctiva, ocular tissues that are highly relevant for the treatment of dry eye or keratoconjunctivitis sicca, is higher for the formulation containing 0.05% by weight cyclosporin A and 0.625% by weight castor oil (Ding 1E) than the formulation containing 0.05% by weight cyclosporin A and 1.25% by weight castor oil (the claimed formulation) relative to the formulation containing 0.1% by weight cyclosporin A and 1.25% by weight castor oil (Ding 1D). According to Dr. Attar, this data teaches that the formulation containing 0.05% by weight cyclosporin A and 1.25% by weight castor oil would be less therapeutically effective than the formulation containing 0.05% by weight cyclosporin A and 0.625% by weight castor oil or the formulation containing 0.10% by weight cyclosporin A and 1.25% by weight castor oil. Attar Declaration at ¶ 8. Similarly, according to Dr. Schiffman, this data shows that, since lower levels of cyclosporin A were reaching the ocular tissues relevant for the treatment of dry eye, one of skill in the art would have expected patients receiving the claimed formulation to exhibit a lesser decrease from baseline in corneal staining score and a lesser increase from baseline in Schirmer Score relative to the corneal staining scores and Schirmer Scores of the patients receiving the 0.05% by weight cyclosporin A / 0.625% by weight

castor oil formulation (Ding 1E) in the Phase 2 trials, as illustrated in Schiffman Declaration 1, Exhibit B. *See* Schiffman Declaration 1 at ¶ 13.

As described by Dr. Schiffman in paragraphs 14-15 of Schiffman Declaration 1, surprisingly, the claimed formulation was equally or more therapeutically effective for the treatment of dry eye or keratoconjunctivitis sicca than the formulation containing 0.10% by weight cyclosporin A and 1.25% by weight castor oil (Ding 1D) according to corneal staining score, Schirmer Score, an improvement in the common dry eye/keratoconjunctivitis sicca symptom of blurred vision and a greater decrease in the number of artificial tears used by patients.

Taking the results of the studies and data presented in the Attar and Schiffman 1 Declarations together, it is clear that the specific combination of 0.05% by weight cyclosporin A with 1.25% by weight castor oil is surprisingly critical for therapeutic effectiveness in the treatment of dry eye or keratoconjunctivitis sicca.

Accordingly, the Applicants submit that the Declarations of Drs. Rhett M. Schiffman (Schiffman Declaration 1) and Attar, together with the data presented in those declarations, provide clear and convincing objective evidence that establishes that the claimed formulations, including 0.05% by weight cyclosporin A and 1.25% by weight castor oil, demonstrate surprising and unexpected results, including improved Schirmer Tear Test scores and corneal staining scores (key objective measures of efficacy for dry eye or keratoconjunctivitis sicca) and improved visual blurring and reduced artificial tear use as compared to the prior art, for example, emulsion formulations disclosed in Ding, including formulations with 0.05% by weight cyclosporin A and 0.625% by weight castor oil (Ding 1E) and formulations with 0.10% by weight cyclosporin A and 1.25% by weight castor oil (Ding 1D).

The Claimed Formulations are Commercially Successful

As discussed during the Examiner interview, in addition to having surprising and unexpected results, the claimed formulations have demonstrated commercial success. In support of this position, the Applicants submit herewith as Exhibit 3, a Declaration of Aziz Mottiwala under 37 C.F.R. § 1.132 (hereinafter, “Mottiwala Declaration”), Vice President of Marketing at Allergan for Allergan’s Dry Eye Product Franchise.

As explained by Mr. Mottiwala, RESTASIS®, which is a commercial embodiment of the claimed formulation, has been sold since 2003. *See* Mottiwala Declaration at ¶ 2. Since the launch of RESTASIS® in 2003, worldwide sales of the drug have increased steadily. *See* Mottiwala Declaration at ¶ 3 and Exhibit B to Mottiwala Declaration. Currently, annual worldwide net sales for RESTASIS® are over \$200 million per quarter, and nearing \$800 million annually. *See* Mottiwala Declaration at ¶ 4. This is strong evidence of commercial success. *See Id.* As there is no other FDA-Approved therapeutic treatment for dry eye available on the US market, RESTASIS® owns 100% of the market share. *Id.*

Accordingly, the Applicants assert that the Declaration of Aziz Mottiwala provides objective evidence that unequivocally establishes that the present invention as embodied in RESTASIS® has been met with commercial success.

The Claimed Formulations Satisfied a Long-Felt Need

As discussed during the Interview, the claimed formulations also resolve a long-felt need. In support of this position, the Applicants submit herewith as Exhibit 4, a Declaration of Dr. Rhett M. Schiffman under 37 C.F.R. § 1.132 (hereinafter, “Schiffman Declaration 2”).

According to the MPEP, establishing long-felt need requires objective evidence that an art recognized problem existed in the art for a long period of time without solution. *See* MPEP § 716.04.

First, the need must have been a persistent one that was recognized by those of ordinary skill in the art. *Id.* As explained by Dr. Schiffman, dry eye/keratoconjunctivis sicca has been a known, persistent ocular disorder for many years. Publications on dry eye date back to at least the 1970’s, and interest and publication on the subject has increased substantially since. *See* Schiffman Declaration 2 at ¶¶ 2-4.

Second, the long-felt need must not have been satisfied by another before the invention by applicant. MPEP 716.04. As explained by Dr. Schiffman, no other therapeutic dry-eye drug has been approved by the FDA before or since RESTASIS®. *See* Schiffman Declaration 2 at ¶ 8. Other treatments for dry eye, such as artificial tears, have been commercially available, but they only exhibit a palliative effect, and do not work to increase tear production or otherwise treat the disease. *See* Schiffman Declaration 2 at ¶ 4.

Third, the invention must in fact satisfy the long-felt need. MPEP 716.04. As shown by the FDA's approval of RESTASIS®, and the praise in the industry discussed by Dr. Schiffman at paragraph 8 of Schiffman Declaration 2, the claimed methods have satisfied the long felt need. As explained above, RESTASIS® has been met with great commercial success, which further shows the satisfaction of the long felt need.

Several other companies have tried to develop therapeutic drugs for FDA approval, but many have failed. *See* Schiffman Declaration 2 at ¶ 9 and Exhibit N. The Federal Circuit has implicitly accepted that failure to obtain FDA approval is relevant evidence of failure of others. *Knoll Pharm. Co. v Teva Pharms. USA, Inc.*, 367 F.3d 1381, 1385 (Fed. Cir. 2004).

Accordingly, the Applicants assert that the second Declaration of Dr. Rhett M. Schiffman provides objective evidence that unequivocally establishes that the present invention as embodied in RESTASIS® has satisfied a long felt need and that others have failed to meet such a long felt need.

Hence, in view of the evidence presented above and presented in the attached declarations, the Applicants submit that the unexpected results, commercial success, and satisfaction of long felt need obtained from the claimed formulations successfully rebut the *prima facie* case of obviousness presented in the Office Action. Thus, the Applicants respectfully request that the Examiner withdraw the outstanding rejections under 35 U.S.C. § 103.

Statutory Double Patenting Rejection

Claims 37-56 and 59-61 were provisionally rejected for statutory double patenting in view of claims 37-60 of co-pending U.S. Patent Application No. 13/967,189 and claims 37-60 of copending U.S. Patent Application No. 13/961,808. Claims 37-61 were also provisionally rejected for statutory double patenting in view of claims 37-61 of co-pending U.S. Patent Application No. 13/961,828. Since this is a provisional statutory double patenting rejection, the Applicants request that the Examiner allow the present case to proceed to allowance over the other aforementioned cases. *See* MPEP § 804(2). Also, while the Applicants do not acquiesce to the provisional statutory doubling patenting rejection, the Applicants have amended the claims in copending U.S. Patent Application Nos. 13/961,808 and 13/967,189, thus rendering the provisional statutory double patenting rejection over those two cases moot. Applicants

respectfully request, therefore, that the Office withdraw the provisional statutory double patenting rejections.

Obviousness-Type Double Patenting Rejections

Claims 37-61 were rejected for non-statutory obvious-type double patenting in view of claims 1-8 of the Ding reference.

The Applicants submit that the pending claims are patentably distinct from claims 1-8 of Ding for at least the same reasons argued above. The Applicants respectfully request, therefore, that the Office withdraw the double patenting rejection of Claims 37-61 in view of claims 1-8 of Ding.

Provisional Obviousness-Type Double Patenting Rejection

Claims 37-61 were rejected for provisional non-statutory obvious-type double patenting in view of claims 37-61 of copending U.S. Patent Application No. 13/967,179, claims 37-60 of copending U.S. Patent Application No. 13/961,835, claims 37-61 of copending U.S. Patent Application No. 13/961,818, and claims 37-60 of copending U.S. Patent Application No. 13/967,168.

While the Applicants do not necessarily agree with the provisional non-statutory obviousness-type double patenting rejections recited above, in order to expedite prosecution, terminal disclaimers in the aforementioned applications were filed on October 7, 2013. Thus, the Applicants submit that the provisional obviousness-type double patenting rejection has been rendered moot and request that this provisional obviousness-type double patenting rejection be withdrawn.

Conclusion

In view of the foregoing, the Applicants believe all claims now pending in the present application are in condition for allowance.

The Commissioner is hereby authorized to charge any fees required or necessary for the filing, processing or entering of this paper or any of the enclosed papers, and to refund any overpayment, to deposit account 01-0885.

Docket No. 17618CON6B (AP)

If the Examiner believes a telephone conference would expedite prosecution of this application, please contact the undersigned at (714) 246-6996.

Respectfully submitted,

/Laura L. Wine/

Date: October 23, 2013

Laura L. Wine
Attorney of Record
Registration Number 68,681

Please direct all inquiries and correspondence to:
Laura L. Wine, Esq.
Allergan, Inc.
2525 Dupont Drive, T2-7H
Irvine, California 92612
Tel: (714) 246-6996 Fax: (714) 246-4249

EXHIBIT 1

IN THE UNITED STATES PATENT AND TRADEMARK OFFICE

DECLARATION UNDER 37 C.F.R. 1.132

of Dr. Rhett M. Schiffman,

I, Rhett M. Schiffman, M.D., declare as follows:

1. I am currently a Vice President and Chief Medical Officer at Neurotech. I have an M.D, Masters Degrees in Clinical Research Design and Statistical Analysis and in Health Services Administration, a Bachelor's degree in Bioengineering, and over 12 years of experience in the pharmaceutical industry at Allergan, Inc. ("Allergan"). I was also a clinical investigator in the Phase 3 studies for Restasis®. I am a co-inventor on several issued patents and pending applications related to treatment methods using ophthalmic products. My *curriculum vita*, which contains a list of my publications to which I contributed, is attached to this declaration as Exhibit A.
2. I have been informed of the general nature of the rejections made by the Patent Office with respect to the previously presented claims of the above-referenced patent application and I am familiar with the references that the Patent Office has relied on in making these rejections. For example, I am aware of U.S. Patent No. 5,474,979 to Ding et al. ("Ding").
3. Restasis® is an FDA approved product that is a commercial embodiment of the invention. Specifically, Restasis® is approved as a 0.05% by weight cyclosporin ophthalmic emulsion useful for the treatment of ophthalmic conditions, such as dry eye. Specifically, Restasis® ophthalmic emulsion is indicated to increase tear production in patients whose tear production is presumed to be suppressed due to ocular inflammation associated with keratoconjunctivitis sicca.
4. I have reviewed the pending claims in the present application, and the pending claims cover the specific formulation of Restasis® and/or the approved methods of treatment of dry eye or keratoconjunctivitis sicca for Restasis®.
5. In creating and testing the claimed methods and compositions, several unexpected benefits were discovered using the claimed compositions and/or claimed methods.
6. During development of a drug for the treatment of dry eye disease or keratoconjunctivitis sicca, Allergan performed a randomized, multicenter, double-masked, parallel-group, dose-response controlled Phase 2 trial on several cyclosporin-A and castor oil-containing formulations. In this Phase 2 study of moderate to severe KCS, the safety and efficacy of

four cyclosporin A-containing emulsion compositions were compared to one another: 0.05% by weight cyclosporin A with 0.625% by weight castor oil, 0.10% by weight cyclosporin A with 1.25% by weight castor oil, 0.20% by weight cyclosporin A with 2.5% by weight castor oil, and 0.40% by weight cyclosporin A with 5.0% by weight castor oil. A vehicle containing 2.5% by weight castor oil was also tested and compared to these formulations. In this study, patients with moderate to severe dry eye disease were treated twice daily with one of the aforementioned cyclosporin A-containing formulations or a vehicle. All of the cyclosporin A-containing formulations as well as the vehicle also included 2.2% by weight glycerine, 1.0% by weight polysorbate 80, 0.05% by weight Pemulen, sodium hydroxide, and water. To the best of my knowledge, the specific cyclosporin-A containing formulations tested in humans in this Phase 2 study are disclosed in the Ding reference. Results from this study illustrating the change from baseline in corneal staining and change from baseline in Schirmer Score, key objective testing measures for dry eye or KCS, are shown in Exhibit B, Figures 1 and 2, respectively.

7. As shown in Exhibit B, Figure 1, the 0.1% by weight cyclosporin A/ 1.25% by weight castor oil formulation demonstrated a greater decrease in corneal staining than the 0.05% by weight cyclosporin A/0.625% by weight castor oil formulation. As shown in Exhibit B, Figure 2 the 0.1% by weight cyclosporin A/ 1.25% by weight castor oil formulation demonstrated a greater increase in Schirmer Score (tear production) at week 12 than any other formulation tested, including the 0.05% by weight cyclosporin A/0.625% by weight castor oil formulation. Corneal staining and Schirmer score are key objective measures for determining dry eye or keratoconjunctivitis sicca disease severity.
8. After Allergan's Phase 2 study, Allergan initiated a Phase 3 study. In Allergan's multicenter, randomized, double-masked Phase 3 trials, Allergan compared the efficacy and safety of the formulation containing 0.10% by weight cyclosporin A and 1.25% by weight castor oil to a the claimed formulation (containing 0.05% by weight cyclosporin A and 1.25% by weight castor oil), and to a vehicle containing 1.25% by weight castor oil. The data presented in Exhibit B represents the subpopulation of moderate to severe Phase 2 patients with the same reductions in tear production (≤ 5 mm/5 min) as those enrolled in the Phase 3 studies. In this study, patients with moderate to severe dry eye disease were treated twice daily with either a formulation containing 0.10% by weight cyclosporin A and 1.25% by weight castor oil, a formulation containing 0.05% by weight cyclosporin A and 1.25% by weight castor oil, or the vehicle. Both cyclosporin A-containing formulations and the vehicle also included 2.2% by weight glycerine, 1.0% by weight polysorbate 80, 0.05% by weight Pemulen, sodium hydroxide, and water.

9. I have reviewed the Declaration of Dr. Mayssa Attar (“Attar Declaration”), and I agree with her statements made in paragraphs 6-8, reproduced here. I have attached Exhibit B to the Attar Declaration to this Declaration as Exhibit C:

10. “It was known in the art at the time this application was filed that cyclosporin could be administered topically locally to the eye to target and treat dry eye by using cyclosporin A’s immunomodulatory properties to inhibit T cell activation which would lead to an increase in tear production and potentially other therapeutic effects related cyclosporine’s anti-inflammatory and anti-apoptotic effects and thus limit chronic inflammation in the pathology of dry eye. To elicit it’s therapeutic effect, cyclosporine must be effectively delivered to multiple target tissues of the ocular surface such as the cornea, conjunctiva, and lacrimal gland. The rate and extent at which cyclosporine is differentially delivered to the putative sites of action is critical to achieving therapeutic success in treating dry eye. Generally speaking, it was understood that pharmacokinetic/pharmacodynamic relationship would indicate that as more cyclosporin A reaches the target tissues of the ocular surface, such as the cornea and conjunctiva, the more immunomodulatory and more anti-inflammatory activity can take place and the more therapeutically effective a drug can be in treating dry eye.

11. Pharmacokinetic studies were performed on animal eyes, which compared the pharmacokinetic properties of several cyclosporin A-containing formulations. Those results are attached to this declaration in Exhibit B. As shown in Exhibit B, the relative extent at cyclosporin was absorbed increased in the relevant ocular tissues, here, the cornea and the conjunctiva, where the amount of oil present in the formulation was decreased. Specifically, the amount of cyclosporin A that reached the relevant ocular tissue was higher for the formulation containing 0.05% by weight cyclosporin A and 0.625% by weight castor oil than the formulation containing 0.05% by weight cyclosporin A and 1.25% by weight castor oil relative to the formulation containing 0.1% by weight cyclosporin A and 1.25% by weight castor oil.

12. One of skill in the art would have understood such a result to mean that since there was more cyclosporin A present in the relevant ocular tissues in the formulation containing 0.05% by weight cyclosporin A and 0.625% by weight castor oil and the formulation containing 0.1% by weight cyclosporine A and 1.25% by weight castor oil than the claimed formulation, that those formulations would have been more therapeutically effective than the claimed formulation. Specifically, this data suggests that the formulation containing 0.05% by weight cyclosporin A and 0.625% by weight castor oil would have been more therapeutically effective than the claimed formulation.”

13. Specifically, one of skill in the art would have expected patients receiving the claimed formulations and methods to exhibit a lesser decrease from baseline in corneal staining score and a lesser increase from baseline in Schirmer Score, relative to the patient corneal staining scores and Schirmer Scores demonstrated by the patients receiving the 0.05% by weight cyclosporin A / 0.625% by weight castor oil formulation (Ding 1E) in the Phase 2 trials illustrated in Exhibit B.
14. Surprisingly, the claimed formulation and method was equally or more therapeutically effective for the treatment of dry eye/keratoconjunctivitis sicca than the formulation containing 0.10% by weight cyclosporin A and 1.25% by weight castor oil according to at least four testing parameters. This result was surprising and completely unexpected. These results are attached to this declaration in Exhibit D.
15. As shown in the results in Exhibit D, the claimed formulation and method was unexpectedly superior to the 0.10% by weight cyclosporin A / 1.25% by weight castor oil formulation with respect to several properties. For example, the claimed formulations and methods surprisingly exhibited a comparable or greater decrease in corneal staining score (see Exhibit D, Figure 1), a greater increase in Schirmer Score (see Exhibit D, Figure 2), an improvement in the common dry eye/keratoconjunctivitis sicca symptom of blurred vision (see Exhibit D, Figure 3) and a greater decrease in the number of artificial tears used by patients (see Exhibit D, Figure 4) compared to the formulation containing 0.10% by weight cyclosporin A and 1.25% by weight castor oil.
16. This result was even more surprising, given earlier testing from the Phase 2 study that illustrated that compositions containing 0.10% by weight cyclosporin A and 1.25% by weight castor oil provided more improvement in objective measures (such as corneal staining and increase in Schirmer Score – as illustrated in Exhibit B) in dry eye patients than compositions containing 0.05% by weight cyclosporin A and 0.625% castor oil.
17. I have compared the objective results showing the surprising therapeutic efficacy of the claimed formulation and method relative to the 0.10% by weight cyclosporin A and 1.25% by weight castor oil formulation tested in Phase 3 to the 0.05% by weight cyclosporin A and 0.625% by weight castor oil formulation relative to the 0.10% by weight cyclosporin A and 1.25% by weight castor oil formulation tested in Phase 2. This comparison is attached to this declaration as Exhibit E.
18. As seen in Exhibit E, in the Phase 2 study, the 0.05% by weight cyclosporin A/0.625% by weight castor oil formulation (Ding 1E) only achieved 0.25 times the improvement in Schirmer Tear Test score as the 0.1 % by weight cyclosporin A/1.25% by weight castor

oil formulation and only achieved 0.25 times the decrease in corneal staining as the 0.1 % by weight cyclosporin A/1.25% by weight castor oil formulation. However, in the Phase 3 studies, the claimed formulation and method achieved twice the improvement in Schirmer Tear Test score as the 0.1 % by weight cyclosporin A/1.25% by weight castor oil formulation in the first study and substantially the same improvement in Schirmer Tear Test score as the 0.1 % by weight cyclosporin A/1.25% by weight castor oil formulation in the second Phase 3 study. Also, the claimed formulation achieved substantially the same decrease in corneal staining score compared to the 0.1 % by weight cyclosporin A/1.25% by weight castor oil formulation.

19. As seen in Exhibit E, and further illustrated in Exhibit F, surprisingly, the claimed formulation and method demonstrated an 8-fold increase in relative efficacy for the Schirmer Tear Test Score in the first study of phase 3 compared to the 0.05% by weight cyclosporin A/0.625% by weight castor oil formulation (Ding Example 1E) in the Phase 2 study. Exhibits E and F also illustrate that the claimed formulations demonstrated a 4-fold improvement in the relative efficacy for the Schirmer Tear Test score for the second study of Phase 3 and a 4-fold increase in relative efficacy for decrease in corneal staining score in both of the Phase 3 studies compared to the 0.05% by weight cyclosporin A/0.625% by weight castor oil formulation in the Phase 2 study, the formulation disclosed in the Ding reference (Ding 1E). This was clearly a very surprising result.

20. Taking the results of these studies together, it is clear that the specific combination of 0.05% by weight cyclosporin A with 1.25% by weight castor oil is surprisingly and unexpectedly critical for therapeutic effectiveness in the treatment of dry eye/keratoconjunctivitis sicca.

I hereby declare that all statements made herein of my own knowledge and belief are true; and that all statements made on information and belief are believed to be true; and further that these statements are made with the knowledge that willful false statements and the like so made are punishable by fine or imprisonment, or both, under Section 1001 of Title 18 of the United States Code, and that such willful false statements may jeopardize the validity of the application or any patents issued thereon.

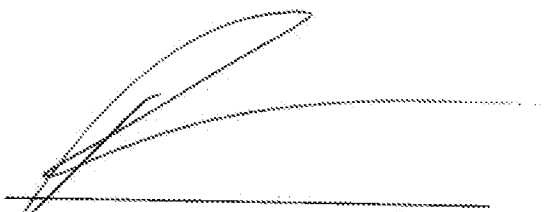

Dr. Rhett M. Schiffman

Date: 10/11/13

EXHIBIT A

CURRICULUM VITAE FOR RHETT M. SCHIFFMAN, M.D., M.S., M.H.S.A.

Current Title: Vice President and Chief Medical Officer
Neurotech

Work Address: 900 Highland Corporate Drive
Building #1, Suite #101
Cumberland, RI 02864

Home Address: 1843 Temple Hills
Laguna Beach, CA 92651

Office Telephone: (401) 495-2395
Cell Telephone: (313) 516-6924
Email: r.schiffman@neurotechusa.com

EDUCATION:

Professional: University of Michigan, School of Public Health,
Ann Arbor, Michigan
2000 M.H.S.A. Health Services Administration

University of Michigan, Rackham Graduate School,
Ann Arbor, Michigan
1989 M.S. Clinical Research Design & Statistical Analysis

Universidad Autonoma de Ciudad Juarez
Instituto de Ciencias Biomedicas
Juarez, Mexico
1983 M.D. Medicine

Undergraduate: Columbia University
School of Engineering and Applied Science
New York, NY
1978 B.S. Bioengineering

POSTDOCTORAL TRAINING:

Fellow: Uveitis and Ocular Immunology, National Eye Institute,
National Institutes of Health, Bethesda, MD
1996-1997

Resident: Ophthalmology, Henry Ford Hospital, Detroit, Michigan
1993 - 1996

Resident: Internal Medicine, Henry Ford Hospital, Detroit, Michigan
1984 - 1986

Intern: Internal Medicine, Henry Ford Hospital, Detroit, Michigan
1983 - 1984

CERTIFICATION AND LICENSURE

Medical Licensure: California, 2002 – C50825
Michigan, 1983 - 4301046984

Board Certification: American Board of Ophthalmology, 1999; 93th percentile on Board examination
American Board of Internal Medicine, 1986; 99th percentile on Board examination

PROFESSIONAL SOCIETIES:

Member, Association for Research in Vision and Ophthalmology
American Academy of Ophthalmology
American Medical Association

PROFESSIONAL EXPERIENCE:

2013-Present Vice President and Chief Medical Officer, Neurotech

2010-2013 Board Member, Glaucoma Research Foundation

2009-2013 Ophthalmology Therapeutic Area Head

2008-2013 Head of Development for Emerging Markets

2007-2013 Head, Global Product Enhancement/Life Cycle Management

2005-2013 Vice President, Development for Ophthalmology and Botox, Allergan Pharmaceuticals

2003-Present Clinical Associate Professor and Attending Physician in Ophthalmology, University of California at Irvine.

2001-2005 Senior Director, Ophthalmology Clinical Research, Allergan Pharmaceuticals, Irvine, California

1999-2001 Member, Leadership Council, Eye Care Services, Henry Ford Health System, Detroit, MI

1999-2001 Director, Quality Improvement, Eye Care Services, Henry Ford Health System, Detroit, MI

1998-2001 Director of the African-American Initiative for Male Health Improvement (AIMHI). Eye Disease Screening Program in Southeast Michigan. Funded by the Michigan Department of Community Health.

1997-2001 Director of Uveitis Services, Eye Care Services, Henry Ford Health System, Detroit, MI
Director of Clinical Research, Eye Care Services, Henry Ford Health System, Detroit, MI
Staff Investigator, Center for Health Services Research, Henry Ford Health System, Detroit, MI

1996-2001 Reviewer to Special Study Section, National Eye Institute, National Institutes of Health, Bethesda, Maryland.

1999-2001 Director, Clinical Research, Eye Care Services, Henry Ford Hospital, Detroit, Michigan

- 1996-1997 Senior Staff Physician, Eye Care Services, Ophthalmology, Henry Ford Health System, Detroit, Michigan (on intergovernmental personnel act to National Eye Institute, National Institutes of Health, Bethesda, Maryland)
- 1994-1995 Associate Medical Director, Henry Ford Hospital Pharmacology Research Unit, Detroit, Michigan
- 1993-2001 Associate Research Director, Eye Care Services, Henry Ford Hospital, Detroit, Michigan
- 1989-2001 Staff, Center for Clinical Effectiveness, Henry Ford Hospital, Detroit, Michigan
- 1988-1994 Requirements Advisory Committee to the Medical Information Management System, Henry Ford Hospital, Detroit, Michigan
- 1989-1993 Coordinator, General Internal Medicine Research, Henry Ford Hospital, Detroit, Michigan
- 1990-1993 Chairman, General Internal Medicine Research Committee, Henry Ford Hospital, Detroit, Michigan
- Member, Research and Academic Affairs Committee, Department of Medicine, Henry Ford Hospital, Detroit, Michigan
- 1986-1993 Senior Staff Physician, General Internal Medicine, Henry Ford Hospital, Detroit, Michigan

TEACHING EXPERIENCE:

- 2003-Present Ophthalmology Residency Training Program, University of California at Irvine
- 1997-2001 Ophthalmology Residency Training Program, Henry Ford Hospital, Detroit, Michigan
- 1986-1993 Internal Medicine Residency Training Program, Henry Ford Hospital, Detroit, Michigan
- 1988-1993 Preceptor, University of Michigan Medical Schools, Ann Arbor, Michigan
- 1991-1993 Preceptor, General Internal Medicine Fellows
- Medical Staff Seminars, General Internal Medicine, Henry Ford Hospital, Detroit, MI:
Introduction to Epidemiology, Introduction to Personal Computing, Medical Decision Analysis

BOOKS & MONOGRAPHS:

1. Ocular Therapy chapter in: Oréfice, Fernando: Uveíte: Clínica e Cirúrgica. Ed. Cultura Médica. Published June 2000.
2. New Concepts in the Pathogenesis, Diagnosis and Treatment of Dry Eye. Ocular Surgery News Monograph; Slack Incorporated. July 1, 1999

3. Schiffman RM: Glaucoma, Ophthalmology chapter in Noble, John: Textbook of Primary Care Medicine. 2nd Edition. 1996. Mosby-Year Book, Inc. 1471-9.

JOURNAL PUBLICATIONS:

1. Day D.G., Walters T.R., Schwartz G.F., Mundorf T.K., Liu C., Schiffman R.M., Bejani M. Bimatoprost 0.03% preservative-free ophthalmic solution versus bimatoprost 0.03% ophthalmic solution (Lumigan) for glaucoma or ocular hypertension: a 12-week, randomised, double-masked trial. *Br J Ophthalmol.* 2013 Jun 6. [Epub ahead of print]
2. Callanan DG, Gupta S, Boyer DS, Ciulla TA, Singer MA, Kuppermann BD, Liu CC, Li XY, Hollander DA, Schiffman RM, Whitcup SM; Ozurdex PLACID Study Group. Dexamethasone Intravitreal Implant in Combination with Laser Photocoagulation for the Treatment of Diffuse Diabetic Macular Edema. *Ophthalmology.* 2013 May 22. S0161-6420(13)00152-8.
3. Katz LJ, Rauchman SH, Cottingham AJ Jr, Simmons ST, Williams JM, Schiffman RM, Hollander DA. Fixed-combination brimonidine-timolol versus latanoprost in glaucoma and ocular hypertension: a 12-week, randomized, comparison study. *Curr Med Res Opin.* 2012 May;28(5):781-8
4. Katz, L.J., Rauchman, S.H., Cottingham Jr., A.J., Simmons, S.T., Williams, J.M., Schiffman, R.M., Hollander, D.A. Fixed-combination brimonidinetimolol versus latanoprost in glaucoma and ocular hypertension: A 12-week, randomized, comparison study. *Current Medical Research and Opinion* 28 (5), pp. 781-788
5. Lowder, C., Belfort Jr., R., Lightman, S., Foster, C.S., Robinson, M.R., Schiffman, R.M., Li, X.-Y., Cui H, Whitcup, S.M. Dexamethasone intravitreal implant for noninfectious intermediate or posterior uveitis. *Arch Ophthalmol* 2011 129 (5):545-553
6. Waterbury, L.D., Galindo, D., Villanueva, L., Nguyen, C., Patel, M., Borbridge, L., Attar, M., Schiffman RM, Hollander, D.A. Ocular penetration and anti-inflammatory activity of ketorolac 0.45% and bromfenac 0.09% against lipopolysaccharide-induced inflammation. *J Ocular Pharmacol and Therapeutics* 2011 27 (2):173-178
7. Xu, K., McDermott, M., Villanueva, L., Schiffman, R.M., Hollander, D.A. Ex vivo corneal epithelial wound healing following exposure to ophthalmic nonsteroidal anti-inflammatory drugs. *Clin Ophthalmol* 2011 5 (1), pp. 269-274.
8. Donnenfeld, E.D., Nichamin, L.D., Hardten, D.R., Raizman, M.B., Trattler, W., Rajpal, R.K., Alpern, L.M., Felix C, Bradford RR, Villanueva L, Hollander DA, Schiffman, R.M. Twice-daily, preservative-free ketorolac 0.45% for treatment of inflammation and pain after cataract surgery. *Am J Ophthalmol* 2011 151 (3):420-426.
9. Spaeth G, Bernstein P, Caprioli J, Schiffman RM. Control of Intraocular Pressure and Intraocular Pressure Fluctuation with Fixed Combination Brimonidine-Timolol versus Brimonidine or Timolol Monotherapy. *Am J Ophthalmol.* 2011 January;151:93-99.
10. Attar, M., Schiffman, R., Borbridge, L., Farnes, Q., Welty, D. Ocular pharmacokinetics of 0.45% ketorolac tromethamine. *Clin Ophthalmol* 2010 4(1), pp. 1403-1408
11. Craven, E.R., Liu, C.-C., Batoosingh, A., Schiffman, R.M., Whitcup, S.M. A randomized, controlled comparison of macroscopic conjunctival hyperemia in patients treated with bimatoprost 0.01% or vehicle who were previously controlled on latanoprost. *Clin Ophthalmol* 2010 4 (1):1433-1440
12. Olson, R., Donnenfeld, E., Bucci Jr., F.A., Price Jr., F.W., Raizman, M., Solomon, K., Devgan, U., Trattler W, Dell S, Wallace RB, Callegan M, Brown H, McDonnell PJ, Conway T, Schiffman RM,

- Hollander, D.A. Methicillin resistance of Staphylococcus species among health care and nonhealth care workers undergoing cataract surgery. *Clin Ophthalmol*. 2010 4(1):1505-1514
13. Katz L, Cohen J, Batoosingh A, Felix C, Shu V, Schiffman R. Twelve-Month, Randomized Controlled Trial of the Efficacy and Safety of Bimatoprost 0.01%, 0.0125%, and 0.03% in Patients with Glaucoma or Ocular Hypertension. *Am J Ophthalmol*. 2010 April;149:661-671.
 14. Lewis R, Gross R, Sall K, Schiffman R, Liu C-C, Batoosingh A, (for the Ganfort® Investigators Group II). The Safety and Efficacy of Bimatoprost/Timolol Fixed Combination: A 1-year Double-masked, Randomized Parallel Comparison to Its Individual Components in Patients With Glaucoma or Ocular Hypertension. *J Glaucoma*. 2010 August;19(6):424-426.
 15. Sherwood MB, Craven ER, Chou C, DuBiner HB, Batoosingh AL, Schiffman RM, Whitcup SM. Twice-daily 0.2% brimonidine-0.5% timolol fixed-combination therapy vs monotherapy with timolol or brimonidine in patients with glaucoma or ocular hypertension: a 12-month randomized trial. *Arch Ophthalmol*. 2006 Sep;124(9):1230-8.
 16. Craven ER, Walters TR, Williams R, Chou C, Cheetham JK, Schiffman R; Combigan Study Group. Brimonidine and timolol fixed-combination therapy versus monotherapy: a 3-month randomized trial in patients with glaucoma or ocular hypertension. *J Ocul Pharmacol Ther*. 2005 Aug;21(4):337-48.
 17. Yee RW, Tepedino M, Bernstein P, Jensen H, Schiffman R, Whitcup SM; Gatifloxacin BID/QID Study Group. A randomized, investigator- masked clinical trial comparing the efficacy and safety of gatifloxacin 0.3% administered BID versus QID for the treatment BID versus QID for the treatment of acute bacterial conjunctivitis of acute bacterial conjunctivitis. *Curr Med Res Opin*. 2005 Mar;21(3):425-31.
 18. Schiffman RM, Jacobsen G, Nussbaum JJ, et al: A Novel Approach for Detection of Diabetic Retinopathy Using DigiScope Retinal Imaging System. *Ophthalmic Surg Lasers Imaging*. 2005 Jan-Feb;36(1):46-56.
 19. Solomon KD, Donnenfeld ED, Raizman M, Stern K, VanDenburgh A, Cheetham JK, Schiffman RM for the Ketorolac Reformulation Study Groups 1 and 2: Safety and Efficacy of Reformulated Ketorolac Tromethamine 0.4% Ophthalmic Solution in Post-photorefractive Keratectomy Patients. *Journal Cataract Refract Surg* 2004 Aug;30(8):1653-1660.
 20. Whitcup SM, Bradford R, Lue J, Schiffman RM, Abelson MB. Efficacy and tolerability of ophthalmic epinastine: a randomized, double-masked, parallel-group, active- and vehicle-controlled environmental trial in patients with seasonal allergic conjunctivitis. *Clin Ther*. 2004 Jan;26(1):29-34.
 21. Abelson MB, Gomes P, Crampton HJ, Schiffman RM, Bradford RR, Whitcup SM. Efficacy and tolerability of ophthalmic epinastine assessed using the conjunctival antigen challenge model in patients with a history of allergic conjunctivitis. *Clin Ther*. 2004 Jan;26(1):35-47.
 22. McDonnell PJ, Taban M, Sarayba MA, Schiffman RM, et al.: Dynamic Morphology of Clear Corneal Incisions. *Ophthalmology*. 2003 Dec;110(12):2342-8.
 23. Desai UR, Alhalel AA, Campen TJ, Schiffman RM, Edwards PA, Jacobsen GR: Central serous chorioretinopathy in African Americans. *J Natl Med Assoc*. 2003 Jul;95(7):553-9.
 24. Javitt JC, Jacobson G, Schiffman RM.: Validity and reliability of the Cataract TyPE Spec: an instrument for measuring outcomes of cataract extraction. *Am J Ophthalmol*. 2003 Aug;136(2):285-90.
 25. Baum JL, Schiffman RM: Reliability and Validity of a Proposed Dry Eye Evaluation Scheme - Reply. *Arch Ophthalmol* 2001 Mar;119(3):456.

26. Schiffman RM, Walt JG, Jacobsen G, Doyle JJ, Lebovics G, Sumner W.:Utility assessment among patients with dry eye disease. *Ophthalmology*. 2003 Jul;110(7):1412-9.
27. Baum JL, Schiffman RM: Reliability and Validity of a Proposed Dry Eye Evaluation Scheme. *Arch Ophthalmol* 2001 Mar;119(3):456.
28. Desai UR, Tawansy K, Schiffman RM: Choroidal Granulomas in Systemic Sarcoidosis. *Retina*. 2001;21(1):40-7.
29. Mangione CM, Lee PP, Spritzer K, Berry S, Hayes RD et. al: Development, Reliability, and Validity of the 25-Item National Eye Institute Visual Function Questionnaire (VFQ-25). Accepted for publication in *Archives of Ophthalmology*.
30. Schiffman RM, Jacobsen G, Whitcup S: Visual Functioning and General Health Status in Patients with Uveitis. *Arch Ophthalmol* 2001 Jun;119(6):841-849.
31. Javitt JC, Schiffman RM: Clinical Success and Quality of Life with Brimonidine 0.2% or Timolol 0.5% used BID in Glaucoma or Ocular Hypertension: A Randomized Clinical Trial. *J Glaucoma*. 2000 Jun;9(3):224-34.
32. Schiffman RM, Christianson MD, Jacobsen G, Hirsch JD, Reis BL.: Reliability and validity of the Ocular Surface Disease Index. *Arch Ophthalmol*. 2000 May;118(5):615-21.
33. Nussenblatt RB, Fortin E, Schiffman R, Rizzo L, Smith J, Van Veldhuisen P, Sran P, Yaffe A, Goldman CK, Waldmann TA, Whitcup SM. Treatment of noninfectious intermediate and posterior uveitis with the humanized anti-Tac mAb: a phase I/II clinical trial. *Proc Natl Acad Sci U S A*. 1999 Jun 22;96(13):7462-6.
34. Nussenblatt RB, Schiffman R, Fortin E, Robinson M, Smith J, Rizzo L, Csaky K, Gery I, Waldmann T, Whitcup SM: Strategies for the treatment of intraocular inflammatory disease. *Transplant Proc*. 1998 Dec;30(8):4124-5.
35. Mangione CM. Lee PP. Pitts J. Gutierrez P. Berry S. Hays RD. Psychometric properties of the National Eye Institute Visual Function Questionnaire (NEI-VFQ). NEI-VFQ Field Test Investigators. *Archives of Ophthalmology*. 116(11):1496-504, 1998 Nov.
36. Desai UR. Alhalel AA. Schiffman RM. Campen TJ. Sundar G. Muhich A. Intraocular pressure elevation after simple pars plana vitrectomy. *Ophthalmology*. 104(5):781-6, 1997 May.
37. Ben-Menachem T. McCarthy BD. Fogel R. Schiffman RM. Patel RV. Zarowitz BJ. Nerenz DR. Bresalier RS. Prophylaxis for stress-related gastrointestinal hemorrhage: a cost effectiveness analysis. *Critical Care Medicine*. 24(2):338-45, 1996 Feb.
38. Ward RE; Purves T; Feldman M; Schiffman RM; Barry S; Christner M; Kipa G; McCarthy BD; Stiphout R: Design considerations of CareWindows, a Windows 3.0-based graphical front end to a Medical Information Management System using a pass-through-requester architecture. *Proc Annu Symp Comput Appl Med Care* 1991; 564-8
39. Stiphout RM; Schiffman RM; Christner MF; Ward R; Purves TM: Medical Information Management System (MIMS) CareWindows. *Proc Annu Symp Comput Appl Med Care* 1991; 929-31
40. Gubbins G, Schiffman RM, Alipati R, Batra S.: Cocaine-Induced Hepatonephrotoxicity. *Henry Ford Hospital Medical Journal* 1990; 38:55-56.

JOURNAL REVIEWER

1. British Journal of Ophthalmology
2. Current Eye Research
3. Ophthalmology
4. Optometry and Vision Science
5. The Lancet

SELECTED PAST SCIENTIFIC ACTIVITIES:

HFHS Principal Investigator

1. Schiffman RM, Chew E, Ferris F, Ellwein L, Hays R, Mangione C: A Randomized Comparison of the Cost, Quality and Acceptability of Four Modes of Administration the National Eye Institute Visual Functioning Questionnaire-25. National Eye Institute.
2. Schiffman RM: National Eye Institute Refractive Error Correction Questionnaire (NEI-RECQ) Phase II Protocol. National Eye Institute through Emmes Corporation.
3. Schiffman RM, Lesser GL, Imami N, Trick GL: A 48-Month, Multi-Center, Randomized, Double-Masked, Placebo-Controlled, Clinical Study to Evaluate the Effectiveness and Safety of Oral Memantine in Daily Doses of 20 Mg and 10 Mg in Patients with Chronic Open-Angle Glaucoma at Risk for Glaucomatous Progression - Allergan Protocol 192944-005.
4. Schiffman RM: A Multicenter, Investigator-Masked, Randomized, Parallel-Group Study to Compare the Safety and Efficacy and Safety of Restasis™ (Cyclosporine 0.05% Ophthalmic Emulsion) vs. An Artificial Tear (Refresh®) Used Twice Daily for Three Months in Patients with Moderate to Severe Keratoconjunctivitis Sicca (Allergan Protocol 192371-008)
5. Schiffman RM, Patel S, Crosswell M and Shankle J: The Retinal Thickness Analyzer in the Management of Uveitic Cystoid Macular Edema.
6. Schiffman RM, Trick GL: Retinal Thickness Analyzer (RTA) - Clinical Validation Study. Talia Technology Ltd.
7. A Multicenter, Randomized, Double-Masked, Controlled Study to Evaluate the Safety and Efficacy of an Intravitreal Fluocinolone Acetonide Insert in Patients with Non-Infectious Uveitis Affecting the Posterior Segment of the Eye. Bausch and Lomb.

SCIENTIFIC ACTIVITIES:

HFHS Collaborative Investigator:

1. Lesser B, Darnley D, Schiffman R: Ocular Hypertension Treatment Study. National Eye Institute, 1993- 1999.
2. Nussenblatt RB, Whitcup SM, Schiffman RM, et. al: The Treatment of Non-infectious Intermediate and Posterior Uveitis with Humanized Anti-Tac Monoclonal Antibody Therapy: Phase I and Phase II. National Eye Institute, National Institutes of Health.

EXHIBIT B

Phase 2 Results - Phase 3 Target Subpopulation

Change from Baseline in Corneal

Staining at Week 12

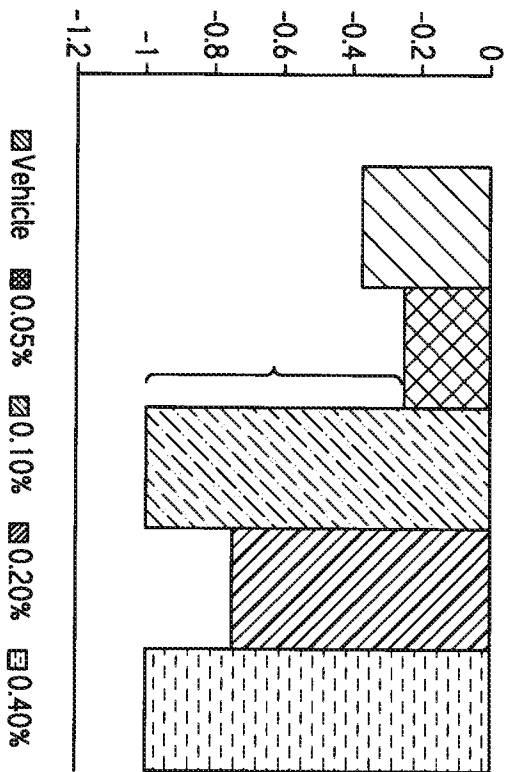

FIG. 1

Change from Baseline in

Schirmer Score at Week 12

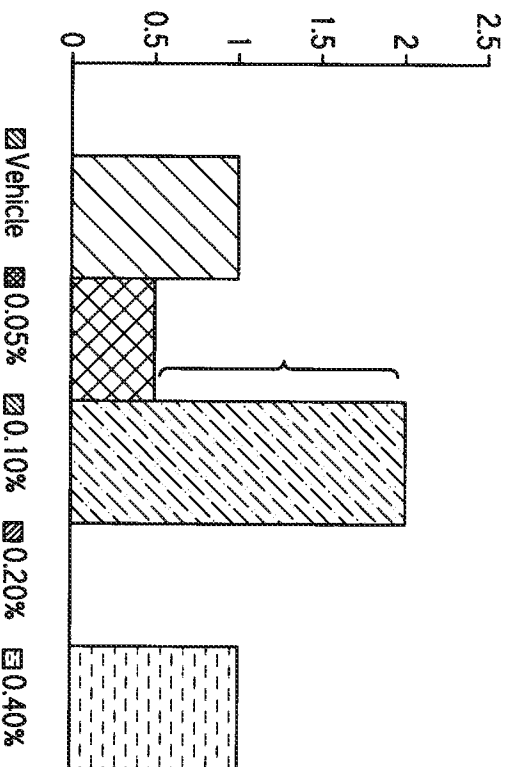

FIG. 2

EXHIBIT C

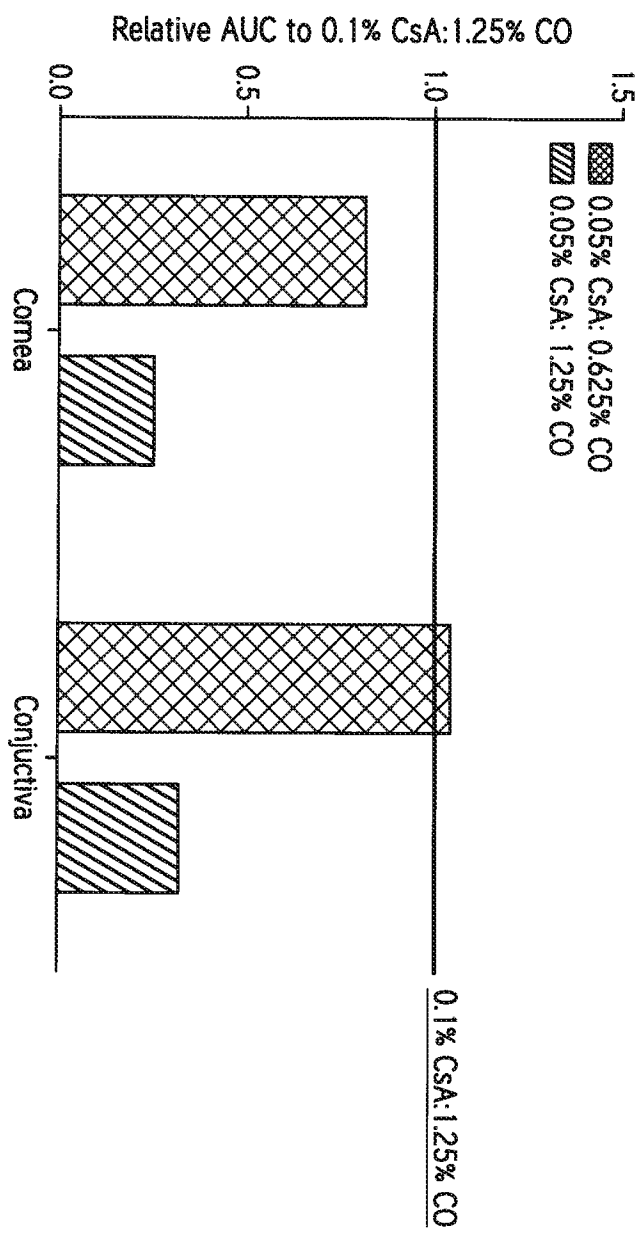

EXHIBIT D

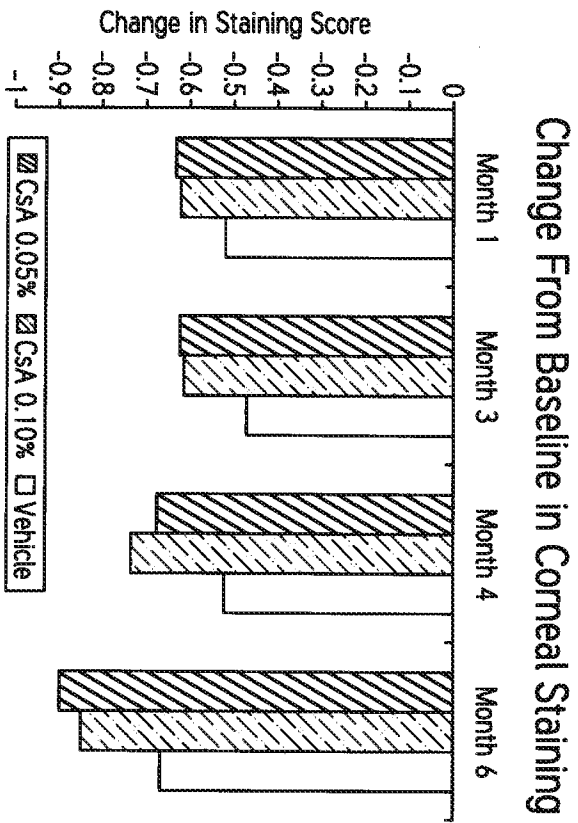

FIG. 1

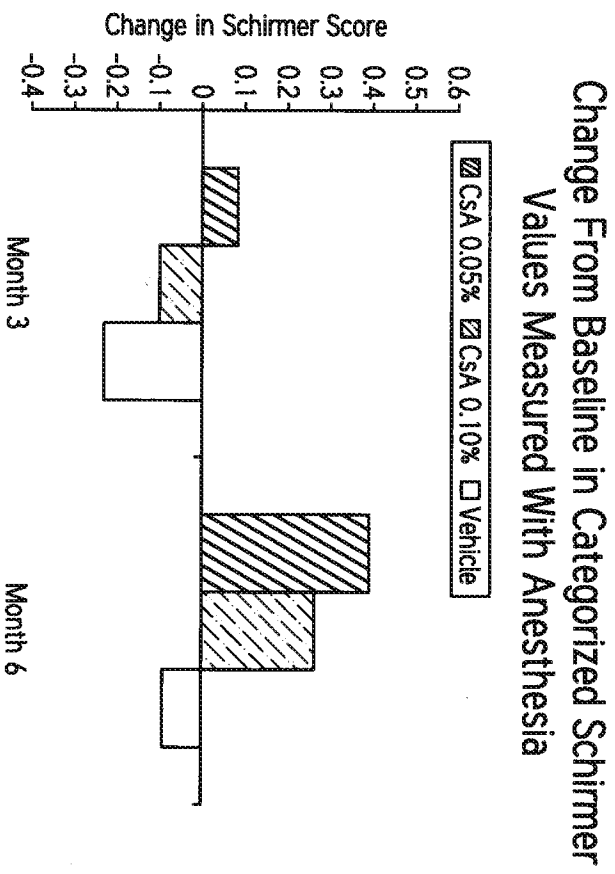

FIG. 2

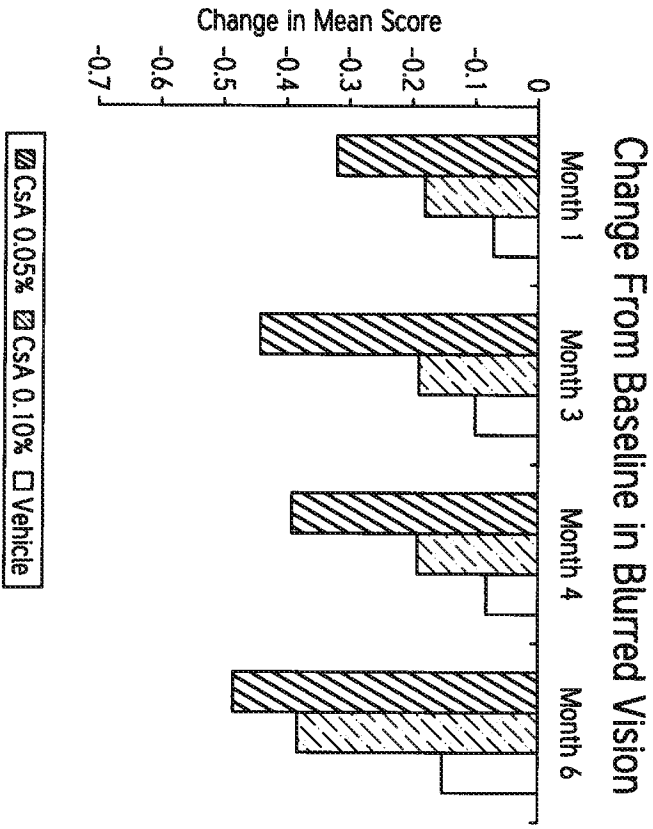

FIG. 3

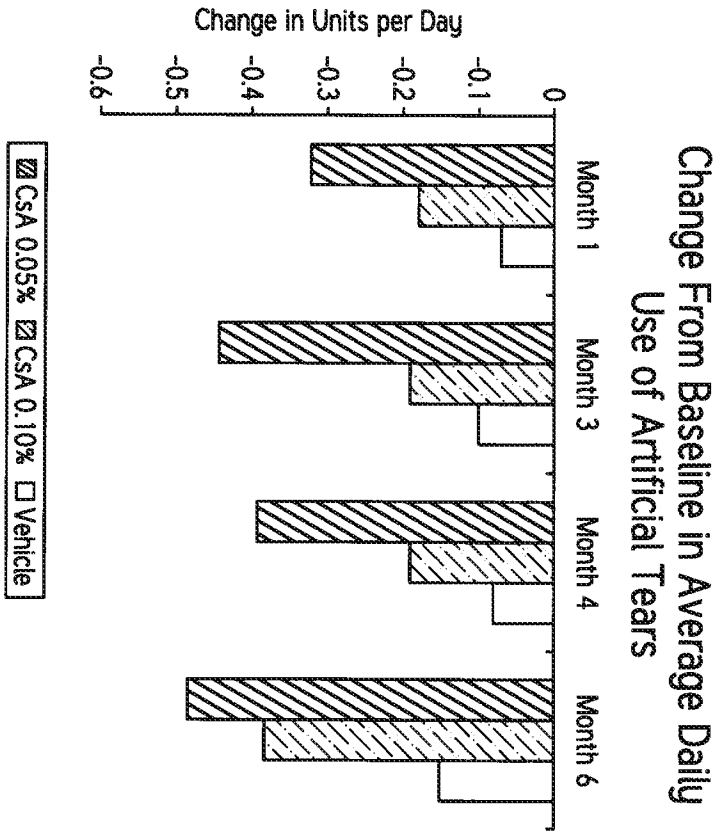

FIG. 4

EXHIBIT E

	Phase 2 001	Phase 3 (1 st study)	Phase 3 (2 nd study)
	0.05% CSA in 0.625% CO	0.05% CSA in 1.25% CO	0.05% CSA in 1.25% CO
	Compared with 0.1% CSA in 1.25% CO		
Improvement in STT	0.25	2	1
		(8-Fold Improvement*)	(4-Fold Improvement*)
Decrease in Corneal Staining	0.25	1	1
		(4-Fold Improvement*)	(4-Fold Improvement*)

*Compared to the 0.05% CSA/0.625% CO Phase 2 formulation (disclosed in Ding)

EXHIBIT F

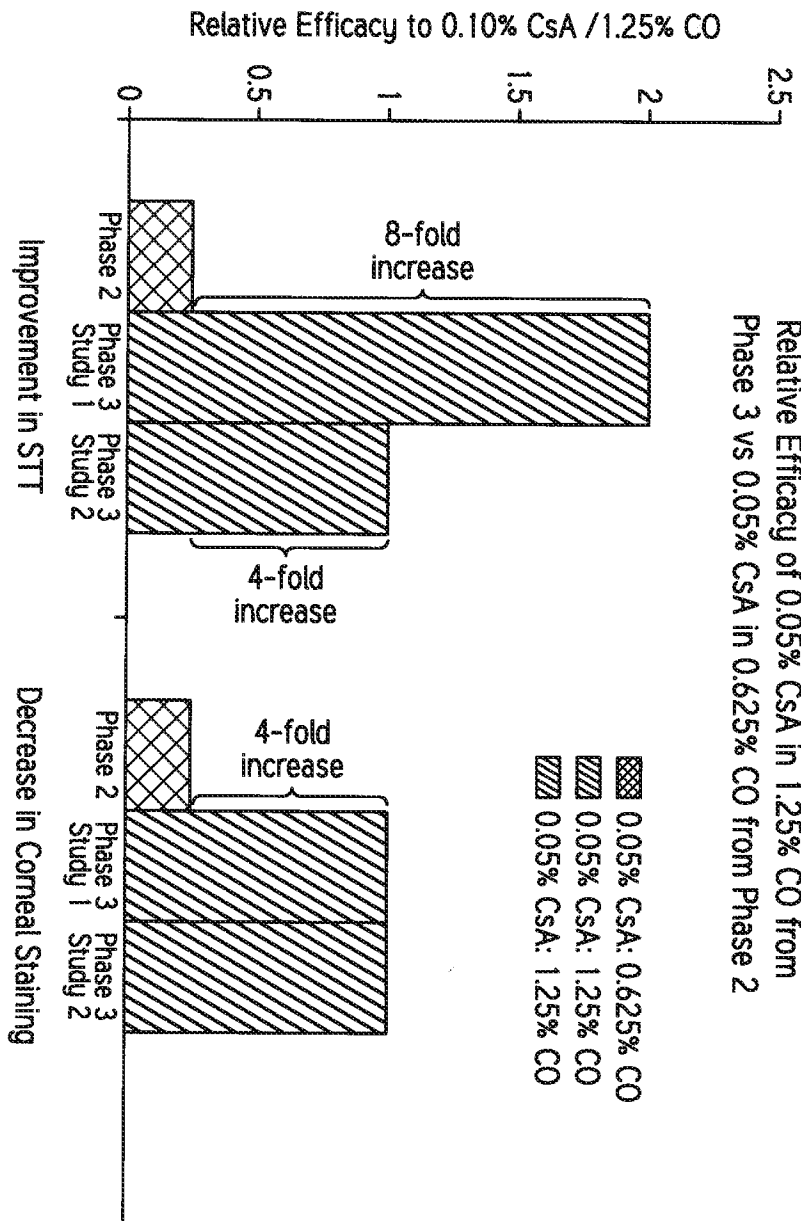

EXHIBIT 2

IN THE UNITED STATES PATENT AND TRADEMARK OFFICE

DECLARATION UNDER 37 C.F.R. 1.132

of Dr. Mayssa Attar, Ph.D.

I, Mayssa Attar, Ph.D., declare as follows:

1. I am currently a Research Investigator at Allergan, Inc. ("Allergan"), specializing in preclinical and clinical pharmacokinetics and pharmacodynamics. I have a Ph.D. in Pharmaceutical Sciences, Bachelor's and Master's degrees in Biochemistry, and almost 15 years of experience in the pharmaceutical industry. I also serve as adjunct faculty at the the University of Southern California, School of Pharmacy. My *curriculum vita*, which contains a list of my publications to which I contributed, is attached to this declaration as Exhibit A.
2. I have been informed of the general nature of the rejections made by the Patent Office with respect to the previously presented claims of the above-referenced patent application and I am familiar with the references that the Patent Office has relied on in making these rejections. For example, I am aware of the "Ding" reference (U.S. Patent No. 5,474,979 to Ding et al.).
3. Restasis® is an FDA approved product that is a commercial embodiment of the invention. Specifically, Restasis® is approved as a 0.05% by weight cyclosporine ophthalmic emulsion useful for the treatment of ophthalmic conditions, such as dry eye. Specifically, Restasis® ophthalmic emulsion is indicated to increase tear production in patients whose tear production is presumed to be suppressed due to ocular inflammation associated with keratoconjunctivitis sicca.
4. I have reviewed the pending claims in the present application, and the pending claims cover the specific formulation of Restasis® and/or the approved methods of treatment of dry eye or keratoconjunctivitis sicca with Restasis®.
5. In creating and testing the claimed methods and compositions, several unexpected results were discovered using the claimed compositions and methods.
6. It was known in the art at the time this application was filed that cyclosporin could be administered topically locally to the eye to target and treat dry eye by using cyclosporin A's immunomodulatory properties to inhibit T cell activation, which would lead to an increase in tear production and potentially other therapeutic effects related to

cyclosporin's anti-inflammatory and anti-apoptotic effects and thus limit chronic inflammation in the pathology of dry eye. To elicit its therapeutic effect, cyclosporin must be effectively delivered to multiple target tissues of the ocular surface such as the cornea, conjunctiva, and lacrimal gland. The rate and extent at which cyclosporin is differentially delivered to the putative sites of action is critical to achieving therapeutic success in treating dry eye. Generally speaking, it was understood that pharmacokinetic/pharmacodynamic relationship would indicate that as more cyclosporin A reaches the target tissues of the ocular surface, such as the cornea and conjunctiva, the more immunomodulatory and more anti-inflammatory activity that can take place and the more therapeutically effective a drug can be in treating dry eye.

7. Pharmacokinetic studies were performed on animal eyes, which compared the pharmacokinetic properties of several cyclosporin A-containing formulations. Those results are attached to this declaration in Exhibit B. As shown in Exhibit B, the relative extent that cyclosporin was absorbed increased in the relevant ocular tissues, here, the cornea and the conjunctiva, where the amount of oil present in the formulation was decreased but the weight percentage of cyclosporin stayed the same. Specifically, the amount of cyclosporin A that reached the relevant ocular tissue was higher for the formulation containing 0.05% by weight cyclosporin A and 0.625% by weight castor oil than the formulation containing 0.05% by weight cyclosporin A and 1.25% by weight castor oil, relative to the formulation containing 0.1% by weight cyclosporin A and 1.25% by weight castor oil. We also noticed that the amount of cyclosporin A that reached the relevant ocular tissue was higher for the formulation containing 0.1% by weight cyclosporin A and 1.25% by weight castor oil than for the claimed formulation and method.
8. One of skill in the art would have understood such a result to mean that since there was more cyclosporin A present in the relevant ocular tissues with the formulation containing 0.05% by weight cyclosporin A and 0.625% by weight castor oil and the formulation containing 0.1% by weight cyclosporin A and 1.25% by weight castor oil than with the claimed formulation, that those formulations would have been more therapeutically effective than the claimed formulation. Specifically, this data teaches one of skill in the art that the formulation containing 0.05% by weight cyclosporin A and 0.625% by weight castor oil would have been more therapeutically effective than the claimed formulation.
9. Surprisingly, an unexpected increase in efficacy was demonstrated relative to the 0.1% cyclosporin A and 1.25% castor oil formulation when we compared the therapeutic efficacy of the claimed formulation and method (containing 0.05% by weight cyclosporin A and 1.25% by weight castor oil) in our multicenter, randomized, double-masked Phase

3 trials to the therapeutic efficacy of a formulation containing 0.05% by weight cyclosporin A and 0.625% cyclosporin in our a randomized, multicenter, double-masked, parallel-group, dose-response controlled Phase 2 trial.

10. As shown in Exhibits C and D, which are attached to this declaration, the corneal staining score and Schirmer scores were dramatically improved for the claimed methods (containing 0.05% by weight cyclosporin A and 1.25% by weight castor oil) compared to the formulations disclosed in Example 1E in Ding (the formulation containing 0.05% by weight cyclosporin A and 0.625% by weight castor oil).
11. I have read the Declaration of Dr. Rhett M. Schiffman, and I agree with his statements made at paragraphs 18-19. Exhibits E and F as referenced by Dr. Schiffman are attached as Exhibits C and D:
12. "As seen in Exhibit E, in the Phase 2 study, the 0.05% by weight cyclosporin A/0.625% by weight castor oil formulation (Ding 1E) only achieved 0.25 times the improvement in Schirmer Tear Test score as the 0.1 % by weight cyclosporin A/1.25% by weight castor oil formulation and only achieved 0.25 times the decrease in corneal staining as the 0.1 % by weight cyclosporin A/1.25% by weight castor oil formulation. However, in the Phase 3 studies, the claimed formulation and method achieved twice the improvement in Schirmer Tear Test score as the 0.1 % by weight cyclosporin A/1.25% by weight castor oil formulation in the first study and substantially the same improvement in Schirmer Tear Test score as the 0.1 % by weight cyclosporin A/1.25% by weight castor oil formulation in the second Phase 3 study. Also, the claimed formulation achieved substantially the same decrease in corneal staining score compared to the 0.1 % by weight cyclosporin A/1.25% by weight castor oil formulation.
13. As seen in Exhibit E, and further illustrated in Exhibit F, surprisingly, the claimed formulation and method demonstrated an 8-fold increase in relative efficacy for the Schirmer Tear Test Score in the first study of phase 3 compared to the 0.05% by weight cyclosporin A/0.625% by weight castor oil formulation (Ding Example 1E) in the Phase 2 study. Exhibits E and F also illustrate that the claimed formulations demonstrated a 4-fold improvement in the relative efficacy for the Schirmer Tear Test score for the second study of Phase 3 and a 4-fold increase in relative efficacy for decrease in corneal staining score in both of the Phase 3 studies compared to the 0.05% by weight cyclosporin A/0.625% by weight castor oil formulation in the Phase 2 study, the formulation disclosed in the Ding reference (Ding 1E). This was clearly a very surprising result."
14. Taking the results of these studies together, it is clear that the specific combination of 0.05% by weight cyclosporin A with 1.25% by weight castor oil is surprisingly critical

for therapeutic effectiveness for the treatment of dry eye/keratoconjunctivitis sicca, even those persons of skill in the art would have expected the formulation or method with the lower concentration of drug found in the relevant ocular tissue to be less therapeutically effective than those compositions with more drug in the ocular tissue (e.g. 0.05% by weight cyclosporin A/0.625% by weight castor oil formulation or 0.10% by weight cyclosporin A/1.25% by weight castor oil formulation disclosed in Ding).

I hereby declare that all statements made herein of my own knowledge and belief are true; and that all statements made on information and belief are believed to be true; and further that these statements are made with the knowledge that willful false statements and the like so made are punishable by fine or imprisonment, or both, under Section 1001 of Title 18 of the United States Code, and that such willful false statements may jeopardize the validity of the application or any patents issued thereon.

A handwritten signature in black ink, consisting of several loops and a long horizontal stroke at the end, positioned above a solid horizontal line.

Mayssa Attar, Ph.D.

Date: 10-14-2013

EXHIBIT A

M A Y S S A A T T A R , P H D

57 Shadowbrook, Irvine, CA 92604

714-381-1853 • mayssa.attar@gmail.com

Linkedin Profile: <http://www.linkedin.com/pub/mayssa-attar/13/707/b90>

PROFESSIONAL SUMMARY

Almost fifteen years of drug development experience; Preclinical and clinical pharmacokinetics, pharmacodynamics, drug metabolism expertise; Oral, ophthalmic, and dermal drug development experience; Pharmacokinetics and clinical pharmacology representative supporting the submission of global regulatory filings; Cross-functional global team leader, functional line manager and matrix leader; Adjunct assistant professor at the University of Southern California, School of Pharmacy.

PROFESSIONAL EXPERIENCE

ALLERGAN • Irvine, CA • 1/1999 – present

Research Investigator, Department of Pharmacokinetics and Drug Disposition

- Serve as Group Head: Translational Sciences; Member of PK Leadership Team
- Serve as a functional line manager to PhD level scientists and cross-functional team leader on early development through market launch teams with responsibility for budgets of >\$15 million
- Set departmental strategy and provide oversight to the design, conduct and data interpretation of in vitro and in vivo studies to characterize drug pharmacokinetics, pharmacodynamics and metabolism from late stage discovery through clinical development; responsible for the review of regulatory submissions
- Serve as a lead representative when interacting with global regulatory agencies for both on-site compliance inspections and regulatory file review (North America, EU, Asia-Pac and other Emerging Regions), due diligence activities, legal activities and key opinion leaders
- Serve as a team member in the development and global registration of RESTASIS[®], ACUVAIL[®], ZYMAXID[®], OZURDEX[®]
- Received 6 successive promotions

UNIVERSITY OF SOUTHERN CALIFORNIA • Los Angeles, CA • 10/2005 - present

Adjunct Assistant Professor, School of Pharmacy, Department of Pharmacology and Pharmaceutical Sciences

- Lecture on the subjects of “Pharmacogenomics” and “Drug Metabolism”
- Mentor students as they consider careers in industry
- Serve as an instructor for FDA/ACCP online course “Pharmacogenomics”

LOEB RESEARCH INSTITUTE • Ottawa, ON• 6/1995 – 8/1998

Research Associate, Hormones, Growth and Development Unit

- Established protocols for isolation and purification of lipids
- Formulated liposomes as model plasma membrane systems
- FTIR-Spectroscopy, NMR

EDUCATION

PhD, Pharmaceutical Sciences, University of Southern California, Los Angeles, CA

Advisor: Vincent H L Lee, PhD, DSc

Thesis: Cytochrome P450 3A metabolism in the rabbit lacrimal gland and conjunctiva

MSc, Biochemistry, University of Ottawa, Ottawa, ON

Advisor: Nongnuj Tanphaichitr, PhD and Morris Kates, PhD

Thesis: A FTIR study of the interaction between sulfoglycolipid and phosphatidylcholine

BSc, with honors, Biochemistry, University of Ottawa, ON

AWARDS AND HONORS

- Allergan Award for Excellence, in recognition of team work to develop a pediatric investigation plan to support registration of RESTASIS® in EU (2011)
- Allergan Award for Excellence, in recognition of membership in a team charged with a departmental initiative to improve efficiencies in our Scientific Writing processes (2010)
- Allergan Award for Excellence, in recognition of collaboration with Bioanalytical Sciences to develop more efficient processes and better laboratory use of LC-MS/MS equipment to support metabolite profiling efforts (2010)
- Allergan Award for Excellence, in recognition of cost savings brought about by introducing new gene expression technology to support Toxicology assessment (2009)
- Allergan Award for Excellence, in recognition of role as Nonclinical Lead and contributing to the FDA approval and subsequent market launch of ACUVAIL™ (2009)
- Allergan Award for Excellence, in recognition of contribution to the development of an enhanced RESTASIS® formulation (2006)
- Rho Chi Honor Society (2005)
- Allergan Award for Excellence, in recognition of developing a high-throughput P450 inhibition assay (2000)
- NSERC grant to support full term of graduate studies (1996-1998)
- Travel scholarship to attend the Gordon Conference (1997)
- Loeb Summer Student Scholarship (1996)
- University Scholarships of Canada (1992-1996, awarded four consecutive years)

PROFESSIONAL AFFILIATIONS

- AAPS
- ARVO
- ISSX
- Editorial Board Member, Current Molecular Pharmacology
- Ad Hoc Reviewer Investigative Ophthalmology and Vision Science
- Ad Hoc Reviewer Journal of Pharmaceutical Sciences

OTHER SKILLS

- Computer: Watson LIMS, Phoenix/WinNonLin, Galileo LIMS, SIMCYP, Spottfire
- Languages: English, French, Arabic

PUBLICATIONS

Articles and Book Chapters

Woodward, D. F., Tang, E. S.H., Attar, M., and Wang, J. W. The biodisposition and hypertrichotic effects of bimatoprost in mouse skin. *Exp Dermatol.* 2013; 22:145–148.

Attar, M., Brassard, J.A., Kim, A.S., Matsumoto, S., Ramos, M., and Vangyi, C. Chapter 24: Safety Evaluation of Ocular Drugs in A Comprehensive Guide to Toxicology in Preclinical Drug Development. Edited by Faqi, A.S. Elsevier Inc., 2013

Waterbury, D.L., Galindo, D., Nguyen, C., Villanueva, L., Patel, M., Borbridge, L., Attar, M., Schiffman, R.M., Hollander, D.A. Ocular Penetration and Anti-inflammatory Activity of Ketorolac 0.45% and Bromfenac 0.09% Against Lipopolysaccharide-Induced Inflammation. *J. Ocul Pharmacol Ther.* 2011; 27 (2):173-8.

Chang-Lin, J., Attar, M., Acheampong, A., Robinson, M.R., Whitcup, S.M., Kuppermann, B.D., Welty, D. Pharmacokinetics and pharmacodynamics of the sustained-release dexamethasone intravitreal implant. *Invest Ophthalmol Vis Sci.* 2011; 52:80-86.

Attar, M., Schiffman, R.M., Borbridge, L., Farnes, Q., Welty, D. Ocular Pharmacokinetics of 0.45% Ketorolac Tromethamine. *Clin Ophthalmol.* 2010; 4: 1403-1408.

Attar M. and Shen J. Chapter 20: The Emerging Significance of Drug Transporters and Metabolizing Enzymes to Ophthalmic Drug Design in Ocular Transporters in Ophthalmic Diseases and Drug Delivery. Edited by Tombran-Tink, J and Barnstable, C.J. Humana Press, 2008.

Attar, M., Ling, KHJ., Tang-Liu, DDS., Neamati, N., and Lee, V.H.L. Characterization of Cytochrome P450 3A in the Rabbit Lacrimal Gland: Glucocorticoid Modulation and the Impact on Androgen Metabolism. *Invest Ophthalmol Vis Sci.* 2005; 46(12): 4697-4706.

Attar M., Shen, J., Ling, K.H.J, and Tang-Liu, D.D.S. Ophthalmic Drug Delivery Considerations at the Cellular Level: Drug Metabolizing Enzymes and Transporters. *Expert Opin Drug Deliv.* 2005; 2(5): 891-908.

Attar, M., Yu, D., Ni, J., Yu, Z., Ling, K.H.J and Tang-Liu, D.D.S. Disposition and biotransformation of the acetylenic retinoid tazarotene in humans. *J Pharm Sci.* 2005; 94(10): 2246-2255.

Attar, M. and Lee, V.H.L. Pharmacogenomic considerations in drug delivery. *Pharmacogenomics* 2003; 4(4): 443-461.

Tanphaichitr, N., Bou Khalil, M., Weerachayanukul, W., Kates, M., Xu, H., Carmona, E., Attar, M., Carrier D. Chapter 11: Physiological and biophysical properties of male germ cell sulfogalactosylglycerolipid in Lipid Metabolism and Male Fertility. Edited by De Vriese S. AOCS Press, 2003

Attar, M., Dong, D., Ling, K.H.J. and Tang-Liu, D.D.S. Cytochrome P450 2C8 and flavin-containing monooxygenases are involved in the metabolism of tazarotenic acid in humans. *Drug Metab Dispos* 2003; 31(4):476-481.

Attar, M., Kates, M., Khalil, M.B., Carrier, D., and Tanphaichitr, N. A Fourier-transform infrared study of the interaction between germ-cell specific sulfogalactosylglycerolipid and phosphatidylcholine. *Chem Phys Lipids* 2000;106(2):101-114.

Attar, M., Wong, P.T.T., Kates, M., Carrier, D., Jacklis, P., Tanphaichitr, N. Interaction between sulfogalactosylceramide and dimyristoylphosphatidylcholine increases the orientational fluctuations of the lipid hydrocarbon chains. *Chem Phys Lipids* 1998; 94(2):227-238.

Tanphaichitr, N., White, D., Taylor, T., Attar, M., Rattanachaiyanont, M., and Kates, M. Role of male germ-cell specific sulfogalactosylglycerolipid (SGG) and its binding protein, SLIP1, in mammalian sperm-egg interaction in The Male Gamete: From Basic Knowledge to Clinical Applications. Edited by Gagnon, C. Cache Press, 1998

White, D., Gadella, B., Kamolvarin, N., Suwajanakorn, S., Attar, M., and Tanphaichitr, N. Role of sperm sulfogalactosylglycerolipid (SGG) on sperm-zona pellucida binding. *Biol Reprod.* 2000; 63(1):147-55.

Abstracts and Posters

Attar, M., Shen, J., Kim, M., Radojicic, Q.C. Cross-Species and Cross-Age Comparison of Esterase Mediated Metabolism in Vitreous: Human versus Rabbit, Dog and Monkey. Presented at ARVO Annual Meeting 2013.

Attar, M., Kim, M., Sachs, G., Scott, D., Struble, C.B., Welty, D. Modulation of Glucocorticoid Receptor Gene Expression: Potential Role in the Pharmacokinetic/ Pharmacodynamic Relationship of OZURDEX®. Presented at ARVO Annual Meeting 2011.

Attar, M., Schiffman, R.M., Borbridge, L., Farnes, Q., Welty, D. Evaluation of the Pharmacokinetics of Ketorolac Ophthalmic Solutions in Rabbit. Presented at ARVO Annual Meeting 2010.

Attar, M., Schiffman, R.M., Borbridge, L., Farnes, Q., and Welty, D. 2009 Pharmacokinetics of a Carboxymethylcellulose (CMC)-Based, Preservative-Free Formulation of 0.45% Ketorolac Tromethamine. Presented at ISOPT Annual Meeting 2009.

Wheeler, L., Robinson, M.R., Attar, M., Siemasko, K., Blanda, W., Whitcup, S.M. and Stern, M.E. 2009 Bioerodible Sustained-Release Ocular Impants in Mice Deliver Efficacious Concentrations of CsA. Presented at ARVO Annual Meeting 2009.

Yu, D., Attar, M., Parizadeh, D. and Tang-Liu, D. 2004. Pharmacokinetic Profile of Oral Tazarotene. Presented at AAD Winter 2004 meeting.

Attar, M., Lee, V.H.L., Tang-Liu, D.S. and Ling K.H.J. 2003. Characterization of Cytochrome P450 1A, 2D and 3A in the Rabbit Eye. Presented at AOPT 2003, Kona, Hawaii.

White, D., Gadella, B., Suwajanakorn, S., Kamolvarin, N., Attar, M., Abi-Khaled, L., and Tanphaichitr, N. 1997. Role of sulfogalactosylglycerolipid (SGG) in sperm-egg interaction. Presented at the Gordon Conference in Plymouth, New Hampshire.

Attar, M., Wong, P.T.T., Kates, M., Carrier, D., Tanphaichitr, N. 1997. An infrared spectroscopic study of the interaction between sulfogalactosylceramide, an analog of germ-cell specific sulfoglycolipid and phospholipid. Presented at the Gordon Conference in Plymouth, New Hampshire.

Kamolvarin, N., Suwajanakorn, S., Gadella, B., Berube, B., Attar, M., Lobsinger, D., and Tanphaichitr, N. 1996. Role of sulfogalactosylglycerolipid (SGG) on sperm-egg interaction and the zona-induced acrosome reaction (AR). Presented at the Society for the Study of Reproduction meeting in London, Ontario

Patents

Farnes, E.Q., Attar, M., Schiffman, R.M., Chang, C., Graham, R.S., Welty, D.F. Ketorolac tromethamine compositions for treating or preventing ocular pain. US Patent 7,842,714 Filed Mar 3, 2009 and Issued Dec 28, 2011.

Blanda, W.M. and Attar, M. Sustained action formulation of cyclosporin form 2. US Patent Application 13/676,551 Filed Nov 14, 2012. Patent Pending.

Morgan, A., Gore, A.V., Attar, M., Pujara, C. Cyclosporin emulsions. US Patent Application EP20110726545 Filed May 25, 2011. Patent Pending.

Attar, M., Graham, R.S., Morgan, A., Schiffman, R.M., Tien, W. Cyclosporin compositions. US Patent Application PCT/US2007/074079 Filed Jul 23, 2007. Patent Pending.

Graham, R.S., Hollander, D., Villanueva, L., Farnes, E.Q., Attar, M., Schiffman, R.M., Chang, C., Welty, D.F. Ketorolac compositions for corneal wound healing. US Patent Application EP20110715353 Filed Apr 6, 2011. Patent Pending.

Graham, R.S., Tien, W.L., Attar, M., Schiffman, R.M., Stern, M.E., Sears, R., Walt, J.G., Cassaro, T. Cyclosporin compositions for ocular rosacea treatment. US Patent Application 12/035,698 Filed Feb 22, 2008. Patent Pending.

EXHIBIT B

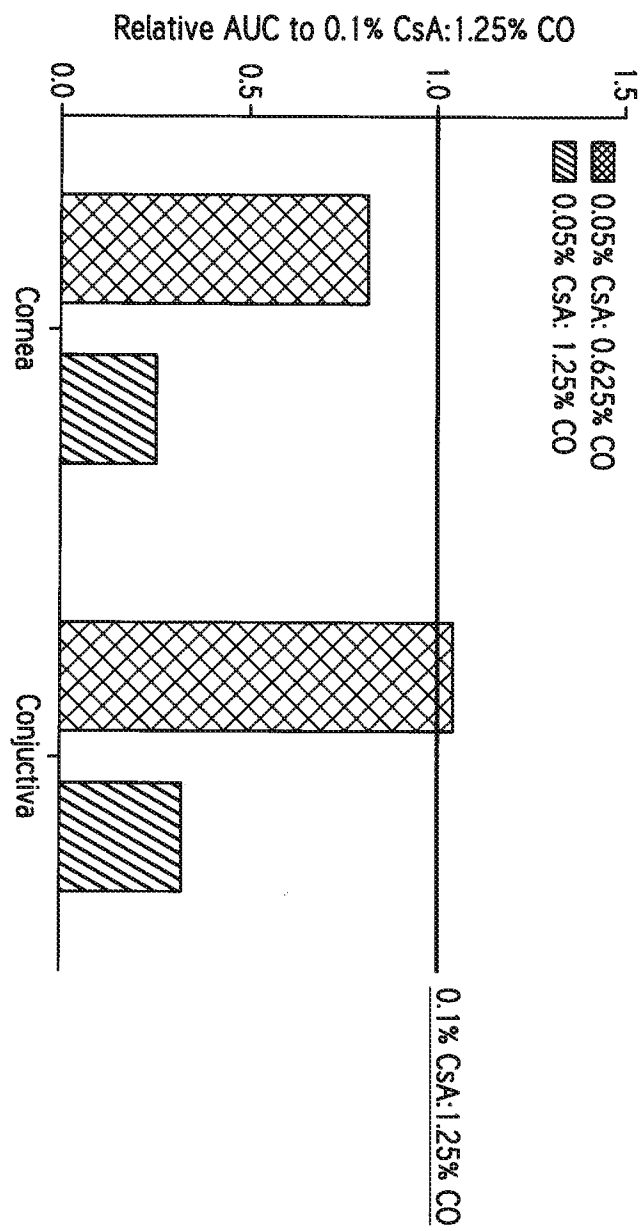

EXHIBIT C

	Phase 2 001	Phase 3 (1 st study)	Phase 3 (2 nd study)
	0.05% CSA in 0.625% CO	0.05% CSA in 1.25% CO	0.05% CSA in 1.25% CO
	Compared with 0.1% CSA in 1.25% CO		
Improvement in STT	0.25	2 (8-Fold Improvement*)	1 (4-Fold Improvement*)
Decrease in Corneal Staining	0.25	1 (4-Fold Improvement*)	1 (4-Fold Improvement*)

*Compared to the 0.05% CSA/0.625% CO Phase 2 formulation (disclosed in Ding)

EXHIBIT D

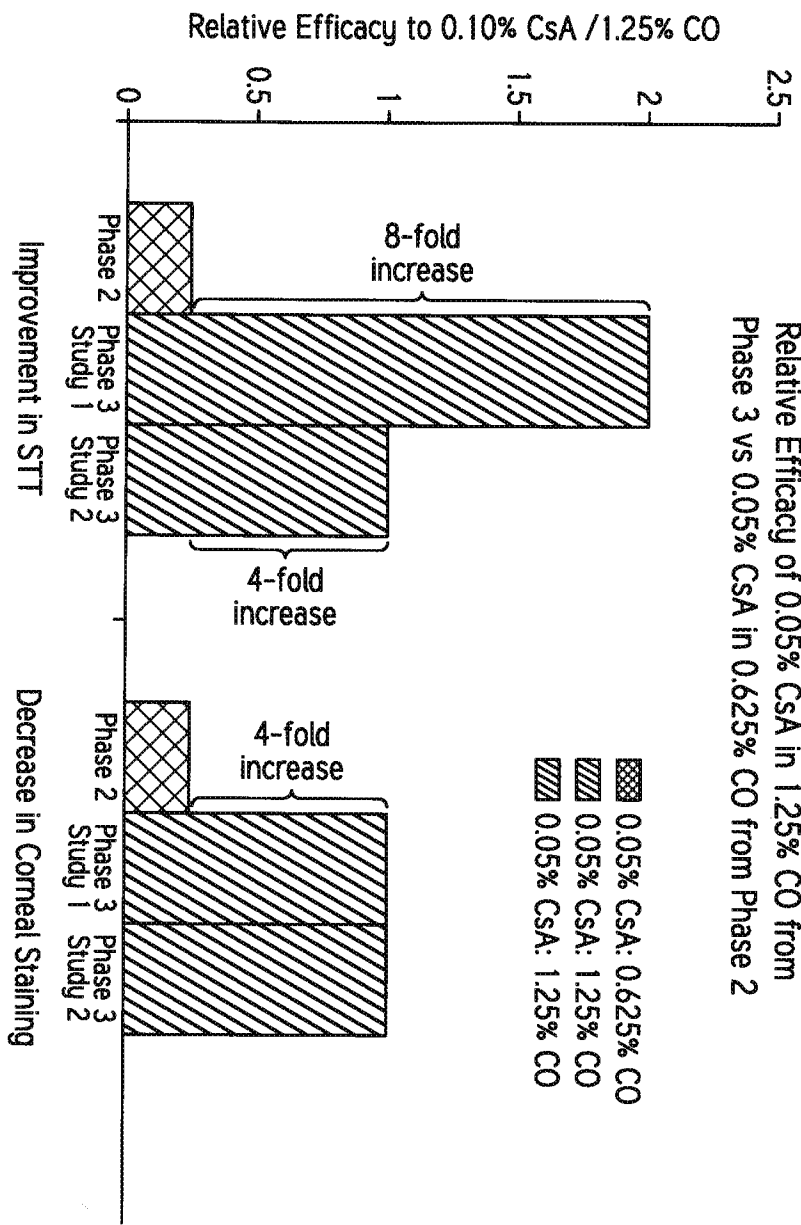

EXHIBIT 3

IN THE UNITED STATES PATENT AND TRADEMARK OFFICE

DECLARATION UNDER 37 C.F.R. 1.132

of Aziz Mottiwala

I, Aziz Mottiwala, declare as follows:

1. I am currently a Vice President of Marketing at Allergan, Inc. ("Allergan") for Allergan's Dry Eye Product Franchise. I have an MBA from the University of Southern California, Marshall School of Business, a Bachelor's degree in Biochemistry, and over 15 years of experience in marketing and sales in the pharmaceutical industry. My *curriculum vita* is attached to this declaration as Exhibit A.
2. I have reviewed the pending claims in the present application, and the pending claims cover the specific formulation of Restasis® that has been sold since 2003. To the best of my knowledge, the Restasis® formulation includes 0.05% by weight cyclosporin A, 1.25% by weight castor oil, Pemulen, polysorbate 80, sodium hydroxide, and water. Restasis® was approved by the FDA on December 23, 2002.
3. Over the past ten years, Allergan has collected data on the world wide sales for Restasis® by quarter. This data is illustrated generally in Exhibit B, and broken out by country in Exhibit C, both attached to this declaration. I personally supervised the compilation of the data presented in Exhibit B and Exhibit C.
4. As illustrated in Exhibit B, the world-wide sales for Restasis® have steadily increased since the product's launch in the first quarter of 2003. Currently, annual world-wide net sales for Restasis® are over \$200 million per quarter, and nearing \$800 million annually. As illustrated in Exhibit C, a majority of the sales are in the US. As there is no other FDA-approved therapeutic treatment for dry eye available on the US market, Restasis® owns 100% of the market share.
5. In my expert opinion, this data is strong evidence of commercial success.
6. I hereby declare that all statements made herein of my own knowledge and belief are true; and that all statements made on information and belief are believed to be true; and further that these statements are made with the knowledge that willful false statements and the like so made are punishable by fine or imprisonment, or both, under Section 1001 of Title 18 of the United States Code, and that such willful false statements may jeopardize the validity of the application or any patents issued thereon.



Aziz Mottiwala

Date: 10-8-13

EXHIBIT A

EDUCATION

University of Southern California, Marshall School of Business, Los Angeles, CA
Master of Business Administration (MBA), Marketing/Corporate Strategy December 2003

- Deans list: Fall 2001, Spring 2002, Fall 2002, Spring 2003, Fall 2003
- Elected to Beta Gamma Sigma National Honor Society

University of California, San Diego, Revelle College, La Jolla, CA
Bachelor of Science, Biochemistry and Cell Biology, June 1999

- Recipient, American Society of Pharmacology and Experimental Therapeutics Research Fellowship.
- Howard Hughes Research Scholar, UCSD School of Medicine, Department of Pharmacology.

EXPERIENCE.

Allergan Inc., Irvine, CA

Vice President, Dry Eye Marketing
February 2013- Current

Leading all strategic development and professional promotions across Allergan's Dry Eye product franchise. Providing strategic direction over both Dry Eye promotions and strategic communications. Also, providing leadership and direction for all key brand forecasts and budgets. Leading long term strategic planning and budgeting, as well as implementation of key marketing plans to exceed corporate financial targets.

Marketing Director, Dry Eye
August 2010- February 2013

Leading all strategic development and professional promotions across Allergan's Dry Eye product franchise. Providing strategic direction over both Dry Eye promotions and strategic communications. Also, providing leadership and direction for all key brand forecasts and budgets. Leading long term strategic planning and budgeting, as well as implementation of key marketing plans to exceed corporate financial targets.

Product Director, Restasis® Professional Marketing
October 2009- August 2010

Professional Promotions across Allergan's Dry Eye product franchise. Providing strategic direction over both Dry Eye promotions and strategic communications. Also, providing leadership and direction for all key brand forecasts and budgets.

Sr. Manager Restasis® Consumer Marketing
October 2007- October 2009

Managed Consumer Promotions across Allergan's Dry Eye product franchise. Responsible for Restasis® Direct-to-Consumer initiatives, including TV, Print and Interactive strategies and media planning. Also directing strategies and tactics for Dry Eye Franchise CRM, and Compliance/Persistence programs.

Product Manager Restasis®/Optometric Strategies
December 2006- October 2007

Developed and implemented marketing plans for Optometric strategies in Dry Eye as well as other therapeutic areas within US Eye Care. Worked with the entire marketing team to drive brand strategy and ensure proper execution of tactics. Also managed brand forecasts and budgets, to ensure proper alignment of resources across the brand team.

IMS/Cambridge Management Consulting, El Segundo, CA

Sr. Consultant, Management Consulting
July 2006- December 2006

Managed project teams including both internal and external resources in the design, development and delivery of client solutions. Provided coaching and direction to Consultants across multiple projects at any given time. Led teams to review and analyze client requirements, and developed associated proposals that ensured profitability and high client satisfaction.

- Projects across several practice areas including Pricing and Reimbursement, Portfolio Development, and Sales Force Effectiveness.
- Assisted a mid size biotech company's business development team in the assessment of several acquisition opportunities.
- Key Projects included development of a commercialization/launch playbook for a startup biotech company, as well as extensive pricing and reimbursement analysis of a Phase III product for a major biotech firm.

EXPERIENCE (continued)

Valeant Pharmaceuticals, Costa Mesa, CA

Product Manager, Neurosciences/Hepatology

September 2004-July 2006

Managing the development, market analysis and implementation of marketing plans for Tasmar[®], Zelapar[®], and most recently Infergen[®]. Driving brand strategy and ensuring proper execution of tactics. Also the primary marketing contact for field sales, providing marketing support to promote sales growth. Developing brand budgets and monitoring annual expense requirements, to ensure optimum utilization of marketing resources.

- Partnered with Business Development to acquire and transition marketing of Infergen[®] for Hep- C
- Produced new promotional materials and tactical programs such as sampling, and speaker programs to support strategy and drive sales.
- Developed Pre-Launch market research plan for Zelapar[®]. Including message testing, concept testing, and forecast development.
- Managed key medical education initiatives, including KOL Advisory boards, major conference symposia, publications and various CME programs.

Analyst, Global Marketing/Commercial Development

September 2003-September 2004

Supported Global Marketing and Development with market analysis and forecasting expertise that integrated secondary data sources and primary market research. Utilized IMS data to develop and execute integrated marketing analysis plans and product forecasts.

- Led the planning and execution of multi-attribute qualitative and quantitative market research projects for development products.
- Developed KOL targeting strategy for Viramidine, a Phase III product for Hepatitis C.
- Developed product forecasts and financial valuation models for business development during the acquisitions of Amarin Corp. and Xcel Pharmaceuticals, as well as the acquisition of Tasmar[®], an in-line product for Parkinson's disease.

Aventis Pharmaceuticals, Bridgewater, NJ

Area Sales Manager (Interim)

August 2002-September 2003

Managed a team of 10 sales associates in the Southern California area. Provided guidance on selling strategies and tactics as well as communicating and implementing key marketing initiatives.

- District Ranking increased from 6 to 2 among 8 districts in a 12-month period.
- Developed nationally implemented ROI tool for sales associates to measure success of promotional programs.

Professional Sales Associate/Field Sales Trainer

September 1999- August 2002

Successfully marketing and increasing market share for therapeutic products for various disease states. Developing specialists as advocates to ensure maximum product pull through, resulting in yearly sales attainment over 100%. Trained 10 new sales associates on product knowledge and selling skills.

- Experience selling therapeutic products in various disease states including: Allergy, Asthma, Diabetes, Arthritis and Osteoporosis.
- Nova Award 2000: National award recognizing outstanding sales performance for a new associate.

Saier Lab, U.C. San Diego Department of Biology, La Jolla, CA

Research Associate

September 1998-June 1999

Printz Lab, U.C. San Diego School of Medicine, La Jolla, CA

Research Associate

December 1997-February 1999

Contributed to three separate research projects addressing genetics, neurology, and psychiatry. Contributed work to a major journal for publication: Palmer, A.; Dulawa, S.C.; Mottiwala, A.A.; Printz, M.P. "Pre-pulse Inhibition of the Air Puff Startle Response in Four Strains of Rats" *Behavioral Neuroscience* 2000 Apr;114(2):374-88

EXHIBIT B

World Wide RESTASIS Sales by QTR

2003-2013 YTD

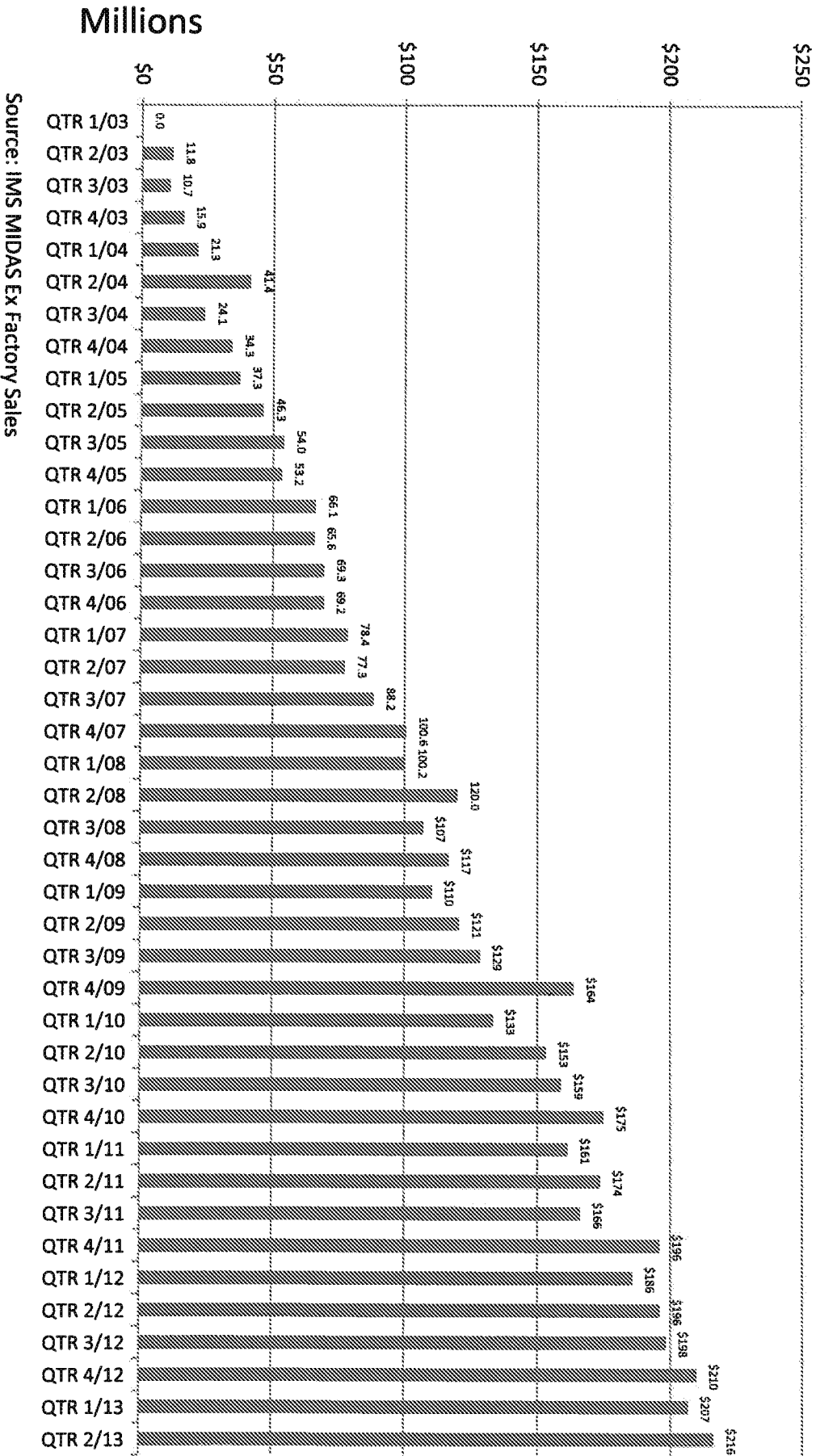

EXHIBIT C

EXHIBIT 4

IN THE UNITED STATES PATENT AND TRADEMARK OFFICE

DECLARATION UNDER 37 C.F.R. 1.132

of Dr. Rhett M. Schiffman

I, Rhett M. Schiffman, M.D., declare as follows:

1. I am currently a Vice President and Chief Medical Officer at Neurotech. I have an M.D., Masters Degrees in Clinical Research Design and Statistical analysis and in Health Services Administration, a Bachelor's degree in Bioengineering, and over 12 years of experience in the pharmaceutical industry at Allergan, Inc. ("Allergan"). I am a co-inventor on several issued patents and pending applications related to treatment methods using ophthalmic products. My *curriculum vita*, which contains a list of my publications to which I contributed, is attached to this declaration as Exhibit A.
2. Dry eye disease, also named keratoconjunctivitis sicca, is among the leading causes of patient visits to ophthalmologists in the United States. This condition has been recognized by the medical community and studied for decades. In the 1970s, over 600 articles were published on dry eye syndrome. The number of articles increased to over 1400 in the 1980s, over 2500 in the 1990s, and over 4800 in the last decade and counting.¹ It is estimated that at least twenty-three million Americans suffer from dry eye disease, which has two main causes: decreased secretion of tears by the lacrimal (tear-producing) glands, and loss of tears due to excess evaporation. Both causes lead to ocular discomfort, often described as feelings of dryness, burning, a sandy/gritty sensation, or itchiness. Symptoms, such as visual fatigue, sensitivity to light, and blurred vision also are characteristics of the disease. This is a serious disorder that, if left untreated or undertreated, progressively damages the ocular surface, and may lead to vision loss.
3. Dry eye disease is a disorder of the "tear film,"² and ocular inflammation is known to play a major role in the symptoms and progression of the disease. Dry eye disease patients can suffer mild irritation (Level 1 severity). In patients with Level 2 to Level 4

¹ Galor et al. (2012), attached as Exhibit B.

² The eye surface is supported and maintained by the tear film, which is composed of three components (lipid, aqueous, and mucin) that make up two fluid layers. Normal healthy tears contain a complex mixture of proteins and other components that are essential for ocular health and comfort. Tears provide nutrients and support the health of cells in the cornea, lubricate the ocular surface, and protect the exposed surface of the eye from infections. Clear vision depends on an even distribution of tears over the ocular surface. Dry eye disease affects the eye surface and changes the tear film composition dramatically. Typical changes include an elevated tear osmolarity, aqueous deficiency, altered mucins and lipid layer, and an altered proteomic profile.

severity scores, the symptoms are quite debilitating.³ If the condition in these cases is untreated or treated inadequately (e.g., only with an agent such as artificial tears), the disease will continue to progress, and will lead to severe eye damage and vision loss.⁴ Severe problems with untreated dry eye can also lead to corneal infection and scarring. Compared across different diseases, dry eye was found to cause degradation in quality of life that is on par with other severe disorders, such as class III/IV Angina.⁵

4. At the time Allergan initiated the Restasis® development program in 1992, dry eye was a well-recognized largely unmet medical condition. No therapeutic treatments were available, apart from the use of artificial tears, which had no direct pharmacology effect, and, blockage of the lacrimal drainage system with punctal plugs or cauterization for the most severe cases, which as we have since learned, made many patients worse by keeping the inflamed tears in constant contact with the ocular surface. In addition, neither artificial tears nor punctal plugs or cauterization actually worked to increase normal tear production in patients suffering from dry eye. Also, a 2002 Gallup poll data where 501 dry eye sufferers were interviewed predating the launch of Restasis®, showed that patients suffering from dry eye were looking for convenient and effective treatment for dry eye that provided long-lasting relief.⁶ Almost 74% of consumers polled in 2002 wished there was a more effective treatment for dry eye.⁷
5. Allergan's investigators completed seminal work in the dry eye disease area, identifying the role of the T-cell and chronic inflammation in the pathogenesis of dry eye disease,⁸ followed by application of cyclosporine (a drug previously used systemically to prevent transplant rejection) to target the disease locally. However, the lipophilic nature of cyclosporine made it extremely difficult to formulate an ocular-friendly preparation with good bioavailability. The multiple target tissues of the ocular surface (cornea, conjunctiva, lacrimal glands, etc.), the composition of the tear film (not a simple salt solution), and the short retention time on the eye contributed many complex issues in creating an efficacious formulation. Various formulations were attempted with

³ Behrens A, Doyle JJ, Stern L, Chuck RS, McDonnell PJ, Azar DT, et al. Dysfunctional tear syndrome. A Delphi approach to treatment recommendations. *Cornea*. 2006;25:900-07, attached hereto as Exhibit C; Dry Eye Workshop. Management and therapy of dry eye disease: report of the management and therapy subcommittee of the international dry eye workshop. *Ocul Surf*. 2007a;5:163-78, attached hereto as Exhibit D.

⁴ Rao S. Topical cyclosporine 0.05% for the prevention of dry eye disease progression. *J Ocular Pharmacol Thera*. 2010;26:157-163, attached hereto as Exhibit E; Deschamps N, Ricaud X, Rabut G, Labbé A, Baudouin C, Denoyer A. The impact of dry eye disease on visual performance while driving. *Am J Ophthalmol*. 2013; 125:184-189, attached hereto as Exhibit F.

⁵ Schiffman R.M., Walt J.G., Jacobsen G., Doyle J.J., Lebovics G., Sumner W. Utility assessment among patients with dry eye disease. *Ophthalmology*. 2003;110:1412-1419, attached hereto as Exhibit G.

⁶ The 2002 Gallup Study of Dry Eye Sufferers, attached hereto as Exhibit H.

⁷ *Id.*

⁸ Stern M.E., Beuerman R.W., Fox R.L., Gao J., Mircheff A.K., Pflugfelder, S.C. A unified theory of the role of the ocular surface in dry eye. *Adv Exp Med Biol*. 1998;438:643-51, attached hereto as Exhibit I.

concentrations up to 2% w/v cyclosporine and were poorly tolerated and absorbed. Ultimately, Allergan successfully formulated Restasis® in its current form, as presently claimed in the current patent application.

6. The approved Restasis® indication was based on statistically significant benefits in each of two pivotal clinical studies in which efficacy was defined as an improvement in the amount of tears produced (measured with a Schirmer score with anesthesia of ≥ 10 mm / 5 min, from a baseline of 0-5 mm). As a normal value for Schirmer's wetting is 10 mm / 5 min, an improvement of ≥ 10 mm / 5 min assured that responders achieved a total reversal of this measure of disease (i.e., a complete response) regardless of their baseline measurements. Patients in these trials suffered from moderate to very severe dry eye symptoms, with 60% of the patients scored as having the most severe Level 4 symptoms (discussed further below). Despite the severity of disease at baseline, and the very high hurdle for success, the proportion of patients experiencing complete response was three-fold higher among subjects taking Restasis® compared with those taking vehicle after 6 months of treatment. This was a highly significant result ($p < .007$).
7. The improvement in symptoms continued for 12 months and beyond in both the Restasis® group and in vehicle treated patients who were switched to Restasis® at month 6. It should be noted that these trials were begun in the late 1990s and were the first of their kind.
8. Restasis® was FDA approved on December 23, 2002. The approval of Restasis® for the treatment of dry eye represented a major paradigm shift in the treatment of dry eye.⁹ Restasis® was the first FDA approved prescription medication for dry eye, and is still the only FDA approved prescription medication for dry eye. Restasis® has been well received by the medical community as a major breakthrough in dry eye treatment, and is currently the #1 selling eye drop in the world. For example, Dr. Henry Perry stated that “[i]t is important in any type of chronic ocular surface disease, especially due to aqueous deficiency, to begin topical cyclosporine.”¹⁰ Another physician, Dr. Christopher Starr stated “I liked Restasis from the beginning and I have increased my prescribing of it over the years as I’ve gained more experience and witnessed its impressive results,” and “[t]he most recent definition of dry eye disease from the Dry Eye WorkShop (DEWS) report notes hyperosmolarity and inflammation as key pathophysiologic factors, which a recommends the use of anti-inflammatory medication such as Restasis beginning with level 2 disease.”¹¹

⁹ Pflugfelder, 2006 attached as Exhibit J.

¹⁰ Ocular Surgery, January 2013, attached as Exhibit K.

¹¹ Ophthalmology Management, September 2013, attached as Exhibit L.

9. Other companies have tried to develop prescription treatments for dry eye, but none have been FDA approved as of this date.¹² A partial listing of companies and drugs for drug eye that have failed are attached hereto as Exhibit N. One example of such drug is Prolacria, a dry eye treatment that was developed for over a decade by Inspire Pharmaceuticals, but was cancelled in 2010 when Prolacria failed to outperform a placebo in their phase III clinical trials.¹³

¹² <http://www.ophthalmologymanagement.com/articleviewer.aspx?articleid=104917> accessed 2013-09-24 and attached as Exhibit M.

¹³ <http://www.bizjournals.com/triangle/stories/2010/08/23/daily11.html?pager=all> accessed 2013-09-24 and attached as Exhibit O.

I hereby declare that all statements made herein of my own knowledge and belief are true; and that all statements made on information and belief are believed to be true; and further that these statements are made with the knowledge that willful false statements and the like so made are punishable by fine or imprisonment, or both, under Section 1001 of Title 18 of the United States Code, and that such willful false statements may jeopardize the validity of the application or any patents issued thereon.

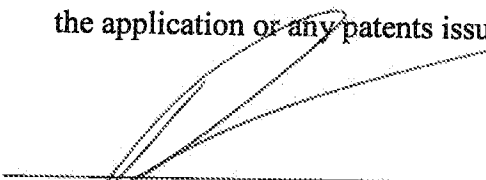

Dr. Rhett M. Schiffman

Date: 10/01/13

EXHIBIT A

CURRICULUM VITAE FOR RHETT M. SCHIFFMAN, M.D., M.S., M.H.S.A.

Current Title: Vice President and Chief Medical Officer
Neurotech

Work Address: 900 Highland Corporate Drive
Building #1, Suite #101
Cumberland, RI 02864

Home Address: 1843 Temple Hills
Laguna Beach, CA 92651

Office Telephone: (401) 495-2395
Cell Telephone: (313) 516-6924
Email: r.schiffman@neurotechusa.com

EDUCATION:

Professional: University of Michigan, School of Public Health,
Ann Arbor, Michigan
2000 M.H.S.A. Health Services Administration

University of Michigan, Rackham Graduate School,
Ann Arbor, Michigan
1989 M.S. Clinical Research Design & Statistical Analysis

Universidad Autonoma de Ciudad Juarez
Instituto de Ciencias Biomedicas
Juarez, Mexico
1983 M.D. Medicine

Undergraduate: Columbia University
School of Engineering and Applied Science
New York, NY
1978 B.S. Bioengineering

POSTDOCTORAL TRAINING:

Fellow: Uveitis and Ocular Immunology, National Eye Institute,
National Institutes of Health, Bethesda, MD
1996-1997

Resident: Ophthalmology, Henry Ford Hospital, Detroit, Michigan
1993 - 1996

Resident: Internal Medicine, Henry Ford Hospital, Detroit, Michigan
1984 - 1986

Intern: Internal Medicine, Henry Ford Hospital, Detroit, Michigan
1983 - 1984

CERTIFICATION AND LICENSURE

Medical Licensure: California, 2002 – C50825
Michigan, 1983 - 4301046984

Board Certification: American Board of Ophthalmology, 1999; 93th percentile on Board examination
American Board of Internal Medicine, 1986; 99th percentile on Board examination

PROFESSIONAL SOCIETIES:

Member, Association for Research in Vision and Ophthalmology
American Academy of Ophthalmology
American Medical Association

PROFESSIONAL EXPERIENCE:

2013-Present Vice President and Chief Medical Officer, Neurotech

2010-2013 Board Member, Glaucoma Research Foundation

2009-2013 Ophthalmology Therapeutic Area Head

2008-2013 Head of Development for Emerging Markets

2007-2013 Head, Global Product Enhancement/Life Cycle Management

2005-2013 Vice President, Development for Ophthalmology and Botox, Allergan Pharmaceuticals

2003-Present Clinical Associate Professor and Attending Physician in Ophthalmology, University of California at Irvine.

2001-2005 Senior Director, Ophthalmology Clinical Research, Allergan Pharmaceuticals, Irvine, California

1999-2001 Member, Leadership Council, Eye Care Services, Henry Ford Health System, Detroit, MI

1999-2001 Director, Quality Improvement, Eye Care Services, Henry Ford Health System, Detroit, MI

1998-2001 Director of the African-American Initiative for Male Health Improvement (AIMHI). Eye Disease Screening Program in Southeast Michigan. Funded by the Michigan Department of Community Health.

1997-2001 Director of Uveitis Services, Eye Care Services, Henry Ford Health System, Detroit, MI
Director of Clinical Research, Eye Care Services, Henry Ford Health System, Detroit, MI
Staff Investigator, Center for Health Services Research, Henry Ford Health System, Detroit, MI

1996-2001 Reviewer to Special Study Section, National Eye Institute, National Institutes of Health, Bethesda, Maryland.

1999-2001 Director, Clinical Research, Eye Care Services, Henry Ford Hospital, Detroit, Michigan

- 1996-1997 Senior Staff Physician, Eye Care Services, Ophthalmology, Henry Ford Health System, Detroit, Michigan (on intergovernmental personnel act to National Eye Institute, National Institutes of Health, Bethesda, Maryland)
- 1994-1995 Associate Medical Director, Henry Ford Hospital Pharmacology Research Unit, Detroit, Michigan
- 1993-2001 Associate Research Director, Eye Care Services, Henry Ford Hospital, Detroit, Michigan
- 1989-2001 Staff, Center for Clinical Effectiveness, Henry Ford Hospital, Detroit, Michigan
- 1988-1994 Requirements Advisory Committee to the Medical Information Management System, Henry Ford Hospital, Detroit, Michigan
- 1989-1993 Coordinator, General Internal Medicine Research, Henry Ford Hospital, Detroit, Michigan
- 1990-1993 Chairman, General Internal Medicine Research Committee, Henry Ford Hospital, Detroit, Michigan
- Member, Research and Academic Affairs Committee, Department of Medicine, Henry Ford Hospital, Detroit, Michigan
- 1986-1993 Senior Staff Physician, General Internal Medicine, Henry Ford Hospital, Detroit, Michigan

TEACHING EXPERIENCE:

- 2003-Present Ophthalmology Residency Training Program, University of California at Irvine
- 1997-2001 Ophthalmology Residency Training Program, Henry Ford Hospital, Detroit, Michigan
- 1986-1993 Internal Medicine Residency Training Program, Henry Ford Hospital, Detroit, Michigan
- 1988-1993 Preceptor, University of Michigan Medical Schools, Ann Arbor, Michigan
- 1991-1993 Preceptor, General Internal Medicine Fellows
- Medical Staff Seminars, General Internal Medicine, Henry Ford Hospital, Detroit, MI:
Introduction to Epidemiology, Introduction to Personal Computing, Medical Decision Analysis

BOOKS & MONOGRAPHS:

1. Ocular Therapy chapter in: Oréface, Fernando: Uveíte: Clínica e Cirúrgica. Ed. Cultura Médica. Published June 2000.
2. New Concepts in the Pathogenesis, Diagnosis and Treatment of Dry Eye. Ocular Surgery News Monograph; Slack Incorporated. July 1, 1999

3. Schiffman RM: Glaucoma, Ophthalmology chapter in Noble, John: Textbook of Primary Care Medicine. 2nd Edition. 1996. Mosby-Year Book, Inc. 1471-9.

JOURNAL PUBLICATIONS:

1. Day D.G., Walters T.R., Schwartz G.F., Mundorf T.K., Liu C., Schiffman R.M., Bejani M. Bimatoprost 0.03% preservative-free ophthalmic solution versus bimatoprost 0.03% ophthalmic solution (Lumigan) for glaucoma or ocular hypertension: a 12-week, randomised, double-masked trial. *Br J Ophthalmol*. 2013 Jun 6. [Epub ahead of print]
2. Callanan DG, Gupta S, Boyer DS, Ciulla TA, Singer MA, Kuppermann BD, Liu CC, Li XY, Hollander DA, Schiffman RM, Whitcup SM; Ozurdex PLACID Study Group. Dexamethasone Intravitreal Implant in Combination with Laser Photocoagulation for the Treatment of Diffuse Diabetic Macular Edema. *Ophthalmology*. 2013 May 22. S0161-6420(13)00152-8.
3. Katz LJ, Rauchman SH, Cottingham AJ Jr, Simmons ST, Williams JM, Schiffman RM, Hollander DA. Fixed-combination brimonidine-timolol versus latanoprost in glaucoma and ocular hypertension: a 12-week, randomized, comparison study. *Curr Med Res Opin*. 2012 May;28(5):781-8
4. Katz, L.J., Rauchman, S.H., Cottingham Jr., A.J., Simmons, S.T., Williams, J.M., Schiffman, R.M., Hollander, D.A. Fixed-combination brimonidinetimolol versus latanoprost in glaucoma and ocular hypertension: A 12-week, randomized, comparison study. *Current Medical Research and Opinion* 28 (5) , pp. 781-788
5. Lowder, C., Belfort Jr., R., Lightman, S., Foster, C.S., Robinson, M.R., Schiffman, R.M., Li, X.-Y., Cui H, Whitcup, S.M. Dexamethasone intravitreal implant for noninfectious intermediate or posterior uveitis. *Arch Ophthalmol* 2011 129 (5):545-553
6. Waterbury, L.D., Galindo, D., Villanueva, L., Nguyen, C., Patel, M., Borbridge, L., Attar, M., Schiffman RM, Hollander, D.A. Ocular penetration and anti-inflammatory activity of ketorolac 0.45% and bromfenac 0.09% against lipopolysaccharide-induced inflammation. *J Ocular Pharmacol and Therapeutics* 2011 27 (2):173-178
7. Xu, K., McDermott, M., Villanueva, L., Schiffman, R.M., Hollander, D.A. Ex vivo corneal epithelial wound healing following exposure to ophthalmic nonsteroidal anti-inflammatory drugs. *Clin Ophthalmol* 2011 5 (1), pp. 269-274.
8. Donnenfeld, E.D., Nichamin, L.D., Hardten, D.R., Raizman, M.B., Trattler, W., Rajpal, R.K., Alpern, L.M., Felix C, Bradford RR, Villanueva L, Hollander DA, Schiffman, R.M. Twice-daily, preservative-free ketorolac 0.45% for treatment of inflammation and pain after cataract surgery. *Am J Ophthalmol* 2011 151 (3):420-426.
9. Spaeth G, Bernstein P, Caprioli J, Schiffman RM. Control of Intraocular Pressure and Intraocular Pressure Fluctuation with Fixed Combination Brimonidine-Timolol versus Brimonidine or Timolol Monotherapy. *Am J Ophthalmol*. 2011 January;151:93-99.
10. Attar, M., Schiffman, R., Borbridge, L., Farnes, Q., Welty, D. Ocular pharmacokinetics of 0.45% ketorolac tromethamine. *Clin Ophthalmol* 2010 4(1), pp. 1403-1408
11. Craven, E.R., Liu, C.-C., Batoosingh, A., Schiffman, R.M., Whitcup, S.M. A randomized, controlled comparison of macroscopic conjunctival hyperemia in patients treated with bimatoprost 0.01% or vehicle who were previously controlled on latanoprost. *Clin Ophthalmol* 2010 4 (1):1433-1440
12. Olson, R., Donnenfeld, E., Bucci Jr., F.A., Price Jr., F.W., Raizman, M., Solomon, K., Devgan, U., Trattler W, Dell S, Wallace RB, Callegan M, Brown H, McDonnell PJ, Conway T, Schiffman RM,

- Hollander, D.A. Methicillin resistance of Staphylococcus species among health care and nonhealth care workers undergoing cataract surgery. *Clin Ophthalmol.* 2010 4(1):1505-1514
13. Katz L, Cohen J, Batoosingh A, Felix C, Shu V, Schiffman R. Twelve-Month, Randomized Controlled Trial of the Efficacy and Safety of Bimatoprost 0.01%, 0.0125%, and 0.03% in Patients with Glaucoma or Ocular Hypertension. *Am J Ophthalmol.* 2010 April;149:661-671.
 14. Lewis R, Gross R, Sall K, Schiffman R, Liu C-C, Batoosingh A, (for the Ganfort® Investigators Group II). The Safety and Efficacy of Bimatoprost/Timolol Fixed Combination: A 1-year Double-masked, Randomized Parallel Comparison to Its Individual Components in Patients With Glaucoma or Ocular Hypertension. *J Glaucoma.* 2010 August;19(6):424-426.
 15. Sherwood MB, Craven ER, Chou C, DuBiner HB, Batoosingh AL, Schiffman RM, Whitcup SM. Twice-daily 0.2% brimonidine-0.5% timolol fixed-combination therapy vs monotherapy with timolol or brimonidine in patients with glaucoma or ocular hypertension: a 12-month randomized trial. *Arch Ophthalmol.* 2006 Sep;124(9):1230-8.
 16. Craven ER, Walters TR, Williams R, Chou C, Cheetham JK, Schiffman R; Combigan Study Group. Brimonidine and timolol fixed-combination therapy versus monotherapy: a 3-month randomized trial in patients with glaucoma or ocular hypertension. *J Ocul Pharmacol Ther.* 2005 Aug;21(4):337-48.
 17. Yee RW, Tepedino M, Bernstein P, Jensen H, Schiffman R, Whitcup SM; Gatifloxacin BID/QID Study Group. A randomized, investigator- masked clinical trial comparing the efficacy and safety of gatifloxacin 0.3% administered BID versus QID for the treatment BID versus QID for the treatment of acute bacterial conjunctivitis of acute bacterial conjunctivitis. *Curr Med Res Opin.* 2005 Mar;21(3):425-31.
 18. Schiffman RM, Jacobsen G, Nussbaum JJ, et al: A Novel Approach for Detection of Diabetic Retinopathy Using DigiScope Retinal Imaging System. *Ophthalmic Surg Lasers Imaging.* 2005 Jan-Feb;36(1):46-56.
 19. Solomon KD, Donnenfeld ED, Raizman M, Stern K, VanDenburgh A, Cheetham JK, Schiffman RM for the Ketorolac Reformulation Study Groups 1 and 2: Safety and Efficacy of Reformulated Ketorolac Tromethamine 0.4% Ophthalmic Solution in Post-photorefractive Keratectomy Patients. *Journal Cataract Refract Surg* 2004 Aug;30(8):1653-1660.
 20. Whitcup SM, Bradford R, Lue J, Schiffman RM, Abelson MB. Efficacy and tolerability of ophthalmic epinastine: a randomized, double-masked, parallel-group, active- and vehicle-controlled environmental trial in patients with seasonal allergic conjunctivitis. *Clin Ther.* 2004 Jan;26(1):29-34.
 21. Abelson MB, Gomes P, Crampton HJ, Schiffman RM, Bradford RR, Whitcup SM. Efficacy and tolerability of ophthalmic epinastine assessed using the conjunctival antigen challenge model in patients with a history of allergic conjunctivitis. *Clin Ther.* 2004 Jan;26(1):35-47.
 22. McDonnell PJ, Taban M, Sarayba MA, Schiffman RM, et al.: Dynamic Morphology of Clear Corneal Incisions. *Ophthalmology.* 2003 Dec;110(12):2342-8.
 23. Desai UR, Alhalel AA, Campen TJ, Schiffman RM, Edwards PA, Jacobsen GR: Central serous chorioretinopathy in African Americans. *J Natl Med Assoc.* 2003 Jul;95(7):553-9.
 24. Javitt JC, Jacobson G, Schiffman RM.: Validity and reliability of the Cataract Type Spec: an instrument for measuring outcomes of cataract extraction. *Am J Ophthalmol.* 2003 Aug;136(2):285-90.
 25. Baum JL, Schiffman RM: Reliability and Validity of a Proposed Dry Eye Evaluation Scheme - Reply. *Arch Ophthalmol* 2001 Mar;119(3):456.

26. Schiffman RM, Walt JG, Jacobsen G, Doyle JJ, Lebovics G, Sumner W.:Utility assessment among patients with dry eye disease. *Ophthalmology*. 2003 Jul;110(7):1412-9.
27. Baum JL, Schiffman RM: Reliability and Validity of a Proposed Dry Eye Evaluation Scheme. *Arch Ophthalmol* 2001 Mar;119(3):456.
28. Desai UR, Tawansy K, Schiffman RM: Choroidal Granulomas in Systemic Sarcoidosis. *Retina*. 2001;21(1):40-7.
29. Mangione CM, Lee PP, Spritzer K, Berry S, Hayes RD et. al: Development, Reliability, and Validity of the 25-Item National Eye Institute Visual Function Questionnaire (VFQ-25). Accepted for publication in *Archives of Ophthalmology*.
30. Schiffman RM, Jacobsen G, Whitcup S: Visual Functioning and General Health Status in Patients with Uveitis. *Arch Ophthalmol* 2001 Jun;119(6):841-849.
31. Javitt JC, Schiffman RM: Clinical Success and Quality of Life with Brimonidine 0.2% or Timolol 0.5% used BID in Glaucoma or Ocular Hypertension: A Randomized Clinical Trial. *J Glaucoma*. 2000 Jun;9(3):224-34.
32. Schiffman RM, Christianson MD, Jacobsen G, Hirsch JD, Reis BL.: Reliability and validity of the Ocular Surface Disease Index. *Arch Ophthalmol*. 2000 May;118(5):615-21.
33. Nussenblatt RB, Fortin E, Schiffman R, Rizzo L, Smith J, Van Veldhuisen P, Sran P, Yaffe A, Goldman CK, Waldmann TA, Whitcup SM. Treatment of noninfectious intermediate and posterior uveitis with the humanized anti-Tac mAb: a phase I/II clinical trial. *Proc Natl Acad Sci U S A*. 1999 Jun 22;96(13):7462-6.
34. Nussenblatt RB, Schiffman R, Fortin E, Robinson M, Smith J, Rizzo L, Csaky K, Gery I, Waldmann T, Whitcup SM: Strategies for the treatment of intraocular inflammatory disease. *Transplant Proc*. 1998 Dec;30(8):4124-5.
35. Mangione CM, Lee PP, Pitts J, Gutierrez P, Berry S, Hays RD. Psychometric properties of the National Eye Institute Visual Function Questionnaire (NEI-VFQ). NEI-VFQ Field Test Investigators. *Archives of Ophthalmology*. 116(11):1496-504, 1998 Nov.
36. Desai UR, Alhalel AA, Schiffman RM, Campen TJ, Sundar G, Muhich A. Intraocular pressure elevation after simple pars plana vitrectomy. *Ophthalmology*. 104(5):781-6, 1997 May.
37. Ben-Menachem T, McCarthy BD, Fogel R, Schiffman RM, Patel RV, Zarowitz BJ, Nerenz DR, Bresalier RS. Prophylaxis for stress-related gastrointestinal hemorrhage: a cost effectiveness analysis. *Critical Care Medicine*. 24(2):338-45, 1996 Feb.
38. Ward RE; Purves T; Feldman M; Schiffman RM; Barry S; Christner M; Kipa G; McCarthy BD; Stiphout R: Design considerations of CareWindows, a Windows 3.0-based graphical front end to a Medical Information Management System using a pass-through-requester architecture. *Proc Annu Symp Comput Appl Med Care* 1991; 564-8
39. Stiphout RM; Schiffman RM; Christner MF; Ward R; Purves TM: Medical Information Management System (MIMS) CareWindows. *Proc Annu Symp Comput Appl Med Care* 1991; 929-31
40. Gubbins G, Schiffman RM, Alipati R, Batra S.: Cocaine-Induced Hepatonephrotoxicity. *Henry Ford Hospital Medical Journal* 1990; 38:55-56.

JOURNAL REVIEWER

1. British Journal of Ophthalmology
2. Current Eye Research
3. Ophthalmology
4. Optometry and Vision Science
5. The Lancet

SELECTED PAST SCIENTIFIC ACTIVITIES:

HFHS Principal Investigator

1. Schiffman RM, Chew E, Ferris F, Ellwein L, Hays R, Mangione C: A Randomized Comparison of the Cost, Quality and Acceptability of Four Modes of Administration the National Eye Institute Visual Functioning Questionnaire-25. National Eye Institute.
2. Schiffman RM: National Eye Institute Refractive Error Correction Questionnaire (NEI-RECQ) Phase II Protocol. National Eye Institute through Emmes Corporation.
3. Schiffman RM, Lesser GL, Imami N, Trick GL: A 48-Month, Multi-Center, Randomized, Double-Masked, Placebo-Controlled, Clinical Study to Evaluate the Effectiveness and Safety of Oral Memantine in Daily Doses of 20 Mg and 10 Mg in Patients with Chronic Open-Angle Glaucoma at Risk for Glaucomatous Progression - Allergan Protocol 192944-005.
4. Schiffman RM: A Multicenter, Investigator-Masked, Randomized, Parallel-Group Study to Compare the Safety and Efficacy and Safety of Restasis™ (Cyclosporine 0.05% Ophthalmic Emulsion) vs. An Artificial Tear (Refresh®) Used Twice Daily for Three Months in Patients with Moderate to Severe Keratoconjunctivitis Sicca (Allergan Protocol 192371-008)
5. Schiffman RM, Patel S, Crosswell M and Shankle J: The Retinal Thickness Analyzer in the Management of Uveitic Cystoid Macular Edema.
6. Schiffman RM, Trick GL: Retinal Thickness Analyzer (RTA) - Clinical Validation Study. Talia Technology Ltd.
7. A Multicenter, Randomized, Double-Masked, Controlled Study to Evaluate the Safety and Efficacy of an Intravitreal Fluocinolone Acetonide Insert in Patients with Non-Infectious Uveitis Affecting the Posterior Segment of the Eye. Bausch and Lomb.

SCIENTIFIC ACTIVITIES:

HFHS Collaborative Investigator:

1. Lesser B, Darnley D, Schiffman R: Ocular Hypertension Treatment Study. National Eye Institute, 1993- 1999.
2. Nussenblatt RB, Whitcup SM, Schiffman RM, et. al: The Treatment of Non-infectious Intermediate and Posterior Uveitis with Humanized Anti-Tac Monoclonal Antibody Therapy: Phase I and Phase II. National Eye Institute, National Institutes of Health.

EXHIBIT B

Dry Eye Medication Use and Expenditures: Data From the Medical Expenditure Panel Survey 2001 to 2006

Anat Galor, MD, MSPH,*† D. Diane Zheng, MS,‡ Kristopher L. Arheart, EdD,‡ Byron L. Lam, MD,† Victor L. Perez, MD,† Kathryn E. McCollister, PhD,‡ Manuel Ocasio, BS,‡ Laura A. McClure, MSPH,‡ and David J. Lee, PhD†‡

Purpose: To study dry eye medication use and expenditures from 2001 to 2006 using a nationally representative sample of US adults.

Methods: This study retrospectively analyzed dry eye medication use and expenditures of participants of the 2001 to 2006 Medical Expenditure Panel Survey, a nationally representative subsample of the National Health Interview Survey. After adjusting for survey design and for inflation using the 2009 inflation index, data from 147 unique participants aged 18 years or older using the prescription medications Restasis and Blephamide were analyzed. The main outcome measures were dry eye medication use and expenditures from 2001 to 2006.

Results: Dry eye medication use and expenditures increased between the years 2001 and 2006, with the mean expenditure per patient per year being \$55 in 2001 to 2002 ($n = 29$), \$137 in 2003 to 2004 ($n = 32$), and \$299 in 2005 to 2006 ($n = 86$). This finding was strongly driven by the introduction of topical cyclosporine emulsion 0.05% (Restasis; Allergan, Irvine, CA). In analysis pooled over all survey years, demographic factors associated with dry eye medication expenditures included gender (female: \$244 vs. male: \$122, $P < 0.0001$), ethnicity (non-Hispanic: \$228 vs. Hispanic: \$106, $P < 0.0001$), and education (greater than high school: \$250 vs. less than high school: \$100, $P < 0.0001$).

Conclusions: We found a pattern of increasing dry eye medication use and expenditures from 2001 to 2006. Predictors of higher dry eye medication expenditures included female gender, non-Hispanic ethnicity, and greater than a high school education.

Key Words: dry eye syndrome, Medical Expenditure Panel Survey, MEPS, expenditures

(*Cornea* 2012;31:1403–1407)

Received for publication June 30, 2011; revision received August 27, 2011; accepted August 31, 2011.

From the *Division of Ophthalmology, Miami Veterans Affairs Medical Center, Miami, FL; †Department of Ophthalmology, Bascom Palmer Eye Institute, Miami, FL; and ‡Department of Epidemiology & Public Health, University of Miami School of Medicine, Miami, FL.

Supported by a grant from the National Eye Institute (1R21EY019096) and an unrestricted grant from the Research to Prevent Blindness.

The authors state that they have no proprietary interest in the products named in this article.

Reprints: Anat Galor, Bascom Palmer Eye Institute, 900 Northwest 17th St, Miami, FL 33132 (e-mail: galor@med.miami.edu).

Copyright © 2012 by Lippincott Williams & Wilkins

Dry eye syndrome (DES) has recently gained recognition as a public health problem.^{1–3} In the decade between 1970 and 1980, 670 articles were published on DES (search terminology dry eye syndrome, limits humans, and English); this increased to 1485 articles in the 1980s, 2511 articles in the 1990s, and 4887 articles in the last decade. Part of this recognition came from several US population-based and international population-based studies demonstrating that the condition was present in between 5% and 30% of the population aged 50 years or older.^{1,2,6–17} Another part of the recognition came from understanding that the symptoms of DES, which include constant irritation, foreign body sensation, and blurred vision, interfere with the ability to work and carry out daily functions.^{18–20} A study using the Impact of Dry Eye Living Questionnaire found that severe dry eye symptoms were correlated with difficulties in physical, social, and mental functioning.²¹ Such difficulties translate into a relatively lower health-related quality of life compared with the general population—patients with severe dry eye symptoms have health-related quality of life scores in the range of conditions like class III/IV angina.²⁰

An additional event that helped push DES into the limelight was the release of the first Food and Drug Administration-approved prescription medication for DES, cyclosporine emulsion 0.05% (Restasis; Allergan, Irvine, CA). The Food and Drug Administration approved the medication in 2002, and the pharmaceutical company Allergan launched cyclosporine emulsion in the United States in late 2003. As part of its sales strategy, Allergan used direct to consumer marketing and commissioned magazine and television advertisements to reach its target audience; it also heavily promoted cyclosporine emulsion within the eye care community. These activities had the effect of increasing physician and patient awareness of the prevalence of DES, its morbidity, and its potential treatments.

Although there is a sense that the economic implications of DES are substantial, few articles have studied the direct costs associated with DES and other ocular surface disorders. These include costs associated with office visits, prescription medication, over-the-counter medication, alternative or complementary medication, and nonpharmacologic purchases (eg, humidifiers). A retrospective claims analysis evaluating costs in 9065 patients who received topical cyclosporine for DES found a mean health care cost of \$336 per patient with a total cost of \$3.05 million.²² A retrospective analysis of the annual cost of DES in patients treated

by an ophthalmologist in 6 European countries estimated a total annual healthcare cost between 0.27 and 1.10 million US dollars per country. However, this cost did not take into consideration patients who self-treated their condition or were treated by their primary care physician.²³

The Medical Expenditure Panel Survey (MEPS) is an annual survey of families and individuals, their medical providers, and employers across the United States. MEPS, which is designed to be representative of the US population, provides the most complete source of data on the cost and use of health care and health insurance coverage.²⁴ Given that prescription cost information is available through the MEPS data set, we examined recent patterns in dry eye medication expenditures. We aimed to confirm our hypothesis that a substantial increase in expenditures has occurred over the past few years, perhaps in response to the increased public and provider awareness of the condition along with the availability of a new prescription medication.

MATERIALS AND METHODS

Sample

The MEPS is a nationally representative subsample of the National Health Interview Survey, a continuous multipurpose and multistage area probability survey of the US civilian noninstitutionalized population living at addressed dwellings. To have an adequate number of persons in important population subgroups, the MEPS oversampled Blacks and Hispanics in all years and began oversampling of Asians in 2002.²⁵ The overall MEPS response rate ranged from 66% in 2001 to 58% in 2006. Sampling weights were applied to ensure that the resulting sample was nationally representative of US households and includes adjustment for oversampling of race/ethnic groups and survey nonresponse.

To obtain dry eye medication expenditures, a comprehensive list of available prescription medications, including name brands, generics, and chemical names, for the study period was first generated and used to identify those MEPS participants who used any medication via the MEPS Prescribed Medicines files. The Prescribed Medicines files contained comprehensive information on medications used by MEPS participants.²⁵ From this list, 2 medications used in the setting of DES were identified: cyclosporine emulsion 0.05%, used to treat aqueous tear deficiency, and sulfacetamide sodium–prednisolone acetate ophthalmic suspension, USP 10%/0.2% (Blephamide), used to treat lipid tear deficiency (blepharitis), among other conditions.

Data from MEPS 2007 were available but were not included in this analysis because the methodology in editing the pharmacy data was changed. Comparison of prescription drug spending before and after 2007 was therefore not recommended by the Agency for Healthcare Research and Quality.²⁶ MEPS initially had an over-the-counter medication section that collected details about nonprescription medication purchases; however, this section was omitted from the questionnaire beginning in 2002.²⁷ Because we were interested in dry eye medication costs in the years since the launch of cyclosporine emulsion, we were unable to include over-the-counter medications in our

analysis. For the study period, 147 unique participants aged 18 years or older were found to have used sulfacetamide sodium–prednisolone acetate ophthalmic suspension and/or cyclosporine emulsion and were included in the analysis. Expenditure of these medications for each participant over 2-year intervals was analyzed. The data were adjusted for survey design, and the expenditure was adjusted for inflation using 2009 inflation index.

Demographic Data

Demographic and insurance information of the qualified participants was obtained from the MEPS Full-Year Consolidated Data Files. Demographic data collected included gender, age, race (white, black, other/multiple), ethnicity (Hispanic, non-Hispanic), health insurance status (private, public only, and uninsured), and education level (less than high school, high school, greater than high school). Family income, measured as a percentage, was calculated by dividing total family income by the applicable poverty line (based on family size and composition). The resulting percentages were grouped into 3 categories: low income/poverty (less than 200%), middle income (200% to less than 400%), and high income (400% or more).

Statistical Analyses

All statistical analyses were performed using SAS 9.2 (SAS Institute, Inc., Cary, NC) and SUDAAN 10 (RTI International, Triangle, NC) statistical packages. To account for complex survey design of the MEPS data, analyses were completed with adjustments for sample weights and design effects. We conducted descriptive analyses to evaluate patterns in dry eye medication expenses per person over a 2-year interval. *T* tests were performed to compare average medication expenditure across different demographic groups. A multivariate linear regression was performed to study demographic variables that predict high dry eye medication expense. The University of Miami Institutional Review Board reviewed and approved this study, which was conducted in accordance with the principles of the Declaration of Helsinki.

RESULTS

More patients used prescription dry eye medications in 2005 to 2006 ($n = 86$) compared with the previous 4 years ($n = 29$ and 32 for 2001–2002 and 2003–2004, respectively), and the total number of prescriptions filled increased with each year (Fig. 1). The cost associated with dry eye prescription medications also increased between 2001 and 2006, with a mean expenditure per patient of \$55 in 2001 to 2002, \$137 in 2003 to 2004, and \$299 in 2005 to 2006 (Fig. 2). The introduction of topical cyclosporine significantly affected both the number of prescriptions filled and the dry eye expenditures because after its introduction, 68% of prescriptions and 80% of expenditures were related to cyclosporine emulsion in 2003 to 2004 and 84% of prescriptions and 92% of expenditures were related to cyclosporine emulsion in 2005 to 2006. The mean cost of sulfacetamide sodium–prednisolone acetate ophthalmic suspension increased from \$36.27 in 2001

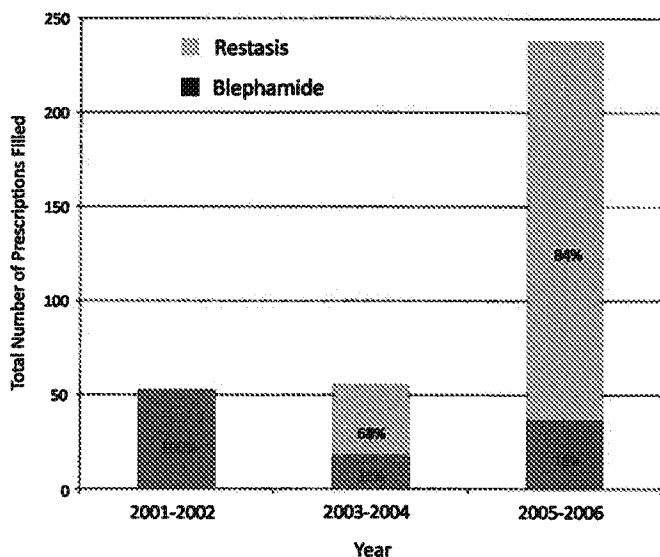

FIGURE 1. Graphic representation of the total number of dry eye prescriptions filled using the MEPS database, 2001 to 2006.

to 2002 to \$54.56 in 2003 to 2004 to \$64.43 in 2005 to 2006. Likewise, the mean cost of cyclosporine emulsion increased from \$98.98 in 2003 to 2004 to \$113.06 in 2005 to 2006. The increase in mean dry eye expenditures over the period, therefore, can be explained by both increased medication usage and cost.

Several demographic factors were associated with medication expenditures in the treatment of dry eye. Gender had a significant effect, with mean spending for women being double that for men (\$244 vs. \$122, $P < 0.0001$) (Table 1, Fig. 2). Similarly, spending for non-Hispanics was double that for the Hispanic population (\$228 vs. \$106, $P < 0.0001$).

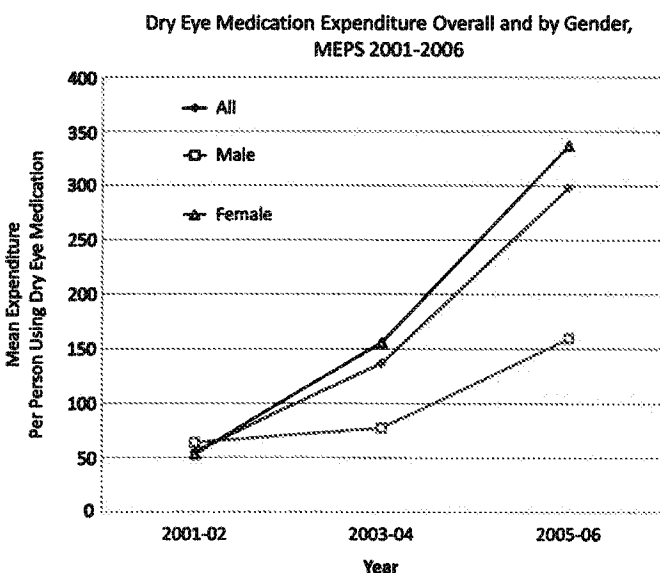

FIGURE 2. Graphic representation of mean dry eye medication expenditures per patient (overall and by gender) using the MEPS database, 2001 to 2006.

Level of education was also an important factor, with individuals with more than a high school education spending more than those with less than a high school education (\$250 vs. \$100, $P < 0.0001$). Race, age, and income status were not found to significantly affect dry eye medication expenditures in our analysis.

In a multivariable linear regression analysis considering all demographic factors, gender and education remained significant predictors of dry eye medication expenditures. Female gender was associated with a \$159 higher mean expenditure compared with male gender ($P = 0.0004$). Greater than high school education was associated with a \$145 higher mean expenditure compared with less than a high school education ($P = 0.0016$). Although not significant in our univariable analysis, with adjustment for all other covariates, those in the 65 and older age group spent \$107 more on dry eye medications than those in the 45- to 64-year-old group ($P = 0.04$).

DISCUSSION

In this nationally representative study of patterns in prescription dry eye medication expenditures from 2001 to 2006, we found that the number of patients treated with prescription dry eye medications and their associated expenditures increased between these years. This finding was strongly driven by the introduction of cyclosporine emulsion in 2003. Considering demographic factors, female gender, non-Hispanic ethnicity, and a greater than high school education were factors significantly associated with a higher mean yearly expenditure for DES in our univariate models.

Although studies have suggested that the economic implications of DES are substantial,²⁸ limited data are available to support this statement. Fiscella et al²² analyzed claims data from a proprietary research database containing pharmacy claims data on over 13 million individuals. They identified 9065 subjects that had one or more prescriptions filled for topical cyclosporine emulsion between January 1, 2004, and December 31, 2005. The mean yearly prescription cost by the health insurance plans was \$336, and the mean out-of-pocket prescription cost for the patient was \$98. This compares favorably with our findings because the cost analysis above includes both patient and insurance expenditures combined.

Putting these numbers in the context of other chronic ocular and nonocular diseases, a recent MEPS study found that patients with glaucoma spent a mean of \$556 per year on prescription glaucoma medications in 2006 (adjusted for inflation using 2009 inflation index).²⁹ Similarly, another article using the MEPS database found that people with spine problems spent a mean of \$397 per year on prescription medications in 2006.³⁰ The findings in this study suggest that although DES is not a blinding condition, individuals are willing to spend a non-trivial amount of money per year to alleviate the discomfort associated with this disorder. It is also important to note that the expenditures presented in this study do not incorporate the costs of nonprescription medications and doctor's visits and therefore the total amount of money spent on the disease is likely to be significantly higher.

We found that several demographic factors affected the expenditures of dry eye medications, including gender, ethnicity,

TABLE 1. Mean and Standard Error Cost (in Dollars) Per Prescription of Dry Eye Medications by Demographic Factors, 2001 to 2006 MEPS Data

Characteristics	N	Mean	SE	P
All	147	217.31	23.41	—
Sex				
Male	34	122.24	6.87	—
Female	113	244.30	24.35	<0.0001
Race				
White	134	220.51	20.63	White vs. Black = 0.07
Black	8	141.94	27.39	White vs. Other = 0.95
Other	5	214.18	95.84	Black vs. Other = 0.47
Ethnicity				
Hispanic	20	106.23	18.89	—
Non-Hispanic	127	227.99	20.78	<0.0001
Age group, yr				
18–44	25	192.51	34.40	18–44 vs. 45–64 = 0.78
45–64	53	206.44	27.06	18–44 vs. 65+ = 0.38
65+	69	235.88	34.50	45–64 vs. 65+ = 0.51
Insurance type				
Private insurance	111	225.06	23.01	Private vs. public = 0.57
Public insurance only	29	194.26	45.82	Private vs. uninsured = 0.02*
Uninsured	7	166.56	7.84	Public vs. uninsured = 0.56*
Education				
Less than HS	27	100.18	15.82	<HS vs. HS = 0.05
HS	43	204.54	46.43	<HS vs. >HS = <0.0001
Greater than HS	77	250.52	21.78	HS vs. >HS = 0.36
Poverty				
Low income/poverty	33	219.62	37.10	Low vs. middle = 0.14
Middle income	40	168.49	25.46	Low vs. high = 0.64
High income	74	240.57	38.41	Middle vs. high = 0.06

Bold values represent factors significantly associated with increased dry eye expenditures.

*Statistical analyses for the uninsured group are reported but are considered unstable due to small sample size.

HS, high school; SE, standard error.

and education. The presence of gender and ethnic disparities in medical expenditures has been described in other conditions, including mental health³¹ and hypertension management.³² An association between higher expenditures and higher education levels has been reported in systemic lupus erythematosus.³³ Although the etiologies behind these discrepancies are not clear, it is important to recognize the role of demographic factors when considering the myriad determinants of health.

As with all retrospective studies, the study findings must be considered bearing in mind its limitations. One limitation is that information on nonprescription medications was not available in the MEPS database, and we could therefore only estimate costs associated with prescription dry eye medications. As many more patients use over-the-counter medications to treat DES, we failed to include patients with less severe forms of the disease in our analysis. Furthermore, because of changes within MEPS that started in 2007,²⁶ medication information for this year was not included in the analysis. Another limitation is that the sample size in the present analysis was relatively small, limiting our ability to examine trends in dry eye medication expenditures and in our comparisons in subgroups of interest (eg, the uninsured). Because of the relatively small sample size, it should not be assumed that

our analytic sample of dry eye medication users are nationally representative despite the fact that they were obtained from a population-based survey. However, if present patterns continue, there will be a growing number of persons in the MEPS who will use these medications, facilitating future subgroup analyses. Furthermore, both cyclosporine emulsion and sulfacetamide sodium–prednisolone acetate ophthalmic suspension can be used to treat ocular surface disorders other than DES. Because we did not have diagnosis information linked to medication use, it is possible that we included patients treated for ocular surface conditions other than DES in our analysis. Finally, we acknowledge that other medications are used to treat subtypes of DES, including corticosteroids and tetracycline derivatives; we chose not to include these in our analysis, given their multiple indications for use. Despite these limitations, there is no other ongoing population-based studies that look specifically at drug medication cost patterns; therefore, the analysis of the MEPS provides us with the best expenditure estimates for newly introduced ocular medications.

In summary, we found a pattern of increased dry eye medication use and expenditure from 2001 to 2006. Women, non-Hispanics, and those with greater than a high school

education had higher expenditures compared with their counterparts. Additional research is necessary to understand the underlying reasons for the difference in dry eye medication expenditures by patient characteristics.

REFERENCES

1. The epidemiology of dry eye disease: report of the epidemiology subcommittee of the International Dry Eye WorkShop (2007). *Ocul Surf*. 2007;5:93-107.
2. Brewitt H, Sistani F. Dry eye disease: the scale of the problem. *Surv Ophthalmol*. 2001;45(suppl 2):S199-S202.
3. Schaumberg DA, Sullivan DA, Dana MR. Epidemiology of dry eye syndrome. *Adv Exp Med Biol*. 2002;506(pt B):989-998.
4. Begley CG, Chalmers RL, Mitchell GL, et al. Characterization of ocular surface symptoms from optometric practices in North America. *Cornea*. 2001;20:610-618.
5. Schein OD, Muñoz B, Tielsch JM, et al. Prevalence of dry eye among the elderly. *Am J Ophthalmol*. 1997;124:723-728.
6. Moss SE, Klein R, Klein BE. Prevalence of and risk factors for dry eye syndrome. *Arch Ophthalmol*. 2000;118:1264-1268.
7. Bandeen-Roche K, Muñoz B, Tielsch JM, et al. Self-reported assessment of dry eye in a population-based setting. *Invest Ophthalmol Vis Sci*. 1997;38:2469-2475.
8. Muñoz B, West SK, Rubin GS, et al. Causes of blindness and visual impairment in a population of older Americans: The Salisbury Eye Evaluation Study. *Arch Ophthalmol*. 2000;118:819-825.
9. McCarty CA, Bansal AK, Livingston PM, et al. The epidemiology of dry eye in Melbourne, Australia. *Ophthalmology*. 1998;105:1114-1119.
10. Chia EM, Mitchell P, Rochtchina E, et al. Prevalence and associations of dry eye syndrome in an older population: the Blue Mountains Eye Study. *Clin Experiment Ophthalmol*. 2003;31:229-232.
11. Hikichi T, Yoshida A, Fukui Y, et al. Prevalence of dry eye in Japanese eye centers. *Graefes Arch Clin Exp Ophthalmol*. 1995;233:555-558.
12. Uchino M, Schaumberg DA, Dogru M, et al. Prevalence of dry eye disease among Japanese visual display terminal users. *Ophthalmology*. 2008;115:1982-1988.
13. Uchino M, Dogru M, Uchino Y, et al. Japan Ministry of Health study on prevalence of dry eye disease among Japanese high school students. *Am J Ophthalmol*. 2008;146:925-929 e2.
14. Shimmura S, Shimazaki J, Tsubota K. Results of a population-based questionnaire on the symptoms and lifestyles associated with dry eye. *Cornea*. 1999;18:408-411.
15. Sahai A, Malik P. Dry eye: prevalence and attributable risk factors in a hospital-based population. *Indian J Ophthalmol*. 2005;53:87-91.
16. Lekhanont K, Rojanaporn D, Chuck RS, et al. Prevalence of dry eye in Bangkok, Thailand. *Cornea*. 2006;25:1162-1167.
17. Lee AJ, Lee J, Saw SM, et al. Prevalence and risk factors associated with dry eye symptoms: a population based study in Indonesia. *Br J Ophthalmol*. 2002;86:1347-1351.
18. Mertzani P, Abetz L, Rajagopalan K, et al. The relative burden of dry eye in patients' lives: comparisons to a U.S. normative sample. *Invest Ophthalmol Vis Sci*. 2005;46:46-50.
19. Miljanovic B, Dana R, Sullivan DA, et al. Impact of dry eye syndrome on vision-related quality of life. *Am J Ophthalmol*. 2007;143:409-415.
20. Schiffman RM, Walt JG, Jacobsen G, et al. Utility assessment among patients with dry eye disease. *Ophthalmology*. 2003;110:1412-1419.
21. Rajagopalan K, Abetz L, Mertzani P, et al. Comparing the discriminative validity of two generic and one disease-specific health-related quality of life measures in a sample of patients with dry eye. *Value Health*. 2005;8:168-174.
22. Fiscella RG, Lee JT, Walt JG, et al. Utilization characteristics of topical cyclosporine and punctal plugs in a managed care database. *Am J Manag Care*. 2008;14:S107-S112.
23. Clegg JP, Guest JF, Lehman A, et al. The annual cost of dry eye syndrome in France, Germany, Italy, Spain, Sweden and the United Kingdom among patients managed by ophthalmologists. *Ophthalmic Epidemiol*. 2006;13:263-274.
24. MEPS Home. Available at: <http://www.meps.ahrq.gov/mepsweb/>. Accessed June 16, 2011.
25. Data overview, Agency for Healthcare Research and Quality. Available at: http://www.meps.ahrq.gov/mepsweb/data_stats/data_overview.jsp. Accessed June 16, 2011.
26. MEPS HC-113: 2007 Full Year Consolidated Data File. Available at: MEPS HC-113: 2007 Full Year Consolidated Data File. Available at: http://www.meps.ahrq.gov/mepsweb/data_stats/download_data/pufs/h113/h113doc.shtml. Accessed November 30, 2011.
27. Summary of questionnaire sections. Panel 6 Round 3 and Panel 7 Round 1. Available at: http://www.meps.ahrq.gov/mepsweb/survey_comp/hc_questions.jsp. Accessed June 16, 2011.
28. Pflugfelder SC. Prevalence, burden, and pharmacoconomics of dry eye disease. *Am J Manag Care*. 2008;14:S102-S106.
29. Lam BL, Zheng DD, Davila EP, et al. Trends in glaucoma medication expenditure: medical expenditure panel survey 2001-2006. *Arch Ophthalmol*. 2011;129:1345-1350.
30. Martin BI, Turner JA, Mirza SK, et al. Trends in health care expenditures, utilization, and health status among US adults with spine problems, 1997-2006. *Spine (Phila Pa 1976)*. 2009;34:2077-2084.
31. Chen J, Rizzo J. Racial and ethnic disparities in use of psychotherapy: evidence from U.S. national survey data. *Psychiatr Serv*. 2010;61:364-372.
32. Basu R, Franzini L, Krueger PM, et al. Gender disparities in medical expenditures attributable to hypertension in the United States. *Womens Health Issues*. 2010;20:114-125.
33. Sutcliffe N, Clarke AE, Taylor R, et al. Total costs and predictors of costs in patients with systemic lupus erythematosus. *Rheumatology (Oxford)*. 2001;40:37-47.

EXHIBIT C

Dysfunctional Tear Syndrome

A Delphi Approach to Treatment Recommendations

Ashley Behrens, MD,* John J. Doyle, MPH,† Lee Stern, MS,† Roy S. Chuck, MD, PhD,* Peter J. McDonnell, MD* and the Dysfunctional Tear Syndrome Study Group: Dimitri T. Azar, MD, Harminder S. Dua, MD, PhD, Milton Hom, OD, Paul M. Karpecki, OD, Peter R. Laibson, MD, Michael A. Lemp, MD, David M. Meisler, MD, Juan Murube del Castillo, MD, PhD, Terrence P. O'Brien, MD, Stephen C. Pflugfelder, MD, Maurizio Rolando, MD, Oliver D. Schein, MD, MPH, Berthold Seitz, MD, Scheffer C. Tseng, MD, PhD, Gysbert van Setten, MD, PhD, Steven E. Wilson, MD, and Samuel C. Yiu, MD, PhD

Purpose: To develop current treatment recommendations for dry eye disease from consensus of expert advice.

Methods: Of 25 preselected international specialists on dry eye, 17 agreed to participate in a modified, 2-round Delphi panel approach. Based on available literature and standards of care, a survey was presented to each panelist. A two-thirds majority was used for consensus building from responses obtained. Treatment algorithms were created. Treatment recommendations for different types and severity levels of dry eye disease were the main outcome.

Results: A new term for dry eye disease was proposed: dysfunctional tear syndrome (DTS). Treatment recommendations were based primarily on patient symptoms and signs. Available diagnostic tests were considered of secondary importance in guiding therapy. Development of algorithms was based on the presence or absence of lid margin disease and disturbances of tear distribution and clearance. Disease severity was considered the most important factor for treatment decision-making and was categorized into 4 levels. Severity was assessed on the basis of tear substitute requirements, symptoms of ocular discomfort, and visual disturbance. Clinical signs present in lids, tear film, conjunctiva, and cornea were also used for categorization of severity. Consensus was reached on treatment algorithms for DTS with and without concurrent lid disease.

Conclusion: Panelist opinion relied on symptoms and signs (not tests) for selection of treatment strategies. Therapy is chosen to match disease severity and presence versus absence of lid margin disease or tear distribution and clearance disturbances.

Received for publication June 21, 2005; revision received January 3, 2006; accepted January 10, 2006.

From the *Wilmer Ophthalmological Institute, Johns Hopkins University School of Medicine, Baltimore, MD; and the †Analytica Group, New York, NY.

Supported by unrestricted educational grants from Allergan Inc. (Irvine, CA) and Research to Prevent Blindness, Inc. (New York, NY).

Disclaimer: Some authors have commercial or proprietary interests in products described in this study (please refer to individual disclosure).

Reprints: Ashley Behrens, MD, The Wilmer Ophthalmological Institute, 255 Woods Building, 600 North Wolfe Street, Baltimore, MD 21287-9278 (e-mail: abehrens@jhmi.edu).

Copyright © 2006 by Lippincott Williams & Wilkins

Key Words: Delphi panel, dry eye, dysfunctional tear syndrome, eye lubricants, cyclosporine A, punctal plugs, steroids, dry eye therapy, consensus, algorithm

(*Cornea* 2006;25:900–907)

The syndrome known as “dry eye” is highly prevalent, affecting 14% to 33% of the population worldwide,^{1–4} depending on the study and definition used. Symptoms related to dry eye are among the leading causes of patient visits to ophthalmologists and optometrists in the United States.⁵ However, a stepwise approach to diagnosis and treatment is not well established.

Treatment algorithms are often complicated, especially when multiple therapeutic agents and strategies are available for one single disease and for different stages of the same disease. Dry eye syndrome is particularly challenging, because the diagnostic criteria used vary among studies, there is poor correlation between signs and symptoms, and efficacy criteria are often not uniform. As a result, there is no clear current approach to assign therapeutic recommendations as “first,” “second,” or “third” line.

Clinical research is usually oriented to assess the efficacy of medications in the treatment of dry eye disease. Reports are based on either comparisons of one medication relative to untreated placebo controls or comparisons between different therapies.^{6,7} Categorization of treatment alternatives is usually not implicit in these studies. Strategies combining medications or medications and surgery are usually not clearly discussed in the literature. A panel of experts may be a good method to develop such strategies based on current knowledge, because publication of research may not precede practice. Furthermore, clinical trials are typically performed on highly selected populations with specific interventions that may not reflect the spectrum of disease encountered in usual practice.

Where unanimity of opinion does not exist because of a paucity of scientific evidence and where there is contradictory evidence, consensus methods can be useful. Such methods have been used in developing therapeutic algorithms in other ophthalmic (glaucoma) and nonophthalmic disease states.^{8,9}

The Delphi panel technique was first proposed in 1946 by the RAND Corporation as a resource to collect information from different experts and to prepare a forecast of future technological capabilities. This tool has been expanded to technological,¹⁰ health,¹¹ and social sciences research.¹² Despite some reasonable criticisms of this technique,¹³ the Delphi approach has been used to provide reproducible consensus to create algorithms of treatment.^{14,15}

In this study, we proposed to establish expert consensus by using the Delphi approach with an international panel to obtain current treatment recommendations for dry eye syndrome.

MATERIALS AND METHODS

Panelist Selection

The ideal number of panelists expected with this technique is not well defined, with reported ranges from 10 to 1685.¹⁶ No specific inclusion criteria are established, other than the qualification of panelists in the topic of interest. Some authors stress the importance of the diversity of panelists' opinion to obtain a wide base of knowledge.¹⁷

The following criteria were considered for inclusion of panelists:

1. Active clinicians (ophthalmologists and optometrists)
2. Scientific contributions to clinical research on dry eye syndrome, as reflected by at least 2 of the following: peer-reviewed publications, other forms of written scientific communication, specialty meeting presentations, and membership in special-interest groups focused on dry eye syndrome
3. International representation
4. Proficiency in English language to facilitate interaction
5. Able to respond to sets of questionnaires and available to attend a final meeting at the Wilmer Ophthalmological Institute in Baltimore, MD

The search for panelists' scientific contributions was conducted over available medical databases (Medline, EMBASE) and other major Internet-based search engines (Scirus.com, Google.com, Alltheweb.com). Twenty-five candidates from 3 continents that met the selection criteria were initially contacted.

A contract research organization (Analytica Group, New York, NY) was selected to act as moderator/facilitator for the questionnaire and panel meeting exercise. A 2-round modified Delphi approach was used.¹⁸ A set of dry eye therapy literature was provided to each panel member along with the first-round questionnaire. These studies were selected in part from an ongoing systematic review of the literature on dry eye disease therapy. Three of the panelists suggested additions of some references that they considered valuable. Those citations were also disseminated to the rest of the panelists.

Preparation of Surveys

Questionnaires were based on collected literature, current practice patterns, and clinical experience in dry eye. Topics in the survey were related to pathophysiology, diagnostic tests, criteria used to guide treatment, and therapeutic alternatives.

Nominal variables were assigned binary values to tabulate responses in a spreadsheet (Excel 2002; Microsoft

Corp., Redmond, WA) for analysis. Ordinal variables were originated from 5-point Likert scales to categorize the strength of agreement and facilitate the statistical analysis.

Survey questions were based on the use of the current classification of dry eye disease and the available guidelines for the treatment. Diagnostic methods and severity assessment were also surveyed. Panelists were asked to support their multi-level treatment recommendation with a categorical, nominal score of 1 to 3, depending on the level of evidence to sustain their decision:

1. Supported by a clinical trial
2. Supported by published literature of some type
3. Supported by my professional opinion

Finally, determinant factors influencing the treatment decision-making process were stratified semiquantitatively to evaluate the most representative for the selection of therapy.

Survey Deployment

The forms were deployed by electronic mail to the panelists. The information obtained from the surveys was tabulated and organized for presentation at the face-to-face meeting of the Delphi process.

Data Analysis

Descriptive statistics were calculated for the questionnaire data by using StatsDirect 2.3.7 for Windows (StatsDirect, Cheshire, UK).

Consensus

There exists controversy regarding the numbers necessary to obtain consensus. Some authors agree that a simple majority (>50%) is enough to constitute consensus,¹⁹ whereas others propose that more than 80% of panelists should be in agreement to have the recommendation considered as consensus.²⁰ Degree of consensus has also been quantified statistically using the Cronbach α method, a method for measuring internal agreement.²¹ For the purposes of this study, consensus was defined as a two-thirds majority.

Personal Interaction

The meeting was conducted by a facilitator (J.J.D.) with previous experience in consensus-building strategies.⁸ Panelists reacted and discussed the data collected from the surveys over an intensive 1-day, 12-hour-long, face-to-face meeting. According to the tabulated initial responses, iterative discussions were conducted toward majority agreement.

RESULTS

Panelists' Response

From the initial selection of 25 candidates who met the inclusion criteria, 17 were able to participate in all stages of the study and therefore were included in the panel. The candidates who refused to join the panel did not have substantive reasons precluding their participation. Most of them declined to participate because of scheduling conflicts. The list of participants is shown in Table 1. All surveys deployed were returned with responses from all of the panelists.

TABLE 1. Experts Who Participated in the Delphi Approach (DTS Study Group)

Panelist Name	City	Country
Dimitri T. Azar, M.D.	Boston, MA	United States
Harminder S. Dua, M.D., Ph.D	Nottingham	England
Milton Hom, O.D.	Azusa, CA	United States
Paul M. Karpecki, O.D.	Overland Park, KS	United States
Peter R. Laibson, M.D.	Philadelphia, PA	United States
Michael A. Lemp, M.D.	Washington, DC	United States
David M. Meisler, M.D.	Cleveland, OH	United States
Juan Murube del Castillo, M.D., Ph.D.	Madrid	Spain
Terrence P. O'Brien, M.D.	Baltimore, MD	United States
Stephen C. Pflugfelder, M.D.	Houston, TX	United States
Maurizio Rolando, M.D.	Genoa	Italy
Oliver D. Schein, M.D., M.P.H.	Baltimore, MD	United States
Berthold Seitz, M.D.	Erlangen	Germany
Scheffer C. Tseng, M.D., Ph.D.	Miami, FL	United States
Gysbert B. van Setten, M.D., Ph.D.	Stockholm	Sweden
Steven E. Wilson, M.D.	Cleveland, OH	United States
Samuel C. Yiu, M.D, Ph.D.	Los Angeles, CA	United States

Conflicts of Interest

Travel expenses of panelists were covered by the contracted company (Analytica Group), which is an independent firm. The Wilmer Eye Institute originated the invitation, and panelists were unaware of any indirect support from pharmaceutical industry to avoid bias in the treatment selection.

Use of Existing Disease/Treatment Guidelines

The majority of panelists (11 of 17) responded that they did not follow any of the available guidelines for the treatment of dry eye syndrome. Three of 17 followed the National Eye Institute guidelines,²² 1 of 17 followed the American Academy of Ophthalmology Preferred Practice Patterns,²³ 1 of 17 followed the Madrid classification,²⁴ and 1 of 17 followed a combination of the first 2 guidelines.

When panel members were asked about their opinions regarding the adherence of the ophthalmic community to new, simplified guidelines for the treatment of dry eye, the majority (13 of 17) agreed that they would use them if most recent findings on the disease were included. Those who responded that they would not use them (4 of 17), based their response on the low sensitivity and specificity of the available tests for the diagnosis of dry eye and the variability of the clinical presentation in different patients.

Diagnostic Tests for Dry Eye

When panelists were surveyed before the meeting on diagnostic measures used to detect dry eye, the most frequently cited tests were slit-lamp examination and fluorescein staining (100% of panelists). Tear breakup time and medical history were also frequently used (both in 94%). Schirmer test with anesthesia (71%) and without anesthesia (65%) were less frequently used, as well as rose bengal staining (65%). A combination of different tests was typically preferred in an effort to improve the specificity and sensitivity (Table 2).

TABLE 2. Most Commonly Used Diagnostic Tests Reported by Panelists for Evaluating a Patient With Probable Dry Eye

Diagnostic Tests	Respondents Regularly Using Them (%)
Fluorescein staining	100
Tear breakup time	94
Schirmer test	71
Rose bengal staining	65
Corneal topography	41
Impression cytology	24
Tear fluorescein clearance	24
Ocular Surface Disease Index Questionnaire	18
NEIVFQ-25*	6
Tear osmolality	6
Conjunctival biopsy	6

*NEIVFQ-25: National Eye Institute Vision Function Questionnaire-25.

Classification of Dry Eye Disease

More than one half of the respondents felt that the current classification of aqueous-deficient versus evaporative dry eye failed to incorporate inflammatory mechanisms and drew a sharp distinction between disorders where there is significant overlap.^{25,26} Furthermore, the historical distinction between Sjögren keratoconjunctivitis sicca (KCS) as representing an autoimmune disorder as opposed to non-Sjögren KCS failed to reflect the evidence that both conditions may share an underlying immune-mediated inflammation. The majority of experts did not consider this useful for establishing a treatment scheme for the ocular disease (12 of 17). The panelists considered the disease severity and the effect of medications on symptoms and signs as the 2 most relevant factors to consider when selecting the adequate therapy for dry eye (Table 3).

Face-to-Face Meeting

At the face-to-face meeting, panel members made comments on the term "dry eye" classically used to name the disease. On the basis of the known pathophysiology, symptoms, and clinical presentation, all panelists agreed that this term did not necessarily reflect the events occurring in the eye. Specifically, all patients with this condition do not necessarily

TABLE 3. Most Relevant Factors Influencing Treatment Decision Making

Factor Considered	Mean Score (Standard Deviation)
Severity of the disease	1.47 (0.72)
Effect of the treatment	1.79 (0.77)
Etiology of the disease	2.08 (1.07)
Diagnosis of Sjögren's syndrome	2.20 (1.05)
Use of artificial tears	3.07 (1.53)
Costs of treatment	3.80 (1.17)
Access to reimbursement	3.92 (1.10)

0 = most relevant; 5 = least relevant.

suffer from reduced tear volume but rather may have abnormalities of tear film composition that include the presence of proinflammatory cytokines.²⁵⁻²⁷ The panelists unanimously recommended dysfunctional tear syndrome (DTS) as a more appropriate term for this disease in future references. This term has been incorporated in the rest of this report in lieu of dry eye disease.

Underlying Pathophysiology and Diagnostic Testing

There was consensus that most cases of DTS have an inflammatory basis that either triggers or maintains the condition. However, panelists also agreed on the difficulty in clearly identifying inflammation in most patients. The panel therefore agreed to subclassify the disease as either DTS with clinically apparent inflammation or DTS without clinically evident inflammation.

After discussion at the meeting, the panelists were in agreement that commonly available clinical diagnostic tests did not correlate with symptoms, should not be used in isolation to establish the diagnosis of DTS, and were of minimal value in the assessment of disease severity.

Creation of Therapeutic Algorithms for DTS

First, the panel recommended that patients with DTS should be classified into 1 of 3 major clinical categories at the time of the initial examination: patients with lid margin disease, patients without lid margin disease, and patients with altered tear distribution and clearance.

The panel agreed that the second group, patients who do not have coexistent lid margin disease, is the most common form of presentation of DTS. Within each of these 3 categories, the panel listed the main subsets or specific disease entities or, in the case of DTS without lid margin disease, the patients were divided by severity (Fig. 1). Second, the panel agreed that the assessment of DTS severity is important to guiding therapy, especially in that subset of DTS patients

without lid margin disease. The panel reached consensus that the level of severity should be based primarily on symptoms and clinical signs.

The panel members agreed that diagnostic tests are secondary considerations in determining disease severity. The value of diagnostic tests was considered to be in confirming clinical assessment. Again, many of the available tests were deemed not useful for the diagnosis, staging, or evaluating response to therapy in DTS.

Panelists agreed on 3 particularly relevant symptoms and historical elements to be considered in DTS: ocular discomfort, tear substitute requirements, and visual disturbances. In ocular discomfort, a variety of symptoms including itch, scratch, burn, foreign body sensation, and/or photophobia may be present. Depending on the frequency and impact on the quality of life of these elements, symptoms could be categorized as either mild to moderate or severe. The relevant clinical signs to be considered in the evaluation of DTS patients are summarized in Table 4. The panel suggested evaluating the presence of these clinical features to assign a severity level fluctuating from mild to severe.

To create a categorization of the severity of the disease, a scoring system was proposed. Basically, patients were aggregated into 1 of 4 levels of severity according to the signs and symptoms involved (Table 5). The severity of disease indicated the appropriate range of therapeutic options available for the patient, because the panelists agreed that certain therapies were most appropriately reserved for patients with more severe DTS.

Treatment Algorithm for Patients With Lid Margin Disease

The proposed treatment algorithm for these individuals began with division of patients according to the site (anterior vs. posterior) of the lid pathology (Fig. 2). Anterior lid margin disease is treated with lid hygiene and antibacterial therapy, whereas posterior lid margin disease is treated initially with

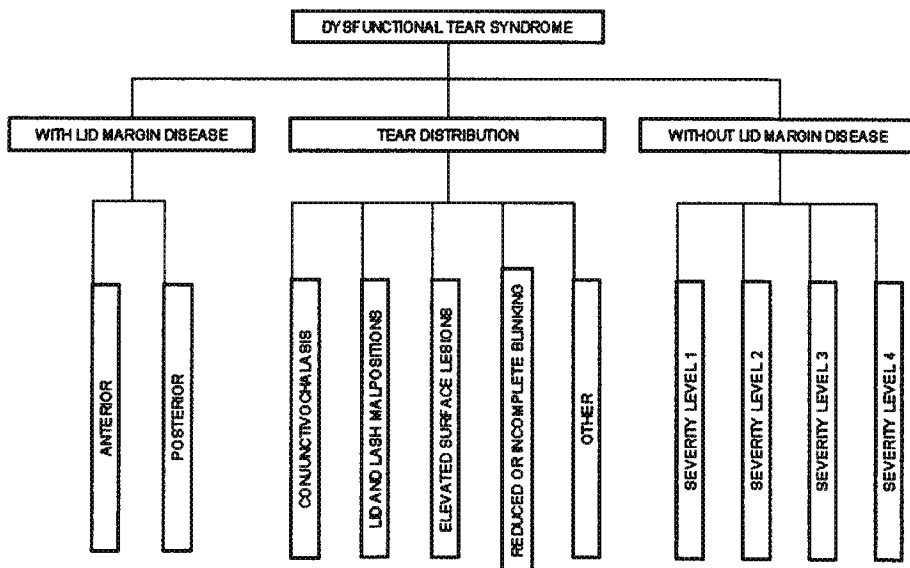

FIGURE 1. Algorithm of the 3 major subsets found in DTS. Each subset should be treated separately, because treatment modality varies according to this separation.

TABLE 4. Clinical Signs in DTS to Consider in Severity Assessment

Lids	Tear Film	Conjunctiva	Cornea	Vision
Telangiectasia	Meniscus	Luster	Punctate changes	Blur
Hyperemia	Foam	Hyperemia	Erosions (micro, macro)	Fluctuations
Scales, crusts	Mucus	Wrinkles	Filaments	
Lash loss or abnormalities	Debris	Staining	Ulceration	
Inspissation	Oil excess	Symblepharon	Vascularization	
Meibomian gland disease		Cicatrization	Scarring	
Anatomical abnormalities			Keratinization	

warm massage, with addition of oral tetracyclines and topical corticosteroids, if necessary.

Treatment Algorithm for DTS Patients With Primary Tear Distribution and Clearance Abnormalities

The panel considered that there were patients in whom the even distribution of tears across the ocular surface is impaired, typically related to an anatomic abnormality or to abnormal lid function (Fig. 3). The recommended therapeutic approach to these patients varied in accordance with the specific underlying problem, which is summarized in Figure 3.

Treatment Algorithm for DTS Patients Without Lid Margin Disease

Patients with mild disease are best managed with patient education about the disease and strategies for minimizing its impact, preserved artificial tears, modification as appropriate of systemic medications that might contribute to the condition, and perhaps changes in the home or work environment to alleviate the symptoms (Fig. 4).

In patients in whom the disease state is moderate or severe, the panelists agreed that the more frequent use of tears

mandated a switch to unpreserved lubricants, with tears during the day, ointment at night, and consideration of progression to a gel formulation during the day if relief was not adequate with tears. In the absence of signs, the panel recommended lubrication, with frequency determined by the clinical response.

In the presence of signs (eg, moderate corneal staining, filaments), the panel agreed on a stepwise introduction of additional therapies. The panelists noted that patients with DTS may have an inflammatory component, which may or may not be clinically evident. In addition to the use of unpreserved tears, the panel recommended a course of topical corticosteroids and/or cyclosporine A to suppress inflammation.

In patients who fail to respond adequately to lubricants and topical immunomodulators, a course of oral tetracycline therapy was recommended, as well as punctal occlusion with

TABLE 5. Levels of Severity of DTS Without Lid Margin Disease According to Symptoms and Signs

Severity*	Patient Profiles
Level 1	<ul style="list-style-type: none"> Mild to moderate symptoms and no signs Mild to moderate conjunctival signs
Level 2	<ul style="list-style-type: none"> Moderate to severe symptoms Tear film signs Mild corneal punctate staining Conjunctival staining
Level 3	<ul style="list-style-type: none"> Severe symptoms Marked corneal punctate staining Central corneal staining Filamentary keratitis
Level 4	<ul style="list-style-type: none"> Severe symptoms Severe corneal staining, erosions Conjunctival scarring

*At least one sign and one symptom of each category should be present to qualify for the corresponding level assignment.

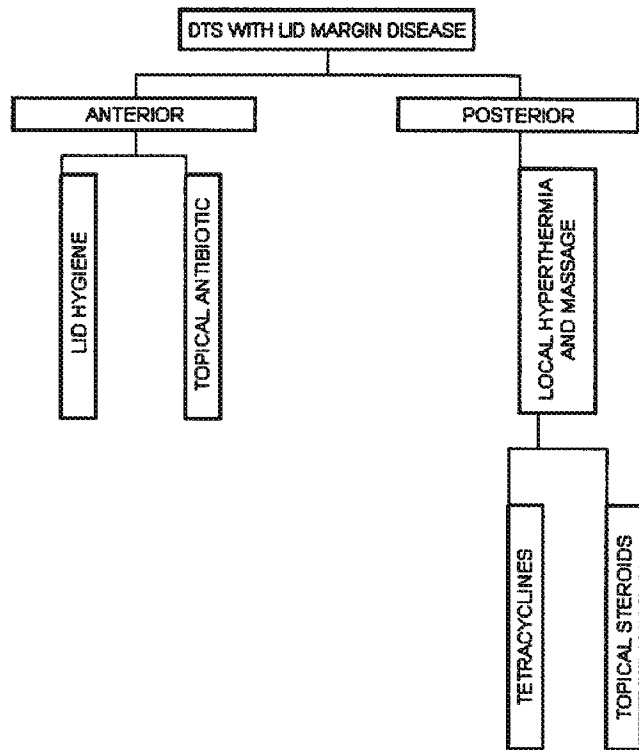

FIGURE 2. Algorithm on treatment recommendations for DTS with lid margin disease.

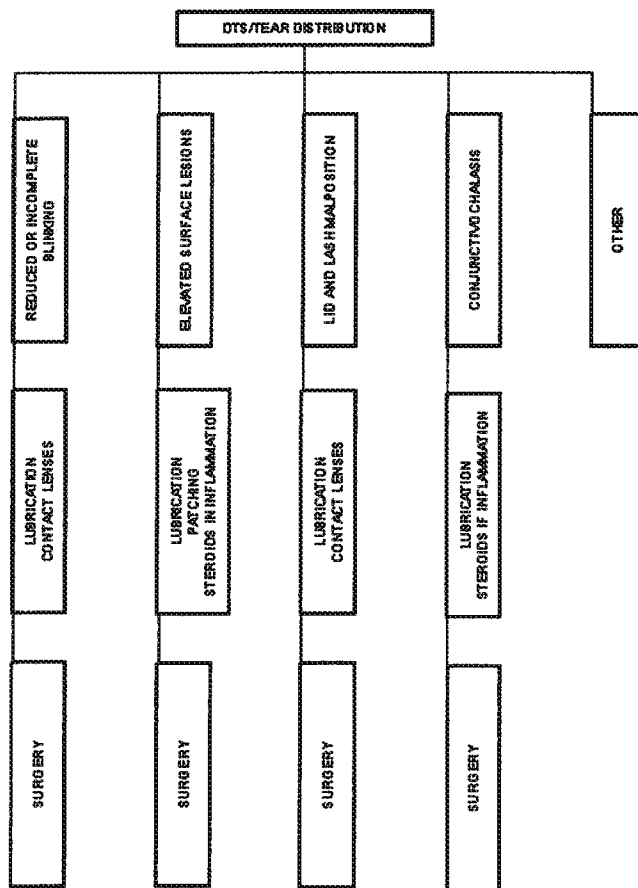

FIGURE 3. Algorithm on treatment recommendations for DTS with abnormal tear distribution.

plugs. Because of the possible presence of non-clinically apparent inflammation, punctal plugs could result in retention of proinflammatory tear components on the ocular surface and may enhance damage to the ocular surface, accelerate the disease process, and produce greater patient discomfort. Therefore, the panel agreed that it is important to treat the inflammatory condition before blockage of tear drainage with punctal plugs.

Patients with severe disease who are not adequately controlled after the above therapeutic interventions may benefit from more advanced interventions. These would include systemic immunomodulators for the control of severe inflammation, topical acetylcysteine for filament formation caused by mucin accumulation, moisture goggles to reduce tear evaporation, and surgery (including punctal cautery) to reduce tear drainage. Patients with Sjögren syndrome would fit within this category.

DISCUSSION

Some researchers have stressed the use of Delphi panels in clinical research, despite some flaws in terms of

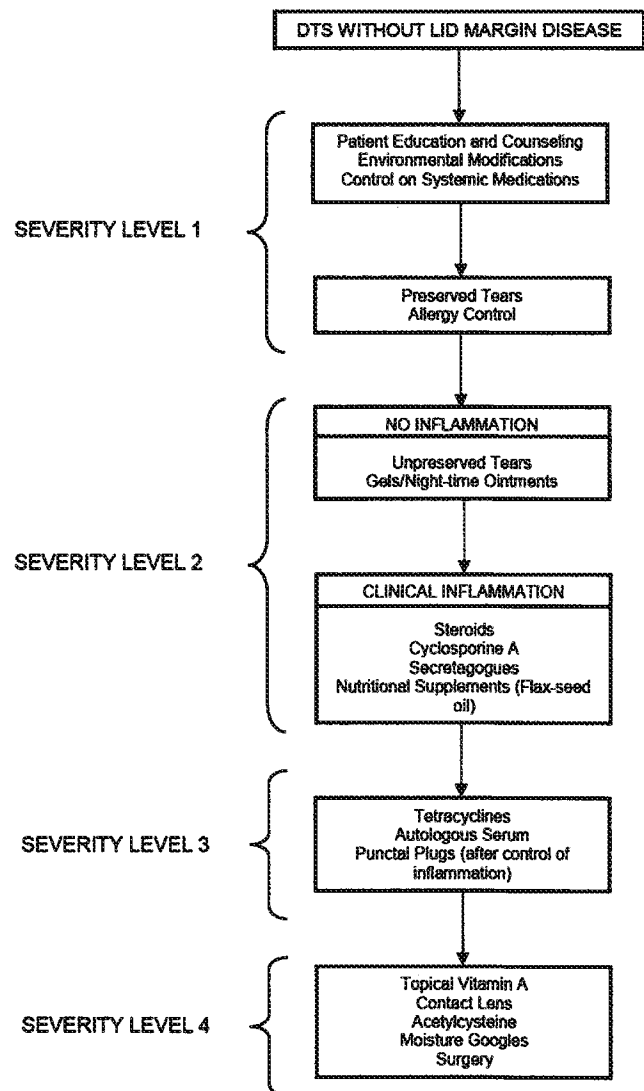

FIGURE 4. Algorithm on treatment recommendations for DTS without lid margin disease according to severity.

reproducibility and other confounding factors that may adversely influence the results.^{28,29} Delphi approach is not necessarily “evidence-based”: Good evidence may exist contradicting a particular consensus; or conversely, evidence for a particular consensus may be absent, because it has not been adequately studied. Especially for areas where there is little or no good evidence in the literature, the process relies on the opinion of the participating panelists, potentially tapping into collective error.³⁰ Moreover, consensus is subject to particular interpretation of evidence and personal experience, which may affect reproducibility.¹⁴ Nonetheless, this process has lately become popular to delineate guidelines of treatment of various disorders.³⁰⁻³³

Bias of panelists’ selection may inevitably occur as a result of the inclusion criteria chosen. It is a common observation that highly published authors tend to have some

form of commercial support from pharmaceutical industry. Nine of 17 panelists disclosed a past or present relationship as a speaker/consultant/research funds recipient from companies having products for the treatment of DTS.

The success of a Delphi panel is based largely on the ability of the facilitator to maintain balanced participation of panelists.³² One of the major challenges in such panels is to avoid the inadvertent control of one or more leaders over the discussion.³⁰ The facilitator in our study was a person with previous experience in consensus panels. He had the ability to encourage homogeneous participation of panel members. The facilitator focused on the varied responses previously given by panelists in the survey to avoid discussions over a single topic/therapeutic approach raised by individual participants during the meeting. Inevitable discrepancies were observed during the DTS panel meeting; however, consensual agreement among panelists was finally achieved.

We believe that one significant consequence of the panel meeting was the recommendation for a change from the term dry eye, frequently used to describe the condition, to the term dysfunctional tear syndrome. Panelists unanimously agreed that the label dry eye reflects neither patient symptoms nor necessarily the pathogenic mechanism of the disease. Panel members also agreed that diagnosing patients with dry eye may be misleading to both colleagues and patients. Patients may be confused when excess tearing is their primary complaint and are diagnosed as having dry eye. Even more confusing for patients is their subsequent treatment with anti-inflammatory agents or antibiotics. For these reasons, the term DTS was coined, because the panel felt that this term was sufficiently broad to encompass the myriad of etiologies while still representing a common denominator among them.

There was consensus that severity of disease should be the primary determinant for the therapeutic strategy chosen. In addition, observation of the patient response to initial therapy was deemed as an important indicator of disease severity and further treatment selection. The failure on improvement using medications in one level assigns the patient to additional therapy in the immediate superior severity level. The available diagnostic tests were not considered important in the assessment of disease severity and therefore were not included in the classification. However, this should not underestimate the value of these tests in the diagnosis of DTS, because they were regularly used by panelists to confirm the presence of the disease.

The task of creating guidelines for DTS is complex, because practitioners encountering DTS are faced with a multifactorial disorder with several pathophysiological events that may require a variety of customized therapeutic schemes. Moreover, significant overlapping between the categories selected by the panel is also likely. The summary treatment recommendations (Table 6) relating severity of disease with clinical symptoms and signs created by the panel may serve as a useful guide. It is recognized that individual patient characteristics may require deviation from recommended treatment, but panelists were clear that the ideal therapy for DTS is often achieved with a combination of interventions. Assignment of levels of severity may work only as a stepwise guide to approaching the best combination of medications to

TABLE 6. Treatment Recommendations for DTS on the Basis of Level of Severity

DTS Severity	Treatment Recommendations	
Level 1	<ul style="list-style-type: none"> • No treatment • Preserved tears • Environmental management • Allergy drops 	<ul style="list-style-type: none"> • Use of hypoallergenic products • Water intake • Psychological support • Avoidance of drugs contributing to dry eye
Level 2	<ul style="list-style-type: none"> • Unpreserved tears • Gels • Ointments • Nutritional support (flaxseed/fatty acids) 	<ul style="list-style-type: none"> • Secretagogues • Topical steroids • Topical cyclosporine A
Level 3	<ul style="list-style-type: none"> • Tetracyclines • Punctal plugs 	
Level 4	<ul style="list-style-type: none"> • Surgery • Systemic anti-inflammatory therapy • Oral cyclosporine • Moisture goggles 	<ul style="list-style-type: none"> • Punctal cautery • Acetylcysteine • Contact lenses

avoid symptoms. It is important to stress that patients may present with signs belonging to different categories of DTS (ie, a patient may have DTS with lid margin disease and exhibit tear distribution problems).

Those particular patients should be treated according to recommendations for both categories to succeed in controlling their symptoms and signs. Published guidelines in other disease areas have proven useful to general practitioners to approach a complex disease like DTS.^{14,15,17} Some examples using the Delphi technique have been reported in esophageal cancer management,¹¹ systemic hypertension treatment algorithms,¹⁵ and acute diarrhea management in children.³⁰ In this study, the Delphi approach was used to gain a practical approach to the diagnosis and treatment of DTS, as opposed to an extensive evaluation of available diagnostic methods or pathophysiology mechanisms, already well documented in the literature³⁴⁻³⁸ (Table 7).

TABLE 7. Advantages of the Proposed Recommendations by the Delphi Panel

- Proposes a new terminology for dry eye disease (dysfunctional tear syndrome) from recent pathophysiologic findings
- Includes novel therapeutic options in the market
- Provides simplified therapeutic recommendations in a stepwise approach
- Patients without lid margin disease/tear distribution problems are assigned to 4 severity levels
- Severity levels are categorized according to patient's signs and symptoms, not tests
- Therapeutic options are oriented by severity levels
- Easier approach for general eye care practitioners

All guidelines are limited by the future development of new treatments and by new insights that future research will bring. We therefore regard these guidelines as a platform onto which future updates may be added.

REFERENCES

- Schein OD, Munoz B, Tielsch JM, et al. Prevalence of dry eye among the elderly. *Am J Ophthalmol*. 1997;124:723-728.
- Schaumberg DA, Sullivan DA, Buring JE, et al. Prevalence of dry eye syndrome among US women. *Am J Ophthalmol*. 2003;136:318-326.
- Lin PY, Tsai SY, Cheng CY, et al. Prevalence of dry eye among an elderly Chinese population in Taiwan: the Shihpai Eye Study. *Ophthalmology*. 2003;110:1096-1101.
- Brewitt H, Sistani F. Dry eye disease: the scale of the problem. *Surv Ophthalmol*. 2001;45:S199-S202.
- Lemp MA. Epidemiology and classification of dry eye. *Adv Exp Med Biol*. 1998;438:791-803.
- Matsuo T, Tsuchida Y, Morimoto N. Trehalose eye drops in the treatment of dry eye syndrome. *Ophthalmology*. 2002;109:2024-2029.
- McDonald CC, Kaye SB, Figueiredo FC, et al. A randomised, crossover, multicentre study to compare the performance of 0.1% (w/v) sodium hyaluronate with 1.4% (w/v) polyvinyl alcohol in the alleviation of symptoms associated with dry eye syndrome. *Eye*. 2002;16:601-607.
- Serie J, Cantor L, Gross R, et al. Best practice treatment algorithm for primary open-angle glaucoma: implications for U.S. ophthalmology practice. *Manag Care Interface*. 2002;15:37-48.
- Coia LR, Minsky BD, John MJ, et al. Patterns of care study decision tree and management guidelines for esophageal cancer. American College of Radiology. *Radiat Med*. 1998;16:321-327.
- Pelton JN. The future of telecommunications: a Delphi survey. *J Commun*. 1981;31:177-189.
- Bellamy N, Anastassiades TP, Buchanan WW, et al. Rheumatoid arthritis anti-rheumatic trials. III. Setting the delta for clinical trials of anti-rheumatic drugs—results of a consensus development (Delphi) exercise. *J Rheumatol*. 1991;18:1908-1915.
- Holmes ER, Tipton DJ, Desselle SP. The impact of the internet on community pharmacy practice: a comparison of a Delphi panel's forecast with emerging trends. *Health Mark Q*. 2002;20:3-29.
- Goodman CM. The Delphi technique: a critique. *J Adv Nurs*. 1987;12:729-734.
- Pearson SD, Margolis CZ, Davis S, et al. Is consensus reproducible? A study of an algorithmic guidelines development process. *Med Care*. 1995;33:643-660.
- Richter A, Ostrowski C, Dombeck MP, et al. Delphi panel study of current hypertension treatment patterns. *Clin Ther*. 2001;23:160-167.
- Powell C. The Delphi technique: myths and realities. *J Adv Nurs*. 2003;41:376-382.
- Murphy MK, Black NA, Lamping DL, et al. Consensus development methods, and their use in clinical guideline development. *Health Technol Assess*. 1998;2:i-iv, 1-88.
- Young LJ, George J. Do guidelines improve the process and outcomes of care in delirium? *Age Ageing*. 2003;32:525-528.
- Evans C. The use of consensus methods and expert panels in pharmacoeconomic studies. Practical applications and methodological shortcomings. *Pharmacoeconomics*. 1997;12:121-129.
- Morris CJ, Cantrill JA. Preventing drug-related morbidity—the development of quality indicators. *J Clin Pharm Ther*. 2003;28:295-305.
- Hughes R. Definitions for public health nutrition: a developing consensus. *Public Health Nutr*. 2003;6:615-620.
- Lemp MA. Report of the National Eye Institute/Industry workshop on Clinical Trials in Dry Eyes. *CLAO J*. 1995;21:221-232.
- Matoba AY, Harris DJ, Meisler DM, et al. *Preferred Practice Patterns: Dry Eye Syndrome*. San Francisco, CA: American Academy of Ophthalmology; 2003.
- Murube J, Benitez Del Castillo JM, Chenzhuo L, et al. The Madrid triple classification of dry eye. *Arch Soc Esp Oftalmol*. 2003;78:587-594.
- Pflugfelder SC. Anti-inflammatory therapy for dry eye. *Am J Ophthalmol*. 2004;137:337-342.
- Baudouin C. The pathology of dry eye. *Surv Ophthalmol*. 2001;45 (Suppl 2):S211-S220.
- Lemp MA. Evaluation and differential diagnosis of keratoconjunctivitis sicca. *J Rheumatol Suppl*. 2000;61:11-14.
- Burnand B, Vader JP, Froehlich F, et al. Reliability of panel-based guidelines for colonoscopy: an international comparison. *Gastrointest Endosc*. 1998;47:162-166.
- Jones J, Hunter D. Consensus methods for medical and health services research. *BMJ*. 1995;311:376-380.
- Armon K, Stephenson T, MacFaul R, et al. An evidence and consensus based guideline for acute diarrhea management. *Arch Dis Child*. 2001;85:132-142.
- Campbell SM, Hann M, Roland MO, et al. The effect of panel membership and feedback on ratings in a two-round Delphi survey: results of a randomized controlled trial. *Med Care*. 1999;37:964-968.
- Washington DL, Bernstein SJ, Kahan JP, et al. Reliability of clinical guideline development using mail-only versus in-person expert panels. *Med Care*. 2003;41:1374-1381.
- Mathis R, Doyle S. A quality mix: using evidence and experience to evaluate new technologies. *J Healthc Qual*. 2003;25:4-6.
- Smith JA, Vitale S, Reed GF, et al. Dry eye signs and symptoms in women with premature ovarian failure. *Arch Ophthalmol*. 2004;122:151-156.
- Horwath-Winter J, Berghold A, Schmut O, et al. Evaluation of the clinical course of dry eye syndrome. *Arch Ophthalmol*. 2003;121:1364-1368.
- Bron AJ, Evans VE, Smith JA. Grading of corneal and conjunctival staining in the context of other dry eye tests. *Cornea*. 2003;22:640-650.
- Sade de Paiva C, Lindsey JL, Pflugfelder SC. Assessing the severity of keratitis sicca with videokeratographic indices. *Ophthalmology*. 2003;110:1102-1109.
- Begley CG, Chalmers RL, Abetz L, et al. The relationship between habitual patient-reported symptoms and clinical signs among patients with dry eye of varying severity. *Invest Ophthalmol Vis Sci*. 2003;44:4753-4761.

EXHIBIT D

DEWS Management and Therapy

Management and Therapy of Dry Eye Disease: Report of the Management and Therapy Subcommittee of the International Dry Eye WorkShop (2007)

ABSTRACT The members of the Management and Therapy Subcommittee assessed current dry eye therapies. Each member wrote a succinct evidence-based review on an assigned aspect of the topic, and the final report was written after review by and with consensus of all subcommittee members and the entire Dry Eye WorkShop membership. In addition to its own review of the literature, the Subcommittee reviewed the Dry Eye Preferred Practice Patterns of the American Academy of Ophthalmology and the International Task Force (ITF) Delphi Panel on Dry Eye. The Subcommittee favored the approach taken by the ITF, whose recommended treatments were based on level of disease severity. The recommendations of the Subcommittee are based on a modification of the ITF severity grading scheme, and suggested treatments were chosen from a menu of therapies for which evidence of therapeutic effect had been presented.

KEYWORDS DEWS, dry eye disease, Dry Eye WorkShop, management, therapy

Accepted for publication January 2007.

Management and Therapy Subcommittee members: **Stephen C. Pflugfelder, MD (Chair)**; Gerd Geerling, MD; Shigero Kinoshita, MD; Michael A. Lemp, MD; James McCulley, MD; Daniel Nelson, MD; Gary N. Novack, PhD; Jun Shimazaki, MD; Clive Wilson, PhD.

Proprietary interests of Subcommittee members are disclosed on pages 202 and 204.

Reprints are not available. Articles can be accessed at: www.tearfilm.org.

Correspondence in regard to this chapter should be addressed to Stephen C. Pflugfelder MD, Ophthalmology-Ocular Surf Ctr, Cullen Eye Institute, 6565 Fannin Street NC 205, Houston, TX 77030. Tel: 713-798-4732. Fax: 713-798-1457. Email: stevenp@bcm.tmc.edu

©2007 Ethis Communications, Inc. *The Ocular Surface* ISSN: 1542-0124. (No authors listed). Management and therapy of dry eye disease: report of the Management and Therapy Subcommittee of the International Dry Eye WorkShop (2007). 2007;5(2):163-178.

I. INTRODUCTION

This report summarizes the management and therapeutic options for treating dry eye disease. The level of evidence for supporting data from the literature is evaluated according to the modified American Academy of Ophthalmology Preferred Practices guidelines (Table 1).

II. GOALS OF THE MANAGEMENT AND THERAPY SUBCOMMITTEE

Goals of this committee were to identify appropriate therapeutic methods for the management of dry eye disease and recommend a sequence or strategy for their application, based on evidence-based review of the literature.

The quality of the evidence in the literature was graded according to a modification of the scheme used in the American Academy of Ophthalmology Preferred Practice Patterns series. When possible, peer-reviewed full publications, not abstracts, were used. The report was reviewed

Table 1. Evidence grading scheme

Clinical Studies

Level 1. Evidence obtained from at least one properly conducted, well-designed, randomized, controlled trial, or evidence from well-designed studies applying rigorous statistical approaches.

Level 2. Evidence obtained from one of the following: a well-designed controlled trial without randomization, a well-designed cohort or case-control analytic study, preferably from one or more center, or a well-designed study accessible to more rigorous statistical analysis.

Level 3. Evidence obtained from one of the following: descriptive studies, case reports, reports of expert committees, expert opinion.

Basic Science Studies

Level 1. Well-performed studies confirming a hypothesis with adequate controls published in a high-impact journal.

Level 2. Preliminary or limited published study.

Level 3. Meeting abstracts or unpublished presentations.

This evidence grading scheme is based on that used in the American Academy of Ophthalmology Preferred Practice Pattern series.

OUTLINE

- I. Introduction
- II. Goals of the Management and Therapy Subcommittee
- III. Assessment of current dry eye therapies
 - A. Tear supplementation: lubricants
 - 1. General characteristics and effects
 - 2. Preservatives
 - 3. Electrolyte composition
 - 4. Osmolarity
 - 5. Viscosity agents
 - 6. Summary
 - B. Tear Retention
 - 1. Punctal occlusion
 - a. Rationale
 - b. Types
 - c. Clinical studies
 - d. Indications and contraindications
 - e. Complications
 - f. Summary
 - 2. Moisture chamber spectacles
 - 3. Contact lenses
 - C. Tear stimulation: secretagogues
 - D. Biological tear substitutes
 - 1. Serum
 - 2. Salivary gland autotransplantation
 - E. Anti-inflammatory therapy
 - 1. Cyclosporine
 - 2. Corticosteroids
 - a. Clinical studies
 - b. Basic research
 - 3. Tetracyclines
 - a. Properties of tetracyclines and their derivatives
 - 1) Antibacterial properties
 - 2) Anti-inflammatory
 - 3) Anti-angiogenic properties
 - b. Clinical applications of tetracycline
 - 1) Acne Rosacea
 - 2) Chronic posterior blepharitis: meibomianitis, meibomian gland dysfunction
 - 3) Dosage and safety
 - F. Essential fatty acids
 - G. Environmental strategies
- IV. Treatment recommendations
- V. Unanswered questions and future directions

by all subcommittee members and by the entire Dry Eye WorkShop membership. Comments and suggested revisions were discussed by the subcommittee members and incorporated into the report where deemed appropriate by consensus.

III. ASSESSMENT OF CURRENT DRY EYE THERAPIES**A. Tear Supplementation: Lubricants****1. General Characteristics and Effects**

The term "artificial tears" is a misnomer for most products that identify themselves as such, because they do not mimic the composition of human tears. Most function as lubricants, although some more recent formulations mimic the electrolyte composition of human tears (TheraTears® [Advanced Vision Research, Woburn, MA]).^{1,2} The ocular lubricants presently available in the United States are approved based on the US Food and Drug Administration (FDA) monograph on over-the-counter (OTC) products (21 CFR 349) and are not based on clinical efficacy. The monograph specifies permitted active ingredients (eg, demulcents, emulsifiers, surfactants, and viscosity agents) and concentrations, but gives only limited guidance on inactive additives and solution parameters. Certain inactive ingredients that are used in artificial tears sold in the US (eg, castor oil in Endura™ [Allergan, Inc., Irvine, CA] and guar in Systane® [Alcon, Ft Worth, TX]) are not listed in the monograph.

It is difficult to prove that any ingredient in an ocular lubricant acts as an active agent. If there is an active ingredient, it is the polymeric base or viscosity agent, but this has proved difficult to demonstrate. This is either because it is not possible to detect the effects or differences in clinical trials with presently available clinical tests or because the currently available agents do not have any discernable clinical activity beyond a lubrication effect. Although certain artificial tears have demonstrated more success than others in reducing symptoms of irritation or decreasing ocular surface dye staining in head-to-head comparisons, there have been no large scale, masked, comparative clinical trials to evaluate the wide variety of ocular lubricants.

What is the clinical effect of ocular lubricants or artificial tears? Do they lubricate, replace missing tear constituents, reduce elevated tear film osmolarity, dilute or wash out inflammatory or inflammation-inducing agents? Do they, in some instances, actually wash out essential substances found in normal human tears? These questions remain to be answered as more sensitive clinical tests become available to detect changes in the ocular surface.

The foremost objectives in caring for patients with dry eye disease are to improve the patient's ocular comfort and quality of life, and to return the ocular surface and tear film to the normal homeostatic state. Although symptoms can rarely be eliminated, they can often be improved, leading to an improvement in the quality of life. It is more difficult to demonstrate that topical lubricants improve the ocular surface and the tear film abnormalities associated with dry eye. Most clinical studies fail to demonstrate significant correlation between symptoms and clinical test values or between the clinical test values themselves.³⁻⁵ It is not unusual for a dry eye with only mild symptoms to show significant rose bengal staining. Until agents are developed that can restore the ocular surface and tear film to their

normal homeostatic state, the symptoms and signs of dry eye disease will continue.

Ocular lubricants are characterized by hypotonic or isotonic buffered solutions containing electrolytes, surfactants, and various types of viscosity agents. In theory, the ideal artificial lubricant should be preservative-free, contain potassium, bicarbonate, and other electrolytes and have a polymeric system to increase its retention time.^{1,6-8} Physical properties should include a neutral to slightly alkaline pH. Osmolarities of artificial tears have been measured to range from about 181 to 354 mOsm/L.⁹ The main variables in the formulation of ocular lubricants regard the concentration of and choice of electrolytes, the osmolarity and the type of viscosity/polymeric system, the presence or absence of preservative, and, if present, the type of preservative.

2. Preservatives

The single most critical advance in the treatment of dry eye came with the elimination of preservatives, such as benzalkonium chloride (**BAK**), from OTC lubricants. Because of the risk of contamination of multidose products, most either contain a preservative or employ some mechanism for minimizing contamination. The FDA has required that multidose artificial tears contain preservatives to prevent microbial growth.¹⁰ Preservatives are not required in unit dose vials that are discarded after a single use. The widespread availability of nonpreserved preparations allows patients to administer lubricants more frequently without concern about the toxic effects of preservatives. For patients with moderate-to-severe dry eye disease, the absence of preservatives is of more critical importance than the particular polymeric agent used in ocular lubricants. The ocular surface inflammation associated with dry eye is exacerbated by preserved lubricants; however, nonpreserved solutions are inadequate in themselves to improve the surface inflammation and epithelial pathology seen in dry eye disease.¹¹

Benzalkonium chloride is the most frequently used preservative in topical ophthalmic preparations, as well as in topical lubricants. Its epithelial toxic effects have been well established.¹²⁻¹⁷ The toxicity of BAK is related to its concentration, the frequency of dosing, the level or amount of tear secretion, and the severity of the ocular surface disease. In the patient with mild dry eye, BAK-preserved drops are usually well tolerated when used 4-6 times a day or less. In patients with moderate-to-severe dry eye, the potential for BAK toxicity is high, due to decreased tear secretion and decreased turnover.¹⁷ Some patients may be using other topical preparations (eg, glaucoma medications) that contain BAK, increasing their exposure to the toxic effects of BAK. Also, the potential for toxicity exists with patient abuse of other OTC products that contain BAK, such as vasoconstrictors.

BAK can damage the corneal and conjunctival epithelium, affecting cell-to-cell junctions and cell shape and microvilli, eventually leading to cell necrosis with sloughing of 1-2 layers of epithelial cells.¹⁷ Preservative-free formulations are absolutely necessary for patients with severe dry

eye with ocular surface disease and impairment of lacrimal gland secretion, or for patients on multiple, preserved topical medications for chronic eye disease. Patients with severe dry eye, greatly reduced tear secretion, and punctal occlusion are at particular risk for preservative toxicity. In such patients, the instilled agent cannot be washed out; if this risk has not been appreciated by the clinician, preserved drops might be used at high frequency.

Another additive used in OTC formulations is disodium (**EDTA**). It augments the preservative efficacy of BAK and other preservatives, but, by itself, it is not a sufficient preservative. Used in some nonpreserved solutions, it may help limit microbial growth in opened unit-dose vials. Although use of EDTA may allow a lower concentration of preservative, EDTA may itself be toxic to the ocular surface epithelium. A study comparing two preservative-free solutions, Hypotears PF® (Novartis Ophthalmics, East Hanover, NJ) containing EDTA and Refresh® (Allergan, Inc., Irvine, CA) without EDTA, showed that both formulations had identical safety profiles and were completely nontoxic to the rabbit corneal epithelium.¹⁸ Other studies found that EDTA-containing preparations increased corneal epithelial permeability.^{19,20} The potential exists that patients with severe dry eye will find that EDTA-containing preparations increase irritation.

Nonpreserved, single unit-dose tear substitutes are more costly for the manufacturer to produce, more costly for the patients to purchase, and less convenient to use than bottled ocular lubricants. For these reasons, reclosable unit dose vials (eg, Refresh Free [Allergan Inc., Irvine, CA]; Tears Natural Free® [Alcon, Fort Worth, TX]) were introduced. Less toxic preservatives, such as polyquad (polyquaternium-1), sodium chlorite (Purite®), and sodium perborate were developed to allow the use of multidose bottled lubricants and to avoid the known toxicity of BAK-containing solutions.^{21,22} The "vanishing" preservatives were sodium perborate and sodium chlorite (TheraTears® [Advanced Vision Research, Woburn, MA], Genteal® [Novartis, East Hanover, NJ], and Refresh Tears® [Allergan Inc., Irvine, CA]).

Sodium chlorite degrades to chloride ions and water upon exposure to UV light after instillation. Sodium perborate is converted to water and oxygen on contact with the tear film. For patients with severe dry eye, even vanishing preservatives may not totally degrade, due to a decrease in tear volume, and may be irritating. Patients prefer bottled preparations for reasons of both cost and ease of use. The ideal lubricant would come in a multidose, easy-to-use bottle that contains a preservative that completely dissipates before reaching the tear film, or is completely nontoxic and nonirritating and maintains absolute sterility with frequent use. One such multi-use, preservative-free product has been introduced to the market (Visine Pure-Tears® [Pfizer, Inc, NJ]).

Ocular ointments and gels are also used in treatment of dry eye disease. Ointments are formulated with a specific mixture of mineral oil and petrolatum. Some contain lanolin,

which can be irritating to the eye and delay corneal wound healing.²³ Individuals with sensitivity to wool may also be sensitive to lanolin.²³ Some ointments contain parabens as preservatives, and these ointments are not well tolerated by patients with severe dry eye. In general, ointments do not support bacterial growth and, therefore, do not require preservatives. Gels containing high molecular weight cross-linked polymers of acrylic acid (carbomers) have longer retention times than artificial tear solutions, but have less visual blurring effect than petrolatum ointments.

3. Electrolyte Composition

Solutions containing electrolytes and or ions have been shown to be beneficial in treating ocular surface damage due to dry eye.^{1,6,20,24,25} To date, potassium and bicarbonate seem to be the most critical. Potassium is important to maintain corneal thickness.⁷ In a dry-eye rabbit model, a hypotonic tear-matched electrolyte solution (TheraTears® [Advanced Vision Research, Woburn, MA]) increased conjunctival goblet cell density and corneal glycogen content, and reduced tear osmolarity and rose bengal staining after 2 weeks of treatment.²⁵ The restoration of conjunctival goblet cells seen in the dry-eye rabbit model has been corroborated in patients with dry eye after LASIK.²⁶

Bicarbonate-containing solutions promote the recovery of epithelial barrier function in damaged corneal epithelium and aid in maintaining normal epithelial ultrastructure. They may also be important for maintaining the mucin layer of the tear film.⁶ Ocular lubricants are available that mimic the electrolyte composition of human tears, eg, TheraTears® (Advanced Vision Research, Woburn, MA) and BION Tears® (Alcon, Fort Worth, TX).^{1,2} These also contain bicarbonate, which is critical for forming and maintaining the protective mucin gel in the stomach.²⁷ Bicarbonate may play a similar role for gel-forming mucins on the ocular surface. Because bicarbonate is converted to carbon dioxide when in contact with air and can diffuse through the plastic unit dose vials, foil packaging of the plastic vials is required to maintain stability.

4. Osmolarity

Tears of patients with dry eye have a higher tear film osmolarity (crystalloid osmolarity) than do those of normal patients.^{28,29} Elevated tear film osmolarity causes morphological and biochemical changes to the corneal and conjunctival epithelium^{18,30} and is pro-inflammatory.³¹ This knowledge influenced the development of hypo-osmotic artificial tears such as Hypotears® (230 mOsm/L [Novartis Ophthalmics, East Hanover, NJ]) and subsequently TheraTears® (181 mOsm/L [Advanced Vision Research, Woburn, MA]).³²

Colloidal osmolality is another factor that varies in artificial tear formulations. While crystalloid osmolarity is related to the presence of ions, colloidal osmolality is dependent largely on macromolecule content. Colloidal osmolarity, also known as *oncotic pressure*, is involved in the control of water transport in tissues. Differences in colloidal

osmolality affect the net water flow across membranes, and water flow is eliminated by applying hydrostatic pressure to the downside of the water flow. The magnitude of this osmotic pressure is determined by osmolality differences on the two sides of the membrane. Epithelial cells swell due to damage to their cellular membranes or due to a dysfunction in the pumping mechanism. Following the addition of a fluid with a high colloidal osmolality to the damaged cell surface, deturgescence occurs, leading to a return of normal cell physiology. Theoretically, an artificial tear formulation with a high colloidal osmolality may be of value. Holly and Esquivel evaluated many different artificial tear formulations and showed that Hypotears® (Novartis Ophthalmics, East Hanover, NJ) had the highest colloidal osmolality of all of the formulations tested.³³ Formulations with higher colloidal osmolality have since been marketed (Dwelle® [Dry Eye Company, Silverdale, WA]).

Protection against the adverse effects of increased osmolarity (osmoprotection) has led to development of OTC drops incorporating compatible solutes (such as glycerin, erythritol, and levocarnitine (Optive® [Allergan Inc., Irvine, CA])). It is thought that the compatible solutes distribute between the tears and the intracellular fluids to protect against potential cellular damage from hyperosmolar tears.³⁴

5. Viscosity Agents

The stability of the tear film depends on the chemical-physical characteristics of that film interacting with the conjunctival and corneal epithelium via the membrane-spanning mucins (ie, MUC-16 and MUC-4). In the classical three-layered tear film model, the mucin layer is usually thought of as a surfactant or wetting agent, acting to lower the surface tension of the relatively hydrophobic ocular surface, rendering the corneal and conjunctival cells "wetable."³³ Currently, the tear film is probably best described as a hydrated, mucin gel whose mucin concentration decreases with distance from the epithelial cell surface. It may have a protective role similar to that of mucin in the stomach.³⁵ It may also serve as a "sink" or storage vehicle for substances secreted by the main and accessory lacrimal glands and the ocular surface cells. This may explain why most of the available water-containing lubricants are only minimally effective in restoring the normal homeostasis of the ocular surface. In addition to washing away and diluting out irritating or toxic substances in the tear film, artificial lubricants hydrate gel-forming mucin. While some patients with dry eye have decreased aqueous lacrimal gland secretion, alterations or deficiencies involving mucin also cause dry eye.

Macromolecular complexes added to artificial lubricants act as viscosity agents. The addition of a viscosity agent increases residence time, providing a longer interval of patient comfort. For example, when a viscous, anionic charged carboxymethyl-cellulose (CMC, 100,000 mw) solution was compared with a neutral hydroxymethylcellulose (HPMC) solution, CMC was shown to have a significantly slower rate of clearance from the eye.³⁶ Viscous agents in active drug

formulations may also prolong ocular surface contact, increasing the duration of action and penetration of the drug.

Viscous agents may also protect the ocular surface epithelium. It is known that rose bengal stains abnormal corneal and conjunctival epithelial cells expressing an altered mucin glycocalyx.³⁷ Agents such as hydroxymethylcellulose (HMC), which decrease rose bengal staining in dry eye subjects,³⁸ may either "coat and protect" the surface epithelium or help restore the protective effect of mucins.

In the US, carboxymethyl cellulose is the most commonly used polymeric viscosity agent (IRI Market Share Data, Chicago, IL), typically in concentrations from 0.25% to 1%, with differences in molecular weight also contributing to final product viscosity. Carboxymethyl cellulose has been found to bind to and be retained by human epithelial cells.³⁹ Other viscosity agents included in the FDA monograph (in various concentrations) include polyvinyl alcohol, polyethylene glycol, glycol 400, propylene glycol hydroxymethyl cellulose and hydroxypropyl cellulose.

The blurring of vision and esthetic disadvantages of caking and drying on eyelashes are drawbacks of highly viscous agents that patients with mild to moderate dry eye will not tolerate. Lower molecular-weight viscous agents help to minimize these problems. Because patient compliance, comfort, and convenience are important considerations, a range of tear substitute formulations with varying viscosities are needed.

Hydroxypropyl-guar (HP-guar) has been used as a gelling agent in a solution containing glycol 400 and propylene glycol (Systane[®], Alcon, Fort Worth, TX). It has been suggested that HP-guar preferentially binds to the more hydrophobic, desiccated or damaged areas of the surface epithelial cells, providing temporary protection for these cells.^{40,41} Several commercial preparations containing oil in the form of castor oil (Endura[™] [Allergan Inc., Irvine, CA]) or mineral oil (Soothe[®] [Bausch & Lomb, Rochester, NY]) are purported to aid in restoring or increasing the lipid layer of the tear film.^{42,43} Hyaluronic acid is a viscosity agent that has been investigated for years as an "active" compound added to tear substitute formulations for the treatment of dry eye. Hyaluronic acid (0.2%) has significantly longer ocular surface residence times than 0.3 percent HPMC or 1.4 percent polyvinyl alcohol.⁴⁴ Some clinical studies reported improvement in⁴⁴⁻⁴⁸ dry eye in patients treated with sodium hyaluronate-containing solutions compared to other lubricant solutions, whereas others did not.⁴⁸ Although lubricant preparations containing sodium hyaluronate have not been approved for use in the US, they are frequently used in some countries.

6. Summary

Although many topical lubricants, with various viscosity agents, may improve symptoms and objective findings, there is no evidence that any agent is superior to another. Most clinical trials involving topical lubricant preparations will document some improvement (but not resolution) of subjective symptoms and improvement in some objective

parameters.⁴ However, the improvements noted are not necessarily any better than those seen with the vehicle or other nonpreserved artificial lubricants. The elimination of preservatives and the development of newer, less toxic preservatives have made ocular lubricants better tolerated by dry eye patients. However, ocular lubricants, which have been shown to provide some protection of the ocular surface epithelium and some improvement in patient symptoms and objective findings, have not been demonstrated in controlled clinical trials to be sufficient to resolve the ocular surface disorder and inflammation seen in most dry eye sufferers.

B. Tear Retention

1. Punctal Occlusion

a. Rationale

While the concept of permanently occluding the lacrimal puncta with cautery to treat dry eye extends back 70 years,⁴⁹ and, although the first dissolvable implants were used 45 years ago,⁵⁰ the modern era of punctal plug use began in 1975 with the report by Freeman.⁵¹ Freeman described the use of a dumbbell-shaped silicone plug, which rests on the opening of the punctum and extends into the canaliculus. His report established a concept of punctal occlusion, which opened the field for development of a variety of removable, long-lasting plugs to retard tear clearance in an attempt to treat the ocular surface of patients with deficient aqueous tear production. The Freeman style plug remains the prototype for most styles of punctal plugs.

b. Types

Punctal plugs are divided into two main types: absorbable and nonabsorbable. The former are made of collagen or polymers and last for variable periods of time (3 days to 6 months). The latter nonabsorbable "permanent" plugs include the Freeman style, which consists of a surface collar resting on the punctal opening, a neck, and a wider base. In contrast, the Herrick plug (Lacrimedics [Eastsound, WA]) is shaped like a golf tee and is designed to reside within the canaliculus. It is blue for visualization; other variations are radiopaque. A newly designed cylindrical Smartplug[™] (Medennium Inc [Irvine, CA]) expands and increases in diameter in situ following insertion into the canaliculus due to thermodynamic properties of its hydrophilic acrylic composition.

c. Clinical Studies

A variety of clinical studies evaluating the efficacy of punctal plugs have been reported.⁵²⁻⁵⁶ These series generally fall into Level II evidence. Their use has been associated with objective and subjective improvement in patients with both Sjogren and non-Sjogren aqueous tear deficient dry eye, filamentary keratitis, contact lens intolerance, Stevens-Johnson disease, severe trachoma, neurotrophic keratopathy, post-penetrating keratoplasty, diabetic keratopathy, and post-photorefractive keratectomy or laser in situ keratomileusis. Several studies have been performed

to evaluate the effects of punctal plugs on the efficacy of glaucoma medications in reducing intraocular pressure, and these studies have reported conflicting results.^{57,58} Beneficial outcome in dry eye symptoms has been reported in 74-86% of patients treated with punctal plugs. Objective indices of improvement reported with the use of punctal plugs include improved corneal staining, prolonged tear film breakup time (TFBUT), decrease in tear osmolarity, and increase in goblet cell density. Overall, the clinical utility of punctal plugs in the management of dry eye disease has been well documented.

d. Indications and Contraindications

In a recent review on punctal plugs, it was reported that in a major eye clinic, punctal plugs are considered indicated in patients who are symptomatic of dry eyes, have a Schirmer test (with anesthesia) result less than 5 mm at 5 minutes, and show evidence of ocular surface dye staining.⁵⁶

Contraindications to the use of punctal plugs include allergy to the materials used in the plugs to be implanted, punctal ectropion, and pre-existing nasolacrimal duct obstruction, which would, presumably, negate the need for punctal occlusion. It has been suggested that plugs may be contraindicated in dry eye patients with clinical ocular surface inflammation, because occlusion of tear outflow would prolong contact of the abnormal tears containing proinflammatory cytokines with the ocular surface. Treatment of the ocular surface inflammation prior to plug insertion has been recommended. Acute or chronic infection of the lacrimal canaliculus or lacrimal sac is also a contraindication to use of a plug.

e. Complications

The most common complication of punctal plugs is spontaneous plug extrusion, which is particularly common with the Freeman-style plugs. Over time, an extrusion rate of 50% has been reported, but many of these extrusions took place after extensive periods of plug residence. Most extrusions are of small consequence, except for inconvenience and expense. More troublesome complications include internal migration of a plug, biofilm formation and infection,⁵⁹ and pyogenic granuloma formation. Removal of migrated canaliculus plugs can be difficult and may require surgery to the nasolacrimal duct system.^{60,61}

f. Summary

The extensive literature on the use of punctal plugs in the management of dry eye disease has documented their utility. Several recent reports, however, have suggested that absorption of tears by the nasolacrimal ducts into surrounding tissues and blood vessels may provide a feedback mechanism to the lacrimal gland regulating tear production.⁶² In one study, placement of punctal plugs in patients with normal tear production caused a significant decrease in tear production for up to 2 weeks after plug insertion.⁶³ This cautionary note should be considered when deciding

whether to incorporate punctal occlusion into a dry eye disease management plan.

2. Moisture Chamber Spectacles

The wearing of moisture-conserving spectacles has for many years been advocated to alleviate ocular discomfort associated with dry eye. However, the level of evidence supporting its efficacy for dry eye treatment has been relatively limited. Tsubota et al, using a sensitive moisture sensor, reported an increase in periocular humidity in subjects wearing such spectacles.⁶⁴ Addition of side panels to the spectacles was shown to further increase the humidity.⁶⁵ The clinical efficacy of moisture chamber spectacles has been reported in case reports.^{66,67} Kurihashi proposed a related treatment for dry eye patients, in the form of a wet gauze eye mask.⁶⁸ Conversely, Nichols et al recently reported in their epidemiologic study that spectacle wearers were twice as likely as emmetropes to report dry eye disease.⁶⁹ The reason for this observation was not explained.

There have been several reports with relatively high level of evidence describing the relationship between environmental humidity and dry eye. Korb et al reported that increases in periocular humidity caused a significant increase in thickness of the tear film lipid layer.⁷⁰ Dry eye subjects wearing spectacles showed significantly longer interblink intervals than those who did not wear spectacles, and duration of blink (blinking time) was significantly longer in the latter subjects.⁷⁰ Instillation of artificial tears caused a significant increase in the interblink interval and a decrease in the blink rate.⁷¹ Maruyama et al reported that dry eye symptoms worsened in soft contact lens wearers when environmental humidity decreased.⁷²

3. Contact Lenses

Contact lenses may help to protect and hydrate the corneal surface in severe dry eye conditions. Several different contact lens materials and designs have been evaluated, including silicone rubber lenses and gas permeable scleral-bearing hard contact lenses with or without fenestration.⁷³⁻⁷⁷ Improved visual acuity and comfort, decreased corneal epitheliopathy, and healing of persistent corneal epithelial defects have been reported.⁷³⁻⁷⁷ Highly oxygen-permeable materials enable overnight wear in appropriate circumstances.⁷⁵ There is a small risk of corneal vascularization and possible corneal infection associated with the use of contact lenses by dry eye patients.

C. Tear Stimulation: Secretagogues

Several potential topical pharmacologic agents may stimulate aqueous secretion, mucous secretion, or both. The agents currently under investigation by pharmaceutical companies are diquafosol (one of the P2Y2 receptor agonists), rebamipide, gefarnate, ecabet sodium (mucous secretion stimulants), and 15(S)-HETE (MUC1 stimulant). Among them, a diquafosol eye drop has been favorably evaluated in clinical trials. 2% diquafosol (INS365, DE-089 [Santen, Osaka, Japan]; Inspire [Durham, NC]) proved to

be effective in the treatment of dry eye in a randomized, double-masked trial in humans to reduce ocular surface staining.⁷⁸ A similar study demonstrated the ocular safety and tolerability of diquafosol in a double-masked, placebo-controlled, randomized study.⁷⁹ This agent is capable of stimulating both aqueous and mucous secretion in animals and humans.⁸⁰⁻⁸³ Beneficial effects on corneal epithelial barrier function, as well as increased tear secretion, has been demonstrated in the rat dry eye model.⁸⁴ Diquafosol also has been shown to stimulate mucin release from goblet cells in a rabbit dry eye model.^{85,86}

The effects of rebamipide (OPC-12759 [Otsuka, Rockville, MD]; Novartis [Basel, Switzerland]) have been evaluated in human clinical trials. In animal studies, rebamipide increased the mucin-like substances on the ocular surface of N-acetylcysteine-treated rabbit eyes.⁸⁷ It also had hydroxyl radical scavenging effects on UVB-induced corneal damage in mice.⁸⁸

Ecabet sodium (Senju [Osaka, Japan]; ISTA [Irvine, CA]) is being evaluated in clinical trials internationally, but only limited results have yet been published. A single instillation of ecabet sodium ophthalmic solution elicited a statistically significant increase in tear mucin in dry eye patients.⁸⁹ Gefarnate (Santen [Osaka, Japan]) has been evaluated in animal studies. Gefarnate promoted mucin production after conjunctival injury in monkeys.⁹⁰ Gefarnate increased PAS-positive cell density in rabbit conjunctiva and stimulated mucin-like glycoprotein stimulation from rat cultured corneal epithelium.^{91,92} An *in vivo* rabbit experiment showed a similar result.^{93,94}

The agent 15(S)-HETE, a unique molecule, can stimulate MUC1 mucin expression on ocular surface epithelium.⁹⁵ 15(S)-HETE protected the cornea in a rabbit model of desiccation-induced injury, probably because of mucin secretion.⁹⁶ It has been shown to have beneficial effects on secretion of mucin-like glycoprotein by the rabbit corneal epithelium.⁹⁷ Other laboratory studies confirm the stimulatory effect of 15(S)-HETE.⁹⁸⁻¹⁰¹ Some of these agents may become useful clinical therapeutic modalities in the near future.

Two orally administered cholinergic agonists, pilocarpine and cevimeline, have been evaluated in clinical trials for treatment of Sjogren syndrome associated keratoconjunctivitis sicca (KCS). Patients who were treated with pilocarpine at a dose of 5 mg QID experienced a significantly greater overall improvement than placebo-treated patients in "ocular problems" in their ability to focus their eyes during reading, and in symptoms of blurred vision compared with placebo-treated patients.¹⁰² The most commonly reported side effect from this medication was excessive sweating, which occurred in over 40% of patients. Two percent of the patients taking pilocarpine withdrew from the study because of drug-related side effects. Other studies have reported efficacy of pilocarpine for ocular signs and symptoms of Sjogren syndrome KCS,¹⁰³⁻¹⁰⁵ including an increase in conjunctival goblet cell density after 1 and 2 months of therapy.¹⁰⁶

Cevimeline is another oral cholinergic agonist that was found to significantly improve symptoms of dryness and aqueous tear production and ocular surface disease compared to placebo when taken in doses of 15 or 30 mg TID.^{107,108} This agent may have fewer adverse systemic side effects than oral pilocarpine.

D. Biological Tear Substitutes

Naturally occurring biological, ie, nonpharmaceutical fluids, can be used to substitute for natural tears. The use of serum or saliva for this purpose has been reported in humans. They are usually unpreserved. When of autologous origin, they lack antigenicity and contain various epitheliotrophic factors, such as growth factors, neurotrophins, vitamins, immunoglobulins, and extracellular matrix proteins involved in ocular surface maintenance. Biological tear substitutes maintain the morphology and support the proliferation of primary human corneal epithelial cells better than pharmaceutical tear substitutes.¹⁰⁹ However, despite biomechanical and biochemical similarities, relevant compositional differences compared with normal tears exist and are of clinical relevance.¹¹⁰ Additional practical problems concern sterility and stability, and a labor-intensive production process or a surgical procedure (saliva) is required to provide the natural tear substitute to the ocular surface.

I. Serum

Serum is the fluid component of full blood that remains after clotting. Its topical use for ocular surface disease was much stimulated by Tsubota's prolific work in the late 1990s.¹¹¹ The practicalities and published evidence of autologous serum application were recently reviewed.¹¹² The use of blood and its components as a pharmaceutical preparation in many countries is restricted by specific national laws. To produce serum eye drops and to use them for outpatients, a license by an appropriate national body may be required in certain countries. The protocol used for the production of serum eye drops determines their composition and efficacy. An optimized protocol for the production was recently published.¹¹³ Concentrations between 20% and 100% of serum have been used. The efficacy seems to be dose-dependent.

Because of significant variations in patient populations, production and storage regimens, and treatment protocols, the efficacy of serum eye drops in dry eyes has varied substantially between studies.¹¹³ Three published prospective randomized studies with similar patient populations (predominantly immune disease associated dry eye, ie, Sjogren syndrome) are available. When comparing 20% serum with 0.9% saline applied 6 times per day, Tananuvat et al found only a trend toward improvement of symptoms and signs of dry eyes,¹¹⁴ whereas Kojima et al reported significant improvement of symptom scores, fluorescein-breakup time (FBUT), and fluorescein and rose bengal staining.¹¹⁵

A prospective clinical cross-over trial compared 50% serum eyedrops against the commercial lubricant previously

used by each patient. Symptoms improved in 10 out of 16 patients, and impression cytological findings improved in 12 out of 25 eyes.¹¹⁶ Noda-Tsuruya and colleagues found that 20% autologous serum significantly improved TFBIUT and decreased conjunctival rose bengal and cornea fluorescein staining 1-3 months postoperatively, compared to treatment with artificial tears, which did not change these parameters.¹¹⁷ Additional reports of successful treatment of persistent epithelial defects—where success is more clearly defined as “healing of the defect”—with autologous serum substantiate the impression that this is a valuable therapeutic option for ocular surface disease.¹¹⁸

2. Salivary Gland Autotransplantation

Salivary submandibular gland transplantation is capable of replacing deficient mucin and the aqueous tear film phase. This procedure requires collaboration between an ophthalmologist and a maxillofacial surgeon. With appropriate microvascular anastomosis, 80% of grafts survive. In patients with absolute aqueous tear deficiency, viable submandibular gland grafts, in the long-term, provide significant improvement of Schirmer test FBUT, and rose bengal staining, as well as reduction of discomfort and the need for pharmaceutical tear substitutes. Due to the hypo-osmolarity of saliva, compared to tears, excessive salivary tearing can induce a microcystic corneal edema, which is temporary, but can lead to epithelial defects.¹¹⁰ Hence, this operation is indicated only in end-stage dry eye disease with an absolute aqueous tear deficiency (Schirmer-test wetting of 1 mm or less), a conjunctivalized surface epithelium, and persistent severe pain despite punctal occlusion and at least hourly application of unpreserved tear substitutes. For this group of patients, such surgery is capable of substantially reducing discomfort, but often has no effect on vision.^{119,120}

E. Anti-inflammatory Therapy

Disease or dysfunction of the tear secretory glands leads to changes in tear composition, such as hyperosmolarity, that stimulate the production of inflammatory mediators on the ocular surface.^{31,121} Inflammation may, in turn, cause dysfunction or disappearance of cells responsible for tear secretion or retention.¹²² Inflammation can also be initiated by chronic irritative stress (eg, contact lenses) and systemic inflammatory/autoimmune disease (eg, rheumatoid arthritis). Regardless of the initiating cause, a vicious circle of inflammation can develop on the ocular surface in dry eye that leads to ocular surface disease. Based on the concept that inflammation is a key component of the pathogenesis of dry eye, the efficacy of a number of anti-inflammatory agents for treatment of dry eye disease has been evaluated in clinical trials and animal models.

1. Cyclosporine

The potential of cyclosporine-A (CsA) for treating dry eye disease was initially recognized in dogs that develop spontaneous KCS.¹²³ The therapeutic efficacy of CsA for human KCS was then documented in several small, single-

center, randomized, double-masked clinical trials.^{124,125} CsA emulsion for treatment of KCS was subsequently evaluated in several large multicenter, randomized, double-masked clinical trials.

In a Phase 2 clinical trial, four concentrations of CsA (0.05%, 0.1%, 0.2%, or 0.4%) administered twice daily to both eyes of 129 patients for 12 weeks was compared to vehicle treatment of 33 patients.¹²⁶ CsA was found to significantly decrease conjunctival rose bengal staining, superficial punctate keratitis, and ocular irritation symptoms (sandy or gritty feeling, dryness, and itching) in a subset of 90 patients with moderate-to-severe KCS. There was no clear dose response; CsA 0.1% produced the most consistent improvement in objective endpoints, whereas CsA 0.05% gave the most consistent improvement in patient symptoms (Level 1).

Two independent Phase 3 clinical trials compared twice-daily treatment with 0.05% or 0.1% CsA or vehicle in 877 patients with moderate-to-severe dry eye disease.¹²⁷ When the results of the two Phase 3 trials were combined for statistical analysis, patients treated with CsA, 0.05% or 0.1%, showed significantly ($P < 0.05$) greater improvement in two objective signs of dry eye disease (corneal fluorescein staining and anesthetized Schirmer test values) compared to those treated with vehicle. An increased Schirmer test score was observed in 59% of patients treated with CsA, with 15% of patients having an increase of 10 mm or more. In contrast, only 4% of vehicle-treated patients had this magnitude of change in their Schirmer test scores ($P < 0.0001$).

CsA 0.05% treatment also produced significantly greater improvements ($P < 0.05$) in three subjective measures of dry eye disease (blurred vision symptoms, need for concomitant artificial tears, and the global response to treatment). No dose-response effect was noted. Both doses of CSA exhibited an excellent safety profile with no significant systemic or ocular adverse events, except for transient burning symptoms after instillation in 17% of patients. Burning was reported in 7% of patients receiving the vehicle. No CsA was detected in the blood of patients treated with topical CsA for 12 months. Clinical improvement from CsA that was observed in these trials was accompanied by improvement in other disease parameters. Treated eyes had an approximately 200% increase in conjunctival goblet cell density.¹²⁸ Furthermore, there was decreased expression of immune activation markers (ie, HLA-DR), apoptosis markers (ie, Fas), and the inflammatory cytokine IL-6 by the conjunctival epithelial cells.^{129,130} The numbers of CD3-, CD4-, and CD8-positive T lymphocytes in the conjunctiva decreased in cyclosporine-treated eyes, whereas vehicle-treated eyes showed an increased number of cells expressing these markers.¹³¹ After treatment with 0.05% cyclosporine, there was a significant decrease in the number of cells expressing the lymphocyte activation markers CD11a and HLA-DR, indicating less activation of lymphocytes compared with vehicle-treated eyes.

Two additional immunophilins, pimecrolimus and tacrolimus, have been evaluated in clinical trials of KCS.

2. Corticosteroids

a. Clinical Studies

Corticosteroids are an effective anti-inflammatory therapy in dry eye disease. Level I evidence is published for a number of corticosteroid formulations. In a 4-week, double-masked, randomized study in 64 patients with KCS and delayed tear clearance, loteprednol etabonate 0.5% ophthalmic suspension (Lotemax [Bausch and Lomb, Rochester, NY]), q.i.d., was found to be more effective than its vehicle in improving some signs and symptoms.¹³²

In a 4-week, open-label, randomized study in 32 patients with KCS, patients receiving fluorometholone plus artificial tear substitutes (ATS) experienced lower symptom severity scores and lower fluorescein and rose bengal staining than patients receiving either ATS alone or ATS plus flurbiprofen.¹³³

A prospective, randomized clinical trial compared the severity of ocular irritation symptoms and corneal fluorescein staining in two groups of patients, one treated with topical nonpreserved methylprednisolone for 2 weeks, followed by punctal occlusion (Group 1), with a group that received punctal occlusion alone (Group 2).¹³⁴ After 2 months, 80% of patients in Group 1 and 33% of patients in Group 2 had complete relief of ocular irritation symptoms. Corneal fluorescein staining was negative in 80% of eyes in Group 1 and 60% of eyes in Group 2 after 2 months. No steroid-related complications were observed in this study.

Level III evidence is also available to support the efficacy of corticosteroids. In an open-label, non-comparative trial, extemporaneously formulated nonpreserved methylprednisolone 1% ophthalmic suspension was found to be clinically effective in 21 patients with Sjogren syndrome KCS.¹³⁵ In a review, it was stated that "...clinical improvement of KCS has been observed after therapy with anti-inflammatory agents, including corticosteroids."¹³⁶

In the US Federal Regulations, ocular corticosteroids receiving "class labeling" are indicated for the treatment "...of steroid responsive inflammatory conditions of the palpebral and bulbar conjunctiva, cornea and anterior segment of the globe such as allergic conjunctivitis, acne rosacea, superficial punctate keratitis, herpes zoster keratitis, iritis, cyclitis, selected infective conjunctivides, when the inherent hazard of steroid use is accepted to obtain an advisable diminution in edema and inflammation." We interpret that KCS is included in this list of steroid-responsive inflammatory conditions.¹³⁷⁻¹⁴⁰

b. Basic Research

Corticosteroids are the standard anti-inflammatory agent for numerous basic research studies of inflammation, including the types that are involved in KCS. The corticosteroid methylprednisolone was noted to preserve corneal epithelial smoothness and barrier function in an experimental murine model of dry eye.¹⁴¹ This was attributed to its ability to maintain the integrity of corneal epithelial tight junctions and decrease desquamation of apical corneal epithelial cells.¹⁴² A concurrent study showed

that methylprednisolone prevented an increase in MMP-9 protein in the corneal epithelium, as well as gelatinase activity in the corneal epithelium and tears in response to experimental dry eye.¹⁴¹

Preparations of topically applied androgen and estrogen steroid hormones are currently being evaluated in randomized clinical trials. A trial of topically applied 0.03% testosterone was reported to increase the percentage of patients that had meibomian gland secretions with normal viscosity and to relieve discomfort symptoms after 6 months of treatment compared to vehicle.¹⁴³ TFBUT and lipid layer thickness were observed to increase in a patient with KCS who was treated with topical androgen for 3 months.¹⁴⁴ Tear production and ocular irritation symptoms were reported to increase following treatment with topical 17 beta-oestradiol solution for 4 months.¹⁴⁵

3. Tetracyclines

a. Properties of Tetracyclines and Their Derivatives

1) Antibacterial Properties

The antimicrobial effect of oral tetracycline treatment analogues (eg, minocycline, doxycycline) has previously been discussed by Shine et al,¹⁴⁶ Dougherty et al,¹⁴⁷ and Ta et al.¹⁴⁸ It is hypothesized that a decrease in bacterial flora producing lipolytic exoenzymes^{146,148} and inhibition of lipase production¹⁴⁷ with resultant decrease in meibomian lipid breakdown products¹⁴⁶ may contribute to improvement in clinical parameters in dry eye-associated diseases.

2) Anti-Inflammatory Properties

The tetracyclines have anti-inflammatory as well as antibacterial properties that may make them useful for the management of chronic inflammatory diseases. These agents decrease the activity of collagenase, phospholipase A2, and several matrix metalloproteinases, and they decrease the production of interleukin (IL)-1 and tumor necrosis factor (TNF)-alpha in a wide range of tissues, including the corneal epithelium.¹⁴⁹⁻¹⁵¹ At high concentrations, tetracyclines inhibit staphylococcal exotoxin-induced cytokines and chemokines.^{152,153}

3) Anti-angiogenic Properties

Angiogenesis, the formation of new blood vessels, occurs in many diseases. These include benign conditions (eg, rosacea) and malignant processes (eg, cancer). Minocycline and doxycycline inhibit angiogenesis induced by implanted tumors in rabbit cornea.¹⁵⁴ The anti-angiogenic effect of tetracycline may have therapeutic implications in inflammatory processes accompanied by new blood vessel formation. Well-controlled studies must be performed, at both the laboratory and clinical levels, to investigate this potential.¹⁵⁵

b. Clinical Applications of Tetracycline

1) Acne Rosacea

Rosacea, including its ocular manifestations, is an inflammatory disorder, occurring mainly in adults, with peak severity in the third and fourth decades. Current recom-

recommendations are to treat rosacea with long-term doxycycline, minocycline, tetracycline, or erythromycin.¹⁵⁶ These recommendations may be tempered by certain recent reports that in women, the risk of developing breast cancer and of breast cancer morbidity increases cumulatively with duration of antibiotic use, including tetracyclines.^{157,158} Another large study did not substantiate these findings.¹⁵⁹

Tetracyclines and their analogues are effective in the treatment of ocular rosacea,^{160,161} for which a single daily dose of doxycycline may be effective.¹⁶² In addition to the anti-inflammatory effects of tetracyclines, their ability to inhibit angiogenesis may contribute to their effectiveness in rosacea-related disorders. Factors that promote angiogenesis include protease-triggered release of angiogenic factors stored in the extracellular matrix, inactivation of endothelial growth factor inhibitors, and release of angiogenic factors from activated macrophages.^{155,163}

Tetracyclines are also known to inhibit matrix metalloproteinase expression, suggesting a rationale for their use in ocular rosacea.¹⁶⁴ Although tetracyclines have been used for management of this disease, no randomized, placebo-controlled, clinical trials have been performed to assess their efficacy.¹³³

2) Chronic Posterior Blepharitis: Meibomianitis, Meibomian Gland Dysfunction

Chronic blepharitis is typically characterized by inflammation of the eyelids. There are multiple forms of chronic blepharitis, including staphylococcal, seborrheic (alone, mixed seborrheic/staphylococcal, seborrheic with meibomian seborrhea, seborrheic with secondary meibomitis), primary meibomitis, and others, like atopic, psoriatic, and fungal infections.¹⁶⁵ Meibomian gland dysfunction (MGD) has been associated with apparent aqueous-deficient dry eye. Use of tetracycline in patients with meibomianitis has been shown to decrease lipase production by tetracycline-sensitive as well as resistant strains of staphylococci. This decrease in lipase production was associated with clinical improvement.¹⁴⁷ Similarly, minocycline has been shown to decrease the production of diglycerides and free fatty acids in meibomian secretions. This may be due to lipase inhibition by the antibiotic or a direct effect on the ocular flora.¹⁴⁶ One randomized, controlled clinical trial of tetracycline in ocular rosacea compared symptom improvement in 24 patients treated with either tetracycline or doxycycline.¹⁶⁶ All but one patient reported an improvement in symptoms after 6 weeks of therapy. No placebo group was included in this trial.

A prospective, randomized, double-blind, placebo-controlled, partial crossover trial compared the effect of oxytetracycline to provide symptomatic relief of blepharitis with or without rosacea. Only 25% of the patients with blepharitis without rosacea responded to the antibiotic, whereas 50% responded when both diseases were present.¹⁶⁷ In another trial of 10 patients with both acne rosacea and concomitant meibomianitis, acne rosacea without concomitant ocular involvement, or seborrheic blepharitis, minocycline 50 mg daily for 2 weeks followed by 100 mg

daily for a total of 3 months significantly decreased bacterial flora ($P = 0.0013$). Clinical improvement was seen in all patients with meibomianitis.¹⁴⁸

Because of the improvement observed in small clinical trials of patients with meibomianitis, the American Academy of Ophthalmology recommends the chronic use of either doxycycline or tetracycline for the management of meibomianitis.¹⁶⁵ Larger randomized placebo-controlled trials assessing symptom improvement rather than surrogate markers are needed to clarify the role of this antibiotic in blepharitis treatment.¹⁵³ Tetracycline derivatives (eg, minocycline, doxycycline) have been recommended as treatment options for chronic blepharitis because of their high concentration in tissues, low renal clearance, long half-life, high level of binding to serum proteins, and decreased risk of photosensitization.¹⁶⁸

Several studies have described the beneficial effects of minocycline and other tetracycline derivatives (eg, doxycycline) in the treatment of chronic blepharitis.^{146,147,168,169} Studies have shown significant changes in the aqueous tear parameters, such as tear volume and tear flow, following treatment with tetracycline derivatives (eg, minocycline). One study also demonstrated a decrease in aqueous tear production that occurred along with clinical improvement.¹⁷⁰

A recently published randomized, prospective study by Yoo Se et al compared different doxycycline doses in 150 patients (300 eyes) who had chronic meibomian gland dysfunction and who did not respond to lid hygiene and topical therapy for more than 2 months.¹⁷¹ All topical therapy was stopped for at least 2 weeks prior to beginning the study. After determining the TFBU and Schirmer test scores, patients were divided into three groups: a high dose group (doxycycline, 200 mg, twice a day), a low dose group (doxycycline, 20 mg, twice a day) and a control group (placebo). After one month, TFBU, Schirmer scores, and symptoms improved. Both the high- and low-dose groups had statistically significant improvement in TFBU after treatment. This implies that low-dose doxycycline (20 mg twice a day) therapy may be effective in patients with chronic meibomian gland dysfunction.

3) Dosage and Safety

Systemic administration of tetracyclines is widely recognized for the ability to suppress inflammation and improve symptoms of meibomianitis.^{172,173} The optimal dosing schedule has not been established; however, a variety of dose regimens have been proposed including 50 or 100 mg doxycycline once a day,¹⁷⁴ or an initial dose of 50 mg a day for the first 2 weeks followed by 100 mg a day for a period of 2.5 months, in an intermittent fashion.^{146-148,170} Others have proposed use of a low dose of doxycycline (20 mg) for treatment of chronic blepharitis on a long-term basis.¹⁷¹ The safety issues associated with long-term oral tetracycline therapy, including minocycline, are well known. Many management approaches have been suggested for the use of tetracycline and its derivatives; however, a safe but adequate option in management needs to be considered because of

Table 2. Dry eye severity grading scheme

Dry Eye Severity Level	1	2	3	4*
Discomfort, severity & frequency	Mild and/or episodic occurs under environ stress	Moderate episodic or chronic, stress or no stress	Severe frequent or constant without stress	Severe and/or disabling and constant
Visual symptoms	None or episodic mild fatigue	Annoying and/or activity limiting episodic	Annoying, chronic and/or constant limiting activity	Constant and/or possibly disabling
Conjunctival injection	None to mild	None to mild	+/-	+ /++
Conjunctival staining	None to mild	Variable	Moderate to marked	Marked
Corneal staining (severity/location)	None to mild	Variable	Marked central	Severe punctate erosions
Corneal/tear signs	None to mild	Mild debris, ↓ meniscus	Filamentary keratitis, mucus clumping, ↑ tear debris	Filamentary keratitis, mucus clumping, ↑ tear debris, ulceration
Lid/meibomian glands	MGD variably present	MGD variably present	Frequent	Trichiasis, keratinization, symblepharon
TFBUT (sec)	Variable	≤ 10	≤ 5	Immediate
Schirmer score (mm/5 min)	Variable	≤ 10	≤ 5	≤ 2

*Must have signs AND symptoms. TFBUT: fluorescein tear break-up time. MGD: meibomian gland disease

Reprinted with permission from Behrens A, Doyle JJ, Stern L, et al. Dysfunctional tear syndrome. A Delphi approach to treatment recommendations. *Cornea* 2006;25:90-7

the new information regarding the potentially hazardous effects of prolonged use of oral antibiotics. A recent study suggested that a 3-month course of 100 mg of minocycline might be sufficient to bring significant meibomianitis under control, as continued control was maintained for at least 3 months after cessation of therapy.¹⁷⁰

In an experimental murine model of dry eye, topically applied doxycycline was found to preserve corneal epithelial smoothness and barrier function.¹⁴¹ It also preserved the integrity of corneal epithelial tight junctions in dry eyes, leading to a marked decrease in apical corneal epithelial cell desquamation.¹⁴² This corresponded to a decrease in MMP-9 protein in the corneal epithelium and reduced gelatinase activity in the corneal epithelium and tears.¹⁴¹

F. Essential Fatty Acids

Essential fatty acids are necessary for complete health. They cannot be synthesized by vertebrates and must be obtained from dietary sources. Among the essential fatty acids are 18 carbon omega-6 and omega-3 fatty acids. In the typical western diet, 20-25 times more omega-6 than omega-3 fatty acids are consumed. Omega-6 fatty acids are precursors for arachidonic acid and certain proinflammatory lipid mediators (PGE2 and LTB4). In contrast, certain omega-3 fatty acids (eg, EPA found in fish oil) inhibit the synthesis of these lipid mediators and block production of IL-1 and TNF-alpha.^{175,176}

A beneficial clinical effect of fish oil omega-3 fatty acids on rheumatoid arthritis has been observed in several

double-masked, placebo-controlled clinical trials.^{177,178} In a prospective, placebo-controlled clinical trial of the essential fatty acids, linoleic acid and gamma-linolenic acid administered orally twice daily produced significant improvement in ocular irritation symptoms and ocular surface lissamine green staining.¹⁷⁹ Decreased conjunctival HLA-DR staining also was observed.

G. Environmental Strategies

Factors that may decrease tear production or increase tear evaporation, such as the use of systemic anticholinergic medications (eg, antihistamines and antidepressants) and desiccating environmental stresses (eg, low humidity and air conditioning drafts) should be minimized or eliminated.¹⁸⁰⁻¹⁸² Video display terminals should be lowered below eye level to decrease the interpalpebral aperture, and patients should be encouraged to take periodic breaks with eye closure when reading or working on a computer.¹⁸³ A humidified environment is recommended to reduce tear evaporation. This is particularly beneficial in dry climates and high altitudes. Nocturnal lagophthalmos can be treated by wearing swim goggles, taping the eyelid closed, or tarsorrhaphy.

IV. TREATMENT RECOMMENDATIONS

In addition to material presented above, the subcommittee members reviewed the Dry Eye Preferred Practice Patterns of the American Academy of Ophthalmology and the International Task Force (ITF) Delphi Panel on dry

Table 3. Dry eye menu of treatments

Artificial tears substitutes
Gels/Ointments
Moisture chamber spectacles
Anti-inflammatory agents (topical CsA and corticosteroids, omega-3 fatty acids)
Tetracyclines
Plugs
Secretagogues
Serum
Contact lenses
Systemic immunosuppressives
Surgery (AMT, lid surgery, tarsorrhaphy, MM & SG transplant)

AMT = amniotic membrane transplantation; MM = mucous membrane; SG = salivary gland

eye treatment prior to formulating their treatment guidelines.^{184,185} The group favored the approach taken by the ITF, which based treatment recommendations on disease severity. A modification of the ITF severity grading scheme that contains 4 levels of disease severity based on signs and symptoms was formulated (Table 2). The subcommittee members chose treatments for each severity level from a menu of therapies for which evidence of therapeutic effect has been presented (Table 3). The treatment recommendations by severity level are presented in Table 4. It should be noted that these recommendations may be modified by practitioners based on individual patient profiles and clinical experience. The therapeutic recommendations for level 4 severity disease include surgical modalities to treat or prevent sight-threatening corneal complications. Discussion of these therapies is beyond the scope of this report.

V. UNANSWERED QUESTIONS AND FUTURE DIRECTIONS

There have been tremendous advances in the treatment of dry eye and ocular surface disease in the last two decades, including FDA approval of cyclosporin emulsion as the first therapeutic agent for treatment of KCS in the United States. There has been a commensurate increase in knowledge regarding the pathophysiology of dry eye. This has led to a paradigm shift in dry eye management from simply lubricating and hydrating the ocular surface with artificial tears to strategies that stimulate natural production of tear constituents, maintain ocular surface epithelial health and barrier function, and inhibit the inflammatory factors that adversely impact the ability of ocular surface and glandular epithelia to produce tears. Preliminary experience using this new therapeutic approach suggests that quality of life can be improved for many patients with dry eye and that initiating these strategies early in the course of the disease may prevent potentially blinding complications of dry eye. It is likely that future therapies will focus on

Table 4. Treatment recommendations by severity level**Level 1:**

Education and environmental/dietary modifications
Elimination of offending systemic medications
Artificial tear substitutes, gels/ointments
Eye lid therapy

Level 2:

If Level 1 treatments are inadequate, add:
Anti-inflammatories
Tetracyclines (for meibomianitis, rosacea)
Punctal plugs
Secretagogues
Moisture chamber spectacles

Level 3:

If Level 2 treatments are inadequate, add:
Serum
Contact lenses
Permanent punctal occlusion

Level 4:

If Level 3 treatments are inadequate, add:
Systemic anti-inflammatory agents
Surgery (lid surgery, tarsorrhaphy; mucus membrane, salivary gland, amniotic membrane transplantation)

Modified from: International Task Force Guidelines for Dry Eye¹⁸⁵

replacing specific tear factors that have an essential role in maintaining ocular surface homeostasis or inhibiting key inflammatory mediators that cause death or dysfunction of tear secreting cells. This will require additional research to identify these key factors and better diagnostic tests to accurately measure their concentrations in minute tear fluid samples. Furthermore, certain disease parameters may be identified that will identify whether a patient has a high probability of responding to a particular therapy. Based on the progress that has been made and the number of therapies in the pipeline, the future of dry eye therapy seems bright.

REFERENCES

(Parenthetical codes following references indicate level of evidence, as described in Table 1. CS = Clinical Study; BS = Basic Science.)

- Gilbard JP, Rossi SR, Heyda KG. Ophthalmic solutions, the ocular surface, and a unique therapeutic artificial tear formulation. *Am J Ophthalmol* 1989;107:348-55 (BS1)
- Gilbard JP. Human tear film electrolyte concentrations in health and dry-eye disease. *Int Ophthalmol Clin* 1994;34:27-36 (CS2)
- Schein O, Tielsch J, Munoz B, et al. Relation between signs and symptoms of dry eye in the elderly. *Ophthalmology* 1997;104:1395-1400 (CS2)
- Nelson JD, Gordon JF. Topical fibronectin in the treatment of keratoconjunctivitis sicca. Chiron Keratoconjunctivitis Sicca Study Group. *Am J Ophthalmol* 1992;114:441-7 (CS2)
- Nelson JD. Impression cytology. *Cornea* 1988;7:71-81 (BS1)
- Ubels J, McCartney M, Lantz W, et al. Effects of preservative-free artificial tear solutions on corneal epithelial structure and function. *Arch Ophthalmol* 1995;113:371-8 (BS1)
- Green K, MacKeen DL, Slagle T, Cheeks L. Tear potassium contributes to maintenance of corneal thickness. *Ophthalmic Res* 1992;24:99-102 (BS1)

8. Holly F, Lemp M. Surface chemistry of the tear film: Implications for dry eye syndromes, contact lenses, and ophthalmic polymers. *Contact Lens Soc Am J* 1971;5:12-9 (BS2)
9. Perrigan DM, Morgan A, Quintero S, et al. Comparison of osmolarity values of selected ocular lubricants. ARVO 2004 poster session 449
10. Kaufman B, Novack GD. Compliance issues in manufacturing of drugs. *Ocul Surf* 2003;1:80-5
11. Albietsz J, Bruce A. The conjunctival epithelium in dry eye subtypes: Effect of preserved and nonpreserved topical treatments. *Curr Eye Res* 2001;22:8-18 (CS2)
12. Gasset AR, Ishii Y, Kaufman H, Miller T. Cytotoxicity of ophthalmic preservatives. *Am J Ophthalmol* 1974;78:98-105 (BS1)
13. Wilson F. Adverse external effects of topical ophthalmic medications. *Surv Ophthalmol* 1979;24:57-88 (CS3)
14. Burstein N. Corneal cytotoxicity of topically applied drugs, vehicles and preservatives. *Surv Ophthalmol* 1980;25:15-30 (CS3)
15. Burstein N. The effects of topical drugs and preservatives on the tears and corneal epithelium in dry eye. *Trans Ophthalmol Soc UK*. 1985;104:402-9 (CS3)
16. Brubaker R, McLaren J. Uses of the fluorophotometer in glaucoma research. *Ophthalmology* 1985;92:884-90 (BS1)
17. Smith L, George M, Berdy G, Abelson M. Comparative effects of preservative free tear substitutes on the rabbit cornea: a scanning electron microscopic evaluation (ARVO abstract). *Invest Ophthalmol Vis Sci* 1991;32 (Suppl):733 (BS1)
18. Gilbard JP, Farris RL, Santamaria J 2nd. Osmolarity of tear microvolumes in keratoconjunctivitis sicca. *Arch Ophthalmol* 1978;96:677-81 (BS2)
19. Lopez Bernal D, Ubels JL. Quantitative evaluation of the corneal epithelial barrier: effect of artificial tears and preservatives. *Curr Eye Res* 1991;10:645-56 (BS1)
20. Bernal DL, Ubels JL. Artificial tear composition and promotion of recovery of the damaged corneal epithelium. *Cornea* 1993;12:115-20 (BS1)
21. Noecker R. Effects of common ophthalmic preservatives on ocular health. *Adv Ther* 2001;18:205-15 (CS1)
22. Tripathi BJ, Tripathi RC, Koli SP. Cytotoxicity of ophthalmic preservatives on human corneal epithelium. *Lens Eye Toxicity Res* 1992;9:361-75 (BS1)
23. Herrema J, Friedenwald J. Retardation of wound healing in the corneal epithelium by lanolin. *Am J Ophthalmol* 1950;33:1421 (CS3)
24. Nelson J, Drake M, Brewer J, Tuley M. Evaluation of physiologic tear substitute in patients with keratoconjunctivitis sicca. *Adv Exp Med Biol* 1994;350:453-7 (CS2)
25. Gilbard JP, Rossi SR. An electrolyte-based solution that increases corneal glyco-gen and conjunctival goblet-cell density in a rabbit model for keratoconjunctivitis sicca. *Ophthalmology* 1992;99:600-4 (BS1)
26. Lenton LM, Albietsz JM. Effect of carmellose-based artificial tears on the ocular surface in eyes after laser in situ keratomileusis. *J Refract Surg* 1999;15(2 Suppl):S227-S231 (CS2)
27. Slomiany BL, Slomiany A. Role of mucus in gastric mucosal protection. *J Physiol Pharmacol* 1991; 42:147-61 (BS1)
28. Gilbard JP. Tear film osmolarity and keratoconjunctivitis sicca. *CLAO J* 1985;11:243-50 (CS1)
29. Gilbard J. Tear film osmolarity and keratoconjunctivitis sicca. Lubbock TX, Dry Eye Institute, 1986 (CS3)
30. Gilbard J, Carter J, Sang D, et al. Morphologic effect of hyperosmolarity on rabbit corneal epithelium. *Ophthalmology* 1984;91:1205-12 (BS1)
31. Luo L, Li D, Corrales R, Pflugfelder S. Hyperosmolar saline is a proinflammatory stress on the mouse ocular surface. *Eye Contact Lens* 2005;31:186-93 (BS1)
32. Gilbard JP, Kenyon KR. Tear diluents in the treatment of keratoconjunctivitis sicca. *Ophthalmology* 1985;92:646-50 (CS2)
33. Holly F, Esquivel E. Colloid osmotic pressure of artificial tears. *J Ocul Pharmacol* 1985;1:327-36 (BS1)
34. Yancey PH. Organic osmolytes as compatible, metabolic and counteracting cryoprotectants in high osmolarity and other stresses. *J Exp Biol* 2005;208:2819-30 (BS2)
35. Holly F, Lemp M. Wettability and wetting of corneal epithelium. *Exp Eye Res* 1971;11:239-50 (BS1)
36. Hawi A, Smith T, Digenis G. A quantitative comparison of artificial tear clearance rates in humans using gamma scintigraphy (ARVO abstract). *Invest Ophthalmol Vis Sci* 1990;31 (Suppl):517 (BS1)
37. Argueso P, Tisdale A, Spurr-Michaud S, et al. Mucin characteristics of human corneal-limbal epithelial cells that exclude the rose bengal anionic dye. *Invest Ophthalmol Vis Sci* 2006;47:113-9 (BS1)
38. Versura P, Maltarello M, Stecher F, et al. Dry eye before and after therapy with hydroxypropylmethylcellulose. *Ophthalmologica* 1989;198:152-62 (CS3)
39. Simmons PA, Garrett Q, Xu S, et al. Interaction of carboxymethylcellulose with human corneal cells. ARVO 2006, E-Abstract 2759 (BS1)
40. Christiansen M, Cohen S, Rinehart J, et al. Clinical evaluation of an HP-guar gellable lubricant eye drop for the relief of dryness of the eye. *Curr Eye Res* 2004;28:55-62 (CS2)
41. Di Pascuale MA, Goto E, Tseng SC. Sequential changes of lipid tear film after the instillation of a single drop of a new emulsion eye drop in dry eye patients. *Ophthalmology* 2004;111:783-91 (CS2)
42. Korb DR, Scaffidi RC, Greiner JV, et al. The effect of two novel lubricant eye drops on tear film lipid layer thickness in subjects with dry eye symptoms. *Optom Vis Sci* 2005;82:594-601 (CS2)
43. Snibson GR, Greaves JL, Soper ND, et al. Precorneal residence times of sodium hyaluronate solutions studied by quantitative gamma scintigraphy. *Eye* 1990;4:594-602 (CS3)
44. Polack F, McNiece M. The treatment of dry eyes with NA hyaluronate (Healon). *Cornea* 1982;1:1333 (CS3)
45. Stuart JC, Linn JG. Dilute sodium hyaluronate (Healon) in the treatment of ocular surface disorders. *Ann Ophthalmol* 1985;17:190-2 (CS3)
46. DeLuise V, Peterson W. The use of topical Healon tears in the management of refractory dry-eye syndrome. *Ann Ophthalmol* 1984;16:823-4 (CS3)
47. Sand B, Marnar K, Norn M. Sodium hyaluronate in the treatment of keratoconjunctivitis sicca. *Acta Ophthalmol* 1989; 67:181-3 (CS3)
48. Nelson JD, Farris RL. Sodium hyaluronate and polyvinyl alcohol artificial tear preparations a comparison in patients with keratoconjunctivitis sicca. *Arch Ophthalmol* 1988;106:484-7 (CS2)
49. Beetham WP. Filamentary keratitis. *Trans Am Ophthalmol Soc* 1936;33:413-35 (CS1)
50. Foulds WS. Intracanalicular gelatin implants in the treatment of keratoconjunctivitis sicca. *Br J Ophthalmol* 1961;45:625-7 (CS2)
51. Freeman JM. The punctum plug: evaluation of a new treatment for the dry eye. *Trans Am Acad Ophthalmol Otolaryngol* 1975;79:OP874-9 (CS2)
52. Tuberville AW, Frederick WR, Wood TO. Punctal occlusion in tear deficiency syndromes. *Ophthalmology* 1982;89:1170-2 (CS2)
53. Willis RM, Folberg R, Krachmer JH, et al. The treatment of aqueous-deficient dry eye with removable punctal plugs. A clinical and impression-cytological study. *Ophthalmology* 1987;94:514-8 (CS2)
54. Gilbard JP, Rossi SR, Azar DT, Gray KL. Effect of punctal occlusion by Freeman silicone plug insertion on tear osmolarity in dry eye disorders. *CLAO J* 1989;15:216-8 (CS2)
55. Balaram M, Schaumberg DA, Dana MR. Efficacy and tolerability outcomes after punctal occlusion with silicone plugs in dry eye syndrome. *Am J Ophthalmol* 2001;131:30-6 (CS1)
56. Baxter SA, Laibson PR. Punctal plugs in the management of dry eyes. *Ocul Surf* 2004;2:255-65 (CS3)
57. Bartlett JD, Boan K, Corliss D, Gaddie IB. Efficacy of silicone punctal plugs as adjuncts to topical pharmacotherapy of glaucoma—a pilot study. Punctal Plugs in Glaucoma Study Group. *J Am Optom Assoc* 1996;67:664-8 (CS2)
58. Huang TC, Lee DA. Punctal occlusion and topical medications for glaucoma. *Am J Ophthalmol* 1989;107:151-5 (CS2)
59. Sugita J, Yokoi N, Fullwood NJ, et al. The detection of bacteria and bacterial biofilms in punctal plug holes. *Cornea* 2001;20: 362-5 (CS3)
60. Gerding H, Koppers J, Busse H. Symptomatic cicatricial occlusion of canaliculi after insertion of Herrick lacrimal plugs. *Am J Ophthalmol* 2003;136:926-8 (CS3)
61. Lee J, Flanagan JC. Complications associated with silicone intracanalicular plugs. *Ophthalm Plast Reconstr Surg* 2001;17:465-9 (CS3)
62. Paulsen F. The human lacrimal glands. *Adv Anat Embryol Cell Biol* 2003;170:III-XI,1-106 (BS1)
63. Yen MT, Pflugfelder SC, Feuer WJ. The effect of punctal occlusion on tear production, tear clearance, and ocular surface sensation in normal subjects. *Am J Ophthalmol* 2001;131:314-23 (CS2)
64. Tsubota K. The effect of wearing spectacles on the humidity of the eye. *Am J Ophthalmol* 1989;15:108-92-3 (BS2)
65. Tsubota K, Yamada M, Urayama K. Spectacle side panels and moist inserts for the treatment of dry-eye patients. *Cornea* 1994;13:197-201 (BS1)
66. Gresset J, Simonet P, Gordon D. Combination of a side shield with an ocular moisture chamber. *Am J Optom Physiol Opt* 1984;61:610-2 (CS3)
67. Savar DE. A new approach to ocular moisture chambers. *J Pediatr Ophthalmol Strabismus* 1978;15:51-3 (CS3)
68. Kurihashi K. Moisture aid during sleep for the treatment of dry eye: wet gauze eye mask. *Ophthalmologica* 1994;208:216-9 (CS3)
69. Nichols JJ, Ziegler C, Mitchell GL, Nichols KK. Self-reported dry eye dis-

- ease across refractive modalities. *Invest Ophthalmol Vis Sci* 2005;46:1911-4 (CS2)
70. Korb DR, Greiner JV, Glonek T, et al. Effect of periocular humidity on the tear film lipid layer. *Cornea* 1996;15:129-34 (BS2)
 71. Tsubota K, Hata S, Okusawa Y, et al. Quantitative videographic analysis of blinking in normal subjects and patients with dry eye. *Arch Ophthalmol* 1996;114:715-20 (BS1)
 72. Maruyama K, Yokoi N, Takamata A, Kinoshita S. Effect of environmental conditions on tear dynamics in soft contact lens wearers. *Invest Ophthalmol Vis Sci* 2004;45:2563-8 (BS1)
 73. Bacon AS, Astin C, Dart JK. Silicone rubber contact lenses for the compromised cornea. *Cornea* 1994;13:422-8 (CS3)
 74. Pullum KW, Whiting MA, Buckley RJ. Scleral contact lenses: the expanding role. *Cornea* 2005;24:269-77 (CS3)
 75. Tappin MJ, Pullum KW, Buckley RJ. Scleral contact lenses for overnight wear in the management of ocular surface disorders. *Eye* 2001;15(Pt 2):168-72 (CS3)
 76. Romero-Rangel T, Stavrou P, Cotter J, et al. Gas-permeable scleral contact lens therapy in ocular surface disease. *Am J Ophthalmol* 2000;130:25-32 (CS3)
 77. Rosenthal F, Cotter JM, Baum J. Treatment of persistent corneal epithelial defect with extended wear of a fluid-ventilated gas-permeable scleral contact lens. *Am J Ophthalmol* 2000;130:33-41 (CS3)
 78. Tauber J, Davitt WF, Bokosky JE, et al. Double-masked, placebo-controlled safety and efficacy trial of difluposol tetrasodium (INS365) ophthalmic solution for the treatment of dry eye. *Cornea* 2004;23:784-92 (CS1)
 79. Mundasad MV, Novack GD, Allgood VE, et al. Ocular safety of INS365 ophthalmic solution: a P2Y₂ agonist in healthy subjects. *J Ocul Pharmacol Ther* 2001;17:173-9 (CS1)
 80. Murakami T, Fujihara T, Horibe Y, Nakamura M. Difluposol elicits increases in net Cl⁻ transport through P2Y₂ receptor stimulation in rabbit conjunctiva. *Ophthalmic Res* 2004;36:89-93 (BS1)
 81. Li DQ, Lokeshwar BL, Solomon A, et al. Regulation of MMP-9 in human corneal epithelial cells. *Exp Eye Res* 2001;73:449-59 (BS1)
 82. Murakami T, Fujita H, Fujihara T, et al. Novel noninvasive sensitive determination of tear volume changes in normal cats. *Ophthalmic Res* 2002;34:371-4 (BS1)
 83. Yerxa BR, Mundasad M, Sylvester RN, et al. Ocular safety of INS365 ophthalmic solution, a P2Y₂ agonist, in patients with mild to moderate dry eye disease. *Adv Exp Med Biol* 2002;506(Pt B):1251-7 (BS2)
 84. Fujihara T, Murakami T, Fujita H, et al. Improvement of corneal barrier function by the P2Y₂ agonist INS365 in a rat dry eye model. *Invest Ophthalmol Vis Sci* 2001;42:96-100 (BS1)
 85. Fujihara T, Murakami T, Nagano T, et al. INS365 suppresses loss of corneal epithelial integrity by secretion of mucin-like glycoprotein in a rabbit short-term dry eye model. *J Ocul Pharmacol Ther* 2002;18:363-70 (BS1)
 86. Yerxa BR, Douglass JG, Elena PP, et al. Potency and duration of action of synthetic P2Y₂ receptor agonists on Schirmer scores in rabbits. *Adv Exp Med Biol* 2002;506(Pt A):261-5 (BS2)
 87. Urashima H, Okamoto T, Takeji Y, et al. Rebamipide increases the amount of mucin-like substances on the conjunctiva and cornea in the N-acetylcysteine-treated in vivo model. *Cornea* 2004;23:613-9 (BS1)
 88. Tanito M, Takanashi T, Kaidzu S, et al. Cytoprotective effects of rebamipide and caroteol hydrochloride against ultraviolet B-induced corneal damage in mice. *Invest Ophthalmol Vis Sci* 2003;44:2980-5 (BS3)
 89. Masuda K, Tokushige H, Ogawa T, et al. Effect of topical ecabet sodium on mucin levels in the tear fluid of patients with dry eye. *SERI-ARVO2003*.
 90. Tshida H, Nakata K, Hamano T, et al. Effect of gefarnate on the ocular surface in squirrel monkeys. *Cornea* 2002;21:292-9 (BS3)
 91. Nakamura M, Endo K, Nakata K, Hamano T. Gefarnate increases PAS positive cell density in rabbit conjunctiva. *Br J Ophthalmol* 1998;82:1320-3 (BS3)
 92. Nakamura M, Endo K, Nakata K, Hamano T. Gefarnate stimulates secretion of mucin-like glycoproteins by corneal epithelium in vitro and protects corneal epithelium from desiccation in vivo. *Exp Eye Res* 1997;65:569-74 (BS3)
 93. Toshida H, Nakata K, Hamano T, et al. Gefarnate stimulates goblet cell repopulation following an experimental wound to the tarsal conjunctiva in the dry eye rabbit. *Adv Exp Med Biol* 2002;506(Pt A):353-7 (BS 3)
 94. Hamano T. Dry eye treatment with eye drops that stimulate mucin production. *Adv Exp Med Biol* 1998;438:965-8 (CS3)
 95. Jumblatt JE, Cunningham L, Jumblatt MM. Effects of 15(S)-HETE on human conjunctival mucin secretion. *Adv Exp Med Biol* 2002;506(Pt A):323-7 (BS1)
 96. Gamache DA, Wei ZY, Weimer LK, et al. Corneal protection by the ocular mucin secretagogue 15(S)-HETE in a rabbit model of desiccation-induced corneal defect. *J Ocul Pharmacol Ther* 2002;18:349-61 (BS2)
 97. Jackson RS 2nd, Van Dyken SJ, McCartney MD, Ubels JL. The eicosanoid, 15-(S)-HETE, stimulates secretion of mucin-like glycoprotein by the corneal epithelium. *Cornea* 2001;20:516-21 (BS2)
 98. Azar RG, Edelhauser HF. Evaluation of the effects of 15(S)-HETE on corneal epithelial cells: an electrophysiological and cytochemical study. *Adv Exp Med Biol* 2002;506(Pt A):329-33 (BS3)
 99. Ubels JL, Aupperlee MD, Jackson RS 2nd, et al. Topically applied 15-(S)-HETE stimulates mucin production by corneal epithelium. *Adv Exp Med Biol* 2002;506(Pt A):317-21 (BS2)
 100. Gamache DA, Wei ZY, Weimer LK, et al. Preservation of corneal integrity by the mucin secretagogue 15(S)-HETE in a rabbit model of desiccation-induced dry eye. *Adv Exp Med Biol* 2002;506(Pt A):335-40 (BS2)
 101. Jumblatt JE, Cunningham LT, Li Y, Jumblatt MM. Characterization of human ocular mucin secretion mediated by 15(S)-HETE. *Cornea* 2002;21:818-24 (BS3)
 102. Vivino FB, Al-Hashimi I, Khan K, et al. Pilocarpine tablets for the treatment of dry mouth and dry eye symptoms in patients with Sjogren's syndrome. *Arch Intern Med* 1999;159:174-81 (CS1)
 103. Takaya M, Ichikawa Y, Yamada C, et al. Treatment with pilocarpine hydrochloride for sicca symptoms in Sjogren's syndrome. *Ryumachi* 1997;37:453-7 (CS2)
 104. Tsifetaki N, Kitsos G, Paschides CA, et al. Oral pilocarpine for the treatment of ocular symptoms in patients with Sjogren's syndrome: a randomized 12-week controlled study. *Ann Rheum Dis* 2003;62:1204-7 (CS2)
 105. Papas AS, Sherrer YS, Charney M, et al. Successful treatment of dry mouth and dry eye symptoms in Sjogren's syndrome patients with oral pilocarpine: A randomized, placebo-controlled, dose-adjustment study. *J Clin Rheumatol* 2004;4:169-77 (CS1)
 106. Aragona P, Di Pietro R, Spinella R, Moberic M. Conjunctival epithelium improvement after systemic pilocarpine in patients with Sjogren's syndrome. *Br J Ophthalmol* 2006;90:166-70 (CS2)
 107. Petrone D, Condemi JJ, Fife R, et al. Double-blind randomized placebo-controlled study of cevimeline in Sjogren's syndrome patients with xerostomia and keratoconjunctivitis sicca. *Arthritis Rheum* 2002;46:748-54 (CS1)
 108. Ono M, Takamura E, Shinozaki K, et al. Therapeutic effect of cevimeline on dry eye in patients with Sjogren's syndrome: a randomized, double-blind clinical study. *Am J Ophthalmol* 2004;138:6-17 (CS1)
 109. Geerling G, Daniels JT, Dart JK, et al. Toxicity of natural tear substitutes in a fully defined culture model of human corneal epithelial cells. *Invest Ophthalmol Vis Sci* 2001;42:948-56 (BS1)
 110. Geerling G, Honnicke K, Schroder C, et al. Quality of salivary tears following autologous submandibular gland transplantation for severe dry eye. *Graefes Arch Clin Exp Ophthalmol* 2000;38:45-52 (BS1)
 111. Tsubota K, Goto E, Fujita H, et al. Treatment of dry eye by autologous serum application in Sjogren's syndrome. *Br J Ophthalmol* 1999;83:390-5 (CS2)
 112. Geerling G, Hartwig D. Autologous serum eyedrops for ocular surface disorders, in Reinhard T, Larkin F (eds). *Cornea and external eye disease*. Berlin, Heidelberg, Springer, 2005, pp 2-19
 113. Liu L, Hartwig D, Harloff S, et al. An optimised protocol for the production of autologous serum eyedrops. *Graefes Arch Clin Exp Ophthalmol* 2005;243:706-14 (BS1)
 114. Tananuvat N, Daniell M, Sullivan LJ, et al. Controlled study of the use of autologous serum in dry eye patients. *Cornea* 2001;20:802-6 (CS1)
 115. Kojima T, Ishida R, Dogru M, et al. The effect of autologous serum eyedrops in the treatment of severe dry eye disease: a prospective randomized case-control study. *Am J Ophthalmol* 2005;139:242-6 (CS1)
 116. Noble BA, Loh RS, MacLennan S, et al. Comparison of autologous serum eye drops with conventional therapy in a randomised controlled crossover trial for ocular surface disease. *Br J Ophthalmol* 2004;88:647-52 (CS1)
 117. Noda-Tsuruya T, Asano-Kato N, Toda I, Tsubota K. Autologous serum eye drops for dry eye after LASIK. *J Refract Surg* 2006;22:61-6 (CS1)
 118. Schulze SD, Sekundo W, Kroll P. Autologous serum for the treatment of corneal epithelial abrasions in diabetic patients undergoing vitrectomy. *Am J Ophthalmol* 2006;142:207-11 (BS1)
 119. Geerling G, Sieg P, Bastian GO, Laqua H. Transplantation of the autologous submandibular gland for most severe cases of keratoconjunctivitis sicca. *Ophthalmology* 1998;105:327-35 (CS2)
 120. Schroder, Sieg P, Framme C, et al. [Transplantation of the submandibular gland in absolute dry eyes. Effect on the ocular surface]. *Klin Monatsbl Augenheilkd* 2002;219:494-501 (CS2)
 121. Luo L, Li DQ, Doshi A, et al. Experimental dry eye stimulates production

- of inflammatory cytokines and MMP-9 and activates MAPK signaling pathways on the ocular surface. *Invest Ophthalmol Vis Sci* 2004;45:4293-301 (BS1)
122. Niederkorn JY, Stern ME, Pflugfelder SC, et al. Desiccating stress induces T cell-mediated Sjogren's syndrome-like lacrimal keratoconjunctivitis. *J Immunol* 2006;176:3950-7 (BS1)
123. Kaswan RL, Salisbury MA, Ward DA. Spontaneous canine keratoconjunctivitis sicca. A useful model for human keratoconjunctivitis sicca: treatment with cyclosporine eye drops. *Arch Ophthalmol* 1989;107:1210-16 (BS2)
124. Gunduz K, Ozdemir O. Topical cyclosporin treatment of keratoconjunctivitis sicca in secondary Sjogren's syndrome. *Acta Ophthalmol* 1994;72:38-42 (CS2)
125. Laibovitz RA, Solch S, Andriano J. Pilot trial of cyclosporin 1% ophthalmic ointment in the treatment of keratoconjunctivitis sicca. *Cornea* 1993;12:315-23 (CS1)
126. Stevenson D, Tauber J, Reis BL. Efficacy and safety of cyclosporin A ophthalmic emulsion in the treatment of moderate-to-severe dry eye disease. A dose-ranging, randomized trial. *Ophthalmology* 2000;107:967-74 (CS1)
127. Sall K, Stevenson OD, Mundorf TK, Reis BL. Two multicenter, randomized studies of the efficacy and safety of cyclosporine ophthalmic emulsion in moderate to severe dry eye disease. *Ophthalmology* 2000;107:631-9 (CS1)
128. Kunert KS, Tisdale AS, Gipson IK. Goblet cell numbers and epithelial proliferation in the conjunctiva of patients with dry eye syndrome treated with cyclosporine. *Arch Ophthalmol* 2002;120:330-7 (BS1)
129. Brignole F, Pisella PJ, De Saint Jean M, et al. Flow cytometric analysis of inflammatory markers in KCS: 6-month treatment with topical cyclosporin A. *Invest Ophthalmol Vis Sci* 2001;42:90-5 (BS1)
130. Turner K, Pflugfelder SC, Ji Z, et al. Interleukin-6 levels in the conjunctival epithelium of patients with dry eye disease treated with cyclosporine ophthalmic emulsion. *Cornea* 2000;19:492-6 (BS1)
131. Kunert KS, Tisdale AS, Stern ME, Smith JA. Analysis of topical cyclosporine treatment of patients with dry eye syndrome: effect on conjunctival lymphocytes. *Arch Ophthalmol* 2000;118:1489-96 (BS1)
132. Pflugfelder SC, Maskin SL, Anderson B, et al. A randomized, double-masked, placebo-controlled, multicenter comparison of loteprednol etabonate ophthalmic suspension, 0.5%, and placebo for treatment of keratoconjunctivitis sicca in patients with delayed tear clearance. *Am J Ophthalmol* 2004;138:444-57 (CS1)
133. Avunduk AM, Avunduk MC, Varnell ED, Kaufman HE. The comparison of efficacies of topical corticosteroids and nonsteroidal antiinflammatory drops on dry eye patients: A clinical and immunocytochemical study. *Am J Ophthalmol* 2003;136:593-602 (CS1)
134. Sainz de la Maza Serra SM, Simon Castellvi C, Kabbani O. Nonpreserved topical steroids and punctal occlusion for severe keratoconjunctivitis sicca. *Arch Soc Esp Ophthalmol* 2000;75:751-56 (CS1)
135. Marsh P, Pflugfelder SC. Topical nonpreserved methylprednisolone therapy for keratoconjunctivitis sicca in Sjogren syndrome. *Ophthalmology* 1999;106:811-6 (CS3)
136. Pflugfelder SC. Antiinflammatory therapy for dry eye. *Am J Ophthalmol* 2004;137:337-42 (CS3)
137. Anonymous. Certain ophthalmic antibiotic combination drugs for human use; Drug efficacy study implementation. *Fed Reg* 1982;47:21296
138. Anonymous. Certain steroid preparations for ophthalmic and/or otic use. *Fed Reg* 1980a;45:57776-80
139. Anonymous. Certain ophthalmic antibiotic combination drugs for human use; Drug efficacy study implementation. *Fed Reg* 1980b;45:57780-3
140. Anonymous. Certain steroid preparations for ophthalmic or otic use. *Fed Reg* 1976;41:34340-2
141. De Paiva CS, Corrales RM, Villarreal AL, et al. Apical corneal barrier disruption in experimental murine dry eye is abrogated by methylprednisolone and doxycycline. *Invest Ophthalmol Vis Sci* 2006;47:2847-56 (BS1)
142. De Paiva CS, Corrales RM, Villarreal AL, et al. Corticosteroid and doxycycline suppress MMP-9 and inflammatory cytokine expression, MAPK activation in the corneal epithelium in experimental dry eye. *Exp Eye Res* 2006;83:526-35 (BS1)
143. Schiffman RM, Bradford R, Bunnell B, et al. A multicenter, double-masked, randomized, vehicle-controlled, parallel-group study to evaluate the safety and efficacy of testosterone ophthalmic solution in patients with meibomian gland dysfunction. ARVO 2006, E-Abstract 5608 (CS3)
144. Worda C, Nepp J, Huber J, Sator MO. Treatment of keratoconjunctivitis sicca with topical androgen. *Maturitas* 2001;37:209-12 (CS3)
145. Sator MO, Joura EA, Golaszewski T, et al. Treatment of menopausal keratoconjunctivitis sicca with topical oestradiol. *Br J Obstet Gynaecol* 1998;105:100-2 (CS2)
146. Shine WE, McCulley JP, Pandya AG. Minocycline effect on meibomian gland lipids in meibomianitis patients. *Exp Eye Res* 2003;76:417-20 (CS2)
147. Dougherty JM, McCulley JP, Silvany RE, et al. The role of tetracycline in chronic blepharitis. *Invest Ophthalmol Vis Sci* 1991;32:2970-5 (CS2)
148. Ta CN, Shine WE, McCulley JP, et al. Effects of minocycline on the ocular flora of patients with acne rosacea or seborrheic blepharitis. *Cornea* 2003;22:545-8 (CS2)
149. Solomon A, Rosenblatt M, Li DQ, et al. Doxycycline inhibition of interleukin-1 in the corneal epithelium. *Invest Ophthalmol Vis Sci* 2000;41:2544-57 (CS2)
150. Li Y, Kuang K, Yerxa B, et al. Rabbit conjunctival epithelium transports fluid, and P2Y2(2) receptor agonists stimulate Cl(-) and fluid secretion. *Am J Physiol Cell Physiol* 2001;281:C595-602 (BS1)
151. Li DQ, Luo L, Chen Z, et al. JNK and ERK MAP kinases mediate induction of IL-1beta, TNF-alpha and IL-8 following hyperosmolar stress in human limbal epithelial cells. *Exp Eye Res* 2006;82:588-96. Epub 2005 Oct 3 (BS1)
152. Krakauer T, Buckley M. Doxycycline is anti-inflammatory and inhibits staphylococcal exotoxin-induced cytokines and chemokines. *Antimicrob Agents Chemother* 2003;47:3630-3 (BS1)
153. Voils SA, Evans ME, Lane MT, et al. Use of macrolides and tetracyclines for chronic inflammatory diseases. *Ann Pharmacother* 2005;39:86-94 (CS3)
154. Tamargo RJ, Bok RA, Brem H. Angiogenesis inhibition by minocycline. *Cancer Res* 1991;51:672-5 (BS1)
155. Sapadin AN, Fleischmajer R. Tetracyclines: Nonantibiotic properties and their clinical implications *J Am Acad Dermatol* 2006;54:258-65 (CS3)
156. Habif TP. Clinical dermatology, 4th ed. St Louis: Mosby-Year Book, 2004, pp 162-89 (CS3)
157. Velicer CM, Heckbert SR, Lampe JW, et al. Antibiotic use in relation to the risk of breast cancer. *JAMA* 2004;291:827-35
158. Velicer CM, Heckbert SR, Rutter C, et al. Association between antibiotic use prior to breast cancer diagnosis and breast tumour characteristics (United States). *Cancer Causes Control (Netherlands)* 2006;17:307-13
159. Garcia Rodriguez LA, Gonzalez-Perez A. Use of antibiotics and risk of breast cancer. *Am J Epidemiology* 2005;161:616-9
160. Macdonald A, Feiwel M. Perioral dermatitis: aetiology and treatment with tetracycline. *Br J Dermatol* 1972;87:315-9 (CS3)
161. Jansen T, Plewig G. Rosacea: classification and treatment. *J R Soc Med* 1997;90:144-50 (CS3)
162. Frucht-Pery J, Chayet AS, Feldman ST, et al. The effect of doxycycline on ocular rosacea. *Am J Ophthalmol* 1989;107:434-5 (CS2)
163. Wilkin JK. Rosacea. pathophysiology and treatment. *Arch Dermatol* 1994;130:359-62 (BS1)
164. Stone DU, Chodosh J. Oral tetracyclines for ocular rosacea: an evidence-based review of the literature. *Cornea* 2004;23:106-9 (CS1)
165. McCulley JP, Dougherty JM, Deneau DG. Classification of chronic blepharitis. *Ophthalmology* 1982;89:1173-80 (CS2)
166. Frucht-Pery J, Sagi E, Hemo I, Ever-Hadani P. Efficacy of doxycycline and tetracycline in ocular rosacea. *Am J Ophthalmol* 1993;116:88-92 (CS1)
167. Seal DV, Wright P, Picker L, et al. Placebo controlled trial of fusidic acid gel and oxytetracycline for recurrent blepharitis and rosacea. *Br J Ophthalmol* 1995;79:42-5 (CS1)
168. Hoepflich PD, Warshauer DM. Entry of four tetracyclines into saliva and tears. *Antimicrob Agents Chemother* 1974;3:330-6 (BS1)
169. Gulbenkian A, Myers J, Freis D. Hamster flank organ hydrolase and lipase activity. *J Invest Dermatol* 1980;75:289-92 (BS1)
170. Aronowicz JD, Shine WE, Oral D, et al. Short term oral minocycline treatment of meibomianitis. *Br J Ophthalmol* 2006;90:856-60 (CS2)
171. Yoo SE, Lee DC, Chang MH. The effect of low-dose doxycycline therapy in chronic meibomian gland dysfunction. *Korean J Ophthalmol* 2005;19:258-63 (CS2)
172. Browning DJ, Proia AD. Ocular rosacea. *Surv Ophthalmol* 1986;31:145-58 (CS3)
173. Esterly NB, Koransky JS, Furey NL, et al. Neutrophil chemotaxis in patients with acne receiving oral tetracycline therapy. *Arch Dermatol* 1984;120:1308-13 (BS1)
174. Gilbard JP. The scientific context and basis of the pharmacologic management of dry eyes. *Ophthalmol Clin North Am* 2005;18:475-84, v (CS3)
175. James MJ, Gibson RA, Cleland LG. Dietary polyunsaturated fatty acids and inflammatory mediator production. *Am J Clin Nutr* 2000;71(1 Suppl):343S-8S (BS2)
176. Endres S, Ghorbani R, Kelley VE, et al. The effect of dietary supplementation with n-3 polyunsaturated fatty acids on the synthesis of interleukin-1 and tumor necrosis factor by mononuclear cells. *N Engl J Med*

DEWS MANAGEMENT AND THERAPY

- 1989;320:265-71 (BS1)
177. James MJ, Cleland LG. Dietary n-3 fatty acids and therapy for rheumatoid arthritis. *Semin Arthritis Rheum* 1997;27:85-97 (CS3)
178. Kremer JM. n-3 fatty acid supplements in rheumatoid arthritis. *Am J Clin Nutr* 2000;71(1 Suppl):349S-51S (CS1)
179. Barabino S, Rolando M, Camicione F, et al. Systemic linoleic and gamma-linolenic acid therapy in dry eye syndrome with an inflammatory component. *Cornea* 2003;22:97-101 (CS2)
180. Seedor JA, Lamberts D, Bergmann RB, Perry HD. Filamentary keratitis associated with diphenhydramine hydrochloride (Benadryl). *Am J Ophthalmol* 1986;101:376-7 (CS3)
181. Moss SE, Klein R, Klein BE. Prevalence of and risk factors for dry eye syndrome. *Arch Ophthalmol* 2000;118:1264-68
182. Mader TH, Stulting RD. Keratoconjunctivitis sicca caused by diphenoxylate hydrochloride with atropine sulfate (Lomotil). *Am J Ophthalmol* 1991;111:377-8 (CS2)
183. Tsubota K, Nakamura K. Dry eyes and video display terminals. *N Engl J Med* 1993;25:328-584 (CS2)
184. Matoba AY, Harris DJ, Mark DB, et al. Dry eye syndrome, American Academy of Ophthalmology, 2003
185. Behrens A, Doyle JJ, Stern L, et al. Dysfunctional tear syndrome: A Delphi approach to treatment recommendations. *Cornea* 2006;25:900-7

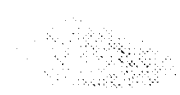

EXHIBIT E