

**IN THE UNITED STATES PATENT AND TRADEMARK OFFICE**

Applicant: Acheampong, *et al.*

Serial No.: TBA

Filed: Herewith

For: METHODS OF PROVIDING  
THERAPEUTIC EFFECTS USING  
CYCLOSPORIN COMPONENTS

Examiner: TBA

Group Art Unit: TBA

Confirmation No. TBA

Customer No.: 51957

**PRELIMINARY AMENDMENT**

Commissioner for Patents  
P.O. Box 1450  
Alexandria, VA 22313-1450

Dear Sir:

Prior to examining the above-referenced application, please amend the specification as described on page 2 of this paper, and please amend the claims as described on pages 3-6 of this paper. Remarks follow on page 7.

Amendments to the Specification

Please replace page 1, lines 5-10 of the specification filed herewith with the following amended paragraph:

This application is a continuation of copending U.S. Application Serial No. 13/961,808 filed August 7, 2013, which is a continuation of copending U.S. Application Serial No. 11/897,177, filed August 28, 2007, which is a continuation of U.S. Application Serial No. 10/927,857, filed August 27, 2004, now abandoned, which claimed the benefit of U.S. Provisional Application No. 60/503,137 filed September 15, 2003, which ~~is~~ are incorporated in ~~its~~ their entirety herein by reference.

Amendments to the claims

The following list of claims will replace all previous versions of claims presented in this application:

1. – 36. (Canceled)

37. (New) A topical ophthalmic emulsion for treating an eye of a human, wherein the topical ophthalmic emulsion comprises cyclosporin A in an amount of about 0.05% by weight, polysorbate 80, Pemulen, water, and castor oil in an amount of about 1.25% by weight; and

wherein the topical ophthalmic emulsion is therapeutically effective in treating dry eye disease.

38. (New) The topical ophthalmic emulsion of Claim 37, wherein the topical ophthalmic emulsion further comprises a tonicity agent or a demulcent component.

39. (New) The topical ophthalmic emulsion of Claim 38, wherein the tonicity agent or the demulcent component is glycerine.

40. (New) The topical ophthalmic emulsion of Claim 37, wherein the topical ophthalmic emulsion further comprises a buffer.

41. (New) The topical ophthalmic emulsion of Claim 40, wherein the buffer is sodium hydroxide.

42. (New) The topical ophthalmic emulsion of Claim 37, wherein the topical ophthalmic emulsion further comprises glycerine and a buffer.

43. (New) The topical ophthalmic emulsion of Claim 37, wherein the topical ophthalmic emulsion comprises polysorbate 80 in an amount of about 1.0% by weight.

44. (New) The topical ophthalmic emulsion of Claim 37, wherein the topical ophthalmic emulsion comprises Pemulen in an amount of about 0.05% by weight.

45. (New) The topical ophthalmic emulsion of Claim 37, wherein the topical ophthalmic emulsion further comprises glycerine in an amount of about 2.2% by weight and a buffer.

46. (New) The topical ophthalmic emulsion of Claim 45, wherein the buffer is sodium hydroxide.

47. (New) The topical ophthalmic emulsion of Claim 37, wherein, when the topical ophthalmic emulsion is administered to an eye of a human in an effective amount in treating dry eye disease, the blood of the human has substantially no detectable concentration of cyclosporin A.

48. (New) The topical ophthalmic emulsion of Claim 42, wherein the topical ophthalmic emulsion has a pH in the range of about 7.2 to about 7.6.

49. (New) The topical ophthalmic emulsion of Claim 37, wherein the topical ophthalmic emulsion is as substantially therapeutically effective as an emulsion comprising cyclosporin A in an amount of 0.1% by weight and castor oil in an amount of 1.25% by weight.

50. (New) The topical ophthalmic emulsion of Claim 37, wherein the topical ophthalmic emulsion achieves at least as much therapeutic effectiveness as an emulsion comprising cyclosporin A in an amount of 0.1% by weight and castor oil in an amount of 1.25% by weight.

51. (New) The topical ophthalmic emulsion of Claim 37, wherein the topical ophthalmic emulsion breaks down more quickly in the eye of a human, once administered to the eye of the human, thereby reducing vision distortion in the eye of the human as compared to an emulsion that contains only 50% as much castor oil.

52. (New) The topical ophthalmic emulsion of Claim 37, wherein the topical ophthalmic emulsion, when administered to the eye of a human, demonstrates a reduction in adverse events in the human, relative to an emulsion comprising cyclosporin A in an amount of 0.1% by weight and castor oil in an amount of 1.25% by weight.

53. (New) The topical ophthalmic emulsion of Claim 52, wherein the adverse events include side effects.

54. (New) A topical ophthalmic emulsion for treating an eye of a human, wherein the topical ophthalmic emulsion is therapeutically effective in treating dry eye and wherein the topical ophthalmic emulsion comprises:

cyclosporin A in an amount of about 0.05% by weight;

castor oil in an amount of about 1.25% by weight;

polysorbate 80 in an amount of about 1.0% by weight;

Pemulen in an amount of about 0.05% by weight;

a tonicity component or a demulcent component in an amount of about 2.2% by weight;

a buffer; and

water.

55. (New) The topical ophthalmic emulsion of Claim 54, wherein the buffer is sodium hydroxide.

56. (New) The topical ophthalmic emulsion of Claim 54, wherein the tonicity component or the demulcent component is glycerine.

57. (New) The topical ophthalmic emulsion of Claim 54, wherein, when the topical ophthalmic emulsion is administered to an eye of a human in an effective amount in treating dry eye disease, the blood of the human has substantially no detectable concentration of the cyclosporin A.

58. (New) The topical ophthalmic emulsion of Claim 54, wherein the topical ophthalmic emulsion has a pH in the range of about 7.2 to about 7.6.

59. (New) A topical ophthalmic emulsion for treating an eye of a human, the topical ophthalmic emulsion comprising:

cyclosporin A in an amount of about 0.05% by weight;

castor oil in an amount of about 1.25% by weight;

polysorbate 80 in an amount of about 1.0% by weight;

Pemulen in an amount of about 0.05% by weight;

glycerine in an amount of about 2.2% by weight;

sodium hydroxide; and

water;

wherein the emulsion is therapeutically effective in treating dry eye disease.

60. (New) The topical ophthalmic emulsion of Claim 59, wherein the topical ophthalmic emulsion has a pH in the range of about 7.2 to about 7.6.

REMARKS

The applicants have canceled claims 1-36 and have added claims 37-60. Support for the limitations recited in the new claims may be found throughout the specification, and at least at page 5, lines 5-14, page 26, lines 5-19, and page 27, lines 4-31 of the application specification filed herewith. No new matter has been added.

The claims of the present application may vary in scope from the claims pursued in the parent applications. To the extent any prior amendments or characterizations of the scope of any claim, or the specification, or referenced art could be construed as a disclaimer of any subject matter supported by the present disclosure, the Applicants hereby rescind and retract such disclaimer.

Specifically, the Applicants would like to bring to the Examiner's attention comments made in the Response filed on June 15, 2009 in U.S. Patent Application Serial No. 10/927,857 (now abandoned) and comments made in the Amendment filed on June 15, 2009 in U.S. Patent Application Serial No. 11/897,177 (currently pending) regarding U.S. Patent No. 5,474,979 and the present application specification. Since these comments have been filed, the Applicants have collected evidence that supports the patentability of the pending claims.

The Commissioner is hereby authorized to charge any fees required or necessary for the filing, processing or entering of this paper or any of the enclosed papers, and to refund any overpayment, to deposit account 01-0885.

Respectfully submitted,

/Laura L. Wine/

---

Laura L. Wine  
Attorney of Record  
Registration Number 68,681

Date: August 14, 2013

Please direct all inquiries and correspondence to:  
Laura L. Wine, Esq.  
Allergan, Inc.  
2525 Dupont Drive, T2-7H  
Irvine, California 92612  
Tel: (714) 246-6996 Fax: (714) 246-4249

**CERTIFICATION AND REQUEST FOR PRIORITIZED EXAMINATION  
 UNDER 37 CFR 1.102(e)** (Page 1 of 1)

|                       |  |   |  |
|-----------------------|--|---|--|
| First Named Inventor: | <b>Andrew Acheampong</b>   | Nonprovisional Application Number (if known): |  |
| Title of Invention:   | <b>METHODS OF PROVIDING THERAPEUTIC EFFECTS USING CYCLOSPORIN COMPONENTS</b> |   |  |

**APPLICANT HEREBY CERTIFIES THE FOLLOWING AND REQUESTS PRIORITIZED EXAMINATION FOR THE ABOVE-IDENTIFIED APPLICATION.**

1. The processing fee set forth in 37 CFR 1.17(i)(1), the prioritized examination fee set forth in 37 CFR 1.17(c), and if not already paid, the publication fee set forth in 37 CFR 1.18(d) have been filed with the request. The basic filing fee, search fee, examination fee, and any required excess claims and application size fees are filed with the request or have been already been paid.
2. The application contains or is amended to contain no more than four independent claims and no more than thirty total claims, and no multiple dependent claims.
3. The applicable box is checked below:

**I.  Original Application (Track One) - Prioritized Examination under § 1.102(e)(1)**

- i. (a) The application is an original nonprovisional utility application filed under 35 U.S.C. 111(a). This certification and request is being filed with the utility application via EFS-Web.  
 ---OR---  
 (b) The application is an original nonprovisional plant application filed under 35 U.S.C. 111(a). This certification and request is being filed with the plant application in paper.
- ii. The executed inventor's oath or declaration is filed with the application. (37 CFR 1.63 and 1.64)

**II.  Request for Continued Examination - Prioritized Examination under § 1.102(e)(2)**

- i. A request for continued examination has been filed with, or prior to, this form.
- ii. If the application is a utility application, this certification and request is being filed via EFS-Web.
- iii. The application is an original nonprovisional utility application filed under 35 U.S.C. 111(a), or is a national stage entry under 35 U.S.C. 371.
- iv. This certification and request is being filed prior to the mailing of a first Office action responsive to the request for continued examination.
- v. No prior request for continued examination has been granted prioritized examination status under 37 CFR 1.102(e)(2).

|   |   |
|---|---|
| Signature <b>/Laura L. Wine/</b>        | Date <b>August 14, 2013</b>                   |
| Name (Print/Typed) <b>Laura L. Wine</b> | Practitioner Registration Number <b>68681</b> |

**Note:** This form must be signed in accordance with 37 CFR 1.33. See 37 CFR 1.4(d) for signature requirements and certifications. Submit multiple forms if more than one signature is required.\*

\*Total of 1 forms are submitted.



## Privacy Act Statement

The **Privacy Act of 1974 (P.L. 93-579)** requires that you be given certain information in connection with your submission of the attached form related to a patent application or patent. Accordingly, pursuant to the requirements of the Act, please be advised that: (1) the general authority for the collection of this information is 35 U.S.C. 2(b)(2); (2) furnishing of the information solicited is voluntary; and (3) the principal purpose for which the information is used by the U.S. Patent and Trademark Office is to process and/or examine your submission related to a patent application or patent. If you do not furnish the requested information, the U.S. Patent and Trademark Office may not be able to process and/or examine your submission, which may result in termination of proceedings or abandonment of the application or expiration of the patent.

The information provided by you in this form will be subject to the following routine uses:

1. The information on this form will be treated confidentially to the extent allowed under the Freedom of Information Act (5 U.S.C. 552) and the Privacy Act (5 U.S.C. 552a). Records from this system of records may be disclosed to the Department of Justice to determine whether disclosure of these records is required by the Freedom of Information Act.
2. A record from this system of records may be disclosed, as a routine use, in the course of presenting evidence to a court, magistrate, or administrative tribunal, including disclosures to opposing counsel in the course of settlement negotiations.
3. A record in this system of records may be disclosed, as a routine use, to a Member of Congress submitting a request involving an individual, to whom the record pertains, when the individual has requested assistance from the Member with respect to the subject matter of the record.
4. A record in this system of records may be disclosed, as a routine use, to a contractor of the Agency having need for the information in order to perform a contract. Recipients of information shall be required to comply with the requirements of the Privacy Act of 1974, as amended, pursuant to 5 U.S.C. 552a(m).
5. A record related to an International Application filed under the Patent Cooperation Treaty in this system of records may be disclosed, as a routine use, to the International Bureau of the World Intellectual Property Organization, pursuant to the Patent Cooperation Treaty.
6. A record in this system of records may be disclosed, as a routine use, to another federal agency for purposes of National Security review (35 U.S.C. 181) and for review pursuant to the Atomic Energy Act (42 U.S.C. 218(c)).
7. A record from this system of records may be disclosed, as a routine use, to the Administrator, General Services, or his/her designee, during an inspection of records conducted by GSA as part of that agency's responsibility to recommend improvements in records management practices and programs, under authority of 44 U.S.C. 2904 and 2906. Such disclosure shall be made in accordance with the GSA regulations governing inspection of records for this purpose, and any other relevant (*i.e.*, GSA or Commerce) directive. Such disclosure shall not be used to make determinations about individuals.
8. A record from this system of records may be disclosed, as a routine use, to the public after either publication of the application pursuant to 35 U.S.C. 122(b) or issuance of a patent pursuant to 35 U.S.C. 151. Further, a record may be disclosed, subject to the limitations of 37 CFR 1.14, as a routine use, to the public if the record was filed in an application which became abandoned or in which the proceedings were terminated and which application is referenced by either a published application, an application open to public inspection or an issued patent.
9. A record from this system of records may be disclosed, as a routine use, to a Federal, State, or local law enforcement agency, if the USPTO becomes aware of a violation or potential violation of law or regulation.

## Electronic Patent Application Fee Transmittal

| <b>Application Number:</b>  |   |          |        |                      |
|---|---|----------|--------|----------------------|
| <b>Filing Date:</b>   |   |          |        |                      |
| <b>Title of Invention:</b>  | METHODS OF PROVIDING THERAPEUTIC EFFECTS USING CYCLOSPORIN COMPONENTS |          |        |                      |
| <b>First Named Inventor/Applicant Name:</b>   | Andrew Acheampong   |          |        |                      |
| <b>Filer:</b>   | Laura Lee Wine/Lauren Barberena                                       |          |        |                      |
| <b>Attorney Docket Number:</b>  | 17618CON2B (AP)   |          |        |                      |
| Filed as Large Entity   |   |          |        |                      |
| <b>Track I Prioritized Examination - Nonprovisional Application under 35 USC 111(a) Filing Fees</b> |   |          |        |                      |
| Description   | Fee Code  | Quantity | Amount | Sub-Total in USD(\$) |
| <b>Basic Filing:</b>  |   |          |        |                      |
| Utility application filing  | 1011  | 1        | 280    | 280                  |
| Utility Search Fee  | 1111  | 1        | 600    | 600                  |
| Utility Examination Fee   | 1311  | 1        | 720    | 720                  |
| Request for Prioritized Examination   | 1817  | 1        | 4000   | 4000                 |
| <b>Pages:</b>   |   |          |        |                      |
| <b>Claims:</b>  |   |          |        |                      |
| Claims in Excess of 20  | 1202  | 3        | 80     | 240                  |
| <b>Miscellaneous-Filing:</b>  |   |          |        |                      |

| Description                              | Fee Code | Quantity | Amount | Sub-Total in USD(\$) |
|--|----------|----------|--------|----------------------|
| Publ. Fee- Early, Voluntary, or Normal   | 1504     | 1        | 300    | 300                  |
| OTHER PUBLICATION PROCESSING FEE         | 1808     | 1        | 130    | 130                  |
| <b>Petition:</b>                         |          |          |        |                      |
| <b>Patent-Appeals-and-Interference:</b>  |          |          |        |                      |
| <b>Post-Allowance-and-Post-Issuance:</b> |          |          |        |                      |
| <b>Extension-of-Time:</b>                |          |          |        |                      |
| <b>Miscellaneous:</b>                    |          |          |        |                      |
| <b>Total in USD (\$)</b>                 |          |          |        | <b>6270</b>          |

## Electronic Acknowledgement Receipt

|   |   |
|---|---|
| <b>EFS ID:</b>                              | 16593528  |
| <b>Application Number:</b>                  | 13967189  |
| <b>International Application Number:</b>    |   |
| <b>Confirmation Number:</b>                 | 4818  |
| <b>Title of Invention:</b>                  | METHODS OF PROVIDING THERAPEUTIC EFFECTS USING CYCLOSPORIN COMPONENTS |
| <b>First Named Inventor/Applicant Name:</b> | Andrew Acheampong   |
| <b>Customer Number:</b>                     | 51957   |
| <b>Filer:</b>                               | Laura Lee Wine/Lauren Barberena                                       |
| <b>Filer Authorized By:</b>                 | Laura Lee Wine  |
| <b>Attorney Docket Number:</b>              | 17618CON2B (AP)   |
| <b>Receipt Date:</b>                        | 14-AUG-2013   |
| <b>Filing Date:</b>                         |   |
| <b>Time Stamp:</b>                          | 18:56:04  |
| <b>Application Type:</b>                    | Utility under 35 USC 111(a)   |

### Payment information:

|  |                 |
|--|-----------------|
| Submitted with Payment                   | yes             |
| Payment Type                             | Deposit Account |
| Payment was successfully received in RAM | \$6270          |
| RAM confirmation Number                  | 6280            |
| Deposit Account                          | 010885          |
| Authorized User                          |                 |

The Director of the USPTO is hereby authorized to charge indicated fees and credit any overpayment as follows:  
Charge any Additional Fees required under 37 C.F.R. Section 1.17 (Patent application and reexamination processing fees)  
Charge any Additional Fees required under 37 C.F.R. Section 1.21 (Miscellaneous fees and charges)

| <b>File Listing:</b>   |  |                                 |   |                         |                         |
|--|--|---------------------------------|---|-------------------------|-------------------------|
| <b>Document Number</b>   | <b>Document Description</b>                                | <b>File Name</b>                | <b>File Size(Bytes)/ Message Digest</b>             | <b>Multi Part /.zip</b> | <b>Pages (if appl.)</b> |
| 1  |  | 17618CON_SPEC.pdf               | 4360450<br>9b080e02f8cb41c5b767d994b15dca09f38dd180 | yes                     | 34                      |
|  | <b>Multipart Description/PDF files in .zip description</b> |                                 |   |                         |                         |
|  | <b>Document Description</b>                                |                                 | <b>Start</b>  | <b>End</b>              |                         |
|  | Specification  |                                 | 1   | 28                      |                         |
|  | Claims   |                                 | 29  | 33                      |                         |
| Abstract   |  | 34                              | 34  |                         |                         |
| <b>Warnings:</b>   |  |                                 |   |                         |                         |
| <b>Information:</b>  |  |                                 |   |                         |                         |
| 2  | Application Data Sheet                                     | 17618CON2B_ADS.pdf              | 1505486<br>76589eca6d26b270f1c4b8b6c49ac7f0c916afd9 | no                      | 8                       |
| <b>Warnings:</b>   |  |                                 |   |                         |                         |
| <b>Information:</b>  |  |                                 |   |                         |                         |
| 3  | Oath or Declaration filed                                  | 17618CON2B_DECS.pdf             | 628594<br>53d34ff82a0d42446d338021a29746cdcec3bc75  | no                      | 6                       |
| <b>Warnings:</b>   |  |                                 |   |                         |                         |
| The page size in the PDF is too large. The pages should be 8.5 x 11 or A4. If this PDF is submitted, the pages will be resized upon entry into the Image File Wrapper and may affect subsequent processing |  |                                 |   |                         |                         |
| <b>Information:</b>  |  |                                 |   |                         |                         |
| 4  | Power of Attorney  | 17618CON2B_POA.pdf              | 1931208<br>b399b0ff4cef322968c0420686c4c8839483b79  | no                      | 2                       |
| <b>Warnings:</b>   |  |                                 |   |                         |                         |
| <b>Information:</b>  |  |                                 |   |                         |                         |
| 5  |  | 17618CON2B_PRELIM_AMENDMENT.pdf | 106412<br>581cda4dfcb1b3b1c241b35cd16682e00108f716  | yes                     | 7                       |
|  | <b>Multipart Description/PDF files in .zip description</b> |                                 |   |                         |                         |
|  | <b>Document Description</b>                                |                                 | <b>Start</b>  | <b>End</b>              |                         |
|  | Preliminary Amendment                                      |                                 | 1   | 1                       |                         |
| Specification  |  | 2                               | 2   |                         |                         |

|  |  |   |   |
|--|--|---|---|
|  | Claims   | 3 | 6 |
|  | Applicant Arguments/Remarks Made in an Amendment | 7 | 7 |

**Warnings:**

**Information:**

|   |                  |                                     |   |    |   |
|---|------------------|-------------------------------------|---|----|---|
| 6 | TrackOne Request | 17618CON2B_PRIORITIZED_EX<br>AM.pdf | 153236<br><small>26dfacc03da02daa83f2ddb89a2c3ab62cc535b5</small> | no | 2 |
|---|------------------|-------------------------------------|---|----|---|

**Warnings:**

**Information:**

|   |                      |              |  |    |   |
|---|----------------------|--------------|--|----|---|
| 7 | Fee Worksheet (SB06) | fee-info.pdf | 42020<br><small>9aa08e84c0b4ec795b5f25400b1798c19ba060eb</small> | no | 2 |
|---|----------------------|--------------|--|----|---|

**Warnings:**

**Information:**

|                                     |  |  |         |
|-------------------------------------|--|--|---------|
| <b>Total Files Size (in bytes):</b> |  |  | 8727406 |
|-------------------------------------|--|--|---------|

**This Acknowledgement Receipt evidences receipt on the noted date by the USPTO of the indicated documents, characterized by the applicant, and including page counts, where applicable. It serves as evidence of receipt similar to a Post Card, as described in MPEP 503.**

**New Applications Under 35 U.S.C. 111**

**If a new application is being filed and the application includes the necessary components for a filing date (see 37 CFR 1.53(b)-(d) and MPEP 506), a Filing Receipt (37 CFR 1.54) will be issued in due course and the date shown on this Acknowledgement Receipt will establish the filing date of the application.**

**National Stage of an International Application under 35 U.S.C. 371**

**If a timely submission to enter the national stage of an international application is compliant with the conditions of 35 U.S.C. 371 and other applicable requirements a Form PCT/DO/EO/903 indicating acceptance of the application as a national stage submission under 35 U.S.C. 371 will be issued in addition to the Filing Receipt, in due course.**

**New International Application Filed with the USPTO as a Receiving Office**

**If a new international application is being filed and the international application includes the necessary components for an international filing date (see PCT Article 11 and MPEP 1810), a Notification of the International Application Number and of the International Filing Date (Form PCT/RO/105) will be issued in due course, subject to prescriptions concerning national security, and the date shown on this Acknowledgement Receipt will establish the international filing date of the application.**

METHODS OF PROVIDING THERAPEUTIC EFFECTS  
USING CYCLOSPORIN COMPONENTS

5 Related Application

This application is a continuation of U.S. Application Serial No. 10/927,857, filed August 27, 2004, which claimed the benefit of U.S. Provisional Application No. 60/503,137 filed September 15, 2003, which is incorporated in its  
10 entirety herein by reference.

Background of the Invention

The present invention relates to methods of providing desired therapeutic effects to humans or animals using  
15 compositions including cyclosporin components. More particularly, the invention relates to methods including administering to an eye of a human or animal a therapeutically effective amount of a cyclosporin component to provide a desired therapeutic effect, preferably a  
20 desired ophthalmic or ocular therapeutic effect.

The use of cyclosporin-A and cyclosporin A derivatives to treat ophthalmic conditions has been the subject of various patents, for example Ding et al U.S. Patent 5,474,979; Garst U.S. Patent 6,254,860; and Garst U.S.  
25 6,350,442, this disclosure of each of which is incorporated in its entirety herein by reference. In addition, cyclosporin A compositions used in treating ophthalmic conditions is the subject of a number of publications. Such publications include, for example, "Blood  
30 concentrations of cyclosporin a during long-term treatment with cyclosporin a ophthalmic emulsions in patients with moderate to severe dry eye disease," Small et al, *J Ocul Pharmacol Ther*, 2002 Oct, 18(5):411-8; "Distribution of

cyclosporin A in ocular tissues after topical administration to albino rabbits and beagle dogs," Acheampong et al, *Curr Eye Res*, 1999 Feb, 18(2):91-103b; "Cyclosporine distribution into the conjunctiva, cornea, lacrimal gland, and systemic blood following topical dosing of cyclosporine to rabbit, dog, and human eyes," Acheampong et al, *Adv Exp Med Biol*, 1998, 438:1001-4; "Preclinical safety studies of cyclosporine ophthalmic emulsion," Angelov et al, *Adv Exp Med Biol*, 1998, 438:991-5; 10 "Cyclosporin & Emulsion & Eye," Stevenson et al, *Ophthalmology*, 2000 May, 107(5):967-74; and "Two multicenter, randomized studies of the efficacy and safety of cyclosporine ophthalmic emulsion in moderate to severe dry eye disease. CsA Phase 3 Study Group," Sall et al, 15 *Ophthalmology*, 2000 Apr, 107(4):631-9. Each of these publications is incorporated in its entirety herein by reference. In addition, cyclosporin A-containing oil-in-water emulsions have been clinically tested, under conditions of confidentiality, since the mid 1990's in order to obtain U.S. Food and Drug Administration (FDA) 20 regulatory approval.

Examples of useful cyclosporin A-containing emulsions are set out in Ding et al U.S. Patent 5,474,979. Example 1 of this patent shows a series of emulsions in which the 25 ratio of cyclosporin A to castor oil in each of these compositions was 0.08 or greater, except for Composition B, which included 0.2% by weight cyclosporin A and 5% by weight castor oil. The Ding et al patent placed no significance in Composition B relative to Compositions A, C and D of Example 1. 30

Over time, it has become apparent that cyclosporin A emulsions for ophthalmic use preferably have less than 0.2%



by weight of cyclosporin A. With cyclosporin A concentrations less than 0.2%, the amount of castor oil employed has been reduced since one of the functions of the castor oil is to solubilize the cyclosporin A. Thus, if  
5 reduced amounts of cyclosporin are employed, reduced amounts of castor oil are needed to provide effective solubilization of cyclosporin A.

There continues to be a need for providing enhanced methods of treating ophthalmic or ocular conditions with  
10 cyclosporin-containing emulsions.

#### Summary of the Invention

New methods of treating a human or animal using cyclosporin component-containing emulsions have been  
15 discovered. Such methods provide substantial overall efficacy in providing desired therapeutic effects. In addition, other important benefits are obtained employing the present methods. For example, patient safety is enhanced. In particular, the present methods provide for  
20 reduced risks of side effects and/or drug interactions. Prescribing physicians advantageously have increased flexibility in prescribing such methods and the compositions useful in such methods, for example, because of the reduced risks of harmful side effects and/or drug  
25 interactions. The present methods can be easily practiced.

In short, the present methods provide substantial and acceptable overall efficacy, together with other advantages, such as increased safety and/or flexibility.

In one aspect of the present invention, the present  
30 methods comprise administering to an eye of a human or animal a composition in the form of an emulsion comprising water, a hydrophobic component and a cyclosporin component

in a therapeutically effective amount of less than 0.1% by weight of the composition. The weight ratio of the cyclosporin component to the hydrophobic component is less than 0.08.

5           It has been found that the relatively increased amounts of hydrophobic component together with relatively reduced, yet therapeutically effective, amounts of cyclosporin component provide substantial and advantageous benefits. For example, the overall efficacy of the present  
10 compositions, for example in treating dry eye disease, is substantially equal to an identical composition in which the cyclosporin component is present in an amount of 0.1% by weight. Further, a relatively high concentration of hydrophobic component is believed to provide for a more  
15 quick or rapid breaking down or resolving of the emulsion in the eye, which reduces vision distortion which may be caused by the presence of the emulsion in the eye and/or facilitates the therapeutic effectiveness of the composition. Additionally, and importantly, using reduced  
20 amounts of the active cyclosporin component mitigates against undesirable side effects and/or potential drug interactions.

In short, the present invention provides at least one advantageous benefit, and preferably a plurality of  
25 advantageous benefits.

The present methods are useful in treating any suitable condition which is therapeutically sensitive to or treatable with cyclosporin components. Such conditions preferably are ophthalmic or ocular conditions, that is  
30 relating to or having to do with one or more parts of an eye of a human or animal. Included among such conditions are, without limitation, dry eye syndrome,

phacoanaphylactic endophthalmitis, uveitis, vernal conjunctivitis, atopic keratoconjunctivitis, corneal graft rejection and the like conditions. The present invention is particularly effective in treating dry eye syndrome.

5       Employing reduced concentrations of cyclosporin component, as in the present invention, is advantageously effective to provide the blood of the human or animal under treatment with reduced concentrations of cyclosporin component, preferably with substantially no detectable  
10 concentration of the cyclosporin component. The cyclosporin component concentration of blood can be advantageously measured using a validated liquid chromatography/mass spectrometry-mass spectrometry (VLC/MS-MS) analytical method, such as described elsewhere herein.

15       In one embodiment, in the present methods the blood of the human or animal has concentrations of cyclosporin component of 0.1 ng/ml or less.

Any suitable cyclosporin component effective in the present methods may be used.

20       Cyclosporins are a group of nonpolar cyclic oligopeptides with known immunosuppressant activity. Cyclosporin A, along with several other minor metabolites, cyclosporin B through I, have been identified. In addition, a number of synthetic analogs have been prepared.

25       In general, commercially available cyclosporins may contain a mixture of several individual cyclosporins which all share a cyclic peptide structure consisting of eleven amino acid residues with a total molecular weight of about 1,200, but with different substituents or configurations of  
30 some of the amino acids.

The term "cyclosporin component" as used herein is intended to include any individual member of the

cyclosporin group and derivatives thereof, as well as mixtures of two or more individual cyclosporins and derivatives thereof.

Particularly preferred cyclosporin components include, without limitation, cyclosporin A, derivatives of cyclosporin A and the like and mixtures thereof. Cyclosporin A is an especially useful cyclosporin component.

Any suitable hydrophobic component may be employed in the present invention. Advantageously, the cyclosporin component is solubilized in the hydrophobic component. The hydrophobic component may be considered as comprising a discontinuous phase in the presently useful cyclosporin component-containing emulsions.

The hydrophobic component preferably is present in the emulsion compositions in an amount greater than about 0.625% by weight. For example, the hydrophobic component may be present in an amount of up to about 1.0% by weight or about 1.5% by weight or more of the composition.

Preferably, the hydrophobic component comprises one or more oily materials. Examples of useful oil materials include, without limitation, vegetable oils, animal oils, mineral oils, synthetic oils and the like and mixtures thereof. In a very useful embodiment, the hydrophobic component comprises one or more higher fatty acid glycerides. Excellent results are obtained when the hydrophobic component comprises castor oil.

The presently useful compositions may include one or more other components in amounts effective to facilitate the usefulness and effectiveness of the compositions. Examples of such other components include, without limitation, emulsifier components, tonicity components,

polyelectrolyte components, surfactant components, viscosity inducing components, acids and/or bases to adjust the pH of the composition, buffer components, preservative components and the like. Components may be employed which are effective to perform two or more functions in the presently useful compositions. For example, components which are effective as both emulsifiers and surfactants may be employed, and/or components which are effective as both polyelectrolyte components and viscosity inducing components may be employed. The specific composition chosen for use in the present invention advantageously is selected taking into account various factors present in the specific application at hand, for example, the desired therapeutic effect to be achieved, the desired properties of the compositions to be employed, the sensitivities of the human or animal to whom the composition is to be administered, and the like factors.

The presently useful compositions advantageously are ophthalmically acceptable. A composition, component or material is ophthalmically acceptable when it is compatible with ocular tissue, that is, it does not cause significant or undue detrimental effects when brought into contact with ocular tissues.

Such compositions have pH's within the physiological range of about 6 to about 10, preferably in a range of about 7.0 to about 8.0 and more preferably in a range of about 7.2 to about 7.6.

The present methods preferably provide for an administering step comprising topically administering the presently useful compositions to the eye or eyes of a human or animal.

Each and every feature described herein, and each and

every combination of two or more of such features, is included within the scope of the present invention provided that the features included in such a combination are not mutually inconsistent.

5           These and other aspects and advantages of the present invention are apparent in the following detailed description, example and claims.

#### Detailed Description

10           The present methods are effective for treating an eye of a human or animal. Such methods, in general, comprise administering, preferably topically administering, to an eye of a human or animal a cyclosporin component-containing emulsion. The emulsion contains water, for example U.S.  
15 pure water, a hydrophobic component and a cyclosporin component in a therapeutically effective amount of less than 0.1% by weight of the emulsion. In addition, beneficial results have been found when the weight ratio of the cyclosporin component to the hydrophobic component is  
20 less than 0.08.

          As noted above, the present administering step preferably includes topically administering the emulsion to the eye of a patient of a human or animal. Such administering may involve a single use of the presently  
25 useful compositions, or repeated or periodic use of such compositions, for example, as required or desired to achieve the therapeutic effect to be obtained. The topical administration of the presently useful composition may involve providing the composition in the form of eye drops  
30 or similar form or other form so as to facilitate such topical administration.

          The present methods have been found to be very

effective in providing the desired therapeutic effect or effects while, at the same time, substantially reducing, or even substantially eliminating, side effects which may result from the presence of the cyclosporin component in the blood of the human or animal being treated, and eye irritation which, in the past, has been caused by the presence of certain components in prior art cyclosporin-containing emulsions. Also, the use of the present compositions which include reduced amounts of the cyclosporin components allow for more frequent administration of the present compositions to achieve the desired therapeutic effect or effects without substantially increasing the risk of side effects and/or eye irritation.

The present methods are useful in treating any condition which is therapeutically sensitive to or treatable with cyclosporin components. Such conditions preferably are ophthalmic or ocular conditions, that is relating to or having to do with one or more parts of an eye of a human or animal. Included among such conditions are, without limitation, dry eye syndrome, phacoanaphylactic endophthalmitis, uveitis, vernal conjunctivitis, atopic kerapoconjunctivitis, corneal graft rejection and the like conditions. The present invention is particularly effective in treating dry eye syndrome.

The frequency of administration and the amount of the presently useful composition to use during each administration varies depending upon the therapeutic effect to be obtained, the severity of the condition being treated and the like factors. The presently useful compositions are designed to allow the prescribing physician substantial flexibility in treating various ocular conditions to achieve the desired therapeutic effect or effects with

reduced risk of side effects and/or eye irritation. Such administration may occur on an as needed basis, for example, in treating or managing dry eye syndrome, on a one time basis or on a repeated or periodic basis once, twice, 5 thrice or more times daily depending on the needs of the human or animal being treated and other factors involved in the application at hand.

One of the important advantages of the present invention is the reduced concentration of the cyclosporin component in the blood of the human or animal as a result 10 of administering the present composition as described herein. One very useful embodiment of the present administering step provides no substantial detectable concentration of cyclosporin component in the blood of the 15 human or animal. Cyclosporin component concentration in blood preferably is determined using a liquid chromatography-mass spectroscopy-mass spectroscopy (LC-MS/MS), which test has a cyclosporin component detection limit of 0.1 ng/ml. Cyclosporin component concentrations 20 below or less than 0.1 ng/ml are therefore considered substantially undetectable.

The LC-MS/MS test is advantageously run as follows.

One ml of blood is acidified with 0.2 ml of 0.1 N HCl solution, then extracted with 5 ml of methyl t-butyl ether. 25 After separation from the acidified aqueous layer, the organic phase is neutralized with 2 ml of 0.1 N NaOH, evaporated, reconstituted in a water/acetonitrile-based mobil phase, and injected onto a 2.1 x 50 mm, 3µm pore size C-8 reverse phase high pressure liquid chromatography 30 (HPLC) column (Keystone Scientific, Bellefonte, PA). Compounds are gradient-eluted at 0.2 mL/min and detected using an API III triple quadrupole mass spectrometer with a



turbo-ionspray source (PE-Sciex, Concord, Ontario, Canada).

Molecular reaction monitoring enhances the sensitivity and selectivity of this assay. Protonated molecules for the analyte and an internal standard are collisionally dissociated and product ions at  $m/z$  425 are monitored for the analyte and the internal standard. Under these conditions, cyclosporin A and the internal standard cyclosporin G elute with retention times of about 3.8 minutes. The lower limit of quantitation is 0.1 ng/mL, at which concentration the coefficient of variation and deviation from nominal concentration is <15%.

As noted previously, any suitable cyclosporin component effective in the present methods may be employed.

Very useful cyclosporin components include, without limitation, cyclosporin A, derivatives of cyclosporin A and the like and mixtures thereof.

The chemical structure for cyclosporin A is represented by Formula 1

Formula I

5

10

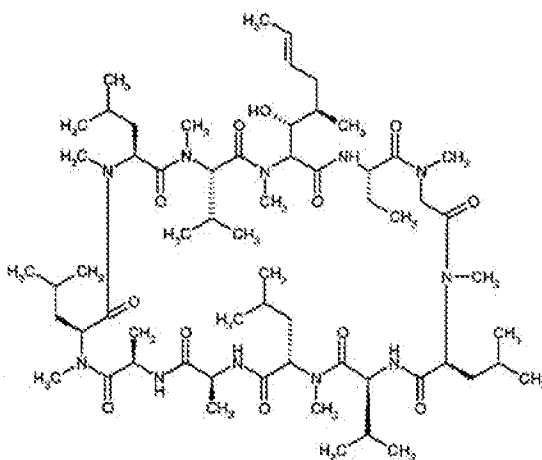

15

As used herein the term "derivatives" of a cyclosporin refer to compounds having structures sufficiently similar to the cyclosporin so as to function in a manner substantially similar to or substantially identical to the cyclosporin, for example, cyclosporin A, in the present methods. Included, without limitation, within the useful cyclosporin A derivatives are those selected from ((R)-methylthio-Sar)<sup>3</sup>-(4'-hydroxy-MeLeu) cyclosporin A, ((R)-

20 (Cyclo)alkylthio-Sar)<sup>3</sup>-(4'-hydroxy-MeLeu)<sup>4</sup>-cyclosporin A, and ((R)-(Cyclo)alkylthio-Sar)<sup>3</sup>-cyclosporin A derivatives described below.

25 These cyclosporin derivatives are represented by the following general formulas (II), (III), and (IV) respectively:

30

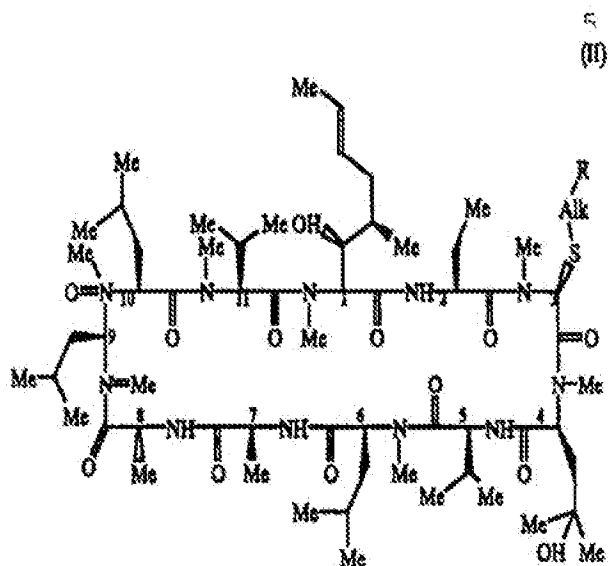
Formula II

20

Formula III

25

30

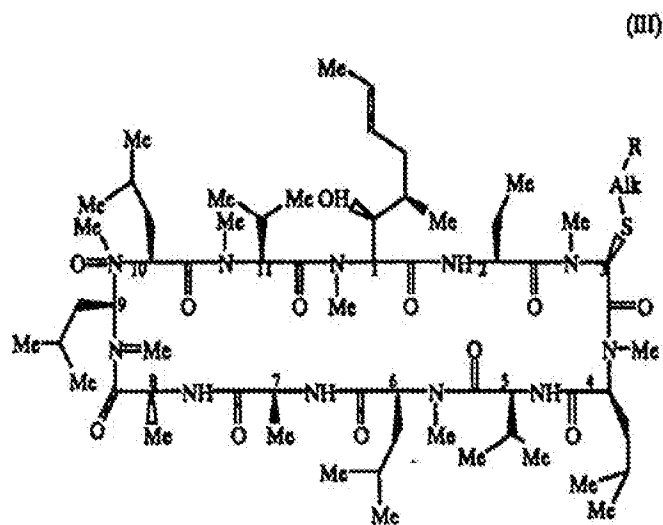

Formula IV

5

(f)

10

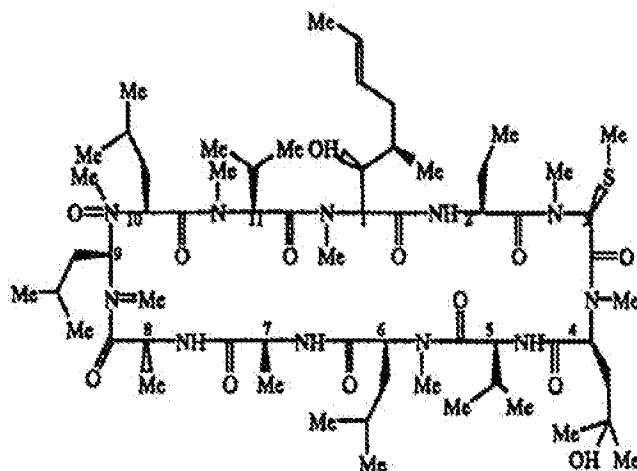

15

wherein Me is methyl; Alk is 2-6C alkylene or 3-6C cycloalkylene; R is OH, COOH, alkoxy-carbonyl,  $-NR_1R_2$  or  $N(R_3)-(CH_2)_n-NR_1R_2$ ; wherein  $R_1, R_2$  is H, alkyl, 3-6C cycloalkyl, phenyl (optionally substituted by halo, alkoxy, alkoxy-carbonyl, amino, alkylamino or dialkylamino), benzyl or saturated or unsaturated heterocyclyl having 5 or 6 members and 1-3 heteroatoms; or  $NR_1R_2$  is a 5 or 6 membered heterocycle which may contain a further N, O or S heteroatom and may be alkylated;  $R_3$  is H or alkyl and n is 2-4; and the alkyl moieties contain 1-4C.

In one embodiment, the cyclosporin component is effective as an immunosuppressant. Without wishing to be limited to any particular theory of operation, it is believed that, in certain embodiments of the present invention, the cyclosporin component acts to enhance or restore lacrimal gland tearing in providing the desired

therapeutic effect.

One important feature of the present invention is that the presently useful compositions contain less than 0.1% by weight of the cyclosporin component. The advantages of such low-concentrations of cyclosporin components have been discussed in some detail elsewhere herein. Low concentrations of cyclosporin component, together with concentrations of the hydrophobic component such that the weight ratio of cyclosporin component to hydrophobic component is greater than 0.08, provides one or more substantial advantages in the present methods.

Any suitable hydrophobic component may be employed in the present invention. Such hydrophobic component may be considered as comprising a discontinuous phase in the presently useful cyclosporin component-containing emulsions, with the water or aqueous phase being considered the continuous phase in such emulsion. The hydrophobic component is preferably selected so as to solubilize the cyclosporin component, which is often substantially insoluble in the aqueous phase. Thus, with a suitable hydrophobic component included in the presently useful emulsions, the cyclosporin component is preferably solubilized in the emulsions.

In one very useful embodiment, the hydrophobic component comprises an oily material, in particular, a material which is substantially not miscible in water. Examples of useful oily materials include, without limitation, vegetable oils, animal oils, mineral oils, synthetic oils, and the like and mixtures thereof. Thus, the present hydrophilic components may comprise naturally occurring oils, including, without limitation refined naturally occurring oils, or naturally occurring oils which

have been processed to alter their chemical structures to some extent or oils which are substantially entirely synthetic. One very useful hydrophobic component includes higher fatty acid glycerides.

5           Examples of useful hydrophobic components include, without limitation, olive oil, arachis oil, castor oil, mineral oil, silicone fluid and the like and mixtures thereof. Higher fatty acid glycerides such as olive oil, peanut oil, castor oil and the like and mixtures thereof  
10 are particularly useful in the present invention. Excellent results are obtained using a hydrophobic component comprising castor oil. Without wishing to limit the invention to any particular theory of operation, it is believed that castor oil includes a relatively high  
15 concentration of ricinoleic acid which itself may be useful in benefitting ocular tissue and/or in providing one or more therapeutic effects when administered to an eye.

          The hydrophobic component is preferably present in the presently useful cyclosporin component-containing emulsion  
20 compositions in an amount greater than about 0.625% by weight. For example, the hydrophobic component may be present in an amount up to about 0.75% by weight or about 1.0% by weight or about 1.5% by weight or more of the presently useful emulsion compositions.

25           The presently useful compositions may include one or more other components in amounts effective to facilitate the usefulness and effectiveness of the present methods and/or the presently useful compositions. Examples of such other components include, without limitation, emulsifier  
30 components, surfactant components, tonicity components, poly electrolyte components, emulsion stability components, viscosity inducing components, demulcent components, acid

and/or bases to adjust the pH of the composition, buffer components, preservative components and the like.

In one very useful embodiment, the presently useful compositions are substantially free of preservatives.  
5 Thus, the presently useful compositions may be sterilized and maintained in a sterile condition prior to use, for example, provided in a sealed package or otherwise maintained in a substantially sterile condition.

Any suitable emulsifier component may be employed in  
10 the presently useful compositions, provided, that such emulsifier component is effective in forming maintaining the emulsion and/or in the hydrophobic component in emulsion, while having no significant or undue detrimental effect or effects on the compositions during storage or  
15 use.

In addition, the presently useful compositions, as well as each of the components of the present compositions in the concentration present in the composition advantageously are ophthalmically acceptable.

20 Useful emulsifier components may be selected from such component which are conventionally used and well known in the art. Examples of such emulsifier components include, without limitation, surface active components or surfactant components which may be anionic, cationic, nonionic or  
25 amphorteric in nature. In general, the emulsifier component includes a hydrophobic constituent and a hydrophilic constituent. Advantageously, the emulsifier component is water soluble in the presently useful compositions. Preferably, the emulsifier component is  
30 nonionic. Specific examples of suitable emulsifier components include, without limitation, polysorbate 80, polyoxyalkylene alkylene ethers, polyalkylene oxide ethers

of alkyl alcohols, polyalkylene oxide ethers of alkylphenols, other emulsifiers/surfactants, preferably nonionic emulsifiers/surfactants, useful in ophthalmic compositions, and the like and mixtures thereof.

5       The emulsifier component is present in an amount effective in forming the present emulsion and/or in maintaining the hydrophobic component in emulsion with the water or aqueous component. In one preferred embodiment, the emulsifier component is present in an amount in a range  
10 of about 0.1% to about 5%, more preferably about 0.2% to about 2% and still more preferably about 0.5% to about 1.5% by weight of the presently useful compositions.

Polyelectrolyte or emulsion stabilizing components may be included in the presently useful compositions. Such  
15 components are believed to be effective in maintaining the electrolyte balance in the presently useful emulsions, thereby stabilizing the emulsions and preventing the emulsions from breaking down prior to use. In one embodiment, the presently useful compositions include a  
20 polyanionic component effective as an emulsion stabilizing component. Examples of suitable polyanionic components useful in the presently useful compositions include, without limitation, anionic cellulose derivatives, anionic acrylic acid-containing polymers, anionic methacrylic acid-  
25 containing polymers, anionic amino acid-containing polymers and the like and mixtures thereof.

A particularly useful class of polyanionic components include one or more polymeric materials having multiple anionic charges. Examples include, but are not limited to:

30

metal carboxy methylcelluloses  
metal carboxy methylhydroxyethylcelluloses



- metal carboxy methylstarchs
- metal carboxy methylhydroxyethylstarchs
- hydrolyzed polyacrylamides and polyacrylonitriles
- heparin
- 5 gucoaminoglycans
- hyaluronic acid
- chondroitin sulfate
- dermatan sulfate
- peptides and polypeptides
- 10 alginic acid
- metal alginates
- homopolymers and copolymers of one or more of:
  - acrylic and methacrylic acids
  - metal acrylates and methacrylates
  - 15 vinylsulfonic acid
  - metal vinylsulfonate
  - amino acids, such as aspartic acid, glutamic acid and the like
  - metal salts of amino acids
  - 20 p-styrenesulfonic acid
  - metal p-styrenesulfonate
  - 2-methacryloyloxyethylsulfonic acids
  - metal 2-methacryloyloxethylsulfonates
  - 3-methacryloyloxy-2-hydroxypropylsulfonic acids
  - 25 metal 3-methacryloyloxy-2-
    - hydroxypropylsulfonates
  - 2-acrylamido-2-methylpropanesulfonic acids
  - metal 2-acrylamido-2-methylpropanesulfonates
  - allylsulfonic acid
  - 30 metal allylsulfonate and the like.

One particularly useful emulsion stabilizing component

includes crosslinked polyacrylates, such as carbomers and Pemulen® materials. Pemulen® is a registered trademark of B.F. Goodrich for polymeric emulsifiers and are commercially available from B.F. Goodrich Company, Specialty Polymers & Chemicals Division, Cleveland, Ohio. Pemulen® materials include acrylate/C10-30 alkyl acrylate cross-polymers, or high molecular weight co-polymers of acrylic acid and a long chain alkyl methacrylate cross-linked with allyl ethers of pentaerythritol.

10 The presently useful polyanionic components may also be used to provide a suitable viscosity to the presently useful compositions. Thus, the polyanionic components may be useful in stabilizing the presently useful emulsions and in providing a suitable degree of viscosity to the  
15 presently useful compositions.

The polyelectrolyte or emulsion stabilizing component advantageously is present in an amount effective to at least assist in stabilizing the cyclosporin component-containing emulsion. For example, the  
20 polyelectrolyte/emulsion stabilizing component may be present in an amount in a range of about 0.01% by weight or less to about 1% by weight or more, preferably about 0.02% by weight to about 0.5% by weight, of the composition.

Any suitable tonicity component may be employed in  
25 accordance with the present invention. Preferably, such tonicity component is non-ionic, for example, in order to avoid interfering with the other components in the presently useful emulsions and to facilitate maintaining the stability of the emulsion prior to use. Useful  
30 tonicity agents include, without limitation, glycerine, mannitol, sorbitol and the like and mixtures thereof. The presently useful emulsions are preferably within the range

of plus or minus about 20% or about 10% from being isotonic.

Ophthalmic demulcent components may be included in effective amounts in the presently useful compositions. For example, ophthalmic demulcent components such as carboxymethylcellulose, other cellulose polymers, dextran 70, gelatin, glycerine, polyethylene glycols (e.g., PEG 300 and PEG 400), polysorbate 80, propylene glycol, polyvinyl alcohol, povidone and the like and mixtures thereof, may be used in the present ophthalmic compositions, for example, compositions useful for treating dry eye.

The demulcent components are preferably present in the compositions, for example, in the form of eye drops, in an amount effective in enhancing the lubricity of the presently useful compositions. The amount of demulcent component in the present compositions may be in a range of at least about 0.01% or about 0.02% to about 0.5% or about 1.0% by weight of the composition.

Many of the presently useful polyelectrolyte/emulsion stabilizing components may also be effective as demulcent components, and vice versa. The emulsifier/surfactant components may also be effective as demulcent components and vice versa.

The pH of the emulsions can be adjusted in a conventional manner using sodium hydroxide and/or hydrochloric acid to a physiological pH level. The pH of the presently useful emulsions preferably is in the range of about 6 to about 10, more preferably about 7.0 to about 8.0 and still more preferably about 7.2 to about 7.6.

Although buffer components are not required in the presently useful compositions, suitable buffer components, for example, and without limitation, phosphates, citrates,

acetates, borates and the like and mixtures thereof, may be employed to maintain a suitable pH in the presently useful compositions.

5 The presently useful compositions may include an effective amount of a preservative component. Any suitable preservative or combination of preservatives may be employed. Examples of suitable preservatives include, without limitation, benzalkonium chloride, methyl and ethyl parabens, hexetidine, phenyl mercuric salts and the like  
10 and mixtures thereof. The amounts of preservative components included in the present compositions are such to be effective in preserving the compositions and can vary based on the specific preservative component employed, the specific composition involved, the specific application  
15 involved, and the like factors. Preservative concentrations often are in the range of about 0.00001% to about 0.05% or about 0.1% (w/v) of the composition, although other concentrations of certain preservatives may be employed.

20 Very useful examples of preservative components in the present invention include, but are not limited to, chlorite components. Specific examples of chlorite components useful as preservatives in accordance with the present invention include stabilized chlorine dioxide (SCD), metal  
25 chlorites such as alkali metal and alkaline earth metal chlorites, and the like and mixtures thereof. Technical grade (or USP grade) sodium chlorite is a very useful preservative component. The exact chemical composition of many chlorite components, for example, SCD, is not  
30 completely understood. The manufacture or production of certain chlorite components is described in McNicholas U.S. Patent 3,278,447, which is incorporated in its entirety by

reference herein. Specific examples of useful SCD products include that sold under the trademark Dura Klor by Rio Linda Chemical Company, Inc., and that sold under the trademark Anthium Dioxide® by International Dioxide, Inc.

5 An especially useful SCD is a product sold under the trademark Bio-Cide® by Bio-Cide International, Inc., as well as a product identified by Allergan, Inc. by the trademark Purite®.

Other useful preservatives include antimicrobial  
10 peptides. Among the antimicrobial peptides which may be employed include, without limitation, defensins, peptides related to defensins, cecropins, peptides related to cecropins, magainins and peptides related to magainins and  
15 other amino acid polymers with antibacterial, antifungal and/or antiviral activities. Mixtures of antimicrobial peptides or mixtures of antimicrobial peptides with other preservatives are also included within the scope of the present invention.

The compositions of the present invention may include  
20 viscosity modifying agents or components, such as cellulose polymers, including hydroxypropyl methyl cellulose (HPMC), hydroxyethyl cellulose (HEC), ethyl hydroxyethyl cellulose, hydroxypropyl cellulose, methyl cellulose and carboxymethyl cellulose; carbomers (e.g. carbopol, and the like);  
25 polyvinyl alcohol; polyvinyl pyrrolidone; alginates; carrageenans; and guar, karaya, agarose, locust bean, tragacanth and xanthan gums. Such viscosity modifying components are employed, if at all, in an amount effective to provide a desired viscosity to the present compositions.  
30 The concentration of such viscosity modifiers will typically vary between about 0.01 to about 5 % w/v of the

total composition, although other concentrations of certain viscosity modifying components may be employed.

The presently useful compositions may be produced using conventional and well known methods useful in  
5 producing ophthalmic products including oil-in-water emulsions.

In one example, the oily phase of the emulsion can be combined with the cyclosporin component to solubilize the cyclosporin component in the oily material phase. The oily  
10 phase and the water may be separately heated to an appropriate temperature. This temperature may be the same in both cases, generally a few degrees to about 10°C above the melting temperature of the ingredient(s) having the highest melting point in the case of a solid or semi-solid  
15 oily phase for emulsifier components in the oily phase. Where the oily phase is a liquid at room temperature, a suitable temperature for preparation of a composition may be determined by routine experimentation in which the melting point of the ingredients aside from the oily phase  
20 is determined. In cases where all components of either the oily phase or the water phase are soluble at room temperature, no heating may be necessary. Non-emulsifying agents which are water soluble are dissolved in the water and oil soluble components including the surfactant  
25 components are dissolved in the oily phase.

To create an oil-in-water emulsion, the final oil phase is gently mixed into either an intermediate, preferably de-ionized water, phase or into the final water phase to create a suitable dispersion and the product is  
30 allowed to cool with or without stirring. In the case where the final oil phase is first gently mixed into an intermediate water phase, the resulting emulsion

concentrate is thereafter mixed in the appropriate ratio with the final aqueous phase. In such cases, the emulsion concentrate and the final aqueous phase may not be at the same temperature or heated above room temperature, as the emulsion may be already formed at this point.

The oil-in-water emulsions of the present invention can be sterilized after preparation using heat, for example, autoclave steam sterilization or can be sterile filtered using, for example, a 0.22 micron sterile filter. Sterilization employing a sterilization filter can be used when the emulsion droplet (or globule or particle) size and characteristics allows this. The droplet size distribution of the emulsion need not be entirely below the particle size cutoff of the 0.22 micron sterile filtration membrane to be sterile-filtratable. In cases wherein the droplet size distribution of the emulsion is above the particle size cutoff of the 0.22 micron sterile filtration membrane, the emulsion needs to be able to deform or change while passing through the filtration membrane and then reform after passing through. This property is easily determined by routine testing of emulsion droplet size distributions and percent of total oil in the compositions before and after filtration. Alternatively, a loss of a small amount of larger droplet sized material may be acceptable.

The present oil-in-water emulsions preferably are thermodynamically stable, much like microemulsions, and yet may not be isotropic transparent compositions as are microemulsions. The emulsions of the present invention advantageously have a shelf life exceeding one year at room temperature.

The following non-limiting examples illustrate certain aspects of the present invention.

EXAMPLE 1

Two compositions are selected for testing. These compositions are produced in accordance with well known techniques and have the following make-ups:

|    | <u>Composition I</u> | <u>Composition II</u> |
|----|----------------------|-----------------------|
|    | wt%                  | wt%                   |
| 5  |                      |                       |
|    |                      |                       |
|    |                      |                       |
|    |                      |                       |
|    |                      |                       |
|    |                      |                       |
| 10 |                      |                       |
|    |                      |                       |
|    |                      |                       |
|    |                      |                       |
|    |                      |                       |
|    |                      |                       |
|    |                      |                       |
|    |                      |                       |
| 15 |                      |                       |
|    |                      |                       |
|    |                      |                       |

20 These compositions are employed in a Phase 3, double-masked, randomized, parallel group study for the treatment of dry eye disease.

The results of this study indicate that Composition II, in accordance with the present invention, which has a reduced concentration of cyclosporin A and a cyclosporin A to castor oil ratio of less than 0.08, provides overall efficacy in treating dry eye disease substantially equal to that of Composition I. This is surprising for a number of reasons. For example, the reduced concentration of cyclosporin A in Composition II would have been expected to result in reduced overall efficacy in treating dry eye disease. Also, the large amount of castor oil relative to the amount of cyclosporin A in Composition II might have been expected to cause increased eye irritation relative to



Composition I. However, both Composition I and Composition II are found to be substantially non-irritating in use.

Using relatively increased amounts of castor oil, with reduced amounts of cyclosporin component, as in Composition II, is believed to take advantage of the benefits, for example the ocular lubrication benefits, of castor oil, as well as the presence of ricinoleic acid in the castor oil, to at least assist in treating dry eye syndrome in combination with cyclosporin A.

In addition, it is found that the high concentration of castor oil relative to cyclosporin component, as in Composition II, provides the advantage of more quickly or rapidly (for example, relative to a composition which includes only 50% as much castor oil) breaking down or resolving the emulsion in the eye, for example, as measured by split-lamp techniques to monitor the composition in the eye for phase separation. Such rapid break down of the emulsion in the eye reduces vision distortion as the result of the presence of the emulsion in the eye, as well as facilitating the therapeutic effectiveness of the composition in treating dry eye disease.

Using reduced amounts of cyclosporin A, as in Composition II, to achieve therapeutic effectiveness mitigates even further against undesirable side effects and potential drug interactions. Prescribing physicians can provide (prescribe) Composition II to more patients and/or with fewer restrictions and/or with reduced risk of the occurrence of adverse events, e.g., side effects, drug interactions and the like, relative to providing Composition I.

While this invention has been described with respect to various specific examples and embodiments, it is to be

understood that the invention is not limited thereto and that it can be variously practiced within the scope of the following claims.

**WHAT IS CLAIMED IS:**

1. A method of treating an eye of a human or animal comprising:

administering to an eye of a human or animal a composition in the form of an emulsion comprising water, a hydrophobic component and a cyclosporin component in a therapeutically effective amount of less than 0.1% by weight of the composition, the weight ratio of the cyclosporin component to the hydrophobic component is less than 0.08.

2. The method of claim 1 wherein the administering step is effective in treating a condition selected from the group consisting of dry eye syndrome, phacoanaphylactic endophthalmitis, uveitis, vernal conjunctivitis, atopic keratoconjunctivitis and corneal graft rejection.

3. The method of claim 1 wherein the administering step is effective in treating dry eye syndrome.

4. The method of claim 1 wherein the blood of the human or animal has substantially no detectable concentration of the cyclosporin component.

5. The method of claim 1 wherein the blood of the human or animal has substantially no detectable concentration of the cyclosporin component as measured using a validated liquid chromatography/mass spectrometry-mass spectrometry analytical method.

6. The method of claim 1 wherein the blood of the human or animal has a concentration of the cyclosporin component of 0.1 ng/ml or less.

7. The method of claim 1 wherein the cyclosporin component comprises a material selected from cyclosporin A, derivatives of cyclosporin A and mixtures thereof.

8. The method of claim 1 wherein the cyclosporin component comprises cyclosporin A.

9. The method of claim 1 wherein the cyclosporin component is solubilized in the hydrophobic component present in the composition.

10. The method of claim 1 wherein the hydrophobic component is present in the composition in an amount greater than 0.625% by weight of the composition.

11. The method of claim 1 wherein the hydrophobic component comprises an oily material.

12. The method of claim 1 wherein the hydrophobic component comprises an ingredient selected from the group consisting of vegetable oils, animal oils, mineral oils, synthetic oils and mixtures thereof.

13. The method of claim 1 wherein the hydrophobic component comprises castor oil.

14. The method of claim 1 wherein the administering step comprises topically administering the composition to the eye of the human.

15. The method of claim 1 wherein the composition comprises an effective amount of an emulsifier component.

16. The method of claim 1 wherein the composition comprises an effective amount of a tonicity component.

17. The method of claim 1 wherein the composition comprises an effective amount of an organic tonicity component.

18. The method of claim 1 wherein the composition comprises a polyelectrolyte component in an amount effective in stabilizing the composition.

19. The method of claim 1 wherein the composition has a pH in the range of about 7.0 to about 8.0.

20. The method of claim 1 wherein the composition has a pH in the range of about 7.2 to about 7.6.

21. A composition for treating an eye of a human or animal comprising an emulsion comprising water, a hydrophobic component, and a cyclosporin component in a therapeutically effective amount of less than 0.1% by weight, the weight ratio of the cyclosporin component to the hydrophobic component being less than 0.08.

22. The composition of claim 21 having a make-up so that when the composition is administered to an eye of a

human in an effective amount in treating dry eye syndrome, the blood of the human has substantially no detectable concentration of the cyclosporin component.

23. The composition of claim 21 wherein the cyclosporin component comprises a material selected from cyclosporin A, derivatives of cyclosporin A and mixtures thereof.

24. The composition of claim 21 wherein the cyclosporin component comprises cyclosporin A.

25. The composition of claim 21 in the form of an emulsion.

26. The composition of claim 21 wherein the hydrophobic component is present in an amount greater than 0.625% by weight of the composition.

27. The composition of claim 21 wherein the hydrophobic component is an oily material.

28. The composition of claim 21 wherein the hydrophobic component comprises an ingredient selected from the group consisting of vegetable oils, animal oils, mineral oils, synthetic oils, and mixtures thereof.

29. The composition of claim 21 wherein the hydrophobic component comprises castor oil.

30. The composition of claim 21 wherein the administering step comprises topically administering the composition to the eye of the human.

31. The composition of claim 21 wherein the composition comprises an effective amount of an emulsifier component.

32. The composition of claim 21 wherein the composition comprises an effective amount of a tonicity component.

33. The composition of claim 21 wherein the composition comprises an effective amount of an organic tonicity component.

34. The composition of claim 21 wherein the composition comprises a polyelectrolytic component in an amount effective in stabilizing the composition.

35. The composition of claim 21 wherein the composition includes water and has a pH in the range of about 7.0 to about 8.0.

36. The composition of claim 21 wherein the composition includes water and has a pH in the range of about 7.2 to about 7.6.

METHODS OF PROVIDING THERAPEUTIC EFFECTS  
USING CYCLOSPORIN COMPONENTS

Abstract of the Disclosure

5

Methods of treating an eye of a human or animal include administering to an eye of a human or animal a composition in the form of an emulsion including water, a hydrophobic component and a cyclosporin component in a therapeutically effective amount of less than 0.1% by weight of the composition. The weight ratio of the cyclosporin component to the hydrophobic component is less than 0.8.

10



Under the Paperwork Reduction Act of 1995, no persons are required to respond to a collection of information unless it contains a valid OMB control number.

|   |   |                        |                 |
|---|---|------------------------|-----------------|
| <b>Application Data Sheet 37 CFR 1.76</b>   |   | Attorney Docket Number | 17618CON2B (AP) |
|   |   | Application Number     |                 |
| Title of Invention  | METHODS OF PROVIDING THERAPEUTIC EFFECTS USING CYCLOSPORIN COMPONENTS |                        |                 |
| The application data sheet is part of the provisional or nonprovisional application for which it is being submitted. The following form contains the bibliographic data arranged in a format specified by the United States Patent and Trademark Office as outlined in 37 CFR 1.76. This document may be completed electronically and submitted to the Office in electronic format using the Electronic Filing System (EFS) or the document may be printed and included in a paper filed application. |   |                        |                 |

## Secrecy Order 37 CFR 5.2

|                          |   |
|--------------------------|---|
| <input type="checkbox"/> | Portions or all of the application associated with this Application Data Sheet may fall under a Secrecy Order pursuant to 37 CFR 5.2 (Paper filers only. Applications that fall under Secrecy Order may not be filed electronically.) |
|--------------------------|---|

## Inventor Information:

|   |                   |                       |                    |                               |                                       |
|---|-------------------|-----------------------|--------------------|-------------------------------|---------------------------------------|
| <b>Inventor 1</b>   |                   |                       |                    |                               | <input type="button" value="Remove"/> |
| <b>Legal Name</b>   |                   |                       |                    |                               |                                       |
| <b>Prefix</b>   | <b>Given Name</b> | <b>Middle Name</b>    | <b>Family Name</b> | <b>Suffix</b>                 |                                       |
|   | Andrew            |                       | Acheampong         |                               |                                       |
| <b>Residence Information (Select One)</b> <input checked="" type="radio"/> US Residency <input type="radio"/> Non US Residency <input type="radio"/> Active US Military Service |                   |                       |                    |                               |                                       |
| <b>City</b>   | Irvine            | <b>State/Province</b> | CA                 | <b>Country of Residence i</b> | US                                    |

### Mailing Address of Inventor:

|                    |                |                       |    |  |  |
|--------------------|----------------|-----------------------|----|--|--|
| <b>Address 1</b>   | 16 Wintergreen |                       |    |  |  |
| <b>Address 2</b>   |                |                       |    |  |  |
| <b>City</b>        | Irvine         | <b>State/Province</b> | CA |  |  |
| <b>Postal Code</b> | 92604          | <b>Country i</b>      | US |  |  |

|   |                   |                       |                    |                               |                                       |
|---|-------------------|-----------------------|--------------------|-------------------------------|---------------------------------------|
| <b>Inventor 2</b>   |                   |                       |                    |                               | <input type="button" value="Remove"/> |
| <b>Legal Name</b>   |                   |                       |                    |                               |                                       |
| <b>Prefix</b>   | <b>Given Name</b> | <b>Middle Name</b>    | <b>Family Name</b> | <b>Suffix</b>                 |                                       |
|   | Diane             | D.                    | Tang-Liu           |                               |                                       |
| <b>Residence Information (Select One)</b> <input checked="" type="radio"/> US Residency <input type="radio"/> Non US Residency <input type="radio"/> Active US Military Service |                   |                       |                    |                               |                                       |
| <b>City</b>   | Las Vegas         | <b>State/Province</b> | NV                 | <b>Country of Residence i</b> | US                                    |

### Mailing Address of Inventor:

|                    |                                    |                       |    |  |  |
|--------------------|------------------------------------|-----------------------|----|--|--|
| <b>Address 1</b>   | 3726 Las Vegas Blvd S. Unit 3303 W |                       |    |  |  |
| <b>Address 2</b>   |                                    |                       |    |  |  |
| <b>City</b>        | Las Vegas                          | <b>State/Province</b> | NV |  |  |
| <b>Postal Code</b> | 89158                              | <b>Country i</b>      | US |  |  |

|   |                   |                    |                    |               |                                       |
|---|-------------------|--------------------|--------------------|---------------|---------------------------------------|
| <b>Inventor 3</b>   |                   |                    |                    |               | <input type="button" value="Remove"/> |
| <b>Legal Name</b>   |                   |                    |                    |               |                                       |
| <b>Prefix</b>   | <b>Given Name</b> | <b>Middle Name</b> | <b>Family Name</b> | <b>Suffix</b> |                                       |
|   | James             | N.                 | Chang              |               |                                       |
| <b>Residence Information (Select One)</b> <input checked="" type="radio"/> US Residency <input type="radio"/> Non US Residency <input type="radio"/> Active US Military Service |                   |                    |                    |               |                                       |

Under the Paperwork Reduction Act of 1995, no persons are required to respond to a collection of information unless it contains a valid OMB control number.

|   |   |                        |                 |  |
|---|---|------------------------|-----------------|--|
| <b>Application Data Sheet 37 CFR 1.76</b> |   | Attorney Docket Number | 17618CON2B (AP) |  |
|   |   | Application Number     |                 |  |
| Title of Invention                        | METHODS OF PROVIDING THERAPEUTIC EFFECTS USING CYCLOSPORIN COMPONENTS |                        |                 |  |

|      |               |                |    |                        |    |
|------|---------------|----------------|----|------------------------|----|
| City | Newport Beach | State/Province | CA | Country of Residence i | US |
|------|---------------|----------------|----|------------------------|----|

**Mailing Address of Inventor:**

|             |               |                |    |  |  |
|-------------|---------------|----------------|----|--|--|
| Address 1   | 36 Cervantes  |                |    |  |  |
| Address 2   |               |                |    |  |  |
| City        | Newport Beach | State/Province | CA |  |  |
| Postal Code | 92660         | Country i      | US |  |  |

Inventor 4

Remove

**Legal Name**

| Prefix | Given Name | Middle Name | Family Name | Suffix |
|--------|------------|-------------|-------------|--------|
|        | David      | F.          | Power       |        |

Residence Information (Select One)  US Residency  Non US Residency  Active US Military Service

|      |        |                |    |                        |    |
|------|--------|----------------|----|------------------------|----|
| City | Hubert | State/Province | NC | Country of Residence i | US |
|------|--------|----------------|----|------------------------|----|

**Mailing Address of Inventor:**

|             |               |                |    |  |  |
|-------------|---------------|----------------|----|--|--|
| Address 1   | 202 Fox Way N |                |    |  |  |
| Address 2   |               |                |    |  |  |
| City        | Hubert        | State/Province | NC |  |  |
| Postal Code | 28539         | Country i      | US |  |  |

All Inventors Must Be Listed - Additional Inventor Information blocks may be generated within this form by selecting the **Add** button.

Add

**Correspondence Information:**

Enter either Customer Number or complete the Correspondence Information section below. For further information see 37 CFR 1.33(a).

 An Address is being provided for the correspondence information of this application.

|                 |                         |           |              |
|-----------------|-------------------------|-----------|--------------|
| Customer Number | 51957                   |           |              |
| Email Address   | patents_ip@allergan.com | Add Email | Remove Email |

**Application Information:**

|   |   |   |                          |
|---|---|---|--------------------------|
| Title of the Invention                  | METHODS OF PROVIDING THERAPEUTIC EFFECTS USING CYCLOSPORIN COMPONENTS |   |                          |
| Attorney Docket Number                  | 17618CON2B (AP)   | Small Entity Status Claimed               | <input type="checkbox"/> |
| Application Type                        | Nonprovisional  |   |                          |
| Subject Matter                          | Utility   |   |                          |
| Total Number of Drawing Sheets (if any) |   | Suggested Figure for Publication (if any) |                          |

|   |   |                 |
|---|---|-----------------|
| <b>Application Data Sheet 37 CFR 1.76</b> | Attorney Docket Number  | 17618CON2B (AP) |
|   | Application Number  |                 |
| Title of Invention                        | METHODS OF PROVIDING THERAPEUTIC EFFECTS USING CYCLOSPORIN COMPONENTS |                 |

**Publication Information:**

|                          |   |
|--------------------------|---|
| <input type="checkbox"/> | Request Early Publication (Fee required at time of Request 37 CFR 1.219)  |
| <input type="checkbox"/> | <b>Request Not to Publish.</b> I hereby request that the attached application not be published under 35 U.S.C. 122(b) and certify that the invention disclosed in the attached application <b>has not and will not</b> be the subject of an application filed in another country, or under a multilateral international agreement, that requires publication at eighteen months after filing. |

**Representative Information:**

|  |  |  |   |
|--|--|--|---|
| <p>Representative information should be provided for all practitioners having a power of attorney in the application. Providing this information in the Application Data Sheet does not constitute a power of attorney in the application (see 37 CFR 1.32). Either enter Customer Number or complete the Representative Name section below. If both sections are completed the customer Number will be used for the Representative Information during processing.</p> |  |  |   |
| Please Select One:   | <input checked="" type="radio"/> Customer Number | <input type="radio"/> US Patent Practitioner | <input type="radio"/> Limited Recognition (37 CFR 11.9) |
| Customer Number  | 51597  |  |   |

**Domestic Benefit/National Stage Information:**

|   |                    |                          |                          |
|---|--------------------|--------------------------|--------------------------|
| <p>This section allows for the applicant to either claim benefit under 35 U.S.C. 119(e), 120, 121, or 365(c) or indicate National Stage entry from a PCT application. Providing this information in the application data sheet constitutes the specific reference required by 35 U.S.C. 119(e) or 120, and 37 CFR 1.78.</p> |                    |                          |                          |
| Prior Application Status  | Pending            | <a href="#">Remove</a>   |                          |
| Application Number  | Continuity Type    | Prior Application Number | Filing Date (YYYY-MM-DD) |
|   | Continuation of    | 13961808                 | 2013-08-07               |
| Prior Application Status  | Pending            | <a href="#">Remove</a>   |                          |
| Application Number  | Continuity Type    | Prior Application Number | Filing Date (YYYY-MM-DD) |
| 13961808  | Continuation of    | 11897177                 | 2007-08-28               |
| Prior Application Status  | Abandoned          | <a href="#">Remove</a>   |                          |
| Application Number  | Continuity Type    | Prior Application Number | Filing Date (YYYY-MM-DD) |
| 11897177  | Continuation of    | 10927857                 | 2004-08-27               |
| Prior Application Status  | Expired            | <a href="#">Remove</a>   |                          |
| Application Number  | Continuity Type    | Prior Application Number | Filing Date (YYYY-MM-DD) |
| 10927857  | non provisional of | 60503137                 | 2003-09-15               |
| Additional Domestic Benefit/National Stage Data may be generated within this form by selecting the <b>Add</b> button.   |                    |                          | <a href="#">Add</a>      |

**Foreign Priority Information:**

|   |   |                 |
|---|---|-----------------|
| <b>Application Data Sheet 37 CFR 1.76</b> | Attorney Docket Number  | 17618CON2B (AP) |
|   | Application Number  |                 |
| Title of Invention                        | METHODS OF PROVIDING THERAPEUTIC EFFECTS USING CYCLOSPORIN COMPONENTS |                 |

This section allows for the applicant to claim priority to a foreign application. Providing this information in the application data sheet constitutes the claim for priority as required by 35 U.S.C. 119(b) and 37 CFR 1.55(d). When priority is claimed to a foreign application that is eligible for retrieval under the priority document exchange program (PDX) the information will be used by the Office to automatically attempt retrieval pursuant to 37 CFR 1.55(h)(1) and (2). Under the PDX program, applicant bears the ultimate responsibility for ensuring that a copy of the foreign application is received by the Office from the participating foreign intellectual property office, or a certified copy of the foreign priority application is filed, within the time period specified in 37 CFR 1.55(g)(1).

| Application Number | Country <sup>i</sup> | Filing Date (YYYY-MM-DD) | Access Code <sup>i</sup> (if applicable) |
|--------------------|----------------------|--------------------------|--|
|                    |                      |                          |  |

Additional Foreign Priority Data may be generated within this form by selecting the **Add** button.

## Statement under 37 CFR 1.55 or 1.78 for AIA (First Inventor to File) Transition Applications

This application (1) claims priority to or the benefit of an application filed before March 16, 2013 and (2) also contains, or contained at any time, a claim to a claimed invention that has an effective filing date on or after March 16, 2013.

NOTE: By providing this statement under 37 CFR 1.55 or 1.78, this application, with a filing date on or after March 16, 2013, will be examined under the first inventor to file provisions of the AIA.

## Authorization to Permit Access:

Authorization to Permit Access to the Instant Application by the Participating Offices

|   |   |                 |
|---|---|-----------------|
| <b>Application Data Sheet 37 CFR 1.76</b> | Attorney Docket Number  | 17618CON2B (AP) |
|   | Application Number  |                 |
| Title of Invention                        | METHODS OF PROVIDING THERAPEUTIC EFFECTS USING CYCLOSPORIN COMPONENTS |                 |

If checked, the undersigned hereby grants the USPTO authority to provide the European Patent Office (EPO), the Japan Patent Office (JPO), the Korean Intellectual Property Office (KIPO), the World Intellectual Property Office (WIPO), and any other intellectual property offices in which a foreign application claiming priority to the instant patent application is filed access to the instant patent application. See 37 CFR 1.14(c) and (h). This box should not be checked if the applicant does not wish the EPO, JPO, KIPO, WIPO, or other intellectual property office in which a foreign application claiming priority to the instant patent application is filed to have access to the instant patent application.

In accordance with 37 CFR 1.14(h)(3), access will be provided to a copy of the instant patent application with respect to: 1) the instant patent application-as-filed; 2) any foreign application to which the instant patent application claims priority under 35 U.S.C. 119(a)-(d) if a copy of the foreign application that satisfies the certified copy requirement of 37 CFR 1.55 has been filed in the instant patent application; and 3) any U.S. application-as-filed from which benefit is sought in the instant patent application.

In accordance with 37 CFR 1.14(c), access may be provided to information concerning the date of filing this Authorization.

## Applicant Information:

|  |  |  |                                       |
|--|--|--|---------------------------------------|
| Providing assignment information in this section does not substitute for compliance with any requirement of part 3 of Title 37 of CFR to have an assignment recorded by the Office.  |  |  |                                       |
| <b>Applicant 1</b>   |  |  | <input type="button" value="Remove"/> |
| If the applicant is the inventor (or the remaining joint inventor or inventors under 37 CFR 1.45), this section should not be completed. The information to be provided in this section is the name and address of the legal representative who is the applicant under 37 CFR 1.43; or the name and address of the assignee, person to whom the inventor is under an obligation to assign the invention, or person who otherwise shows sufficient proprietary interest in the matter who is the applicant under 37 CFR 1.46. If the applicant is an applicant under 37 CFR 1.46 (assignee, person to whom the inventor is obligated to assign, or person who otherwise shows sufficient proprietary interest) together with one or more joint inventors, then the joint inventor or inventors who are also the applicant should be identified in this section. |  |  |                                       |
| <input type="button" value="Clear"/>   |  |  |                                       |
| <input checked="" type="radio"/> Assignee  | <input type="radio"/> Legal Representative under 35 U.S.C. 117 | <input type="radio"/> Joint Inventor                                   |                                       |
| <input type="radio"/> Person to whom the inventor is obligated to assign.  |  | <input type="radio"/> Person who shows sufficient proprietary interest |                                       |
| If applicant is the legal representative, indicate the authority to file the patent application, the inventor is:  |  |  |                                       |
|  |  |  |                                       |
| Name of the Deceased or Legally Incapacitated Inventor : <input type="text"/>  |  |  |                                       |
| If the Applicant is an Organization check here. <input checked="" type="checkbox"/>  |  |  |                                       |
| Organization Name  | Allergan, Inc.   |  |                                       |
| <b>Mailing Address Information:</b>  |  |  |                                       |
| Address 1  | 2525 Dupont Drive  |  |                                       |
| Address 2  |  |  |                                       |
| City   | Irvine   | State/Province   | CA                                    |
| Country <sup>i</sup>   | US   | Postal Code  | 92612                                 |
| Phone Number   |  | Fax Number   |                                       |

Under the Paperwork Reduction Act of 1995, no persons are required to respond to a collection of information unless it contains a valid OMB control number.

|   |   |                 |
|---|---|-----------------|
| <b>Application Data Sheet 37 CFR 1.76</b> | Attorney Docket Number  | 17618CON2B (AP) |
|   | Application Number  |                 |
| Title of Invention                        | METHODS OF PROVIDING THERAPEUTIC EFFECTS USING CYCLOSPORIN COMPONENTS |                 |

|               |                        |
|---------------|------------------------|
| Email Address | patent_ip@allergan.com |
|---------------|------------------------|

Additional Applicant Data may be generated within this form by selecting the Add button.

Add

**Non-Applicant Assignee Information:**

Providing assignment information in this section does not substitute for compliance with any requirement of part 3 of Title 37 of CFR to have an assignment recorded by the Office.

**Assignee 1**

Complete this section only if non-applicant assignee information is desired to be included on the patent application publication in accordance with 37 CFR 1.215(b). Do not include in this section an applicant under 37 CFR 1.46 (assignee, person to whom the inventor is obligated to assign, or person who otherwise shows sufficient proprietary interest), as the patent application publication will include the name of the applicant(s).

Remove

If the Assignee is an Organization check here. 

| Prefix | Given Name | Middle Name | Family Name | Suffix |
|--------|------------|-------------|-------------|--------|
|        |            |             |             |        |

**Mailing Address Information:**

|               |  |                |  |  |
|---------------|--|----------------|--|--|
| Address 1     |  |                |  |  |
| Address 2     |  |                |  |  |
| City          |  | State/Province |  |  |
| Country i     |  | Postal Code    |  |  |
| Phone Number  |  | Fax Number     |  |  |
| Email Address |  |                |  |  |

Additional Assignee Data may be generated within this form by selecting the Add button.

Add

**Signature:**

Remove

NOTE: This form must be signed in accordance with 37 CFR 1.33. See 37 CFR 1.4 for signature requirements and certifications

|            |                 |           |                   |                     |       |
|------------|-----------------|-----------|-------------------|---------------------|-------|
| Signature  | /Laura L. Wine/ |           | Date (YYYY-MM-DD) | 2013-08-14          |       |
| First Name | Laura           | Last Name | Wine              | Registration Number | 68681 |

Additional Signature may be generated within this form by selecting the Add button.

Add

Under the Paperwork Reduction Act of 1995, no persons are required to respond to a collection of information unless it contains a valid OMB control number.

|   |   |                 |
|---|---|-----------------|
| <b>Application Data Sheet 37 CFR 1.76</b> | Attorney Docket Number  | 17618CON2B (AP) |
|   | Application Number  |                 |
| Title of Invention                        | METHODS OF PROVIDING THERAPEUTIC EFFECTS USING CYCLOSPORIN COMPONENTS |                 |

This collection of information is required by 37 CFR 1.76. The information is required to obtain or retain a benefit by the public which is to file (and by the USPTO to process) an application. Confidentiality is governed by 35 U.S.C. 122 and 37 CFR 1.14. This collection is estimated to take 23 minutes to complete, including gathering, preparing, and submitting the completed application data sheet form to the USPTO. Time will vary depending upon the individual case. Any comments on the amount of time you require to complete this form and/or suggestions for reducing this burden, should be sent to the Chief Information Officer, U.S. Patent and Trademark Office, U.S. Department of Commerce, P.O. Box 1450, Alexandria, VA 22313-1450. DO NOT SEND FEES OR COMPLETED FORMS TO THIS ADDRESS. **SEND TO: Commissioner for Patents, P.O. Box 1450, Alexandria, VA 22313-1450.**

# Privacy Act Statement

The Privacy Act of 1974 (P.L. 93-579) requires that you be given certain information in connection with your submission of the attached form related to a patent application or patent. Accordingly, pursuant to the requirements of the Act, please be advised that: (1) the general authority for the collection of this information is 35 U.S.C. 2(b)(2); (2) furnishing of the information solicited is voluntary; and (3) the principal purpose for which the information is used by the U.S. Patent and Trademark Office is to process and/or examine your submission related to a patent application or patent. If you do not furnish the requested information, the U.S. Patent and Trademark Office may not be able to process and/or examine your submission, which may result in termination of proceedings or abandonment of the application or expiration of the patent.

The information provided by you in this form will be subject to the following routine uses:

1. The information on this form will be treated confidentially to the extent allowed under the Freedom of Information Act (5 U.S.C. 552) and the Privacy Act (5 U.S.C. 552a). Records from this system of records may be disclosed to the Department of Justice to determine whether the Freedom of Information Act requires disclosure of these records.
2. A record from this system of records may be disclosed, as a routine use, in the course of presenting evidence to a court, magistrate, or administrative tribunal, including disclosures to opposing counsel in the course of settlement negotiations.
3. A record in this system of records may be disclosed, as a routine use, to a Member of Congress submitting a request involving an individual, to whom the record pertains, when the individual has requested assistance from the Member with respect to the subject matter of the record.
4. A record in this system of records may be disclosed, as a routine use, to a contractor of the Agency having need for the information in order to perform a contract. Recipients of information shall be required to comply with the requirements of the Privacy Act of 1974, as amended, pursuant to 5 U.S.C. 552a(m).
5. A record related to an International Application filed under the Patent Cooperation Treaty in this system of records may be disclosed, as a routine use, to the International Bureau of the World Intellectual Property Organization, pursuant to the Patent Cooperation Treaty.
6. A record in this system of records may be disclosed, as a routine use, to another federal agency for purposes of National Security review (35 U.S.C. 181) and for review pursuant to the Atomic Energy Act (42 U.S.C. 218(c)).
7. A record from this system of records may be disclosed, as a routine use, to the Administrator, General Services, or his/her designee, during an inspection of records conducted by GSA as part of that agency's responsibility to recommend improvements in records management practices and programs, under authority of 44 U.S.C. 2904 and 2906. Such disclosure shall be made in accordance with the GSA regulations governing inspection of records for this purpose, and any other relevant (i.e., GSA or Commerce) directive. Such disclosure shall not be used to make determinations about individuals.
8. A record from this system of records may be disclosed, as a routine use, to the public after either publication of the application pursuant to 35 U.S.C. 122(b) or issuance of a patent pursuant to 35 U.S.C. 151. Further, a record may be disclosed, subject to the limitations of 37 CFR 1.14, as a routine use, to the public if the record was filed in an application which became abandoned or in which the proceedings were terminated and which application is referenced by either a published application, an application open to public inspections or an issued patent.
9. A record from this system of records may be disclosed, as a routine use, to a Federal, State, or local law enforcement agency, if the USPTO becomes aware of a violation or potential violation of law or regulation.



Under the Paperwork Reduction Act of 1995, no persons are required to respond to a collection of information unless it displays a valid OMB control number.

**DECLARATION (37 CFR 1.63) FOR UTILITY OR DESIGN APPLICATION USING AN APPLICATION DATA SHEET (37 CFR 1.76)**

|                           |  |
|---------------------------|--|
| <b>Title of Invention</b> | METHODS OF PROVIDING THERAPEUTIC EFFECTS USING CYCLOSPORIN COMPONENTS<br>Docket No.: 17618CON2(AP) |
|---------------------------|--|

As the below named inventor, I hereby declare that:

This declaration is directed to:  The attached application, or  
 United States application or PCT international application number 13/961,808  
filed on 8/7/2013.

The above-identified application was made or authorized to be made by me.

I believe that I am the original inventor or an original joint inventor of a claimed invention in the application.

I hereby acknowledge that any willful false statement made in this declaration is punishable under 18 U.S.C. 1001 by fine or imprisonment of not more than five (5) years, or both.

**WARNING:**

Petitioner/applicant is cautioned to avoid submitting personal information in documents filed in a patent application that may contribute to identity theft. Personal information such as social security numbers, bank account numbers, or credit card numbers (other than a check or credit card authorization form PTO-2038 submitted for payment purposes) is never required by the USPTO to support a petition or an application. If this type of personal information is included in documents submitted to the USPTO, petitioners/applicants should consider redacting such personal information from the documents before submitting them to the USPTO. Petitioner/applicant is advised that the record of a patent application is available to the public after publication of the application (unless a non-publication request in compliance with 37 CFR 1.213(a) is made in the application) or issuance of a patent. Furthermore, the record from an abandoned application may also be available to the public if the application is referenced in a published application or an issued patent (see 37 CFR 1.14). Checks and credit card authorization forms PTO-2038 submitted for payment purposes are not retained in the application file and therefore are not publicly available.

**LEGAL NAME OF INVENTOR**

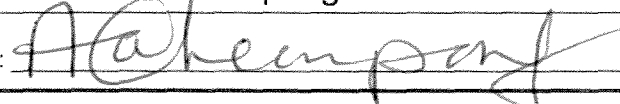
Inventor: Andrew Acheampong Date (Optional) : \_\_\_\_\_  
Signature: 

Note: An application data sheet (PTO/AIA/14 or equivalent), including naming the entire inventive entity, must accompany this form. Use an additional PTO/SB/AIA01 form for each additional inventor.

This collection of information is required by 35 U.S.C. 115 and 37 CFR 1.63. The information is required to obtain or retain a benefit by the public which is to file (and by the USPTO to process) an application. Confidentiality is governed by 35 U.S.C. 122 and 37 CFR 1.11 and 1.14. This collection is estimated to take 1 minute to complete, including gathering, preparing, and submitting the completed application form to the USPTO. Time will vary depending upon the individual case. Any comments on the amount of time you require to complete this form and/or suggestions for reducing this burden, should be sent to the Chief Information Officer, U.S. Patent and Trademark Office, U.S. Department of Commerce, P.O. Box 1450, Alexandria, VA 22313-1450. DO NOT SEND FEES OR COMPLETED FORMS TO THIS ADDRESS. **SEND TO: Commissioner for Patents, P.O. Box 1450, Alexandria, VA 22313-1450.**

If you need assistance in completing the form, call 1-800-PTO-9199 and select option 2.

Under the Paperwork Reduction Act of 1995, no persons are required to respond to a collection of information unless it displays a valid OMB control number.

## DECLARATION (37 CFR 1.63) FOR UTILITY OR DESIGN APPLICATION USING AN APPLICATION DATA SHEET (37 CFR 1.76)

|                           |  |
|---------------------------|--|
| <b>Title of Invention</b> | METHODS OF PROVIDING THERAPEUTIC EFFECTS USING CYCLOSPORIN COMPONENTS<br>Docket No.: 17618CON2(AP) |
|---------------------------|--|

As the below named inventor, I hereby declare that:

This declaration is directed to:  The attached application, or  
 United States application or PCT international application number 13/961,808  
 filed on 8/7/2013

The above-identified application was made or authorized to be made by me.

I believe that I am the original inventor or an original joint inventor of a claimed invention in the application.

I hereby acknowledge that any willful false statement made in this declaration is punishable under 18 U.S.C. 1001 by fine or imprisonment of not more than five (5) years, or both.

### WARNING:

Petitioner/applicant is cautioned to avoid submitting personal information in documents filed in a patent application that may contribute to identity theft. Personal information such as social security numbers, bank account numbers, or credit card numbers (other than a check or credit card authorization form PTO-2038 submitted for payment purposes) is never required by the USPTO to support a petition or an application. If this type of personal information is included in documents submitted to the USPTO, petitioners/applicants should consider redacting such personal information from the documents before submitting them to the USPTO. Petitioner/applicant is advised that the record of a patent application is available to the public after publication of the application (unless a non-publication request in compliance with 37 CFR 1.213(a) is made in the application) or issuance of a patent. Furthermore, the record from an abandoned application may also be available to the public if the application is referenced in a published application or an issued patent (see 37 CFR 1.14). Checks and credit card authorization forms PTO-2038 submitted for payment purposes are not retained in the application file and therefore are not publicly available.

#### LEGAL NAME OF INVENTOR

Inventor: DIANE D. TANG-LIU Date (Optional): \_\_\_\_\_  
 Signature: 

Note: An application data sheet (PTO/AIA/14 or equivalent), including naming the entire inventive entity, must accompany this form. Use an additional PTO/SB/AIA/01 form for each additional inventor.

This collection of information is required by 35 U.S.C. 115 and 37 CFR 1.63. The information is required to obtain or retain a benefit by the public which is to file (and by the USPTO to process) an application. Confidentiality is governed by 35 U.S.C. 122 and 37 CFR 1.11 and 1.14. This collection is estimated to take 1 minute to complete, including gathering, preparing, and submitting the completed application form to the USPTO. Time will vary depending upon the individual case. Any comments on the amount of time you require to complete this form and/or suggestions for reducing this burden, should be sent to the Chief Information Officer, U.S. Patent and Trademark Office, U.S. Department of Commerce, P.O. Box 1450, Alexandria, VA 22313-1450. DO NOT SEND FEES OR COMPLETED FORMS TO THIS ADDRESS. SEND TO: Commissioner for Patents, P.O. Box 1450, Alexandria, VA 22313-1450.

*If you need assistance in completing the form, call 1-800-PTO-9199 and select option 2.*

Under the Paperwork Reduction Act of 1995, no persons are required to respond to a collection of information unless it displays a valid OMB control number.

## DECLARATION (37 CFR 1.63) FOR UTILITY OR DESIGN APPLICATION USING AN APPLICATION DATA SHEET (37 CFR 1.76)

|                           |  |
|---------------------------|--|
| <b>Title of Invention</b> | METHODS OF PROVIDING THERAPEUTIC EFFECTS USING CYCLOSPORIN COMPONENTS<br>Docket No.: 17618CON2(AP) |
|---------------------------|--|

As the below named inventor, I hereby declare that:

This declaration is directed to:  The attached application, or  
 United States application or PCT international application number 13/961,808  
 filed on 8/7/2013

The above-identified application was made or authorized to be made by me.

I believe that I am the original inventor or an original joint inventor of a claimed invention in the application.

I hereby acknowledge that any willful false statement made in this declaration is punishable under 18 U.S.C. 1001 by fine or imprisonment of not more than five (5) years, or both.

### WARNING:

Petitioner/applicant is cautioned to avoid submitting personal information in documents filed in a patent application that may contribute to identity theft. Personal information such as social security numbers, bank account numbers, or credit card numbers (other than a check or credit card authorization form PTO-2038 submitted for payment purposes) is never required by the USPTO to support a petition or an application. If this type of personal information is included in documents submitted to the USPTO, petitioners/applicants should consider redacting such personal information from the documents before submitting them to the USPTO. Petitioner/applicant is advised that the record of a patent application is available to the public after publication of the application (unless a non-publication request in compliance with 37 CFR 1.213(a) is made in the application) or issuance of a patent. Furthermore, the record from an abandoned application may also be available to the public if the application is referenced in a published application or an issued patent (see 37 CFR 1.14). Checks and credit card authorization forms PTO-2038 submitted for payment purposes are not retained in the application file and therefore are not publicly available.

LEGAL NAME OF INVENTOR

Inventor: DAVID F. POWER Date (Optional): 8-12-2013

Signature: 

Note: An application data sheet (PTO/AIA/14 or equivalent), including naming the entire inventive entity, must accompany this form. Use an additional PTO/SB/AIA01 form for each additional inventor.

This collection of information is required by 35 U.S.C. 115 and 37 CFR 1.63. The information is required to obtain or retain a benefit by the public which is to file (and by the USPTO to process) an application. Confidentiality is governed by 35 U.S.C. 122 and 37 CFR 1.11 and 1.14. This collection is estimated to take 1 minute to complete, including gathering, preparing, and submitting the completed application form to the USPTO. Time will vary depending upon the individual case. Any comments on the amount of time you require to complete this form and/or suggestions for reducing this burden, should be sent to the Chief Information Officer, U.S. Patent and Trademark Office, U.S. Department of Commerce, P.O. Box 1450, Alexandria, VA 22313-1450. DO NOT SEND FEES OR COMPLETED FORMS TO THIS ADDRESS. **SEND TO: Commissioner for Patents, P.O. Box 1450, Alexandria, VA 22313-1450.**

*If you need assistance in completing the form, call 1-800-PTO-9199 and select option 2.*

Under the Paperwork Reduction Act of 1995, no persons are required to respond to a collection of information unless it displays a valid OMB control number.

**SUBSTITUTE STATEMENT IN LIEU OF AN OATH OR DECLARATION FOR UTILITY  
OR DESIGN PATENT APPLICATION (35 U.S.C. 115(d) AND 37 CFR 1.64)**

|   |  |       |    |         |       |         |    |
|---|--|-------|----|---------|-------|---------|----|
| Title of Invention  | Methods of Providing Therapeutic Effects Using Cyclosporin Components<br>Docket No.: 17618CON2(AP) |       |    |         |       |         |    |
| This statement is directed to:  |  |       |    |         |       |         |    |
| <input type="checkbox"/> The attached application,  |  |       |    |         |       |         |    |
| OR  |  |       |    |         |       |         |    |
| <input checked="" type="checkbox"/> United States application or PCT international application number <u>13/961,808</u> filed on <u>8-7-13</u>                                    |  |       |    |         |       |         |    |
| <b>LEGAL NAME of inventor to whom this substitute statement applies:</b><br>(E.g., Given Name (first and middle (if any)) and Family Name or Surname)                             |  |       |    |         |       |         |    |
| James N. Chang  |  |       |    |         |       |         |    |
| Residence (except for a deceased or legally incapacitated inventor):  |  |       |    |         |       |         |    |
| City  | Newport Beach  | State | CA | Country | US    |         |    |
| Mailing Address (except for a deceased or legally incapacitated inventor):  |  |       |    |         |       |         |    |
| 36 Cervantes  |  |       |    |         |       |         |    |
| City  | Newport Beach  | State | CA | Zip     | 92660 | Country | US |
| I believe the above-named inventor or joint inventor to be the original inventor or an original joint inventor of a claimed invention in the application.                         |  |       |    |         |       |         |    |
| The above-identified application was made or authorized to be made by me.   |  |       |    |         |       |         |    |
| I hereby acknowledge that any willful false statement made in this statement is punishable under 18 U.S.C. 1001 by fine or imprisonment of not more than five (5) years, or both. |  |       |    |         |       |         |    |
| Relationship to the inventor to whom this substitute statement applies:   |  |       |    |         |       |         |    |
| <input type="checkbox"/> Legal Representative (for deceased or legally incapacitated inventor only),  |  |       |    |         |       |         |    |
| <input checked="" type="checkbox"/> Assignee,   |  |       |    |         |       |         |    |
| <input type="checkbox"/> Person to whom the inventor is under an obligation to assign,  |  |       |    |         |       |         |    |
| <input type="checkbox"/> Person who otherwise shows a sufficient proprietary interest in the matter (petition under 37 CFR 1.46 is required), or                                  |  |       |    |         |       |         |    |
| <input type="checkbox"/> Joint inventor.  |  |       |    |         |       |         |    |

[Page 1 of 2]

This collection of information is required by 35 U.S.C. 115 and 37 CFR 1.63. The information is required to obtain or retain a benefit by the public which is to file (and by the USPTO to process) an application. Confidentiality is governed by 35 U.S.C. 122 and 37 CFR 1.11 and 1.14. This collection is estimated to take 1 minute to complete, including gathering, preparing, and submitting the completed application form to the USPTO. Time will vary depending upon the individual case. Any comments on the amount of time you require to complete this form and/or suggestions for reducing this burden, should be sent to the Chief Information Officer, U.S. Patent and Trademark Office, U.S. Department of Commerce, P.O. Box 1450, Alexandria, VA 22313-1450. DO NOT SEND FEES OR COMPLETED FORMS TO THIS ADDRESS. SEND TO: Commissioner for Patents, P.O. Box 1450, Alexandria, VA 22313-1450.

If you need assistance in completing the form, call 1-800-PTO-0199 and select option 2.

Under the Paperwork Reduction Act of 1995, no persons are required to respond to a collection of information unless it displays a valid OMB control number.

## SUBSTITUTE STATEMENT

Circumstances permitting execution of this substitute statement:

- Inventor is deceased,  
 Inventor is under legal incapacity,  
 Inventor cannot be found or reached after diligent effort, or  
 Inventor has refused to execute the oath or declaration under 37 CFR 1.63.

If there are joint inventors, please check the appropriate box below:

- An application data sheet under 37 CFR 1.76 (PTO/AIA/14 or equivalent) naming the entire inventive entity has been or is currently submitted.

OR

- An application data sheet under 37 CFR 1.76 (PTO/AIA/14 or equivalent) has not been submitted. Thus, a Substitute Statement Supplemental Sheet (PTO/AIA/11 or equivalent) naming the entire inventive entity and providing inventor information is attached. See 37 CFR 1.64(b).

### WARNING:

Petitioner/applicant is cautioned to avoid submitting personal information in documents filed in a patent application that may contribute to identity theft. Personal information such as social security numbers, bank account numbers, or credit card numbers (other than a check or credit card authorization form PTO-2038 submitted for payment purposes) is never required by the USPTO to support a petition or an application. If this type of personal information is included in documents submitted to the USPTO, petitioners/applicants should consider redacting such personal information from the documents before submitting them to the USPTO. Petitioner/applicant is advised that the record of a patent application is available to the public after publication of the application (unless a non-publication request in compliance with 37 CFR 1.213(a) is made in the application) or issuance of a patent. Furthermore, the record from an abandoned application may also be available to the public if the application is referenced in a published application or an issued patent (see 37 CFR 1.14). Checks and credit card authorization forms PTO-2038 submitted for payment purposes are not retained in the application file and therefore are not publicly available.

### PERSON EXECUTING THIS SUBSTITUTE STATEMENT:

Name: **Debra D. Condino** TITLE: ASSISTANT SECRETARY  
 COMPANY: ALLEGAN, INC. (SIGNED)  
 Date (Optional):

Signature: *D Condino*

Residence (unless provided in an application data sheet, PTO/AIA/14 or equivalent):

|                    |                 |                   |
|--------------------|-----------------|-------------------|
| City <b>Irvine</b> | State <b>CA</b> | Country <b>US</b> |
|--------------------|-----------------|-------------------|

Mailing Address (unless provided in an application data sheet, PTO/AIA/14 or equivalent)

2525 Dupont Drive-T2-7H

|                    |                 |                  |                   |
|--------------------|-----------------|------------------|-------------------|
| City <b>Irvine</b> | State <b>CA</b> | Zip <b>92612</b> | Country <b>US</b> |
|--------------------|-----------------|------------------|-------------------|

Note: Use an additional PTO/AIA/02 form for each inventor who is deceased, legally incapacitated, cannot be found or reached after diligent effort, or has refused to execute the oath or declaration under 37 CFR 1.63.

## Privacy Act Statement

The Privacy Act of 1974 (P.L. 93-579) requires that you be given certain information in connection with your submission of the attached form related to a patent application or patent. Accordingly, pursuant to the requirements of the Act, please be advised that: (1) the general authority for the collection of this information is 35 U.S.C. 2(b)(2); (2) furnishing of the information solicited is voluntary; and (3) the principal purpose for which the information is used by the U.S. Patent and Trademark Office is to process and/or examine your submission related to a patent application or patent. If you do not furnish the requested information, the U.S. Patent and Trademark Office may not be able to process and/or examine your submission, which may result in termination of proceedings or abandonment of the application or expiration of the patent.

The information provided by you in this form will be subject to the following routine uses:

1. The information on this form will be treated confidentially to the extent allowed under the Freedom of Information Act (5 U.S.C. 552) and the Privacy Act (5 U.S.C. 552a). Records from this system of records may be disclosed to the Department of Justice to determine whether disclosure of these records is required by the Freedom of Information Act.
2. A record from this system of records may be disclosed, as a routine use, in the course of presenting evidence to a court, magistrate, or administrative tribunal, including disclosures to opposing counsel in the course of settlement negotiations.
3. A record in this system of records may be disclosed, as a routine use, to a Member of Congress submitting a request involving an individual, to whom the record pertains, when the individual has requested assistance from the Member with respect to the subject matter of the record.
4. A record in this system of records may be disclosed, as a routine use, to a contractor of the Agency having need for the information in order to perform a contract. Recipients of information shall be required to comply with the requirements of the Privacy Act of 1974, as amended, pursuant to 5 U.S.C. 552a(m).
5. A record related to an International Application filed under the Patent Cooperation Treaty in this system of records may be disclosed, as a routine use, to the International Bureau of the World Intellectual Property Organization, pursuant to the Patent Cooperation Treaty.
6. A record in this system of records may be disclosed, as a routine use, to another federal agency for purposes of National Security review (35 U.S.C. 181) and for review pursuant to the Atomic Energy Act (42 U.S.C. 218(c)).
7. A record from this system of records may be disclosed, as a routine use, to the Administrator, General Services, or his/her designee, during an inspection of records conducted by GSA as part of that agency's responsibility to recommend improvements in records management practices and programs, under authority of 44 U.S.C. 2904 and 2906. Such disclosure shall be made in accordance with the GSA regulations governing inspection of records for this purpose, and any other relevant (i.e., GSA or Commerce) directive. Such disclosure shall not be used to make determinations about individuals.
8. A record from this system of records may be disclosed, as a routine use, to the public after either publication of the application pursuant to 35 U.S.C. 122(b) or issuance of a patent pursuant to 35 U.S.C. 151. Further, a record may be disclosed, subject to the limitations of 37 CFR 1.14, as a routine use, to the public if the record was filed in an application which became abandoned or in which the proceedings were terminated and which application is referenced by either a published application, an application open to public inspection or an issued patent.
9. A record from this system of records may be disclosed, as a routine use, to a Federal, State, or local law enforcement agency, if the USPTO becomes aware of a violation or potential violation of law or regulation.

Under the Paperwork Reduction Act of 1995, no persons are required to respond to a collection of information unless it displays a valid OMB control number.

## TRANSMITTAL FOR POWER OF ATTORNEY TO ONE OR MORE REGISTERED PRACTITIONERS

**NOTE:** This form is to be submitted with the Power of Attorney by Applicant form (PTO/AIA/82B or equivalent) to identify the application to which the Power of Attorney is directed, in accordance with 37 CFR 1.5. If the Power of Attorney by Applicant form is not accompanied by this transmittal form or an equivalent, the Power of Attorney will not be recognized in the application.

|                        |   |
|------------------------|---|
| Application Number     | unknown   |
| Filing Date            | herewith  |
| First Named Inventor   | Andrew Acheampong   |
| Title                  | METHODS OF PROVIDING THERAPEUTIC EFFECTS USING CYCLOSPORIN COMPONENTS |
| Art Unit               |   |
| Examiner Name          |   |
| Attorney Docket Number | 17618CON2B (AP)   |

### SIGNATURE of Applicant or Patent Practitioner

|                     |                 |           |                 |
|---------------------|-----------------|-----------|-----------------|
| Signature           | /Laura L. Wine/ | Date      | August 14, 2013 |
| Name                | Laura L. Wine   | Telephone | 714-246-6996    |
| Registration Number | 68,681          |           |                 |

**NOTE:** This form must be signed in accordance with 37 CFR 1.33. See 37 CFR 1.4(d) for signature requirements and certifications.

\*Total of 1 forms are submitted.

This collection of information is required by 37 CFR 1.31, 1.32 and 1.33. The information is required to obtain or retain a benefit by the public which is to file (and by the USPTO to process) an application. Confidentiality is governed by 35 U.S.C. 122 and 37 CFR 1.11 and 1.14. This collection is estimated to take 3 minutes to complete, including gathering, preparing, and submitting the completed application form to the USPTO. Time will vary depending upon the individual case. Any comments on the amount of time you require to complete this form and/or suggestions for reducing this burden, should be sent to the Chief Information Officer, U.S. Patent and Trademark Office, U.S. Department of Commerce, P.O. Box 1450, Alexandria, VA 22313-1450. DO NOT SEND FEES OR COMPLETED FORMS TO THIS ADDRESS. **SEND TO: Commissioner for Patents, P.O. Box 1450, Alexandria, VA 22313-1450.**

*If you need assistance in completing the form, call 1-800-PTO-9199 and select option 2.*

Under the Paperwork Reduction Act of 1995, no persons are required to respond to a collection of information unless it displays a valid OMB control number.

## POWER OF ATTORNEY BY APPLICANT

I hereby revoke all previous powers of attorney given in the application identified in the attached transmittal letter.

I hereby appoint Practitioner(s) associated with the following Customer Number as my/our attorney(s) or agent(s), and to transact all business in the United States Patent and Trademark Office connected therewith for the application referenced in the attached transmittal letter (form PTO/AIA/82A or equivalent):

51957

**OR**

I hereby appoint Practitioner(s) named below as my/our attorney(s) or agent(s), and to transact all business in the United States Patent and Trademark Office connected therewith for the application referenced in the attached transmittal letter (form PTO/AIA/82A or equivalent):

| Name | Registration Number | Name | Registration Number |
|------|---------------------|------|---------------------|
|      |                     |      |                     |
|      |                     |      |                     |
|      |                     |      |                     |
|      |                     |      |                     |
|      |                     |      |                     |
|      |                     |      |                     |

Please recognize or change the correspondence address for the application identified in the attached transmittal letter to:

The address associated with the above-mentioned Customer Number.

**OR**

The address associated with Customer Number:

**OR**

Firm or Individual Name

Address

City

State

Zip

Country

Telephone

Email

I am the Applicant:

Inventor or Joint Inventor

Legal Representative of a Deceased or Legally Incapacitated Inventor

Assignee or Person to Whom the Inventor is Under an Obligation to Assign

Person Who Otherwise Shows Sufficient Proprietary Interest (e.g., a petition under 37 CFR 1.46(b)(2) was granted in the application or is concurrently being filed with this document)

**SIGNATURE of Applicant for Patent**

|                   |   |           |              |
|-------------------|---|-----------|--------------|
| Signature         |  | Date      |              |
| Name              | Debra D. Condino, Reg. No. 31,007   | Telephone | 714-246-2388 |
| Title and Company | Assistant Secretary, Allergan, Inc.   |           |              |

**NOTE:** Signature - This form must be signed by the applicant in accordance with 37 CFR 1.33. See 37 CFR 1.4 for signature requirements and certifications. Submit multiple forms for more than one signature, see below \*.

\*Total of \_\_\_\_\_ forms are submitted.

This collection of information is required by 37 CFR 1.31, 1.32 and 1.33. The information is required to obtain or retain a benefit by the public which is to file (and by the USPTO to process) an application. Confidentiality is governed by 35 U.S.C. 122 and 37 CFR 1.11 and 1.14. This collection is estimated to take 3 minutes to complete, including gathering, preparing, and submitting the completed application form to the USPTO. Time will vary depending upon the individual case. Any comments on the amount of time you require to complete this form and/or suggestions for reducing this burden, should be sent to the Chief Information Officer, U.S. Patent and Trademark Office, U.S. Department of Commerce, P.O. Box 1450, Alexandria, VA 22313-1450. **DO NOT SEND FEES OR COMPLETED FORMS TO THIS ADDRESS. SEND TO: Commissioner for Patents, P.O. Box 1450, Alexandria, VA 22313-1450.**

*If you need assistance in completing the form, call 1-800-PTO-9199 and select option 2.*



## Electronic Patent Application Fee Transmittal

|   |   |
|---|---|
| <b>Application Number:</b>                  | 13967189  |
| <b>Filing Date:</b>                         |   |
| <b>Title of Invention:</b>                  | METHODS OF PROVIDING THERAPEUTIC EFFECTS USING CYCLOSPORIN COMPONENTS |
| <b>First Named Inventor/Applicant Name:</b> | Andrew Acheampong   |
| <b>Filer:</b>                               | Laura Lee Wine/Lauren Barberena                                       |
| <b>Attorney Docket Number:</b>              | 17618CON2B (AP)   |

Filed as Large Entity

### Utility under 35 USC 111(a) Filing Fees

| Description            | Fee Code | Quantity | Amount | Sub-Total in USD(\$) |
|------------------------|----------|----------|--------|----------------------|
| <b>Basic Filing:</b>   |          |          |        |                      |
| <b>Pages:</b>          |          |          |        |                      |
| <b>Claims:</b>         |          |          |        |                      |
| Claims in Excess of 20 | 1202     | 1        | 80     | 80                   |

**Miscellaneous-Filing:**

**Petition:**

**Patent-Appeals-and-Interference:**

**Post-Allowance-and-Post-Issuance:**

**Extension-of-Time:**

| Description              | Fee Code | Quantity | Amount | Sub-Total in USD(\$) |
|--------------------------|----------|----------|--------|----------------------|
| <b>Miscellaneous:</b>    |          |          |        |                      |
| <b>Total in USD (\$)</b> |          |          |        | <b>80</b>            |

## Electronic Acknowledgement Receipt

|   |   |
|---|---|
| <b>EFS ID:</b>                              | 16594189  |
| <b>Application Number:</b>                  | 13967189  |
| <b>International Application Number:</b>    |   |
| <b>Confirmation Number:</b>                 | 4818  |
| <b>Title of Invention:</b>                  | METHODS OF PROVIDING THERAPEUTIC EFFECTS USING CYCLOSPORIN COMPONENTS |
| <b>First Named Inventor/Applicant Name:</b> | Andrew Acheampong   |
| <b>Customer Number:</b>                     | 51957   |
| <b>Filer:</b>                               | Laura Lee Wine/Lauren Barberena                                       |
| <b>Filer Authorized By:</b>                 | Laura Lee Wine  |
| <b>Attorney Docket Number:</b>              | 17618CON2B (AP)   |
| <b>Receipt Date:</b>                        | 14-AUG-2013   |
| <b>Filing Date:</b>                         |   |
| <b>Time Stamp:</b>                          | 19:56:57  |
| <b>Application Type:</b>                    | Utility under 35 USC 111(a)   |

### Payment information:

|  |                 |
|--|-----------------|
| Submitted with Payment                   | yes             |
| Payment Type                             | Deposit Account |
| Payment was successfully received in RAM | \$80            |
| RAM confirmation Number                  | 6828            |
| Deposit Account                          | 010885          |
| Authorized User                          |                 |

The Director of the USPTO is hereby authorized to charge indicated fees and credit any overpayment as follows:  
Charge any Additional Fees required under 37 C.F.R. Section 1.17 (Patent application and reexamination processing fees)  
Charge any Additional Fees required under 37 C.F.R. Section 1.21 (Miscellaneous fees and charges)

**File Listing:**

| Document Number | Document Description | File Name    | File Size(Bytes)/<br>Message Digest                   | Multi Part /.zip | Pages (if appl.) |
|-----------------|----------------------|--------------|---|------------------|------------------|
| 1               | Fee Worksheet (SB06) | fee-info.pdf | 30698<br><br>5ca960e737fe250aaf1a5f4557295ff39ac9e1dd | no               | 2                |

**Warnings:****Information:**

|                                     |       |
|-------------------------------------|-------|
| <b>Total Files Size (in bytes):</b> | 30698 |
|-------------------------------------|-------|

**This Acknowledgement Receipt evidences receipt on the noted date by the USPTO of the indicated documents, characterized by the applicant, and including page counts, where applicable. It serves as evidence of receipt similar to a Post Card, as described in MPEP 503.**

**New Applications Under 35 U.S.C. 111**

**If a new application is being filed and the application includes the necessary components for a filing date (see 37 CFR 1.53(b)-(d) and MPEP 506), a Filing Receipt (37 CFR 1.54) will be issued in due course and the date shown on this Acknowledgement Receipt will establish the filing date of the application.**

**National Stage of an International Application under 35 U.S.C. 371**

**If a timely submission to enter the national stage of an international application is compliant with the conditions of 35 U.S.C. 371 and other applicable requirements a Form PCT/DO/EO/903 indicating acceptance of the application as a national stage submission under 35 U.S.C. 371 will be issued in addition to the Filing Receipt, in due course.**

**New International Application Filed with the USPTO as a Receiving Office**

**If a new international application is being filed and the international application includes the necessary components for an international filing date (see PCT Article 11 and MPEP 1810), a Notification of the International Application Number and of the International Filing Date (Form PCT/RO/105) will be issued in due course, subject to prescriptions concerning national security, and the date shown on this Acknowledgement Receipt will establish the international filing date of the application.**

|   |                        |                    |                   |
|---|------------------------|--------------------|-------------------|
| <b>INFORMATION DISCLOSURE<br/>STATEMENT BY APPLICANT</b><br>( Not for submission under 37 CFR 1.99) | Application Number     |                    | 13967189          |
|   | Filing Date            |                    | 2013-08-14        |
|   | First Named Inventor   | ACHEAMPONG, ANDREW |                   |
|   | Art Unit               |                    | 1653              |
|   | Examiner Name          | TBD                |                   |
|   | Attorney Docket Number |                    | 17618-US-BCON2-AP |

| U.S.PATENTS       |         |               |                        |            |   |  |
|-------------------|---------|---------------|------------------------|------------|---|--|
| Examiner Initial* | Cite No | Patent Number | Kind Code <sup>1</sup> | Issue Date | Name of Patentee or Applicant of cited Document | Pages,Columns,Lines where Relevant Passages or Relevant Figures Appear |
|                   | 1       | 3278447       |                        | 1966-10-11 | Thomas McNicholas                               |  |
|                   | 2       | 4388229       |                        | 1983-06-14 | Cherng-Chyi Fu                                  |  |
|                   | 3       | 4388307       |                        | 1983-06-14 | Thomas Cavanak                                  |  |
|                   | 4       | 4614736       |                        | 1986-09-30 | Devallee et al                                  |  |
|                   | 5       | 4649047       |                        | 1987-03-10 | Renee Kaswan                                    |  |
|                   | 6       | 4764503       |                        | 1988-08-16 | Roland Wenger                                   |  |
|                   | 7       | 4814323       |                        | 1989-03-21 | Andrieu et al                                   |  |
|                   | 8       | 4839342       |                        | 1989-06-13 | Renee Kaswan                                    |  |

**INFORMATION DISCLOSURE  
STATEMENT BY APPLICANT**  
( Not for submission under 37 CFR 1.99)

|                        |                    |
|------------------------|--------------------|
| Application Number     | 13967189           |
| Filing Date            | 2013-08-14         |
| First Named Inventor   | ACHEAMPONG, ANDREW |
| Art Unit               | 1653               |
| Examiner Name          | TBD                |
| Attorney Docket Number | 17618-US-BCON2-AP  |

|    |         |  |            |                   |  |
|----|---------|--|------------|-------------------|--|
| 9  | 4970076 |  | 1990-11-13 | David Horrobin    |  |
| 10 | 4990337 |  | 1991-02-05 | Kurihara et al    |  |
| 11 | 4996193 |  | 1991-02-26 | Hewitt et al      |  |
| 12 | 5047396 |  | 1991-09-10 | Orban et al       |  |
| 13 | 5051402 |  | 1991-09-24 | Kurihara et al    |  |
| 14 | 5053000 |  | 1991-10-01 | Booth et al       |  |
| 15 | 5286730 |  | 1994-02-15 | Caufield et al    |  |
| 16 | 5286731 |  | 1994-02-15 | Caufield et al    |  |
| 17 | 5294604 |  | 1994-03-15 | Nussenblatt et al |  |
| 18 | 5296158 |  | 1994-03-22 | MacGilp et al     |  |
| 19 | 5342625 |  | 1994-08-30 | Hauer et al       |  |

**INFORMATION DISCLOSURE  
STATEMENT BY APPLICANT**  
( Not for submission under 37 CFR 1.99)

|                        |                    |
|------------------------|--------------------|
| Application Number     | 13967189           |
| Filing Date            | 2013-08-14         |
| First Named Inventor   | ACHEAMPONG, ANDREW |
| Art Unit               | 1653               |
| Examiner Name          | TBD                |
| Attorney Docket Number | 17618-US-BCON2-AP  |

|  |    |         |  |            |                 |  |
|--|----|---------|--|------------|-----------------|--|
|  | 20 | 5368854 |  | 1994-11-29 | Donna Rennick   |  |
|  | 21 | 5411952 |  | 1995-05-02 | Renee Kaswan    |  |
|  | 22 | 5424078 |  | 1995-06-13 | Anthony Dziabo  |  |
|  | 23 | 5474919 |  | 1995-12-12 | Chartrain et al |  |
|  | 24 | 5474979 |  | 1995-12-12 | Ding et al      | U.S. Application No. 08/243,279 and its entire prosecution history** |
|  | 25 | 5504068 |  | 1996-04-02 | Komiya et al    |  |
|  | 26 | 5540931 |  | 1996-07-30 | Hewitt et al    |  |
|  | 27 | 5543393 |  | 1996-08-06 | Kim et al       |  |
|  | 28 | 5589455 |  | 1996-12-31 | Jong Woo        |  |
|  | 29 | 5591971 |  | 1997-01-07 | Shahar et al    |  |
|  | 30 | 5614491 |  | 1997-03-25 | Walch et al     |  |

**INFORMATION DISCLOSURE  
STATEMENT BY APPLICANT**  
( Not for submission under 37 CFR 1.99)

|                        |                    |
|------------------------|--------------------|
| Application Number     | 13967189           |
| Filing Date            | 2013-08-14         |
| First Named Inventor   | ACHEAMPONG, ANDREW |
| Art Unit               | 1653               |
| Examiner Name          | TBD                |
| Attorney Docket Number | 17618-US-BCON2-AP  |

|    |         |  |            |                    |  |
|----|---------|--|------------|--------------------|--|
| 31 | 5639724 |  | 1997-06-17 | Thomas Cavanak     |  |
| 32 | 5652212 |  | 1997-07-29 | Cavanak et al      |  |
| 33 | 5719123 |  | 1998-02-17 | Morley et al       |  |
| 34 | 5739105 |  | 1998-04-14 | Kim et al          |  |
| 35 | 5753166 |  | 1998-05-19 | Dalton et al       |  |
| 36 | 5766629 |  | 1998-06-16 | Cho et al          |  |
| 37 | 5798333 |  | 1998-08-25 | Bernard Sherman    |  |
| 38 | 5807820 |  | 1998-09-15 | Elias et al        |  |
| 39 | 5827822 |  | 1998-10-27 | Floch'h et al      |  |
| 40 | 5827862 |  | 1998-10-27 | Yoshitaka Yamamura |  |
| 41 | 5834017 |  | 1998-11-10 | Cho et al          |  |



**INFORMATION DISCLOSURE  
STATEMENT BY APPLICANT**  
( Not for submission under 37 CFR 1.99)

|                        |                    |
|------------------------|--------------------|
| Application Number     | 13967189           |
| Filing Date            | 2013-08-14         |
| First Named Inventor   | ACHEAMPONG, ANDREW |
| Art Unit               | 1653               |
| Examiner Name          | TBD                |
| Attorney Docket Number | 17618-US-BCON2-AP  |

|    |         |  |            |                 |  |
|----|---------|--|------------|-----------------|--|
| 42 | 5843452 |  | 1998-12-01 | Wiedmann et al  |  |
| 43 | 5843891 |  | 1998-12-01 | Bernard Sherman |  |
| 44 | 5858401 |  | 1999-01-12 | Bhalani et al   |  |
| 45 | 5866159 |  | 1999-02-02 | Hauer et al     |  |
| 46 | 5891846 |  | 1999-04-06 | Ishida et al    |  |
| 47 | 5916589 |  | 1999-06-29 | Hauer et al     |  |
| 48 | 5929030 |  | 1999-07-27 | Hamied et al    |  |
| 49 | 5951971 |  | 1999-09-14 | Kawashima et al |  |
| 50 | 5962014 |  | 1999-10-05 | Hauer et al     |  |
| 51 | 5962017 |  | 1999-10-05 | Hauer et al     |  |
| 52 | 5962019 |  | 1999-10-05 | Cho et al       |  |

**INFORMATION DISCLOSURE  
STATEMENT BY APPLICANT**  
( Not for submission under 37 CFR 1.99)

|                        |                    |
|------------------------|--------------------|
| Application Number     | 13967189           |
| Filing Date            | 2013-08-14         |
| First Named Inventor   | ACHEAMPONG, ANDREW |
| Art Unit               | 1653               |
| Examiner Name          | TBD                |
| Attorney Docket Number | 17618-US-BCON2-AP  |

|    |         |  |            |                 |  |
|----|---------|--|------------|-----------------|--|
| 53 | 5977066 |  | 1999-11-02 | Thomas Cavanak  |  |
| 54 | 5981479 |  | 1999-11-09 | Ko et al        |  |
| 55 | 5981607 |  | 1999-11-09 | Ding et al      | U.S. Application No. 09/008,924 and its entire prosecution history** |
| 56 | 5998365 |  | 1999-12-07 | Bernard Sherman |  |
| 57 | 6004566 |  | 1999-12-21 | Friedman et al  |  |
| 58 | 6007840 |  | 1999-12-28 | Hauer et al     |  |
| 59 | 6008191 |  | 1999-12-28 | Amarjit Singh   |  |
| 60 | 6008192 |  | 1999-12-28 | Al-Razzak et al |  |
| 61 | 6022852 |  | 2000-02-08 | Klokkers et al  |  |
| 62 | 6024978 |  | 2000-02-15 | Hauer et al     |  |
| 63 | 6046163 |  | 2000-04-04 | Stuchlik et al  |  |

**INFORMATION DISCLOSURE  
STATEMENT BY APPLICANT**  
( Not for submission under 37 CFR 1.99)

|                        |                    |
|------------------------|--------------------|
| Application Number     | 13967189           |
| Filing Date            | 2013-08-14         |
| First Named Inventor   | ACHEAMPONG, ANDREW |
| Art Unit               | 1653               |
| Examiner Name          | TBD                |
| Attorney Docket Number | 17618-US-BCON2-AP  |

|    |         |  |            |                 |  |
|----|---------|--|------------|-----------------|--|
| 64 | 6057289 |  | 2000-05-02 | Nirmal Mulye    |  |
| 65 | 6159933 |  | 2000-12-12 | Bernard Sherman |  |
| 66 | 6197335 |  | 2001-03-06 | Bernard Sherman |  |
| 67 | 6254860 |  | 2001-07-03 | Michael Garst   |  |
| 68 | 6254885 |  | 2001-07-03 | Cho et al       |  |
| 69 | 6267985 |  | 2001-07-31 | Chen et al      |  |
| 70 | 6284268 |  | 2001-09-04 | Mishra et al    |  |
| 71 | 6294192 |  | 2001-09-25 | Patel et al     |  |
| 72 | 6306825 |  | 2001-10-23 | Thomas Cavanak  |  |
| 73 | 6323204 |  | 2001-11-27 | James Burke     |  |
| 74 | 6346511 |  | 2002-02-12 | Singh et al     |  |

**INFORMATION DISCLOSURE  
STATEMENT BY APPLICANT**  
( Not for submission under 37 CFR 1.99)

|                        |                    |
|------------------------|--------------------|
| Application Number     | 13967189           |
| Filing Date            | 2013-08-14         |
| First Named Inventor   | ACHEAMPONG, ANDREW |
| Art Unit               | 1653               |
| Examiner Name          | TBD                |
| Attorney Docket Number | 17618-US-BCON2-AP  |

|    |         |  |            |                  |  |
|----|---------|--|------------|------------------|--|
| 75 | 6350442 |  | 2002-02-26 | Michael Garst    |  |
| 76 | 6413547 |  | 2002-07-02 | Bennett et al    |  |
| 77 | 6420355 |  | 2002-07-16 | Richter et al    |  |
| 78 | 6468968 |  | 2002-10-22 | Cavanak et al    |  |
| 79 | 6475519 |  | 2002-11-05 | Meinzer et al    |  |
| 80 | 6486124 |  | 2002-11-26 | Olbrich et al    |  |
| 81 | 6544953 |  | 2003-04-08 | Tsuzuki et al    |  |
| 82 | 6555526 |  | 2003-04-29 | Toshihiko Matsuo |  |
| 83 | 6562873 |  | 2003-05-13 | Olejnik et al    |  |
| 84 | 6569463 |  | 2003-03-27 | Patel et al      |  |
| 85 | 6582718 |  | 2003-06-24 | Yoichi Kawashima |  |

|   |                        |                    |
|---|------------------------|--------------------|
| <b>INFORMATION DISCLOSURE<br/>STATEMENT BY APPLICANT</b><br>( Not for submission under 37 CFR 1.99) | Application Number     | 13967189           |
|   | Filing Date            | 2013-08-14         |
|   | First Named Inventor   | ACHEAMPONG, ANDREW |
|   | Art Unit               | 1653               |
|   | Examiner Name          | TBD                |
|   | Attorney Docket Number | 17618-US-BCON2-AP  |

|  |    |         |  |            |                |  |
|--|----|---------|--|------------|----------------|--|
|  | 86 | 6656460 |  | 2003-12-02 | Benita et al   |  |
|  | 87 | 6872705 |  | 2005-03-29 | Robert Lyons   |  |
|  | 88 | 7202209 |  | 2007-04-10 | James N. Chang | U.S. Application No. 11/181,428 and its entire prosecution history** |
|  | 89 | 7276476 |  | 2007-10-02 | Chang et al    | U.S. Application No. 11/181,187 and its entire prosecution history** |
|  | 90 | 7288520 |  | 2007-10-30 | Chang et al    | U.S. Application No. 11/255,821 and its entire prosecution history** |
|  | 91 | 7297679 |  | 2007-11-20 | James Chang    | U.S. Application No. 11/181,178 and its entire prosecution history** |
|  | 92 | 7501393 |  | 2009-03-10 | Tien et al     | U.S. Application No. 11/161,218 and its entire prosecution history** |
|  | 93 | 8211855 |  | 2012-07-03 | Chang et al    | U.S. Application No. 11/857,223 and its entire prosecution history** |
|  | 94 | 8288348 |  | 2012-10-16 | Chang et al    | U.S. Application No. 11/917,448 and its entire prosecution history** |

If you wish to add additional U.S. Patent citation information please click the Add button.

**U.S.PATENT APPLICATION PUBLICATIONS**

| Examiner Initial* | Cite No | Publication Number | Kind Code <sup>1</sup> | Publication Date | Name of Patentee or Applicant of cited Document | Pages, Columns, Lines where Relevant Passages or Relevant Figures Appear |
|-------------------|---------|--------------------|------------------------|------------------|---|--|
|-------------------|---------|--------------------|------------------------|------------------|---|--|

**INFORMATION DISCLOSURE  
STATEMENT BY APPLICANT**  
( Not for submission under 37 CFR 1.99)

|                        |                    |
|------------------------|--------------------|
| Application Number     | 13967189           |
| Filing Date            | 2013-08-14         |
| First Named Inventor   | ACHEAMPONG, ANDREW |
| Art Unit               | 1653               |
| Examiner Name          | TBD                |
| Attorney Docket Number | 17618-US-BCON2-AP  |

|    |             |  |            |                  |  |
|----|-------------|--|------------|------------------|--|
| 1  | 20010003589 |  | 2001-06-14 | Neuer et al      |  |
| 2  | 20010014665 |  | 2001-08-16 | Fischer et al    |  |
| 3  | 20010036449 |  | 2001-11-01 | Michael Garst    |  |
| 4  | 20020012680 |  | 2002-01-31 | Patel et al      |  |
| 5  | 20020013272 |  | 2002-01-31 | Cavanak et al    |  |
| 6  | 20020016290 |  | 2002-02-07 | Floc'h et al     |  |
| 7  | 20020016292 |  | 2002-02-07 | Richter et al    |  |
| 8  | 20020025927 |  | 2002-02-28 | Olbrich et al    |  |
| 9  | 20020045601 |  | 2002-04-18 | Yoichi Kawashima |  |
| 10 | 20020107183 |  | 2002-08-08 | Petszulat et al  |  |
| 11 | 20020119190 |  | 2002-08-29 | Meinzer et al    |  |

**INFORMATION DISCLOSURE  
STATEMENT BY APPLICANT**  
( Not for submission under 37 CFR 1.99)

|                        |                    |                   |
|------------------------|--------------------|-------------------|
| Application Number     |                    | 13967189          |
| Filing Date            |                    | 2013-08-14        |
| First Named Inventor   | ACHEAMPONG, ANDREW |                   |
| Art Unit               |                    | 1653              |
| Examiner Name          | TBD                |                   |
| Attorney Docket Number |                    | 17618-US-BCON2-AP |

|  |    |             |  |            |                     |  |
|--|----|-------------|--|------------|---------------------|--|
|  | 12 | 20020165134 |  | 2002-11-07 | Richter et al       |  |
|  | 13 | 20030021816 |  | 2003-01-30 | Kang et al          |  |
|  | 14 | 20030044452 |  | 2003-03-06 | Ryuji Ueno          |  |
|  | 15 | 20030055028 |  | 2003-03-20 | Stergiopoulos et al |  |
|  | 16 | 20030059470 |  | 2003-03-27 | Rainer Muller       |  |
|  | 17 | 20030060402 |  | 2003-03-27 | Cavanak et al       |  |
|  | 18 | 20030087813 |  | 2003-05-08 | Or et al            |  |
|  | 19 | 20030104992 |  | 2003-06-05 | Or et al            |  |
|  | 20 | 20030108626 |  | 2003-06-12 | Benita et al        |  |
|  | 21 | 20030109425 |  | 2003-06-12 | Or et al            |  |
|  | 22 | 20030109426 |  | 2003-06-12 | Or et al            |  |

**INFORMATION DISCLOSURE  
STATEMENT BY APPLICANT**  
( Not for submission under 37 CFR 1.99)

|                        |                    |
|------------------------|--------------------|
| Application Number     | 13967189           |
| Filing Date            | 2013-08-14         |
| First Named Inventor   | ACHEAMPONG, ANDREW |
| Art Unit               | 1653               |
| Examiner Name          | TBD                |
| Attorney Docket Number | 17618-US-BCON2-AP  |

|    |             |  |            |                   |  |
|----|-------------|--|------------|-------------------|--|
| 23 | 20030133984 |  | 2003-07-17 | Ambuhl et al      |  |
| 24 | 20030143250 |  | 2003-07-31 | Hauer et al       |  |
| 25 | 20030147954 |  | 2003-08-07 | Yang et al        |  |
| 26 | 20030166517 |  | 2003-09-04 | Fricker et al     |  |
| 27 | 20050014691 |  | 2005-01-20 | Bakhit et al      |  |
| 28 | 20050059583 |  | 2005-03-17 | Andrew Acheampong | U.S. Application No. 10/927,857 and its entire prosecution history** |
| 29 | 20070015691 |  | 2007-01-18 | James Chang       | U.S. Application No. 11/181,409 and its entire prosecution history** |
| 30 | 20070027072 |  | 2007-02-01 | Tien et al        |  |
| 31 | 20070087962 |  | 2007-04-19 | Tien et al        |  |
| 32 | 20070149447 |  | 2007-06-28 | Chang et al       | U.S. Application No. 11/679,934 and its entire prosecution history** |
| 33 | 20070299004 |  | 2007-12-27 | Acheampong et al  | U.S. Application No. 11/897,177 and its entire prosecution history** |



**INFORMATION DISCLOSURE  
STATEMENT BY APPLICANT**  
( Not for submission under 37 CFR 1.99)

|                        |                    |
|------------------------|--------------------|
| Application Number     | 13967189           |
| Filing Date            | 2013-08-14         |
| First Named Inventor   | ACHEAMPONG, ANDREW |
| Art Unit               | 1653               |
| Examiner Name          | TBD                |
| Attorney Docket Number | 17618-US-BCON2-AP  |

|    |             |  |            |                 |  |
|----|-------------|--|------------|-----------------|--|
| 34 | 20080039378 |  | 2008-02-14 | Graham et al    | U.S. Application No. 11/781,095 and its entire prosecution history** |
| 35 | 20080070834 |  | 2008-03-20 | Chang et al     | U.S. Application No. 11/940,652 and its entire prosecution history** |
| 36 | 20080146497 |  | 2008-06-19 | Graham et al    | U.S. Application No. 11/858,200 and its entire prosecution history** |
| 37 | 20080207495 |  | 2008-08-28 | Graham et al    | U.S. Application No. 12/035,698 and its entire prosecution history** |
| 38 | 20090131307 |  | 2009-05-21 | Tien et al      | U.S. Application No. 12/361,335 and its entire prosecution history** |
| 39 | 20100279951 |  | 2010-11-04 | Morgan et al    | U.S. Application No. 12/771,952 and its entire prosecution history** |
| 40 | 20110009339 |  | 2011-01-13 | Rhett Schiffman | U.S. Application No. 12/759,431 and its entire prosecution history** |
| 41 | 20110294744 |  | 2011-12-01 | Morgan et al    | U.S. Application No. 13/115,764 and its entire prosecution history** |
| 42 | 20120270805 |  | 2012-10-25 | Chang et al     | U.S. Application No. 13/536,479 and its entire prosecution history** |
| 43 | 20130059796 |  | 2013-03-07 | Chang et al     | U.S. Application No. 13/649,287 and its entire prosecution history** |

If you wish to add additional U.S. Published Application citation information please click the Add button.

**FOREIGN PATENT DOCUMENTS**

**INFORMATION DISCLOSURE  
STATEMENT BY APPLICANT**  
( Not for submission under 37 CFR 1.99)

|                        |                    |
|------------------------|--------------------|
| Application Number     | 13967189           |
| Filing Date            | 2013-08-14         |
| First Named Inventor   | ACHEAMPONG, ANDREW |
| Art Unit               | 1653               |
| Examiner Name          | TBD                |
| Attorney Docket Number | 17618-US-BCON2-AP  |

| Examiner Initial* | Cite No | Foreign Document Number <sup>3</sup> | Country Code <sup>2</sup> | Kind Code <sup>4</sup> | Publication Date | Name of Patentee or Applicant of cited Document           | Pages, Columns, Lines where Relevant Passages or Relevant Figures Appear | T <sup>5</sup>           |
|-------------------|---------|--------------------------------------|---------------------------|------------------------|------------------|---|--|--------------------------|
|                   | 1       | 19810655                             | DE                        |                        | 1999-09-16       | Eberhard-Karis-<br>Universitat Tubingen<br>Universitatskl |  | <input type="checkbox"/> |
|                   | 2       | 0471293                              | EP                        |                        | 1992-02-19       | ABBOTT<br>LABORATORIES                                    |  | <input type="checkbox"/> |
|                   | 3       | 0547229                              | EP                        |                        | 1993-01-07       | LLT Institute Co., Ltd.                                   |  | <input type="checkbox"/> |
|                   | 4       | 0760237                              | EP                        |                        | 1997-03-05       | Cipla Limited   |  | <input type="checkbox"/> |
|                   | 5       | 1995-031211                          | WO                        |                        | 1995-11-23       | Allergan Inc.   |  | <input type="checkbox"/> |
|                   | 6       | 2000-000179                          | WO                        |                        | 2000-01-06       | Won Jin Biopharma Co.,<br>Ltd                             |  | <input type="checkbox"/> |
|                   | 7       | 2001-032142                          | WO                        |                        | 2001-05-10       | Cipla Limited   |  | <input type="checkbox"/> |
|                   | 8       | 2001-041671                          | WO                        |                        | 2001-06-14       | Transneuronix, Inc.                                       |  | <input type="checkbox"/> |
|                   | 9       | 2002-009667                          | WO                        |                        | 2002-02-07       | Pharmasol GMBH  |  | <input type="checkbox"/> |
|                   | 10      | 2002-049603                          | WO                        |                        | 2002-06-27       | LG Household & Health<br>Care Ltd.                        |  | <input type="checkbox"/> |

|   |                        |                    |
|---|------------------------|--------------------|
| <b>INFORMATION DISCLOSURE<br/>STATEMENT BY APPLICANT</b><br>( Not for submission under 37 CFR 1.99) | Application Number     | 13967189           |
|   | Filing Date            | 2013-08-14         |
|   | First Named Inventor   | ACHEAMPONG, ANDREW |
|   | Art Unit               | 1653               |
|   | Examiner Name          | TBD                |
|   | Attorney Docket Number | 17618-US-BCON2-AP  |

|    |             |    |  |            |   |                          |
|----|-------------|----|--|------------|---|--------------------------|
| 11 | 2003-030834 | WO |  | 2003-04-17 | Enanta Pharmaceuticals, Inc.                      | <input type="checkbox"/> |
| 12 | 2003-053405 | WO |  | 2003-07-03 | Yissum Research Development Company of the Hebrew | <input type="checkbox"/> |

If you wish to add additional Foreign Patent Document citation information please click the Add button

### NON-PATENT LITERATURE DOCUMENTS

| Examiner Initials* | Cite No | Include name of the author (in CAPITAL LETTERS), title of the article (when appropriate), title of the item (book, magazine, journal, serial, symposium, catalog, etc), date, pages(s), volume-issue number(s), publisher, city and/or country where published. | T <sup>5</sup>           |
|--------------------|---------|---|--------------------------|
|                    | 1       | ABDULRAZIK, M. ET AL, Ocular Delivery of Cyclosporin A II. Effect of Submicron Emulsion's Surface Charge on Ocular Distribution of Topical Cyclosporin A, S.T.P. Pharma Sciences, Dec. 2001, 427-432, 11(6)   | <input type="checkbox"/> |
|                    | 2       | ACHEAMPONG, ANDREW ET AL, Cyclosporine Distribution into the Conjunctiva, Cornea, Lacrimal Gland and Systemic Blood Following Topical Dosing of Cyclosporine to Rabbit, Dog and Human eyes, 1996, 179   | <input type="checkbox"/> |
|                    | 3       | ACHEAMPONG, ANDREW ET AL, Cyclosporine Distribution Into The Conjunctiva, Cornea, Lacrimal Gland, and Systemic Blood Following Topical Dosing of Cyclosporine to Rabbit, Dog, and Human Eyes, Adv. Exp. Med. Biol., 1998, 1001-1004, 438                        | <input type="checkbox"/> |
|                    | 4       | ACHEAMPONG, ANDREW ET AL, Distribution of Cyclosporin A in Ocular Tissues After Topical Administration to Albino Rabbits and Beagle Dogs, Current Eye Research, 1999, 91-103, 18(2)   | <input type="checkbox"/> |
|                    | 5       | AKPEK, ESEN KARAMURSEL ET AL, A Randomized Trial of Topical Cyclosporin 0.05% in Topical Steroid-Resistant Atopic Keratoconjunctivitis, Ophthalmology, 2004, 476-482, 111   | <input type="checkbox"/> |
|                    | 6       | ANGELOV, O. ET AL, Preclinical Safety Studies of Cyclosporine Ophthalmic Emulsion, Adv Exp Med Biol, 1998, 991-995, 438   | <input type="checkbox"/> |
|                    | 7       | ANGELOV, O. ET AL, Safety Assessment of Cyclosporine Ophthalmic Emulsion in Rabbits and Dogs, XIth Congress of the European Society of Ophthalmology, 1997, 25-28, 1-5, Soc. Ophthalmol Eur., HU  | <input type="checkbox"/> |

**INFORMATION DISCLOSURE  
STATEMENT BY APPLICANT**  
( Not for submission under 37 CFR 1.99)

|                        |                    |
|------------------------|--------------------|
| Application Number     | 13967189           |
| Filing Date            | 2013-08-14         |
| First Named Inventor   | ACHEAMPONG, ANDREW |
| Art Unit               | 1653               |
| Examiner Name          | TBD                |
| Attorney Docket Number | 17618-US-BCON2-AP  |

|    |   |                          |
|----|---|--------------------------|
| 8  | ARDIZZONE, SANDRO ET AL, A Practical Guide to the Management of Distal Ulcerative Colitis, Drugs, 1998, 519-542, 55(4)  | <input type="checkbox"/> |
| 9  | BANIC, MARKO ET AL, Effect of Cyclosporine in a Murine Model of Experimental Colitis, Digestive Diseases and Sciences, June 2002, 1362-1368, 47(6)  | <input type="checkbox"/> |
| 10 | BONINI, S. ET AL, Vernal Keratoconjunctivitis, Eye, 2004, 345-351, 18   | <input type="checkbox"/> |
| 11 | BREWSTER, MARCUS ET AL, Enhanced Delivery of Ganciclovir to the Brain Through the Use of Redox Targeting, Antimicrobial Agents and Chemotherapy, Apr 1994, 817-823, 38(4)   | <input type="checkbox"/> |
| 12 | BREWSTER, MARCUS ET AL, Intravenous and Oral Pharmacokinetic Evaluation of a 2-Hydroxypropyl-β-cyclodextrin-Based Formulation of Carbamazepine in the Dog: Comparison with Commercially Available Tablets and Suspensions, Journal of Pharmaceutical Sciences, March 1997, 335-339, 86(3) | <input type="checkbox"/> |
| 13 | BREWSTER, MARCUS ET AL, Preparation, Characterization, and Anesthetic Properties of 2-Hydroxypropyl-β-cyclodextrin Complexes of Pregnanolone and Pregnenolone in Rat and Mouse, Journal of Pharmaceutical Sciences, October 1995, 1154-1159, 84(10)                                       | <input type="checkbox"/> |
| 14 | BRINKMEIER, THOMAS ET AL, Pyodermatitis-Pyostomatitis Vegetans: A Clinical Course of Two Decades with Response to Cyclosporine and Low-Dose Prednisolone, Acta Derm Venereol, 2001, 134-136, 81   | <input type="checkbox"/> |
| 15 | CASTILLO, JOSE M. BENITEZ DEL ET AL, Influence of Topical Cyclosporine A and Dissolvent on Corneal Epithelium Permeability of Fluorescein, Documenta Ophthalmologica, 1995, 49-55, 91   | <input type="checkbox"/> |
| 16 | CHEEKS, LISA ET AL, Influence of Vehicle and Anterior Chamber Protein Concentration on Cyclosporine Penetration Through the Isolated Rabbit Cornea, Current Eye Research, 1992, 641-649, 11(7)  | <input type="checkbox"/> |
| 17 | Database WPI Week 200044, Derwent Pub. Ltd., London, GB; An 2000-492678 & JP2000/143542, 2000, 2 Pages  | <input type="checkbox"/> |
| 18 | DING, SHULIN ET AL, Cyclosporine Ophthalmic O/W emulsion: Formulation and Emulsion Characterization, Pharm Res, 1997, 1 page, 14 (11)   | <input type="checkbox"/> |

**INFORMATION DISCLOSURE  
STATEMENT BY APPLICANT**  
( Not for submission under 37 CFR 1.99)

|                        |                    |
|------------------------|--------------------|
| Application Number     | 13967189           |
| Filing Date            | 2013-08-14         |
| First Named Inventor   | ACHEAMPONG, ANDREW |
| Art Unit               | 1653               |
| Examiner Name          | TBD                |
| Attorney Docket Number | 17618-US-BCON2-AP  |

|    |  |                          |
|----|--|--------------------------|
| 19 | DONNENFELD, ERIC D., The Economics Of Using Restasis, Ophthalmology Management, 10/2003, 3 pages, US   | <input type="checkbox"/> |
| 20 | DROSOS, A. A. ET AL, Efficacy and Safety of Cyclosporine-A Therapy for Primary Sjogren's Syndrome, Ter. Arkh., 1998, 77-80, 60(4)  | <input type="checkbox"/> |
| 21 | DROSOS, A.A. ET AL, Cyclosporin A Therapy in Patients with Primary Sjogren's Syndrome: Results at One Year, Scand J Rheumatology, 1986, 246-249, 61  | <input type="checkbox"/> |
| 22 | EISEN, DRORE ET AL, Topical Cyclosporine for Oral Mucosal Disorders, J Am Acad Dermatol, Dec. 1990, 1259-1264, 23  | <input type="checkbox"/> |
| 23 | EPSTEIN, JOEL ET AL, Topical Cyclosporine in a Bioadhesive for Treatment of Oral Lichenoid Muscosal Reactions, Oral Surg Oral Med Oral Pathol Oral, 1996, 532-536, 82  | <input type="checkbox"/> |
| 24 | ERDMANN, S. ET AL, Pemphigus Vulgaris Der Mund- Und Kehlkopfschleimhaut Pemphigus Vulgaris of the Oral Mucosa and the Larynx, H+G Zeitschrift Fuer Hautkrankheiten, 1997, 283-286, 72(4)   | <input type="checkbox"/> |
| 25 | FDA Concludes Restasis (Cyclosporine) Not Effective for Dry Eye (6/18/1999). Accessed online at <a href="http://www.dryeyeinfo.org/Restasis_Cyclosporine.htm">http://www.dryeyeinfo.org/Restasis_Cyclosporine.htm</a> on 8/14/09. 1 Page | <input type="checkbox"/> |
| 26 | GAETA, G.M. ET AL, Cyclosporin Bioadhesive Gel in the Topical Treatment of Erosive Oral Lichen Planus, International Journal of Immunopathology and Pharmacology, 1994, 125-132, 7(2)  | <input type="checkbox"/> |
| 27 | GIPSON, ILENE ET AL, Character of Ocular Surface Mucins and Their Alteration in Dry Eye Disease, The Ocular Surface, April 2004, 131-148, 2(2)   | <input type="checkbox"/> |
| 28 | GREMSE, DAVID ET AL, Ulcerative Colitis in Children, Pediatr Drugs, 2002, 807-815, 4(12)   | <input type="checkbox"/> |
| 29 | GUNDUZ, KAAAN ET AL, Topical Cyclosporin Treatment of Keratoconjunctivitis Sicca in Secondary Sjogren's Syndrome, Acta Ophthalmologica, 1994, 438-442, 72  | <input type="checkbox"/> |

**INFORMATION DISCLOSURE  
STATEMENT BY APPLICANT**

( Not for submission under 37 CFR 1.99)

|                        |                    |
|------------------------|--------------------|
| Application Number     | 13967189           |
| Filing Date            | 2013-08-14         |
| First Named Inventor   | ACHEAMPONG, ANDREW |
| Art Unit               | 1653               |
| Examiner Name          | TBD                |
| Attorney Docket Number | 17618-US-BCON2-AP  |

|    |   |                          |
|----|---|--------------------------|
| 30 | <a href="http://web.archive.org/web/2001030625323/http://www.surfactant.co.kr/surfactants/pegester.html">http://web.archive.org/web/2001030625323/http://www.surfactant.co.kr/surfactants/pegester.html</a> , 2001, 6 Pages, retrieved on 7/05/2008 | <input type="checkbox"/> |
| 31 | HUNTER, P.A. ET AL, Cyclosporin A Applied Topically to the Recipient Eye Inhibits Corneal Graft Rejection, Clin Exp Immunol, 1981, 173-177, 45  | <input type="checkbox"/> |
| 32 | JUMAA, MUHANNAD ET AL, Physicochemical Properties and Hemolytic Effect of Different Lipid Emulsion Formulations Using a Mixture of Emulsifiers, Pharmaceutica Acta Helvetiae, 1999, 293-301, 73   | <input type="checkbox"/> |
| 33 | KANAI, A. ET AL, The Effect on the Cornea of Alpha Cyclodextrin Vehicle for Eye Drops, Transplantation Proceedings, February 1989, 3150-3152, Vol. 21   | <input type="checkbox"/> |
| 34 | KANPOLAT, AYFER ET AL, Penetration of Cyclosporin A into the Rabbit Cornea and Aqueous Humor after Topical Drop and Collagen Shield Administration, Cornea/External Disease, April 1994, 119-122, 20(2)   | <input type="checkbox"/> |
| 35 | KAUR, RABINDER ET AL, Solid Dispersions of Drugs in Polyocetylthylene 40 Stearate: Dissolution Rates and Physico-Chemical Interactions, Journal of Pharmacy and Pharmacology, December 1979, 48P  | <input type="checkbox"/> |
| 36 | KUWANO, MITSUAKI ET AL, Cyclosporine A Formulation Affects Its Ocular Distribution in Rabbits, Pharmaceutical Research, January 2002, 108-111, 19(1)  | <input type="checkbox"/> |
| 37 | Lambert Technologies Corp. Material Safety Data Sheet for LUMULSE™ POE-40 MS KP, last revision 8/22/2003. 3 pages   | <input type="checkbox"/> |
| 38 | LEIBOVITZ, Z. ET AL., Our Experience In Processing Maize (Corn) Germ Oil, Journal Of The American Oil Chemists Society, 02/1983, 395-399, 80 (2), US  | <input type="checkbox"/> |
| 39 | LIXIN, XIE ET AL, Effect Of Cyclosporine A Delivery System in Corneal Transplantation, Chinese Medical Journal, 2002, 110-113, 115 (1), US  | <input type="checkbox"/> |
| 40 | LOPATIN, D.E., Chemical Compositions and Functions of Saliva, 8/24/2001, 31 Pages   | <input type="checkbox"/> |

**INFORMATION DISCLOSURE  
STATEMENT BY APPLICANT**  
( Not for submission under 37 CFR 1.99)

|                        |                    |
|------------------------|--------------------|
| Application Number     | 13967189           |
| Filing Date            | 2013-08-14         |
| First Named Inventor   | ACHEAMPONG, ANDREW |
| Art Unit               | 1653               |
| Examiner Name          | TBD                |
| Attorney Docket Number | 17618-US-BCON2-AP  |

|    |  |                          |
|----|--|--------------------------|
| 41 | LYONS, R.T. ET AL, Influence of Three Emulsion Formulation Parameters on the Ocular Bioavailability of Cyclosporine A in Albino Rabbits, Am Assoc Pharm Sci, 2000, 1 Page, 2(4)  | <input type="checkbox"/> |
| 42 | PEDERSEN, ANNE MARIE ET AL, Primary Sjogren's Syndrome: Oral Aspects on Pathogenesis, Diagnostic Criteria, Clinical Features and Approaches for Therapy, Expert Opin Pharma, 2001, 1415-1436, 2(9)                               | <input type="checkbox"/> |
| 43 | PHILLIPS, THOMAS ET AL, Cyclosporine Has a Direct Effect on the Differentiation of a Mucin-Secreting Cell Line, Journal of Cellular Physiology, 2000, 400-408, 184   | <input type="checkbox"/> |
| 44 | PRESENT, D.H. ET AL, Cyclosporine and Other Immunosuppressive Agents: Current and Future Role in the Treatment of Inflammatory Bowel Disease, American Journal of Gastroenterology, 1993, 627-630, 88(5)                         | <input type="checkbox"/> |
| 45 | Restasis ® Product Information Sheet, Allergan, Inc., 2009, 5 Pages  | <input type="checkbox"/> |
| 46 | Restasis® Increasing Tear Production, Retrieved on 08/14/2009, <a href="http://www.restasisprofessional.com/_clinical/clinical_increasing.htm">http://www.restasisprofessional.com/_clinical/clinical_increasing.htm</a> 3 pages | <input type="checkbox"/> |
| 47 | ROBINSON, N.A. ET AL, Desquamative Gingivitis: A Sign of Mucocutaneous Disorders - a Review, Australian Dental Journal, 2003, 205-211, 48(4)   | <input type="checkbox"/> |
| 48 | RUDINGER, J., Characteristics of the Amino Acids as Components of a Peptide Hormone Sequence, Peptide Hormones, 1976, 1-7  | <input type="checkbox"/> |
| 49 | SALL, KENNETH ET AL, Two Multicenter, Randomized Studies of the Efficacy and Safety of Cyclosporine Ophthalmic Emulsion in Moderate to Severe Dry Eye Disease, Ophthalmology, 2000, 631-639, 107                                 | <input type="checkbox"/> |
| 50 | SANDBORN, WILLIAM ET AL, A Placebo-Controlled Trial of Cyclosporine Enemas for Mildly to Moderately Active Left-Sided Ulcerative Colitis, Gastroenterology, 1994, 1429-1435, 106   | <input type="checkbox"/> |
| 51 | SANDBORN, WILLIAM ET AL, Cyclosporine Enemas for Treatment-Resistant, Mildly to Moderately Active, Left-Sided Ulcerative Colitis, American Journal of Gastroenterology, 1993, 640-645, 88(5)                                     | <input type="checkbox"/> |

**INFORMATION DISCLOSURE  
STATEMENT BY APPLICANT**  
( Not for submission under 37 CFR 1.99)

|                        |                    |
|------------------------|--------------------|
| Application Number     | 13967189           |
| Filing Date            | 2013-08-14         |
| First Named Inventor   | ACHEAMPONG, ANDREW |
| Art Unit               | 1653               |
| Examiner Name          | TBD                |
| Attorney Docket Number | 17618-US-BCON2-AP  |

|    |   |                          |
|----|---|--------------------------|
| 52 | SCHWAB, MATTHIAS ET AL, Pharmacokinetic Considerations in the Treatment of Inflammatory Bowel Disease, Clin Pharm, 2001, 723-751, 60(10)  | <input type="checkbox"/> |
| 53 | SECCHI, ANTONIO ET AL, Topical Use of Cyclosporine in the Treatment of Vernal Keratoconjunctivitis, American Journal of Ophthalmology, December 1990, 641-645, 110  | <input type="checkbox"/> |
| 54 | SMALL, DAVE ET AL, The Ocular Pharmacokinetics of Cyclosporine in Albino Rabbits and Beagle Dogs, Ocular Drug Delivery and Metabolism, 1999, 54   | <input type="checkbox"/> |
| 55 | SMALL, DAVID ET AL, Blood Concentrations of Cyclosporin A During Long-Term Treatment With Cyclosporin A ophthalmic Emulsions in Patients with Moderate to Severe Dry Eye Disease, Journal of Ocular Pharmacology and Therapeutics, 2002, 411-418, 18(5) | <input type="checkbox"/> |
| 56 | SMILEK, DAWN ET AL, A Single Amino Acid Change in a Myelin Basic Protein Peptide Confers the Capacity to Prevent Rather Than Induce Experimental Autoimmune Encephalomyelitis, Proc. Natl. Acad. Sci., Nov 1991, 9633-9637, 88                          | <input type="checkbox"/> |
| 57 | STEPHENSON, MICHELLE, The Latest Uses Of Restasis, Review Of Ophthalmology, 12/30/2005, 7 Pages, US   | <input type="checkbox"/> |
| 58 | STEVENSON, DARA ET AL, Efficacy and Safety of Cyclosporin A ophthalmic Emulsion in the Treatment of Moderate-to-Severe Dry Eye Disease, Ophthalmology, 2000, 967-974, 107   | <input type="checkbox"/> |
| 59 | TESAVIBUL, N. ET AL, Topical Cyclosporine A (CsA) for Ocular Surface Abnormalities in Graft Versus Host Disease Patients, Invest Ophthalmol Vis Sci, Feb 1996, S1026, 37(3)   | <input type="checkbox"/> |
| 60 | The Online Medical Dictionary, Derivative, Analog, Analogue, Xerostomia, accessed 7/7/2005 and 7/13/2005, 6 Pages   | <input type="checkbox"/> |
| 61 | TIBELL, A. ET AL., Cyclosporin A In Fat Emulsion Carriers: Experimental Studies On Pharmacokinetics And Tissue Distribution, Pharmacology & Toxicology, 1995, 115-121, 76, US   | <input type="checkbox"/> |
| 62 | TSUBOTA, KAZUO ET AL, Use of Topical Cyclosporin A in a Primary Sjogren's Syndrome Mouse Model, Invest Ophthalmol Vis Sci, Aug. 1998, 1551-1559, 39(9)  | <input type="checkbox"/> |



|   |                        |                    |
|---|------------------------|--------------------|
| <b>INFORMATION DISCLOSURE<br/>STATEMENT BY APPLICANT</b><br>( Not for submission under 37 CFR 1.99) | Application Number     | 13967189           |
|   | Filing Date            | 2013-08-14         |
|   | First Named Inventor   | ACHEAMPONG, ANDREW |
|   | Art Unit               | 1653               |
|   | Examiner Name          | TBD                |
|   | Attorney Docket Number | 17618-US-BCON2-AP  |

|    |  |                          |
|----|--|--------------------------|
| 63 | VAN DER REIJDEN, WILLY ET AL, Treatment of Oral Dryness Related Complaints (Xerostomia) in Sjogren's Syndrome, Ann Rheum Dis, 1999, 465-473, 58      | <input type="checkbox"/> |
| 64 | WINTER, T.A. ET AL, Cyclosporin A Retention Enemas in Refractory Distal Ulcerative Colitis and 'Pouchitis', Scand J Gastroenterol, 1993, 701-704, 28 | <input type="checkbox"/> |
| 65 | U.S. Pending Application: 13/961,808 Filed on August 07, 2013  | <input type="checkbox"/> |
| 66 | U.S. Pending Application: 13/961,818 Filed on August 07, 2013  | <input type="checkbox"/> |
| 67 | U.S. Pending Application: 13/961,828 Filed on August 07, 2013  | <input type="checkbox"/> |
| 68 | U.S. Pending Application: 13/961,835 Filed on August 07, 2013  | <input type="checkbox"/> |
| 69 | U.S. Pending Application: 13/967,179 Filed on August 14, 2013  | <input type="checkbox"/> |
| 70 | U.S. Pending Application: 13/967,163 Filed on August 14, 2013  | <input type="checkbox"/> |
| 71 | U.S. Pending Application: 13/967,168 Filed on August 14, 2013  | <input type="checkbox"/> |

If you wish to add additional non-patent literature document citation information please click the Add button

**EXAMINER SIGNATURE**

|                    |  |                 |  |
|--------------------|--|-----------------|--|
| Examiner Signature |  | Date Considered |  |
|--------------------|--|-----------------|--|

\*EXAMINER: Initial if reference considered, whether or not citation is in conformance with MPEP 609. Draw line through a citation if not in conformance and not considered. Include copy of this form with next communication to applicant.

**INFORMATION DISCLOSURE  
STATEMENT BY APPLICANT**  
( Not for submission under 37 CFR 1.99)

|                        |                    |
|------------------------|--------------------|
| Application Number     | 13967189           |
| Filing Date            | 2013-08-14         |
| First Named Inventor   | ACHEAMPONG, ANDREW |
| Art Unit               | 1653               |
| Examiner Name          | TBD                |
| Attorney Docket Number | 17618-US-BCON2-AP  |

<sup>1</sup> See Kind Codes of USPTO Patent Documents at [www.USPTO.GOV](http://www.USPTO.GOV) or MPEP 901.04. <sup>2</sup> Enter office that issued the document, by the two-letter code (WIPO Standard ST.3). <sup>3</sup> For Japanese patent documents, the indication of the year of the reign of the Emperor must precede the serial number of the patent document. <sup>4</sup> Kind of document by the appropriate symbols as indicated on the document under WIPO Standard ST.16 if possible. <sup>5</sup> Applicant is to place a check mark here if English language translation is attached.

|   |                        |                    |
|---|------------------------|--------------------|
| <b>INFORMATION DISCLOSURE<br/>STATEMENT BY APPLICANT</b><br>( Not for submission under 37 CFR 1.99) | Application Number     | 13967189           |
|   | Filing Date            | 2013-08-14         |
|   | First Named Inventor   | ACHEAMPONG, ANDREW |
|   | Art Unit               | 1653               |
|   | Examiner Name          | TBD                |
|   | Attorney Docket Number | 17618-US-BCON2-AP  |

**CERTIFICATION STATEMENT**

Please see 37 CFR 1.97 and 1.98 to make the appropriate selection(s):

That each item of information contained in the information disclosure statement was first cited in any communication from a foreign patent office in a counterpart foreign application not more than three months prior to the filing of the information disclosure statement. See 37 CFR 1.97(e)(1).

**OR**

That no item of information contained in the information disclosure statement was cited in a communication from a foreign patent office in a counterpart foreign application, and, to the knowledge of the person signing the certification after making reasonable inquiry, no item of information contained in the information disclosure statement was known to any individual designated in 37 CFR 1.56(c) more than three months prior to the filing of the information disclosure statement. See 37 CFR 1.97(e)(2).

\*\* Signature indicates consideration of publication and file history. The Examiner has access to these materials through the PTO computer systems. If additional copies are desired, please notify the Applicants through their attorneys.

- See attached certification statement.
- Fee set forth in 37 CFR 1.17 (p) has been submitted herewith.
- None

**SIGNATURE**

A signature of the applicant or representative is required in accordance with CFR 1.33, 10.18. Please see CFR 1.4(d) for the form of the signature.

|            |                 |                     |            |
|------------|-----------------|---------------------|------------|
| Signature  | /Laura L. Wine/ | Date (YYYY-MM-DD)   | 2013-09-04 |
| Name/Print | Laura L. Wine   | Registration Number | 68,681     |

This collection of information is required by 37 CFR 1.97 and 1.98. The information is required to obtain or retain a benefit by the public which is to file (and by the USPTO to process) an application. Confidentiality is governed by 35 U.S.C. 122 and 37 CFR 1.14. This collection is estimated to take 1 hour to complete, including gathering, preparing and submitting the completed application form to the USPTO. Time will vary depending upon the individual case. Any comments on the amount of time you require to complete this form and/or suggestions for reducing this burden, should be sent to the Chief Information Officer, U.S. Patent and Trademark Office, U.S. Department of Commerce, P.O. Box 1450, Alexandria, VA 22313-1450. **DO NOT SEND FEES OR COMPLETED FORMS TO THIS ADDRESS. SEND TO: Commissioner for Patents, P.O. Box 1450, Alexandria, VA 22313-1450.**

## Privacy Act Statement

The Privacy Act of 1974 (P.L. 93-579) requires that you be given certain information in connection with your submission of the attached form related to a patent application or patent. Accordingly, pursuant to the requirements of the Act, please be advised that: (1) the general authority for the collection of this information is 35 U.S.C. 2(b)(2); (2) furnishing of the information solicited is voluntary; and (3) the principal purpose for which the information is used by the U.S. Patent and Trademark Office is to process and/or examine your submission related to a patent application or patent. If you do not furnish the requested information, the U.S. Patent and Trademark Office may not be able to process and/or examine your submission, which may result in termination of proceedings or abandonment of the application or expiration of the patent.

The information provided by you in this form will be subject to the following routine uses:

1. The information on this form will be treated confidentially to the extent allowed under the Freedom of Information Act (5 U.S.C. 552) and the Privacy Act (5 U.S.C. 552a). Records from this system of records may be disclosed to the Department of Justice to determine whether the Freedom of Information Act requires disclosure of these records.
2. A record from this system of records may be disclosed, as a routine use, in the course of presenting evidence to a court, magistrate, or administrative tribunal, including disclosures to opposing counsel in the course of settlement negotiations.
3. A record in this system of records may be disclosed, as a routine use, to a Member of Congress submitting a request involving an individual, to whom the record pertains, when the individual has requested assistance from the Member with respect to the subject matter of the record.
4. A record in this system of records may be disclosed, as a routine use, to a contractor of the Agency having need for the information in order to perform a contract. Recipients of information shall be required to comply with the requirements of the Privacy Act of 1974, as amended, pursuant to 5 U.S.C. 552a(m).
5. A record related to an International Application filed under the Patent Cooperation Treaty in this system of records may be disclosed, as a routine use, to the International Bureau of the World Intellectual Property Organization, pursuant to the Patent Cooperation Treaty.
6. A record in this system of records may be disclosed, as a routine use, to another federal agency for purposes of National Security review (35 U.S.C. 181) and for review pursuant to the Atomic Energy Act (42 U.S.C. 218(c)).
7. A record from this system of records may be disclosed, as a routine use, to the Administrator, General Services, or his/her designee, during an inspection of records conducted by GSA as part of that agency's responsibility to recommend improvements in records management practices and programs, under authority of 44 U.S.C. 2904 and 2906. Such disclosure shall be made in accordance with the GSA regulations governing inspection of records for this purpose, and any other relevant (i.e., GSA or Commerce) directive. Such disclosure shall not be used to make determinations about individuals.
8. A record from this system of records may be disclosed, as a routine use, to the public after either publication of the application pursuant to 35 U.S.C. 122(b) or issuance of a patent pursuant to 35 U.S.C. 151. Further, a record may be disclosed, subject to the limitations of 37 CFR 1.14, as a routine use, to the public if the record was filed in an application which became abandoned or in which the proceedings were terminated and which application is referenced by either a published application, an application open to public inspections or an issued patent.
9. A record from this system of records may be disclosed, as a routine use, to a Federal, State, or local law enforcement agency, if the USPTO becomes aware of a violation or potential violation of law or regulation.

## Electronic Acknowledgement Receipt

|   |   |
|---|---|
| <b>EFS ID:</b>                              | 16766225  |
| <b>Application Number:</b>                  | 13967189  |
| <b>International Application Number:</b>    |   |
| <b>Confirmation Number:</b>                 | 4818  |
| <b>Title of Invention:</b>                  | METHODS OF PROVIDING THERAPEUTIC EFFECTS USING CYCLOSPORIN COMPONENTS |
| <b>First Named Inventor/Applicant Name:</b> | Andrew Acheampong   |
| <b>Customer Number:</b>                     | 51957   |
| <b>Filer:</b>                               | Laura Lee Wine/Ken Dinh   |
| <b>Filer Authorized By:</b>                 | Laura Lee Wine  |
| <b>Attorney Docket Number:</b>              | 17618CON2B (AP)   |
| <b>Receipt Date:</b>                        | 04-SEP-2013   |
| <b>Filing Date:</b>                         | 14-AUG-2013   |
| <b>Time Stamp:</b>                          | 21:16:24  |
| <b>Application Type:</b>                    | Utility under 35 USC 111(a)   |

### Payment information:

|                        |    |
|------------------------|----|
| Submitted with Payment | no |
|------------------------|----|

### File Listing:

| Document Number | Document Description                               | File Name                     | File Size(Bytes)/<br>Message Digest                               | Multi Part /.zip | Pages (if appl.) |
|-----------------|--|-------------------------------|---|------------------|------------------|
| 1               | Information Disclosure Statement (IDS) Form (SB08) | 17618CON2B-IDS_09_04_2013.pdf | 541590<br><small>9f394d44a6793efa377b6aed3106a35c65a9adc9</small> | no               | 24               |

### Warnings:

### Information:

|   |                   |                    |  |    |    |
|---|-------------------|--------------------|--|----|----|
| This is not an USPTO supplied IDS fillable form |                   |                    |  |    |    |
| 2   | Foreign Reference | DE19810655A1.pdf   | 642494                                   | no | 6  |
|   |                   |                    | 66c4343c7b75f50b599232ff7f6585b47f92b215 |    |    |
| <b>Warnings:</b>                                |                   |                    |  |    |    |
| <b>Information:</b>                             |                   |                    |  |    |    |
| 3   | Foreign Reference | EP-0760237.PDF     | 364223                                   | no | 11 |
|   |                   |                    | 11ca6edfbedb8a6c1f617c247c539021b6d7c292 |    |    |
| <b>Warnings:</b>                                |                   |                    |  |    |    |
| <b>Information:</b>                             |                   |                    |  |    |    |
| 4   | Foreign Reference | EP0547229.pdf      | 8161789                                  | no | 17 |
|   |                   |                    | c7d5e4da56de1fdb56b99581372eaf79241ffe4  |    |    |
| <b>Warnings:</b>                                |                   |                    |  |    |    |
| <b>Information:</b>                             |                   |                    |  |    |    |
| 5   | Foreign Reference | EP0471293.pdf      | 1658633                                  | no | 7  |
|   |                   |                    | 61d962d13391b303b02217687d26cd36ea64c9a1 |    |    |
| <b>Warnings:</b>                                |                   |                    |  |    |    |
| <b>Information:</b>                             |                   |                    |  |    |    |
| 6   | Foreign Reference | WO-1995-031211.pdf | 609318                                   | no | 28 |
|   |                   |                    | 785816ee787dd5564887887c172789c0434e5316 |    |    |
| <b>Warnings:</b>                                |                   |                    |  |    |    |
| <b>Information:</b>                             |                   |                    |  |    |    |
| 7   | Foreign Reference | WO2000-000179.pdf  | 1156948                                  | no | 67 |
|   |                   |                    | 9ccd79b7e6bf89086a66181561ecf369d4c6df5a |    |    |
| <b>Warnings:</b>                                |                   |                    |  |    |    |
| <b>Information:</b>                             |                   |                    |  |    |    |
| 8   | Foreign Reference | WO-2001-032142.pdf | 393715                                   | no | 19 |
|   |                   |                    | 2363e2b822d3076474c793023490c20efaf9c7fa |    |    |
| <b>Warnings:</b>                                |                   |                    |  |    |    |
| <b>Information:</b>                             |                   |                    |  |    |    |
| 9   | Foreign Reference | WO2001-041671.pdf  | 477723                                   | no | 21 |
|   |                   |                    | a384ff47dd523974818c54030a51b37a8918ffbf |    |    |
| <b>Warnings:</b>                                |                   |                    |  |    |    |
| <b>Information:</b>                             |                   |                    |  |    |    |
| 10  | Foreign Reference | WO2002-009667.pdf  | 2610140                                  | no | 47 |
|   |                   |                    | f18e7844afe73b52f294b3cde2c525461d8f6da8 |    |    |

|                     |                       |   |   |    |    |
|---------------------|-----------------------|---|---|----|----|
| <b>Warnings:</b>    |                       |   |   |    |    |
| <b>Information:</b> |                       |   |   |    |    |
| 11                  | Foreign Reference     | WO2002-049603.pdf                                   | 540840<br>206d73970083fdb8f2793db01373453fd9928caf  | no | 25 |
| <b>Warnings:</b>    |                       |   |   |    |    |
| <b>Information:</b> |                       |   |   |    |    |
| 12                  | Foreign Reference     | WO2003-053405.pdf                                   | 495859<br>0d8699e29563ce29b3373ac58605c6958ccbfb1   | no | 22 |
| <b>Warnings:</b>    |                       |   |   |    |    |
| <b>Information:</b> |                       |   |   |    |    |
| 13                  | Foreign Reference     | WO2003-030834.pdf                                   | 884924<br>73f73deb9297abb6844121ece2cf99d1170cce48  | no | 36 |
| <b>Warnings:</b>    |                       |   |   |    |    |
| <b>Information:</b> |                       |   |   |    |    |
| 14                  | Non Patent Literature | Abdulrazik-2001.pdf                                 | 2020446<br>b968c117d8bcaecd650fd6654bae4ba3db2b0fef | no | 6  |
| <b>Warnings:</b>    |                       |   |   |    |    |
| <b>Information:</b> |                       |   |   |    |    |
| 15                  | Non Patent Literature | Acheampong-1996.pdf                                 | 77280<br>fdcc9eccdd28fa37ec7a80c28fe04a96b186308e3  | no | 1  |
| <b>Warnings:</b>    |                       |   |   |    |    |
| <b>Information:</b> |                       |   |   |    |    |
| 16                  | Non Patent Literature | AcheampongCyclosporinDistribution1001-1004-1998.pdf | 143254<br>66c7d564002661f5af66d6c394f16f314f024f4   | no | 4  |
| <b>Warnings:</b>    |                       |   |   |    |    |
| <b>Information:</b> |                       |   |   |    |    |
| 17                  | Non Patent Literature | Acheampong_1999.pdf                                 | 3760656<br>56867109cd7e843043e532d47d09b7e2ef238663 | no | 13 |
| <b>Warnings:</b>    |                       |   |   |    |    |
| <b>Information:</b> |                       |   |   |    |    |
| 18                  | Non Patent Literature | AkpekOph111_3_476_482_2004.pdf                      | 667675<br>749fbcc7440650cffe44ba25d09130c7ca7ffd2f  | no | 8  |
| <b>Warnings:</b>    |                       |   |   |    |    |
| <b>Information:</b> |                       |   |   |    |    |
| 19                  | Non Patent Literature | AngelovSafetyAssessmentAN98071079_1997.pdf          | 214241<br>ae47dd3e3dcccda539cebee3d5766073e8171482a | no | 4  |

|                     |                       |   |   |    |    |
|---------------------|-----------------------|---|---|----|----|
| <b>Warnings:</b>    |                       |   |   |    |    |
| <b>Information:</b> |                       |   |   |    |    |
| 20                  | Non Patent Literature | Angelov-1998.pdf                            | 747092<br>3babe85b48f13e0b436934e2fb66a6f224c2cb44  | no | 5  |
| <b>Warnings:</b>    |                       |   |   |    |    |
| <b>Information:</b> |                       |   |   |    |    |
| 21                  | Non Patent Literature | ArdizzoneGBPoroDrugs519_542_1998.pdf        | 3937988<br>ddc7128be23a94fb204d5a5f13047aa0133a9a11 | no | 26 |
| <b>Warnings:</b>    |                       |   |   |    |    |
| <b>Information:</b> |                       |   |   |    |    |
| 22                  | Non Patent Literature | BanicDigDisSci1362_1638_2002.pdf            | 848297<br>bd631465aef4a7f1f3f1660872a340421d06bd24  | no | 8  |
| <b>Warnings:</b>    |                       |   |   |    |    |
| <b>Information:</b> |                       |   |   |    |    |
| 23                  | Non Patent Literature | Bonini_2004.pdf                             | 2094249<br>9295f1e169d3ca4f4a97007838344654f73a0ab4 | no | 9  |
| <b>Warnings:</b>    |                       |   |   |    |    |
| <b>Information:</b> |                       |   |   |    |    |
| 24                  | Non Patent Literature | Brewster_1994.pdf                           | 2611645<br>f8dd875c527914d4d072c7d0b00c7c10c30e04b0 | no | 7  |
| <b>Warnings:</b>    |                       |   |   |    |    |
| <b>Information:</b> |                       |   |   |    |    |
| 25                  | Non Patent Literature | Brewster_1997.pdf                           | 2034358<br>c8c310235391b73a2515b79e5b7e69614cc154a1 | no | 5  |
| <b>Warnings:</b>    |                       |   |   |    |    |
| <b>Information:</b> |                       |   |   |    |    |
| 26                  | Non Patent Literature | Brewster_1995.pdf                           | 2435845<br>a87c613e9945ed2cb3e12ca36fc33523b6a62f2d | no | 6  |
| <b>Warnings:</b>    |                       |   |   |    |    |
| <b>Information:</b> |                       |   |   |    |    |
| 27                  | Non Patent Literature | Brinkmeier_PyodermatitisActaDerm_4_2001.pdf | 462833<br>060bc24a762e8db058262428845c9fb8b9f914b   | no | 4  |
| <b>Warnings:</b>    |                       |   |   |    |    |
| <b>Information:</b> |                       |   |   |    |    |
| 28                  | Non Patent Literature | Castillo_1995.pdf                           | 2056885<br>f717067b8ac69bd61564f4dd29c6d1b10f5005d6 | no | 8  |



|                     |                       |   |   |    |   |
|---------------------|-----------------------|---|---|----|---|
| <b>Warnings:</b>    |                       |   |   |    |   |
| <b>Information:</b> |                       |   |   |    |   |
| 29                  | Non Patent Literature | CheeksInfluenceofVehicle1992.pdf        | 2450001<br>42b02fe1b3a1aac46ca35d929021b4907a8823ca | no | 9 |
| <b>Warnings:</b>    |                       |   |   |    |   |
| <b>Information:</b> |                       |   |   |    |   |
| 30                  | Non Patent Literature | Database_200044.pdf                     | 76280<br>a1aa73b3e4580a5dfb752ca3d23b9aa23e0f0fb3   | no | 2 |
| <b>Warnings:</b>    |                       |   |   |    |   |
| <b>Information:</b> |                       |   |   |    |   |
| 31                  | Non Patent Literature | DingPharmacAn98040585_1997.pdf          | 48725<br>0b046fb716cb7285c9f07c53e6595d8370eaa2e    | no | 1 |
| <b>Warnings:</b>    |                       |   |   |    |   |
| <b>Information:</b> |                       |   |   |    |   |
| 32                  | Non Patent Literature | Donnenfeld_2003.pdf                     | 1514822<br>7a86cc202e471cce379f185113a1353747c98e63 | no | 3 |
| <b>Warnings:</b>    |                       |   |   |    |   |
| <b>Information:</b> |                       |   |   |    |   |
| 33                  | Non Patent Literature | Drosos_1998.pdf                         | 1638443<br>0e40d7b9b2ae76200baa9068530b5f21eefeaefb | no | 5 |
| <b>Warnings:</b>    |                       |   |   |    |   |
| <b>Information:</b> |                       |   |   |    |   |
| 34                  | Non Patent Literature | Drosos_1986.pdf                         | 1032892<br>820c8e084c1b12333b1f635ec09c8afefd19579e | no | 5 |
| <b>Warnings:</b>    |                       |   |   |    |   |
| <b>Information:</b> |                       |   |   |    |   |
| 35                  | Non Patent Literature | EisenTopicalcyclosporine6_1990.pdf      | 752102<br>32ad87759ef79c77880006a594495cd6b992032d  | no | 6 |
| <b>Warnings:</b>    |                       |   |   |    |   |
| <b>Information:</b> |                       |   |   |    |   |
| 36                  | Non Patent Literature | Epstein_1996.pdf                        | 1582082<br>f316d19218cefcd0cca0e9be34264fe6f7503daa | no | 5 |
| <b>Warnings:</b>    |                       |   |   |    |   |
| <b>Information:</b> |                       |   |   |    |   |
| 37                  | Non Patent Literature | ErdmannMeetingattheDeptofDerm4_1997.pdf | 462543<br>9f3fbb7197e803def6b46260fd835c5aaa5eef07  | no | 4 |

|                     |                       |  |   |    |    |
|---------------------|-----------------------|--|---|----|----|
| <b>Warnings:</b>    |                       |  |   |    |    |
| <b>Information:</b> |                       |  |   |    |    |
| 38                  | Non Patent Literature | FDA_Concludes_Restasis_1999.pdf                | 93984<br>63cff26925570cb091fa44ee5b19b28a3ff6a<br>b6b   | no | 1  |
| <b>Warnings:</b>    |                       |  |   |    |    |
| <b>Information:</b> |                       |  |   |    |    |
| 39                  | Non Patent Literature | Gaeta_1994.pdf                                 | 1817635<br>70f11e97d1851a46d0c18bb53f489f77ac5<br>a37e  | no | 9  |
| <b>Warnings:</b>    |                       |  |   |    |    |
| <b>Information:</b> |                       |  |   |    |    |
| 40                  | Non Patent Literature | Gipson_vol2no2_18_2004.pdf                     | 2242587<br>0dc513ea67454195d9aef8bd3a8703267cb<br>04156 | no | 18 |
| <b>Warnings:</b>    |                       |  |   |    |    |
| <b>Information:</b> |                       |  |   |    |    |
| 41                  | Non Patent Literature | Gremse_UlcerativeColitis_in_Children10.pdf     | 1041954<br>091237aaaaa18ec3e0d7b0639e55086a00c<br>290a2 | no | 10 |
| <b>Warnings:</b>    |                       |  |   |    |    |
| <b>Information:</b> |                       |  |   |    |    |
| 42                  | Non Patent Literature | Gunduz_TopicalcyclosporinActivaOphth6_1994.pdf | 618144<br>4e3e7164d3de6e5be5691d0d7c6e8bc52a<br>76e871  | no | 6  |
| <b>Warnings:</b>    |                       |  |   |    |    |
| <b>Information:</b> |                       |  |   |    |    |
| 43                  | Non Patent Literature | Hunter_1981.pdf                                | 3004241<br>774fdd0660b54d79c4de0be05f7a3f8afdd5<br>71da | no | 5  |
| <b>Warnings:</b>    |                       |  |   |    |    |
| <b>Information:</b> |                       |  |   |    |    |
| 44                  | Non Patent Literature | Jumaa_1999.pdf                                 | 1946168<br>f50e943dc61513d9fed6651ee99968f6d36<br>a553  | no | 9  |
| <b>Warnings:</b>    |                       |  |   |    |    |
| <b>Information:</b> |                       |  |   |    |    |
| 45                  | Non Patent Literature | KanaiEffectontheCornea1989.pdf                 | 868139<br>f60019d56376bcecff6bb85e0eb3238f9545<br>90b4  | no | 3  |
| <b>Warnings:</b>    |                       |  |   |    |    |
| <b>Information:</b> |                       |  |   |    |    |
| 46                  | Non Patent Literature | KanpolatPenetrationofCyclosporin1994.pdf       | 359650<br>43be2c9cd6ba4e612554d7dd526b1e2b4f3<br>43b4e  | no | 4  |

|                     |                       |  |   |    |    |
|---------------------|-----------------------|--|---|----|----|
| <b>Warnings:</b>    |                       |  |   |    |    |
| <b>Information:</b> |                       |  |   |    |    |
| 47                  | Non Patent Literature | Kaur_1979.pdf                                      | 906300<br>496c705d93f0d7baa2424db48fbf424512f96e6     | no | 2  |
| <b>Warnings:</b>    |                       |  |   |    |    |
| <b>Information:</b> |                       |  |   |    |    |
| 48                  | Non Patent Literature | KuwanoCyclosporineA_Pharm<br>19_1_108_111_2002.pdf | 1878659<br>4e9a19149a7164165e1106060b80c8485b150be7   | no | 4  |
| <b>Warnings:</b>    |                       |  |   |    |    |
| <b>Information:</b> |                       |  |   |    |    |
| 49                  | Non Patent Literature | Lambert_2003.pdf                                   | 460126<br>a4c43396f9847fb7308efc0741e187941cd8aca8    | no | 3  |
| <b>Warnings:</b>    |                       |  |   |    |    |
| <b>Information:</b> |                       |  |   |    |    |
| 50                  | Non Patent Literature | Leibovitz_1983.pdf                                 | 1024735<br>2c50222cc641655f84228b313ee6df845bd32761   | no | 5  |
| <b>Warnings:</b>    |                       |  |   |    |    |
| <b>Information:</b> |                       |  |   |    |    |
| 51                  | Non Patent Literature | Lixin_2002.pdf                                     | 1887719<br>6552422b21a2e5430452221f662f614d7560ede7   | no | 4  |
| <b>Warnings:</b>    |                       |  |   |    |    |
| <b>Information:</b> |                       |  |   |    |    |
| 52                  | Non Patent Literature | LopatinChemicalcompositions<br>31pgs2001.pdf       | 13079081<br>55c1ea8f4cfc4343e8d36c01dadadf7516e0c55   | no | 31 |
| <b>Warnings:</b>    |                       |  |   |    |    |
| <b>Information:</b> |                       |  |   |    |    |
| 53                  | Non Patent Literature | Polyethylene_Glycol_Ester_200<br>1.pdf             | 459916<br>86544da882fd05b2012425cb171c42eb144c32ab    | no | 6  |
| <b>Warnings:</b>    |                       |  |   |    |    |
| <b>Information:</b> |                       |  |   |    |    |
| 54                  | Non Patent Literature | LyonsInfluenceofThreeEmulsio<br>n2000.pdf          | 59547<br>ea3c95c367170b2d95ca78b32f69875baf2a4c35     | no | 1  |
| <b>Warnings:</b>    |                       |  |   |    |    |
| <b>Information:</b> |                       |  |   |    |    |
| 55                  | Non Patent Literature | PedersenExpertOpin1415_143<br>6_2001.pdf           | 4262912<br>0ffbaccdd587d316724d2c00a7e64fcdcb6eed49e4 | no | 22 |

|                                     |                       |   |   |          |    |
|-------------------------------------|-----------------------|---|---|----------|----|
| <b>Warnings:</b>                    |                       |   |   |          |    |
| <b>Information:</b>                 |                       |   |   |          |    |
| 56                                  | Non Patent Literature | Phillips_CyclosporineJOCP1_2000.pdf             | 1385594<br>63acd4c243d41621f7001e9c76dbf167d4e51d   | no       | 10 |
| <b>Warnings:</b>                    |                       |   |   |          |    |
| <b>Information:</b>                 |                       |   |   |          |    |
| 57                                  | Non Patent Literature | Present_1993.pdf                                | 1624134<br>baefc9d58e2e27ac5b6a99bd9151eb6a41e80d81 | no       | 4  |
| <b>Warnings:</b>                    |                       |   |   |          |    |
| <b>Information:</b>                 |                       |   |   |          |    |
| 58                                  | Non Patent Literature | RestasisProductInfoSheets.pdf                   | 56377<br>844b6588f9ea989c6c37ffe4c0b220c950ffa4dea  | no       | 5  |
| <b>Warnings:</b>                    |                       |   |   |          |    |
| <b>Information:</b>                 |                       |   |   |          |    |
| 59                                  | Non Patent Literature | Restasis_Increasing_tear_Production_2009.pdf    | 332259<br>0a1285bcf642f927562ba180ba3ba5446eb2afe4  | no       | 3  |
| <b>Warnings:</b>                    |                       |   |   |          |    |
| <b>Information:</b>                 |                       |   |   |          |    |
| 60                                  | Non Patent Literature | Robinsonaustraliandentaljournal206_211_2003.pdf | 768117<br>798558b0fd44a086f71fe1076b47333898b7e976  | no       | 6  |
| <b>Warnings:</b>                    |                       |   |   |          |    |
| <b>Information:</b>                 |                       |   |   |          |    |
| <b>Total Files Size (in bytes):</b> |                       |   |   | 92386808 |    |

**This Acknowledgement Receipt evidences receipt on the noted date by the USPTO of the indicated documents, characterized by the applicant, and including page counts, where applicable. It serves as evidence of receipt similar to a Post Card, as described in MPEP 503.**

**New Applications Under 35 U.S.C. 111**

**If a new application is being filed and the application includes the necessary components for a filing date (see 37 CFR 1.53(b)-(d) and MPEP 506), a Filing Receipt (37 CFR 1.54) will be issued in due course and the date shown on this Acknowledgement Receipt will establish the filing date of the application.**

**National Stage of an International Application under 35 U.S.C. 371**

**If a timely submission to enter the national stage of an international application is compliant with the conditions of 35 U.S.C. 371 and other applicable requirements a Form PCT/DO/EO/903 indicating acceptance of the application as a national stage submission under 35 U.S.C. 371 will be issued in addition to the Filing Receipt, in due course.**

**New International Application Filed with the USPTO as a Receiving Office**

**If a new international application is being filed and the international application includes the necessary components for an international filing date (see PCT Article 11 and MPEP 1810), a Notification of the International Application Number and of the International Filing Date (Form PCT/RO/105) will be issued in due course, subject to prescriptions concerning national security, and the date shown on this Acknowledgement Receipt will establish the international filing date of the application.**

## Electronic Acknowledgement Receipt

|   |   |
|---|---|
| <b>EFS ID:</b>                              | 16766268  |
| <b>Application Number:</b>                  | 13967189  |
| <b>International Application Number:</b>    |   |
| <b>Confirmation Number:</b>                 | 4818  |
| <b>Title of Invention:</b>                  | METHODS OF PROVIDING THERAPEUTIC EFFECTS USING CYCLOSPORIN COMPONENTS |
| <b>First Named Inventor/Applicant Name:</b> | Andrew Acheampong   |
| <b>Customer Number:</b>                     | 51957   |
| <b>Filer:</b>                               | Laura Lee Wine/Ken Dinh   |
| <b>Filer Authorized By:</b>                 | Laura Lee Wine  |
| <b>Attorney Docket Number:</b>              | 17618CON2B (AP)   |
| <b>Receipt Date:</b>                        | 04-SEP-2013   |
| <b>Filing Date:</b>                         | 14-AUG-2013   |
| <b>Time Stamp:</b>                          | 21:36:02  |
| <b>Application Type:</b>                    | Utility under 35 USC 111(a)   |

### Payment information:

|                        |    |
|------------------------|----|
| Submitted with Payment | no |
|------------------------|----|

### File Listing:

| Document Number | Document Description  | File Name                           | File Size(Bytes)/<br>Message Digest                 | Multi Part /.zip | Pages (if appl.) |
|-----------------|-----------------------|-------------------------------------|---|------------------|------------------|
| 1               | Non Patent Literature | RudingerPeptideHormones1_7_1976.pdf | 2488192<br>b6fc18b6ad98c34de41f2d461a1f5736500be985 | no               | 11               |

### Warnings:

### Information:

|                     |                       |  |  |    |    |
|---------------------|-----------------------|--|--|----|----|
| 2                   | Non Patent Literature | Sall_2000.pdf                              | 208829                                   | no | 9  |
|                     |                       |  | 065c18613831a6d2cf5a88066e70ae03daae1b29 |    |    |
| <b>Warnings:</b>    |                       |  |  |    |    |
| <b>Information:</b> |                       |  |  |    |    |
| 3                   | Non Patent Literature | SandbornGastroenterology1429_1435_1994.pdf | 872000                                   | no | 7  |
|                     |                       |  | 730e8bcd0c58076ab6f0163f4551eff0f507e5c6 |    |    |
| <b>Warnings:</b>    |                       |  |  |    |    |
| <b>Information:</b> |                       |  |  |    |    |
| 4                   | Non Patent Literature | Sandborn_1993.pdf                          | 1969241                                  | no | 6  |
|                     |                       |  | 10802f861668ec206f085b7aa854a3b76526cf59 |    |    |
| <b>Warnings:</b>    |                       |  |  |    |    |
| <b>Information:</b> |                       |  |  |    |    |
| 5                   | Non Patent Literature | SchwabPharmacokinet723_751_2001.pdf        | 4260474                                  | no | 30 |
|                     |                       |  | decfedf8ccd3394e49e7e8a02f40d13d5023683f |    |    |
| <b>Warnings:</b>    |                       |  |  |    |    |
| <b>Information:</b> |                       |  |  |    |    |
| 6                   | Non Patent Literature | Secchi_1990.pdf                            | 3200224                                  | no | 5  |
|                     |                       |  | 8a65624bb284fb7ad8f4cc8ba5ee1a92ffe4b94  |    |    |
| <b>Warnings:</b>    |                       |  |  |    |    |
| <b>Information:</b> |                       |  |  |    |    |
| 7                   | Non Patent Literature | Small_1999.pdf                             | 166579                                   | no | 1  |
|                     |                       |  | a6352b5109a02b19264b6b81164b62c48168e92f |    |    |
| <b>Warnings:</b>    |                       |  |  |    |    |
| <b>Information:</b> |                       |  |  |    |    |
| 8                   | Non Patent Literature | Small_2002.pdf                             | 70523                                    | no | 8  |
|                     |                       |  | 777a603fb0b19562a66c525571b8108210c829a2 |    |    |
| <b>Warnings:</b>    |                       |  |  |    |    |
| <b>Information:</b> |                       |  |  |    |    |
| 9                   | Non Patent Literature | Smilek_1991.pdf                            | 1645292                                  | no | 5  |
|                     |                       |  | a604ec7f03b90bf8fd3c8882dedce3c7b3fc802d |    |    |
| <b>Warnings:</b>    |                       |  |  |    |    |
| <b>Information:</b> |                       |  |  |    |    |
| 10                  | Non Patent Literature | Stephenson_The_latest_uses_of_Restasis.pdf | 2875746                                  | no | 7  |
|                     |                       |  | c5d5cdd66d2f333c39c173e5e665d5bacd00eada |    |    |
| <b>Warnings:</b>    |                       |  |  |    |    |
| <b>Information:</b> |                       |  |  |    |    |

|                     |                       |   |  |    |    |
|---------------------|-----------------------|---|--|----|----|
| 11                  | Non Patent Literature | Stevenson_2000.pdf                                  | 255058                                   | no | 8  |
|                     |                       |   | 2f70a01929808bc46f5e822eb9cfc28fcea7ab4  |    |    |
| <b>Warnings:</b>    |                       |   |  |    |    |
| <b>Information:</b> |                       |   |  |    |    |
| 12                  | Non Patent Literature | TesavibulTopicalCyclosporine1996.pdf                | 56707                                    | no | 1  |
|                     |                       |   | fc4bba0a0ff0194e2146e1e1d552551410edeb   |    |    |
| <b>Warnings:</b>    |                       |   |  |    |    |
| <b>Information:</b> |                       |   |  |    |    |
| 13                  | Non Patent Literature | Medical_Dictionary_2005.pdf                         | 670357                                   | no | 6  |
|                     |                       |   | 2816eb8d1deb894d8911bacd15ed728364426c81 |    |    |
| <b>Warnings:</b>    |                       |   |  |    |    |
| <b>Information:</b> |                       |   |  |    |    |
| 14                  | Non Patent Literature | Tibell_Cyclosporin_A_in_Fat_Emulsion_115_121_76.pdf | 697241                                   | no | 7  |
|                     |                       |   | 5c1942bd49b4119100efa0409c42cda5c7182d19 |    |    |
| <b>Warnings:</b>    |                       |   |  |    |    |
| <b>Information:</b> |                       |   |  |    |    |
| 15                  | Non Patent Literature | Tsubota_1998.pdf                                    | 2353818                                  | no | 10 |
|                     |                       |   | f0929e8a59cf1006529e4db58b285eec963b5c0e |    |    |
| <b>Warnings:</b>    |                       |   |  |    |    |
| <b>Information:</b> |                       |   |  |    |    |
| 16                  | Non Patent Literature | Van_der_Reijden_1999.pdf                            | 2709253                                  | no | 9  |
|                     |                       |   | daff1e358e3501bd4ae2d9ea3dbc422c6cdaf    |    |    |
| <b>Warnings:</b>    |                       |   |  |    |    |
| <b>Information:</b> |                       |   |  |    |    |
| 17                  | Non Patent Literature | Winter_1993.pdf                                     | 1231303                                  | no | 4  |
|                     |                       |   | 441701043d7f2a34aab980c3e2a2b0db53eb3d7f |    |    |
| <b>Warnings:</b>    |                       |   |  |    |    |
| <b>Information:</b> |                       |   |  |    |    |
| 18                  | Non Patent Literature | 13961808.pdf  | 2596695                                  | no | 34 |
|                     |                       |   | b8da58d00b60f65ec787da63f914356d1a9e5412 |    |    |
| <b>Warnings:</b>    |                       |   |  |    |    |
| <b>Information:</b> |                       |   |  |    |    |
| 19                  | Non Patent Literature | 13961818.pdf  | 2596695                                  | no | 34 |
|                     |                       |   | 2646cb6a43b286789cda2d11e5189ca4a1ef6e93 |    |    |
| <b>Warnings:</b>    |                       |   |  |    |    |
| <b>Information:</b> |                       |   |  |    |    |

|                                     |                       |              |  |          |    |
|-------------------------------------|-----------------------|--------------|--|----------|----|
| 20                                  | Non Patent Literature | 13961828.pdf | 2596695                                  | no       | 34 |
|                                     |                       |              | 660e95b406b8f6ac91600605af4712d74c8677bb |          |    |
| <b>Warnings:</b>                    |                       |              |  |          |    |
| <b>Information:</b>                 |                       |              |  |          |    |
| 21                                  | Non Patent Literature | 13961835.pdf | 2596695                                  | no       | 34 |
|                                     |                       |              | b413c7b00aa4d49d4ac9b55502711b44656b4027 |          |    |
| <b>Warnings:</b>                    |                       |              |  |          |    |
| <b>Information:</b>                 |                       |              |  |          |    |
| 22                                  | Non Patent Literature | 13967179.pdf | 2596695                                  | no       | 34 |
|                                     |                       |              | ba315619ae42dcc9441a806c6070c7f21412c47d |          |    |
| <b>Warnings:</b>                    |                       |              |  |          |    |
| <b>Information:</b>                 |                       |              |  |          |    |
| 23                                  | Non Patent Literature | 13967163.pdf | 2596695                                  | no       | 34 |
|                                     |                       |              | 597b1bba8cf47cb818eb51c45eca2e943c4b4463 |          |    |
| <b>Warnings:</b>                    |                       |              |  |          |    |
| <b>Information:</b>                 |                       |              |  |          |    |
| 24                                  | Non Patent Literature | 13967168.pdf | 2596695                                  | no       | 34 |
|                                     |                       |              | 2244ea61fc0c84bfa743e5a148d34b2d6ba9564e |          |    |
| <b>Warnings:</b>                    |                       |              |  |          |    |
| <b>Information:</b>                 |                       |              |  |          |    |
| <b>Total Files Size (in bytes):</b> |                       |              |  | 43907702 |    |

**This Acknowledgement Receipt evidences receipt on the noted date by the USPTO of the indicated documents, characterized by the applicant, and including page counts, where applicable. It serves as evidence of receipt similar to a Post Card, as described in MPEP 503.**

**New Applications Under 35 U.S.C. 111**

**If a new application is being filed and the application includes the necessary components for a filing date (see 37 CFR 1.53(b)-(d) and MPEP 506), a Filing Receipt (37 CFR 1.54) will be issued in due course and the date shown on this Acknowledgement Receipt will establish the filing date of the application.**

**National Stage of an International Application under 35 U.S.C. 371**

**If a timely submission to enter the national stage of an international application is compliant with the conditions of 35 U.S.C. 371 and other applicable requirements a Form PCT/DO/EO/903 indicating acceptance of the application as a national stage submission under 35 U.S.C. 371 will be issued in addition to the Filing Receipt, in due course.**

**New International Application Filed with the USPTO as a Receiving Office**

**If a new international application is being filed and the international application includes the necessary components for an international filing date (see PCT Article 11 and MPEP 1810), a Notification of the International Application Number and of the International Filing Date (Form PCT/RO/105) will be issued in due course, subject to prescriptions concerning national security, and the date shown on this Acknowledgement Receipt will establish the international filing date of the application.**





UNITED STATES PATENT AND TRADEMARK OFFICE

UNITED STATES DEPARTMENT OF COMMERCE
United States Patent and Trademark Office
Address: COMMISSIONER FOR PATENTS
P.O. Box 1450
Alexandria, Virginia 22313-1450
www.uspto.gov

Table with 7 columns: APPLICATION NUMBER, FILING or 371(c) DATE, GRP ART UNIT, FIL FEE REC'D, ATTY,DOCKET.NO, TOT CLAIMS, IND CLAIMS. Row 1: 13/967,189, 08/14/2013, 1653, 2220, 17618CON2B (AP), 24, 3

CONFIRMATION NO. 4818

51957
ALLERGAN, INC.
2525 DUPONT DRIVE, T2-7H
IRVINE, CA 92612-1599

FILING RECEIPT



Date Mailed: 09/05/2013

Receipt is acknowledged of this non-provisional patent application. The application will be taken up for examination in due course. Applicant will be notified as to the results of the examination. Any correspondence concerning the application must include the following identification information: the U.S. APPLICATION NUMBER, FILING DATE, NAME OF APPLICANT, and TITLE OF INVENTION. Fees transmitted by check or draft are subject to collection. Please verify the accuracy of the data presented on this receipt. If an error is noted on this Filing Receipt, please submit a written request for a Filing Receipt Correction. Please provide a copy of this Filing Receipt with the changes noted thereon. If you received a "Notice to File Missing Parts" for this application, please submit any corrections to this Filing Receipt with your reply to the Notice. When the USPTO processes the reply to the Notice, the USPTO will generate another Filing Receipt incorporating the requested corrections

Inventor(s)

Andrew Acheampong, Irvine, CA;
Diane D. Tang-Liu, Las Vegas, NV;
James N. Chang, Newport Beach, CA;
David F. Power, Hubert, NC;

Applicant(s)

Allergan, Inc., Irvine, CA

Assignment For Published Patent Application

Allergan, Inc., Irvine, CA

Power of Attorney: The patent practitioners associated with Customer Number 51957

Domestic Priority data as claimed by applicant

This application is a CON of 13/961,808 08/07/2013
which is a CON of 11/897,177 08/28/2007
which is a CON of 10/927,857 08/27/2004 ABN
which claims benefit of 60/503,137 09/15/2003

Foreign Applications for which priority is claimed (You may be eligible to benefit from the Patent Prosecution Highway program at the USPTO. Please see http://www.uspto.gov for more information.) - None.

Foreign application information must be provided in an Application Data Sheet in order to constitute a claim to foreign priority. See 37 CFR 1.55 and 1.76.

Permission to Access - A proper Authorization to Permit Access to Application by Participating Offices (PTO/SB/39 or its equivalent) has been received by the USPTO.

**If Required, Foreign Filing License Granted:** 08/29/2013

The country code and number of your priority application, to be used for filing abroad under the Paris Convention, is **US 13/967,189**

**Projected Publication Date:** 12/12/2013

**Non-Publication Request:** No

**Early Publication Request:** No

**Title**

METHODS OF PROVIDING THERAPEUTIC EFFECTS USING CYCLOSPORIN COMPONENTS

**Preliminary Class**

435

**Statement under 37 CFR 1.55 or 1.78 for AIA (First Inventor to File) Transition Applications:** No

### **PROTECTING YOUR INVENTION OUTSIDE THE UNITED STATES**

Since the rights granted by a U.S. patent extend only throughout the territory of the United States and have no effect in a foreign country, an inventor who wishes patent protection in another country must apply for a patent in a specific country or in regional patent offices. Applicants may wish to consider the filing of an international application under the Patent Cooperation Treaty (PCT). An international (PCT) application generally has the same effect as a regular national patent application in each PCT-member country. The PCT process **simplifies** the filing of patent applications on the same invention in member countries, but **does not result** in a grant of "an international patent" and does not eliminate the need of applicants to file additional documents and fees in countries where patent protection is desired.

Almost every country has its own patent law, and a person desiring a patent in a particular country must make an application for patent in that country in accordance with its particular laws. Since the laws of many countries differ in various respects from the patent law of the United States, applicants are advised to seek guidance from specific foreign countries to ensure that patent rights are not lost prematurely.

Applicants also are advised that in the case of inventions made in the United States, the Director of the USPTO must issue a license before applicants can apply for a patent in a foreign country. The filing of a U.S. patent application serves as a request for a foreign filing license. The application's filing receipt contains further information and guidance as to the status of applicant's license for foreign filing.

Applicants may wish to consult the USPTO booklet, "General Information Concerning Patents" (specifically, the section entitled "Treaties and Foreign Patents") for more information on timeframes and deadlines for filing foreign patent applications. The guide is available either by contacting the USPTO Contact Center at 800-786-9199, or it can be viewed on the USPTO website at <http://www.uspto.gov/web/offices/pac/doc/general/index.html>.

For information on preventing theft of your intellectual property (patents, trademarks and copyrights), you may wish to consult the U.S. Government website, <http://www.stopfakes.gov>. Part of a Department of Commerce initiative, this website includes self-help "toolkits" giving innovators guidance on how to protect intellectual property in specific countries such as China, Korea and Mexico. For questions regarding patent enforcement issues, applicants may call the U.S. Government hotline at 1-866-999-HALT (1-866-999-4258).

**LICENSE FOR FOREIGN FILING UNDER**  
**Title 35, United States Code, Section 184**  
**Title 37, Code of Federal Regulations, 5.11 & 5.15**

**GRANTED**

The applicant has been granted a license under 35 U.S.C. 184, if the phrase "IF REQUIRED, FOREIGN FILING LICENSE GRANTED" followed by a date appears on this form. Such licenses are issued in all applications where the conditions for issuance of a license have been met, regardless of whether or not a license may be required as set forth in 37 CFR 5.15. The scope and limitations of this license are set forth in 37 CFR 5.15(a) unless an earlier license has been issued under 37 CFR 5.15(b). The license is subject to revocation upon written notification. The date indicated is the effective date of the license, unless an earlier license of similar scope has been granted under 37 CFR 5.13 or 5.14.

This license is to be retained by the licensee and may be used at any time on or after the effective date thereof unless it is revoked. This license is automatically transferred to any related applications(s) filed under 37 CFR 1.53(d). This license is not retroactive.

The grant of a license does not in any way lessen the responsibility of a licensee for the security of the subject matter as imposed by any Government contract or the provisions of existing laws relating to espionage and the national security or the export of technical data. Licensees should apprise themselves of current regulations especially with respect to certain countries, of other agencies, particularly the Office of Defense Trade Controls, Department of State (with respect to Arms, Munitions and Implements of War (22 CFR 121-128)); the Bureau of Industry and Security, Department of Commerce (15 CFR parts 730-774); the Office of Foreign Assets Control, Department of Treasury (31 CFR Parts 500+) and the Department of Energy.

**NOT GRANTED**

No license under 35 U.S.C. 184 has been granted at this time, if the phrase "IF REQUIRED, FOREIGN FILING LICENSE GRANTED" DOES NOT appear on this form. Applicant may still petition for a license under 37 CFR 5.12, if a license is desired before the expiration of 6 months from the filing date of the application. If 6 months has lapsed from the filing date of this application and the licensee has not received any indication of a secrecy order under 35 U.S.C. 181, the licensee may foreign file the application pursuant to 37 CFR 5.15(b).

---

***SelectUSA***

The United States represents the largest, most dynamic marketplace in the world and is an unparalleled location for business investment, innovation, and commercialization of new technologies. The U.S. offers tremendous resources and advantages for those who invest and manufacture goods here. Through SelectUSA, our nation works to promote and facilitate business investment. SelectUSA provides information assistance to the international investor community; serves as an ombudsman for existing and potential investors; advocates on behalf of U.S. cities, states, and regions competing for global investment; and counsels U.S. economic development organizations on investment attraction best practices. To learn more about why the United States is the best country in the world to develop technology, manufacture products, deliver services, and grow your business, visit <http://www.SelectUSA.gov> or call +1-202-482-6800.

**PATENT APPLICATION FEE DETERMINATION RECORD**

Substitute for Form PTO-875

Application or Docket Number  
13/967,189

**APPLICATION AS FILED - PART I**

(Column 1) (Column 2)

| FOR   | NUMBER FILED  | NUMBER EXTRA |
|---|---|--------------|
| BASIC FEE<br>(37 CFR 1.16(a), (b), or (c))        | N/A   | N/A          |
| SEARCH FEE<br>(37 CFR 1.16(k), (l), or (m))       | N/A   | N/A          |
| EXAMINATION FEE<br>(37 CFR 1.16(o), (p), or (q))  | N/A   | N/A          |
| TOTAL CLAIMS<br>(37 CFR 1.16(j))                  | 24 minus 20 = *   | 4            |
| INDEPENDENT CLAIMS<br>(37 CFR 1.16(h))            | 3 minus 3 = *   |              |
| APPLICATION SIZE FEE<br>(37 CFR 1.16(s))          | If the specification and drawings exceed 100 sheets of paper, the application size fee due is \$310 (\$155 for small entity) for each additional 50 sheets or fraction thereof. See 35 U.S.C. 41(a)(1)(G) and 37 CFR 1.16(s). |              |
| MULTIPLE DEPENDENT CLAIM PRESENT (37 CFR 1.16(j)) |   |              |

\* If the difference in column 1 is less than zero, enter "0" in column 2.

**SMALL ENTITY**

| RATE(\$) | FEE(\$) |
|----------|---------|
| N/A      |         |
| N/A      |         |
| N/A      |         |
|          |         |
|          |         |
|          |         |
|          |         |
| TOTAL    |         |

**OR OTHER THAN SMALL ENTITY**

| RATE(\$) | FEE(\$) |
|----------|---------|
| N/A      | 280     |
| N/A      | 600     |
| N/A      | 720     |
| x 80 =   | 320     |
| x 420 =  | 0.00    |
|          | 0.00    |
|          | 0.00    |
| TOTAL    | 1920    |

**APPLICATION AS AMENDED - PART II**

(Column 1) (Column 2) (Column 3)

| AMENDMENT A   |                                 | CLAIMS REMAINING AFTER AMENDMENT |       | HIGHEST NUMBER PREVIOUSLY PAID FOR | PRESENT EXTRA |
|---|---------------------------------|----------------------------------|-------|------------------------------------|---------------|
|   | Total<br>(37 CFR 1.16(i))       | *                                | Minus | **                                 | =             |
|   | Independent<br>(37 CFR 1.16(h)) | *                                | Minus | ***                                | =             |
| Application Size Fee (37 CFR 1.16(s))                           |                                 |                                  |       |                                    |               |
| FIRST PRESENTATION OF MULTIPLE DEPENDENT CLAIM (37 CFR 1.16(j)) |                                 |                                  |       |                                    |               |

**SMALL ENTITY**

| RATE(\$)        | ADDITIONAL FEE(\$) |
|-----------------|--------------------|
| x =             |                    |
| x =             |                    |
|                 |                    |
|                 |                    |
| TOTAL ADD'L FEE |                    |

**OR OTHER THAN SMALL ENTITY**

| RATE(\$)        | ADDITIONAL FEE(\$) |
|-----------------|--------------------|
| x =             |                    |
| x =             |                    |
|                 |                    |
|                 |                    |
| TOTAL ADD'L FEE |                    |

(Column 1) (Column 2) (Column 3)

| AMENDMENT B   |                                 | CLAIMS REMAINING AFTER AMENDMENT |       | HIGHEST NUMBER PREVIOUSLY PAID FOR | PRESENT EXTRA |
|---|---------------------------------|----------------------------------|-------|------------------------------------|---------------|
|   | Total<br>(37 CFR 1.16(i))       | *                                | Minus | **                                 | =             |
|   | Independent<br>(37 CFR 1.16(h)) | *                                | Minus | ***                                | =             |
| Application Size Fee (37 CFR 1.16(s))                           |                                 |                                  |       |                                    |               |
| FIRST PRESENTATION OF MULTIPLE DEPENDENT CLAIM (37 CFR 1.16(j)) |                                 |                                  |       |                                    |               |

**SMALL ENTITY**

| RATE(\$)        | ADDITIONAL FEE(\$) |
|-----------------|--------------------|
| x =             |                    |
| x =             |                    |
|                 |                    |
|                 |                    |
| TOTAL ADD'L FEE |                    |

**OR OTHER THAN SMALL ENTITY**

| RATE(\$)        | ADDITIONAL FEE(\$) |
|-----------------|--------------------|
| x =             |                    |
| x =             |                    |
|                 |                    |
|                 |                    |
| TOTAL ADD'L FEE |                    |

\* If the entry in column 1 is less than the entry in column 2, write "0" in column 3.

\*\* If the "Highest Number Previously Paid For" IN THIS SPACE is less than 20, enter "20".

\*\*\* If the "Highest Number Previously Paid For" IN THIS SPACE is less than 3, enter "3".

The "Highest Number Previously Paid For" (Total or Independent) is the highest found in the appropriate box in column 1.



UNITED STATES PATENT AND TRADEMARK OFFICE

UNITED STATES DEPARTMENT OF COMMERCE  
United States Patent and Trademark Office  
Address: COMMISSIONER FOR PATENTS  
P.O. Box 1450  
Alexandria, Virginia 22313-1450  
www.uspto.gov

| APPLICATION NUMBER | FILING OR 371(C) DATE | FIRST NAMED APPLICANT | ATTY. DOCKET NO./TITLE |
|--------------------|-----------------------|-----------------------|------------------------|
| 13/967,189         | 08/14/2013            | Andrew Acheampong     | 17618CON2B (AP)        |

**CONFIRMATION NO. 4818**

**POA ACCEPTANCE LETTER**

51957  
ALLERGAN, INC.  
2525 DUPONT DRIVE, T2-7H  
IRVINE, CA 92612-1599



Date Mailed: 09/05/2013

**NOTICE OF ACCEPTANCE OF POWER OF ATTORNEY**

This is in response to the Power of Attorney filed 08/14/2013.

The Power of Attorney in this application is accepted. Correspondence in this application will be mailed to the above address as provided by 37 CFR 1.33.

/btsebhatu/

Office of Data Management, Application Assistance Unit (571) 272-4000, or (571) 272-4200, or 1-888-786-0101

## Electronic Acknowledgement Receipt

|   |   |
|---|---|
| <b>EFS ID:</b>                              | 16593528  |
| <b>Application Number:</b>                  | 13967189  |
| <b>International Application Number:</b>    |   |
| <b>Confirmation Number:</b>                 | 4818  |
| <b>Title of Invention:</b>                  | METHODS OF PROVIDING THERAPEUTIC EFFECTS USING CYCLOSPORIN COMPONENTS |
| <b>First Named Inventor/Applicant Name:</b> | Andrew Acheampong   |
| <b>Customer Number:</b>                     | 51957   |
| <b>Filer:</b>                               | Laura Lee Wine/Lauren Barberena                                       |
| <b>Filer Authorized By:</b>                 | Laura Lee Wine  |
| <b>Attorney Docket Number:</b>              | 17618CON2B (AP)   |
| <b>Receipt Date:</b>                        | 14-AUG-2013   |
| <b>Filing Date:</b>                         |   |
| <b>Time Stamp:</b>                          | 18:56:04  |
| <b>Application Type:</b>                    | Utility under 35 USC 111(a)   |

### Payment information:

|  |                 |   |  |
|--|-----------------|---|--|
| Submitted with Payment                   | yes             |   |  |
| Payment Type                             | Deposit Account | Adjustment date: 09/20/2013 CKHLOK<br>08/15/2013 INTEFSW 00006200 010885 13967189<br>07 FC:1000 130.00 CR |  |
| Payment was successfully received in RAM | \$6270          |   |  |
| RAM confirmation Number                  | 6280            | 09/20/2013 CKHLOK 00000002 010885 13967189  |  |
| Deposit Account                          | 010885          | 01 FC:1030 140.00 DA  |  |
| Authorized User                          |                 |   |  |

The Director of the USPTO is hereby authorized to charge indicated fees and credit any overpayment as follows:

Charge any Additional Fees required under 37 C.F.R. Section 1.17 (Patent application and reexamination processing fees)

Charge any Additional Fees required under 37 C.F.R. Section 1.21 (Miscellaneous fees and charges)

|  |  |   |   |
|--|--|---|---|
|  | Claims   | 3 | 6 |
|  | Applicant Arguments/Remarks Made in an Amendment | 7 | 7 |

**Warnings:**

**Information:**

|   |                  |                                     |   |    |   |
|---|------------------|-------------------------------------|---|----|---|
| 6 | TrackOne Request | 17618CON2B_PRIORITIZED_EX<br>AM.pdf | 153236<br><small>26dfacc03da02daa83f2ddb99a2c3ab62cc535b5</small> | no | 2 |
|---|------------------|-------------------------------------|---|----|---|

**Warnings:**

**Information:**

|   |                      |              |  |    |   |
|---|----------------------|--------------|--|----|---|
| 7 | Fee Worksheet (SB06) | fee-info.pdf | 42020<br><small>9aa08e84c0b4ec795b5f25400b1798c19ba060eb</small> | no | 2 |
|---|----------------------|--------------|--|----|---|

**Warnings:**

**Information:**

|                                     |  |         |
|-------------------------------------|--|---------|
| <b>Total Files Size (in bytes):</b> |  | 8727406 |
|-------------------------------------|--|---------|

**This Acknowledgement Receipt evidences receipt on the noted date by the USPTO of the indicated documents, characterized by the applicant, and including page counts, where applicable. It serves as evidence of receipt similar to a Post Card, as described in MPEP 503.**

**New Applications Under 35 U.S.C. 111**

**If a new application is being filed and the application includes the necessary components for a filing date (see 37 CFR 1.53(b)-(d) and MPEP 506), a Filing Receipt (37 CFR 1.54) will be issued in due course and the date shown on this Acknowledgement Receipt will establish the filing date of the application.**

**National Stage of an International Application under 35 U.S.C. 371**

**If a timely submission to enter the national stage of an international application is compliant with the conditions of 35 U.S.C. 371 and other applicable requirements a Form PCT/DO/EO/903 indicating acceptance of the application as a national stage submission under 35 U.S.C. 371 will be issued in addition to the Filing Receipt, in due course.**

**New International Application Filed with the USPTO as a Receiving Office**

**If a new international application is being filed and the international application includes the necessary components for an international filing date (see PCT Article 11 and MPEP 1810), a Notification of the International Application Number and of the International Filing Date (Form PCT/RO/105) will be issued in due course, subject to prescriptions concerning national security, and the date shown on this Acknowledgement Receipt will establish the international filing date of the application.**

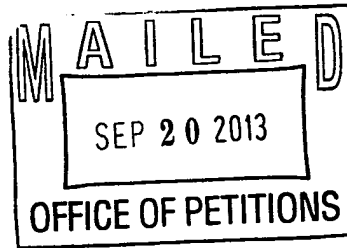

ALLERGAN, INC.  
2525 DUPONT DRIVE, T2-7H  
IRVINE CA 92612-1599

Doc Code: TRACK1.GRANT

|  |                                    |
|--|------------------------------------|
| <p><b>Decision Granting Request for<br/>Prioritized Examination<br/>(Track I or After RCE)</b></p>   | <p>Application No.: 13/967,189</p> |
| <p>1. THE REQUEST FILED <u>August 14, 2013</u> IS <b>GRANTED</b>.</p> <p>The above-identified application has met the requirements for prioritized examination</p> <p>A. <input checked="" type="checkbox"/> for an original nonprovisional application (Track I).<br/> B. <input type="checkbox"/> for an application undergoing continued examination (RCE).</p> <p>2. <b>The above-identified application will undergo prioritized examination.</b> The application will be accorded special status throughout its entire course of prosecution until one of the following occurs:</p> <p>A. filing a <b><u>petition for extension of time</u></b> to extend the time period for filing a reply;<br/> B. filing an <b><u>amendment to amend the application to contain more than four independent claims, more than thirty total claims</u></b>, or a multiple dependent claim;<br/> C. filing a <b><u>request for continued examination</u></b>;<br/> D. filing a notice of appeal;<br/> E. filing a request for suspension of action;<br/> F. mailing of a notice of allowance;<br/> G. mailing of a final Office action;<br/> H. completion of examination as defined in 37 CFR 41.102; or<br/> I. abandonment of the application.</p> <p>Telephone inquiries with regard to this decision should be directed to <b><u>Michelle R. Eason</u></b> at (571) 272-4231. In his/her absence, calls may be directed to Brian W. Brown at (571) 272-5338.</p> <p><u>/Michelle R. Eason/</u><br/>(Signature) <span style="float: right;"><u>Paralegal Specialist, Office of Petitions</u><br/>(Title)</span></p> |                                    |



|   |                        |                    |                   |  |
|---|------------------------|--------------------|-------------------|--|
| <b>INFORMATION DISCLOSURE STATEMENT BY APPLICANT</b><br>( Not for submission under 37 CFR 1.99) | Application Number     |                    | 13967189          |  |
|   | Filing Date            |                    | 2013-08-14        |  |
|   | First Named Inventor   | ACHEAMPONG, ANDREW |                   |  |
|   | Art Unit               |                    | 1653              |  |
|   | Examiner Name          | TBD                |                   |  |
|   | Attorney Docket Number |                    | 17618-US-BCON2-AP |  |

| U.S.PATENTS       |         |               |                        |            |   |  |
|-------------------|---------|---------------|------------------------|------------|---|--|
| Examiner Initial* | Cite No | Patent Number | Kind Code <sup>1</sup> | Issue Date | Name of Patentee or Applicant of cited Document | Pages,Columns,Lines where Relevant Passages or Relevant Figures Appear |
|                   | 1       |               |                        |            |   |  |

If you wish to add additional U.S. Patent citation information please click the Add button.

| U.S.PATENT APPLICATION PUBLICATIONS |         |                    |                        |                  |   |  |
|-------------------------------------|---------|--------------------|------------------------|------------------|---|--|
| Examiner Initial*                   | Cite No | Publication Number | Kind Code <sup>1</sup> | Publication Date | Name of Patentee or Applicant of cited Document | Pages,Columns,Lines where Relevant Passages or Relevant Figures Appear |
|                                     | 1       |                    |                        |                  |   |  |

If you wish to add additional U.S. Published Application citation information please click the Add button.

| FOREIGN PATENT DOCUMENTS |         |                                      |                           |                        |                  |   |  |                          |
|--------------------------|---------|--------------------------------------|---------------------------|------------------------|------------------|---|--|--------------------------|
| Examiner Initial*        | Cite No | Foreign Document Number <sup>3</sup> | Country Code <sup>2</sup> | Kind Code <sup>4</sup> | Publication Date | Name of Patentee or Applicant of cited Document | Pages,Columns,Lines where Relevant Passages or Relevant Figures Appear | T <sup>5</sup>           |
|                          | 1       |                                      |                           |                        |                  |   |  | <input type="checkbox"/> |

If you wish to add additional Foreign Patent Document citation information please click the Add button

| NON-PATENT LITERATURE DOCUMENTS |         |   |                |
|---------------------------------|---------|---|----------------|
| Examiner Initials*              | Cite No | Include name of the author (in CAPITAL LETTERS), title of the article (when appropriate), title of the item (book, magazine, journal, serial, symposium, catalog, etc), date, pages(s), volume-issue number(s), publisher, city and/or country where published. | T <sup>5</sup> |
|                                 |         |   |                |

|   |                        |                    |
|---|------------------------|--------------------|
| <b>INFORMATION DISCLOSURE<br/>STATEMENT BY APPLICANT</b><br>( Not for submission under 37 CFR 1.99) | Application Number     | 13967189           |
|   | Filing Date            | 2013-08-14         |
|   | First Named Inventor   | ACHEAMPONG, ANDREW |
|   | Art Unit               | 1653               |
|   | Examiner Name          | TBD                |
|   | Attorney Docket Number | 17618-US-BCON2-AP  |

|   |  |                          |
|---|--|--------------------------|
| 1 | U.S. Re-Examination Application: 90/009,944 and its entire prosecution history, Filed on August, 27, 2011 ** | <input type="checkbox"/> |
|---|--|--------------------------|

If you wish to add additional non-patent literature document citation information please click the Add button

**EXAMINER SIGNATURE**

|                    |  |                 |  |
|--------------------|--|-----------------|--|
| Examiner Signature |  | Date Considered |  |
|--------------------|--|-----------------|--|

\*EXAMINER: Initial if reference considered, whether or not citation is in conformance with MPEP 609. Draw line through a citation if not in conformance and not considered. Include copy of this form with next communication to applicant.

<sup>1</sup> See Kind Codes of USPTO Patent Documents at [www.USPTO.GOV](http://www.USPTO.GOV) or MPEP 901.04. <sup>2</sup> Enter office that issued the document, by the two-letter code (WIPO Standard ST.3). <sup>3</sup> For Japanese patent documents, the indication of the year of the reign of the Emperor must precede the serial number of the patent document. <sup>4</sup> Kind of document by the appropriate symbols as indicated on the document under WIPO Standard ST.16 if possible. <sup>5</sup> Applicant is to place a check mark here if English language translation is attached.

|   |                        |                    |
|---|------------------------|--------------------|
| <b>INFORMATION DISCLOSURE<br/>STATEMENT BY APPLICANT</b><br>( Not for submission under 37 CFR 1.99) | Application Number     | 13967189           |
|   | Filing Date            | 2013-08-14         |
|   | First Named Inventor   | ACHEAMPONG, ANDREW |
|   | Art Unit               | 1653               |
|   | Examiner Name          | TBD                |
|   | Attorney Docket Number | 17618-US-BCON2-AP  |

**CERTIFICATION STATEMENT**

Please see 37 CFR 1.97 and 1.98 to make the appropriate selection(s):

That each item of information contained in the information disclosure statement was first cited in any communication from a foreign patent office in a counterpart foreign application not more than three months prior to the filing of the information disclosure statement. See 37 CFR 1.97(e)(1).

**OR**

That no item of information contained in the information disclosure statement was cited in a communication from a foreign patent office in a counterpart foreign application, and, to the knowledge of the person signing the certification after making reasonable inquiry, no item of information contained in the information disclosure statement was known to any individual designated in 37 CFR 1.56(c) more than three months prior to the filing of the information disclosure statement. See 37 CFR 1.97(e)(2).

\*\* Signature indicates consideration of publication and file history. The Examiner has access to these materials through the PTO computer systems. If additional copies are desired, please notify the Applicants through their attorneys.

- See attached certification statement.
- Fee set forth in 37 CFR 1.17 (p) has been submitted herewith.
- None

**SIGNATURE**

A signature of the applicant or representative is required in accordance with CFR 1.33, 10.18. Please see CFR 1.4(d) for the form of the signature.

|            |                 |                     |            |
|------------|-----------------|---------------------|------------|
| Signature  | /Laura L. Wine/ | Date (YYYY-MM-DD)   | 2013-09-24 |
| Name/Print | Laura L. Wine   | Registration Number | 68,681     |

This collection of information is required by 37 CFR 1.97 and 1.98. The information is required to obtain or retain a benefit by the public which is to file (and by the USPTO to process) an application. Confidentiality is governed by 35 U.S.C. 122 and 37 CFR 1.14. This collection is estimated to take 1 hour to complete, including gathering, preparing and submitting the completed application form to the USPTO. Time will vary depending upon the individual case. Any comments on the amount of time you require to complete this form and/or suggestions for reducing this burden, should be sent to the Chief Information Officer, U.S. Patent and Trademark Office, U.S. Department of Commerce, P.O. Box 1450, Alexandria, VA 22313-1450. **DO NOT SEND FEES OR COMPLETED FORMS TO THIS ADDRESS. SEND TO: Commissioner for Patents, P.O. Box 1450, Alexandria, VA 22313-1450.**

## Privacy Act Statement

The Privacy Act of 1974 (P.L. 93-579) requires that you be given certain information in connection with your submission of the attached form related to a patent application or patent. Accordingly, pursuant to the requirements of the Act, please be advised that: (1) the general authority for the collection of this information is 35 U.S.C. 2(b)(2); (2) furnishing of the information solicited is voluntary; and (3) the principal purpose for which the information is used by the U.S. Patent and Trademark Office is to process and/or examine your submission related to a patent application or patent. If you do not furnish the requested information, the U.S. Patent and Trademark Office may not be able to process and/or examine your submission, which may result in termination of proceedings or abandonment of the application or expiration of the patent.

The information provided by you in this form will be subject to the following routine uses:

1. The information on this form will be treated confidentially to the extent allowed under the Freedom of Information Act (5 U.S.C. 552) and the Privacy Act (5 U.S.C. 552a). Records from this system of records may be disclosed to the Department of Justice to determine whether the Freedom of Information Act requires disclosure of these records.
2. A record from this system of records may be disclosed, as a routine use, in the course of presenting evidence to a court, magistrate, or administrative tribunal, including disclosures to opposing counsel in the course of settlement negotiations.
3. A record in this system of records may be disclosed, as a routine use, to a Member of Congress submitting a request involving an individual, to whom the record pertains, when the individual has requested assistance from the Member with respect to the subject matter of the record.
4. A record in this system of records may be disclosed, as a routine use, to a contractor of the Agency having need for the information in order to perform a contract. Recipients of information shall be required to comply with the requirements of the Privacy Act of 1974, as amended, pursuant to 5 U.S.C. 552a(m).
5. A record related to an International Application filed under the Patent Cooperation Treaty in this system of records may be disclosed, as a routine use, to the International Bureau of the World Intellectual Property Organization, pursuant to the Patent Cooperation Treaty.
6. A record in this system of records may be disclosed, as a routine use, to another federal agency for purposes of National Security review (35 U.S.C. 181) and for review pursuant to the Atomic Energy Act (42 U.S.C. 218(c)).
7. A record from this system of records may be disclosed, as a routine use, to the Administrator, General Services, or his/her designee, during an inspection of records conducted by GSA as part of that agency's responsibility to recommend improvements in records management practices and programs, under authority of 44 U.S.C. 2904 and 2906. Such disclosure shall be made in accordance with the GSA regulations governing inspection of records for this purpose, and any other relevant (i.e., GSA or Commerce) directive. Such disclosure shall not be used to make determinations about individuals.
8. A record from this system of records may be disclosed, as a routine use, to the public after either publication of the application pursuant to 35 U.S.C. 122(b) or issuance of a patent pursuant to 35 U.S.C. 151. Further, a record may be disclosed, subject to the limitations of 37 CFR 1.14, as a routine use, to the public if the record was filed in an application which became abandoned or in which the proceedings were terminated and which application is referenced by either a published application, an application open to public inspections or an issued patent.
9. A record from this system of records may be disclosed, as a routine use, to a Federal, State, or local law enforcement agency, if the USPTO becomes aware of a violation or potential violation of law or regulation.

## Electronic Acknowledgement Receipt

|   |   |
|---|---|
| <b>EFS ID:</b>                              | 16951660  |
| <b>Application Number:</b>                  | 13967189  |
| <b>International Application Number:</b>    |   |
| <b>Confirmation Number:</b>                 | 4818  |
| <b>Title of Invention:</b>                  | METHODS OF PROVIDING THERAPEUTIC EFFECTS USING CYCLOSPORIN COMPONENTS |
| <b>First Named Inventor/Applicant Name:</b> | Andrew Acheampong   |
| <b>Customer Number:</b>                     | 51957   |
| <b>Filer:</b>                               | Laura Lee Wine/Ken Dinh   |
| <b>Filer Authorized By:</b>                 | Laura Lee Wine  |
| <b>Attorney Docket Number:</b>              | 17618CON2B (AP)   |
| <b>Receipt Date:</b>                        | 25-SEP-2013   |
| <b>Filing Date:</b>                         | 14-AUG-2013   |
| <b>Time Stamp:</b>                          | 14:00:05  |
| <b>Application Type:</b>                    | Utility under 35 USC 111(a)   |

### Payment information:

|                        |    |
|------------------------|----|
| Submitted with Payment | no |
|------------------------|----|

### File Listing:

| Document Number | Document Description                               | File Name                     | File Size(Bytes)/<br>Message Digest                               | Multi Part /.zip | Pages (if appl.) |
|-----------------|--|-------------------------------|---|------------------|------------------|
| 1               | Information Disclosure Statement (IDS) Form (SB08) | 17618CON2B-IDS_09_24_2013.pdf | 493644<br><small>9bea8e0d9774981a910a583f8c42412d852a9239</small> | no               | 4                |

### Warnings:

### Information:

This is not an USPTO supplied IDS fillable form

|   |                       |              |  |    |    |
|---|-----------------------|--------------|--|----|----|
| 2 | Non Patent Literature | 90009944.pdf | 1904560                                  | no | 39 |
|   |                       |              | 4b5aa1ab68a1940d5930d4265e9053cf67203dc9 |    |    |

**Warnings:**

**Information:**

|                                     |         |
|-------------------------------------|---------|
| <b>Total Files Size (in bytes):</b> | 2398204 |
|-------------------------------------|---------|

**This Acknowledgement Receipt evidences receipt on the noted date by the USPTO of the indicated documents, characterized by the applicant, and including page counts, where applicable. It serves as evidence of receipt similar to a Post Card, as described in MPEP 503.**

**New Applications Under 35 U.S.C. 111**

**If a new application is being filed and the application includes the necessary components for a filing date (see 37 CFR 1.53(b)-(d) and MPEP 506), a Filing Receipt (37 CFR 1.54) will be issued in due course and the date shown on this Acknowledgement Receipt will establish the filing date of the application.**

**National Stage of an International Application under 35 U.S.C. 371**

**If a timely submission to enter the national stage of an international application is compliant with the conditions of 35 U.S.C. 371 and other applicable requirements a Form PCT/DO/EO/903 indicating acceptance of the application as a national stage submission under 35 U.S.C. 371 will be issued in addition to the Filing Receipt, in due course.**

**New International Application Filed with the USPTO as a Receiving Office**

**If a new international application is being filed and the international application includes the necessary components for an international filing date (see PCT Article 11 and MPEP 1810), a Notification of the International Application Number and of the International Filing Date (Form PCT/RO/105) will be issued in due course, subject to prescriptions concerning national security, and the date shown on this Acknowledgement Receipt will establish the international filing date of the application.**

**IN THE UNITED STATES PATENT AND TRADEMARK OFFICE**

Applicant: Acheampong, *et al.*

Serial No.: 13/967,189

Filed: August 14, 2013

For: METHODS OF PROVIDING  
THERAPEUTIC EFFECTS USING  
CYCLOSPORIN COMPONENTS

Examiner: Marcela M. Cordero Garcia

Group Art Unit: 1658

Confirmation No. 4818

Customer No.: 51957

**COMMUNICATION UNDER MPEP 502.03**

Commissioner for Patents  
P.O. Box 1450  
Alexandria, VA 22313-1450

Dear Sir:

Recognizing that Internet communications are not secure, I hereby authorize the USPTO to communicate with me concerning any subject matter of this application by electronic mail. I understand that a copy of these communications will be made of record in the application file.

Respectfully submitted,

/Laura L. Wine/

Date: October 1, 2013

\_\_\_\_\_  
Laura L. Wine  
Attorney of Record  
Registration Number 68,681

Please direct all inquiries and correspondence to:  
Laura L. Wine, Esq.  
Allergan, Inc.  
2525 Dupont Drive, T2-7H  
Irvine, California 92612  
Tel: (714) 246-6996 Fax: (714) 246-4249

## Electronic Acknowledgement Receipt

|   |   |
|---|---|
| <b>EFS ID:</b>                              | 17013203  |
| <b>Application Number:</b>                  | 13967189  |
| <b>International Application Number:</b>    |   |
| <b>Confirmation Number:</b>                 | 4818  |
| <b>Title of Invention:</b>                  | METHODS OF PROVIDING THERAPEUTIC EFFECTS USING CYCLOSPORIN COMPONENTS |
| <b>First Named Inventor/Applicant Name:</b> | Andrew Acheampong   |
| <b>Customer Number:</b>                     | 51957   |
| <b>Filer:</b>                               | Laura Lee Wine/Alexis Swan  |
| <b>Filer Authorized By:</b>                 | Laura Lee Wine  |
| <b>Attorney Docket Number:</b>              | 17618CON2B (AP)   |
| <b>Receipt Date:</b>                        | 01-OCT-2013   |
| <b>Filing Date:</b>                         | 14-AUG-2013   |
| <b>Time Stamp:</b>                          | 19:14:47  |
| <b>Application Type:</b>                    | Utility under 35 USC 111(a)   |

### Payment information:

|                        |    |
|------------------------|----|
| Submitted with Payment | no |
|------------------------|----|

### File Listing:

| Document Number | Document Description          | File Name                     | File Size(Bytes)/<br>Message Digest                                | Multi Part /.zip | Pages (if appl.) |
|-----------------|-------------------------------|-------------------------------|--|------------------|------------------|
| 1               | Miscellaneous Incoming Letter | 17618CON2B-Comm-Under-502.pdf | 104511<br><small>027353835e952dadcd6f6cea5ab134b2fb923e692</small> | no               | 1                |

### Warnings:

### Information:



**This Acknowledgement Receipt evidences receipt on the noted date by the USPTO of the indicated documents, characterized by the applicant, and including page counts, where applicable. It serves as evidence of receipt similar to a Post Card, as described in MPEP 503.**

**New Applications Under 35 U.S.C. 111**

**If a new application is being filed and the application includes the necessary components for a filing date (see 37 CFR 1.53(b)-(d) and MPEP 506), a Filing Receipt (37 CFR 1.54) will be issued in due course and the date shown on this Acknowledgement Receipt will establish the filing date of the application.**

**National Stage of an International Application under 35 U.S.C. 371**

**If a timely submission to enter the national stage of an international application is compliant with the conditions of 35 U.S.C. 371 and other applicable requirements a Form PCT/DO/EO/903 indicating acceptance of the application as a national stage submission under 35 U.S.C. 371 will be issued in addition to the Filing Receipt, in due course.**

**New International Application Filed with the USPTO as a Receiving Office**

**If a new international application is being filed and the international application includes the necessary components for an international filing date (see PCT Article 11 and MPEP 1810), a Notification of the International Application Number and of the International Filing Date (Form PCT/RO/105) will be issued in due course, subject to prescriptions concerning national security, and the date shown on this Acknowledgement Receipt will establish the international filing date of the application.**

|   |   |
|---|---|
| <b>Doc Code: DIST.E.FILE</b><br><b>Document Description: Electronic Terminal Disclaimer - Filed</b> | PTO/SB/25<br>U.S. Patent and Trademark Office<br>Department of Commerce |
|---|---|

|                             |  |
|-----------------------------|--|
| Electronic Petition Request | <b>TERMINAL DISCLAIMER TO OBIATE A PROVISIONAL DOUBLE PATENTING REJECTION OVER A PENDING "REFERENCE" APPLICATION</b> |
|-----------------------------|--|

|                    |          |
|--------------------|----------|
| Application Number | 13967189 |
|--------------------|----------|

|             |             |
|-------------|-------------|
| Filing Date | 14-Aug-2013 |
|-------------|-------------|

|                      |                   |
|----------------------|-------------------|
| First Named Inventor | Andrew Acheampong |
|----------------------|-------------------|

|                        |                 |
|------------------------|-----------------|
| Attorney Docket Number | 17618CON2B (AP) |
|------------------------|-----------------|

|                    |   |
|--------------------|---|
| Title of Invention | METHODS OF PROVIDING THERAPEUTIC EFFECTS USING CYCLOSPORIN COMPONENTS |
|--------------------|---|

- Filing of terminal disclaimer does not obviate requirement for response under 37 CFR 1.111 to outstanding Office Action
- This electronic Terminal Disclaimer is not being used for a Joint Research Agreement.

| Owner          | Percent Interest |
|----------------|------------------|
| Allergan, Inc. | 100%             |

The owner(s) of percent interest listed above in the instant application hereby disclaims, except as provided below, the terminal part of the statutory term of any patent granted on the instant application which would extend beyond the expiration date of the full statutory term of any patent granted on pending reference Application Number(s)

- 13961808 filed on 08/07/2013
- 13961818 filed on 08/07/2013
- 13961828 filed on 08/07/2013
- 13961835 filed on 08/07/2013
- 13967179 filed on 08/14/2013
- 13967163 filed on 08/14/2013
- 13967168 filed on 08/14/2013

as the term of any patent granted on said reference application may be shortened by any terminal disclaimer filed prior to the grant of any patent on the pending reference application. The owner hereby agrees that any patent so granted on the instant application shall be enforceable only for and during such period that it and any patent granted on the reference application are commonly owned. This agreement runs with any patent granted on the instant application and is binding upon the grantee, its successors or assigns.

In making the above disclaimer, the owner does not disclaim the terminal part of any patent granted on the instant application that would extend to the expiration date of the full statutory term of any patent granted on said reference application, "as the term of any patent granted on said reference application may be shortened by any terminal disclaimer filed prior to the grant of any patent on the pending reference application," in the event that any such patent granted on the pending reference application: expires for failure to pay a maintenance fee, is held unenforceable, is found invalid by a court of competent jurisdiction, is statutorily disclaimed in whole or terminally disclaimed under 37 CFR 1.321, has all claims canceled by a reexamination certificate, is reissued, or is in any manner terminated prior to the expiration of its full statutory term as shortened by any terminal disclaimer filed prior to its grant.

- Terminal disclaimer fee under 37 CFR 1.20(d) is included with Electronic Terminal Disclaimer request.
- I certify, in accordance with 37 CFR 1.4(d)(4), that the terminal disclaimer fee under 37 CFR 1.20(d) required for this terminal disclaimer has already been paid in the above-identified application.

- Applicant claims SMALL ENTITY status. See 37 CFR 1.27.
- Applicant is no longer claiming SMALL ENTITY status. See 37 CFR 1.27(g)(2).
- Applicant(s) status remains as SMALL ENTITY.
- Applicant(s) status remains as other than SMALL ENTITY.

I hereby declare that all statements made herein of my own knowledge are true and that all statements made on information and belief are believed to be true; and further that these statements were made with the knowledge that willful false statements and the like so made are punishable by fine or imprisonment, or both, under Section 1001 of Title 18 of the United States Code and that such willful false statements may jeopardize the validity of the application or any patent issued thereon.

THIS PORTION MUST BE COMPLETED BY THE SIGNATORY OR SIGNATORIES

I certify, in accordance with 37 CFR 1.4(d)(4) that I am:

- An attorney or agent registered to practice before the Patent and Trademark Office who is of record in this application  
  
Registration Number 68681
- A sole inventor
- A joint inventor; I certify that I am authorized to sign this submission on behalf of all of the inventors
- A joint inventor; all of whom are signing this request
- The assignee of record of the entire interest that has properly made itself of record pursuant to 37 CFR 3.71

|           |              |
|-----------|--------------|
| Signature | /Laura Wine/ |
| Name      | Laura Wine   |

\*Statement under 37 CFR 3.73(b) is required if terminal disclaimer is signed by the assignee (owner).  
Form PTO/SB/96 may be used for making this certification. See MPEP § 324.

## Electronic Patent Application Fee Transmittal

|   |   |
|---|---|
| <b>Application Number:</b>                  | 13967189  |
| <b>Filing Date:</b>                         | 14-Aug-2013   |
| <b>Title of Invention:</b>                  | METHODS OF PROVIDING THERAPEUTIC EFFECTS USING CYCLOSPORIN COMPONENTS |
| <b>First Named Inventor/Applicant Name:</b> | Andrew Acheampong   |
| <b>Filer:</b>                               | Laura Lee Wine/Lauren Barberena                                       |
| <b>Attorney Docket Number:</b>              | 17618CON2B (AP)   |

Filed as Large Entity

### Utility under 35 USC 111(a) Filing Fees

| Description                      | Fee Code | Quantity | Amount | Sub-Total in USD(\$) |
|----------------------------------|----------|----------|--------|----------------------|
| <b>Basic Filing:</b>             |          |          |        |                      |
| Statutory or Terminal Disclaimer | 1814     | 1        | 160    | 160                  |

**Pages:**

**Claims:**

**Miscellaneous-Filing:**

**Petition:**

**Patent-Appeals-and-Interference:**

**Post-Allowance-and-Post-Issuance:**

**Extension-of-Time:**

| Description              | Fee Code | Quantity | Amount | Sub-Total in USD(\$) |
|--------------------------|----------|----------|--------|----------------------|
| <b>Miscellaneous:</b>    |          |          |        |                      |
| <b>Total in USD (\$)</b> |          |          |        | <b>160</b>           |

Doc Code: DISQ.E.FILE

Document Description: Electronic Terminal Disclaimer – Approved

Application No.: 13967189

Filing Date: 14-Aug-2013

Applicant/Patent under Reexamination: Acheampong et al.

Electronic Terminal Disclaimer filed on October 7, 2013

APPROVED

**This patent is subject to a terminal disclaimer**

DISAPPROVED

Approved/Disapproved by: Electronic Terminal Disclaimer automatically approved by EFS-Web

U.S. Patent and Trademark Office

## Electronic Acknowledgement Receipt

|   |   |
|---|---|
| <b>EFS ID:</b>                              | 17062246  |
| <b>Application Number:</b>                  | 13967189  |
| <b>International Application Number:</b>    |   |
| <b>Confirmation Number:</b>                 | 4818  |
| <b>Title of Invention:</b>                  | METHODS OF PROVIDING THERAPEUTIC EFFECTS USING CYCLOSPORIN COMPONENTS |
| <b>First Named Inventor/Applicant Name:</b> | Andrew Acheampong   |
| <b>Customer Number:</b>                     | 51957   |
| <b>Filer:</b>                               | Laura Lee Wine/Lauren Barberena                                       |
| <b>Filer Authorized By:</b>                 | Laura Lee Wine  |
| <b>Attorney Docket Number:</b>              | 17618CON2B (AP)   |
| <b>Receipt Date:</b>                        | 07-OCT-2013   |
| <b>Filing Date:</b>                         | 14-AUG-2013   |
| <b>Time Stamp:</b>                          | 19:23:13  |
| <b>Application Type:</b>                    | Utility under 35 USC 111(a)   |

### Payment information:

|  |                 |
|--|-----------------|
| Submitted with Payment                   | yes             |
| Payment Type                             | Deposit Account |
| Payment was successfully received in RAM | \$160           |
| RAM confirmation Number                  | 5853            |
| Deposit Account                          | 010885          |
| Authorized User                          |                 |

The Director of the USPTO is hereby authorized to charge indicated fees and credit any overpayment as follows:

Charge any Additional Fees required under 37 C.F.R. Section 1.17 (Patent application and reexamination processing fees)

Charge any Additional Fees required under 37 C.F.R. Section 1.21 (Miscellaneous fees and charges)



**File Listing:**

| Document Number | Document Description                 | File Name                | File Size(Bytes)/<br>Message Digest               | Multi Part /.zip | Pages (if appl.) |
|-----------------|--------------------------------------|--------------------------|---|------------------|------------------|
| 1               | Electronic Terminal Disclaimer-Filed | eTerminal-Disclaimer.pdf | 39377<br>e57b54e68b01cc1fb6a28b7b31bc520e3843ed09 | no               | 3                |

**Warnings:****Information:**

|   |                      |              |   |    |   |
|---|----------------------|--------------|---|----|---|
| 2 | Fee Worksheet (SB06) | fee-info.pdf | 30732<br>1d7282f4dae13a260a3de13ebef3eae1729695a1 | no | 2 |
|---|----------------------|--------------|---|----|---|

**Warnings:****Information:**

|                                     |       |
|-------------------------------------|-------|
| <b>Total Files Size (in bytes):</b> | 70109 |
|-------------------------------------|-------|

This Acknowledgement Receipt evidences receipt on the noted date by the USPTO of the indicated documents, characterized by the applicant, and including page counts, where applicable. It serves as evidence of receipt similar to a Post Card, as described in MPEP 503.

**New Applications Under 35 U.S.C. 111**

If a new application is being filed and the application includes the necessary components for a filing date (see 37 CFR 1.53(b)-(d) and MPEP 506), a Filing Receipt (37 CFR 1.54) will be issued in due course and the date shown on this Acknowledgement Receipt will establish the filing date of the application.

**National Stage of an International Application under 35 U.S.C. 371**

If a timely submission to enter the national stage of an international application is compliant with the conditions of 35 U.S.C. 371 and other applicable requirements a Form PCT/DO/EO/903 indicating acceptance of the application as a national stage submission under 35 U.S.C. 371 will be issued in addition to the Filing Receipt, in due course.

**New International Application Filed with the USPTO as a Receiving Office**

If a new international application is being filed and the international application includes the necessary components for an international filing date (see PCT Article 11 and MPEP 1810), a Notification of the International Application Number and of the International Filing Date (Form PCT/RO/105) will be issued in due course, subject to prescriptions concerning national security, and the date shown on this Acknowledgement Receipt will establish the international filing date of the application.



UNITED STATES PATENT AND TRADEMARK OFFICE

UNITED STATES DEPARTMENT OF COMMERCE
United States Patent and Trademark Office
Address: COMMISSIONER FOR PATENTS
P.O. Box 1450
Alexandria, Virginia 22313-1450
www.uspto.gov

Table with 5 columns: APPLICATION NO., FILING DATE, FIRST NAMED INVENTOR, ATTORNEY DOCKET NO., CONFIRMATION NO.
Row 1: 13/967,189, 08/14/2013, Andrew Acheampong, 17618CON2B (AP), 4818
Row 2: 51957, 7590, 10/10/2013, ALLERGAN, INC., 2525 DUPONT DRIVE, T2-7H, IRVINE, CA 92612-1599
Row 3: EXAMINER, CORDERO GARCIA, MARCELA M
Row 4: ART UNIT, PAPER NUMBER, 1658
Row 5: NOTIFICATION DATE, DELIVERY MODE, 10/10/2013, ELECTRONIC

Please find below and/or attached an Office communication concerning this application or proceeding.

The time period for reply, if any, is set in the attached communication.

Notice of the Office communication was sent electronically on above-indicated "Notification Date" to the following e-mail address(es):

patents\_ip@allergan.com
pair\_allergan@firsttofile.com

|   |   |  |  |
|---|---|--|--|
| <b><i>Applicant-Initiated Interview Summary</i></b> | <b>Application No.</b><br>13/967,189            | <b>Applicant(s)</b><br>ACHEAMPONG ET AL. |  |
|   | <b>Examiner</b><br>MARCELA M. CORDERO<br>GARCIA | <b>Art Unit</b><br>1658                  |  |

All participants (applicant, applicant's representative, PTO personnel):

- (1) MARCELA M. CORDERO GARCIA. (3) \_\_\_\_\_.
- (2) LAURA WINE. (4) \_\_\_\_\_.

Date of Interview: 27 September 2013.

Type:  Telephonic  Video Conference  
 Personal [copy given to:  applicant  applicant's representative]

Exhibit shown or demonstration conducted:  Yes  No.  
If Yes, brief description: \_\_\_\_\_.

Issues Discussed 101 112 102 103 Others  
(For each of the checked box(es) above, please describe below the issue and detailed description of the discussion)

Claim(s) discussed: 37 and 59.

Identification of prior art discussed: Ding et al. (US 5,474,979).

**Substance of Interview**

(For each issue discussed, provide a detailed description and indicate if agreement was reached. Some topics may include: identification or clarification of a reference or a portion thereof, claim interpretation, proposed amendments, arguments of any applied references etc...)

See Continuation Sheet.

**Applicant recordation instructions:** The formal written reply to the last Office action must include the substance of the interview. (See MPEP section 713.04). If a reply to the last Office action has already been filed, applicant is given a non-extendable period of the longer of one month or thirty days from this interview date, or the mailing date of this interview summary form, whichever is later, to file a statement of the substance of the interview

**Examiner recordation instructions:** Examiners must summarize the substance of any interview of record. A complete and proper recordation of the substance of an interview should include the items listed in MPEP 713.04 for complete and proper recordation including the identification of the general thrust of each argument or issue discussed, a general indication of any other pertinent matters discussed regarding patentability and the general results or outcome of the interview, to include an indication as to whether or not agreement was reached on the issues raised.

Attachment

## Summary of Record of Interview Requirements

### Manual of Patent Examining Procedure (MPEP), Section 713.04, Substance of Interview Must be Made of Record

A complete written statement as to the substance of any face-to-face, video conference, or telephone interview with regard to an application must be made of record in the application whether or not an agreement with the examiner was reached at the interview.

### Title 37 Code of Federal Regulations (CFR) § 1.133 Interviews

Paragraph (b)

In every instance where reconsideration is requested in view of an interview with an examiner, a complete written statement of the reasons presented at the interview as warranting favorable action must be filed by the applicant. An interview does not remove the necessity for reply to Office action as specified in §§ 1.111, 1.135. (35 U.S.C. 132)

37 CFR §1.2 Business to be transacted in writing.

All business with the Patent or Trademark Office should be transacted in writing. The personal attendance of applicants or their attorneys or agents at the Patent and Trademark Office is unnecessary. The action of the Patent and Trademark Office will be based exclusively on the written record in the Office. No attention will be paid to any alleged oral promise, stipulation, or understanding in relation to which there is disagreement or doubt.

The action of the Patent and Trademark Office cannot be based exclusively on the written record in the Office if that record is itself incomplete through the failure to record the substance of interviews.

It is the responsibility of the applicant or the attorney or agent to make the substance of an interview of record in the application file, unless the examiner indicates he or she will do so. It is the examiner's responsibility to see that such a record is made and to correct material inaccuracies which bear directly on the question of patentability.

Examiners must complete an Interview Summary Form for each interview held where a matter of substance has been discussed during the interview by checking the appropriate boxes and filling in the blanks. Discussions regarding only procedural matters, directed solely to restriction requirements for which interview recordation is otherwise provided for in Section 812.01 of the Manual of Patent Examining Procedure, or pointing out typographical errors or unreadable script in Office actions or the like, are excluded from the interview recordation procedures below. Where the substance of an interview is completely recorded in an Examiners Amendment, no separate Interview Summary Record is required.

The Interview Summary Form shall be given an appropriate Paper No., placed in the right hand portion of the file, and listed on the "Contents" section of the file wrapper. In a personal interview, a duplicate of the Form is given to the applicant (or attorney or agent) at the conclusion of the interview. In the case of a telephone or video-conference interview, the copy is mailed to the applicant's correspondence address either with or prior to the next official communication. If additional correspondence from the examiner is not likely before an allowance or if other circumstances dictate, the Form should be mailed promptly after the interview rather than with the next official communication.

The Form provides for recordation of the following information:

- Application Number (Series Code and Serial Number)
- Name of applicant
- Name of examiner
- Date of interview
- Type of interview (telephonic, video-conference, or personal)
- Name of participant(s) (applicant, attorney or agent, examiner, other PTO personnel, etc.)
- An indication whether or not an exhibit was shown or a demonstration conducted
- An identification of the specific prior art discussed
- An indication whether an agreement was reached and if so, a description of the general nature of the agreement (may be by attachment of a copy of amendments or claims agreed as being allowable). Note: Agreement as to allowability is tentative and does not restrict further action by the examiner to the contrary.
- The signature of the examiner who conducted the interview (if Form is not an attachment to a signed Office action)

It is desirable that the examiner orally remind the applicant of his or her obligation to record the substance of the interview of each case. It should be noted, however, that the Interview Summary Form will not normally be considered a complete and proper recordation of the interview unless it includes, or is supplemented by the applicant or the examiner to include, all of the applicable items required below concerning the substance of the interview.

A complete and proper recordation of the substance of any interview should include at least the following applicable items:

- 1) A brief description of the nature of any exhibit shown or any demonstration conducted,
- 2) an identification of the claims discussed,
- 3) an identification of the specific prior art discussed,
- 4) an identification of the principal proposed amendments of a substantive nature discussed, unless these are already described on the Interview Summary Form completed by the Examiner,
- 5) a brief identification of the general thrust of the principal arguments presented to the examiner,  
(The identification of arguments need not be lengthy or elaborate. A verbatim or highly detailed description of the arguments is not required. The identification of the arguments is sufficient if the general nature or thrust of the principal arguments made to the examiner can be understood in the context of the application file. Of course, the applicant may desire to emphasize and fully describe those arguments which he or she feels were or might be persuasive to the examiner.)
- 6) a general indication of any other pertinent matters discussed, and
- 7) if appropriate, the general results or outcome of the interview unless already described in the Interview Summary Form completed by the examiner.

Examiners are expected to carefully review the applicant's record of the substance of an interview. If the record is not complete and accurate, the examiner will give the applicant an extendable one month time period to correct the record.

### Examiner to Check for Accuracy

If the claims are allowable for other reasons of record, the examiner should send a letter setting forth the examiner's version of the statement attributed to him or her. If the record is complete and accurate, the examiner should place the indication, "Interview Record OK" on the paper recording the substance of the interview along with the date and the examiner's initials.

Continuation of Substance of Interview including description of the general nature of what was agreed to if an agreement was reached, or any other comments: Applicants' representative contacted Examiner to request an in-person interview to discuss the case and also indicated that Applicants would be willing to amend the trademark Pemulen in the claims for acrylate/C10-30 alkyl acrylate cross-polymer (see attachment). This potential amendment was not deemed sufficient to make the claims allowable. During the in-person interview on 10/3/2013 the following attendees were present: Laura Wine, Debra Condino, Dr. Rhett Schiffman, Dr. Maysa Attar and Examiner Cordero Garcia. Applicant's representatives described the backroung of dry eye disease, the process of arriving at the claimed invention and discussed: a) unexpected results, b) commercial success and c) long felt need. Further, the Ding et al. patent (US 5,474,979) was discussed with regards to its contents and relation to the claimed invention. With regards to the presented unexpected results, Examiner indicated that it would be necessary to include in a 37 CFR 1.32 declaration all the experimental conditions for the various clinical trials used in the 'unexpected results' evidence, in order to determine whether these clinical trials can be effectively used in the comparison of therapeutic effects of the cyclosporin compositions of Ding et al. with the claimed invention. Examiner also indicated that a first Office Action on the merits would be provided shortly after the interview since the proposed amendment would not obviate all rejections deemed necessary (see attached Office Action) and also briefly discussed potential statutory and non-statutory double patenting issues for the instant application. A courtesy draft of the Office Action was provided to Applicants' representatives.

|                              |   |  |  |
|------------------------------|---|--|--|
| <b>Office Action Summary</b> | <b>Application No.</b><br>13/967,189            | <b>Applicant(s)</b><br>ACHEAMPONG ET AL. |  |
|                              | <b>Examiner</b><br>MARCELA M. CORDERO<br>GARCIA | <b>Art Unit</b><br>1658                  | <b>AIA (First Inventor to File) Status</b><br>No |

-- The MAILING DATE of this communication appears on the cover sheet with the correspondence address --

**Period for Reply**

A SHORTENED STATUTORY PERIOD FOR REPLY IS SET TO EXPIRE 3 MONTH(S) OR THIRTY (30) DAYS, WHICHEVER IS LONGER, FROM THE MAILING DATE OF THIS COMMUNICATION.

- Extensions of time may be available under the provisions of 37 CFR 1.136(a). In no event, however, may a reply be timely filed after SIX (6) MONTHS from the mailing date of this communication.
- If NO period for reply is specified above, the maximum statutory period will apply and will expire SIX (6) MONTHS from the mailing date of this communication.
- Failure to reply within the set or extended period for reply will, by statute, cause the application to become ABANDONED (35 U.S.C. § 133). Any reply received by the Office later than three months after the mailing date of this communication, even if timely filed, may reduce any earned patent term adjustment. See 37 CFR 1.704(b).

**Status**

- 1)  Responsive to communication(s) filed on 8/14/2013.  
 A declaration(s)/affidavit(s) under **37 CFR 1.130(b)** was/were filed on \_\_\_\_\_.
- 2a)  This action is **FINAL**.                      2b)  This action is non-final.
- 3)  An election was made by the applicant in response to a restriction requirement set forth during the interview on \_\_\_\_\_; the restriction requirement and election have been incorporated into this action.
- 4)  Since this application is in condition for allowance except for formal matters, prosecution as to the merits is closed in accordance with the practice under *Ex parte Quayle*, 1935 C.D. 11, 453 O.G. 213.

**Disposition of Claims**

- 5)  Claim(s) 37-60 is/are pending in the application.  
5a) Of the above claim(s) \_\_\_\_\_ is/are withdrawn from consideration.
- 6)  Claim(s) \_\_\_\_\_ is/are allowed.
- 7)  Claim(s) 37-60 is/are rejected.
- 8)  Claim(s) \_\_\_\_\_ is/are objected to.
- 9)  Claim(s) \_\_\_\_\_ are subject to restriction and/or election requirement.

\* If any claims have been determined allowable, you may be eligible to benefit from the **Patent Prosecution Highway** program at a participating intellectual property office for the corresponding application. For more information, please see [http://www.uspto.gov/patents/init\\_events/pph/index.jsp](http://www.uspto.gov/patents/init_events/pph/index.jsp) or send an inquiry to [PPHfeedback@uspto.gov](mailto:PPHfeedback@uspto.gov).

**Application Papers**

- 10)  The specification is objected to by the Examiner.
- 11)  The drawing(s) filed on \_\_\_\_\_ is/are: a)  accepted or b)  objected to by the Examiner.  
Applicant may not request that any objection to the drawing(s) be held in abeyance. See 37 CFR 1.85(a).  
Replacement drawing sheet(s) including the correction is required if the drawing(s) is objected to. See 37 CFR 1.121(d).

**Priority under 35 U.S.C. § 119**

- 12)  Acknowledgment is made of a claim for foreign priority under 35 U.S.C. § 119(a)-(d) or (f).

**Certified copies:**

- a)  All    b)  Some \*    c)  None of the:
  - 1.  Certified copies of the priority documents have been received.
  - 2.  Certified copies of the priority documents have been received in Application No. \_\_\_\_\_.
  - 3.  Copies of the certified copies of the priority documents have been received in this National Stage application from the International Bureau (PCT Rule 17.2(a)).

\* See the attached detailed Office action for a list of the certified copies not received.

**Attachment(s)**

- 1)  Notice of References Cited (PTO-892)
- 2)  Information Disclosure Statement(s) (PTO/SB/08)  
Paper No(s)/Mail Date 9/4/2013 and 9/25/2013.
- 3)  Interview Summary (PTO-413)  
Paper No(s)/Mail Date 20131004.
- 4)  Other: \_\_\_\_\_.

Art Unit: 1658

### **DETAILED ACTION**

1. The present application is being examined under the pre-AIA first to invent provisions.

#### ***Status of the claims***

2. Claims 37-60 are pending in the application. Claims 37-60 are presented for examination on the merits.

#### ***Claim Rejections - 35 USC § 112***

The following is a quotation of 35 U.S.C. 112(a):

(a) IN GENERAL.—The specification shall contain a written description of the invention, and of the manner and process of making and using it, in such full, clear, concise, and exact terms as to enable any person skilled in the art to which it pertains, or with which it is most nearly connected, to make and use the same, and shall set forth the best mode contemplated by the inventor or joint inventor of carrying out the invention.

The following is a quotation of 35 U.S.C. 112 (pre-AIA), first paragraph:

The specification shall contain a written description of the invention, and of the manner and process of making and using it, in such full, clear, concise, and exact terms as to enable any person skilled in the art to which it pertains, or with which it is most nearly connected, to make and use the same and shall set forth the best mode contemplated by the inventor of carrying out his invention.

The following is a quotation of 35 U.S.C. 112(b):

(b) CONCLUSION.—The specification shall conclude with one or more claims particularly pointing out and distinctly claiming the subject matter which the inventor or a joint inventor regards as the invention.

The following is a quotation of 35 U.S.C. 112 (pre-AIA), second paragraph:

The specification shall conclude with one or more claims particularly pointing out and distinctly claiming the subject matter which the applicant regards as his invention.

3. Claim 37, 54 and 59 (and dependent claims thereof, i.e., 38-53, 55-58 and 60) are rejected under 35 U.S.C. 112, second paragraph, as being indefinite for failing to particularly point out and distinctly claim the subject matter which applicant regards as the invention for containing the trademark/trade name Pemulen® . Where a trademark

Art Unit: 1658

or trade name is used in a claim as a limitation to identify or describe a particular material or product, the claim does not comply with the requirements of 35 U.S.C. 112, second paragraph (see MPEP 2173.05 (u)). The claim scope is uncertain since the trademark or trade name cannot be used properly to identify any particular material or product. A trademark or trade name is used to identify a source of goods, and not the goods themselves. Thus, a trademark or trade name does not identify or describe the goods associated with the trademark or trade name. In the present case, the trademark/trade name is used to identify/describe acrylate/C10-30 alkyl acrylate cross-polymers, or high molecular weight co-polymers of acrylic acid and a long chain alkyl methacrylate cross-linked with allyl ethers of pentaerythritol (see paragraph bridging pages 19-20 of the disclosure) and, accordingly, the identification/description is indefinite.

***Claim Rejections - 35 USC § 103***

4. The following is a quotation of 35 U.S.C. 103(a) which forms the basis for all obviousness rejections set forth in this Office action:

(a) A patent may not be obtained though the invention is not identically disclosed or described as set forth in section 102 of this title, if the differences between the subject matter sought to be patented and the prior art are such that the subject matter as a whole would have been obvious at the time the invention was made to a person having ordinary skill in the art to which said subject matter pertains. Patentability shall not be negated by the manner in which the invention was made.

5. Claims 37-60 are rejected under 35 U.S.C. 103(a) as being unpatentable over Ding et al. (US 5,474,979, cited in the IDS dated 12/27/2004).

Ding et al. disclose topical ophthalmic emulsions for treating an eye of human having KCS (dry eye disease):



Art Unit: 1658

| <u>Example 1</u> |         |         |         |         |         |
|------------------|---------|---------|---------|---------|---------|
|                  | A       | B       | C       | D       | E       |
| Cyclosporin A    | 0.40%   | 0.20%   | 0.20%   | 0.10%   | 0.05%   |
| Castor oil       | 5.00%   | 5.00%   | 2.50%   | 1.25%   | 0.625%  |
| Polysorbate 80   | 1.00%   | 1.00%   | 1.00%   | 1.00%   | 1.00%   |
| Pemulen @        | 0.05%   | 0.05%   | 0.05%   | 0.05%   | 0.05%   |
| Glycerine        | 2.20%   | 2.20%   | 2.20%   | 2.20%   | 2.20%   |
| NaOH             | qs      | qs      | qs      | qs      | qs      |
| Purified water   | qs      | qs      | qs      | qs      | qs      |
| pH               | 7.2-7.6 | 7.2-7.6 | 7.2-7.6 | 7.2-7.6 | 7.2-7.6 |

Thus, a comparison of the instantly claimed and some of the Ding et al. embodiments is presented below:

|                | DING et al. 1-D | instant invention | DING et al. 1-E |
|----------------|-----------------|-------------------|-----------------|
| Cyclosporin    | 0.10%           | 0.05%             | 0.05%           |
| Castor oil     | 1.25%           | 1.25%             | 0.625%          |
| Polysorbate 80 | 1.00%           | 1.00%             | 1.00%           |
| Pemulen        | 0.05%           | 0.05%             | 0.05%           |
| Glycerine      | 2.20%           | 2.20%             | 2.20%           |
| NaOH           | qs              | qs                | qs              |
| Purified water | qs              | qs                | qs              |
| pH             | 7.2-7.6         | 7.2-7.6           | 7.2-7.6         |

Furthermore, the claims of Ding et al. disclose ranges for the components (e.g., claims 1-8). For example, Ding et al. discloses a pharmaceutical emulsion comprising

Art Unit: 1658

cyclosporin A, castor oil, Pemulen, glycerine, polysorbate 80, water in amounts sufficient to prevent crystallization of cyclosporin A for a period of up to about nine months, said pharmaceutical emulsion being suitable for topical application to ocular tissue, wherein the cyclosporin A is present in an amount between about 0.05 to and about 0.40%, by weight, the castor oil is present in an amount of between about 0.625%, by weight, and about 5.0%, by weight, the polysorbate 80 is present in an amount of about 1.0%, by weight, the Pemulen is present in an amount of about 0.05%, by weight, and the glycerine is present in an amount of about 2.2%, by weight (e.g., claims 7-8).

The formulations set forth in Examples 1-4 were made for treatment of keratoconjunctivitis sicca (dry eye) syndrome with Examples 2, 3 and 4 without the active ingredient cyclosporin utilized to determine the toxicity of the emulsified components.

Ding et al. teach that the formulations in Examples 1-4 were applied to rabbit eyes eight times a day for seven days and were found to cause only slight to mild discomfort and slight hyperemia in the rabbit eyes. Slit lamp examination revealed no changes in the surface tissue. In addition, the cyclosporin containing castor oil emulsion, as hereinabove set forth in Examples 1A-1D, was also tested for ocular bioavailability in rabbits; and the therapeutic level of cyclosporin was found in the tissues of interest after dosage. Ding et al. go on to teach that this substantiates that cyclosporin in an ophthalmic delivery system is useful for treating dry eye.

One of ordinary skill in the art at the time the invention was made would have been motivated to modify the invention of Ding et al., e.g., Example 1E, by making any composition encompassed by the ranges disclosed in Ding et al. One of ordinary skill in the art at the time the invention was made would have been motivated to do so given the guidance provided by Ding et al., i.e., the amount of castor oil in the emulsions is taught to be cyclosporin to castor oil is between 0.12 and 0.02, which, for 0.05% corresponds to 0.4% to 2.5% of castor oil (which encompasses 1.25%). See, e.g., col. 3. One of ordinary skill in the art, at the time the invention was made, would have had a reasonable expectation of success for doing so because 1.25% was known to be non-irritating as shown in Example 1D, because such modifications are routinely determined and optimized in the art through routine experimentation [see MPEP 2144.05 (I) regarding optimization of ranges] and because the active ingredients, cyclosporin A and castor oil were present at overlapping concentrations between the instant invention and the invention of Ding et al. [see MPEP 2144.05 (I) regarding overlapping ranges]. Moreover, differences in concentration or temperature will not support the patentability of subject matter encompassed by the prior art unless there is evidence indicating such concentration or temperature is critical [see MPEP 2144.05 (II)]. Furthermore, to establish **unexpected results** over a claimed range, applicants should compare a sufficient number of tests both inside and outside the claimed range to show the criticality of the claimed range (MPEP 716.02).

Claim scope is not limited by claim language that suggests or makes optional but does not require steps to be performed, or by claim language that does not limit a claim

Art Unit: 1658

to a particular structure. However, examples of claim language, although not exhaustive, that may raise a question as to the limiting effect of the language in a claim are:

- (A) “adapted to” or “adapted for” clauses;
- (B) “wherein” clauses; and
- (C) “whereby” clauses.

The determination of whether each of these clauses is a limitation in a claim depends on the specific facts of the case. In the instant case, the limitations “, [...] the blood of the human has substantially no detectable concentration of cyclosporin A”, “wherein the emulsion breaks down more quickly in the eye of a human, once administered to the eye of the human, thereby reducing vision distortion in the eye of the human as compare to an emulsion that contains only 50% as much castor oil”, “wherein the ophthalmic emulsion, when administered to the eye of a human, demonstrates a reduction in adverse events in the human” and “wherein the adverse events include side effects”; it is noted that such functional effects would necessarily flow from the compositions of Ding et al. which comprise all the claimed components and amounts as set forth above.

From the teaching of the reference, it is apparent that one of ordinary skill in the art would have had a reasonable expectation of success in producing the claimed invention. Therefore, the invention as a whole was prima facie obvious to one of ordinary skill in the art at the time the invention was made, as evidenced by the references, especially in the absence of evidence to the contrary.

### ***Double Patenting***

6. The nonstatutory double patenting rejection is based on a judicially created doctrine grounded in public policy (a policy reflected in the statute) so as to prevent the unjustified or improper timewise extension of the “right to exclude” granted by a patent and to prevent possible harassment by multiple assignees. A nonstatutory double patenting rejection is appropriate where the claims at issue are not identical, but at least one examined application claim is not patentably distinct from the reference claim(s) because the examined application claim is either anticipated by, or would have been obvious over, the reference claim(s). See, e.g., *In re Berg*, 140 F.3d 1428, 46 USPQ2d 1226 (Fed. Cir. 1998); *In re Goodman*, 11 F.3d 1046, 29 USPQ2d 2010 (Fed. Cir. 1993); *In re Longi*, 759 F.2d 887, 225 USPQ 645 (Fed. Cir. 1985); *In re Van Ornum*, 686 F.2d 937, 214 USPQ 761 (CCPA 1982); *In re Vogel*, 422 F.2d 438, 164 USPQ 619 (CCPA 1970); and *In re Thorington*, 418 F.2d 528, 163 USPQ 644 (CCPA 1969).

A timely filed terminal disclaimer in compliance with 37 CFR 1.321(c) or 1.321(d) may be used to overcome an actual or provisional rejection based on a nonstatutory double patenting ground provided the reference application or patent either is shown to be commonly owned with this application, or claims an invention made as a result of activities undertaken within the scope of a joint research agreement. A terminal disclaimer must be signed in compliance with 37 CFR 1.321(b).

The USPTO internet Web site contains terminal disclaimer forms which may be used. Please visit <http://www.uspto.gov/forms/>. The filing date of the application will determine what form should be used. A web-based eTerminal Disclaimer may be filled

Art Unit: 1658

out completely online using web-screens. An eTerminal Disclaimer that meets all requirements is auto-processed and approved immediately upon submission. For more information about eTerminal Disclaimers, refer to <http://www.uspto.gov/patents/process/file/efs/guidance/eTD-info-l.jsp>.

7. Claims 37-60 are rejected on the ground of nonstatutory obviousness-type double patenting as being unpatentable over claims 1-8 of U.S. Patent No. 5,474,979. Although the conflicting claims are not identical, they are not patentably distinct from each other because Ding et al. (US 5,474,979) claims pharmaceutical emulsions comprising of cyclosporine A, castor oil, Pemulen ® (crosslinked polyacrylate stabilizer), glycerine and water as instantly claimed (see claims 6-8 of Ding et al.) for topical application comprising to ocular tissue wherein the cyclosporine A is presents in an amount of between about 0.05 to and about 0.40% by weight (which encompasses about 0.05% cyclosporin A), castor oil from about 0.625% to about 5.0% (which encompasses 1.25% of castor oil), Pemulen ® at about 0.05%, and glycerin at about 2.2%. (see, e.g., claim 8). Additionally, a different emulsifier, i.e., polysorbate 80, is taught at about 1.0% (see also claim 8). The emulsion contains water as set forth in claims 6-8 of Ding et al.

Furthermore, the instant specification was used to determine what is encompassed in the compositions claimed by Ding et al. and examination of Examples 1A-E shows that composition 1E comprises all the components and ranges instantly claimed except for the castor oil, which is encompassed by the claimed ranges to cyclosporin to castor oil.

Art Unit: 1658

One of ordinary skill in the art at the time the invention was made would have been motivated to modify the invention of Ding et al. by making any compositions encompassed by the ranges taught by Ding et al. One of ordinary skill in the art would have been motivated to do so in order to create nonirritating emulsions of cyclosporin suitable for topical application to ocular tissue. One of ordinary skill in the art, at the time the invention was made, would have had a reasonable expectation of success for doing so because such modifications are routinely determined and optimized in the art through routine experimentation [see MPEP 2144.05 (I) regarding optimization of ranges] and because the active ingredients, cyclosporin A and castor oil were present at overlapping concentrations between the instant invention and the invention of Ding et al. [see MPEP 2144.05 (I) regarding overlapping ranges]. Moreover, differences in concentration or temperature will not support the patentability of subject matter encompassed by the prior art unless there is evidence indicating such concentration or temperature is critical [see MPEP 2144.05 (II)]. Furthermore, to establish **unexpected results** over a claimed range, applicants should compare a sufficient number of tests both inside and outside the claimed range to show the criticality of the claimed range (MPEP 716.02).

Claim scope is not limited by claim language that suggests or makes optional but does not require steps to be performed, or by claim language that does not limit a claim to a particular structure. However, examples of claim language, although not exhaustive, that may raise a question as to the limiting effect of the language in a claim are:

Art Unit: 1658

- (A) “adapted to” or “adapted for” clauses;
- (B) “wherein” clauses; and
- (C) “whereby” clauses.

The determination of whether each of these clauses is a limitation in a claim depends on the specific facts of the case. In the instant case, the limitations “wherein the topical ophthalmic emulsion is therapeutically effective in treating KCS”, “wherein, when the topical ophthalmic emulsion is administered to an eye of a human, [...] the blood of the human has substantially no detectable concentration of cyclosporin A”, “wherein the emulsion breaks down more quickly in the eye of a human, once administered to the eye of the human, thereby reducing vision distortion in the eye of the human as compare to an emulsion that contains only 50% as much castor oil”, “wherein the ophthalmic emulsion, when administered to the eye of a human, demonstrates a reduction in adverse events in the human” and “wherein the adverse events include side effects”; it is noted that such functional effects would necessarily flow from the compositions claimed and exemplified by Ding et al. which comprise all the claimed components and amounts as set forth above.

From the teaching of the reference, it is apparent that one of ordinary skill in the art would have had a reasonable expectation of success in producing the claimed invention. Therefore, the invention as a whole was prima facie obvious to one of ordinary skill in the art at the time the invention was made, as evidenced by the references, especially in the absence of evidence to the contrary.



Art Unit: 1658

8. Claims 37-60 are provisionally rejected on the ground of nonstatutory double patenting as being unpatentable over claims 37-61 of copending Application No. 13/967,179. Although the claims at issue are not identical, they are not patentably distinct from each other because US '179 is drawn to a method which encompasses the administration of the instantly claimed compositions and thus inherently disclose such compositions, e.g., claim 37 is drawn to a method of treating dry eye disease, the method comprising topically administering to the eye of the human an emulsion at a frequency of twice a day, wherein the emulsion comprises cyclosporin A in an amount of about 0.05% by weight, polysorbate 80, Pemulen, water, and castor oil in an amount of about 1.25% by weight; and wherein the topical ophthalmic emulsion is effective in treating dry eye disease. Thus, it inherently discloses a topical ophthalmic emulsion for treating an eye of a human, wherein the topical ophthalmic emulsion comprises cyclosporin A in an amount of about 0.05% by weight, polysorbate 80, Pemulen, water, and castor oil in an amount of about 1.25% by weight; and wherein the topical ophthalmic emulsion is therapeutically effective in treating dry eye disease (claim 37 of the instant application). The other claims in US '179 are also drawn to the corresponding use of the claimed compositions.

This is a provisional nonstatutory double patenting rejection because the patentably indistinct claims have not in fact been patented.

9. Claims 37-60 are provisionally rejected on the ground of nonstatutory double patenting as being unpatentable over claims 37-61 of copending Application No. 13/961,835. Although the claims at issue are not identical, they are not patentably

Art Unit: 1658

distinct from each other because US '835 is drawn to a method of increasing tear production in the eye of a human, the method comprising topically administering to the eye of the human an emulsion at a frequency of twice a day, wherein the emulsion comprises cyclosporin A in an amount of about 0.05% by weight, polysorbate 80, Pemulen, water, and castor oil in an amount of about 1.25% by weight; and wherein the topical ophthalmic emulsion is effective in increasing tear production.

Thus, it inherently discloses a topical ophthalmic emulsion for treating an eye of a human, wherein the topical ophthalmic emulsion comprises cyclosporin A in an amount of about 0.05% by weight, polysorbate 80, Pemulen, water, and castor oil in an amount of about 1.25% by weight; and wherein the topical ophthalmic emulsion is therapeutically effective in treating dry eye disease (claim 37 of the instant application). The other claims in US '179 are also drawn to the corresponding use of the claimed compositions. Moreover, differences in concentration or temperature will not support the patentability of subject matter encompassed by the prior art unless there is evidence indicating such concentration or temperature is critical [see MPEP 2144.05 (II)]. Furthermore, to establish **unexpected results** over a claimed range, applicants should compare a sufficient number of tests both inside and outside the claimed range to show the criticality of the claimed range (MPEP 716.02).

This is a provisional nonstatutory double patenting rejection because the patentably indistinct claims have not in fact been patented.

10. Claims 37-60 are provisionally rejected on the ground of nonstatutory double patenting as being unpatentable over claims 37-61 of copending Application No.

Art Unit: 1658

13/961,818. Although the claims at issue are not identical, they are not patentably distinct from each other because US '818 is drawn to a method which encompasses the administration of the instantly claimed compositions and thus inherently disclose such compositions, e.g., claim 37 is drawn to a method of treating dry eye disease, the method comprising topically administering to the eye of the human an emulsion at a frequency of twice a day, wherein the emulsion comprises cyclosporin A in an amount of about 0.05% by weight, polysorbate 80, Pemulen, water, and castor oil in an amount of about 1.25% by weight; and wherein the topical ophthalmic emulsion is effective in treating dry eye disease. Thus, it inherently discloses a topical ophthalmic emulsion for treating an eye of a human, wherein the topical ophthalmic emulsion comprises cyclosporin A in an amount of about 0.05% by weight, polysorbate 80, Pemulen, water, and castor oil in an amount of about 1.25% by weight; and wherein the topical ophthalmic emulsion is therapeutically effective in treating dry eye disease (claim 37 of the instant application). The other claims in US '818 are also drawn to the corresponding use of the claimed compositions. Moreover, differences in concentration or temperature will not support the patentability of subject matter encompassed by the prior art unless there is evidence indicating such concentration or temperature is critical [see MPEP 2144.05 (II)]. Furthermore, to establish **unexpected results** over a claimed range, applicants should compare a sufficient number of tests both inside and outside the claimed range to show the criticality of the claimed range (MPEP 716.02).

This is a provisional nonstatutory double patenting rejection because the patentably indistinct claims have not in fact been patented.

Art Unit: 1658

11. Claims 37-60 are provisionally rejected on the ground of nonstatutory double patenting as being unpatentable over claims 37-61 of copending Application No. 13/961,835. Although the claims at issue are not identical, they are not patentably distinct from each other because US '835 is drawn to a method of increasing tear production in the eye of a human, the method comprising topically administering to the eye of the human an emulsion at a frequency of twice a day, wherein the emulsion comprises cyclosporin A in an amount of about 0.05% by weight, polysorbate 80, Pemulen, water, and castor oil in an amount of about 1.25% by weight; and wherein the topical ophthalmic emulsion is effective in increasing tear production.

Thus, it inherently discloses a topical ophthalmic emulsion for treating an eye of a human, wherein the topical ophthalmic emulsion comprises cyclosporin A in an amount of about 0.05% by weight, polysorbate 80, Pemulen, water, and castor oil in an amount of about 1.25% by weight; and wherein the topical ophthalmic emulsion is therapeutically effective in treating dry eye disease (claim 37 of the instant application). The other claims in US '179 are also drawn to the corresponding use of the claimed compositions. Moreover, differences in concentration or temperature will not support the patentability of subject matter encompassed by the prior art unless there is evidence indicating such concentration or temperature is critical [see MPEP 2144.05 (II)]. Furthermore, to establish **unexpected results** over a claimed range, applicants should compare a sufficient number of tests both inside and outside the claimed range to show the criticality of the claimed range (MPEP 716.02).

This is a provisional nonstatutory double patenting rejection because the patentably indistinct claims have not in fact been patented.

***Statutory double patenting***

12. A rejection based on double patenting of the “same invention” type finds its support in the language of 35 U.S.C. 101 which states that “whoever invents or discovers any new and useful process... may obtain a patent therefor...” (Emphasis added). Thus, the term “same invention,” in this context, means an invention drawn to identical subject matter. See *Miller v. Eagle Mfg. Co.*, 151 U.S. 186 (1894); *In re Vogel*, 422 F.2d 438, 164 USPQ 619 (CCPA 1970); and *In re Ockert*, 245 F.2d 467, 114 USPQ 330 (CCPA 1957).

A statutory type (35 U.S.C. 101) double patenting rejection can be overcome by canceling or amending the claims that are directed to the same invention so they are no longer coextensive in scope. The filing of a terminal disclaimer cannot overcome a double patenting rejection based upon 35 U.S.C. 101.

13. Claims 37-60 are provisionally rejected under 35 U.S.C. 101 as claiming the same invention as that of claims 37-60 of copending Application No. 13/961,808. This is a provisional statutory double patenting rejection since the claims directed to the same invention have not in fact been patented.

The claims are identical to each other, i.e., claim 37 in both applications is drawn to a topical ophthalmic emulsion for treating an eye of a human, wherein the topical ophthalmic emulsion comprises cyclosporin A in an amount of about 0.05% by weight, polysorbate 80, Pemulen, water, and castor oil in an amount of about 1.25% by

Art Unit: 1658

weight; and wherein the topical ophthalmic emulsion is therapeutically effective in treating dry eye disease.

The other claims (38-56, 58-61 in the instant application and 38-60 in US '808) are also identical.

14. Claims 37-60 are provisionally rejected under 35 U.S.C. 101 as claiming the same invention as that of claims 37-56, 58-61 of copending Application No. 13/967,163. This is a provisional statutory double patenting rejection since the claims directed to the same invention have not in fact been patented.

The claims are identical too each other, i.e., claim 37 in both applications is drawn to a topical ophthalmic emulsion for treating an eye of a human, wherein the topical ophthalmic emulsion comprises cyclosporin A in an amount of about 0.05% by weight, polysorbate 80, Pemulen, water, and castor oil in an amount of about 1.25% by weight; and wherein the topical ophthalmic emulsion is therapeutically effective in treating dry eye disease.

The other claims (38-56, 58-61 in the instant application and 38-60 in US '808) are also identical.

15. Claims 37-60 are provisionally rejected under 35 U.S.C. 101 as claiming the same invention as that of claims 37-56, 58-61 of copending Application No. 13/961,828. This is a provisional statutory double patenting rejection since the claims directed to the same invention have not in fact been patented.

The claims are identical too each other, i.e., claim 37 in both applications is drawn to a topical ophthalmic emulsion for treating an eye of a human, wherein the

Art Unit: 1658

topical ophthalmic emulsion comprises cyclosporin A in an amount of about 0.05% by weight, polysorbate 80, Pemulen, water, and castor oil in an amount of about 1.25% by weight; and wherein the topical ophthalmic emulsion is therapeutically effective in treating dry eye disease.

The other claims (38-61 in the instant application and 38-61 in US '828) are also identical.

### ***Conclusion***

16. No claim is currently allowed.

The prior art made of record and not relied upon is considered pertinent to applicant's disclosure.

17. Any inquiry concerning this communication or earlier communications from the examiner should be directed to MARCELA M. CORDERO GARCIA whose telephone number is (571)272-2939. The examiner can normally be reached on M-F 8:30-5:00.

If attempts to reach the examiner by telephone are unsuccessful, the examiner's supervisor, Karlheinz R. Skowronek can be reached on (571)-272-9047. The fax phone number for the organization where this application or proceeding is assigned is 571-273-8300.

Information regarding the status of an application may be obtained from the Patent Application Information Retrieval (PAIR) system. Status information for published applications may be obtained from either Private PAIR or Public PAIR. Status information for unpublished applications is available through Private PAIR only. For more information about the PAIR system, see <http://pair-direct.uspto.gov>. Should

Art Unit: 1658

you have questions on access to the Private PAIR system, contact the Electronic Business Center (EBC) at 866-217-9197 (toll-free). If you would like assistance from a USPTO Customer Service Representative or access to the automated information system, call 800-786-9199 (IN USA OR CANADA) or 571-272-1000.

/MARCELA M CORDERO GARCIA/  
Primary Examiner, Art Unit 1658

MMCG 10/2013



|   |   |  |  |
|---|---|--|--|
| <b><i>Applicant-Initiated Interview Summary</i></b> | <b>Application No.</b><br>13/967,189            | <b>Applicant(s)</b><br>ACHEAMPONG ET AL. |  |
|   | <b>Examiner</b><br>MARCELA M. CORDERO<br>GARCIA | <b>Art Unit</b><br>1658                  |  |

All participants (applicant, applicant's representative, PTO personnel):

(1) MARCELA M. CORDERO GARCIA. (3)\_\_\_\_\_.

(2) LAURA WINE. (4)\_\_\_\_\_.

Date of Interview: 27 September 2013.

Type:  Telephonic  Video Conference  
 Personal [copy given to:  applicant  applicant's representative]

Exhibit shown or demonstration conducted:  Yes  No.  
If Yes, brief description: \_\_\_\_\_.

Issues Discussed 101 112 102 103 Others  
(For each of the checked box(es) above, please describe below the issue and detailed description of the discussion)

Claim(s) discussed: 37 and 59.

Identification of prior art discussed: Ding et al. (US 5,474,979).

**Substance of Interview**

(For each issue discussed, provide a detailed description and indicate if agreement was reached. Some topics may include: identification or clarification of a reference or a portion thereof, claim interpretation, proposed amendments, arguments of any applied references etc...)

See Continuation Sheet.

**Applicant recordation instructions:** The formal written reply to the last Office action must include the substance of the interview. (See MPEP section 713.04). If a reply to the last Office action has already been filed, applicant is given a non-extendable period of the longer of one month or thirty days from this interview date, or the mailing date of this interview summary form, whichever is later, to file a statement of the substance of the interview

**Examiner recordation instructions:** Examiners must summarize the substance of any interview of record. A complete and proper recordation of the substance of an interview should include the items listed in MPEP 713.04 for complete and proper recordation including the identification of the general thrust of each argument or issue discussed, a general indication of any other pertinent matters discussed regarding patentability and the general results or outcome of the interview, to include an indication as to whether or not agreement was reached on the issues raised.

Attachment

## Summary of Record of Interview Requirements

### Manual of Patent Examining Procedure (MPEP), Section 713.04, Substance of Interview Must be Made of Record

A complete written statement as to the substance of any face-to-face, video conference, or telephone interview with regard to an application must be made of record in the application whether or not an agreement with the examiner was reached at the interview.

### Title 37 Code of Federal Regulations (CFR) § 1.133 Interviews

Paragraph (b)

In every instance where reconsideration is requested in view of an interview with an examiner, a complete written statement of the reasons presented at the interview as warranting favorable action must be filed by the applicant. An interview does not remove the necessity for reply to Office action as specified in §§ 1.111, 1.135. (35 U.S.C. 132)

37 CFR §1.2 Business to be transacted in writing.

All business with the Patent or Trademark Office should be transacted in writing. The personal attendance of applicants or their attorneys or agents at the Patent and Trademark Office is unnecessary. The action of the Patent and Trademark Office will be based exclusively on the written record in the Office. No attention will be paid to any alleged oral promise, stipulation, or understanding in relation to which there is disagreement or doubt.

The action of the Patent and Trademark Office cannot be based exclusively on the written record in the Office if that record is itself incomplete through the failure to record the substance of interviews.

It is the responsibility of the applicant or the attorney or agent to make the substance of an interview of record in the application file, unless the examiner indicates he or she will do so. It is the examiner's responsibility to see that such a record is made and to correct material inaccuracies which bear directly on the question of patentability.

Examiners must complete an Interview Summary Form for each interview held where a matter of substance has been discussed during the interview by checking the appropriate boxes and filling in the blanks. Discussions regarding only procedural matters, directed solely to restriction requirements for which interview recordation is otherwise provided for in Section 812.01 of the Manual of Patent Examining Procedure, or pointing out typographical errors or unreadable script in Office actions or the like, are excluded from the interview recordation procedures below. Where the substance of an interview is completely recorded in an Examiners Amendment, no separate Interview Summary Record is required.

The Interview Summary Form shall be given an appropriate Paper No., placed in the right hand portion of the file, and listed on the "Contents" section of the file wrapper. In a personal interview, a duplicate of the Form is given to the applicant (or attorney or agent) at the conclusion of the interview. In the case of a telephone or video-conference interview, the copy is mailed to the applicant's correspondence address either with or prior to the next official communication. If additional correspondence from the examiner is not likely before an allowance or if other circumstances dictate, the Form should be mailed promptly after the interview rather than with the next official communication.

The Form provides for recordation of the following information:

- Application Number (Series Code and Serial Number)
- Name of applicant
- Name of examiner
- Date of interview
- Type of interview (telephonic, video-conference, or personal)
- Name of participant(s) (applicant, attorney or agent, examiner, other PTO personnel, etc.)
- An indication whether or not an exhibit was shown or a demonstration conducted
- An identification of the specific prior art discussed
- An indication whether an agreement was reached and if so, a description of the general nature of the agreement (may be by attachment of a copy of amendments or claims agreed as being allowable). Note: Agreement as to allowability is tentative and does not restrict further action by the examiner to the contrary.
- The signature of the examiner who conducted the interview (if Form is not an attachment to a signed Office action)

It is desirable that the examiner orally remind the applicant of his or her obligation to record the substance of the interview of each case. It should be noted, however, that the Interview Summary Form will not normally be considered a complete and proper recordation of the interview unless it includes, or is supplemented by the applicant or the examiner to include, all of the applicable items required below concerning the substance of the interview.

A complete and proper recordation of the substance of any interview should include at least the following applicable items:

- 1) A brief description of the nature of any exhibit shown or any demonstration conducted,
- 2) an identification of the claims discussed,
- 3) an identification of the specific prior art discussed,
- 4) an identification of the principal proposed amendments of a substantive nature discussed, unless these are already described on the Interview Summary Form completed by the Examiner,
- 5) a brief identification of the general thrust of the principal arguments presented to the examiner,  
(The identification of arguments need not be lengthy or elaborate. A verbatim or highly detailed description of the arguments is not required. The identification of the arguments is sufficient if the general nature or thrust of the principal arguments made to the examiner can be understood in the context of the application file. Of course, the applicant may desire to emphasize and fully describe those arguments which he or she feels were or might be persuasive to the examiner.)
- 6) a general indication of any other pertinent matters discussed, and
- 7) if appropriate, the general results or outcome of the interview unless already described in the Interview Summary Form completed by the examiner.

Examiners are expected to carefully review the applicant's record of the substance of an interview. If the record is not complete and accurate, the examiner will give the applicant an extendable one month time period to correct the record.

### Examiner to Check for Accuracy

If the claims are allowable for other reasons of record, the examiner should send a letter setting forth the examiner's version of the statement attributed to him or her. If the record is complete and accurate, the examiner should place the indication, "Interview Record OK" on the paper recording the substance of the interview along with the date and the examiner's initials.

Continuation of Substance of Interview including description of the general nature of what was agreed to if an agreement was reached, or any other comments: Applicants' representative contacted Examiner to request an in-person interview to discuss the case and also indicated that Applicants would be willing to amend the trademark Pemulen in the claims for acrylate/C10-30 alkyl acrylate cross-polymer (see attachment). This potential amendment was not deemed sufficient to make the claims allowable. During the in-person interview on 10/3/2013 the following attendees were present: Laura Wine, Debra Condino, Dr. Rhett Schiffman, Dr. Maysa Attar and Examiner Cordero Garcia. Applicant's representatives described the backroung of dry eye disease, the process of arriving at the claimed invention and discussed: a) unexpected results, b) commercial success and c) long felt need. Further, the Ding et al. patent (US 5,474,979) was discussed with regards to its contents and relation to the claimed invention. With regards to the presented unexpected results, Examiner indicated that it would be necessary to include in a 37 CFR 1.32 declaration all the experimental conditions for the various clinical trials used in the 'unexpected results' evidence, in order to determine whether these clinical trials can be effectively used in the comparison of therapeutic effects of the cyclosporin compositions of Ding et al. with the claimed invention. Examiner also indicated that a first Office Action on the merits would be provided shortly after the interview since the proposed amendment would not obviate all rejections deemed necessary (see attached Office Action) and also briefly discussed potential statutory and non-statutory double patenting issues for the instant application. A courtesy draft of the Office Action was provided to Applicants' representatives.

**EAST Search History****EAST Search History (Prior Art)**

| <b>Ref #</b> | <b>Hits</b> | <b>Search Query</b>  | <b>DBs</b>                               | <b>Default Operator</b> | <b>Plurals</b> | <b>Time Stamp</b>   |
|--------------|-------------|--|--|-------------------------|----------------|---------------------|
| L1           | 12          | cyclosporin same castor same polysorbate same pemulen                | US-PGPUB; USPAT;<br>EPO; JPO;<br>DERWENT | ADJ                     | ON             | 2013/10/05<br>09:54 |
| L2           | 19          | cyclosporin same "0.05" same castor same "1.25"                      | US-PGPUB; USPAT;<br>EPO; JPO;<br>DERWENT | ADJ                     | ON             | 2013/10/05<br>09:59 |
| L3           | 89          | cyclosporin same castor same polysorbate                             | US-PGPUB; USPAT;<br>EPO; JPO;<br>DERWENT | ADJ                     | ON             | 2013/10/05<br>10:21 |
| L4           | 4           | cyclosporin same castor same polysorbate same pemulen same hydroxide | US-PGPUB; USPAT;<br>EPO; JPO;<br>DERWENT | ADJ                     | ON             | 2013/10/05<br>10:21 |

**10/ 5/ 2013 10:22:28 AM**

|   |                        |                    |            |
|---|------------------------|--------------------|------------|
| <b>INFORMATION DISCLOSURE<br/>STATEMENT BY APPLICANT</b><br>( Not for submission under 37 CFR 1.99) | Application Number     |                    | 13967189   |
|   | Filing Date            |                    | 2013-08-14 |
|   | First Named Inventor   | ACHEAMPONG, ANDREW |            |
|   | Art Unit               | 1653               |            |
|   | Examiner Name          | TBD                |            |
|   | Attorney Docket Number | 17618-US-BCON2-AP  |            |

ALL REFERENCES CONSIDERED EXCEPT WHERE LINED THROUGH. /M.M.C.G./

| U.S.PATENTS       |         |               |                        |            |   |  |
|-------------------|---------|---------------|------------------------|------------|---|--|
| Examiner Initial* | Cite No | Patent Number | Kind Code <sup>1</sup> | Issue Date | Name of Patentee or Applicant of cited Document | Pages,Columns,Lines where Relevant Passages or Relevant Figures Appear |
|                   | 1       | 3278447       |                        | 1966-10-11 | Thomas McNicholas                               |  |
|                   | 2       | 4388229       |                        | 1983-06-14 | Cherng-Chyi Fu                                  |  |
|                   | 3       | 4388307       |                        | 1983-06-14 | Thomas Cavanak                                  |  |
|                   | 4       | 4614736       |                        | 1986-09-30 | Devallee et al                                  |  |
|                   | 5       | 4649047       |                        | 1987-03-10 | Renee Kaswan                                    |  |
|                   | 6       | 4764503       |                        | 1988-08-16 | Roland Wenger                                   |  |
|                   | 7       | 4814323       |                        | 1989-03-21 | Andrieu et al                                   |  |
|                   | 8       | 4839342       |                        | 1989-06-13 | Renee Kaswan                                    |  |

|  |                        |                    |                   |                      |
|--|------------------------|--------------------|-------------------|----------------------|
| <b>Receipt date: 09/04/2013</b><br><br><b>INFORMATION DISCLOSURE<br/>STATEMENT BY APPLICANT</b><br>( Not for submission under 37 CFR 1.99) | Application Number     |                    | 13967189          | 13967189 - GAU: 1658 |
|  | Filing Date            |                    | 2013-08-14        |                      |
|  | First Named Inventor   | ACHEAMPONG, ANDREW |                   |                      |
|  | Art Unit               |                    | 1653              |                      |
|  | Examiner Name          | TBD                |                   |                      |
|  | Attorney Docket Number |                    | 17618-US-BCON2-AP |                      |

ALL REFERENCES CONSIDERED EXCEPT WHERE LINED THROUGH. /M.M.C.G./

|    |         |  |            |                   |  |
|----|---------|--|------------|-------------------|--|
| 9  | 4970076 |  | 1990-11-13 | David Horrobin    |  |
| 10 | 4990337 |  | 1991-02-05 | Kurihara et al    |  |
| 11 | 4996193 |  | 1991-02-26 | Hewitt et al      |  |
| 12 | 5047396 |  | 1991-09-10 | Orban et al       |  |
| 13 | 5051402 |  | 1991-09-24 | Kurihara et al    |  |
| 14 | 5053000 |  | 1991-10-01 | Booth et al       |  |
| 15 | 5286730 |  | 1994-02-15 | Caufield et al    |  |
| 16 | 5286731 |  | 1994-02-15 | Caufield et al    |  |
| 17 | 5294604 |  | 1994-03-15 | Nussenblatt et al |  |
| 18 | 5296158 |  | 1994-03-22 | MacGilp et al     |  |
| 19 | 5342625 |  | 1994-08-30 | Hauer et al       |  |

|  |                        |  |                    |                      |  |
|--|------------------------|--|--------------------|----------------------|--|
| <b>Receipt date: 09/04/2013</b><br><br><b>INFORMATION DISCLOSURE<br/>STATEMENT BY APPLICANT</b><br>( Not for submission under 37 CFR 1.99) | Application Number     |  | 13967189           | 13967189 - GAU: 1658 |  |
|  | Filing Date            |  | 2013-08-14         |                      |  |
|  | First Named Inventor   |  | ACHEAMPONG, ANDREW |                      |  |
|  | Art Unit               |  | 1653               |                      |  |
|  | Examiner Name          |  | TBD                |                      |  |
|  | Attorney Docket Number |  | 17618-US-BCON2-AP  |                      |  |

ALL REFERENCES CONSIDERED EXCEPT WHERE LINED THROUGH. /M.M.C.G./

|  |    |         |  |            |                 |  |
|--|----|---------|--|------------|-----------------|--|
|  | 20 | 5368854 |  | 1994-11-29 | Donna Rennick   |  |
|  | 21 | 5411952 |  | 1995-05-02 | Renee Kaswan    |  |
|  | 22 | 5424078 |  | 1995-06-13 | Anthony Dziabo  |  |
|  | 23 | 5474919 |  | 1995-12-12 | Chartrain et al |  |
|  | 24 | 5474979 |  | 1995-12-12 | Ding et al      | U.S. Application No. 08/243,279 and its entire prosecution history** |
|  | 25 | 5504068 |  | 1996-04-02 | Komiya et al    |  |
|  | 26 | 5540931 |  | 1996-07-30 | Hewitt et al    |  |
|  | 27 | 5543393 |  | 1996-08-06 | Kim et al       |  |
|  | 28 | 5589455 |  | 1996-12-31 | Jong Woo        |  |
|  | 29 | 5591971 |  | 1997-01-07 | Shahar et al    |  |
|  | 30 | 5614491 |  | 1997-03-25 | Walch et al     |  |

|  |                        |                    |                      |
|--|------------------------|--------------------|----------------------|
| <b>Receipt date: 09/04/2013</b><br><br><b>INFORMATION DISCLOSURE<br/>STATEMENT BY APPLICANT</b><br>( Not for submission under 37 CFR 1.99) | Application Number     | 13967189           | 13967189 - GAU: 1658 |
|  | Filing Date            | 2013-08-14         |                      |
|  | First Named Inventor   | ACHEAMPONG, ANDREW |                      |
|  | Art Unit               | 1653               |                      |
|  | Examiner Name          | TBD                |                      |
|  | Attorney Docket Number | 17618-US-BCON2-AP  |                      |

ALL REFERENCES CONSIDERED EXCEPT WHERE LINED THROUGH. /M.M.C.G./

|  |    |         |  |            |                    |  |
|--|----|---------|--|------------|--------------------|--|
|  | 31 | 5639724 |  | 1997-06-17 | Thomas Cavanak     |  |
|  | 32 | 5652212 |  | 1997-07-29 | Cavanak et al      |  |
|  | 33 | 5719123 |  | 1998-02-17 | Morley et al       |  |
|  | 34 | 5739105 |  | 1998-04-14 | Kim et al          |  |
|  | 35 | 5753166 |  | 1998-05-19 | Dalton et al       |  |
|  | 36 | 5766629 |  | 1998-06-16 | Cho et al          |  |
|  | 37 | 5798333 |  | 1998-08-25 | Bernard Sherman    |  |
|  | 38 | 5807820 |  | 1998-09-15 | Elias et al        |  |
|  | 39 | 5827822 |  | 1998-10-27 | Floch'h et al      |  |
|  | 40 | 5827862 |  | 1998-10-27 | Yoshitaka Yamamura |  |
|  | 41 | 5834017 |  | 1998-11-10 | Cho et al          |  |



|  |                        |                    |                   |                      |
|--|------------------------|--------------------|-------------------|----------------------|
| <b>Receipt date: 09/04/2013</b><br><br><b>INFORMATION DISCLOSURE<br/>STATEMENT BY APPLICANT</b><br>( Not for submission under 37 CFR 1.99) | Application Number     |                    | 13967189          | 13967189 - GAU: 1658 |
|  | Filing Date            |                    | 2013-08-14        |                      |
|  | First Named Inventor   | ACHEAMPONG, ANDREW |                   |                      |
|  | Art Unit               |                    | 1653              |                      |
|  | Examiner Name          | TBD                |                   |                      |
|  | Attorney Docket Number |                    | 17618-US-BCON2-AP |                      |

ALL REFERENCES CONSIDERED EXCEPT WHERE LINED THROUGH. /M.M.C.G./

|  |    |         |  |            |                 |  |
|--|----|---------|--|------------|-----------------|--|
|  | 42 | 5843452 |  | 1998-12-01 | Wiedmann et al  |  |
|  | 43 | 5843891 |  | 1998-12-01 | Bernard Sherman |  |
|  | 44 | 5858401 |  | 1999-01-12 | Bhalani et al   |  |
|  | 45 | 5866159 |  | 1999-02-02 | Hauer et al     |  |
|  | 46 | 5891846 |  | 1999-04-06 | Ishida et al    |  |
|  | 47 | 5916589 |  | 1999-06-29 | Hauer et al     |  |
|  | 48 | 5929030 |  | 1999-07-27 | Hamied et al    |  |
|  | 49 | 5951971 |  | 1999-09-14 | Kawashima et al |  |
|  | 50 | 5962014 |  | 1999-10-05 | Hauer et al     |  |
|  | 51 | 5962017 |  | 1999-10-05 | Hauer et al     |  |
|  | 52 | 5962019 |  | 1999-10-05 | Cho et al       |  |

|  |                        |                    |                   |                      |
|--|------------------------|--------------------|-------------------|----------------------|
| <b>Receipt date: 09/04/2013</b><br><br><b>INFORMATION DISCLOSURE<br/>STATEMENT BY APPLICANT</b><br>( Not for submission under 37 CFR 1.99) | Application Number     |                    | 13967189          | 13967189 - GAU: 1658 |
|  | Filing Date            |                    | 2013-08-14        |                      |
|  | First Named Inventor   | ACHEAMPONG, ANDREW |                   |                      |
|  | Art Unit               |                    | 1653              |                      |
|  | Examiner Name          | TBD                |                   |                      |
|  | Attorney Docket Number |                    | 17618-US-BCON2-AP |                      |

ALL REFERENCES CONSIDERED EXCEPT WHERE LINED THROUGH. /M.M.C.G./

|  |    |         |  |            |                 |  |
|--|----|---------|--|------------|-----------------|--|
|  | 53 | 5977066 |  | 1999-11-02 | Thomas Cavanak  |  |
|  | 54 | 5981479 |  | 1999-11-09 | Ko et al        |  |
|  | 55 | 5981607 |  | 1999-11-09 | Ding et al      | U.S. Application No. 09/008,924 and its entire prosecution history** |
|  | 56 | 5998365 |  | 1999-12-07 | Bernard Sherman |  |
|  | 57 | 6004566 |  | 1999-12-21 | Friedman et al  |  |
|  | 58 | 6007840 |  | 1999-12-28 | Hauer et al     |  |
|  | 59 | 6008191 |  | 1999-12-28 | Amarjit Singh   |  |
|  | 60 | 6008192 |  | 1999-12-28 | Al-Razzak et al |  |
|  | 61 | 6022852 |  | 2000-02-08 | Klokkers et al  |  |
|  | 62 | 6024978 |  | 2000-02-15 | Hauer et al     |  |
|  | 63 | 6046163 |  | 2000-04-04 | Stuchlik et al  |  |

|  |                        |                    |                   |                      |
|--|------------------------|--------------------|-------------------|----------------------|
| <b>Receipt date: 09/04/2013</b><br><br><b>INFORMATION DISCLOSURE<br/>STATEMENT BY APPLICANT</b><br>( Not for submission under 37 CFR 1.99) | Application Number     |                    | 13967189          | 13967189 - GAU: 1658 |
|  | Filing Date            |                    | 2013-08-14        |                      |
|  | First Named Inventor   | ACHEAMPONG, ANDREW |                   |                      |
|  | Art Unit               |                    | 1653              |                      |
|  | Examiner Name          | TBD                |                   |                      |
|  | Attorney Docket Number |                    | 17618-US-BCON2-AP |                      |

ALL REFERENCES CONSIDERED EXCEPT WHERE LINED THROUGH. /M.M.C.G./

|  |    |         |  |            |                 |  |
|--|----|---------|--|------------|-----------------|--|
|  | 64 | 6057289 |  | 2000-05-02 | Nirmal Mulye    |  |
|  | 65 | 6159933 |  | 2000-12-12 | Bernard Sherman |  |
|  | 66 | 6197335 |  | 2001-03-06 | Bernard Sherman |  |
|  | 67 | 6254860 |  | 2001-07-03 | Michael Garst   |  |
|  | 68 | 6254885 |  | 2001-07-03 | Cho et al       |  |
|  | 69 | 6267985 |  | 2001-07-31 | Chen et al      |  |
|  | 70 | 6284268 |  | 2001-09-04 | Mishra et al    |  |
|  | 71 | 6294192 |  | 2001-09-25 | Patel et al     |  |
|  | 72 | 6306825 |  | 2001-10-23 | Thomas Cavanak  |  |
|  | 73 | 6323204 |  | 2001-11-27 | James Burke     |  |
|  | 74 | 6346511 |  | 2002-02-12 | Singh et al     |  |

|  |                        |                    |                      |
|--|------------------------|--------------------|----------------------|
| <b>Receipt date: 09/04/2013</b><br><br><b>INFORMATION DISCLOSURE<br/>STATEMENT BY APPLICANT</b><br>( Not for submission under 37 CFR 1.99) | Application Number     | 13967189           | 13967189 - GAU: 1658 |
|  | Filing Date            | 2013-08-14         |                      |
|  | First Named Inventor   | ACHEAMPONG, ANDREW |                      |
|  | Art Unit               | 1653               |                      |
|  | Examiner Name          | TBD                |                      |
|  | Attorney Docket Number | 17618-US-BCON2-AP  |                      |

ALL REFERENCES CONSIDERED EXCEPT WHERE LINED THROUGH. /M.M.C.G./

|  |    |         |  |            |                  |  |
|--|----|---------|--|------------|------------------|--|
|  | 75 | 6350442 |  | 2002-02-26 | Michael Garst    |  |
|  | 76 | 6413547 |  | 2002-07-02 | Bennett et al    |  |
|  | 77 | 6420355 |  | 2002-07-16 | Richter et al    |  |
|  | 78 | 6468968 |  | 2002-10-22 | Cavanak et al    |  |
|  | 79 | 6475519 |  | 2002-11-05 | Meinzer et al    |  |
|  | 80 | 6486124 |  | 2002-11-26 | Olbrich et al    |  |
|  | 81 | 6544953 |  | 2003-04-08 | Tsuzuki et al    |  |
|  | 82 | 6555526 |  | 2003-04-29 | Toshihiko Matsuo |  |
|  | 83 | 6562873 |  | 2003-05-13 | Olejniak et al   |  |
|  | 84 | 6569463 |  | 2003-03-27 | Patel et al      |  |
|  | 85 | 6582718 |  | 2003-06-24 | Yoichi Kawashima |  |

|  |                        |                    |                      |
|--|------------------------|--------------------|----------------------|
| <b>Receipt date: 09/04/2013</b><br><br><b>INFORMATION DISCLOSURE STATEMENT BY APPLICANT</b><br>( Not for submission under 37 CFR 1.99) | Application Number     | 13967189           | 13967189 - GAU: 1658 |
|  | Filing Date            | 2013-08-14         |                      |
|  | First Named Inventor   | ACHEAMPONG, ANDREW |                      |
|  | Art Unit               | 1653               |                      |
|  | Examiner Name          | TBD                |                      |
|  | Attorney Docket Number | 17618-US-BCON2-AP  |                      |

ALL REFERENCES CONSIDERED EXCEPT WHERE LINED THROUGH. /M.M.C.G./

|    |         |  |            |                |  |
|----|---------|--|------------|----------------|--|
| 86 | 6656460 |  | 2003-12-02 | Benita et al   |  |
| 87 | 6872705 |  | 2005-03-29 | Robert Lyons   |  |
| 88 | 7202209 |  | 2007-04-10 | James N. Chang | U.S. Application No. 11/181,428 and its entire prosecution history** |
| 89 | 7276476 |  | 2007-10-02 | Chang et al    | U.S. Application No. 11/181,187 and its entire prosecution history** |
| 90 | 7288520 |  | 2007-10-30 | Chang et al    | U.S. Application No. 11/255,821 and its entire prosecution history** |
| 91 | 7297679 |  | 2007-11-20 | James Chang    | U.S. Application No. 11/181,178 and its entire prosecution history** |
| 92 | 7501393 |  | 2009-03-10 | Tien et al     | U.S. Application No. 11/161,218 and its entire prosecution history** |
| 93 | 8211855 |  | 2012-07-03 | Chang et al    | U.S. Application No. 11/857,223 and its entire prosecution history** |
| 94 | 8288348 |  | 2012-10-16 | Chang et al    | U.S. Application No. 11/917,448 and its entire prosecution history** |

If you wish to add additional U.S. Patent citation information please click the Add button.

**U.S.PATENT APPLICATION PUBLICATIONS**

| Examiner Initial* | Cite No | Publication Number | Kind Code <sup>1</sup> | Publication Date | Name of Patentee or Applicant of cited Document | Pages,Columns,Lines where Relevant Passages or Relevant Figures Appear |
|-------------------|---------|--------------------|------------------------|------------------|---|--|
|-------------------|---------|--------------------|------------------------|------------------|---|--|

|  |                        |                    |                      |
|--|------------------------|--------------------|----------------------|
| <b>Receipt date: 09/04/2013</b><br><br><b>INFORMATION DISCLOSURE<br/>STATEMENT BY APPLICANT</b><br>( Not for submission under 37 CFR 1.99) | Application Number     | 13967189           | 13967189 - GAU: 1658 |
|  | Filing Date            | 2013-08-14         |                      |
|  | First Named Inventor   | ACHEAMPONG, ANDREW |                      |
|  | Art Unit               | 1653               |                      |
|  | Examiner Name          | TBD                |                      |
|  | Attorney Docket Number | 17618-US-BCON2-AP  |                      |

ALL REFERENCES CONSIDERED EXCEPT WHERE LINED THROUGH. /M.M.C.G./

|    |             |  |            |                  |  |
|----|-------------|--|------------|------------------|--|
| 1  | 20010003589 |  | 2001-06-14 | Neuer et al      |  |
| 2  | 20010014665 |  | 2001-08-16 | Fischer et al    |  |
| 3  | 20010036449 |  | 2001-11-01 | Michael Garst    |  |
| 4  | 20020012680 |  | 2002-01-31 | Patel et al      |  |
| 5  | 20020013272 |  | 2002-01-31 | Cavanak et al    |  |
| 6  | 20020016290 |  | 2002-02-07 | Floc'h et al     |  |
| 7  | 20020016292 |  | 2002-02-07 | Richter et al    |  |
| 8  | 20020025927 |  | 2002-02-28 | Olbrich et al    |  |
| 9  | 20020045601 |  | 2002-04-18 | Yoichi Kawashima |  |
| 10 | 20020107183 |  | 2002-08-08 | Petszulat et al  |  |
| 11 | 20020119190 |  | 2002-08-29 | Meinzer et al    |  |

|  |                        |                    |                      |
|--|------------------------|--------------------|----------------------|
| <b>Receipt date: 09/04/2013</b><br><br><b>INFORMATION DISCLOSURE<br/>STATEMENT BY APPLICANT</b><br>( Not for submission under 37 CFR 1.99) | Application Number     | 13967189           | 13967189 - GAU: 1658 |
|  | Filing Date            | 2013-08-14         |                      |
|  | First Named Inventor   | ACHEAMPONG, ANDREW |                      |
|  | Art Unit               | 1653               |                      |
|  | Examiner Name          | TBD                |                      |
|  | Attorney Docket Number | 17618-US-BCON2-AP  |                      |

ALL REFERENCES CONSIDERED EXCEPT WHERE LINED THROUGH. /M.M.C.G./

|  |    |             |  |            |                     |  |
|--|----|-------------|--|------------|---------------------|--|
|  | 12 | 20020165134 |  | 2002-11-07 | Richter et al       |  |
|  | 13 | 20030021816 |  | 2003-01-30 | Kang et al          |  |
|  | 14 | 20030044452 |  | 2003-03-06 | Ryuji Ueno          |  |
|  | 15 | 20030055028 |  | 2003-03-20 | Stergiopoulos et al |  |
|  | 16 | 20030059470 |  | 2003-03-27 | Rainer Muller       |  |
|  | 17 | 20030060402 |  | 2003-03-27 | Cavanak et al       |  |
|  | 18 | 20030087813 |  | 2003-05-08 | Or et al            |  |
|  | 19 | 20030104992 |  | 2003-06-05 | Or et al            |  |
|  | 20 | 20030108626 |  | 2003-06-12 | Benita et al        |  |
|  | 21 | 20030109425 |  | 2003-06-12 | Or et al            |  |
|  | 22 | 20030109426 |  | 2003-06-12 | Or et al            |  |

|  |                        |                    |                      |
|--|------------------------|--------------------|----------------------|
| <b>Receipt date: 09/04/2013</b><br><br><b>INFORMATION DISCLOSURE<br/>STATEMENT BY APPLICANT</b><br>( Not for submission under 37 CFR 1.99) | Application Number     | 13967189           | 13967189 - GAU: 1658 |
|  | Filing Date            | 2013-08-14         |                      |
|  | First Named Inventor   | ACHEAMPONG, ANDREW |                      |
|  | Art Unit               | 1653               |                      |
|  | Examiner Name          | TBD                |                      |
|  | Attorney Docket Number | 17618-US-BCON2-AP  |                      |

ALL REFERENCES CONSIDERED EXCEPT WHERE LINED THROUGH. /M.M.C.G./

|    |             |  |            |                   |  |
|----|-------------|--|------------|-------------------|--|
| 23 | 20030133984 |  | 2003-07-17 | Ambuhl et al      |  |
| 24 | 20030143250 |  | 2003-07-31 | Hauer et al       |  |
| 25 | 20030147954 |  | 2003-08-07 | Yang et al        |  |
| 26 | 20030166517 |  | 2003-09-04 | Fricker et al     |  |
| 27 | 20050014691 |  | 2005-01-20 | Bakhit et al      |  |
| 28 | 20050059583 |  | 2005-03-17 | Andrew Acheampong | U.S. Application No. 10/927,857 and its entire prosecution history** |
| 29 | 20070015691 |  | 2007-01-18 | James Chang       | U.S. Application No. 11/181,409 and its entire prosecution history** |
| 30 | 20070027072 |  | 2007-02-01 | Tien et al        |  |
| 31 | 20070087962 |  | 2007-04-19 | Tien et al        |  |
| 32 | 20070149447 |  | 2007-06-28 | Chang et al       | U.S. Application No. 11/679,934 and its entire prosecution history** |
| 33 | 20070299004 |  | 2007-12-27 | Acheampong et al  | U.S. Application No. 11/897,177 and its entire prosecution history** |



|   |                        |  |                    |                      |  |
|---|------------------------|--|--------------------|----------------------|--|
| <b>Receipt date: 09/04/2013</b><br><br><b>INFORMATION DISCLOSURE STATEMENT BY APPLICANT</b><br><b>( Not for submission under 37 CFR 1.99)</b> | Application Number     |  | 13967189           | 13967189 - GAU: 1658 |  |
|   | Filing Date            |  | 2013-08-14         |                      |  |
|   | First Named Inventor   |  | ACHEAMPONG, ANDREW |                      |  |
|   | Art Unit               |  | 1653               |                      |  |
|   | Examiner Name          |  | TBD                |                      |  |
|   | Attorney Docket Number |  | 17618-US-BCON2-AP  |                      |  |

ALL REFERENCES CONSIDERED EXCEPT WHERE LINED THROUGH. /M.M.C.G./

|    |             |  |            |                 |  |
|----|-------------|--|------------|-----------------|--|
| 34 | 20080039378 |  | 2008-02-14 | Graham et al    | U.S. Application No. 11/781,095 and its entire prosecution history** |
| 35 | 20080070834 |  | 2008-03-20 | Chang et al     | U.S. Application No. 11/940,652 and its entire prosecution history** |
| 36 | 20080146497 |  | 2008-06-19 | Graham et al    | U.S. Application No. 11/858,200 and its entire prosecution history** |
| 37 | 20080207495 |  | 2008-08-28 | Graham et al    | U.S. Application No. 12/035,698 and its entire prosecution history** |
| 38 | 20090131307 |  | 2009-05-21 | Tien et al      | U.S. Application No. 12/361,335 and its entire prosecution history** |
| 39 | 20100279951 |  | 2010-11-04 | Morgan et al    | U.S. Application No. 12/771,952 and its entire prosecution history** |
| 40 | 20110009339 |  | 2011-01-13 | Rhett Schiffman | U.S. Application No. 12/759,431 and its entire prosecution history** |
| 41 | 20110294744 |  | 2011-12-01 | Morgan et al    | U.S. Application No. 13/115,764 and its entire prosecution history** |
| 42 | 20120270805 |  | 2012-10-25 | Chang et al     | U.S. Application No. 13/536,479 and its entire prosecution history** |
| 43 | 20130059796 |  | 2013-03-07 | Chang et al     | U.S. Application No. 13/649,287 and its entire prosecution history** |

If you wish to add additional U.S. Published Application citation information please click the Add button.

**FOREIGN PATENT DOCUMENTS**

|  |                        |                    |                      |
|--|------------------------|--------------------|----------------------|
| <b>Receipt date: 09/04/2013</b><br><br><b>INFORMATION DISCLOSURE STATEMENT BY APPLICANT</b><br>( Not for submission under 37 CFR 1.99) | Application Number     | 13967189           | 13967189 - GAU: 1658 |
|  | Filing Date            | 2013-08-14         |                      |
|  | First Named Inventor   | ACHEAMPONG, ANDREW |                      |
|  | Art Unit               | 1653               |                      |
|  | Examiner Name          | TBD                |                      |
|  | Attorney Docket Number | 17618-US-BCON2-AP  |                      |

ALL REFERENCES CONSIDERED EXCEPT WHERE LINED THROUGH. /M.M.C.G./

| Examiner Initial* | Cite No | Foreign Document Number <sup>3</sup> | Country Code <sup>2</sup> | Kind Code <sup>4</sup> | Publication Date | Name of Patentee or Applicant of cited Document           | Pages, Columns, Lines where Relevant Passages or Relevant Figures Appear | T <sup>5</sup>           |
|-------------------|---------|--------------------------------------|---------------------------|------------------------|------------------|---|--|--------------------------|
|                   | 1       | 19810655                             | DE                        |                        | 1999-09-16       | Eberhard-Karis-<br>Universitat Tubingen<br>Universitatskl |  | <input type="checkbox"/> |
|                   | 2       | 0471293                              | EP                        |                        | 1992-02-19       | ABBOTT<br>LABORATORIES                                    |  | <input type="checkbox"/> |
|                   | 3       | 0547229                              | EP                        |                        | 1993-01-07       | LLT Institute Co., Ltd.                                   |  | <input type="checkbox"/> |
|                   | 4       | 0760237                              | EP                        |                        | 1997-03-05       | Cipla Limited   |  | <input type="checkbox"/> |
|                   | 5       | 1995-031211                          | WO                        |                        | 1995-11-23       | Allergan Inc.   |  | <input type="checkbox"/> |
|                   | 6       | 2000-000179                          | WO                        |                        | 2000-01-06       | Won Jin Biopharma Co.,<br>Ltd                             |  | <input type="checkbox"/> |
|                   | 7       | 2001-032142                          | WO                        |                        | 2001-05-10       | Cipla Limited   |  | <input type="checkbox"/> |
|                   | 8       | 2001-041671                          | WO                        |                        | 2001-06-14       | Transneuronix, Inc.                                       |  | <input type="checkbox"/> |
|                   | 9       | 2002-009667                          | WO                        |                        | 2002-02-07       | Pharmasol GMBH  |  | <input type="checkbox"/> |
|                   | 10      | 2002-049603                          | WO                        |                        | 2002-06-27       | LG Household & Health<br>Care Ltd.                        |  | <input type="checkbox"/> |

|  |                        |                    |                      |
|--|------------------------|--------------------|----------------------|
| <b>Receipt date: 09/04/2013</b><br><br><b>INFORMATION DISCLOSURE STATEMENT BY APPLICANT</b><br>( Not for submission under 37 CFR 1.99) | Application Number     | 13967189           | 13967189 - GAU: 1658 |
|  | Filing Date            | 2013-08-14         |                      |
|  | First Named Inventor   | ACHEAMPONG, ANDREW |                      |
|  | Art Unit               | 1653               |                      |
|  | Examiner Name          | TBD                |                      |
|  | Attorney Docket Number | 17618-US-BCON2-AP  |                      |

ALL REFERENCES CONSIDERED EXCEPT WHERE LINED THROUGH. /M.M.C.G./

|    |             |    |  |            |   |                          |
|----|-------------|----|--|------------|---|--------------------------|
| 11 | 2003-030834 | WO |  | 2003-04-17 | Enanta Pharmaceuticals, Inc.                      | <input type="checkbox"/> |
| 12 | 2003-053405 | WO |  | 2003-07-03 | Yissum Research Development Company of the Hebrew | <input type="checkbox"/> |

If you wish to add additional Foreign Patent Document citation information please click the Add button

**NON-PATENT LITERATURE DOCUMENTS**

| Examiner Initials* | Cite No | Include name of the author (in CAPITAL LETTERS), title of the article (when appropriate), title of the item (book, magazine, journal, serial, symposium, catalog, etc), date, pages(s), volume-issue number(s), publisher, city and/or country where published. | T <sup>5</sup>           |
|--------------------|---------|---|--------------------------|
|                    | 1       | ABDULRAZIK, M. ET AL, Ocular Delivery of Cyclosporin A II. Effect of Submicron Emulsion's Surface Charge on Ocular Distribution of Topical Cyclosporin A, S.T.P. Pharma Sciences, Dec. 2001, 427-432, 11(6)   | <input type="checkbox"/> |
|                    | 2       | ACHEAMPONG, ANDREW ET AL, Cyclosporine Distribution into the Conjunctiva, Cornea, Lacrimal Gland and Systemic Blood Following Topical Dosing of Cyclosporine to Rabbit, Dog and Human eyes, 1996, 179   | <input type="checkbox"/> |
|                    | 3       | ACHEAMPONG, ANDREW ET AL, Cyclosporine Distribution Into The Conjunctiva, Cornea, Lacrimal Gland, and Systemic Blood Following Topical Dosing of Cyclosporine to Rabbit, Dog, and Human Eyes, Adv. Exp. Med. Biol., 1998, 1001-1004, 438                        | <input type="checkbox"/> |
|                    | 4       | ACHEAMPONG, ANDREW ET AL, Distribution of Cyclosporin A in Ocular Tissues After Topical Administration to Albino Rabbits and Beagle Dogs, Current Eye Research, 1999, 91-103, 18(2)   | <input type="checkbox"/> |
|                    | 5       | AKPEK, ESEN KARAMURSEL ET AL, A Randomized Trial of Topical Cyclosporin 0.05% in Topical Steroid-Resistant Atopic Keratoconjunctivitis, Ophthalmology, 2004, 476-482, 111   | <input type="checkbox"/> |
|                    | 6       | ANGELOV, O. ET AL, Preclinical Safety Studies of Cyclosporine Ophthalmic Emulsion, Adv Exp Med Biol, 1998, 991-995, 438   | <input type="checkbox"/> |
|                    | 7       | ANGELOV, O. ET AL, Safety Assessment of Cyclosporine Ophthalmic Emulsion in Rabbits and Dogs, XIth Congress of the European Society of Ophthalmology, 1997, 25-28, 1-5, Soc. Ophthalmol Eur., HU  | <input type="checkbox"/> |

|   |                        |                    |                      |
|---|------------------------|--------------------|----------------------|
| <b>Receipt date: 09/04/2013</b><br><br><b>INFORMATION DISCLOSURE STATEMENT BY APPLICANT</b><br><b>( Not for submission under 37 CFR 1.99)</b> | Application Number     | 13967189           | 13967189 - GAU: 1658 |
|   | Filing Date            | 2013-08-14         |                      |
|   | First Named Inventor   | ACHEAMPONG, ANDREW |                      |
|   | Art Unit               | 1653               |                      |
|   | Examiner Name          | TBD                |                      |
|   | Attorney Docket Number | 17618-US-BCON2-AP  |                      |

ALL REFERENCES CONSIDERED EXCEPT WHERE LINED THROUGH /M.M.C.G./

|    |   |                          |
|----|---|--------------------------|
| 8  | ARDIZZONE, SANDRO ET AL, A Practical Guide to the Management of Distal Ulcerative Colitis, Drugs, 1998, 519-542, 55(4)  | <input type="checkbox"/> |
| 9  | BANIC, MARKO ET AL, Effect of Cyclosporine in a Murine Model of Experimental Colitis, Digestive Diseases and Sciences, June 2002, 1362-1368, 47(6)  | <input type="checkbox"/> |
| 10 | BONINI, S. ET AL, Vernal Keratoconjunctivitis, Eye, 2004, 345-351, 18   | <input type="checkbox"/> |
| 11 | BREWSTER, MARCUS ET AL, Enhanced Delivery of Ganciclovir to the Brain Through the Use of Redox Targeting, Antimicrobial Agents and Chemotherapy, Apr 1994, 817-823, 38(4)   | <input type="checkbox"/> |
| 12 | BREWSTER, MARCUS ET AL, Intravenous and Oral Pharmacokinetic Evaluation of a 2-Hydroxypropyl-β-cyclodextrin-Based Formulation of Carbamazepine in the Dog: Comparison with Commercially Available Tablets and Suspensions, Journal of Pharmaceutical Sciences, March 1997, 335-339, 86(3) | <input type="checkbox"/> |
| 13 | BREWSTER, MARCUS ET AL, Preparation, Characterization, and Anesthetic Properties of 2-Hydroxypropyl-β-cyclodextrin Complexes of Pregnanolone and Pregnenolone in Rat and Mouse, Journal of Pharmaceutical Sciences, October 1995, 1154-1159, 84(10)                                       | <input type="checkbox"/> |
| 14 | BRINKMEIER, THOMAS ET AL, Pyodermatitis-Pyostomatitis Vegetans: A Clinical Course of Two Decades with Response to Cyclosporine and Low-Dose Prednisolone, Acta Derm Venereol, 2001, 134-136, 81   | <input type="checkbox"/> |
| 15 | CASTILLO, JOSE M. BENITEZ DEL ET AL, Influence of Topical Cyclosporine A and Dissolvent on Corneal Epithelium Permeability of Fluorescein, Documenta Ophthalmologica, 1995, 49-55, 91   | <input type="checkbox"/> |
| 16 | CHEEKS, LISA ET AL, Influence of Vehicle and Anterior Chamber Protein Concentration on Cyclosporine Penetration Through the Isolated Rabbit Cornea, Current Eye Research, 1992, 641-649, 11(7)  | <input type="checkbox"/> |
| 17 | Database WPI Week 200044, Derwent Pub. Ltd., London, GB; An 2000-492678 & JP2000/143542, 2000, 2 Pages  | <input type="checkbox"/> |
| 18 | DING, SHULIN ET AL, Cyclosporine Ophthalmic O/W emulsion: Formulation and Emulsion Characterization, Pharm Res, 1997, 1 page, 14 (11)   | <input type="checkbox"/> |

|   |                        |                    |                      |
|---|------------------------|--------------------|----------------------|
| <b>Receipt date: 09/04/2013</b><br><br><b>INFORMATION DISCLOSURE STATEMENT BY APPLICANT</b><br><b>( Not for submission under 37 CFR 1.99)</b> | Application Number     | 13967189           | 13967189 - GAU: 1658 |
|   | Filing Date            | 2013-08-14         |                      |
|   | First Named Inventor   | ACHEAMPONG, ANDREW |                      |
|   | Art Unit               | 1653               |                      |
|   | Examiner Name          | TBD                |                      |
|   | Attorney Docket Number | 17618-US-BCON2-AP  |                      |

ALL REFERENCES CONSIDERED EXCEPT WHERE LINED THROUGH. /M.M.C.G./

|    |  |                          |
|----|--|--------------------------|
| 19 | DONNENFELD, ERIC D., The Economics Of Using Restasis, Ophthalmology Management, 10/2003, 3 pages, US   | <input type="checkbox"/> |
| 20 | DROSOS, A. A. ET AL, Efficacy and Safety of Cyclosporine-A Therapy for Primary Sjogren's Syndrome, Ter. Arkh., 1998, 77-80, 60(4)  | <input type="checkbox"/> |
| 21 | DROSOS, A.A. ET AL, Cyclosporin A Therapy in Patients with Primary Sjogren's Syndrome: Results at One Year, Scand J Rheumatology, 1986, 246-249, 61  | <input type="checkbox"/> |
| 22 | EISEN, DRORE ET AL, Topical Cyclosporine for Oral Mucosal Disorders, J Am Acad Dermatol, Dec. 1990, 1259-1264, 23  | <input type="checkbox"/> |
| 23 | EPSTEIN, JOEL ET AL, Topical Cyclosporine in a Bioadhesive for Treatment of Oral Lichenoid Muscosal Reactions, Oral Surg Oral Med Oral Pathol Oral, 1996, 532-536, 82  | <input type="checkbox"/> |
| 24 | ERDMANN, S. ET AL, Pemphigus Vulgaris Der Mund- Und Kehlkopfschleimhaut Pemphigus Vulgaris of the Oral Mucosa and the Larynx, H+G Zeitschrift Fuer Hautkrankheiten, 1997, 283-286, 72(4)   | <input type="checkbox"/> |
| 25 | FDA Concludes Restasis (Cyclosporine) Not Effective for Dry Eye (6/18/1999). Accessed online at <a href="http://www.dryeyeinfo.org/Restasis_Cyclosporine.htm">http://www.dryeyeinfo.org/Restasis_Cyclosporine.htm</a> on 8/14/09. 1 Page | <input type="checkbox"/> |
| 26 | GAETA, G.M. ET AL, Cyclosporin Bioadhesive Gel in the Topical Treatment of Erosive Oral Lichen Planus, International Journal of Immunopathology and Pharmacology, 1994, 125-132, 7(2)  | <input type="checkbox"/> |
| 27 | GIPSON, ILENE ET AL, Character of Ocular Surface Mucins and Their Alteration in Dry Eye Disease, The Ocular Surface, April 2004, 131-148, 2(2)   | <input type="checkbox"/> |
| 28 | GREMSE, DAVID ET AL, Ulcerative Colitis in Children, Pediatr Drugs, 2002, 807-815, 4(12)   | <input type="checkbox"/> |
| 29 | GUNDUZ, KAAAN ET AL, Topical Cyclosporin Treatment of Keratoconjunctivitis Sicca in Secondary Sjogren's Syndrome, Acta Ophthalmologica, 1994, 438-442, 72  | <input type="checkbox"/> |

|   |                          |                    |          |                      |
|---|--------------------------|--------------------|----------|----------------------|
| <b>INFORMATION DISCLOSURE<br/>STATEMENT BY APPLICANT</b><br>( Not for submission under 37 CFR 1.99) | Receipt date: 09/04/2013 | Application Number | 13967189 | 13967189 - GAU: 1658 |
|   | Filing Date              | 2013-08-14         |          |                      |
|   | First Named Inventor     | ACHEAMPONG, ANDREW |          |                      |
|   | Art Unit                 | 1653               |          |                      |
|   | Examiner Name            | TBD                |          |                      |
|   | Attorney Docket Number   | 17618-US-BCON2-AP  |          |                      |

ALL REFERENCES CONSIDERED EXCEPT WHERE LINED THROUGH. /M.M.C.G./

|    |   |                          |
|----|---|--------------------------|
| 30 | <a href="http://web.archive.org/web/2001030625323/http://www.surfactant.co.kr/surfactants/pegester.html">http://web.archive.org/web/2001030625323/http://www.surfactant.co.kr/surfactants/pegester.html</a> , 2001, 6 Pages, retrieved on 7/05/2008 | <input type="checkbox"/> |
| 31 | HUNTER, P.A. ET AL, Cyclosporin A Applied Topically to the Recipient Eye Inhibits Corneal Graft Rejection, Clin Exp Immunol, 1981, 173-177, 45  | <input type="checkbox"/> |
| 32 | JUMAA, MUHANNAD ET AL, Physicochemical Properties and Hemolytic Effect of Different Lipid Emulsion Formulations Using a Mixture of Emulsifiers, Pharmaceutica Acta Helvetiae, 1999, 293-301, 73   | <input type="checkbox"/> |
| 33 | KANAI, A. ET AL, The Effect on the Cornea of Alpha Cyclodextrin Vehicle for Eye Drops, Transplantation Proceedings, February 1989, 3150-3152, Vol. 21   | <input type="checkbox"/> |
| 34 | KANPOLAT, AYFER ET AL, Penetration of Cyclosporin A into the Rabbit Cornea and Aqueous Humor after Topical Drop and Collagen Shield Administration, Cornea/External Disease, April 1994, 119-122, 20(2)   | <input type="checkbox"/> |
| 35 | KAUR, RABINDER ET AL, Solid Dispersions of Drugs in Polyocetylthylene 40 Stearate: Dissolution Rates and Physico-Chemical Interactions, Journal of Pharmacy and Pharmacology, December 1979, 48P  | <input type="checkbox"/> |
| 36 | KUWANO, MITSUAKI ET AL, Cyclosporine A Formulation Affects Its Ocular Distribution in Rabbits, Pharmaceutical Research, January 2002, 108-111, 19(1)  | <input type="checkbox"/> |
| 37 | Lambert Technologies Corp. Material Safety Data Sheet for LUMULSE™ POE-40 MS KP, last revision 8/22/2003. 3 pages   | <input type="checkbox"/> |
| 38 | LEIBOVITZ, Z. ET AL., Our Experience In Processing Maize (Corn) Germ Oil, Journal Of The American Oil Chemists Society, 02/1983, 395-399, 80 (2), US  | <input type="checkbox"/> |
| 39 | LIXIN, XIE ET AL, Effect Of Cyclosporine A Delivery System in Corneal Transplantation, Chinese Medical Journal, 2002, 110-113, 115 (1), US  | <input type="checkbox"/> |
| 40 | LOPATIN, D.E., Chemical Compositions and Functions of Saliva, 8/24/2001, 31 Pages   | <input type="checkbox"/> |

|   |                        |                    |                      |
|---|------------------------|--------------------|----------------------|
| <b>Receipt date: 09/04/2013</b><br><br><b>INFORMATION DISCLOSURE<br/>STATEMENT BY APPLICANT</b><br><b>( Not for submission under 37 CFR 1.99)</b> | Application Number     | 13967189           | 13967189 - GAU: 1658 |
|   | Filing Date            | 2013-08-14         |                      |
|   | First Named Inventor   | ACHEAMPONG, ANDREW |                      |
|   | Art Unit               | 1653               |                      |
|   | Examiner Name          | TBD                |                      |
|   | Attorney Docket Number | 17618-US-BCON2-AP  |                      |

ALL REFERENCES CONSIDERED EXCEPT WHERE LINED THROUGH. /M.M.C.G./

|    |  |                          |
|----|--|--------------------------|
| 41 | LYONS, R.T. ET AL, Influence of Three Emulsion Formulation Parameters on the Ocular Bioavailability of Cyclosporine A in Albino Rabbits, Am Assoc Pharm Sci, 2000, 1 Page, 2(4)  | <input type="checkbox"/> |
| 42 | PEDERSEN, ANNE MARIE ET AL, Primary Sjogren's Syndrome: Oral Aspects on Pathogenesis, Diagnostic Criteria, Clinical Features and Approaches for Therapy, Expert Opin Pharma, 2001, 1415-1436, 2(9)                               | <input type="checkbox"/> |
| 43 | PHILLIPS, THOMAS ET AL, Cyclosporine Has a Direct Effect on the Differentiation of a Mucin-Secreting Cell Line, Journal of Cellular Physiology, 2000, 400-408, 184   | <input type="checkbox"/> |
| 44 | PRESENT, D.H. ET AL, Cyclosporine and Other Immunosuppressive Agents: Current and Future Role in the Treatment of Inflammatory Bowel Disease, American Journal of Gastroenterology, 1993, 627-630, 88(5)                         | <input type="checkbox"/> |
| 45 | Restasis ® Product Information Sheet, Allergan, Inc., 2009, 5 Pages  | <input type="checkbox"/> |
| 46 | Restasis® Increasing Tear Production, Retrieved on 08/14/2009, <a href="http://www.restasisprofessional.com/_clinical/clinical_increasing.htm">http://www.restasisprofessional.com/_clinical/clinical_increasing.htm</a> 3 pages | <input type="checkbox"/> |
| 47 | ROBINSON, N.A. ET AL, Desquamative Gingivitis: A Sign of Mucocutaneous Disorders - a Review, Australian Dental Journal, 2003, 205-211, 48(4)   | <input type="checkbox"/> |
| 48 | RUDINGER, J., Characteristics of the Amino Acids as Components of a Peptide Hormone Sequence, Peptide Hormones, 1976, 1-7  | <input type="checkbox"/> |
| 49 | SALL, KENNETH ET AL, Two Multicenter, Randomized Studies of the Efficacy and Safety of Cyclosporine Ophthalmic Emulsion in Moderate to Severe Dry Eye Disease, Ophthalmology, 2000, 631-639, 107                                 | <input type="checkbox"/> |
| 50 | SANDBORN, WILLIAM ET AL, A Placebo-Controlled Trial of Cyclosporine Enemas for Mildly to Moderately Active Left-Sided Ulcerative Colitis, Gastroenterology, 1994, 1429-1435, 106   | <input type="checkbox"/> |
| 51 | SANDBORN, WILLIAM ET AL, Cyclosporine Enemas for Treatment-Resistant, Mildly to Moderately Active, Left-Sided Ulcerative Colitis, American Journal of Gastroenterology, 1993, 640-645, 88(5)                                     | <input type="checkbox"/> |

|   |                        |                    |                      |
|---|------------------------|--------------------|----------------------|
| <b>Receipt date: 09/04/2013</b><br><br><b>INFORMATION DISCLOSURE<br/>STATEMENT BY APPLICANT</b><br><b>( Not for submission under 37 CFR 1.99)</b> | Application Number     | 13967189           | 13967189 - GAU: 1658 |
|   | Filing Date            | 2013-08-14         |                      |
|   | First Named Inventor   | ACHEAMPONG, ANDREW |                      |
|   | Art Unit               | 1653               |                      |
|   | Examiner Name          | TBD                |                      |
|   | Attorney Docket Number | 17618-US-BCON2-AP  |                      |

ALL REFERENCES CONSIDERED EXCEPT WHERE LINED THROUGH. /M.M.C.G./

|    |   |                          |
|----|---|--------------------------|
| 52 | SCHWAB, MATTHIAS ET AL, Pharmacokinetic Considerations in the Treatment of Inflammatory Bowel Disease, Clin Pharm, 2001, 723-751, 60(10)  | <input type="checkbox"/> |
| 53 | SECCHI, ANTONIO ET AL, Topical Use of Cyclosporine in the Treatment of Vernal Keratoconjunctivitis, American Journal of Ophthalmology, December 1990, 641-645, 110  | <input type="checkbox"/> |
| 54 | SMALL, DAVE ET AL, The Ocular Pharmacokinetics of Cyclosporine in Albino Rabbits and Beagle Dogs, Ocular Drug Delivery and Metabolism, 1999, 54   | <input type="checkbox"/> |
| 55 | SMALL, DAVID ET AL, Blood Concentrations of Cyclosporin A During Long-Term Treatment With Cyclosporin A ophthalmic Emulsions in Patients with Moderate to Severe Dry Eye Disease, Journal of Ocular Pharmacology and Therapeutics, 2002, 411-418, 18(5) | <input type="checkbox"/> |
| 56 | SMILEK, DAWN ET AL, A Single Amino Acid Change in a Myelin Basic Protein Peptide Confers the Capacity to Prevent Rather Than Induce Experimental Autoimmune Encephalomyelitis, Proc. Natl. Acad. Sci., Nov 1991, 9633-9637, 88                          | <input type="checkbox"/> |
| 57 | STEPHENSON, MICHELLE, The Latest Uses Of Restasis, Review Of Ophthalmology, 12/30/2005, 7 Pages, US   | <input type="checkbox"/> |
| 58 | STEVENSON, DARA ET AL, Efficacy and Safety of Cyclosporin A ophthalmic Emulsion in the Treatment of Moderate-to-Severe Dry Eye Disease, Ophthalmology, 2000, 967-974, 107   | <input type="checkbox"/> |
| 59 | TESAVIBUL, N. ET AL, Topical Cyclosporine A (CsA) for Ocular Surface Abnormalities in Graft Versus Host Disease Patients, Invest Ophthalmol Vis Sci, Feb 1996, S1026, 37(3)   | <input type="checkbox"/> |
| 60 | The Online Medical Dictionary, Derivative, Analog, Analogue, Xerostomia, accessed 7/7/2005 and 7/13/2005, 6 Pages   | <input type="checkbox"/> |
| 61 | TIBELL, A. ET AL., Cyclosporin A In Fat Emulsion Carriers: Experimental Studies On Pharmacokinetics And Tissue Distribution, Pharmacology & Toxicology, 1995, 115-121, 76, US   | <input type="checkbox"/> |
| 62 | TSUBOTA, KAZUO ET AL, Use of Topical Cyclosporin A in a Primary Sjogren's Syndrome Mouse Model, Invest Ophthalmol Vis Sci, Aug. 1998, 1551-1559, 39(9)  | <input type="checkbox"/> |



|  |                        |                    |                      |
|--|------------------------|--------------------|----------------------|
| <b>Receipt date: 09/04/2013</b><br><br><b>INFORMATION DISCLOSURE STATEMENT BY APPLICANT</b><br>( Not for submission under 37 CFR 1.99) | Application Number     | 13967189           | 13967189 - GAU: 1658 |
|  | Filing Date            | 2013-08-14         |                      |
|  | First Named Inventor   | ACHEAMPONG, ANDREW |                      |
|  | Art Unit               | 1653               |                      |
|  | Examiner Name          | TBD                |                      |
|  | Attorney Docket Number | 17618-US-BCON2-AP  |                      |

ALL REFERENCES CONSIDERED EXCEPT WHERE LINED THROUGH. /M.M.C.G./

|    |  |                          |
|----|--|--------------------------|
| 63 | VAN DER REIJDEN, WILLY ET AL, Treatment of Oral Dryness Related Complaints (Xerostomia) in Sjogren's Syndrome, Ann Rheum Dis, 1999, 465-473, 58      | <input type="checkbox"/> |
| 64 | WINTER, T.A. ET AL, Cyclosporin A Retention Enemas in Refractory Distal Ulcerative Colitis and 'Pouchitis', Scand J Gastroenterol, 1993, 701-704, 28 | <input type="checkbox"/> |
| 65 | U.S. Pending Application: 13/961,808 Filed on August 07, 2013  | <input type="checkbox"/> |
| 66 | U.S. Pending Application: 13/961,818 Filed on August 07, 2013  | <input type="checkbox"/> |
| 67 | U.S. Pending Application: 13/961,828 Filed on August 07, 2013  | <input type="checkbox"/> |
| 68 | U.S. Pending Application: 13/961,835 Filed on August 07, 2013  | <input type="checkbox"/> |
| 69 | U.S. Pending Application: 13/967,179 Filed on August 14, 2013  | <input type="checkbox"/> |
| 70 | U.S. Pending Application: 13/967,163 Filed on August 14, 2013  | <input type="checkbox"/> |
| 71 | U.S. Pending Application: 13/967,168 Filed on August 14, 2013  | <input type="checkbox"/> |

If you wish to add additional non-patent literature document citation information please click the Add button

**EXAMINER SIGNATURE**

|                    |                          |                 |            |
|--------------------|--------------------------|-----------------|------------|
| Examiner Signature | /Marcela Cordero Garcia/ | Date Considered | 10/04/2013 |
|--------------------|--------------------------|-----------------|------------|

\*EXAMINER: Initial if reference considered, whether or not citation is in conformance with MPEP 609. Draw line through a citation if not in conformance and not considered. Include copy of this form with next communication to applicant.

|   |                        |                    |                      |
|---|------------------------|--------------------|----------------------|
| <b>Receipt date: 09/04/2013</b><br><br><b>INFORMATION DISCLOSURE<br/>STATEMENT BY APPLICANT</b><br><b>( Not for submission under 37 CFR 1.99)</b> | Application Number     | 13967189           | 13967189 - GAU: 1658 |
|   | Filing Date            | 2013-08-14         |                      |
|   | First Named Inventor   | ACHEAMPONG, ANDREW |                      |
|   | Art Unit               | 1653               |                      |
|   | Examiner Name          | TBD                |                      |
|   | Attorney Docket Number | 17618-US-BCON2-AP  |                      |

<sup>1</sup> See Kind Codes of USPTO Patent Documents at [www.USPTO.GOV](http://www.USPTO.GOV) or MPEP 901.04. <sup>2</sup> Enter office that issued the document, by the two-letter code (WIPO Standard ST.3). <sup>3</sup> For Japanese patent documents, the indication of the year of the reign of the Emperor must precede the serial number of the patent document. <sup>4</sup> Kind of document by the appropriate symbols as indicated on the document under WIPO Standard ST.16 if possible. <sup>5</sup> Applicant is to place a check mark here if English language translation is attached.

|  |                        |                    |                      |
|--|------------------------|--------------------|----------------------|
| <b>Receipt date: 09/04/2013</b><br><br><b>INFORMATION DISCLOSURE STATEMENT BY APPLICANT</b><br>( Not for submission under 37 CFR 1.99) | Application Number     | 13967189           | 13967189 - GAU: 1658 |
|  | Filing Date            | 2013-08-14         |                      |
|  | First Named Inventor   | ACHEAMPONG, ANDREW |                      |
|  | Art Unit               | 1653               |                      |
|  | Examiner Name          | TBD                |                      |
|  | Attorney Docket Number | 17618-US-BCON2-AP  |                      |

**CERTIFICATION STATEMENT**

Please see 37 CFR 1.97 and 1.98 to make the appropriate selection(s):

That each item of information contained in the information disclosure statement was first cited in any communication from a foreign patent office in a counterpart foreign application not more than three months prior to the filing of the information disclosure statement. See 37 CFR 1.97(e)(1).

**OR**

That no item of information contained in the information disclosure statement was cited in a communication from a foreign patent office in a counterpart foreign application, and, to the knowledge of the person signing the certification after making reasonable inquiry, no item of information contained in the information disclosure statement was known to any individual designated in 37 CFR 1.56(c) more than three months prior to the filing of the information disclosure statement. See 37 CFR 1.97(e)(2).

\*\* Signature indicates consideration of publication and file history. The Examiner has access to these materials through the PTO computer systems. If additional copies are desired, please notify the Applicants through their attorneys.

- See attached certification statement.
- Fee set forth in 37 CFR 1.17 (p) has been submitted herewith.
- None

**SIGNATURE**

A signature of the applicant or representative is required in accordance with CFR 1.33, 10.18. Please see CFR 1.4(d) for the form of the signature.

|            |                 |                     |            |
|------------|-----------------|---------------------|------------|
| Signature  | /Laura L. Wine/ | Date (YYYY-MM-DD)   | 2013-09-04 |
| Name/Print | Laura L. Wine   | Registration Number | 68,681     |

This collection of information is required by 37 CFR 1.97 and 1.98. The information is required to obtain or retain a benefit by the public which is to file (and by the USPTO to process) an application. Confidentiality is governed by 35 U.S.C. 122 and 37 CFR 1.14. This collection is estimated to take 1 hour to complete, including gathering, preparing and submitting the completed application form to the USPTO. Time will vary depending upon the individual case. Any comments on the amount of time you require to complete this form and/or suggestions for reducing this burden, should be sent to the Chief Information Officer, U.S. Patent and Trademark Office, U.S. Department of Commerce, P.O. Box 1450, Alexandria, VA 22313-1450. **DO NOT SEND FEES OR COMPLETED FORMS TO THIS ADDRESS. SEND TO: Commissioner for Patents, P.O. Box 1450, Alexandria, VA 22313-1450.**

**Privacy Act Statement**

The Privacy Act of 1974 (P.L. 93-579) requires that you be given certain information in connection with your submission of the attached form related to a patent application or patent. Accordingly, pursuant to the requirements of the Act, please be advised that: (1) the general authority for the collection of this information is 35 U.S.C. 2(b)(2); (2) furnishing of the information solicited is voluntary; and (3) the principal purpose for which the information is used by the U.S. Patent and Trademark Office is to process and/or examine your submission related to a patent application or patent. If you do not furnish the requested information, the U.S. Patent and Trademark Office may not be able to process and/or examine your submission, which may result in termination of proceedings or abandonment of the application or expiration of the patent.

The information provided by you in this form will be subject to the following routine uses:

1. The information on this form will be treated confidentially to the extent allowed under the Freedom of Information Act (5 U.S.C. 552) and the Privacy Act (5 U.S.C. 552a). Records from this system of records may be disclosed to the Department of Justice to determine whether the Freedom of Information Act requires disclosure of these records.
2. A record from this system of records may be disclosed, as a routine use, in the course of presenting evidence to a court, magistrate, or administrative tribunal, including disclosures to opposing counsel in the course of settlement negotiations.
3. A record in this system of records may be disclosed, as a routine use, to a Member of Congress submitting a request involving an individual, to whom the record pertains, when the individual has requested assistance from the Member with respect to the subject matter of the record.
4. A record in this system of records may be disclosed, as a routine use, to a contractor of the Agency having need for the information in order to perform a contract. Recipients of information shall be required to comply with the requirements of the Privacy Act of 1974, as amended, pursuant to 5 U.S.C. 552a(m).
5. A record related to an International Application filed under the Patent Cooperation Treaty in this system of records may be disclosed, as a routine use, to the International Bureau of the World Intellectual Property Organization, pursuant to the Patent Cooperation Treaty.
6. A record in this system of records may be disclosed, as a routine use, to another federal agency for purposes of National Security review (35 U.S.C. 181) and for review pursuant to the Atomic Energy Act (42 U.S.C. 218(c)).
7. A record from this system of records may be disclosed, as a routine use, to the Administrator, General Services, or his/her designee, during an inspection of records conducted by GSA as part of that agency's responsibility to recommend improvements in records management practices and programs, under authority of 44 U.S.C. 2904 and 2906. Such disclosure shall be made in accordance with the GSA regulations governing inspection of records for this purpose, and any other relevant (i.e., GSA or Commerce) directive. Such disclosure shall not be used to make determinations about individuals.
8. A record from this system of records may be disclosed, as a routine use, to the public after either publication of the application pursuant to 35 U.S.C. 122(b) or issuance of a patent pursuant to 35 U.S.C. 151. Further, a record may be disclosed, subject to the limitations of 37 CFR 1.14, as a routine use, to the public if the record was filed in an application which became abandoned or in which the proceedings were terminated and which application is referenced by either a published application, an application open to public inspections or an issued patent.
9. A record from this system of records may be disclosed, as a routine use, to a Federal, State, or local law enforcement agency, if the USPTO becomes aware of a violation or potential violation of law or regulation.

Connecting via Winsock to STN at stnc.cas.org on port 23

Welcome to STN International! Enter x:x

LOGINID:SSSPTA1654MCG

PASSWORD:

TERMINAL (ENTER 1, 2, 3, OR ?):2

\* \* \* \* \* Welcome to STN International \* \* \* \* \*

- NEWS 1 FEB 1 Instructor-led and on-demand STN training options available from CAS
- NEWS 2 MAY 23 Get the Latest Version of STN Express, Version 8.5.1!
- NEWS 3 DEC 10 New SDI STANDARD Option Streamlines SDI Set-ups on STN
- NEWS 4 JAN 17 Cooperative Patent Classification (CPC) Search and Display Capabilities Now Available in CA/CAPLUS Family of Databases and USPAT Databases on STN
- NEWS 5 JAN 23 INPADOC: CPC Backfile Data Now Available
- NEWS 6 JAN 28 Reloaded MEDLINE on STN  
Now Includes 2013 MeSH Vocabulary and New Fields
- NEWS 7 JAN 31 INPADOC Databases Enhanced with Calculated Expiration Dates
- NEWS 8 JAN 31 INPADOC Enhanced with Citing Patent Information
- NEWS 9 JAN 31 INPAFAMDB Enhanced with Patent Family Counts
- NEWS 10 FEB 6 Enhancements to COMPENDEX
- NEWS 11 FEB 22 2013 MARPAT Backfile Expansion Update
- NEWS 12 MAR 06 Derwent World Patents Index (DWPI) New Coverage - Indonesia
- NEWS 13 MAR 11 JAPIO Will No Longer Be Updated from March 2013 Onwards
- NEWS 14 MAR 22 Cooperative Patent Classification (CPC) Added to USPATOLD on STN
- NEWS 15 MAR 25 SciSearch on STN Now Includes New Fields  
Find Grant Information More Easily
- NEWS 16 APR 29 Embase Alert (EMBAL) Enhanced with Articles-in-Press Content and Optimized for Use as a Companion Database for Embase
- NEWS 17 APR 30 Derwent WPI: The New Cooperative Patent Classification Is Now Available
- NEWS 18 MAY 21 STN Updated to Reflect Streamlining of CAS Roles
- NEWS 19 MAY 24 CABA Has Been Reloaded on May 24, 2013
- NEWS 20 MAY 28 STN Adds Indian Patent Full Text File - INFULL
- NEWS 21 JUL 09 TULSA and TULSA2 were reloaded on July 8, 2013
- NEWS 22 JUL 15 New IFIALL Database on STN Increases US Patent Retrieval Capabilities
- NEWS 23 JUL 24 Find the Most Comprehensive and Timely Results When Searching the Newly Enhanced Embase Alert(TM) together with Embase(TM)
- NEWS 24 JUL 31 New PV Cluster on STN(R) Simplifies Pharmacovigilance Alerting and Searching
- NEWS 25 AUG 09 DWPI Manual Code Revision - submit your suggestions
- NEWS 26 AUG 15 PCTFULL documents with Chinese, Japanese, or Korean as filing language have English machine translations
- NEWS 27 AUG 16 The 2013 Inventory of Existing Chemical Substances in China is Now Available on STN
- NEWS 28 SEP 10 CAS Expands Coverage of Philippines Patents
- NEWS 29 SEP 13 STN on the Web Enhanced with Updated Structure and BLAST Plug-ins
- NEWS 30 SEP 24 Emtree Thesaurus Updated in Embase
- NEWS 31 SEP 27 Application Numbers for U.S. Patents in CA/CAPLUS and USPATFUL/USPAT2 Enhanced with U.S. Series Code Information

NEWS 32 OCT 04 Impacts of U.S. Government Shutdown on STN Databases

NEWS EXPRESS 23 MAY 2012 CURRENT WINDOWS VERSION IS V8.5.1,  
AND CURRENT DISCOVER FILE IS DATED 22 JULY 2013.

NEWS HOURS STN Operating Hours Plus Help Desk Availability  
NEWS LOGIN Welcome Banner and News Items  
NEWS TRAINING Find instructor-led and self-directed training opportunities

Enter NEWS followed by the item number or name to see news on that specific topic.

All use of STN is subject to the provisions of the STN customer agreement. This agreement limits use to scientific research. Use for software development or design, implementation of commercial gateways, or use of CAS and STN data in the building of commercial products is prohibited and may result in loss of user privileges and other penalties.

\* \* \* \* \* STN Columbus \* \* \* \* \*

FILE 'HOME' ENTERED AT 10:05:57 ON 05 OCT 2013

=> file caplus embase medline biosis

| COST IN U.S. DOLLARS | SINCE FILE ENTRY | TOTAL SESSION |
|----------------------|------------------|---------------|
| FULL ESTIMATED COST  | 0.24             | 0.24          |

FILE 'CAPLUS' ENTERED AT 10:06:16 ON 05 OCT 2013

USE IS SUBJECT TO THE TERMS OF YOUR STN CUSTOMER AGREEMENT.  
PLEASE SEE "HELP USAGETERMS" FOR DETAILS.  
COPYRIGHT (C) 2013 AMERICAN CHEMICAL SOCIETY (ACS)

FILE 'EMBASE' ENTERED AT 10:06:16 ON 05 OCT 2013

Copyright (c) 2013 Elsevier B.V. All rights reserved.

FILE 'MEDLINE' ENTERED AT 10:06:16 ON 05 OCT 2013

FILE 'BIOSIS' ENTERED AT 10:06:16 ON 05 OCT 2013

Copyright (c) 2013 The Thomson Corporation

=> (cyclosporin or cyclosporine) (10A) (castor (3a) oil)

L1 261 (CYCLOSPORIN OR CYCLOSPORINE) (10A) (CASTOR (3A) OIL)

=> (cyclosporin or cyclosporine) (10A) (castor (3a) oil) (10a) ((0.05) and (1.25))

PROXIMITY OPERATION NOT ALLOWED

Certain operators may not be nested in combination with other operators. A nested operator is valid only when it occurs at the same level or above the operator outside the nested phrase as determined by the following precedence list:

1. Numeric
2. (W), (NOTW), (A), (NOTA)
3. (S), (NOTS)
4. (P), (NOTP)
5. (L), (NOTL)
6. AND, NOT
7. OR

For example, '(MONOCLONAL(W)ANTIBOD?)(L)ANTIGEN?' is valid since (W) is above (L) on the precedence list. However, '((THIN(W)LAYER)(L)PHOSPHOLIPID#)(A)LACTONE#' is not valid since (L)

is below (A) on the precedence list. The only exception is the 'OR' operator. This operator may be used in combination with any other operator. For example, '(ATOMIC OR NUCLEAR)(W)REACTOR' is valid.

=> (cyclosporin or cyclosporine) (10A) (castor (3a) oil) (10a) (pemulen and polysorbate)

PROXIMITY OPERATION NOT ALLOWED

Certain operators may not be nested in combination with other operators. A nested operator is valid only when it occurs at the same level or above the operator outside the nested phrase as determined by the following precedence list:

1. Numeric
2. (W), (NOTW), (A), (NOTA)
3. (S), (NOTS)
4. (P), (NOTP)
5. (L), (NOTL)
6. AND, NOT
7. OR

For example, '(MONOCLONAL(W)ANTIBOD?)(L)ANTIGEN?' is valid since (W) is above (L) on the precedence list. However, '((THIN(W)LAYER)(L)PHOSPHOLIPID#)(A)LACTONE#' is not valid since (L) is below (A) on the precedence list. The only exception is the 'OR' operator. This operator may be used in combination with any other operator. For example, '(ATOMIC OR NUCLEAR)(W)REACTOR' is valid.

=> (cyclosporin or cyclosporine) (10A) (castor oil) (10a) (pemulen and polysorbate)  
PROXIMITY OPERATION NOT ALLOWED

Certain operators may not be nested in combination with other operators. A nested operator is valid only when it occurs at the same level or above the operator outside the nested phrase as determined by the following precedence list:

1. Numeric
2. (W), (NOTW), (A), (NOTA)
3. (S), (NOTS)
4. (P), (NOTP)
5. (L), (NOTL)
6. AND, NOT
7. OR

For example, '(MONOCLONAL(W)ANTIBOD?)(L)ANTIGEN?' is valid since (W) is above (L) on the precedence list. However, '((THIN(W)LAYER)(L)PHOSPHOLIPID#)(A)LACTONE#' is not valid since (L) is below (A) on the precedence list. The only exception is the 'OR' operator. This operator may be used in combination with any other operator. For example, '(ATOMIC OR NUCLEAR)(W)REACTOR' is valid.

=> (cyclosporin or cyclosporine) (10A) (castor oil) (10a) (pemulen) 10a polysorbate  
MISSING OPERATOR PEMULEN) 10A

The search profile that was entered contains terms or nested terms that are not separated by a logical operator.

=> (cyclosporin or cyclosporine) (10A) (castor oil) (10A) (pemulen) (10a)  
(polysorbate)

L2 1 (CYCLOSPORIN OR CYCLOSPORINE) (10A) (CASTOR OIL) (10A) (PEMULEN)  
(10A) (POLYSORBATE)

=> d ibib abs total

L2 ANSWER 1 OF 1 CAPLUS COPYRIGHT 2013 ACS on STN

ACCESSION NUMBER: 1996:38846 CAPLUS  
 DOCUMENT NUMBER: 124:66660  
 ORIGINAL REFERENCE NO.: 124:12317a,12320a  
 TITLE: Lacrimal gland-specific emulsions for topical application to ocular tissue  
 INVENTOR(S): Ding, Shulin; Tien, Walter L.; Olejnik, Orest  
 PATENT ASSIGNEE(S): Allergan, Inc., USA  
 SOURCE: PCT Int. Appl., 27 pp.  
 CODEN: PIXXD2  
 DOCUMENT TYPE: Patent  
 LANGUAGE: English  
 FAMILY ACC. NUM. COUNT: 1  
 PATENT INFORMATION:

| PATENT NO.  | KIND | DATE     | APPLICATION NO. | DATE        |
|---|------|----------|-----------------|-------------|
| WO 9531211  | A1   | 19951123 | WO 1995-US6302  | 19950517    |
| W: AM, AT, AU, BB, BG, BR, BY, CA, CH, CN, CZ, DE, DK, EE, ES, FI, GB, GE, HU, JP, KE, KG, KP, KR, KZ, LK, LR, LT, LU, LV, MD, MG, MN, MW, MX, NO, NZ, PL, PT, RO, RU, SD, SE, SI, SK, TJ, TT, UA, US, UZ<br>RW: KE, MW, SD, SZ, UG, AT, BE, CH, DE, DK, ES, FR, GB, GR, IE, IT, LU, MC, NL, PT, SE, BF, BJ, CF, CG, CI, CM, GA, GN, ML, MR, NE, SN, TD, TG |      |          |                 |             |
| US 5474979  | A    | 19951212 | US 1994-243279  | 19940517    |
| CA 2190485  | A1   | 19951123 | CA 1995-2190485 | 19950517    |
| CA 2190485  | C    | 20030415 |                 |             |
| CA 2309033  | A1   | 19951123 | CA 1995-2309033 | 19950517    |
| CA 2309033  | C    | 20030826 |                 |             |
| AU 9526409  | A    | 19951205 | AU 1995-26409   | 19950517    |
| AU 693213   | B2   | 19980625 |                 |             |
| EP 759773   | A1   | 19970305 | EP 1995-921294  | 19950517    |
| EP 759773   | B1   | 20010808 |                 |             |
| R: AT, BE, CH, DE, DK, ES, FR, GB, GR, IE, IT, LI, LU, MC, NL, PT, SE   |      |          |                 |             |
| CN 1152876  | A    | 19970625 | CN 1995-194078  | 19950517    |
| CN 1229136  | C    | 20051130 |                 |             |
| BR 9507664  | A    | 19971007 | BR 1995-7664    | 19950517    |
| JP 10500414   | T    | 19980113 | JP 1995-529895  | 19950517    |
| JP 3441462  | B2   | 20030902 |                 |             |
| EP 1044678  | A1   | 20001018 | EP 2000-202069  | 19950517    |
| EP 1044678  | B1   | 20030312 |                 |             |
| R: AT, BE, CH, DE, DK, ES, FR, GB, GR, IT, LI, LU, NL, SE, MC, PT, IE   |      |          |                 |             |
| AT 203911   | T    | 20010815 | AT 1995-921294  | 19950517    |
| ES 2161895  | T3   | 20011216 | ES 1995-921294  | 19950517    |
| PT 759773   | E    | 20020228 | PT 1995-921294  | 19950517    |
| AT 234076   | T    | 20030315 | AT 2000-202069  | 19950517    |
| PT 1044678  | E    | 20030829 | PT 2000-202069  | 19950517    |
| ES 2194670  | T3   | 20031201 | ES 2000-202069  | 19950517    |
| MX 2002000724   | A    | 20030425 | MX 2002-724     | 19961115    |
| CN 1288722  | A    | 20010328 | CN 2000-120126  | 20000714    |
| CN 1198587  | C    | 20050427 |                 |             |
| HK 1034190  | A1   | 20051209 | HK 2001-104710  | 20010709    |
| GR 3036945  | T3   | 20020131 | GR 2001-401814  | 20011018    |
| KR 450703   | B1   | 20041001 | KR 2001-88637   | 20011229    |
| JP 2003231646   | A    | 20030819 | JP 2003-63234   | 20030310    |
| JP 4119284  | B2   | 20080716 |                 |             |
| PRIORITY APPLN. INFO.:  |      |          |                 |             |
|   |      |          | US 1994-243279  | A 19940517  |
|   |      |          | CA 1995-2190485 | A3 19950517 |
|   |      |          | EP 1995-921294  | A3 19950517 |
|   |      |          | JP 1995-529895  | A3 19950517 |
|   |      |          | WO 1995-US6302  | W 19950517  |
|   |      |          | KR 1996-706523  | A3 19961118 |



ASSIGNMENT HISTORY FOR US PATENT AVAILABLE IN LSUS DISPLAY FORMAT

AB A pharmaceutical composition is disclosed in the form of a nonirritating emulsion which includes at least one cyclosporin in admixt. with a higher fatty acid glyceride and polysorbate 80. More particularly, the cyclosporin may be cyclosporine A and the higher fatty acid glyceride may be castor oil. The composition allows a high comfort level and low irritation potential suitable for delivery of medications to sensitive areas such as ocular tissues with enhanced absorption in the lacrimal gland. In addition, the composition has stability for up to 9 mo without crystallization of cyclosporin.

For example, an ophthalmic emulsion containing cyclosporin A 0.2, castor oil 2.5, Polysorbate-80 1.0, Pemulen 0.05, glycerol 2.2, NaOH q.s., and purified water to 100% was formulated to treat keratoconjunctivitis sicca.

OS.CITING REF COUNT: 36 THERE ARE 36 CAPLUS RECORDS THAT CITE THIS RECORD (38 CITINGS)  
REFERENCE COUNT: 2 THERE ARE 2 CITED REFERENCES AVAILABLE FOR THIS RECORD. ALL CITATIONS AVAILABLE IN THE RE FORMAT

=> logoff h

| COST IN U.S. DOLLARS | SINCE FILE ENTRY | TOTAL SESSION |
|----------------------|------------------|---------------|
| FULL ESTIMATED COST  | 34.05            | 34.29         |

SESSION WILL BE HELD FOR 120 MINUTES  
STN INTERNATIONAL SESSION SUSPENDED AT 10:09:07 ON 05 OCT 2013

**Interview Agenda**

**U.S. Patent Application Nos. 13/967,189; 13/967,179; 13/967,163; and 13/967,168 – METHODS OF PROVIDING THERAPEUTIC EFFECTS USING CYCLOSPORIN COMPONENTS**

**Examiner Marcela Cordero Garcia – (410) 262-3037**

- **Introduction**
- **Discussion of Claimed Subject Matter**
  - **Background on Dry Eye Disease**
  - **The Development and Innovation of the Claimed Formulation**
- **Presentation of Objective Evidence of Non-Obviousness**
  - **Unexpected Results**
  - **Commercial Success**
  - **Long Felt Need/Failure of Others**
- **Brief Discussion of Prior Art**
  - **Ding (U.S. Patent No. 5,474,979)**
- **Discussion of Clarifying Amendments**

**UNITED STATES PATENT AND TRADEMARK OFFICE**

UNITED STATES DEPARTMENT OF COMMERCE  
**United States Patent and Trademark Office**  
 Address: COMMISSIONER FOR PATENTS  
 P.O. Box 1450  
 Alexandria, Virginia 22313-1450  
 www.uspto.gov

**BIB DATA SHEET**
**CONFIRMATION NO. 4818**

| SERIAL NUMBER   | FILING or 371(c)<br>DATE  | CLASS  | GROUP ART UNIT          | ATTORNEY DOCKET<br>NO.  |                     |                           |
|---|---|--|-------------------------|---|---------------------|---------------------------|
| 13/967,189  | 08/14/2013  | 514  | 1658                    | 17618CON2B (AP)   |                     |                           |
| <b>APPLICANTS</b><br>Allergan, Inc., Irvine, CA, Assignee (with 37 CFR 1.172 Interest);<br>Andrew Acheampong, Irvine, CA;<br>Diane D. Tang-Liu, Las Vegas, NV;<br>James N. Chang, Newport Beach, CA;<br>David F. Power, Hubert, NC; |   |  |                         |   |                     |                           |
| <b>** CONTINUING DATA *****</b><br>This application is a CON of 13/961,808 08/07/2013<br>which is a CON of 11/897,177 08/28/2007<br>which is a CON of 10/927,857 08/27/2004 ABN<br>which claims benefit of 60/503,137 09/15/2003    |   |  |                         |   |                     |                           |
| <b>** FOREIGN APPLICATIONS *****</b>  |   |  |                         |   |                     |                           |
| <b>** IF REQUIRED, FOREIGN FILING LICENSE GRANTED **</b><br>08/29/2013  |   |  |                         |   |                     |                           |
| Foreign Priority claimed  | <input type="checkbox"/> Yes <input checked="" type="checkbox"/> No   | <input type="checkbox"/> Met after Allowance | <b>STATE OR COUNTRY</b> | <b>SHEETS DRAWINGS</b>  | <b>TOTAL CLAIMS</b> | <b>INDEPENDENT CLAIMS</b> |
| 35 USC 119(a-d) conditions met  | <input type="checkbox"/> Yes <input checked="" type="checkbox"/> No   |  | CA                      | 0   | 24                  | 3                         |
| Verified and  | /MARCELA M CORDERO GARCIA/<br>Examiner's Signature  |  | Initials                |   |                     |                           |
| Acknowledged  |   |  |                         |   |                     |                           |
| <b>ADDRESS</b><br>ALLERGAN, INC.<br>2525 DUPONT DRIVE, T2-7H<br>IRVINE, CA 92612-1599<br>UNITED STATES  |   |  |                         |   |                     |                           |
| <b>TITLE</b><br>METHODS OF PROVIDING THERAPEUTIC EFFECTS USING CYCLOSPORIN COMPONENTS   |   |  |                         |   |                     |                           |
| <b>FILING FEE RECEIVED</b><br>2220  | FEES: Authority has been given in Paper<br>No. _____ to charge/credit DEPOSIT ACCOUNT<br>No. _____ for following: |  |                         | <input type="checkbox"/> All Fees<br><input type="checkbox"/> 1.16 Fees (Filing)<br><input type="checkbox"/> 1.17 Fees (Processing Ext. of time)<br><input type="checkbox"/> 1.18 Fees (Issue)<br><input type="checkbox"/> Other _____<br><input type="checkbox"/> Credit |                     |                           |

**DRAFT CLAIM AMENDMENT**  
U.S. Patent Application No. 13/967,189  
Attorney Ref: 17618CON2B (AP)  
FOR DISCUSSION PURPOSES ONLY

37. (**Currently Amended**) A topical ophthalmic emulsion for treating an eye of a human, wherein the topical ophthalmic emulsion comprises cyclosporin A in an amount of about 0.05% by weight, polysorbate 80, ~~Pemulen-acrylate/C10-30 alkyl acrylate cross-polymer~~, water, and castor oil in an amount of about 1.25% by weight; and

wherein the topical ophthalmic emulsion is therapeutically effective in treating dry eye disease.

59. (**Currently Amended**) A topical ophthalmic emulsion for treating an eye of a human, the topical ophthalmic emulsion comprising:

cyclosporin A in an amount of about 0.05% by weight;

castor oil in an amount of about 1.25% by weight;

polysorbate 80 in an amount of about 1.0% by weight;

~~Pemulen-acrylate/C10-30 alkyl acrylate cross-polymer~~ in an amount of about 0.05% by weight;

glycerine in an amount of about 2.2% by weight;

sodium hydroxide; and

water;

wherein the emulsion is therapeutically effective in treating dry eye disease.

|  |   |   |
|--|---|---|
| <b>Search Notes</b><br><br> | <b>Application/Control No.</b><br><br>13967189  | <b>Applicant(s)/Patent Under Reexamination</b><br><br>ACHEAMPONG ET AL. |
|  | <b>Examiner</b><br><br>MARCELA M CORDERO GARCIA | <b>Art Unit</b><br><br>1658   |

| CPC- SEARCHED |      |          |
|---------------|------|----------|
| Symbol        | Date | Examiner |
|               |      |          |

| CPC COMBINATION SETS - SEARCHED |      |          |
|---------------------------------|------|----------|
| Symbol                          | Date | Examiner |
|                                 |      |          |

| US CLASSIFICATION SEARCHED |          |           |          |
|----------------------------|----------|-----------|----------|
| Class                      | Subclass | Date      | Examiner |
| none                       | none     | 10/4/2013 | MMCG     |

| SEARCH NOTES                  |           |          |
|-------------------------------|-----------|----------|
| Search Notes                  | Date      | Examiner |
| EAST search (attached)        | 10/5/2013 | MMCG     |
| STN search (attached)         | 10/5/2013 | MMCG     |
| also ran PALM inventor search | 10/5/2013 | MMCG     |

| INTERFERENCE SEARCH     |                         |      |          |
|-------------------------|-------------------------|------|----------|
| US Class/<br>CPC Symbol | US Subclass / CPC Group | Date | Examiner |
|                         |                         |      |          |

|  |  |
|--|--|
|  |  |
|--|--|

|   |                        |                    |            |  |
|---|------------------------|--------------------|------------|--|
| <b>INFORMATION DISCLOSURE<br/>STATEMENT BY APPLICANT</b><br>( Not for submission under 37 CFR 1.99) | Application Number     |                    | 13967189   |  |
|   | Filing Date            |                    | 2013-08-14 |  |
|   | First Named Inventor   | ACHEAMPONG, ANDREW |            |  |
|   | Art Unit               | 1653               |            |  |
|   | Examiner Name          | TBD                |            |  |
|   | Attorney Docket Number | 17618-US-BCON2-AP  |            |  |

ALL REFERENCES CONSIDERED EXCEPT WHERE LINED THROUGH. /M.M.C.G./

| U.S.PATENTS       |         |               |                        |            |   |  |
|-------------------|---------|---------------|------------------------|------------|---|--|
| Examiner Initial* | Cite No | Patent Number | Kind Code <sup>1</sup> | Issue Date | Name of Patentee or Applicant of cited Document | Pages,Columns,Lines where Relevant Passages or Relevant Figures Appear |
|                   | 1       |               |                        |            |   |  |

If you wish to add additional U.S. Patent citation information please click the Add button.

| U.S.PATENT APPLICATION PUBLICATIONS |         |                    |                        |                  |   |  |
|-------------------------------------|---------|--------------------|------------------------|------------------|---|--|
| Examiner Initial*                   | Cite No | Publication Number | Kind Code <sup>1</sup> | Publication Date | Name of Patentee or Applicant of cited Document | Pages,Columns,Lines where Relevant Passages or Relevant Figures Appear |
|                                     | 1       |                    |                        |                  |   |  |

If you wish to add additional U.S. Published Application citation information please click the Add button.

| FOREIGN PATENT DOCUMENTS |         |                                      |                           |                        |                  |   |  |                          |
|--------------------------|---------|--------------------------------------|---------------------------|------------------------|------------------|---|--|--------------------------|
| Examiner Initial*        | Cite No | Foreign Document Number <sup>3</sup> | Country Code <sup>2</sup> | Kind Code <sup>4</sup> | Publication Date | Name of Patentee or Applicant of cited Document | Pages,Columns,Lines where Relevant Passages or Relevant Figures Appear | T <sup>5</sup>           |
|                          | 1       |                                      |                           |                        |                  |   |  | <input type="checkbox"/> |

If you wish to add additional Foreign Patent Document citation information please click the Add button

| NON-PATENT LITERATURE DOCUMENTS |         |   |                |
|---------------------------------|---------|---|----------------|
| Examiner Initials*              | Cite No | Include name of the author (in CAPITAL LETTERS), title of the article (when appropriate), title of the item (book, magazine, journal, serial, symposium, catalog, etc), date, pages(s), volume-issue number(s), publisher, city and/or country where published. | T <sup>5</sup> |
|                                 |         |   |                |

|  |                        |                    |            |                      |
|--|------------------------|--------------------|------------|----------------------|
| <b>Receipt date: 09/25/2013</b><br><br><b>INFORMATION DISCLOSURE STATEMENT BY APPLICANT</b><br>( Not for submission under 37 CFR 1.99) | Application Number     |                    | 13967189   | 13967189 - GAU: 1658 |
|  | Filing Date            |                    | 2013-08-14 |                      |
|  | First Named Inventor   | ACHEAMPONG, ANDREW |            |                      |
|  | Art Unit               | 1653               |            |                      |
|  | Examiner Name          | TBD                |            |                      |
|  | Attorney Docket Number | 17618-US-BCON2-AP  |            |                      |

ALL REFERENCES CONSIDERED EXCEPT WHERE LINED THROUGH. /M.M.C.G./

|   |  |                          |
|---|--|--------------------------|
| 1 | U.S. Re-Examination Application: 90/009,944 and its entire prosecution history, Filed on August, 27, 2011 ** | <input type="checkbox"/> |
|---|--|--------------------------|

If you wish to add additional non-patent literature document citation information please click the Add button

**EXAMINER SIGNATURE**

|                    |                                 |                 |            |
|--------------------|---------------------------------|-----------------|------------|
| Examiner Signature | <i>/Marcela Cordero Garcia/</i> | Date Considered | 10/04/2013 |
|--------------------|---------------------------------|-----------------|------------|

\*EXAMINER: Initial if reference considered, whether or not citation is in conformance with MPEP 609. Draw line through a citation if not in conformance and not considered. Include copy of this form with next communication to applicant.

<sup>1</sup> See Kind Codes of USPTO Patent Documents at [www.USPTO.GOV](http://www.USPTO.GOV) or MPEP 901.04. <sup>2</sup> Enter office that issued the document, by the two-letter code (WIPO Standard ST.3). <sup>3</sup> For Japanese patent documents, the indication of the year of the reign of the Emperor must precede the serial number of the patent document. <sup>4</sup> Kind of document by the appropriate symbols as indicated on the document under WIPO Standard ST.16 if possible. <sup>5</sup> Applicant is to place a check mark here if English language translation is attached.

|   |                        |                    |                      |
|---|------------------------|--------------------|----------------------|
| <b>Receipt date: 09/25/2013</b><br><br><b>INFORMATION DISCLOSURE STATEMENT BY APPLICANT</b><br><b>( Not for submission under 37 CFR 1.99)</b> | Application Number     | 13967189           | 13967189 - GAU: 1658 |
|   | Filing Date            | 2013-08-14         |                      |
|   | First Named Inventor   | ACHEAMPONG, ANDREW |                      |
|   | Art Unit               | 1653               |                      |
|   | Examiner Name          | TBD                |                      |
|   | Attorney Docket Number | 17618-US-BCON2-AP  |                      |

**CERTIFICATION STATEMENT**

Please see 37 CFR 1.97 and 1.98 to make the appropriate selection(s):

That each item of information contained in the information disclosure statement was first cited in any communication from a foreign patent office in a counterpart foreign application not more than three months prior to the filing of the information disclosure statement. See 37 CFR 1.97(e)(1).

**OR**

That no item of information contained in the information disclosure statement was cited in a communication from a foreign patent office in a counterpart foreign application, and, to the knowledge of the person signing the certification after making reasonable inquiry, no item of information contained in the information disclosure statement was known to any individual designated in 37 CFR 1.56(c) more than three months prior to the filing of the information disclosure statement. See 37 CFR 1.97(e)(2).

\*\* Signature indicates consideration of publication and file history. The Examiner has access to these materials through the PTO computer systems. If additional copies are desired, please notify the Applicants through their attorneys.

- See attached certification statement.
- Fee set forth in 37 CFR 1.17 (p) has been submitted herewith.
- None

**SIGNATURE**

A signature of the applicant or representative is required in accordance with CFR 1.33, 10.18. Please see CFR 1.4(d) for the form of the signature.

|            |                 |                     |            |
|------------|-----------------|---------------------|------------|
| Signature  | /Laura L. Wine/ | Date (YYYY-MM-DD)   | 2013-09-24 |
| Name/Print | Laura L. Wine   | Registration Number | 68,681     |

This collection of information is required by 37 CFR 1.97 and 1.98. The information is required to obtain or retain a benefit by the public which is to file (and by the USPTO to process) an application. Confidentiality is governed by 35 U.S.C. 122 and 37 CFR 1.14. This collection is estimated to take 1 hour to complete, including gathering, preparing and submitting the completed application form to the USPTO. Time will vary depending upon the individual case. Any comments on the amount of time you require to complete this form and/or suggestions for reducing this burden, should be sent to the Chief Information Officer, U.S. Patent and Trademark Office, U.S. Department of Commerce, P.O. Box 1450, Alexandria, VA 22313-1450. **DO NOT SEND FEES OR COMPLETED FORMS TO THIS ADDRESS. SEND TO: Commissioner for Patents, P.O. Box 1450, Alexandria, VA 22313-1450.**



**Privacy Act Statement**

The Privacy Act of 1974 (P.L. 93-579) requires that you be given certain information in connection with your submission of the attached form related to a patent application or patent. Accordingly, pursuant to the requirements of the Act, please be advised that: (1) the general authority for the collection of this information is 35 U.S.C. 2(b)(2); (2) furnishing of the information solicited is voluntary; and (3) the principal purpose for which the information is used by the U.S. Patent and Trademark Office is to process and/or examine your submission related to a patent application or patent. If you do not furnish the requested information, the U.S. Patent and Trademark Office may not be able to process and/or examine your submission, which may result in termination of proceedings or abandonment of the application or expiration of the patent.

The information provided by you in this form will be subject to the following routine uses:

1. The information on this form will be treated confidentially to the extent allowed under the Freedom of Information Act (5 U.S.C. 552) and the Privacy Act (5 U.S.C. 552a). Records from this system of records may be disclosed to the Department of Justice to determine whether the Freedom of Information Act requires disclosure of these records.
2. A record from this system of records may be disclosed, as a routine use, in the course of presenting evidence to a court, magistrate, or administrative tribunal, including disclosures to opposing counsel in the course of settlement negotiations.
3. A record in this system of records may be disclosed, as a routine use, to a Member of Congress submitting a request involving an individual, to whom the record pertains, when the individual has requested assistance from the Member with respect to the subject matter of the record.
4. A record in this system of records may be disclosed, as a routine use, to a contractor of the Agency having need for the information in order to perform a contract. Recipients of information shall be required to comply with the requirements of the Privacy Act of 1974, as amended, pursuant to 5 U.S.C. 552a(m).
5. A record related to an International Application filed under the Patent Cooperation Treaty in this system of records may be disclosed, as a routine use, to the International Bureau of the World Intellectual Property Organization, pursuant to the Patent Cooperation Treaty.
6. A record in this system of records may be disclosed, as a routine use, to another federal agency for purposes of National Security review (35 U.S.C. 181) and for review pursuant to the Atomic Energy Act (42 U.S.C. 218(c)).
7. A record from this system of records may be disclosed, as a routine use, to the Administrator, General Services, or his/her designee, during an inspection of records conducted by GSA as part of that agency's responsibility to recommend improvements in records management practices and programs, under authority of 44 U.S.C. 2904 and 2906. Such disclosure shall be made in accordance with the GSA regulations governing inspection of records for this purpose, and any other relevant (i.e., GSA or Commerce) directive. Such disclosure shall not be used to make determinations about individuals.
8. A record from this system of records may be disclosed, as a routine use, to the public after either publication of the application pursuant to 35 U.S.C. 122(b) or issuance of a patent pursuant to 35 U.S.C. 151. Further, a record may be disclosed, subject to the limitations of 37 CFR 1.14, as a routine use, to the public if the record was filed in an application which became abandoned or in which the proceedings were terminated and which application is referenced by either a published application, an application open to public inspections or an issued patent.
9. A record from this system of records may be disclosed, as a routine use, to a Federal, State, or local law enforcement agency, if the USPTO becomes aware of a violation or potential violation of law or regulation.

**IN THE UNITED STATES PATENT AND TRADEMARK OFFICE**

Applicant: Acheampong, *et al.*

Serial No.: 13/967,189

Filed: August 14, 2013

For: METHODS OF PROVIDING  
THERAPEUTIC EFFECTS USING  
CYCLOSPORIN COMPONENTS

Examiner: Marcela M Cordero Garcia

Group Art Unit: 1658

Confirmation No. 4818

Customer No.: 51957

**RESPONSE TO NON FINAL OFFICE ACTION DATED OCTOBER 10, 2013**

Commissioner for Patents  
P.O. Box 1450  
Alexandria, VA 22313-1450

Dear Sir:

These papers are filed in reply to the Office Action mailed October 10, 2013.

Amendments to the claims begin at page 2;

Summary of the Interview begins at page 6;

Remarks follow on page 7.

**AMENDMENTS TO THE CLAIMS**

The following claims replace all prior versions of claims submitted in this application. Only those claims being amended herein show their changes in highlighted form, where insertions appear as underlined text (e.g., insertions) while deletions appear as strikethrough or surrounded by double brackets (e.g. deletions or [[deletions]]).

1. – 36. (Canceled)

37. **(Currently Amended)** A first topical ophthalmic emulsion for treating an eye of a human, wherein the first topical ophthalmic emulsion comprises cyclosporin A in an amount of about 0.05% by weight, polysorbate 80, ~~Pemulen~~ acrylate/C10-30 alkyl acrylate cross-polymer, water, and castor oil in an amount of about 1.25% by weight; and

wherein the first topical ophthalmic emulsion is therapeutically effective in treating dry eye disease; and

wherein the first topical ophthalmic emulsion provides overall efficacy substantially equal to a second topical ophthalmic emulsion comprising cyclosporin A in an amount of about 0.1% by weight and castor oil in an amount of about 1.25% by weight.

38. **(Currently Amended)** The first topical ophthalmic emulsion of Claim 37, wherein the first topical ophthalmic emulsion further comprises a tonicity agent or a demulcent component.

39. **(Currently Amended)** The first topical ophthalmic emulsion of Claim 38, wherein the tonicity agent or the demulcent component is glycerine.

40. **(Currently Amended)** The first topical ophthalmic emulsion of Claim 37, wherein the first topical ophthalmic emulsion further comprises a buffer.

41. **(Currently Amended)** The first topical ophthalmic emulsion of Claim 40, wherein the buffer is sodium hydroxide.

42. **(Currently Amended)** The first topical ophthalmic emulsion of Claim 37, wherein the first topical ophthalmic emulsion further comprises glycerine and a buffer.

43. **(Currently Amended)** The first topical ophthalmic emulsion of Claim 37, wherein the first topical ophthalmic emulsion comprises polysorbate 80 in an amount of about 1.0% by weight.

44. **(Currently Amended)** The first topical ophthalmic emulsion of Claim 37, wherein the first topical ophthalmic emulsion comprises ~~Penulen~~ acrylate/C10-30 alkyl acrylate cross-polymer in an amount of about 0.05% by weight.

45. **(Currently Amended)** The first topical ophthalmic emulsion of Claim 37, wherein the first topical ophthalmic emulsion further comprises glycerine in an amount of about 2.2% by weight and a buffer.

46. **(Currently Amended)** The first topical ophthalmic emulsion of Claim 45, wherein the buffer is sodium hydroxide.

47. **(Currently Amended)** The first topical ophthalmic emulsion of Claim 37, wherein, when the first topical ophthalmic emulsion is administered to an eye of a human in an effective amount in treating dry eye disease, the blood of the human has substantially no detectable concentration of cyclosporin A.

48. **(Currently Amended)** The first topical ophthalmic emulsion of Claim 42, wherein the first topical ophthalmic emulsion has a pH in the range of about 7.2 to about 7.6.

49. – 60. (Canceled)

61. **(New)** A first topical ophthalmic emulsion for treating an eye of a human, wherein the first topical ophthalmic emulsion comprises cyclosporin A in an amount of about 0.05% by weight, polysorbate 80, acrylate/C10-30 alkyl acrylate cross-polymer, water, and castor oil in an amount of about 1.25% by weight; and

wherein the first topical ophthalmic emulsion is therapeutically effective in treating dry eye disease and wherein the first topical ophthalmic emulsion achieves at least as much therapeutic effectiveness as a second topical ophthalmic emulsion comprising cyclosporin A in an amount of about 0.1% by weight and castor oil in an amount of about 1.25% by weight.

62. **(New)** A first topical ophthalmic emulsion for treating an eye of a human, wherein the first topical ophthalmic emulsion comprises cyclosporin A in an amount of about 0.05% by weight, polysorbate 80, acrylate/C10-30 alkyl acrylate cross-polymer, water, and castor oil in an amount of about 1.25% by weight; and

wherein the first topical ophthalmic emulsion breaks down more quickly in the eye of a human, once administered to the eye of the human, thereby reducing vision distortion in the eye of the human as compared to a second topical ophthalmic emulsion that contains only about 50% as much castor oil as the first topical ophthalmic emulsion.

63. **(New)** A first topical ophthalmic emulsion for treating an eye of a human, wherein the first topical ophthalmic emulsion comprises cyclosporin A in an amount of about 0.05% by weight, polysorbate 80, acrylate/C10-30 alkyl acrylate cross-polymer, water, and castor oil in an amount of about 1.25% by weight; and

wherein the first topical ophthalmic emulsion, when administered to the eye of a human, demonstrates a reduction in adverse events in the human, relative to a second topical ophthalmic emulsion comprising cyclosporin A in an amount of about 0.1% by weight and castor oil in an amount of about 1.25% by weight.

64. **(New)** The first topical ophthalmic emulsion of Claim 63, wherein the adverse events are side effects.

65. **(New)** The first topical ophthalmic emulsion of Claim 64, wherein the side effects are selected from the group consisting of visual distortion and eye irritation.

66. **(New)** The first topical ophthalmic emulsion of Claim 61, wherein, when the first topical ophthalmic emulsion is administered to an eye of a human, the blood of the human has substantially no detectable concentration of cyclosporin A.

67. **(New)** The first topical ophthalmic emulsion of Claim 62, wherein, when the first topical ophthalmic emulsion is administered to an eye of a human, the blood of the human has substantially no detectable concentration of cyclosporin A.

68. **(New)** The first topical ophthalmic emulsion of Claim 63, wherein, when the first topical ophthalmic emulsion is administered to an eye of a human, the blood of the human has substantially no detectable concentration of cyclosporin A.

## SUMMARY OF INTERVIEW

### Attendees, Date and Type of Interview

An in-person interview was conducted on October 3, 2013 at the USPTO and was attended by Examiner Cordero Garcia, Laura L. Wine, Dr. Rhett Schiffman, Dr. Mayssa Attar, and Debra Condino.

### Exhibits and/or Demonstrations

Data demonstrating unexpected results and commercial success of the claimed formulation were presented. Data and information regarding the claimed formulation's satisfaction of a long felt need were also presented.

### Identification of Claims Discussed

The Claims were discussed, focusing on Claims 37 and 54.

### Identification of Prior Art Discussed

The prior art of record was discussed, focusing on Ding (U.S. Patent No. 5,474,979).

### Principal Arguments and Other Matters

The Applicants presented data demonstrating unexpected results, commercial success, and satisfaction of a long felt need of the claimed formulation. While the Applicants do not acquiesce to any *prima facie* case of obviousness, the evidence of non-obviousness presented at the interview overcomes the *prima facie* obviousness rejection.

### Results of Interview

It was agreed that the evidence of non-obviousness presented rendered the claims allowable and overcame the prior art of record. It was agreed that the Applicants would file a response, presenting arguments discussed at the interview.

## REMARKS

This Reply responds to the Office Action sent October 10, 2013, in which the Office Action rejected Claims 37-60. Claims 49-60 are newly cancelled. Claims 37-48 have been amended. Claims 61-68 are new. Thus, Claims 37-48 and 61-68 are currently pending. No new matter has been added by this amendment, and all amendments to the claims are fully supported by the originally filed application. The Applicants respectfully submit that the claims are in condition for allowance.

### Claim Rejections

#### *35 U.S.C. § 112, second paragraph*

Claims 37-60 were rejected under 35 U.S.C. § 112, second paragraph as being indefinite for failing to particularly point out and distinctly claim the subject matter which Applicants regard as the invention. The Applicants submit that the amendments to the claims submitted herewith render the rejection under 35 U.S.C. § 112, second paragraph moot. Thus, the Applicants respectfully request that the claim rejections under 35 U.S.C. § 112, second paragraph be withdrawn.

#### 35 U.S.C. 103(a)

The Office Action rejected Claims 37-60 under 35 U.S.C. 103(a) as being unpatentable as obvious in view of U.S. Patent No. 5,474,979 to Ding et al. (“Ding”).

The Applicants submit that the *prima facie* case of obviousness has not been properly established against the pending claims. However, the Applicants submit that the unexpected results, commercial success, and satisfaction of long felt need obtained with the claimed formulations and failure of others overcome the *prima facie* obviousness rejection asserted in the Office Action.

The Federal Circuit has held that objective evidence of nonobviousness must always be taken into account before a conclusion on obviousness is reached. Similarly, M.P.E.P. 716.01(a) states that “[a]ffidavits or declarations, when timely presented, containing evidence of criticality or unexpected results, commercial success, long-left but unsolved needs, failure of others, skepticism of experts, etc., must be considered by the



Patent Office in determining the issue of obviousness of claims for patentability under 35 U.S.C. 103.” Thus, the *Graham* factors, including the use of objective evidence of secondary considerations to rebut a *prima facie* case of obviousness, remains the framework to be followed for a determination of obviousness. The Federal Circuit has even stated that “evidence of secondary considerations may often be the most probative and cogent evidence in the record. It may often establish that an invention appearing to have been obvious in light of the prior art was not.” See, *Stratoflex Inc. v. Aeroquip Corp.*, 713 F.2d 1530, 1538 (Fed. Cir. 1983).

*The Claimed Formulations Provide Surprising and Unexpected Results*

As discussed in the interview with the Examiner, the claimed formulations provide surprising and unexpected results in view of the prior art (e.g. Ding). According to MPEP § 2144.05 (III), the Applicants can rebut a presumption of obviousness based on a claimed invention that falls within a prior art range by showing “(1) [t]hat the prior art taught away from the claimed invention...or (2) **that there are new and unexpected results relative to the prior art.**” *Iron Grip Barbell Co., Inc. v. USA Sports, Inc.*, 392 F.3d 1317, 1322, 73 USPQ2d 1225, 1228 (Fed. Cir. 2004).

In support of this position, the Applicants submit herewith as Exhibit 1 a Declaration of Dr. Rhett M. Schiffman under 37 C.F.R. § 1.132 (hereinafter, “Schiffman Declaration 1”), Chief Medical Officer at Neurotech, with over 12 years of experience as a clinician in the eye care field. The Applicants also submit herewith as Exhibit 2, a Declaration of Dr. Mayssa Attar under 37 C.F.R. § 1.132 (hereinafter, “Attar Declaration”), Research Investigator at Allergan, Inc., the assignee of record of the present application, with about 15 years of experience in the pharmacokinetics field.

As described by Dr. Schiffman and Dr. Attar in their respective declarations, supported by examples and experiments, the claimed formulations provided unexpected results compared to the prior art with regards to two key objective testing parameters for dry eye or keratoconjunctivis sicca: Schirmer Tear Testing and decrease in corneal staining, and with regards to reduction in blurred vision and decreased use of artificial tears. Specifically, the claimed formulations provided unexpected results compared to

formulations 1E and 1D disclosed in Ding, which included 0.05% by weight cyclosporin A and 0.625% by weight castor oil and 0.10% by weight cyclosporin A and 1.25% by weight castor oil, respectively. *See* Ding, col. 4, lines 34-43.

As described by Dr. Schiffman in paragraphs 17-20 of Schiffman Declaration 1 and as seen in Exhibits E and F to Schiffman Declaration 1, surprisingly, the claimed formulation demonstrated an 8-fold increase in relative efficacy for the Schirmer Tear Test score in the first study of Allergan’s Phase 3 trials compared to the relative efficacy for the 0.05% by weight cyclosporin A/0.625% by weight castor oil formulation disclosed in Example 1E of Ding, tested in Phase 2 trials. The data presented herewith represents the subpopulation of Phase 2 patients with the same reductions in tear production ( $\leq 5$  mm/5 min) as those enrolled in the Phase 3 studies. Schiffman Declaration 1 at ¶ 8. Exhibits E and F also illustrate that the claimed formulations also demonstrated a 4-fold improvement in the relative efficacy for the Schirmer Tear Test score for the second study of Phase 3 and a 4-fold increase in relative efficacy for decrease in corneal staining score in both of the Phase 3 studies compared to the 0.05% by weight cyclosporin A/0.625% by weight castor oil formulation tested in Phase 2 and disclosed in Ding (Ding 1E). This was clearly a very surprising and unexpected result.

**Exhibit E of Schiffman Declaration 1**

|                              | Phase 2 001                        | Phase 3 (1 <sup>st</sup> study) | Phase 3 (2 <sup>nd</sup> study) |
|------------------------------|------------------------------------|---------------------------------|---------------------------------|
|                              | 0.05% CsA in 0.625% CO             | 0.05% CsA in 1.25% CO           | 0.05% CsA in 1.25% CO           |
|                              | Compared with 0.1% CsA in 1.25% CO |                                 |                                 |
| Improvement in STT           | 0.25                               | 2<br>(8-Fold Improvement*)      | 1<br>(4-Fold Improvement*)      |
| Decrease in Corneal Staining | 0.25                               | 1<br>(4-Fold Improvement*)      | 1<br>(4-Fold Improvement*)      |

\*Compared to the 0.05% CsA/0.625% CO Phase 2 formulation (disclosed in Ding)

**Exhibit F of Schiffman Declaration 1**

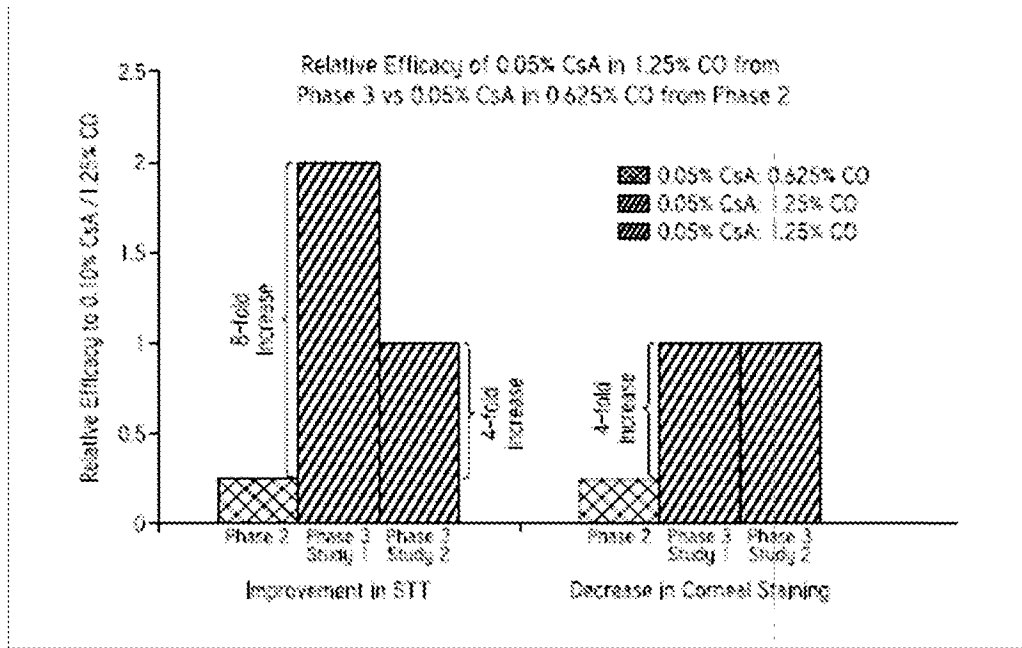

This dramatic increase in relative efficacy between the claimed formulation and the formulation disclosed in Examples 1E and 1D of Ding was especially unexpected in view of pharmacokinetic data. As described by Dr. Attar in paragraph 7 of the Attar Declaration, pharmacokinetic studies were performed on animal eyes, which compared the pharmacokinetic properties of several cyclosporin A-containing formulations, including formulations containing 0.05% by weight cyclosporin A and 0.625% by weight castor oil, formulations containing 0.05% by weight cyclosporin A and 1.25% by weight castor oil, and formulations containing 0.1% by weight cyclosporin A and 1.25% by weight castor oil. This data was compiled and organized in Exhibit B to the Attar Declaration, reproduced below:

**Exhibit B to Attar Declaration**

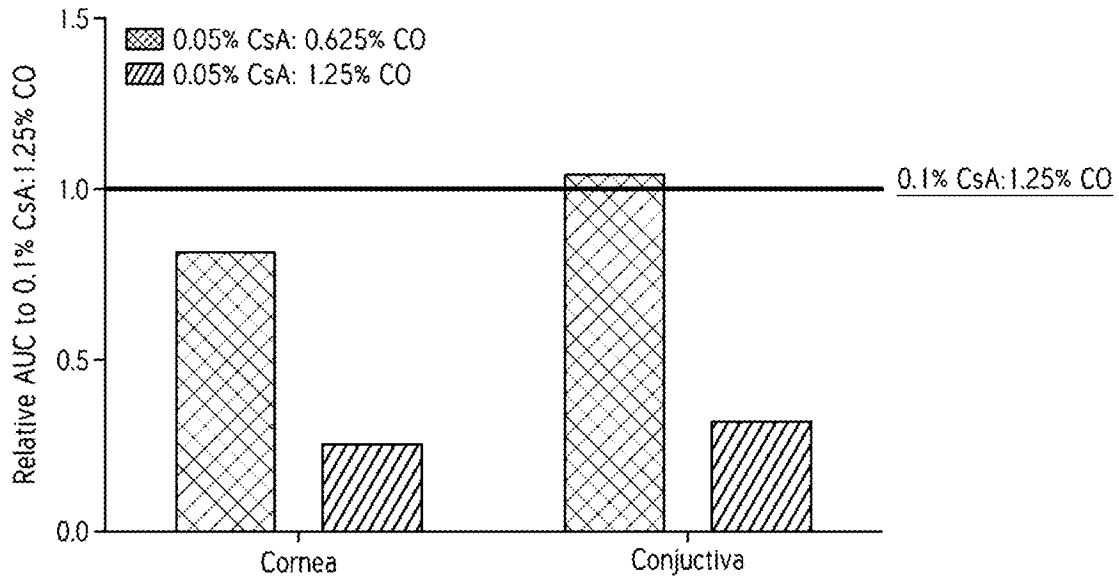

As described in paragraph 7 of the Attar Declaration, this chart shows that the amount of cyclosporin A that reaches the cornea and conjunctiva, ocular tissues that are highly relevant for the treatment of dry eye or keratoconjunctivitis sicca, is higher for the formulation containing 0.05% by weight cyclosporin A and 0.625% by weight castor oil (Ding 1E) than the formulation containing 0.05% by weight cyclosporin A and 1.25% by weight castor oil (the claimed formulation) relative to the formulation containing 0.1% by weight cyclosporin A and 1.25% by weight castor oil (Ding 1D). According to Dr. Attar, this data teaches that the formulation containing 0.05% by weight cyclosporin A and 1.25% by weight castor oil would be less therapeutically effective than the formulation containing 0.05% by weight cyclosporin A and 0.625% by weight castor oil or the formulation containing 0.10% by weight cyclosporin A and 1.25% by weight castor oil. Attar Declaration at ¶ 8. Similarly, according to Dr. Schiffman, this data shows that, since lower levels of cyclosporin A were reaching the ocular tissues relevant for the treatment of dry eye, one of skill in the art would have expected patients receiving the claimed formulation to exhibit a lesser decrease from baseline in corneal staining score

and a lesser increase from baseline in Schirmer Score relative to the corneal staining scores and Schirmer Scores of the patients receiving the 0.05% by weight cyclosporin A / 0.625% by weight castor oil formulation (Ding 1E) in the Phase 2 trials, as illustrated in Schiffman Declaration 1, Exhibit B. *See* Schiffman Declaration 1 at ¶ 13.

As described by Dr. Schiffman in paragraphs 14-15 of Schiffman Declaration 1, surprisingly, the claimed formulation was equally or more therapeutically effective for the treatment of dry eye or keratoconjunctivitis sicca than the formulation containing 0.10% by weight cyclosporin A and 1.25% by weight castor oil (Ding 1D) according to corneal staining score, Schirmer Score, an improvement in the common dry eye/keratoconjunctivitis sicca symptom of blurred vision and a greater decrease in the number of artificial tears used by patients.

Taking the results of the studies and data presented in the Attar and Schiffman 1 Declarations together, it is clear that the specific combination of 0.05% by weight cyclosporin A with 1.25% by weight castor oil is surprisingly critical for therapeutic effectiveness in the treatment of dry eye or keratoconjunctivitis sicca.

Accordingly, the Applicants submit that the Declarations of Drs. Rhett M. Schiffman (Schiffman Declaration 1) and Attar, together with the data presented in those declarations, provide clear and convincing objective evidence that establishes that the claimed formulations, including 0.05% by weight cyclosporin A and 1.25% by weight castor oil, demonstrate surprising and unexpected results, including improved Schirmer Tear Test scores and corneal staining scores (key objective measures of efficacy for dry eye or keratoconjunctivitis sicca) and improved visual blurring and reduced artificial tear use as compared to the prior art, for example, emulsion formulations disclosed in Ding, including formulations with 0.05% by weight cyclosporin A and 0.625% by weight castor oil (Ding 1E) and formulations with 0.10% by weight cyclosporin A and 1.25% by weight castor oil (Ding 1D).

*The Claimed Formulations are Commercially Successful*

As discussed during the Examiner interview, in addition to having surprising and unexpected results, the claimed formulations have demonstrated commercial success. In

support of this position, the Applicants submit herewith as Exhibit 3, a Declaration of Aziz Mottiwala under 37 C.F.R. § 1.132 (hereinafter, “Mottiwala Declaration”), Vice President of Marketing at Allergan for Allergan’s Dry Eye Product Franchise.

As explained by Mr. Mottiwala, RESTASIS®, which is a commercial embodiment of the claimed formulation, has been sold since 2003. *See* Mottiwala Declaration at ¶ 2. Since the launch of RESTASIS® in 2003, worldwide sales of the drug have increased steadily. *See* Mottiwala Declaration at ¶ 3 and Exhibit B to Mottiwala Declaration. Currently, annual world-wide net sales for RESTASIS® are over \$200 million per quarter, and nearing \$800 million annually. *See* Mottiwala Declaration at ¶ 4. This is strong evidence of commercial success. *See Id.* As there is no other FDA-Approved therapeutic treatment for dry eye available on the US market, RESTASIS® owns 100% of the market share. *Id.*

Accordingly, the Applicants assert that the Declaration of Aziz Mottiwala provides objective evidence that unequivocally establishes that the present invention as embodied in RESTASIS® has been met with commercial success.

#### *The Claimed Formulations Satisfied a Long-Felt Need*

As discussed during the Interview, the claimed formulations also resolve a long-felt need. In support of this position, the Applicants submit herewith as Exhibit 4, a Declaration of Dr. Rhett M. Schiffman under 37 C.F.R. § 1.132 (hereinafter, “Schiffman Declaration 2”).

According to the MPEP, establishing long-felt need requires objective evidence that an art recognized problem existed in the art for a long period of time without solution. *See* MPEP § 716.04.

First, the need must have been a persistent one that was recognized by those of ordinary skill in the art. *Id.* As explained by Dr. Schiffman, dry eye/keratoconjunctivis sicca has been a known, persistent ocular disorder for many years. Publications on dry eye date back to at least the 1970’s, and interest and publication on the subject has increased substantially since. *See* Schiffman Declaration 2 at ¶¶ 2-4.

Second, the long-felt need must not have been satisfied by another before the invention by applicant. MPEP 716.04. As explained by Dr. Schiffman, no other therapeutic dry-eye drug has been approved by the FDA before or since RESTASIS®. *See* Schiffman Declaration 2 at ¶ 8. Other treatments for dry eye, such as artificial tears, have been commercially available, but they only exhibit a palliative effect, and do not work to increase tear production or otherwise treat the disease. *See* Schiffman Declaration 2 at ¶ 4.

Third, the invention must in fact satisfy the long-felt need. MPEP 716.04. As shown by the FDA's approval of RESTASIS®, and the praise in the industry discussed by Dr. Schiffman at paragraph 8 of Schiffman Declaration 2, the claimed methods have satisfied the long felt need. As explained above, RESTASIS® has been met with great commercial success, which further shows the satisfaction of the long felt need.

Several other companies have tried to develop therapeutic drugs for FDA approval, but many have failed. *See* Schiffman Declaration 2 at ¶ 9 and Exhibit N. The Federal Circuit has implicitly accepted that failure to obtain FDA approval is relevant evidence of failure of others. *Knoll Pharm. Co. v Teva Pharms. USA, Inc.*, 367 F.3d 1381, 1385 (Fed. Cir. 2004).

Accordingly, the Applicants assert that the second Declaration of Dr. Rhett M. Schiffman provides objective evidence that unequivocally establishes that the present invention as embodied in RESTASIS® has satisfied a long felt need and that others have failed to meet such a long felt need.

Hence, in view of the evidence presented above and presented in the attached declarations, the Applicants submit that the unexpected results, commercial success, and satisfaction of long felt need obtained from the claimed formulations successfully rebut the *prima facie* case of obviousness presented in the Office Action. Thus, the Applicants respectfully request that the Examiner withdraw the outstanding rejections under 35 U.S.C. § 103.

*Obviousness-Type Double Patenting Rejections*

Claims 37-60 were rejected for non-statutory obvious-type double patenting in view of claims 1-8 of the Ding reference.

The Applicants submit that the pending claims are patentably distinct from claims 1-8 of Ding for at least the same reasons argued above. The Applicants respectfully request, therefore, that the Office withdraw the double patenting rejection of Claims 37-60 in view of claims 1-8 of Ding.

*Provisional Obviousness-Type Double Patenting Rejection*

Claims 37-60 were rejected for provisional non-statutory obvious-type double patenting in view of claims 37-61 of copending U.S. Patent Application No. 13/967,179, claims 37-60 of copending U.S. Patent Application No. 13/961,835, claims 37-61 of copending U.S. Patent Application No. 13/961,818, and claims 37-60 of copending U.S. Patent Application No. 13/967,168.

While the Applicants do not necessarily agree with the provisional non-statutory obviousness-type double patenting rejections recited above, in order to expedite prosecution, terminal disclaimers in the aforementioned applications were filed on October 7, 2013. Thus, the Applicants submit that the provisional obviousness-type double patenting rejection has been rendered moot and request that this provisional obviousness-type double patenting rejection be withdrawn.

*Statutory Double Patenting Rejection*

Claims 37-60 were provisionally rejected for statutory double patenting in view of claims 37-56, 58-61 of copending U.S. Patent Application No. 13/967,163 and claims 37-56, 58-61 of copending U.S. Patent Application No. 13/961,828. Claims 37-60 were also provisionally rejected for statutory double patenting in view of claims 37-60 of copending U.S. Patent Application No. 13/961,808. The Applicants submit that the amendments to the claims filed herewith render the provisional statutory double patenting rejection over claims 37-56, 58-61 of copending U.S. Patent Application No. 13/967,163 and claims 37-56, 58-61 of copending U.S. Patent Application No. 13/961,828 moot.



Since this is a provisional statutory double patenting rejection, the Applicants request that the Examiner allow the present case to proceed to allowance over copending U.S. Patent Application No. 13/961,808. *See* MPEP § 804(2). Applicants respectfully request, therefore, that the Office withdraw the provisional statutory double patenting rejections.

**Conclusion**

In view of the foregoing, the Applicants believe all claims now pending in the present application are in condition for allowance.

The Commissioner is hereby authorized to charge any fees required or necessary for the filing, processing or entering of this paper or any of the enclosed papers, and to refund any overpayment, to deposit account 01-0885.

If the Examiner believes a telephone conference would expedite prosecution of this application, please contact the undersigned at (714) 246-6996.

Respectfully submitted,

/Laura L. Wine/

Date: October 23, 2013

---

Laura L. Wine  
Attorney of Record  
Registration Number 68,681

Please direct all inquiries and correspondence to:  
Laura L. Wine, Esq.  
Allergan, Inc.  
2525 Dupont Drive, T2-7H  
Irvine, California 92612  
Tel: (714) 246-6996 Fax: (714) 246-4249

## Electronic Patent Application Fee Transmittal

|   |   |
|---|---|
| <b>Application Number:</b>                  | 13967189  |
| <b>Filing Date:</b>                         | 14-Aug-2013   |
| <b>Title of Invention:</b>                  | METHODS OF PROVIDING THERAPEUTIC EFFECTS USING CYCLOSPORIN COMPONENTS |
| <b>First Named Inventor/Applicant Name:</b> | Andrew Acheampong   |
| <b>Filer:</b>                               | Laura Lee Wine  |
| <b>Attorney Docket Number:</b>              | 17618CON2B (AP)   |

Filed as Large Entity

### Utility under 35 USC 111(a) Filing Fees

| Description                       | Fee Code | Quantity | Amount | Sub-Total in USD(\$) |
|-----------------------------------|----------|----------|--------|----------------------|
| <b>Basic Filing:</b>              |          |          |        |                      |
| <b>Pages:</b>                     |          |          |        |                      |
| <b>Claims:</b>                    |          |          |        |                      |
| Independent claims in excess of 3 | 1201     | 1        | 420    | 420                  |

**Miscellaneous-Filing:**

**Petition:**

**Patent-Appeals-and-Interference:**

**Post-Allowance-and-Post-Issuance:**

**Extension-of-Time:**

| Description              | Fee Code | Quantity | Amount | Sub-Total in USD(\$) |
|--------------------------|----------|----------|--------|----------------------|
| <b>Miscellaneous:</b>    |          |          |        |                      |
| <b>Total in USD (\$)</b> |          |          |        | <b>420</b>           |

## Electronic Acknowledgement Receipt

|   |   |
|---|---|
| <b>EFS ID:</b>                              | 17210168  |
| <b>Application Number:</b>                  | 13967189  |
| <b>International Application Number:</b>    |   |
| <b>Confirmation Number:</b>                 | 4818  |
| <b>Title of Invention:</b>                  | METHODS OF PROVIDING THERAPEUTIC EFFECTS USING CYCLOSPORIN COMPONENTS |
| <b>First Named Inventor/Applicant Name:</b> | Andrew Acheampong   |
| <b>Customer Number:</b>                     | 51957   |
| <b>Filer:</b>                               | Laura Lee Wine  |
| <b>Filer Authorized By:</b>                 |   |
| <b>Attorney Docket Number:</b>              | 17618CON2B (AP)   |
| <b>Receipt Date:</b>                        | 23-OCT-2013   |
| <b>Filing Date:</b>                         | 14-AUG-2013   |
| <b>Time Stamp:</b>                          | 17:23:23  |
| <b>Application Type:</b>                    | Utility under 35 USC 111(a)   |

### Payment information:

|  |                 |
|--|-----------------|
| Submitted with Payment                   | yes             |
| Payment Type                             | Deposit Account |
| Payment was successfully received in RAM | \$420           |
| RAM confirmation Number                  | 4890            |
| Deposit Account                          | 010885          |
| Authorized User                          |                 |

The Director of the USPTO is hereby authorized to charge indicated fees and credit any overpayment as follows:

Charge any Additional Fees required under 37 C.F.R. Section 1.16 (National application filing, search, and examination fees)

Charge any Additional Fees required under 37 C.F.R. Section 1.17 (Patent application and reexamination processing fees)

Charge any Additional Fees required under 37 C.F.R. Section 1.19 (Document supply fees)

Charge any Additional Fees required under 37 C.F.R. Section 1.20 (Post Issuance fees)

Charge any Additional Fees required under 37 C.F.R. Section 1.21 (Miscellaneous fees and charges)

**File Listing:**

| Document Number | Document Description                               | File Name                | File Size(Bytes)/ Message Digest                   | Multi Part /.zip | Pages (if appl.) |
|-----------------|--|--------------------------|--|------------------|------------------|
| 1               | Affidavit-traversing rejectns or objectns rule 132 | 17618CON2B-Exhibit-1.pdf | 670148<br>d43c6d440b6bac54805bd50936ee9689001a8f9d | no               | 26               |

**Warnings:**

The page size in the PDF is too large. The pages should be 8.5 x 11 or A4. If this PDF is submitted, the pages will be resized upon entry into the Image File Wrapper and may affect subsequent processing

**Information:**

|   |  |                          |  |    |    |
|---|--|--------------------------|--|----|----|
| 2 | Affidavit-traversing rejectns or objectns rule 132 | 17618CON2B-Exhibit-2.pdf | 452124<br>312fb156acf1ee5b36c77f3d5c9608e9d365b4ac | no | 19 |
|---|--|--------------------------|--|----|----|

**Warnings:**

The page size in the PDF is too large. The pages should be 8.5 x 11 or A4. If this PDF is submitted, the pages will be resized upon entry into the Image File Wrapper and may affect subsequent processing

**Information:**

|   |  |                          |  |    |    |
|---|--|--------------------------|--|----|----|
| 3 | Affidavit-traversing rejectns or objectns rule 132 | 17618CON2B-Exhibit-3.pdf | 269817<br>60467d2777513aa6b96972fa56ad6d929b9e4ffc | no | 10 |
|---|--|--------------------------|--|----|----|

**Warnings:**

The page size in the PDF is too large. The pages should be 8.5 x 11 or A4. If this PDF is submitted, the pages will be resized upon entry into the Image File Wrapper and may affect subsequent processing

**Information:**

|   |  |                          |   |    |     |
|---|--|--------------------------|---|----|-----|
| 4 | Affidavit-traversing rejectns or objectns rule 132 | 17618CON2B-Exhibit-4.pdf | 7072016<br>e9b31287d9350c7259b0d288ff61512da926e736 | no | 115 |
|---|--|--------------------------|---|----|-----|

**Warnings:**

The page size in the PDF is too large. The pages should be 8.5 x 11 or A4. If this PDF is submitted, the pages will be resized upon entry into the Image File Wrapper and may affect subsequent processing

**Information:**

|   |  |                               |   |     |    |
|---|--|-------------------------------|---|-----|----|
| 5 |  | 17618CON2B_Response_NFOA .pdf | 1512843<br>a394fc7e91e22e29842271951aae21efed928f73 | yes | 16 |
|---|--|-------------------------------|---|-----|----|

**Multipart Description/PDF files in .zip description**

| Document Description                                  | Start | End |
|---|-------|-----|
| Amendment/Req. Reconsideration-After Non-Final Reject | 1     | 1   |
| Claims  | 2     | 5   |

|  |  |   |    |
|--|--|---|----|
|  | Applicant summary of interview with examiner     | 6 | 6  |
|  | Applicant Arguments/Remarks Made in an Amendment | 7 | 16 |

**Warnings:**

**Information:**

|   |                      |              |  |    |   |
|---|----------------------|--------------|--|----|---|
| 6 | Fee Worksheet (SB06) | fee-info.pdf | 30754                                    | no | 2 |
|   |                      |              | 5457404800ecb2db02ad2375ff5d929aed23f221 |    |   |

**Warnings:**

**Information:**

|                                     |  |          |
|-------------------------------------|--|----------|
| <b>Total Files Size (in bytes):</b> |  | 10007702 |
|-------------------------------------|--|----------|

**This Acknowledgement Receipt evidences receipt on the noted date by the USPTO of the indicated documents, characterized by the applicant, and including page counts, where applicable. It serves as evidence of receipt similar to a Post Card, as described in MPEP 503.**

**New Applications Under 35 U.S.C. 111**

**If a new application is being filed and the application includes the necessary components for a filing date (see 37 CFR 1.53(b)-(d) and MPEP 506), a Filing Receipt (37 CFR 1.54) will be issued in due course and the date shown on this Acknowledgement Receipt will establish the filing date of the application.**

**National Stage of an International Application under 35 U.S.C. 371**

**If a timely submission to enter the national stage of an international application is compliant with the conditions of 35 U.S.C. 371 and other applicable requirements a Form PCT/DO/EO/903 indicating acceptance of the application as a national stage submission under 35 U.S.C. 371 will be issued in addition to the Filing Receipt, in due course.**

**New International Application Filed with the USPTO as a Receiving Office**

**If a new international application is being filed and the international application includes the necessary components for an international filing date (see PCT Article 11 and MPEP 1810), a Notification of the International Application Number and of the International Filing Date (Form PCT/RO/105) will be issued in due course, subject to prescriptions concerning national security, and the date shown on this Acknowledgement Receipt will establish the international filing date of the application.**

# EXHIBIT 1

IN THE UNITED STATES PATENT AND TRADEMARK OFFICE

DECLARATION UNDER 37 C.F.R. 1.132

of Dr. Rhett M. Schiffman,

I, Rhett M. Schiffman, M.D., declare as follows:

1. I am currently a Vice President and Chief Medical Officer at Neurotech. I have an M.D, Masters Degrees in Clinical Research Design and Statistical Analysis and in Health Services Administration, a Bachelor's degree in Bioengineering, and over 12 years of experience in the pharmaceutical industry at Allergan, Inc. ("Allergan"). I was also a clinical investigator in the Phase 3 studies for Restasis®. I am a co-inventor on several issued patents and pending applications related to treatment methods using ophthalmic products. My *curriculum vita*, which contains a list of my publications to which I contributed, is attached to this declaration as Exhibit A.
2. I have been informed of the general nature of the rejections made by the Patent Office with respect to the previously presented claims of the above-referenced patent application and I am familiar with the references that the Patent Office has relied on in making these rejections. For example, I am aware of U.S. Patent No. 5,474,979 to Ding et al. ("Ding").
3. Restasis® is an FDA approved product that is a commercial embodiment of the invention. Specifically, Restasis® is approved as a 0.05% by weight cyclosporin ophthalmic emulsion useful for the treatment of ophthalmic conditions, such as dry eye. Specifically, Restasis® ophthalmic emulsion is indicated to increase tear production in patients whose tear production is presumed to be suppressed due to ocular inflammation associated with keratoconjunctivitis sicca.
4. I have reviewed the pending claims in the present application, and the pending claims cover the specific formulation of Restasis® and/or the approved methods of treatment of dry eye or keratoconjunctivitis sicca for Restasis®.
5. In creating and testing the claimed methods and compositions, several unexpected benefits were discovered using the claimed compositions and/or claimed methods.
6. During development of a drug for the treatment of dry eye disease or keratoconjunctivitis sicca, Allergan performed a randomized, multicenter, double-masked, parallel-group, dose-response controlled Phase 2 trial on several cyclosporin-A and castor oil-containing formulations. In this Phase 2 study of moderate to severe KCS, the safety and efficacy of



four cyclosporin A-containing emulsion compositions were compared to one another: 0.05% by weight cyclosporin A with 0.625% by weight castor oil, 0.10% by weight cyclosporin A with 1.25% by weight castor oil, 0.20% by weight cyclosporin A with 2.5% by weight castor oil, and 0.40% by weight cyclosporin A with 5.0% by weight castor oil. A vehicle containing 2.5% by weight castor oil was also tested and compared to these formulations. In this study, patients with moderate to severe dry eye disease were treated twice daily with one of the aforementioned cyclosporin A-containing formulations or a vehicle. All of the cyclosporin A-containing formulations as well as the vehicle also included 2.2% by weight glycerine, 1.0% by weight polysorbate 80, 0.05% by weight Pemulen, sodium hydroxide, and water. To the best of my knowledge, the specific cyclosporin-A containing formulations tested in humans in this Phase 2 study are disclosed in the Ding reference. Results from this study illustrating the change from baseline in corneal staining and change from baseline in Schirmer Score, key objective testing measures for dry eye or KCS, are shown in Exhibit B, Figures 1 and 2, respectively.

7. As shown in Exhibit B, Figure 1, the 0.1% by weight cyclosporin A/ 1.25% by weight castor oil formulation demonstrated a greater decrease in corneal staining than the 0.05% by weight cyclosporin A/0.625% by weight castor oil formulation. As shown in Exhibit B, Figure 2 the 0.1% by weight cyclosporin A/ 1.25% by weight castor oil formulation demonstrated a greater increase in Schirmer Score (tear production) at week 12 than any other formulation tested, including the 0.05% by weight cyclosporin A/0.625% by weight castor oil formulation. Corneal staining and Schirmer score are key objective measures for determining dry eye or keratoconjunctivitis sicca disease severity.
8. After Allergan's Phase 2 study, Allergan initiated a Phase 3 study. In Allergan's multicenter, randomized, double-masked Phase 3 trials, Allergan compared the efficacy and safety of the formulation containing 0.10% by weight cyclosporin A and 1.25% by weight castor oil to a the claimed formulation (containing 0.05% by weight cyclosporin A and 1.25% by weight castor oil), and to a vehicle containing 1.25% by weight castor oil. The data presented in Exhibit B represents the subpopulation of moderate to severe Phase 2 patients with the same reductions in tear production ( $\leq 5$  mm/5 min) as those enrolled in the Phase 3 studies. In this study, patients with moderate to severe dry eye disease were treated twice daily with either a formulation containing 0.10% by weight cyclosporin A and 1.25% by weight castor oil, a formulation containing 0.05% by weight cyclosporin A and 1.25% by weight castor oil, or the vehicle. Both cyclosporin A-containing formulations and the vehicle also included 2.2% by weight glycerine, 1.0% by weight polysorbate 80, 0.05% by weight Pemulen, sodium hydroxide, and water.

9. I have reviewed the Declaration of Dr. Mayssa Attar (“Attar Declaration”), and I agree with her statements made in paragraphs 6-8, reproduced here. I have attached Exhibit B to the Attar Declaration to this Declaration as Exhibit C:
  
10. “It was known in the art at the time this application was filed that cyclosporin could be administered topically locally to the eye to target and treat dry eye by using cyclosporin A’s immunomodulatory properties to inhibit T cell activation which would lead to an increase in tear production and potentially other therapeutic effects related cyclosporine’s anti-inflammatory and anti-apoptotic effects and thus limit chronic inflammation in the pathology of dry eye. To elicit it’s therapeutic effect, cyclosporine must be effectively delivered to multiple target tissues of the ocular surface such as the cornea, conjunctiva, and lacrimal gland. The rate and extent at which cyclosporine is differentially delivered to the putative sites of action is critical to achieving therapeutic success in treating dry eye. Generally speaking, it was understood that pharmacokinetic/pharmacodynamic relationship would indicate that as more cyclosporin A reaches the target tissues of the ocular surface, such as the cornea and conjunctiva, the more immunomodulatory and more anti-inflammatory activity can take place and the more therapeutically effective a drug can be in treating dry eye.
  
11. Pharmacokinetic studies were performed on animal eyes, which compared the pharmacokinetic properties of several cyclosporin A-containing formulations. Those results are attached to this declaration in Exhibit B. As shown in Exhibit B, the relative extent at cyclosporin was absorbed increased in the relevant ocular tissues, here, the cornea and the conjunctiva, where the amount of oil present in the formulation was decreased. Specifically, the amount of cyclosporin A that reached the relevant ocular tissue was higher for the formulation containing 0.05% by weight cyclosporin A and 0.625% by weight castor oil than the formulation containing 0.05% by weight cyclosporin A and 1.25% by weight castor oil relative to the formulation containing 0.1% by weight cyclosporin A and 1.25% by weight castor oil.
  
12. One of skill in the art would have understood such a result to mean that since there was more cyclosporin A present in the relevant ocular tissues in the formulation containing 0.05% by weight cyclosporin A and 0.625% by weight castor oil and the formulation containing 0.1% by weight cyclosporine A and 1.25% by weight castor oil than the claimed formulation, that those formulations would have been more therapeutically effective than the claimed formulation. Specifically, this data suggests that the formulation containing 0.05% by weight cyclosporin A and 0.625% by weight castor oil would have been more therapeutically effective than the claimed formulation.”

13. Specifically, one of skill in the art would have expected patients receiving the claimed formulations and methods to exhibit a lesser decrease from baseline in corneal staining score and a lesser increase from baseline in Schirmer Score, relative to the patient corneal staining scores and Schirmer Scores demonstrated by the patients receiving the 0.05% by weight cyclosporin A / 0.625% by weight castor oil formulation (Ding 1E) in the Phase 2 trials illustrated in Exhibit B.
14. Surprisingly, the claimed formulation and method was equally or more therapeutically effective for the treatment of dry eye/keratoconjunctivitis sicca than the formulation containing 0.10% by weight cyclosporin A and 1.25% by weight castor oil according to at least four testing parameters. This result was surprising and completely unexpected. These results are attached to this declaration in Exhibit D.
15. As shown in the results in Exhibit D, the claimed formulation and method was unexpectedly superior to the 0.10% by weight cyclosporin A / 1.25% by weight castor oil formulation with respect to several properties. For example, the claimed formulations and methods surprisingly exhibited a comparable or greater decrease in corneal staining score (see Exhibit D, Figure 1), a greater increase in Schirmer Score (see Exhibit D, Figure 2), an improvement in the common dry eye/keratoconjunctivitis sicca symptom of blurred vision (see Exhibit D, Figure 3) and a greater decrease in the number of artificial tears used by patients (see Exhibit D, Figure 4) compared to the formulation containing 0.10% by weight cyclosporin A and 1.25% by weight castor oil.
16. This result was even more surprising, given earlier testing from the Phase 2 study that illustrated that compositions containing 0.10% by weight cyclosporin A and 1.25% by weight castor oil provided more improvement in objective measures (such as corneal staining and increase in Schirmer Score – as illustrated in Exhibit B) in dry eye patients than compositions containing 0.05% by weight cyclosporin A and 0.625% castor oil.
17. I have compared the objective results showing the surprising therapeutic efficacy of the claimed formulation and method relative to the 0.10% by weight cyclosporin A and 1.25% by weight castor oil formulation tested in Phase 3 to the 0.05% by weight cyclosporin A and 0.625% by weight castor oil formulation relative to the 0.10% by weight cyclosporin A and 1.25% by weight castor oil formulation tested in Phase 2. This comparison is attached to this declaration as Exhibit E.
18. As seen in Exhibit E, in the Phase 2 study, the 0.05% by weight cyclosporin A/0.625% by weight castor oil formulation (Ding 1E) only achieved 0.25 times the improvement in Schirmer Tear Test score as the 0.1 % by weight cyclosporin A/1.25% by weight castor

oil formulation and only achieved 0.25 times the decrease in corneal staining as the 0.1 % by weight cyclosporin A/1.25% by weight castor oil formulation. However, in the Phase 3 studies, the claimed formulation and method achieved twice the improvement in Schirmer Tear Test score as the 0.1 % by weight cyclosporin A/1.25% by weight castor oil formulation in the first study and substantially the same improvement in Schirmer Tear Test score as the 0.1 % by weight cyclosporin A/1.25% by weight castor oil formulation in the second Phase 3 study. Also, the claimed formulation achieved substantially the same decrease in corneal staining score compared to the 0.1 % by weight cyclosporin A/1.25% by weight castor oil formulation.

19. As seen in Exhibit E, and further illustrated in Exhibit F, surprisingly, the claimed formulation and method demonstrated an 8-fold increase in relative efficacy for the Schirmer Tear Test Score in the first study of phase 3 compared to the 0.05% by weight cyclosporin A/0.625% by weight castor oil formulation (Ding Example 1E) in the Phase 2 study. Exhibits E and F also illustrate that the claimed formulations demonstrated a 4-fold improvement in the relative efficacy for the Schirmer Tear Test score for the second study of Phase 3 and a 4-fold increase in relative efficacy for decrease in corneal staining score in both of the Phase 3 studies compared to the 0.05% by weight cyclosporin A/0.625% by weight castor oil formulation in the Phase 2 study, the formulation disclosed in the Ding reference (Ding 1E). This was clearly a very surprising result.
  
20. Taking the results of these studies together, it is clear that the specific combination of 0.05% by weight cyclosporin A with 1.25% by weight castor oil is surprisingly and unexpectedly critical for therapeutic effectiveness in the treatment of dry eye/keratoconjunctivitis sicca.

I hereby declare that all statements made herein of my own knowledge and belief are true; and that all statements made on information and belief are believed to be true; and further that these statements are made with the knowledge that willful false statements and the like so made are punishable by fine or imprisonment, or both, under Section 1001 of Title 18 of the United States Code, and that such willful false statements may jeopardize the validity of the application or any patents issued thereon.

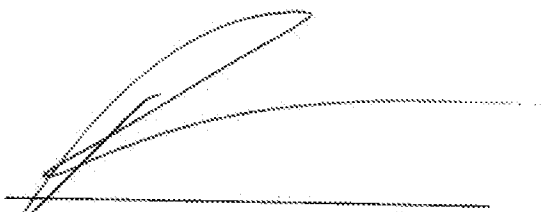

\_\_\_\_\_

Dr. Rhett M. Schiffman

Date: 10/11/13

# EXHIBIT A

**CURRICULUM VITAE FOR RHETT M. SCHIFFMAN, M.D., M.S., M.H.S.A.**

**Current Title:** Vice President and Chief Medical Officer  
Neurotech

**Work Address:** 900 Highland Corporate Drive  
Building #1, Suite #101  
Cumberland, RI 02864

**Home Address:** 1843 Temple Hills  
Laguna Beach, CA 92651

**Office Telephone:** (401) 495-2395  
**Cell Telephone:** (313) 516-6924  
**Email:** r.schiffman@neurotechusa.com

**EDUCATION:**

**Professional:** University of Michigan, School of Public Health,  
Ann Arbor, Michigan  
2000 M.H.S.A. Health Services Administration

University of Michigan, Rackham Graduate School,  
Ann Arbor, Michigan  
1989 M.S. Clinical Research Design & Statistical Analysis

Universidad Autonoma de Ciudad Juarez  
Instituto de Ciencias Biomedicas  
Juarez, Mexico  
1983 M.D. Medicine

**Undergraduate:** Columbia University  
School of Engineering and Applied Science  
New York, NY  
1978 B.S. Bioengineering

**POSTDOCTORAL TRAINING:**

**Fellow:** Uveitis and Ocular Immunology, National Eye Institute,  
National Institutes of Health, Bethesda, MD  
1996-1997

**Resident:** Ophthalmology, Henry Ford Hospital, Detroit, Michigan  
1993 - 1996

**Resident:** Internal Medicine, Henry Ford Hospital, Detroit, Michigan  
1984 - 1986

**Intern:** Internal Medicine, Henry Ford Hospital, Detroit, Michigan  
1983 - 1984

## CERTIFICATION AND LICENSURE

Medical Licensure: California, 2002 – C50825

Michigan, 1983 - 4301046984

Board Certification: American Board of Ophthalmology, 1999; 93<sup>th</sup> percentile on Board examination

American Board of Internal Medicine, 1986; 99<sup>th</sup> percentile on Board examination

## PROFESSIONAL SOCIETIES:

Member, Association for Research in Vision and Ophthalmology  
American Academy of Ophthalmology  
American Medical Association

## PROFESSIONAL EXPERIENCE:

2013-Present Vice President and Chief Medical Officer, Neurotech

2010-2013 Board Member, Glaucoma Research Foundation

2009-2013 Ophthalmology Therapeutic Area Head

2008-2013 Head of Development for Emerging Markets

2007-2013 Head, Global Product Enhancement/Life Cycle Management

2005-2013 Vice President, Development for Ophthalmology and Botox, Allergan Pharmaceuticals

2003-Present Clinical Associate Professor and Attending Physician in Ophthalmology, University of California at Irvine.

2001-2005 Senior Director, Ophthalmology Clinical Research, Allergan Pharmaceuticals, Irvine, California

1999-2001 Member, Leadership Council, Eye Care Services, Henry Ford Health System, Detroit, MI

1999-2001 Director, Quality Improvement, Eye Care Services, Henry Ford Health System, Detroit, MI

1998-2001 Director of the African-American Initiative for Male Health Improvement (AIMHI). Eye Disease Screening Program in Southeast Michigan. Funded by the Michigan Department of Community Health.

1997-2001 Director of Uveitis Services, Eye Care Services, Henry Ford Health System, Detroit, MI  
Director of Clinical Research, Eye Care Services, Henry Ford Health System, Detroit, MI  
Staff Investigator, Center for Health Services Research, Henry Ford Health System, Detroit, MI

1996-2001 Reviewer to Special Study Section, National Eye Institute, National Institutes of Health, Bethesda, Maryland.

1999-2001 Director, Clinical Research, Eye Care Services, Henry Ford Hospital, Detroit, Michigan



- 1996-1997 Senior Staff Physician, Eye Care Services, Ophthalmology, Henry Ford Health System, Detroit, Michigan (on intergovernmental personnel act to National Eye Institute, National Institutes of Health, Bethesda, Maryland)
- 1994-1995 Associate Medical Director, Henry Ford Hospital Pharmacology Research Unit, Detroit, Michigan
- 1993-2001 Associate Research Director, Eye Care Services, Henry Ford Hospital, Detroit, Michigan
- 1989-2001 Staff, Center for Clinical Effectiveness, Henry Ford Hospital, Detroit, Michigan
- 1988-1994 Requirements Advisory Committee to the Medical Information Management System, Henry Ford Hospital, Detroit, Michigan
- 1989-1993 Coordinator, General Internal Medicine Research, Henry Ford Hospital, Detroit, Michigan
- 1990-1993 Chairman, General Internal Medicine Research Committee, Henry Ford Hospital, Detroit, Michigan
- Member, Research and Academic Affairs Committee, Department of Medicine, Henry Ford Hospital, Detroit, Michigan
- 1986-1993 Senior Staff Physician, General Internal Medicine, Henry Ford Hospital, Detroit, Michigan

**TEACHING EXPERIENCE:**

- 2003-Present Ophthalmology Residency Training Program, University of California at Irvine
- 1997-2001 Ophthalmology Residency Training Program, Henry Ford Hospital, Detroit, Michigan
- 1986-1993 Internal Medicine Residency Training Program, Henry Ford Hospital, Detroit, Michigan
- 1988-1993 Preceptor, University of Michigan Medical Schools, Ann Arbor, Michigan
- 1991-1993 Preceptor, General Internal Medicine Fellows
- Medical Staff Seminars, General Internal Medicine, Henry Ford Hospital, Detroit, MI:  
Introduction to Epidemiology, Introduction to Personal Computing, Medical Decision Analysis

**BOOKS & MONOGRAPHS:**

1. Ocular Therapy chapter in: Oréfice, Fernando: Uveíte: Clínica e Cirúrgica. Ed. Cultura Médica. Published June 2000.
2. New Concepts in the Pathogenesis, Diagnosis and Treatment of Dry Eye. Ocular Surgery News Monograph; Slack Incorporated. July 1, 1999

3. Schiffman RM: Glaucoma, Ophthalmology chapter in Noble, John: Textbook of Primary Care Medicine. 2<sup>nd</sup> Edition. 1996. Mosby-Year Book, Inc. 1471-9.

**JOURNAL PUBLICATIONS:**

1. Day D.G., Walters T.R., Schwartz G.F., Mundorf T.K., Liu C., Schiffman R.M., Bejani M. Bimatoprost 0.03% preservative-free ophthalmic solution versus bimatoprost 0.03% ophthalmic solution (Lumigan) for glaucoma or ocular hypertension: a 12-week, randomised, double-masked trial. *Br J Ophthalmol*. 2013 Jun 6. [Epub ahead of print]
2. Callanan DG, Gupta S, Boyer DS, Ciulla TA, Singer MA, Kuppermann BD, Liu CC, Li XY, Hollander DA, Schiffman RM, Whitcup SM; Ozurdex PLACID Study Group. Dexamethasone Intravitreal Implant in Combination with Laser Photocoagulation for the Treatment of Diffuse Diabetic Macular Edema. *Ophthalmology*. 2013 May 22. S0161-6420(13)00152-8.
3. Katz LJ, Rauchman SH, Cottingham AJ Jr, Simmons ST, Williams JM, Schiffman RM, Hollander DA. Fixed-combination brimonidine-timolol versus latanoprost in glaucoma and ocular hypertension: a 12-week, randomized, comparison study. *Curr Med Res Opin*. 2012 May;28(5):781-8
4. Katz, L.J., Rauchman, S.H., Cottingham Jr., A.J., Simmons, S.T., Williams, J.M., Schiffman, R.M., Hollander, D.A. Fixed-combination brimonidinetimolol versus latanoprost in glaucoma and ocular hypertension: A 12-week, randomized, comparison study. *Current Medical Research and Opinion* 28 (5), pp. 781-788
5. Lowder, C., Belfort Jr., R., Lightman, S., Foster, C.S., Robinson, M.R., Schiffman, R.M., Li, X.-Y., Cui H, Whitcup, S.M. Dexamethasone intravitreal implant for noninfectious intermediate or posterior uveitis. *Arch Ophthalmol* 2011 129 (5):545-553
6. Waterbury, L.D., Galindo, D., Villanueva, L., Nguyen, C., Patel, M., Borbridge, L., Attar, M., Schiffman RM, Hollander, D.A. Ocular penetration and anti-inflammatory activity of ketorolac 0.45% and bromfenac 0.09% against lipopolysaccharide-induced inflammation. *J Ocular Pharmacol and Therapeutics* 2011 27 (2):173-178
7. Xu, K., McDermott, M., Villanueva, L., Schiffman, R.M., Hollander, D.A. Ex vivo corneal epithelial wound healing following exposure to ophthalmic nonsteroidal anti-inflammatory drugs. *Clin Ophthalmol* 2011 5 (1), pp. 269-274.
8. Donnenfeld, E.D., Nichamin, L.D., Hardten, D.R., Raizman, M.B., Trattler, W., Rajpal, R.K., Alpern, L.M., Felix C, Bradford RR, Villanueva L, Hollander DA, Schiffman, R.M. Twice-daily, preservative-free ketorolac 0.45% for treatment of inflammation and pain after cataract surgery. *Am J Ophthalmol* 2011 151 (3):420-426.
9. Spaeth G, Bernstein P, Caprioli J, Schiffman RM. Control of Intraocular Pressure and Intraocular Pressure Fluctuation with Fixed Combination Brimonidine-Timolol versus Brimonidine or Timolol Monotherapy. *Am J Ophthalmol*. 2011 January;151:93-99.
10. Attar, M., Schiffman, R., Borbridge, L., Farnes, Q., Welty, D. Ocular pharmacokinetics of 0.45% ketorolac tromethamine. *Clin Ophthalmol* 2010 4(1), pp. 1403-1408
11. Craven, E.R., Liu, C.-C., Batoosingh, A., Schiffman, R.M., Whitcup, S.M. A randomized, controlled comparison of macroscopic conjunctival hyperemia in patients treated with bimatoprost 0.01% or vehicle who were previously controlled on latanoprost. *Clin Ophthalmol* 2010 4 (1):1433-1440
12. Olson, R., Donnenfeld, E., Bucci Jr., F.A., Price Jr., F.W., Raizman, M., Solomon, K., Devgan, U., Trattler W, Dell S, Wallace RB, Callegan M, Brown H, McDonnell PJ, Conway T, Schiffman RM,

- Hollander, D.A. Methicillin resistance of Staphylococcus species among health care and nonhealth care workers undergoing cataract surgery. *Clin Ophthalmol*. 2010 4(1):1505-1514
13. Katz L, Cohen J, Batoosingh A, Felix C, Shu V, Schiffman R. Twelve-Month, Randomized Controlled Trial of the Efficacy and Safety of Bimatoprost 0.01%, 0.0125%, and 0.03% in Patients with Glaucoma or Ocular Hypertension. *Am J Ophthalmol*. 2010 April;149:661-671.
  14. Lewis R, Gross R, Sall K, Schiffman R, Liu C-C, Batoosingh A, (for the Ganfort® Investigators Group II). The Safety and Efficacy of Bimatoprost/Timolol Fixed Combination: A 1-year Double-masked, Randomized Parallel Comparison to Its Individual Components in Patients With Glaucoma or Ocular Hypertension. *J Glaucoma*. 2010 August;19(6):424-426.
  15. Sherwood MB, Craven ER, Chou C, DuBiner HB, Batoosingh AL, Schiffman RM, Whitcup SM. Twice-daily 0.2% brimonidine-0.5% timolol fixed-combination therapy vs monotherapy with timolol or brimonidine in patients with glaucoma or ocular hypertension: a 12-month randomized trial. *Arch Ophthalmol*. 2006 Sep;124(9):1230-8.
  16. Craven ER, Walters TR, Williams R, Chou C, Cheetham JK, Schiffman R; Combigan Study Group. Brimonidine and timolol fixed-combination therapy versus monotherapy: a 3-month randomized trial in patients with glaucoma or ocular hypertension. *J Ocul Pharmacol Ther*. 2005 Aug;21(4):337-48.
  17. Yee RW, Tepedino M, Bernstein P, Jensen H, Schiffman R, Whitcup SM; Gatifloxacin BID/QID Study Group. A randomized, investigator- masked clinical trial comparing the efficacy and safety of gatifloxacin 0.3% administered BID versus QID for the treatment BID versus QID for the treatment of acute bacterial conjunctivitis of acute bacterial conjunctivitis. *Curr Med Res Opin*. 2005 Mar;21(3):425-31.
  18. Schiffman RM, Jacobsen G, Nussbaum JJ, et al: A Novel Approach for Detection of Diabetic Retinopathy Using DigiScope Retinal Imaging System. *Ophthalmic Surg Lasers Imaging*. 2005 Jan-Feb;36(1):46-56.
  19. Solomon KD, Donnenfeld ED, Raizman M, Stern K, VanDenburgh A, Cheetham JK, Schiffman RM for the Ketorolac Reformulation Study Groups 1 and 2: Safety and Efficacy of Reformulated Ketorolac Tromethamine 0.4% Ophthalmic Solution in Post-photorefractive Keratectomy Patients. *Journal Cataract Refract Surg* 2004 Aug;30(8):1653-1660.
  20. Whitcup SM, Bradford R, Lue J, Schiffman RM, Abelson MB. Efficacy and tolerability of ophthalmic epinastine: a randomized, double-masked, parallel-group, active- and vehicle-controlled environmental trial in patients with seasonal allergic conjunctivitis. *Clin Ther*. 2004 Jan;26(1):29-34.
  21. Abelson MB, Gomes P, Crampton HJ, Schiffman RM, Bradford RR, Whitcup SM. Efficacy and tolerability of ophthalmic epinastine assessed using the conjunctival antigen challenge model in patients with a history of allergic conjunctivitis. *Clin Ther*. 2004 Jan;26(1):35-47.
  22. McDonnell PJ, Taban M, Sarayba MA, Schiffman RM, et al.: Dynamic Morphology of Clear Corneal Incisions. *Ophthalmology*. 2003 Dec;110(12):2342-8.
  23. Desai UR, Alhalel AA, Campen TJ, Schiffman RM, Edwards PA, Jacobsen GR: Central serous chorioretinopathy in African Americans. *J Natl Med Assoc*. 2003 Jul;95(7):553-9.
  24. Javitt JC, Jacobson G, Schiffman RM.: Validity and reliability of the Cataract TyPE Spec: an instrument for measuring outcomes of cataract extraction. *Am J Ophthalmol*. 2003 Aug;136(2):285-90.
  25. Baum JL, Schiffman RM: Reliability and Validity of a Proposed Dry Eye Evaluation Scheme - Reply. *Arch Ophthalmol* 2001 Mar;119(3):456.

26. Schiffman RM, Walt JG, Jacobsen G, Doyle JJ, Lebovics G, Sumner W.:Utility assessment among patients with dry eye disease. *Ophthalmology*. 2003 Jul;110(7):1412-9.
27. Baum JL, Schiffman RM: Reliability and Validity of a Proposed Dry Eye Evaluation Scheme. *Arch Ophthalmol* 2001 Mar;119(3):456.
28. Desai UR, Tawansy K, Schiffman RM: Choroidal Granulomas in Systemic Sarcoidosis. *Retina*. 2001;21(1):40-7.
29. Mangione CM, Lee PP, Spritzer K, Berry S, Hayes RD et. al: Development, Reliability, and Validity of the 25-Item National Eye Institute Visual Function Questionnaire (VFQ-25). Accepted for publication in *Archives of Ophthalmology*.
30. Schiffman RM, Jacobsen G, Whitcup S: Visual Functioning and General Health Status in Patients with Uveitis. *Arch Ophthalmol* 2001 Jun;119(6):841-849.
31. Javitt JC, Schiffman RM: Clinical Success and Quality of Life with Brimonidine 0.2% or Timolol 0.5% used BID in Glaucoma or Ocular Hypertension: A Randomized Clinical Trial. *J Glaucoma*. 2000 Jun;9(3):224-34.
32. Schiffman RM, Christianson MD, Jacobsen G, Hirsch JD, Reis BL.: Reliability and validity of the Ocular Surface Disease Index. *Arch Ophthalmol*. 2000 May;118(5):615-21.
33. Nussenblatt RB, Fortin E, Schiffman R, Rizzo L, Smith J, Van Veldhuisen P, Sran P, Yaffe A, Goldman CK, Waldmann TA, Whitcup SM. Treatment of noninfectious intermediate and posterior uveitis with the humanized anti-Tac mAb: a phase I/II clinical trial. *Proc Natl Acad Sci U S A*. 1999 Jun 22;96(13):7462-6.
34. Nussenblatt RB, Schiffman R, Fortin E, Robinson M, Smith J, Rizzo L, Csaky K, Gery I, Waldmann T, Whitcup SM: Strategies for the treatment of intraocular inflammatory disease. *Transplant Proc*. 1998 Dec;30(8):4124-5.
35. Mangione CM. Lee PP. Pitts J. Gutierrez P. Berry S. Hays RD. Psychometric properties of the National Eye Institute Visual Function Questionnaire (NEI-VFQ). NEI-VFQ Field Test Investigators. *Archives of Ophthalmology*. 116(11):1496-504, 1998 Nov.
36. Desai UR. Alhalel AA. Schiffman RM. Campen TJ. Sundar G. Muhich A. Intraocular pressure elevation after simple pars plana vitrectomy. *Ophthalmology*. 104(5):781-6, 1997 May.
37. Ben-Menachem T. McCarthy BD. Fogel R. Schiffman RM. Patel RV. Zarowitz BJ. Nerenz DR. Bresalier RS. Prophylaxis for stress-related gastrointestinal hemorrhage: a cost effectiveness analysis. *Critical Care Medicine*. 24(2):338-45, 1996 Feb.
38. Ward RE; Purves T; Feldman M; Schiffman RM; Barry S; Christner M; Kipa G; McCarthy BD; Stiphout R: Design considerations of CareWindows, a Windows 3.0-based graphical front end to a Medical Information Management System using a pass-through-requester architecture. *Proc Annu Symp Comput Appl Med Care* 1991; 564-8
39. Stiphout RM; Schiffman RM; Christner MF; Ward R; Purves TM: Medical Information Management System (MIMS) CareWindows. *Proc Annu Symp Comput Appl Med Care* 1991; 929-31
40. Gubbins G, Schiffman RM, Alipati R, Batra S.: Cocaine-Induced Hepatonephrotoxicity. *Henry Ford Hospital Medical Journal* 1990; 38:55-56.

## **JOURNAL REVIEWER**

1. British Journal of Ophthalmology
2. Current Eye Research
3. Ophthalmology
4. Optometry and Vision Science
5. The Lancet

## **SELECTED PAST SCIENTIFIC ACTIVITIES:**

### HFHS Principal Investigator

1. Schiffman RM, Chew E, Ferris F, Ellwein L, Hays R, Mangione C: A Randomized Comparison of the Cost, Quality and Acceptability of Four Modes of Administration the National Eye Institute Visual Functioning Questionnaire-25. National Eye Institute.
2. Schiffman RM: National Eye Institute Refractive Error Correction Questionnaire (NEI-RECQ) Phase II Protocol. National Eye Institute through Emmes Corporation.
3. Schiffman RM, Lesser GL, Imami N, Trick GL: A 48-Month, Multi-Center, Randomized, Double-Masked, Placebo-Controlled, Clinical Study to Evaluate the Effectiveness and Safety of Oral Memantine in Daily Doses of 20 Mg and 10 Mg in Patients with Chronic Open-Angle Glaucoma at Risk for Glaucomatous Progression - Allergan Protocol 192944-005.
4. Schiffman RM: A Multicenter, Investigator-Masked, Randomized, Parallel-Group Study to Compare the Safety and Efficacy and Safety of Restasis™ (Cyclosporine 0.05% Ophthalmic Emulsion) vs. An Artificial Tear (Refresh®) Used Twice Daily for Three Months in Patients with Moderate to Severe Keratoconjunctivitis Sicca (Allergan Protocol 192371-008)
5. Schiffman RM, Patel S, Crosswell M and Shankle J: The Retinal Thickness Analyzer in the Management of Uveitic Cystoid Macular Edema.
6. Schiffman RM, Trick GL: Retinal Thickness Analyzer (RTA) - Clinical Validation Study. Talia Technology Ltd.
7. A Multicenter, Randomized, Double-Masked, Controlled Study to Evaluate the Safety and Efficacy of an Intravitreal Fluocinolone Acetonide Insert in Patients with Non-Infectious Uveitis Affecting the Posterior Segment of the Eye. Bausch and Lomb.

## **SCIENTIFIC ACTIVITIES:**

### HFHS Collaborative Investigator:

1. Lesser B, Darnley D, Schiffman R: Ocular Hypertension Treatment Study. National Eye Institute, 1993- 1999.
2. Nussenblatt RB, Whitcup SM, Schiffman RM, et. al: The Treatment of Non-infectious Intermediate and Posterior Uveitis with Humanized Anti-Tac Monoclonal Antibody Therapy: Phase I and Phase II. National Eye Institute, National Institutes of Health.

# EXHIBIT B

Phase 2 Results - Phase 3 Target Subpopulation

Change from Baseline in Corneal

Staining at Week 12

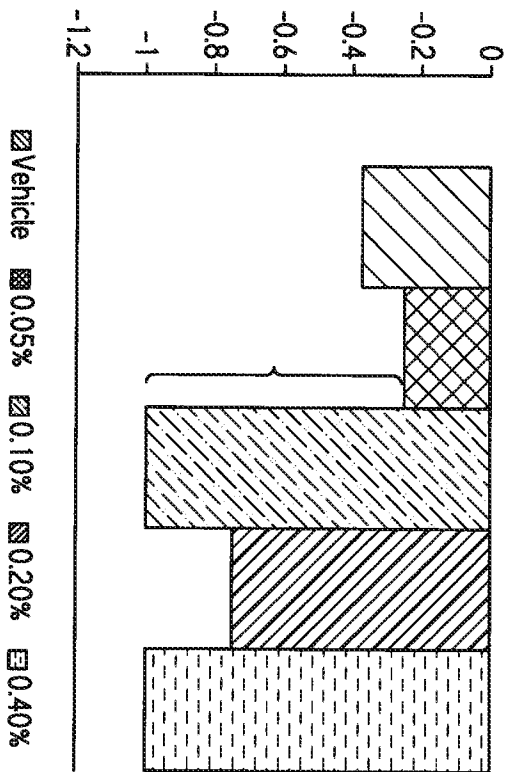

FIG. 1

Change from Baseline in

Schirmer Score at Week 12

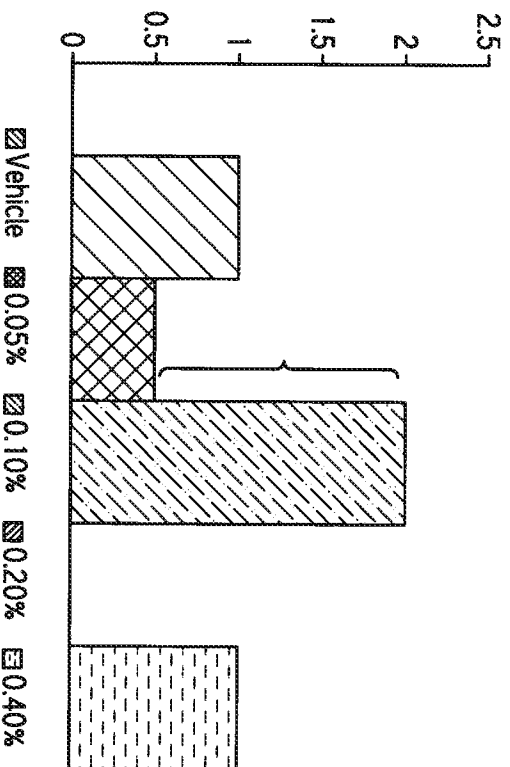
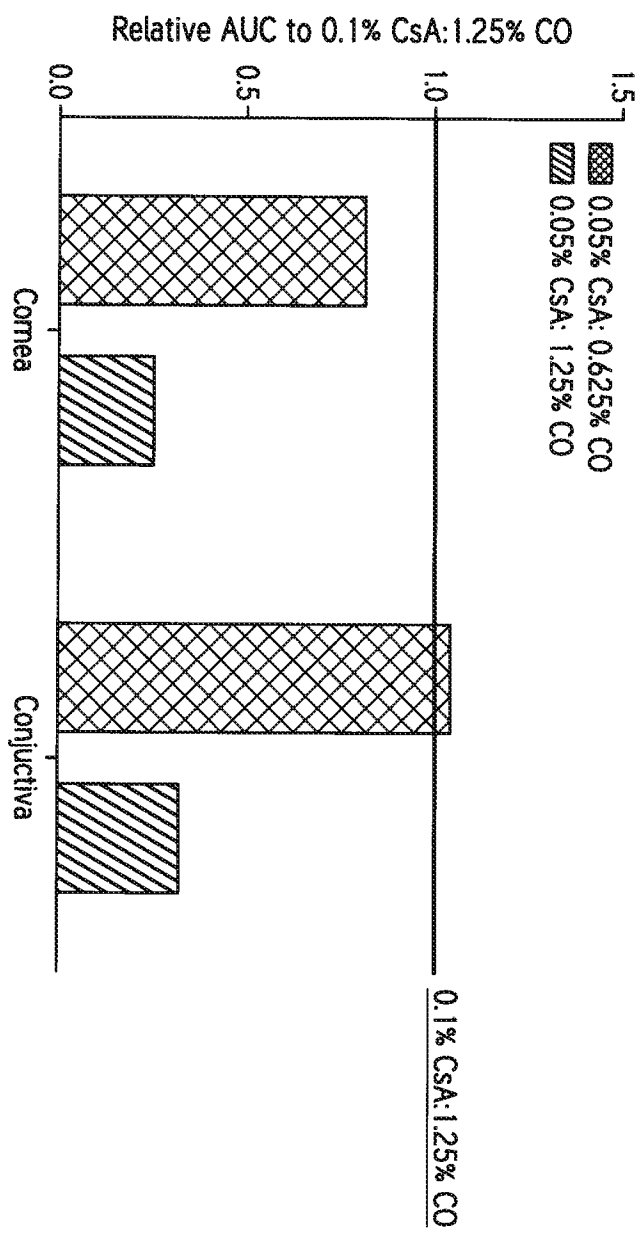

FIG. 2

# EXHIBIT C





# EXHIBIT D

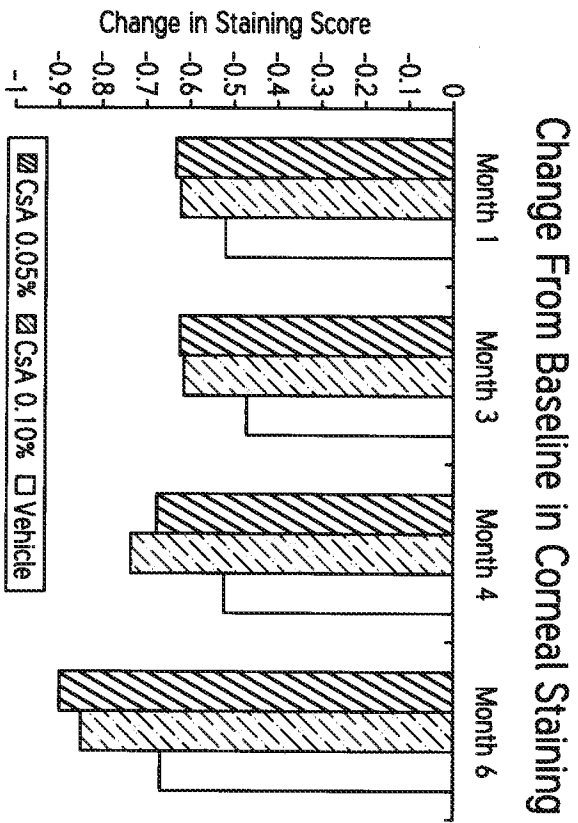

**FIG. 1**

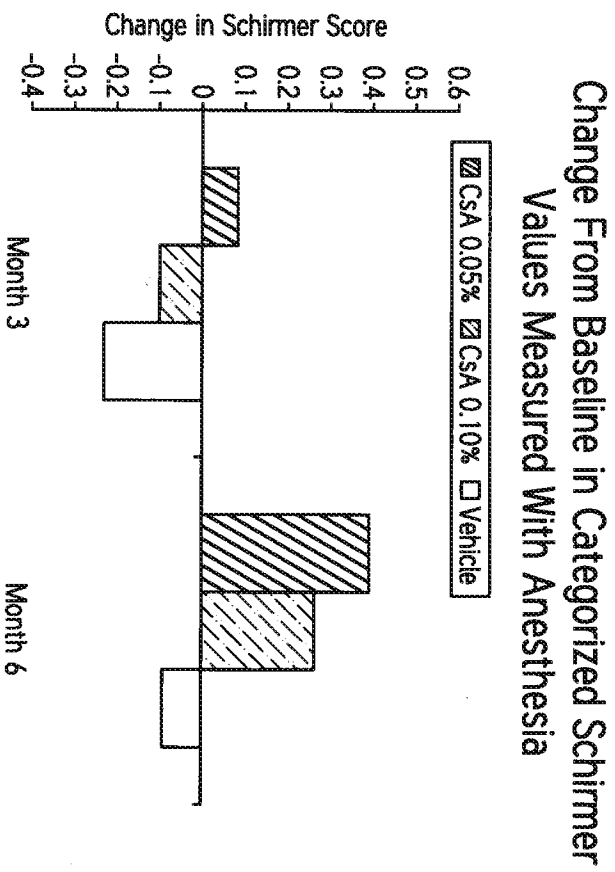

**FIG. 2**

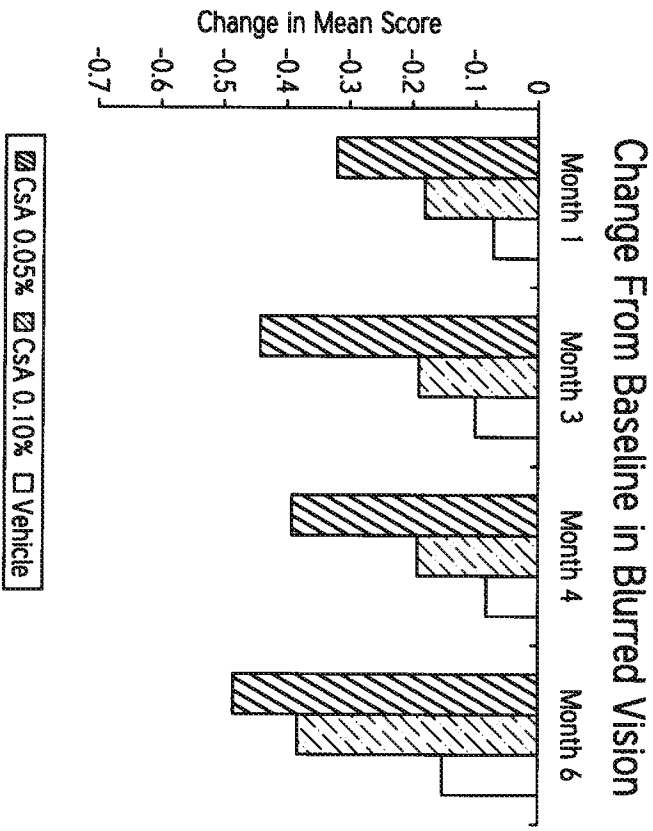

**FIG. 3**

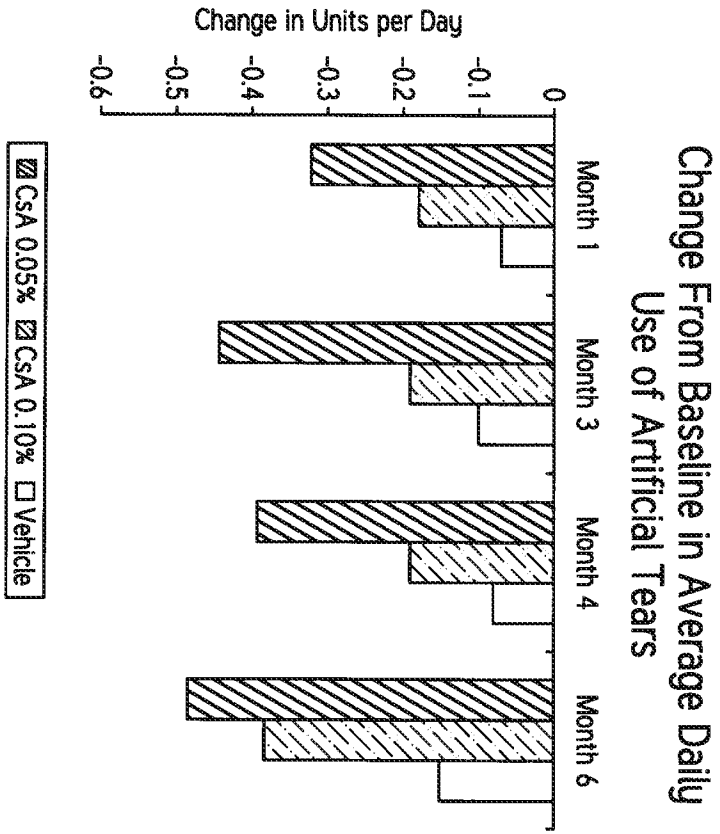

**FIG. 4**

# EXHIBIT E

|                              |                                    |                                 |                                 |
|------------------------------|------------------------------------|---------------------------------|---------------------------------|
|                              | Phase 2 001                        | Phase 3 (1 <sup>st</sup> study) | Phase 3 (2 <sup>nd</sup> study) |
|                              | 0.05% CSA in 0.625% CO             | 0.05% CSA in 1.25% CO           | 0.05% CSA in 1.25% CO           |
|                              | Compared with 0.1% CSA in 1.25% CO |                                 |                                 |
| Improvement in STT           | 0.25                               | 2<br>(8-Fold Improvement*)      | 1<br>(4-Fold Improvement*)      |
| Decrease in Corneal Staining | 0.25                               | 1<br>(4-Fold Improvement*)      | 1<br>(4-Fold Improvement*)      |

\*Compared to the 0.05% CSA/0.625% CO Phase 2 formulation (disclosed in Ding)

# EXHIBIT F

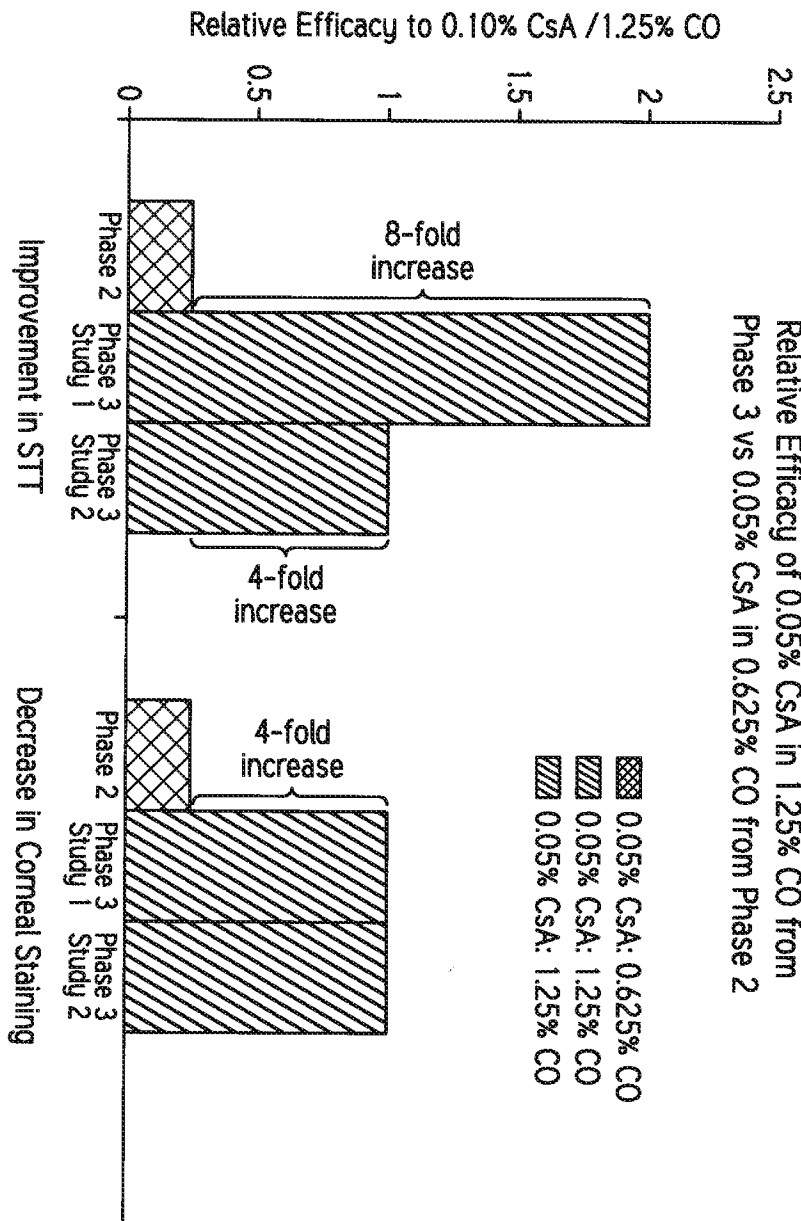



## EXHIBIT 2

IN THE UNITED STATES PATENT AND TRADEMARK OFFICE

DECLARATION UNDER 37 C.F.R. 1.132

of Dr. Mayssa Attar, Ph.D.

I, Mayssa Attar, Ph.D., declare as follows:

1. I am currently a Research Investigator at Allergan, Inc. ("Allergan"), specializing in preclinical and clinical pharmacokinetics and pharmacodynamics. I have a Ph.D. in Pharmaceutical Sciences, Bachelor's and Master's degrees in Biochemistry, and almost 15 years of experience in the pharmaceutical industry. I also serve as adjunct faculty at the the University of Southern California, School of Pharmacy. My *curriculum vita*, which contains a list of my publications to which I contributed, is attached to this declaration as Exhibit A.
2. I have been informed of the general nature of the rejections made by the Patent Office with respect to the previously presented claims of the above-referenced patent application and I am familiar with the references that the Patent Office has relied on in making these rejections. For example, I am aware of the "Ding" reference (U.S. Patent No. 5,474,979 to Ding et al.).
3. Restasis® is an FDA approved product that is a commercial embodiment of the invention. Specifically, Restasis® is approved as a 0.05% by weight cyclosporine ophthalmic emulsion useful for the treatment of ophthalmic conditions, such as dry eye. Specifically, Restasis® ophthalmic emulsion is indicated to increase tear production in patients whose tear production is presumed to be suppressed due to ocular inflammation associated with keratoconjunctivitis sicca.
4. I have reviewed the pending claims in the present application, and the pending claims cover the specific formulation of Restasis® and/or the approved methods of treatment of dry eye or keratoconjunctivitis sicca with Restasis®.
5. In creating and testing the claimed methods and compositions, several unexpected results were discovered using the claimed compositions and methods.
6. It was known in the art at the time this application was filed that cyclosporin could be administered topically locally to the eye to target and treat dry eye by using cyclosporin A's immunomodulatory properties to inhibit T cell activation, which would lead to an increase in tear production and potentially other therapeutic effects related to

cyclosporin's anti-inflammatory and anti-apoptotic effects and thus limit chronic inflammation in the pathology of dry eye. To elicit its therapeutic effect, cyclosporin must be effectively delivered to multiple target tissues of the ocular surface such as the cornea, conjunctiva, and lacrimal gland. The rate and extent at which cyclosporin is differentially delivered to the putative sites of action is critical to achieving therapeutic success in treating dry eye. Generally speaking, it was understood that pharmacokinetic/pharmacodynamic relationship would indicate that as more cyclosporin A reaches the target tissues of the ocular surface, such as the cornea and conjunctiva, the more immunomodulatory and more anti-inflammatory activity that can take place and the more therapeutically effective a drug can be in treating dry eye.

7. Pharmacokinetic studies were performed on animal eyes, which compared the pharmacokinetic properties of several cyclosporin A-containing formulations. Those results are attached to this declaration in Exhibit B. As shown in Exhibit B, the relative extent that cyclosporin was absorbed increased in the relevant ocular tissues, here, the cornea and the conjunctiva, where the amount of oil present in the formulation was decreased but the weight percentage of cyclosporin stayed the same. Specifically, the amount of cyclosporin A that reached the relevant ocular tissue was higher for the formulation containing 0.05% by weight cyclosporin A and 0.625% by weight castor oil than the formulation containing 0.05% by weight cyclosporin A and 1.25% by weight castor oil, relative to the formulation containing 0.1% by weight cyclosporin A and 1.25% by weight castor oil. We also noticed that the amount of cyclosporin A that reached the relevant ocular tissue was higher for the formulation containing 0.1% by weight cyclosporin A and 1.25% by weight castor oil than for the claimed formulation and method.
8. One of skill in the art would have understood such a result to mean that since there was more cyclosporin A present in the relevant ocular tissues with the formulation containing 0.05% by weight cyclosporin A and 0.625% by weight castor oil and the formulation containing 0.1% by weight cyclosporin A and 1.25% by weight castor oil than with the claimed formulation, that those formulations would have been more therapeutically effective than the claimed formulation. Specifically, this data teaches one of skill in the art that the formulation containing 0.05% by weight cyclosporin A and 0.625% by weight castor oil would have been more therapeutically effective than the claimed formulation.
9. Surprisingly, an unexpected increase in efficacy was demonstrated relative to the 0.1% cyclosporin A and 1.25% castor oil formulation when we compared the therapeutic efficacy of the claimed formulation and method (containing 0.05% by weight cyclosporin A and 1.25% by weight castor oil) in our multicenter, randomized, double-masked Phase

3 trials to the therapeutic efficacy of a formulation containing 0.05% by weight cyclosporin A and 0.625% cyclosporin in our a randomized, multicenter, double-masked, parallel-group, dose-response controlled Phase 2 trial.

10. As shown in Exhibits C and D, which are attached to this declaration, the corneal staining score and Schirmer scores were dramatically improved for the claimed methods (containing 0.05% by weight cyclosporin A and 1.25% by weight castor oil) compared to the formulations disclosed in Example 1E in Ding (the formulation containing 0.05% by weight cyclosporin A and 0.625% by weight castor oil).
11. I have read the Declaration of Dr. Rhett M. Schiffman, and I agree with his statements made at paragraphs 18-19. Exhibits E and F as referenced by Dr. Schiffman are attached as Exhibits C and D:
12. "As seen in Exhibit E, in the Phase 2 study, the 0.05% by weight cyclosporin A/0.625% by weight castor oil formulation (Ding 1E) only achieved 0.25 times the improvement in Schirmer Tear Test score as the 0.1 % by weight cyclosporin A/1.25% by weight castor oil formulation and only achieved 0.25 times the decrease in corneal staining as the 0.1 % by weight cyclosporin A/1.25% by weight castor oil formulation. However, in the Phase 3 studies, the claimed formulation and method achieved twice the improvement in Schirmer Tear Test score as the 0.1 % by weight cyclosporin A/1.25% by weight castor oil formulation in the first study and substantially the same improvement in Schirmer Tear Test score as the 0.1 % by weight cyclosporin A/1.25% by weight castor oil formulation in the second Phase 3 study. Also, the claimed formulation achieved substantially the same decrease in corneal staining score compared to the 0.1 % by weight cyclosporin A/1.25% by weight castor oil formulation.
13. As seen in Exhibit E, and further illustrated in Exhibit F, surprisingly, the claimed formulation and method demonstrated an 8-fold increase in relative efficacy for the Schirmer Tear Test Score in the first study of phase 3 compared to the 0.05% by weight cyclosporin A/0.625% by weight castor oil formulation (Ding Example 1E) in the Phase 2 study. Exhibits E and F also illustrate that the claimed formulations demonstrated a 4-fold improvement in the relative efficacy for the Schirmer Tear Test score for the second study of Phase 3 and a 4-fold increase in relative efficacy for decrease in corneal staining score in both of the Phase 3 studies compared to the 0.05% by weight cyclosporin A/0.625% by weight castor oil formulation in the Phase 2 study, the formulation disclosed in the Ding reference (Ding 1E). This was clearly a very surprising result."
14. Taking the results of these studies together, it is clear that the specific combination of 0.05% by weight cyclosporin A with 1.25% by weight castor oil is surprisingly critical

for therapeutic effectiveness for the treatment of dry eye/keratoconjunctivitis sicca, even those persons of skill in the art would have expected the formulation or method with the lower concentration of drug found in the relevant ocular tissue to be less therapeutically effective than those compositions with more drug in the ocular tissue (e.g. 0.05% by weight cyclosporin A/0.625% by weight castor oil formulation or 0.10% by weight cyclosporin A/1.25% by weight castor oil formulation disclosed in Ding).

I hereby declare that all statements made herein of my own knowledge and belief are true; and that all statements made on information and belief are believed to be true; and further that these statements are made with the knowledge that willful false statements and the like so made are punishable by fine or imprisonment, or both, under Section 1001 of Title 18 of the United States Code, and that such willful false statements may jeopardize the validity of the application or any patents issued thereon.

A handwritten signature in black ink, consisting of several loops and a long horizontal stroke at the end, positioned above a solid horizontal line.

Mayssa Attar, Ph.D.

Date: 10-14-2013

# EXHIBIT A

# M A Y S S A A T T A R , P H D

57 Shadowbrook, Irvine, CA 92604

714-381-1853 • [mayssa.attar@gmail.com](mailto:mayssa.attar@gmail.com)

Linkedin Profile: <http://www.linkedin.com/pub/mayssa-attar/13/707/b90>

## PROFESSIONAL SUMMARY

---

Almost fifteen years of drug development experience; Preclinical and clinical pharmacokinetics, pharmacodynamics, drug metabolism expertise; Oral, ophthalmic, and dermal drug development experience; Pharmacokinetics and clinical pharmacology representative supporting the submission of global regulatory filings; Cross-functional global team leader, functional line manager and matrix leader; Adjunct assistant professor at the University of Southern California, School of Pharmacy.

---

## PROFESSIONAL EXPERIENCE

### **ALLERGAN • Irvine, CA • 1/1999 – present**

#### **Research Investigator, Department of Pharmacokinetics and Drug Disposition**

- Serve as Group Head: Translational Sciences; Member of PK Leadership Team
- Serve as a functional line manager to PhD level scientists and cross-functional team leader on early development through market launch teams with responsibility for budgets of >\$15 million
- Set departmental strategy and provide oversight to the design, conduct and data interpretation of in vitro and in vivo studies to characterize drug pharmacokinetics, pharmacodynamics and metabolism from late stage discovery through clinical development; responsible for the review of regulatory submissions
- Serve as a lead representative when interacting with global regulatory agencies for both on-site compliance inspections and regulatory file review (North America, EU, Asia-Pac and other Emerging Regions), due diligence activities, legal activities and key opinion leaders
- Serve as a team member in the development and global registration of RESTASIS<sup>®</sup>, ACUVAIL<sup>®</sup>, ZYMAXID<sup>®</sup>, OZURDEX<sup>®</sup>
- Received 6 successive promotions

### **UNIVERSITY OF SOUTHERN CALIFORNIA • Los Angeles, CA • 10/2005 - present**

#### **Adjunct Assistant Professor, School of Pharmacy, Department of Pharmacology and Pharmaceutical Sciences**

- Lecture on the subjects of “Pharmacogenomics” and “Drug Metabolism”
- Mentor students as they consider careers in industry
- Serve as an instructor for FDA/ACCP online course “Pharmacogenomics”



**LOEB RESEARCH INSTITUTE • Ottawa, ON• 6/1995 – 8/1998**

**Research Associate, Hormones, Growth and Development Unit**

- Established protocols for isolation and purification of lipids
- Formulated liposomes as model plasma membrane systems
- FTIR-Spectroscopy, NMR

**EDUCATION**

**PhD, Pharmaceutical Sciences, University of Southern California, Los Angeles, CA**

Advisor: Vincent H L Lee, PhD, DSc

Thesis: Cytochrome P450 3A metabolism in the rabbit lacrimal gland and conjunctiva

**MSc, Biochemistry, University of Ottawa, Ottawa, ON**

Advisor: Nongnuj Tanphaichitr, PhD and Morris Kates, PhD

Thesis: A FTIR study of the interaction between sulfoglycolipid and phosphatidylcholine

**BSc, with honors, Biochemistry, University of Ottawa, ON**

**AWARDS AND HONORS**

- Allergan Award for Excellence, in recognition of team work to develop a pediatric investigation plan to support registration of RESTASIS® in EU (2011)
- Allergan Award for Excellence, in recognition of membership in a team charged with a departmental initiative to improve efficiencies in our Scientific Writing processes (2010)
- Allergan Award for Excellence, in recognition of collaboration with Bioanalytical Sciences to develop more efficient processes and better laboratory use of LC-MS/MS equipment to support metabolite profiling efforts (2010)
- Allergan Award for Excellence, in recognition of cost savings brought about by introducing new gene expression technology to support Toxicology assessment (2009)
- Allergan Award for Excellence, in recognition of role as Nonclinical Lead and contributing to the FDA approval and subsequent market launch of ACUVAIL™ (2009)
- Allergan Award for Excellence, in recognition of contribution to the development of an enhanced RESTASIS® formulation (2006)
- Rho Chi Honor Society (2005)
- Allergan Award for Excellence, in recognition of developing a high-throughput P450 inhibition assay (2000)
- NSERC grant to support full term of graduate studies (1996-1998)
- Travel scholarship to attend the Gordon Conference (1997)
- Loeb Summer Student Scholarship (1996)
- University Scholarships of Canada (1992-1996, awarded four consecutive years)

## PROFESSIONAL AFFILIATIONS

- AAPS
- ARVO
- ISSX
- Editorial Board Member, Current Molecular Pharmacology
- Ad Hoc Reviewer Investigative Ophthalmology and Vision Science
- Ad Hoc Reviewer Journal of Pharmaceutical Sciences

## OTHER SKILLS

- Computer: Watson LIMS, Phoenix/WinNonLin, Galileo LIMS, SIMCYP, Spottfire
- Languages: English, French, Arabic

## PUBLICATIONS

### Articles and Book Chapters

Woodward, D. F., Tang, E. S.H., Attar, M., and Wang, J. W. The biodisposition and hypertrichotic effects of bimatoprost in mouse skin. *Exp Dermatol.* 2013; 22:145–148.

Attar, M., Brassard, J.A., Kim, A.S., Matsumoto, S., Ramos, M., and Vangyi, C. Chapter 24: Safety Evaluation of Ocular Drugs in A Comprehensive Guide to Toxicology in Preclinical Drug Development. Edited by Faqi, A.S. Elsevier Inc., 2013

Waterbury, D.L., Galindo, D., Nguyen, C., Villanueva, L., Patel, M., Borbridge, L., Attar, M., Schiffman, R.M., Hollander, D.A. Ocular Penetration and Anti-inflammatory Activity of Ketorolac 0.45% and Bromfenac 0.09% Against Lipopolysaccharide-Induced Inflammation. *J. Ocul Pharmacol Ther.* 2011; 27 (2):173-8.

Chang-Lin, J., Attar, M., Acheampong, A., Robinson, M.R., Whitcup, S.M., Kuppermann, B.D., Welty, D. Pharmacokinetics and pharmacodynamics of the sustained-release dexamethasone intravitreal implant. *Invest Ophthalmol Vis Sci.* 2011; 52:80-86.

Attar, M., Schiffman, R.M., Borbridge, L., Farnes, Q., Welty, D. Ocular Pharmacokinetics of 0.45% Ketorolac Tromethamine. *Clin Ophthalmol.* 2010; 4: 1403-1408.

Attar M. and Shen J. Chapter 20: The Emerging Significance of Drug Transporters and Metabolizing Enzymes to Ophthalmic Drug Design in Ocular Transporters in Ophthalmic Diseases and Drug Delivery. Edited by Tombran-Tink, J and Barnstable, C.J. Humana Press, 2008.

Attar, M., Ling, KHJ., Tang-Liu, DDS., Neamati, N., and Lee, V.H.L. Characterization of Cytochrome P450 3A in the Rabbit Lacrimal Gland: Glucocorticoid Modulation and the Impact on Androgen Metabolism. *Invest Ophthalmol Vis Sci.* 2005; 46(12): 4697-4706.

Attar M., Shen, J., Ling, K.H.J, and Tang-Liu, D.D.S. Ophthalmic Drug Delivery Considerations at the Cellular Level: Drug Metabolizing Enzymes and Transporters. *Expert Opin Drug Deliv.* 2005; 2(5): 891-908.

Attar, M., Yu, D., Ni, J., Yu, Z., Ling, K.H.J and Tang-Liu, D.D.S. Disposition and biotransformation of the acetylenic retinoid tazarotene in humans. *J Pharm Sci.* 2005; 94(10): 2246-2255.

Attar, M. and Lee, V.H.L. Pharmacogenomic considerations in drug delivery. *Pharmacogenomics* 2003; 4(4): 443-461.

Tanphaichitr, N., Bou Khalil, M., Weerachayanukul, W., Kates, M., Xu, H., Carmona, E., Attar, M., Carrier D. Chapter 11: Physiological and biophysical properties of male germ cell sulfogalactosylglycerolipid in Lipid Metabolism and Male Fertility. Edited by De Vriese S. AOCS Press, 2003

Attar, M., Dong, D., Ling, K.H.J. and Tang-Liu, D.D.S. Cytochrome P450 2C8 and flavin-containing monooxygenases are involved in the metabolism of tazarotenic acid in humans. *Drug Metab Dispos* 2003; 31(4):476-481.

Attar, M., Kates, M., Khalil, M.B., Carrier, D., and Tanphaichitr, N. A Fourier-transform infrared study of the interaction between germ-cell specific sulfogalactosylglycerolipid and phosphatidylcholine. *Chem Phys Lipids* 2000;106(2):101-114.

Attar, M., Wong, P.T.T., Kates, M., Carrier, D., Jacklis, P., Tanphaichitr, N. Interaction between sulfogalactosylceramide and dimyristoylphosphatidylcholine increases the orientational fluctuations of the lipid hydrocarbon chains. *Chem Phys Lipids* 1998; 94(2):227-238.

Tanphaichitr, N., White, D., Taylor, T., Attar, M., Rattanachaiyanont, M., and Kates, M. Role of male germ-cell specific sulfogalactosylglycerolipid (SGG) and its binding protein, SLIP1, in mammalian sperm-egg interaction in The Male Gamete: From Basic Knowledge to Clinical Applications. Edited by Gagnon, C. Cache Press, 1998

White, D., Gadella, B., Kamolvarin, N., Suwajanakorn, S., Attar, M., and Tanphaichitr, N. Role of sperm sulfogalactosylglycerolipid (SGG) on sperm-zona pellucida binding. *Biol Reprod.* 2000; 63(1):147-55.

### **Abstracts and Posters**

Attar, M., Shen, J., Kim, M., Radojicic, Q.C. Cross-Species and Cross-Age Comparison of Esterase Mediated Metabolism in Vitreous: Human versus Rabbit, Dog and Monkey. Presented at ARVO Annual Meeting 2013.

Attar, M., Kim, M., Sachs, G., Scott, D., Struble, C.B., Welty, D. Modulation of Glucocorticoid Receptor Gene Expression: Potential Role in the Pharmacokinetic/ Pharmacodynamic Relationship of OZURDEX®. Presented at ARVO Annual Meeting 2011.

Attar, M., Schiffman, R.M., Borbridge, L., Farnes, Q., Welty, D. Evaluation of the Pharmacokinetics of Ketorolac Ophthalmic Solutions in Rabbit. Presented at ARVO Annual Meeting 2010.

Attar, M., Schiffman, R.M., Borbridge, L., Farnes, Q., and Welty, D. 2009 Pharmacokinetics of a Carboxymethylcellulose (CMC)-Based, Preservative-Free Formulation of 0.45% Ketorolac Tromethamine. Presented at ISOPT Annual Meeting 2009.

Wheeler, L., Robinson, M.R., Attar, M., Siemasko, K., Blanda, W., Whitcup, S.M. and Stern, M.E. 2009 Bioerodible Sustained-Release Ocular Impants in Mice Deliver Efficacious Concentrations of CsA. Presented at ARVO Annual Meeting 2009.

Yu, D., Attar, M., Parizadeh, D. and Tang-Liu, D. 2004. Pharmacokinetic Profile of Oral Tazarotene. Presented at AAD Winter 2004 meeting.

Attar, M., Lee, V.H.L., Tang-Liu, D.S. and Ling K.H.J. 2003. Characterization of Cytochrome P450 1A, 2D and 3A in the Rabbit Eye. Presented at AOPT 2003, Kona, Hawaii.

White, D., Gadella, B., Suwajanakorn, S., Kamolvarin, N., Attar, M., Abi-Khaled, L., and Tanphaichitr, N. 1997. Role of sulfogalactosylglycerolipid (SGG) in sperm-egg interaction. Presented at the Gordon Conference in Plymouth, New Hampshire.

Attar, M., Wong, P.T.T., Kates, M., Carrier, D., Tanphaichitr, N. 1997. An infrared spectroscopic study of the interaction between sulfogalactosylceramide, an analog of germ-cell specific sulfoglycolipid and phospholipid. Presented at the Gordon Conference in Plymouth, New Hampshire.

Kamolvarin, N., Suwajanakorn, S., Gadella, B., Berube, B., Attar, M., Lobsinger, D., and Tanphaichitr, N. 1996. Role of sulfogalactosylglycerolipid (SGG) on sperm-egg interaction and the zona-induced acrosome reaction (AR). Presented at the Society for the Study of Reproduction meeting in London, Ontario

## **Patents**

Farnes, E.Q., Attar, M., Schiffman, R.M., Chang, C., Graham, R.S., Welty, D.F. Ketorolac tromethamine compositions for treating or preventing ocular pain. US Patent 7,842,714 Filed Mar 3, 2009 and Issued Dec 28, 2011.

Blanda, W.M. and Attar, M. Sustained action formulation of cyclosporin form 2. US Patent Application 13/676,551 Filed Nov 14, 2012. Patent Pending.

Morgan, A., Gore, A.V., Attar, M., Pujara, C. Cyclosporin emulsions. US Patent Application EP20110726545 Filed May 25, 2011. Patent Pending.

Attar, M., Graham, R.S., Morgan, A., Schiffman, R.M., Tien, W. Cyclosporin compositions. US Patent Application PCT/US2007/074079 Filed Jul 23, 2007. Patent Pending.

Graham, R.S., Hollander, D., Villanueva, L., Farnes, E.Q., Attar, M., Schiffman, R.M., Chang, C., Welty, D.F. Ketorolac compositions for corneal wound healing. US Patent Application EP20110715353 Filed Apr 6, 2011. Patent Pending.

Graham, R.S., Tien, W.L., Attar, M., Schiffman, R.M., Stern, M.E., Sears, R., Walt, J.G., Cassaro, T. Cyclosporin compositions for ocular rosacea treatment. US Patent Application 12/035,698 Filed Feb 22, 2008. Patent Pending.

# EXHIBIT B

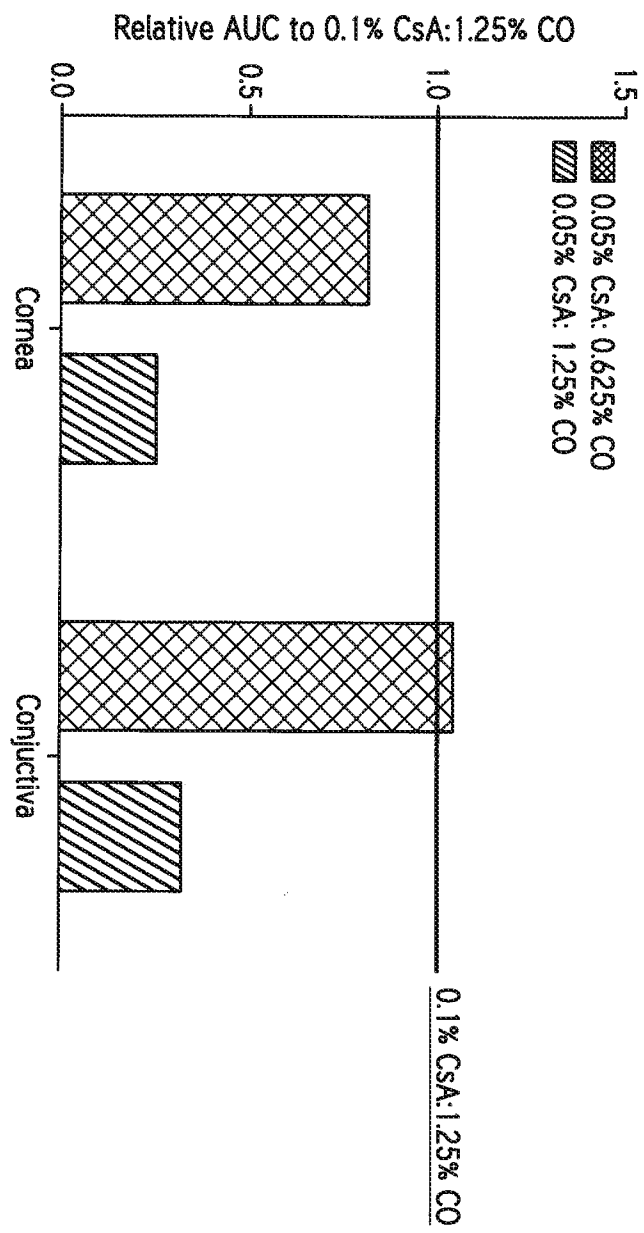

# EXHIBIT C



|                              |                                    |                                 |                                 |
|------------------------------|------------------------------------|---------------------------------|---------------------------------|
|                              | Phase 2 001                        | Phase 3 (1 <sup>st</sup> study) | Phase 3 (2 <sup>nd</sup> study) |
|                              | 0.05% CSA in 0.625% CO             | 0.05% CSA in 1.25% CO           | 0.05% CSA in 1.25% CO           |
|                              | Compared with 0.1% CSA in 1.25% CO |                                 |                                 |
| Improvement in STT           | 0.25                               | 2<br>(8-Fold Improvement*)      | 1<br>(4-Fold Improvement*)      |
| Decrease in Corneal Staining | 0.25                               | 1<br>(4-Fold Improvement*)      | 1<br>(4-Fold Improvement*)      |

\*Compared to the 0.05% CSA/0.625% CO Phase 2 formulation (disclosed in Ding)

## EXHIBIT D

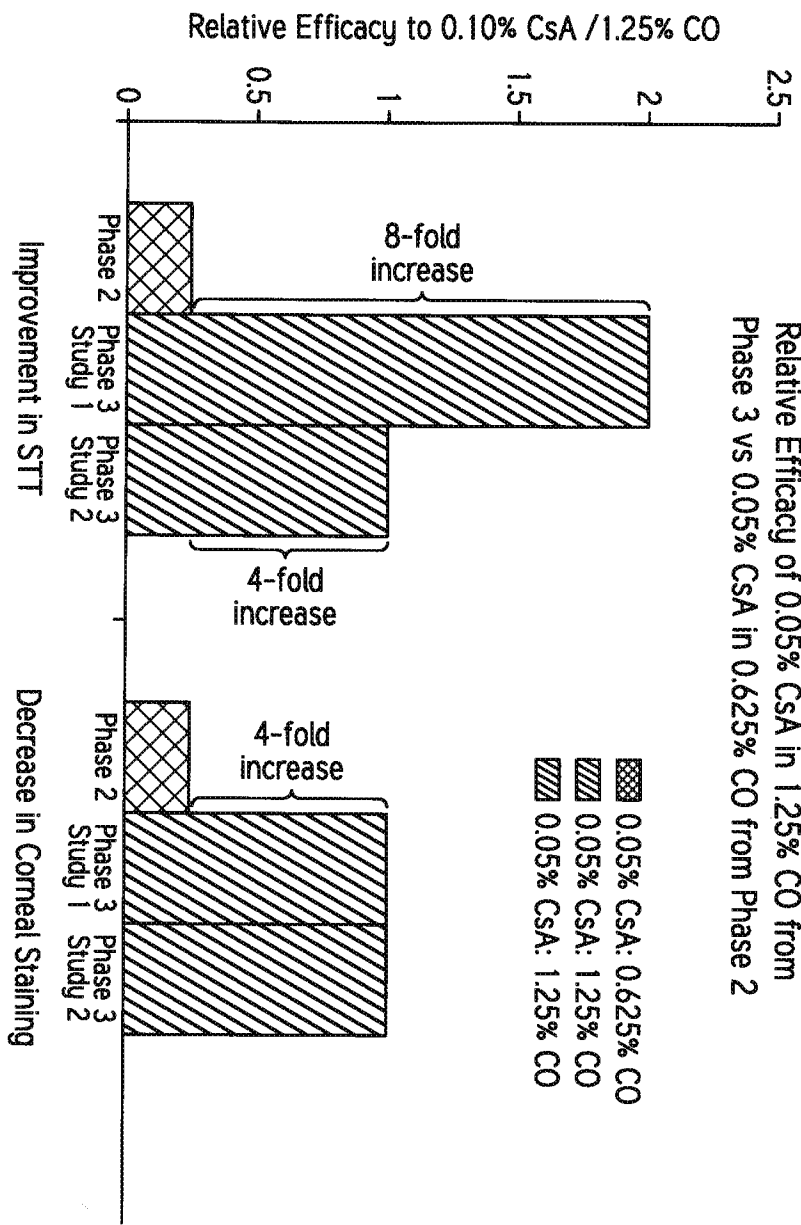

## EXHIBIT 3

IN THE UNITED STATES PATENT AND TRADEMARK OFFICE

DECLARATION UNDER 37 C.F.R. 1.132

of Aziz Mottiwala

I, Aziz Mottiwala, declare as follows:

1. I am currently a Vice President of Marketing at Allergan, Inc. ("Allergan") for Allergan's Dry Eye Product Franchise. I have an MBA from the University of Southern California, Marshall School of Business, a Bachelor's degree in Biochemistry, and over 15 years of experience in marketing and sales in the pharmaceutical industry. My *curriculum vita* is attached to this declaration as Exhibit A.
2. I have reviewed the pending claims in the present application, and the pending claims cover the specific formulation of Restasis® that has been sold since 2003. To the best of my knowledge, the Restasis® formulation includes 0.05% by weight cyclosporin A, 1.25% by weight castor oil, Pemulen, polysorbate 80, sodium hydroxide, and water. Restasis® was approved by the FDA on December 23, 2002.
3. Over the past ten years, Allergan has collected data on the world wide sales for Restasis® by quarter. This data is illustrated generally in Exhibit B, and broken out by country in Exhibit C, both attached to this declaration. I personally supervised the compilation of the data presented in Exhibit B and Exhibit C.
4. As illustrated in Exhibit B, the world-wide sales for Restasis® have steadily increased since the product's launch in the first quarter of 2003. Currently, annual world-wide net sales for Restasis® are over \$200 million per quarter, and nearing \$800 million annually. As illustrated in Exhibit C, a majority of the sales are in the US. As there is no other FDA-approved therapeutic treatment for dry eye available on the US market, Restasis® owns 100% of the market share.
5. In my expert opinion, this data is strong evidence of commercial success.
6. I hereby declare that all statements made herein of my own knowledge and belief are true; and that all statements made on information and belief are believed to be true; and further that these statements are made with the knowledge that willful false statements and the like so made are punishable by fine or imprisonment, or both, under Section 1001 of Title 18 of the United States Code, and that such willful false statements may jeopardize the validity of the application or any patents issued thereon.



---

Aziz Mottiwala

Date: 10-8-13

# **EXHIBIT A**

## EDUCATION

University of Southern California, Marshall School of Business, Los Angeles, CA  
*Master of Business Administration (MBA), Marketing/Corporate Strategy* December 2003

- Deans list: Fall 2001, Spring 2002, Fall 2002, Spring 2003, Fall 2003
- Elected to Beta Gamma Sigma National Honor Society

University of California, San Diego, Revelle College, La Jolla, CA  
*Bachelor of Science, Biochemistry and Cell Biology*, June 1999

- Recipient, American Society of Pharmacology and Experimental Therapeutics Research Fellowship.
- Howard Hughes Research Scholar, UCSD School of Medicine, Department of Pharmacology.

## EXPERIENCE.

**Allergan Inc., Irvine, CA**

*Vice President, Dry Eye Marketing*  
*February 2013- Current*

Leading all strategic development and professional promotions across Allergan's Dry Eye product franchise. Providing strategic direction over both Dry Eye promotions and strategic communications. Also, providing leadership and direction for all key brand forecasts and budgets. Leading long term strategic planning and budgeting, as well as implementation of key marketing plans to exceed corporate financial targets.

*Marketing Director, Dry Eye*  
*August 2010- February 2013*

Leading all strategic development and professional promotions across Allergan's Dry Eye product franchise. Providing strategic direction over both Dry Eye promotions and strategic communications. Also, providing leadership and direction for all key brand forecasts and budgets. Leading long term strategic planning and budgeting, as well as implementation of key marketing plans to exceed corporate financial targets.

*Product Director, Restasis® Professional Marketing*  
*October 2009- August 2010*

Professional Promotions across Allergan's Dry Eye product franchise. Providing strategic direction over both Dry Eye promotions and strategic communications. Also, providing leadership and direction for all key brand forecasts and budgets.

*Sr. Manager Restasis® Consumer Marketing*  
*October 2007- October 2009*

Managed Consumer Promotions across Allergan's Dry Eye product franchise. Responsible for Restasis® Direct-to-Consumer initiatives, including TV, Print and Interactive strategies and media planning. Also directing strategies and tactics for Dry Eye Franchise CRM, and Compliance/Persistence programs.

*Product Manager Restasis®/Optometric Strategies*  
*December 2006- October 2007*

Developed and implemented marketing plans for Optometric strategies in Dry Eye as well as other therapeutic areas within US Eye Care. Worked with the entire marketing team to drive brand strategy and ensure proper execution of tactics. Also managed brand forecasts and budgets, to ensure proper alignment of resources across the brand team.

**IMS/Cambridge Management Consulting, El Segundo, CA**

*Sr. Consultant, Management Consulting*  
*July 2006- December 2006*

Managed project teams including both internal and external resources in the design, development and delivery of client solutions. Provided coaching and direction to Consultants across multiple projects at any given time. Led teams to review and analyze client requirements, and developed associated proposals that ensured profitability and high client satisfaction.

- Projects across several practice areas including Pricing and Reimbursement, Portfolio Development, and Sales Force Effectiveness.
- Assisted a mid size biotech company's business development team in the assessment of several acquisition opportunities.
- Key Projects included development of a commercialization/launch playbook for a startup biotech company, as well as extensive pricing and reimbursement analysis of a Phase III product for a major biotech firm.



**EXPERIENCE (continued)**

**Valeant Pharmaceuticals, Costa Mesa, CA**

*Product Manager, Neurosciences/Hepatology*

*September 2004-July 2006*

Managing the development, market analysis and implementation of marketing plans for Tasmar<sup>®</sup>, Zelapar<sup>®</sup>, and most recently Infergen<sup>®</sup>. Driving brand strategy and ensuring proper execution of tactics. Also the primary marketing contact for field sales, providing marketing support to promote sales growth. Developing brand budgets and monitoring annual expense requirements, to ensure optimum utilization of marketing resources.

- Partnered with Business Development to acquire and transition marketing of Infergen<sup>®</sup> for Hep- C
- Produced new promotional materials and tactical programs such as sampling, and speaker programs to support strategy and drive sales.
- Developed Pre-Launch market research plan for Zelapar<sup>®</sup>. Including message testing, concept testing, and forecast development.
- Managed key medical education initiatives, including KOL Advisory boards, major conference symposia, publications and various CME programs.

*Analyst, Global Marketing/Commercial Development*

*September 2003-September 2004*

Supported Global Marketing and Development with market analysis and forecasting expertise that integrated secondary data sources and primary market research. Utilized IMS data to develop and execute integrated marketing analysis plans and product forecasts.

- Led the planning and execution of multi-attribute qualitative and quantitative market research projects for development products.
- Developed KOL targeting strategy for Viramidine, a Phase III product for Hepatitis C.
- Developed product forecasts and financial valuation models for business development during the acquisitions of Amarin Corp. and Xcel Pharmaceuticals, as well as the acquisition of Tasmar<sup>®</sup>, an in-line product for Parkinson's disease.

**Aventis Pharmaceuticals, Bridgewater, NJ**

*Area Sales Manager (Interim)*

*August 2002-September 2003*

Managed a team of 10 sales associates in the Southern California area. Provided guidance on selling strategies and tactics as well as communicating and implementing key marketing initiatives.

- District Ranking increased from 6 to 2 among 8 districts in a 12-month period.
- Developed nationally implemented ROI tool for sales associates to measure success of promotional programs.

*Professional Sales Associate/Field Sales Trainer*

*September 1999- August 2002*

Successfully marketing and increasing market share for therapeutic products for various disease states. Developing specialists as advocates to ensure maximum product pull through, resulting in yearly sales attainment over 100%. Trained 10 new sales associates on product knowledge and selling skills.

- Experience selling therapeutic products in various disease states including: Allergy, Asthma, Diabetes, Arthritis and Osteoporosis.
- Nova Award 2000: National award recognizing outstanding sales performance for a new associate.

**Saier Lab, U.C. San Diego Department of Biology, La Jolla, CA**

*Research Associate*

*September 1998-June 1999*

**Printz Lab, U.C. San Diego School of Medicine, La Jolla, CA**

*Research Associate*

*December 1997-February 1999*

Contributed to three separate research projects addressing genetics, neurology, and psychiatry. Contributed work to a major journal for publication: Palmer, A.; Dulawa, S.C.; Mottiwala, A.A.; Printz, M.P. "Pre-pulse Inhibition of the Air Puff Startle Response in Four Strains of Rats" *Behavioral Neuroscience* 2000 Apr;114(2):374-88

## **EXHIBIT B**

# World Wide RESTASIS Sales by QTR

## 2003-2013 YTD

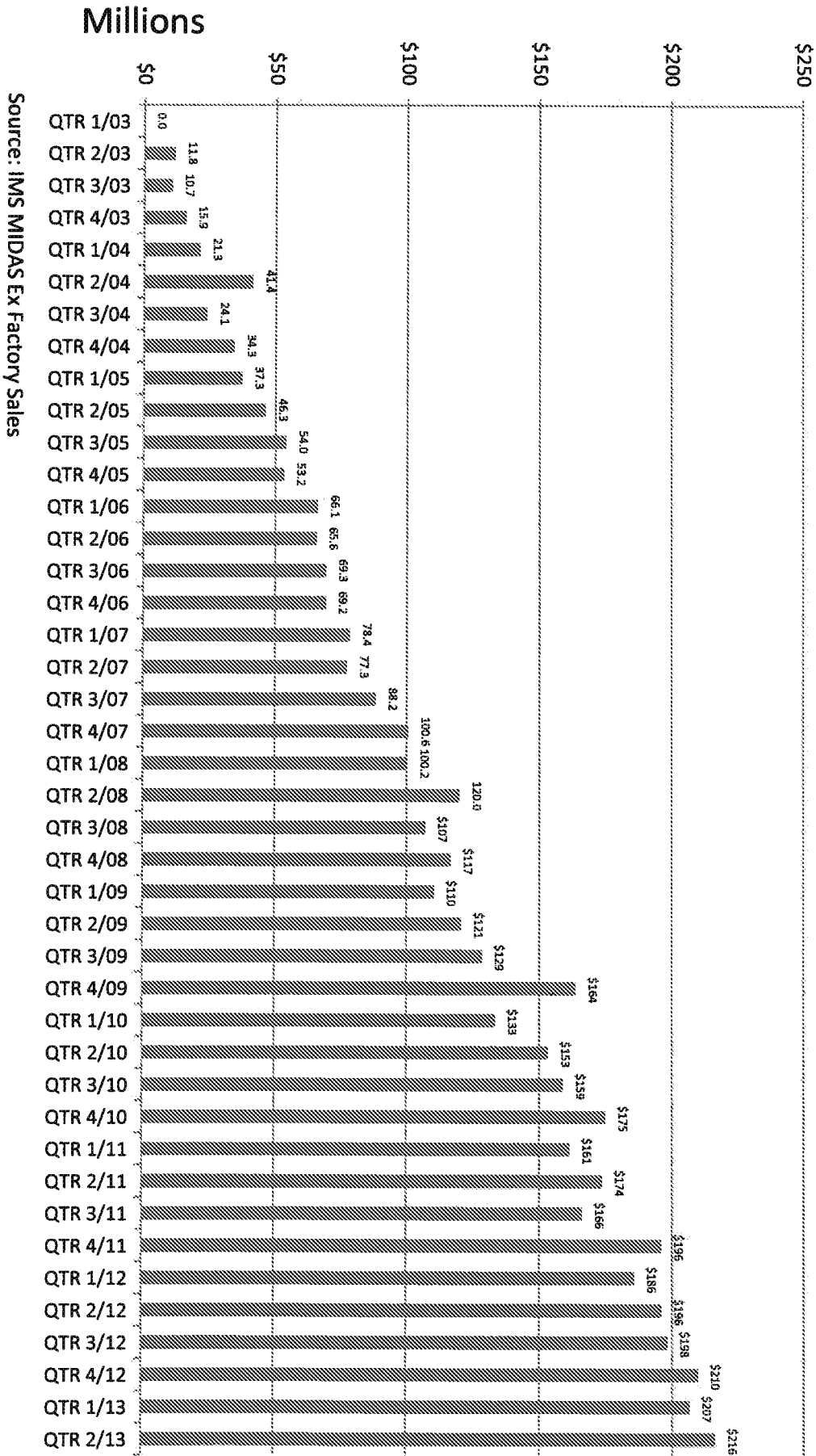

# **EXHIBIT C**



# **EXHIBIT 4**

IN THE UNITED STATES PATENT AND TRADEMARK OFFICE

DECLARATION UNDER 37 C.F.R. 1.132

of Dr. Rhett M. Schiffman

I, Rhett M. Schiffman, M.D., declare as follows:

1. I am currently a Vice President and Chief Medical Officer at Neurotech. I have an M.D., Masters Degrees in Clinical Research Design and Statistical analysis and in Health Services Administration, a Bachelor's degree in Bioengineering, and over 12 years of experience in the pharmaceutical industry at Allergan, Inc. ("Allergan"). I am a co-inventor on several issued patents and pending applications related to treatment methods using ophthalmic products. My *curriculum vita*, which contains a list of my publications to which I contributed, is attached to this declaration as Exhibit A.
2. Dry eye disease, also named keratoconjunctivitis sicca, is among the leading causes of patient visits to ophthalmologists in the United States. This condition has been recognized by the medical community and studied for decades. In the 1970s, over 600 articles were published on dry eye syndrome. The number of articles increased to over 1400 in the 1980s, over 2500 in the 1990s, and over 4800 in the last decade and counting.<sup>1</sup> It is estimated that at least twenty-three million Americans suffer from dry eye disease, which has two main causes: decreased secretion of tears by the lacrimal (tear-producing) glands, and loss of tears due to excess evaporation. Both causes lead to ocular discomfort, often described as feelings of dryness, burning, a sandy/gritty sensation, or itchiness. Symptoms, such as visual fatigue, sensitivity to light, and blurred vision also are characteristics of the disease. This is a serious disorder that, if left untreated or undertreated, progressively damages the ocular surface, and may lead to vision loss.
3. Dry eye disease is a disorder of the "tear film,"<sup>2</sup> and ocular inflammation is known to play a major role in the symptoms and progression of the disease. Dry eye disease patients can suffer mild irritation (Level 1 severity). In patients with Level 2 to Level 4

---

<sup>1</sup> Galor et al. (2012), attached as Exhibit B.

<sup>2</sup> The eye surface is supported and maintained by the tear film, which is composed of three components (lipid, aqueous, and mucin) that make up two fluid layers. Normal healthy tears contain a complex mixture of proteins and other components that are essential for ocular health and comfort. Tears provide nutrients and support the health of cells in the cornea, lubricate the ocular surface, and protect the exposed surface of the eye from infections. Clear vision depends on an even distribution of tears over the ocular surface. Dry eye disease affects the eye surface and changes the tear film composition dramatically. Typical changes include an elevated tear osmolarity, aqueous deficiency, altered mucins and lipid layer, and an altered proteomic profile.

severity scores, the symptoms are quite debilitating.<sup>3</sup> If the condition in these cases is untreated or treated inadequately (e.g., only with an agent such as artificial tears), the disease will continue to progress, and will lead to severe eye damage and vision loss.<sup>4</sup> Severe problems with untreated dry eye can also lead to corneal infection and scarring. Compared across different diseases, dry eye was found to cause degradation in quality of life that is on par with other severe disorders, such as class III/IV Angina.<sup>5</sup>

4. At the time Allergan initiated the Restasis® development program in 1992, dry eye was a well-recognized largely unmet medical condition. No therapeutic treatments were available, apart from the use of artificial tears, which had no direct pharmacology effect, and, blockage of the lacrimal drainage system with punctal plugs or cauterization for the most severe cases, which as we have since learned, made many patients worse by keeping the inflamed tears in constant contact with the ocular surface. In addition, neither artificial tears nor punctal plugs or cauterization actually worked to increase normal tear production in patients suffering from dry eye. Also, a 2002 Gallup poll data where 501 dry eye sufferers were interviewed predating the launch of Restasis®, showed that patients suffering from dry eye were looking for convenient and effective treatment for dry eye that provided long-lasting relief.<sup>6</sup> Almost 74% of consumers polled in 2002 wished there was a more effective treatment for dry eye.<sup>7</sup>
5. Allergan's investigators completed seminal work in the dry eye disease area, identifying the role of the T-cell and chronic inflammation in the pathogenesis of dry eye disease,<sup>8</sup> followed by application of cyclosporine (a drug previously used systemically to prevent transplant rejection) to target the disease locally. However, the lipophilic nature of cyclosporine made it extremely difficult to formulate an ocular-friendly preparation with good bioavailability. The multiple target tissues of the ocular surface (cornea, conjunctiva, lacrimal glands, etc.), the composition of the tear film (not a simple salt solution), and the short retention time on the eye contributed many complex issues in creating an efficacious formulation. Various formulations were attempted with

---

<sup>3</sup> Behrens A, Doyle JJ, Stern L, Chuck RS, McDonnell PJ, Azar DT, et al. Dysfunctional tear syndrome. A Delphi approach to treatment recommendations. *Cornea*. 2006;25:900-07, attached hereto as Exhibit C; Dry Eye Workshop. Management and therapy of dry eye disease: report of the management and therapy subcommittee of the international dry eye workshop. *Ocul Surf*. 2007a;5:163-78, attached hereto as Exhibit D.

<sup>4</sup> Rao S. Topical cyclosporine 0.05% for the prevention of dry eye disease progression. *J Ocular Pharmacol Thera*. 2010;26:157-163, attached hereto as Exhibit E; Deschamps N, Ricaud X, Rabut G, Labbé A, Baudouin C., Denoyer A. The impact of dry eye disease on visual performance while driving. *Am J Ophthalmol*. 2013; 125:184-189, attached hereto as Exhibit F.

<sup>5</sup> Schiffman R.M., Walt J.G., Jacobsen G., Doyle J.J., Lebovics G., Sumner W. Utility assessment among patients with dry eye disease. *Ophthalmology*. 2003;110:1412-1419, attached hereto as Exhibit G.

<sup>6</sup> The 2002 Gallup Study of Dry Eye Sufferers, attached hereto as Exhibit H.

<sup>7</sup> *Id.*

<sup>8</sup> Stern M.E., Beuerman R.W., Fox R.L., Gao J., Mircheff A.K., Pflugfelder, S.C. A unified theory of the role of the ocular surface in dry eye. *Adv Exp Med Biol*. 1998;438:643-51, attached hereto as Exhibit I.



concentrations up to 2% w/v cyclosporine and were poorly tolerated and absorbed. Ultimately, Allergan successfully formulated Restasis® in its current form, as presently claimed in the current patent application.

6. The approved Restasis® indication was based on statistically significant benefits in each of two pivotal clinical studies in which efficacy was defined as an improvement in the amount of tears produced (measured with a Schirmer score with anesthesia of  $\geq 10$  mm / 5 min, from a baseline of 0-5 mm). As a normal value for Schirmer's wetting is 10 mm / 5 min, an improvement of  $\geq 10$  mm / 5 min assured that responders achieved a total reversal of this measure of disease (i.e., a complete response) regardless of their baseline measurements. Patients in these trials suffered from moderate to very severe dry eye symptoms, with 60% of the patients scored as having the most severe Level 4 symptoms (discussed further below). Despite the severity of disease at baseline, and the very high hurdle for success, the proportion of patients experiencing complete response was three-fold higher among subjects taking Restasis® compared with those taking vehicle after 6 months of treatment. This was a highly significant result ( $p < .007$ ).
7. The improvement in symptoms continued for 12 months and beyond in both the Restasis® group and in vehicle treated patients who were switched to Restasis® at month 6. It should be noted that these trials were begun in the late 1990s and were the first of their kind.
8. Restasis® was FDA approved on December 23, 2002. The approval of Restasis® for the treatment of dry eye represented a major paradigm shift in the treatment of dry eye.<sup>9</sup> Restasis® was the first FDA approved prescription medication for dry eye, and is still the only FDA approved prescription medication for dry eye. Restasis® has been well received by the medical community as a major breakthrough in dry eye treatment, and is currently the #1 selling eye drop in the world. For example, Dr. Henry Perry stated that "[i]t is important in any type of chronic ocular surface disease, especially due to aqueous deficiency, to begin topical cyclosporine."<sup>10</sup> Another physician, Dr. Christopher Starr stated "I liked Restasis from the beginning and I have increased my prescribing of it over the years as I've gained more experience and witnessed its impressive results," and "[t]he most recent definition of dry eye disease from the Dry Eye WorkShop (DEWS) report notes hyperosmolarity and inflammation as key pathophysiologic factors, which recommends the use of anti-inflammatory medication such as Restasis beginning with level 2 disease."<sup>11</sup>

---

<sup>9</sup> Pflugfelder, 2006 attached as Exhibit J.

<sup>10</sup> Ocular Surgery, January 2013, attached as Exhibit K.

<sup>11</sup> Ophthalmology Management, September 2013, attached as Exhibit L.

9. Other companies have tried to develop prescription treatments for dry eye, but none have been FDA approved as of this date.<sup>12</sup> A partial listing of companies and drugs for drug eye that have failed are attached hereto as Exhibit N. One example of such drug is Prolacria, a dry eye treatment that was developed for over a decade by Inspire Pharmaceuticals, but was cancelled in 2010 when Prolacria failed to outperform a placebo in their phase III clinical trials.<sup>13</sup>

---

<sup>12</sup> <http://www.ophthalmologymanagement.com/articleviewer.aspx?articleid=104917> accessed 2013-09-24 and attached as Exhibit M.

<sup>13</sup> <http://www.bizjournals.com/triangle/stories/2010/08/23/daily11.html?pager=all> accessed 2013-09-24 and attached as Exhibit O.

I hereby declare that all statements made herein of my own knowledge and belief are true; and that all statements made on information and belief are believed to be true; and further that these statements are made with the knowledge that willful false statements and the like so made are punishable by fine or imprisonment, or both, under Section 1001 of Title 18 of the United States Code, and that such willful false statements may jeopardize the validity of the application or any patents issued thereon.

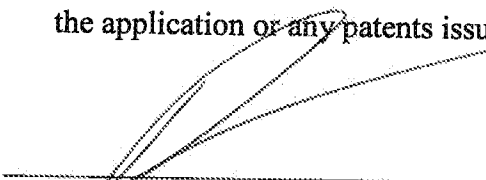
  
\_\_\_\_\_  
Dr. Rhett M. Schiffman

Date: 10/01/13

# EXHIBIT A

## CURRICULUM VITAE FOR RHETT M. SCHIFFMAN, M.D., M.S., M.H.S.A.

Current Title: Vice President and Chief Medical Officer  
Neurotech

Work Address: 900 Highland Corporate Drive  
Building #1, Suite #101  
Cumberland, RI 02864

Home Address: 1843 Temple Hills  
Laguna Beach, CA 92651

Office Telephone: (401) 495-2395  
Cell Telephone: (313) 516-6924  
Email: r.schiffman@neurotechusa.com

### EDUCATION:

Professional: University of Michigan, School of Public Health,  
Ann Arbor, Michigan  
2000 M.H.S.A. Health Services Administration

University of Michigan, Rackham Graduate School,  
Ann Arbor, Michigan  
1989 M.S. Clinical Research Design & Statistical Analysis

Universidad Autonoma de Ciudad Juarez  
Instituto de Ciencias Biomedicas  
Juarez, Mexico  
1983 M.D. Medicine

Undergraduate: Columbia University  
School of Engineering and Applied Science  
New York, NY  
1978 B.S. Bioengineering

### POSTDOCTORAL TRAINING:

Fellow: Uveitis and Ocular Immunology, National Eye Institute,  
National Institutes of Health, Bethesda, MD  
1996-1997

Resident: Ophthalmology, Henry Ford Hospital, Detroit, Michigan  
1993 - 1996

Resident: Internal Medicine, Henry Ford Hospital, Detroit, Michigan  
1984 - 1986

Intern: Internal Medicine, Henry Ford Hospital, Detroit, Michigan  
1983 - 1984

**CERTIFICATION AND LICENSURE**

Medical Licensure: California, 2002 – C50825  
Michigan, 1983 - 4301046984

Board Certification: American Board of Ophthalmology, 1999; 93th percentile on Board examination  
American Board of Internal Medicine, 1986; 99<sup>th</sup> percentile on Board examination

**PROFESSIONAL SOCIETIES:**

Member, Association for Research in Vision and Ophthalmology  
American Academy of Ophthalmology  
American Medical Association

**PROFESSIONAL EXPERIENCE:**

2013-Present Vice President and Chief Medical Officer, Neurotech

2010-2013 Board Member, Glaucoma Research Foundation

2009-2013 Ophthalmology Therapeutic Area Head

2008-2013 Head of Development for Emerging Markets

2007-2013 Head, Global Product Enhancement/Life Cycle Management

2005-2013 Vice President, Development for Ophthalmology and Botox, Allergan Pharmaceuticals

2003-Present Clinical Associate Professor and Attending Physician in Ophthalmology, University of California at Irvine.

2001-2005 Senior Director, Ophthalmology Clinical Research, Allergan Pharmaceuticals, Irvine, California

1999-2001 Member, Leadership Council, Eye Care Services, Henry Ford Health System, Detroit, MI

1999-2001 Director, Quality Improvement, Eye Care Services, Henry Ford Health System, Detroit, MI

1998-2001 Director of the African-American Initiative for Male Health Improvement (AIMHI). Eye Disease Screening Program in Southeast Michigan. Funded by the Michigan Department of Community Health.

1997-2001 Director of Uveitis Services, Eye Care Services, Henry Ford Health System, Detroit, MI  
Director of Clinical Research, Eye Care Services, Henry Ford Health System, Detroit, MI  
Staff Investigator, Center for Health Services Research, Henry Ford Health System, Detroit, MI

1996-2001 Reviewer to Special Study Section, National Eye Institute, National Institutes of Health, Bethesda, Maryland.

1999-2001 Director, Clinical Research, Eye Care Services, Henry Ford Hospital, Detroit, Michigan

- 1996-1997 Senior Staff Physician, Eye Care Services, Ophthalmology, Henry Ford Health System, Detroit, Michigan (on intergovernmental personnel act to National Eye Institute, National Institutes of Health, Bethesda, Maryland)
- 1994-1995 Associate Medical Director, Henry Ford Hospital Pharmacology Research Unit, Detroit, Michigan
- 1993-2001 Associate Research Director, Eye Care Services, Henry Ford Hospital, Detroit, Michigan
- 1989-2001 Staff, Center for Clinical Effectiveness, Henry Ford Hospital, Detroit, Michigan
- 1988-1994 Requirements Advisory Committee to the Medical Information Management System, Henry Ford Hospital, Detroit, Michigan
- 1989-1993 Coordinator, General Internal Medicine Research, Henry Ford Hospital, Detroit, Michigan
- 1990-1993 Chairman, General Internal Medicine Research Committee, Henry Ford Hospital, Detroit, Michigan
- Member, Research and Academic Affairs Committee, Department of Medicine, Henry Ford Hospital, Detroit, Michigan
- 1986-1993 Senior Staff Physician, General Internal Medicine, Henry Ford Hospital, Detroit, Michigan

**TEACHING EXPERIENCE:**

- 2003-Present Ophthalmology Residency Training Program, University of California at Irvine
- 1997-2001 Ophthalmology Residency Training Program, Henry Ford Hospital, Detroit, Michigan
- 1986-1993 Internal Medicine Residency Training Program, Henry Ford Hospital, Detroit, Michigan
- 1988-1993 Preceptor, University of Michigan Medical Schools, Ann Arbor, Michigan
- 1991-1993 Preceptor, General Internal Medicine Fellows
- Medical Staff Seminars, General Internal Medicine, Henry Ford Hospital, Detroit, MI:  
Introduction to Epidemiology, Introduction to Personal Computing, Medical Decision Analysis

**BOOKS & MONOGRAPHS:**

1. Ocular Therapy chapter in: Oréface, Fernando: Uveíte: Clínica e Cirúrgica. Ed. Cultura Médica. Published June 2000.
2. New Concepts in the Pathogenesis, Diagnosis and Treatment of Dry Eye. Ocular Surgery News Monograph; Slack Incorporated. July 1, 1999

3. Schiffman RM: Glaucoma, Ophthalmology chapter in Noble, John: Textbook of Primary Care Medicine. 2<sup>nd</sup> Edition. 1996. Mosby-Year Book, Inc. 1471-9.

#### JOURNAL PUBLICATIONS:

1. Day D.G., Walters T.R., Schwartz G.F., Mundorf T.K., Liu C., Schiffman R.M., Bejani M. Bimatoprost 0.03% preservative-free ophthalmic solution versus bimatoprost 0.03% ophthalmic solution (Lumigan) for glaucoma or ocular hypertension: a 12-week, randomised, double-masked trial. *Br J Ophthalmol*. 2013 Jun 6. [Epub ahead of print]
2. Callanan DG, Gupta S, Boyer DS, Ciulla TA, Singer MA, Kuppermann BD, Liu CC, Li XY, Hollander DA, Schiffman RM, Whitcup SM; Ozurdex PLACID Study Group. Dexamethasone Intravitreal Implant in Combination with Laser Photocoagulation for the Treatment of Diffuse Diabetic Macular Edema. *Ophthalmology*. 2013 May 22. S0161-6420(13)00152-8.
3. Katz LJ, Rauchman SH, Cottingham AJ Jr, Simmons ST, Williams JM, Schiffman RM, Hollander DA. Fixed-combination brimonidine-timolol versus latanoprost in glaucoma and ocular hypertension: a 12-week, randomized, comparison study. *Curr Med Res Opin*. 2012 May;28(5):781-8
4. Katz, L.J., Rauchman, S.H., Cottingham Jr., A.J., Simmons, S.T., Williams, J.M., Schiffman, R.M., Hollander, D.A. Fixed-combination brimonidinetimolol versus latanoprost in glaucoma and ocular hypertension: A 12-week, randomized, comparison study. *Current Medical Research and Opinion* 28 (5) , pp. 781-788
5. Lowder, C., Belfort Jr., R., Lightman, S., Foster, C.S., Robinson, M.R., Schiffman, R.M., Li, X.-Y., Cui H, Whitcup, S.M. Dexamethasone intravitreal implant for noninfectious intermediate or posterior uveitis. *Arch Ophthalmol* 2011 129 (5):545-553
6. Waterbury, L.D., Galindo, D., Villanueva, L., Nguyen, C., Patel, M., Borbridge, L., Attar, M., Schiffman RM, Hollander, D.A. Ocular penetration and anti-inflammatory activity of ketorolac 0.45% and bromfenac 0.09% against lipopolysaccharide-induced inflammation. *J Ocular Pharmacol and Therapeutics* 2011 27 (2):173-178
7. Xu, K., McDermott, M., Villanueva, L., Schiffman, R.M., Hollander, D.A. Ex vivo corneal epithelial wound healing following exposure to ophthalmic nonsteroidal anti-inflammatory drugs. *Clin Ophthalmol* 2011 5 (1), pp. 269-274.
8. Donnenfeld, E.D., Nichamin, L.D., Hardten, D.R., Raizman, M.B., Trattler, W., Rajpal, R.K., Alpern, L.M., Felix C, Bradford RR, Villanueva L, Hollander DA, Schiffman, R.M. Twice-daily, preservative-free ketorolac 0.45% for treatment of inflammation and pain after cataract surgery. *Am J Ophthalmol* 2011 151 (3):420-426.
9. Spaeth G, Bernstein P, Caprioli J, Schiffman RM. Control of Intraocular Pressure and Intraocular Pressure Fluctuation with Fixed Combination Brimonidine-Timolol versus Brimonidine or Timolol Monotherapy. *Am J Ophthalmol*. 2011 January;151:93-99.
10. Attar, M., Schiffman, R., Borbridge, L., Farnes, Q., Welty, D. Ocular pharmacokinetics of 0.45% ketorolac tromethamine. *Clin Ophthalmol* 2010 4(1), pp. 1403-1408
11. Craven, E.R., Liu, C.-C., Batoosingh, A., Schiffman, R.M., Whitcup, S.M. A randomized, controlled comparison of macroscopic conjunctival hyperemia in patients treated with bimatoprost 0.01% or vehicle who were previously controlled on latanoprost. *Clin Ophthalmol* 2010 4 (1):1433-1440
12. Olson, R., Donnenfeld, E., Bucci Jr., F.A., Price Jr., F.W., Raizman, M., Solomon, K., Devgan, U., Trattler W, Dell S, Wallace RB, Callegan M, Brown H, McDonnell PJ, Conway T, Schiffman RM,



- Hollander, D.A. Methicillin resistance of Staphylococcus species among health care and nonhealth care workers undergoing cataract surgery. *Clin Ophthalmol.* 2010 4(1):1505-1514
13. Katz L, Cohen J, Batoosingh A, Felix C, Shu V, Schiffman R. Twelve-Month, Randomized Controlled Trial of the Efficacy and Safety of Bimatoprost 0.01%, 0.0125%, and 0.03% in Patients with Glaucoma or Ocular Hypertension. *Am J Ophthalmol.* 2010 April;149:661-671.
  14. Lewis R, Gross R, Sall K, Schiffman R, Liu C-C, Batoosingh A, (for the Ganfort® Investigators Group II ). The Safety and Efficacy of Bimatoprost/Timolol Fixed Combination: A 1-year Double-masked, Randomized Parallel Comparison to Its Individual Components in Patients With Glaucoma or Ocular Hypertension. *J Glaucoma.* 2010 August;19(6):424-426.
  15. Sherwood MB, Craven ER, Chou C, DuBiner HB, Batoosingh AL, Schiffman RM, Whitcup SM. Twice-daily 0.2% brimonidine-0.5% timolol fixed-combination therapy vs monotherapy with timolol or brimonidine in patients with glaucoma or ocular hypertension: a 12-month randomized trial. *Arch Ophthalmol.* 2006 Sep;124(9):1230-8.
  16. Craven ER, Walters TR, Williams R, Chou C, Cheetham JK, Schiffman R; Combigan Study Group. Brimonidine and timolol fixed-combination therapy versus monotherapy: a 3-month randomized trial in patients with glaucoma or ocular hypertension. *J Ocul Pharmacol Ther.* 2005 Aug;21(4):337-48.
  17. Yee RW, Tepedino M, Bernstein P, Jensen H, Schiffman R, Whitcup SM; Gatifloxacin BID/QID Study Group. A randomized, investigator- masked clinical trial comparing the efficacy and safety of gatifloxacin 0.3% administered BID versus QID for the treatment BID versus QID for the treatment of acute bacterial conjunctivitis of acute bacterial conjunctivitis. *Curr Med Res Opin.* 2005 Mar;21(3):425-31.
  18. Schiffman RM, Jacobsen G, Nussbaum JJ, et al: A Novel Approach for Detection of Diabetic Retinopathy Using DigiScope Retinal Imaging System. *Ophthalmic Surg Lasers Imaging.* 2005 Jan-Feb;36(1):46-56.
  19. Solomon KD, Donnenfeld ED, Raizman M, Stern K, VanDenburgh A, Cheetham JK, Schiffman RM for the Ketorolac Reformulation Study Groups 1 and 2: Safety and Efficacy of Reformulated Ketorolac Tromethamine 0.4% Ophthalmic Solution in Post-photorefractive Keratectomy Patients. *Journal Cataract Refract Surg* 2004 Aug;30(8):1653-1660.
  20. Whitcup SM, Bradford R, Lue J, Schiffman RM, Abelson MB. Efficacy and tolerability of ophthalmic epinastine: a randomized, double-masked, parallel-group, active- and vehicle-controlled environmental trial in patients with seasonal allergic conjunctivitis. *Clin Ther.* 2004 Jan;26(1):29-34.
  21. Abelson MB, Gomes P, Crampton HJ, Schiffman RM, Bradford RR, Whitcup SM. Efficacy and tolerability of ophthalmic epinastine assessed using the conjunctival antigen challenge model in patients with a history of allergic conjunctivitis. *Clin Ther.* 2004 Jan;26(1):35-47.
  22. McDonnell PJ, Taban M, Sarayba MA, Schiffman RM, et al.: Dynamic Morphology of Clear Corneal Incisions. *Ophthalmology.* 2003 Dec;110(12):2342-8.
  23. Desai UR, Alhalel AA, Campen TJ, Schiffman RM, Edwards PA, Jacobsen GR: Central serous chorioretinopathy in African Americans. *J Natl Med Assoc.* 2003 Jul;95(7):553-9.
  24. Javitt JC, Jacobson G, Schiffman RM.: Validity and reliability of the Cataract Type Spec: an instrument for measuring outcomes of cataract extraction. *Am J Ophthalmol.* 2003 Aug;136(2):285-90.
  25. Baum JL, Schiffman RM: Reliability and Validity of a Proposed Dry Eye Evaluation Scheme - Reply. *Arch Ophthalmol* 2001 Mar;119(3):456.

26. Schiffman RM, Walt JG, Jacobsen G, Doyle JJ, Lebovics G, Sumner W.:Utility assessment among patients with dry eye disease. *Ophthalmology*. 2003 Jul;110(7):1412-9.
27. Baum JL, Schiffman RM: Reliability and Validity of a Proposed Dry Eye Evaluation Scheme. *Arch Ophthalmol* 2001 Mar;119(3):456.
28. Desai UR, Tawansy K, Schiffman RM: Choroidal Granulomas in Systemic Sarcoidosis. *Retina*. 2001;21(1):40-7.
29. Mangione CM, Lee PP, Spritzer K, Berry S, Hayes RD et. al: Development, Reliability, and Validity of the 25-Item National Eye Institute Visual Function Questionnaire (VFQ-25). Accepted for publication in *Archives of Ophthalmology*.
30. Schiffman RM, Jacobsen G, Whitcup S: Visual Functioning and General Health Status in Patients with Uveitis. *Arch Ophthalmol* 2001 Jun;119(6):841-849.
31. Javitt JC, Schiffman RM: Clinical Success and Quality of Life with Brimonidine 0.2% or Timolol 0.5% used BID in Glaucoma or Ocular Hypertension: A Randomized Clinical Trial. *J Glaucoma*. 2000 Jun;9(3):224-34.
32. Schiffman RM, Christianson MD, Jacobsen G, Hirsch JD, Reis BL.: Reliability and validity of the Ocular Surface Disease Index. *Arch Ophthalmol*. 2000 May;118(5):615-21.
33. Nussenblatt RB, Fortin E, Schiffman R, Rizzo L, Smith J, Van Veldhuisen P, Sran P, Yaffe A, Goldman CK, Waldmann TA, Whitcup SM. Treatment of noninfectious intermediate and posterior uveitis with the humanized anti-Tac mAb: a phase I/II clinical trial. *Proc Natl Acad Sci U S A*. 1999 Jun 22;96(13):7462-6.
34. Nussenblatt RB, Schiffman R, Fortin E, Robinson M, Smith J, Rizzo L, Csaky K, Gery I, Waldmann T, Whitcup SM: Strategies for the treatment of intraocular inflammatory disease. *Transplant Proc*. 1998 Dec;30(8):4124-5.
35. Mangione CM. Lee PP. Pitts J. Gutierrez P. Berry S. Hays RD. Psychometric properties of the National Eye Institute Visual Function Questionnaire (NEI-VFQ). NEI-VFQ Field Test Investigators. *Archives of Ophthalmology*. 116(11):1496-504, 1998 Nov.
36. Desai UR. Alhalel AA. Schiffman RM. Campen TJ. Sundar G. Muhich A. Intraocular pressure elevation after simple pars plana vitrectomy. *Ophthalmology*. 104(5):781-6, 1997 May.
37. Ben-Menachem T. McCarthy BD. Fogel R. Schiffman RM. Patel RV. Zarowitz BJ. Nerenz DR. Bresalier RS. Prophylaxis for stress-related gastrointestinal hemorrhage: a cost effectiveness analysis. *Critical Care Medicine*. 24(2):338-45, 1996 Feb.
38. Ward RE; Purves T; Feldman M; Schiffman RM; Barry S; Christner M; Kipa G; McCarthy BD; Stiphout R: Design considerations of CareWindows, a Windows 3.0-based graphical front end to a Medical Information Management System using a pass-through-requester architecture. *Proc Annu Symp Comput Appl Med Care* 1991; 564-8
39. Stiphout RM; Schiffman RM; Christner MF; Ward R; Purves TM: Medical Information Management System (MIMS) CareWindows. *Proc Annu Symp Comput Appl Med Care* 1991; 929-31
40. Gubbins G, Schiffman RM, Alipati R, Batra S.: Cocaine-Induced Hepatonephrotoxicity. *Henry Ford Hospital Medical Journal* 1990; 38:55-56.

## JOURNAL REVIEWER

1. British Journal of Ophthalmology
2. Current Eye Research
3. Ophthalmology
4. Optometry and Vision Science
5. The Lancet

## SELECTED PAST SCIENTIFIC ACTIVITIES:

### HFHS Principal Investigator

1. Schiffman RM, Chew E, Ferris F, Ellwein L, Hays R, Mangione C: A Randomized Comparison of the Cost, Quality and Acceptability of Four Modes of Administration the National Eye Institute Visual Functioning Questionnaire-25. National Eye Institute.
2. Schiffman RM: National Eye Institute Refractive Error Correction Questionnaire (NEI-RECQ) Phase II Protocol. National Eye Institute through Emmes Corporation.
3. Schiffman RM, Lesser GL, Imami N, Trick GL: A 48-Month, Multi-Center, Randomized, Double-Masked, Placebo-Controlled, Clinical Study to Evaluate the Effectiveness and Safety of Oral Memantine in Daily Doses of 20 Mg and 10 Mg in Patients with Chronic Open-Angle Glaucoma at Risk for Glaucomatous Progression - Allergan Protocol 192944-005.
4. Schiffman RM: A Multicenter, Investigator-Masked, Randomized, Parallel-Group Study to Compare the Safety and Efficacy and Safety of Restasis™ (Cyclosporine 0.05% Ophthalmic Emulsion) vs. An Artificial Tear (Refresh®) Used Twice Daily for Three Months in Patients with Moderate to Severe Keratoconjunctivitis Sicca (Allergan Protocol 192371-008)
5. Schiffman RM, Patel S, Crosswell M and Shankle J: The Retinal Thickness Analyzer in the Management of Uveitic Cystoid Macular Edema.
6. Schiffman RM, Trick GL: Retinal Thickness Analyzer (RTA) - Clinical Validation Study. Talia Technology Ltd.
7. A Multicenter, Randomized, Double-Masked, Controlled Study to Evaluate the Safety and Efficacy of an Intravitreal Fluocinolone Acetonide Insert in Patients with Non-Infectious Uveitis Affecting the Posterior Segment of the Eye. Bausch and Lomb.

## SCIENTIFIC ACTIVITIES:

### HFHS Collaborative Investigator:

1. Lesser B, Darnley D, Schiffman R: Ocular Hypertension Treatment Study. National Eye Institute, 1993- 1999.
2. Nussenblatt RB, Whitcup SM, Schiffman RM, et. al: The Treatment of Non-infectious Intermediate and Posterior Uveitis with Humanized Anti-Tac Monoclonal Antibody Therapy: Phase I and Phase II. National Eye Institute, National Institutes of Health.

# EXHIBIT B

# Dry Eye Medication Use and Expenditures: Data From the Medical Expenditure Panel Survey 2001 to 2006

Anat Galor, MD, MSPH,\*† D. Diane Zheng, MS,‡ Kristopher L. Arheart, EdD,‡ Byron L. Lam, MD,† Victor L. Perez, MD,† Kathryn E. McCollister, PhD,‡ Manuel Ocasio, BS,‡ Laura A. McClure, MSPH,‡ and David J. Lee, PhD††

**Purpose:** To study dry eye medication use and expenditures from 2001 to 2006 using a nationally representative sample of US adults.

**Methods:** This study retrospectively analyzed dry eye medication use and expenditures of participants of the 2001 to 2006 Medical Expenditure Panel Survey, a nationally representative subsample of the National Health Interview Survey. After adjusting for survey design and for inflation using the 2009 inflation index, data from 147 unique participants aged 18 years or older using the prescription medications Restasis and Blephamide were analyzed. The main outcome measures were dry eye medication use and expenditures from 2001 to 2006.

**Results:** Dry eye medication use and expenditures increased between the years 2001 and 2006, with the mean expenditure per patient per year being \$55 in 2001 to 2002 (n = 29), \$137 in 2003 to 2004 (n = 32), and \$299 in 2005 to 2006 (n = 86). This finding was strongly driven by the introduction of topical cyclosporine emulsion 0.05% (Restasis; Allergan, Irvine, CA). In analysis pooled over all survey years, demographic factors associated with dry eye medication expenditures included gender (female: \$244 vs. male: \$122,  $P < 0.0001$ ), ethnicity (non-Hispanic: \$228 vs. Hispanic: \$106,  $P < 0.0001$ ), and education (greater than high school: \$250 vs. less than high school: \$100,  $P < 0.0001$ ).

**Conclusions:** We found a pattern of increasing dry eye medication use and expenditures from 2001 to 2006. Predictors of higher dry eye medication expenditures included female gender, non-Hispanic ethnicity, and greater than a high school education.

**Key Words:** dry eye syndrome, Medical Expenditure Panel Survey, MEPS, expenditures

(*Cornea* 2012;31:1403–1407)

Received for publication June 30, 2011; revision received August 27, 2011; accepted August 31, 2011.

From the \*Division of Ophthalmology, Miami Veterans Affairs Medical Center, Miami, FL; †Department of Ophthalmology, Bascom Palmer Eye Institute, Miami, FL; and ‡Department of Epidemiology & Public Health, University of Miami School of Medicine, Miami, FL.

Supported by a grant from the National Eye Institute (1R21EY019096) and an unrestricted grant from the Research to Prevent Blindness.

The authors state that they have no proprietary interest in the products named in this article.

Reprints: Anat Galor, Bascom Palmer Eye Institute, 900 Northwest 17th St, Miami, FL 33132 (e-mail: galor@med.miami.edu).

Copyright © 2012 by Lippincott Williams & Wilkins

Dry eye syndrome (DES) has recently gained recognition as a public health problem.<sup>1–3</sup> In the decade between 1970 and 1980, 670 articles were published on DES (search terminology dry eye syndrome, limits humans, and English); this increased to 1485 articles in the 1980s, 2511 articles in the 1990s, and 4887 articles in the last decade. Part of this recognition came from several US population-based and international population-based studies demonstrating that the condition was present in between 5% and 30% of the population aged 50 years or older.<sup>1,2,6–17</sup> Another part of the recognition came from understanding that the symptoms of DES, which include constant irritation, foreign body sensation, and blurred vision, interfere with the ability to work and carry out daily functions.<sup>18–20</sup> A study using the Impact of Dry Eye Living Questionnaire found that severe dry eye symptoms were correlated with difficulties in physical, social, and mental functioning.<sup>21</sup> Such difficulties translate into a relatively lower health-related quality of life compared with the general population—patients with severe dry eye symptoms have health-related quality of life scores in the range of conditions like class III/IV angina.<sup>20</sup>

An additional event that helped push DES into the limelight was the release of the first Food and Drug Administration-approved prescription medication for DES, cyclosporine emulsion 0.05% (Restasis; Allergan, Irvine, CA). The Food and Drug Administration approved the medication in 2002, and the pharmaceutical company Allergan launched cyclosporine emulsion in the United States in late 2003. As part of its sales strategy, Allergan used direct to consumer marketing and commissioned magazine and television advertisements to reach its target audience; it also heavily promoted cyclosporine emulsion within the eye care community. These activities had the effect of increasing physician and patient awareness of the prevalence of DES, its morbidity, and its potential treatments.

Although there is a sense that the economic implications of DES are substantial, few articles have studied the direct costs associated with DES and other ocular surface disorders. These include costs associated with office visits, prescription medication, over-the-counter medication, alternative or complementary medication, and nonpharmacologic purchases (eg, humidifiers). A retrospective claims analysis evaluating costs in 9065 patients who received topical cyclosporine for DES found a mean health care cost of \$336 per patient with a total cost of \$3.05 million.<sup>22</sup> A retrospective analysis of the annual cost of DES in patients treated

by an ophthalmologist in 6 European countries estimated a total annual healthcare cost between 0.27 and 1.10 million US dollars per country. However, this cost did not take into consideration patients who self-treated their condition or were treated by their primary care physician.<sup>23</sup>

The Medical Expenditure Panel Survey (MEPS) is an annual survey of families and individuals, their medical providers, and employers across the United States. MEPS, which is designed to be representative of the US population, provides the most complete source of data on the cost and use of health care and health insurance coverage.<sup>24</sup> Given that prescription cost information is available through the MEPS data set, we examined recent patterns in dry eye medication expenditures. We aimed to confirm our hypothesis that a substantial increase in expenditures has occurred over the past few years, perhaps in response to the increased public and provider awareness of the condition along with the availability of a new prescription medication.

## MATERIALS AND METHODS

### Sample

The MEPS is a nationally representative subsample of the National Health Interview Survey, a continuous multipurpose and multistage area probability survey of the US civilian noninstitutionalized population living at addressed dwellings. To have an adequate number of persons in important population subgroups, the MEPS oversampled Blacks and Hispanics in all years and began oversampling of Asians in 2002.<sup>25</sup> The overall MEPS response rate ranged from 66% in 2001 to 58% in 2006. Sampling weights were applied to ensure that the resulting sample was nationally representative of US households and includes adjustment for oversampling of race/ethnic groups and survey nonresponse.

To obtain dry eye medication expenditures, a comprehensive list of available prescription medications, including name brands, generics, and chemical names, for the study period was first generated and used to identify those MEPS participants who used any medication via the MEPS Prescribed Medicines files. The Prescribed Medicines files contained comprehensive information on medications used by MEPS participants.<sup>25</sup> From this list, 2 medications used in the setting of DES were identified: cyclosporine emulsion 0.05%, used to treat aqueous tear deficiency, and sulfacetamide sodium–prednisolone acetate ophthalmic suspension, USP 10%/0.2% (Blephamide), used to treat lipid tear deficiency (blepharitis), among other conditions.

Data from MEPS 2007 were available but were not included in this analysis because the methodology in editing the pharmacy data was changed. Comparison of prescription drug spending before and after 2007 was therefore not recommended by the Agency for Healthcare Research and Quality.<sup>26</sup> MEPS initially had an over-the-counter medication section that collected details about nonprescription medication purchases; however, this section was omitted from the questionnaire beginning in 2002.<sup>27</sup> Because we were interested in dry eye medication costs in the years since the launch of cyclosporine emulsion, we were unable to include over-the-counter medications in our

analysis. For the study period, 147 unique participants aged 18 years or older were found to have used sulfacetamide sodium–prednisolone acetate ophthalmic suspension and/or cyclosporine emulsion and were included in the analysis. Expenditure of these medications for each participant over 2-year intervals was analyzed. The data were adjusted for survey design, and the expenditure was adjusted for inflation using 2009 inflation index.

### Demographic Data

Demographic and insurance information of the qualified participants was obtained from the MEPS Full-Year Consolidated Data Files. Demographic data collected included gender, age, race (white, black, other/multiple), ethnicity (Hispanic, non-Hispanic), health insurance status (private, public only, and uninsured), and education level (less than high school, high school, greater than high school). Family income, measured as a percentage, was calculated by dividing total family income by the applicable poverty line (based on family size and composition). The resulting percentages were grouped into 3 categories: low income/poverty (less than 200%), middle income (200% to less than 400%), and high income (400% or more).

### Statistical Analyses

All statistical analyses were performed using SAS 9.2 (SAS Institute, Inc., Cary, NC) and SUDAAN 10 (RTI International, Triangle, NC) statistical packages. To account for complex survey design of the MEPS data, analyses were completed with adjustments for sample weights and design effects. We conducted descriptive analyses to evaluate patterns in dry eye medication expenses per person over a 2-year interval. *T* tests were performed to compare average medication expenditure across different demographic groups. A multivariate linear regression was performed to study demographic variables that predict high dry eye medication expense. The University of Miami Institutional Review Board reviewed and approved this study, which was conducted in accordance with the principles of the Declaration of Helsinki.

## RESULTS

More patients used prescription dry eye medications in 2005 to 2006 ( $n = 86$ ) compared with the previous 4 years ( $n = 29$  and  $32$  for 2001–2002 and 2003–2004, respectively), and the total number of prescriptions filled increased with each year (Fig. 1). The cost associated with dry eye prescription medications also increased between 2001 and 2006, with a mean expenditure per patient of \$55 in 2001 to 2002, \$137 in 2003 to 2004, and \$299 in 2005 to 2006 (Fig. 2). The introduction of topical cyclosporine significantly affected both the number of prescriptions filled and the dry eye expenditures because after its introduction, 68% of prescriptions and 80% of expenditures were related to cyclosporine emulsion in 2003 to 2004 and 84% of prescriptions and 92% of expenditures were related to cyclosporine emulsion in 2005 to 2006. The mean cost of sulfacetamide sodium–prednisolone acetate ophthalmic suspension increased from \$36.27 in 2001

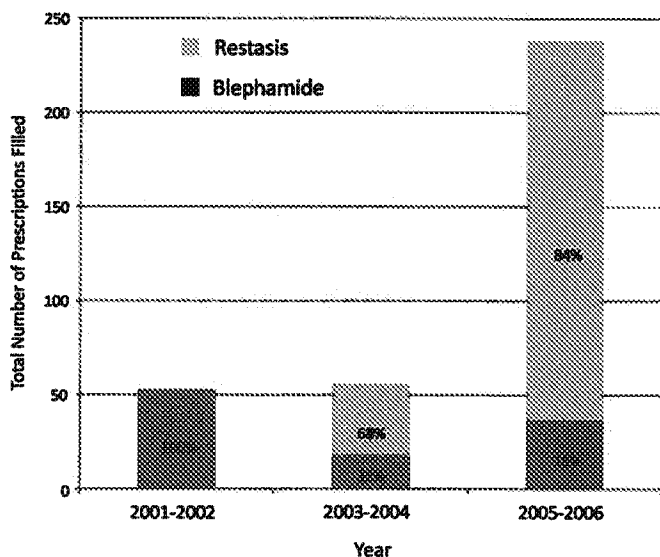

**FIGURE 1.** Graphic representation of the total number of dry eye prescriptions filled using the MEPS database, 2001 to 2006.

to 2002 to \$54.56 in 2003 to 2004 to \$64.43 in 2005 to 2006. Likewise, the mean cost of cyclosporine emulsion increased from \$98.98 in 2003 to 2004 to \$113.06 in 2005 to 2006. The increase in mean dry eye expenditures over the period, therefore, can be explained by both increased medication usage and cost.

Several demographic factors were associated with medication expenditures in the treatment of dry eye. Gender had a significant effect, with mean spending for women being double that for men (\$244 vs. \$122,  $P < 0.0001$ ) (Table 1, Fig. 2). Similarly, spending for non-Hispanics was double that for the Hispanic population (\$228 vs. \$106,  $P < 0.0001$ ).

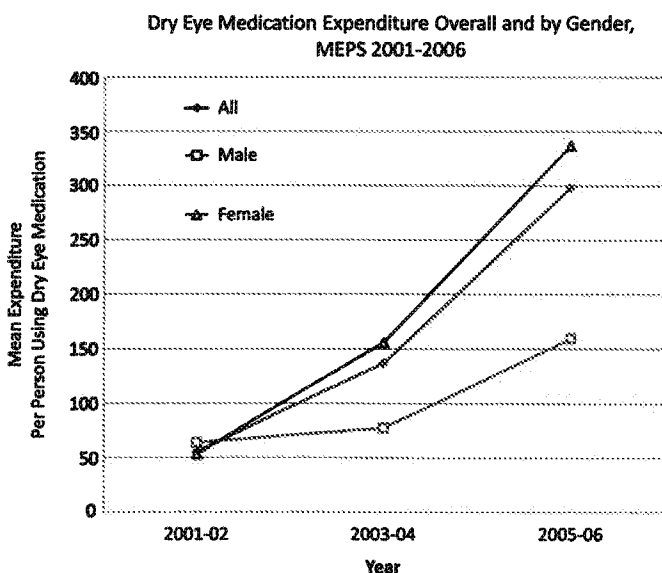

**FIGURE 2.** Graphic representation of mean dry eye medication expenditures per patient (overall and by gender) using the MEPS database, 2001 to 2006.

Level of education was also an important factor, with individuals with more than a high school education spending more than those with less than a high school education (\$250 vs. \$100,  $P < 0.0001$ ). Race, age, and income status were not found to significantly affect dry eye medication expenditures in our analysis.

In a multivariable linear regression analysis considering all demographic factors, gender and education remained significant predictors of dry eye medication expenditures. Female gender was associated with a \$159 higher mean expenditure compared with male gender ( $P = 0.0004$ ). Greater than high school education was associated with a \$145 higher mean expenditure compared with less than a high school education ( $P = 0.0016$ ). Although not significant in our univariable analysis, with adjustment for all other covariates, those in the 65 and older age group spent \$107 more on dry eye medications than those in the 45- to 64-year-old group ( $P = 0.04$ ).

### DISCUSSION

In this nationally representative study of patterns in prescription dry eye medication expenditures from 2001 to 2006, we found that the number of patients treated with prescription dry eye medications and their associated expenditures increased between these years. This finding was strongly driven by the introduction of cyclosporine emulsion in 2003. Considering demographic factors, female gender, non-Hispanic ethnicity, and a greater than high school education were factors significantly associated with a higher mean yearly expenditure for DES in our univariate models.

Although studies have suggested that the economic implications of DES are substantial,<sup>28</sup> limited data are available to support this statement. Fiscella et al<sup>22</sup> analyzed claims data from a proprietary research database containing pharmacy claims data on over 13 million individuals. They identified 9065 subjects that had one or more prescriptions filled for topical cyclosporine emulsion between January 1, 2004, and December 31, 2005. The mean yearly prescription cost by the health insurance plans was \$336, and the mean out-of-pocket prescription cost for the patient was \$98. This compares favorably with our findings because the cost analysis above includes both patient and insurance expenditures combined.

Putting these numbers in the context of other chronic ocular and nonocular diseases, a recent MEPS study found that patients with glaucoma spent a mean of \$556 per year on prescription glaucoma medications in 2006 (adjusted for inflation using 2009 inflation index).<sup>29</sup> Similarly, another article using the MEPS database found that people with spine problems spent a mean of \$397 per year on prescription medications in 2006.<sup>30</sup> The findings in this study suggest that although DES is not a blinding condition, individuals are willing to spend a non-trivial amount of money per year to alleviate the discomfort associated with this disorder. It is also important to note that the expenditures presented in this study do not incorporate the costs of nonprescription medications and doctor's visits and therefore the total amount of money spent on the disease is likely to be significantly higher.

We found that several demographic factors affected the expenditures of dry eye medications, including gender, ethnicity,

**TABLE 1.** Mean and Standard Error Cost (in Dollars) Per Prescription of Dry Eye Medications by Demographic Factors, 2001 to 2006 MEPS Data

| Characteristics       | N   | Mean   | SE    | P                             |
|-----------------------|-----|--------|-------|-------------------------------|
| All                   | 147 | 217.31 | 23.41 | —                             |
| Sex                   |     |        |       |                               |
| Male                  | 34  | 122.24 | 6.87  | —                             |
| Female                | 113 | 244.30 | 24.35 | <0.0001                       |
| Race                  |     |        |       |                               |
| White                 | 134 | 220.51 | 20.63 | White vs. Black = 0.07        |
| Black                 | 8   | 141.94 | 27.39 | White vs. Other = 0.95        |
| Other                 | 5   | 214.18 | 95.84 | Black vs. Other = 0.47        |
| Ethnicity             |     |        |       |                               |
| Hispanic              | 20  | 106.23 | 18.89 | —                             |
| Non-Hispanic          | 127 | 227.99 | 20.78 | <0.0001                       |
| Age group, yr         |     |        |       |                               |
| 18–44                 | 25  | 192.51 | 34.40 | 18–44 vs. 45–64 = 0.78        |
| 45–64                 | 53  | 206.44 | 27.06 | 18–44 vs. 65+ = 0.38          |
| 65+                   | 69  | 235.88 | 34.50 | 45–64 vs. 65+ = 0.51          |
| Insurance type        |     |        |       |                               |
| Private insurance     | 111 | 225.06 | 23.01 | Private vs. public = 0.57     |
| Public insurance only | 29  | 194.26 | 45.82 | Private vs. uninsured = 0.02* |
| Uninsured             | 7   | 166.56 | 7.84  | Public vs. uninsured = 0.56*  |
| Education             |     |        |       |                               |
| Less than HS          | 27  | 100.18 | 15.82 | <HS vs. HS = 0.05             |
| HS                    | 43  | 204.54 | 46.43 | <HS vs. >HS = <0.0001         |
| Greater than HS       | 77  | 250.52 | 21.78 | HS vs. >HS = 0.36             |
| Poverty               |     |        |       |                               |
| Low income/poverty    | 33  | 219.62 | 37.10 | Low vs. middle = 0.14         |
| Middle income         | 40  | 168.49 | 25.46 | Low vs. high = 0.64           |
| High income           | 74  | 240.57 | 38.41 | Middle vs. high = 0.06        |

Bold values represent factors significantly associated with increased dry eye expenditures.

\*Statistical analyses for the uninsured group are reported but are considered unstable due to small sample size.

HS, high school; SE, standard error.

and education. The presence of gender and ethnic disparities in medical expenditures has been described in other conditions, including mental health<sup>31</sup> and hypertension management.<sup>32</sup> An association between higher expenditures and higher education levels has been reported in systemic lupus erythematosus.<sup>33</sup> Although the etiologies behind these discrepancies are not clear, it is important to recognize the role of demographic factors when considering the myriad determinants of health.

As with all retrospective studies, the study findings must be considered bearing in mind its limitations. One limitation is that information on nonprescription medications was not available in the MEPS database, and we could therefore only estimate costs associated with prescription dry eye medications. As many more patients use over-the-counter medications to treat DES, we failed to include patients with less severe forms of the disease in our analysis. Furthermore, because of changes within MEPS that started in 2007,<sup>26</sup> medication information for this year was not included in the analysis. Another limitation is that the sample size in the present analysis was relatively small, limiting our ability to examine trends in dry eye medication expenditures and in our comparisons in subgroups of interest (eg, the uninsured). Because of the relatively small sample size, it should not be assumed that

our analytic sample of dry eye medication users are nationally representative despite the fact that they were obtained from a population-based survey. However, if present patterns continue, there will be a growing number of persons in the MEPS who will use these medications, facilitating future subgroup analyses. Furthermore, both cyclosporine emulsion and sulfacetamide sodium–prednisolone acetate ophthalmic suspension can be used to treat ocular surface disorders other than DES. Because we did not have diagnosis information linked to medication use, it is possible that we included patients treated for ocular surface conditions other than DES in our analysis. Finally, we acknowledge that other medications are used to treat subtypes of DES, including corticosteroids and tetracycline derivatives; we chose not to include these in our analysis, given their multiple indications for use. Despite these limitations, there is no other ongoing population-based studies that look specifically at drug medication cost patterns; therefore, the analysis of the MEPS provides us with the best expenditure estimates for newly introduced ocular medications.

In summary, we found a pattern of increased dry eye medication use and expenditure from 2001 to 2006. Women, non-Hispanics, and those with greater than a high school



education had higher expenditures compared with their counterparts. Additional research is necessary to understand the underlying reasons for the difference in dry eye medication expenditures by patient characteristics.

## REFERENCES

1. The epidemiology of dry eye disease: report of the epidemiology subcommittee of the International Dry Eye WorkShop (2007). *Ocul Surf*. 2007;5:93-107.
2. Brewitt H, Sistani F. Dry eye disease: the scale of the problem. *Surv Ophthalmol*. 2001;45(suppl 2):S199-S202.
3. Schaumberg DA, Sullivan DA, Dana MR. Epidemiology of dry eye syndrome. *Adv Exp Med Biol*. 2002;506(pt B):989-998.
4. Begley CG, Chalmers RL, Mitchell GL, et al. Characterization of ocular surface symptoms from optometric practices in North America. *Cornea*. 2001;20:610-618.
5. Schein OD, Muñoz B, Tielsch JM, et al. Prevalence of dry eye among the elderly. *Am J Ophthalmol*. 1997;124:723-728.
6. Moss SE, Klein R, Klein BE. Prevalence of and risk factors for dry eye syndrome. *Arch Ophthalmol*. 2000;118:1264-1268.
7. Bandeen-Roche K, Muñoz B, Tielsch JM, et al. Self-reported assessment of dry eye in a population-based setting. *Invest Ophthalmol Vis Sci*. 1997;38:2469-2475.
8. Muñoz B, West SK, Rubin GS, et al. Causes of blindness and visual impairment in a population of older Americans: The Salisbury Eye Evaluation Study. *Arch Ophthalmol*. 2000;118:819-825.
9. McCarty CA, Bansal AK, Livingston PM, et al. The epidemiology of dry eye in Melbourne, Australia. *Ophthalmology*. 1998;105:1114-1119.
10. Chia EM, Mitchell P, Rochtchina E, et al. Prevalence and associations of dry eye syndrome in an older population: the Blue Mountains Eye Study. *Clin Experiment Ophthalmol*. 2003;31:229-232.
11. Hikichi T, Yoshida A, Fukui Y, et al. Prevalence of dry eye in Japanese eye centers. *Graefes Arch Clin Exp Ophthalmol*. 1995;233:555-558.
12. Uchino M, Schaumberg DA, Dogru M, et al. Prevalence of dry eye disease among Japanese visual display terminal users. *Ophthalmology*. 2008;115:1982-1988.
13. Uchino M, Dogru M, Uchino Y, et al. Japan Ministry of Health study on prevalence of dry eye disease among Japanese high school students. *Am J Ophthalmol*. 2008;146:925-929 e2.
14. Shimmura S, Shimazaki J, Tsubota K. Results of a population-based questionnaire on the symptoms and lifestyles associated with dry eye. *Cornea*. 1999;18:408-411.
15. Sahai A, Malik P. Dry eye: prevalence and attributable risk factors in a hospital-based population. *Indian J Ophthalmol*. 2005;53:87-91.
16. Lekhanont K, Rojanaporn D, Chuck RS, et al. Prevalence of dry eye in Bangkok, Thailand. *Cornea*. 2006;25:1162-1167.
17. Lee AJ, Lee J, Saw SM, et al. Prevalence and risk factors associated with dry eye symptoms: a population based study in Indonesia. *Br J Ophthalmol*. 2002;86:1347-1351.
18. Mertzani P, Abetz L, Rajagopalan K, et al. The relative burden of dry eye in patients' lives: comparisons to a U.S. normative sample. *Invest Ophthalmol Vis Sci*. 2005;46:46-50.
19. Miljanovic B, Dana R, Sullivan DA, et al. Impact of dry eye syndrome on vision-related quality of life. *Am J Ophthalmol*. 2007;143:409-415.
20. Schiffman RM, Walt JG, Jacobsen G, et al. Utility assessment among patients with dry eye disease. *Ophthalmology*. 2003;110:1412-1419.
21. Rajagopalan K, Abetz L, Mertzani P, et al. Comparing the discriminative validity of two generic and one disease-specific health-related quality of life measures in a sample of patients with dry eye. *Value Health*. 2005;8:168-174.
22. Fiscella RG, Lee JT, Walt JG, et al. Utilization characteristics of topical cyclosporine and punctal plugs in a managed care database. *Am J Manag Care*. 2008;14:S107-S112.
23. Clegg JP, Guest JF, Lehman A, et al. The annual cost of dry eye syndrome in France, Germany, Italy, Spain, Sweden and the United Kingdom among patients managed by ophthalmologists. *Ophthalmic Epidemiol*. 2006;13:263-274.
24. MEPS Home. Available at: <http://www.meps.ahrq.gov/mepsweb/>. Accessed June 16, 2011.
25. Data overview, Agency for Healthcare Research and Quality. Available at: [http://www.meps.ahrq.gov/mepsweb/data\\_stats/data\\_overview.jsp](http://www.meps.ahrq.gov/mepsweb/data_stats/data_overview.jsp). Accessed June 16, 2011.
26. MEPS HC-113: 2007 Full Year Consolidated Data File. Available at: MEPS HC-113: 2007 Full Year Consolidated Data File. Available at: [http://www.meps.ahrq.gov/mepsweb/data\\_stats/download\\_data/pufs/h113/h113doc.shtml](http://www.meps.ahrq.gov/mepsweb/data_stats/download_data/pufs/h113/h113doc.shtml). Accessed November 30, 2011.
27. Summary of questionnaire sections. Panel 6 Round 3 and Panel 7 Round 1. Available at: [http://www.meps.ahrq.gov/mepsweb/survey\\_comp/hc\\_questions.jsp](http://www.meps.ahrq.gov/mepsweb/survey_comp/hc_questions.jsp). Accessed June 16, 2011.
28. Pflugfelder SC. Prevalence, burden, and pharmacoconomics of dry eye disease. *Am J Manag Care*. 2008;14:S102-S106.
29. Lam BL, Zheng DD, Davila EP, et al. Trends in glaucoma medication expenditure: medical expenditure panel survey 2001-2006. *Arch Ophthalmol*. 2011;129:1345-1350.
30. Martin BI, Turner JA, Mirza SK, et al. Trends in health care expenditures, utilization, and health status among US adults with spine problems, 1997-2006. *Spine (Phila Pa 1976)*. 2009;34:2077-2084.
31. Chen J, Rizzo J. Racial and ethnic disparities in use of psychotherapy: evidence from U.S. national survey data. *Psychiatr Serv*. 2010;61:364-372.
32. Basu R, Franzini L, Krueger PM, et al. Gender disparities in medical expenditures attributable to hypertension in the United States. *Womens Health Issues*. 2010;20:114-125.
33. Sutcliffe N, Clarke AE, Taylor R, et al. Total costs and predictors of costs in patients with systemic lupus erythematosus. *Rheumatology (Oxford)*. 2001;40:37-47.

# EXHIBIT C

# Dysfunctional Tear Syndrome

## A Delphi Approach to Treatment Recommendations

Ashley Behrens, MD,\* John J. Doyle, MPH,† Lee Stern, MS,† Roy S. Chuck, MD, PhD,\* Peter J. McDonnell, MD\* and the Dysfunctional Tear Syndrome Study Group: Dimitri T. Azar, MD, Harminder S. Dua, MD, PhD, Milton Hom, OD, Paul M. Karpecki, OD, Peter R. Laibson, MD, Michael A. Lemp, MD, David M. Meisler, MD, Juan Murube del Castillo, MD, PhD, Terrence P. O'Brien, MD, Stephen C. Pflugfelder, MD, Maurizio Rolando, MD, Oliver D. Schein, MD, MPH, Berthold Seitz, MD, Scheffer C. Tseng, MD, PhD, Gysbert van Setten, MD, PhD, Steven E. Wilson, MD, and Samuel C. Yiu, MD, PhD

**Purpose:** To develop current treatment recommendations for dry eye disease from consensus of expert advice.

**Methods:** Of 25 preselected international specialists on dry eye, 17 agreed to participate in a modified, 2-round Delphi panel approach. Based on available literature and standards of care, a survey was presented to each panelist. A two-thirds majority was used for consensus building from responses obtained. Treatment algorithms were created. Treatment recommendations for different types and severity levels of dry eye disease were the main outcome.

**Results:** A new term for dry eye disease was proposed: dysfunctional tear syndrome (DTS). Treatment recommendations were based primarily on patient symptoms and signs. Available diagnostic tests were considered of secondary importance in guiding therapy. Development of algorithms was based on the presence or absence of lid margin disease and disturbances of tear distribution and clearance. Disease severity was considered the most important factor for treatment decision-making and was categorized into 4 levels. Severity was assessed on the basis of tear substitute requirements, symptoms of ocular discomfort, and visual disturbance. Clinical signs present in lids, tear film, conjunctiva, and cornea were also used for categorization of severity. Consensus was reached on treatment algorithms for DTS with and without concurrent lid disease.

**Conclusion:** Panelist opinion relied on symptoms and signs (not tests) for selection of treatment strategies. Therapy is chosen to match disease severity and presence versus absence of lid margin disease or tear distribution and clearance disturbances.

Received for publication June 21, 2005; revision received January 3, 2006; accepted January 10, 2006.

From the \*Wilmer Ophthalmological Institute, Johns Hopkins University School of Medicine, Baltimore, MD; and the †Analytica Group, New York, NY.

Supported by unrestricted educational grants from Allergan Inc. (Irvine, CA) and Research to Prevent Blindness, Inc. (New York, NY).

Disclaimer: Some authors have commercial or proprietary interests in products described in this study (please refer to individual disclosure).

Reprints: Ashley Behrens, MD, The Wilmer Ophthalmological Institute, 255 Woods Building, 600 North Wolfe Street, Baltimore, MD 21287-9278 (e-mail: abehrens@jhmi.edu).

Copyright © 2006 by Lippincott Williams & Wilkins

**Key Words:** Delphi panel, dry eye, dysfunctional tear syndrome, eye lubricants, cyclosporine A, punctal plugs, steroids, dry eye therapy, consensus, algorithm

(*Cornea* 2006;25:900–907)

The syndrome known as “dry eye” is highly prevalent, affecting 14% to 33% of the population worldwide,<sup>1–4</sup> depending on the study and definition used. Symptoms related to dry eye are among the leading causes of patient visits to ophthalmologists and optometrists in the United States.<sup>5</sup> However, a stepwise approach to diagnosis and treatment is not well established.

Treatment algorithms are often complicated, especially when multiple therapeutic agents and strategies are available for one single disease and for different stages of the same disease. Dry eye syndrome is particularly challenging, because the diagnostic criteria used vary among studies, there is poor correlation between signs and symptoms, and efficacy criteria are often not uniform. As a result, there is no clear current approach to assign therapeutic recommendations as “first,” “second,” or “third” line.

Clinical research is usually oriented to assess the efficacy of medications in the treatment of dry eye disease. Reports are based on either comparisons of one medication relative to untreated placebo controls or comparisons between different therapies.<sup>6,7</sup> Categorization of treatment alternatives is usually not implicit in these studies. Strategies combining medications or medications and surgery are usually not clearly discussed in the literature. A panel of experts may be a good method to develop such strategies based on current knowledge, because publication of research may not precede practice. Furthermore, clinical trials are typically performed on highly selected populations with specific interventions that may not reflect the spectrum of disease encountered in usual practice.

Where unanimity of opinion does not exist because of a paucity of scientific evidence and where there is contradictory evidence, consensus methods can be useful. Such methods have been used in developing therapeutic algorithms in other ophthalmic (glaucoma) and nonophthalmic disease states.<sup>8,9</sup>

The Delphi panel technique was first proposed in 1946 by the RAND Corporation as a resource to collect information from different experts and to prepare a forecast of future technological capabilities. This tool has been expanded to technological,<sup>10</sup> health,<sup>11</sup> and social sciences research.<sup>12</sup> Despite some reasonable criticisms of this technique,<sup>13</sup> the Delphi approach has been used to provide reproducible consensus to create algorithms of treatment.<sup>14,15</sup>

In this study, we proposed to establish expert consensus by using the Delphi approach with an international panel to obtain current treatment recommendations for dry eye syndrome.

## MATERIALS AND METHODS

### Panelist Selection

The ideal number of panelists expected with this technique is not well defined, with reported ranges from 10 to 1685.<sup>16</sup> No specific inclusion criteria are established, other than the qualification of panelists in the topic of interest. Some authors stress the importance of the diversity of panelists' opinion to obtain a wide base of knowledge.<sup>17</sup>

The following criteria were considered for inclusion of panelists:

1. Active clinicians (ophthalmologists and optometrists)
2. Scientific contributions to clinical research on dry eye syndrome, as reflected by at least 2 of the following: peer-reviewed publications, other forms of written scientific communication, specialty meeting presentations, and membership in special-interest groups focused on dry eye syndrome
3. International representation
4. Proficiency in English language to facilitate interaction
5. Able to respond to sets of questionnaires and available to attend a final meeting at the Wilmer Ophthalmological Institute in Baltimore, MD

The search for panelists' scientific contributions was conducted over available medical databases (Medline, EMBASE) and other major Internet-based search engines (Scirus.com, Google.com, Alltheweb.com). Twenty-five candidates from 3 continents that met the selection criteria were initially contacted.

A contract research organization (Analytica Group, New York, NY) was selected to act as moderator/facilitator for the questionnaire and panel meeting exercise. A 2-round modified Delphi approach was used.<sup>18</sup> A set of dry eye therapy literature was provided to each panel member along with the first-round questionnaire. These studies were selected in part from an ongoing systematic review of the literature on dry eye disease therapy. Three of the panelists suggested additions of some references that they considered valuable. Those citations were also disseminated to the rest of the panelists.

### Preparation of Surveys

Questionnaires were based on collected literature, current practice patterns, and clinical experience in dry eye. Topics in the survey were related to pathophysiology, diagnostic tests, criteria used to guide treatment, and therapeutic alternatives.

Nominal variables were assigned binary values to tabulate responses in a spreadsheet (Excel 2002; Microsoft

Corp., Redmond, WA) for analysis. Ordinal variables were originated from 5-point Likert scales to categorize the strength of agreement and facilitate the statistical analysis.

Survey questions were based on the use of the current classification of dry eye disease and the available guidelines for the treatment. Diagnostic methods and severity assessment were also surveyed. Panelists were asked to support their multi-level treatment recommendation with a categorical, nominal score of 1 to 3, depending on the level of evidence to sustain their decision:

1. Supported by a clinical trial
2. Supported by published literature of some type
3. Supported by my professional opinion

Finally, determinant factors influencing the treatment decision-making process were stratified semiquantitatively to evaluate the most representative for the selection of therapy.

### Survey Deployment

The forms were deployed by electronic mail to the panelists. The information obtained from the surveys was tabulated and organized for presentation at the face-to-face meeting of the Delphi process.

### Data Analysis

Descriptive statistics were calculated for the questionnaire data by using StatsDirect 2.3.7 for Windows (StatsDirect, Cheshire, UK).

### Consensus

There exists controversy regarding the numbers necessary to obtain consensus. Some authors agree that a simple majority (>50%) is enough to constitute consensus,<sup>19</sup> whereas others propose that more than 80% of panelists should be in agreement to have the recommendation considered as consensus.<sup>20</sup> Degree of consensus has also been quantified statistically using the Cronbach  $\alpha$  method, a method for measuring internal agreement.<sup>21</sup> For the purposes of this study, consensus was defined as a two-thirds majority.

### Personal Interaction

The meeting was conducted by a facilitator (J.J.D.) with previous experience in consensus-building strategies.<sup>8</sup> Panelists reacted and discussed the data collected from the surveys over an intensive 1-day, 12-hour-long, face-to-face meeting. According to the tabulated initial responses, iterative discussions were conducted toward majority agreement.

## RESULTS

### Panelists' Response

From the initial selection of 25 candidates who met the inclusion criteria, 17 were able to participate in all stages of the study and therefore were included in the panel. The candidates who refused to join the panel did not have substantive reasons precluding their participation. Most of them declined to participate because of scheduling conflicts. The list of participants is shown in Table 1. All surveys deployed were returned with responses from all of the panelists.

**TABLE 1.** Experts Who Participated in the Delphi Approach (DTS Study Group)

| Panelist Name                         | City              | Country       |
|---------------------------------------|-------------------|---------------|
| Dimitri T. Azar, M.D.                 | Boston, MA        | United States |
| Harminder S. Dua, M.D., Ph.D          | Nottingham        | England       |
| Milton Hom, O.D.                      | Azusa, CA         | United States |
| Paul M. Karpecki, O.D.                | Overland Park, KS | United States |
| Peter R. Laibson, M.D.                | Philadelphia, PA  | United States |
| Michael A. Lemp, M.D.                 | Washington, DC    | United States |
| David M. Meisler, M.D.                | Cleveland, OH     | United States |
| Juan Murube del Castillo, M.D., Ph.D. | Madrid            | Spain         |
| Terrence P. O'Brien, M.D.             | Baltimore, MD     | United States |
| Stephen C. Pflugfelder, M.D.          | Houston, TX       | United States |
| Maurizio Rolando, M.D.                | Genoa             | Italy         |
| Oliver D. Schein, M.D., M.P.H.        | Baltimore, MD     | United States |
| Berthold Seitz, M.D.                  | Erlangen          | Germany       |
| Scheffer C. Tseng, M.D., Ph.D.        | Miami, FL         | United States |
| Gysbert B. van Setten, M.D., Ph.D.    | Stockholm         | Sweden        |
| Steven E. Wilson, M.D.                | Cleveland, OH     | United States |
| Samuel C. Yiu, M.D, Ph.D.             | Los Angeles, CA   | United States |

### Conflicts of Interest

Travel expenses of panelists were covered by the contracted company (Analytica Group), which is an independent firm. The Wilmer Eye Institute originated the invitation, and panelists were unaware of any indirect support from pharmaceutical industry to avoid bias in the treatment selection.

### Use of Existing Disease/Treatment Guidelines

The majority of panelists (11 of 17) responded that they did not follow any of the available guidelines for the treatment of dry eye syndrome. Three of 17 followed the National Eye Institute guidelines,<sup>22</sup> 1 of 17 followed the American Academy of Ophthalmology Preferred Practice Patterns,<sup>23</sup> 1 of 17 followed the Madrid classification,<sup>24</sup> and 1 of 17 followed a combination of the first 2 guidelines.

When panel members were asked about their opinions regarding the adherence of the ophthalmic community to new, simplified guidelines for the treatment of dry eye, the majority (13 of 17) agreed that they would use them if most recent findings on the disease were included. Those who responded that they would not use them (4 of 17), based their response on the low sensitivity and specificity of the available tests for the diagnosis of dry eye and the variability of the clinical presentation in different patients.

### Diagnostic Tests for Dry Eye

When panelists were surveyed before the meeting on diagnostic measures used to detect dry eye, the most frequently cited tests were slit-lamp examination and fluorescein staining (100% of panelists). Tear breakup time and medical history were also frequently used (both in 94%). Schirmer test with anesthesia (71%) and without anesthesia (65%) were less frequently used, as well as rose bengal staining (65%). A combination of different tests was typically preferred in an effort to improve the specificity and sensitivity (Table 2).

**TABLE 2.** Most Commonly Used Diagnostic Tests Reported by Panelists for Evaluating a Patient With Probable Dry Eye

| Diagnostic Tests                           | Respondents Regularly Using Them (%) |
|--|--------------------------------------|
| Fluorescein staining                       | 100                                  |
| Tear breakup time                          | 94                                   |
| Schirmer test                              | 71                                   |
| Rose bengal staining                       | 65                                   |
| Corneal topography                         | 41                                   |
| Impression cytology                        | 24                                   |
| Tear fluorescein clearance                 | 24                                   |
| Ocular Surface Disease Index Questionnaire | 18                                   |
| NEIVFQ-25*                                 | 6                                    |
| Tear osmolarity                            | 6                                    |
| Conjunctival biopsy                        | 6                                    |

\*NEIVFQ-25: National Eye Institute Vision Function Questionnaire-25.

### Classification of Dry Eye Disease

More than one half of the respondents felt that the current classification of aqueous-deficient versus evaporative dry eye failed to incorporate inflammatory mechanisms and drew a sharp distinction between disorders where there is significant overlap.<sup>25,26</sup> Furthermore, the historical distinction between Sjögren keratoconjunctivitis sicca (KCS) as representing an autoimmune disorder as opposed to non-Sjögren KCS failed to reflect the evidence that both conditions may share an underlying immune-mediated inflammation. The majority of experts did not consider this useful for establishing a treatment scheme for the ocular disease (12 of 17). The panelists considered the disease severity and the effect of medications on symptoms and signs as the 2 most relevant factors to consider when selecting the adequate therapy for dry eye (Table 3).

### Face-to-Face Meeting

At the face-to-face meeting, panel members made comments on the term "dry eye" classically used to name the disease. On the basis of the known pathophysiology, symptoms, and clinical presentation, all panelists agreed that this term did not necessarily reflect the events occurring in the eye. Specifically, all patients with this condition do not necessarily

**TABLE 3.** Most Relevant Factors Influencing Treatment Decision Making

| Factor Considered               | Mean Score (Standard Deviation) |
|---------------------------------|---------------------------------|
| Severity of the disease         | 1.47 (0.72)                     |
| Effect of the treatment         | 1.79 (0.77)                     |
| Etiology of the disease         | 2.08 (1.07)                     |
| Diagnosis of Sjögren's syndrome | 2.20 (1.05)                     |
| Use of artificial tears         | 3.07 (1.53)                     |
| Costs of treatment              | 3.80 (1.17)                     |
| Access to reimbursement         | 3.92 (1.10)                     |

0 = most relevant; 5 = least relevant.

suffer from reduced tear volume but rather may have abnormalities of tear film composition that include the presence of proinflammatory cytokines.<sup>25-27</sup> The panelists unanimously recommended dysfunctional tear syndrome (DTS) as a more appropriate term for this disease in future references. This term has been incorporated in the rest of this report in lieu of dry eye disease.

### Underlying Pathophysiology and Diagnostic Testing

There was consensus that most cases of DTS have an inflammatory basis that either triggers or maintains the condition. However, panelists also agreed on the difficulty in clearly identifying inflammation in most patients. The panel therefore agreed to subclassify the disease as either DTS with clinically apparent inflammation or DTS without clinically evident inflammation.

After discussion at the meeting, the panelists were in agreement that commonly available clinical diagnostic tests did not correlate with symptoms, should not be used in isolation to establish the diagnosis of DTS, and were of minimal value in the assessment of disease severity.

### Creation of Therapeutic Algorithms for DTS

First, the panel recommended that patients with DTS should be classified into 1 of 3 major clinical categories at the time of the initial examination: patients with lid margin disease, patients without lid margin disease, and patients with altered tear distribution and clearance.

The panel agreed that the second group, patients who do not have coexistent lid margin disease, is the most common form of presentation of DTS. Within each of these 3 categories, the panel listed the main subsets or specific disease entities or, in the case of DTS without lid margin disease, the patients were divided by severity (Fig. 1). Second, the panel agreed that the assessment of DTS severity is important to guiding therapy, especially in that subset of DTS patients

without lid margin disease. The panel reached consensus that the level of severity should be based primarily on symptoms and clinical signs.

The panel members agreed that diagnostic tests are secondary considerations in determining disease severity. The value of diagnostic tests was considered to be in confirming clinical assessment. Again, many of the available tests were deemed not useful for the diagnosis, staging, or evaluating response to therapy in DTS.

Panelists agreed on 3 particularly relevant symptoms and historical elements to be considered in DTS: ocular discomfort, tear substitute requirements, and visual disturbances. In ocular discomfort, a variety of symptoms including itch, scratch, burn, foreign body sensation, and/or photophobia may be present. Depending on the frequency and impact on the quality of life of these elements, symptoms could be categorized as either mild to moderate or severe. The relevant clinical signs to be considered in the evaluation of DTS patients are summarized in Table 4. The panel suggested evaluating the presence of these clinical features to assign a severity level fluctuating from mild to severe.

To create a categorization of the severity of the disease, a scoring system was proposed. Basically, patients were aggregated into 1 of 4 levels of severity according to the signs and symptoms involved (Table 5). The severity of disease indicated the appropriate range of therapeutic options available for the patient, because the panelists agreed that certain therapies were most appropriately reserved for patients with more severe DTS.

### Treatment Algorithm for Patients With Lid Margin Disease

The proposed treatment algorithm for these individuals began with division of patients according to the site (anterior vs. posterior) of the lid pathology (Fig. 2). Anterior lid margin disease is treated with lid hygiene and antibacterial therapy, whereas posterior lid margin disease is treated initially with

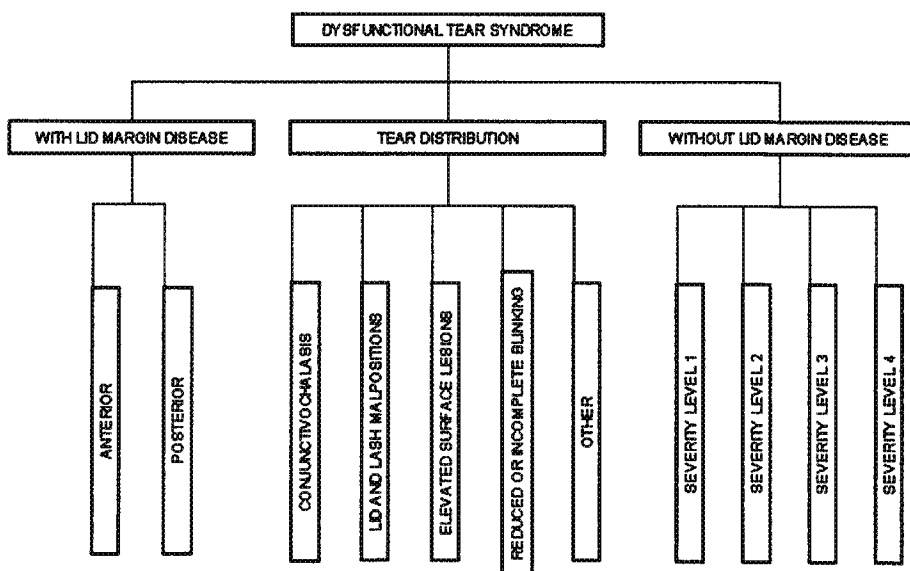

FIGURE 1. Algorithm of the 3 major subsets found in DTS. Each subset should be treated separately, because treatment modality varies according to this separation.

**TABLE 4. Clinical Signs in DTS to Consider in Severity Assessment**

| Lids                       | Tear Film  | Conjunctiva   | Cornea                  | Vision       |
|----------------------------|------------|---------------|-------------------------|--------------|
| Telangiectasia             | Meniscus   | Luster        | Punctate changes        | Blur         |
| Hyperemia                  | Foam       | Hyperemia     | Erosions (micro, macro) | Fluctuations |
| Scales, crusts             | Mucus      | Wrinkles      | Filaments               |              |
| Lash loss or abnormalities | Debris     | Staining      | Ulceration              |              |
| Inspissation               | Oil excess | Symblepharon  | Vascularization         |              |
| Meibomian gland disease    |            | Cicatrization | Scarring                |              |
| Anatomical abnormalities   |            |               | Keratinization          |              |

warm massage, with addition of oral tetracyclines and topical corticosteroids, if necessary.

**Treatment Algorithm for DTS Patients With Primary Tear Distribution and Clearance Abnormalities**

The panel considered that there were patients in whom the even distribution of tears across the ocular surface is impaired, typically related to an anatomic abnormality or to abnormal lid function (Fig. 3). The recommended therapeutic approach to these patients varied in accordance with the specific underlying problem, which is summarized in Figure 3.

**Treatment Algorithm for DTS Patients Without Lid Margin Disease**

Patients with mild disease are best managed with patient education about the disease and strategies for minimizing its impact, preserved artificial tears, modification as appropriate of systemic medications that might contribute to the condition, and perhaps changes in the home or work environment to alleviate the symptoms (Fig. 4).

In patients in whom the disease state is moderate or severe, the panelists agreed that the more frequent use of tears

mandated a switch to unpreserved lubricants, with tears during the day, ointment at night, and consideration of progression to a gel formulation during the day if relief was not adequate with tears. In the absence of signs, the panel recommended lubrication, with frequency determined by the clinical response.

In the presence of signs (eg, moderate corneal staining, filaments), the panel agreed on a stepwise introduction of additional therapies. The panelists noted that patients with DTS may have an inflammatory component, which may or may not be clinically evident. In addition to the use of unpreserved tears, the panel recommended a course of topical corticosteroids and/or cyclosporine A to suppress inflammation.

In patients who fail to respond adequately to lubricants and topical immunomodulators, a course of oral tetracycline therapy was recommended, as well as punctal occlusion with

**TABLE 5. Levels of Severity of DTS Without Lid Margin Disease According to Symptoms and Signs**

| Severity* | Patient Profiles   |
|-----------|--|
| Level 1   | <ul style="list-style-type: none"> <li>Mild to moderate symptoms and no signs</li> <li>Mild to moderate conjunctival signs</li> </ul>  |
| Level 2   | <ul style="list-style-type: none"> <li>Moderate to severe symptoms</li> <li>Tear film signs</li> <li>Mild corneal punctate staining</li> <li>Conjunctival staining</li> </ul>                      |
| Level 3   | <ul style="list-style-type: none"> <li>Visual signs</li> <li>Severe symptoms</li> <li>Marked corneal punctate staining</li> <li>Central corneal staining</li> <li>Filamentary keratitis</li> </ul> |
| Level 4   | <ul style="list-style-type: none"> <li>Severe symptoms</li> <li>Severe corneal staining, erosions</li> <li>Conjunctival scarring</li> </ul>  |

\*At least one sign and one symptom of each category should be present to qualify for the corresponding level assignment.

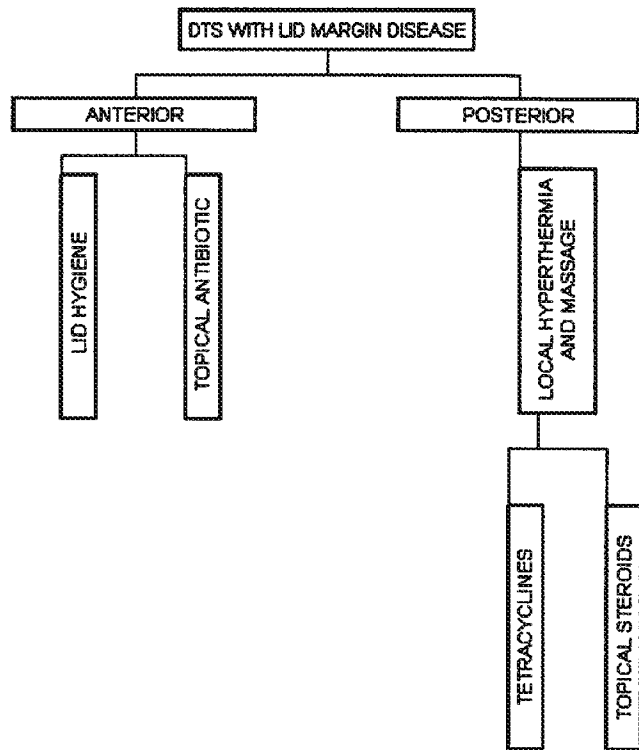

**FIGURE 2. Algorithm on treatment recommendations for DTS with lid margin disease.**

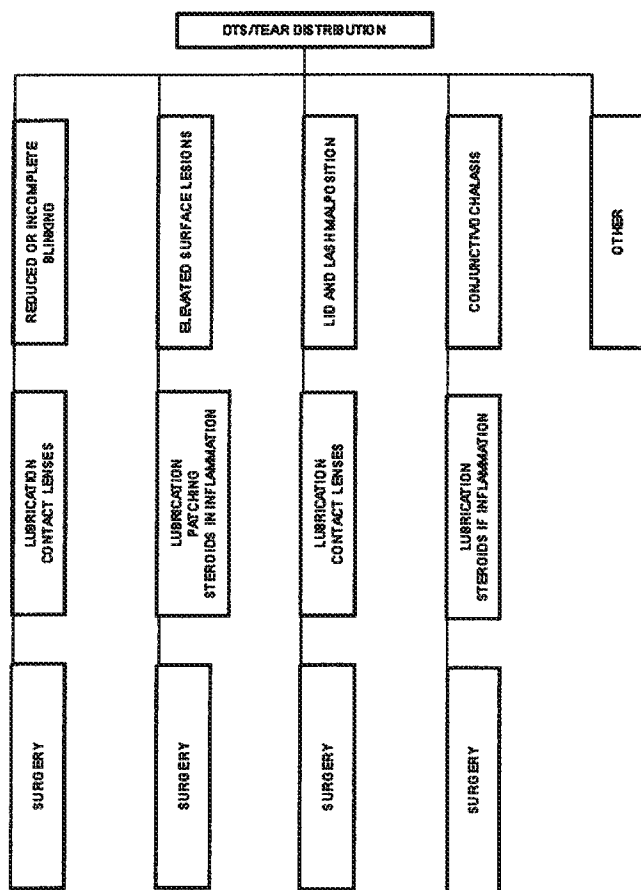

FIGURE 3. Algorithm on treatment recommendations for DTS with abnormal tear distribution.

plugs. Because of the possible presence of non-clinically apparent inflammation, punctal plugs could result in retention of proinflammatory tear components on the ocular surface and may enhance damage to the ocular surface, accelerate the disease process, and produce greater patient discomfort. Therefore, the panel agreed that it is important to treat the inflammatory condition before blockage of tear drainage with punctal plugs.

Patients with severe disease who are not adequately controlled after the above therapeutic interventions may benefit from more advanced interventions. These would include systemic immunomodulators for the control of severe inflammation, topical acetylcysteine for filament formation caused by mucin accumulation, moisture goggles to reduce tear evaporation, and surgery (including punctal cautery) to reduce tear drainage. Patients with Sjögren syndrome would fit within this category.

**DISCUSSION**

Some researchers have stressed the use of Delphi panels in clinical research, despite some flaws in terms of

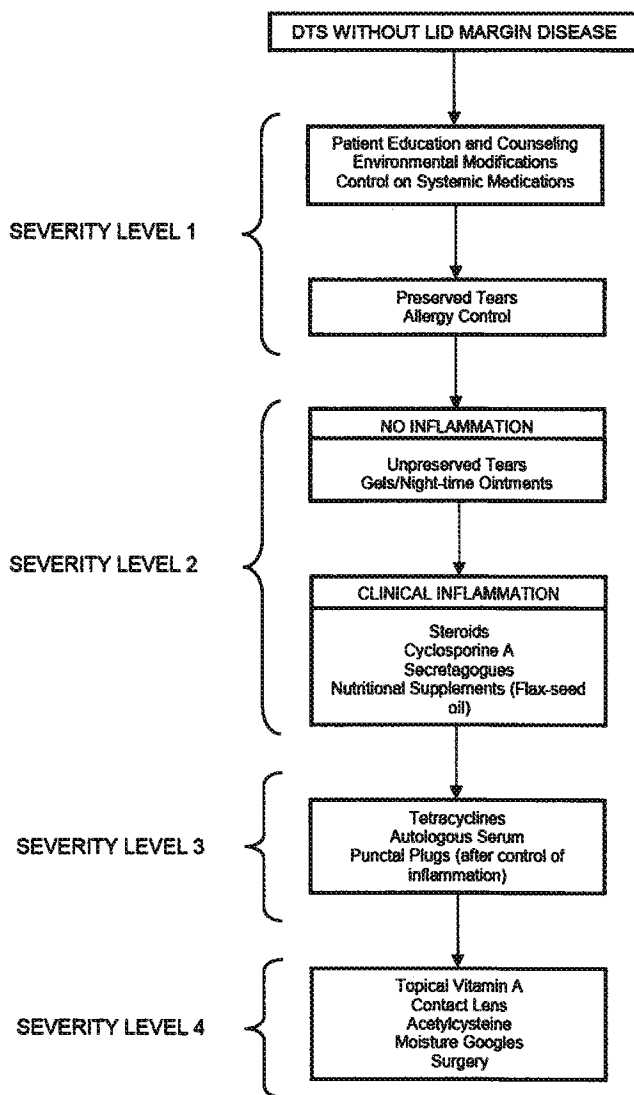

FIGURE 4. Algorithm on treatment recommendations for DTS without lid margin disease according to severity.

reproducibility and other confounding factors that may adversely influence the results.<sup>28,29</sup> Delphi approach is not necessarily “evidence-based”: Good evidence may exist contradicting a particular consensus; or conversely, evidence for a particular consensus may be absent, because it has not been adequately studied. Especially for areas where there is little or no good evidence in the literature, the process relies on the opinion of the participating panelists, potentially tapping into collective error.<sup>30</sup> Moreover, consensus is subject to particular interpretation of evidence and personal experience, which may affect reproducibility.<sup>14</sup> Nonetheless, this process has lately become popular to delineate guidelines of treatment of various disorders.<sup>30-33</sup>

Bias of panelists’ selection may inevitably occur as a result of the inclusion criteria chosen. It is a common observation that highly published authors tend to have some



form of commercial support from pharmaceutical industry. Nine of 17 panelists disclosed a past or present relationship as a speaker/consultant/research funds recipient from companies having products for the treatment of DTS.

The success of a Delphi panel is based largely on the ability of the facilitator to maintain balanced participation of panelists.<sup>32</sup> One of the major challenges in such panels is to avoid the inadvertent control of one or more leaders over the discussion.<sup>30</sup> The facilitator in our study was a person with previous experience in consensus panels. He had the ability to encourage homogeneous participation of panel members. The facilitator focused on the varied responses previously given by panelists in the survey to avoid discussions over a single topic/therapeutic approach raised by individual participants during the meeting. Inevitable discrepancies were observed during the DTS panel meeting; however, consensual agreement among panelists was finally achieved.

We believe that one significant consequence of the panel meeting was the recommendation for a change from the term dry eye, frequently used to describe the condition, to the term dysfunctional tear syndrome. Panelists unanimously agreed that the label dry eye reflects neither patient symptoms nor necessarily the pathogenic mechanism of the disease. Panel members also agreed that diagnosing patients with dry eye may be misleading to both colleagues and patients. Patients may be confused when excess tearing is their primary complaint and are diagnosed as having dry eye. Even more confusing for patients is their subsequent treatment with anti-inflammatory agents or antibiotics. For these reasons, the term DTS was coined, because the panel felt that this term was sufficiently broad to encompass the myriad of etiologies while still representing a common denominator among them.

There was consensus that severity of disease should be the primary determinant for the therapeutic strategy chosen. In addition, observation of the patient response to initial therapy was deemed as an important indicator of disease severity and further treatment selection. The failure on improvement using medications in one level assigns the patient to additional therapy in the immediate superior severity level. The available diagnostic tests were not considered important in the assessment of disease severity and therefore were not included in the classification. However, this should not underestimate the value of these tests in the diagnosis of DTS, because they were regularly used by panelists to confirm the presence of the disease.

The task of creating guidelines for DTS is complex, because practitioners encountering DTS are faced with a multifactorial disorder with several pathophysiological events that may require a variety of customized therapeutic schemes. Moreover, significant overlapping between the categories selected by the panel is also likely. The summary treatment recommendations (Table 6) relating severity of disease with clinical symptoms and signs created by the panel may serve as a useful guide. It is recognized that individual patient characteristics may require deviation from recommended treatment, but panelists were clear that the ideal therapy for DTS is often achieved with a combination of interventions. Assignment of levels of severity may work only as a stepwise guide to approaching the best combination of medications to

**TABLE 6.** Treatment Recommendations for DTS on the Basis of Level of Severity

| DTS Severity | Treatment Recommendations  |   |
|--------------|--|---|
| Level 1      | <ul style="list-style-type: none"> <li>• No treatment</li> <li>• Preserved tears</li> <li>• Environmental management</li> <li>• Allergy drops</li> </ul>           | <ul style="list-style-type: none"> <li>• Use of hypoallergenic products</li> <li>• Water intake</li> <li>• Psychological support</li> <li>• Avoidance of drugs contributing to dry eye</li> </ul> |
| Level 2      | <ul style="list-style-type: none"> <li>• Unpreserved tears</li> <li>• Gels</li> <li>• Ointments</li> <li>• Nutritional support (flaxseed/fatty acids)</li> </ul>   | <ul style="list-style-type: none"> <li>• Secretagogues</li> <li>• Topical steroids</li> <li>• Topical cyclosporine A</li> </ul>   |
| Level 3      | <ul style="list-style-type: none"> <li>• Tetracyclines</li> <li>• Punctal plugs</li> </ul>   |   |
| Level 4      | <ul style="list-style-type: none"> <li>• Surgery</li> <li>• Systemic anti-inflammatory therapy</li> <li>• Oral cyclosporine</li> <li>• Moisture goggles</li> </ul> | <ul style="list-style-type: none"> <li>• Punctal cautery</li> <li>• Acetylcysteine</li> <li>• Contact lenses</li> </ul>   |

avoid symptoms. It is important to stress that patients may present with signs belonging to different categories of DTS (ie, a patient may have DTS with lid margin disease and exhibit tear distribution problems).

Those particular patients should be treated according to recommendations for both categories to succeed in controlling their symptoms and signs. Published guidelines in other disease areas have proven useful to general practitioners to approach a complex disease like DTS.<sup>14,15,17</sup> Some examples using the Delphi technique have been reported in esophageal cancer management,<sup>11</sup> systemic hypertension treatment algorithms,<sup>15</sup> and acute diarrhea management in children.<sup>30</sup> In this study, the Delphi approach was used to gain a practical approach to the diagnosis and treatment of DTS, as opposed to an extensive evaluation of available diagnostic methods or pathophysiology mechanisms, already well documented in the literature<sup>34-38</sup> (Table 7).

**TABLE 7.** Advantages of the Proposed Recommendations by the Delphi Panel

|   |
|---|
| <ul style="list-style-type: none"> <li>• Proposes a new terminology for dry eye disease (dysfunctional tear syndrome) from recent pathophysiologic findings</li> <li>• Includes novel therapeutic options in the market</li> <li>• Provides simplified therapeutic recommendations in a stepwise approach</li> <li>• Patients without lid margin disease/tear distribution problems are assigned to 4 severity levels</li> <li>• Severity levels are categorized according to patient's signs and symptoms, not tests</li> <li>• Therapeutic options are oriented by severity levels</li> <li>• Easier approach for general eye care practitioners</li> </ul> |
|---|

All guidelines are limited by the future development of new treatments and by new insights that future research will bring. We therefore regard these guidelines as a platform onto which future updates may be added.

## REFERENCES

- Schein OD, Munoz B, Tielsch JM, et al. Prevalence of dry eye among the elderly. *Am J Ophthalmol*. 1997;124:723-728.
- Schaumberg DA, Sullivan DA, Buring JE, et al. Prevalence of dry eye syndrome among US women. *Am J Ophthalmol*. 2003;136:318-326.
- Lin PY, Tsai SY, Cheng CY, et al. Prevalence of dry eye among an elderly Chinese population in Taiwan: the Shihpai Eye Study. *Ophthalmology*. 2003;110:1096-1101.
- Brewitt H, Sistani F. Dry eye disease: the scale of the problem. *Surv Ophthalmol*. 2001;45:S199-S202.
- Lemp MA. Epidemiology and classification of dry eye. *Adv Exp Med Biol*. 1998;438:791-803.
- Matsuo T, Tsuchida Y, Morimoto N. Trehalose eye drops in the treatment of dry eye syndrome. *Ophthalmology*. 2002;109:2024-2029.
- McDonald CC, Kaye SB, Figueiredo FC, et al. A randomised, crossover, multicentre study to compare the performance of 0.1% (w/v) sodium hyaluronate with 1.4% (w/v) polyvinyl alcohol in the alleviation of symptoms associated with dry eye syndrome. *Eye*. 2002;16:601-607.
- Serie J, Cantor L, Gross R, et al. Best practice treatment algorithm for primary open-angle glaucoma: implications for U.S. ophthalmology practice. *Manag Care Interface*. 2002;15:37-48.
- Coia LR, Minsky BD, John MJ, et al. Patterns of care study decision tree and management guidelines for esophageal cancer. American College of Radiology. *Radiat Med*. 1998;16:321-327.
- Pelton JN. The future of telecommunications: a Delphi survey. *J Commun*. 1981;31:177-189.
- Bellamy N, Anastassiades TP, Buchanan WW, et al. Rheumatoid arthritis anti-rheumatic trials. III. Setting the delta for clinical trials of anti-rheumatic drugs—results of a consensus development (Delphi) exercise. *J Rheumatol*. 1991;18:1908-1915.
- Holmes ER, Tipton DJ, Desselle SP. The impact of the internet on community pharmacy practice: a comparison of a Delphi panel's forecast with emerging trends. *Health Mark Q*. 2002;20:3-29.
- Goodman CM. The Delphi technique: a critique. *J Adv Nurs*. 1987;12:729-734.
- Pearson SD, Margolis CZ, Davis S, et al. Is consensus reproducible? A study of an algorithmic guidelines development process. *Med Care*. 1995;33:643-660.
- Richter A, Ostrowski C, Dombeck MP, et al. Delphi panel study of current hypertension treatment patterns. *Clin Ther*. 2001;23:160-167.
- Powell C. The Delphi technique: myths and realities. *J Adv Nurs*. 2003;41:376-382.
- Murphy MK, Black NA, Lamping DL, et al. Consensus development methods, and their use in clinical guideline development. *Health Technol Assess*. 1998;2:i-iv, 1-88.
- Young LJ, George J. Do guidelines improve the process and outcomes of care in delirium? *Age Ageing*. 2003;32:525-528.
- Evans C. The use of consensus methods and expert panels in pharmacoeconomic studies. Practical applications and methodological shortcomings. *Pharmacoeconomics*. 1997;12:121-129.
- Morris CJ, Cantrill JA. Preventing drug-related morbidity—the development of quality indicators. *J Clin Pharm Ther*. 2003;28:295-305.
- Hughes R. Definitions for public health nutrition: a developing consensus. *Public Health Nutr*. 2003;6:615-620.
- Lemp MA. Report of the National Eye Institute/Industry workshop on Clinical Trials in Dry Eyes. *CLAO J*. 1995;21:221-232.
- Matoba AY, Harris DJ, Meisler DM, et al. *Preferred Practice Patterns: Dry Eye Syndrome*. San Francisco, CA: American Academy of Ophthalmology; 2003.
- Murube J, Benitez Del Castillo JM, Chenzhuo L, et al. The Madrid triple classification of dry eye. *Arch Soc Esp Oftalmol*. 2003;78:587-594.
- Pflugfelder SC. Anti-inflammatory therapy for dry eye. *Am J Ophthalmol*. 2004;137:337-342.
- Baudouin C. The pathology of dry eye. *Surv Ophthalmol*. 2001;45 (Suppl 2):S211-S220.
- Lemp MA. Evaluation and differential diagnosis of keratoconjunctivitis sicca. *J Rheumatol Suppl*. 2000;61:11-14.
- Burand B, Vader JP, Froehlich F, et al. Reliability of panel-based guidelines for colonoscopy: an international comparison. *Gastrointest Endosc*. 1998;47:162-166.
- Jones J, Hunter D. Consensus methods for medical and health services research. *BMJ*. 1995;311:376-380.
- Armon K, Stephenson T, MacFaul R, et al. An evidence and consensus based guideline for acute diarrhea management. *Arch Dis Child*. 2001;85:132-142.
- Campbell SM, Hann M, Roland MO, et al. The effect of panel membership and feedback on ratings in a two-round Delphi survey: results of a randomized controlled trial. *Med Care*. 1999;37:964-968.
- Washington DL, Bernstein SJ, Kahan JP, et al. Reliability of clinical guideline development using mail-only versus in-person expert panels. *Med Care*. 2003;41:1374-1381.
- Mathis R, Doyle S. A quality mix: using evidence and experience to evaluate new technologies. *J Healthc Qual*. 2003;25:4-6.
- Smith JA, Vitale S, Reed GF, et al. Dry eye signs and symptoms in women with premature ovarian failure. *Arch Ophthalmol*. 2004;122:151-156.
- Horwath-Winter J, Berghold A, Schmut O, et al. Evaluation of the clinical course of dry eye syndrome. *Arch Ophthalmol*. 2003;121:1364-1368.
- Bron AJ, Evans VE, Smith JA. Grading of corneal and conjunctival staining in the context of other dry eye tests. *Cornea*. 2003;22:640-650.
- Sade de Paiva C, Lindsey JL, Pflugfelder SC. Assessing the severity of keratitis sicca with videokeratographic indices. *Ophthalmology*. 2003;110:1102-1109.
- Begley CG, Chalmers RL, Abetz L, et al. The relationship between habitual patient-reported symptoms and clinical signs among patients with dry eye of varying severity. *Invest Ophthalmol Vis Sci*. 2003;44:4753-4761.

# EXHIBIT D

# DEWS Management and Therapy

## Management and Therapy of Dry Eye Disease: Report of the Management and Therapy Subcommittee of the International Dry Eye WorkShop (2007)

**ABSTRACT** The members of the Management and Therapy Subcommittee assessed current dry eye therapies. Each member wrote a succinct evidence-based review on an assigned aspect of the topic, and the final report was written after review by and with consensus of all subcommittee members and the entire Dry Eye WorkShop membership. In addition to its own review of the literature, the Subcommittee reviewed the Dry Eye Preferred Practice Patterns of the American Academy of Ophthalmology and the International Task Force (ITF) Delphi Panel on Dry Eye. The Subcommittee favored the approach taken by the ITF, whose recommended treatments were based on level of disease severity. The recommendations of the Subcommittee are based on a modification of the ITF severity grading scheme, and suggested treatments were chosen from a menu of therapies for which evidence of therapeutic effect had been presented.

**KEYWORDS** DEWS, dry eye disease, Dry Eye WorkShop, management, therapy

Accepted for publication January 2007.

Management and Therapy Subcommittee members: **Stephen C. Pflugfelder, MD (Chair)**; Gerd Geerling, MD; Shigero Kinoshita, MD; Michael A. Lemp, MD; James McCulley, MD; Daniel Nelson, MD; Gary N. Novack, PhD; Jun Shimazaki, MD; Clive Wilson, PhD.

Proprietary interests of Subcommittee members are disclosed on pages 202 and 204.

Reprints are not available. Articles can be accessed at: [www.tearfilm.org](http://www.tearfilm.org).

Correspondence in regard to this chapter should be addressed to Stephen C. Pflugfelder MD, Ophthalmology-Ocular Surf Ctr, Cullen Eye Institute, 6565 Fannin Street NC 205, Houston, TX 77030. Tel: 713-798-4732. Fax: 713-798-1457. Email: [stevemp@bcm.tmc.edu](mailto:stevemp@bcm.tmc.edu)

©2007 Ethis Communications, Inc. *The Ocular Surface* ISSN: 1542-0124. (No authors listed). Management and therapy of dry eye disease: report of the Management and Therapy Subcommittee of the International Dry Eye WorkShop (2007). 2007;5(2):163-178.

### I. INTRODUCTION

This report summarizes the management and therapeutic options for treating dry eye disease. The level of evidence for supporting data from the literature is evaluated according to the modified American Academy of Ophthalmology Preferred Practices guidelines (Table 1).

### II. GOALS OF THE MANAGEMENT AND THERAPY SUBCOMMITTEE

Goals of this committee were to identify appropriate therapeutic methods for the management of dry eye disease and recommend a sequence or strategy for their application, based on evidence-based review of the literature.

The quality of the evidence in the literature was graded according to a modification of the scheme used in the American Academy of Ophthalmology Preferred Practice Patterns series. When possible, peer-reviewed full publications, not abstracts, were used. The report was reviewed

**Table 1.** Evidence grading scheme

| Clinical Studies   |
|--|
| <b>Level 1.</b> Evidence obtained from at least one properly conducted, well-designed, randomized, controlled trial, or evidence from well-designed studies applying rigorous statistical approaches.  |
| <b>Level 2.</b> Evidence obtained from one of the following: a well-designed controlled trial without randomization, a well-designed cohort or case-control analytic study, preferably from one or more center, or a well-designed study accessible to more rigorous statistical analysis. |
| <b>Level 3.</b> Evidence obtained from one of the following: descriptive studies, case reports, reports of expert committees, expert opinion.  |
| Basic Science Studies  |
| <b>Level 1.</b> Well-performed studies confirming a hypothesis with adequate controls published in a high-impact journal.  |
| <b>Level 2.</b> Preliminary or limited published study.  |
| <b>Level 3.</b> Meeting abstracts or unpublished presentations.  |

This evidence grading scheme is based on that used in the American Academy of Ophthalmology Preferred Practice Pattern series.

**OUTLINE**

- I. Introduction
- II. Goals of the Management and Therapy Subcommittee
- III. Assessment of current dry eye therapies
  - A. Tear supplementation: lubricants
    - 1. General characteristics and effects
    - 2. Preservatives
    - 3. Electrolyte composition
    - 4. Osmolarity
    - 5. Viscosity agents
    - 6. Summary
  - B. Tear Retention
    - 1. Punctal occlusion
      - a. Rationale
      - b. Types
      - c. Clinical studies
      - d. Indications and contraindications
      - e. Complications
      - f. Summary
    - 2. Moisture chamber spectacles
    - 3. Contact lenses
  - C. Tear stimulation: secretagogues
  - D. Biological tear substitutes
    - 1. Serum
    - 2. Salivary gland autotransplantation
  - E. Anti-inflammatory therapy
    - 1. Cyclosporine
    - 2. Corticosteroids
      - a. Clinical studies
      - b. Basic research
    - 3. Tetracyclines
      - a. Properties of tetracyclines and their derivatives
        - 1) Antibacterial properties
        - 2) Anti-inflammatory
        - 3) Anti-angiogenic properties
      - b. Clinical applications of tetracycline
        - 1) Acne Rosacea
        - 2) Chronic posterior blepharitis: meibomianitis, meibomian gland dysfunction
        - 3) Dosage and safety
  - F. Essential fatty acids
  - G. Environmental strategies
- IV. Treatment recommendations
- V. Unanswered questions and future directions

by all subcommittee members and by the entire Dry Eye WorkShop membership. Comments and suggested revisions were discussed by the subcommittee members and incorporated into the report where deemed appropriate by consensus.

**III. ASSESSMENT OF CURRENT DRY EYE THERAPIES****A. Tear Supplementation: Lubricants****1. General Characteristics and Effects**

The term "artificial tears" is a misnomer for most products that identify themselves as such, because they do not mimic the composition of human tears. Most function as lubricants, although some more recent formulations mimic the electrolyte composition of human tears (TheraTears® [Advanced Vision Research, Woburn, MA]).<sup>1,2</sup> The ocular lubricants presently available in the United States are approved based on the US Food and Drug Administration (FDA) monograph on over-the-counter (OTC) products (21 CFR 349) and are not based on clinical efficacy. The monograph specifies permitted active ingredients (eg, demulcents, emulsifiers, surfactants, and viscosity agents) and concentrations, but gives only limited guidance on inactive additives and solution parameters. Certain inactive ingredients that are used in artificial tears sold in the US (eg, castor oil in Endura™ [Allergan, Inc., Irvine, CA] and guar in Systane® [Alcon, Ft Worth, TX]) are not listed in the monograph.

It is difficult to prove that any ingredient in an ocular lubricant acts as an active agent. If there is an active ingredient, it is the polymeric base or viscosity agent, but this has proved difficult to demonstrate. This is either because it is not possible to detect the effects or differences in clinical trials with presently available clinical tests or because the currently available agents do not have any discernable clinical activity beyond a lubrication effect. Although certain artificial tears have demonstrated more success than others in reducing symptoms of irritation or decreasing ocular surface dye staining in head-to-head comparisons, there have been no large scale, masked, comparative clinical trials to evaluate the wide variety of ocular lubricants.

What is the clinical effect of ocular lubricants or artificial tears? Do they lubricate, replace missing tear constituents, reduce elevated tear film osmolarity, dilute or wash out inflammatory or inflammation-inducing agents? Do they, in some instances, actually wash out essential substances found in normal human tears? These questions remain to be answered as more sensitive clinical tests become available to detect changes in the ocular surface.

The foremost objectives in caring for patients with dry eye disease are to improve the patient's ocular comfort and quality of life, and to return the ocular surface and tear film to the normal homeostatic state. Although symptoms can rarely be eliminated, they can often be improved, leading to an improvement in the quality of life. It is more difficult to demonstrate that topical lubricants improve the ocular surface and the tear film abnormalities associated with dry eye. Most clinical studies fail to demonstrate significant correlation between symptoms and clinical test values or between the clinical test values themselves.<sup>3-5</sup> It is not unusual for a dry eye with only mild symptoms to show significant rose bengal staining. Until agents are developed that can restore the ocular surface and tear film to their

normal homeostatic state, the symptoms and signs of dry eye disease will continue.

Ocular lubricants are characterized by hypotonic or isotonic buffered solutions containing electrolytes, surfactants, and various types of viscosity agents. In theory, the ideal artificial lubricant should be preservative-free, contain potassium, bicarbonate, and other electrolytes and have a polymeric system to increase its retention time.<sup>1,6-8</sup> Physical properties should include a neutral to slightly alkaline pH. Osmolarities of artificial tears have been measured to range from about 181 to 354 mOsm/L.<sup>9</sup> The main variables in the formulation of ocular lubricants regard the concentration of and choice of electrolytes, the osmolarity and the type of viscosity/polymeric system, the presence or absence of preservative, and, if present, the type of preservative.

## 2. Preservatives

The single most critical advance in the treatment of dry eye came with the elimination of preservatives, such as benzalkonium chloride (**BAK**), from OTC lubricants. Because of the risk of contamination of multidose products, most either contain a preservative or employ some mechanism for minimizing contamination. The FDA has required that multidose artificial tears contain preservatives to prevent microbial growth.<sup>10</sup> Preservatives are not required in unit dose vials that are discarded after a single use. The widespread availability of nonpreserved preparations allows patients to administer lubricants more frequently without concern about the toxic effects of preservatives. For patients with moderate-to-severe dry eye disease, the absence of preservatives is of more critical importance than the particular polymeric agent used in ocular lubricants. The ocular surface inflammation associated with dry eye is exacerbated by preserved lubricants; however, nonpreserved solutions are inadequate in themselves to improve the surface inflammation and epithelial pathology seen in dry eye disease.<sup>11</sup>

Benzalkonium chloride is the most frequently used preservative in topical ophthalmic preparations, as well as in topical lubricants. Its epithelial toxic effects have been well established.<sup>12-17</sup> The toxicity of BAK is related to its concentration, the frequency of dosing, the level or amount of tear secretion, and the severity of the ocular surface disease. In the patient with mild dry eye, BAK-preserved drops are usually well tolerated when used 4-6 times a day or less. In patients with moderate-to-severe dry eye, the potential for BAK toxicity is high, due to decreased tear secretion and decreased turnover.<sup>17</sup> Some patients may be using other topical preparations (eg, glaucoma medications) that contain BAK, increasing their exposure to the toxic effects of BAK. Also, the potential for toxicity exists with patient abuse of other OTC products that contain BAK, such as vasoconstrictors.

BAK can damage the corneal and conjunctival epithelium, affecting cell-to-cell junctions and cell shape and microvilli, eventually leading to cell necrosis with sloughing of 1-2 layers of epithelial cells.<sup>17</sup> Preservative-free formulations are absolutely necessary for patients with severe dry

eye with ocular surface disease and impairment of lacrimal gland secretion, or for patients on multiple, preserved topical medications for chronic eye disease. Patients with severe dry eye, greatly reduced tear secretion, and punctal occlusion are at particular risk for preservative toxicity. In such patients, the instilled agent cannot be washed out; if this risk has not been appreciated by the clinician, preserved drops might be used at high frequency.

Another additive used in OTC formulations is disodium (**EDTA**). It augments the preservative efficacy of BAK and other preservatives, but, by itself, it is not a sufficient preservative. Used in some nonpreserved solutions, it may help limit microbial growth in opened unit-dose vials. Although use of EDTA may allow a lower concentration of preservative, EDTA may itself be toxic to the ocular surface epithelium. A study comparing two preservative-free solutions, Hypotears PF® (Novartis Ophthalmics, East Hanover, NJ) containing EDTA and Refresh® (Allergan, Inc., Irvine, CA) without EDTA, showed that both formulations had identical safety profiles and were completely nontoxic to the rabbit corneal epithelium.<sup>18</sup> Other studies found that EDTA-containing preparations increased corneal epithelial permeability.<sup>19,20</sup> The potential exists that patients with severe dry eye will find that EDTA-containing preparations increase irritation.

Nonpreserved, single unit-dose tear substitutes are more costly for the manufacturer to produce, more costly for the patients to purchase, and less convenient to use than bottled ocular lubricants. For these reasons, reclosable unit dose vials (eg, Refresh Free [Allergan Inc., Irvine, CA]; Tears Natural Free® [Alcon, Fort Worth, TX]) were introduced. Less toxic preservatives, such as polyquad (polyquaternium-1), sodium chlorite (Purite®), and sodium perborate were developed to allow the use of multidose bottled lubricants and to avoid the known toxicity of BAK-containing solutions.<sup>21,22</sup> The "vanishing" preservatives were sodium perborate and sodium chlorite (TheraTears® [Advanced Vision Research, Woburn, MA], Genteal® [Novartis, East Hanover, NJ], and Refresh Tears® [Allergan Inc., Irvine, CA]).

Sodium chlorite degrades to chloride ions and water upon exposure to UV light after instillation. Sodium perborate is converted to water and oxygen on contact with the tear film. For patients with severe dry eye, even vanishing preservatives may not totally degrade, due to a decrease in tear volume, and may be irritating. Patients prefer bottled preparations for reasons of both cost and ease of use. The ideal lubricant would come in a multidose, easy-to-use bottle that contains a preservative that completely dissipates before reaching the tear film, or is completely nontoxic and nonirritating and maintains absolute sterility with frequent use. One such multi-use, preservative-free product has been introduced to the market (Visine Pure-Tears® [Pfizer, Inc, NJ]).

Ocular ointments and gels are also used in treatment of dry eye disease. Ointments are formulated with a specific mixture of mineral oil and petrolatum. Some contain lanolin,

which can be irritating to the eye and delay corneal wound healing.<sup>23</sup> Individuals with sensitivity to wool may also be sensitive to lanolin.<sup>23</sup> Some ointments contain parabens as preservatives, and these ointments are not well tolerated by patients with severe dry eye. In general, ointments do not support bacterial growth and, therefore, do not require preservatives. Gels containing high molecular weight cross-linked polymers of acrylic acid (carbomers) have longer retention times than artificial tear solutions, but have less visual blurring effect than petrolatum ointments.

### 3. Electrolyte Composition

Solutions containing electrolytes and or ions have been shown to be beneficial in treating ocular surface damage due to dry eye.<sup>1,6,20,24,25</sup> To date, potassium and bicarbonate seem to be the most critical. Potassium is important to maintain corneal thickness.<sup>7</sup> In a dry-eye rabbit model, a hypotonic tear-matched electrolyte solution (TheraTears® [Advanced Vision Research, Woburn, MA]) increased conjunctival goblet cell density and corneal glycogen content, and reduced tear osmolarity and rose bengal staining after 2 weeks of treatment.<sup>25</sup> The restoration of conjunctival goblet cells seen in the dry-eye rabbit model has been corroborated in patients with dry eye after LASIK.<sup>26</sup>

Bicarbonate-containing solutions promote the recovery of epithelial barrier function in damaged corneal epithelium and aid in maintaining normal epithelial ultrastructure. They may also be important for maintaining the mucin layer of the tear film.<sup>6</sup> Ocular lubricants are available that mimic the electrolyte composition of human tears, eg, TheraTears® (Advanced Vision Research, Woburn, MA) and BION Tears® (Alcon, Fort Worth, TX).<sup>1,2</sup> These also contain bicarbonate, which is critical for forming and maintaining the protective mucin gel in the stomach.<sup>27</sup> Bicarbonate may play a similar role for gel-forming mucins on the ocular surface. Because bicarbonate is converted to carbon dioxide when in contact with air and can diffuse through the plastic unit dose vials, foil packaging of the plastic vials is required to maintain stability.

### 4. Osmolarity

Tears of patients with dry eye have a higher tear film osmolarity (crystalloid osmolarity) than do those of normal patients.<sup>28,29</sup> Elevated tear film osmolarity causes morphological and biochemical changes to the corneal and conjunctival epithelium<sup>18,30</sup> and is pro-inflammatory.<sup>31</sup> This knowledge influenced the development of hypo-osmotic artificial tears such as Hypotears® (230 mOsm/L [Novartis Ophthalmics, East Hanover, NJ]) and subsequently TheraTears® (181 mOsm/L [Advanced Vision Research, Woburn, MA]).<sup>32</sup>

Colloidal osmolality is another factor that varies in artificial tear formulations. While crystalloid osmolarity is related to the presence of ions, colloidal osmolality is dependent largely on macromolecule content. Colloidal osmolarity, also known as *oncotic pressure*, is involved in the control of water transport in tissues. Differences in colloidal

osmolality affect the net water flow across membranes, and water flow is eliminated by applying hydrostatic pressure to the downside of the water flow. The magnitude of this osmotic pressure is determined by osmolality differences on the two sides of the membrane. Epithelial cells swell due to damage to their cellular membranes or due to a dysfunction in the pumping mechanism. Following the addition of a fluid with a high colloidal osmolality to the damaged cell surface, deturgescence occurs, leading to a return of normal cell physiology. Theoretically, an artificial tear formulation with a high colloidal osmolality may be of value. Holly and Esquivel evaluated many different artificial tear formulations and showed that Hypotears® (Novartis Ophthalmics, East Hanover, NJ) had the highest colloidal osmolality of all of the formulations tested.<sup>33</sup> Formulations with higher colloidal osmolality have since been marketed (Dwelle® [Dry Eye Company, Silverdale, WA]).

Protection against the adverse effects of increased osmolarity (osmoprotection) has led to development of OTC drops incorporating compatible solutes (such as glycerin, erythritol, and levocarnitine (Optive® [Allergan Inc., Irvine, CA])). It is thought that the compatible solutes distribute between the tears and the intracellular fluids to protect against potential cellular damage from hyperosmolar tears.<sup>34</sup>

### 5. Viscosity Agents

The stability of the tear film depends on the chemical-physical characteristics of that film interacting with the conjunctival and corneal epithelium via the membrane-spanning mucins (ie, MUC-16 and MUC-4). In the classical three-layered tear film model, the mucin layer is usually thought of as a surfactant or wetting agent, acting to lower the surface tension of the relatively hydrophobic ocular surface, rendering the corneal and conjunctival cells "wetable."<sup>33</sup> Currently, the tear film is probably best described as a hydrated, mucin gel whose mucin concentration decreases with distance from the epithelial cell surface. It may have a protective role similar to that of mucin in the stomach.<sup>35</sup> It may also serve as a "sink" or storage vehicle for substances secreted by the main and accessory lacrimal glands and the ocular surface cells. This may explain why most of the available water-containing lubricants are only minimally effective in restoring the normal homeostasis of the ocular surface. In addition to washing away and diluting out irritating or toxic substances in the tear film, artificial lubricants hydrate gel-forming mucin. While some patients with dry eye have decreased aqueous lacrimal gland secretion, alterations or deficiencies involving mucin also cause dry eye.

Macromolecular complexes added to artificial lubricants act as viscosity agents. The addition of a viscosity agent increases residence time, providing a longer interval of patient comfort. For example, when a viscous, anionic charged carboxymethyl-cellulose (CMC, 100,000 mw) solution was compared with a neutral hydroxymethylcellulose (HPMC) solution, CMC was shown to have a significantly slower rate of clearance from the eye.<sup>36</sup> Viscous agents in active drug

formulations may also prolong ocular surface contact, increasing the duration of action and penetration of the drug.

Viscous agents may also protect the ocular surface epithelium. It is known that rose bengal stains abnormal corneal and conjunctival epithelial cells expressing an altered mucin glycocalyx.<sup>37</sup> Agents such as hydroxymethylcellulose (HMC), which decrease rose bengal staining in dry eye subjects,<sup>38</sup> may either "coat and protect" the surface epithelium or help restore the protective effect of mucins.

In the US, carboxymethyl cellulose is the most commonly used polymeric viscosity agent (IRI Market Share Data, Chicago, IL), typically in concentrations from 0.25% to 1%, with differences in molecular weight also contributing to final product viscosity. Carboxymethyl cellulose has been found to bind to and be retained by human epithelial cells.<sup>39</sup> Other viscosity agents included in the FDA monograph (in various concentrations) include polyvinyl alcohol, polyethylene glycol, glycol 400, propylene glycol hydroxymethyl cellulose and hydroxypropyl cellulose.

The blurring of vision and esthetic disadvantages of caking and drying on eyelashes are drawbacks of highly viscous agents that patients with mild to moderate dry eye will not tolerate. Lower molecular-weight viscous agents help to minimize these problems. Because patient compliance, comfort, and convenience are important considerations, a range of tear substitute formulations with varying viscosities are needed.

Hydroxypropyl-guar (HP-guar) has been used as a gelling agent in a solution containing glycol 400 and propylene glycol (Systane<sup>®</sup>, Alcon, Fort Worth, TX). It has been suggested that HP-guar preferentially binds to the more hydrophobic, desiccated or damaged areas of the surface epithelial cells, providing temporary protection for these cells.<sup>40,41</sup> Several commercial preparations containing oil in the form of castor oil (Endura<sup>™</sup> [Allergan Inc., Irvine, CA]) or mineral oil (Soothe<sup>®</sup> [Bausch & Lomb, Rochester, NY]) are purported to aid in restoring or increasing the lipid layer of the tear film.<sup>42,43</sup> Hyaluronic acid is a viscosity agent that has been investigated for years as an "active" compound added to tear substitute formulations for the treatment of dry eye. Hyaluronic acid (0.2%) has significantly longer ocular surface residence times than 0.3 percent HPMC or 1.4 percent polyvinyl alcohol.<sup>44</sup> Some clinical studies reported improvement in<sup>44-48</sup> dry eye in patients treated with sodium hyaluronate-containing solutions compared to other lubricant solutions, whereas others did not.<sup>48</sup> Although lubricant preparations containing sodium hyaluronate have not been approved for use in the US, they are frequently used in some countries.

## 6. Summary

Although many topical lubricants, with various viscosity agents, may improve symptoms and objective findings, there is no evidence that any agent is superior to another. Most clinical trials involving topical lubricant preparations will document some improvement (but not resolution) of subjective symptoms and improvement in some objective

parameters.<sup>4</sup> However, the improvements noted are not necessarily any better than those seen with the vehicle or other nonpreserved artificial lubricants. The elimination of preservatives and the development of newer, less toxic preservatives have made ocular lubricants better tolerated by dry eye patients. However, ocular lubricants, which have been shown to provide some protection of the ocular surface epithelium and some improvement in patient symptoms and objective findings, have not been demonstrated in controlled clinical trials to be sufficient to resolve the ocular surface disorder and inflammation seen in most dry eye sufferers.

## B. Tear Retention

### 1. Punctal Occlusion

#### a. Rationale

While the concept of permanently occluding the lacrimal puncta with cautery to treat dry eye extends back 70 years,<sup>49</sup> and, although the first dissolvable implants were used 45 years ago,<sup>50</sup> the modern era of punctal plug use began in 1975 with the report by Freeman.<sup>51</sup> Freeman described the use of a dumbbell-shaped silicone plug, which rests on the opening of the punctum and extends into the canaliculus. His report established a concept of punctal occlusion, which opened the field for development of a variety of removable, long-lasting plugs to retard tear clearance in an attempt to treat the ocular surface of patients with deficient aqueous tear production. The Freeman style plug remains the prototype for most styles of punctal plugs.

#### b. Types

Punctal plugs are divided into two main types: absorbable and nonabsorbable. The former are made of collagen or polymers and last for variable periods of time (3 days to 6 months). The latter nonabsorbable "permanent" plugs include the Freeman style, which consists of a surface collar resting on the punctal opening, a neck, and a wider base. In contrast, the Herrick plug (Lacrimedics [Eastsound, WA]) is shaped like a golf tee and is designed to reside within the canaliculus. It is blue for visualization; other variations are radiopaque. A newly designed cylindrical Smartplug<sup>™</sup> (Medennium Inc [Irvine, CA]) expands and increases in diameter in situ following insertion into the canaliculus due to thermodynamic properties of its hydrophilic acrylic composition.

#### c. Clinical Studies

A variety of clinical studies evaluating the efficacy of punctal plugs have been reported.<sup>52-56</sup> These series generally fall into Level II evidence. Their use has been associated with objective and subjective improvement in patients with both Sjogren and non-Sjogren aqueous tear deficient dry eye, filamentary keratitis, contact lens intolerance, Stevens-Johnson disease, severe trachoma, neurotrophic keratopathy, post-penetrating keratoplasty, diabetic keratopathy, and post-photorefractive keratectomy or laser in situ keratomileusis. Several studies have been performed



to evaluate the effects of punctal plugs on the efficacy of glaucoma medications in reducing intraocular pressure, and these studies have reported conflicting results.<sup>57,58</sup> Beneficial outcome in dry eye symptoms has been reported in 74-86% of patients treated with punctal plugs. Objective indices of improvement reported with the use of punctal plugs include improved corneal staining, prolonged tear film breakup time (TFBUT), decrease in tear osmolarity, and increase in goblet cell density. Overall, the clinical utility of punctal plugs in the management of dry eye disease has been well documented.

#### **d. Indications and Contraindications**

In a recent review on punctal plugs, it was reported that in a major eye clinic, punctal plugs are considered indicated in patients who are symptomatic of dry eyes, have a Schirmer test (with anesthesia) result less than 5 mm at 5 minutes, and show evidence of ocular surface dye staining.<sup>56</sup>

Contraindications to the use of punctal plugs include allergy to the materials used in the plugs to be implanted, punctal ectropion, and pre-existing nasolacrimal duct obstruction, which would, presumably, negate the need for punctal occlusion. It has been suggested that plugs may be contraindicated in dry eye patients with clinical ocular surface inflammation, because occlusion of tear outflow would prolong contact of the abnormal tears containing proinflammatory cytokines with the ocular surface. Treatment of the ocular surface inflammation prior to plug insertion has been recommended. Acute or chronic infection of the lacrimal canaliculus or lacrimal sac is also a contraindication to use of a plug.

#### **e. Complications**

The most common complication of punctal plugs is spontaneous plug extrusion, which is particularly common with the Freeman-style plugs. Over time, an extrusion rate of 50% has been reported, but many of these extrusions took place after extensive periods of plug residence. Most extrusions are of small consequence, except for inconvenience and expense. More troublesome complications include internal migration of a plug, biofilm formation and infection,<sup>59</sup> and pyogenic granuloma formation. Removal of migrated canaliculus plugs can be difficult and may require surgery to the nasolacrimal duct system.<sup>60,61</sup>

#### **f. Summary**

The extensive literature on the use of punctal plugs in the management of dry eye disease has documented their utility. Several recent reports, however, have suggested that absorption of tears by the nasolacrimal ducts into surrounding tissues and blood vessels may provide a feedback mechanism to the lacrimal gland regulating tear production.<sup>62</sup> In one study, placement of punctal plugs in patients with normal tear production caused a significant decrease in tear production for up to 2 weeks after plug insertion.<sup>63</sup> This cautionary note should be considered when deciding

whether to incorporate punctal occlusion into a dry eye disease management plan.

#### **2. Moisture Chamber Spectacles**

The wearing of moisture-conserving spectacles has for many years been advocated to alleviate ocular discomfort associated with dry eye. However, the level of evidence supporting its efficacy for dry eye treatment has been relatively limited. Tsubota et al, using a sensitive moisture sensor, reported an increase in periocular humidity in subjects wearing such spectacles.<sup>64</sup> Addition of side panels to the spectacles was shown to further increase the humidity.<sup>65</sup> The clinical efficacy of moisture chamber spectacles has been reported in case reports.<sup>66,67</sup> Kurihashi proposed a related treatment for dry eye patients, in the form of a wet gauze eye mask.<sup>68</sup> Conversely, Nichols et al recently reported in their epidemiologic study that spectacle wearers were twice as likely as emmetropes to report dry eye disease.<sup>69</sup> The reason for this observation was not explained.

There have been several reports with relatively high level of evidence describing the relationship between environmental humidity and dry eye. Korb et al reported that increases in periocular humidity caused a significant increase in thickness of the tear film lipid layer.<sup>70</sup> Dry eye subjects wearing spectacles showed significantly longer interblink intervals than those who did not wear spectacles, and duration of blink (blinking time) was significantly longer in the latter subjects.<sup>70</sup> Instillation of artificial tears caused a significant increase in the interblink interval and a decrease in the blink rate.<sup>71</sup> Maruyama et al reported that dry eye symptoms worsened in soft contact lens wearers when environmental humidity decreased.<sup>72</sup>

#### **3. Contact Lenses**

Contact lenses may help to protect and hydrate the corneal surface in severe dry eye conditions. Several different contact lens materials and designs have been evaluated, including silicone rubber lenses and gas permeable scleral-bearing hard contact lenses with or without fenestration.<sup>73-77</sup> Improved visual acuity and comfort, decreased corneal epitheliopathy, and healing of persistent corneal epithelial defects have been reported.<sup>73-77</sup> Highly oxygen-permeable materials enable overnight wear in appropriate circumstances.<sup>75</sup> There is a small risk of corneal vascularization and possible corneal infection associated with the use of contact lenses by dry eye patients.

#### **C. Tear Stimulation: Secretagogues**

Several potential topical pharmacologic agents may stimulate aqueous secretion, mucous secretion, or both. The agents currently under investigation by pharmaceutical companies are diquafosol (one of the P2Y2 receptor agonists), rebamipide, gefarnate, ecabet sodium (mucous secretion stimulants), and 15(S)-HETE (MUC1 stimulant). Among them, a diquafosol eye drop has been favorably evaluated in clinical trials. 2% diquafosol (INS365, DE-089 [Santen, Osaka, Japan]; Inspire [Durham, NC]) proved to

be effective in the treatment of dry eye in a randomized, double-masked trial in humans to reduce ocular surface staining.<sup>78</sup> A similar study demonstrated the ocular safety and tolerability of diquafosol in a double-masked, placebo-controlled, randomized study.<sup>79</sup> This agent is capable of stimulating both aqueous and mucous secretion in animals and humans.<sup>80-83</sup> Beneficial effects on corneal epithelial barrier function, as well as increased tear secretion, has been demonstrated in the rat dry eye model.<sup>84</sup> Diquafosol also has been shown to stimulate mucin release from goblet cells in a rabbit dry eye model.<sup>85,86</sup>

The effects of rebamipide (OPC-12759 [Otsuka, Rockville, MD]; Novartis [Basel, Switzerland]) have been evaluated in human clinical trials. In animal studies, rebamipide increased the mucin-like substances on the ocular surface of N-acetylcysteine-treated rabbit eyes.<sup>87</sup> It also had hydroxyl radical scavenging effects on UVB-induced corneal damage in mice.<sup>88</sup>

Ecabet sodium (Senju [Osaka, Japan]; ISTA [Irvine, CA]) is being evaluated in clinical trials internationally, but only limited results have yet been published. A single instillation of ecabet sodium ophthalmic solution elicited a statistically significant increase in tear mucin in dry eye patients.<sup>89</sup> Gefarnate (Santen [Osaka, Japan]) has been evaluated in animal studies. Gefarnate promoted mucin production after conjunctival injury in monkeys.<sup>90</sup> Gefarnate increased PAS-positive cell density in rabbit conjunctiva and stimulated mucin-like glycoprotein stimulation from rat cultured corneal epithelium.<sup>91,92</sup> An *in vivo* rabbit experiment showed a similar result.<sup>93,94</sup>

The agent 15(S)-HETE, a unique molecule, can stimulate MUC1 mucin expression on ocular surface epithelium.<sup>95</sup> 15(S)-HETE protected the cornea in a rabbit model of desiccation-induced injury, probably because of mucin secretion.<sup>96</sup> It has been shown to have beneficial effects on secretion of mucin-like glycoprotein by the rabbit corneal epithelium.<sup>97</sup> Other laboratory studies confirm the stimulatory effect of 15(S)-HETE.<sup>98-101</sup> Some of these agents may become useful clinical therapeutic modalities in the near future.

Two orally administered cholinergic agonists, pilocarpine and cevimeline, have been evaluated in clinical trials for treatment of Sjogren syndrome associated keratoconjunctivitis sicca (KCS). Patients who were treated with pilocarpine at a dose of 5 mg QID experienced a significantly greater overall improvement than placebo-treated patients in "ocular problems" in their ability to focus their eyes during reading, and in symptoms of blurred vision compared with placebo-treated patients.<sup>102</sup> The most commonly reported side effect from this medication was excessive sweating, which occurred in over 40% of patients. Two percent of the patients taking pilocarpine withdrew from the study because of drug-related side effects. Other studies have reported efficacy of pilocarpine for ocular signs and symptoms of Sjogren syndrome KCS,<sup>103-105</sup> including an increase in conjunctival goblet cell density after 1 and 2 months of therapy.<sup>106</sup>

Cevimeline is another oral cholinergic agonist that was found to significantly improve symptoms of dryness and aqueous tear production and ocular surface disease compared to placebo when taken in doses of 15 or 30 mg TID.<sup>107,108</sup> This agent may have fewer adverse systemic side effects than oral pilocarpine.

#### D. Biological Tear Substitutes

Naturally occurring biological, ie, nonpharmaceutical fluids, can be used to substitute for natural tears. The use of serum or saliva for this purpose has been reported in humans. They are usually unpreserved. When of autologous origin, they lack antigenicity and contain various epitheliotrophic factors, such as growth factors, neurotrophins, vitamins, immunoglobulins, and extracellular matrix proteins involved in ocular surface maintenance. Biological tear substitutes maintain the morphology and support the proliferation of primary human corneal epithelial cells better than pharmaceutical tear substitutes.<sup>109</sup> However, despite biomechanical and biochemical similarities, relevant compositional differences compared with normal tears exist and are of clinical relevance.<sup>110</sup> Additional practical problems concern sterility and stability, and a labor-intensive production process or a surgical procedure (saliva) is required to provide the natural tear substitute to the ocular surface.

#### I. Serum

Serum is the fluid component of full blood that remains after clotting. Its topical use for ocular surface disease was much stimulated by Tsubota's prolific work in the late 1990s.<sup>111</sup> The practicalities and published evidence of autologous serum application were recently reviewed.<sup>112</sup> The use of blood and its components as a pharmaceutical preparation in many countries is restricted by specific national laws. To produce serum eye drops and to use them for outpatients, a license by an appropriate national body may be required in certain countries. The protocol used for the production of serum eye drops determines their composition and efficacy. An optimized protocol for the production was recently published.<sup>113</sup> Concentrations between 20% and 100% of serum have been used. The efficacy seems to be dose-dependent.

Because of significant variations in patient populations, production and storage regimens, and treatment protocols, the efficacy of serum eye drops in dry eyes has varied substantially between studies.<sup>113</sup> Three published prospective randomized studies with similar patient populations (predominantly immune disease associated dry eye, ie, Sjogren syndrome) are available. When comparing 20% serum with 0.9% saline applied 6 times per day, Tananuvat et al found only a trend toward improvement of symptoms and signs of dry eyes,<sup>114</sup> whereas Kojima et al reported significant improvement of symptom scores, fluorescein-breakup time (FBUT), and fluorescein and rose bengal staining.<sup>115</sup>

A prospective clinical cross-over trial compared 50% serum eyedrops against the commercial lubricant previously

used by each patient. Symptoms improved in 10 out of 16 patients, and impression cytological findings improved in 12 out of 25 eyes.<sup>116</sup> Noda-Tsuruya and colleagues found that 20% autologous serum significantly improved TFBI and decreased conjunctival rose bengal and cornea fluorescein staining 1-3 months postoperatively, compared to treatment with artificial tears, which did not change these parameters.<sup>117</sup> Additional reports of successful treatment of persistent epithelial defects—where success is more clearly defined as “healing of the defect”—with autologous serum substantiate the impression that this is a valuable therapeutic option for ocular surface disease.<sup>118</sup>

## 2. Salivary Gland Autotransplantation

Salivary submandibular gland transplantation is capable of replacing deficient mucin and the aqueous tear film phase. This procedure requires collaboration between an ophthalmologist and a maxillofacial surgeon. With appropriate microvascular anastomosis, 80% of grafts survive. In patients with absolute aqueous tear deficiency, viable submandibular gland grafts, in the long-term, provide significant improvement of Schirmer test FBUT, and rose bengal staining, as well as reduction of discomfort and the need for pharmaceutical tear substitutes. Due to the hypo-osmolarity of saliva, compared to tears, excessive salivary tearing can induce a microcystic corneal edema, which is temporary, but can lead to epithelial defects.<sup>110</sup> Hence, this operation is indicated only in end-stage dry eye disease with an absolute aqueous tear deficiency (Schirmer-test wetting of 1 mm or less), a conjunctivalized surface epithelium, and persistent severe pain despite punctal occlusion and at least hourly application of unpreserved tear substitutes. For this group of patients, such surgery is capable of substantially reducing discomfort, but often has no effect on vision.<sup>119,120</sup>

## E. Anti-inflammatory Therapy

Disease or dysfunction of the tear secretory glands leads to changes in tear composition, such as hyperosmolarity, that stimulate the production of inflammatory mediators on the ocular surface.<sup>31,121</sup> Inflammation may, in turn, cause dysfunction or disappearance of cells responsible for tear secretion or retention.<sup>122</sup> Inflammation can also be initiated by chronic irritative stress (eg, contact lenses) and systemic inflammatory/autoimmune disease (eg, rheumatoid arthritis). Regardless of the initiating cause, a vicious circle of inflammation can develop on the ocular surface in dry eye that leads to ocular surface disease. Based on the concept that inflammation is a key component of the pathogenesis of dry eye, the efficacy of a number of anti-inflammatory agents for treatment of dry eye disease has been evaluated in clinical trials and animal models.

### 1. Cyclosporine

The potential of cyclosporine-A (CsA) for treating dry eye disease was initially recognized in dogs that develop spontaneous KCS.<sup>123</sup> The therapeutic efficacy of CsA for human KCS was then documented in several small, single-

center, randomized, double-masked clinical trials.<sup>124,125</sup> CsA emulsion for treatment of KCS was subsequently evaluated in several large multicenter, randomized, double-masked clinical trials.

In a Phase 2 clinical trial, four concentrations of CsA (0.05%, 0.1%, 0.2%, or 0.4%) administered twice daily to both eyes of 129 patients for 12 weeks was compared to vehicle treatment of 33 patients.<sup>126</sup> CsA was found to significantly decrease conjunctival rose bengal staining, superficial punctate keratitis, and ocular irritation symptoms (sandy or gritty feeling, dryness, and itching) in a subset of 90 patients with moderate-to-severe KCS. There was no clear dose response; CsA 0.1% produced the most consistent improvement in objective endpoints, whereas CsA 0.05% gave the most consistent improvement in patient symptoms (Level 1).

Two independent Phase 3 clinical trials compared twice-daily treatment with 0.05% or 0.1% CsA or vehicle in 877 patients with moderate-to-severe dry eye disease.<sup>127</sup> When the results of the two Phase 3 trials were combined for statistical analysis, patients treated with CsA, 0.05% or 0.1%, showed significantly ( $P < 0.05$ ) greater improvement in two objective signs of dry eye disease (corneal fluorescein staining and anesthetized Schirmer test values) compared to those treated with vehicle. An increased Schirmer test score was observed in 59% of patients treated with CsA, with 15% of patients having an increase of 10 mm or more. In contrast, only 4% of vehicle-treated patients had this magnitude of change in their Schirmer test scores ( $P < 0.0001$ ).

CsA 0.05% treatment also produced significantly greater improvements ( $P < 0.05$ ) in three subjective measures of dry eye disease (blurred vision symptoms, need for concomitant artificial tears, and the global response to treatment). No dose-response effect was noted. Both doses of CSA exhibited an excellent safety profile with no significant systemic or ocular adverse events, except for transient burning symptoms after instillation in 17% of patients. Burning was reported in 7% of patients receiving the vehicle. No CsA was detected in the blood of patients treated with topical CsA for 12 months. Clinical improvement from CsA that was observed in these trials was accompanied by improvement in other disease parameters. Treated eyes had an approximately 200% increase in conjunctival goblet cell density.<sup>128</sup> Furthermore, there was decreased expression of immune activation markers (ie, HLA-DR), apoptosis markers (ie, Fas), and the inflammatory cytokine IL-6 by the conjunctival epithelial cells.<sup>129,130</sup> The numbers of CD3-, CD4-, and CD8-positive T lymphocytes in the conjunctiva decreased in cyclosporine-treated eyes, whereas vehicle-treated eyes showed an increased number of cells expressing these markers.<sup>131</sup> After treatment with 0.05% cyclosporine, there was a significant decrease in the number of cells expressing the lymphocyte activation markers CD11a and HLA-DR, indicating less activation of lymphocytes compared with vehicle-treated eyes.

Two additional immunophilins, pimecrolimus and tacrolimus, have been evaluated in clinical trials of KCS.

## 2. Corticosteroids

### a. Clinical Studies

Corticosteroids are an effective anti-inflammatory therapy in dry eye disease. Level I evidence is published for a number of corticosteroid formulations. In a 4-week, double-masked, randomized study in 64 patients with KCS and delayed tear clearance, loteprednol etabonate 0.5% ophthalmic suspension (Lotemax [Bausch and Lomb, Rochester, NY]), q.i.d., was found to be more effective than its vehicle in improving some signs and symptoms.<sup>132</sup>

In a 4-week, open-label, randomized study in 32 patients with KCS, patients receiving fluorometholone plus artificial tear substitutes (ATS) experienced lower symptom severity scores and lower fluorescein and rose bengal staining than patients receiving either ATS alone or ATS plus flurbiprofen.<sup>133</sup>

A prospective, randomized clinical trial compared the severity of ocular irritation symptoms and corneal fluorescein staining in two groups of patients, one treated with topical nonpreserved methylprednisolone for 2 weeks, followed by punctal occlusion (Group 1), with a group that received punctal occlusion alone (Group 2).<sup>134</sup> After 2 months, 80% of patients in Group 1 and 33% of patients in Group 2 had complete relief of ocular irritation symptoms. Corneal fluorescein staining was negative in 80% of eyes in Group 1 and 60% of eyes in Group 2 after 2 months. No steroid-related complications were observed in this study.

Level III evidence is also available to support the efficacy of corticosteroids. In an open-label, non-comparative trial, extemporaneously formulated nonpreserved methylprednisolone 1% ophthalmic suspension was found to be clinically effective in 21 patients with Sjogren syndrome KCS.<sup>135</sup> In a review, it was stated that "...clinical improvement of KCS has been observed after therapy with anti-inflammatory agents, including corticosteroids."<sup>136</sup>

In the US Federal Regulations, ocular corticosteroids receiving "class labeling" are indicated for the treatment "...of steroid responsive inflammatory conditions of the palpebral and bulbar conjunctiva, cornea and anterior segment of the globe such as allergic conjunctivitis, acne rosacea, superficial punctate keratitis, herpes zoster keratitis, iritis, cyclitis, selected infective conjunctivides, when the inherent hazard of steroid use is accepted to obtain an advisable diminution in edema and inflammation." We interpret that KCS is included in this list of steroid-responsive inflammatory conditions.<sup>137-140</sup>

### b. Basic Research

Corticosteroids are the standard anti-inflammatory agent for numerous basic research studies of inflammation, including the types that are involved in KCS. The corticosteroid methylprednisolone was noted to preserve corneal epithelial smoothness and barrier function in an experimental murine model of dry eye.<sup>141</sup> This was attributed to its ability to maintain the integrity of corneal epithelial tight junctions and decrease desquamation of apical corneal epithelial cells.<sup>142</sup> A concurrent study showed

that methylprednisolone prevented an increase in MMP-9 protein in the corneal epithelium, as well as gelatinase activity in the corneal epithelium and tears in response to experimental dry eye.<sup>141</sup>

Preparations of topically applied androgen and estrogen steroid hormones are currently being evaluated in randomized clinical trials. A trial of topically applied 0.03% testosterone was reported to increase the percentage of patients that had meibomian gland secretions with normal viscosity and to relieve discomfort symptoms after 6 months of treatment compared to vehicle.<sup>143</sup> TFBUT and lipid layer thickness were observed to increase in a patient with KCS who was treated with topical androgen for 3 months.<sup>144</sup> Tear production and ocular irritation symptoms were reported to increase following treatment with topical 17 beta-oestradiol solution for 4 months.<sup>145</sup>

## 3. Tetracyclines

### a. Properties of Tetracyclines and Their Derivatives

#### 1) Antibacterial Properties

The antimicrobial effect of oral tetracycline treatment analogues (eg, minocycline, doxycycline) has previously been discussed by Shine et al,<sup>146</sup> Dougherty et al,<sup>147</sup> and Ta et al.<sup>148</sup> It is hypothesized that a decrease in bacterial flora producing lipolytic exoenzymes<sup>146,148</sup> and inhibition of lipase production<sup>147</sup> with resultant decrease in meibomian lipid breakdown products<sup>146</sup> may contribute to improvement in clinical parameters in dry eye-associated diseases.

#### 2) Anti-Inflammatory Properties

The tetracyclines have anti-inflammatory as well as antibacterial properties that may make them useful for the management of chronic inflammatory diseases. These agents decrease the activity of collagenase, phospholipase A2, and several matrix metalloproteinases, and they decrease the production of interleukin (IL)-1 and tumor necrosis factor (TNF)-alpha in a wide range of tissues, including the corneal epithelium.<sup>149-151</sup> At high concentrations, tetracyclines inhibit staphylococcal exotoxin-induced cytokines and chemokines.<sup>152,153</sup>

#### 3) Anti-angiogenic Properties

Angiogenesis, the formation of new blood vessels, occurs in many diseases. These include benign conditions (eg, rosacea) and malignant processes (eg, cancer). Minocycline and doxycycline inhibit angiogenesis induced by implanted tumors in rabbit cornea.<sup>154</sup> The anti-angiogenic effect of tetracycline may have therapeutic implications in inflammatory processes accompanied by new blood vessel formation. Well-controlled studies must be performed, at both the laboratory and clinical levels, to investigate this potential.<sup>155</sup>

### b. Clinical Applications of Tetracycline

#### 1) Acne Rosacea

Rosacea, including its ocular manifestations, is an inflammatory disorder, occurring mainly in adults, with peak severity in the third and fourth decades. Current recom-

recommendations are to treat rosacea with long-term doxycycline, minocycline, tetracycline, or erythromycin.<sup>156</sup> These recommendations may be tempered by certain recent reports that in women, the risk of developing breast cancer and of breast cancer morbidity increases cumulatively with duration of antibiotic use, including tetracyclines.<sup>157,158</sup> Another large study did not substantiate these findings.<sup>159</sup>

Tetracyclines and their analogues are effective in the treatment of ocular rosacea,<sup>160,161</sup> for which a single daily dose of doxycycline may be effective.<sup>162</sup> In addition to the anti-inflammatory effects of tetracyclines, their ability to inhibit angiogenesis may contribute to their effectiveness in rosacea-related disorders. Factors that promote angiogenesis include protease-triggered release of angiogenic factors stored in the extracellular matrix, inactivation of endothelial growth factor inhibitors, and release of angiogenic factors from activated macrophages.<sup>155,163</sup>

Tetracyclines are also known to inhibit matrix metalloproteinase expression, suggesting a rationale for their use in ocular rosacea.<sup>164</sup> Although tetracyclines have been used for management of this disease, no randomized, placebo-controlled, clinical trials have been performed to assess their efficacy.<sup>133</sup>

## 2) Chronic Posterior Blepharitis: Meibomianitis, Meibomian Gland Dysfunction

Chronic blepharitis is typically characterized by inflammation of the eyelids. There are multiple forms of chronic blepharitis, including staphylococcal, seborrheic (alone, mixed seborrheic/staphylococcal, seborrheic with meibomian seborrhea, seborrheic with secondary meibomitis), primary meibomitis, and others, like atopic, psoriatic, and fungal infections.<sup>165</sup> Meibomian gland dysfunction (MGD) has been associated with apparent aqueous-deficient dry eye. Use of tetracycline in patients with meibomianitis has been shown to decrease lipase production by tetracycline-sensitive as well as resistant strains of staphylococci. This decrease in lipase production was associated with clinical improvement.<sup>147</sup> Similarly, minocycline has been shown to decrease the production of diglycerides and free fatty acids in meibomian secretions. This may be due to lipase inhibition by the antibiotic or a direct effect on the ocular flora.<sup>146</sup> One randomized, controlled clinical trial of tetracycline in ocular rosacea compared symptom improvement in 24 patients treated with either tetracycline or doxycycline.<sup>166</sup> All but one patient reported an improvement in symptoms after 6 weeks of therapy. No placebo group was included in this trial.

A prospective, randomized, double-blind, placebo-controlled, partial crossover trial compared the effect of oxytetracycline to provide symptomatic relief of blepharitis with or without rosacea. Only 25% of the patients with blepharitis without rosacea responded to the antibiotic, whereas 50% responded when both diseases were present.<sup>167</sup> In another trial of 10 patients with both acne rosacea and concomitant meibomianitis, acne rosacea without concomitant ocular involvement, or seborrheic blepharitis, minocycline 50 mg daily for 2 weeks followed by 100 mg

daily for a total of 3 months significantly decreased bacterial flora ( $P = 0.0013$ ). Clinical improvement was seen in all patients with meibomianitis.<sup>148</sup>

Because of the improvement observed in small clinical trials of patients with meibomianitis, the American Academy of Ophthalmology recommends the chronic use of either doxycycline or tetracycline for the management of meibomianitis.<sup>165</sup> Larger randomized placebo-controlled trials assessing symptom improvement rather than surrogate markers are needed to clarify the role of this antibiotic in blepharitis treatment.<sup>153</sup> Tetracycline derivatives (eg, minocycline, doxycycline) have been recommended as treatment options for chronic blepharitis because of their high concentration in tissues, low renal clearance, long half-life, high level of binding to serum proteins, and decreased risk of photosensitization.<sup>168</sup>

Several studies have described the beneficial effects of minocycline and other tetracycline derivatives (eg, doxycycline) in the treatment of chronic blepharitis.<sup>146,147,168,169</sup> Studies have shown significant changes in the aqueous tear parameters, such as tear volume and tear flow, following treatment with tetracycline derivatives (eg, minocycline). One study also demonstrated a decrease in aqueous tear production that occurred along with clinical improvement.<sup>170</sup>

A recently published randomized, prospective study by Yoo Se et al compared different doxycycline doses in 150 patients (300 eyes) who had chronic meibomian gland dysfunction and who did not respond to lid hygiene and topical therapy for more than 2 months.<sup>171</sup> All topical therapy was stopped for at least 2 weeks prior to beginning the study. After determining the TF BUT and Schirmer test scores, patients were divided into three groups: a high dose group (doxycycline, 200 mg, twice a day), a low dose group (doxycycline, 20 mg, twice a day) and a control group (placebo). After one month, TF BUT, Schirmer scores, and symptoms improved. Both the high- and low-dose groups had statistically significant improvement in TF BUT after treatment. This implies that low-dose doxycycline (20 mg twice a day) therapy may be effective in patients with chronic meibomian gland dysfunction.

## 3) Dosage and Safety

Systemic administration of tetracyclines is widely recognized for the ability to suppress inflammation and improve symptoms of meibomianitis.<sup>172,173</sup> The optimal dosing schedule has not been established; however, a variety of dose regimens have been proposed including 50 or 100 mg doxycycline once a day,<sup>174</sup> or an initial dose of 50 mg a day for the first 2 weeks followed by 100 mg a day for a period of 2.5 months, in an intermittent fashion.<sup>146-148,170</sup> Others have proposed use of a low dose of doxycycline (20 mg) for treatment of chronic blepharitis on a long-term basis.<sup>171</sup> The safety issues associated with long-term oral tetracycline therapy, including minocycline, are well known. Many management approaches have been suggested for the use of tetracycline and its derivatives; however, a safe but adequate option in management needs to be considered because of

**Table 2.** Dry eye severity grading scheme

| Dry Eye Severity Level               | 1  | 2   | 3  | 4*   |
|--------------------------------------|--|---|--|--|
| Discomfort, severity & frequency     | Mild and/or episodic occurs under environ stress | Moderate episodic or chronic, stress or no stress | Severe frequent or constant without stress           | Severe and/or disabling and constant                             |
| Visual symptoms                      | None or episodic mild fatigue                    | Annoying and/or activity limiting episodic        | Annoying, chronic and/or constant limiting activity  | Constant and/or possibly disabling                               |
| Conjunctival injection               | None to mild                                     | None to mild                                      | +/-  | + /++  |
| Conjunctival staining                | None to mild                                     | Variable  | Moderate to marked                                   | Marked   |
| Corneal staining (severity/location) | None to mild                                     | Variable  | Marked central                                       | Severe punctate erosions   |
| Corneal/tear signs                   | None to mild                                     | Mild debris, ↓ meniscus                           | Filamentary keratitis, mucus clumping, ↑ tear debris | Filamentary keratitis, mucus clumping, ↑ tear debris, ulceration |
| Lid/meibomian glands                 | MGD variably present                             | MGD variably present                              | Frequent   | Trichiasis, keratinization, symblepharon                         |
| TFBUT (sec)                          | Variable   | ≤ 10  | ≤ 5  | Immediate  |
| Schirmer score (mm/5 min)            | Variable   | ≤ 10  | ≤ 5  | ≤ 2  |

\*Must have signs AND symptoms. TFBUT: fluorescein tear break-up time. MGD: meibomian gland disease

Reprinted with permission from Behrens A, Doyle JJ, Stern L, et al. Dysfunctional tear syndrome. A Delphi approach to treatment recommendations. *Cornea* 2006;25:90-7

the new information regarding the potentially hazardous effects of prolonged use of oral antibiotics. A recent study suggested that a 3-month course of 100 mg of minocycline might be sufficient to bring significant meibomianitis under control, as continued control was maintained for at least 3 months after cessation of therapy.<sup>170</sup>

In an experimental murine model of dry eye, topically applied doxycycline was found to preserve corneal epithelial smoothness and barrier function.<sup>141</sup> It also preserved the integrity of corneal epithelial tight junctions in dry eyes, leading to a marked decrease in apical corneal epithelial cell desquamation.<sup>142</sup> This corresponded to a decrease in MMP-9 protein in the corneal epithelium and reduced gelatinase activity in the corneal epithelium and tears.<sup>141</sup>

#### F. Essential Fatty Acids

Essential fatty acids are necessary for complete health. They cannot be synthesized by vertebrates and must be obtained from dietary sources. Among the essential fatty acids are 18 carbon omega-6 and omega-3 fatty acids. In the typical western diet, 20-25 times more omega-6 than omega-3 fatty acids are consumed. Omega-6 fatty acids are precursors for arachidonic acid and certain proinflammatory lipid mediators (PGE2 and LTB4). In contrast, certain omega-3 fatty acids (eg, EPA found in fish oil) inhibit the synthesis of these lipid mediators and block production of IL-1 and TNF-alpha.<sup>175,176</sup>

A beneficial clinical effect of fish oil omega-3 fatty acids on rheumatoid arthritis has been observed in several

double-masked, placebo-controlled clinical trials.<sup>177,178</sup> In a prospective, placebo-controlled clinical trial of the essential fatty acids, linoleic acid and gamma-linolenic acid administered orally twice daily produced significant improvement in ocular irritation symptoms and ocular surface lissamine green staining.<sup>179</sup> Decreased conjunctival HLA-DR staining also was observed.

#### G. Environmental Strategies

Factors that may decrease tear production or increase tear evaporation, such as the use of systemic anticholinergic medications (eg, antihistamines and antidepressants) and desiccating environmental stresses (eg, low humidity and air conditioning drafts) should be minimized or eliminated.<sup>180-182</sup> Video display terminals should be lowered below eye level to decrease the interpalpebral aperture, and patients should be encouraged to take periodic breaks with eye closure when reading or working on a computer.<sup>183</sup> A humidified environment is recommended to reduce tear evaporation. This is particularly beneficial in dry climates and high altitudes. Nocturnal lagophthalmos can be treated by wearing swim goggles, taping the eyelid closed, or tarsorrhaphy.

#### IV. TREATMENT RECOMMENDATIONS

In addition to material presented above, the subcommittee members reviewed the Dry Eye Preferred Practice Patterns of the American Academy of Ophthalmology and the International Task Force (ITF) Delphi Panel on dry

**Table 3.** Dry eye menu of treatments

|   |
|---|
| Artificial tears substitutes  |
| Gels/Ointments  |
| Moisture chamber spectacles   |
| Anti-inflammatory agents (topical CsA and corticosteroids, omega-3 fatty acids) |
| Tetracyclines   |
| Plugs   |
| Secretagogues   |
| Serum   |
| Contact lenses  |
| Systemic immunosuppressives   |
| Surgery (AMT, lid surgery, tarsorrhaphy, MM & SG transplant)                    |

AMT = amniotic membrane transplantation; MM = mucous membrane; SG = salivary gland

eye treatment prior to formulating their treatment guidelines.<sup>184,185</sup> The group favored the approach taken by the ITF, which based treatment recommendations on disease severity. A modification of the ITF severity grading scheme that contains 4 levels of disease severity based on signs and symptoms was formulated (Table 2). The subcommittee members chose treatments for each severity level from a menu of therapies for which evidence of therapeutic effect has been presented (Table 3). The treatment recommendations by severity level are presented in Table 4. It should be noted that these recommendations may be modified by practitioners based on individual patient profiles and clinical experience. The therapeutic recommendations for level 4 severity disease include surgical modalities to treat or prevent sight-threatening corneal complications. Discussion of these therapies is beyond the scope of this report.

#### V. UNANSWERED QUESTIONS AND FUTURE DIRECTIONS

There have been tremendous advances in the treatment of dry eye and ocular surface disease in the last two decades, including FDA approval of cyclosporin emulsion as the first therapeutic agent for treatment of KCS in the United States. There has been a commensurate increase in knowledge regarding the pathophysiology of dry eye. This has led to a paradigm shift in dry eye management from simply lubricating and hydrating the ocular surface with artificial tears to strategies that stimulate natural production of tear constituents, maintain ocular surface epithelial health and barrier function, and inhibit the inflammatory factors that adversely impact the ability of ocular surface and glandular epithelia to produce tears. Preliminary experience using this new therapeutic approach suggests that quality of life can be improved for many patients with dry eye and that initiating these strategies early in the course of the disease may prevent potentially blinding complications of dry eye. It is likely that future therapies will focus on

**Table 4.** Treatment recommendations by severity level**Level 1:**

Education and environmental/dietary modifications  
Elimination of offending systemic medications  
Artificial tear substitutes, gels/ointments  
Eye lid therapy

**Level 2:**

If Level 1 treatments are inadequate, add:  
Anti-inflammatories  
Tetracyclines (for meibomianitis, rosacea)  
Punctal plugs  
Secretagogues  
Moisture chamber spectacles

**Level 3:**

If Level 2 treatments are inadequate, add:  
Serum  
Contact lenses  
Permanent punctal occlusion

**Level 4:**

If Level 3 treatments are inadequate, add:  
Systemic anti-inflammatory agents  
Surgery (lid surgery, tarsorrhaphy; mucus membrane, salivary gland, amniotic membrane transplantation)

Modified from: International Task Force Guidelines for Dry Eye<sup>185</sup>

replacing specific tear factors that have an essential role in maintaining ocular surface homeostasis or inhibiting key inflammatory mediators that cause death or dysfunction of tear secreting cells. This will require additional research to identify these key factors and better diagnostic tests to accurately measure their concentrations in minute tear fluid samples. Furthermore, certain disease parameters may be identified that will identify whether a patient has a high probability of responding to a particular therapy. Based on the progress that has been made and the number of therapies in the pipeline, the future of dry eye therapy seems bright.

#### REFERENCES

(Parenthetical codes following references indicate level of evidence, as described in Table 1. CS = Clinical Study; BS = Basic Science.)

- Gilbard JP, Rossi SR, Heyda KG. Ophthalmic solutions, the ocular surface, and a unique therapeutic artificial tear formulation. *Am J Ophthalmol* 1989;107:348-55 (BS1)
- Gilbard JP. Human tear film electrolyte concentrations in health and dry-eye disease. *Int Ophthalmol Clin* 1994;34:27-36 (CS2)
- Schein O, Tielsch J, Munoz B, et al. Relation between signs and symptoms of dry eye in the elderly. *Ophthalmology* 1997;104:1395-1400 (CS2)
- Nelson JD, Gordon JF. Topical fibronectin in the treatment of keratoconjunctivitis sicca. Chiron Keratoconjunctivitis Sicca Study Group. *Am J Ophthalmol* 1992;114:441-7 (CS2)
- Nelson JD. Impression cytology. *Cornea* 1988;7:71-81 (BS1)
- Ubels J, McCartney M, Lantz W, et al. Effects of preservative-free artificial tear solutions on corneal epithelial structure and function. *Arch Ophthalmol* 1995;113:371-8 (BS1)
- Green K, MacKeen DL, Slagle T, Cheeks L. Tear potassium contributes to maintenance of corneal thickness. *Ophthalmic Res* 1992;24:99-102 (BS1)

8. Holly F, Lemp M. Surface chemistry of the tear film: Implications for dry eye syndromes, contact lenses, and ophthalmic polymers. *Contact Lens Soc Am J* 1971;5:12-9 (BS2)
9. Perrigan DM, Morgan A, Quintero S, et al. Comparison of osmolarity values of selected ocular lubricants. ARVO 2004 poster session 449
10. Kaufman B, Novack GD. Compliance issues in manufacturing of drugs. *Ocul Surf* 2003;1:80-5
11. Albiets J, Bruce A. The conjunctival epithelium in dry eye subtypes: Effect of preserved and nonpreserved topical treatments. *Curr Eye Res* 2001;22:8-18 (CS2)
12. Gasset AR, Ishii Y, Kaufman H, Miller T. Cytotoxicity of ophthalmic preservatives. *Am J Ophthalmol* 1974;78:98-105 (BS1)
13. Wilson F. Adverse external effects of topical ophthalmic medications. *Surv Ophthalmol* 1979;24:57-88 (CS3)
14. Burstein N. Corneal cytotoxicity of topically applied drugs, vehicles and preservatives. *Surv Ophthalmol* 1980;25:15-30 (CS3)
15. Burstein N. The effects of topical drugs and preservatives on the tears and corneal epithelium in dry eye. *Trans Ophthalmol Soc UK*. 1985;104:402-9 (CS3)
16. Brubaker R, McLaren J. Uses of the fluorophotometer in glaucoma research. *Ophthalmology* 1985;92:884-90 (BS1)
17. Smith L, George M, Berdy G, Abelson M. Comparative effects of preservative free tear substitutes on the rabbit cornea: a scanning electron microscopic evaluation (ARVO abstract). *Invest Ophthalmol Vis Sci* 1991;32 (Suppl):733 (BS1)
18. Gilbard JP, Farris RL, Santamaria J 2nd. Osmolarity of tear microvolumes in keratoconjunctivitis sicca. *Arch Ophthalmol* 1978;96:677-81 (BS2)
19. Lopez Bernal D, Ubels JL. Quantitative evaluation of the corneal epithelial barrier: effect of artificial tears and preservatives. *Curr Eye Res* 1991;10:645-56 (BS1)
20. Bernal DL, Ubels JL. Artificial tear composition and promotion of recovery of the damaged corneal epithelium. *Cornea* 1993;12:115-20 (BS1)
21. Noecker R. Effects of common ophthalmic preservatives on ocular health. *Adv Ther* 2001;18:205-15 (CS1)
22. Tripathi BJ, Tripathi RC, Koli SP. Cytotoxicity of ophthalmic preservatives on human corneal epithelium. *Lens Eye Toxicity Res* 1992;9:361-75 (BS1)
23. Herrema J, Friedenwald J. Retardation of wound healing in the corneal epithelium by lanolin. *Am J Ophthalmol* 1950;33:1421 (CS3)
24. Nelson J, Drake M, Brewer J, Tuley M. Evaluation of physiologic tear substitute in patients with keratoconjunctivitis sicca. *Adv Exp Med Biol* 1994;350:453-7 (CS2)
25. Gilbard JP, Rossi SR. An electrolyte-based solution that increases corneal glyco-gen and conjunctival goblet-cell density in a rabbit model for keratoconjunctivitis sicca. *Ophthalmology* 1992;99:600-4 (BS1)
26. Lenton LM, Albiets JM. Effect of carmellose-based artificial tears on the ocular surface in eyes after laser in situ keratomileusis. *J Refract Surg* 1999;15(2 Suppl):S227-S231 (CS2)
27. Slomiany BL, Slomiany A. Role of mucus in gastric mucosal protection. *J Physiol Pharmacol* 1991; 42:147-61 (BS1)
28. Gilbard JP. Tear film osmolarity and keratoconjunctivitis sicca. *CLAO J* 1985;11:243-50 (CS1)
29. Gilbard J. Tear film osmolarity and keratoconjunctivitis sicca. Lubbock TX, Dry Eye Institute, 1986 (CS3)
30. Gilbard J, Carter J, Sang D, et al. Morphologic effect of hyperosmolarity on rabbit corneal epithelium. *Ophthalmology* 1984;91:1205-12 (BS1)
31. Luo L, Li D, Corrales R, Pflugfelder S. Hyperosmolar saline is a proinflammatory stress on the mouse ocular surface. *Eye Contact Lens* 2005;31:186-93 (BS1)
32. Gilbard JP, Kenyon KR. Tear diluents in the treatment of keratoconjunctivitis sicca. *Ophthalmology* 1985;92:646-50 (CS2)
33. Holly F, Esquivel E. Colloid osmotic pressure of artificial tears. *J Ocul Pharmacol* 1985;1:327-36 (BS1)
34. Yancey PH. Organic osmolytes as compatible, metabolic and counteracting cryoprotectants in high osmolarity and other stresses. *J Exp Biol* 2005;208:2819-30 (BS2)
35. Holly F, Lemp M. Wettability and wetting of corneal epithelium. *Exp Eye Res* 1971;11:239-50 (BS1)
36. Hawi A, Smith T, Digenis G. A quantitative comparison of artificial tear clearance rates in humans using gamma scintigraphy (ARVO abstract). *Invest Ophthalmol Vis Sci* 1990;31 (Suppl):517 (BS1)
37. Argueso P, Tisdale A, Spurr-Michaud S, et al. Mucin characteristics of human corneal-limbal epithelial cells that exclude the rose bengal anionic dye. *Invest Ophthalmol Vis Sci* 2006;47:113-9 (BS1)
38. Versura P, Maltarello M, Stecher F, et al. Dry eye before and after therapy with hydroxypropylmethylcellulose. *Ophthalmologica* 1989;198:152-62 (CS3)
39. Simmons PA, Garrett Q, Xu S, et al. Interaction of carboxymethylcellulose with human corneal cells. ARVO 2006, E-Abstract 2759 (BS1)
40. Christiansen M, Cohen S, Rinehart J, et al. Clinical evaluation of an HP-guar gellable lubricant eye drop for the relief of dryness of the eye. *Curr Eye Res* 2004;28:55-62 (CS2)
41. Di Pascuale MA, Goto E, Tseng SC. Sequential changes of lipid tear film after the instillation of a single drop of a new emulsion eye drop in dry eye patients. *Ophthalmology* 2004;111:783-91 (CS2)
42. Korb DR, Scaffidi RC, Greiner JV, et al. The effect of two novel lubricant eye drops on tear film lipid layer thickness in subjects with dry eye symptoms. *Optom Vis Sci* 2005;82:594-601 (CS2)
43. Snibson GR, Greaves JL, Soper ND, et al. Precorneal residence times of sodium hyaluronate solutions studied by quantitative gamma scintigraphy. *Eye* 1990;4:594-602 (CS3)
44. Polack F, McNiece M. The treatment of dry eyes with NA hyaluronate (Healon). *Cornea* 1982;1:1333 (CS3)
45. Stuart JC, Linn JG. Dilute sodium hyaluronate (Healon) in the treatment of ocular surface disorders. *Ann Ophthalmol* 1985;17:190-2 (CS3)
46. DeLuise V, Peterson W. The use of topical Healon tears in the management of refractory dry-eye syndrome. *Ann Ophthalmol* 1984;16:823-4 (CS3)
47. Sand B, Marnar K, Norn M. Sodium hyaluronate in the treatment of keratoconjunctivitis sicca. *Acta Ophthalmol* 1989; 67:181-3 (CS3)
48. Nelson JD, Farris RL. Sodium hyaluronate and polyvinyl alcohol artificial tear preparations a comparison in patients with keratoconjunctivitis sicca. *Arch Ophthalmol* 1988;106:484-7 (CS2)
49. Beetham WP. Filamentary keratitis. *Trans Am Ophthalmol Soc* 1936;33:413-35 (CS1)
50. Foulds WS. Intracanalicular gelatin implants in the treatment of keratoconjunctivitis sicca. *Br J Ophthalmol* 1961;45:625-7 (CS2)
51. Freeman JM. The punctum plug: evaluation of a new treatment for the dry eye. *Trans Am Acad Ophthalmol Otolaryngol* 1975;79:OP874-9 (CS2)
52. Tuberville AW, Frederick WR, Wood TO. Punctal occlusion in tear deficiency syndromes. *Ophthalmology* 1982;89:1170-2 (CS2)
53. Willis RM, Folberg R, Krachmer JH, et al. The treatment of aqueous-deficient dry eye with removable punctal plugs. A clinical and impression-cytological study. *Ophthalmology* 1987;94:514-8 (CS2)
54. Gilbard JP, Rossi SR, Azar DT, Gray KL. Effect of punctal occlusion by Freeman silicone plug insertion on tear osmolarity in dry eye disorders. *CLAO J* 1989;15:216-8 (CS2)
55. Balaram M, Schaumberg DA, Dana MR. Efficacy and tolerability outcomes after punctal occlusion with silicone plugs in dry eye syndrome. *Am J Ophthalmol* 2001;131:30-6 (CS1)
56. Baxter SA, Laibson PR. Punctal plugs in the management of dry eyes. *Ocul Surf* 2004;2:255-65 (CS3)
57. Bartlett JD, Boan K, Corliss D, Gaddie IB. Efficacy of silicone punctal plugs as adjuncts to topical pharmacotherapy of glaucoma—a pilot study. Punctal Plugs in Glaucoma Study Group. *J Am Optom Assoc* 1996;67:664-8 (CS2)
58. Huang TC, Lee DA. Punctal occlusion and topical medications for glaucoma. *Am J Ophthalmol* 1989;107:151-5 (CS2)
59. Sugita J, Yokoi N, Fullwood NJ, et al. The detection of bacteria and bacterial biofilms in punctal plug holes. *Cornea* 2001;20: 362-5 (CS3)
60. Gerding H, Koppers J, Busse H. Symptomatic cicatricial occlusion of canaliculi after insertion of Herrick lacrimal plugs. *Am J Ophthalmol* 2003;136:926-8 (CS3)
61. Lee J, Flanagan JC. Complications associated with silicone intracanalicular plugs. *Ophthalm Plast Reconstr Surg* 2001;17:465-9 (CS3)
62. Paulsen F. The human lacrimal glands. *Adv Anat Embryol Cell Biol* 2003;170:III-XI,1-106 (BS1)
63. Yen MT, Pflugfelder SC, Feuer WJ. The effect of punctal occlusion on tear production, tear clearance, and ocular surface sensation in normal subjects. *Am J Ophthalmol* 2001;131:314-23 (CS2)
64. Tsubota K. The effect of wearing spectacles on the humidity of the eye. *Am J Ophthalmol* 1989;15:108-92-3 (BS2)
65. Tsubota K, Yamada M, Urayama K. Spectacle side panels and moist inserts for the treatment of dry-eye patients. *Cornea* 1994;13:197-201 (BS1)
66. Gresset J, Simonet P, Gordon D. Combination of a side shield with an ocular moisture chamber. *Am J Optom Physiol Opt* 1984;61:610-2 (CS3)
67. Savar DE. A new approach to ocular moisture chambers. *J Pediatr Ophthalmol Strabismus* 1978;15:51-3 (CS3)
68. Kurihashi K. Moisture aid during sleep for the treatment of dry eye: wet gauze eye mask. *Ophthalmologica* 1994;208:216-9 (CS3)
69. Nichols JJ, Ziegler C, Mitchell GL, Nichols KK. Self-reported dry eye dis-



- ease across refractive modalities. *Invest Ophthalmol Vis Sci* 2005;46:1911-4 (CS2)
70. Korb DR, Greiner JV, Glonek T, et al. Effect of periocular humidity on the tear film lipid layer. *Cornea* 1996;15:129-34 (BS2)
  71. Tsubota K, Hata S, Okusawa Y, et al. Quantitative videographic analysis of blinking in normal subjects and patients with dry eye. *Arch Ophthalmol* 1996;114:715-20 (BS1)
  72. Maruyama K, Yokoi N, Takamata A, Kinoshita S. Effect of environmental conditions on tear dynamics in soft contact lens wearers. *Invest Ophthalmol Vis Sci* 2004;45:2563-8 (BS1)
  73. Bacon AS, Astin C, Dart JK. Silicone rubber contact lenses for the compromised cornea. *Cornea* 1994;13:422-8 (CS3)
  74. Pullum KW, Whiting MA, Buckley RJ. Scleral contact lenses: the expanding role. *Cornea* 2005;24:269-77 (CS3)
  75. Tappin MJ, Pullum KW, Buckley RJ. Scleral contact lenses for overnight wear in the management of ocular surface disorders. *Eye* 2001;15(Pt 2):168-72 (CS3)
  76. Romero-Rangel T, Stavrou P, Cotter J, et al. Gas-permeable scleral contact lens therapy in ocular surface disease. *Am J Ophthalmol* 2000;130:25-32 (CS3)
  77. Rosenthal F, Cotter JM, Baum J. Treatment of persistent corneal epithelial defect with extended wear of a fluid-ventilated gas-permeable scleral contact lens. *Am J Ophthalmol* 2000;130:33-41 (CS3)
  78. Tauber J, Davitt WF, Bokosky JE, et al. Double-masked, placebo-controlled safety and efficacy trial of difluposol tetrasodium (INS365) ophthalmic solution for the treatment of dry eye. *Cornea* 2004;23:784-92 (CS1)
  79. Mundasad MV, Novack GD, Allgood VE, et al. Ocular safety of INS365 ophthalmic solution: a P2Y<sub>2</sub> agonist in healthy subjects. *J Ocul Pharmacol Ther* 2001;17:173-9 (CS1)
  80. Murakami T, Fujihara T, Horibe Y, Nakamura M. Difluposol elicits increases in net Cl<sup>-</sup> transport through P2Y<sub>2</sub> receptor stimulation in rabbit conjunctiva. *Ophthalmic Res* 2004;36:89-93 (BS1)
  81. Li DQ, Lokeshwar BL, Solomon A, et al. Regulation of MMP-9 in human corneal epithelial cells. *Exp Eye Res* 2001;73:449-59 (BS1)
  82. Murakami T, Fujita H, Fujihara T, et al. Novel noninvasive sensitive determination of tear volume changes in normal cats. *Ophthalmic Res* 2002;34:371-4 (BS1)
  83. Yerxa BR, Mundasad M, Sylvester RN, et al. Ocular safety of INS365 ophthalmic solution, a P2Y<sub>2</sub> agonist, in patients with mild to moderate dry eye disease. *Adv Exp Med Biol* 2002;506(Pt B):1251-7 (BS2)
  84. Fujihara T, Murakami T, Fujita H, et al. Improvement of corneal barrier function by the P2Y<sub>2</sub> agonist INS365 in a rat dry eye model. *Invest Ophthalmol Vis Sci* 2001;42:96-100 (BS1)
  85. Fujihara T, Murakami T, Nagano T, et al. INS365 suppresses loss of corneal epithelial integrity by secretion of mucin-like glycoprotein in a rabbit short-term dry eye model. *J Ocul Pharmacol Ther* 2002;18:363-70 (BS1)
  86. Yerxa BR, Douglass JG, Elena PP, et al. Potency and duration of action of synthetic P2Y<sub>2</sub> receptor agonists on Schirmer scores in rabbits. *Adv Exp Med Biol* 2002;506(Pt A):261-5 (BS2)
  87. Urashima H, Okamoto T, Takeji Y, et al. Rebamipide increases the amount of mucin-like substances on the conjunctiva and cornea in the N-acetylcysteine-treated in vivo model. *Cornea* 2004;23:613-9 (BS1)
  88. Tanito M, Takanashi T, Kaidzu S, et al. Cytoprotective effects of rebamipide and carterolol hydrochloride against ultraviolet B-induced corneal damage in mice. *Invest Ophthalmol Vis Sci* 2003;44:2980-5 (BS3)
  89. Masuda K, Tokushige H, Ogawa T, et al. Effect of topical ecabet sodium on mucin levels in the tear fluid of patients with dry eye. *SERI-ARVO2003*.
  90. Tshida H, Nakata K, Hamano T, et al. Effect of gefarnate on the ocular surface in squirrel monkeys. *Cornea* 2002;21:292-9 (BS3)
  91. Nakamura M, Endo K, Nakata K, Hamano T. Gefarnate increases PAS positive cell density in rabbit conjunctiva. *Br J Ophthalmol* 1998;82:1320-3 (BS3)
  92. Nakamura M, Endo K, Nakata K, Hamano T. Gefarnate stimulates secretion of mucin-like glycoproteins by corneal epithelium in vitro and protects corneal epithelium from desiccation in vivo. *Exp Eye Res* 1997;65:569-74 (BS3)
  93. Tshida H, Nakata K, Hamano T, et al. Gefarnate stimulates goblet cell repopulation following an experimental wound to the tarsal conjunctiva in the dry eye rabbit. *Adv Exp Med Biol* 2002;506(Pt A):353-7 (BS 3)
  94. Hamano T. Dry eye treatment with eye drops that stimulate mucin production. *Adv Exp Med Biol* 1998;438:965-8 (CS3)
  95. Jumblatt JE, Cunningham L, Jumblatt MM. Effects of 15(S)-HETE on human conjunctival mucin secretion. *Adv Exp Med Biol* 2002;506(Pt A):323-7 (BS1)
  96. Gamache DA, Wei ZY, Weimer LK, et al. Corneal protection by the ocular mucin secretagogue 15(S)-HETE in a rabbit model of desiccation-induced corneal defect. *J Ocul Pharmacol Ther* 2002;18:349-61 (BS2)
  97. Jackson RS 2nd, Van Dyken SJ, McCartney MD, Ubels JL. The eicosanoid, 15-(S)-HETE, stimulates secretion of mucin-like glycoprotein by the corneal epithelium. *Cornea* 2001;20:516-21 (BS2)
  98. Azar RG, Edelhauser HF. Evaluation of the effects of 15(S)-HETE on corneal epithelial cells: an electrophysiological and cytochemical study. *Adv Exp Med Biol* 2002;506(Pt A):329-33 (BS3)
  99. Ubels JL, Aupperlee MD, Jackson RS 2nd, et al. Topically applied 15-(S)-HETE stimulates mucin production by corneal epithelium. *Adv Exp Med Biol* 2002;506(Pt A):317-21 (BS2)
  100. Gamache DA, Wei ZY, Weimer LK, et al. Preservation of corneal integrity by the mucin secretagogue 15(S)-HETE in a rabbit model of desiccation-induced dry eye. *Adv Exp Med Biol* 2002;506(Pt A):335-40 (BS2)
  101. Jumblatt JE, Cunningham LT, Li Y, Jumblatt MM. Characterization of human ocular mucin secretion mediated by 15(S)-HETE. *Cornea* 2002;21:818-24 (BS3)
  102. Vivino FB, Al-Hashimi I, Khan K, et al. Pilocarpine tablets for the treatment of dry mouth and dry eye symptoms in patients with Sjogren's syndrome. *Arch Intern Med* 1999;159:174-81 (CS1)
  103. Takaya M, Ichikawa Y, Yamada C, et al. Treatment with pilocarpine hydrochloride for sicca symptoms in Sjogren's syndrome. *Ryumachi* 1997;37:453-7 (CS2)
  104. Tsifetaki N, Kitsos G, Paschides CA, et al. Oral pilocarpine for the treatment of ocular symptoms in patients with Sjogren's syndrome: a randomized 12-week controlled study. *Ann Rheum Dis* 2003;62:1204-7 (CS2)
  105. Papas AS, Sherrer YS, Charney M, et al. Successful treatment of dry mouth and dry eye symptoms in Sjogren's syndrome patients with oral pilocarpine: A randomized, placebo-controlled, dose-adjustment study. *J Clin Rheumatol* 2004;4:169-77 (CS1)
  106. Aragona P, Di Pietro R, Spinella R, Moberic M. Conjunctival epithelium improvement after systemic pilocarpine in patients with Sjogren's syndrome. *Br J Ophthalmol* 2006;90:166-70 (CS2)
  107. Petrone D, Condemi JJ, Fife R, et al. Double-blind randomized placebo-controlled study of cevimeline in Sjogren's syndrome patients with xerostomia and keratoconjunctivitis sicca. *Arthritis Rheum* 2002;46:748-54 (CS1)
  108. Ono M, Takamura E, Shinozaki K, et al. Therapeutic effect of cevimeline on dry eye in patients with Sjogren's syndrome: a randomized, double-blind clinical study. *Am J Ophthalmol* 2004;138:6-17 (CS1)
  109. Geerling G, Daniels JT, Dart JK, et al. Toxicity of natural tear substitutes in a fully defined culture model of human corneal epithelial cells. *Invest Ophthalmol Vis Sci* 2001;42:948-56 (BS1)
  110. Geerling G, Honnicke K, Schroder C, et al. Quality of salivary tears following autologous submandibular gland transplantation for severe dry eye. *Graefes Arch Clin Exp Ophthalmol* 2000;38:45-52 (BS1)
  111. Tsubota K, Goto E, Fujita H, et al. Treatment of dry eye by autologous serum application in Sjogren's syndrome. *Br J Ophthalmol* 1999;83:390-5 (CS2)
  112. Geerling G, Hartwig D. Autologous serum eyedrops for ocular surface disorders, in Reinhard T, Larkin F (eds). *Cornea and external eye disease*. Berlin, Heidelberg, Springer, 2005, pp 2-19
  113. Liu L, Hartwig D, Harloff S, et al. An optimised protocol for the production of autologous serum eyedrops. *Graefes Arch Clin Exp Ophthalmol* 2005;243:706-14 (BS1)
  114. Tananuvat N, Daniell M, Sullivan LJ, et al. Controlled study of the use of autologous serum in dry eye patients. *Cornea* 2001;20:802-6 (CS1)
  115. Kojima T, Ishida R, Dogru M, et al. The effect of autologous serum eyedrops in the treatment of severe dry eye disease: a prospective randomized case-control study. *Am J Ophthalmol* 2005;139:242-6 (CS1)
  116. Noble BA, Loh RS, MacLennan S, et al. Comparison of autologous serum eye drops with conventional therapy in a randomised controlled crossover trial for ocular surface disease. *Br J Ophthalmol* 2004;88:647-52 (CS1)
  117. Noda-Tsuruya T, Asano-Kato N, Tada I, Tsubota K. Autologous serum eye drops for dry eye after LASIK. *J Refract Surg* 2006;22:61-6 (CS1)
  118. Schulze SD, Sekundo W, Kroll P. Autologous serum for the treatment of corneal epithelial abrasions in diabetic patients undergoing vitrectomy. *Am J Ophthalmol* 2006;142:207-11 (BS1)
  119. Geerling G, Sieg P, Bastian GO, Laqua H. Transplantation of the autologous submandibular gland for most severe cases of keratoconjunctivitis sicca. *Ophthalmology* 1998;105:327-35 (CS2)
  120. Schroder, Sieg P, Framme C, et al. [Transplantation of the submandibular gland in absolute dry eyes. Effect on the ocular surface]. *Klin Monatsbl Augenheilkd* 2002;219:494-501 (CS2)
  121. Luo L, Li DQ, Doshi A, et al. Experimental dry eye stimulates production

- of inflammatory cytokines and MMP-9 and activates MAPK signaling pathways on the ocular surface. *Invest Ophthalmol Vis Sci* 2004;45:4293-301 (BS1)
122. Niederkorn JY, Stern ME, Pflugfelder SC, et al. Desiccating stress induces T cell-mediated Sjogren's syndrome-like lacrimal keratoconjunctivitis. *J Immunol* 2006;176:3950-7 (BS1)
123. Kaswan RL, Salisbury MA, Ward DA. Spontaneous canine keratoconjunctivitis sicca. A useful model for human keratoconjunctivitis sicca: treatment with cyclosporine eye drops. *Arch Ophthalmol* 1989;107:1210-16 (BS2)
124. Gunduz K, Ozdemir O. Topical cyclosporin treatment of keratoconjunctivitis sicca in secondary Sjogren's syndrome. *Acta Ophthalmol* 1994;72:38-42 (CS2)
125. Laibovitz RA, Solch S, Andriano J. Pilot trial of cyclosporin 1% ophthalmic ointment in the treatment of keratoconjunctivitis sicca. *Cornea* 1993;12:315-23 (CS1)
126. Stevenson D, Tauber J, Reis BL. Efficacy and safety of cyclosporin A ophthalmic emulsion in the treatment of moderate-to-severe dry eye disease. A dose-ranging, randomized trial. *Ophthalmology* 2000;107:967-74 (CS1)
127. Sall K, Stevenson OD, Mundorf TK, Reis BL. Two multicenter, randomized studies of the efficacy and safety of cyclosporine ophthalmic emulsion in moderate to severe dry eye disease. *Ophthalmology* 2000;107:631-9 (CS1)
128. Kunert KS, Tisdale AS, Gipson IK. Goblet cell numbers and epithelial proliferation in the conjunctiva of patients with dry eye syndrome treated with cyclosporine. *Arch Ophthalmol* 2002;120:330-7 (BS1)
129. Brignole F, Pisella PJ, De Saint Jean M, et al. Flow cytometric analysis of inflammatory markers in KCS: 6-month treatment with topical cyclosporin A. *Invest Ophthalmol Vis Sci* 2001;42:90-5 (BS1)
130. Turner K, Pflugfelder SC, Ji Z, et al. Interleukin-6 levels in the conjunctival epithelium of patients with dry eye disease treated with cyclosporine ophthalmic emulsion. *Cornea* 2000;19:492-6 (BS1)
131. Kunert KS, Tisdale AS, Stern ME, Smith JA. Analysis of topical cyclosporine treatment of patients with dry eye syndrome: effect on conjunctival lymphocytes. *Arch Ophthalmol* 2000;118:1489-96 (BS1)
132. Pflugfelder SC, Maskin SL, Anderson B, et al. A randomized, double-masked, placebo-controlled, multicenter comparison of loteprednol etabonate ophthalmic suspension, 0.5%, and placebo for treatment of keratoconjunctivitis sicca in patients with delayed tear clearance. *Am J Ophthalmol* 2004;138:444-57 (CS1)
133. Avunduk AM, Avunduk MC, Varnell ED, Kaufman HE. The comparison of efficacies of topical corticosteroids and nonsteroidal antiinflammatory drops on dry eye patients: A clinical and immunocytochemical study. *Am J Ophthalmol* 2003;136:593-602 (CS1)
134. Sainz de la Maza Serra SM, Simon Castellvi C, Kabbani O. Nonpreserved topical steroids and punctal occlusion for severe keratoconjunctivitis sicca. *Arch Soc Esp Ophthalmol* 2000;75:751-56 (CS1)
135. Marsh P, Pflugfelder SC. Topical nonpreserved methylprednisolone therapy for keratoconjunctivitis sicca in Sjogren syndrome. *Ophthalmology* 1999;106:811-6 (CS3)
136. Pflugfelder SC. Antiinflammatory therapy for dry eye. *Am J Ophthalmol* 2004;137:337-42 (CS3)
137. Anonymous. Certain ophthalmic antibiotic combination drugs for human use; Drug efficacy study implementation. *Fed Reg* 1982;47:21296
138. Anonymous. Certain steroid preparations for ophthalmic and/or otic use. *Fed Reg* 1980a;45:57776-80
139. Anonymous. Certain ophthalmic antibiotic combination drugs for human use; Drug efficacy study implementation. *Fed Reg* 1980b;45:57780-3
140. Anonymous. Certain steroid preparations for ophthalmic or otic use. *Fed Reg* 1976;41:34340-2
141. De Paiva CS, Corrales RM, Villarreal AL, et al. Apical corneal barrier disruption in experimental murine dry eye is abrogated by methylprednisolone and doxycycline. *Invest Ophthalmol Vis Sci* 2006;47:2847-56 (BS1)
142. De Paiva CS, Corrales RM, Villarreal AL, et al. Corticosteroid and doxycycline suppress MMP-9 and inflammatory cytokine expression, MAPK activation in the corneal epithelium in experimental dry eye. *Exp Eye Res* 2006;83:526-35 (BS1)
143. Schiffman RM, Bradford R, Bunnell B, et al. A multicenter, double-masked, randomized, vehicle-controlled, parallel-group study to evaluate the safety and efficacy of testosterone ophthalmic solution in patients with meibomian gland dysfunction. ARVO 2006, E-Abstract 5608 (CS3)
144. Worda C, Nepp J, Huber J, Sator MO. Treatment of keratoconjunctivitis sicca with topical androgen. *Maturitas* 2001;37:209-12 (CS3)
145. Sator MO, Joura EA, Golaszewski T, et al. Treatment of menopausal keratoconjunctivitis sicca with topical oestradiol. *Br J Obstet Gynaecol* 1998;105:100-2 (CS2)
146. Shine WE, McCulley JP, Pandya AG. Minocycline effect on meibomian gland lipids in meibomianitis patients. *Exp Eye Res* 2003;76:417-20 (CS2)
147. Dougherty JM, McCulley JP, Silvano RE, et al. The role of tetracycline in chronic blepharitis. *Invest Ophthalmol Vis Sci* 1991;32:2970-5 (CS2)
148. Ta CN, Shine WE, McCulley JP, et al. Effects of minocycline on the ocular flora of patients with acne rosacea or seborrheic blepharitis. *Cornea* 2003;22:545-8 (CS2)
149. Solomon A, Rosenblatt M, Li DQ, et al. Doxycycline inhibition of interleukin-1 in the corneal epithelium. *Invest Ophthalmol Vis Sci* 2000;41:2544-57 (CS2)
150. Li Y, Kuang K, Yerxa B, et al. Rabbit conjunctival epithelium transports fluid, and P2Y2(2) receptor agonists stimulate Cl(-) and fluid secretion. *Am J Physiol Cell Physiol* 2001;281:C595-602 (BS1)
151. Li DQ, Luo L, Chen Z, et al. JNK and ERK MAP kinases mediate induction of IL-1beta, TNF-alpha and IL-8 following hyperosmolar stress in human limbal epithelial cells. *Exp Eye Res* 2006;82:588-96. Epub 2005 Oct 3 (BS1)
152. Krakauer T, Buckley M. Doxycycline is anti-inflammatory and inhibits staphylococcal exotoxin-induced cytokines and chemokines. *Antimicrob Agents Chemother* 2003;47:3630-3 (BS1)
153. Voils SA, Evans ME, Lane MT, et al. Use of macrolides and tetracyclines for chronic inflammatory diseases. *Ann Pharmacother* 2005;39:86-94 (CS3)
154. Tamargo RJ, Bok RA, Brem H. Angiogenesis inhibition by minocycline. *Cancer Res* 1991;51:672-5 (BS1)
155. Sapadin AN, Fleischmajer R. Tetracyclines: Nonantibiotic properties and their clinical implications *J Am Acad Dermatol* 2006;54:258-65 (CS3)
156. Habif TP. Clinical dermatology, 4th ed. St Louis: Mosby-Year Book, 2004, pp 162-89 (CS3)
157. Velicer CM, Heckbert SR, Lampe JW, et al. Antibiotic use in relation to the risk of breast cancer. *JAMA* 2004;291:827-35
158. Velicer CM, Heckbert SR, Rutter C, et al. Association between antibiotic use prior to breast cancer diagnosis and breast tumour characteristics (United States). *Cancer Causes Control (Netherlands)* 2006;17:307-13
159. Garcia Rodriguez LA, Gonzalez-Perez A. Use of antibiotics and risk of breast cancer. *Am J Epidemiology* 2005;161:616-9
160. Macdonald A, Feiwel M. Perioral dermatitis: aetiology and treatment with tetracycline. *Br J Dermatol* 1972;87:315-9 (CS3)
161. Jansen T, Plewig G. Rosacea: classification and treatment. *J R Soc Med* 1997;90:144-50 (CS3)
162. Frucht-Pery J, Chayet AS, Feldman ST, et al. The effect of doxycycline on ocular rosacea. *Am J Ophthalmol* 1989;107:434-5 (CS2)
163. Wilkin JK. Rosacea. pathophysiology and treatment. *Arch Dermatol* 1994;130:359-62 (BS1)
164. Stone DU, Chodosh J. Oral tetracyclines for ocular rosacea: an evidence-based review of the literature. *Cornea* 2004;23:106-9 (CS1)
165. McCulley JP, Dougherty JM, Deneau DG. Classification of chronic blepharitis. *Ophthalmology* 1982;89:1173-80 (CS2)
166. Frucht-Pery J, Sagi E, Hemo I, Ever-Hadani P. Efficacy of doxycycline and tetracycline in ocular rosacea. *Am J Ophthalmol* 1993;116:88-92 (CS1)
167. Seal DV, Wright P, Picker L, et al. Placebo controlled trial of fusidic acid gel and oxytetracycline for recurrent blepharitis and rosacea. *Br J Ophthalmol* 1995;79:42-5 (CS1)
168. Hoepflich PD, Warshauer DM. Entry of four tetracyclines into saliva and tears. *Antimicrob Agents Chemother* 1974;3:330-6 (BS1)
169. Gulbenkian A, Myers J, Freis D. Hamster flank organ hydrolase and lipase activity. *J Invest Dermatol* 1980;75:289-92 (BS1)
170. Aronowicz JD, Shine WE, Oral D, et al. Short term oral minocycline treatment of meibomianitis. *Br J Ophthalmol* 2006;90:856-60 (CS2)
171. Yoo SE, Lee DC, Chang MH. The effect of low-dose doxycycline therapy in chronic meibomian gland dysfunction. *Korean J Ophthalmol* 2005;19:258-63 (CS2)
172. Browning DJ, Proia AD. Ocular rosacea. *Surv Ophthalmol* 1986;31:145-58 (CS3)
173. Esterly NB, Koransky JS, Furey NL, et al. Neutrophil chemotaxis in patients with acne receiving oral tetracycline therapy. *Arch Dermatol* 1984;120:1308-13 (BS1)
174. Gilbard JP. The scientific context and basis of the pharmacologic management of dry eyes. *Ophthalmol Clin North Am* 2005;18:475-84, v (CS3)
175. James MJ, Gibson RA, Cleland LG. Dietary polyunsaturated fatty acids and inflammatory mediator production. *Am J Clin Nutr* 2000;71(1 Suppl):343S-8S (BS2)
176. Endres S, Ghorbani R, Kelley VE, et al. The effect of dietary supplementation with n-3 polyunsaturated fatty acids on the synthesis of interleukin-1 and tumor necrosis factor by mononuclear cells. *N Engl J Med*

## DEWS MANAGEMENT AND THERAPY

- 1989;320:265-71 (BS1)
177. James MJ, Cleland LG. Dietary n-3 fatty acids and therapy for rheumatoid arthritis. *Semin Arthritis Rheum* 1997;27:85-97 (CS3)
178. Kremer JM. n-3 fatty acid supplements in rheumatoid arthritis. *Am J Clin Nutr* 2000;71(1 Suppl):349S-51S (CS1)
179. Barabino S, Rolando M, Camicione F, et al. Systemic linoleic and gamma-linolenic acid therapy in dry eye syndrome with an inflammatory component. *Cornea* 2003;22:97-101 (CS2)
180. Seedor JA, Lamberts D, Bergmann RB, Perry HD. Filamentary keratitis associated with diphenhydramine hydrochloride (Benadryl). *Am J Ophthalmol* 1986;101:376-7 (CS3)
181. Moss SE, Klein R, Klein BE. Prevalence of and risk factors for dry eye syndrome. *Arch Ophthalmol* 2000;118:1264-68
182. Mader TH, Stulting RD. Keratoconjunctivitis sicca caused by diphenoxylate hydrochloride with atropine sulfate (Lomotil). *Am J Ophthalmol* 1991;111:377-8 (CS2)
183. Tsubota K, Nakamura K. Dry eyes and video display terminals. *N Engl J Med* 1993;25:328:584 (CS2)
184. Matoba AY, Harris DJ, Mark DB, et al. Dry eye syndrome, American Academy of Ophthalmology, 2003
185. Behrens A, Doyle JJ, Stern L, et al. Dysfunctional tear syndrome: A Delphi approach to treatment recommendations. *Cornea* 2006;25:900-7



# EXHIBIT E

## Topical Cyclosporine 0.05% for the Prevention of Dry Eye Disease Progression

Sanjay N. Rao

### Abstract

**Purpose:** To assess the prognosis of dry eye in patients treated with cyclosporine 0.05% or artificial tears by using the International Task Force (ITF) guidelines.

**Methods:** This was a single-center, investigator-masked, prospective, randomized, longitudinal trial. Dry eye patients received twice-daily treatment with either cyclosporine 0.05% (Restasis®; Allergan, Inc., Irvine, CA;  $n = 36$ ) or artificial tears (Refresh Endura®; Allergan, Inc., Irvine, CA;  $n = 22$ ) for 12 months. Disease severity was determined at baseline and month 12 according to the consensus guidelines developed by the ITF. Dry eye signs and symptoms were evaluated at baseline and months 4, 8, and 12.

**Results:** Baseline sign and symptom scores and the proportion of patients with the disease severity level 2 or 3 were comparable in both groups ( $P > 0.05$ ). At month 12, 34 of 36 cyclosporine patients (94%) and 15 of 22 artificial tear patients (68%) experienced improvements or no change in their disease severity ( $P = 0.007$ ) while 2 of 36 cyclosporine patients (6%) and 7 of 22 artificial tears patients (32%) had disease progression ( $P < 0.01$ ). Cyclosporine 0.05% improved Schirmer test scores, tear breakup time, and Ocular Surface Disease Index scores throughout the study, with significant ( $P < 0.01$ ) differences compared with artificial tears being observed at months 8 and 12.

**Conclusions:** Treatment with cyclosporine 0.05% may slow or prevent disease progression in patients with dry eye at severity levels 2 or 3.

### Introduction

PATIENTS WITH DRY EYE disease suffer from ocular irritation often accompanied by vision impairment, which limits important daily activities and negatively impacts quality of life (QoL).<sup>1-3</sup> The prevalence of dry eye disease is estimated to be from 5% to >30%.<sup>4,5</sup> The largest US cross-sectional survey studies, the Women's Health Study (WHS) and the Physician Health Study (PHS), indicated that the prevalence of dry eye disease among women and men aged over 50 years is 7.8% and 4.3%, respectively. Using this prevalence data, ~4.9 million Americans aged over 50 years are estimated to be affected by dry eye disease.<sup>6,7</sup>

The diagnosis and treatment of dry eye is challenging.<sup>8</sup> The Wilmer Eye Institute at Johns Hopkins University recently invited the International Task Force (ITF) of 17 dry eye experts to create guidelines for the diagnosis and treatment of dry eye disease by using a Delphi consensus technique.<sup>9</sup> The ITF panel categorized dry eye disease severity

into 4 levels (Table 1), with increasing severity from 1 to 4, and developed consensus treatment guidelines. The level of disease severity was considered the most important factor in determining the appropriate range of therapeutic options.<sup>9</sup> While counseling, education, and preserved artificial tears were recommended for the management of patients diagnosed at severity level 1, unpreserved artificial tears, topical cyclosporine, and/or corticosteroids were recommended for patients at severity level 2. Punctal plugs, oral tetracyclines, systemic immunomodulators, and surgery were reserved for the management of dry eye patients diagnosed at severity levels 3 and 4.<sup>9</sup>

A key recommendation of the ITF panel was the use of topical anti-inflammatory therapy in patients with clinically apparent ocular surface inflammation.<sup>9</sup> This recommendation stemmed from the recent evidence indicating that inflammation plays a major role in the disease etiology and may be a unifying mechanism that underlies dry eye

TABLE 1. CRITERIA USED TO DETERMINE THE LEVELS OF DRY EYE SEVERITY ACCORDING TO ITF GUIDELINES<sup>8</sup>

|         | <i>Symptoms</i>    | <i>Signs</i>                            | <i>Staining</i>                                 |
|---------|--------------------|---|---|
| Level 1 | Mild to moderate   | Mild/moderate conjunctival signs        | None  |
| Level 2 | Moderate to severe | Tear film signs, visual signs           | Mild punctate corneal and conjunctival staining |
| Level 3 | Severe             | Corneal filamentary keratitis           | Central corneal staining                        |
| Level 4 | Severe             | Corneal erosions, conjunctival scarring | Severe corneal staining                         |

Disease severity is categorized into 4 levels based on the severity of symptoms and signs. At least one sign and one symptom of each category should be present to qualify for the corresponding level assignment.

disease.<sup>10-12</sup> Therefore, it was suggested that the chronic use of safe anti-inflammatory therapies that normalize tear film composition early in the disease process may have the potential to slow, prevent, or reverse dry eye progression.<sup>13</sup>

Ophthalmic cyclosporine 0.05% emulsion (Restasis<sup>®</sup>; Allergan, Inc., Irvine, CA) is the only anti-inflammatory medication approved by the Food and Drug Administration to increase tear production in dry eye patients.<sup>14</sup> In T lymphocytes, cyclosporine binds to cyclophilin A and inhibits calcineurin-catalyzed dephosphorylation of the nuclear factor for T-cell activation.<sup>15,16</sup> Cyclosporine thereby inhibits IL-2 transcription, which upon secretion stimulates T-cell division by a self-propagating autocrine and paracrine loop.<sup>16</sup> In humans, topical administration of cyclosporine 0.05% has been shown to decrease the number of activated T cells and expression of inflammatory markers in the conjunctiva of dry eye patients.<sup>17,18</sup> These findings suggest that topical cyclosporine 0.05% targets the underlying inflammatory processes in dry eye disease. Therefore, chronic treatment with cyclosporine 0.05% may offer the potential to alter the course of dry eye disease.

Wilson and Stulting recently evaluated the clinical applicability of the ITF guidelines.<sup>13</sup> Physicians participating in that study successfully implemented the ITF guidelines for diagnosis and treatment of dry eye patients.<sup>13</sup> Using the ITF guidelines, this study was designed to assess the prognosis of dry eye disease in patients treated with cyclosporine 0.05% or artificial tears.

## Methods

### Study design

This was a single-center, investigator-masked, randomized, prospective, longitudinal clinical trial. The study was approved by the Western institutional review board in Olympia, WA, and was registered with ClinicalTrials.gov (identifier # NCT00567983). Inclusion criteria were of age 18 years or older, diagnosis of dry eye without lid margin disease or altered tear distribution and clearance, and a disease severity of level 2 or 3 as defined by the ITF guidelines (Table 1).<sup>9</sup> Primary exclusion criteria were prior use of topical cyclosporine 0.05% within the last year, topical or systemic use of anti-inflammatory or anti-allergy medications, active ocular infection or inflammatory disease, or uncontrolled systemic disease that can exacerbate dry eye disease. Patients who wore contact lenses were also excluded from the study. All participating patients signed a written consent form before initiation of the study-specific procedures.

Patients were randomly assigned in a 3:2 ratio to twice-daily treatment with either cyclosporine 0.05% or artificial tears (Refresh Endura<sup>®</sup>; Allergan, Inc., Irvine, CA) in both eyes for 12 months. The randomization ratio was an empirical estimation due to lack of adequate epidemiological information to conduct power calculations prior to initiating the study. Randomization was performed by a statistical program and was overseen by the research coordinator. Patients were enrolled in the study and initiated therapy after screening and randomization on the same day at the baseline visit (month 0). All patients were allowed to utilize rescue artificial tears as needed if discomfort was experienced. The primary objective of this study was to assess the potential of topical cyclosporine 0.05% therapy to halt or slow disease progression relative to control at month 12 based on the ITF severity categorization (Table 1). The secondary outcome variables were the changes in dry eye signs and symptoms. The study was conducted in compliance with regulations of the Health Insurance Portability and Accountability Act and the Declaration of Helsinki.

### Disease severity and dry eye signs and symptoms

Disease severity was assessed according to the ITF consensus guidelines at baseline and month 12 (Table 1).<sup>9</sup> Patients were evaluated for signs and symptoms of dry eye by Schirmer test with anesthesia, tear breakup time (TBUT), ocular surface staining, and Ocular Surface Disease Index (OSDI) at baseline (month 0) and after receiving the study treatments at months 4, 8, and 12. In each study visit, TBUT was evaluated first, followed by ocular surface staining and Schirmer test, respectively. The TBUT was measured using fluorescein dye. Ocular surface damage was assessed by the Oxford method using sodium fluorescein to stain the cornea and lissamine green to stain the nasal and temporal bulbar conjunctiva.<sup>19</sup> The scoring scale for ocular staining was 0 to 5 in cornea, 0 to 5 in temporal conjunctiva, and 0 to 5 in nasal conjunctiva, with 0 representing no staining and 5 representing severe staining. These individual scores were then summed for the total Oxford score, which ranged from 0 to 15. The change from baseline was calculated by subtracting the baseline score from the months 4, 8, and 12 scores. The symptoms of ocular irritation and their impact on visual functioning was assessed by OSDI, a validated 12-item questionnaire, on a scale of 0 to 100 with 0 representing asymptomatic and 100 representing severe debilitating dry eye disease.<sup>20</sup>

### Goblet cell density

The density of goblet cells in bulbar conjunctiva was evaluated at baseline and month 12. Impression cytology was performed in both eyes after evaluation of TBUT, ocular staining, and Schirmer test. Goblet cells were collected on cellulose acetate filters (HAWP 304 FO; Millipore Corp., Billerica, MA). The filters were fixated in glacial acetic acid, formaldehyde, and 70% ethanol and subsequently stained with a modified periodic acid-Schiff Papanicolaou stain. Goblet cells were counted in 5 (400 × 400 mm) representative microscopic fields on each filter.<sup>21</sup>

### Statistical analyses

Patients who completed 12 months of treatment were included in the analyses. The results were presented as mean ± SD. Intergroup comparisons of categorical variables were performed using the chi-square or Fisher's exact test. Continuous variables were analyzed using nonparametric tests (Mann-Whitney tests for between-group comparisons and Wilcoxon signed rank tests for within-group comparisons). A *P* value < 0.05 was considered a statistically significant difference. Statview software (SAS Institute, Cary, NC) was used for all analyses.

## Results

### Patient disposition and disease characteristics

Of 74 patients enrolled between February 2006 and January 2007, 58 patients completed the 12-month study and were included in the analyses (Table 2). Forty-one patients were female and 17 patients were male. The distribution of patients with disease severity of level 2 or 3 was similar in both treatment groups at baseline. Approximately two-thirds of dry eye patients in both groups were diagnosed at severity level 2, while one-third of patients was diagnosed at severity level 3 (Table 2). There were no significant

between-group differences in the mean age (*P* = 0.667) or distribution of gender (*P* = 0.800).

Sixteen patients discontinued the study. The number of discontinuations was significantly higher among patients treated with artificial tears compared with those treated with cyclosporine 0.05% (11 vs. 5; *P* = 0.028; Table 2). Of 11 discontinuations in the artificial tear group, 9 patients discontinued the study because of discomfort upon instillation, and 2 patients were lost to follow-up or moved. Seven of these patients had a disease severity of level 2, and 4 patients had a disease severity of level 3. Of the 5 discontinuations in the cyclosporine group, 2 patients discontinued the study because of discomfort upon instillation while 3 were lost to follow-up or moved. Three of these patients had a disease severity of level 2, and 2 patients had a disease severity of level 3.

### Disease severity

At month 12, significantly more patients treated with artificial tears had more severe signs and symptoms of disease than did those treated with cyclosporine 0.05% and, therefore, were categorized as progressing to a higher disease severity level (7 of 22 [32%] patients vs. 2 of 36 [6%], respectively; *P* < 0.007; Fig. 1). In contrast, a greater percentage of patients treated with cyclosporine 0.05% had less severe signs and symptoms of disease and were categorized as improving to a lower disease severity level (14 of 36 [39%] patients vs. 4 of 22 [18%] patients, respectively). This difference, however, was not statistically significant (*P* = 0.098). When combined with those who did not have a change in the disease severity levels at month 12, significantly more patients treated with cyclosporine 0.05% had either improvements or no change in disease severity than did those treated with artificial tears (34 of 36 [94%] patients vs. 15 of 22 [68%] patients, respectively; *P* = 0.007).

### Schirmer test scores

The mean baseline Schirmer test score was 7.7 ± 0.6 mm in patients randomized to artificial tears and 7.9 ± 1.2 mm

TABLE 2. PATIENTS' DISPOSITION AND DISEASE CHARACTERISTICS

|   | Artificial Tear | Cyclosporine 0.05%      |
|---|-----------------|-------------------------|
| Patients ( <i>n</i> )                                   |                 |                         |
| Enrolled in study                                       | 33              | 41                      |
| Discontinued study                                      | 11 <sup>a</sup> | 5 <sup>b</sup>          |
| Completed study   | 22              | 36                      |
| Mean age <sup>c</sup> ± SD, years                       | 48.2 ± 6.3      | 47.5 ± 5.9 <sup>d</sup> |
| Range   | 39–59           | 30–57                   |
| Gender <sup>e</sup> , <i>n</i> (%)                      |                 |                         |
| Female  | 16 (73)         | 25 (69) <sup>e</sup>    |
| Dry eye severity at baseline, <sup>c</sup> <i>n</i> (%) |                 |                         |
| Level 2   | 15 (68)         | 24 (67)                 |
| Level 3   | 7 (32)          | 12 (33)                 |

<sup>a</sup>Nine patients discontinued the study because of discomfort upon instillation. Two patients were lost to follow-up or moved. *P* = 0.028 compared to patients who received cyclosporine 0.05%.

<sup>b</sup>Two patients discontinued the study because of discomfort upon instillation. Three patients were lost to follow-up or moved.

<sup>c</sup>For patients who completed 12-month study.

<sup>d</sup>*P* = 0.667 compared to the mean age of patients who received artificial tears.

<sup>e</sup>*P* = 0.800 compared to the artificial tear group.

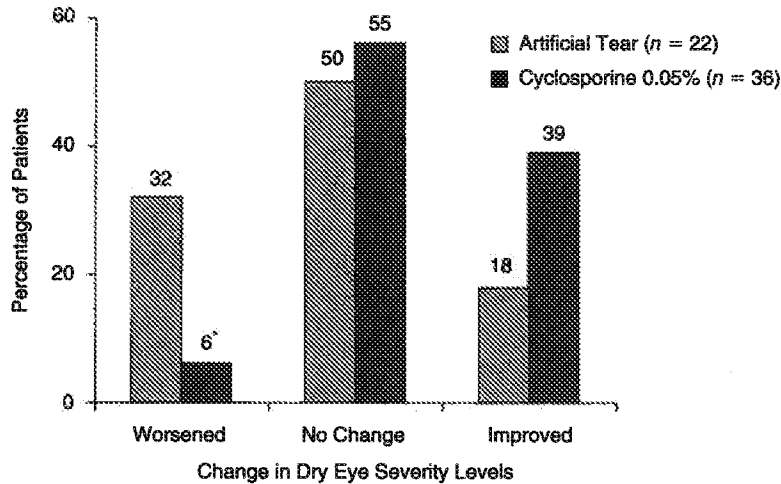

**FIG. 1.** Changes in dry eye severity at month 12 compared with baseline. Patients were treated with cyclosporine 0.05% or artificial tears for 12 months. Disease severity was assessed according to the International Task Force (ITF) consensus guidelines at baseline and month 12. The changes in disease severity levels were categorized as worsened, no change, or improved when a patient had a, respectively, higher, same, or lower disease severity level at month 12 compared with baseline. \* $P < 0.007$  compared with the treatment with artificial tears.

in patients randomized to cyclosporine 0.05% ( $P = 0.625$ ). Patients treated with artificial tears did not have a significant change in their Schirmer test scores throughout the study, whereas those treated with cyclosporine 0.05% had increasingly higher mean Schirmer test scores at each follow-up visit. The mean Schirmer test scores of patients treated with cyclosporine 0.05% were significantly greater than those of patients treated with artificial tears at month 8 ( $9.1 \pm 1.0$  mm vs.  $7.5 \pm 1.1$  mm;  $P < 0.001$ ) and month 12 ( $9.8 \pm 1.0$  mm vs.  $7.6 \pm 1.1$ ;  $P < 0.001$ ; Fig. 2).

**TBUT**

The mean baseline TBUT was  $5.0 \pm 0.8$  s in patients randomized to artificial tears and  $4.9 \pm 0.8$  s in patients

randomized to cyclosporine 0.05% ( $P = 0.550$ ). The mean TBUT of patients treated with artificial tears slightly decreased throughout the study, whereas patients treated with cyclosporine 0.05% had increasingly longer mean TBUT at each follow-up visit (Fig. 3). The mean TBUT of patients treated with cyclosporine 0.05% was significantly longer than those of patients treated with artificial tears at months 8 ( $6.2 \pm 1.4$  s vs.  $4.6 \pm 0.6$  s;  $P = 0.001$ ) and 12 ( $6.5 \pm 1.1$  s vs.  $4.6 \pm 0.7$  s;  $P < 0.001$ ).

**Ocular surface staining scores**

At baseline, patients randomized to cyclosporine 0.05% or artificial tears had similar mean Oxford staining scores

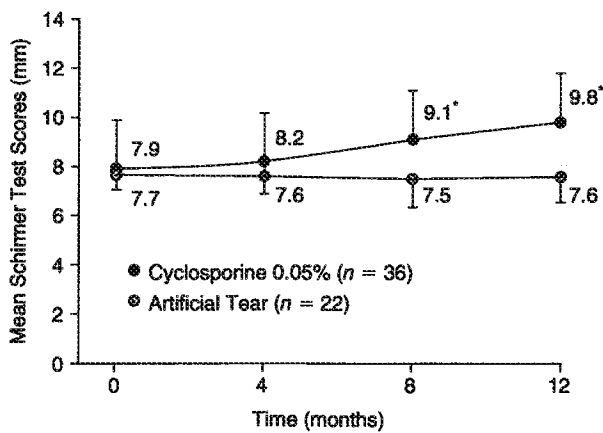

**FIG. 2.** Schirmer test scores. Patients were treated with cyclosporine 0.05% or artificial tears for 12 months. Schirmer I test was performed with anesthesia at indicated study visits. \* $P < 0.001$  compared with patients treated with artificial tears.

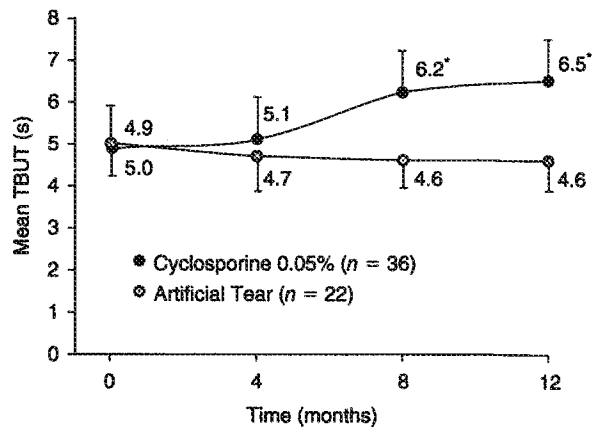

**FIG. 3.** TBUT. Patients were treated with cyclosporine 0.05% or artificial tears for 12 months. Tear breakup time (TBUT) was measured with fluorescein dye at indicated study visits. \* $P \leq 0.001$  compared with patients treated with artificial tears.



TABLE 3. MEAN OCULAR SURFACE STAINING SCORES

|          | Artificial tear (n = 22)   | Cyclosporine 0.05% (n = 36) | P             |
|----------|----------------------------|-----------------------------|---------------|
| Baseline | 7.86 ± 1.13 (NA)           | 8.44 ± 0.94 (NA)            | 0.056 (NA)    |
| Month 4  | 7.73 ± 0.99 (-0.12 ± 0.64) | 8.31 ± 0.95 (-0.13 ± 0.35)  | 0.036 (0.787) |
| Month 8  | 7.53 ± 1.01 (-0.25 ± 0.94) | 7.78 ± 0.93 (-0.64 ± 0.63)  | 0.576 (0.087) |
| Month 12 | 7.54 ± 0.91 (-0.32 ± 0.94) | 7.28 ± 1.28 (-1.19 ± 1.36)  | 0.223 (0.011) |

Patients were treated with cyclosporine 0.05% or artificial tears for 12 months. Ocular surface damage was assessed at indicated times by the Oxford method. The mean changes from baseline and corresponding P values are indicated in brackets.\* The change from baseline was calculated by subtracting the baseline score from the month 4, 8, or 12 scores.

NA = not applicable.

\*The changes from baseline were paired comparisons. If a data point was missing, the baseline was also excluded from that calculation.

(8.4 ± 0.9 vs. 7.9 ± 1.1;  $P = 0.056$ ; Table 3). At month 4, patients treated with cyclosporine 0.05% had significantly higher mean staining scores than those treated with artificial tears (8.3 ± 1.0 vs. 7.7 ± 1.0;  $P < 0.036$ ). There was no between-group difference in ocular staining at months 8 and 12 (Table 3). Nonetheless, the mean improvement from baseline in the ocular staining scores of patients treated with cyclosporine 0.05% was significantly greater than of those treated with artificial tears at month 12 (1.2 ± 1.4 vs. 0.3 ± 0.9, respectively;  $P = 0.011$ ; Table 3). These findings indicate that cyclosporine 0.05% improved ocular surface staining significantly more than did artificial tears at month 12 compared with baseline.

### OSDI Scores

Patients randomized to artificial tears or cyclosporine 0.05% had similar OSDI scores at baseline (19.1 ± 1.9 and 18.9 ± 2.9, respectively;  $P = 0.571$ ). The mean OSDI scores of patients treated with artificial tears remained unchanged throughout the study (Fig. 4). Patients treated with cyclosporine 0.05%, however, had increasingly lower OSDI scores at each study visit, with the scores at months 8 and 12 being significantly lower than those of patients treated with artificial tears (17.4 ± 3.4 vs. 19.6 ± 1.6 at month 8;  $P = 0.011$  and 14.9 ± 4.2 vs. 19.7 ± 2.0 at month 12;  $P < 0.001$ ).

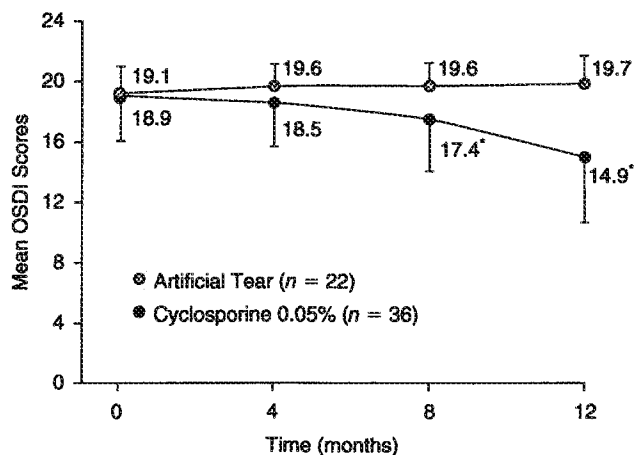

### Goblet cell density

At baseline, patients randomized to artificial tears or cyclosporine 0.05% had similar mean goblet cell density in bulbar conjunctiva (95.8 ± 12.5 cells and 93.6 ± 9.4 cells, respectively;  $P = 0.446$ ; Fig. 5). By month 12, goblet cell density was significantly higher in patients treated with cyclosporine 0.05% than those treated with artificial tears (116.8 ± 14.8 cells vs. 92.7 ± 11.0 cells;  $P < 0.001$ ).

### Safety

No adverse events attributable to the study medications were reported other than discomfort upon instillation during the study.

### Discussion

Dry eye is a multifactorial disorder of the tears and the ocular surface that results in tear film instability and symptoms of discomfort and visual disturbance.<sup>22</sup> Traditionally, treatment of dry eye has been palliative and largely based on over-the-counter artificial eyedrops and lubricating ointments.<sup>23</sup> The vast majority of patients seek new therapies after using several over-the-counter products over years.<sup>23</sup> However, it is not known if dry eye severity progresses through the course of disease during the years. Recently developed ITF guidelines provide a clinical standard for

FIG. 4. Ocular Surface Disease Index (OSDI) scores. Patients were treated with cyclosporine 0.05% or artificial tears for 12 months. Dry eye signs and symptoms were assessed by the self-reported OSDI questionnaire at indicated study visits. \* $P < 0.011$  and \*\* $P < 0.001$  compared with patients treated with artificial tears at months 8 and 12, respectively.

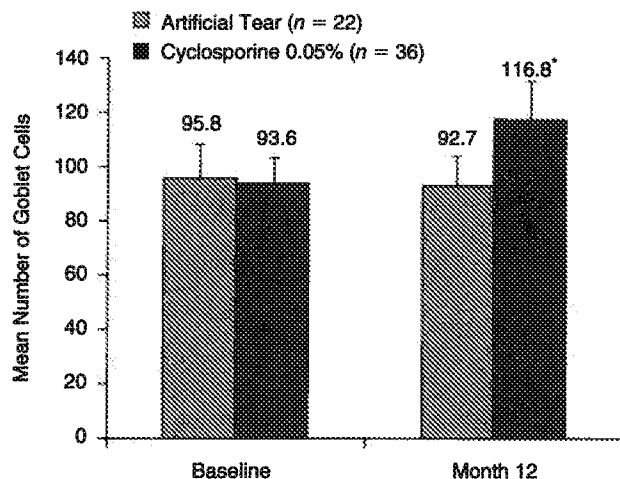

FIG. 5. Conjunctival goblet cell density at baseline and month 12. Patients were treated with cyclosporine 0.05% or artificial tears for 12 months. Conjunctival goblet cells were collected by impression cytology and counted following staining with modified periodic acid-Schiff Papanicolaou at baseline and month 12. \* $P < 0.001$  compared with artificial tears at month 12.

categorization of dry eye patients based on the disease severity and thereby allow longitudinal studies to evaluate the progression of dry eye disease. This study not only sought to assess the progression of dry eye disease in patients treated with artificial tears, but also evaluated the impact of cyclosporine 0.05% therapy in modulating the course of dry eye disease.

Treatment of dry eye patients with cyclosporine 0.05% improved Schirmer test scores, TBUT, conjunctival goblet cell density, ocular surface staining scores, and OSDI scores throughout the study. Treatment with artificial tears was not effective in improving the signs and symptoms of dry eye disease. Similar to these findings, several other studies demonstrated that cyclosporine 0.05% significantly increased tear production, decreased the intensity of ocular staining, and decreased the severity of symptoms in patients with moderate to severe dry eye.<sup>24,25</sup> A recent prospective study indicated that cyclosporine 0.05% therapy significantly improved signs and symptoms in patients at all stages of dry eye disease: mild, moderate, and severe.<sup>26</sup> Other studies have shown that treatment with cyclosporine 0.05% also increased conjunctival goblet cell density in patients with dry eye disease.<sup>21,27</sup>

Physicians participating in a study to develop treatment regimens based on the ITF consensus guidelines for newly diagnosed dry eye patients chose to treat over 40% of patients at severity level 1 with the severity level 2 treatments (ie, unpreserved tears and topical cyclosporine 0.05%).<sup>13</sup> Hence, the use of ITF guidelines resulted in greater focus on treatment of the disease at early stages. This shift in the patterns of anti-inflammatory therapy use stems from the notion that early interruption of inflammatory cycles may be instrumental in preventing disease progression.<sup>13</sup> The impact of dry eye in limiting daily activities and causing discomfort is known to become clinically more significant as the disease progresses from mild to moderate in severity.<sup>2</sup>

In addition to alleviating dry eye signs and symptoms, topical cyclosporine 0.05% therapy appears to be capable of slowing the rate of disease progression. Reassessment of patients at the end of the study period (month 12) indicated that a greater number of cyclosporine patients compared with the artificial tear patients (94% vs. 68%) had improvements or no change in their disease severity status, and far fewer (6% vs. 32%) experienced disease progression. These findings suggest the progressive nature of dry eye disease and indicate that dry eye patients may benefit from cyclosporine 0.05% therapy by achieving disease stabilization or a slower rate of progression. A recent retrospective study provided evidence that cyclosporine 0.05% therapy may change the course of dry eye disease. In that study, 8 chronic dry eye patients diagnosed at severity level 2 or 3 were free of signs and symptoms of dry eye disease for a minimum of 1 year after completing a 6- to 72-month course of cyclosporine 0.05% therapy.<sup>28</sup>

In some patients, dry eye is a difficult-to-treat disease that requires long-term anti-inflammatory therapy. The safety profile of a topical anti-inflammatory agent and its suitability for long-term use is, therefore, a key factor in successful management of dry eye disease. Topical corticosteroids have been effective in alleviating the signs and symptoms of dry eye following short-term use (2–4 weeks).<sup>29,30</sup> Prolonged administration of topical corticosteroids is complicated by the associated adverse events including elevation of intraocular pressure, defects in visual acuity and fields of vision, cataract formation, and increased risk of ocular infections.<sup>29,31</sup> Topical cyclosporine 0.05%, however, appears to be safe for a long-term use. Several clinical studies demonstrated that cyclosporine 0.05% was well tolerated for up to 3 years with most adverse events being transient in nature and mild to moderate in severity.<sup>24,25,32</sup>

The present study had a number of limitations. The sample size was small, as this was a pilot study to assess the feasibility of the study design. It should also be noted that the differences between the treatment groups reported in this study can be applied only to the use of Refresh Endura<sup>®</sup> as the artificial tears. Other artificial tears may have variable efficacies in alleviating the signs and symptoms of dry eye.

Strategies to treat dry eye disease are evolving as our understanding of dry eye as a tear volume insufficiency condition is changing to a disease of abnormal tear film composition with proinflammatory characteristics.<sup>10,33,34</sup> The findings of the current study are the first evidence indicating that dry eye can be progressive in patients treated with artificial tears alone, whereas topical anti-inflammatory therapy with cyclosporine 0.05% may slow or prevent the disease progression in patients with dry eye at severity level 2 or 3. Large-scale, controlled studies are warranted to confirm these findings.

#### Acknowledgment

Hadi Moini, PhD, of Pacific Communications provided editorial assistance for this manuscript.

#### Author Disclosure Statements

This study was supported by an unrestricted grant from Allergan, Inc., Irvine, CA. The author has no proprietary interest in any material or method mentioned in this study.

## References

1. Ishida, R., Kojima, T., Dogru, M., et al. The application of a new continuous functional visual acuity measurement system in dry eye syndromes. *Am. J. Ophthalmol.* 139:253–258, 2005.
2. Mertzani, P., Abetz, L., Rajagopalan, K., et al. The relative burden of dry eye in patients' lives: comparisons to a U.S. normative sample. *Invest. Ophthalmol. Vis. Sci.* 46:46–50, 2005.
3. Miljanovic, B., Dana, R., Sullivan, D.A., et al. Impact of dry eye syndrome on vision-related quality of life. *Am. J. Ophthalmol.* 143:409–415, 2007.
4. Lin, P.Y., Tsai, S.Y., Cheng, C.Y., et al. Prevalence of dry eye among an elderly Chinese population in Taiwan: the Shihpai Eye Study. *Ophthalmology.* 110:1096–1101, 2003.
5. McCarty, C.A., Bansal, A.K., Livingston, P.M., et al. The epidemiology of dry eye in Melbourne, Australia. *Ophthalmology.* 105:1114–1119, 1998.
6. Schaumberg, D.A., Sullivan, D.A., Buring, J.E., et al. Prevalence of dry eye syndrome among US women. *Am. J. Ophthalmol.* 136:318–326, 2003.
7. Miljanovic, B.M. et al. Association for research in vision and ophthalmology. *Invest. Ophthalmol. Vis. Sci.* 48:E-abstract 4293, 2007.
8. Methodologies to diagnose and monitor dry eye disease: report of the Diagnostic Methodology Subcommittee of the International Dry Eye WorkShop (2007). *Ocul. Surf.* 5:108–152, 2007.
9. Behrens, A., Doyle, J.J., Stern, L., et al.; Dysfunctional tear syndrome study group. Dysfunctional tear syndrome: a Delphi approach to treatment recommendations. *Cornea.* 25:900–907, 2006.
10. Pflugfelder, S.C. Antiinflammatory therapy for dry eye. *Am. J. Ophthalmol.* 137:337–342, 2004.
11. Stern, M.E., Beuerman, R.W., Fox, R.I., et al. The pathology of dry eye: the interaction between the ocular surface and lacrimal glands. *Cornea.* 17:584–589, 1998.
12. Wilson, S.E. Inflammation: a unifying theory for the origin of dry eye syndrome. *Manag. Care.* 12:14–19, 2003.
13. Wilson, S.E., and Stulting, R.D. Agreement of physician treatment practices with the international task force guidelines for diagnosis and treatment of dry eye disease. *Cornea.* 26:284–289, 2007.
14. Restasis® [package insert]. Irvine, CA: Allergan, Inc.; 2004.
15. Matsuda, S., and Koyasu, S. Mechanisms of action of cyclosporine. *Immunopharmacology.* 47:119–125, 2000.
16. Donnenfeld, E., and Pflugfelder, S.C. Topical ophthalmic cyclosporine: pharmacology and clinical uses. *Surv. Ophthalmol.* 54:321–338, 2009.
17. Kunert, K.S., Tisdale, A.S., Stern, M.E., et al. Analysis of topical cyclosporine treatment of patients with dry eye syndrome: effect on conjunctival lymphocytes. *Arch. Ophthalmol.* 118:1489–1496, 2000.
18. Turner, K., Pflugfelder, S.C., Ji, Z., et al. Interleukin-6 levels in the conjunctival epithelium of patients with dry eye disease treated with cyclosporine ophthalmic emulsion. *Cornea.* 19:492–496, 2000.
19. Bron, A.J., Evans, V.E., and Smith, J.A. Grading of corneal and conjunctival staining in the context of other dry eye tests. *Cornea.* 22:640–650, 2003.
20. Schiffman, R.M., Christianson, M.D., Jacobsen, G., et al. Reliability and validity of the Ocular Surface Disease Index. *Arch. Ophthalmol.* 118:615–621, 2000.
21. Pflugfelder, S.C., De Paiva, C.S., Villarreal, A.L., et al. Effects of sequential artificial tear and cyclosporine emulsion therapy on conjunctival goblet cell density and transforming growth factor-beta2 production. *Cornea.* 27:64–69, 2008.
22. The definition and classification of dry eye disease: report of the Definition and Classification Subcommittee of the International Dry Eye WorkShop (2007). *Ocul. Surf.* 5:75–92, 2007.
23. The Gallup Organization, Inc. *The 2008 Gallup Study of Dry Eye Sufferers.* Princeton, NJ: Multi-Sponsor Surveys, Inc.; 2008.
24. Sall, K., Stevenson, O.D., Mundorf, T.K., et al. Two multicenter, randomized studies of the efficacy and safety of cyclosporine ophthalmic emulsion in moderate to severe dry eye disease. CsA Phase 3 Study Group. *Ophthalmology.* 107:631–639, 2000.
25. Stevenson, D., Tauber, J., and Reis, B.L. Efficacy and safety of cyclosporin A ophthalmic emulsion in the treatment of moderate-to-severe dry eye disease: a dose-ranging, randomized trial. The Cyclosporin A Phase 2 Study Group. *Ophthalmology.* 107:967–974, 2000.
26. Perry, H.D., Solomon, R., Donnenfeld, E.D., et al. Evaluation of topical cyclosporine for the treatment of dry eye disease. *Arch. Ophthalmol.* 126:1046–1050, 2008.
27. Kunert, K.S., Tisdale, A.S., and Gipson, I.K. Goblet cell numbers and epithelial proliferation in the conjunctiva of patients with dry eye syndrome treated with cyclosporine. *Arch. Ophthalmol.* 120:330–337, 2002.
28. Wilson, S.E., and Perry, H.D. Long-term resolution of chronic dry eye symptoms and signs after topical cyclosporine treatment. *Ophthalmology.* 114:76–79, 2007.
29. Marsh, P., and Pflugfelder, S.C. Topical nonpreserved methylprednisolone therapy for keratoconjunctivitis sicca in Sjögren syndrome. *Ophthalmology.* 106:811–816, 1999.
30. Pflugfelder, S.C., Maskin, S.L., Anderson, B., et al. A randomized, double-masked, placebo-controlled, multicenter comparison of loteprednol etabonate ophthalmic suspension, 0.5%, and placebo for treatment of keratoconjunctivitis sicca in patients with delayed tear clearance. *Am. J. Ophthalmol.* 138:444–457, 2004.
31. Lotemax [package insert]. Tampa, FL: Bausch & Lomb, Inc.; 2006.
32. Barber, L.D., Pflugfelder, S.C., Tauber, J., et al. Phase III safety evaluation of cyclosporine 0.1% ophthalmic emulsion administered twice daily to dry eye disease patients for up to 3 years. *Ophthalmology.* 112:1790–1794, 2005.
33. Baudouin, C. The pathology of dry eye. *Surv. Ophthalmol.* 45(Suppl 2):S211–S220, 2001.
34. Lemp, M.A. Evaluation and differential diagnosis of keratoconjunctivitis sicca. *J. Rheumatol. Suppl.* 61:11–14, 2000.

Received: August 21, 2009

Accepted: January 31, 2010

Address correspondence to:

Dr. Sanjay N. Rao

Lakeside Eye Group, SC

180 N. Michigan Ste 1900

Chicago, IL 60601

E-mail: sanjayrao@pol.net



This article has been cited by:

1. Pinnita Prabhasawat, Nattaporn Tesavibul, Chulavech Karnchanachetanee, Sirilux Kasemson. 2013. Efficacy of Cyclosporine 0.05% Eye Drops in Stevens Johnson Syndrome with Chronic Dry Eye. *Journal of Ocular Pharmacology and Therapeutics* 29:3, 372-377. [Abstract] [Full Text HTML] [Full Text PDF] [Full Text PDF with Links]
2. Shengyan Liu, Lyndon Jones, Frank X. Gu. 2012. Development of Mucoadhesive Drug Delivery System Using Phenylboronic Acid Functionalized Poly( D , L -lactide)- b -Dextran Nanoparticles. *Macromolecular Bioscience* 12:12, 1622-1626. [CrossRef]
3. Burçin Yavuz, Sibel Bozdağ Pehlivan, Nurşen Ünlü. 2012. An Overview on Dry Eye Treatment: Approaches for Cyclosporin A Delivery. *The Scientific World Journal* 2012, 1-11. [CrossRef]
4. Sanjay N. Rao. 2011. Reversibility of Dry Eye Deceleration After Topical Cyclosporine 0.05% Withdrawal. *Journal of Ocular Pharmacology and Therapeutics* 27:6, 603-609. [Abstract] [Full Text HTML] [Full Text PDF] [Full Text PDF with Links]
5. C. Di Tommaso, F. Behar-Cohen, R. Gurny, M. Möller. 2011. Colloidal systems for the delivery of cyclosporin A to the anterior segment of the eye. *Annales Pharmaceutiques Françaises* 69:2, 116-123. [CrossRef]

# EXHIBIT F

# The Impact of Dry Eye Disease on Visual Performance While Driving

NATHALIE DESCHAMPS, XAVIER RICAUD, GHISLAINE RABUT, ANTOINE LABBÉ, CHRISTOPHE BAUDOIN, AND ALEXANDRE DENOYER

• **PURPOSE:** A specific simulator was used to assess the driving visual performance in patients with dry eye disease (DED) and to determine clinical predictors of visual impairments while driving.

• **DESIGN:** Prospective case-control study.

• **METHODS:** The study was conducted in the Center for Clinical Investigation of Quinze-Vingts National Ophthalmology Hospital, Paris, France. Twenty dry eye patients and 20 age- and sex-matched control subjects were included. Vision-related driving ability was assessed using a specific driving simulator displaying randomly located targets with a progressive increase in contrast to be identified. Other examinations included clinical examinations, serial measurements of corneal higher-order aberrations (HOAs), and vision-related quality-of-life questionnaire (Ocular Surface Disease Index [OSDI]). Data collected during driving test (ie, the number of targets seen, their position, and the response time) were compared between groups and analyzed according to clinical data, aberration dynamics, and quality-of-life index.

• **RESULTS:** The percentage of targets missed as well as average response time were significantly increased in DED patients as compared with controls ( $P < .01$ ). More specifically, the visual function of DED patients was more impaired in specific situations, such as cross-road or roundabout approaches. In DED patients, the response time was found to positively correlate with the progression index for HOAs ( $P < .01$ ) and with the OSDI "symptoms" subscale ( $P < .05$ ).

• **CONCLUSIONS:** Degradation of ocular optical qualities related to DED is associated with visual impairments during driving. This study objectively has demonstrated the impact of tear film-related aberration changes on activities of daily living in DED. (Am J Ophthalmol 2013;156:184–189. © 2013 by Elsevier Inc. All rights reserved.)

AJO.com

Supplemental Material available at AJO.com.

Accepted for publication Feb 28, 2013.

From the Quinze-Vingts National Ophthalmology Hospital, Clinical Center for Investigations 503, Paris, France (N.D., X.R., G.R., A.L., C.B., A.D.); Ambroise Paré Hospital, University of Versailles Saint-Quentin en Yvelines, Versailles, France (A.L., C.B.); and Pierre et Marie Curie University Paris 6, Vision Institute, National Institute of Health and Medical Research, National Center for Scientific Research, Paris, France (C.B., A.D.).

Inquiries to Alexandre Denoyer, CHNO des Quinze-Vingts, Service 3, 28 rue de Charenton, F-75012 Paris, France; e-mail: alexandre.denoyer@gmail.com

**D**RY EYE DISEASE (DED) IS RECOGNIZED AS a growing public health problem and one of the most frequent reasons for seeking eye care. The DED definition has evolved with recent epidemiologic studies as well as a better understanding of the pathophysiology of the disease. It is estimated to affect from 5% to over 30% of the population, depending on the diagnostic criteria.<sup>3</sup> This common health problem is likely to be overlooked because it tends not to be a common cause of visual morbidity as standardly measured. Nevertheless, there is increasing evidence that DED is a major cause of visual disturbance, which degrades the quality of everyday life and can impact health status.<sup>2</sup>

According to a recent overview arising from the 2007 International Dry Eye Workshop, DED causes damage to the ocular surface and symptoms of ocular discomfort associated with impaired visual quality.<sup>3</sup> Indeed, patients with DED often report vision-related difficulties in doing daily activities. In clinical practice, the main difficulty in managing DED stems from the variability of the symptoms, the lack of a single reliable diagnostic test, and weak correlations between clinical tests, optical and biological examinations, and patient-reported deterioration in quality of life.<sup>4–6</sup> The precorneal tear film plays an important role in ocular optical quality since it is the most anterior refractive surface of the eye.<sup>7,8</sup> In the majority of patients with DED, the visual acuity is still 20/20 as standardly measured, but instability of the tear film introduces wavefront higher-order aberration (HOA) changes that always contribute to a decrease in the quality of vision.<sup>9,10</sup> Our team recently demonstrated that a specific analysis of the time course of HOAs provides objective and quantitative data that are correlated with both clinical signs and patient-reported outcomes, raising the possibility of using this instrument as a new surrogate marker for the disease.<sup>11</sup>

Beyond conventional clinical examination and visual acuity measurement, a specific evaluation of the visual function in daily living tasks is now required to better define the impact of the disease on this population's health status but also to better assess eligibility or changes over time in clinical trials. Although DED patients commonly complain of difficulties in doing vision-related daily activities, as previously reported using quality-of-life questionnaires,<sup>12</sup> no study has been conducted to determine whether or not DED could be responsible for an objective decrease in visual performance while driving. The present study addresses the impact of DED on a crucial daily

activity of modern living. A driving simulator dedicated to visual function evaluation was used in patients with DED and in age- and sex-matched healthy controls in order to better specify the relationship between driving difficulties, objective ocular signs and optical degradation, and patient-reported vision-related quality of life.

---

## METHODS

• **PATIENTS:** The study was conducted in the Clinical Center for Investigation of Ocular Surface Pathology (Quinze-Vingts National Ophthalmology Hospital, National Institute for Health and Medical Research 503, Paris, France) in accordance with the Declaration of Helsinki, Scotland amendment, 2000. Previous approval was obtained from the National Ethical Research Committee (Comité de Protection des Personnes Ile de France V, agreement number 10793). All patients gave informed consent to participate in this clinical research study. Twenty white patients with DED and 20 white age- and sex-matched control subjects were prospectively and consecutively included. DED was diagnosed by the association of ocular symptoms and tear film abnormalities (Schirmer I test <5 mm/5 min and/or tear break-up test <10 s), with or without ocular surface damage (corneal and conjunctival staining), according to the DEWS criteria from the modified Delphi Panel Report.<sup>4,13</sup> Only the subjects with a best-corrected visual acuity of at least 0 logMAR were included, since this study focused on a decrease in visual function related to tear film degradation and ocular symptoms but not to extensive corneal damage. At inclusion time, all patients were treated with tear substitutes only, without any anti-inflammatory or cyclosporin medication, and without changes within the last 3 months. Healthy age- and sex-matched subjects with no ocular pathology, with no treatment, and without any symptoms or signs of DED (Schirmer I test >10 mm/5 min and Oxford score = 0) were included as controls. All participants were in good general health and were licensed drivers with at least weekly driving practice. Exclusion criteria were any ocular pathology but DED, eyelid malposition or dynamic disorders, previous ocular/eyelid surgery, contact lens wear, systemic disorder, pregnancy, and treatment changes within the last 3 months.

• **CLINICAL EXAMINATION AND QUESTIONNAIRE:** Slit-lamp evaluations were conducted in a defined sequence<sup>14</sup> and included tear break-up time measurement (s, mean of 3 consecutive tests), ocular surface fluorescein staining (grade 0-5, according to the Oxford score), lissamine green staining (grade 0-9, according to the van Bijsterveld score), and Schirmer I test (mm/5 min, without anesthesia). Before clinical examination, a trained interviewer (G.R.) administered the French version of the Ocular Surface Disease

Index (OSDI) questionnaire, which was developed to quantify the specific impact of DED on vision-targeted health-related quality of life.<sup>15</sup> This disease-specific questionnaire includes 3 subscales: ocular symptoms (OSDI-symptoms), vision-related activities of daily living (OSDI-function), and environmental triggers. Each subscale (0-100) was computed, as well as an overall averaged score (0-100).

• **DYNAMIC ABERROMETRY:** Serial measurements of corneal and ocular wavefront aberrations were simultaneously performed every second for 10 s after blinking using the dynamic aberrometer KR-1 (Topcon, Clichy, France). The entire procedure has been previously described.<sup>11</sup> Briefly, HOAs were recorded in mesopic conditions without any pharmacologic mydriasis, analyzed by expanding the set of Zernike polynomials up to the sixth order, and expressed for the central 4-mm diameter. The progression index of total (third- to sixth-order) HOAs was defined as the slope of the linear regression line of HOAs throughout the recording period, as previously defined.<sup>11</sup>

• **DRIVING TEST:** We used a driving simulator purchased from Develter Innovation (Ile de France, France). This simulator has an automatic shift. Driving tests were performed with the best spectacle correction in scotopic conditions on a standardized 5-km circuit. Each test had a series of 7 lighted targets, increasing in intensity for 15 s and then disappearing. Lighted targets randomly appeared during the test at various positions and various driving conditions: straight forward, straight backward, at a crossroad entrance, and on the right-hand or left-hand side of a crossroad. For each target seen, the patient had to press a remote button on the wheel. Data included the number of targets seen/missed, their respective location, and the average response time. The results were determined as the mean of 3 consecutive tests.

• **STATISTICAL ANALYSIS:** All data are given as the mean  $\pm$  SD. For ocular examinations—clinical evaluation, tear osmolarity measurement, and wavefront aberrometry—1 eye per patient was selected using a random number table in order not to bias the statistical relevance of the results. Data were controlled for normality, homogeneity of variances, and sphericity in order to perform the adequate tests. The 2 groups were compared using parametric *t* tests. In the DED group, scatterplots and Spearman correlation coefficients were used to assess the association between pairs of variables. The probability level of significance was adjusted according to the post hoc Bonferroni procedure in order to maintain an overall type I error equal to 0.05.

---

## RESULTS

THE PROFILE, CLINICAL FEATURES, AND OSDI SCORES OF each group are detailed in the Table. Six patients presented



**TABLE. Subject Profiles and Ocular Surface Disease Index Scores Between Dry Eye Patients and Age- and Sex-matched Controls**

|                              | Dry Eye Patients (n = 20), Mean ± SD (min/max [95% CI]) | Controls (n = 20), Mean ± SD (min, max [95% CI]) |
|------------------------------|---|--|
| Age (y)                      | 53.4 ± 16.2 (22/84 [46.3-60.5])                         | 53.1 ± 16.4 (22/84 [45.9-60.3])                  |
| Sex ratio (m/f)              | 0.25  | 0.25   |
| Clinical data                |   |  |
| Tear break-up time (s)       | 5.9 ± 2.2 (2/10 [5.0-6.9])                              | 11.4 ± 3.7 (4/15 [9.9-13.1])                     |
| Schirmer (mm)                | 9.5 ± 5.4 (1/20 [7.2-11.9])                             | 19.6 ± 0.6 (15/20 [19.4-19.9])                   |
| Oxford (0-5)                 | 1.1-0.8 (0-4 [0.7-1.4])                                 | 0  |
| Van Bijsterveld (0-9)        | 2.7 ± 1.6 (0-6 [1.9-3.3])                               | 0.1 ± 0.1 (0/1 [0-0.1])                          |
| Ocular Surface Disease Index |   |  |
| Overall score                | 48.1 ± 18.4 (10.4/89.6 [40.6-56.6])                     | 2.2 ± 2.9 (0/10.4 [0.9-3.3])                     |
| OSDI symptoms                | 43.3 ± 15.6 (15/80 [36.4-50.1])                         | 2.1 ± 3.1 (0/15 [0.8-3.5])                       |
| OSDI functions               | 41.3 ± 27.8 (0/93.8 [29.1-53.4])                        | 1.8 ± 2.9 (0/12.5 [0.5-3.1])                     |
| OSDI triggers                | 58.3 ± 29.2 (8.3/100 [45.6-71.1])                       | 2.4 ± 3.9 (0/16.7 [0.7-4.1])                     |

OSDI = Ocular Surface Disease Index.

mild-severity DED and 14 patients presented moderate-severity DED, according to the Delphi approach.<sup>3</sup> Significant differences in all the clinical characteristics and OSDI scores were found between DED patients and controls (paired *t* test, *P* < .01 for each).

• **COMPARATIVE ANALYSIS OF ABERRATION DYNAMICS BETWEEN GROUPS:** Significant variation with time in corneal total HOAs (repeated-measures ANOVA, *P* < .01), third-order coma (*P* < .01), and third-order trefoil (*P* < .01) was found in DED patients, whereas no significant change occurred in the control group throughout the recording period. As detailed in Figure 1, the progression index of corneal total HOAs and of corneal third-order trefoil was significantly higher in DED patients than in healthy controls (*P* < .01 and *P* < .05, respectively).

• **DRIVING VISUAL PERFORMANCE:** The average response time to identify targets was significantly higher in DED patients than in controls (*P* < .01) (Figure 2, Left). Moreover, a significant difference in the average number of targets seen was found between groups (*P* < .01), further depending on target location (Figure 2, Right): interestingly, targets appearing at a crossroad entrance and at the right-hand side of a crossroad were more often missed by DED patients than by healthy subjects (*P* < .01 and *P* < .05, respectively). On the contrary, targets appearing straight on (forward or backward) were equally detected in the 2 groups.

In DED patients, a positive correlation was found between the response time to identify targets and the progression index for corneal HOAs (*R*<sup>2</sup> = 0.40, *P* < .01) as well as between response time and the OSDI “symptoms” subscore (*R*<sup>2</sup> = 0.25, *P* < .05) (Figure 3). No significant correlation was found between the driving simulation data and the other computed data (Supplemental Table,

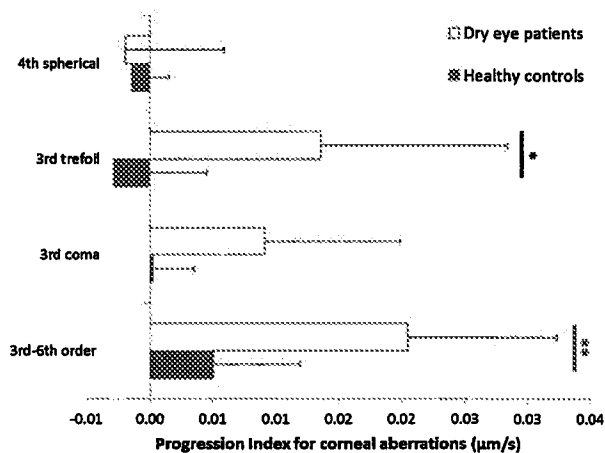

**FIGURE 1.** Comparative analysis of corneal aberration dynamics between dry eye patients and age- and sex-matched controls. Significant difference in the progression index for third- to sixth-order higher-order aberrations and for third-order trefoil between dry eye patients and controls (paired *t* test, \**P* < .05, \*\**P* < .01).

available at AJO.com). Following a stepwise regression procedure, the response time was found to significantly depend on the progression index for corneal HOAs only (*R*<sup>2</sup> increment = 0.40, *P* < .01).

## DISCUSSION

DED IS A CHRONIC OCULAR SURFACE DISEASE THAT affects millions of people worldwide.<sup>3</sup> The majority of patients with DED experience chronic ocular discomfort associated with impaired daily visual function and subsequent vision-related quality-of-life disturbance, further

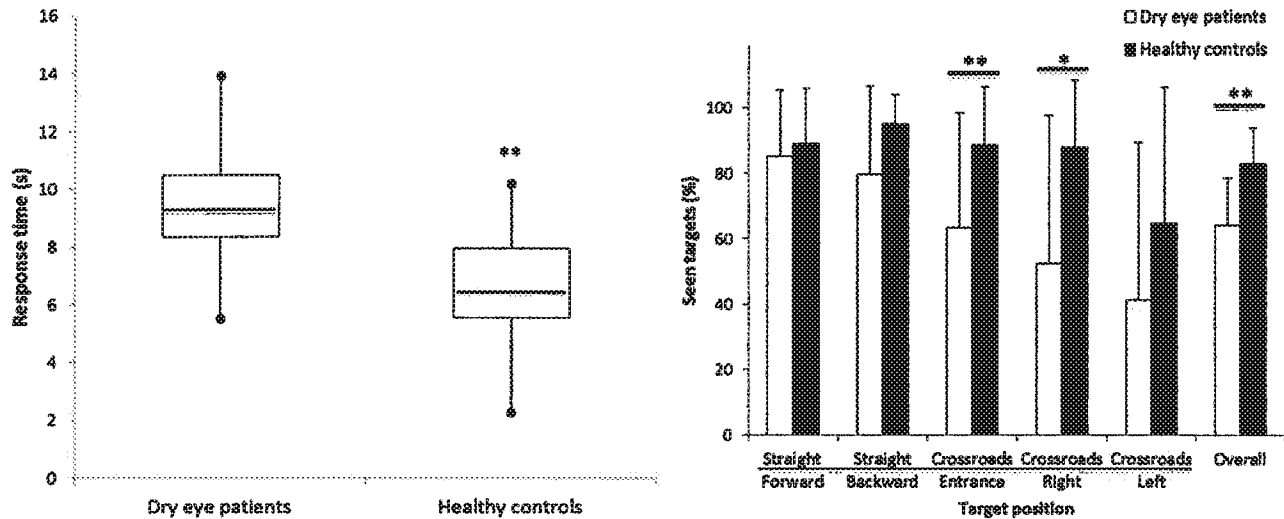

FIGURE 2. Comparative analysis of visual performance while driving between dry eye patients and age- and sex-matched controls. (Left) Average response time to identify targets in dry eye patients and in controls. Data are presented as median, 95% confidence interval, and range. (Right) Percentage of targets seen depending on target location (paired t test, \* $P < .05$ , \*\* $P < .01$ ).

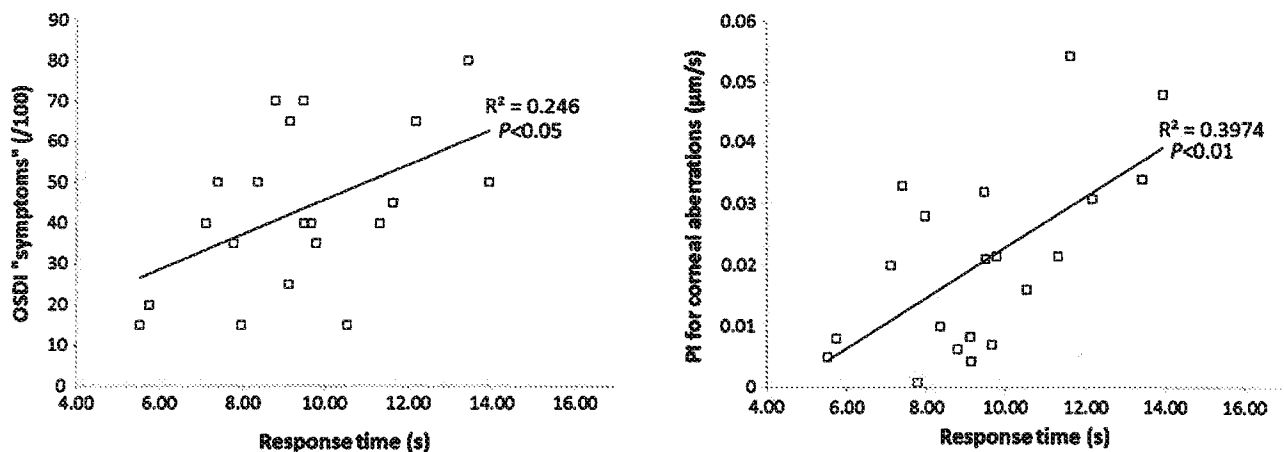

FIGURE 3. Linear relations between visual performance while driving and the other data in dry eye patients. Visual performance while driving, as assessed by the response time to identify targets during a driving simulation, was analyzed in correlation with the other data. (Left) Positive correlation between the response time and Ocular Surface Disease Index (OSDI) "symptoms" subscore (Spearman correlation test,  $P < .05$ ). (Right) Positive correlation between the response time and progression index (PI) for corneal higher-order aberrations ( $P < .01$ ).

impacting health status.<sup>2</sup> The present study objectively reports that the visual function is impaired during specific driving situations in DED patients as compared with healthy controls, further demonstrating that driving visual performance is correlated with ocular optical aberrations and patient-felt quality of life in this disease.

Tear film instability is reported to increase the progression with time of corneal HOAs after a blink.<sup>16-18</sup> The present study originally found a relation between tear film-related ocular optical degradation and driving difficulties. An increased blink rate is thought to compensate for corneal

dryness, which stimulates tear secretion and creates a new tear film layer.<sup>19</sup> Goto and associates<sup>19</sup> found a deterioration of visual function during the fixation without blinking in 22 DED patients compared with 8 controls. The deterioration of vision after blinking supports the hypothesis that the tear film of patients with DED is unstable, especially when blinking is delayed. Precisely, we reported herein that DED patients missed more frequently targets at crossroad entrances than targets appearing straight on. We could hypothesize that this result is linked with a decrease in blink rate and subsequent increase in corneal HOAs when

## REFERENCES

1. The epidemiology of dry eye disease: report of the epidemiology subcommittee of the International Dry Eye Workshop. *Ocul Surf* 2007;5(2):93–107.
2. Baudouin C, Creuzot-Garcher C, Hoang-Xuan T, et al. Severe impairment of health-related quality of life in patients suffering from ocular surface diseases. *J Fr Ophthalmol* 2008; 31(4):369–378.
3. The definition and classification of dry eye disease: report of the definition and classification subcommittee of the International Dry Eye Workshop. *Ocul Surf* 2007;5(2):75–92.
4. Schein OD, Tielsch JM, Munoz B, et al. Relation between signs and symptoms of dry eye in the elderly. A population-based perspective. *Ophthalmology* 1997;104(9):1395–1401.
5. Begley CG, Chalmers RL, Abetz L, et al. The relationship between habitual patient-reported symptoms and clinical signs among patients with dry eye of varying severity. *Invest Ophthalmol Vis Sci* 2003;44(11):4753–4761.
6. Nichols KK, Nichols JJ, Mitchell GL. The lack of association between signs and symptoms in patients with dry eye disease. *Cornea* 2004;23(8):762–770.
7. Rieger G. The importance of the precorneal tear film for the quality of optical imaging. *Br J Ophthalmol* 1992;76(3): 157–158.
8. Koh S, Maeda N, Kuroda T, et al. Effect of tear film break-up on higher-order aberrations measured with wavefront sensor. *Am J Ophthalmol* 2002;134(1):115–117.
9. Liu H, Thibos L, Begley CG, Bradley A. Measurement of the time course of optical quality and visual deterioration during tear break-up. *Invest Ophthalmol Vis Sci* 2010;51(6): 3318–3326.
10. Tutt R, Bradley A, Begley C, Thibos LN. Optical and visual impact of tear break-up in human eyes. *Invest Ophthalmol Vis Sci* 2000;41(13):4117–4123.
11. Denoyer A, Rabut G, Baudouin C. Tear film aberration dynamics and vision-related quality of life in patients with dry eye disease. *Ophthalmology* 2012;119(9):1811–1818.
12. Tong L, Waduthantri S, Lamoureux E, et al. Impact of symptomatic dry eye on vision-related daily activities: The Singapore Malay Eye Study. *Eye* 2010;24(9):1486–1491.
13. Behrens A, Doyle JJ, Stern L, et al. Dysfunctional tear syndrome. A Delphi approach to treatment recommendations. *Cornea* 2006;25(8):900–907.
14. Foulks G, Bron AJ. A clinical description of meibomian gland dysfunction. *Ocul Surf* 2003;1(3):107–126.
15. Schiffman RM, Christianson MD, Jacobsen G, et al. Reliability and validity of the Ocular Surface Disease Index. *Arch Ophthalmol* 2000;118(5):615–621.
16. Ferrer-Blasco T, Garcia-Lazaro S, Montés-Mico R, et al. Dynamics changes in the air-tear film interface modulation transfer function. *Graefes Arch Clin Exp Ophthalmol* 2010; 248(1):127–132.
17. Montés-Mico R, Alió JL, Charman WN. Dynamic changes in the tear film in dry eyes. *Invest Ophthalmol Vis Sci* 2005;46(5): 1615–1619.
18. Montés-Micó R, Cáliz A, Alió JL. Wavefront analysis of higher order aberrations in dry eye patients. *J Refract Surg* 2004;20(3):243–247.
19. Goto E, Yami Y, Matsumoto Y, Tsubota K. Impaired functional visual acuity of dry eye patients. *Am J Ophthalmol* 2002;133(2):181–186.
20. Owsley C, McGwin G Jr. Vision and driving. *Vision Res* 2010; 50(23):2348–2361.
21. Rubin GS, Roche KB, Prasada-rao P, et al. Visual impairment and disability in older adults. *Optom Vis Sci* 1994;71(12): 750–760.
22. Rolando M, Lester M, Macri A, Calabria G. Low spatial-contrast sensitivity in dry eyes. *Cornea* 1998;17(4):376–379.
23. Owsley C, Stalvey BT, Wells J, Sloan ME, McGwin G Jr. Visual risk factors for crash involvement in older drivers with cataract. *Arch Ophthalmol* 2001;119(6):881–887.
24. Owsley C, Ball K, McGwin G Jr, et al. Visual processing impairment and risk of motor vehicle crash among older adults. *JAMA* 1998;279(14):1083–1088.
25. Miljanovic B, Dana R, Sullivan D, Schaumberg D. Impact of dry eye syndrome on vision-related quality of life. *Am J Ophthalmol* 2007;143(3):409–415.
26. Huang FC, Tseng SH, Shih MH, Chen FK. Effect of artificial tears on corneal surface regularity, contrast sensitivity, and glare disability in dry eye. *Ophthalmology* 2002;109(10): 1934–1940.

a specific driving situation requires more attention. Indeed, the elapsed time between blinks is known to increase in specific conditions, such as high driving speed.<sup>19</sup> In the present study, it could also have been interesting to record blink rate during the simulation to more precisely examine this point. Hence, other aspects of vision than standard visual acuity may be taken into account to better reflect the daily visual function, as clearly detailed by Owsley and McGwin.<sup>20</sup>

The association between loss of contrast sensitivity and driving disability has been previously studied on the one hand, and a decrease in contrast sensitivity has been reported in DED patients on the other hand. However, nothing was known about a direct link between DED-related contrast sensitivity impairments and driving difficulties. Although conventional contrast sensitivity testing was not performed in the present study, we reported a pronounced increase in response time in the DED group, which corresponds to the need for higher signal intensity to be perceived since the target contrast was increasing with time during a 15-second period. Rubin and associates studied the relationships between various indexes of visual function and driving ability in a population of 222 healthy volunteers.<sup>21</sup> The authors reported contrast sensitivity as the strongest correlating factor for subject-felt driving difficulty. Indeed, standard visual acuity, the most commonly used measure of visual function, does not correlate with some types of functional disability, such as driving.<sup>21,22</sup> Owsley and associates also reported that people with low contrast sensitivity have 8 times more road accidents than other people.<sup>23,24</sup> In dry eye, Rolando and associates compared 30 DED patients (18 patients with corneal damage and 12 without) with 15 healthy subjects.<sup>22</sup> They showed a significant decrease in contrast sensitivity in both DED groups as compared with controls. Interestingly, the authors confirmed that the quality of vision was reduced in DED whatever the visual acuity as standardly measured. In the present study, it could also have been interesting to perform conventional contrast testing, but our primary goal was to assess the visual performance in more realistic conditions. Our study confirms that visual impairments in patients with DED are not accurately evaluated by routine examination, further indicating the need for new visual criteria to better reflect visual function in daily living.

The subjective relationship between DED and driving difficulties has been previously described through the use of vision-related quality-of-life questionnaires.<sup>17,25</sup> Complementarily, our study is the first, to our knowledge, to objectively assess visual function in DED patients

while driving, further establishing a direct link between DED, ocular optical degradation, and driving difficulties. Miljanovic and associates assessed vision-related quality of life with a questionnaire in a series of 190 DED patients vs 399 controls. They reported a decrease in driving ability in DED patients as compared with controls.<sup>25</sup> Herein several quantitative standardized measures of visual quality were correlated with patients' subjective perceptions, showing a significant correlation between the patient-reported OSDI symptoms score and visual difficulties during daytime driving as objectively assessed by a driving simulation. Difficulty in viewing lighted targets may be related to a disability in seeing or identifying external signals such as lights or traffic signs, but also pedestrians or other vehicles, when driving. Although subjects may have more difficulty while driving, it does not necessarily mean that they cannot drive safely. Future studies should evaluate the correlation with accidents rates. Such an approach could aid in developing efficient counseling for patients with DED and also in improving the driver's environment by providing, for example, high-contrast signs. The delayed reaction time found in DED patients could be linked with subject-felt discomfort when driving regularly, which could explain a feeling of insecurity and some loss of confidence in patients with ocular dryness. Since this feeling is reported to be enhanced when driving at night, it could be interesting to perform such a simulation in mesopic/scotopic conditions. Otherwise, a future study using artificial tears in driving conditions may aid in determining whether such a driving simulator could be useful in the evaluation of treatments.<sup>26</sup>

A current challenge for a physician in managing DED stems from the difficulty in making allowances for both objective clinical findings and patients' complaints in order to assist the patient as best as possible and optimize the therapeutic strategy. Today's lifestyle—which includes intensive daily visual activities, such as reading, driving, and using a computer/smart phone—requires excellent visual performance to achieve well-being. Our results better elucidate one of the reasons in which DED is responsible for a decrease in patient-perceived quality of life by establishing a direct link between DED, ocular optical degradations, and impairment in visual performance while driving. Hence we demonstrate that, beyond the conventional visual acuity measurement, specific ocular optical degradations related to DED may impact on daily living tasks, such as driving. We believe that such objective measures of visual performance could be relevant to better evaluate the severity of the disease and the impact of DED on this population's health status worldwide.

---

ALL AUTHORS HAVE COMPLETED AND SUBMITTED THE ICMJE FORM FOR DISCLOSURE OF POTENTIAL CONFLICTS OF INTEREST and none were reported. The authors indicate no funding support. Contribution of authors: design of the study (A.D., C.B., N.D.); conduct of the study (A.D., N.D.); collection and management of the data (A.D., A.L., G.R., N.D., X.R.); analysis and interpretation of the data (A.D., N.D.); preparation of the manuscript (A.D., N.D.); and review and approval of the manuscript (A.D., C.B.).

---

# EXHIBIT G

# Utility Assessment among Patients with Dry Eye Disease

Rhett M. Schiffman, MD, MHSA,<sup>1</sup> John G. Walt, MBA,<sup>1</sup> Gordon Jacobsen, MS,<sup>2</sup> John J. Doyle, MPH,<sup>3</sup> Gary Lebovics, BA,<sup>3</sup> Walton Sumner, MD<sup>4</sup>

**Purpose:** To determine utilities (patient preferences) for dry eye disease.

**Design:** Survey study.

**Participants:** Fifty-six patients with mild, moderate, or severe dry eye treated by ophthalmologists in the Eye Care Services department of Henry Ford Health Care System.

**Testing:** Patients completed interactive software utility assessment questionnaires by the time trade-off (TTO) method. Utility scores were scaled such that a score of 1.0 = perfect health and 0 = death. Dry eye severity was independently classified using clinical parameters and physician/patient assessments. Global health status, visual functioning, and ocular symptoms were assessed by the Short Form-36 Health Survey, 25-Item National Eye Institute Visual Function Questionnaire (NEI VFQ-25), and Ocular Surface Disease Index survey instruments.

**Main Outcome Measures:** Utility scores for a range of dry eye severity states. These utilities were compared with utilities reported for other disease states. Correlations with the general and vision-related health status measures were conducted.

**Results:** Fifty-six patients completed the utility assessments with acceptable reliability. Mean utilities for moderate (0.78) and severe dry eye (0.72) by TTO were similar to historical reports for moderate (0.75) and more severe (class III/IV) angina (0.71), respectively. Utility scores correlated with the NEI VFQ-25 composite score ( $\rho = 0.32$ ;  $P = 0.037$ ) and with components of other health measures.

**Conclusions:** Utilities for the more severe forms of dry eye are in the range of conditions like class III/IV angina (0.71) that are widely recognized as lowering health utilities. Our results underscore how significantly dry eye impacts patients compared with other medical conditions. *Ophthalmology* 2003;110:1412-1419 © 2003 by the American Academy of Ophthalmology.

Dry eye disease is one of the most frequently encountered ocular morbidities, with as many as 4.3 million Americans older than age 65 with symptoms either often or all the time.<sup>1</sup> The dry eye syndrome is composed of a number of diverse medical and ocular diseases that involve decreased tear production and/or increased tear evaporation.<sup>2</sup> Because of the wide-ranging etiologies of dry eye and the great variability of clinical signs of the condition, it has been difficult to develop a consistent classification system for dry eye or reliable and valid measures of disease severity. This has complicated efforts to determine the incidence and

prevalence of dry eye, to monitor disease progression and response to treatment, and to adequately quantify the impact that dry eye has on patients' quality of life. To this end, we have used several validated instruments to evaluate dry eye,<sup>3</sup> including the health-related Short Form-36 Health Survey (SF-36),<sup>4</sup> the vision-related quality-of-life measure NEI VFQ-25,<sup>5</sup> the Ocular Surface Disease Index (OSDI), and the Patient Perception of Ocular Symptoms.<sup>3</sup> Although nearly all of these measures yield a multidimensional profile of health status, none yields a single measure of how patients value various health states or outcomes.

Utility assessment is a formal method for quantifying patient preferences for health outcomes. For assessment at the societal or policy level, scale utility scores are typically anchored at perfect health (utility = 1) and death (utility = 0) and are measured on an interval scale.<sup>6</sup> Investigators might also assess clinical scale utility scores with less extreme anchors, such as the presence or absence of a condition of interest, for example, perfect vision (utility = 1) and blindness (utility = 0). The closer the utility value is to 1.0, the better the quality of life associated with that health state. Once utilities are scaled by use of comparable anchors, the impact of very different health states on quality of life can easily be compared.

Utilities can be measured in a number of ways. The time trade-off (TTO)<sup>7</sup> and standard gamble methods are the most

Originally received: August 16, 2001.

Accepted: September 4, 2002.

Manuscript no. 210603.

<sup>1</sup> Allergan, Inc., Irvine, California.

<sup>2</sup> Henry Ford Health System, Detroit, Michigan.

<sup>3</sup> The Analytica Group, New York, New York.

<sup>4</sup> Washington University, St. Louis, Missouri.

Presented at the annual meeting of the American Academy of Ophthalmology, New Orleans, Louisiana, November 2001.

Supported in part by a grant from Allergan, Inc., Irvine, California.

Walton Sumner is president of Computer Assisted Patient Education and U-Titer author. Computer Assisted Patient Education licenses U-Titer for commercial use and supports U-Titer without charge for academic use.

Reprint requests to Rhett Schiffman, MD, MHSA, Allergan, Inc., 2525 Dupont Dr., Irvine, CA, 92623-9534.

widely used. Numerous researchers have concluded that patients most readily understand TTO.<sup>8-11</sup> Hence, the TTO method was used in this study. In TTO, the subject is offered two choices: (1) living  $t$  years, the life expectancy for a person in the current disease state followed by death, or (2) being in perfect health for fewer years ( $x < t$ ) followed by death. The time in complete health,  $x$ , is varied until the subject is indifferent between the two choices. The utility weight is then  $x/t$ . A benefit of TTO compared with other utility tests is that it is more intuitive to patients while still capturing their risk preference. A limitation of TTO is that results might be biased upward, because subjects are asked to give up years at the end of life, which might be valued less.<sup>11,12</sup>

The purpose of this study was to measure utilities by TTO for the full severity range of dry eye states in a group of patients with dry eye and to determine how utilities correlate with disease severity and other health and vision quality-of-life measures. These utilities then could be used to compare patient preferences for dry eye disease outcomes with different symptomatic medical conditions, such as angina or blindness. They also could be used as weights in the calculation of quality-adjusted life years.<sup>6</sup> These quality-adjusted life years could be used as "denominators" in cost-utility analyses that allow health care policy makers to rigorously compare costs and health benefits across a wide range of medical interventions.

## Material and Methods

### Study Overview

Eligible participants completed several questionnaires between August 2000 and March 2001 to assess their sociodemographic status, general health status, visual functioning, and ocular symptoms. Next, they completed TTO utility assessments and underwent a detailed ophthalmic examination. Questionnaires and utility assessments were completed before the examination to ensure that the clinical encounter would not influence patients' responses. A convenience sample of patients returned 2 weeks later to complete the utility assessments a second time to determine test-retest reliability.

This study was conducted in compliance with the Code of Federal Regulations for sponsors and investigator obligations. Institutional review board/ethics committee approval was obtained. Written informed consent was obtained from all patients before enrollment.

### Patient Selection

Patients were recruited if they were at least 18 years of age, had been diagnosed with dry eye (International Classification of Diseases, ninth revision = 375.15) at the Henry Ford Health System in the last 6 months and had symptoms for at least 3 months. Those scoring  $\geq 8$  on the OSDI were confirmed as symptomatic. A minimum score of 8 was chosen to ensure that all patients had at least mild symptoms, because a prior study found normal subjects to have an OSDI composite score of  $4.5 \pm 6.6$  (mean  $\pm$  standard deviation [SD]).<sup>3</sup> Participants had a life expectancy  $\geq 1$  year, corrected visual acuity of 20/40 or better in each eye, were English speaking, and were able to complete surveys without significant assistance. Those older than age 65 were screened with the Fol-

stein mini-mental status examination questionnaire<sup>13</sup> to confirm that they were cognitively intact to participate in the study.

Exclusion criteria included uncontrolled systemic disease or disability affecting daily activities (such as ocular allergy, infection, irritation, or inflammation unrelated to dry eye disease). Also excluded were patients who had undergone ocular surgery (including cataract surgery) within the previous 6 months, who had undergone temporary or permanent punctal occlusion within the past 3 months, and those known to be allergic to any component of any study agent (e.g., lissamine green, fluorescein, or anesthetic).

Patient enrollment was prospective and consecutive from August 2000 to March 2001.

### Main Outcome Measures

**Utility Assessments for Dry Eye Disease.** Utility assessments were made by means of the computerized interview U-titer software program (Computer Assisted Patient Education, Houston, TX), which provides a standard framework for measuring utilities,<sup>14</sup> taking into account patient life expectancy while permitting investigators the flexibility to program disease-specific scenarios for patients. U-titer has been used to measure utilities for psoriasis,<sup>15</sup> angina,<sup>16</sup> osteoporosis,<sup>17</sup> and prostate cancer.<sup>18</sup>

For the TTO utility assessments, patients reacted to a total of 9 scenarios or health states, including asymptomatic dry eye (requiring routine artificial tear use to completely avoid symptoms), mild dry eye (requiring only occasional treatment to treat periodic dry eye symptoms), moderate dry eye (requiring somewhat more frequent treatment for more persistent symptoms), severe dry eye (requiring very frequent treatment for very severe symptoms), severe dry eye requiring tarsorrhaphy, monocular painful blindness, and binocular painful blindness. See Figure 1 for an example scenario and Figure 2 for a sample utility assessment question. Painful blindness was specified, because many symptomatic patients with dry eye perceive their dry eye symptoms as painful. Patients also assessed the utility of their current dry eye status. Finally, patients reacted to a scenario about their own comorbidities in the absence of dry eye. It is believed that patients can project what it would be like if they did not have the health condition being studied but had all other comorbidities.<sup>7,16,19-21</sup> As described later, this projection permitted us to estimate the utility for each of the health states in the absence of comorbidities.

**Scaling of Utility Scores.** TTO dry eye utility scores, which were reported on a scale with anchors of "death" and "perfect painless vision," were converted to a scale ranging from "death" to "perfect health." The latter scale is the traditional policy scale that permits comparisons with the broadest range of health states. This rescaling was conducted using the patients' own comorbidity utility score. The comorbidity utility score represents a subject's health were he or she to have all their current comorbidities but no dry eye. It represents the upper limit of what a patient's utility score could be before dry eye symptoms are taken into account. To rescale, the patient's utility score was multiplied by the reported comorbidity utility score to achieve a final utility score, which incorporates dry eye and all comorbidity and is scaled from "death" to "perfect health."<sup>19</sup>

**Dry Eye-specific Utility Loss.** If one fails to take comorbidity into account, it is possible to overestimate the lost utility because of the condition of interest and hence to overestimate the potential benefit of treatment.<sup>19</sup> To compute the magnitude of utility loss caused by dry eye alone, the patient's final utility score (comorbidity-adjusted dry eye utility score, the preference for having dry eye disease in the presence of associated comorbidities, on the "death" to "perfect health" scale) is subtracted from the patient's comorbidity utility score (the preference for being free of dry eye,

**Severe Dry Eye**

Imagine that your eyes feel dry, gritty or sore most or all of the time. Your vision is frequently blurred and fluctuates quite a bit. You use eye drops in both eyes every 1-2 hrs, but that provides only temporary and partial relief of your symptoms. You will use a lubricant at bedtime in both eyes. You will also undergo a painless 10-minute procedure in the doctor's office to block off the tear drainage system. There are no complications from this procedure.

Now imagine there's a treatment that would cure all of your symptoms of dry eye, including any vision problems you might have from dry eyes. You would no longer require any eye drops or any other medications for your dry eyes, nor would you require any procedures or surgeries for your eyes. This treatment, however, is accompanied by a reduction in your life expectancy (you will live a shorter life). Now, think about how much life expectancy you would be willing to trade in order to cure your symptoms of dry eye.

Figure 1. Sample scenario presented to patients undergoing the time trade-off utility assessment.

but still having all other comorbidities, also on the "death" to "perfect health" scale).

#### Additional Measures

**Disease Severity.** The severity of dry eye disease was rated by physician assessment and also by a composite disease severity score. The composite disease severity score, described previously,<sup>3</sup> is substantially less dependent on physicians' subjective assessments and is easily computed. It combines traditional clinical measures of dry eye (Schirmer's type-1 and ocular surface staining) with a symptom-based measure (patient perception of ocular symptoms) to evaluate dry eye in adherence with the recommendations of the National Eye Institute Workshop on Clinical Trials in Dry Eyes.<sup>2</sup>

**Health Status Measures.** General health-related quality-of-

life was measured with the SF-36. Vision-related quality of life and ocular symptoms were assessed with the OSDI, the Patient's Perception of Ocular Symptoms, and the NEI VFQ-25. All surveys were completed by self-administration.

The SF-36 is a reliable, valid, and responsive measure of global health status that measures health status in 8 dimensions, including physical functioning, role limitation because of physical disability, bodily pain, general health, vitality, social functioning, emotional limitation because of emotional disability, and mental health. These measures are summarized by a physical component summary score and mental component summary score.<sup>4</sup>

The OSDI, developed by Allergan, Inc., is a reliable, valid, 12-item questionnaire designed to measure ocular disability from ocular surface disease (Drug Information J 1997;31:1436). The

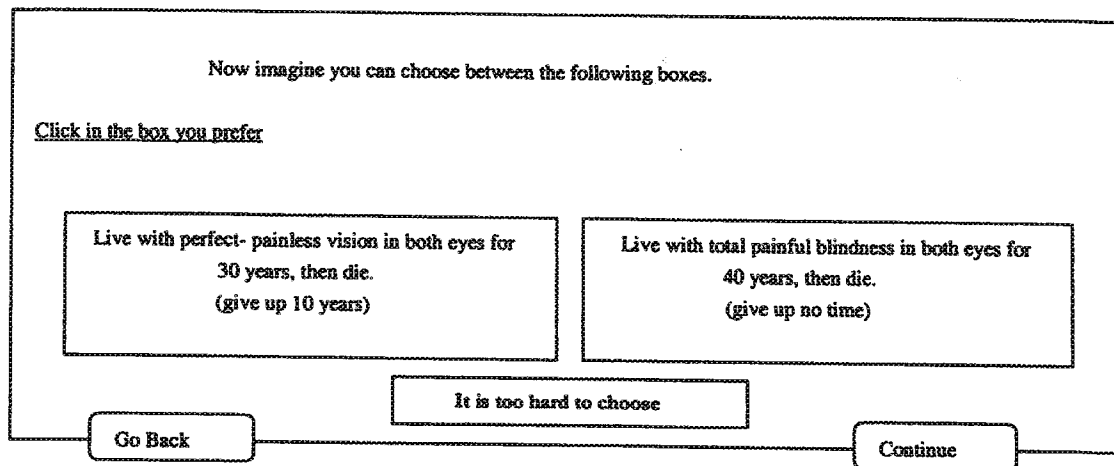

Figure 2. Sample question posed by U-titer in the time trade-off method of utility assessment. The number of years the patient has to consider is varied systematically until a point of indecision is reached. The initial number of years proposed to respondents depends on the demographic characteristics of the patient.



three subscales assess vision-related function, ocular symptoms, and environmental triggers.<sup>3</sup>

The Patient's Perception of Ocular Symptoms is a nine-level subjective facial expression scale used previously in dry eye studies<sup>3</sup> and is a component of the disease severity composite score.

The NEI VFQ-25 is a reliable 25-item questionnaire containing 12 scales: General Health, General Vision, Visual Pain, Near Vision, Distance Vision, Driving, Color Vision, Peripheral Vision, Vision-specific Social Functioning, Mental Health, Role Difficulties, and Dependency. It has been validated across a broad range of ocular disorders.<sup>5</sup>

**Clinical and Sociodemographic Measures.** Clinical measures included "walking-around" binocular Early Treatment of Diabetic Retinopathy Study visual acuity, ocular surface staining with fluorescein for the cornea and lissamine green for the conjunctiva (graded according to the Oxford scale), and tear production using Schirmer's test type-1 (without anesthesia). Sociodemographic data collected included age, race, gender, educational level, and household income.

### Statistical Methods

Mean utility scores ( $\pm$  SD) were computed for all health states. To determine whether associations existed between patients' current dry eye utility and other health status measures, data were extracted from prospectively completed data forms, and Spearman correlation coefficients were computed. The  $\kappa$  statistic was used to evaluate agreement between patients and physicians regarding their assessments of disease severity. Finally, test-retest reliability was evaluated by computing intraclass correlations.

**Statistical Power.** The target sample size of 20 patients in each of mild, moderate, and severe dry eye groups (on the basis of physician assessment) was selected to detect an effect size of 0.4 for the utility scores, using a power of 0.80 and an  $\alpha$  of 0.05. In this setting, an effect size of 0.4 corresponds to a difference between the largest and smallest group means that is approximately equal to the common standard deviation. Therefore, the chosen sample size yields adequate power to detect a mean group difference of 0.2, given an SD of approximately 0.2. This difference is clinically relevant; for example, mild angina has been shown to have a utility of 0.90, moderate angina 0.70, and severe angina 0.50.<sup>22</sup> For the total of 60 patients within each health state, a correlation coefficient of 0.36 would be detectable with a power of 0.80 (at an  $\alpha$  level of 0.05).

## Results

### Study Population and Disposition

Fifty-seven patients with dry eye were enrolled. The mean age of this sample was  $52.7 \pm 13.9$  years (range, 22–77). Eighty-one percent of patients were female. Sixty-one percent were white, and 39% were black. The mean number of years of education was  $14.5 \pm 2.8$  (mean  $\pm$  SD), and the mean yearly income was  $\$49,000 \pm \$25,600$  (mean  $\pm$  SD).

Patients reporting higher utilities for binocular blindness than monocular blindness (indicating their preference for binocular blindness) or a higher utility for severe dry eye requiring surgery than for asymptomatic dry eye (indicating their preference for severe dry eye requiring surgery) were considered to have not understood the utility assessment process and were deemed interview failures. The interview failure (misordering rate) for the utility assessment was 29%. There were no significant predictors of interview failure as assessed by linear regression using sociodemographic factors (such as age and gender) as independent

Table 1. Test-retest Reliability by Utility Assessment Method

| Disease Severity Scenario        | Time Trade-off (n = 11) |       |
|----------------------------------|-------------------------|-------|
|                                  | Intraclass Correlation  | P     |
| Asymptomatic dry eye             | 0.75                    | 0.005 |
| Mild dry eye                     | 0.50                    | 0.100 |
| Moderate dry eye                 | 0.43                    | 0.161 |
| Severe dry eye                   | 0.73                    | 0.007 |
| Severe dry eye requiring surgery | 0.31                    | 0.323 |
| Current dry eye                  | 0.07                    | 0.837 |

variables. Thus, assessments were based on 40 patients. Of the 40 patients, physicians classified 10 as having severe dry eye, 16 moderate dry eye, and 14 mild dry eye.

### Study Validation

**Test-retest Reliability.** Overall, reliability was moderate to good for each of the dry eye states, as assessed by an analysis of test-retest reliability for a subset of patients (n = 11) who returned for a repeat utility assessment. Because of the modest sample size, only asymptomatic dry eye and severe dry eye scenarios were statistically significant (Table 1). The lowest test-retest reliability was seen for patients' self-assessment of their own condition ("current dry eye"), which was the only outcome that could theoretically change between test and retest.

**Patient-physician Agreement in Designation of Dry Eye Severity.** There was mild agreement between patients' self-assessment of disease severity and physician-assessed severity ( $\kappa = 0.39$ , 95% confidence interval, 0.18–0.61) and between self-assessed severity and disease severity composite score ( $\kappa = 0.33$ ; 95% confidence interval, 0.13–0.52). For each disease severity, patients tended to grade their dry eye condition as less severe than that was assessed by the physician. This finding is not surprising considering that the National Eye Institute/Industry Workshop on Clinical Trials in Dry Eyes concluded that subjective and clinical findings in dry eye patients do not correlate with each other.<sup>2</sup>

### Utility Scores for Comorbidity, Blindness, and Dry Eye

Table 2 displays utility scores for comorbidity, blindness and for each dry eye severity grade. Blindness and dry eye scores are adjusted for comorbidity and scaled such that 0 = death and 1 = perfect health. Comorbidity is also scaled from death to perfect health.

For each dry eye state, utility scores ranged from 0.62 to 0.78. As expected, scores for the dry eye states made internal sense relative to the most extreme visual outcome assessed (binocular painful blindness). For example, utility for the most severe form of dry eye (requiring surgery) was 0.62 compared with 0.35 for binocular painful blindness. When patients were asked to rate their own current dry eye state, the mean utility score was the same as the mild dry eye utility score (0.81). However, the reported values ranged from 0.16 to 0.97.

### Utility Loss Solely Attributable to Dry Eye

The lost utilities ("dysutility") caused by each blindness and dry eye state are presented in Table 3. As expected, there was modest condition-specific loss of utility for the mildest dry eye conditions (0.07), whereas the greatest loss of utility occurred with binocular blindness (0.52). Dry eye-specific utility loss because of the pa-

Table 2. Utility Assessments of Ocular Conditions and Comorbidities

|        | Time Trade-off Utility Score (n = 43) |                             |                             |                      |              |                  |                |                                  |                 |
|--------|---------------------------------------|-----------------------------|-----------------------------|----------------------|--------------|------------------|----------------|----------------------------------|-----------------|
|        | Comorbidity in the Absence of Dry Eye | Monocular Painful Blindness | Binocular Painful Blindness | Asymptomatic Dry Eye | Mild Dry Eye | Moderate Dry Eye | Severe Dry Eye | Severe Dry Eye Requiring Surgery | Current Dry Eye |
| Mean   | 0.88                                  | 0.64                        | 0.35                        | 0.78                 | 0.81         | 0.78             | 0.72           | 0.62                             | 0.81            |
| SD     | 0.14                                  | 0.29                        | 0.31                        | 0.23                 | 0.18         | 0.19             | 0.23           | 0.26                             | 0.19            |
| Median | 0.94                                  | 0.74                        | 0.33                        | 0.86                 | 0.85         | 0.82             | 0.77           | 0.68                             | 0.85            |

Scale: 0 = death to 1 = perfect health.  
SD = standard deviation.

tients' current dry eye status (0.07) was on the average comparable to mild dry eye.

### Association Between Current Dry Eye Utility Scores and Other Health Measures

In general, worsening utility scores for current dry eye correlated with worsening scores on the health status measures. The magnitude of correlation was generally mild. Unadjusted utilities for current dry eye correlated significantly with the ocular symptoms subscale of the OSDI, the bodily pain and role-emotional subscales of the SF-36, as well as the distance acuity and composite scores of the NEI VFQ (all  $P \leq 0.048$ ) (Table 4). For adjusted utilities, significant associations were seen with the physical functioning, role physical, bodily pain, and vitality subscales, and the physical component summary score of the SF-36 (all  $P \leq 0.045$ ), and also with the NEI VFQ composite score ( $P = 0.037$ ).

### Comparison of Utilities Between Dry Eye and Other Diseases

Table 5 compares our utility scores with other medical conditions reported on a scale of 0 = death to 1 = perfect health. Although all utilities listed were anchored on this policy scale, only some of these explicitly incorporated medical comorbidities as we have done. Those studies that explicitly reported comorbidity adjustments are denoted with asterisks in Table 5. Because of the possible differences in method, some caution should be exercised when making direct comparisons.

Mild dry eye requiring only intermittent treatment was the dry eye state resulting in the least dysutility (utility = 0.81). This level of dysutility is greater than that experienced by patients with mild psoriasis (utility = 0.89). The comorbidity-adjusted utility for moderate dry eye (0.78) was in the range of that reported for

moderate angina (0.75), which was also comorbidity-adjusted. Severe dry eye and severe dry eye requiring tarsorrhaphy were associated with more dramatic reductions in utility (0.72 and 0.62, respectively). This is in the range of utilities reported by patients with class III/IV angina (comorbidity-adjusted utility = 0.71) and is worse than the utility for disabling hip fracture (0.65). Dry eye requiring tarsorrhaphy had even lower utility than monocular painful blindness (0.64). Conditions producing more dysutility than the most severe form of dry eye included moderate and major stroke, complete blindness, and AIDS. As a control, the utility calculated in this study for binocular painful blindness (0.35) was found to be similar to that seen in a previous study examining complete blindness (0.33).<sup>23</sup>

### Discussion

To our knowledge, this is the first report of utilities for dry eye disease. We estimated the mean utility loss of severe dry eye in the absence of comorbidities to be 0.16 by the TTO method (Table 3). The interpretation of this lost utility is that patients expecting to live 10 more years would give up, on average, 1.6 years of that time to be rid of severe dry eye. This loss of utility is similar to that reported for moderate to severe (class III/IV) angina.<sup>19</sup> Less severe dry eye problems might carry a quality-of-life impact greater than that of mild chronic psoriasis. Even moderate dry eye yields comorbidity-adjusted utility scores and lost utility comparable to moderate angina (calculated from references 7 and 19). This suggests that effective treatments for dry eye disease can be expected to restore patient benefits of a magnitude comparable to the benefits produced by treatment for angina.

Numerous methods are available to measure utility. TTO

Table 3. Lost Utility Caused Solely by Ocular Condition

|        | Time Trade-off Lost Utility* (n = 43) |                             |                      |              |                  |                |                                  |                 |
|--------|---------------------------------------|-----------------------------|----------------------|--------------|------------------|----------------|----------------------------------|-----------------|
|        | Monocular Painful Blindness           | Binocular Painful Blindness | Asymptomatic Dry Eye | Mild Dry Eye | Moderate Dry Eye | Severe Dry Eye | Severe Dry Eye Requiring Surgery | Current Dry Eye |
| Mean   | 0.24                                  | 0.52                        | 0.10                 | 0.07         | 0.10             | 0.16           | 0.26                             | 0.07            |
| SD     | 0.22                                  | 0.29                        | 0.16                 | 0.07         | 0.10             | 0.14           | 0.20                             | 0.07            |
| Median | 0.16                                  | 0.49                        | 0.03                 | 0.04         | 0.07             | 0.12           | 0.19                             | 0.04            |

Scale: 0 = No lost utility; 1 = utility loss equivalent to the difference between perfect health and death.  
\*Lost utility = (Utility of comorbidities alone)-(Utility of ocular condition adjusted for comorbidities).

Table 4. Correlation of Unadjusted and Comorbidity-adjusted Current Dry Eye Utility Scores With Other Health Measures

|                            | Time Trade-off (n = 43) |        |          |        |
|----------------------------|-------------------------|--------|----------|--------|
|                            | Unadjusted              |        | Adjusted |        |
|                            | $\rho$                  | P      | $\rho$   | P      |
| OSDI                       |                         |        |          |        |
| Vision                     | -0.17                   | 0.298  | -0.14    | 0.377  |
| Environmental triggers     | -0.12                   | 0.447  | 0.01     | 0.931  |
| Ocular symptoms            | -0.31                   | 0.048* | -0.21    | 0.186  |
| Total                      | -0.16                   | 0.326  | -0.08    | 0.632  |
| SF-36                      |                         |        |          |        |
| Physical functioning       | 0.29                    | 0.060  | 0.36     | 0.018* |
| Role limitation/physical   | 0.30                    | 0.057  | 0.35     | 0.024* |
| Bodily pain                | 0.33                    | 0.035* | 0.32     | 0.037* |
| General health             | 0.16                    | 0.310  | 0.15     | 0.348  |
| Vitality                   | 0.19                    | 0.241  | 0.33     | 0.033* |
| Social functioning         | 0.27                    | 0.084  | 0.26     | 0.103  |
| Role-emotional             | 0.32                    | 0.036* | 0.24     | 0.125  |
| Mental health              | 0.27                    | 0.086  | 0.19     | 0.241  |
| Physical component summary | 0.30                    | 0.056  | 0.31     | 0.045* |
| Mental component summary   | 0.27                    | 0.084  | 0.16     | 0.315  |
| NEI VFQ-25                 |                         |        |          |        |
| General health             | 0.12                    | 0.453  | 0.25     | 0.112  |
| General vision             | 0.16                    | 0.327  | 0.21     | 0.173  |
| Ocular pain                | 0.09                    | 0.594  | 0.09     | 0.579  |
| Near vision                | 0.24                    | 0.122  | 0.24     | 0.127  |
| Distance acuity            | 0.31                    | 0.047* | 0.25     | 0.110  |
| Social functioning         | 0.17                    | 0.273  | 0.19     | 0.232  |
| Mental health              | 0.18                    | 0.253  | 0.17     | 0.291  |
| Role difficulties          | 0.28                    | 0.078  | 0.30     | 0.056  |
| Dependency                 | 0.19                    | 0.234  | 0.15     | 0.350  |
| Driving                    | 0.26                    | 0.106  | 0.15     | 0.342  |
| Color vision               | 0.22                    | 0.166  | 0.28     | 0.070  |
| Peripheral vision          | 0.02                    | 0.922  | 0.24     | 0.130  |
| NEI VFQ-25 composite       | 0.33                    | 0.036* | 0.32     | 0.037* |

\*P  $\leq$  0.05.

OSDI = Ocular Surface Disease Index.

incorporates the quantity of life directly into the utility measure, which some believe makes this a preferred measure<sup>24</sup>; however, others have argued that, because the years given up are at the end of life, this could lead to an upward bias.<sup>12</sup> Perhaps the most important consideration is that comparisons across medical conditions should be made only using similar utility assessment methods and on similar scales.

TTO utilities had only modest correlations with the other health status measures. This was expected, because TTO requires patients to trade years of life, which depends in part on one's degree of risk aversion. The OSDI, NEI VFQ, and SF-36 require no such trade-offs and are not related to the respondent's risk tolerance. In general, unadjusted scores, which did not incorporate comorbidity, correlated better with the vision-related subscales, such as the ocular symptoms subscale of the OSDI and the distance acuity subscale of the NEI VFQ, whereas comorbidity-adjusted utility scores correlated better with global health status measures. Although current dry eye utility significantly correlated with NEI VFQ-25 composite score, the NEI VFQ-25 is not an

adequate replacement for the TTO assay, because it is not a preference-based measure. Furthermore, the NEI VFQ-25 composite score is an unweighted average of the individual components and is not as theoretically valid as the TTO assay. Nonetheless, it is interesting to note that they correlate, underscoring how utility measures are important for measuring the way patients value their health state.

Several observations support the validity of our results. First, our utilities for monocular and binocular blindness are comparable with previously reported results.<sup>9,23</sup> Utilities for dry eye were acceptably reliable on the basis of test-retest intraclass correlations (the lowest reliability was seen for patients' self-assessment of their own condition, consistent with the fluctuations that patients with dry eye have with their symptoms). Moreover, the correlations of unadjusted and comorbidity-adjusted utility scores with other health status measures were in the expected direction for each health measure.

Although we specified "painful" blindness instead of blindness in our scenarios (because dry eye has painful symptoms), this did not result in any reduction in utility scores as might have been expected. It might be that our patients were more risk-averse compared with previously reported populations, or perhaps the marginal dysutility of "painful" in the presence of blindness was perceived as insignificant. Notwithstanding this, our utilities for blindness are strikingly similar to other reports.<sup>9,23</sup>

Some of our observations reflect the well-known complexity of utility assessment analysis and the multiple etiologies of dry eye disease. For example, our rate of misordered data was comparable to previous reports for utilities by TTO.<sup>7</sup> Although a high failure rate has the potential to bias the data, there were no significant predictors of failure rate in our analysis, indicating impartiality. The failure rate might have been lower had we used a selected patient group rather than consecutive enrollment. Also, physician-patient agreement on disease severity was weak, underscoring the differences between patient and physician perceptions of symptoms, and is consistent with the lack of correlation between dry eye symptoms and clinical signs.<sup>2</sup>

We did observe variability in dry eye utilities, as has been reported with utility assessments for other diseases.<sup>7</sup> As a result, it should be cautioned that our utilities might not apply to individual patients; however, from a societal prospective, these estimates (and particularly their trends) seem reasonable given the comparable results with previous reports for blindness.<sup>9,23</sup>

Increasing severity of dry eye from the asymptomatic dry eye to moderate dry eye range did not result in markedly lower mean utilities. For example, TTO utilities were higher for asymptomatic dry eye than for mild dry eye. However, the mean TTO utilities declined as the severity of dry eye increased across the entire spectrum of disease, consistent with our expectations.

Finally, although some analysts recommend assessing utilities from patients not affected with the medical condition of interest (to capture the societal perspective),<sup>22</sup> we desired to maximize the relevance of responses and therefore deliberately chose to sample patients with dry eye. This population also permitted us to correlate patients' utility

Table 5. Utility of Dry Eye Compared with Other Health States

| Health State                      | Medical Condition of Subjects | Mean Utility Time Trade-off | Data Source |
|-----------------------------------|-------------------------------|-----------------------------|-------------|
| Treatment with warfarin           | Atrial fibrillation           | 0.98                        | 25          |
| Mild psoriasis                    | Psoriasis                     | 0.89                        | 15          |
| Mild dry eye*                     | Dry eye                       | 0.81                        | This study  |
| Asymptomatic dry eye*             | Dry eye                       | 0.78                        | This study  |
| Moderate dry eye*                 | Dry eye                       | 0.78                        | This study  |
| Moderate angina*                  | Angina                        | 0.75 <sup>†</sup>           | 7, 19       |
| Severe dry eye*                   | Dry eye                       | 0.72                        | This study  |
| Class III/IV angina*              | Angina                        | 0.71                        | 19          |
| Disabling hip fracture            | Hip fracture                  | 0.65                        | 17          |
| Monocular painful blindness*      | Dry eye                       | 0.64                        | This study  |
| Severe dry eye with tarsorrhaphy* | Dry eye                       | 0.62                        | This study  |
| Moderate stroke                   | Atrial fibrillation           | 0.39                        | 25          |
| Binocular painful blindness*      | Dry eye                       | 0.35                        | This study  |
| Complete blindness                | Cataract                      | 0.33                        | 23          |
| AIDS                              | HIV                           | 0.21                        | 26          |
| Major stroke                      | Atrial fibrillation           | 0.11                        | 25          |

\*Comorbidity explicitly incorporated in utility.  
<sup>†</sup>Calculated from data presented in both articles.

assessments with other clinical and vision-related quality-of-life measures among patients with the disease.

In summary, all severities of dry eye disease reduced quality of life, with severe dry eye resulting in lost utility comparable to that reported for moderate to severe (class III/IV) angina, underscoring the seriousness with which patients with dry eye view their disease. This substantial lost utility represents an opportunity for therapeutic interventions, and these results provide the basis for rigorous cost-effectiveness analyses for dry eye disease.

## References

- Schein OD, Munoz B, Tielsch JM, Bandeen-Roche K, West S. Prevalence of dry eye among the elderly. *Am J Ophthalmol* 1997;124:723-8.
- Lemp MA. Report of the National Eye Institute/Industry workshop on clinical trials in dry eyes. *CLAO* 1995;21:221-32.
- Schiffman RM, Christianson MD, Jacobsen G, Hirsch JD, Reis BL. Reliability and validity of the Ocular Surface Disease Index. *Arch Ophthalmol* 2000;118:615-21.
- McHorney CA, Ware JE Jr, Raczek AE. The MOS 36-Item Short-Form Health Survey (SF-36): II. Psychometric and clinical tests of validity in measuring physical and mental health constructs. *Med Care* 1993;31:247-63.
- Mangione CM, Lee PP, Gutierrez PR, Spritzer K, Berry S, Hays RD. Development of the 25-item National Eye Institute Visual Function Questionnaire. *Arch Ophthalmol* 2001;119:1050-8.
- Drummond MF, O'Brien BJ, Stoddart GL, Torrance GW. *Methods for the Economic Evaluation of Health Care Programmes*, 2nd ed. New York: Oxford University Press, 1997: 139-99.
- Nease RF, Whitcup SM, Ellwein LB, Fox G, Littenberg B. Utility-based estimates of the relative morbidity of visual impairment and angina. *Ophthalmic Epidemiol* 2000;7:169-85.
- Brown GC, Sharma S, Brown MM, Kistler J. Utility values and age-related macular degeneration. *Arch Ophthalmol* 2000; 118:47-51.
- Brown MM, Brown GC, Sharma S, Kistler J, Brown H. Utility values associated with blindness in an adult population. *Br J Ophthalmol* 2001;85:327-31.
- Brown MM, Brown GC, Sharma S, Shah G. Utility values and diabetic retinopathy. *Am J Ophthalmol* 1999;128:324-30.
- Torrance GW. Social preferences for health states: an empirical evaluation of three measurement techniques. *Socio-Econ Plan Sci* 1976;10:129-36.
- Johannesson M, Pliskin JS, Weinstein MC. A note on QALYs, time tradeoff, and discounting. *Med Decis Making* 1994;14: 188-93.
- Folstein MF, Folstein SE, McHugh PR. "Mini-mental state." A practical method for grading the cognitive state of patients for the clinician. *J Psychiatr Res* 1975;12:189-98.
- Sumner W, Nease R, Littenberg B. U-titer: a utility assessment tool. *Proc Annu Symp Comput Appl Med Care* 1991: 701-5.
- Zug KA, Littenberg B, Baughman RD, et al. Assessing the preferences of patients with psoriasis. A quantitative, utility approach. *Arch Dermatol* 1995;131:561-8.
- Nease RF Jr, Kneeland T, O'Connor GT, et al. Variation in patient utilities for outcomes of the management of chronic stable angina. Implications for clinical practice guidelines. Ischemic Heart Disease Patient Outcomes Research Team. *JAMA* 1995;273:1185-90.
- Gabriel SE, Kneeland TS, Melton LJ 3rd, Moncur MM, Ettinger B, Tosteson AN. Health-related quality of life in economic evaluations for osteoporosis: whose values should we use? *Med Decis Making* 1999;19:141-8.
- Albertsen PC, Nease RF Jr, Potosky AL. Assessment of patient preferences among men with prostate cancer. *J Urol* 1998;159:158-63.
- Harris RA, Nease RF Jr. The importance of patient preferences for comorbidities in cost-effectiveness analyses. *J Health Econ* 1997;16:113-9.
- Detsky AS, McLaughlin JR, Abrams HB, et al. A cost-utility analysis of the home parenteral nutrition program at Toronto

- General Hospital: 1970–1982. *JPEN J Parenter Enteral Nutr* 1986;10:49–57.
21. Tousignant P, Cosio MG, Levy RD, Groome PA. Quality adjusted life years added by treatment of obstructive sleep apnea. *Sleep* 1994;17:52–60.
  22. Torrance GW, Feeny D. Utilities and quality-adjusted life years. *Int J Technol Assess Health Care* 1989;5:559–75.
  23. Bass EB, Wills S, Scott IU, et al. Preference values for visual states in patients planning to undergo cataract surgery. *Med Decis Making* 1997;17:324–30.
  24. Richardson J. Cost utility analysis: what should be measured? *Soc Sci Med* 1994;39:7–21.
  25. Gage BF, Cardinali AB, Owens DK. The effect of stroke and stroke prophylaxis with aspirin or warfarin on quality of life. *Arch Intern Med* 1996;156:1829–36.
  26. Sanders GD, Owens DK, Padian N, Cardinali AB, Sullivan AN, Nease RF. A computer-based interview to identify HIV risk behaviors and to assess patient preferences for HIV-related health states. *Proc Annu Symp Comput Appl Med Care*, Washington, DC 1994:20–4.

# EXHIBIT H

**THE 2002 GALLUP STUDY OF  
DRY EYE SUFFERERS**

**Summary Volume**

*Wolfgang Storz*  
*Summary*  
*11/02*

*www.gallup.com*

## ATTITUDES TOWARD DRY EYE

---

- ◆ Eight in ten dry eye sufferers (79%) agree that if left untreated, dry eye can lead to more serious eye problems. Despite this widespread agreement, six in ten (61%) say they don't treat their dry eye as regularly as they should.
- ◆ Three in four (74%) wish there was a more effective treatment for their dry eye, yet nearly as many (69%) say they are satisfied with the treatment being used. However, it should be noted that almost twice as many strongly agree that they wish there was something more effective than are satisfied with the current treatment (34% vs. 19%).
- ◆ A majority of sufferers take their dry eye problem seriously as only one in three (35%) agree "*dry eyes are no big deal*".
- ◆ Fewer than four in ten (36%) feel their dry eye problem might be a symptom of another health problem.

**The Question:** Please indicate the extent to which you agree or disagree with each of the following statements. (Q. 30)



## ATTITUDES TOWARD DRY EYE

|   | <u>Agree<br/>Strongly</u><br>% | <u>Agree<br/>Somewhat</u><br>% | <u>Disagree<br/>Somewhat</u><br>% | <u>Disagree<br/>Strongly</u><br>% | <u>Don't<br/>Know</u><br>% | <u>Total</u><br>% |
|---|--------------------------------|--------------------------------|-----------------------------------|-----------------------------------|----------------------------|-------------------|
| You can never be too careful when it comes to eye health.         | 73                             | 22                             | 4                                 | 0                                 | 1                          | 100               |
| If left untreated, dry eye can lead to more serious eye problems. | 31                             | 48                             | 18                                | 2                                 | 1                          | 100               |
| I wish there was something more effective to treat my dry eye.    | 34                             | 40                             | 19                                | 5                                 | 2                          | 100               |
| I am satisfied with the dry eye treatment I am using.             | 19                             | 50                             | 21                                | 8                                 | 2                          | 100               |
| Dry eyes are an inevitable part of aging.                         | 14                             | 53                             | 26                                | 6                                 | 1                          | 100               |
| I don't treat my dry eye as regularly as I should.                | 13                             | 48                             | 23                                | 14                                | 2                          | 100               |
| I am worried my dry eye is a symptom of another health problem.   | 10                             | 26                             | 37                                | 25                                | 2                          | 100               |
| Dry eyes are no big deal.   | 6                              | 29                             | 32                                | 31                                | 2                          | 100               |

(n=501)

## IMPORTANCE OF ATTRIBUTES IN BRAND PURCHASE DECISION

- ◆ A doctor's recommendation (85%) is the attribute most likely to be rated very important in the brand purchase decision of eye ointment or gel. Majorities also assign very important ratings to a product that is long-lasting (73%) or fast-acting (66%).
- ◆ Substantially smaller proportions rate as very important the brand reputation (40%) or price (31%).

|                       | Users of Ointment/Gel  |                            |                            |                              |                    | Total<br>% |
|-----------------------|------------------------|----------------------------|----------------------------|------------------------------|--------------------|------------|
|                       | Very<br>Important<br>% | Somewhat<br>Important<br>% | Not Very<br>Important<br>% | Not At All<br>Important<br>% | Don't<br>Know<br>% |            |
| Physician recommended | 85                     | 5                          | 1                          | 5                            | 4                  | 100        |
| Long-lasting          | 73                     | 14                         | 2                          | 2                            | 9                  | 100        |
| Fast-acting           | 66                     | 17                         | 4                          | 2                            | 11                 | 100        |
| Brand reputation      | 40                     | 23                         | 12                         | 10                           | 15                 | 100        |
| Price                 | 31                     | 23                         | 32                         | 1                            | 13                 | 100        |

(n=47\*)

\* Sample size too small for reliable statistical analysis.

**The Question:** How important are the following attributes in your decision of what brand of eye ointment or gel to purchase? (Q. 29)

# EXHIBIT I

## A UNIFIED THEORY OF THE ROLE OF THE OCULAR SURFACE IN DRY EYE

Michael E. Stern,<sup>1</sup> Roger W. Beuerman,<sup>2</sup> Robert I. Fox,<sup>3</sup> Jianping Gao,<sup>1</sup>  
Austin K. Mircheff,<sup>4</sup> and Stephen C. Pflugfelder<sup>5</sup>

<sup>1</sup>Allergan, Inc.

Irvine, California

<sup>2</sup>Louisiana State University Eye Center  
New Orleans, Louisiana

<sup>3</sup>Scripps Research Foundation  
La Jolla, California

<sup>4</sup>University of Southern California  
Los Angeles, California

<sup>5</sup>University of Miami  
Miami, Florida

### 1. INTRODUCTION

Dry eye symptoms arise from a series of etiologies and are manifest in different patients with varying severity. The National Eye Institute/Industry Workshop on Clinical Trials in Dry Eyes, under the chairmanship of Dr. Michael A. Lemp, defined specific subtypes of dry eye in order to standardize clinical tests used in diagnosis and design of clinical studies.<sup>1</sup> The use of artificial tears is palliative at best, resulting in a reduction of ocular surface eyelid shear forces and some symptomatic relief. Future research should focus on mechanistic endpoints. What causative factor(s) initiates the sequence of events resulting in the clinical symptoms suffered by the patient?

This review emphasizes observations that the ocular surface (cornea, conjunctiva, accessory lacrimal glands, and meibomian glands), the main lacrimal gland, and the interconnecting reflexive innervation compose a "functional unit" (Fig. 1) whose parts act together as a servomechanism and not in isolation. In the normal individual, when afferent nerves of the ocular surface are stimulated, a reflex results in immediate blinking, withdrawal of the head, and secretion of copious amounts of reflex tears from the main lacrimal gland. These tears contain proteins, mucin, and water. Similarly, in people who face chronic ocular surface irritation due to environmental factors (contact lens, low humidity, wind, etc.), there is chronic stimulation of the lacrimal gland resulting in secretion of "sup-

**LACRIMAL GLAND / OCULAR SURFACE  
Functional Unit**

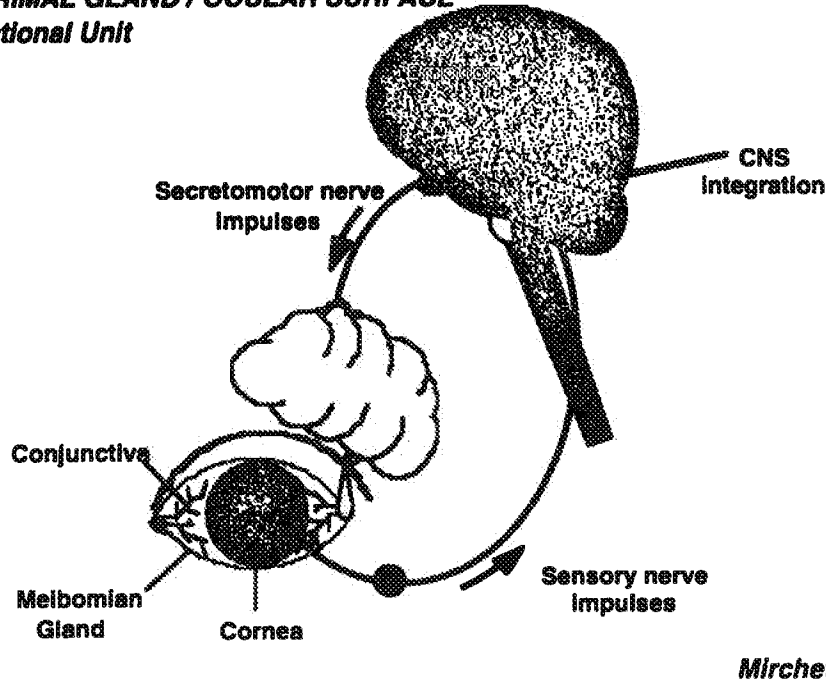

*Mircheff*

Figure 1. The functional unit comprising the ocular surface, the main lacrimal gland, and the interconnecting innervation.

portive" tears that can maintain and repair the ocular surface. In individuals suffering from dry eye, however, chronic inflammation of the ocular surface as well as of the lacrimal glands can be detected.

This "chronic" inflammation results in inflammatory cytokine secretion from the main lacrimal gland as well as the ocular surface that may interrupt both afferent and efferent arcs of the reflex and therefore impair function. The result of this pathology is a constant ocular surface irritation, which in its most severe form propagates a debilitating disease progression resulting in an inability of the patient to function normally at home or in the workplace.

The alterations in each component of the ocular surface/lacrimal gland reflex will be described.

## 2. OCULAR SURFACE

The ocular surface is challenged by the shear force across its surface due to blinking,<sup>2</sup> air currents, low humidity-induced desiccation, and foreign bodies (including contact lenses). Additionally, the ocular surface is confronted with several types of bacteria as well as viruses. The ocular surface in normal individuals remains intact and is able to repair the damage produced by these constant insults. Pflugfelder *et al.*<sup>3</sup> have shown, that diagnostic dyes, rose bengal and fluorescein, do not stain normal conjunctiva or cornea. Nelson *et al.*,<sup>4</sup> using impression cytology, however have indicated that some transient ab-

normalities can be found in clinically normal conjunctiva of people living in challenging environments. Patients with Sjögren's syndrome, who demonstrate a severe lack of aqueous tears, stain abundantly in the exposure zone.<sup>4</sup> In normal individuals, minor traumas, such as those already described, are rapidly healed and pose no chronic threat to the ocular surface. This is possibly due to the presence of a trophic surface environment consisting of a normal, non-inflammatory tear film. The tears in the normal individual may vary in quantity. It appears that a chronic alteration in nerve stimulation of the lacrimal gland in a dry eye individual results in inflammation and lymphocytic infiltration of the lacrimal glands. This results in secretion of diminished and altered tears that contain inflammatory cytokines, resulting in an abnormal ocular surface epithelium. The conjunctival and corneal epithelia have also been demonstrated to be competent to secrete IL-1 $\alpha$ , TNF- $\alpha$ , IL-6, and IL-8.<sup>5</sup> The question then becomes, what conditions result in the inability of the ocular surface and the lacrimal glands to respond normally to chronic environmental challenges? Although this has not been resolved, several studies have indicated that a dramatic loss in systemic androgens found in a major target population, the peri- and post-menopausal female, results in a loss of support for lacrimal secretory function and production of an anti-inflammatory environment.<sup>6,7</sup>

### 3. CONJUNCTIVA

The conjunctiva covers the entire ocular surface outside of the cornea. Its surface is composed of a stratified mucus-secreting epithelium and a population of goblet cells also responsible for the mucus secretion. Mucus is one of the main defense mechanisms against various microtrauma. Shear forces applied during blinking (12–15/min) can cause significant trauma to the non-lubricated ocular surface.<sup>2</sup> If superficial trauma is induced by placing a Schirmer test strip or impression cytology membrane on the conjunctival surface, the eye will stain with rose bengal. In the normal eye, staining will no longer be observed after 24 h, indicating that a reparative process actively restores the normal surface barrier. Pflugfelder et al. (personal communications) have developed a model of conjunctival responses to microtrauma in the rabbit using nitrocellulose membranes to remove the superficial two cell layers. Then healing and cellular wound healing behavior are followed. An increase in epithelial proliferation was detected within 1 h and remained elevated for 3 days. Abnormal patterns of expression of various cell markers were detected for 1 week. A marker for basal epithelial cells, cytokeratin 14, was expressed throughout the entire epithelium,<sup>8</sup> and the number of cells staining for the presence of conjunctival mucin was reduced.<sup>9</sup> Increases in the concentrations of mRNA for inflammatory cytokines such as TNF- $\alpha$ , IL-1 $\alpha$ , and IL-8 were also detected within conjunctival epithelial cells at the site of the microtrauma.<sup>10</sup> This phenomenon is important in part because of the conjunctival squamous metaplasia seen in moderate to severe dry eye as well as in Sjögren's syndrome. This response is seen as chronic wound healing due to the constant motion of the upper eyelid shear forces generated during blinking. Cytokine synthesis is then initiated in the traumatized corneal and conjunctival epithelium, as well as cytokines present in the lacrimal secretions, in an individual with an unsupported ocular surface (Fig. 1). In Sjögren's syndrome patients, T-cell infiltration of the conjunctiva has been found in both the epithelium and stroma.<sup>11,12</sup> Increased levels of IL-1 $\alpha$ , TNF- $\alpha$ , IL-6, IL-8, and IL-10 have been found in the conjunctival epithelium of these patients when compared to control.<sup>5,13</sup> These patients, for the most part, also demonstrated expression of immune activation markers HLA-DR and ICAM-1.<sup>5</sup> The immunomodulatory drug cyclosporine,<sup>13</sup> as well as steroids,

have been found to reduce ocular surface rose bengal staining. Additionally, studies in the dry eye dog model have demonstrated that cyclosporine A eliminates both the conjunctival and lacrimal gland lymphocytic infiltrates.<sup>4</sup>

Alterations in the conjunctiva, such as those mentioned, occur as increased tear film abnormalities in people with keratoconjunctivitis sicca (KCS). A chronic inflammatory environment on the ocular surface results in pathologic alterations of the conjunctival epithelium known as squamous metaplasia.<sup>3,15</sup> A decrease in tear fluid secretion has been correlated with an increase in conjunctival rose bengal staining.<sup>4</sup> Patients with Sjögren's syndrome, who are unable to tear even in response to stimulation of the nasal mucosa,<sup>16</sup> have very severe ocular surface irritation. Patients with a decrease in lacrimation also have a decrease in various proteins such as lactoferrin and lysozyme.<sup>17,18</sup> Several other proteins, secreted in tears, that may be trophic to the ocular surface as well as providing an anti-inflammatory environment, are also being investigated.<sup>13,17</sup> It is reasonable to assume that in situations where these proteins are diminished, a pathogenic environment will exist in the ocular surface.

In many types of dry eye, in particular those associated with systemic signs of autoimmune disease, the lacrimal gland becomes infiltrated with lymphocytes. These inflammatory cells adversely affect the function of the lacrimal gland, resulting in altered tear composition and compromise of the ocular surface. The initial glandular dysfunction, however, is most probably caused by a "disconnect" at the neural/glandular interface in the perivascular region. Interruption of the neural signal at this juncture is probably part of the same mechanism that initiates the migration and proliferation of lymphocytes in the lacrimal gland and conjunctiva.

#### 4. OCULAR SURFACE INNERVATION

The ocular surface is exquisitely innervated, with the cornea having a density of free nerve endings approximately 60X that of tooth pulp. Corneal sensation is very acute and is centrally processed and interpreted solely as pain. The conjunctiva does not transmit as acute sensations as does the cornea and is known to feel itch as well as some temperature discrimination. It is well known that corneal stimulation results in a rapid reflex including immediate blinking, profuse reflex tearing, and withdrawal of the head. The neural pathway for this reflex as well as normal tearing have been partially elucidated (Fig. 2). Sensory (afferent) traffic from the cornea and conjunctiva travels down the ophthalmic branch (1) of the trigeminal nerve (V) through the trigeminal ganglion into the spinal trigeminal nucleus located in the brainstem. The initial synapse occurs in this nucleus, and neurons then travel up to the midbrain (pons), or the preganglionic sympathetic neurons in the spinal cord and then the superior cervical ganglion, located in the paravertebral sympathetic chain. Efferent fibers from the pons extend, via the facial (VII) nerve, to the pterygopalatine ganglion located adjacent to the orbit, where they again synapse and then send fibers to the lacrimal gland where they influence the secretomotor function (modulation of water and protein transport). Sympathetic fibers from the superior cervical ganglion also enter the lacrimal gland. Schafer *et al.*<sup>19</sup> have indicated that parasympathetic neural transmission can be inhibited by cytokines. Therefore, the pro-inflammatory cytokines such as are found in the lacrimal and salivary gland biopsies of patients with Sjögren's syndrome may inhibit neural stimulation of these target tissues.

It is important to note that the control of accessory lacrimal glandular secretion as well as conjunctival goblet cell secretion is only now being investigated. Work by Seiffert

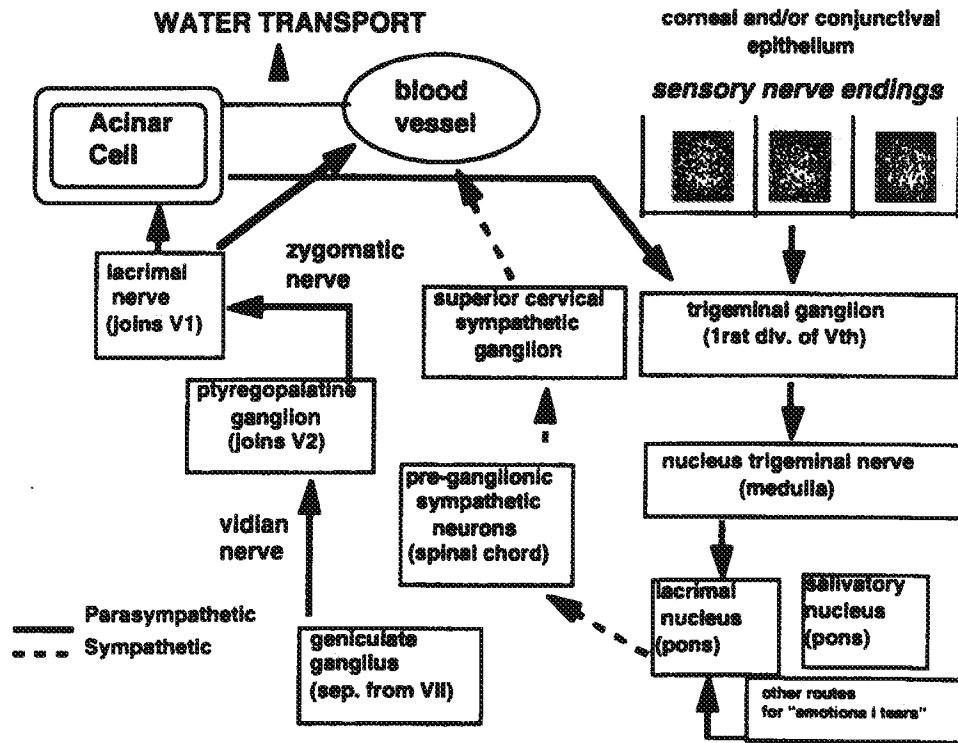

Figure 2. Afferent and efferent paths of lacrimal gland innervation for stimulation of tear flow.

et al.,<sup>20</sup> has demonstrated that the accessory glands are innervated, and Dartt et al.,<sup>21</sup> have also shown that the conjunctival goblet cells are innervated and respond to the presence of vasoactive intestinal peptide (VIP).

## 5. LACRIMAL GLAND

The lacrimal glands sit at the other end of the neural reflex. The main lacrimal gland resides just superior and temporal to the ocular globe. The accessory glands of Wolfring and Krause reside with the superior bulbar conjunctiva and the upper lid respectively. Although the etiology of dry eye is believed to be multifactorial and can be related to deficiencies in any of the three layers of the tear film, the major cause in Sjögren's syndrome has been reported to be a deficiency in aqueous tear production from the main and accessory lacrimal glands.<sup>1,7</sup> As in the salivary glands of patients with Sjögren's syndrome, as well as the conjunctiva in dogs with KCS,<sup>14</sup> the lacrimal glands of patients with immune-related dry eye have been found to be progressively infiltrated with lymphocytes. Immunohistochemical studies have demonstrated that these infiltrates consist primarily of CD4+ T cells and B cells.<sup>22,23</sup> Classically, this type of lymphocytic accumulation in the interstitium of the lacrimal or salivary gland is thought to result in immune-associated destruction of the epithelial cells in the target tissues, reduce aqueous tear secretion, and subsequently cause dry eye. The possible mechanisms are currently under investigation and discussion. The accumulated evidence indicates that the epithelial cells in the lacrimal and salivary



tissues have the potential to be antigen-presenting cells. *In vitro*, the lacrimal acinar cells have shown the ability to express MHC II following carbachol induction.<sup>24</sup> *In vivo*, acinar cells in the salivary gland of patients and the lacrimal gland of MRL/lpr mouse model of Sjögren's syndrome strongly express class II antigens.<sup>5,25,26</sup> Additionally, a recent study using PCR-single-strand conformation polymorphism (SSCP) showed that some infiltrating T cells in both lacrimal and salivary glands of Sjögren's patients recognize the shared epitopes on autoantigens, suggesting the importance of restricted epitopes of common autoantigens in the initiation of Sjögren's syndrome.<sup>27</sup> Therefore, it is reasonable to propose that the epithelial cells in inflamed lacrimal or salivary tissues are able to present autoantigens to the cell surface receptors such as T cell antigen receptors. The activated T cells can then secrete inflammatory cytokines such as IL-1 $\beta$ , IL-2, IFN- $\gamma$ , and TNF- $\alpha$ , which may contribute to a continued local autoimmune stimulation and result in infiltration and proliferation of migrating T-cells within the glands, which, left unchecked, would result in glandular destruction.<sup>28-30</sup> Additionally, these pro-inflammatory cytokines can inhibit neural transmission of parasympathetic pathways and subsequently suppress neural stimulation of the lacrimal gland.<sup>19</sup>

It has become clear that lacrimal gland function is significantly influenced by sex hormones.<sup>31,32</sup> Among these actions discovered during the past decade, androgen has been found to exert essential and specific effects on maintaining the normal glandular function as well as suppressing the inflammation in the lacrimal gland of normal and autoimmune animal models.<sup>32-37</sup> This unique capacity of androgens is initiated through its specific binding to receptors in the acinar nuclei of the lacrimal gland and, in turn, lead to an altered expression of various cytokines and proto-oncogenes in these lacrimal gland epithelial cells.<sup>7,38</sup> The immunosuppressive activity of androgens in lacrimal gland during Sjögren's syndrome is proposed to be attributed to its ability to induce the accumulation of anti-inflammatory cytokines such as TGF- $\beta$ .<sup>7,39</sup> Given the critical role that androgen plays in many aspects of lacrimal gland, from anatomy to molecular modulation, it has been hypothesized that a decrease in androgen level below a certain threshold may result in lacrimal atrophy.<sup>6</sup> Apoptosis in the plasma cells of the lacrimal gland interstitium was detected 4 h following withdrawal of androgen in ovariectomized rabbits with atrophic and necrotic changes in the acinar cells occurring over the ensuing several days.<sup>37</sup> The resulting apoptotic fragments are also suggested to be a source of potential autoantigens and could be subsequently presented either by interstitial antigen-presenting cells or acinar cells to CD4 cell antigen receptors to initiate the autoimmune response. Our recent study in KCS dogs indicated that apoptosis plays an important role in dry eye pathogenesis. The data suggest that both the elevated epithelial cell apoptosis and the suppressed lymphocytic apoptosis in the lacrimal and conjunctival tissues of KCS dogs may be involved in the dry eye mechanisms.<sup>40</sup>

## 6. SUMMARY

It is our belief that the pathology of dry eye occurs when systemic androgen levels fall below the threshold necessary for support of secretory function and generation of an anti-inflammatory environment (Fig. 3). When this occurs, both the lacrimal gland and the ocular surface become irritated and inflamed, and they secrete cytokines that interfere with the normal neural connections that drive the tearing reflex. This leaves the lacrimal gland in an isolated condition, perhaps exacerbating atrophic alterations of the glandular tissue. These changes allow for antigen presentation at the surface of the lacrimal acinar

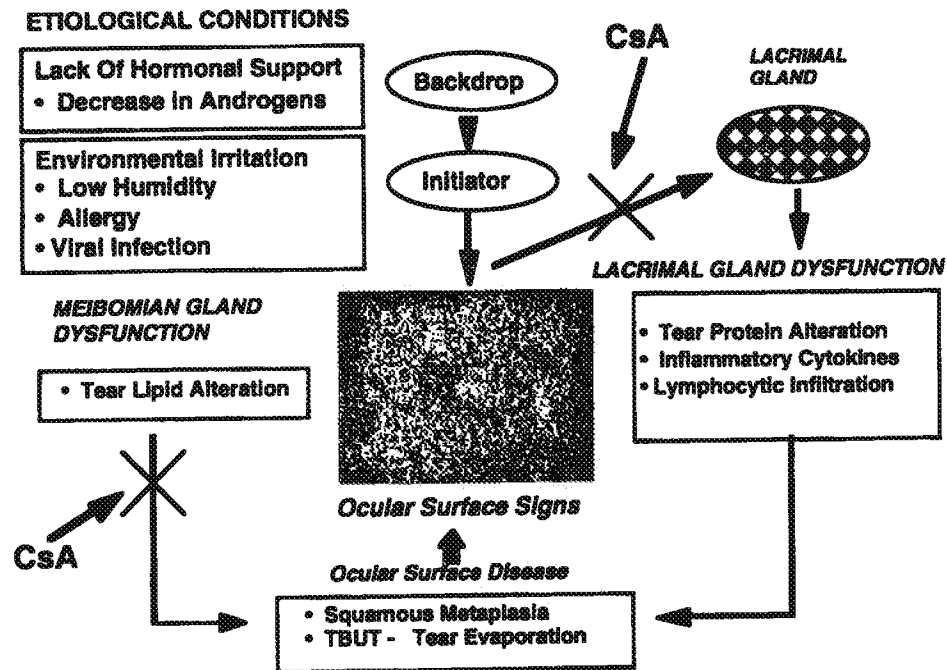

Figure 3. Proposed model of etiology and pathogenesis of dry eye. Included are etiologic factors (background, initiator) and the sequence of events resulting in alterations of the ocular surface. Possible therapeutic interventions (cyclosporine, androgens) are indicated.

cells and increase lymphocytic infiltration of the gland. A similar series of events may be occurring on the ocular surface.

From this hypothesis we conclude:

1. The ocular surface, lacrimal gland, and interconnecting innervation act as an integrated servo-mechanism.
2. Once the lacrimal gland loses its androgen support, it is subject to immune/ neurally mediated dysfunction.
3. The ocular surface is an appropriate target for dry eye therapeutics.

## REFERENCES

1. Lemp ME. Report of the National Eye Institute / Workshop on Clinical Trials in Dry Eye. *CLAO J.* 1995;221-232.
2. Kessing AV. A new division of the conjunctiva on the basis of x-ray examination. *Acta Ophthalmol.* 1967;45:680-683.
3. Pflugfelder SC, Tseng SCG, Yoshino K, Monroy D, Felix C, Reis. Correlation of goblet cell density and mucosal epithelial mucin expression with rose bengal staining in patients with ocular irritation. *Ophthalmology*, in press.
4. Nelson JD, Havener VR, Cameron JD. Cellose acetate impression of the ocular surface. *Arch Ophthalmol.* 1983;101:1869-1872.
5. Jones DT, Monroy D, Ji Z, Atherton SS, Pflugfelder SC. Sjogren's syndrome; cytokine and Epstein-Barr virus gene expression within the conjunctival epithelium. *Invest Ophthalmol Vis Sci.* 1994;35:3493-3503.

6. Mircheff AK, Warren DW, Wood RL. Hormonal support of lacrimal function, primary lacrimal deficiency, autoimmunity, and peripheral tolerance in the lacrimal gland. *Ocul Immunol Inflamm.* 1996;4:145-172.
7. Sullivan DA, Wickham LA, Krenzer KL, et al. In: Pleyer U, Hartmann C, Sterry W, eds. *Oculodermal Diseases- Immunology of Bullous Oculo-Muco-Cutaneous Disorders*. Buren, The Netherlands: Aeolus Press, 1997 in press.
8. Yen MT, Pflugfelder SC, Crouse CA, Atherton SS. Cytoskeletal antigen expression in ocular mucosa-associated lymphoid tissue. *Invest Ophthalmol Vis Sci.* 1992;33:3235-3243.
9. Huang AJW, Tseng SCG. Development of monoclonal antibodies to rabbit ocular mucin. *Invest Ophthalmol Vis Sci.* 1987;28:1483-1491.
10. Naqui R, Ji Z, Pflugfelder SC. Immune cytokine RNA expression by human conjunctival epithelium after superficial microtrauma. ARVO abstracts. *Invest Ophthalmol Vis Sci.* 1996;37:356.
11. Hikichi T, Yoshida A, Tsubota K. Lymphocytic infiltration of conjunctiva and salivary gland in Sjigren's syndrome. *Arch Ophthalmol.* 1993;111:21-22.
12. Raphael M, Bellefghih S, Piette, JCH. Conjunctival biopsy in Sjigren's syndrome; correlations between histologic and immunohistochemical features. *Histopathology.* 1988;13:191-202.
13. Pflugfelder SC, Ji Z, Naqui R. Immune cytokine RNA expression in normal and Sjigren's syndrome conjunctiva. ARVO Abstracts. *Invest Ophthalmol Vis Sci.* 1996;37:S358.
14. Stern MS, Gelber TA, Gao J, Ghosn CR. The effects of topical cyclosporin A (CsA) on dry eye dogs (KCS). ARVO Abstracts. *Invest Ophthalmol Vis Sci.* 1996;37:S4715.
15. Pflugfelder SC, Huang AJW, Feuer W. Conjunctival cytologic features of primary Sjigren's syndrome. *Ophthalmology.* 1990;97:985-991.
16. Tsubota K. The importance of the Schirmer test with nasal stimulation. *Am J Ophthalmol.* 1991;111:106-108.
17. Seal DV, Mackie IA. Diagnostic implications of tear protein profiles. *Br J Ophthalmol.* 1984;68:321-324.
18. Danjo Y, Lee M, Horimoto K, Hamano T. Ocular surface damage and tear lactoferrin level in dry eye syndrome. *Acta Ophthalmol.* 1994;72:433-447.
19. Schafer M, Carter L, Stein C. Interleukin 1 beta and corticotropin-releasing factor inhibit pain by releasing opioids from immune cells in inflamed tissue. *Proc Natl Acad Sci USA.* 1994;91:4219-4213.
20. Seifert P, Spitznas M. Demonstration of nerve fibers in human accessory lacrimal glands. *Graefes Arch Clin Exp Ophthalmol.* 1994;232:107-114.
21. Dartt DA, Baker AK, Vailan C, Rose PE. Vasoactive intestinal polypeptide stimulation of protein secretion from rat lacrimal gland acini. *Am J Physiol.* 1984;247:G502-G509.
22. Pflugfelder SC, Wilhelmus KR, Osato MS, Matoba AY, Fond RL. The autoimmune nature of aqueous tear deficiency. *Ophthalmology.* 1986;93:1513-1517.
23. Pepose JS, Akata RF, Pflugfelder SC, Vorgt W. Mononuclear cell phenotypes and immunoglobulin rearrangements in lacrimal gland biopsies from patients with Sjigren's syndrome. *Ophthalmology.* 1990;97:1599-1605.
24. Mircheff AK, Wood RL, Gierow JP. Traffic of major histocompatibility complex Class II molecules in rabbit lacrimal gland acinar cells. *Invest Ophthalmol Vis Sci.* 1994;35:3943-3915.
25. Fox RI, Bumol T, Fantozzi R, et al. Expression of histocompatibility antigen HLA-DR by salivary gland epithelial cells in Sjigren's syndrome. *Arthritis Rheum.* 1986;29:1105-1111.
26. Homma M, Sugai S, Tojo T, Miyasaka N, Akizuki M, eds. *Sjigren's syndrome. State of the Art*. Amsterdam: Kugler Press; 1994.
27. Matsumoto I, Tsubota K, Satake Y, et al. Common T cell receptor clonotype in lacrimal glands and labial salivary glands from patients with Sjigren's syndrome. *J Clin Invest.* 1996;97:1969-1977.
28. Kroemer G, Martinez A. Cytokines and autoimmune diseases. *Clin Immunol Immunopathol.* 1991;61:275-195.
29. Rowe D, Griffiths M, Stewart J, Novick D, Beverly PCL, Isenberg DA. HLA class I and II, interferon, interleukin 2 and interleukin 2 receptor expression on labial biopsy specimens from patients with Sjigren's syndrome. *Ann Rheum Dis.* 1987;46:580-586.
30. Oxholm P, Daniels TE, Bendtzen K. Cytokine expression in labial salivary glands from patients with primary Sjigren's syndrome. *Autoimmunity.* 1992;12:185-191.
31. Ahmed SA, Penhale WJ, Talal N. Sex hormones, immune responses and autoimmune diseases. *Am J Pathol.* 1985;121:531-551.
32. Ahmed SA, Talal N. Sex hormones and the immune system-part 2. Animal data. *Baillieres Clin Rheumatol.* 1990;4:13-31.
33. Sullivan DA, Bloch KJ, Allansmith MR. Hormonal influence on the secretory immune system of the eye: Androgen regulation of secretory component levels in rat tears. *J Immunol.* 1984;132:1130-1135.

34. Vendramini AC, Soo C, Sullivan DA. Testosterone-induced suppression of autoimmune disease in lacrimal tissue of a mouse model (NZB/NZW F1) of Sjögren's syndrome. *Invest Ophthalmol Vis Sci.* 1991;32:3002–3006.
35. Sato EH, Sullivan DA. Comparative influence of steroid hormones and immunosuppressive agents on autoimmune expression in lacrimal glands of female mouse model of Sjögren's syndrome. *Invest Ophthalmol Vis Sci.* 1994;35:2632–2642.
37. Azzarolo AM, Kaswan RL, Mircheff AK, Warren DW. Androgen prevention of lacrimal gland regression after ovariectomy of rabbits. ARVO Abstracts. *Invest Ophthalmol Vis Sci.* 1994;35:S1793.
38. Azzarolo AM, Olsen E, Huang ZM, et al. Rapid onset of cell death in lacrimal glands after ovariectomy. ARVO Abstracts. *Invest Ophthalmol Vis Sci.* 1996;37:S856.
39. Clark JH, Schrader WT, O'Malley Mechanisms of action of steroid hormones. In: Wilson JD, Foster DW, eds. *William Textbook of Endocrinology*. Philadelphia: WB Saunders 1992: 35–90.
40. Huang Z, Gao J, Wickham LA, Sullivan DA Influence of gender and androgen treatment on TGF- $\beta$ 1 mRNA levels in the rat lacrimal gland. ARVO Abstracts. *Invest Ophthalmol Vis Sci.* 1995;35:S991.
41. Gao J, Gelber-Schwalb TA, Addeo JV, Stern ME. Apoptosis in the lacrimal gland and conjunctiva of dry eye dogs. This volume.

# EXHIBIT J

---

## **Integrating Restasis into the Management of Dry Eye**

---

**Stephen C. Pflugfelder, MD**

The approval of cyclosporin emulsion for treatment of the inflammatory component of dry eye by the US Food and Drug Administration in December 2002 represents a major paradigm shift in the treatment of dry eye and in our understanding of its pathogenesis. There is mounting evidence from basic and clinical research demonstrating that inflammation is both a cause and consequence of dry eye. Certain inflammatory mediators, such as interleukin 1 have been found to cause lacrimal dysfunction through functional paralysis of the secretory epithelia,<sup>1</sup> whereas others (eg, interferon- $\gamma$  and tumor necrosis factor- $\alpha$ ) may interfere with normal differentiation and promote apoptosis of lacrimal gland and ocular surface epithelial cells.<sup>2,3</sup>

Topical cyclosporine emulsion has been found to have a salutary effect on ocular irritation symptoms, tear production, and ocular surface epithelial disease in patients with keratoconjunctivitis sicca.<sup>4</sup> Several mechanisms of action of cyclosporine emulsion have been identified, including inhibition of epithelial apoptosis and cytokine production by the activated T lymphocytes that infiltrate the conjunctiva in keratoconjunctivitis sicca.<sup>5,6</sup> T-cell infiltration of the conjunctiva has been found to be a feature of Sjögren and non-Sjögren syndrome keratoconjunctivitis sicca.<sup>7</sup> These T cells seem to be chemoattracted by the stressed ocular surface epithelia and once in place produce factors such as IFN- $\gamma$  that push differentiation of the ocular surface epithelium toward a poorly wettable skinlike pattern. These findings suggest that keratoconjunctivitis sicca is similar to psoriasis and inflammatory bowel disease, conditions where T cells have been identified to play a key role in the epithelial pathology.<sup>8,9</sup> The improved understanding of the pathogenesis of keratoconjunctivitis sicca, particularly the role of T cells in this process, helps to explain the observed clinical efficacy of topical cyclosporine emulsion for treatment of this condition.

How does cyclosporine emulsion fit into the armamentarium for treatment of keratoconjunctivitis sicca? An international task force held at the Wilmer Eye Institute in December 2003 proposed a treatment algorithm for treatment of dry eye based on scientific evidence and clinical experience.<sup>10</sup> This group categorized dry eye into 4 severity levels based on irritation symptoms, clinical signs, and diagnostic tests. Patients with level 1 severity complain of mild episodic irritation symptoms, may have an unstable tear film, mild conjunctival dye staining and no corneal epithelial disease. In level 2, patients now experience chronic irritation symptoms and show evidence of peripheral corneal epithelial disease. In level 3, the central cornea is involved and patients may develop filamentary keratitis and level 4 is blinding dry eye, such as severe Sjögren syndrome or Stevens-Johnson syndrome where the cornea may opacify or ulcerate. Therapy of level 1 disease consisted of artificial tears, elimination of offending environmental factors, or systemic medications increasing oral intake of omega-3 fatty acids. The addition of cyclosporine emulsion to these other therapies was recommended for treatment of level 2 and worse disease where the chronic nature of the disease and ocular surface epithelial changes indicates an inflammatory component. There was consensus among the group that ocular surface inflammation should be controlled before temporary or permanent punctual occlusion.

The improved understanding of the role of inflammation in the pathogenesis of dry eye raises the issue of whether cyclosporine therapy should be initiated prophylactically in patients who are at high risk for developing level 2 severity or worse disease, such as patients with Stevens-Johnson syndrome, systemic autoimmune conditions (eg, rheumatoid arthritis and systemic lupus erythematosus) or early signs of graft-versus-host disease after allogenic bone marrow transplant.<sup>11</sup> Early intervention may minimize the risks of developing debilitating irritation and blinding complications such as permanent goblet cell loss, stem cell deficiency, or corneal ulceration that can develop in these diseases. Additional evidence will be required to address this issue.

## ■ References

1. Zoukhri D. Effect of inflammation on lacrimal gland function. *Exp Eye Res.* 2006;82:885-898.
2. Nakamura M, Matute-Bello G, Liles WC, et al. Differential response of human lung epithelial cells to fas-induced apoptosis. *Am J Pathol.* 2004;164:1949-1958.
3. Wei L, Debets R, Hegmans JJ, et al. IL-1 beta and IFN-gamma induce the regenerative epidermal phenotype of psoriasis in the transwell skin organ culture system. IFN-gamma up-regulates the expression of keratin 17 and keratinocyte transglutaminase via endogenous IL-1 production. *J Pathol.* 1999;187:358-364.

4. Sall K, Stevenson OD, Mundorf TK, et al. Two multicenter, randomized studies of the efficacy and safety of cyclosporine ophthalmic emulsion in moderate to severe dry eye disease. *Ophthalmology*. 2000;107:631–639.
5. Strong B, Farley W, Stern ME, et al. Topical cyclosporine inhibits conjunctival epithelial apoptosis in experimental murine keratoconjunctivitis sicca. *Cornea*. 2005;24:80–85.
6. Matsuda S, Koyasu S. Mechanisms of action of cyclosporine. *Immunopharmacology*. 2000;47:119–125.
7. Stern ME, Gao J, Schwalb TA, et al. Conjunctival T-cell subpopulations in Sjogren's and non-Sjogren's patients with dry eye. *Invest Ophthalmol Vis Sci*. 2002;43:2609–2614.
8. Chow S, Rizzo C, Ravitskiy L, et al. The role of T cells in cutaneous autoimmune disease. *Autoimmunity*. 2005;38:303–317.
9. Korzenik JR, Podolsky DK. Evolving knowledge and therapy of inflammatory bowel disease. *Nat Rev Drug Discov*. 2006;5:197–209.
10. Behrens A, Doyle JJ, Stern L, et al. Dysfunctional tear syndrome: a Delphi approach to treatment recommendations. *Cornea*. 2006. In press.
11. Kim SK. Ocular graft vs host disease. *Ocular Surface*. 2005;3:S177–S179.



# EXHIBIT K

# OCULAR SURGERY NEWS®

Volume 31 • Number 1  
JANUARY 10, 2013

A SLACK Incorporated® publication

**OSN EXCLUSIVES**

**COMPLICATIONS CONSULT**

**Unfolding of IOL key to glued intrascleral fixation**

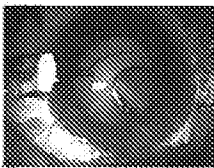

The surgeon needs to be aware of the 'lucky 7' inverted 'C' sign and the 'upright C' sign during the process of unfolding the IOL. 33

**LINDSTROM'S PERSPECTIVE**

**Ocular surface management critical to patient satisfaction 6**

**IN THE JOURNALS**

**Phaco with torsional oritudinal ultrasound result in high endothelial cell loss**  
Small-incision phacemulsification with nasal or longitudinal incision may result in significant endothelial cell loss. 23

**PHACO MANAGEMENT BY THE PREMIER SURGEON**

**Keys to being a leader in ophthalmic setting**  
Bridging the gap between managing and leading can be difficult to accomplish. 28

**Operating Highlights**

**From New York**

Operating Highlights from New York. In-depth coverage starts on page 14.

**COVER STORY**

## Panel recommends treating ocular surface prior to any refractive procedure

Eighty-six percent of patients with dry eye have both meibomian gland dysfunction and aqueous deficiency, an important consideration when optimizing the corneal surface before surgery — any type of ophthalmic surgery.

Whether PRK, LASIK or cataract surgery is the scheduled procedure, the greatest risk factor for a poor outcome in refractive surgery is pre-existing dry eye, according to Eric D. Donnemfeld, MD, who chaired the OSN New York Dry Eye, Anti-inflammatory and Allergy Corneal Health Roundtable.

"We have taken a new approach of evaluating patients for ocular surface disease before considering any type of surgery, including cataract surgery," Donnemfeld said. "We can improve the outcomes dramatically by managing these patients."

OSN New York Corneal Health roundtable participants tackle the issues of treating aqueous deficiency as well as meibomian gland dysfunction, giving their own twists on current recommendations. Crossing specialty lines, a glaucoma specialist adds his thoughts on advances in medical management of glaucoma that trend toward minimizing the effect on the ocular surface.

Cover story starts on page 10



Marguerite B. McDonald, MD, FACS, is among authors who have published studies on the utility of a preoperative course of cyclosporine.

## Retained subretinal perfluorocarbon more prevalent with smaller-gauge vitrectomy

A higher incidence of retained perfluorocarbon was found in patients who underwent 23-gauge vitrectomy rather than traditional 20-gauge repair of retinal detachment.

"After transitioning from traditional 20-gauge vitrectomy to 23-gauge vitrectomy, it appeared to me that there was an increased incidence of subretinal perfluorocarbon liquid," Sunir J. Garg, MD, said.

Garg retrospectively reviewed 234 retinal detachment repairs he had done over a 3-year

period and found a 10.3% incidence of retained PFCL when he used the smaller-gauge instrumentation. Incidence was 2.3% in the 20-gauge cases.

"Although microincision vitrectomy is a great advance, with any new technology comes subtle changes that we might not appreciate or realize," Garg said. "I expected there might be a slightly higher rate of subretinal PFCL with 23-gauge vitrectomy, but not a 4.5-fold increase."

Reducing turbulence within the eye is the critical part of primary surgery. Garg has begun using valved 23-gauge cannulas, which create less turbulence, he said.

Two other options for decreasing turbulence are reducing the infusion pressure when using non-valved cannulas and clamping the infusion line when removing instruments from the eye.

A follow-up study using valved 23-gauge cannulas is currently under way.

For more on this story, see page 9.

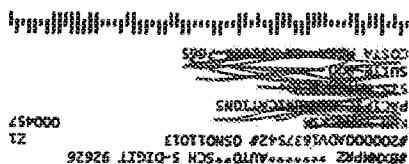

**Surgical Maneuvers**  
High-viscosity OVD helpful in AACCS

The optimized viscoelastic device aids in chamber stability and corneal protection. 3

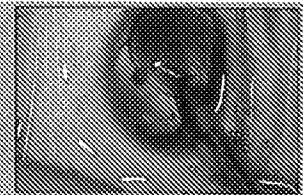

## COVER STORY

## Panel recommends treating ocular surface prior to any refractive procedure

The biggest risk factor for a poor outcome in refractive surgery is pre-existing dry eye, according to a panel of experts.

"We have taken a new approach of evaluating patients for ocular surface disease before considering any type of surgery, including cataract surgery," Eric D. Donnenfeld, MD, OSN Cornea/External Disease Board Member, said at a panel gathered to address management of ocular surface disease. Patients who are being evaluated for LASIK and PRK overwhelmingly have preoperative dry eye, he said.

"We can improve the outcomes dramatically by managing these patients," Donnenfeld said at OSN New York during the Dry Eye, Anti-inflammatory and Allergy Corneal Health Round Table, which he chaired.

### Getting started

Donnenfeld kicked off the discussion with the case of a 43-year-old myopic woman with mild to moderate dry eye. The edited round table follows; the panelists discussed off-label use of some products.

**Donnenfeld:** In a myopic patient with active staining of the conjunctiva and cornea and with mild to moderate dry eye, what is the best refractive procedure? Many ophthalmologists would say PRK, and others would say no treatment, as would be expected, but there are additional options.

**Douglas A. Katsev, MD:** If the patient is 43 years old, it is hard to put in a phakic IOL. PRK, in my experience, causes less dry eye than LASIK, but certainly maximizing the tear film and treating with all appropriate medications and heat to the lids is the most important thing to do before getting started in any direction.

**Donnenfeld:** How common is it to have mixed mechanism disease, that is, both meibomian gland dysfunction (MGD) and aqueous deficiency, and how would you treat it?

**Marguerite B. McDonald, MD, FACS:** Michael Lemp published a paper proving that 86% of the patients with dry eye have concomitant MGD.

**Donnenfeld:** So this is the rule. In the past, we treated one or the other. We need to think about treating both of these diseases to maximize results. Let's start by talking about aqueous-deficient dry eye. What would be your starting point for managing this patient?

### Treating aqueous deficiency

**Henry D. Perry, MD:** I would start with non-preserved artificial tears and topical cyclosporine, which is sometimes underused in patients with mild dry eye disease. It is important in any type of chronic ocular surface disease, especially due to aqueous deficiency, to begin topical cyclosporine.

**Donnenfeld:** What if the patient does not want to wait 3 to 6 months for cyclosporine to hit full stride?

**Perry:** Then we also have nutritional supplements. Fish oil, especially omega-3, is helpful, and we can see results in as little as 2 weeks.

**Donnenfeld:** I like nutritional supplements as well. In our practice, we use second-generation omega-3 fish oils in which the natural triglyceride provides significantly greater DHA and EPA absorption than first-generation fish oils that have been converted with alcohol to an ethyl ester form. I believe brands such as Nordic Natural in stores and PRN in doctors' offices, which is what I use, provide much better results.

In addition, we have been adding topical corticosteroids such as loteprednol when we initiate therapy. Combination immunomodulation does great work to get these patients comfortable, and it reduces burning and stinging.

**McDonald:** Some experts have recommended a run of topical steroids first and then starting Restasis (cyclosporine ophthalmic emulsion 0.05%, Allergan). I start patients on both simultaneously, largely because when patients have steroids first, they never want to start cyclosporine. They do anything they can to stay on the topical steroids, which do two things: They blunt or totally eliminate the stinging that often accompanies the induction of cyclosporine therapy, and they give immediate symptomatic relief. So patients have real belief that your suggested regimen is working. And in 4 to 6 weeks, you can turn this person from a suboptimal candidate for laser surgery into a pretty good candidate.

**Donnenfeld:** That is the key here. You need to evaluate these patients, and if they respond, they become good candidates for LASIK or PRK. If they do not respond, then you are probably best off doing nothing. There is a new steroid that will be coming out that I think is going to be exciting for this type of case, and that is loteprednol gel, which will be available in the first quarter of 2013. I think that will provide even more ocular surface coverage and better contact time.

**Perry:** In our office, when we start topical cyclosporine, we always start a low-dose corticosteroid. Several authors have shown the efficacy of increasing the success of topical cyclosporine with low-dose loteprednol, and it has been shown by two other groups that the concomitant use of steroids is beneficial, not only in the initial treatment, but also in allowing the success of the long-term use of topical cyclosporine.

**Katsev:** When you are going to start cyclosporine, patients need to know that they are going to be taking this medication for 4 to 6 months. They need to communicate to me that they are willing to take it that much. I also start topical steroids, so I need commitment for 4 to 6 months and

### Round table participants



Eric D. Donnenfeld  
Moderator



Richard M. Awdeh



Douglas A. Katsev



Kenneth R. Kenyon



Marguerite B.  
McDonald

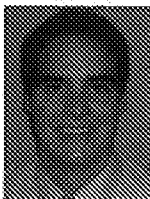

Robert J. Noecker



Henry D. Perry

I need to know that they understand the disease.

**McDonald:** With loteprednol etabonate starting at the same time as cyclosporine, I prescribe four times a day for 2 weeks, twice a day for 2 weeks, and then the patient is off the loteprednol while the cyclosporine continues.

**Donnenfeld:** That is the Asclepius Panel recommendation.

**Kenneth R. Kenyon, MD:** I continue to believe that it is important to definitively diagnose aqueous-deficient dry eye by determining if the patient, in fact, has aqueous deficiency. Back in the day, we performed basic secretion Schirmer tests with topical anesthetic. Three decades later, I continue to use this same test to screen for aqueous deficiency. The notion that a patient with a basic secretion Schirmer score of perhaps 10 mm in 5 minutes has an aqueous-deficient dry eye and therefore deserves Restasis and/or punctum occlusion is simply incorrect. In such a case, other mechanisms of ocular surface disease, such as MGD, exposure or decreased corneal sensation, must be investigated.

I am sure we all have our differing views, but I will say that it is important to be clear when you are doing a pre-laser vision correction workup to have space on your diagnostic forms for both lids and tear functions. It will keep you out of trouble; it will keep you out of malpractice suits. I am certainly concurrent with everything else that has been offered about various medical and pharmaceutical therapies, but a Schirmer test tells me a heck of a lot and then allows me to decide whether to go down the route of plugs or even punctum cauterization, which after the inflammatory component of the surface is under control, is a time-honored valid therapy.

**Donnenfeld:** Punctal plugs work fairly well in aqueous-deficient dry eye. You want to stabilize the ocular surface first. If you want to make a patient unhappy, in my experience, put a punctal plug in someone with significant MGD. Those patients are just miserable. So, when do you start punctal plugs in these patients?

**Kenyon:** I have become cognizant of the notion that you do not want to create an ocular surface cesspool, as it were, by totally denying all aqueous and, hence, other toxic waste outflow. But after you get the surface in good anti-inflammatory status, then it is time to intervene with punctum occlusion, whether by a homemade "quick and dirty" 3-mm length of 5-0 chromic suture or with more extended duration intracanalicular inserts such as Oasis or semi-permanent silicone plugs. These are all variations on the theme. But first it is anti-inflammatory and then it is punctal

occlusion, if you, in fact, have a true aqueous-deficient component.

**Anti-inflammatories in glaucoma**  
**Donnenfeld:** Do you find that anti-inflammatory therapy, notably cyclosporine, plays a role in glaucoma management?

**Robert J. Noecker, MD, MBA:** Without a doubt. When you look at the demographic information, these are two diseases with parallel comorbidities. In the general population, a rough statistic for ocular surface disease in age-matched controls is around 15% vs. around 50% in the glaucoma population. The argument is that glaucoma therapy tends to make people worse.

**Donnenfeld:** A lot of glaucoma specialists resist the idea of early surgery, but for the corneal specialist, often the best thing to do is to get the patient off the glaucoma drops. Often, I will recommend something simple, like laser trabeculectomy or selective laser trabeculoplasty in phakic patients or an iStent (Glaukos) if the patient is having cataract surgery, to get a patient off of a glaucoma medication.

**Noecker:** Certainly SLT and laser interventions are easier to do. And now we have microinvasive glaucoma surgeries, which are lowering the bar in terms of not causing significant morbidity commonly associated with glaucoma surgery.

The other point is that it is an amazing time in glaucoma medical therapy because there are so many options to avoid the common preservative we talk about: benzalkonium chloride (BAK). If it is not possible from a formulary standpoint to eliminate BAK, then every new formulation has less and less BAK than the formulation had 5 or 10 years ago. You can have people on a preservative-free prostaglandin or a non-BAK alternative preservative prostaglandin. You can have them on preservative-free dorzolamide timolol. You can have them on preservative-free timolol alone. You can have alternatively preserved brimonidine. So you could do a whole treatment regimen without ever having to worry about the preservative effect. Active ingredients certainly and pH also play a role, but the preservative is the common denominator.

**Donnenfeld:** As a corneal specialist, if you can get patients off of these drops for a lifetime, the quality of life and the improved vision are significant.

**Meibomian mechanism**

**Donnenfeld:** Because we are talking about a mixed mechanism of ocular surface disease, let's move on to the management of MGD. What would be your first line of therapy for managing someone with MGD?

Cover story continues on page 12

**POINT / COUNTER**

**With the emphasis on optimizing the ocular surface and minimizing preop dry eye, what is the value of the Schirmer test in particular before conducting refractive surgery?**

**POINT**

**Popularity of Schirmer test eroding**

Ocular surface optimization should be considered an integral part and package of current day refractive surgery in order to deliver the optimal visual outcome, meet our patients' high expectations, and convert them to satisfied customers. In this endeavor there are various venues to pursue with regard to pre-refractive surgery detection of dry eyes, and one age-old test is the Schirmer test. Since its entry into this arena, Schirmer test rapidly gained popularity among clinicians, primarily driven by the fact that it is readily available, is relatively inexpensive, is easy to perform, and lacks clinically noticeable side effects. However, like everything else in life, its sustained popularity as an aqueous tear deficiency test has been slowly eroding, as reflected by one of the ASCRS surveys that reported 70% of the surgeons are not using pre-refractive surgery Schirmer test.



Thomas John

So why is there a change of heart toward Schirmer test? It is multifactorial, and some of the reasons may be attributed to the fact that the results can be quite variable. Based on the Schirmer test, one report showed that 17% of asymptomatic subjects would be misdiagnosed as dry eye patients. A more recent study showed that subclinical tear deficiency indicated by low Schirmer test values did not influence PRK outcomes in patients matched by age and magnitude of refractive correction.

It is important to listen to patient symptoms of dry eye, look for clinical biomicroscopic signs of dry eyes even in those asymptomatic individuals, and consider incorporating some of the newer, technology-driven dry eye tests that may be suitable in your refractive surgery practice.

**References:**

Solomon KD, et al. *J Cataract Refract Surg.* 2002;28(2):346-355.  
Tuunanen TH, Tervo TM. *J Cataract Refract Surg.* 1996; 22:702-708.  
Van Bijsterveld OP. *Arch Ophthalmol.* 1969;82:10.

**Thomas John, MD,** is an OSN Cornea/External Disease Board Member. *Disclosure:* John has no relevant financial disclosures.

**COUNTER**

**Schirmer test still relevant**

Dry eye continues to be a significant problem and a cause of dissatisfaction after laser surgery. There are a lot of reasons why these patients might have dry eyes, but the key reason is preop dry eye disease. So when we are thinking about laser, we should be thinking about preop diagnosis of dry eye disease. In a study that asked physicians what they do to evaluate patients before refractive surgery, as expected nearly 100% of physicians said they perform corneal topography, but only 30% of the physicians performed Schirmer's. We may argue that Schirmer's isn't the best dry eye test; nonetheless it is interesting to see that the physicians were not thinking about that. That's a take-home message. Let's think about it before the laser, not afterward.



Penny Asbell

Excerpted from Asbell PA, Gadaría N, Lee K-I. "The Ocular Surface and Its Impact on LASIK and PRK" presented at OSN New York, Nov. 16-18, 2012.

**Reference:**

Solomon KD, et al. *J Cataract Refract Surg.* 2002;28(2):346-355.

**Penny Asbell, MD, MBA, FACS,** is OSN Contact Lenses Section Editor. *Disclosure:* Asbell receives research funding from, is on the speakers bureau for or consults for the following: NIH, Toni and Martin Sosnoff Fund, Alcon, Allergan, Aton, Bausch + Lomb, Merck, Inspire, Clinical Research Consultants, Johnson and Johnson, Pfizer, Santen, Research to Prevent Blindness and Vistakon Pharma.

Cover story continued from page 11

Perry: The first thing is be sure of the diagnosis, as Dr. Kenyon said. I like to express the glands to get a feeling for the consistency and where we are in terms of the MGD in that particular patient. Heat is essential to melt the fats to get them flowing, and it is important that we remember that in this particular disease the change from long-chain fatty acids to free fatty acids with the inflammation leads to saponification or a soap formation. The problem

**"We have taken a new approach of evaluating patients for ocular surface disease before considering any type of surgery."**

— ERIC D. DONNENFELD, MD

is that there is too much detergent in the tears. Artificial tears can do a lot to help, and topical cyclosporine, topical steroids and nutritional supplements are also helpful. Lid hyperthermia is essential. Oral doxycycline changes the equilibrium constant from free fatty acids back to long-chain fatty acids and helps decrease the inflammation, as does topical azithromycin. Pulsed light therapy also helps in terms of heating, but there have been some disasters that occurred when the iris was fried by mistake.

Donnenfeld: I have become a big believer in nutritional supplements. What do you recommend to your patients who have MGD?

Richard M. Awdeh, MD: The increased importance of nutritional supplements is clear, both to us as a society and to us in clinic and with our patients. I will recommend that patients go on a vitamin therapy or TheraTears (Akorn) type of nutritional supplement, but additionally I ask patients to review their diet for rich foods — chocolates, cheeses, wines, caffeine, nuts — and I will ask them to modify their diet.

For these patients, I do not like putting them on an oral systemic therapy unless we get to that point, and if we do, then we will put them on oral doxycycline 100 mg two times per day for a few weeks and then switch to 100 mg daily. We ask them to take it with a snack and avoid sun exposure and ambient sun.

We have had success with topical azithromycin, again doing a staged approach, starting a low-dose steroid and then tapering the steroid down as the azithromycin has time to work.

With topical cyclosporine, there are instances when patients are not comfortable with it. We have a compounding pharmacy that creates the topical cyclosporine in different concentrations and in different vehicles, including a corn oil, for instance. We sometimes notice a good response in

patients who were previously intolerant.

Kenyon: Half of my blepharitis and meibomitis patients do well simply with a warm compress for 5 minutes and erythromycin. That is traditional. Another 25% with any hint of rosacea will be knocked off with low-dose doxycycline or minocycline, which can go on benignly for years. So all this is good stuff, including LipiFlow (TearScience), but there is still a lot out there in the traditional armamentarium.

**LipiFlow expression**

Donnenfeld: Consider the case of a 55-year-old patient with a long history of tired eyes, no medications, no corneal or conjunctival staining, drinks heavily, 2+ MGD, shortened tear break-up time who is treated with hot compresses, nutrition and LipiFlow. Patients who have marginally compensated ocular surfaces respond by blinking more often, and when they blink more often, they develop tired eyes. He had the therapy, the tired eyes got better, and the blinking reduced.

Kenyon: I have no proprietary interest here, but one of my practice partners, Jack V. Greiner, MD, has been doing studies for TearScience, so I have watched developments with interest. I believe LipiFlow works, but it is pricey.

Having said that, Greiner has done follow-up studies on some of his patients for more than 2 years, and this single 12-minute pulsed heat therapy does indeed unblock the glands. Whether it is by the subjective surveys such as the Ocular Surface Disease Index and the Standard Patient Evaluation of Eye Dryness, or all the objective measures, LipiFlow therapy does seem to have a protracted effect. So despite the self-pay "sticker shock" disadvantage, you can at least reassure patients that they will benefit for at least a year or perhaps longer.

McDonald: When we do hot compresses at home, most of that heat is wicked away by the lid structures, which are highly vascular. So little of the externally applied heat gets all the way back to where we want it to — the meibomian glands. But with the LipiFlow system, the heat is applied from the tarsal plate conjunctival side of the lid, so that the altered meibum becomes liquefied; then gentle pulsations start and the altered meibum is extruded. It is a much more effective way to apply heat, and to a much higher temperature — though still to a controlled and comfortable degree — than patients could ever get at home.

**Tears and optimizing the surface for surgery**

Donnenfeld: Consider the same patient who is going to have LASIK or PRK who had mixed mechanism ocular surface disease and is now better. Let's talk about what can be done surgically.

Literature now shows that making thin planar flaps gives better results. Bevel and side cuts provide better adhesion. Flaps can be smaller. In the old days, we were making 9.5-mm flaps for myopes. In a patient with a small pupil, you can go down to 8.1- or 8-mm flaps. You have half the surface area; half the corneal nerves are cut. There are a lot of ways for surgical modification. I do not think personally that there is now a big difference between PRK and small-flap LASIK with advanced techniques. In the old days when we made 150- $\mu$ m flaps there was a big difference, but now I think PRK and LASIK are both reasonable techniques for managing these patients.

Awdeh: I agree. The key is to get the patient to baseline before surgery and to make sure that their symptoms have improved. Make sure that your objective is such that the patient is also true to the Schirmer's test and staining of the cornea.

Donnenfeld: Dr. McDonald, you wrote one of the definitive articles on using cyclosporine in these patients. How long do you continue cyclosporine after LASIK, and does it really affect the visual results?

McDonald: Yes. There are now at least five papers in the peer-reviewed literature documenting that whether you are old or young, male or female, and dry or not, you will have a better post-LASIK clinical outcome with a preop run-in of cyclosporine and using it for at least 3 months afterward. One of those papers is ours, using cyclosporine in extremely dry eye patients, who are considered very high-risk LASIK candidates. It made a big difference in the percentage of patients who achieved 20/20 uncorrected vision and in the percentage that needed an enhancement, both in favor of the cyclosporine-treated group.

Kenyon: Based on your work, I use Restasis for at least a month preop in any patient with a Schirmer test value of less than 5 mm basic secretion. I can continue it for up to 3 months postop. I always do LASIK in these patients because I think that their ocular surface is less compromised from the beginning, so the neurotrophic component of creating a LASIK flap is far offset by the need for the epithelium to regenerate in a potentially drier environment. If you do everything that we have described here to optimize the ocular surface first, then you will not get into trouble later with ocular surface difficulties, whether due to a single

mechanism or a combined mechanism.

Donnenfeld: Ed Manche just published a paper in *Ophthalmology*, in which LASIK was done in one eye and PRK in the other eye, and patient healing was evaluated. There was no difference in dry eye between the two groups, and the healing was better in the LASIK group because of the problems of epithelial remodeling.

**References:**

- Byun YJ, et al. *Cornea*. 2012;doi:10.1097/ICO.0b013e31818c69ef.  
Greiner JV. *Clin Experiment Ophthalmol*. 2012;doi:10.1111/ceo.12033.  
Greiner JV. *Curr Eye Res*. 2012;doi:10.3109/02713683.2011.631721.  
Lemp MA, et al. *Cornea*. 2012;doi:10.1097/ICO.0b013e318225415a.  
Murakami Y, et al. *Ophthalmology*. 2012;doi:10.1016/j.ophtha.2012.06.013.  
Salib GM, et al. *J Cataract Refract Surg*. 2006;doi:10.1016/j.jcrs.2005.10.034.  
Sheppard JD, et al. *J Ocul Pharmacol Ther*. 2011;doi:10.1089/jop.2010.0085.

Richard M. Awdeh, MD, can be reached at Bascom Palmer Institute, 900 NW 17th St., Miami, FL 33136; 305-243-2020; email: richard.awdeh@aya.yale.edu or richard.awdeh@gmail.com.

Eric D. Donnenfeld, MD, can be reached at Ophthalmic Consultants of Long Island, 2000 North Village Ave., Rockville Centre, NY 11570; 516-766-2519; fax: 516-766-3714; email: eric-donnenfeld@gmail.com.

Douglas A. Katsev, MD, can be reached at Samsam Santa Barbara Medical Foundation Clinic, 29 W. Anapamu St., Santa Barbara, CA 93101; 805-681-8930; email: katsev@aol.com.

Kenneth R. Kenyon, MD, can be reached at Eye Health Vision Center, 51 State Road, Dartmouth, MA 02747; 508-994-1400; fax: 508-992-7701; email: kenkenyon@cs.com.

Marguerite B. McDonald, MD, FACS, can be reached at Ophthalmic Consultants of Long Island, 360 Merrick Road, Lynbrook, NY 11563; 516-766-2519; email: margueritemcdmd@aol.com.

Robert J. Noecker, MD, MBA, can be reached at Ophthalmic Consultants of Connecticut, 75 Kings Highway Cutoff, Fairfield, CT 06824; 203-366-8000; fax: 203-330-4598; email: noeckerjr@gmail.com.

Henry D. Perry, MD, can be reached at Ophthalmic Consultants of Long Island, 2000 N. Village Ave., Suite 302, Rockville Centre, NY 11570; 516-766-2519; fax: 516-766-3714; email: hankcornea@aol.com.

Disclosures: Awdeh is a consultant for Abbott Medical Optics, Bausch + Lomb, Ciba and Ista Pharmaceuticals, and has ownership interest in Ciba. Donnenfeld is a consultant for Abbott Medical Optics, Acufocus, Allergan, Alcon Laboratories, Aqueys, Bausch + Lomb, Better Vision Network, CRST, Elenza, Glaukos, Lacriphen, LenSx, Merck, NovaBay, Odyssey, Pfizer, PRN, QLT, Sarcodex, TearLab, TLC Laser Centers, TruVision and WaveTec, and has ownership interest in Lacriphen. Katsev is a consultant for Abbott Medical Optics, Bausch + Lomb and Ista, is on the speakers bureau for Alcon Laboratories and Allergan, and has ownership interest in TruVision. Kenyon has no relevant financial disclosures. McDonald is a consultant for Abbott Medical Optics, Alcon Laboratories, Allergan, Bausch + Lomb, FOCUS Laboratories, IOP, Ista Pharmaceuticals, OCUSOFT, TearLab and Topcon, and has ownership interest in Ace Vision Group and Acufocus. Noecker is a consultant for Alcon Laboratories, Allergan, Endo Optics, Lumenis and Ocular Therapeutics, is on the speakers bureau for Alcon Laboratories, Allergan, IOP Inc., Lumenis, Merck and Quantel, and does contracted research for Glaukos, Lumenis and Merck. Perry has no relevant financial disclosures.

# EXHIBIT L

Article Date: 9/1/2013

## **Focus on Dry Eye**

# **Restasis: 10 years after launch**

**The drug has found a strong niche in dry eye therapy.**

**By Jerry Helzner, Senior Editor**

Launched by Allergan in the United States in April 2003, Restasis (cyclosporine ophthalmic emulsion 0.05%) had the advantage of being the first — and still the only — FDA-approved prescription drug for chronic dry eye disease. For people who had spent years trying to cope with their disease, primarily with oceans of artificial tears, just two drops of Restasis each day was designed to attack the underlying inflammatory characteristic of the disease and allow patients to produce more natural tears.

## **Sales continue strong growth**

Now, a decade after it was introduced, Restasis can be deemed a success. Ophthalmologists interviewed for this article say it has earned a significant place in their overall treatment plan for combating dry eye disease. Patients worldwide have now accounted for 16 million prescriptions for the drug, translating to a compounded 40% annual sales growth, according to Allergan. In 2004, its first full year of US sales, Restasis totaled \$98 million in revenues. This year, Allergan expects Restasis to record between \$870 and \$900 million in worldwide sales, making it the company's best-selling ophthalmic drug by far.

In the latest reported quarter, the second quarter 2013, Restasis was still growing sales by double-digits (10.5%), even though the drug has been in the marketplace for a decade. What's more, Restasis has been blessed with an ongoing marketing campaign featuring a series of television ads that focus on the endorsement of cornea specialist Alison Tendler, MD, of Vance Thompson Vision in Sioux Falls, S.D.

Given that Restasis has made a considerable impact on the treatment of dry eye disease over the past 10 years, what have ophthalmologists who treat dry eye learned about the drug during this time that allows them to use it more effectively? This article will focus on the experiences of three corneal specialists who have successfully integrated Restasis into their arsenal of dry eye treatments, two of whom actually use Restasis themselves.

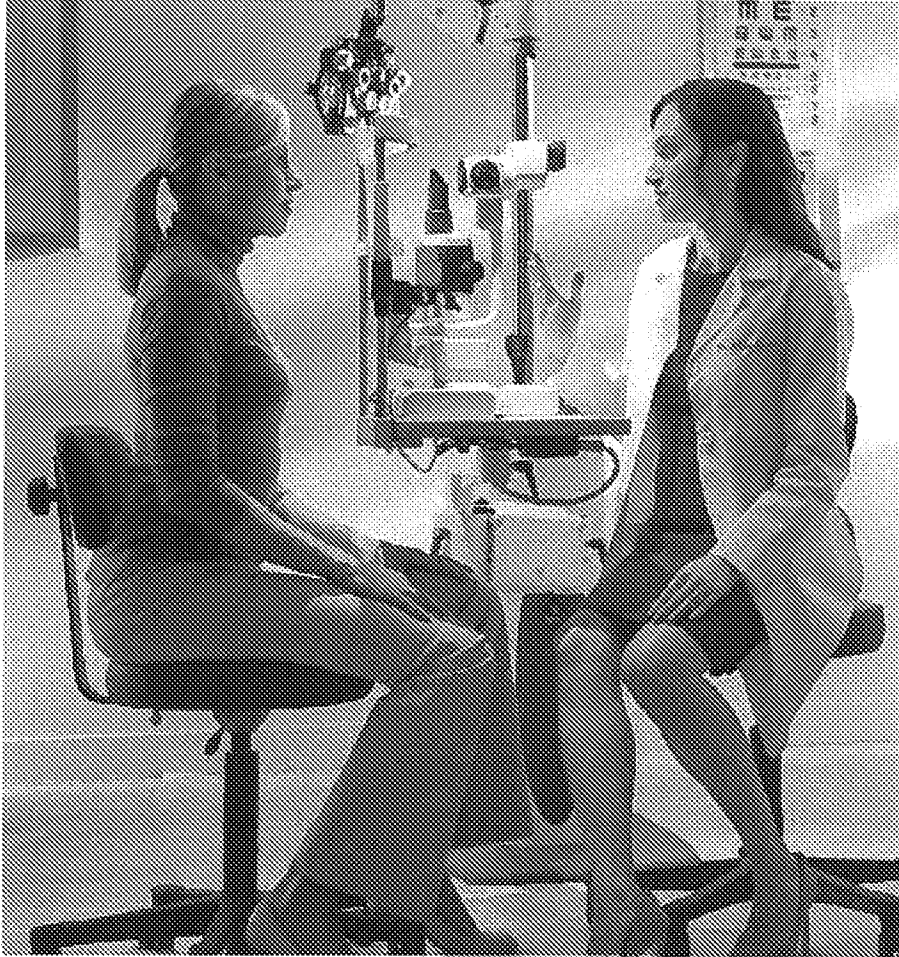

A scene from one of a series of Restasis television ads featuring spokesperson Allison Tendler, MD.

## **THE LEARNING CURVE**

### **Restasis needs time to work**

Stephen Pflugfelder, MD, of the Cullen Eye Institute at Baylor College of Medicine in Houston, has extensive experience with Restasis, having served as an investigator in the drug's pivotal phase 3 trial. He believes Restasis came along at just the right time. "In terms of treating dry eye and ocular surface disease, prior to the introduction of Restasis, artificial tears just weren't cutting it because inflammation is a big part of the disease," he says. "Restasis has helped us to treat the inflammation."

Dr. Pflugfelder says he went through a learning curve in the use of Restasis that has helped him to be more accurate in selecting patients for whom the drug is most effective. "First, it's very important for both doctors and patients to recognize that it takes a while for Restasis to begin to work," he notes. "It could be four to six weeks and it could even be longer, but I have found that the drug's effectiveness gets better with time. It is so safe that you can use it indefinitely, which is a major advantage."

Dr. Pflugfelder says patients who produce low tear volume at baseline tend to do better on Restasis than patients who produce more of their own tears. He has also conducted in-house research that points to patients with low goblet cells as good responders to Restasis therapy. "Restasis appears to have the ability to repair goblet cells," he notes.

#### **Can Allergan fight off generic Restasis?**

If imitation is the sincerest form of flattery, than Allergan should feel quite flattered these days. As the basic patent for Restasis is set to expire in May 2014, generic drug manufacturers are salivating at the chance to get into the marketplace



with their version of what is now close to a \$1-billion-a-year drug.

A generic version of Restasis may be close at hand if recent FDA draft guidance becomes a reality. In June, the federal agency proposed that human trials of generic Restasis may not be necessary if laboratory testing can demonstrate the chemical equivalence of the drugs. With that standard for approval, the timetable for a generic version could be pushed ahead by years. That fact was not lost on Allergan stockholders as the price of Allergan shares tumbled 12% the day after the FDA draft guidance was announced.

Allergan has already begun the fight to ensure that human trials are conducted for any generic version of Restasis. In a statement issued following the FDA announcement, Allergan said it believes the FDA's proposed testing method "cannot predict clinical safety and efficacy, and thus cannot be used to establish bioequivalence."

Allergan said it will provide feedback to the FDA during the 60-day comment period. The company asserts it is weighing all options in an effort to prove the FDA's proposal, if carried out, would not be in the best interests of consumers.

Two factors could work in Allergan's favor to forestall competition. First, the Restasis manufacturing process is highly complex and could delay a potential competitor's ability to make the drug. Second, an improved, next-generation Restasis would provide a competitive advantage and more years of patent protection for the improved product. Allergan is also now conducting a phase 2 clinical trial for a next-generation dry eye therapy called Restasis X. The company would not comment on a possible timetable for approval of the next-generation product.

## **Short-course steroids can help**

Because Restasis takes a while to begin to work, Dr. Pflugfelder often starts his dry eye patients with a short course of topical steroids, which lasts about a month. "The topical steroid does two things," he says. "It provides earlier relief for the patient and it mitigates the burning or stinging sensation that many patients feel when they begin Restasis."

## **TREATMENT PLANS AND TIPS**

### **Dr. Pflugfelder's treatment plan**

The cornea specialists interviewed for this article agree that Restasis must be part of an overall treatment plan. It is not a panacea that can stand on its own. "No single drug can work for all patients," says Dr. Pflugfelder. "An overall treatment plan for dry eye disease could include one or more of the following: supplements such as fish oil, the antibiotic anti-inflammatory doxycycline, punctal plugs and the antibiotic AzaSite (azithromycin, InSite Vision, Alameda, Calif.)."

About 80% of the patients to whom he prescribes the drug do well on it, Dr. Pflugfelder says. "I have patients who have gone from debilitating dry eye to functioning very well. Another benefit is that these patients can decrease the use of artificial tears."

### **The doctor is also a patient**

Christopher Starr, MD, FACS, of New York-Presbyterian Hospital, Weill Cornell Medical Center in New York, was just completing his fellowship training when Restasis was launched in the United States a decade ago. "I have had the benefit of being able to prescribe Restasis for my entire career," he notes. "I consider it the foundation of my dry eye treatment plan."

Dr. Starr also has dry eyes and uses the drug himself with good effect. "I keep it in my medicine cabinet, right near my toothbrush, because that way I'm sure to use it," he laughs.

Unlike Dr. Pflugfelder, who recommends patients refrigerate Restasis to reduce any stinging sensation from instilling the drug, Dr. Starr has never found the need to refrigerate it himself because he feels the drop is comfortable upon instillation.

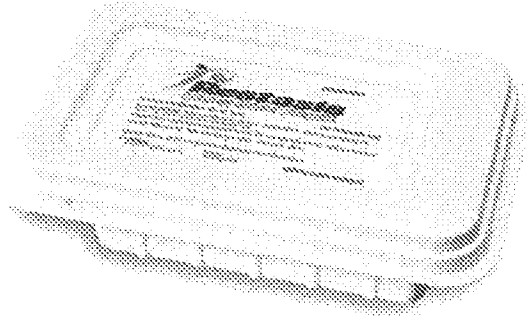

## Dr. Starr's treatment plan

"I liked Restasis from the beginning and I have increased my prescribing of it over the years as I've gained more experience and witnessed its impressive results," says Dr. Starr. The definition of dry eye disease has changed as knowledge of the disease continues to grow, he notes. "The most recent definition of dry eye disease from the Dry Eye WorkShop (DEWS) report notes hyperosmolarity and inflammation as key pathophysiologic factors, which supports the use of anti-inflammatory medication such as Restasis."

Dr. Starr agrees that treating dry eye disease requires an overall treatment plan tailored to each patient because dry eye is a multi-factorial disease. "I start most patients with early moderate and higher disease severity on Restasis because those patients are more likely to have significant ocular surface inflammation," he says. "A short course of the topical steroid Lotemax (lotoprednol, Bausch + Lomb, Tampa) with Restasis can be used to jump start the reduction of inflammation and help ease the mild burning associated with the initiation of Restasis."

## Treating hyperosmolarity

Dr. Starr prescribes Restasis for most patients with significant hyperosmolarity as diagnosed by the TearLab device (TearLab Corporation, San Diego). Other elements of his dry eye treatment regimen can include AzaSite, which he finds helpful in treating anterior and posterior blepharitis off-label, omega-3 fatty acid supplementation, an emphasis on lid hygiene, warm compresses and lid massage, adjunctive use of artificial tears for symptom control and punctal plugs, among other treatments.

"We consider a decrease in the use of artificial tears a metric of success in treating this disease," Dr. Starr says. "A significant reduction in artificial tear use was seen in the pivotal clinical trials for Restasis."

Dr. Starr finds that educating patients in the proper use of Restasis is one of the primary keys to success with the drug. "First, patients must understand that Restasis is not an artificial tear and should not be used 'as needed,'" he says. "They should use one drop in the morning and one drop in the evening, no more and no less. They should expect some mild burning or stinging at first but a short-course of topical steroid and time will lessen this."

Dr. Starr says that some patients need as much as three to six months to obtain the full benefits of Restasis. This needs to be explained up front to maintain patient compliance through this initial period.

## Dr. Yeu's treatment plan

Elizabeth Yeu, MD, of Virginia Eye Consultants in Norfolk, is another cornea specialist who both prescribes Restasis and uses it for her own dry eye condition. "I truly believe in the product for early-to-moderate dry eye," she says. "It does not work that well in the more severe case, stages three and four."

Dr. Yeu postpones using Restasis in patients who already have a burning sensation in their eyes. "First, we want to calm the eye down with a topical steroid before starting Restasis," she says. "If they have a foreign-body sensation or blurred vision but no burning we can start Restasis right away."

***"Dr. Yeu says she postpones using Restasis in patients who already have a burning sensation in their eyes"***

## Episcleritis and lid inflammation

Dr. Yeu also likes to use Restasis for episcleritis, characterized by redness and inflammation. "With dry eye, you must customize the treatment for each patient," she says. "Younger patients tend to have more symptoms and few signs. For them, Restasis can be very helpful along with omega-3s. Older patients can be just the opposite, with strong signs and few symptoms. They don't seem to have the discomfort we see in younger patients. That could be because they have been on a number of medications and their senses have become a bit dulled over the years. But they do very well with Restasis, especially if they have a good tear film."

Dr. Yeu also treats inflamed lids as she wants to stop lid inflammation from spilling over onto and affecting the ocular surface. "I find that about 80% of my dry eye patients do very well on Restasis and just about all patients get some level of relief," she observes. "Patients who come off Restasis, for whatever reason, almost always get worse. Though they may not have seen improvement from the Restasis when they were using it, it was at least keeping the disease from getting worse. Restasis itself can only do so much, especially with patients who are dealing with other health factors that limit the effectiveness of the Restasis." **OM**

# EXHIBIT M

Article Date: 11/1/2010

## **Dry Eye Drug Development: When Will the Floodgates Open?**

**New therapies have the potential to turn the prescription market from a trickle to a deluge.**

**By René Luthe, Senior Associate Editor**

Clinicians waiting for a new prescription drug for their long-suffering dry eye patients are going to have to wait a little longer. While many drug makers are on the case, their offerings will not be an option in the near future. Allergan's Restasis remains the only game in town in the way of prescription remedies. "The regulatory approval process for dry eye drugs is a nightmare," concedes EyeGate Pharma's president and chief executive officer, Stephen From.

What gives? Miami's William B. Trattler, MD, allows that part of the problem may be the FDA setting the bar too high. Yet the main problem, he believes, is dry eye's own peculiar nature. "Dry eye can be caused by aqueous deficiency or it can be due to poor tear film quality related to Meibomian gland dysfunction," Dr. Trattler notes. "Or, it can be a combination of these two forms of dry eye. Importantly, inflammation is present in both conditions."

However, not all the news is discouraging: Some drugs are inching closer to approval and researchers continue to gain valuable insights into the disease. Here's a snapshot of prescription dry eye remedies on the horizon.

### **More Obstacles Than Most**

The combination of factors at work in dry eye disease is widely held to be the main reason for the lack of progress on the new-drug front. "The disease itself is highly variable," says Simon Chandler, PhD, director of clinical research at Ista Pharmaceuticals.

Eddy Anglade, MD, chief medical officer at Lux Biosciences, agrees. "There isn't a very good correlation between signs and symptoms," he says, "so trying to find that group of patients who have disease that will respond in a way that is convincing from a regulatory standpoint is challenging, given that the current regulatory approval standard is to demonstrate significance in a sign and in a symptom."

It has been so difficult to achieve, Mr. From points out, that no company has succeeded in getting a New Drug Application (NDA) filing approved. Where many drugs run aground, he says, is in trying to transition from phase 2 clinical trials to phase 3. "Most people worry about translating from animal models into humans," Mr. From explains. "In dry eye, we worry about phase 2 data translating into phase 3 — can somebody repeat a study a second time?"

Other experts familiar with FDA clinical trials and dry eye disease concur. Dry eye's variability means that when it is time for sponsors to scale their phase 2 trials to phase 3, the drug's efficacy may be harder to demonstrate. The disease's multifactorial nature also contributes to the difficulty in navigating the approval process. For each different cause, there is at least one way to potentially treat it. Matching the drug to the right kind of patient is crucial (see "Clinical Trial Pearls," below).

Part of the problem might reside with the regulatory process itself. The process for clearance of a new drug is complex and as the knowledge base concerning dry eye disease expands, the scientific basis for drug testing changes. According to Michael A. Lemp, MD, clinical professor at Georgetown and George Washington universities, "it was anticipated that the FDA would issue new guidelines for clinical trials in dry eye disease several years ago, but these have not been made public. The delay may rest with senior management within the Agency."

The result is that there is no "one-stop shopping" source where would-be sponsors can learn the guidelines for clinical trial endpoints. Instead, sponsors must go to the FDA and make a proposal as to how they would perform a clinical trial; the FDA reviews the proposal and informs the sponsor if it is acceptable, or which portions are acceptable or unacceptable.

"While the FDA is quite open to these inquiries and willing to listen to novel approaches, many times companies new to this field feel as if they are guessing what the FDA wants," Dr. Lemp explains. "They wonder if the FDA has changed what is acceptable since the last time they heard. It's like trying to read the tea leaves."

## Chugging Along

Despite the regulatory hurdles, some dry eye drugs are making slow but steady progress toward beleaguered physicians and their patients. Most are anti-inflammatories, so their approval would fulfill a wish of Dr. Trattler's. "I use pulses of topical steroids frequently for dry eye patients, and if there were additional anti-inflammatory drugs that could work in this area, that would be very helpful for patients, since dry eye is an inflammatory condition."

● **EGP-437.** The closest drug to the goal is EyeGate's EGP-437. Currently in a phase 3 efficacy study, it's a dexamethasone-derived corticosteroid solution delivered to the eye via an iontophoretic drug delivery system that enables the drug to overcome the problem of low bioavailability that limits other topical agents. "You have to try to bypass natural barriers that are in place: the tear film and cornea," Mr. From says. "It's very difficult to get a large quantity of drug into the front of the eye, or any drug to the posterior pole of the eye for retinal diseases." Iontophoresis also allows EGP-437 to bypass the method physicians have had to resort to deliver large quantities of drug into the eye: needles.

The doughnut-shaped applicator holds a sponge saturated with drug; the applicator is placed on the sclera after a topical anesthetic is applied to prevent the patient's blinking. An electrode at the base of the applicator is connected to a small, handheld generator that supplies a charge. A negatively charged drug in the foam portion gets a negative charge to the electrode, thus using the principle of electrorepulsion to push the drug at a high velocity into the eye.

The process, Mr. From says, requires only a couple of minutes. "Depending on how high the current is, or how long we leave this on the eye, will dictate how much drug goes into the eye and how deep it penetrates into the eye."

EGP-437 is a small molecule. In its recently-completed phase 2 study, it was able to treat multiple signs and symptoms of dry eye, rather than just one in each category, Mr. From says, "So we actually had the lucky advantage of being able to choose the best sign and the best symptom for our phase 3 trial." Even better, he says, was its onset of action, which begins within hours. "If you're a Sjögren's patient and you have severe dry eye, you are in a lot of discomfort and pain" and at risk for scarring, Mr. From explains. Such patients would welcome a therapy with rapid onset of action. "No other drug that I'm aware of works as quickly as our drug is working," he says.

Although data from EyeGate's 83-patient phase 2 trial are not yet available, the company did say that staining decreased in both fluorescein and lissamine green dyes, that conjunctival redness was reduced and that tear film breakup time increased.

As for dosage, the drug would be administered in a physician's office, probably on a quarterly basis, according to Mr. From, depending on severity. The company has begun

enrolling patients for the phase 3 clinical trial of approximately 180 planned. Mr. From anticipates that the trial should be completed during the first quarter of 2011, with top-line data available at the end of that period.

He describes EyeGate's approach as acute therapy for a chronic problem. "We are able to put so much drug in so quickly to the tissues of the eye that we're knocking down the inflammatory cascade very rapidly. The drug doesn't stay in the eye very long, but the pharmacological effect lasts for a long time."

- **CF101.** Can-Fite BioPharma Ltd. recently opened an Investigational New Drug application (IND) with the FDA for a phase 3 study of its lead drug, CF101, for treatment of moderate to severe dry eye disease. Dr. Pnina Fishman, Can-Fite's CEO, says that CF101 exerts an anti-inflammatory effect and also an immunomodulatory one. The study will be initiated in few months.

An earlier phase 2 study, in which CF101 was taken orally as a monotherapy for 12 weeks, showed a statistically significant benefit in the clearing of fluorescein staining in the nasal, temporal, pupillary and inferior cornea, the company reports. CF101 also was found to be safe and well tolerated in the Phase 2. Further, the study showed a decrease in intraocular pressure in patients with dry eye, findings that have prompted Can-Fite to initiate a phase 2 clinical study for the drug's treatment of glaucoma.

The randomized, double-masked phase 3 trial will compare two oral doses of CF101 to placebo. Approximately 240 patients will be enrolled at multiple centers, to be treated for 24 weeks. The clinical endpoints are improvement of corneal fluorescein staining, tear production and dry eye symptom score.

- **Low-dose bromfenac.** Ista Pharmaceuticals' phase 2 trial of low-dose bromfenac (Remura) demonstrated improvement in both a key sign (lissamine green staining) and in symptoms (as measured by the Ocular Surface Disease Index) of dry eye in 38 patients over a six-week period. Further, patients treated with low-dose bromfenac maintained the improvement in signs and symptoms for 10 days after discontinuing treatment. The company is currently in the process of initiating the efficacy portion of the phase 3 program, which will entail two studies with a total of approximately 1,000 patients followed over a six-week period, according to Dr. Chandler. The safety portion of the phase 3 trial is tentatively scheduled to begin later this year and will comprise a six-month and a 12-month trial, with a total of approximately 4,000 patients.

Dr. Chandler notes that low-dose bromfenac could address the impact of inflammation on the ocular surface, a central feature of dry eye. "Controlling inflammation could both quiet the symptoms — that is, irritation, dryness, gritty, sandy feeling, burning in some cases — and improve the signs, such as staining, of ocular surface disease," he explains. The approach yields a dual benefit, Dr. Chandler contends, because of bromfenac's efficacy in dealing with pain as well as its ability to interrupt the inflammatory cycle, thereby allowing the ocular surface to heal. "There are very few medications that truly address the inflammatory cascade that is central to the disease while improving patient comfort," he says.

Although the inflammatory etiology of dry eye remains theoretical, Dr. Chandler says it does explain the results seen in the phase 2 open-label trial. Dr. Chandler contends that low-dose bromfenac has an onset of action that is "much faster" than the approximately eight weeks required for topical cyclosporine. In studies completed to date, he says, the drug produced a response rate that hovers around 70%.

Regarding safety, Dr. Chandler points out that higher-dose bromfenac studied in more than 1,600 patients did not result in any serious corneal adverse events; ocular adverse events observed in these studies resolved with no sequelae. From the perspective of global clinical experience with bromfenac, in about 19 million ophthalmic uses of the currently marketed higher concentration, there have been 22 serious corneal adverse events reported overall. Not all were considered drug related, Dr. Chandler points out, and most were in subjects who had undergone cataract surgery. "Lowering the concentration of bromfenac as we have done could further reduce the likelihood of severe corneal adverse events," he says. As part

of its commitment to patient safety, Ista has incorporated frequent monitoring of the cornea into the protocols for the large safety trials being planned.

- **SAR 1118.** Sarcodine Corp. says that the phase 2 results for SAR-1118, a topical small-molecule lymphocyte function-associated antigen-1 antagonist, showed clear improvements in signs and symptoms of dry eye at 12 weeks. The trial was a randomized, multisite, doublemasked study involving 230 subjects. Various dose levels (0.1, 1.0 and 5.0%) were compared to placebo, with subjects receiving the drops BID for 12 weeks. The primary objective measure was inferior corneal staining; major secondary measures were OSDI symptom score and tear production by Schirmer test. The company will present full details of the phase 2 study in spring 2011. Sarcodine is currently preparing for a phase 3 trial to begin in mid-2011.

- **Mapracorat.** Bausch + Lomb is addressing the issue of tear hyperosmolarity in dry eye disease, which research suggests is a mechanism involved in ocular surface inflammation, with its selective glucocorticoid receptor agonist (mapracorat), currently in phase 2 trials. In vitro studies suggest mapracorat inhibits hyperosmolar-induced cytokine release and mitogenactivated protein kinase pathways in human corneal epithelial cells. Development of the compound continues to progress as a novel product with a new mechanism of action for the treatment of dry eye, according to B+L.

A study in the September 2010 issue of *Molecular Vision* showed it to have comparable activity to dexamethasone in combating inflammation. The investigators evaluated mapracorat's anti-inflammatory effects in an in vitro osmotic stress model that induced hyperosmolar conditions in cultured human corneal cells. The model stimulated the release of pro-inflammatory cytokines interleukin-6, interleukin-8 and monocyte chemoattractant protein-1, and also altered the phosphorylation state of p38 and c-Jun N-terminal kinase (JNK), and the transcriptional activity of NFkappaB and AP-1. The researchers found that the incubation of cells with mapracorat inhibited hyperosmolar-induced cytokine release with potency comparable to the dexamethasone control group. Additionally, increased phosphorylation of p38 and JNK caused by hyperosmolarity was inhibited by mapracorat, and the compound caused a significant decrease in the hyperosmolar-induced rise in NFkappaB and AP-1 transcriptional activity.

- **RX-10045.** One of a class of medicines called resolvins, RX-10045 is a small-molecule lipid mediator that Resolvix Pharmaceuticals says activates the body's own mechanisms for shutting off inflammation. It is administered as a topical eye drop. Resolvix completed a phase 2 trial last year for chronic dry eye. In the randomized, placebo-controlled, 232-patient trial, RX-10045 produced dose-dependent, statistically significant improvement on the primary endpoints for both the signs and symptoms of dry eye, and was generally shown to be safe and well tolerated, the company says.

The phase 2 study examined three doses of RX-10045 and used a controlled adverse environment (CAE) simulator to measure corneal staining in a stressful drying environment, as well as daily patient diaries using a standard visual analog scale to assess symptom improvement over the course of the 28-day study. The drug produced a significant dose-dependent improvement from baseline in symptoms recorded in daily patient diaries. It also reduced staining of the central cornea by 75% ( $P < 0.00001$ ) versus placebo, the difference approaching statistical significance ( $P = 0.11$ ). Additionally, the drug showed a significant improvement in CAE-induced staining in the inferior cornea and in the composite of central and inferior cornea, which also approached statistical significance over placebo ( $P = 0.09$ ).

Resolvix says the phase 3 trial should begin by the end of the year.

- **AzaSite.** Currently there is no prescription product indicated for blepharitis, a void Inspire Pharmaceuticals would like to fill with AzaSite (azithromycin). The drug is already approved as a treatment for bacterial conjunctivitis, but it did not meet statistically significant endpoints in two phase 2 trials for anterior blepharitis last spring. Though a four-week trial did demonstrate improvement in measured signs and symptoms compared to placebo, statistical significance was not achieved for the primary endpoint of mean lid margin hyperemia.



On the secondary endpoints, however, Inspire president and chief executive officer Adrian Adams reports seeing some statistical significance in the areas of signs and symptoms. In the two-week trial, there were no statistically significant improvements for AzaSite compared to vehicle; this included the primary endpoint of clearing of lid debris.

The company says it will use the data obtained from these studies to continue to develop trial parameters using AzaSite as a treatment for both anterior and posterior blepharitis, and expects to refine the trial design through the end of this year. The refinement will include study populations and "seeking improved mappability for assessing and measuring signs and symptoms," says Mr. Adams. "With that, we are looking to utilize the photographic reading centers to maximize the trial."

Inspire anticipates completing the additional phase 2 AzaSite clinical work in 2011. The initiation of the phase 3 trial should begin sometime later next year.

- **LX-214.** Lux Biosciences' dose-ascending phase 1 trial showed that LX-214, a novel topical formulation of voclosporin, was well tolerated by healthy volunteers. There was no difference in tolerability between the vehicle control and the concentrations of drug tested (0.2% and 0.02%). In five subjects diagnosed with dry eye syndrome, the cohort "showed some improvement in their signs (measured by Schirmer's tear test) and symptoms (measured by the OSDI); most notably, the changes observed occurred in the relatively brief timeframe of the study, two weeks compared to what has been reported previously with cyclosporine emulsion," according to Dr. Anglade.

Voclosporin affects the immune response at the surface of the eye, he explains. "We think by controlling the local inflammatory response, it will allow the tear-producing lacrimal gland and the surface of the eye to heal and improve tear production.

LX-214 belongs to a class of agents known as calcineurin phosphatase inhibitors, developed by the company into a nanomicellar formulation. "This renders LX214, a highly insoluble compound, a solution as opposed to an emulsion," Dr. Anglade explains. He believes the drug's solution formulation will help make it better tolerated than cyclosporine emulsion.

Another advantage, says Dr. Anglade, is voclosporin's higher concentration. "A limitation of other forms of topical cyclosporine is that sufficiently high concentrations may not be achieved locally. The ability to achieve high local concentrations may translate into improved efficacy. We'll be able to assess that concept hopefully in the phase 3 when we do a large dose-ranging study."

Dr. Anglade adds that the company is planning a phase 2 proof-of-concept study for the near future.

- **Restasis X.** Allergan reports that it is currently testing a new variation of cyclosporine, Restasis X, in phase 2 clinical trials. The company is not able to speculate on expected timing for FDA approval.

In related news, in a study published in the August issue of the *British Journal of Ophthalmology*, researchers evaluated the efficacy and safety of two concentrations (0.05% and 0.1%) of cyclosporine A in aqueous solution compared to vehicle in treating the signs and symptoms of moderate-to-severe dry eye patients.<sup>1</sup> At Day 21, the 1% group showed statistically significant improvement ( $p < 0.05$ ) in four symptoms and three ocular signs; the 0.05% showed statistically significant improvement in three symptoms and three signs; and the vehicle-only group in two symptoms and two signs. According to the researchers, at Day 42, the 0.1% group performed demonstrated improvement in four symptoms, while the 0.05% group demonstrated improvement in one symptom and one sign.

## Hope for The Future

Dr. Lemp's vantage point as a participant in many FDA trials gives him reason to believe that the regulatory situation for dry eye drugs will soon improve. "As we learn more about the pathological processes at work in dry eye disease, new treatment strategies are emerging and data to support new endpoints are being published," he notes.

For one thing, in a meeting earlier this year, the FDA's Wiley Chambers, MD, expanded the criteria for primary endpoints that the agency will accept, including studies that document a correlation between signs and symptoms. Included in that slide was a list of inflammatory cytokines in the tears and tear osmolarity. "That's new," says Dr. Lemp. "That's potentially big."

Patient-reported outcomes are gaining favor with the FDA as well. The most common vehicle for reporting patient symptoms has been the 100-point scale OSDI. However, showing the required 29-point improvement in symptoms has been onerous. It has required sponsors to find patients who were highly symptomatic — "Who at least start out with 50 to 60 points on the scale," Dr. Lemp says. "And that rules out 90% of the population with dry eye."

New studies re-examining the relationships between subjective patient changes and levels of disease severity, novel ways to assess patient-reported improvement and a better understanding of the relationship between signs and symptoms in dry eye disease all have the potential to open the door to less onerous but scientifically rigorous study designs, Dr. Lemp notes. He believes that this augurs well for demonstration of clinical efficacy and the appearance of an expanded therapeutic portfolio of drugs for the more effective management of dry eye disease.

Perhaps the best reason to believe that the fortunes of prescription dry eye drugs will improve? "Let's put it this way, to my knowledge, there are probably more than 30 drugs in the pipeline," says Dr. Lemp. Many companies are investing in the dry eye market, and not just "the usual suspects" such as Alcon, Allergan and B+L.

The fact that Restasis could generate an approximate half a billion dollars in revenue last year despite its demonstrated effect in only about 15% of the patients studied (according to the package label), indicates significant unmet medical need and a healthy bottom line for those willing to invest.

With industry on board and the FDA willing to update its clinical trial criteria, the conditions for victories seem to be increasingly in place. **OM**

## Reference

1. Baiza-Durán L, Medrano-Palafox J, Hernández-Quintela E, Lozano-Alcazar J, Alaníz-de la O JF. A comparative clinical trial of the efficacy of two different aqueous solutions of cyclosporine for the treatment of moderate-to-severe dry eye syndrome. *Br J Ophthalmol*. 2010 Aug 1. [Epub ahead of print]

### Clinical Trial Pearls

Ora, Inc. has been helping drug makers navigate clinical trials for 15 years, says George Ousler, director of the company's dry eye department, so they have a lot of experience in knowing what makes for a successful program. Here are his recommendations:

- **Identify proper inclusion/exclusion criteria.** Because there are many different causes of dry eye, and different medications that could potentially treat it, it is critical that companies take the time to match the medication's mechanism of action to the appropriate patient population.
- **Focus on both signs and symptoms.** Related to proper inclusion criteria, it is necessary to only include patients who show both signs and symptoms of dry eye. "It sounds pretty straightforward, but there's actually a fair amount of lack of correlation between the two," Mr. Ousler says.
- **Design well-controlled studies and standardize.** Certain clinical models enable better control for the endpoints of dry eye. Toward this end, Ora has developed the Controlled Adverse Environment (CAE). By controlling environmental factors such as humidity, temperature, air flow and visual tasking, "you can establish a screening tool to identify the right patient, and an endpoint to demonstrate efficacy. If it's better controlled, there's not so much background noise like traditional environmental studies," Mr. Ousler explains.

- **Reduce clinical sites.** This helps to keep the trial well controlled and standardized.
- **Enlist the right crew.** "It's more than just running a trial; you have to work with a group of people who understand the disease as well as the entire clinical/regulatory pathway," Mr. Ousler says.

---

*Ophthalmology Management*, Issue: November 2010

# EXHIBIT N

| COMPANY       | FAILED COMPOUND                     |
|---------------|-------------------------------------|
| Alacerty      | ALTY-0501                           |
| Alcon         | Rejena (sodium hyaluronate 0.18%)   |
| Alcon         | Cilomilast (AL-38583)               |
| Alcon         | AL43546                             |
| Alcon         | Durezol                             |
| Alcon         | ESBA105                             |
| Bausch + Lomb | Mapracorat (BOL-303242-X)           |
| EyeGate       | EGP-437                             |
| InSite        | AzasitePlus                         |
| Inspire       | Prolactria (diquafosal tetrasodium) |
| ISTA          | Remura                              |

| COMPANY     | FAILED COMPOUND          |
|-------------|--------------------------|
| ISTA        | Ecabet                   |
| ISTA        | Xibrom                   |
| LUN         | voclosporin              |
| MacuSight   | sirolimus                |
| Novartis    | ANZ885                   |
| Novartis    | AIN457                   |
| OPKO Health | Civamide                 |
| Pfizer      | tofacitinib (CP-690,550) |
| RegenerRx   | RGN259                   |
| Santen      | rivoglitazone (DE-101)   |
| Santen      | DE-110                   |
| Siron       | Zyclorin (cyclosporine)  |

# EXHIBIT O

**From the Triangle Business Journal**

**:<http://www.bizjournals.com/triangle/stories/2010/08/23/daily31.html>**

Aug 25, 2010, 12:52pm EDT

## **Inspire shelves dry-eye drug, shifts focus with Allergan**

Jeff Drew

After a decade of development and disappointment, Inspire Pharmaceuticals finally has put a stop to its efforts to win U.S. Food and Drug Administration approval of a dry eye drug now called Prolacria.

The Durham company on Wednesday unveiled a modified collaboration agreement with longtime partner Allergan (NYSE: AGN) that opens the way for Inspire to close the door on Prolacria and move its focus to pink eye treatment AzaSite and the company's promising cystic fibrosis program.

Investors hailed the new agreement, pushing up Inspire shares by 3.88 percent, to \$4.66, in mid-day trading Wednesday.

Inspire twice saw its dry eye drug fail to outperform a placebo in the last stage of human testing. The company tried changing the drug's name and adjusted the end point of the phase III clinical trial but ended up with the same results.

After studying the potential of moving forward with Prolacria, Inspire and Allergan were ready to move on. But the complicated nature of their drug development deal – which involves another dry eye treatment, Restasis – left Inspire facing a significant and immediate revenue hit.

Inspire (Nasdaq; ISPH) receives royalties from Allergan on sales of Restasis and received payments from the Irish company for hitting development milestones on Prolacria. The previous terms called for a 30 percent reduction in Inspire's Restasis royalty rate of 7.5 percent if the company dropped the Prolacria program and didn't begin contributing to the marketing and promotion of Restasis.

The new terms keep Inspire's Restasis royalty rate unchanged at 7.5 percent for 2010, before reducing it by 3 percentage points in 2011, a further 0.25 percentage point in 2013, and a final 0.50 percentage point in 2014. The rate will remain at 3.75 percent until 2020, when the contract runs out.

Restasis generated \$11.2 million in royalty revenue for Inspire during the second quarter, which ended June 30. That was up from \$8.9 million in the year-ago quarter.

For the quarter, Restasis accounted for more than 40 percent of Inspire's total revenue of \$27.3 million and topped AzaSite, which produced revenue of \$9.6 million.

"This agreement provides clarity on the revenue stream and respective responsibilities of the parties in our ophthalmic collaboration," said Adrian Adams, president and CEO of Inspire, which has 240 employees.

Reporter e-mail: [jdrew@bizjournals.com](mailto:jdrew@bizjournals.com)



Under the Paperwork Reduction Act of 1995, no persons are required to respond to a collection of information unless it displays a valid OMB control number.

|   |   |                                  |                                       |
|---|---|----------------------------------|---------------------------------------|
| <b>PATENT APPLICATION FEE DETERMINATION RECORD</b><br>Substitute for Form PTO-875 | Application or Docket Number<br><b>13/967,189</b> | Filing Date<br><b>08/14/2013</b> | <input type="checkbox"/> To be Mailed |
|---|---|----------------------------------|---------------------------------------|

ENTITY:  LARGE  SMALL  MICRO

**APPLICATION AS FILED – PART I**

| FOR   | NUMBER FILED  | NUMBER EXTRA | RATE (\$) | FEE (\$) |
|---|---|--------------|-----------|----------|
| <input type="checkbox"/> BASIC FEE<br><small>(37 CFR 1.16(a), (b), or (c))</small>        | N/A   | N/A          | N/A       |          |
| <input type="checkbox"/> SEARCH FEE<br><small>(37 CFR 1.16(k), (l), or (m))</small>       | N/A   | N/A          | N/A       |          |
| <input type="checkbox"/> EXAMINATION FEE<br><small>(37 CFR 1.16(o), (p), or (q))</small>  | N/A   | N/A          | N/A       |          |
| TOTAL CLAIMS<br><small>(37 CFR 1.16(i))</small>   | minus 20 =  | *            | X \$ =    |          |
| INDEPENDENT CLAIMS<br><small>(37 CFR 1.16(h))</small>                                     | minus 3 =   | *            | X \$ =    |          |
| <input type="checkbox"/> APPLICATION SIZE FEE<br><small>(37 CFR 1.16(s))</small>          | If the specification and drawings exceed 100 sheets of paper, the application size fee due is \$310 (\$155 for small entity) for each additional 50 sheets or fraction thereof. See 35 U.S.C. 41(a)(1)(G) and 37 CFR 1.16(s). |              |           |          |
| <input type="checkbox"/> MULTIPLE DEPENDENT CLAIM PRESENT <small>(37 CFR 1.16(j))</small> |   |              |           |          |
| <small>* If the difference in column 1 is less than zero, enter "0" in column 2.</small>  |   |              | TOTAL     |          |

**APPLICATION AS AMENDED – PART II**

|   | (Column 1)  | (Column 2)                       | (Column 3)                         | PRESENT EXTRA | RATE (\$)       | ADDITIONAL FEE (\$) |
|---|---|----------------------------------|------------------------------------|---------------|-----------------|---------------------|
| <b>AMENDMENT</b>  | <b>10/23/2013</b>   | CLAIMS REMAINING AFTER AMENDMENT | HIGHEST NUMBER PREVIOUSLY PAID FOR |               |                 |                     |
|   | Total <small>(37 CFR 1.16(i))</small>   | * 20                             | Minus                              | ** 24         | = 0             | X \$80 = 0          |
|   | Independent <small>(37 CFR 1.16(h))</small>                                   | * 4                              | Minus                              | ***3          | = 1             | X \$420 = 420       |
|   | <input type="checkbox"/> Application Size Fee <small>(37 CFR 1.16(s))</small> |                                  |                                    |               |                 |                     |
| <input type="checkbox"/> FIRST PRESENTATION OF MULTIPLE DEPENDENT CLAIM <small>(37 CFR 1.16(j))</small> |   |                                  |                                    |               |                 |                     |
|   |   |                                  |                                    |               | TOTAL ADD'L FEE | <b>420</b>          |

|   | (Column 1)  | (Column 2)                       | (Column 3)                         | PRESENT EXTRA | RATE (\$)       | ADDITIONAL FEE (\$) |
|---|---|----------------------------------|------------------------------------|---------------|-----------------|---------------------|
| <b>AMENDMENT</b>  |   | CLAIMS REMAINING AFTER AMENDMENT | HIGHEST NUMBER PREVIOUSLY PAID FOR |               |                 |                     |
|   | Total <small>(37 CFR 1.16(i))</small>   | *                                | Minus                              | **            | =               | X \$ =              |
|   | Independent <small>(37 CFR 1.16(h))</small>                                   | *                                | Minus                              | ***           | =               | X \$ =              |
|   | <input type="checkbox"/> Application Size Fee <small>(37 CFR 1.16(s))</small> |                                  |                                    |               |                 |                     |
| <input type="checkbox"/> FIRST PRESENTATION OF MULTIPLE DEPENDENT CLAIM <small>(37 CFR 1.16(j))</small> |   |                                  |                                    |               |                 |                     |
|   |   |                                  |                                    |               | TOTAL ADD'L FEE |                     |

\* If the entry in column 1 is less than the entry in column 2, write "0" in column 3.  
 \*\* If the "Highest Number Previously Paid For" IN THIS SPACE is less than 20, enter "20".  
 \*\*\* If the "Highest Number Previously Paid For" IN THIS SPACE is less than 3, enter "3".

The "Highest Number Previously Paid For" (Total or Independent) is the highest number found in the appropriate box in column 1.

LIE  
/LASHAWN MORGAN/

This collection of information is required by 37 CFR 1.16. The information is required to obtain or retain a benefit by the public which is to file (and by the USPTO to process) an application. Confidentiality is governed by 35 U.S.C. 122 and 37 CFR 1.14. This collection is estimated to take 12 minutes to complete, including gathering, preparing, and submitting the completed application form to the USPTO. Time will vary depending upon the individual case. Any comments on the amount of time you require to complete this form and/or suggestions for reducing this burden, should be sent to the Chief Information Officer, U.S. Patent and Trademark Office, U.S. Department of Commerce, P.O. Box 1450, Alexandria, VA 22313-1450. DO NOT SEND FEES OR COMPLETED FORMS TO THIS ADDRESS. **SEND TO: Commissioner for Patents, P.O. Box 1450, Alexandria, VA 22313-1450.**

If you need assistance in completing the form, call 1-800-PTO-9199 and select option 2.

**IN THE UNITED STATES PATENT AND TRADEMARK OFFICE**

Applicant: Acheampong, *et al.*

Serial No.: 13/967,189

Filed: August 14, 2013

For: METHODS OF PROVIDING  
THERAPEUTIC EFFECTS USING  
CYCLOSPORIN COMPONENTS

Examiner: Marcela M Cordero Garcia

Group Art Unit: 1658

Confirmation No. 4818

Customer No.: 51957

**DECLARATION PURSUANT TO 37 C.F.R. § 1.131**

Commissioner for Patents  
Alexandria, VA 22313-1450

We, Andrew Acheampong, Diane D. Tang-Liu, David F. Power, and Allergan, Inc., the assignee of the above-identified application and a party qualified under 37 C.F.R. § 1.46, having executed a Substitute Statement in lieu of Oath or Declaration under 35 USC § 115(d) and 37 CFR § 1.64 on behalf of James N. Chang, declare as follows:

1. We are the inventors of the above-described patent application or a party qualified under 37 C.F.R. § 1.46.
2. We have been advised that the Examiner has identified U.S. Patent Application Serial No. 10/621,053, published as U.S. Patent Application Publication No. 2005/0014691 and U.S. Patent No. 6,984,628 (“the ‘961 publication”) as a possible reference citable against the claims of the present application. We have been informed that the ‘961 publication has an effective filing date of July 15, 2003.
3. Prior to July 15, 2003, the invention as claimed in the above captioned U.S. Patent Application Ser. No. 13/967,189 was conceived and reduced to practice in the United

States as evidenced by the documents attached hereto as Exhibit A and Exhibit B. Exhibit A includes pertinent portions of a Clinical Study Report for a Phase III study for RESTASIS® (the “clinical study report”) completed by Allergan, Inc. (“Allergan”), the assignee of record of the above captioned U.S. Patent Application, prior to July 15, 2003. Also, attached as Exhibit B is the pertinent portion of a formulation report for Allergan Formulation No. 9054X, referenced in the clinical study report. The dates on these documents have been redacted. The date of the Exhibits are both prior to July 15, 2003. Both Exhibits are confidential internal Allergan documents.

4. As shown on page 1 of Exhibit A, the clinical study report is on a multicenter, double-masked, randomized, vehicle-controlled, parallel-group study of the safety and efficacy of cyclosporine (ciclosporin) 0.05% and 0.1% ophthalmic emulsions in patients with moderate to severe keratoconjunctivitis sicca (or dry eye). Although the date has been redacted on this document, we confirm that the document is dated prior to July 15, 2003. Page 2 of Exhibit A shows another page of the clinical study report explaining that the investigational studies that were the subject of the clinical study report were conducted in the USA. Page 3 of Exhibit A shows another page of the clinical study report listing the investigational products for the study. On page 3, under IDENTITY OF INVESTIGATIONAL PRODUCTS, ciclosporin 0.05% ophthalmic emulsion is listed, with reference to Allergan formulation number 9054X. Exhibit B describes the formulation for Allergan formulation number 9054X which is an embodiment of the invention as claimed in the above-captioned U.S. Patent Application. As shown in Exhibit B, Allergan formulation number 9054X contains 0.05% cyclosporin A, 1.25% castor oil, 0.05% Pemulen TR-2 (a C10-30 alkyl acrylate cross polymer), 2.2% glycerin, 1.0% polysorbate 80, water, and sodium hydroxide (a buffer) at a pH of 7.4. Although the date has been redacted on this document, we confirm that the document is dated prior to July 15, 2003.

5. Accordingly, the subject matter of the claimed invention was reduced to practice in the United States before the effective filing date of the ‘961 publication.

Docket No. 17618CON2B (AP)

I declare that the statements I have made in this declaration are true and that I made them knowing that willful false statements and the like are punishable by fine or imprisonment, or both, under 18 U.S.C. § 1001, and that such willful false statements may jeopardize the validity of any patent issuing from the present application.

Date: 12/1/13

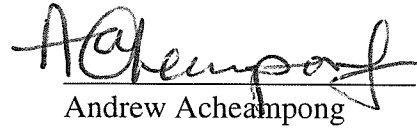
  
Andrew Acheanpong

Docket No. 17618CON2B (AP)

I declare that the statements I have made in this declaration are true and that I made them knowing that willful false statements and the like are punishable by fine or imprisonment, or both, under 18 U.S.C. § 1001, and that such willful false statements may jeopardize the validity of any patent issuing from the present application.

Date: Nov 30, 2013

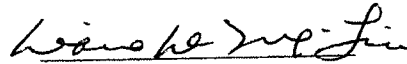
  
Diane D. Tang-Liu

\* 3 DTL

Docket No. 17618CON2B (AP)

I declare that the statements I have made in this declaration are true and that I made them knowing that willful false statements and the like are punishable by fine or imprisonment, or both, under 18 U.S.C. § 1001, and that such willful false statements may jeopardize the validity of any patent issuing from the present application.

Date: 11/29/2013

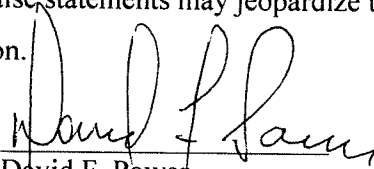
  
David F. Power

Docket No. 17618CON2B (AP)

I declare that the statements I have made in this declaration are true and that I made them knowing that willful false statements and the like are punishable by fine or imprisonment, or both, under 18 U.S.C. § 1001, and that such willful false statements may jeopardize the validity of any patent issuing from the present application.

Date: 12/1/13

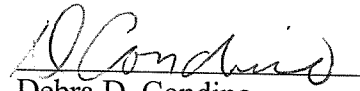
  
Debra D. Condino  
Assistant Secretary  
Allergan, Inc. (Assignee)

# EXHIBIT A



Allergan-Confidential

**CLINICAL STUDY REPORT**

**Study Title**

**A Multicentre, Double-Masked, Randomised, Vehicle-Controlled, Parallel-Group Study of the Safety and Efficacy of Cyclosporine (Ciclosporin) 0.05% and 0.1% Ophthalmic Emulsions Used Twice Daily for Up To One Year in Patients with Moderate to Severe Keratoconjunctivitis Sicca**

**Study Number: 192371-002**

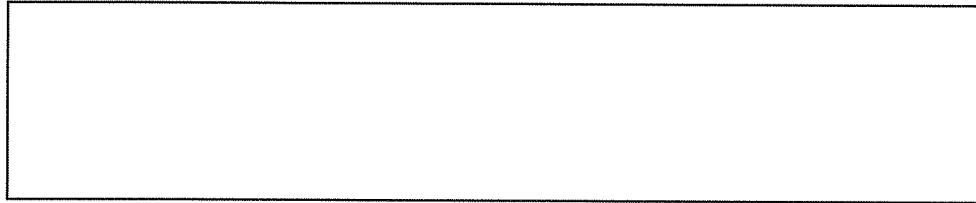

02NOV00 192371-002

## 2. SYNOPSIS

|  |  |                                      |
|--|--|--------------------------------------|
| Name of Sponsor/Company:<br>Allergan   | Individual Study Table<br>Referring to Part of the Dossier | (For National Authority Use<br>Only) |
| Name of Finished Product:<br>Ciclosporin   |  |                                      |
| Name of Active ingredient:<br>Ciclosporin  |  |                                      |
| <p><b>Title of study:</b> A multicentre, double-masked, randomised, vehicle-controlled, parallel-group study of the safety and efficacy of cyclosporine (ciclosporin) 0.05% and 0.1% ophthalmic emulsions used twice daily (BID) for up to one year in patients with moderate to severe keratoconjunctivitis sicca (KCS).</p> <p><b>Study Number:</b> 192371-002</p> <p><i>The clinical study report covers data collected from months 6 to 12, ie from end of vehicle-controlled masked treatment phase, to end of ciclosporin treatment extension phase.</i></p> |  |                                      |
| <p><b>Study centre(s):</b> 14 investigational sites in the USA.</p>  |  |                                      |

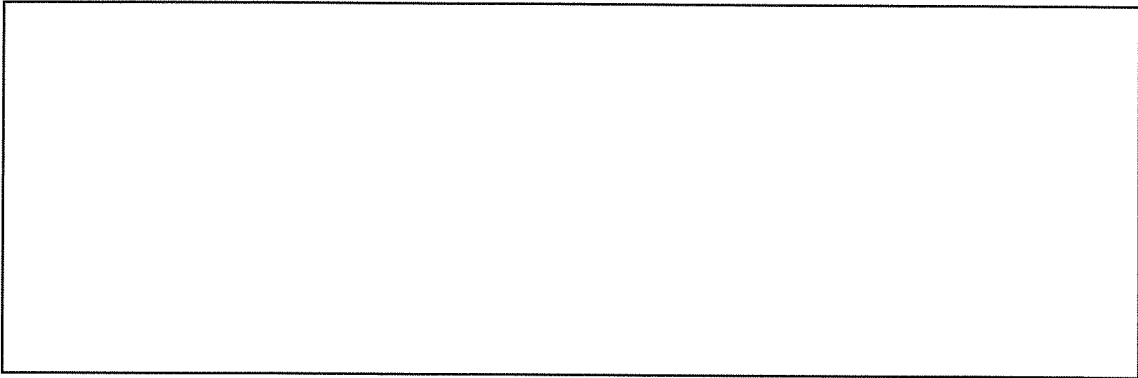

9.4.2 IDENTITY OF INVESTIGATIONAL PRODUCT(S)

The investigational product (ciclosporin ophthalmic emulsion) was provided in unit dose vials. One vial contained one application for both eyes, and had the following identity:

- ciclosporin 0.05% ophthalmic emulsion (Allergan formulation number 9054X), which contained 0.05% ciclosporin, castor oil, glycerin, polysorbate 80, Pemulen, purified water, and sodium hydroxide to adjust pH to 7.4
- ciclosporin 0.1% ophthalmic emulsion (Allergan formulation number 8735X), which contained 0.10% ciclosporin, castor oil, glycerin, polysorbate 80, Pemulen, purified water, and sodium hydroxide to adjust pH to 7.4

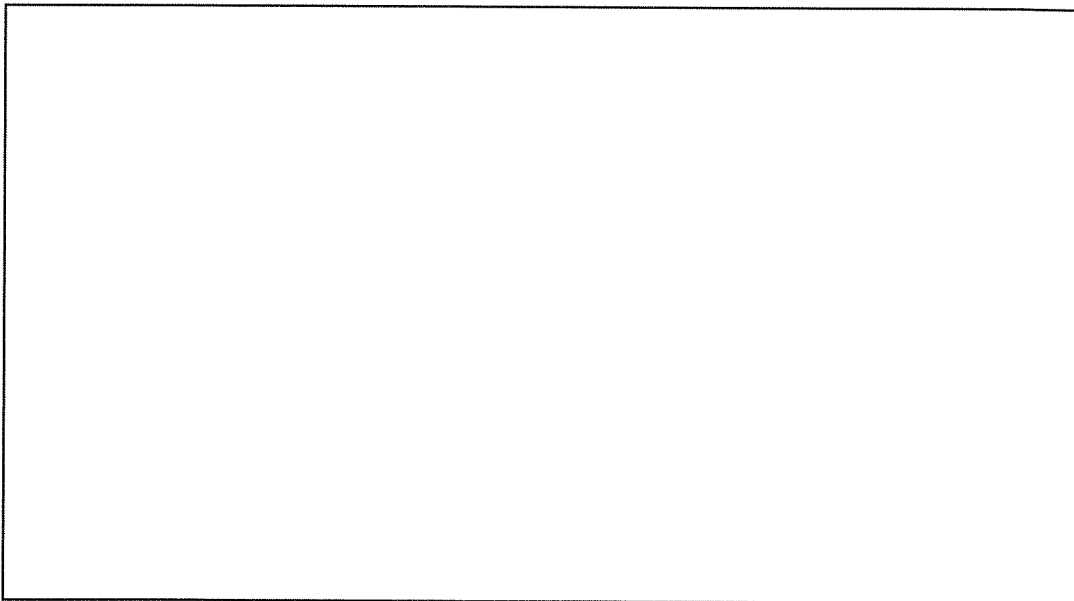

# EXHIBIT B

## X-Number Formulation Report

X-Number: 09054X

**Dosage Form:** Emulsion

|                                   |      |       |                 |
|-----------------------------------|------|-------|-----------------|
| [1] SODIUM HYDROXIDE<br>Grade: NF | 7.4  | pH    | pH Adjust       |
| GLYCERIN<br>Grade: USP            | 2.2  | % w/w | Other           |
| CASTOR OIL<br>Grade: USP          | 1.25 | % w/w | Other           |
| POLYSORBATE 80<br>Grade: NF       | 1.0  | % w/w | Other           |
| CYCLOSPORINE<br>Grade: USP        | 0.05 | % w/w | Active          |
| [2] PEMULEN TR-2<br>Grade: NF     | 0.05 | % w/w | Other           |
| PURIFIED WATER<br>Grade: USP      | NA   | % w/w | Competitor Ingd |

[1]USE 5N SODIUM HYDROXIDE

[2]ACRYLIC ACID/ALKYL METHACRYLATE COPOLYMER BY BFGOODRICH

## Electronic Acknowledgement Receipt

|   |   |
|---|---|
| <b>EFS ID:</b>                              | 17542127  |
| <b>Application Number:</b>                  | 13967189  |
| <b>International Application Number:</b>    |   |
| <b>Confirmation Number:</b>                 | 4818  |
| <b>Title of Invention:</b>                  | METHODS OF PROVIDING THERAPEUTIC EFFECTS USING CYCLOSPORIN COMPONENTS |
| <b>First Named Inventor/Applicant Name:</b> | Andrew Acheampong   |
| <b>Customer Number:</b>                     | 51957   |
| <b>Filer:</b>                               | Laura Lee Wine/Alexis Swan  |
| <b>Filer Authorized By:</b>                 | Laura Lee Wine  |
| <b>Attorney Docket Number:</b>              | 17618CON2B (AP)   |
| <b>Receipt Date:</b>                        | 02-DEC-2013   |
| <b>Filing Date:</b>                         | 14-AUG-2013   |
| <b>Time Stamp:</b>                          | 16:46:17  |
| <b>Application Type:</b>                    | Utility under 35 USC 111(a)   |

### Payment information:

|                        |    |
|------------------------|----|
| Submitted with Payment | no |
|------------------------|----|

### File Listing:

| Document Number | Document Description      | File Name                    | File Size(Bytes)/<br>Message Digest                 | Multi Part /.zip | Pages (if appl.) |
|-----------------|---------------------------|------------------------------|---|------------------|------------------|
| 1               | Oath or Declaration filed | 17618CON2B131DECLARATION.pdf | 5443499<br>ec057ee4c245d2518ad4370e796f0e5bc474689e | no               | 12               |

### Warnings:

### Information:

**This Acknowledgement Receipt evidences receipt on the noted date by the USPTO of the indicated documents, characterized by the applicant, and including page counts, where applicable. It serves as evidence of receipt similar to a Post Card, as described in MPEP 503.**

**New Applications Under 35 U.S.C. 111**

**If a new application is being filed and the application includes the necessary components for a filing date (see 37 CFR 1.53(b)-(d) and MPEP 506), a Filing Receipt (37 CFR 1.54) will be issued in due course and the date shown on this Acknowledgement Receipt will establish the filing date of the application.**

**National Stage of an International Application under 35 U.S.C. 371**

**If a timely submission to enter the national stage of an international application is compliant with the conditions of 35 U.S.C. 371 and other applicable requirements a Form PCT/DO/EO/903 indicating acceptance of the application as a national stage submission under 35 U.S.C. 371 will be issued in addition to the Filing Receipt, in due course.**

**New International Application Filed with the USPTO as a Receiving Office**

**If a new international application is being filed and the international application includes the necessary components for an international filing date (see PCT Article 11 and MPEP 1810), a Notification of the International Application Number and of the International Filing Date (Form PCT/RO/105) will be issued in due course, subject to prescriptions concerning national security, and the date shown on this Acknowledgement Receipt will establish the international filing date of the application.**

|   |   |
|---|---|
| <b>Doc Code: DIST.E.FILE</b><br><b>Document Description: Electronic Terminal Disclaimer - Filed</b> | PTO/SB/25<br>U.S. Patent and Trademark Office<br>Department of Commerce |
|---|---|

|                             |   |
|-----------------------------|---|
| Electronic Petition Request | <b>TERMINAL DISCLAIMER TO OBIVATE A PROVISIONAL DOUBLE PATENTING REJECTION OVER A PENDING "REFERENCE" APPLICATION</b> |
| Application Number          | 13967189  |
| Filing Date                 | 14-Aug-2013   |
| First Named Inventor        | Andrew Acheampong   |
| Attorney Docket Number      | 17618CON2B (AP)   |
| Title of Invention          | METHODS OF PROVIDING THERAPEUTIC EFFECTS USING CYCLOSPORIN COMPONENTS   |

- Filing of terminal disclaimer does not obviate requirement for response under 37 CFR 1.111 to outstanding Office Action
- This electronic Terminal Disclaimer is not being used for a Joint Research Agreement.

| Owner          | Percent Interest |
|----------------|------------------|
| Allergan, Inc. | 100%             |

The owner(s) of percent interest listed above in the instant application hereby disclaims, except as provided below, the terminal part of the statutory term of any patent granted on the instant application which would extend beyond the expiration date of the full statutory term of any patent granted on pending reference Application Number(s)

11897177 filed on 08/28/2007  
12035698 filed on 02/22/2008  
13649287 filed on 10/11/2012

as the term of any patent granted on said reference application may be shortened by any terminal disclaimer filed prior to the grant of any patent on the pending reference application. The owner hereby agrees that any patent so granted on the instant application shall be enforceable only for and during such period that it and any patent granted on the reference application are commonly owned. This agreement runs with any patent granted on the instant application and is binding upon the grantee, its successors or assigns.

In making the above disclaimer, the owner does not disclaim the terminal part of any patent granted on the instant application that would extend to the expiration date of the full statutory term of any patent granted on said reference application, "as the term of any patent granted on said reference application may be shortened by any terminal disclaimer filed prior to the grant of any patent on the pending reference application," in the event that any such patent granted on the pending reference application: expires for failure to pay a maintenance fee, is held unenforceable, is found invalid by a court of competent jurisdiction, is statutorily disclaimed in whole or terminally disclaimed under 37 CFR 1.321, has all claims canceled by a reexamination certificate, is reissued, or is in any manner terminated prior to the expiration of its full statutory term as shortened by any terminal disclaimer filed prior to its grant.



Terminal disclaimer fee under 37 CFR 1.20(d) is included with Electronic Terminal Disclaimer request.

I certify, in accordance with 37 CFR 1.4(d)(4), that the terminal disclaimer fee under 37 CFR 1.20(d) required for this terminal disclaimer has already been paid in the above-identified application.

Applicant claims the following fee status:

Small Entity

Micro Entity

Regular Undiscounted

I hereby declare that all statements made herein of my own knowledge are true and that all statements made on information and belief are believed to be true; and further that these statements were made with the knowledge that willful false statements and the like so made are punishable by fine or imprisonment, or both, under Section 1001 of Title 18 of the United States Code and that such willful false statements may jeopardize the validity of the application or any patent issued thereon.

THIS PORTION MUST BE COMPLETED BY THE SIGNATORY OR SIGNATORIES

I certify, in accordance with 37 CFR 1.4(d)(4) that I am:

An attorney or agent registered to practice before the Patent and Trademark Office who is of record in this application

Registration Number 68681

A sole inventor

A joint inventor; I certify that I am authorized to sign this submission on behalf of all of the inventors

A joint inventor; all of whom are signing this request

The assignee of record of the entire interest that has properly made itself of record pursuant to 37 [CFR 3.71](#)

|           |                 |
|-----------|-----------------|
| Signature | /Laura L. Wine/ |
| Name      | Laura L. Wine   |

\*Statement under 37 CFR 3.73(b) is required if terminal disclaimer is signed by the assignee (owner).  
Form PTO/SB/96 may be used for making this certification. See MPEP § 324.

## Electronic Patent Application Fee Transmittal

|   |   |
|---|---|
| <b>Application Number:</b>                  | 13967189  |
| <b>Filing Date:</b>                         | 14-Aug-2013   |
| <b>Title of Invention:</b>                  | METHODS OF PROVIDING THERAPEUTIC EFFECTS USING CYCLOSPORIN COMPONENTS |
| <b>First Named Inventor/Applicant Name:</b> | Andrew Acheampong   |
| <b>Filer:</b>                               | Laura Lee Wine  |
| <b>Attorney Docket Number:</b>              | 17618CON2B (AP)   |

Filed as Large Entity

### Utility under 35 USC 111(a) Filing Fees

| Description                      | Fee Code | Quantity | Amount | Sub-Total in USD(\$) |
|----------------------------------|----------|----------|--------|----------------------|
| <b>Basic Filing:</b>             |          |          |        |                      |
| Statutory or Terminal Disclaimer | 1814     | 1        | 160    | 160                  |

**Pages:**

**Claims:**

**Miscellaneous-Filing:**

**Petition:**

**Patent-Appeals-and-Interference:**

**Post-Allowance-and-Post-Issuance:**

**Extension-of-Time:**

| Description              | Fee Code | Quantity | Amount | Sub-Total in USD(\$) |
|--------------------------|----------|----------|--------|----------------------|
| <b>Miscellaneous:</b>    |          |          |        |                      |
| <b>Total in USD (\$)</b> |          |          |        | <b>160</b>           |

Doc Code: DISQ.E.FILE

Document Description: Electronic Terminal Disclaimer – Approved

Application No.: 13967189

Filing Date: 14-Aug-2013

Applicant/Patent under Reexamination: Acheampong et al.

Electronic Terminal Disclaimer filed on December 9, 2013

APPROVED

**This patent is subject to a terminal disclaimer**

DISAPPROVED

Approved/Disapproved by: Electronic Terminal Disclaimer automatically approved by EFS-Web

U.S. Patent and Trademark Office

## Electronic Acknowledgement Receipt

|   |   |
|---|---|
| <b>EFS ID:</b>                              | 17600815  |
| <b>Application Number:</b>                  | 13967189  |
| <b>International Application Number:</b>    |   |
| <b>Confirmation Number:</b>                 | 4818  |
| <b>Title of Invention:</b>                  | METHODS OF PROVIDING THERAPEUTIC EFFECTS USING CYCLOSPORIN COMPONENTS |
| <b>First Named Inventor/Applicant Name:</b> | Andrew Acheampong   |
| <b>Customer Number:</b>                     | 51957   |
| <b>Filer:</b>                               | Laura Lee Wine  |
| <b>Filer Authorized By:</b>                 |   |
| <b>Attorney Docket Number:</b>              | 17618CON2B (AP)   |
| <b>Receipt Date:</b>                        | 09-DEC-2013   |
| <b>Filing Date:</b>                         | 14-AUG-2013   |
| <b>Time Stamp:</b>                          | 13:26:07  |
| <b>Application Type:</b>                    | Utility under 35 USC 111(a)   |

### Payment information:

|  |                 |
|--|-----------------|
| Submitted with Payment                   | yes             |
| Payment Type                             | Deposit Account |
| Payment was successfully received in RAM | \$160           |
| RAM confirmation Number                  | 12052           |
| Deposit Account                          | 010885          |
| Authorized User                          |                 |

The Director of the USPTO is hereby authorized to charge indicated fees and credit any overpayment as follows:

Charge any Additional Fees required under 37 C.F.R. Section 1.16 (National application filing, search, and examination fees)

Charge any Additional Fees required under 37 C.F.R. Section 1.17 (Patent application and reexamination processing fees)

Charge any Additional Fees required under 37 C.F.R. Section 1.19 (Document supply fees)

Charge any Additional Fees required under 37 C.F.R. Section 1.20 (Post Issuance fees)

Charge any Additional Fees required under 37 C.F.R. Section 1.21 (Miscellaneous fees and charges)

### File Listing:

| Document Number | Document Description                 | File Name                | File Size(Bytes)/ Message Digest                  | Multi Part /.zip | Pages (if appl.) |
|-----------------|--------------------------------------|--------------------------|---|------------------|------------------|
| 1               | Electronic Terminal Disclaimer-Filed | eTerminal-Disclaimer.pdf | 35625<br>b42c6617df023c7d6712af4055984a052bc0b33e | no               | 2                |

### Warnings:

### Information:

|   |                      |              |   |    |   |
|---|----------------------|--------------|---|----|---|
| 2 | Fee Worksheet (SB06) | fee-info.pdf | 30586<br>d3da5b425a3a6a3bf70ea5813136d8ed1a54af8d | no | 2 |
|---|----------------------|--------------|---|----|---|

### Warnings:

### Information:

**Total Files Size (in bytes):**

66211

**This Acknowledgement Receipt evidences receipt on the noted date by the USPTO of the indicated documents, characterized by the applicant, and including page counts, where applicable. It serves as evidence of receipt similar to a Post Card, as described in MPEP 503.**

#### **New Applications Under 35 U.S.C. 111**

**If a new application is being filed and the application includes the necessary components for a filing date (see 37 CFR 1.53(b)-(d) and MPEP 506), a Filing Receipt (37 CFR 1.54) will be issued in due course and the date shown on this Acknowledgement Receipt will establish the filing date of the application.**

#### **National Stage of an International Application under 35 U.S.C. 371**

**If a timely submission to enter the national stage of an international application is compliant with the conditions of 35 U.S.C. 371 and other applicable requirements a Form PCT/DO/EO/903 indicating acceptance of the application as a national stage submission under 35 U.S.C. 371 will be issued in addition to the Filing Receipt, in due course.**

#### **New International Application Filed with the USPTO as a Receiving Office**

**If a new international application is being filed and the international application includes the necessary components for an international filing date (see PCT Article 11 and MPEP 1810), a Notification of the International Application Number and of the International Filing Date (Form PCT/RO/105) will be issued in due course, subject to prescriptions concerning national security, and the date shown on this Acknowledgement Receipt will establish the international filing date of the application.**



UNITED STATES PATENT AND TRADEMARK OFFICE

UNITED STATES DEPARTMENT OF COMMERCE
United States Patent and Trademark Office
Address: COMMISSIONER FOR PATENTS
P.O. Box 1450
Alexandria, Virginia 22313-1450
www.uspto.gov

Table with 4 columns: APPLICATION NUMBER (13/967,189), FILING OR 371(C) DATE (08/14/2013), FIRST NAMED APPLICANT (Andrew Acheampong), ATTY. DOCKET NO./TITLE (17618CON2B (AP))

CONFIRMATION NO. 4818

PUBLICATION NOTICE

51957
ALLERGAN, INC.
2525 DUPONT DRIVE, T2-7H
IRVINE, CA 92612-1599



Title:METHODS OF PROVIDING THERAPEUTIC EFFECTS USING CYCLOSPORIN COMPONENTS

Publication No.US-2013-0331341-A1
Publication Date:12/12/2013

NOTICE OF PUBLICATION OF APPLICATION

The above-identified application will be electronically published as a patent application publication pursuant to 37 CFR 1.211, et seq. The patent application publication number and publication date are set forth above.

The publication may be accessed through the USPTO's publically available Searchable Databases via the Internet at www.uspto.gov. The direct link to access the publication is currently http://www.uspto.gov/patft/.

The publication process established by the Office does not provide for mailing a copy of the publication to applicant. A copy of the publication may be obtained from the Office upon payment of the appropriate fee set forth in 37 CFR 1.19(a)(1). Orders for copies of patent application publications are handled by the USPTO's Office of Public Records. The Office of Public Records can be reached by telephone at (703) 308-9726 or (800) 972-6382, by facsimile at (703) 305-8759, by mail addressed to the United States Patent and Trademark Office, Office of Public Records, Alexandria, VA 22313-1450 or via the Internet.

In addition, information on the status of the application, including the mailing date of Office actions and the dates of receipt of correspondence filed in the Office, may also be accessed via the Internet through the Patent Electronic Business Center at www.uspto.gov using the public side of the Patent Application Information and Retrieval (PAIR) system. The direct link to access this status information is currently http://pair.uspto.gov/. Prior to publication, such status information is confidential and may only be obtained by applicant using the private side of PAIR.

Further assistance in electronically accessing the publication, or about PAIR, is available by calling the Patent Electronic Business Center at 1-866-217-9197.

Office of Data Management, Application Assistance Unit (571) 272-4000, or (571) 272-4200, or 1-888-786-0101



NOTICE OF ALLOWANCE AND FEE(S) DUE

51957 7590 12/27/2013
ALLERGAN, INC.
2525 DUPONT DRIVE, T2-7H
IRVINE, CA 92612-1599

Table with 2 columns: EXAMINER (CORDERO GARCIA, MARCELA M), ART UNIT, PAPER NUMBER

1676
DATE MAILED: 12/27/2013

Table with 5 columns: APPLICATION NO., FILING DATE, FIRST NAMED INVENTOR, ATTORNEY DOCKET NO., CONFIRMATION NO.

13/967,189 08/14/2013 Andrew Acheampong 17618CON2B (AP) 4818
TITLE OF INVENTION: METHODS OF PROVIDING THERAPEUTIC EFFECTS USING CYCLOSPORIN COMPONENTS

Table with 7 columns: APPLN. TYPE, ENTITY STATUS, ISSUE FEE DUE, PUBLICATION FEE DUE, PREV. PAID ISSUE FEE, TOTAL FEE(S) DUE, DATE DUE

THE APPLICATION IDENTIFIED ABOVE HAS BEEN EXAMINED AND IS ALLOWED FOR ISSUANCE AS A PATENT. PROSECUTION ON THE MERITS IS CLOSED. THIS NOTICE OF ALLOWANCE IS NOT A GRANT OF PATENT RIGHTS. THIS APPLICATION IS SUBJECT TO WITHDRAWAL FROM ISSUE AT THE INITIATIVE OF THE OFFICE OR UPON PETITION BY THE APPLICANT. SEE 37 CFR 1.313 AND MPEP 1308.

THE ISSUE FEE AND PUBLICATION FEE (IF REQUIRED) MUST BE PAID WITHIN THREE MONTHS FROM THE MAILING DATE OF THIS NOTICE OR THIS APPLICATION SHALL BE REGARDED AS ABANDONED. THIS STATUTORY PERIOD CANNOT BE EXTENDED. SEE 35 U.S.C. 151. THE ISSUE FEE DUE INDICATED ABOVE DOES NOT REFLECT A CREDIT FOR ANY PREVIOUSLY PAID ISSUE FEE IN THIS APPLICATION. IF AN ISSUE FEE HAS PREVIOUSLY BEEN PAID IN THIS APPLICATION (AS SHOWN ABOVE), THE RETURN OF PART B OF THIS FORM WILL BE CONSIDERED A REQUEST TO REAPPLY THE PREVIOUSLY PAID ISSUE FEE TOWARD THE ISSUE FEE NOW DUE.

HOW TO REPLY TO THIS NOTICE:

I. Review the ENTITY STATUS shown above. If the ENTITY STATUS is shown as SMALL or MICRO, verify whether entitlement to that entity status still applies.
If the ENTITY STATUS is the same as shown above, pay the TOTAL FEE(S) DUE shown above.
If the ENTITY STATUS is changed from that shown above, on PART B - FEE(S) TRANSMITTAL, complete section number 5 titled "Change in Entity Status (from status indicated above)".
For purposes of this notice, small entity fees are 1/2 the amount of undiscounted fees, and micro entity fees are 1/2 the amount of small entity fees.

II. PART B - FEE(S) TRANSMITTAL, or its equivalent, must be completed and returned to the United States Patent and Trademark Office (USPTO) with your ISSUE FEE and PUBLICATION FEE (if required). If you are charging the fee(s) to your deposit account, section "4b" of Part B - Fee(s) Transmittal should be completed and an extra copy of the form should be submitted. If an equivalent of Part B is filed, a request to reapply a previously paid issue fee must be clearly made, and delays in processing may occur due to the difficulty in recognizing the paper as an equivalent of Part B.

III. All communications regarding this application must give the application number. Please direct all communications prior to issuance to Mail Stop ISSUE FEE unless advised to the contrary.

IMPORTANT REMINDER: Utility patents issuing on applications filed on or after Dec. 12, 1980 may require payment of maintenance fees. It is patentee's responsibility to ensure timely payment of maintenance fees when due.



**PART B - FEE(S) TRANSMITTAL**

**Complete and send this form, together with applicable fee(s), to: Mail Mail Stop ISSUE FEE  
 Commissioner for Patents  
 P.O. Box 1450  
 Alexandria, Virginia 22313-1450  
 or Fax (571)-273-2885**

**INSTRUCTIONS:** This form should be used for transmitting the ISSUE FEE and PUBLICATION FEE (if required). Blocks 1 through 5 should be completed where appropriate. All further correspondence including the Patent, advance orders and notification of maintenance fees will be mailed to the current correspondence address as indicated unless corrected below or directed otherwise in Block 1, by (a) specifying a new correspondence address; and/or (b) indicating a separate "FEE ADDRESS" for maintenance fee notifications.

Note: A certificate of mailing can only be used for domestic mailings of the Fee(s) Transmittal. This certificate cannot be used for any other accompanying papers. Each additional paper, such as an assignment or formal drawing, must have its own certificate of mailing or transmission.

CURRENT CORRESPONDENCE ADDRESS (Note: Use Block 1 for any change of address)

51957                      7590                      12/27/2013  
**ALLERGAN, INC.**  
 2525 DUPONT DRIVE, T2-7H  
 IRVINE, CA 92612-1599

**Certificate of Mailing or Transmission**

I hereby certify that this Fee(s) Transmittal is being deposited with the United States Postal Service with sufficient postage for first class mail in an envelope addressed to the Mail Stop ISSUE FEE address above, or being facsimile transmitted to the USPTO (571) 273-2885, on the date indicated below.

|                    |
|--------------------|
| (Depositor's name) |
| (Signature)        |
| (Date)             |

| APPLICATION NO. | FILING DATE | FIRST NAMED INVENTOR | ATTORNEY DOCKET NO. | CONFIRMATION NO. |
|-----------------|-------------|----------------------|---------------------|------------------|
| 13/967,189      | 08/14/2013  | Andrew Acheampong    | 17618CON2B (AP)     | 4818             |

TITLE OF INVENTION: METHODS OF PROVIDING THERAPEUTIC EFFECTS USING CYCLOSPORIN COMPONENTS

| APPLN. TYPE    | ENTITY STATUS | ISSUE FEE DUE | PUBLICATION FEE DUE | PREV. PAID ISSUE FEE | TOTAL FEE(S) DUE | DATE DUE   |
|----------------|---------------|---------------|---------------------|----------------------|------------------|------------|
| nonprovisional | UNDISCOUNTED  | \$1780        | \$0                 | \$0                  | \$1780           | 03/27/2014 |

| EXAMINER                  | ART UNIT | CLASS-SUBCLASS |
|---------------------------|----------|----------------|
| CORDERO GARCIA, MARCELA M | 1676     | 514-020500     |

|   |   |
|---|---|
| <p>1. Change of correspondence address or indication of "Fee Address" (37 CFR 1.363).</p> <p><input type="checkbox"/> Change of correspondence address (or Change of Correspondence Address form PTO/SB/122) attached.</p> <p><input type="checkbox"/> "Fee Address" indication (or "Fee Address" Indication form PTO/SB/47; Rev 03-02 or more recent) attached. <b>Use of a Customer Number is required.</b></p> | <p>2. For printing on the patent front page, list</p> <p>(1) The names of up to 3 registered patent attorneys or agents OR, alternatively, _____ 1</p> <p>(2) The name of a single firm (having as a member a registered attorney or agent) and the names of up to 2 registered patent attorneys or agents. If no name is listed, no name will be printed. _____ 2</p> <p>_____ 3</p> |
|---|---|

**3. ASSIGNEE NAME AND RESIDENCE DATA TO BE PRINTED ON THE PATENT (print or type)**

PLEASE NOTE: Unless an assignee is identified below, no assignee data will appear on the patent. If an assignee is identified below, the document has been filed for recordation as set forth in 37 CFR 3.11. Completion of this form is NOT a substitute for filing an assignment.

(A) NAME OF ASSIGNEE \_\_\_\_\_ (B) RESIDENCE: (CITY and STATE OR COUNTRY) \_\_\_\_\_

Please check the appropriate assignee category or categories (will not be printed on the patent) :  Individual  Corporation or other private group entity  Government

|   |  |
|---|--|
| <p>4a. The following fee(s) are submitted:</p> <p><input type="checkbox"/> Issue Fee</p> <p><input type="checkbox"/> Publication Fee (No small entity discount permitted)</p> <p><input type="checkbox"/> Advance Order - # of Copies _____</p> | <p>4b. Payment of Fee(s): (<b>Please first reapply any previously paid issue fee shown above</b>)</p> <p><input type="checkbox"/> A check is enclosed.</p> <p><input type="checkbox"/> Payment by credit card. Form PTO-2038 is attached.</p> <p><input type="checkbox"/> The Director is hereby authorized to charge the required fee(s), any deficiency, or credits any overpayment, to Deposit Account Number _____ (enclose an extra copy of this form).</p> |
|---|--|

**5. Change in Entity Status** (from status indicated above)

Applicant certifying micro entity status. See 37 CFR 1.29

Applicant asserting small entity status. See 37 CFR 1.27

Applicant changing to regular undiscounted fee status.

**NOTE:** Absent a valid certification of Micro Entity Status (see forms PTO/SB/15A and 15B), issue fee payment in the micro entity amount will not be accepted at the risk of application abandonment.

**NOTE:** If the application was previously under micro entity status, checking this box will be taken to be a notification of loss of entitlement to micro entity status.

**NOTE:** Checking this box will be taken to be a notification of loss of entitlement to small or micro entity status, as applicable.

**NOTE:** This form must be signed in accordance with 37 CFR 1.31 and 1.33. See 37 CFR 1.4 for signature requirements and certifications.

Authorized Signature \_\_\_\_\_ Date \_\_\_\_\_

Typed or printed name \_\_\_\_\_ Registration No. \_\_\_\_\_



UNITED STATES PATENT AND TRADEMARK OFFICE

UNITED STATES DEPARTMENT OF COMMERCE
United States Patent and Trademark Office
Address: COMMISSIONER FOR PATENTS
P.O. Box 1450
Alexandria, Virginia 22313-1450
www.uspto.gov

Table with 5 columns: APPLICATION NO., FILING DATE, FIRST NAMED INVENTOR, ATTORNEY DOCKET NO., CONFIRMATION NO.
13/967,189 08/14/2013 Andrew Acheampong 17618CON2B (AP) 4818

51957 7590 12/27/2013
ALLERGAN, INC.
2525 DUPONT DRIVE, T2-7H
IRVINE, CA 92612-1599

EXAMINER

CORDERO GARCIA, MARCELA M

ART UNIT PAPER NUMBER

1676

DATE MAILED: 12/27/2013

Determination of Patent Term Adjustment under 35 U.S.C. 154 (b)

(application filed on or after May 29, 2000)

The Patent Term Adjustment to date is 0 day(s). If the issue fee is paid on the date that is three months after the mailing date of this notice and the patent issues on the Tuesday before the date that is 28 weeks (six and a half months) after the mailing date of this notice, the Patent Term Adjustment will be 0 day(s).

If a Continued Prosecution Application (CPA) was filed in the above-identified application, the filing date that determines Patent Term Adjustment is the filing date of the most recent CPA.

Applicant will be able to obtain more detailed information by accessing the Patent Application Information Retrieval (PAIR) WEB site (http://pair.uspto.gov).

Any questions regarding the Patent Term Extension or Adjustment determination should be directed to the Office of Patent Legal Administration at (571)-272-7702. Questions relating to issue and publication fee payments should be directed to the Customer Service Center of the Office of Patent Publication at 1-(888)-786-0101 or (571)-272-4200.

## OMB Clearance and PRA Burden Statement for PTOL-85 Part B

The Paperwork Reduction Act (PRA) of 1995 requires Federal agencies to obtain Office of Management and Budget approval before requesting most types of information from the public. When OMB approves an agency request to collect information from the public, OMB (i) provides a valid OMB Control Number and expiration date for the agency to display on the instrument that will be used to collect the information and (ii) requires the agency to inform the public about the OMB Control Number's legal significance in accordance with 5 CFR 1320.5(b).

The information collected by PTOL-85 Part B is required by 37 CFR 1.311. The information is required to obtain or retain a benefit by the public which is to file (and by the USPTO to process) an application. Confidentiality is governed by 35 U.S.C. 122 and 37 CFR 1.14. This collection is estimated to take 12 minutes to complete, including gathering, preparing, and submitting the completed application form to the USPTO. Time will vary depending upon the individual case. Any comments on the amount of time you require to complete this form and/or suggestions for reducing this burden, should be sent to the Chief Information Officer, U.S. Patent and Trademark Office, U.S. Department of Commerce, P.O. Box 1450, Alexandria, Virginia 22313-1450. DO NOT SEND FEES OR COMPLETED FORMS TO THIS ADDRESS. SEND TO: Commissioner for Patents, P.O. Box 1450, Alexandria, Virginia 22313-1450. Under the Paperwork Reduction Act of 1995, no persons are required to respond to a collection of information unless it displays a valid OMB control number.

### Privacy Act Statement

**The Privacy Act of 1974 (P.L. 93-579)** requires that you be given certain information in connection with your submission of the attached form related to a patent application or patent. Accordingly, pursuant to the requirements of the Act, please be advised that: (1) the general authority for the collection of this information is 35 U.S.C. 2(b)(2); (2) furnishing of the information solicited is voluntary; and (3) the principal purpose for which the information is used by the U.S. Patent and Trademark Office is to process and/or examine your submission related to a patent application or patent. If you do not furnish the requested information, the U.S. Patent and Trademark Office may not be able to process and/or examine your submission, which may result in termination of proceedings or abandonment of the application or expiration of the patent.

The information provided by you in this form will be subject to the following routine uses:

1. The information on this form will be treated confidentially to the extent allowed under the Freedom of Information Act (5 U.S.C. 552) and the Privacy Act (5 U.S.C. 552a). Records from this system of records may be disclosed to the Department of Justice to determine whether disclosure of these records is required by the Freedom of Information Act.
2. A record from this system of records may be disclosed, as a routine use, in the course of presenting evidence to a court, magistrate, or administrative tribunal, including disclosures to opposing counsel in the course of settlement negotiations.
3. A record in this system of records may be disclosed, as a routine use, to a Member of Congress submitting a request involving an individual, to whom the record pertains, when the individual has requested assistance from the Member with respect to the subject matter of the record.
4. A record in this system of records may be disclosed, as a routine use, to a contractor of the Agency having need for the information in order to perform a contract. Recipients of information shall be required to comply with the requirements of the Privacy Act of 1974, as amended, pursuant to 5 U.S.C. 552a(m).
5. A record related to an International Application filed under the Patent Cooperation Treaty in this system of records may be disclosed, as a routine use, to the International Bureau of the World Intellectual Property Organization, pursuant to the Patent Cooperation Treaty.
6. A record in this system of records may be disclosed, as a routine use, to another federal agency for purposes of National Security review (35 U.S.C. 181) and for review pursuant to the Atomic Energy Act (42 U.S.C. 218(c)).
7. A record from this system of records may be disclosed, as a routine use, to the Administrator, General Services, or his/her designee, during an inspection of records conducted by GSA as part of that agency's responsibility to recommend improvements in records management practices and programs, under authority of 44 U.S.C. 2904 and 2906. Such disclosure shall be made in accordance with the GSA regulations governing inspection of records for this purpose, and any other relevant (i.e., GSA or Commerce) directive. Such disclosure shall not be used to make determinations about individuals.
8. A record from this system of records may be disclosed, as a routine use, to the public after either publication of the application pursuant to 35 U.S.C. 122(b) or issuance of a patent pursuant to 35 U.S.C. 151. Further, a record may be disclosed, subject to the limitations of 37 CFR 1.14, as a routine use, to the public if the record was filed in an application which became abandoned or in which the proceedings were terminated and which application is referenced by either a published application, an application open to public inspection or an issued patent.
9. A record from this system of records may be disclosed, as a routine use, to a Federal, State, or local law enforcement agency, if the USPTO becomes aware of a violation or potential violation of law or regulation.

**Notices of Allowance and Fee(s) Due mailed between October 1, 2013 and  
December 31, 2013**

(Addendum to PTOL-85)

If the “Notice of Allowance and Fee(s) Due” has a mailing date on or after October 1, 2013 and before January 1, 2014, the following information is applicable to this application.

If the issue fee is being timely paid on or after January 1, 2014, the amount due is the issue fee and publication fee in effect January 1, 2014. On January 1, 2014, the issue fees set forth in 37 CFR 1.18 decrease significantly and the publication fee set forth in 37 CFR 1.18(d)(1) decreases to \$0.

If an issue fee or publication fee has been previously paid in this application, applicant is not entitled to a refund of the difference between the amount paid and the amount in effect on January 1, 2014.

|   |   |  |  |
|---|---|--|--|
| <b><i>Applicant-Initiated Interview Summary</i></b> | <b>Application No.</b><br>13/967,189            | <b>Applicant(s)</b><br>ACHEAMPONG ET AL. |  |
|   | <b>Examiner</b><br>MARCELA M. CORDERO<br>GARCIA | <b>Art Unit</b><br>1658                  |  |

All participants (applicant, applicant's representative, PTO personnel):

(1) MARCELA M. CORDERO GARCIA. (3)\_\_\_\_\_.

(2) LAURA L. WINE. (4)\_\_\_\_\_.

Date of Interview: 12/2/2013.

Type:  Telephonic  Video Conference  
 Personal [copy given to:  applicant  applicant's representative]

Exhibit shown or demonstration conducted:  Yes  No.  
If Yes, brief description: \_\_\_\_\_.

Issues Discussed 101 112 102 103 Others  
(For each of the checked box(es) above, please describe below the issue and detailed description of the discussion)

Claim(s) discussed: All, in general.

Identification of prior art discussed: US 6,984,628.

**Substance of Interview**

(For each issue discussed, provide a detailed description and indicate if agreement was reached. Some topics may include: identification or clarification of a reference or a portion thereof, claim interpretation, proposed amendments, arguments of any applied references etc...)

See Continuation Sheet.

**Applicant recordation instructions:** The formal written reply to the last Office action must include the substance of the interview. (See MPEP section 713.04). If a reply to the last Office action has already been filed, applicant is given a non-extendable period of the longer of one month or thirty days from this interview date, or the mailing date of this interview summary form, whichever is later, to file a statement of the substance of the interview

**Examiner recordation instructions:** Examiners must summarize the substance of any interview of record. A complete and proper recordation of the substance of an interview should include the items listed in MPEP 713.04 for complete and proper recordation including the identification of the general thrust of each argument or issue discussed, a general indication of any other pertinent matters discussed regarding patentability and the general results or outcome of the interview, to include an indication as to whether or not agreement was reached on the issues raised.

Attachment

/MARCELA M CORDERO GARCIA/  
Primary Examiner, Art Unit 1676

## Summary of Record of Interview Requirements

### Manual of Patent Examining Procedure (MPEP), Section 713.04, Substance of Interview Must be Made of Record

A complete written statement as to the substance of any face-to-face, video conference, or telephone interview with regard to an application must be made of record in the application whether or not an agreement with the examiner was reached at the interview.

### Title 37 Code of Federal Regulations (CFR) § 1.133 Interviews

Paragraph (b)

In every instance where reconsideration is requested in view of an interview with an examiner, a complete written statement of the reasons presented at the interview as warranting favorable action must be filed by the applicant. An interview does not remove the necessity for reply to Office action as specified in §§ 1.111, 1.135. (35 U.S.C. 132)

37 CFR §1.2 Business to be transacted in writing.

All business with the Patent or Trademark Office should be transacted in writing. The personal attendance of applicants or their attorneys or agents at the Patent and Trademark Office is unnecessary. The action of the Patent and Trademark Office will be based exclusively on the written record in the Office. No attention will be paid to any alleged oral promise, stipulation, or understanding in relation to which there is disagreement or doubt.

The action of the Patent and Trademark Office cannot be based exclusively on the written record in the Office if that record is itself incomplete through the failure to record the substance of interviews.

It is the responsibility of the applicant or the attorney or agent to make the substance of an interview of record in the application file, unless the examiner indicates he or she will do so. It is the examiner's responsibility to see that such a record is made and to correct material inaccuracies which bear directly on the question of patentability.

Examiners must complete an Interview Summary Form for each interview held where a matter of substance has been discussed during the interview by checking the appropriate boxes and filling in the blanks. Discussions regarding only procedural matters, directed solely to restriction requirements for which interview recordation is otherwise provided for in Section 812.01 of the Manual of Patent Examining Procedure, or pointing out typographical errors or unreadable script in Office actions or the like, are excluded from the interview recordation procedures below. Where the substance of an interview is completely recorded in an Examiners Amendment, no separate Interview Summary Record is required.

The Interview Summary Form shall be given an appropriate Paper No., placed in the right hand portion of the file, and listed on the "Contents" section of the file wrapper. In a personal interview, a duplicate of the Form is given to the applicant (or attorney or agent) at the conclusion of the interview. In the case of a telephone or video-conference interview, the copy is mailed to the applicant's correspondence address either with or prior to the next official communication. If additional correspondence from the examiner is not likely before an allowance or if other circumstances dictate, the Form should be mailed promptly after the interview rather than with the next official communication.

The Form provides for recordation of the following information:

- Application Number (Series Code and Serial Number)
- Name of applicant
- Name of examiner
- Date of interview
- Type of interview (telephonic, video-conference, or personal)
- Name of participant(s) (applicant, attorney or agent, examiner, other PTO personnel, etc.)
- An indication whether or not an exhibit was shown or a demonstration conducted
- An identification of the specific prior art discussed
- An indication whether an agreement was reached and if so, a description of the general nature of the agreement (may be by attachment of a copy of amendments or claims agreed as being allowable). Note: Agreement as to allowability is tentative and does not restrict further action by the examiner to the contrary.
- The signature of the examiner who conducted the interview (if Form is not an attachment to a signed Office action)

It is desirable that the examiner orally remind the applicant of his or her obligation to record the substance of the interview of each case. It should be noted, however, that the Interview Summary Form will not normally be considered a complete and proper recordation of the interview unless it includes, or is supplemented by the applicant or the examiner to include, all of the applicable items required below concerning the substance of the interview.

A complete and proper recordation of the substance of any interview should include at least the following applicable items:

- 1) A brief description of the nature of any exhibit shown or any demonstration conducted,
- 2) an identification of the claims discussed,
- 3) an identification of the specific prior art discussed,
- 4) an identification of the principal proposed amendments of a substantive nature discussed, unless these are already described on the Interview Summary Form completed by the Examiner,
- 5) a brief identification of the general thrust of the principal arguments presented to the examiner,  
(The identification of arguments need not be lengthy or elaborate. A verbatim or highly detailed description of the arguments is not required. The identification of the arguments is sufficient if the general nature or thrust of the principal arguments made to the examiner can be understood in the context of the application file. Of course, the applicant may desire to emphasize and fully describe those arguments which he or she feels were or might be persuasive to the examiner.)
- 6) a general indication of any other pertinent matters discussed, and
- 7) if appropriate, the general results or outcome of the interview unless already described in the Interview Summary Form completed by the examiner.

Examiners are expected to carefully review the applicant's record of the substance of an interview. If the record is not complete and accurate, the examiner will give the applicant an extendable one month time period to correct the record.

### Examiner to Check for Accuracy

If the claims are allowable for other reasons of record, the examiner should send a letter setting forth the examiner's version of the statement attributed to him or her. If the record is complete and accurate, the examiner should place the indication, "Interview Record OK" on the paper recording the substance of the interview along with the date and the examiner's initials.

Continuation of Substance of Interview including description of the general nature of what was agreed to if an agreement was reached, or any other comments: Authorization for communication under MPEP 502.03 was filed on 10/1/2013 by Applicant's representative. Courtesy copy of the OA was given to Applicant's representative via email on 10/7/2013. The emailed copy was identical to the OA of record, therefore, for the sake of clarity it has not been herein included and Applicant's representative. Applicant's representative contacted Examiner on 10/17-18/2013, 10/23/2013, 10/28/2013 and 10/30/2013 and 11/1/2013 to inquire about the application, provide updates regarding the status of the application and filings and/or discuss any potential questions and related applications. Examiner provided updates regarding the status of the examination as requested. On 10/18/2013, Examiner contacted Applicant's representative to discuss the affidavits EXHIBIT 1 and 2 were discussed specifically with regards to the excipients used in phase2 and phase3 of the clinical trials described therein, Applicant's representative indicated that the excipients were identical in these 2 phases and that this was also set forth in the affidavits, which was confirmed by Examiner (e.g., page 2, paragraph 8 of EXHIBIT 1). On 10/23/2013, Applicant's representative along with Maysa Attar contacted Examiner to discuss whether any outstanding questions remained from the examination of the courtesy copies of the affidavits. Examiner did not have any further questions and indicated that she would act on the case when the official papers were filed. Laura Wine contacted Examiner on 10/28/2013 indicating that the response had been filed on 10/23/2013. During the final search Examiner found a potential 102(e) reference (US 6 984,623, Table 5). Examiner contacted Applicant's representative on 11/4/2013 to discuss US 6,984,628, which would necessitate a 102(e) rejection (see Table 5). Applicant's representative filed a 1.131 declaration to obviate such potential rejection (see 1.131 declaration filed 12/2/2013, for which an identical courtesy copy was also emailed to Examiner. Examiner indicated that the declaration was acceptable in a telephonic conversation on 12/9/2013 and requested TDs for 11/897,177, 12/035,698 and 13/649,287 to obviate potential non-statutory double patenting rejections (see TDs submitted on 12/9/2013). Furthermore, Examiner indicated that a TD would be needed with US 6,984,628, however, upon reconsideration, US 6,984,628 does not require a non-statutory double patenting rejection as indicated in a telephonic message on 12/17/2013.

|                               |   |  |  |
|-------------------------------|---|--|--|
| <b>Notice of Allowability</b> | <b>Application No.</b><br>13/967,189            | <b>Applicant(s)</b><br>ACHEAMPONG ET AL. |  |
|                               | <b>Examiner</b><br>MARCELA M. CORDERO<br>GARCIA | <b>Art Unit</b><br>1658                  | <b>AIA (First Inventor to File) Status</b><br>No |

**-- The MAILING DATE of this communication appears on the cover sheet with the correspondence address--**

All claims being allowable, PROSECUTION ON THE MERITS IS (OR REMAINS) CLOSED in this application. If not included herewith (or previously mailed), a Notice of Allowance (PTOL-85) or other appropriate communication will be mailed in due course. **THIS NOTICE OF ALLOWABILITY IS NOT A GRANT OF PATENT RIGHTS.** This application is subject to withdrawal from issue at the initiative of the Office or upon petition by the applicant. See 37 CFR 1.313 and MPEP 1308.

1.  This communication is responsive to 10/7/2013, 10/23/2013, 12/2/2013 and 12/9/2013.  
 A declaration(s)/affidavit(s) under **37 CFR 1.130(b)** was/were filed on \_\_\_\_\_.
2.  An election was made by the applicant in response to a restriction requirement set forth during the interview on \_\_\_\_\_; the restriction requirement and election have been incorporated into this action.
3.  The allowed claim(s) is/are 37-48, 61-68. As a result of the allowed claim(s), you may be eligible to benefit from the **Patent Prosecution Highway** program at a participating intellectual property office for the corresponding application. For more information, please see [http://www.uspto.gov/patents/init\\_events/oph/index.jsp](http://www.uspto.gov/patents/init_events/oph/index.jsp) or send an inquiry to [PPHfeedback@uspto.gov](mailto:PPHfeedback@uspto.gov).
4.  Acknowledgment is made of a claim for foreign priority under 35 U.S.C. § 119(a)-(d) or (f).

**Certified copies:**

- a)  All    b)  Some    \*c)  None of the:
1.  Certified copies of the priority documents have been received.
  2.  Certified copies of the priority documents have been received in Application No. \_\_\_\_\_.
  3.  Copies of the certified copies of the priority documents have been received in this national stage application from the International Bureau (PCT Rule 17.2(a)).

\* Certified copies not received: \_\_\_\_\_.

Applicant has THREE MONTHS FROM THE "MAILING DATE" of this communication to file a reply complying with the requirements noted below. Failure to timely comply will result in ABANDONMENT of this application.

**THIS THREE-MONTH PERIOD IS NOT EXTENDABLE.**

5.  CORRECTED DRAWINGS ( as "replacement sheets") must be submitted.  
 including changes required by the attached Examiner's Amendment / Comment or in the Office action of Paper No./Mail Date \_\_\_\_\_.  
**Identifying indicia such as the application number (see 37 CFR 1.84(c)) should be written on the drawings in the front (not the back) of each sheet. Replacement sheet(s) should be labeled as such in the header according to 37 CFR 1.121(d).**
6.  DEPOSIT OF and/or INFORMATION about the deposit of BIOLOGICAL MATERIAL must be submitted. Note the attached Examiner's comment regarding REQUIREMENT FOR THE DEPOSIT OF BIOLOGICAL MATERIAL.

**Attachment(s)**

- |  |   |
|--|---|
| 1. <input checked="" type="checkbox"/> Notice of References Cited (PTO-892)                                  | 5. <input checked="" type="checkbox"/> Examiner's Amendment/Comment       |
| 2. <input type="checkbox"/> Information Disclosure Statements (PTO/SB/08),<br>Paper No./Mail Date _____      | 6. <input type="checkbox"/> Examiner's Statement of Reasons for Allowance |
| 3. <input type="checkbox"/> Examiner's Comment Regarding Requirement for Deposit<br>of Biological Material   | 7. <input type="checkbox"/> Other _____.                                  |
| 4. <input checked="" type="checkbox"/> Interview Summary (PTO-413),<br>Paper No./Mail Date <u>20131211</u> . |   |

/MARCELA M CORDERO GARCIA/  
Primary Examiner, Art Unit 1658



### DETAILED ACTION

1. The present application is being examined under the pre-AIA first to invent provisions.
2. This Office Action is in response to the reply received on 10/7/2013 and 10/23/2013.

Any rejection from the previous office action, which is not restated here, is withdrawn.

### *Status of the claims*

3. Claims 37-48 and 61-68 are pending. Claims 37-48 and 61-68 are presented for examination on the merits.

### *Declarations under 37 CFR 1.132*

4. The declaration under 37 CFR 1.132 filed 10/23/2013 (EXHIBIT 3 comprising EXHIBITS A, B and C) has been carefully considered, however it is deemed insufficient to overcome the rejection of claims 37-61 based upon Ding et al. (US 5,474,979, cited in the IDS dated 9/12/2013) as set forth in the last Office action because: "Objective evidence of nonobviousness including commercial success must be commensurate in scope with the claims. *In re Tiffin*, 448 F.2d 791, 171 USPQ 294 (CCPA 1971) (evidence showing **commercial** success of thermoplastic foam "cups" used in vending machines was not commensurate in scope with claims directed to thermoplastic foam "containers" broadly). In order to be commensurate \* > in < scope with the claims, the **commercial** success must be due to claimed features, and not due to unclaimed features. *Joy Technologies Inc. v. Manbeck*, 751 F. Supp. 225, 229, 17 USPQ2d 1257,

Art Unit: 1658

1260 (D.D.C. 1990), *aff'd*, 959 F.2d 226, 228, 22 USPQ2d 1153, 1156 (Fed. Cir. 1992) (Features responsible for **commercial** success were recited only in allowed dependent claims, and therefore the evidence of **commercial** success was not commensurate in scope with the broad claims at issue." (MPEP 716.03). In the instant case, compositions comprising any of the previously discussed embodiments of Ding et al. (i.e., Examples D, E) were not commercially available nor were compared in the declaration. Therefore, Examiner cannot ascertain whether the commercial success of the claimed composition was due to the claimed features which are distinct from those embodiments in Ding et al. or other factors such as the fact that the composition was the only composition for treating dry eyes FDA approved and thus, commercially available for sale to the public (see, e.g. EXHIBIT 4, pages 4-5, paragraphs 8-9).

The declaration under 37 CFR 1.132 filed 10/23/2013 (EXHIBIT 4, comprising EXHIBITS A-O) is insufficient to overcome the rejection of claims 37-61 based upon Ding et al. (US 5,474,979, cited in the IDS dated 9/12/2013) as set forth in the last Office action because: "Establishing **long-felt need** requires objective evidence that an art recognized problem existed in the art for a long period of time without solution. The relevance of **long-felt need** and the failure of others to the issue of obviousness depends on several factors: (I) First, the need must have been a persistent one that was recognized by those of ordinary skill in the art; (II) Second, the **long-felt need** must not have been satisfied by another before the invention by applicant and (III) Third, the invention must in fact satisfy the long-felt need (MPEP 716.04). In the instant case, with respect to (II), the prior art abundantly provides for methods of treating dry eye disease

Art Unit: 1658

with cyclosporin and other active agents, e.g., Ding et al. (US 5,474,979, cited in the IDS dated 9/12/2013), Kawashima et al. (US 6,582,718, cited in the IDS dated 9/12/2013), Ding et al. (US 5,981,607, cited in the IDS dated 9/12/2013) and Benita et al. (US 6,656,460, cited in the IDS dated 9/12/2013). Therefore, (II) has not been met and the arguments regarding long-felt need have not been deemed persuasive.

The declaration under 37 CFR 1.132 filed 10/23/2013 (EXHIBIT 1, comprising EXHIBITS A-F) is deemed sufficient to overcome the rejection of claims 37-61 based upon Ding et al. (US 5,474,979, cited in the IDS dated 9/12/2013) as set forth in the last Office action because: After carefully reviewing exhibits A-F, which compare the instantly claimed embodiment having 0.05%/1.25% castor oil with embodiments E and F of Ding et al. (0.10%/1.25% castor oil and 0.05/.625% cyclosporin/castor oil ratios), Examiner is persuaded that, unexpectedly, the claimed formulation (0.05% cyclosporin A/1.25% castor oil) demonstrated an 8-fold increase in relative efficacy for the Schirmer Tear Test score in the first study of Phase 3 trials compared to the relative efficacy for the 0.05% by weight cyclosporin A/0.625% by weight castor oil formulation disclosed in Example 1E of Ding, tested in Phase 2 trials. The data represents a comparison of the subpopulation of Phase 2 patients using compositions with the same reductions in tear production (5 mm/5 min) as those enrolled in the Phase 3 studies. EXHIBIT 1 at paragraph 8. All of the cyclosporin A-containing formulations as well as the vehicle also included 2.2% by weight glycerine, 1.0% by weight polysorbate, 0.05% Pemulen, sodium hydroxide, and water (see paragraph 6, page 2 of EXHIBIT 1).

Exhibits E and F also illustrate that the claimed formulations comprising 0.05% cyclosporin A/1.25% castor oil also demonstrated a 4-fold improvement in the relative efficacy for the Schirmer Tear Test score for the second study of Phase 3 and a 4-fold increase in relative efficacy for decrease in corneal staining score in both of the Phase 3 studies compared to the 0.05% by weight cyclosporin A/0.625% by weight castor oil formulation tested in Phase 2 and disclosed in Ding (Ding 1E). The excipients were the same in the compared compositions. Given that the compositions comprise the same amount of active agent (0.05 % cyclosporin A) as Ding 1E, the improvements are surprising, unexpected and commensurate in scope with the claimed invention.

The declaration under 37 CFR 1.132 filed 10/23/2013 (EXHIBIT 2, comprising EXHIBITS A-D) is deemed sufficient to overcome the rejection of claims 37-61 based upon Ding et al. (US 5,474,979, cited in the IDS dated 9/12/2013) as set forth in the last Office action because: EXHIBITS A-D were carefully reviewed. As described in paragraph 7 of the EXHIBIT 2, the chart in EXHIBIT B shows that the amount of cyclosporin A that reaches the cornea and conjunctiva, ocular tissues that are highly relevant for the treatment of dry eye or keratoconjunctivis sicca, is higher for the formulation containing 0.05% by weight cyclosporin A and 0.625% by weight castor oil (Ding et al. 1E) than the formulation containing 0.05% by weight cyclosporin A and 1.25% by weight castor oil (the claimed formulation) relative to the formulation containing 0.1% by weight cyclosporin A and 1.25% by weight castor oil (Ding et al. 1D). According to Dr. Attar, this data teaches that the formulation containing 0.05% by weight cyclosporin A and 1.25% by weight castor oil would be less therapeutically effective

Art Unit: 1658

than the formulation containing 0.05% by weight cyclosporin A and 0.625% by weight castor oil or the formulation containing 0.10% by weight cyclosporin A and 1.25% by weight castor oil. EXHIBIT A, paragraph 8. Therefore it would be unexpected that the composition with lower uptake in cornea and conjunctiva would have significantly improved activity.

Taking the results of the studies and data presented in the EXHIBITS 1 and 2 together, it is clear that the specific combination of 0.05% by weight cyclosporin A with 1.25% by weight castor oil is surprisingly critical for therapeutic effectiveness in the treatment of dry eye or keratoconjunctivitis sicca.

Accordingly, the Declarations in EXHIBIT 1 and EXHIBIT 2, together with the data presented in those declarations, provide clear and convincing objective evidence that establishes that the claimed formulations, including 0.05% by weight cyclosporin A and 1.25% by weight castor oil, demonstrate surprising and unexpected results, including improved Schirmer Tear Test scores and corneal staining scores (key objective measures of efficacy for dry eye or keratoconjunctivitis sicca) and improved visual blurring and reduced artificial tear use as compared to the prior art, for example, emulsion formulations disclosed in Ding et al., including formulations with 0.05% by weight cyclosporin A and 0.625% by weight castor oil (Ding et al. 1E) and formulations with 0.10% by weight cyclosporin A and 1.25% by weight castor oil (Ding et al. 1D) which are the closest prior art formulations. The unexpected results are commensurate in scope with the claims (MPEP 716.02(d)).

Thus, the obviousness rejection in view of Ding et al. is herein withdrawn.

***Declaration under 37 CFR 1.131***

5. The 37 CFR 1.131 declaration filed on 12/2/2013 has been reviewed and accepted thus obviating a potential 102(e) rejection over US 6,984,628 (corresponding to US 2005/0014691, cited in the IDS dated 9/12/2013).

***Double Patenting***

6. The ODP rejection over Ding et al. is herein withdrawn for the reasons set forth in section 4 above.

***Statutory double patenting rejections***

7. The statutory double patenting rejections over 13/961,808; 13/967,163 and 13/961,828 are withdrawn in view of Applicants' amendments to the instant claims and those of the cited applications.

***Terminal disclaimers***

8. Terminal disclaimers for 13/967,168; 13/967,179; 13/967,163; 13/961,835; 13/961,828; 13/961,818 and 13/961,808 were received and accepted on 10/7/2013. Therefore, the ODP rejections of record have been withdrawn.

Further, upon reconsideration, Examiner also requested TDs for 13/649,287, 12/035,698 and 11/897,177 in a further telephonic communication on 12/9/2013. These TDs were received and accepted on 12/9/2013.

***Conclusion***

9. Claims 37-48 and 61-68 are allowed.

The prior art made of record and not relied upon is considered pertinent to applicant's disclosure.

Art Unit: 1658

10. Any inquiry concerning this communication or earlier communications from the examiner should be directed to MARCELA M. CORDERO GARCIA whose telephone number is (571)272-2939. The examiner can normally be reached on M-F 8:30-5:00.

If attempts to reach the examiner by telephone are unsuccessful, the examiner's supervisor, Karlheinz R. Skowronek can be reached on (571)-272-9047. The fax phone number for the organization where this application or proceeding is assigned is 571-273-8300.

Information regarding the status of an application may be obtained from the Patent Application Information Retrieval (PAIR) system. Status information for published applications may be obtained from either Private PAIR or Public PAIR. Status information for unpublished applications is available through Private PAIR only. For more information about the PAIR system, see <http://pair-direct.uspto.gov>. Should you have questions on access to the Private PAIR system, contact the Electronic Business Center (EBC) at 866-217-9197 (toll-free). If you would like assistance from a USPTO Customer Service Representative or access to the automated information system, call 800-786-9199 (IN USA OR CANADA) or 571-272-1000.

/MARCELA M CORDERO GARCIA/  
Primary Examiner, Art Unit 1676

MMCG 12/2013

Application/Control Number: 13/967,189  
Art Unit: 1658

Page 9



|   |   |  |  |
|---|---|--|--|
| <b><i>Applicant-Initiated Interview Summary</i></b> | <b>Application No.</b><br>13/967,189            | <b>Applicant(s)</b><br>ACHEAMPONG ET AL. |  |
|   | <b>Examiner</b><br>MARCELA M. CORDERO<br>GARCIA | <b>Art Unit</b><br>1658                  |  |

All participants (applicant, applicant's representative, PTO personnel):

(1) MARCELA M. CORDERO GARCIA. (3)\_\_\_\_\_.

(2) LAURA L. WINE. (4)\_\_\_\_\_.

Date of Interview: 12/2/2013.

Type:  Telephonic  Video Conference  
 Personal [copy given to:  applicant  applicant's representative]

Exhibit shown or demonstration conducted:  Yes  No.  
If Yes, brief description: \_\_\_\_\_.

Issues Discussed 101 112 102 103 Others  
(For each of the checked box(es) above, please describe below the issue and detailed description of the discussion)

Claim(s) discussed: All, in general.

Identification of prior art discussed: US 6,984,628.

**Substance of Interview**

(For each issue discussed, provide a detailed description and indicate if agreement was reached. Some topics may include: identification or clarification of a reference or a portion thereof, claim interpretation, proposed amendments, arguments of any applied references etc...)

See Continuation Sheet.

**Applicant recordation instructions:** The formal written reply to the last Office action must include the substance of the interview. (See MPEP section 713.04). If a reply to the last Office action has already been filed, applicant is given a non-extendable period of the longer of one month or thirty days from this interview date, or the mailing date of this interview summary form, whichever is later, to file a statement of the substance of the interview

**Examiner recordation instructions:** Examiners must summarize the substance of any interview of record. A complete and proper recordation of the substance of an interview should include the items listed in MPEP 713.04 for complete and proper recordation including the identification of the general thrust of each argument or issue discussed, a general indication of any other pertinent matters discussed regarding patentability and the general results or outcome of the interview, to include an indication as to whether or not agreement was reached on the issues raised.

Attachment

/MARCELA M CORDERO GARCIA/  
Primary Examiner, Art Unit 1676

## Summary of Record of Interview Requirements

### Manual of Patent Examining Procedure (MPEP), Section 713.04, Substance of Interview Must be Made of Record

A complete written statement as to the substance of any face-to-face, video conference, or telephone interview with regard to an application must be made of record in the application whether or not an agreement with the examiner was reached at the interview.

### Title 37 Code of Federal Regulations (CFR) § 1.133 Interviews

Paragraph (b)

In every instance where reconsideration is requested in view of an interview with an examiner, a complete written statement of the reasons presented at the interview as warranting favorable action must be filed by the applicant. An interview does not remove the necessity for reply to Office action as specified in §§ 1.111, 1.135. (35 U.S.C. 132)

37 CFR §1.2 Business to be transacted in writing.

All business with the Patent or Trademark Office should be transacted in writing. The personal attendance of applicants or their attorneys or agents at the Patent and Trademark Office is unnecessary. The action of the Patent and Trademark Office will be based exclusively on the written record in the Office. No attention will be paid to any alleged oral promise, stipulation, or understanding in relation to which there is disagreement or doubt.

The action of the Patent and Trademark Office cannot be based exclusively on the written record in the Office if that record is itself incomplete through the failure to record the substance of interviews.

It is the responsibility of the applicant or the attorney or agent to make the substance of an interview of record in the application file, unless the examiner indicates he or she will do so. It is the examiner's responsibility to see that such a record is made and to correct material inaccuracies which bear directly on the question of patentability.

Examiners must complete an Interview Summary Form for each interview held where a matter of substance has been discussed during the interview by checking the appropriate boxes and filling in the blanks. Discussions regarding only procedural matters, directed solely to restriction requirements for which interview recordation is otherwise provided for in Section 812.01 of the Manual of Patent Examining Procedure, or pointing out typographical errors or unreadable script in Office actions or the like, are excluded from the interview recordation procedures below. Where the substance of an interview is completely recorded in an Examiners Amendment, no separate Interview Summary Record is required.

The Interview Summary Form shall be given an appropriate Paper No., placed in the right hand portion of the file, and listed on the "Contents" section of the file wrapper. In a personal interview, a duplicate of the Form is given to the applicant (or attorney or agent) at the conclusion of the interview. In the case of a telephone or video-conference interview, the copy is mailed to the applicant's correspondence address either with or prior to the next official communication. If additional correspondence from the examiner is not likely before an allowance or if other circumstances dictate, the Form should be mailed promptly after the interview rather than with the next official communication.

The Form provides for recordation of the following information:

- Application Number (Series Code and Serial Number)
- Name of applicant
- Name of examiner
- Date of interview
- Type of interview (telephonic, video-conference, or personal)
- Name of participant(s) (applicant, attorney or agent, examiner, other PTO personnel, etc.)
- An indication whether or not an exhibit was shown or a demonstration conducted
- An identification of the specific prior art discussed
- An indication whether an agreement was reached and if so, a description of the general nature of the agreement (may be by attachment of a copy of amendments or claims agreed as being allowable). Note: Agreement as to allowability is tentative and does not restrict further action by the examiner to the contrary.
- The signature of the examiner who conducted the interview (if Form is not an attachment to a signed Office action)

It is desirable that the examiner orally remind the applicant of his or her obligation to record the substance of the interview of each case. It should be noted, however, that the Interview Summary Form will not normally be considered a complete and proper recordation of the interview unless it includes, or is supplemented by the applicant or the examiner to include, all of the applicable items required below concerning the substance of the interview.

A complete and proper recordation of the substance of any interview should include at least the following applicable items:

- 1) A brief description of the nature of any exhibit shown or any demonstration conducted,
- 2) an identification of the claims discussed,
- 3) an identification of the specific prior art discussed,
- 4) an identification of the principal proposed amendments of a substantive nature discussed, unless these are already described on the Interview Summary Form completed by the Examiner,
- 5) a brief identification of the general thrust of the principal arguments presented to the examiner,  
(The identification of arguments need not be lengthy or elaborate. A verbatim or highly detailed description of the arguments is not required. The identification of the arguments is sufficient if the general nature or thrust of the principal arguments made to the examiner can be understood in the context of the application file. Of course, the applicant may desire to emphasize and fully describe those arguments which he or she feels were or might be persuasive to the examiner.)
- 6) a general indication of any other pertinent matters discussed, and
- 7) if appropriate, the general results or outcome of the interview unless already described in the Interview Summary Form completed by the examiner.

Examiners are expected to carefully review the applicant's record of the substance of an interview. If the record is not complete and accurate, the examiner will give the applicant an extendable one month time period to correct the record.

### Examiner to Check for Accuracy

If the claims are allowable for other reasons of record, the examiner should send a letter setting forth the examiner's version of the statement attributed to him or her. If the record is complete and accurate, the examiner should place the indication, "Interview Record OK" on the paper recording the substance of the interview along with the date and the examiner's initials.

Continuation of Substance of Interview including description of the general nature of what was agreed to if an agreement was reached, or any other comments: Authorization for communication under MPEP 502.03 was filed on 10/1/2013 by Applicant's representative. Courtesy copy of the OA was given to Applicant's representative via email on 10/7/2013. The emailed copy was identical to the OA of record, therefore, for the sake of clarity it has not been herein included and Applicant's representative. Applicant's representative contacted Examiner on 10/17-18/2013, 10/23/2013, 10/28/2013 and 10/30/2013 and 11/1/2013 to inquire about the application, provide updates regarding the status of the application and filings and/or discuss any potential questions and related applications. Examiner provided updates regarding the status of the examination as requested. On 10/18/2013, Examiner contacted Applicant's representative to discuss the affidavits EXHIBIT 1 and 2 were discussed specifically with regards to the excipients used in phase 2 and phase 3 of the clinical trials described therein, Applicant's representative indicated that the excipients were identical in these 2 phases and that this was also set forth in the affidavits, which was confirmed by Examiner (e.g., page 2, paragraph 8 of EXHIBIT 1). On 10/23/2013, Applicant's representative along with Maysa Attar contacted Examiner to discuss whether any outstanding questions remained from the examination of the courtesy copies of the affidavits. Examiner did not have any further questions and indicated that she would act on the case when the official papers were filed. Laura Wine contacted Examiner on 10/28/2013 indicating that the response had been filed on 10/23/2013. During the final search Examiner found a potential 102(e) reference (US 6,984,623, Table 5). Examiner contacted Applicant's representative on 11/4/2013 to discuss US 6,984,628, which would necessitate a 102(e) rejection (see Table 5). Applicant's representative filed a 1.131 declaration to obviate such potential rejection (see 1.131 declaration filed 12/2/2013, for which an identical courtesy copy was also emailed to Examiner. Examiner indicated that the declaration was acceptable in a telephonic conversation on 12/9/2013 and requested TDs for 11/897,177, 12/035,698 and 13/649,287 to obviate potential non-statutory double patenting rejections (see TDs submitted on 12/9/2013). Furthermore, Examiner indicated that a TD would be needed with US 6,984,628, however, upon reconsideration, US 6,984,628 does not require a non-statutory double patenting rejection as indicated in a telephonic message on 12/17/2013.

|                                   |                                       |   |             |
|-----------------------------------|---------------------------------------|---|-------------|
| <b>Notice of References Cited</b> | Application/Control No.<br>13/967,189 | Applicant(s)/Patent Under<br>Reexamination<br>ACHEAMPONG ET AL. |             |
|                                   | Examiner<br>MARCELA M. CORDERO        | Art Unit<br>1658  | Page 1 of 1 |

**U.S. PATENT DOCUMENTS**

| * | Document Number<br>Country Code-Number-Kind Code | Date<br>MM-YYYY | Name          | Classification |
|---|--|-----------------|---------------|----------------|
| * | A US-6,984,628                                   | 01-2006         | Bakhit et al. | 514/20.8       |
|   | B US-  |                 |               |                |
|   | C US-  |                 |               |                |
|   | D US-  |                 |               |                |
|   | E US-  |                 |               |                |
|   | F US-  |                 |               |                |
|   | G US-  |                 |               |                |
|   | H US-  |                 |               |                |
|   | I US-  |                 |               |                |
|   | J US-  |                 |               |                |
|   | K US-  |                 |               |                |
|   | L US-  |                 |               |                |
|   | M US-  |                 |               |                |

**FOREIGN PATENT DOCUMENTS**

| * | Document Number<br>Country Code-Number-Kind Code | Date<br>MM-YYYY | Country | Name | Classification |
|---|--|-----------------|---------|------|----------------|
|   | N  |                 |         |      |                |
|   | O  |                 |         |      |                |
|   | P  |                 |         |      |                |
|   | Q  |                 |         |      |                |
|   | R  |                 |         |      |                |
|   | S  |                 |         |      |                |
|   | T  |                 |         |      |                |

**NON-PATENT DOCUMENTS**

| * | Document Number<br>Country Code-Number-Kind Code  | Date<br>MM-YYYY | Country | Name | Classification |
|---|---|-----------------|---------|------|----------------|
|   | Include as applicable: Author, Title Date, Publisher, Edition or Volume, Pertinent Pages) |                 |         |      |                |
|   | U   |                 |         |      |                |
|   | V   |                 |         |      |                |
|   | W   |                 |         |      |                |
|   | X   |                 |         |      |                |

\*A copy of this reference is not being furnished with this Office action. (See MPEP § 707.05(a).)  
Dates in MM-YYYY format are publication dates. Classifications may be US or foreign.

## EAST Search History

## EAST Search History (Prior Art)

| Ref # | Hits | Search Query   | DBs   | Default Operator | Plurals | Time Stamp          |
|-------|------|--|---|------------------|---------|---------------------|
| L2    | 25   | cyclosporin same "0.05" same "castor oil" same "1.25"  | US-PGPUB; USPAT;<br>USOCR; FPRS; EPO;<br>JPO; DERWENT;<br>IBM_TDB | ADJ              | ON      | 2013/12/17<br>21:02 |
| L3    | 1    | "13967189"   | US-PGPUB; USPAT;<br>USOCR; FPRS; EPO;<br>JPO; DERWENT;<br>IBM_TDB | ADJ              | ON      | 2013/12/17<br>21:03 |
| L4    | 18   | cyclosporin same "0.05" same "castor oil" same "1.25" and ((a61k38/13).cpc. or (a61k9/0048)".cpc") | US-PGPUB; USPAT;<br>USOCR; FPRS; EPO;<br>JPO; DERWENT;<br>IBM_TDB | ADJ              | ON      | 2013/12/17<br>21:06 |

## EAST Search History (Interference)

| Ref # | Hits | Search Query   | DBs            | Default Operator | Plurals | Time Stamp          |
|-------|------|--|----------------|------------------|---------|---------------------|
| L1    | 5    | cyclosporin same "0.05" same "castor oil" same "1.25"  | USPAT;<br>UPAD | ADJ              | ON      | 2013/12/17<br>21:01 |
| L5    | 3    | cyclosporin same "0.05" same "castor oil" same "1.25" and ((a61k38/13).cpc. or (a61k9/0048)".cpc") | USPAT;<br>UPAD | ADJ              | ON      | 2013/12/17<br>21:08 |

12/ 17/ 2013 9:08:36 PM

C:\Users\mgarcia\Documents\EAST\Workspaces\1166940-b.wsp

|  |   |   |
|--|---|---|
| <b>Search Notes</b><br><br> | <b>Application/Control No.</b><br><br>13967189  | <b>Applicant(s)/Patent Under Reexamination</b><br><br>ACHEAMPONG ET AL. |
|  | <b>Examiner</b><br><br>MARCELA M CORDERO GARCIA | <b>Art Unit</b><br><br>1658   |

| CPC- SEARCHED |            |          |
|---------------|------------|----------|
| Symbol        | Date       | Examiner |
| A61K 38/13    | 12/17/2013 | MMCG     |
| A61K 9/0048   | 12/17/2013 | MMCG     |

| CPC COMBINATION SETS - SEARCHED |      |          |
|---------------------------------|------|----------|
| Symbol                          | Date | Examiner |
|                                 |      |          |

| US CLASSIFICATION SEARCHED |          |           |          |
|----------------------------|----------|-----------|----------|
| Class                      | Subclass | Date      | Examiner |
| none                       | none     | 10/4/2013 | MMCG     |

| SEARCH NOTES                  |            |          |
|-------------------------------|------------|----------|
| Search Notes                  | Date       | Examiner |
| EAST search (attached)        | 10/5/2013  | MMCG     |
| STN search (attached)         | 10/5/2013  | MMCG     |
| also ran PALM inventor search | 10/5/2013  | MMCG     |
| EAST updated (attached)       | 12/17/2013 | MMCG     |
| also ran PALM inventor search | 12/17/2013 | MMCG     |

| INTERFERENCE SEARCH     |                         |            |          |
|-------------------------|-------------------------|------------|----------|
| US Class/<br>CPC Symbol | US Subclass / CPC Group | Date       | Examiner |
| EAST search             | attached                | 12/17/2013 | MMCG     |

|  |  |
|--|--|
|  |  |
|--|--|







|   |   |   |
|---|---|---|
| <b>Issue Classification</b><br> | <b>Application/Control No.</b><br>13967189  | <b>Applicant(s)/Patent Under Reexamination</b><br>ACHEAMPONG ET AL. |
|   | <b>Examiner</b><br>MARCELA M CORDERO GARCIA | <b>Art Unit</b><br>1676   |

| <input checked="" type="checkbox"/> <b>Claims renumbered in the same order as presented by applicant</b> |          |       |          |       |          |       |          |       |          |       |          |       |          |       |          | <input type="checkbox"/> <b>CPA</b> |  | <input checked="" type="checkbox"/> <b>T.D.</b> |  | <input type="checkbox"/> <b>R.1.47</b> |  |
|--|----------|-------|----------|-------|----------|-------|----------|-------|----------|-------|----------|-------|----------|-------|----------|-------------------------------------|--|---|--|--|--|
| Final  | Original | Final | Original | Final | Original | Final | Original | Final | Original | Final | Original | Final | Original | Final | Original |                                     |  |   |  |  |  |
|  |          |       |          |       |          |       |          |       |          |       |          |       |          |       |          |                                     |  |   |  |  |  |
|  |          |       |          |       |          |       |          |       |          |       |          |       |          |       |          |                                     |  |   |  |  |  |
|  |          |       |          |       |          |       |          |       |          |       |          |       |          |       |          |                                     |  |   |  |  |  |
|  |          |       |          |       |          |       |          |       |          |       |          |       |          |       |          |                                     |  |   |  |  |  |
|  |          |       |          |       |          |       |          |       |          |       |          |       |          |       |          |                                     |  |   |  |  |  |
|  |          |       |          |       |          |       |          |       |          |       |          |       |          |       |          |                                     |  |   |  |  |  |
|  |          |       |          |       |          |       |          |       |          |       |          |       |          |       |          |                                     |  |   |  |  |  |
|  |          |       |          |       |          |       |          |       |          |       |          |       |          |       |          |                                     |  |   |  |  |  |
|  |          |       |          |       |          |       |          |       |          |       |          |       |          |       |          |                                     |  |   |  |  |  |
|  |          |       |          |       |          |       |          |       |          |       |          |       |          |       |          |                                     |  |   |  |  |  |
|  |          |       |          |       |          |       |          |       |          |       |          |       |          |       |          |                                     |  |   |  |  |  |
|  |          |       |          |       |          |       |          |       |          |       |          |       |          |       |          |                                     |  |   |  |  |  |
|  |          |       |          |       |          |       |          |       |          |       |          |       |          |       |          |                                     |  |   |  |  |  |
|  |          |       |          |       |          |       |          |       |          |       |          |       |          |       |          |                                     |  |   |  |  |  |
|  |          |       |          |       |          |       |          |       |          |       |          |       |          |       |          |                                     |  |   |  |  |  |
|  |          |       |          |       |          |       |          |       |          |       |          |       |          |       |          |                                     |  |   |  |  |  |
|  |          |       |          |       |          |       |          |       |          |       |          |       |          |       |          |                                     |  |   |  |  |  |
|  |          |       |          |       |          |       |          |       |          |       |          |       |          |       |          |                                     |  |   |  |  |  |

|  |            |                              |                   |
|--|------------|------------------------------|-------------------|
| NONE   |            | <b>Total Claims Allowed:</b> |                   |
|  |            | 20                           |                   |
| (Assistant Examiner)   | (Date)     | O.G. Print Claim(s)          | O.G. Print Figure |
| /MARCELA M CORDERO GARCIA/<br>Primary Examiner.Art Unit 1676 | 12/17/2013 | 1                            | none              |
| (Primary Examiner)   | (Date)     |                              |                   |

**PART B - FEE(S) TRANSMITTAL**

**Complete and send this form, together with applicable fee(s), to: Mail Mail Stop ISSUE FEE  
 Commissioner for Patents  
 P.O. Box 1450  
 Alexandria, Virginia 22313-1450  
 or Fax (571)-273-2885**

**INSTRUCTIONS:** This form should be used for transmitting the ISSUE FEE and PUBLICATION FEE (if required). Blocks 1 through 5 should be completed where appropriate. All further correspondence including the Patent, advance orders and notification of maintenance fees will be mailed to the current correspondence address as indicated unless corrected below or directed otherwise in Block 1, by (a) specifying a new correspondence address; and/or (b) indicating a separate "FEE ADDRESS" for maintenance fee notifications.

Note: A certificate of mailing can only be used for domestic mailings of the Fee(s) Transmittal. This certificate cannot be used for any other accompanying papers. Each additional paper, such as an assignment or formal drawing, must have its own certificate of mailing or transmission.

CURRENT CORRESPONDENCE ADDRESS (Note: Use Block 1 for any change of address)

51957 7590 12/27/2013  
**ALLERGAN, INC.**  
 2525 DUPONT DRIVE, T2-7H  
 IRVINE, CA 92612-1599

**Certificate of Mailing or Transmission**

I hereby certify that this Fee(s) Transmittal is being deposited with the United States Postal Service with sufficient postage for first class mail in an envelope addressed to the Mail Stop ISSUE FEE address above, or being facsimile transmitted to the USPTO (571) 273-2885, on the date indicated below.

|                   |                    |
|-------------------|--------------------|
| Alexis Swan       | (Depositor's name) |
| /Alexis Swan/     | (Signature)        |
| December 30, 2013 | (Date)             |

| APPLICATION NO. | FILING DATE | FIRST NAMED INVENTOR | ATTORNEY DOCKET NO. | CONFIRMATION NO. |
|-----------------|-------------|----------------------|---------------------|------------------|
| 13/967,189      | 08/14/2013  | Andrew Acheampong    | 17618CON2B (AP)     | 4818             |

TITLE OF INVENTION: METHODS OF PROVIDING THERAPEUTIC EFFECTS USING CYCLOSPORIN COMPONENTS

| APPLN. TYPE    | ENTITY STATUS | ISSUE FEE DUE | PUBLICATION FEE DUE | PREV. PAID ISSUE FEE | TOTAL FEE(S) DUE | DATE DUE   |
|----------------|---------------|---------------|---------------------|----------------------|------------------|------------|
| nonprovisional | UNDISCOUNTED  | \$1780        | \$0                 | \$0                  | \$1780           | 03/27/2014 |

| EXAMINER                  | ART UNIT | CLASS-SUBCLASS |
|---------------------------|----------|----------------|
| CORDERO GARCIA, MARCELA M | 1676     | 514-020500     |

|   |  |
|---|--|
| <p>1. Change of correspondence address or indication of "Fee Address" (37 CFR 1.363).</p> <p><input type="checkbox"/> Change of correspondence address (or Change of Correspondence Address form PTO/SB/122) attached.</p> <p><input type="checkbox"/> "Fee Address" indication (or "Fee Address" Indication form PTO/SB/47; Rev 03-02 or more recent) attached. <b>Use of a Customer Number is required.</b></p> | <p>2. For printing on the patent front page, list</p> <p>(1) The names of up to 3 registered patent attorneys or agents OR, alternatively,</p> <p>(2) The name of a single firm (having as a member a registered attorney or agent) and the names of up to 2 registered patent attorneys or agents. If no name is listed, no name will be printed.</p> <p>1 <u>Laura L. Wine</u></p> <p>2 <u>Joel B. German</u></p> <p>3 _____</p> |
|---|--|

**3. ASSIGNEE NAME AND RESIDENCE DATA TO BE PRINTED ON THE PATENT (print or type)**

PLEASE NOTE: Unless an assignee is identified below, no assignee data will appear on the patent. If an assignee is identified below, the document has been filed for recordation as set forth in 37 CFR 3.11. Completion of this form is NOT a substitute for filing an assignment.

(A) NAME OF ASSIGNEE: Allergan, Inc. (B) RESIDENCE: (CITY and STATE OR COUNTRY) Irvine, CA

Please check the appropriate assignee category or categories (will not be printed on the patent):  Individual  Corporation or other private group entity  Government

|  |  |
|--|--|
| <p>4a. The following fee(s) are submitted:</p> <p><input checked="" type="checkbox"/> Issue Fee</p> <p><input type="checkbox"/> Publication Fee (No small entity discount permitted)</p> <p><input type="checkbox"/> Advance Order - # of Copies _____</p> | <p>4b. Payment of Fee(s): (Please first reapply any previously paid issue fee shown above)</p> <p><input type="checkbox"/> A check is enclosed.</p> <p><input type="checkbox"/> Payment by credit card. Form PTO-2038 is attached.</p> <p><input checked="" type="checkbox"/> The Director is hereby authorized to charge the required fee(s), any deficiency, or credits any overpayment, to Deposit Account Number <u>010885</u> (enclose an extra copy of this form).</p> |
|--|--|

**5. Change in Entity Status** (from status indicated above)

Applicant certifying micro entity status. See 37 CFR 1.29

Applicant asserting small entity status. See 37 CFR 1.27

Applicant changing to regular undiscounted fee status.

**NOTE:** Absent a valid certification of Micro Entity Status (see forms PTO/SB/15A and 15B), issue fee payment in the micro entity amount will not be accepted at the risk of application abandonment.

**NOTE:** If the application was previously under micro entity status, checking this box will be taken to be a notification of loss of entitlement to micro entity status.

**NOTE:** Checking this box will be taken to be a notification of loss of entitlement to small or micro entity status, as applicable.

NOTE: This form must be signed in accordance with 37 CFR 1.31 and 1.33. See 37 CFR 1.4 for signature requirements and certifications.

Authorized Signature /Laura L. Wine/ Date December 30, 2013

Typed or printed name Laura L. Wine Registration No. 68,681

**IN THE UNITED STATES PATENT AND TRADEMARK OFFICE**

Applicant: Acheampong, *et al.*

Serial No.: 13/967,189

Filed: August 14, 2013

For: METHODS OF PROVIDING  
THERAPEUTIC EFFECTS USING  
CYCLOSPORIN COMPONENTS

Examiner: Marcela M Cordero Garcia

Group Art Unit: 1658

Confirmation No. 4818

Customer No.: 51957

**COMMENTS ON EXAMINER'S STATEMENT OF REASONS FOR ALLOWANCE  
AND INTERVIEW SUMMARY**

**Mail Stop - Issue Fee**

Commissioner for Patents

P.O. Box 1450

Alexandria, VA 22313-1450

Dear Sir:

In response to the Statement of Reasons for Allowance in the Notice of Allowance mailed December 27, 2013, Applicant respectfully submits the following comments.

**Summary of Interviews** begin on page 2 of this paper.

**Comments on Statement of Reasons for Allowance** begin on page 4 of this paper.

## SUMMARY OF TELEPHONE INTERVIEW

### Attendees, Date and Type of Interviews

Telephone interviews were conducted on October 18, 2013, November 4, 2013, and December 9, 2013 and attended by Examiner Marcela M Cordero Garcia and Laura L. Wine. Laura L. Wine also contacted the Examiner on October 17, 2013, October 23, 2013, October 28, 2013, October 30, 2013, and November 1, 2013, to inquire regarding the status of the application. Dr. Mayssa Attar was also present for the October 23, 2013 status inquiry.

### Identification of Claims Discussed

The Claims were discussed, focusing on Claim 37.

### Identification of References Discussed

On October 18, 2013, U.S. Patent No. 5,474,979 to Ding et al. was discussed. On November 4, U.S. Application Serial No. 10/621,053 (published as U.S. Patent Application Publication No. 2005/0014691 and issued as US 6,984,628 to “Bakhit”) was discussed. On December 9, 2013, U.S. Patent Application Serial Nos. 13/649,287, 12/035,698, and 11/897,177 and US Patent No. 6,984,628 were discussed.

### Principal Arguments and Other Matters

On October 18, 2013 Laura L. Wine and Examiner Cordero Garcia discussed the response and exhibits to be filed in the October 23, 2013 response to non-final office action.

On November 4, 2013 the Bakhit reference was discussed. While the Applicants did not acquiesce to a potential rejection under 35 U.S.C. 102(e), in order to expedite prosecution, on December 2, 2013, the Applicants filed a declaration under 37 CFR 1.131 to swear behind the Bakhit reference, and thus render any potential 102(e) rejection moot. The Examiner indicated that the declaration filed under 37 CFR 1.131 was sufficient to obviate a potential rejection under 102(e) on December 9, 2013.

On December 9, 2013 U.S. Patent Application Serial Nos. 13/649,287, 12/035,698, and 11/897,177 were also discussed. While the Applicants do not acquiesce to any potential obviousness-type double patenting rejections over the claims of these references, in order to expedite prosecution, terminal disclaimers were filed over these copending applications and accepted on December 9, 2013. It was agreed that no terminal disclaimer was necessary in view of US Patent No. 6,984,628, as confirmed by a message from Examiner Cordero on December 17, 2013.

Results of Interviews

It was agreed that the Applicants would file a declaration under 37 CFR 1.131, and that the declaration filed under 37 CFR 1.131 was acceptable and persuasive. It was agreed that the Applicants would file terminal disclaimers over U.S. Patent Application Nos. 13/649,287, 12/035,698, and 11/897,177. The Examiner also agreed that the Claims were allowable.

**COMMENTS ON STATEMENTS OF REASONS FOR ALLOWANCE**

Applicants respectfully submit the following comments on the Examiner's Statement of Reasons for Allowance.

The Applicants respectfully disagree with the Examiner's determination that the evidence of Commercial Success presented in the October 23, 2013 response to Office Action, including the Declaration of Aziz Mottiwala filed under 37 CFR 1.132 and associated Exhibits, was insufficient to overcome the rejection of the Claims under 35 U.S.C. § 103(a) based on Ding et al. The Applicants also respectfully disagree with the Examiner's determination that the evidence of Long Felt Need presented in the October 14, 2013 response to Office Action, including the Declaration of Rhett M. Schiffman ("Schiffman Declaration 2") filed under 37 CFR 1.132 and associated Exhibits, was insufficient to overcome the rejection of the Claims under 35 U.S.C. § 103(a) based on Ding et al.

To the extent that there is any implication in such Statement that the patentability of the claims rests on the recitation of a single feature or the combination of particular features, Applicants respectfully disagree, since patentability rests on each claim taken as a whole. For example, Applicants submit that there are additional features from the claims that are not set forth in the cited art. Further, the Examiner's Statement refers to certain features of the claims. To the extent that the Examiner's Statement omits claim elements, groups claims together, or identifies purportedly distinguishing features of a claim or a group of claims, Applicants respectfully disagree with the Examiner's Statement. Rather, Applicants submit that the claims are allowable, because each claim, taken as a whole, recites a unique combination of features that is not anticipated or rendered obvious by the prior art.

Applicants also hereby traverse and respectfully reserve the right to traverse the characterizations of what any particular reference shows or teaches, or what any combination of references shows or teaches, or the appropriateness of combining references, and reserve the right to continue to do so in the future. In addition, Applicants respectfully traverse any characterizations of which references are deemed to be the closest prior art. Further, by making certain amendments to the claims, Applicants are not conceding that previously pending claims are not patentable. Rather, the amendments are being made to facilitate expeditious prosecution of this application. Applicants reserve the right to pursue at a later date any previously pending or other broader or narrower claims that capture any subject matter supported by the application's

disclosure. Moreover, any arguments in support of patentability and based on a portion of a claim should not be taken as founding patentability solely on the portion in question; rather, it is the combination of features or acts recited in a claim taken as a whole which distinguishes it over the identified references.

Applicants attach herewith payment of the issue fee and requests that the application proceed to issuance. Should the Examiner have any concerns, the Examiner is invited to contact the undersigned at the telephone number below.

Respectfully submitted,

December 30, 2013

/Laura L. Wine /

Laura Wine-T2-7H  
Allergan, Inc.  
2525 Dupont Drive  
Irvine, CA 92612  
Direct: 714-246-6996  
Fax: 714-246-4249

Laura L. Wine  
Reg. No. 68,681

## Electronic Patent Application Fee Transmittal

|   |   |
|---|---|
| <b>Application Number:</b>                  | 13967189  |
| <b>Filing Date:</b>                         | 14-Aug-2013   |
| <b>Title of Invention:</b>                  | METHODS OF PROVIDING THERAPEUTIC EFFECTS USING CYCLOSPORIN COMPONENTS |
| <b>First Named Inventor/Applicant Name:</b> | Andrew Acheampong   |
| <b>Filer:</b>                               | Laura Lee Wine/Alexis Swan  |
| <b>Attorney Docket Number:</b>              | 17618CON2B (AP)   |

Filed as Large Entity

### Utility under 35 USC 111(a) Filing Fees

| Description                              | Fee Code | Quantity | Amount | Sub-Total in USD(\$) |
|--|----------|----------|--------|----------------------|
| <b>Basic Filing:</b>                     |          |          |        |                      |
| <b>Pages:</b>                            |          |          |        |                      |
| <b>Claims:</b>                           |          |          |        |                      |
| <b>Miscellaneous-Filing:</b>             |          |          |        |                      |
| <b>Petition:</b>                         |          |          |        |                      |
| <b>Patent-Appeals-and-Interference:</b>  |          |          |        |                      |
| <b>Post-Allowance-and-Post-Issuance:</b> |          |          |        |                      |
| Utility Appl Issue Fee                   | 1501     | 1        | 1780   | 1780                 |

**Extension-of-Time:**



| Description              | Fee Code | Quantity | Amount | Sub-Total in USD(\$) |
|--------------------------|----------|----------|--------|----------------------|
| <b>Miscellaneous:</b>    |          |          |        |                      |
| <b>Total in USD (\$)</b> |          |          |        | <b>1780</b>          |

## Electronic Acknowledgement Receipt

|   |   |
|---|---|
| <b>EFS ID:</b>                              | 17776414  |
| <b>Application Number:</b>                  | 13967189  |
| <b>International Application Number:</b>    |   |
| <b>Confirmation Number:</b>                 | 4818  |
| <b>Title of Invention:</b>                  | METHODS OF PROVIDING THERAPEUTIC EFFECTS USING CYCLOSPORIN COMPONENTS |
| <b>First Named Inventor/Applicant Name:</b> | Andrew Acheampong   |
| <b>Customer Number:</b>                     | 51957   |
| <b>Filer:</b>                               | Laura Lee Wine/Alexis Swan  |
| <b>Filer Authorized By:</b>                 | Laura Lee Wine  |
| <b>Attorney Docket Number:</b>              | 17618CON2B (AP)   |
| <b>Receipt Date:</b>                        | 30-DEC-2013   |
| <b>Filing Date:</b>                         | 14-AUG-2013   |
| <b>Time Stamp:</b>                          | 12:53:57  |
| <b>Application Type:</b>                    | Utility under 35 USC 111(a)   |

### Payment information:

|  |                 |
|--|-----------------|
| Submitted with Payment                   | yes             |
| Payment Type                             | Deposit Account |
| Payment was successfully received in RAM | \$1780          |
| RAM confirmation Number                  | 11532           |
| Deposit Account                          | 010885          |
| Authorized User                          |                 |

The Director of the USPTO is hereby authorized to charge indicated fees and credit any overpayment as follows:

Charge any Additional Fees required under 37 C.F.R. Section 1.16 (National application filing, search, and examination fees)

Charge any Additional Fees required under 37 C.F.R. Section 1.17 (Patent application and reexamination processing fees)

Charge any Additional Fees required under 37 C.F.R. Section 1.19 (Document supply fees)

Charge any Additional Fees required under 37 C.F.R. Section 1.20 (Post Issuance fees)

Charge any Additional Fees required under 37 C.F.R. Section 1.21 (Miscellaneous fees and charges)

### File Listing:

| Document Number | Document Description        | File Name                | File Size(Bytes)/ Message Digest                    | Multi Part /.zip | Pages (if appl.) |
|-----------------|-----------------------------|--------------------------|---|------------------|------------------|
| 1               | Issue Fee Payment (PTO-85B) | 17618CON2B-Issue-Fee.pdf | 1581958<br>8a7be1d4e0c5175c4832d0f4d5d75bf666387b59 | no               | 1                |

### Warnings:

### Information:

|   |                               |   |   |    |   |
|---|-------------------------------|---|---|----|---|
| 2 | Miscellaneous Incoming Letter | 17618CON2B_INTERVIEWSUM MARYANDCOMMENTSONREAS ONSFORALLOWANCE.pdf | 124861<br>4fd82f97c9c5a1852c613a72c63cd5e84835542 | no | 5 |
|---|-------------------------------|---|---|----|---|

### Warnings:

### Information:

|   |                      |              |   |    |   |
|---|----------------------|--------------|---|----|---|
| 3 | Fee Worksheet (SB06) | fee-info.pdf | 30859<br>cad68fe55041dddfea68bd1121afb08b472c6768 | no | 2 |
|---|----------------------|--------------|---|----|---|

### Warnings:

### Information:

**Total Files Size (in bytes):**

1737678

This Acknowledgement Receipt evidences receipt on the noted date by the USPTO of the indicated documents, characterized by the applicant, and including page counts, where applicable. It serves as evidence of receipt similar to a Post Card, as described in MPEP 503.

#### New Applications Under 35 U.S.C. 111

If a new application is being filed and the application includes the necessary components for a filing date (see 37 CFR 1.53(b)-(d) and MPEP 506), a Filing Receipt (37 CFR 1.54) will be issued in due course and the date shown on this Acknowledgement Receipt will establish the filing date of the application.

#### National Stage of an International Application under 35 U.S.C. 371

If a timely submission to enter the national stage of an international application is compliant with the conditions of 35 U.S.C. 371 and other applicable requirements a Form PCT/DO/EO/903 indicating acceptance of the application as a national stage submission under 35 U.S.C. 371 will be issued in addition to the Filing Receipt, in due course.

#### New International Application Filed with the USPTO as a Receiving Office

If a new international application is being filed and the international application includes the necessary components for an international filing date (see PCT Article 11 and MPEP 1810), a Notification of the International Application Number and of the International Filing Date (Form PCT/RO/105) will be issued in due course, subject to prescriptions concerning national security, and the date shown on this Acknowledgement Receipt will establish the international filing date of the application.

|  |                        |                    |                      |
|--|------------------------|--------------------|----------------------|
| <b>Receipt date: 09/04/2013</b><br><br><b>INFORMATION DISCLOSURE STATEMENT BY APPLICANT</b><br>( Not for submission under 37 CFR 1.99) | Application Number     | 13967189           | 13967189 - GAU: 1658 |
|  | Filing Date            | 2013-08-14         |                      |
|  | First Named Inventor   | ACHEAMPONG, ANDREW |                      |
|  | Art Unit               | 1653               |                      |
|  | Examiner Name          | TBD                |                      |
|  | Attorney Docket Number | 17618-US-BCON2-AP  |                      |

ALL REFERENCES CONSIDERED EXCEPT WHERE LINED THROUGH. /M.M.C.G./

|   |    |         |  |                             |                  |  |
|---|----|---------|--|-----------------------------|------------------|--|
|   | 75 | 6350442 |  | 2002-02-26                  | Michael Garst    |  |
|   | 76 | 6413547 |  | 2002-07-02                  | Bennett et al    |  |
|   | 77 | 6420355 |  | 2002-07-16                  | Richter et al    |  |
|   | 78 | 6468968 |  | 2002-10-22                  | Cavanak et al    |  |
|   | 79 | 6475519 |  | 2002-11-05                  | Meinzer et al    |  |
|   | 80 | 6486124 |  | 2002-11-26                  | Olbrich et al    |  |
|   | 81 | 6544953 |  | 2003-04-08                  | Tsuzuki et al    |  |
|   | 82 | 6555526 |  | 2003-04-29                  | Toshihiko Matsuo |  |
|   | 83 | 6562873 |  | 2003-05-13                  | Olejniak et al   |  |
| Change(s) applied<br>to document,<br>/E.M.S./<br>1/7/2014 |    | 6569463 |  | 05<br><del>2003-03-27</del> | Patel et al      |  |
|   | 85 | 6582718 |  | 2003-06-24                  | Yoichi Kawashima |  |



| APPLICATION NO. | ISSUE DATE | PATENT NO. | ATTORNEY DOCKET NO. | CONFIRMATION NO. |
|-----------------|------------|------------|---------------------|------------------|
| 13/967,189      | 02/04/2014 | 8642556    | 17618CON2B (AP)     | 4818             |

51957 7590 01/15/2014  
ALLERGAN, INC.  
2525 DUPONT DRIVE, T2-7H  
IRVINE, CA 92612-1599

### ISSUE NOTIFICATION

The projected patent number and issue date are specified above.

#### **Determination of Patent Term Adjustment under 35 U.S.C. 154 (b)** (application filed on or after May 29, 2000)

The Patent Term Adjustment is 0 day(s). Any patent to issue from the above-identified application will include an indication of the adjustment on the front page.

If a Continued Prosecution Application (CPA) was filed in the above-identified application, the filing date that determines Patent Term Adjustment is the filing date of the most recent CPA.

Applicant will be able to obtain more detailed information by accessing the Patent Application Information Retrieval (PAIR) WEB site (<http://pair.uspto.gov>).

Any questions regarding the Patent Term Extension or Adjustment determination should be directed to the Office of Patent Legal Administration at (571)-272-7702. Questions relating to issue and publication fee payments should be directed to the Application Assistance Unit (AAU) of the Office of Data Management (ODM) at (571)-272-4200.

APPLICANT(s) (Please see PAIR WEB site <http://pair.uspto.gov> for additional applicants):

Allergan, Inc., Irvine, CA, Assignee (with 37 CFR 1.172 Interest);  
Andrew Acheampong, Irvine, CA;  
Diane D. Tang-Liu, Las Vegas, NV;  
James N. Chang, Newport Beach, CA;  
David F. Power, Hubert, NC;

The United States represents the largest, most dynamic marketplace in the world and is an unparalleled location for business investment, innovation, and commercialization of new technologies. The USA offers tremendous resources and advantages for those who invest and manufacture goods here. Through SelectUSA, our nation works to encourage and facilitate business investment. To learn more about why the USA is the best country in the world to develop technology, manufacture products, and grow your business, visit [SelectUSA.gov](http://SelectUSA.gov).

**IN UNITED STATES PATENT AND TRADEMARK OFFICE**

Patent No.: 8,642,556 Docket No: 17618CON2B (AP)  
Issue Date: February 04, 2014 Application No. 13/967,189  
Patentee: Andrew Acheampong et al.  
Title METHODS OF PROVIDING THERAPEUTIC EFFECTS USING  
CYCLOSPORIN COMPONENTS

---

**REQUEST FOR CERTIFICATION OF CORRECTION**

Attn: Certificate of Correction Branch  
Commissioner for Patents  
P.O. Box 1450  
Alexandria, VA 22313-1450

It is requested that a Certificate of Correction be issued correcting printing errors appearing in the above-identified United States patent. We are including a Patent Proofing Form and a Marked-Up Version of the issued patent for your reference.

Pursuant to 1.20(a), the examiner is authorized to charge the Certificate of Correction fee of \$100.00 or any additional fees or credit overpayment to Deposit Account No. 010885.

Issuance of the Certificate of Correction would neither expand nor contract the scope of the claims as properly allowed, and re-examination is not required.

Respectfully submitted,

**/LAURA L. WINE/**

Date May 8, 2014

By \_\_\_\_\_  
Laura L. Wine:  
Reg. No.: 68681

IN THE UNITED STATES PATENT AND TRADEMARK OFFICE

Applicant: Andrew Acheampong et al.

Examiner: MARCELA M CORDERO GARCIA

Patent No.: 8,642,556

Group Art Unit: 1676

Issue Date: February 04, 2014

Docket No: 17618CON2B (AP)

Application No. 13/967,189

Title: METHODS OF PROVIDING THERAPEUTIC EFFECTS USING CYCLOSPORIN COMPONENTS

Attn: Certificate of Correction Branch  
Commissioner for Patents  
P.O. Box 1450  
Alexandria, VA 22313-1450

We are transmitting herewith the attached:

- Request for Certificate of Correction.
- Certificate of Correction Form - PTO-1050

**Please charge any additional fees or credit overpayment to Deposit Account No.010885.**

Respectfully submitted,

/LAURA L. WINE

Date: May 8, 2014

By Laura L. Wine  
Attorney Name:  
Reg. No.: 68681

## UNITED STATES PATENT AND TRADEMARK OFFICE CERTIFICATE OF CORRECTION

PATENT NO : 8,642,556

Page 1 of 2

DATED : February 04, 2014

INVENTOR(S) : Andrew Acheampong et al.

It is certified that errors appear in the above-identified patent and that said Letters Patent is hereby corrected as shown below:

In column 1, line 34, delete "of:" and insert -- of --, therefor

In column 1, line 34, delete "cyclosporin a" and insert -- cyclosporin A --, therefor.

In column 1, line 35, delete "cyclosporin a" and insert -- cyclosporin A --, therefor.

In column 1, line 37, delete "421" and insert -- 411 --, therefor.

In column 1, line 38, delete "aft" and insert -- after --, therefor.

In column 1, line 40, delete "18(2)" and insert -- 18(2):91 --, therefor.

In column 1, line 44, delete "1999," and insert -- 1998, --, therefor.

In column 1, line 45, delete "1999," and insert -- 1998, --, therefor.

In column 1, line 46, delete "438:991" and insert -- 438:991-5; --, therefor.

In column 1, line 56, delete "A Ministrati on" and insert -- Administration --, therefor.

In column 2, line 15, delete "method" and insert -- methods --, therefor.

In column 2, line 17, delete "employ" and insert -- employing --, therefor.

In column 2, line 19, delete "effects," and insert -- effects --, therefor.

In column 3, line 9, delete "clyclosporin" and insert -- cyclosporin --, therefor.

In column 3, line 42, delete "15%" and insert -- 1.5% --, therefor.

In column 5, line 8, delete "kerapoconiunctivitis," and insert -- keratoconjunctivitis, --, therefor.

In column 5, line 25, delete "treated," and insert -- treated --, therefor.

In column 5, line 38, delete "chromatography mass" and insert -- chromatography-mass --, therefor.

In column 5, line 38, delete "spectroscopy mass" and insert -- spectroscopy-mass --, therefor.

In column 6, line 11, delete "mobil" and insert -- mobile --, therefor.

In column 9, line 26, delete "—NR<sub>1</sub>R<sub>2</sub>:" and insert -- —NR<sub>1</sub>R<sub>2</sub>; --, therefor.

In column 9, line 30, delete "NR<sub>1</sub>R" and insert -- NR<sub>1</sub>R<sub>2</sub> --, therefor.

MAILING ADDRESS OF SENDER:

Atty Docket No: 17618CON2B (AP)

PATENT NO. 8,642,556

Legal Department –T2-7H  
Allergan, Inc.  
2525 Dupont Drive  
Irvine, Ca 92612

No. of additional copies



## UNITED STATES PATENT AND TRADEMARK OFFICE CERTIFICATE OF CORRECTION

PATENT NO : 8,642,556

Page 1 of 2

DATED : February 04, 2014

INVENTOR(S) : Andrew Acheampong et al.

It is certified that errors appear in the above-identified patent and that said Letters Patent is hereby corrected as shown below:

In column 10, line 40, delete "benefitting" and insert - - benefiting - -, therefor.

In column 10, line 62, delete "composition" and insert - - compositions may - -, therefor.

In column 10, line 63, after "in" insert - - a - -.

In column 11, line 14, delete "amphorteric" and insert - - amphoteric - -, therefor.

In column 11, line 15, delete "and" and insert - - and a - -, therefor.

In column 11, line 51, delete "methylhydroxyethylcelluloses" and insert - - methylhydroxyethylcelluloses - -, therefor.

In column 11, line 56, delete "gucoaminoglycans" and insert - - glycosaminoglycans - -, therefor.

In column 11, line 63, delete "of" and insert - - of: - -, therefor.

In column 12, line 1, delete "giutamic" and insert - - glutamic - -, therefor.

In column 12, line 8, delete "hydroxpropylsulonic" and insert - - hydroxypropylsulfonic - -, therefor.

In column 12, line 15, delete "useful" and insert - - useful emulsion - -, therefor.

In column 12, line 22, delete "weight," and insert - - weight - -, therefor.

In column 12, line 23, delete "crosslinked" and insert - - cross-linked - -, therefor.

In column 12, line 67, delete "iso" and insert - - also - -, therefor.

In column 12, line 23, delete "for" and insert - - or - -, therefor.

In column 14, lines 42-43, delete "or globule" and insert - - (or globule - -, therefor.

In column 14, line 51, delete "si e" and insert - - size - -, therefor.

In column 14, lines 55-56, delete "thermodynamicaly" and insert - - thermodynamically - -, therefor.

In column 14, line 57, delete "a are" and insert - - as are - -, therefor.

In column 15, line 8, delete "Premulem ®" and insert - - Pemulem® - -, therefor.

MAILING ADDRESS OF SENDER:

Atty Docket No: 17618CON2B (AP)

PATENT NO. 8,642,556

Legal Department -T2-7H  
Allergan, Inc.  
2525 Dupont Drive  
Irvine, Ca 92612

No. of additional copies

1

## METHODS OF PROVIDING THERAPEUTIC EFFECTS USING CYCLOSPORIN COMPONENTS

### RELATED APPLICATION

This application is a continuation of copending U.S. application Ser. No. 13/961,808 filed Aug. 7, 2013, which is a continuation of copending U.S. application Ser. No. 11/897,177, filed Aug. 28, 2007, which is a continuation of U.S. application Ser. No. 10/927,857, filed Aug. 27, 2004, now abandoned, which claimed the benefit of U.S. Provisional Application No. 60/503,137 filed Sep. 15, 2003, which are incorporated in their entirety herein by reference.

### BACKGROUND OF THE INVENTION

The present invention relates to methods of providing desired therapeutic effects to humans or animals using compositions including cyclosporin components. More particularly, the invention relates to methods including administering to an eye of a human or animal a therapeutically effective amount of a cyclosporin component to provide a desired therapeutic effect, preferably a desired ophthalmic or ocular therapeutic effect.

The use of cyclosporin-A and cyclosporin A derivatives to treat ophthalmic conditions has been the subject of various patents, for example Ding et al U.S. Pat. No. 5,474,979; Garst U.S. Pat. No. 6,254,860; and Garst U.S. Pat. No. 6,350,442, this disclosure of each of which is incorporated in its entirety herein by reference. In addition, cyclosporin A compositions used in treating ophthalmic conditions is the subject of a number of publications. Such publications include, for example, "Blood concentrations of cyclosporin A during long-term treatment with cyclosporin A ophthalmic emulsions in patients with moderate to severe dry eye disease," Small et al, *J Ocul Pharmacol Ther*, 2002 October, 18(5):421-8; "Distribution of cyclosporin A in ocular tissues after topical administration to albino rabbits and beagle dogs," Acheampong et al, *Curr Eye Res*, 1999 February, 18(2):103b; "Cyclosporine distribution into the conjunctiva, cornea, lacrimal gland, and systemic blood following topical dosing of cyclosporine to rabbit, dog, and human eyes," Acheampong et al, *Adv Exp Med Biol*, 1999, 438:1001-4; "Preclinical safety studies of cyclosporine ophthalmic emulsion," Angelov et al, *Adv Exp Med Biol*, 1998, 438:991; "Cyclosporin & Emulsion & Eye," Stevenson et al, *Ophthalmology*, 2000 May, 107(5):967-74; and "Two multicenter, randomized studies of the efficacy and safety of cyclosporine ophthalmic emulsion in moderate to severe dry eye disease. *CsA Phase 3 Study Group*," Sall et al, *Ophthalmology*, 2000 April, 107(4):631-9. Each of these publications is incorporated in its entirety herein by reference. In addition, cyclosporin A-containing oil-in-water emulsions have been clinically tested, under conditions of confidentiality, since the mid 1990's in order to obtain U.S. Food and Drug Administration (FDA) regulatory approval.

Examples of useful cyclosporin A-containing emulsions are set out in Ding et al U.S. Pat. No. 5,474,979. Example 1 of this patent shows a series of emulsions in which the ratio of cyclosporin A to castor oil in each of these compositions was 0.08 or greater, except for Composition B, which included 0.2% by weight cyclosporin A and 5% by weight castor oil. The Ding et al patent placed no significance in Composition B relative to Compositions A, C and D of Example 1.

Over time, it has become apparent that cyclosporin A emulsions for ophthalmic use preferably have less than 0.2% by

2

weight of cyclosporin A. With cyclosporin A concentrations less than 0.2%, the amount of castor oil employed has been reduced since one of the functions of the castor oil is to solubilize the cyclosporin A. Thus, if reduced amounts of cyclosporin are employed, reduced amounts of castor oil are needed to provide effective solubilization of cyclosporin A.

There continues to be a need for providing enhanced methods of treating ophthalmic or ocular conditions with cyclosporin-containing emulsions.

### SUMMARY OF THE INVENTION

New methods of treating a human or animal using cyclosporin component-containing emulsions have been discovered. Such methods provide substantial overall efficacy in providing desired therapeutic effects. In addition, other important benefits are obtained by employing the present methods. For example, patient safety is enhanced. In particular, the present methods provide for reduced risks of side effects, and/or drug interactions. Prescribing physicians advantageously have increased flexibility in prescribing such methods and the compositions useful in such methods, for example, because of the reduced risks of harmful side effects and/or drug interactions. The present methods can be easily practiced. In short, the present methods provide substantial and acceptable overall efficacy, together with other advantages, such as increased safety and/or flexibility.

In one aspect of the present invention, the present methods comprise administering to an eye of a human or animal a composition in the form of an emulsion comprising water, a hydrophobic component and a cyclosporin component in a therapeutically effective amount of less than 0.1% by weight of the composition. The weight ratio of the cyclosporin component to the hydrophobic component is less than 0.08.

It has been found that the relatively increased amounts of hydrophobic component together with relatively reduced, yet therapeutically effective, amounts of cyclosporin component provide substantial and advantageous benefits. For example, the overall efficacy of the present compositions, for example in treating dry eye disease, is substantially equal to an identical composition in which the cyclosporin component is present in an amount of 0.1% by weight. Further, a relatively high concentration of hydrophobic component is believed to provide for a more quick or rapid breaking down or resolving of the emulsion in the eye, which reduces vision distortion which may be caused by the presence of the emulsion in the eye and/or facilitates the therapeutic effectiveness of the composition. Additionally, and importantly, using reduced amounts of the active cyclosporin component mitigates against undesirable side effects and/or potential drug interactions.

In short, the present invention provides at least one advantageous benefit, and preferably a plurality of advantageous benefits.

The present methods are useful in treating any suitable condition which is therapeutically sensitive to or treatable with cyclosporin components. Such conditions preferably are ophthalmic or ocular conditions, that is relating to or having to do with one or more parts of an eye of a human or animal. Included among such conditions are, without limitation, dry eye syndrome, phacoanaphylactic endophthalmitis, uveitis, vernal conjunctivitis, atopic keratoconjunctivitis, corneal graft rejection and the like conditions. The present invention is particularly effective in treating dry eye syndrome.

Employing reduced concentrations of cyclosporin component, as in the present invention, is advantageously effective to provide the blood of the human or animal under treatment

3

with reduced concentrations of cyclosporin component, preferably with substantially no detectable concentration of the cyclosporin component. The cyclosporin component concentration of blood can be advantageously measured using a validated liquid chromatography/mass spectrometry-mass spectrometry (VLC/MS-MS) analytical method, such as described elsewhere herein.

In one embodiment, in the present methods the blood of the human or animal has concentrations of cyclosporin component of 0.1 ng/ml or less.

Any suitable cyclosporin component effective in the present methods may be used.

Cyclosporins are a group of nonpolar cyclic oligopeptides with known immunosuppressant activity. Cyclosporin A, along with several other minor metabolites, cyclosporin B through I, have been identified. In addition, a number of synthetic analogs have been prepared.

In general, commercially available cyclosporins may contain a mixture of several individual cyclosporins which all share a cyclic peptide structure consisting of eleven amino acid residues with a total molecular weight of about 1,200, but with different substituents or configurations of some of the amino acids.

The term "cyclosporin component" as used herein is intended to include any individual member of the cyclosporin group and derivatives thereof, as well as mixtures of two or more individual cyclosporins and derivatives thereof.

Particularly preferred cyclosporin components include, without limitation, cyclosporin A, derivatives of cyclosporin A and the like and mixtures thereof. Cyclosporin A is an especially useful cyclosporin component.

Any suitable hydrophobic component may be employed in the present invention. Advantageously, the cyclosporin component is solubilized in the hydrophobic component. The hydrophobic component may be considered as comprising a discontinuous phase in the presently useful cyclosporin component-containing emulsions.

The hydrophobic component preferably is present in the emulsion compositions in an amount greater than about 0.625% by weight. For example, the hydrophobic component may be present in an amount of up to about 1.0% by weight or about 15% by weight or more of the composition.

Preferably, the hydrophobic component comprises one or more oily materials. Examples of useful oil materials include, without limitation, vegetable oils, animal oils, mineral oils, synthetic oils and the like and mixtures thereof. In a very useful embodiment, the hydrophobic component comprises one or more higher fatty acid glycerides. Excellent results are obtained when the hydrophobic component comprises castor oil.

The presently useful compositions may include one or more other components in amounts effective to facilitate the usefulness and effectiveness of the compositions. Examples of such other components include, without limitation, emulsifier components, tonicity components, polyelectrolyte components, surfactant components, viscosity inducing components, acids and/or bases to adjust the pH of the composition, buffer components, preservative components and the like. Components may be employed which are effective to perform two or more functions in the presently useful compositions. For example, components which are effective as both emulsifiers and surfactants may be employed, and/or components which are effective as both polyelectrolyte components and viscosity inducing components may be employed. The specific composition chosen for use in the present invention advantageously is selected taking into account various factors present in the specific application at

4

hand, for example, the desired therapeutic effect to be achieved, the desired properties of the compositions to be employed, the sensitivities of the human or animal to whom the composition is to be administered, and the like factors.

The presently useful compositions advantageously are ophthalmically acceptable. A composition, component or material is ophthalmically acceptable when it is compatible with ocular tissue, that is, it does not cause significant or undue detrimental effects when brought into contact with ocular tissues.

Such compositions have pH's within the physiological range of about 6 to about 10, preferably in a range of about 7.0 to about 8.0 and more preferably in a range of about 7.2 to about 7.6.

The present methods preferably provide for an administering step comprising topically administering the presently useful compositions to the eye or eyes of a human or animal.

Each and every feature described herein, and each and every combination of two or more of such features, is included within the scope of the present invention provided that the features included in such a combination are not mutually inconsistent.

These and other aspects and advantages of the present invention are apparent in the following detailed description, example and claims.

#### DETAILED DESCRIPTION

The present methods are effective for treating an eye of a human or animal. Such methods, in general, comprise administering, preferably topically administering, to an eye of a human or animal a cyclosporin component-containing emulsion. The emulsion contains water, for example U.S. pure water, a hydrophobic component and a cyclosporin component in a therapeutically effective amount of less than 0.1% by weight of the emulsion. In addition, beneficial results have been found when the weight ratio of the cyclosporin component to the hydrophobic component is less than 0.08.

As noted above, the present administering step preferably includes topically administering the emulsion to the eye of a patient of a human or animal. Such administering may involve a single use of the presently useful compositions, or repeated or periodic use of such compositions, for example, as required or desired to achieve the therapeutic effect to be obtained. The topical administration of the presently useful composition may involve providing the composition in the form of eye drops or similar form or other form so as to facilitate such topical administration.

The present methods have been found to be very effective in providing the desired therapeutic effect or effects while, at the same time, substantially reducing, or even substantially eliminating, side effects which may result from the presence of the cyclosporin component in the blood of the human or animal being treated, and eye irritation which, in the past, has been caused by the presence of certain components in prior art cyclosporin-containing emulsions. Also, the use of the present compositions which include reduced amounts of the cyclosporin components allow for more frequent administration of the present compositions to achieve the desired therapeutic effect or effects without substantially increasing the risk of side effects and/or eye irritation.

5

The present methods are useful in treating any condition which is therapeutically sensitive to or treatable with cyclosporin components. Such conditions preferably are ophthalmic or ocular conditions, that is relating to or having to do with one or more parts of an eye of a human or animal. Included among such conditions are, without limitation, dry eye syndrome, phacoanaphylactic endophthalmitis, uveitis, vernal conjunctivitis, atopic keratoconjunctivitis, corneal graft rejection and the like conditions. The present invention is particularly effective in treating dry eye syndrome.

The frequency of administration and the amount of the presently useful composition to use during each administration varies depending upon the therapeutic effect to be obtained, the severity of the condition being treated and the like factors. The presently useful compositions are designed to allow the prescribing physician substantial flexibility in treating various ocular conditions to achieve the desired therapeutic effect or effects with reduced risk of side effects and/or eye irritation. Such administration may occur on an as needed basis, for example, in treating or managing dry eye syndrome, on a one time basis or on a repeated or periodic basis once, twice, thrice or more times daily depending on the needs of the human or animal being treated, and other factors involved in the application at hand.

One of the important advantages of the present invention is the reduced concentration of the cyclosporin component in the blood of the human or animal as a result of administering the present composition as described herein. One very useful embodiment of the present administering step provides no substantial detectable concentration of cyclosporin component in the blood of the human or animal. Cyclosporin component concentration in blood preferably is determined using a liquid chromatography mass spectroscopy mass spectroscopy

6

copy (LC-MS/MS), which test has a cyclosporin component detection limit of 0.1 ng/ml. Cyclosporin component concentrations below or less than 0.1 ng/ml are therefore considered substantially undetectable.

The LC-MS/MS test is advantageously run as follows.

One ml of blood is acidified with 0.2 ml of 0.1 N HCl solution, then extracted with 5 ml of methyl t-butyl ether. After separation from the acidified aqueous layer, the organic phase is neutralized with 2 ml of 0.1 N NaOH, evaporated, reconstituted in a water/acetonitrile-based mobile phase, and injected onto a 2.1x50 mm, 3 μm pore size C-8 reverse phase high pressure liquid chromatography (HPLC) column (Keystone Scientific, Bellefonte, Pa.). Compounds are gradient-eluted at 0.2 mL/min and detected using an API III triple quadrupole mass spectrometer with a turbo-ion spray source (PE-Sciex, Concord, Ontario, Canada). Molecular reaction monitoring enhances the sensitivity and selectivity of this assay. Protonated molecules for the analyte and an internal standard are collisionally dissociated and product ions at m/z 425 are monitored for the analyte and the internal standard. Under these conditions, cyclosporin A and the internal standard cyclosporin G elute with retention times of about 3.8 minutes. The lower limit of quantitation is 0.1 ng/mL, at which concentration the coefficient of variation and deviation from nominal concentration is <15%.

As noted previously, any suitable cyclosporin component effective in the present methods may be employed. Very useful cyclosporin components include, without limitation, cyclosporin A, derivatives of cyclosporin A and the like and mixtures thereof.

The chemical structure for cyclosporin A is represented by Formula 1

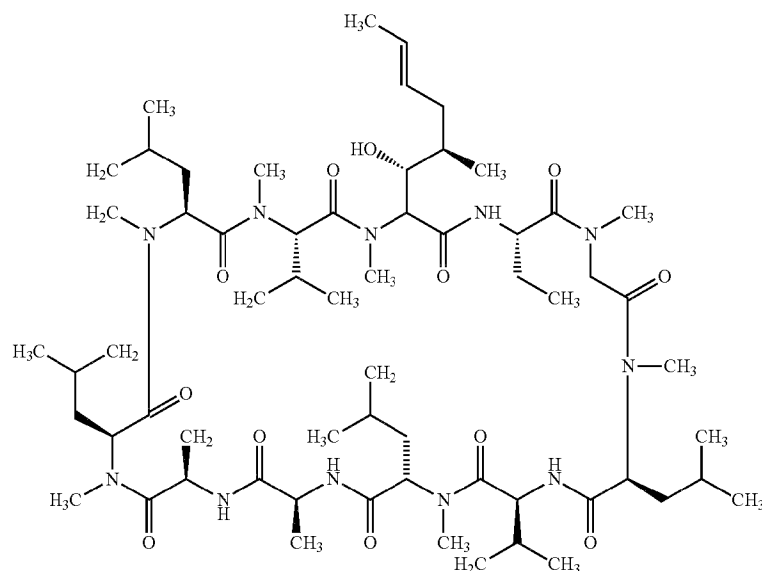

Formula I

-continued

Formula IV

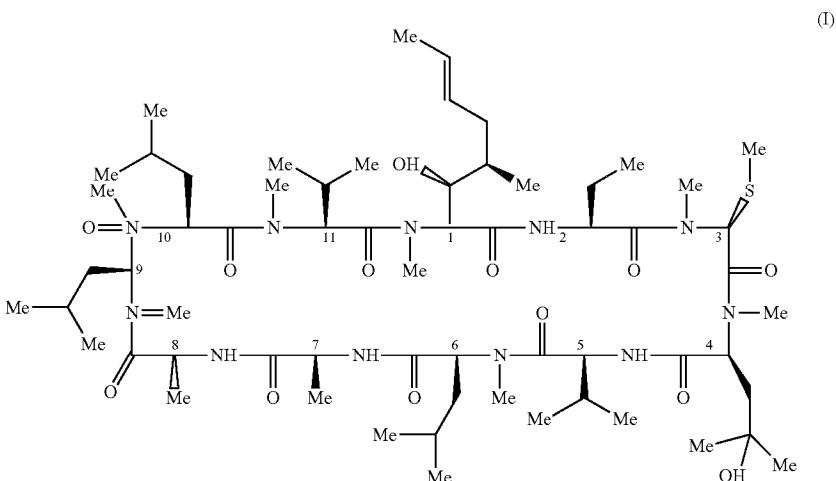

wherein Me is methyl; Alk is 2-6C alkylene or 3-6C cycloalkylene; R is OH, COOH, alkoxy, carbonyl,  $-\text{NR}_1\text{R}_2$  or  $\text{N}(\text{R}_3)-(\text{CH}_2)_n-\text{NR}_1\text{R}_2$  wherein  $\text{R}_1, \text{R}_2$  is H, alkyl, 3-6C cycloalkyl, phenyl (optionally substituted by halo, alkoxy, alkoxy, carbonyl, amino, alkylamino or dialkylamino), benzyl or saturated or unsaturated heterocyclyl having 5 or 6 members and 1-3 heteroatoms; or  $\text{NR}_1\text{R}_2$  is a 5 or 6 membered heterocycle which may contain a further N, O or S heteroatom and may be alkylated;  $\text{R}_3$  is H or alkyl and n is 2-4; and the alkyl moieties contain 1-4C.

In one embodiment, the cyclosporin component is effective as an immunosuppressant. Without wishing to be limited to any particular theory of operation, it is believed that, in certain embodiments of the present invention, the cyclosporin component acts to enhance or restore lacrimal gland tearing in providing the desired therapeutic effect.

One important feature of the present invention is that the presently useful compositions contain less than 0.1% by weight of the cyclosporin component. The advantages of such low-concentrations of cyclosporin components have been discussed in some detail elsewhere herein. Low concentrations of cyclosporin component, together with concentrations of the hydrophobic component such that the weight ratio of cyclosporin component to hydrophobic component is greater than 0.08, provides one or more substantial advantages in the present methods.

Any suitable hydrophobic component may be employed in the present invention. Such hydrophobic component may be considered as comprising a discontinuous phase in the presently useful cyclosporin component-containing emulsions, with the water or aqueous phase being considered the continuous phase in such emulsion. The hydrophobic component is preferably selected so as to solubilize the cyclosporin component, which is often substantially insoluble in the aqueous phase. Thus, with a suitable hydrophobic component included in the presently useful emulsions, the cyclosporin component is preferably solubilized in the emulsions.

In one very useful embodiment, the hydrophobic component comprises an oily material, in particular, a material which is substantially not miscible in water. Examples of useful oily materials include, without limitation, vegetable oils, animal oils, mineral oils, synthetic oils, and the like and mixtures thereof. Thus, the present hydrophilic components

may comprise naturally occurring oils, including, without limitation refined naturally occurring oils, or naturally occurring oils which have been processed to alter their chemical structures to some extent or oils which are substantially entirely synthetic. One very useful hydrophobic component includes higher fatty acid glycerides.

Examples of useful hydrophobic components include, without limitation, olive oil, arachis oil, castor oil, mineral oil, silicone fluid and the like and mixtures thereof. Higher fatty acid glycerides such as olive oil, peanut oil, castor oil and the like and mixtures thereof are particularly useful in the present invention. Excellent results are obtained using a hydrophobic component comprising castor oil. Without wishing to limit the invention to any particular theory of operation, it is believed that castor oil includes a relatively high concentration of ricinoleic acid which itself may be useful in benefiting ocular tissue and/or in providing one or more therapeutic effects when administered to an eye.

The hydrophobic component is preferably present in the presently useful cyclosporin component containing emulsion compositions in an amount greater than about 0.625% by weight. For example, the hydrophobic component may be present in an amount up to about 0.75% by weight or about 1.0% by weight or about 1.5% by weight or more of the presently useful emulsion compositions.

The presently useful compositions may include one or more other components in amounts effective to facilitate the usefulness and effectiveness of the present methods and/or the presently useful compositions. Examples of such other components include, without limitation, emulsifier components, surfactant components, tonicity components, poly electrolyte components, emulsion stability components, viscosity inducing components, demulcent components, acid and/or bases to adjust the pH of the composition, buffer components, preservative components and the like.

In one very useful embodiment, the presently useful compositions are substantially free of preservatives. Thus, the presently useful composition may be sterilized and maintained in a sterile condition prior to use, for example, provided in sealed package or otherwise maintained in a substantially sterile condition.

Any suitable emulsifier component may be employed in the presently useful compositions, provided, that such emul-

11

sifier component is effective in forming maintaining the emulsion and/or in the hydrophobic component in emulsion, while having no significant or undue detrimental effect or effects on the compositions during storage or use.

In addition, the presently useful compositions, as well as each of the components of the present compositions in the concentration present in the composition advantageously are ophthalmically acceptable.

Useful emulsifier components may be selected from such component which are conventionally used and well known in the art. Examples of such emulsifier components include, without limitation, surface active components or surfactant components which may be anionic, cationic, nonionic or amphoteric in nature. In general, the emulsifier component includes a hydrophobic constituent and hydrophilic constituent. Advantageously, the emulsifier component is water soluble in the presently useful compositions. Preferably, the emulsifier component is nonionic. Specific examples of suitable emulsifier components include, without limitation, polysorbate 80, polyoxyalkylene alkylene ethers, polyalkylene oxide ethers of alkyl alcohols, polyalkylene oxide ethers of alkylphenols, other emulsifiers/surfactants, preferably nonionic emulsifiers/surfactants, useful in ophthalmic compositions, and the like and mixtures thereof.

The emulsifier component is present in an amount effective in forming the present emulsion and/or in maintaining the hydrophobic component in emulsion with the water or aqueous component. In one preferred embodiment, the emulsifier component is present in an amount in a range of about 0.1% to about 5%, more preferably about 0.2% to about 2% and still more preferably about 0.5% to about 1.5% by weight of the presently useful compositions.

Polyelectrolyte or emulsion stabilizing components may be included in the presently useful compositions. Such components are believed to be effective in maintaining the electrolyte balance in the presently useful emulsions, thereby stabilizing the emulsions and preventing the emulsions from breaking down prior to use. In one embodiment, the presently useful compositions include a polyanionic component effective as an emulsion stabilizing component. Examples of suitable polyanionic components useful in the presently useful compositions include, without limitation, anionic cellulose derivatives, anionic acrylic acid-containing polymers, anionic methacrylic acid-containing polymers, anionic amino acid-containing polymers and the like and mixtures thereof.

A particularly useful class of polyanionic components include one or more polymeric materials having multiple anionic charges. Examples include, but are not limited to:

- metal carboxy methylcelluloses
- metal carboxy methylhydroxyethylcelluloses
- metal carboxy methylstarches
- metal carboxy methylhydroxyethylstarches
- hydrolyzed polyacrylamides and polyacrylonitriles
- heparin
- gucoaminoglycans
- hyaluronic acid
- chondroitin sulfate
- dermatan sulfate
- peptides and polypeptides
- alginate acid
- metal alginates
- homopolymers and copolymers of one or more of
- acrylic and methacrylic acids
- metal acrylates and methacrylates
- vinylsulfonic acid
- metal vinylsulfonate

12

amino acids, such as aspartic acid, glutamic acid and the like

metal salts of amino acids

p-styrenesulfonic acid

metal p-styrenesulfonate

2-methacryloyloxyethylsulfonic acids

metal 2-methacryloyloxyethylsulfonates

3-methacryloyloxy-2-hydroxypropylsulfonic acids

metal 3-methacryloyloxy-2-hydroxypropylsulfonates

2-acrylamido-2-methylpropanesulfonic acids

metal 2-acrylamido-2-methylpropanesulfonates

allylsulfonic acid

metal allylsulfonate and the like.

One particularly useful stabilizing component includes crosslinked polyacrylates, such as carbomers and Pemulen® materials. Pemulen® is a registered trademark of B.F. Goodrich for polymeric emulsifiers and are commercially available from B.F. Goodrich Company, Specialty Polymers & Chemicals Division, Cleveland, Ohio. Pemulen® materials include acrylate/C10-30 alkyl acrylate cross-polymers, or high molecular weight co-polymers of acrylic acid and a long chain alkyl methacrylate crosslinked with allyl ethers of pentaerythritol.

The presently useful polyanionic components may also be used to provide a suitable viscosity to the presently useful compositions. Thus, the polyanionic components may be useful in stabilizing the presently useful emulsions and in providing a suitable degree of viscosity to the presently useful compositions.

The polyelectrolyte or emulsion stabilizing component advantageously is present in an amount effective to at least assist in stabilizing the cyclosporin component-containing emulsion. For example, the polyelectrolyte/emulsion stabilizing component may be present in an amount in a range of about 0.01% by weight or less to about 1% by weight or more, preferably about 0.02% by weight to about 0.5% by weight, of the composition.

Any suitable tonicity component may be employed in accordance with the present invention. Preferably, such tonicity component is non-ionic, for example, in order to avoid interfering with the other components in the presently useful emulsions and to facilitate maintaining the stability of the emulsion prior to use. Useful tonicity agents include, without limitation, glycerine, mannitol, sorbitol and the like and mixtures thereof. The presently useful emulsions are preferably within the range of plus or minus about 20% or about 10% from being isotonic.

Ophthalmic demulcent components may be included in effective amounts in the presently useful compositions. For example, ophthalmic demulcent components such as carboxymethylcellulose, other cellulose polymers, dextran 70, gelatin, glycerine, polyethylene glycols (e.g., PEG 300 and PEG 400), polysorbate 80, propylene glycol, polyvinyl alcohol, povidone and the like and mixtures thereof, may be used in the present ophthalmic compositions, for example, compositions useful for treating dry eye.

The demulcent components are preferably present in the compositions, for example, in the form of eye drops, in an amount effective in enhancing the lubricity of the presently useful compositions. The amount of demulcent component in the present compositions may be in a range of at least about 0.01% or about 0.02% to about 0.5% or about 1.0% by weight of the composition.

Many of the presently useful polyelectrolyte/emulsion stabilizing components may be effective as demulcent com-

13

ponents, and vice versa. The emulsifier/surfactant components may also be effective as demulcent components and vice versa.

The pH of the emulsions can be adjusted in a conventional manner using sodium hydroxide and/or hydrochloric acid to a physiological pH level. The pH of the presently useful emulsions preferably is in the range of about 6 to about 10, more preferably about 7.0 to about 8.0 and still more preferably about 7.2 to about 7.6.

Although buffer components are not required in the presently useful compositions, suitable buffer components, for example, and without limitation, phosphates, citrates, acetates, borates and the like and mixtures thereof, may be employed to maintain a suitable pH in the presently useful compositions.

The presently useful compositions may include an effective amount of a preservative component. Any suitable preservative or combination of preservatives may be employed. Examples of suitable preservatives include, without limitation, benzalkonium chloride, methyl and ethyl parabens, hexetidine, phenyl mercuric salts and the like and mixtures thereof. The amounts of preservative components included in the present compositions are such to be effective in preserving the compositions and can vary based on the specific preservative component employed, the specific composition involved, the specific application involved, and the like factors. Preservative concentrations often are in the range of about 0.00001% to about 0.05% or about 0.1% (w/v) of the composition, although other concentrations of certain preservatives may be employed.

Very useful examples of preservative components in the present invention include, but are not limited to, chlorite components. Specific examples of chlorite components useful as preservatives in accordance with the present invention include stabilized chlorine dioxide (SCD), metal chlorites such as alkali metal and alkaline earth metal chlorites, and the like and mixtures thereof. Technical grade (or USP grade) sodium chlorite is a very useful preservative component. The exact chemical composition of many chlorite components, for example, SCD, is not completely understood. The manufacture or production of certain chlorite components is described in McNicholas U.S. Pat. No. 3,278,447, which is incorporated in its entirety by reference herein. Specific examples of useful SCD products include that sold under the trademark Dura Klor by Rio Linda Chemical Company, Inc., and that sold under the trademark Anthium Dioxide® by International Dioxide, Inc. An especially useful SCD is a product sold under the trademark Bio-Cide® by Bio-Cide International, Inc., as well as a product identified by Allergan, Inc. by the trademark Purite®.

Other useful preservatives include antimicrobial peptides. Among the antimicrobial peptides which may be employed include, without limitation, defensins, peptides related to defensins, cecropins, peptides related to cecropins, magainins and peptides related to magainins and other amino acid polymers with antibacterial, antifungal and/or antiviral activities. Mixtures of antimicrobial peptides or mixtures of antimicrobial peptides with other preservatives are also included within the scope of the present invention.

The compositions of the present invention may include viscosity modifying agents or components, such as cellulose polymers, including hydroxypropyl methyl cellulose (HPMC), hydroxyethyl cellulose (HEC), ethyl hydroxyethyl cellulose, hydroxypropyl cellulose, methyl cellulose and carboxymethyl cellulose; carbomers (e.g. carbopol, and the like); polyvinyl alcohol; polyvinyl pyrrolidone; alginates; carrageenans; and guar, karaya, agarose, locust bean, traga-

14

canth and xanthan gums. Such viscosity modifying components are employed, if at all, in an amount effective to provide a desired viscosity to the present compositions. The concentration of such viscosity modifiers will typically vary between about 0.01 to about 5% w/v of the total composition, although other concentrations of certain viscosity modifying components may be employed.

The presently useful compositions may be produced using conventional and well known methods useful in producing ophthalmic products including oil-in-water emulsions.

In one example, the oily phase of the emulsion can be combined with the cyclosporin component to solubilize the cyclosporin component in the oily material phase. The oily phase and the water may be separately heated to an appropriate temperature. This temperature may be the same in both cases, generally a few degrees to about 10° C. above the melting temperature of the ingredient(s) having the highest melting point in the case of a solid or semi-solid oily phase for emulsifier components in the oily phase. Where the oily phase is a liquid at room temperature, a suitable temperature for preparation of a composition may be determined by routine experimentation in which the melting point of the ingredients aside from the oily phase is determined. In cases where all components of either the oily phase or the water phase are soluble at room temperature, no heating may be necessary. Non-emulsifying agents which are water soluble are dissolved in the water and oil soluble components including the surfactant components are dissolved in the oily phase.

To create an oil-in-water emulsion, the final oil phase is gently mixed into either an intermediate, preferably de-ionized water, phase or into the final water phase to create a suitable dispersion and the product is allowed to cool with or without stirring. In the case where the final oil phase is first gently mixed into an intermediate water phase, the resulting emulsion concentrate is thereafter mixed in the appropriate ratio with the final aqueous phase. In such cases, the emulsion concentrate and the final aqueous phase may not be at the same temperature or heated above room temperature, as the emulsion may be already formed at this point.

The oil-in-water emulsions of the present invention can be sterilized after preparation using heat, for example, autoclave steam sterilization or can be sterile filtered using, for example, a 0.22 micron sterile filter. Sterilization employing a sterilization filter can be used when the emulsion droplet (or globule or particle) size and characteristics allows this. The droplet size distribution of the emulsion need not be entirely below the particle size cutoff of the 0.22 micron sterile filtration membrane to be sterile-filtratable. In cases wherein the droplet size distribution of the emulsion is above the particle size cutoff of the 0.22 micron sterile filtration membrane, the emulsion needs to be able to deform or change while passing through the filtration membrane and then reform after passing through. This property is easily determined by routine testing of emulsion droplet size distributions and percent of total oil in the compositions before and after filtration. Alternatively, a loss of a small amount of larger droplet sized material may be acceptable.

The present oil-in-water emulsions preferably are thermodynamically stable, much like microemulsions, and yet may not be isotropic transparent compositions, a are microemulsions. The emulsions of the present invention advantageously have a shelf life exceeding one year at room temperature.

The following non-limiting examples illustrate certain aspects of the present invention.

#### EXAMPLE 1

Two compositions are selected for testing. These compositions are produced in accordance with well known techniques and have the following make-ups:

## Electronic Patent Application Fee Transmittal

|   |   |
|---|---|
| <b>Application Number:</b>                  | 13967189  |
| <b>Filing Date:</b>                         | 14-Aug-2013   |
| <b>Title of Invention:</b>                  | METHODS OF PROVIDING THERAPEUTIC EFFECTS USING CYCLOSPORIN COMPONENTS |
| <b>First Named Inventor/Applicant Name:</b> | Andrew Acheampong   |
| <b>Filer:</b>                               | Laura Lee Wine/Maria Stein  |
| <b>Attorney Docket Number:</b>              | 17618CON2B (AP)   |

Filed as Large Entity

### Utility under 35 USC 111(a) Filing Fees

| Description                              | Fee Code | Quantity | Amount | Sub-Total in USD(\$) |
|--|----------|----------|--------|----------------------|
| <b>Basic Filing:</b>                     |          |          |        |                      |
| <b>Pages:</b>                            |          |          |        |                      |
| <b>Claims:</b>                           |          |          |        |                      |
| <b>Miscellaneous-Filing:</b>             |          |          |        |                      |
| <b>Petition:</b>                         |          |          |        |                      |
| <b>Patent-Appeals-and-Interference:</b>  |          |          |        |                      |
| <b>Post-Allowance-and-Post-Issuance:</b> |          |          |        |                      |
| Certificate of Correction                | 1811     | 1        | 100    | 100                  |

**Extension-of-Time:**



| Description              | Fee Code | Quantity | Amount | Sub-Total in USD(\$) |
|--------------------------|----------|----------|--------|----------------------|
| <b>Miscellaneous:</b>    |          |          |        |                      |
| <b>Total in USD (\$)</b> |          |          |        | <b>100</b>           |

## Electronic Acknowledgement Receipt

|   |   |
|---|---|
| <b>EFS ID:</b>                              | 18983200  |
| <b>Application Number:</b>                  | 13967189  |
| <b>International Application Number:</b>    |   |
| <b>Confirmation Number:</b>                 | 4818  |
| <b>Title of Invention:</b>                  | METHODS OF PROVIDING THERAPEUTIC EFFECTS USING CYCLOSPORIN COMPONENTS |
| <b>First Named Inventor/Applicant Name:</b> | Andrew Acheampong   |
| <b>Customer Number:</b>                     | 51957   |
| <b>Filer:</b>                               | Laura Lee Wine/Maria Stein  |
| <b>Filer Authorized By:</b>                 | Laura Lee Wine  |
| <b>Attorney Docket Number:</b>              | 17618CON2B (AP)   |
| <b>Receipt Date:</b>                        | 08-MAY-2014   |
| <b>Filing Date:</b>                         | 14-AUG-2013   |
| <b>Time Stamp:</b>                          | 18:14:23  |
| <b>Application Type:</b>                    | Utility under 35 USC 111(a)   |

### Payment information:

|  |                 |
|--|-----------------|
| Submitted with Payment                   | yes             |
| Payment Type                             | Deposit Account |
| Payment was successfully received in RAM | \$100           |
| RAM confirmation Number                  | 4204            |
| Deposit Account                          | 010885          |
| Authorized User                          |                 |

The Director of the USPTO is hereby authorized to charge indicated fees and credit any overpayment as follows:

Charge any Additional Fees required under 37 C.F.R. Section 1.19 (Document supply fees)

Charge any Additional Fees required under 37 C.F.R. Section 1.20 (Post Issuance fees)

**File Listing:**

| Document Number | Document Description                  | File Name            | File Size(Bytes)/ Message Digest                      | Multi Part /.zip | Pages (if appl.) |
|-----------------|---------------------------------------|----------------------|---|------------------|------------------|
| 1               | Request for Certificate of Correction | 17618CON2BAP_COC.pdf | 12012134<br>e9b7b42739e11874f81d26412d816ecec6d697213 | no               | 10               |

**Warnings:**

**Information:**

|   |                      |              |   |    |   |
|---|----------------------|--------------|---|----|---|
| 2 | Fee Worksheet (SB06) | fee-info.pdf | 30586<br>5a05cba62ae3c648df05258518b429c376f59ab6 | no | 2 |
|---|----------------------|--------------|---|----|---|

**Warnings:**

**Information:**

|                                     |  |  |          |  |  |
|-------------------------------------|--|--|----------|--|--|
| <b>Total Files Size (in bytes):</b> |  |  | 12042720 |  |  |
|-------------------------------------|--|--|----------|--|--|

**This Acknowledgement Receipt evidences receipt on the noted date by the USPTO of the indicated documents, characterized by the applicant, and including page counts, where applicable. It serves as evidence of receipt similar to a Post Card, as described in MPEP 503.**

**New Applications Under 35 U.S.C. 111**

**If a new application is being filed and the application includes the necessary components for a filing date (see 37 CFR 1.53(b)-(d) and MPEP 506), a Filing Receipt (37 CFR 1.54) will be issued in due course and the date shown on this Acknowledgement Receipt will establish the filing date of the application.**

**National Stage of an International Application under 35 U.S.C. 371**

**If a timely submission to enter the national stage of an international application is compliant with the conditions of 35 U.S.C. 371 and other applicable requirements a Form PCT/DO/EO/903 indicating acceptance of the application as a national stage submission under 35 U.S.C. 371 will be issued in addition to the Filing Receipt, in due course.**

**New International Application Filed with the USPTO as a Receiving Office**

**If a new international application is being filed and the international application includes the necessary components for an international filing date (see PCT Article 11 and MPEP 1810), a Notification of the International Application Number and of the International Filing Date (Form PCT/RO/105) will be issued in due course, subject to prescriptions concerning national security, and the date shown on this Acknowledgement Receipt will establish the international filing date of the application.**

UNITED STATES PATENT AND TRADEMARK OFFICE  
**CERTIFICATE OF CORRECTION**

PATENT NO. : 8,642,556 B2  
APPLICATION NO. : 13/967189  
DATED : February 4, 2014  
INVENTOR(S) : Andrew Acheampong et al.

Page 1 of 2

It is certified that error appears in the above-identified patent and that said Letters Patent is hereby corrected as shown below:

In the Specification

In column 1, line 34, delete "of:" and insert -- of --, therefor

In column 1, line 34, delete "cyclosporin a" and insert -- cyclosporin A --, therefor.

In column 1, line 35, delete "cyclosporin a" and insert -- cyclosporin A --, therefor.

In column 1, line 37, delete "421" and insert -- 411 --, therefor.

In column 1, line 38, delete "aft" and insert -- after --, therefor.

In column 1, line 40, delete "18(2)" and insert -- 18(2):91 --, therefor.

In column 1, line 44, delete "1999," and insert -- 1998, --, therefor.

In column 1, line 45, delete "1999," and insert -- 1998, --, therefor.

In column 1, line 46, delete "438:991" and insert --438:991-5; --, therefor.

In column 1, line 56, delete "A Ministrati on" and insert -- Administration --, therefor.

In column 2, line 15, delete "method" and insert -- methods --, therefor.

In column 2, line 17, delete "employ" and insert -- employing --, therefor.

In column 2, line 19, delete "effects," and insert -- effects --, therefor.

In column 3, line 9, delete "clyclosporin" and insert -- cyclosporin --, therefor.

In column 3, line 42, delete "15%" and insert -- 1.5% --, therefor.

In column 5, line 8, delete "kerapoconiunctivitis," and insert -- keratoconjunctivitis, --, therefor.

In column 5, line 25, delete "treated," and insert -- treated --, therefor.

In column 5, line 38, delete "chromatography mass" and insert -- chromatography-mass --, therefor.

In column 5, line 38, delete "spectroscopy mass" and insert -- spectroscopy-mass --, therefor.

In column 6, line 11, delete "mobil" and insert -- mobile --, therefor.

In column 9, line 26, delete "--NR<sub>1</sub>R<sub>2</sub>:" and insert -- --NR<sub>1</sub>R<sub>2</sub>; --, therefor.

In column 9, line 30, delete "NR<sub>1</sub>R" and insert -- NR<sub>1</sub>R<sub>2</sub> --, therefor.

Signed and Sealed this  
First Day of July, 2014



Michelle K. Lee  
*Deputy Director of the United States Patent and Trademark Office*

**CERTIFICATE OF CORRECTION (continued)**

**U.S. Pat. No. 8,642,556 B2**

In column 10, line 40, delete “benefitting” and insert -- benefiting --, therefor.

In column 10, line 62, delete “composition” and insert -- compositions may --, therefor.

In column 10, line 63, after “in” insert -- a --.

In column 11, line 14, delete “amphorteric” and insert -- amphoteric --, therefor.

In column 11, line 15, delete “and” and insert -- and a --, therefor.

In column 11, line 51, delete “methylhydroxyethylcelluloses” and insert -- methylhydroxyethylcelluloses --, therefor.

In column 11, line 56, delete “gucoaminoglycans” and insert -- glycosaminoglycans --, therefor.

In column 11, line 63, delete “of” and insert -- of: --, therefor.

In column 12, line 1, delete “giutamic” and insert -- glutamic --, therefor.

In column 12, line 8, delete “hydroxpropylsulfonic” and insert -- hydroxypropylsulfonic --, therefor.

In column 12, line 15, delete “useful” and insert -- useful emulsion --, therefor.

In column 12, line 22, delete “weight,” and insert -- weight --, therefor.

In column 12, line 23, delete “crosslinked” and insert -- cross-linked --, therefor.

In column 12, line 67, delete “iso” and insert -- also --, therefor.

In column 12, line 23, delete “for” and insert -- or --, therefor.

In column 14, lines 42-43, delete “or globule” and insert -- (or globule --, therefor.

In column 14, line 51, delete “si e” and insert -- size --, therefor.

In column 14, lines 55-56, delete “thermodynamicaly” and insert -- thermodynamically --, therefor.

In column 14, line 57, delete “a are” and insert -- as are --, therefor.

In column 15, line 8, delete “Premulem ®” and insert -- Pemulem® --, therefor.

AO 120 (Rev. 08/10)

|   |   |
|---|---|
| TO: <b>Mail Stop 8</b><br><b>Director of the U.S. Patent and Trademark Office</b><br><b>P.O. Box 1450</b><br><b>Alexandria, VA 22313-1450</b> | <b>REPORT ON THE</b><br><b>FILING OR DETERMINATION OF AN</b><br><b>ACTION REGARDING A PATENT OR</b><br><b>TRADEMARK</b> |
|---|---|

In Compliance with 35 U.S.C. § 290 and/or 15 U.S.C. § 1116 you are hereby advised that a court action has been filed in the U.S. District Court Eastern District of Texas, Marshall Division on the following

Trademarks or  Patents. (  the patent action involves 35 U.S.C. § 292.):

| DOCKET NO.<br>2:14-cv-638   | DATE FILED<br>5/22/2014     | U.S. DISTRICT COURT<br>Eastern District of Texas, Marshall Division                          |
|-----------------------------|-----------------------------|--|
| PLAINTIFF<br>ALLERGAN, INC. |                             | DEFENDANT<br>ACTAVIS PLC, ACTAVIS, INC., WATSON LABORATORIES, INC., and ACTAVIS PHARMA, INC. |
| PATENT OR TRADEMARK NO.     | DATE OF PATENT OR TRADEMARK | HOLDER OF PATENT OR TRADEMARK  |
| 1 8,633,162                 | 1/21/2014                   | Allergan, Inc.   |
| 2 8,642,556                 | 2/4/2014                    | Allergan, Inc.   |
| 3 8,648,048                 | 2/11/2014                   | Allergan, Inc.   |
| 4 8,685,930                 | 4/1/2014                    | Allergan, Inc.   |
| 5                           |                             |  |

In the above—entitled case, the following patent(s)/ trademark(s) have been included:

| DATE INCLUDED           | INCLUDED BY  |                               |
|-------------------------|--|-------------------------------|
|                         | <input type="checkbox"/> Amendment <input type="checkbox"/> Answer <input type="checkbox"/> Cross Bill <input type="checkbox"/> Other Pleading |                               |
| PATENT OR TRADEMARK NO. | DATE OF PATENT OR TRADEMARK  | HOLDER OF PATENT OR TRADEMARK |
| 1                       |  |                               |
| 2                       |  |                               |
| 3                       |  |                               |
| 4                       |  |                               |
| 5                       |  |                               |

In the above—entitled case, the following decision has been rendered or judgement issued:

|                    |
|--------------------|
| DECISION/JUDGEMENT |
|--------------------|

|       |                   |      |
|-------|-------------------|------|
| CLERK | (BY) DEPUTY CLERK | DATE |
|-------|-------------------|------|

Copy 1—Upon initiation of action, mail this copy to Director    Copy 3—Upon termination of action, mail this copy to Director  
 Copy 2—Upon filing document adding patent(s), mail this copy to Director    Copy 4—Case file copy