



US005588009A

United States Patent [19] Will

[11] **Patent Number:** 5,588,009
[45] **Date of Patent:** Dec. 24, 1996

[54] **PERSONAL PAGING, COMMUNICATIONS,
AND LOCATING SYSTEM**

[76] **Inventor:** Craig A. Will, 37675 Fremont Blvd.
No. 23, Fremont, Calif. 94536

[21] **Appl. No.:** 191,111

[22] **Filed:** Feb. 3, 1994

[51] **Int. Cl.⁶** H04L 1/18

[52] **U.S. Cl.** 371/33

[58] **Field of Search** 371/32, 33; 455/54.1,
455/53.1, 89; 379/56, 57

[56] **References Cited**

U.S. PATENT DOCUMENTS

3,439,320	4/1969	Ward	367/191
3,696,384	10/1972	Lester	367/199
3,805,227	4/1974	Lester	367/6
3,805,265	4/1974	Lester	342/44
4,172,969	10/1979	Levine et al.	379/70
4,356,484	10/1982	Eckhardt	340/825.03
4,601,064	7/1986	Shipley	359/172
4,696,054	9/1987	Tsugei et al.	455/89
4,775,996	10/1988	Emerson et al.	379/61
4,823,123	4/1989	Siwiak	340/825.44
4,970,714	11/1990	Chen et al.	370/17
5,062,151	10/1991	Shipley	359/154
5,151,930	9/1992	Hagl	379/57
5,153,582	10/1992	Davis	340/825.44
5,265,033	11/1993	Vajk et al.	364/514
5,396,537	3/1995	Schwendeman	379/57
5,438,611	8/1995	Campana, Jr. et al.	379/58
5,479,408	12/1995	Will	370/94.1
5,493,692	2/1996	Theimer et al.	455/26.1
5,526,401	6/1996	Roach, Jr. et al.	379/59

OTHER PUBLICATIONS

Stallings, William. Data and Computer Communications, Second Edition, MacMillan Publishing, 1988, pp. 107-112 and 141-144.

Weiser, Mark. The Computer for the 21st Century. pp. 94-104 Scientific American, Sep., 1991.

Primary Examiner—Stephen M. Baker

[57] **ABSTRACT**

A method and apparatus for sending paging signals and messages to individuals within a building and accepting responses to the messages. Messages may be initiated by electronic mail, incoming telephone calls, incoming Fax messages, or other sources. Data is sent via radio to a communications unit carried by the individual and displayed visually together with possible responses. Each unit transmits its identity and responses or original messages when desired via coded infrared light (or, in an alternative embodiment, ultrasound) to one or more remote stations located in rooms or along corridors of the building. A remote station relays data to a central station via wire or optical fiber, which tracks the location of units and delivers messages. Communication units are clipped to the clothing of users and can be incorporated into a corporate employee identification badge. The hybrid radio-infrared light approach combines the broad, reliable characteristics of radio communication with the ability of infrared light to allow each unit to be located. This allows highly reliable delivery of messages via an acknowledgement and retransmission protocol, two-way communication with the individual, and capabilities (such as those for transferring incoming telephone calls) that require the location of the individual to be known.

25 Claims, 26 Drawing Sheets

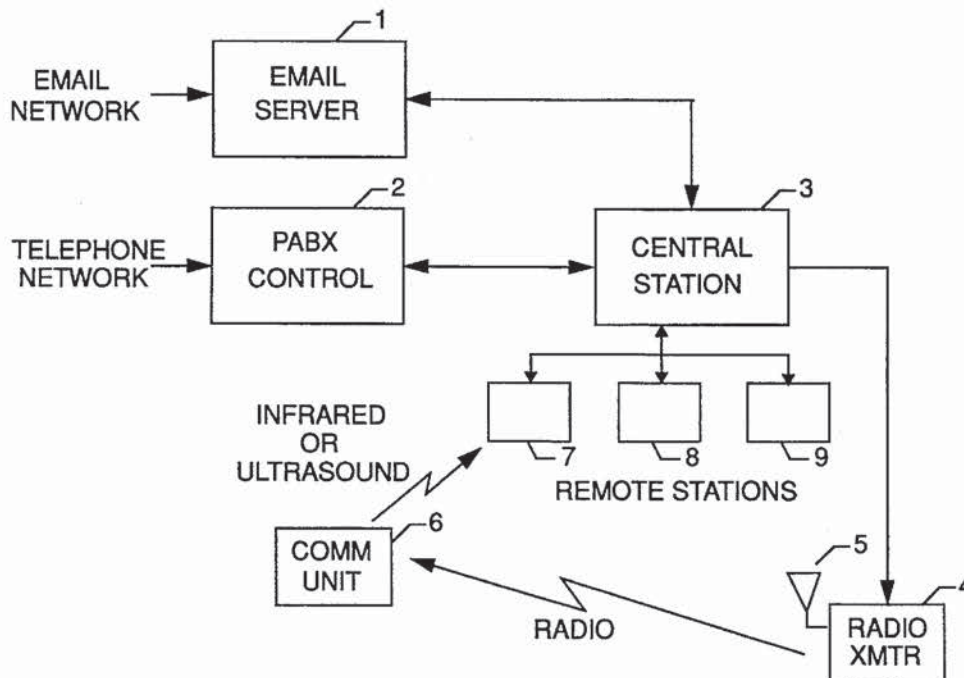

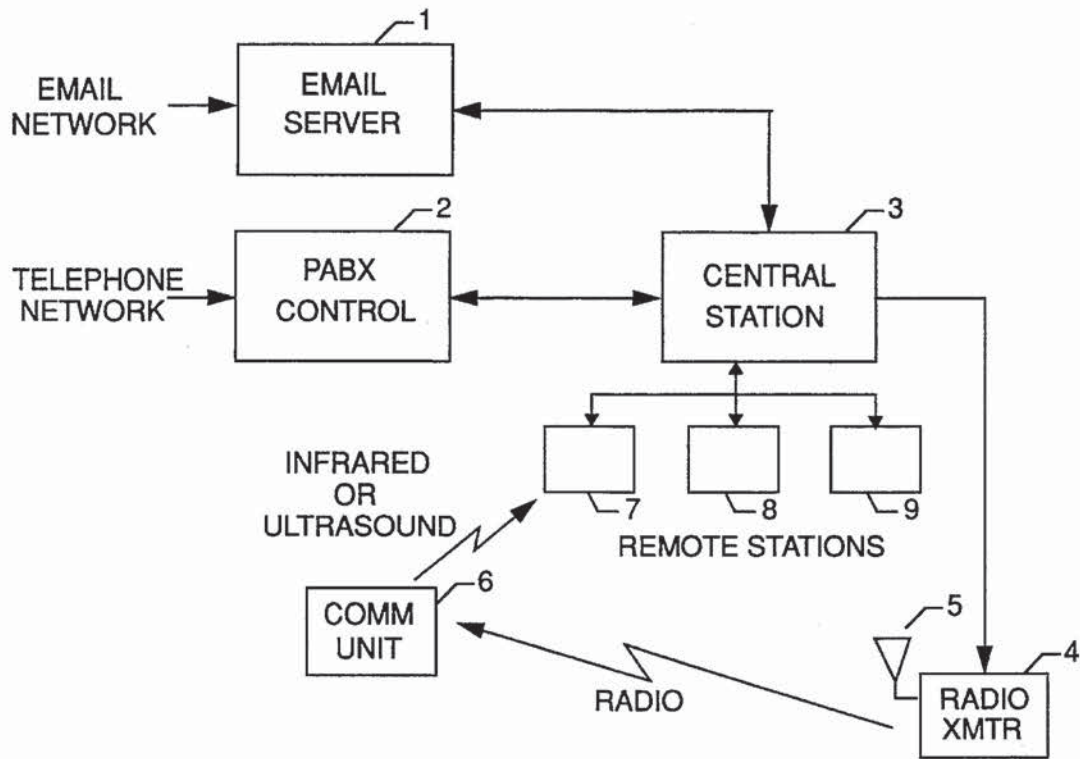

FIG. 1

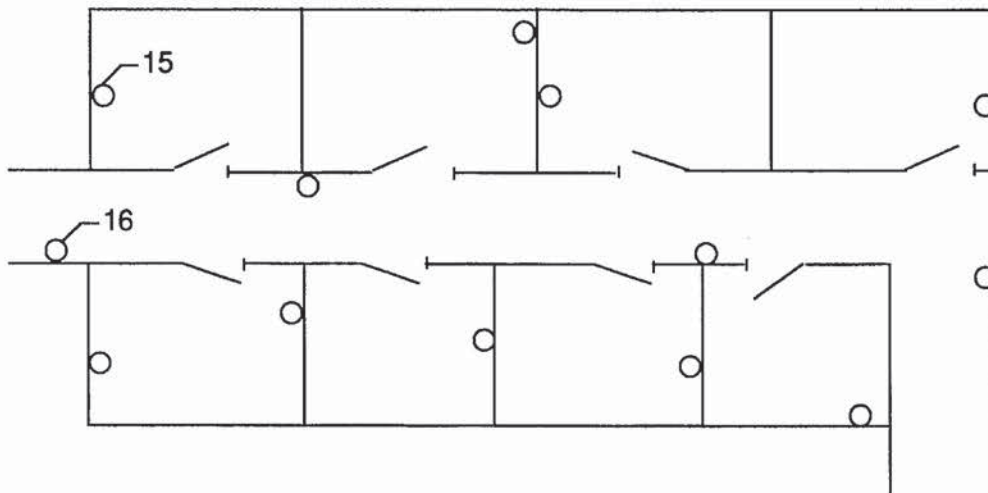

FIG. 2

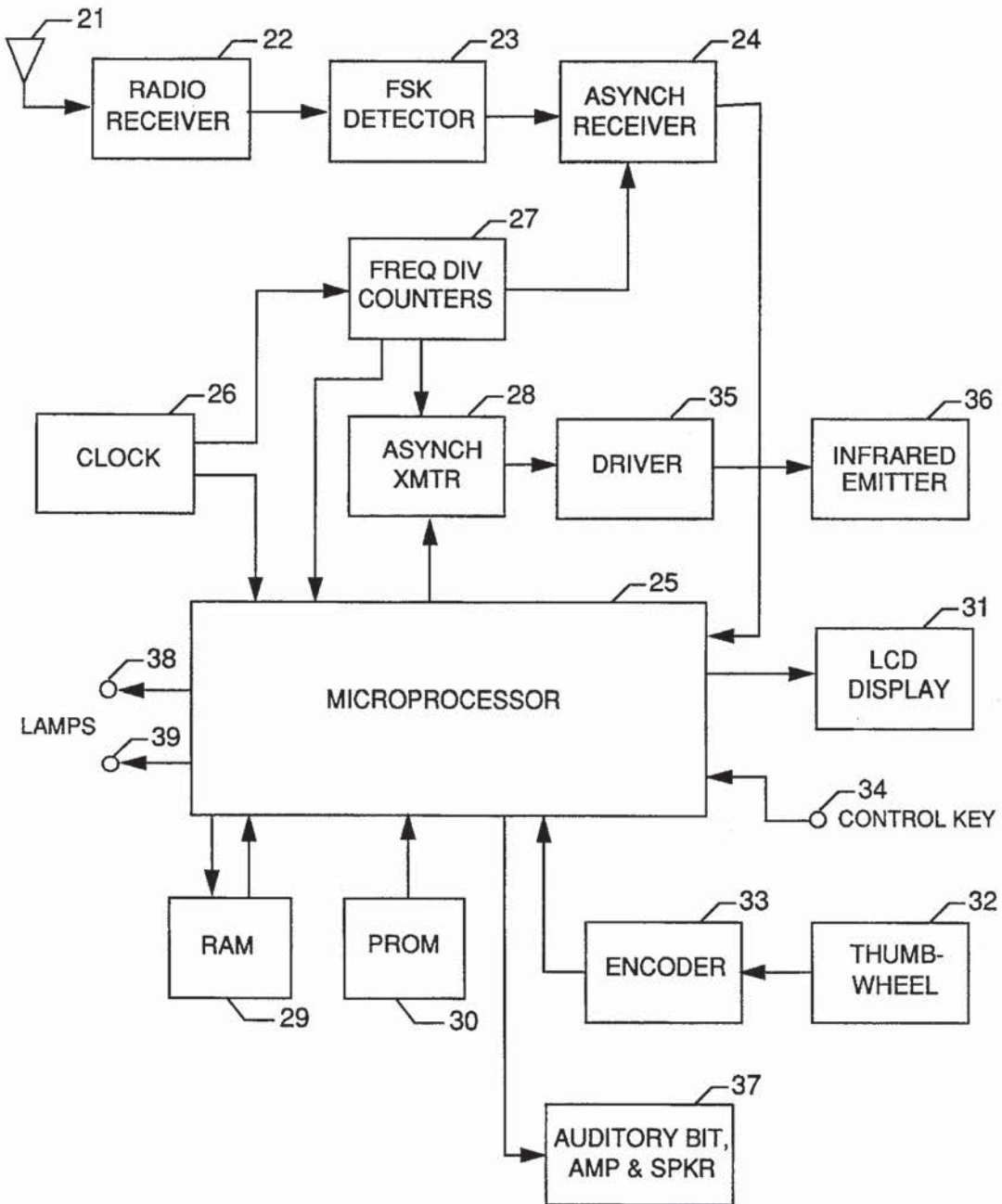

FIG. 3

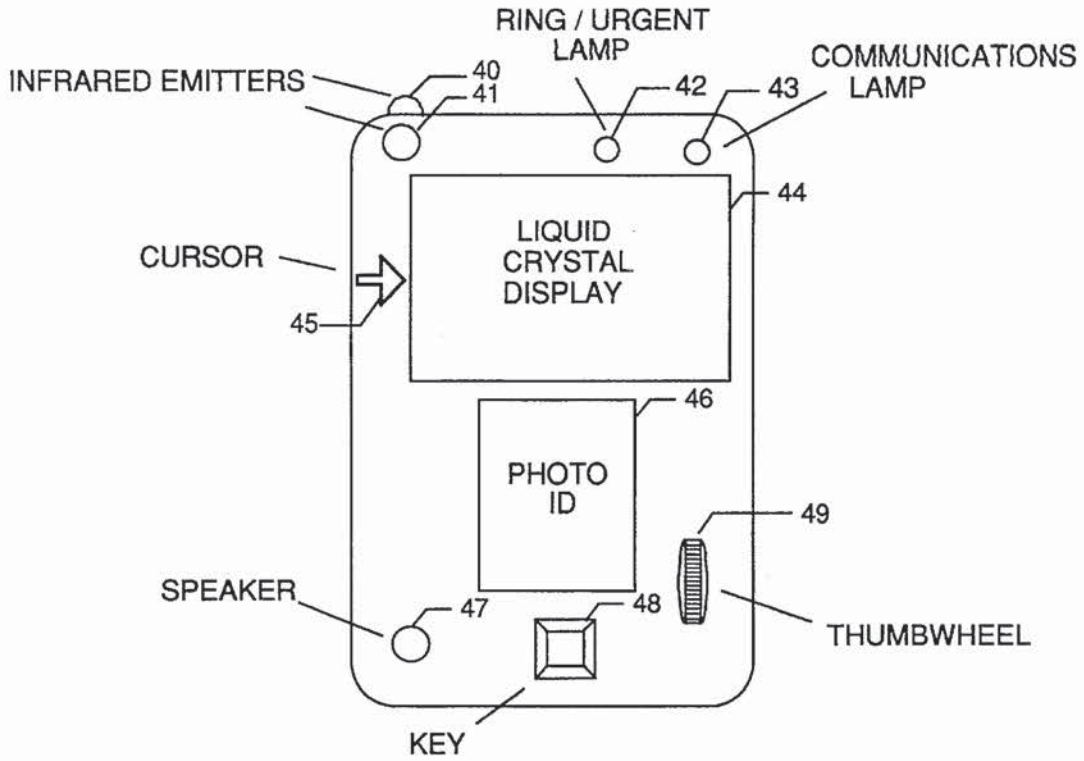

FIG. 4

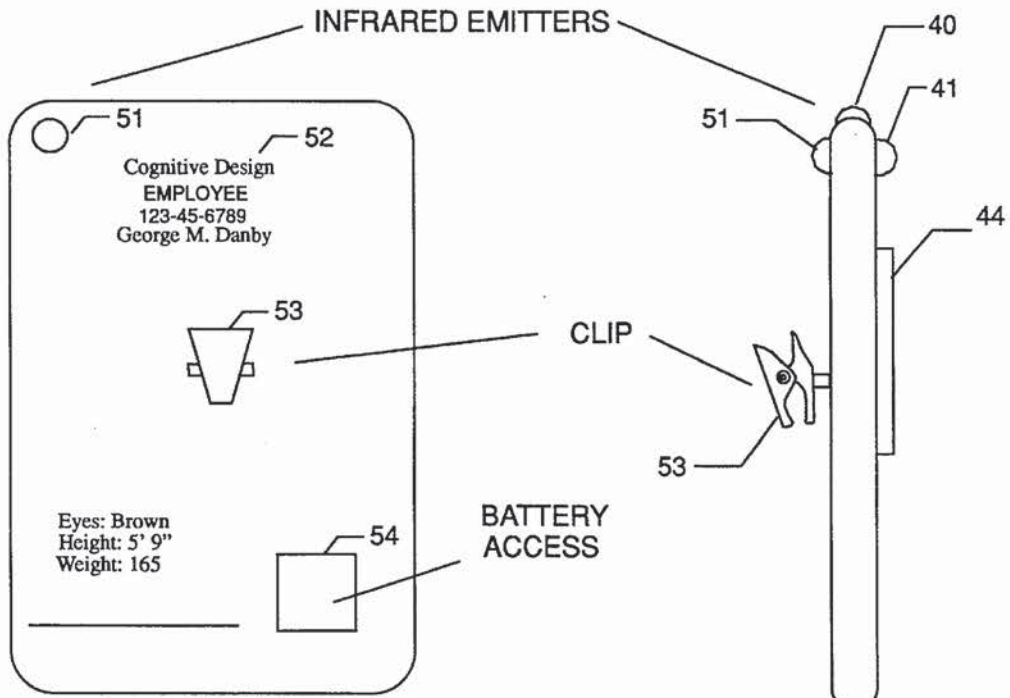
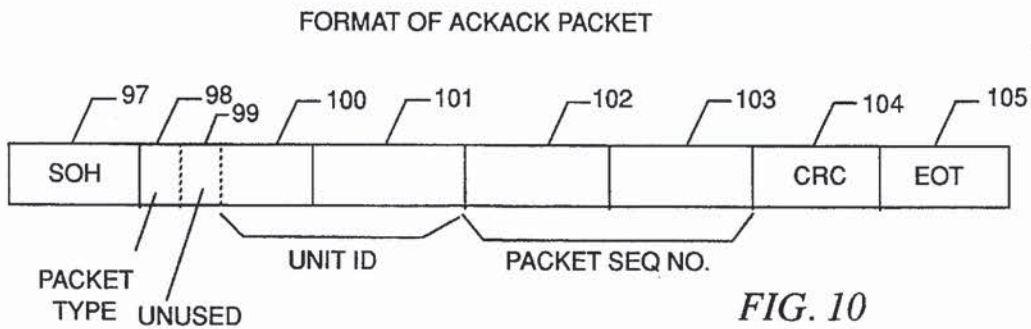
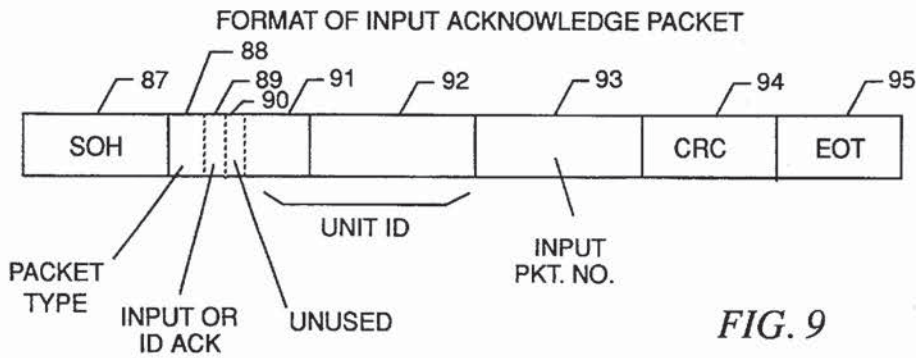
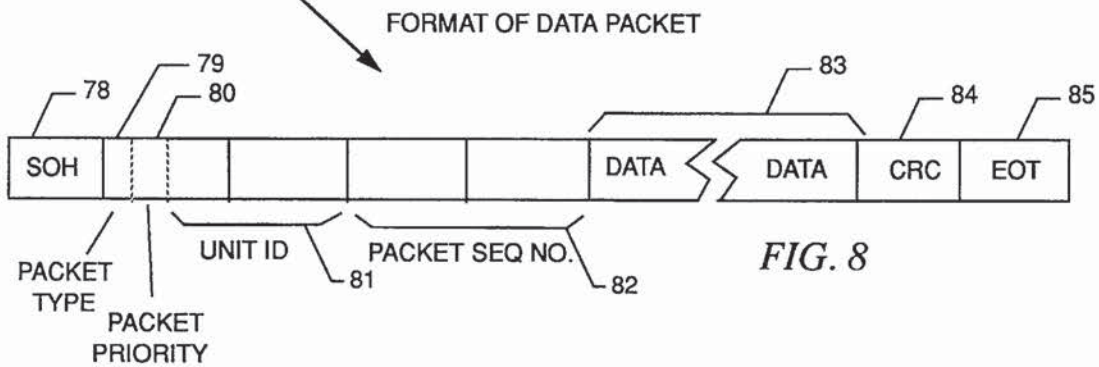
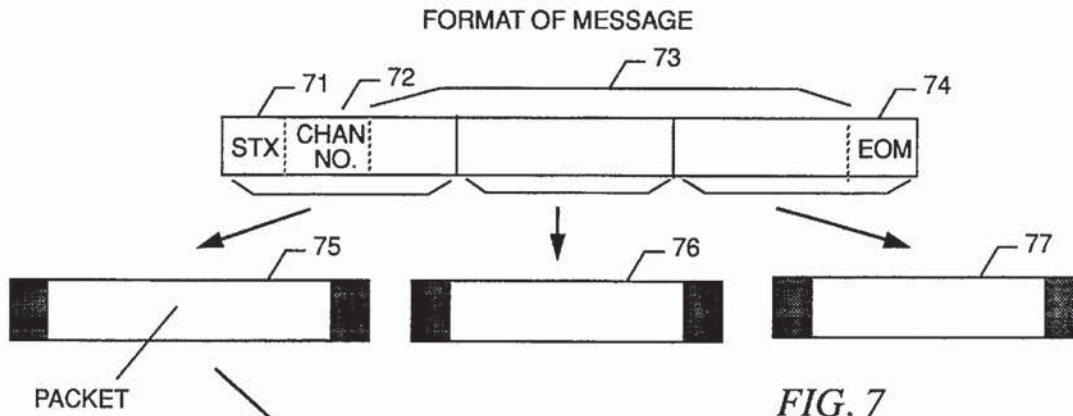
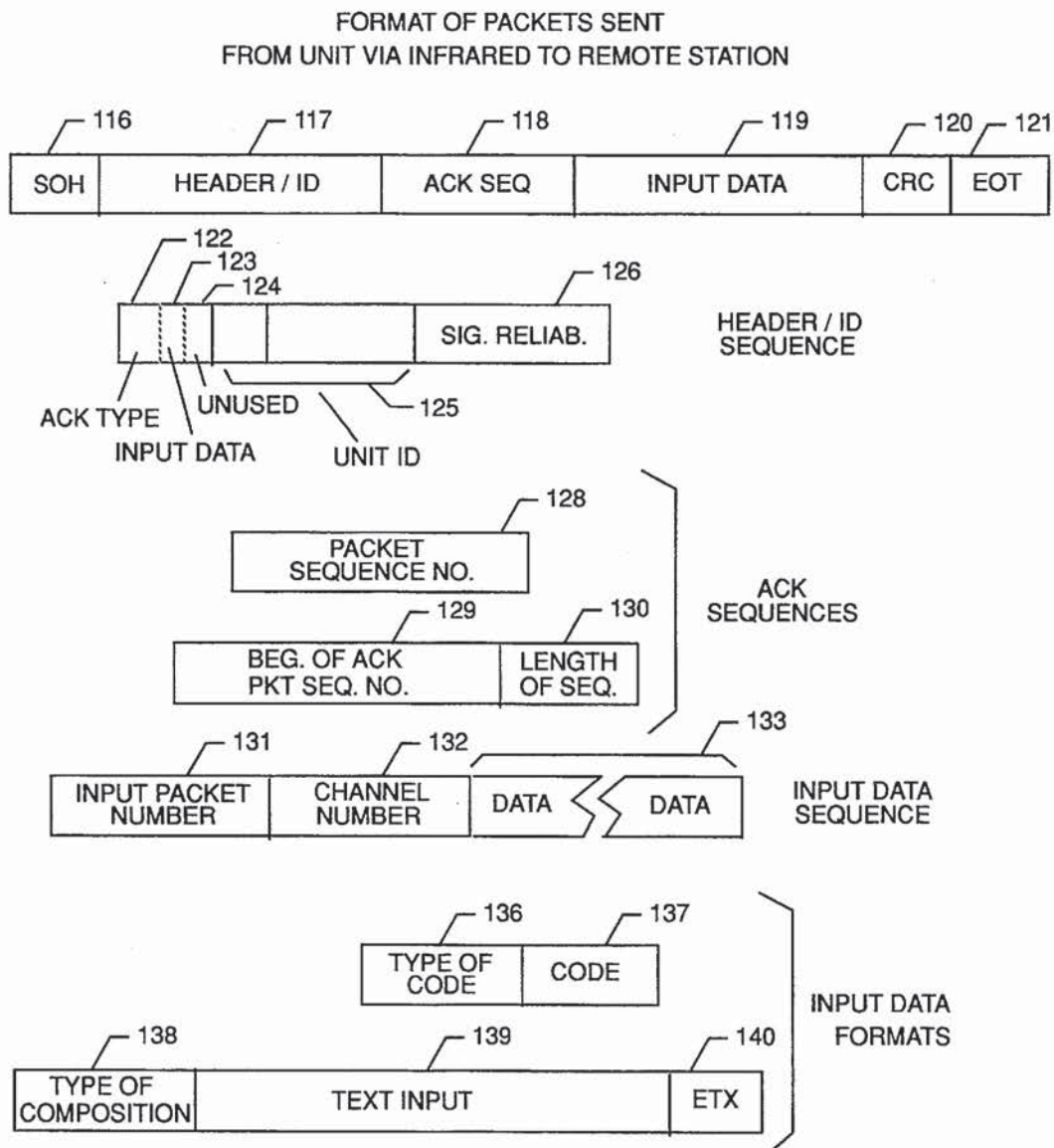
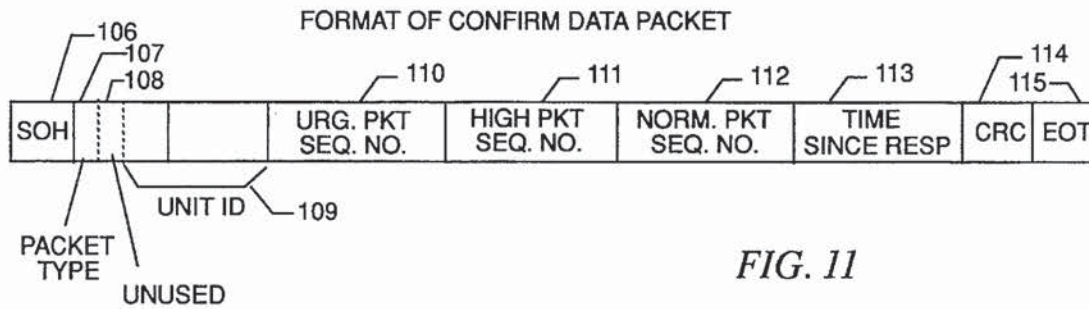

FIG. 5

FIG. 6





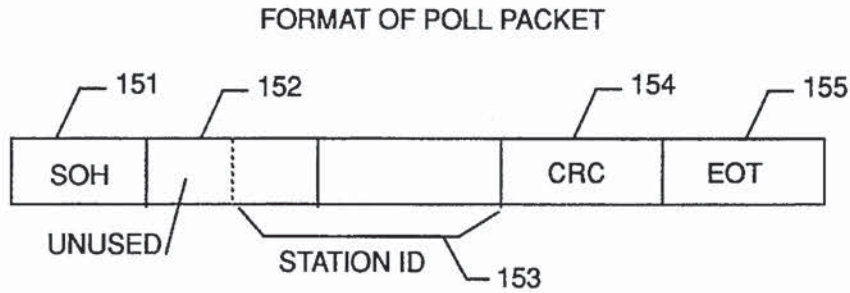

FIG. 13

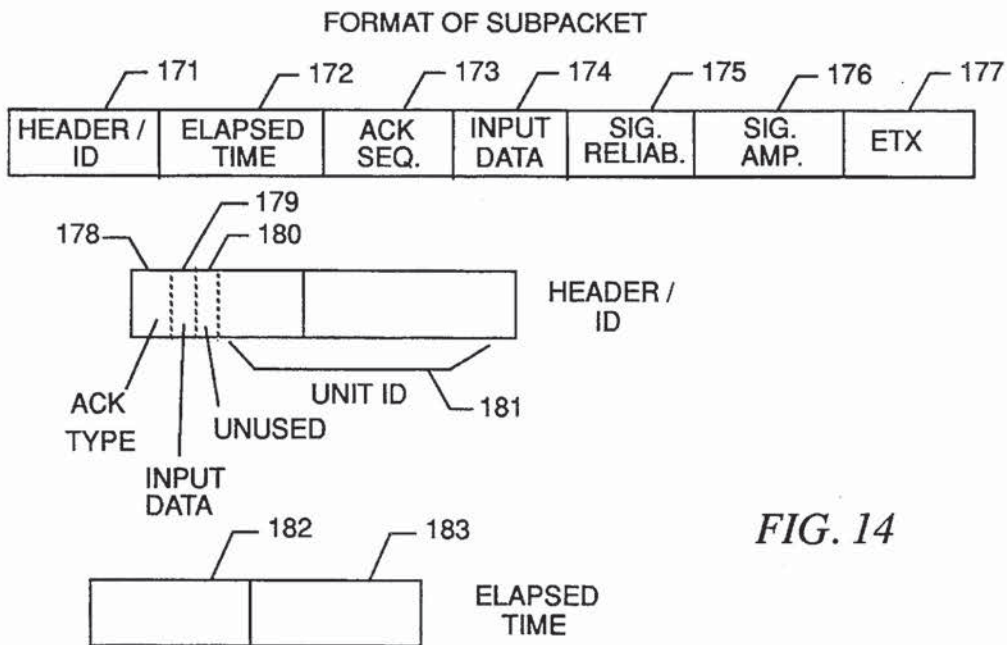
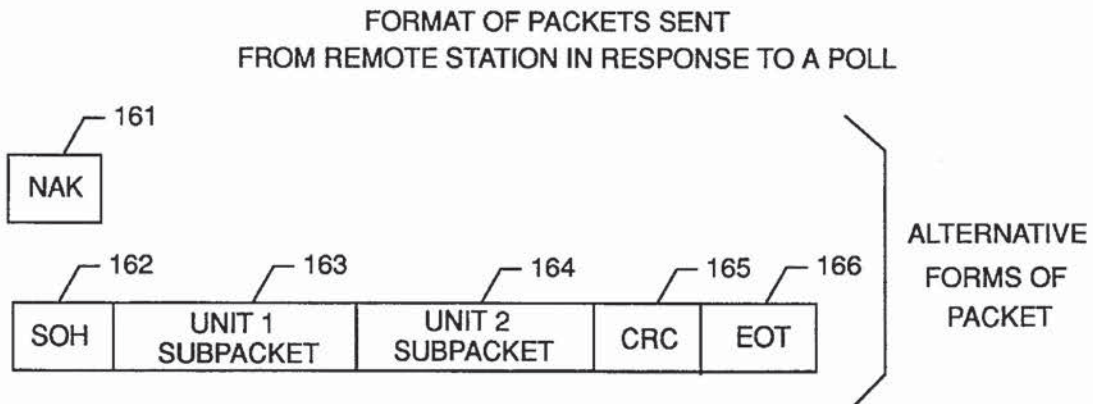

FIG. 14

FORMAT OF MESSAGE WITH RESPONSES

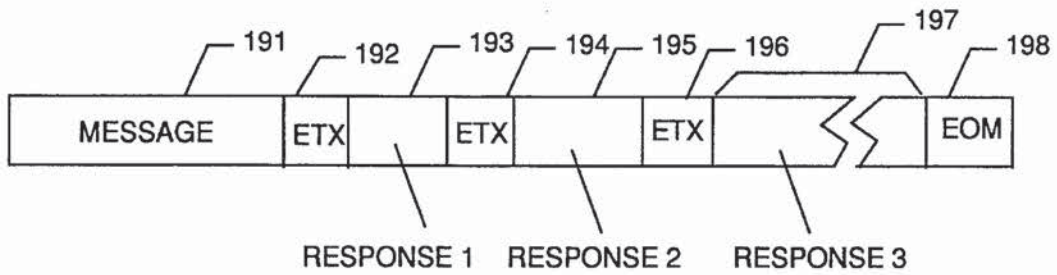

FIG. 15

FORMAT OF MESSAGE DEFINING PREPROGRAMMED
RESPONSES, MESSAGES, AND EMAIL ADDRESSES

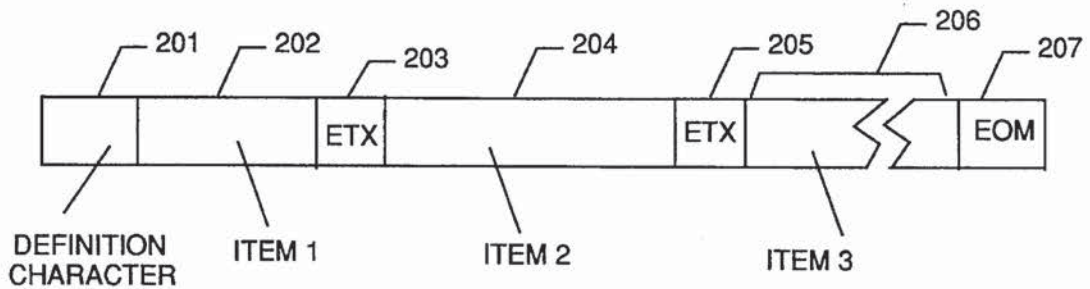

FIG. 16

SOFTWARE ARCHITECTURE FOR CENTRAL STATION

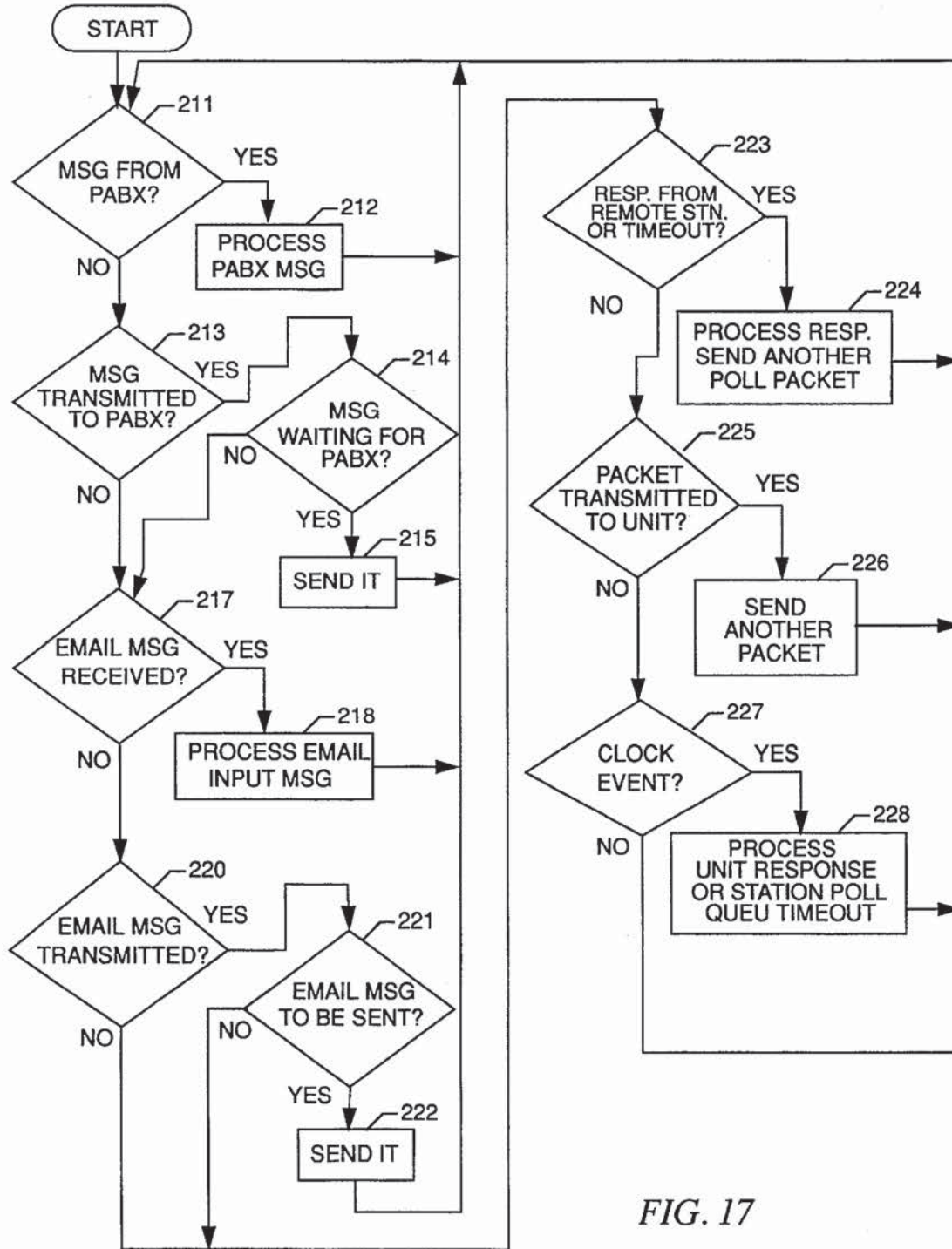

FIG. 17

MODULE TO PROCESS RECEIVED EMAIL MESSAGE

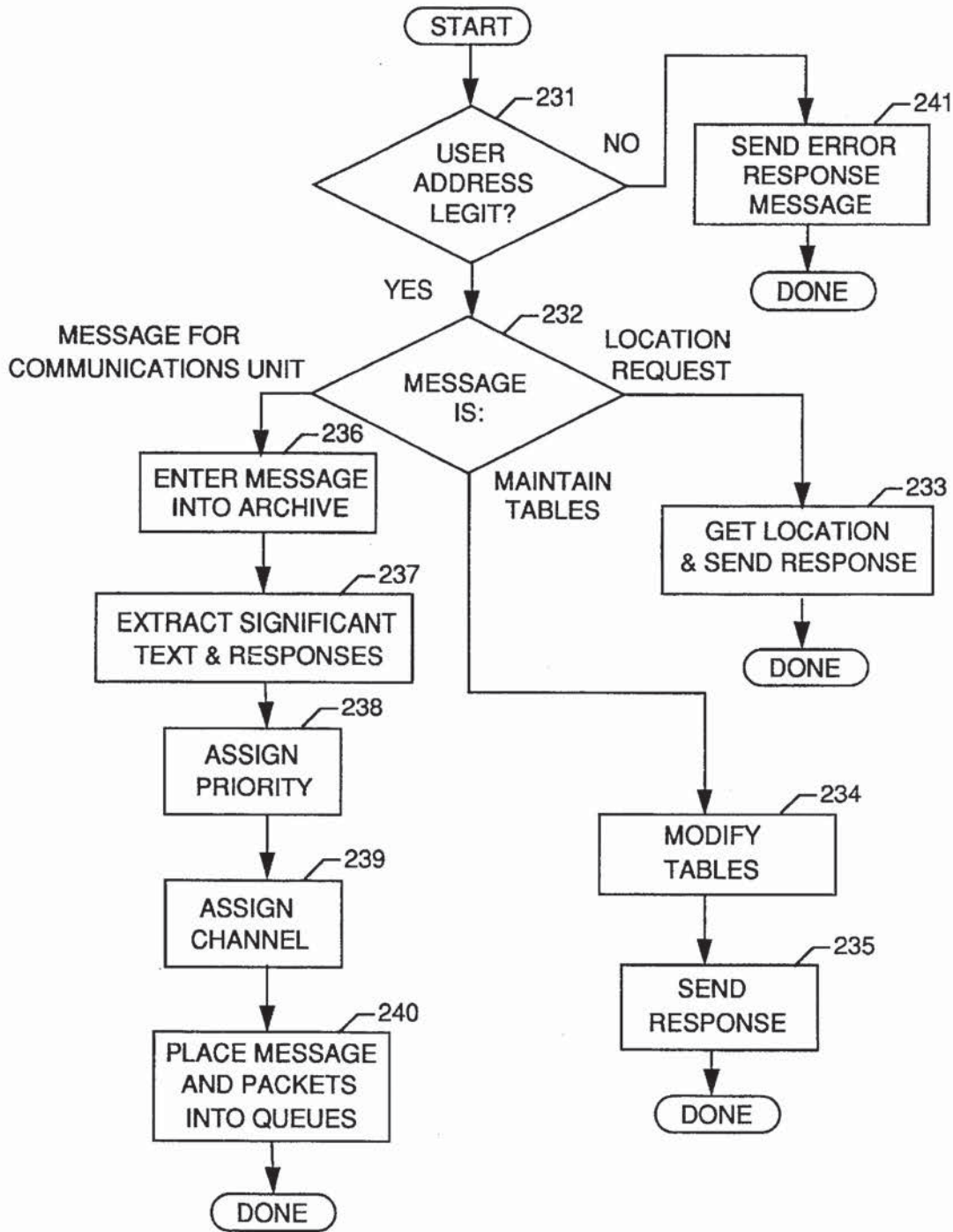

FIG. 18

MODULE TO PROCESS RESPONSE RECEIVED FROM STATION

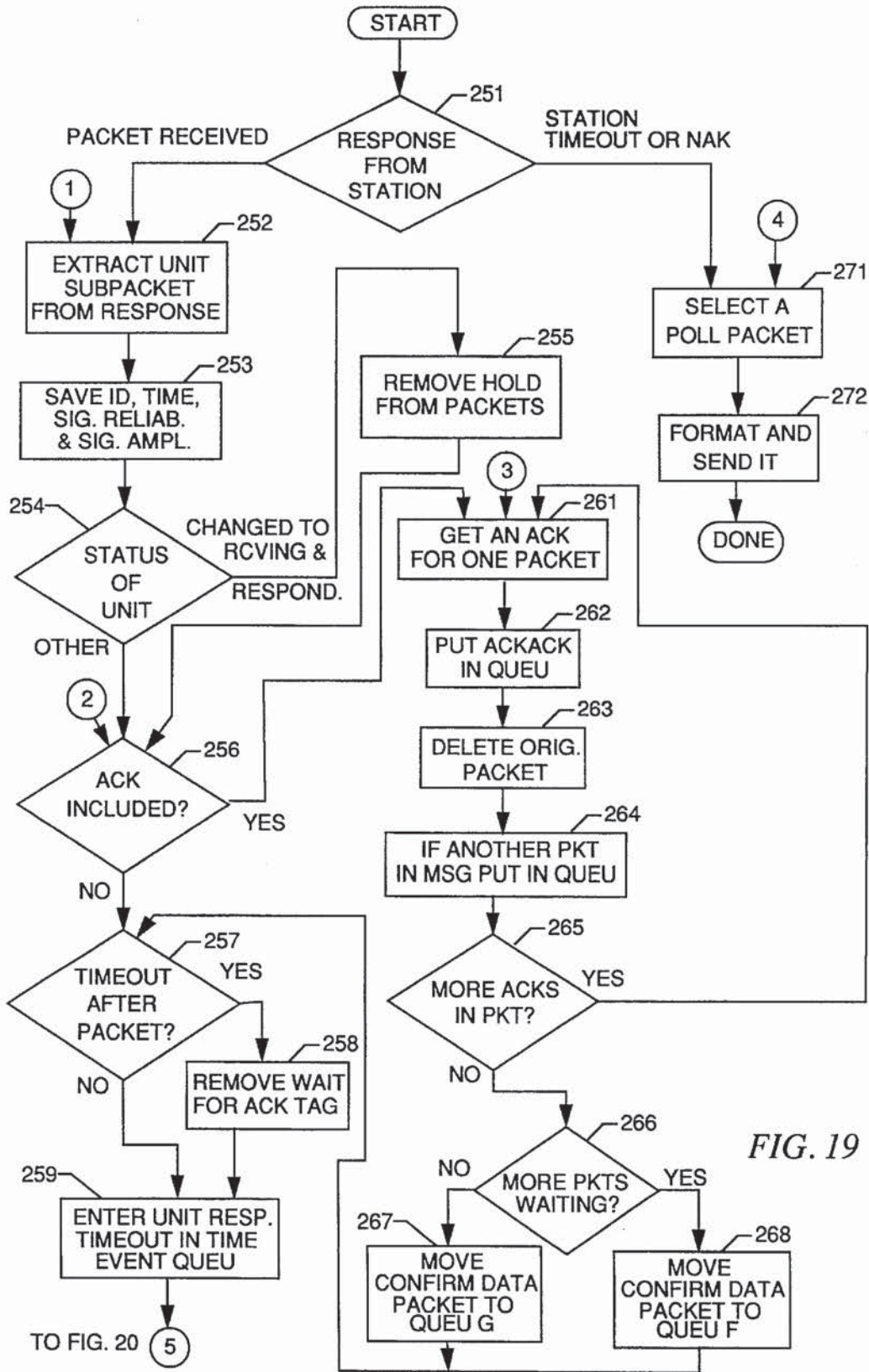

FIG. 19

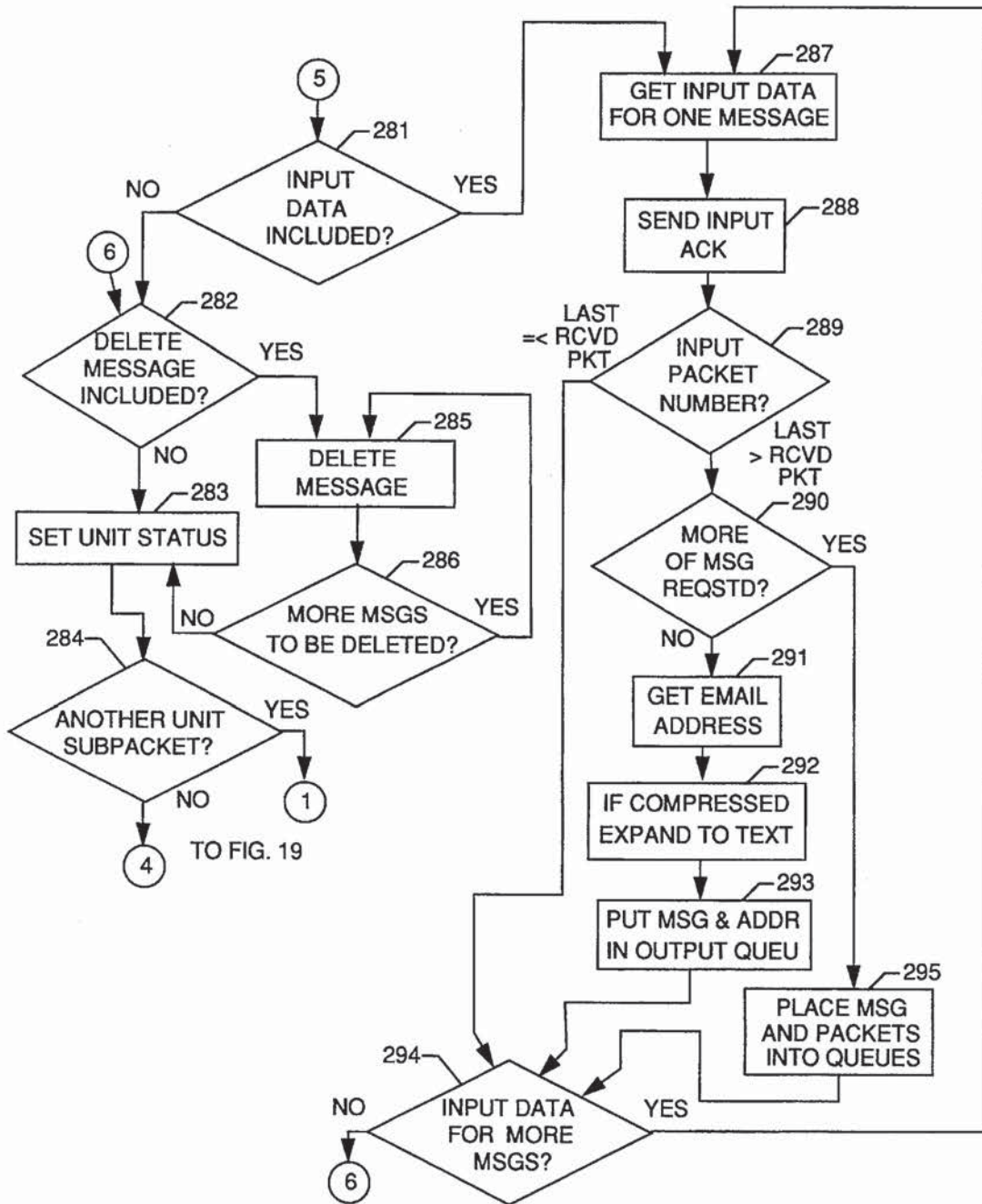

FIG. 20

MODULE INITIATED UPON COMPLETION
OF RADIO PACKET TRANSMISSION

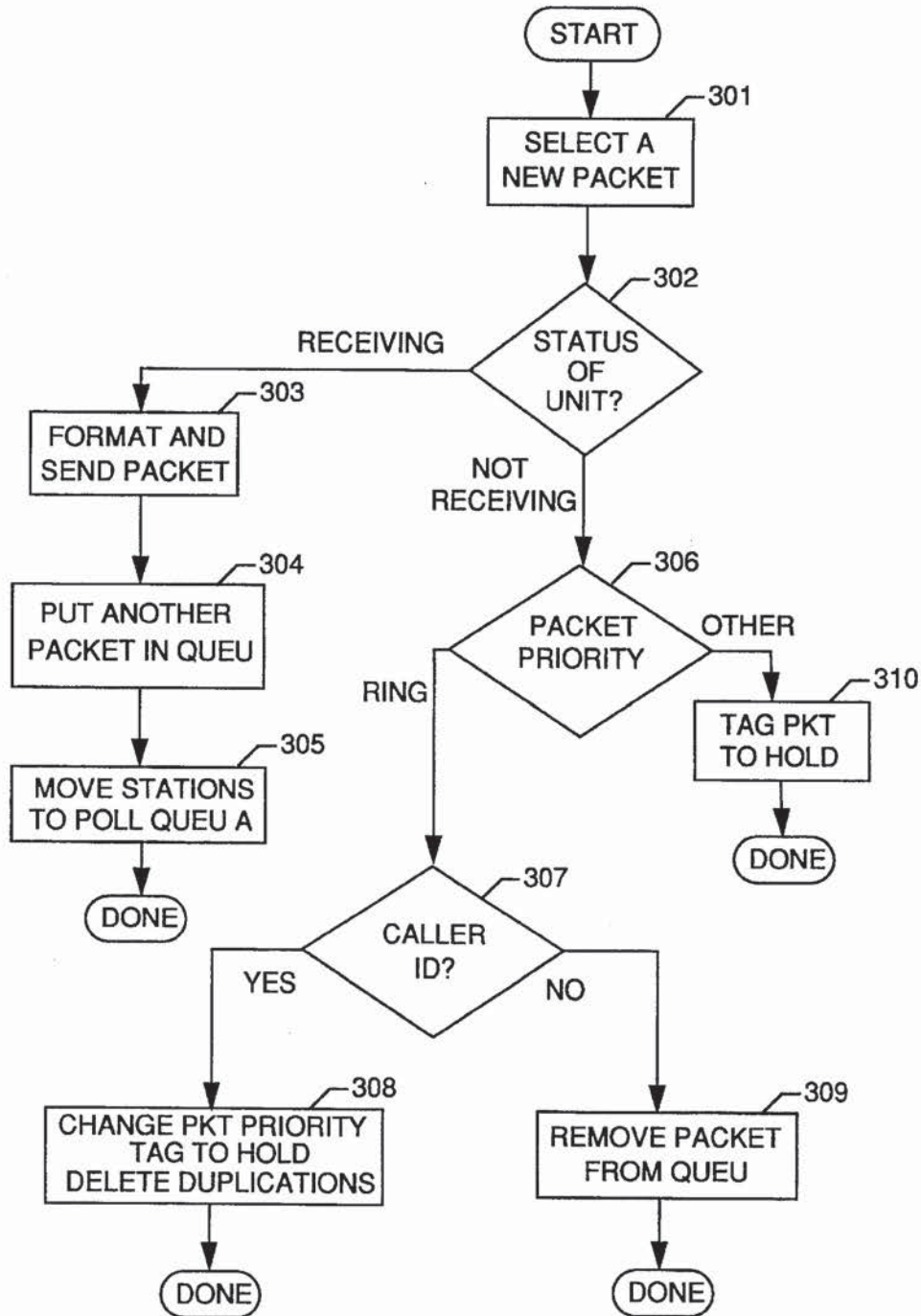

FIG. 21

CENTRAL STATION
CLOCK INTERRUPT MODULE

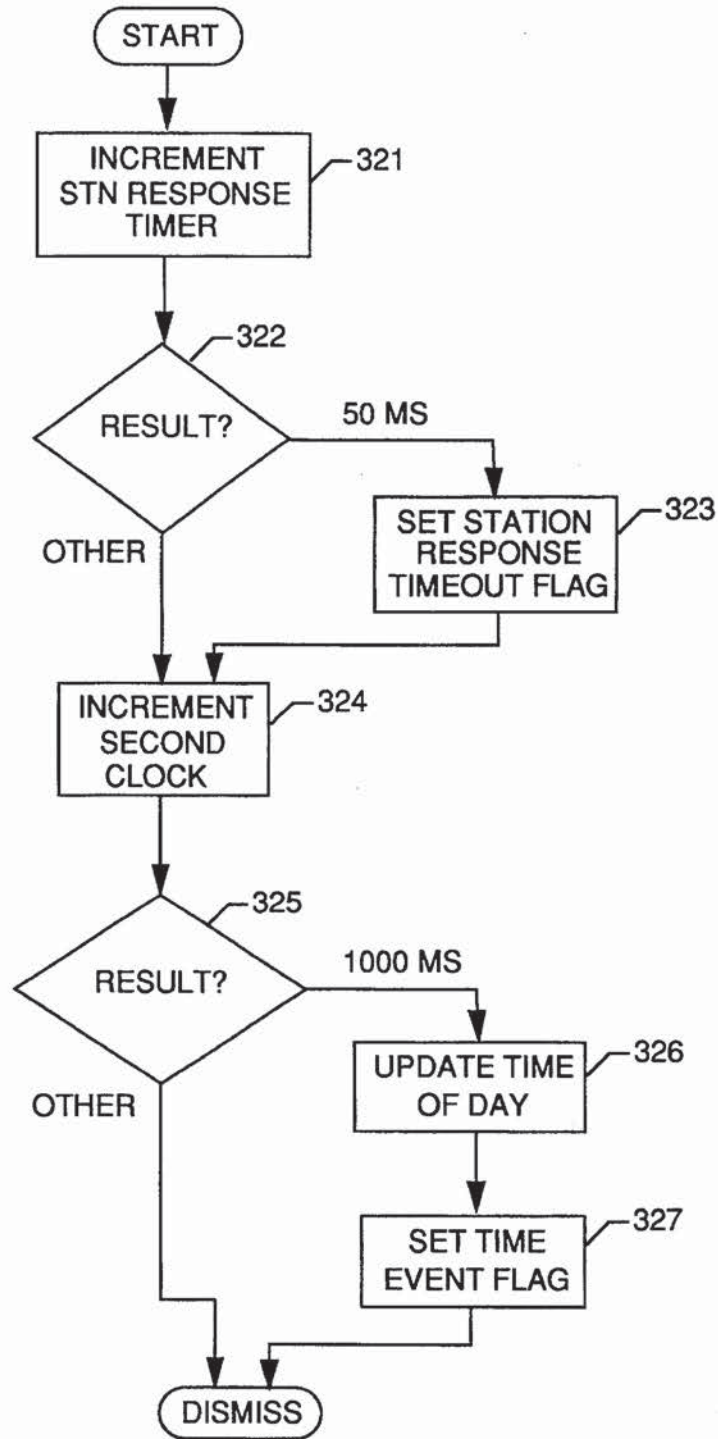

FIG. 22

CENTRAL STATION DATA STRUCTURES

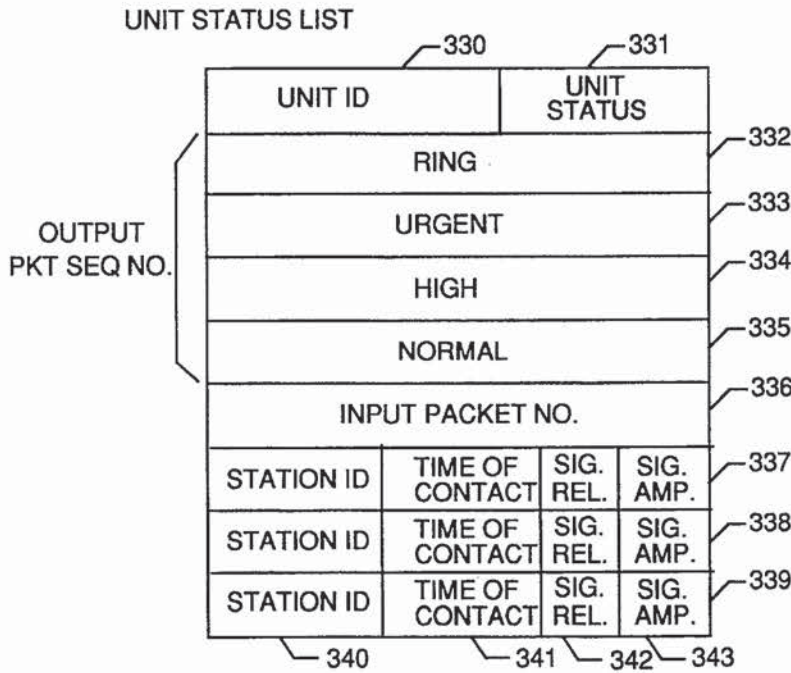

FIG. 23

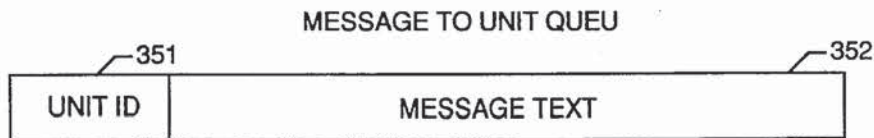

FIG. 24

PACKET TO UNIT QUEUES (A TO G)

	361	362	363	364	365	366
QUEU A	UNIT ID	HOLD BIT	WAIT FOR ACK BIT	NO. OF TR ATTMPTD	POINTER TO TEXT	SEQ NO. IF SENT
QUEU B	UNIT ID	HOLD BIT	WAIT FOR ACK BIT	NO. OF TR ATTMPTD	POINTER TO TEXT	SEQ NO. IF SENT
QUEU C	UNIT ID	HOLD BIT	WAIT FOR ACK BIT	NO. OF TR ATTMPTD	POINTER TO TEXT	SEQ NO. IF SENT
QUEU D	UNIT ID	HOLD BIT	WAIT FOR ACK BIT	NO. OF TR ATTMPTD	POINTER TO TEXT	SEQ NO. IF SENT
QUEU E	UNIT ID	HOLD BIT	WAIT FOR ACK BIT	NO. OF TR ATTMPTD	POINTER TO TEXT	SEQ NO. IF SENT
QUEU F	UNIT ID	HOLD BIT	WAIT FOR ACK BIT	NO. OF TR ATTMPTD	POINTER TO TEXT	SEQ NO. IF SENT
QUEU G	UNIT ID	HOLD BIT	WAIT FOR ACK BIT	NO. OF TR ATTMPTD	POINTER TO TEXT	SEQ NO. IF SENT

FIG. 25

CENTRAL STATION DATA STRUCTURES
(CONTINUED)

POLL QUEUES (A to C)

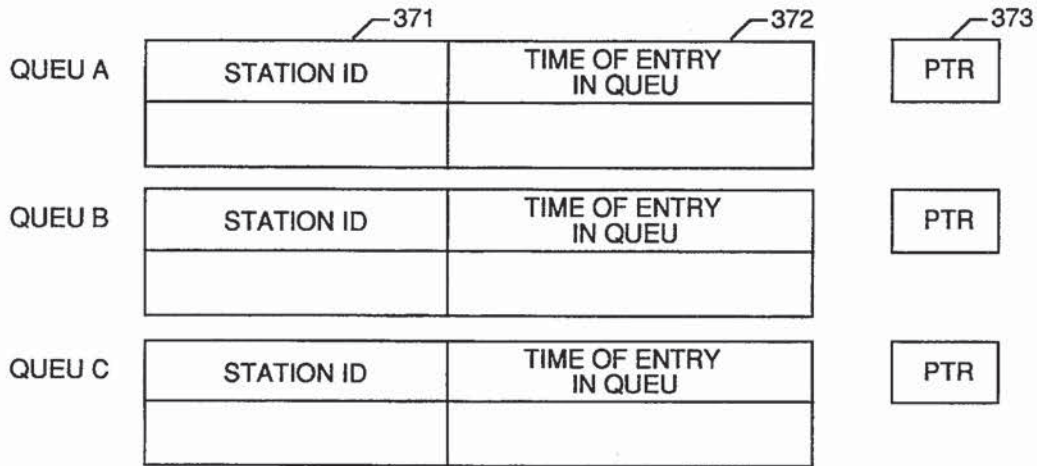
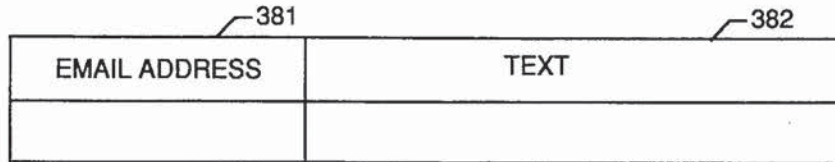
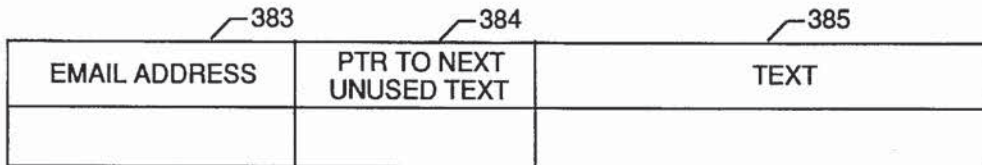

FIG. 26

EMAIL INCOMING MESSAGE QUEUE



EMAIL INCOMING MESSAGE ARCHIVE



EMAIL OUTGOING MESSAGE QUEUE

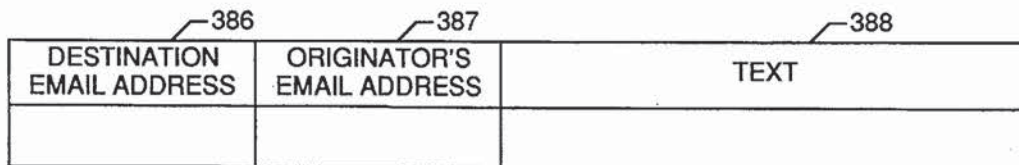

FIG. 27

CENTRAL STATION DATA STRUCTURES
(CONTINUED)

EMAIL ADDRESS TO UNIT ID MAP

401	402
EMAIL ADDRESS	UNIT ID

UNIT ID TO EMAIL ADDRESS MAP

403	404
UNIT ID	EMAIL ADDRESS

CHANNEL TO EMAIL ADDRESS MAP

405	406	407	408
CHANNEL	ASSIGNED BIT	EMAIL ADDRESS	PTR TO INCOMING EMAIL MESSAGE ARCHIVE

FIG. 28

INPUT DATA FROM UNIT QUEUE

409	410	411	412
UNIT ID	CHAN. NO.	INPUT PKT NO.	TEXT

FIG. 29

CENTRAL STATION DATA STRUCTURES
(CONTINUED)

PREPROGRAMMED RESPONSE LIST

CODE	RESPONSE

PREPROGRAMMED MESSAGE LIST

CODE	MESSAGE

PREPROGRAMMED EMAIL ADDRESS LIST

CODE	

FIG. 30

TIME EVENT QUEU

TIME OF FUTURE EVENT	TYPE	QUEU	UNIT/ STATION ID

FIG. 31

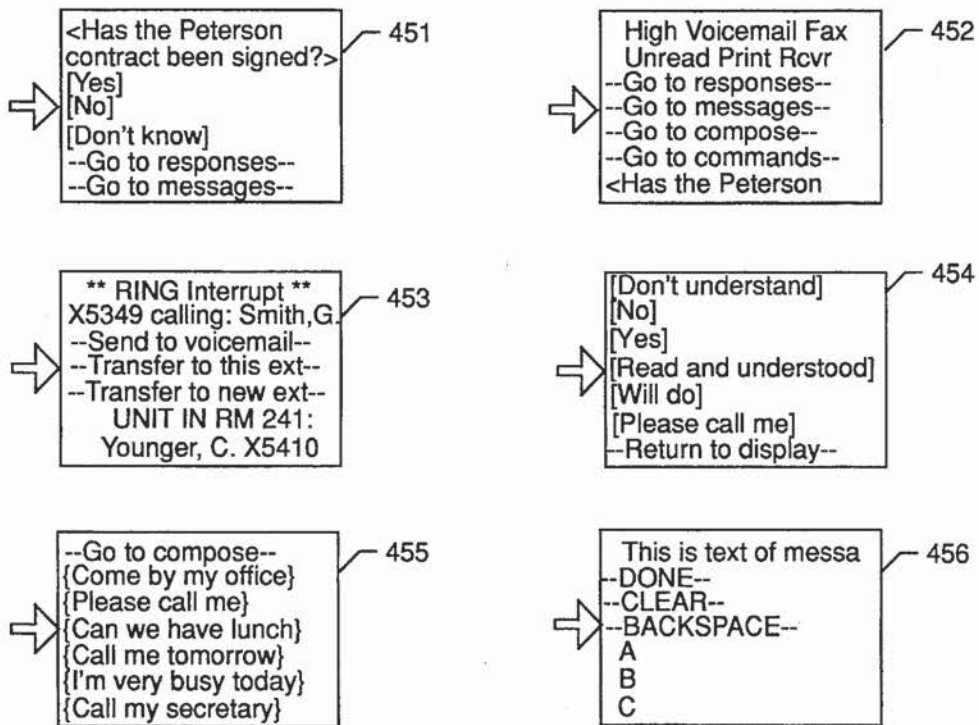
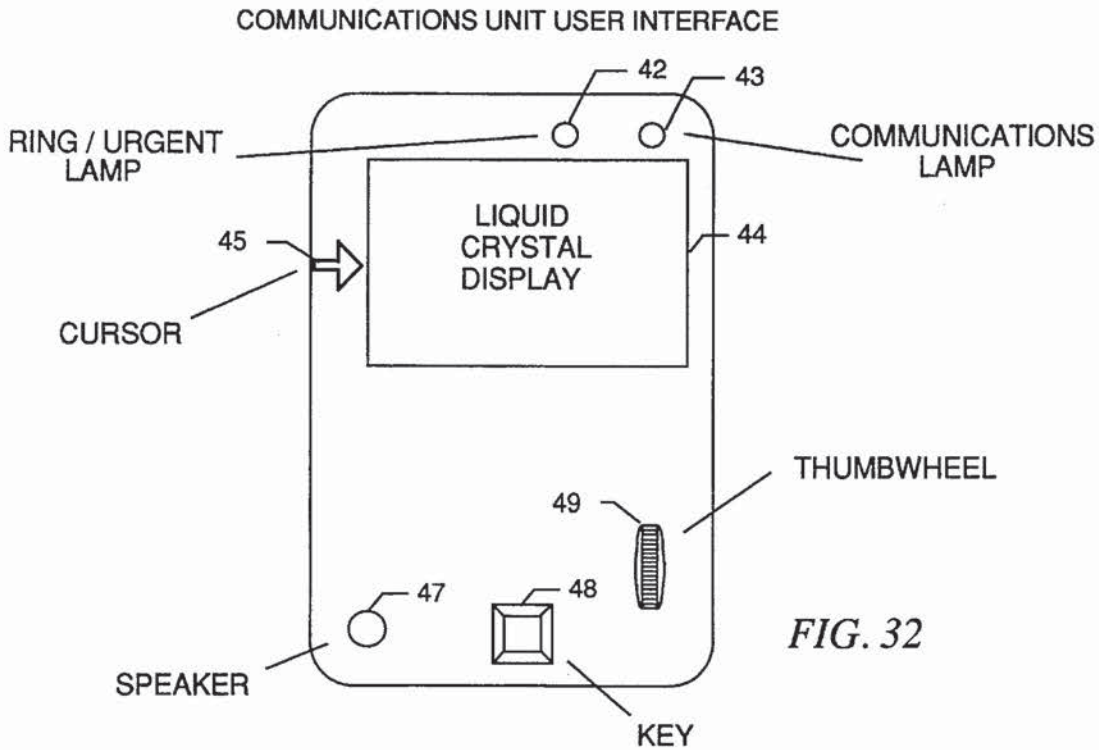

FIG. 33

SOFTWARE ARCHITECTURE
FOR COMMUNICATIONS UNIT

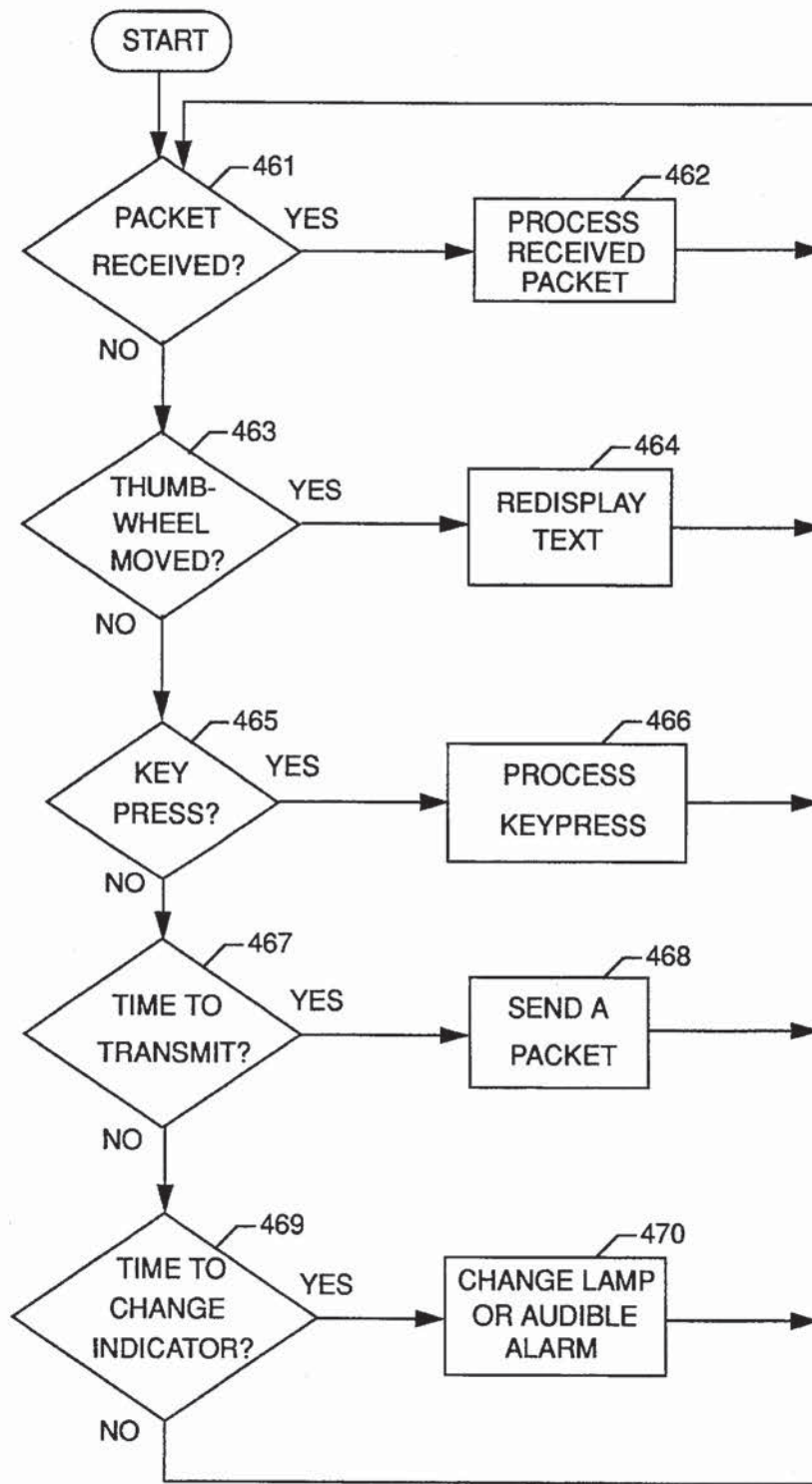

FIG. 34

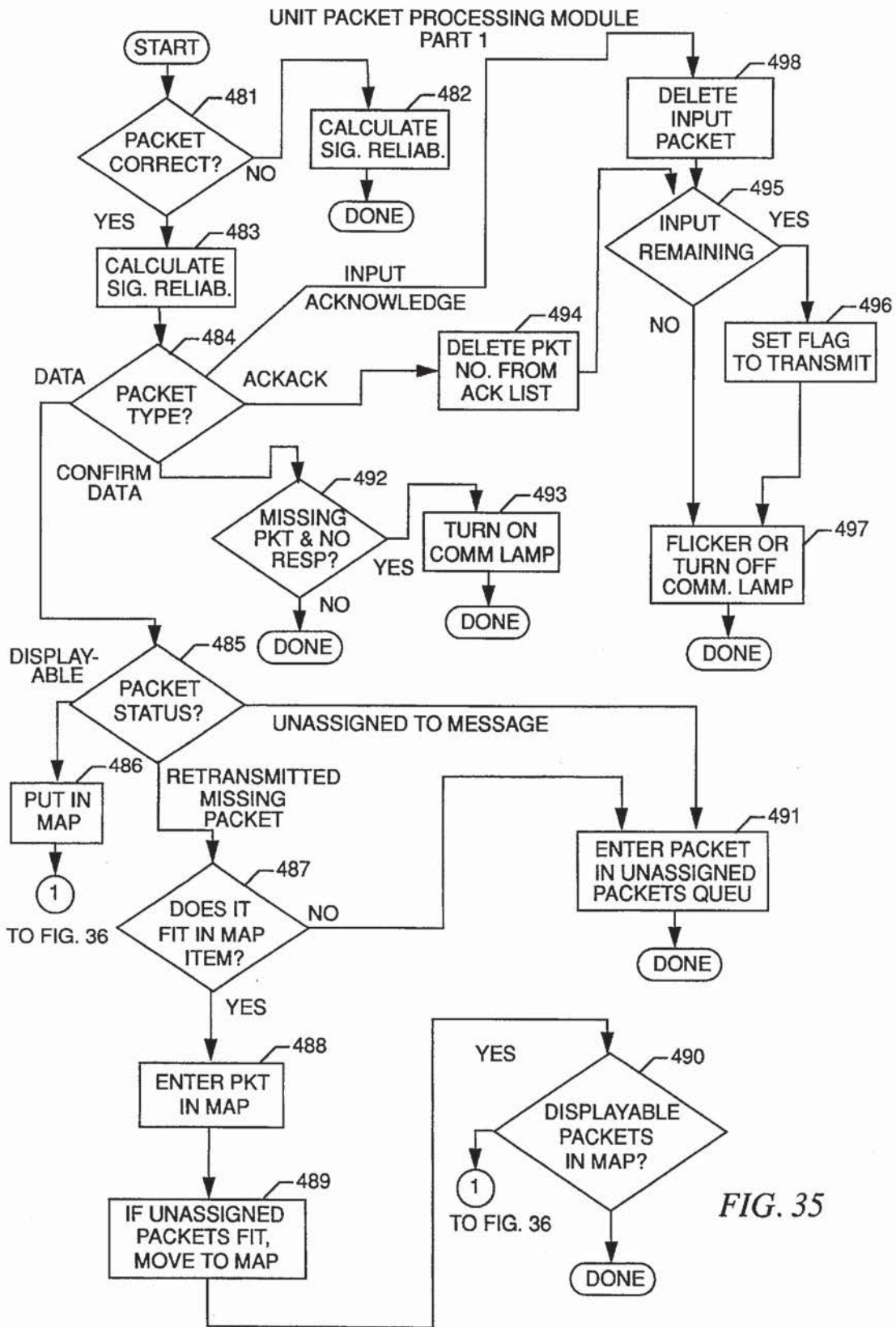

FIG. 35

UNIT PACKET PROCESSING MODULE
PART 2

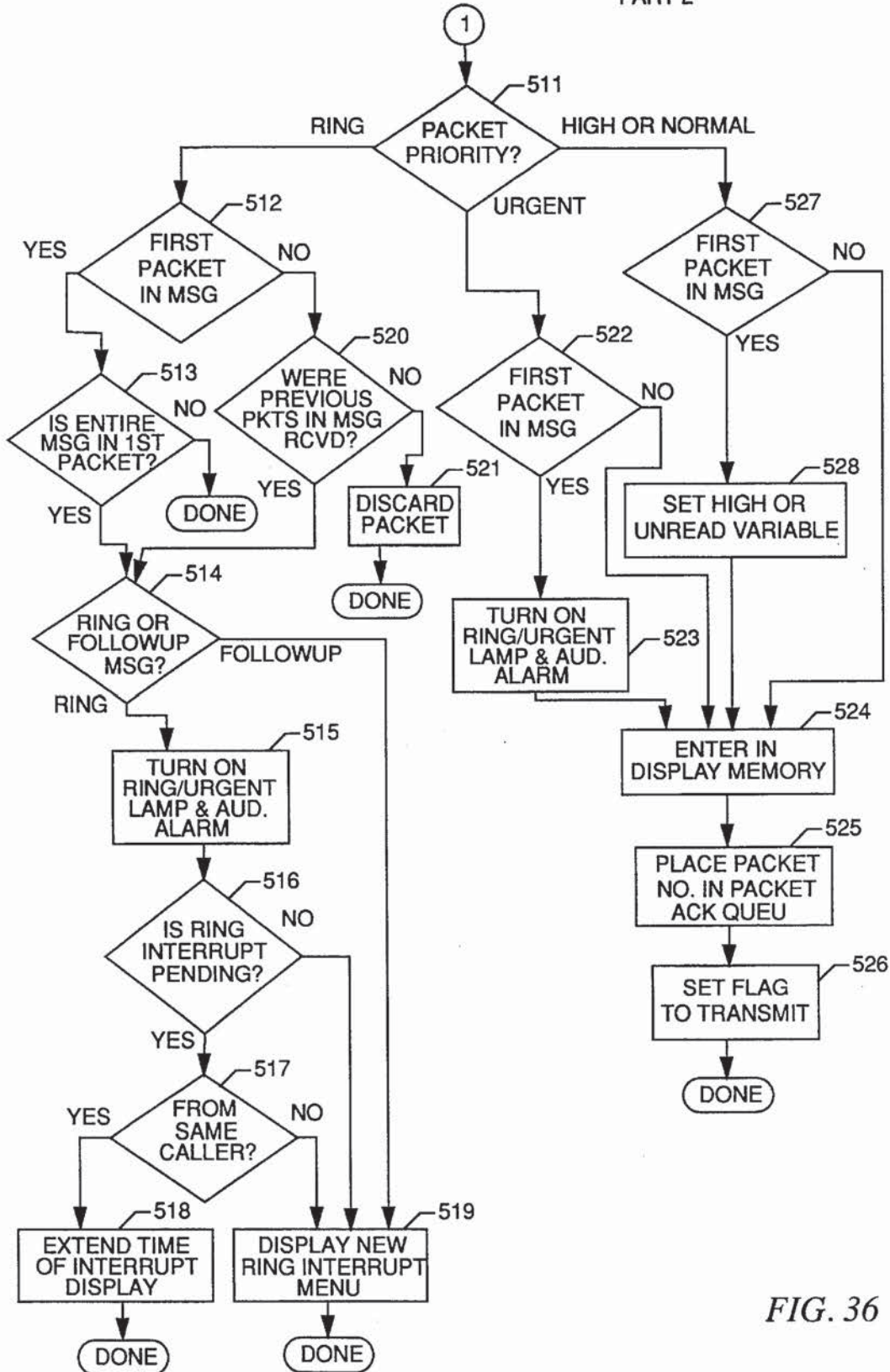

FIG. 36

CLOCK INTERRUPT SOFTWARE
FOR COMMUNICATIONS UNIT
PART 1

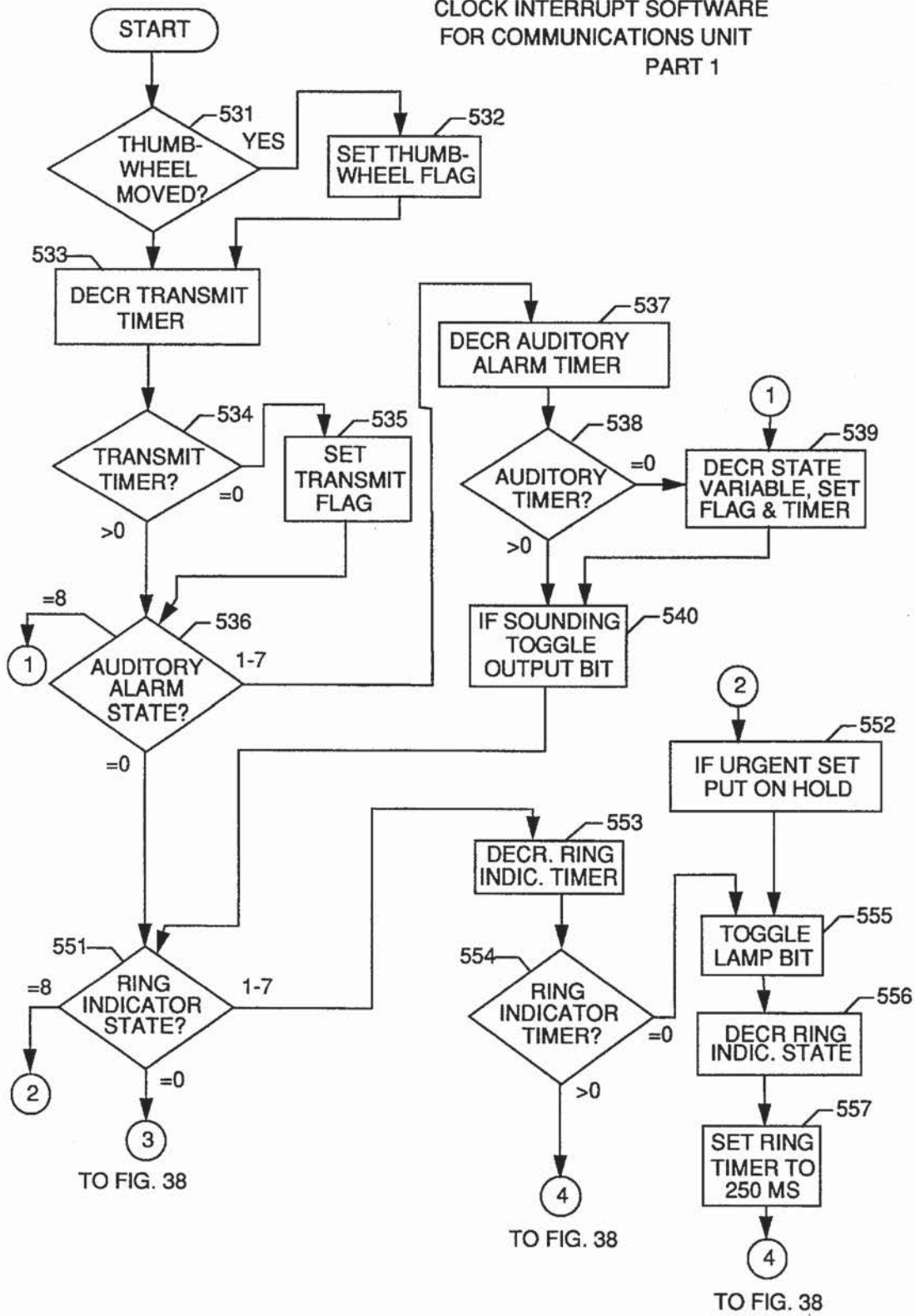

FIG. 37

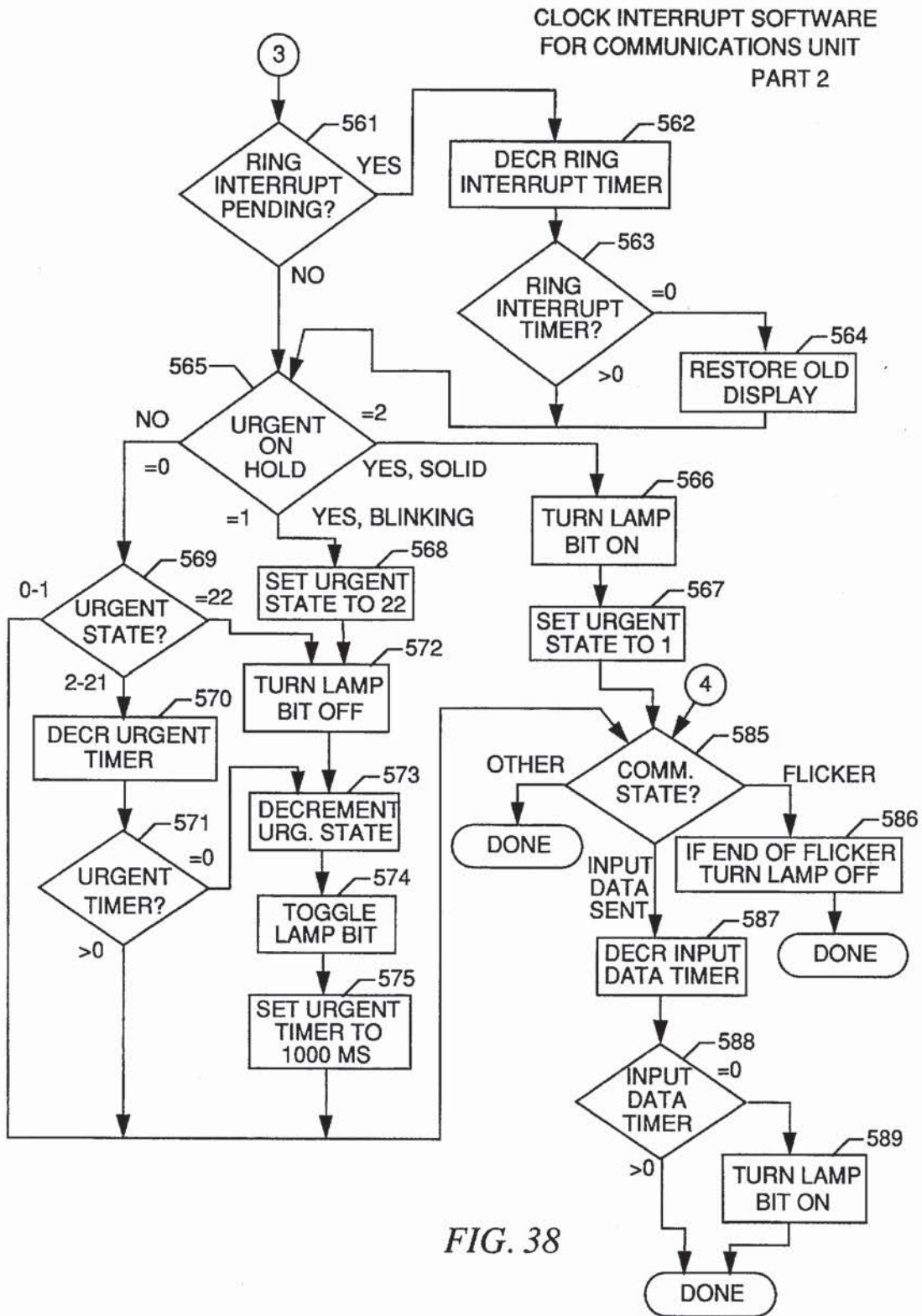

FIG. 38

COMMUNICATIONS UNIT DATA STRUCTURES
INCOMPLETE MESSAGE PACKET MAP

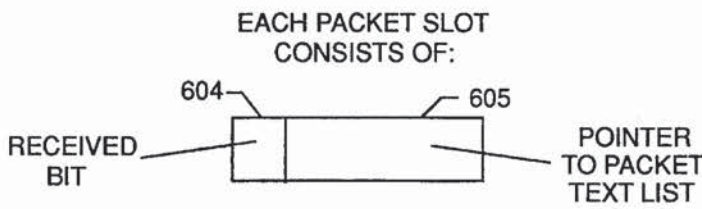
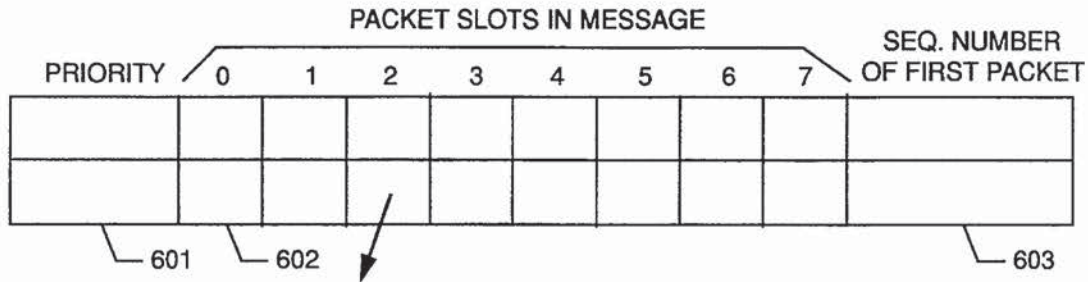

FIG. 39

PACKETS UNASSIGNED TO MESSAGES LIST

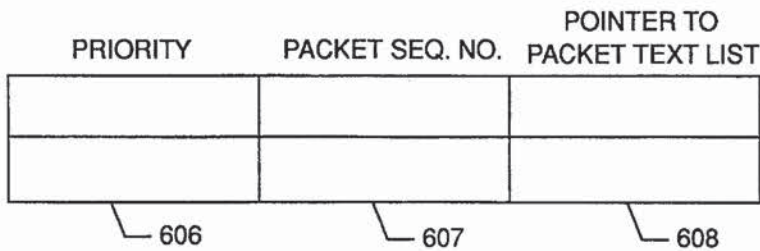

FIG. 40

PACKET TEXT LIST

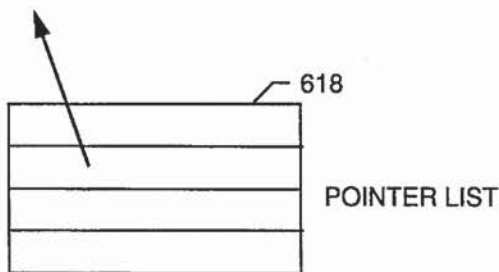
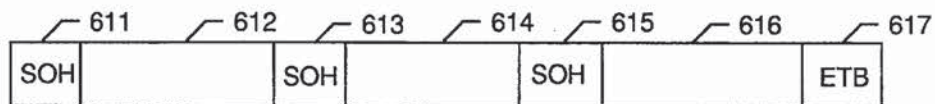

FIG. 41

COMMUNICATIONS UNIT DATA STRUCTURES (CONTINUED)

DISPLAY MEMORY STRUCTURES

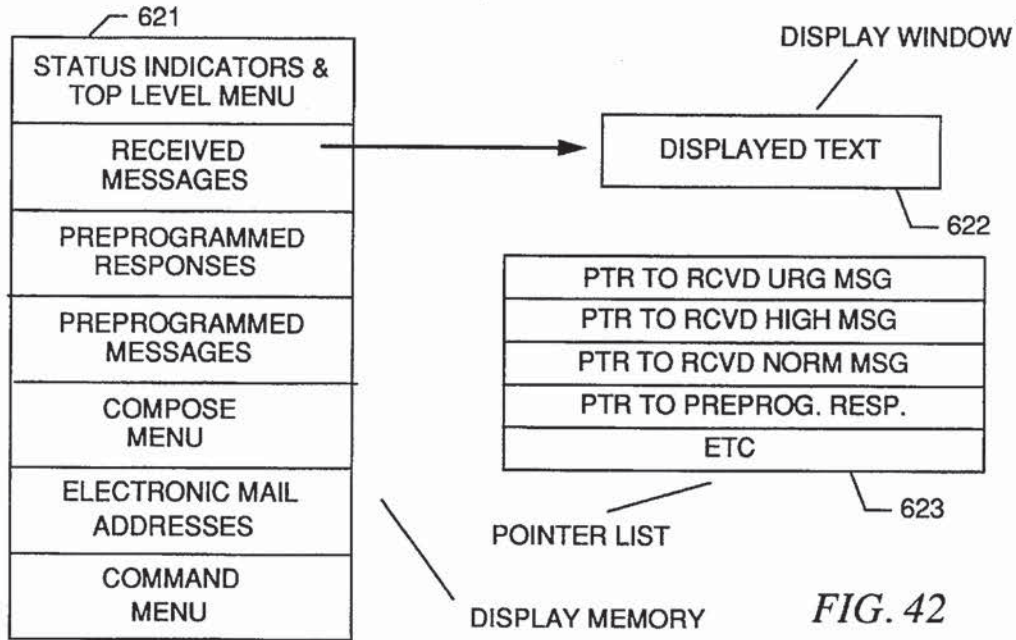
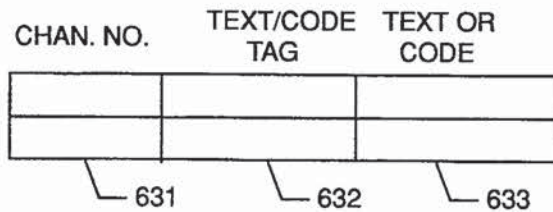
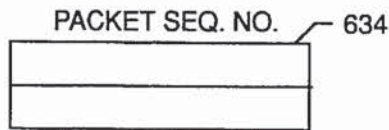

FIG. 42

INPUT DATA QUEUE



PACKET ACKNOWLEDGEMENT QUEUE



UNIT TRANSMISSION BUFFER

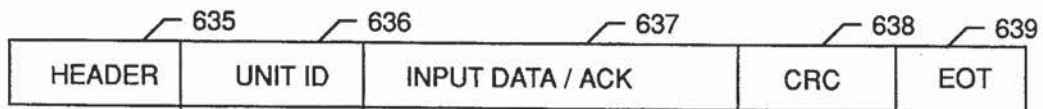

FIG. 43

REMOTE STATION SOFTWARE

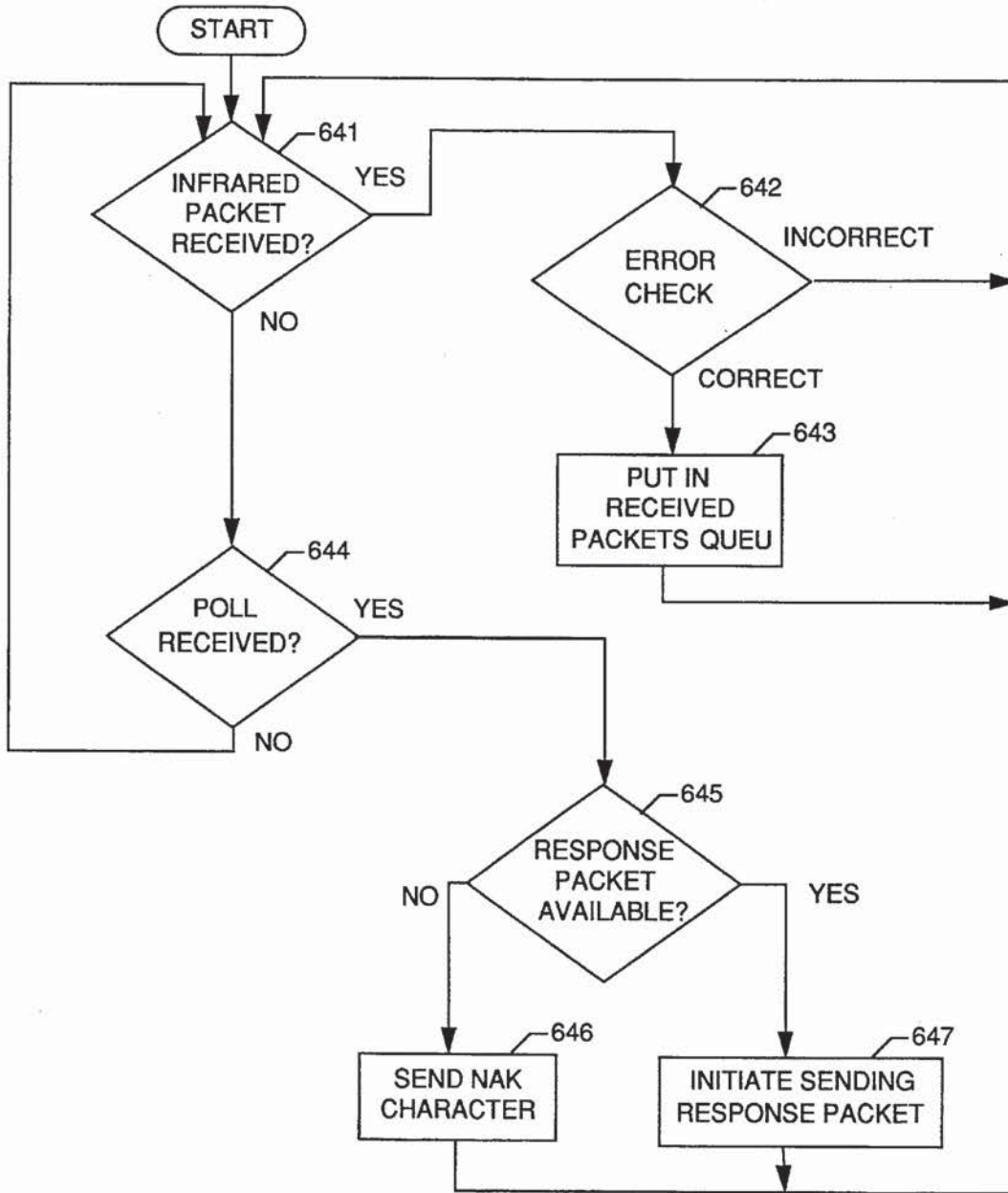

FIG. 44

PERSONAL PAGING, COMMUNICATIONS, AND LOCATING SYSTEM

CROSS-REFERENCE TO RELATED APPLICATIONS

This application relates to a copending application submitted by Craig A. Will entitled "Control of Miniature Personal Digital Assistant Using Menu and Thumbwheel," Ser. No. 08/423,690, filed Apr. 18, 1995. The application also relates to a copending application submitted by Craig A. Will entitled "Wireless Personal Paging, Communications, and Locating System", Ser. No. 08/200,065, filed Feb. 22, 1994, now U.S. Pat. No. 5,479,408, issued Dec. 26, 1995.

FIELD OF THE INVENTION

This invention relates generally to electronic communication systems for sending signals selectively to portable receivers that provide an indication or alarm to specific individuals that is humanly perceptible, and further to systems that indicate the location of individuals. It relates to the transmission of message data encoded as digital pulses modulating a radio wave to portable receivers, and also relates to the transmission of message data, identification, and location information using digital pulses optically, particularly by infrared light, and acoustically, particularly by ultrasound. The invention further relates to the indication of incoming calls from a telephone PBX system and the forwarding and transfer of such calls.

More specifically, the invention relates to a system for communicating with individuals in a building using digitally encoded radio in one direction and either infrared light or ultrasound in the other, with users receiving paging indications and messages and being able to acknowledge and respond to messages and to originate messages, with the system also tracking the location of and providing communications to allow users to transfer incoming telephone calls remotely.

BACKGROUND OF THE INVENTION

A frequent difficulty in an office or similar environment is communicating with a particular individual when they are not in their office but still in the building. This results not only in "telephone tag" where people continue back-and-forth attempts to return telephone calls, but also in its physical analog where one person visits the office of another, only to find that person to be gone.

One solution to this problem has been the increasingly widespread use of paging receivers, and such devices have become more and more miniaturized. Devices have been constructed, for example, that are the size of a credit card or that are included as part of a watch. Such systems, however, are typically one-way, transmitting only a telephone number, perhaps an additional short numeric code, or possibly a brief alphanumeric message, and are designed for use outside a building.

Within a building, there have been two general directions that system designs have taken. One is the use of radio paging systems within a building, which may be configured to allow receipt of electronic mail messages or to allow users to be notified that they have a call that they can then ask to be transferred to a nearby extension. For example, the Hagl invention (U.S. Pat. No. 5,151,930) transmits the fact of the incoming call and the telephone extension of the calling

party by radio to a paging receiver, which indicates to the user that the call has come in and displays the number. The user then locates a telephone instrument and dials a code identifying the user, resulting in the incoming call being transferred to that instrument.

The other direction is the use of automatic personal locating systems that determine where in a building an individual is, and that can automatically route a telephone call to the nearest extension. For example, the Ward invention (U.S. Pat. No. 3,439,320) describes a system that uses ultrasonic sound (using a different frequency for each person) to track the location of individuals in a building so that telephone calls may be routed to them. A number of variations exist using different media. Thus, the Shipley inventions (U.S. Pat. Nos. 4,601,064 and 5,062,151) track the location of individuals that carry devices that repeatedly transmit a digital identifying code via infrared light that is then received by remote sensors installed in individual rooms of a building, with a central computer that polls the remote sensors and determines the location of an individual. Telephone calls can then, if desired, be automatically forwarded to the individual by the PABX system. The individual can, using a switch on the identification device, turn off the forwarding action at a given time if it would be inconvenient.

These approaches have a number of drawbacks. One-way radio paging signals can fail to deliver a messages if the user is in an especially noisy environment, is in a "dead spot" resulting from metal shielding or other interference, or goes outside the range of the transmitter. While these difficulties can be prevented by repeating all transmissions multiple times, this approach does not make efficient use of bandwidth and can also result in considerable delay in receipt of a paging signal or message. One-way communication also does not allow an originator to know whether a message has in fact been received by a user and read, or allow the user to respond. One-way systems that indicate to a user only that a call has come in require the user to find a telephone and dial sufficient digits to cause the call to be transferred, and typically require the caller to be placed on hold during this process, which may be annoying to the caller if the person being paged does not respond or takes a long time to do so.

Systems that automatically track the location of individuals and automatically transfer incoming telephone calls to that location tend to be intrusive, because they necessarily cause a transfer even in circumstances that might be inappropriate (such as transferring a call to an individual who is in an office of someone he or she does not know well or who is in a group meeting that might be disturbed).

The above difficulties are solved by the invention disclosed here (and related inventions) by its provision of both (1) two-way communication and (2) automatic tracking of the location of the individual. This combination allows responses to be sent which are chosen from a set provided with the original message, from a preprogrammed set, or composed by the user. Selection or composition of responses is made easy by use of a thumbwheel that allows display of messages and responses and their choice by pressing a single key (as is described in a copending application). The communication and tracking system also makes possible the transfer of incoming telephone calls remotely by means of selection from a menu.

The present invention provides both two-way communication and tracking by making use of a hybrid communication system with radio used for transmitting data to the user, and infrared light (or, in an alternative embodiment, ultra-

3

sonic sound) used for receiving data from the user. This hybrid system makes effective use of the strengths of each form of communication. Radio is used in one direction for broad coverage, ease of implementation, and relative reliability, while infrared light (or ultrasound) is used in the other direction (for acknowledgements, responses, original messages, and location tracking) because of its low power requirements, simplicity of design, small size of the necessary electronics, low cost, and its ability to determine the location of individuals (since infrared light and ultrasonic sound do not pass through walls). Radio is also desirable because its use could allow the design of a paging receiver that works both with conventional paging systems when outside the building and, in addition, with the system described here when inside the building, using the same components.

The use of this hybrid mix of communication media required the design of a communication protocol to fit the characteristics of the two media. The radio medium is characterized by good but not perfect reliability, and moderate to substantial capacity, depending upon availability of particular bands and whether the station is licensed or unlicensed. The system is particularly applicable for use in the recently allocated 1,900 Mhz band for personal communications services for unlicensed use in a building. The infrared medium has somewhat limited capacity in this context because of the need for data to be transmitted repeatedly and because of the need to minimize drain on the battery and to minimize conflict with other nearby communication units. Ultrasound has a naturally low capacity resulting from its susceptibility to interference from echoes as the signal bounces off walls, floor, and ceiling. Both infrared, and, to a lesser extent, ultrasound, have somewhat variable reliability as the user moves from one room to another and as the unit changes position and orientation in that environment. Infrared and ultrasound, are, of course, desirable because they do not easily penetrate walls and ceilings and thus allow reliable identification of the location of the unit.

One example of the requirements for the protocol is illustrated by the fact that unlike more conventional protocols where data is transmitted and an acknowledgement signal is expected immediately if the data has been correctly received, with this protocol data must be sent without waiting for immediate acknowledgement of previous packets, with data broken down into packets with assigned sequence numbers and both data and acknowledgement packets containing the appropriate numbers. This is necessary because with a hybrid system, one direction can be reliable at a time when the other is not, and vice-versa. Other characteristics of the protocol include modifying the rate of repeated transmissions from units and polling to and transmissions from remote stations depending on the probability of expected responses and the user of indicators to signal to the user the status of the communication links, particularly when communication is being impeded.

SUMMARY OF THE INVENTION

The goal of the method and apparatus disclosed here is to provide a communications system that can send paging signals and brief messages to individuals within a building or complex of buildings, accept and deliver responses to these messages, and identify the location of individuals within the building.

Individuals communicate with a central communications station by means of a miniature communications unit carried

4

by the individual that is typically about the size of a credit card and can be integrated into a wearable plastic corporate identification badge. The communications unit displays messages visually and can provide a visual and/or auditory alarm indicating the receipt of a message. Users can view messages and select or compose responses by means of a thumbwheel rotating cylinder and key. The unit consists of a microprocessor, a memory, a radio antenna and receiver, a speaker, a visual display, an infrared diode emitter, a thumbwheel and key, and visual and auditory indicators.

Communication from the central communications station to each individual unit is carried out by frequency-shift-keyed digital radio, with a single radio transmitter and antenna typically used for a single building or building complex. Communication from each unit to the central communications station is carried out by a combination of infrared light and wire or optical fiber. Remote communication stations that include an infrared light sensor are installed in individual rooms of the building and along corridors, and data is sent from the unit first to a remote station by infrared and then forwarded to the central station by wire or optical fiber.

The communications system is integrated into the telephone and electronic mail systems typically found in an office environment. A message may be generated as a result of a telephone ringing signal, the leaving of a voicemail message, or the receipt of an electronic mail message (either messages specifically intended to be sent to the remote unit or messages directed to the user's normal electronic mail address, the latter particularly if the sender or topic of the message matches a description provided by the user).

The system allows others (if desired by a user) to determine the current physical location of the user by sending an appropriate "location query" electronic mail message, with the originator automatically receiving a return message indicating the last known location of the user. The system also allows information from the personal locating system to control the forwarding of an incoming telephone call to an appropriate extension.

While users can compose any response to a message or an original message, the miniaturization of the communications unit tends to make character entry laborious, and the system is designed on the assumption that responses usually involve the selection of preprogrammed responses included in the message, preprogrammed responses that can be selected from the memory of the unit, or very brief responses composed letter by letter. Examples of possible responses include "Message read and understood", "Will do", "Will call you back in 5 minutes", "Will call you tomorrow", etc. Responses are preferably selected or composed by means of a thumbwheel and single key, which takes up little space. The thumbwheel and key interface is described in detail in the copending application entitled "Control of Miniature Personal Digital Assistant Using Menu and Thumbwheel."

The system uses a communication protocol designed for the special characteristics of a hybrid radio-infrared light system. It is assumed that the radio link is usually highly reliable, but that occasional errors and outages may occur due to electromagnetic interference, metal shielding, or movement of the user outside of the range of reception.

Messages are transmitted or held at any given moment depending upon the status of the communication unit and the priority of the message. Units are in one of five status states: (1) Receiving and Responding; (2) Not Receiving but Responding; (3) Not Receiving or Responding; (4) Receiving but Not Responding; or (5) Not Responding, depending

upon the conditions of the last response received from a unit. Thus, for example, Ring messages (resulting from incoming telephone calls) are not transmitted to a unit that is Not Receiving or Responding (and thus likely out of the building), but if caller identification information is available for the call, the message is stored so that the user is informed of the call upon returning to the building.

Data transmitted both to and from the communications unit is error checked, with correct receipt ensured by retransmission. However, because the communications medium is different (radio versus infrared light) in different directions, it is frequently the case that at any particular time, the communications circuit is reliable in only one direction. Instead of the usual transmission-acknowledge-or-timeout-retransmission protocol, data is sent in the form of short packets, with each packet given a sequence number. Packets continue to be sent even without acknowledgement if there is reason to believe that a unit may be receiving. Acknowledgements are sent with the corresponding packet sequence number when each packet has been received. If an acknowledgement has not been received from a unit under conditions that suggest that such an acknowledgement would have been received if the original packet had been received correctly, that packet is retransmitted. Acknowledgements are themselves acknowledged by a packet sent to the unit via radio that results in reducing the amount of data the unit must repeatedly transmit, and consequently reducing the possibility of conflict due to overlapping transmissions between different units near the same remote station, and reducing battery drain. Units autonomously and repeatedly transmit an identification signal via infrared together with any acknowledgements or input data that may be queued, with intervals between transmissions varying to reduce conflict between units.

If a user has initiated a response or original message but it has not been successfully transmitted from the unit, the unit indicates this by turning on a "Communications Trouble" indicator to indicate that the infrared signal is not being received, so that the user can change the position or orientation of the unit to reestablish contact. The indicator is similarly turned on if packet sequence numbers indicate that a message should have been received but has not so that the central station can more quickly become aware of this and retransmit it.

An alternative embodiment of the system uses ultrasound rather than infrared light as the communications medium for sending data from the communications unit to the remote station.

In a second alternative embodiment, data is not transmitted autonomously from the communication unit, but in response to a poll received via radio.

BRIEF DESCRIPTION OF THE DRAWINGS

FIG. 1 shows a block diagram of the hardware for the communications system, showing the central communications station, PABX system, electronic mail server, radio transmitter, some of the remote receiving stations, and one of the communication units carried by users.

FIG. 2 shows the configuration of infrared detectors and associated remote communications stations in different rooms of a building and along a corridor, with each detector and station shown as a circle.

FIG. 3 is a block diagram that shows the hardware architecture of the communications unit.

FIG. 4 shows a front view of the physical layout of the remote communications unit.

FIG. 5 is a rear view of the unit, showing an additional infrared emitter optional corporate and employee identification information and a clip for attaching the unit to the user's clothing.

FIG. 6 is a side view of the unit, showing the infrared emitters (or ultrasonic transducers) liquid crystal display and clip.

FIG. 7 shows the format of a message sent to the communications unit and how it is broken down into packets for transmission.

FIG. 8 shows the format of a Data packet.

FIG. 9 shows the format of an Input Acknowledgement Packet.

FIG. 10 shows the format of an "AckAck" or "acknowledgement of an acknowledgement" packet.

FIG. 11 shows the format of a Confirm Data packet.

FIG. 12 shows the format of packets sent from the communications unit to one or more remote stations via infrared light.

FIG. 13 shows the format for a Poll packet that is sent from the central communications station over a wire or optical fiber link to all remote communications stations.

FIG. 14 shows the formats of a packet sent from a remote station via the wire or optical fiber circuit in response to a poll.

FIG. 15 shows the format of message text sent from the Central Station to a Communications Unit, including particularly the responses that can be selected to that message.

FIG. 16 shows the format of a message defining programmed responses, messages, and email addresses.

FIG. 17 shows a flowchart of the software architecture for the central communications station.

FIG. 18 shows a flowchart of the software module in the central communications station that processes incoming electronic mail messages.

FIG. 19 shows a flowchart of the first part of the communications software for the central station that processes packets received from the remote station.

FIG. 20 shows a flowchart of part of the communications software for the central station that processes the part of packets from the remote station that contain input data.

FIG. 21 shows a flowchart of the part of the communications software for the central station that selects and sends Data and other nonpoll packets to communications units via radio.

FIG. 22 shows a flowchart of the real-time clock interrupt module.

FIG. 23 shows the format of the Unit Status List.

FIG. 24 shows the Message to Unit Queue, which holds messages to be sent to units.

FIG. 25 shows the data structure of the Packet to Unit Queues, including Queues A, B, C, D, E, F, and G.

FIG. 26 shows the data structure of Poll Queues A, B, and C.

FIG. 27 shows the data structures for the Email Incoming Message Queue, the Email Incoming Message Archive, and the Email Outgoing Message Queue.

FIG. 28 shows the data structures for the maps between email addresses and unit IDs and channels.

FIG. 29 shows the data structure for the Input Data from Unit Queue, which holds packets received from a communications unit.

FIG. 30 shows the data structures that hold the preprogrammed responses, messages, and email addresses.

FIG. 31 shows the data structures for the Time Event Queue.

FIG. 32 shows the layout of the lamps, display and cursor, key, and thumbwheel on the front side of the remote unit.

FIG. 33 shows a variety of displays illustrating different situations and the interface presented in each situation.

FIG. 34 shows a flowchart of the architecture of the software for the communications unit.

FIG. 35 shows a flowchart of the part of the software module in the communications unit devoted to processing incoming packets that have been received by the unit via radio.

FIG. 36 shows a flowchart of the part of the software in the communications unit that processes displayable incoming Data packets that have been received.

FIG. 37 shows a flowchart of the first part of the clock interrupt software for the microprocessor in the communications unit.

FIG. 38 shows a flowchart of the last part of the clock interrupt software for the microprocessor in the communications unit.

FIG. 39 shows the data structure for the Incomplete Message Packet Map.

FIG. 40 shows the data structure for the Packets Unassigned to Messages List, used in the software in the communications unit.

FIG. 41 shows the data structures for the Packet Text List.

FIG. 42 shows the data structure for the Display Memory and the associated Display Window.

FIG. 43 shows the data structures for the Input Data Queue, Packet Acknowledge Queue, and Unit Transmission Buffer.

FIG. 44 shows a flowchart of the software for the microprocessor in the remote communications station.

DESCRIPTION OF THE PREFERRED EMBODIMENT

FIG. 1 shows a block diagram of the hardware for the communications system, showing the central communications station, PABX system, electronic mail server, radio transmitter, some of the remote receiving stations, and one of the communication units carried by users.

The central communications station 3, which consists of a 16-bit microprocessor, memory, a 1 khz real-time clock, and appropriate communication interfaces, transmits messages in the form of digital bitstreams by means of the frequency-shift-keyed radio transmitter 4 and antenna 5. A message is received by communications unit 6, which decodes it, enters the messages into its internal memory, and displays the message visually and turns on visual indicators and/or auditory alarms, as appropriate. The unit will also generate an acknowledgement for each message that is sent to the central station.

Each communications unit 6 transmits an identification code in the form of digitally encoded infrared light, which is received and stored by one or more remote stations 7, 8, and 9 receiving it. Other data, such as acknowledgements of received messages, responses, or original messages are also included with the identification signal when available. The central station periodically polls, by means of a two-way wire or optical fiber communication circuit, each remote

station and receives in return the identification code and any additional data that the station has received from one or more communication units. Each remote station consists of one or more photodiode infrared detectors, an analog-to-digital converter, a microprocessor, memory, and serial communications interfaces.

The two primary sources of messages are the electronic mail network and incoming telephone calls. An incoming electronic mail message is transmitted by a remote workstation through an electronic mail server 1 and to the central communications station 3, which transmits the message via radio 4 to the appropriate communications unit 6. The user can, if desired, choose a response that will be transmitted back to the originator of the message.

An incoming call to the user's extension enters the PABX system control 2, with the call indication, extension number called, calling number and any further identification of caller, if available, passed to the central communications station 3 and then transmitted by radio 4 to the communications unit 6.

The user may select a response, which is passed by infrared light to a remote station 7 (with a code added to identify the remote station), with the response sent to the central communications station 3 and then to the PABX control 2, which can, if desired, initiate a call transfer, either to a receptionist, to a voicemail system, to the extension where the user is located, or to another extension.

(In an alternative embodiment, ultrasound is used instead of infrared light for communication from the communications unit 6 to the remote stations 7, 8, and 9. In this case each remote station has an ultrasonic microphone and appropriate signal processing hardware instead of a photodiode infrared detector. In the remainder of this application, references to "infrared light" can generally be interpreted as meaning "infrared light or, in an alternative embodiment, ultrasound.")

FIG. 2 shows the configuration of infrared detectors and associated remote communications stations in different rooms of a building and along a corridor, with each detector and station shown as a circle. Station 15, for example, is installed in an office, while station 16 is installed in a corridor. Infrared detectors may be mounted on walls or on the ceiling, and more than one detector may be used in a given room to provide more reliable coverage.

FIG. 3 is a block diagram that shows the hardware architecture of the communications unit.

All of the integrated circuits in the communications unit are especially miniature, lightweight, and have low power consumption. The radio signal broadcast from the central communications station is picked up by the antenna 21 and passed to the radio receiver 22 and to the frequency-shift-keyed detector 23. The radio signal has a frequency of approximately 1,900 Mhz, using the band recently assigned for unlicensed use in buildings for personal communications services. (Until this band becomes fully available more conventional bands can be used). The output of the FSK detector is applied to a shift register and associated logic 24 which converts the 4800 bit/second bit serial data to 8-bit parallel form before providing it to the microprocessor 25, generating an interrupt when each character is received.

The microprocessor itself 25 is a 8-bit processor. A Colpitts crystal oscillator 26 operating at 3.932 Mhz provides a real-time clock signal directly to the microprocessor at this frequency and also to frequency dividing counters 27 that provide a 76.8 khz (16 times the 4800 bit/second bit rate) clock signal to the asynchronous character receiver

(shift register) 24, a 38.4 khz clock signal to an asynchronous character transmitter 28, and a 1.2 khz clock signal to the microprocessor for use as a clock generating an interrupt for use with timing of the thumbwheel position encoder and auditory and visual indicators. The thumbwheel position is sampled 18.75 times per second. (A different clock frequency is provided for the transmitter 28 in the case of ultrasonic transmission).

Associated with the microprocessor is a programmable read only memory (PROM) 30 with 4K bytes of storage, and a random access memory (RAM) 29 with 8K bytes of storage. The PROM contains the program for the microprocessor while the RAM contains messages after conversion to digital codes, information extracted from the messages for display to the user, and other information.

Software in the microprocessor extracts information to be displayed, which is placed into a memory and causes characters to be displayed on the liquid crystal display 31. The display also includes indicators indicating that a message is available and its priority. Lamps 38 and 39 also indicate when there is a Ring or Urgent message or indicate the status of the communications circuit. In addition, an auditory bit, audio amplifier, and speaker 37 can provide an auditory alarm. A thumbwheel 32 allows the user to display messages and responses that are stored in memory. The thumbwheel is sampled by an encoder 33 that sends a 10-bit representation of its position to the microprocessor. A user may also press the control key 34 to send a response to a message, to transmit a message, to select a command, or to delete a message.

Data from the communications unit is sent at a rate of 38,400 bits per second, with the microprocessor sending each 8-bit character to the asynchronous transmitter 28, which sends each bit to a driver 35 and to an infrared emitter diode 36. (More than one emitter may be used to provide coverage in different directions). (In the alternative embodiment using ultrasound, the driver and infrared light emitter is replaced by an ultrasonic frequency synthesizer, pulse encoder, amplifier, and ultrasonic transducer.)

When an auditory signal is desired to alert the user, the microprocessor produces it by toggling an Auditory Output Bit at an auditory signal rate that is amplified by an operational amplifier and speaker 37.

FIG. 4 shows a front view of the physical layout of the remote communications unit. At the very top left are infrared diode emitters 40, and 41 (replaced by one or two ultrasonic transducers in the alternative embodiment using ultrasound). Lamp 42 at the top indicates when a Ring or Urgent message has been received, with the lamp flashing at a rate of two flashes per second indicating a Ring and the lamp flashing at a rate of one flash every two seconds for 20 seconds, then turning solid, indicating an Urgent message. At the far right is the Communications lamp 43, which indicates the status of the communications circuits. If the lamp is turned on for any significant period of time, it indicates trouble. If a user has sent input data (i.e., responded to a message) but has not received an acknowledgement of it, the lamp is solidly on. If the unit has failed to receive data and no response from the unit has been received recently, the lamp is also turned on. In contrast, a momentary flicker (150 mS) of the lamp indicates a successful transmission from the unit. Just below is the liquid crystal display 44, with a mark at the center left of the display that serves as a cursor 45 indicating the response being selected or the message being deleted. Below the display is an optional identification photo 46, included when the communications unit is incorporated into a cor-

porate identification badge. At the bottom left is a speaker 47 capable of emitting sounds in the sonic range to server as an auditory alarm. At the bottom center is a key 48 used for deleting messages, for sending a response that has been selected, for executing preprogrammed commands, and for making other selections depending upon the context. At the bottom right is a thumbwheel—a small cylinder 49 that can be rotated either up or down by the user's thumb that is used to control the display of messages, responses, and other information.

FIG. 5 is a rear view of the unit, showing an additional infrared emitter 51, optional corporate and employee identification information 52 and a clip 53 for attaching the unit to the user's clothing. An access plate 54 for replacing the battery is also shown.

FIG. 6 is a side view of the unit, showing the infrared emitters (or ultrasonic transducers) 51, 40, and 41, liquid crystal display 44, and clip 53.

FIG. 7 shows the format of a message sent to the communications unit and how it is broken down into packets for transmission. The upper part of the figure shows the message text, which begins with an STX 71, followed by a 7-bit channel number 72 (assigned when the first packet in the message is placed in the queue for transmission), the actual text of the message 73, ending with an EOM 74.

The message text may include special characters designating specific situations, such as the receipt of a Fax, voicemail message, or Print job, that causes indicators in the communications unit to be displayed. If the entire message stored in the Email Incoming Message Archive is not contained in the message, an ASCIIETB character just before the EOM indicates this.

The message text is broken up into from 1 to 8 packets, depending upon the length of the message, with the example shown a message with 3 packets. Each packet can hold a maximum of 42 data characters. The bottom part of the figure shows how the message text 73 is divided up and placed into packets 75, 76, and 77, with header and error check information added to the beginning and end of each packet.

FIGS. 8-11 show the data formats associated with the transmission of data in packets from the central communications station to the communication units and in the return direction.

FIG. 8 shows the format of a Data packet. The packet begins with an ASCII start-of-header (SOH) character 78, with the higher order bit (which is sent last) set to 0. All data in the figures showing packet formats show 7-bit characters for simplicity; however, each character transmitted is actually 8 bits in length (plus start bit and stop bit for a total of 10 bits). The 8th (higher order) bit is set to 1 except in two cases: An SOH character and an ASCII end-of-transmission (EOT) character. The character following the SOH character in the Data packet contains 2 bits designating the packet type 79 (00 if Data, 01 if Input Data Acknowledgement, 10 if AckAck, and 11 if Not Responding). Two following bits in the character are used to indicate the priority of the packet 80 (Ring, Urgent, High, or Normal). The remaining 3 bits of this character and the 7 bits of the following character contain a 10-bit identification field 81 designating the communications unit. The two characters following that 82 contain a 14-bit Packet Sequence Number (7 bits in each character), followed by from 1 to 42 data characters 83, a 7-bit cyclic redundancy check (CRC) 84, and an EOT 85. The first 2 bits of the Packet Sequence Number are the same as the packet priority. A data packet thus has a total of from 8 to 49 characters.

11

FIG. 9 shows the format of an Input Acknowledgement Packet. This packet is received by the unit via radio. There are two forms of this packet: InputAck and UnitAck. An InputAck acknowledges an Input Data packet sent by the unit. A UnitAck acknowledges the ID sent by the unit if input data is not sent. The packet begins with an SOH character 87, with the following character consisting of the following fields: A 2-bit field indicating the packet type 88 (Data, Input Data Acknowledge, AckAck, or Not Responding), a bit 89 indicating whether this is an InputAck or UnitAck, an unused bit 90, and 3 bits 91 for the upper 3 bits of a 10-bit identification field designating the communications unit. The following character contains the remaining 7 bits 92 of the unit ID, and the character following that 93 a 7-bit Input Packet Number, a packet sequence number for the input data packet that is being acknowledged. The character after that 94 is a CRC and the character following that is an EOT 95.

FIG. 10 shows the format of an "AckAck" or "acknowledgement of an acknowledgement" packet. This packet is received by the unit via radio, and its purpose is to cause the termination of repeated transmissions of acknowledgements from the communications unit. The packet begins with an SOH character 97, with the following character consisting of the following fields: A 2-bit field indicating the packet type 98 (Data, Input Data Acknowledge, or AckAck), 2 unused bits 99, and 3 bits 100 for the upper 3 bits of a 10-bit identification field designating the communications unit. The following character contains the remaining 7 bits 101 of the unit ID, and the two characters following that 102 and 103 a 14-bit Packet Sequence Number for the data packet for which an acknowledgement has been received. The character after that is a CRC 104 and the character following that 105 is an EOT.

FIG. 11 shows the format of a Confirm Data packet. This packet is sent via radio to the communications unit at frequent intervals to confirm that all Data packets sent (except Ring packets) have been received by the unit. The packet begins with an SOH character 106, with the following character consisting of the following fields: A 2-bit field indicating the packet type 107 (11 if Confirm Data), 2 unused bits 108, and 3 bits for the upper 3 bits of a 10-bit ID field 109 designating the communications unit. The following character contains the remaining 7 bits of the unit ID. The following two characters contain the last packet sequence number transmitted for the Urgent priority 110, the next two the same for the High priority 111, and the next two the same for the Normal priority 112. The following character 113 contains the time since a response has been received by the unit, in tenths of a second. The character following that 114 contains a CRC, and the final character 115 an EOT.

(In an alternative embodiment in which transmission from the communications unit is initiated in response to a poll from the central station rather than autonomously, a new type of packet, the Unit Poll packet, is defined. This packet uses essentially the same format as the Confirm Data packet used in FIG. 11. In this case, both Confirm Data and Unit Poll packets have a Packet Type of 11 as identified in field 109. However, bits from field 110 unused in the primary embodiment are used to designate whether the packet is a Confirm Data or a Unit Poll packet, with 00 indicating a Confirm Data packet and 01 indicating a Unit Poll packet.)

FIG. 12 shows the format of packets sent from the communications unit to one or more remote stations via infrared light.

The top diagram in the figure shows the general structure of the packet, including an SOH character 116, a 3-character

12

header/ID sequence 117, an acknowledge sequence 118 of 1 or 2 characters, input data 119 of 3 to 32 characters, a CRC character 120 and an EOT character 121. The acknowledge sequence and input data sequence are optional, as indicated by the bits set in the header/ID sequence.

The diagram just below shows details of the header/ID sequence. The first character consists of the following fields: A 2-bit field 122 indicating the acknowledgement type (00 indicates that no acknowledgement is being transmitted, 10 indicates that a single packet is being acknowledged, while 11 indicates that more than one packet, in a continuous sequence, is being acknowledged), a 1-bit field 123 indicating whether or not input data is being transmitted, 1 bit that is unused 124, and 3 bits of the 10-bit unit ID code 125. The second character consists of a single 7-bit field with the remaining 7 bits of the ID code. The third character contains a 7-bit field 126 containing a number representing the calculated reliability of the radio transmission being received by the unit.

The two diagrams below the header/ID sequence show the two alternative formats for sending an acknowledgement of a data packet received by the unit. In one format 128 a single data packet is acknowledged (with a two-character sequence containing the 14-bit packet sequence number of the data packet). In the other format a continuous sequence of packets is acknowledged, with the first two characters containing the 14-bit packet sequence numbers 129 of the beginning packet being acknowledged and a 7-bit field in the third character 130 containing the length of the sequence being acknowledged.

The next diagram shows the format of an input data sequence, including a 7-bit Input Packet Number 131 in the first character of the input data packet, a 7-bit channel number 132 referring to the original packet that this is a response to (with the number set to 0 if this is an original message and 1 if a response to a message from the PABX control) and 1-20 characters of data 133.

A specific form of the Input Data Sequence 131, 132, and 133 includes as data only a single ASCII DEL character, indicating that the user has deleted the message referred to by the channel number and that the channel number should be deassigned and the message deleted from the Email Incoming Message Archive. Another form has two DEL characters in succession, indicating an Undelete—that is the previous Delete command is to be reversed.

The next two sequences show the input data formats. There are two formats, a two-character compressed fixed length sequence, and a variable length sequence. The two-character sequence consists of an ASCII character 136 indicating the type of code, followed by a 7-bit character 137 indicating the particular code. The ASCII characters used for indicating code type are ENQ, BEL, BS, HT, and VT.

If the type character 136 is an ENQ, this is a Response Code. If the 7-bit code that follows 137 is from 0 to 19, the response indicates one of the responses (with 0 referring to the first response, 1 to the second, etc.) included with the message sent to the unit. If the code 137 is from 21 to 127, the response indicates one of the preprogrammed responses in the Preprogrammed Response List. If the code is 20, it indicates that the user has selected the *MORE* response to obtain more of the email message. (The Preprogrammed Response List, Preprogrammed Message List, and Preprogrammed Email Address List are contained in data structures in both the Central Station and Communications Unit.) If the type character 136 is a BEL, this is a response but using one of the preprogrammed messages in the Preprogrammed

Message List, as indicated by the code 0-127. If the type character is an HT, this is a command code, with the code as indicated by the code character 0-127 and retrieved from a hard-coded Command List. If the type character is a VT, this is an Email Address code, with the code as indicated by the code character 0-127 and retrieved from the Preprogrammed Email Address List. Multiple addresses can be used by providing additional character sequences. If the type character is a BS, this is an original message, with the message as indicated by the code 0-127 and retrieved from the Preprogrammed Message List. The message will be sent to the email address sent in the same or previous transmission of input data.

If the type character is a FF, SO, or SI, this is a variable-length (uncompressed) sequence, which consists of a type character 138, 1 to 30 characters of text 139, followed by an ETX character 140. An FF indicates a composed response, SO a composed message, and SI a composed Email Address. Multiple email addresses can be used by using additional character sequences.

FIG. 13 shows the format for a Poll packet that is sent from the central communications station over a wire or optical fiber link to all remote communications stations. The Poll packet is 5 characters in length, and includes an SOH character 151, a 4-bit unused field 152, the 10-bit address of the remote station ID 153 (different than the ID of the communication units), with 3 bits in one character and 7 in the other, a 7-bit CRC character 154 and an EOT character 155.

FIG. 14 shows the formats of a packet sent from a remote station via the wire or optical communications circuit in response to a poll.

The top two diagrams show the two possible forms of the packet. One is a single NAK character 161, indicating that the station has not received any signals from any unit for a timeout period (the last 4096 seconds, somewhat more than an hour). The other begins with an SOH character 162 and has a subpacket for each unit that it has received a signal for within the timeout period (two are shown in the FIG., 163 and 164), a CRC character 165, and an EOT 166.

Each subpacket consists of the fields shown: A 2-character Header/ID sequence 171, a 2-character elapsed time sequence 172, and ACK sequence of 1 or 2 characters 173, Input Data of 3 to 22 characters 174, a Signal Reliability field 175 7 bits in length (from the same field in the Header ID sequence from the unit), a Signal Amplitude field 176 (indicating the amplitude of the infrared signal as received from the unit at the remote station), and an ETX character 177.

The Header/ID sequence consists of a 2-bit Ack Type field 178 (00 if no acknowledgement transmitted, 01 if a single packet is being acknowledged, 10 if a sequence of packets is being acknowledged), a 1-bit field indicating whether input data is being transmitted 179, 1 bit that is unused 180, and 3 bits of the 10-bit Unit ID code 181. The second character consists of a single 7-bit field with the remaining 7 bits of the ID code.

The Elapsed Time sequence consists of 2 characters 182 and 183, with each character holding 7 bits of a 14-bit code representing the elapsed time in seconds (0-4095) since the remote station has received a packet from a given communications unit.

The ACK and Input Data sequences are formatted as shown in FIG. 12.

FIG. 15 shows the format of message text sent from the Central Station to a Communications Unit, including par-

ticularly the responses that can be selected to that message. The message text 191 is followed by an ETX character 192, then the first response 193, with successive responses 195 and 197 separated by ETX characters 194 and 196, and with the final response followed by an EOM character 198. Note that there is a maximum of 20 responses for any message. The message text, and particularly, responses are formatted with newline characters terminating each physical line, should the text or response exceed the capacity of a single line. An ETX character terminates a response or message text and also terminates the physical line. If there are no responses, the message is terminated by an EOM. (A newline character is an ASCII carriage return.)

FIG. 16 shows the format of a message defining preprogrammed responses, messages, and email addresses. This data is sent from the central station to the communications unit to define the preprogrammed responses, messages, and email addresses that can be selected by the user. The definition character 201 is an ASCII ENQ, BS, or VT, depending upon whether a set of responses, messages, or email addresses are being defined, respectively. Following that are the separate responses 202, 204, and 206, separated by an ETX character 203 and 205, and terminated by an EOM character 207. As above, responses are formatted with newline characters terminating each physical line, should the response or message exceed the capacity of a single line. An ETX or EOM character terminates a response or message and also terminates the physical line.

FIG. 17 shows a flowchart of the software architecture for the central communications station. Software is divided into a number of different modules, of four different types: (1) PABX modules for processing messages to and from the PABX related to telephone calls; (2) Email modules for processing messages received via the electronic mail system or sent through that system; (3) Communications modules for handling the transmission of data to the communication units via radio and for handling communication with remote stations, including the receipt of acknowledgements and input data and necessary polling and other functions; and (4) A clock module that initiates certain events at appropriate times. In all cases a module is entered as the result of a particular test being passed; if the test is not passed control is passed to the next test. When a module has completed processing program control passes to the first test 211.

A test is first made 211 of whether an incoming message has been received from the PABX Control. An interrupt service routine receives characters that constitute messages from the PABX, which can be either a message reporting an incoming call or a message reporting that a particular extension has gone on-hook or off-hook. When the last such character in a message has been received a flag is set indicating to the main program that a message has been received, and the PABX module is then called 212 to process it. An incoming call message will result in any additional caller ID information that may be available at the central station being added and result in the creation of a list of extensions that the user could transfer a call to. The message created for transmission to the unit is then placed in the Message to Unit Queue, and the first packet of that message placed in one of the Packet to Unit Queues. An on-hook or off-hook message is not sent to the communications unit, but changes the Extension On-Hook List, which records the on/off-hook status of each extension, which is used in evaluating whether a given extension might be available for transferring a call.

A test is then made 213 of whether a message has completed transmission to the PABX. If so, a test is made

214 of whether another message is available to be sent to the PABX. If yes, that transmission is initiated 215.

A test is then made 217 to see if an electronic mail message has been received over the local area network connecting the central station with computer workstations. If so, a module is called to process 218 the received email message. An interrupt service routine receives each character from the network, with the end of a message resulting in a flag being set indicating that a message is available to the main program in a buffer memory. Electronic mail intended for a communications unit is sent to a pseudoaddress similar to the normal address of a user. For example, if a user's address is "peterson@cogdes.com", the user's communication unit address might be "peterson%pager@cogdes.com", with all such messages forwarded by email system to the central station. If such a message has arrived, the central station looks up the address to see if it is a legitimate user; if not an error message is returned to the originator of the message. If the user exists, the entire message is placed in the Email Incoming Message Archive. The message is then processed to extract only the most significant information (stripping off most of the header data) and also to extract only the first part of long messages. In addition, if the sender has indicated a set of responses for the communications unit user to choose from, these are extracted, formatted, and added to the message. The resulting message, together with the unit ID, is placed in the Message to Unit Queue and the first packet of the message extracted and placed in the appropriate Packet to Unit Queue depending upon its priority. Details of this can be found in FIG. 18 and the associated text.

A test is then made 220 to see if an outgoing electronic mail message has completed transmission (and another can be sent). If yes, a test is made 221 to see if another message is available (in the Email Outgoing Message Queue) to be sent. If yes, the message is initiated 222. An electronic mail message transmission is initiated by the central station in the following way: The message is placed in a buffer memory and the first character in the message transmitted to the electronic mail interface hardware. The completion of transmission of each character causes an interrupt handler to obtain the next character and transmit it, with the handler setting a flag when the message has been completely sent. When a new message is to be sent, the message that has been in the queue the longest is selected.

A test is then made 223 of whether a response has been received (to a previously transmitted Poll packet) from a remote station. If so, a module is called 224 to process it and send another Poll packet. If the response is a successfully error checked packet, a subpacket for each communications unit that sent a response is extracted. For each acknowledgement included in the subpacket, the original packet is deleted from the appropriate Packet to Unit Queue, an AckAck (acknowledgement of an acknowledgement) packet is placed in the appropriate Packet to Unit Queue, and, if there is another packet in the original message, that Packet is also placed in a Packet to Unit Queue. If input data is included in the subpacket, that data is routed to the appropriate destination (email server, PABX, or other communications unit), and an Input Acknowledge packet placed in the appropriate Packet to Unit Queue. If message has been deleted from the unit memory, that message is also deleted from the Email Incoming Message Archive, and the channel is deassigned. (The information is saved in a temporary store in case the user performs an Undelete operation). If a unit was previously not receiving or responding (i.e., likely out of the building), Data packets that were on hold because of

this tagged to be selected and sent. After the response from that station has been processed, or if the response is a NAK character or a timeout has occurred before a successfully error checked packet has been received, a new poll packet is selected and initiated. Details can be found in FIGS. 19 and 20.

A test is then made 225 of whether a packet has completed transmission to the unit via radio. A packet to be sent is then selected from those in the Packet to Unit Queues, or, if the queues are all empty, a short dummy packet is sent to a dummy unit address. The packet selected depends on a calculation of the relevant urgency of transmitting different packages in queues with different priorities (which are related to the priority of the packet, Ring, Urgent, High, or Normal). The status of the communications unit—whether it is receiving data and responding, whether it is not responding and not likely to be receiving (because of being out of the building)—is also a factor, as is the priority of the packet, with Ring packets, for example, not transmitted if the unit is out of the building. A selected packet is formatted and sent 226 and the polling frequency increased for those stations likely to be near the unit. For more details, see FIG. 21.

(In an alternative embodiment, in which transmission are not made automatically under the control of a timer in each unit, but are made in response to a Poll packet transmitted from the central station to the unit by radio, the selection of a packet to send includes these unit poll packets, as opposed to station poll packets described elsewhere and sent via wire or optical communication).

Finally, a test is made 227 of whether a clock event has occurred. The Time Event Flag is first tested to see if another second has elapsed. If so, that flag is cleared and the Clock Event Queue is tested to see if one or more events are to be executed at the current time.

If the event is a Station Poll Queue Timeout (meaning that a given station has remained in a particular Poll Queue for the prescribed length of time), the given queue and station ID are retrieved, and the appropriate item moved from one queue to another. If the queue the item is being moved to is Queue B, the item in the Clock Event Queue has its queue changed to B, its time set to 900 seconds after the current time, and the item moved to the end of the queue. If the queue the item is being moved to is Queue C, the entry in the Time Event Queue is deleted.

If the event is a Unit ID Response Timeout, the Unit Status field in the Unit Status List is updated (to indicate that the unit is not responding), and Packet to Unit Queues are checked for packets addressed to that unit that have the Waiting for Ack bit set. For each such packet, the Waiting for Ack bit is set to 0. If the status of the unit is Not Receiving or Not Responding, the Hold bit is set to 1. If there are one or more Data packets with Hold bits set, a Confirm Data packet is moved from Packet to Unit Queue G to Packet to Unit Queue F, if it is not already in Queue F.

After processing the clock event 228, program control returns to the start of the program.

FIG. 18 shows a flowchart of the software module in the central communications station that processes incoming electronic mail messages. Incoming email arrives through the Email Server as a result of it being addressed to a pseudoaddress (e.g., "peterson%pager") associated with the user's normal email address (e.g., "peterson"). This may be a result of the originator of the message sending the message specifically to the communications unit (using the pseudoaddress) or the originator sending a message to the normal message address with a copy to the communications unit. It

may also result from the user's workstation having email software set up to forward certain messages automatically. This may be all messages from a certain sender, all with certain keywords in the subject line and/or text, messages with a certain (e.g., urgent) priority, or a combination of the above.

A test is first made **231** of whether the email address is legitimate by looking it up in the Email Address to Unit ID Map. If the address is not found, a response message is generated **241** to the sender indicating that a communications unit is not active for that address, the response message placed in the Email Outgoing Message Queue, and the module is done.

If the email address is legitimate, a test is made **232** of whether the message is a request for the user's present location, a maintenance message from the user or system administrator, or a message intended for a user. (A location request message has "%!" as the first 2 characters in the message text, and no other characters, while a maintenance message has "%\$" as the first 2 characters in the message text, and no other characters on that line.)

If the message is a location request, the present location of the communications unit and the time the unit last responded is looked up in the Unit Status List **233**, a response email message containing this information is sent to the originator, and the module is done. (If the user has set privacy mode, the response says only "Privacy Mode Set").

If the message is a maintenance message, the user's or system administrator's password (contained in encrypted form in the message) is checked and, if the originator has the appropriate privileges, the appropriate changes are made **234**, a response message sent **235** verifying the changes, and the module is done. Changes to and queries of tables that define users, user IDs, telephone extensions, and locations and telephone extensions near remote stations are made using a simple set of commands contained in email messages that can be originated at any workstation connected via the email server to the system. Users can also define preprogrammed responses, messages, and email addresses, and set parameters, in this way.

If the message is intended for a user's communications unit, the first 2048 bytes of the message are entered **236** into the Email Incoming Message Archive, which allows users access to substantial parts of most messages. While most traffic is likely to involve very short messages, there are situations (such as a user stuck in a meeting) where a user may want to read a longer message via the communications unit.

The most significant information in the incoming message is then extracted **237** and packed into the first message to the unit (up to 128 bytes if it is the first part of an incoming message; up to 336 bytes if a user has requested more data from a message stored in the Email Incoming Message Archive). This is done by identifying separate lines in the header message and taking only the text in the subject line, the email address of the sender, message text, and the signature at the end of the message. In addition, canned responses that have been added to the message by the sender (either by the person originating the message or by a software message-sending tool that automatically appends appropriate responses) are extracted, tagged appropriately, and added to the end of the extracted text. The first such response is identified by a "!" character in the first column of the line. When this character is found, the remaining characters on the same line are considered the first response, and each following line (with a newline character, defined as

an ASCII carriage return, indicating a new line) containing an additional response. A priority is then assigned **238** to the message, either Urgent, High, or Normal. An Urgent priority is given when it is specified by the originator of the message (with % Urgent as the first text of the message indicating this). The user can also cause messages from certain email addresses to be sent as Urgent. Messages sent to the communications unit directly are given a High priority, while messages forwarded from the user's workstation are given a Normal priority. Other criteria for assigning priority levels are also possible, and such criteria could be modified by the user. Examples include the length of the message, priority codes that are part of the email header, specific words indicating topics of particular interest, etc.

A channel number is then assigned **239** for this particular message. This is done by scanning the Channel to Email Address Map until an unassigned channel is found, and assigning that channel to the incoming message. The Assigned Bit is set to indicate that the channel is being assigned, the email address of the message originator is entered, and a pointer to the Incoming Email Message Archive that designates the beginning of the message is entered, all in the Channel to Email Address Map.

The compressed form the message (with the channel number the first byte after the STX) is then placed **240** in the Message to Unit Queue, and the first part of the message (up to 42 characters) defined as the first packet and placed in the appropriate Packet to Unit Queue, depending upon the priority of the message.

FIG. 19 shows a flowchart of the first part of the communications software for the central station that processes packets received from the remote station.

A test is first made **251** of the form of the response from the station. There are three options: (1) A packet has been received and successfully error checked; (2) A NAK character has been received; and (3) A Station Response Timeout has occurred (identified by testing the Station Response Timeout Flag) before one of the above has been received.

If the response is a packet with a correct error check, control passes to point 1.

At point 1, the next unit subpacket is extracted **252** from the packet, and the unit ID for that subpacket is also extracted.

The station ID, current time, signal reliability, and signal amplitude is then saved **253** in the Unit Status List for the unit involved and the station the response was received from.

A test is then made **254** of the Unit Status, obtained from the Unit Status List. If the status has changed from that stored, and the new status is Receiving and Responding, the Packet to Unit Queues are scanned for packets for the unit that are on hold, the Hold tag is removed **255** from any such packets, and control passes to point 2. Otherwise, control passes immediately to point 2.

At point 2, a test is made **256** of whether an acknowledgement sequence is included in the unit subpacket. If yes, control passes to point 3. If an acknowledgement sequence is not included, a test is made **257** of whether sufficient time has elapsed (i.e., a timeout) since the transmission of the packet for an acknowledgement to be expected. If yes, the "Wait for Ack" tag bit is removed **258** from any such packets (to allow then to be retransmitted if the Hold bit is not on). If the new unit status is Not Receiving but Responding, the Hold bit is also set for those packets with High or Normal (but not Urgent) priority, so that an attempt to transmit will not be made until the unit status has changed. Control then passes to step **259**.

If a unit response timeout is not presently in the Time Event Queue, a unit response timeout request is then entered **259** in the Time Event Queue, with the time set to the current time plus 90 seconds. If a request is already in the queue, its time is reset to the current time plus 90 seconds. Program control then passes to point **5** in FIG. **20**.

At point **3**, the packet number of a packet needing acknowledgement is extracted **261** from the subpacket (including intervening packet numbers if a sequence of numbers is specified). An AckAck packet for each acknowledgement data packet is then placed **262** in Packet to Unit Queue C. In addition, each original packet is deleted **263** from its original Packet to Unit Queue. If another packet is contained in the message, that packet is extracted and entered **264** in the appropriate Packet to Unit Queue.

A test is then made **265** of whether there are more acknowledgements in the subpacket. If yes, control passes to point **3**. If there are no more acknowledgements in the subpacket, a test is made **266** of whether there are other packets still waiting (in Hold mode) that have not been acknowledged. If yes, the Data Confirm packet for the unit is moved **268** to Packet to Unit Queue F if it is not in that queue already. Control then passes to step **257**. If no, the Data Confirm packet is moved **267** to Packet to Unit Queue G if it is not in that queue already. Control then passes to step **257**.

If the response from the station in test **251** is a NAK or some response other than a successfully error checked packet after the timeout period of 50 mS (indicated by the Station Response Timeout Flag being set), control passes to point **4**.

At point **4**, the next Poll packet to be sent is first selected **271**. This is done as follows: There are three queues (Poll Queues A, B, and C) that hold poll requests, with each remote station ID entered into one of the queues at any given time, depending upon the activity of units near each station. For each queue, a pointer indicates the "next" station ID in the queue, which is the station for which the greatest amount of time has passed since being polled. (This pointer is reset to the top of the queue after the bottom ID in the queue has been polled—the queue is circular, with stations continuing to be polled as long as they are not specifically removed from the queue.) For each of the three queues, the next station is retrieved, including the time that a poll was last sent to that station. A calculation is then made of the "urgency" for each of the three stations, with urgency a measure of the extent to which not sending a poll would result in allowing performance to lag behind what is expected for a particular queue. The calculation is made with the following formula: $urgency = t_{actual} / t_{expected}$, where t_{actual} is the actual time elapsed since the last poll was sent to the given unit and $t_{expected}$ is a parameter selected based on the time that a poll is likely to be in the given queue. While $t_{expected}$ for each queue varies depending upon the data rate of the wire or optical fiber transmission line and the number of units, typical values are 50 mS for Poll Queue A, 500 mS for Poll Queue B, and 1000 mS for Poll Queue C.

After the calculation is made for the next item in each queue, the queue with the greatest urgency value is selected and a poll packet is formatted for the appropriate item in that queue and sent **272** to the corresponding station. Actual transmission of the packet is done by an interrupt service routine, which interrupts after each character is sent. After transmission of the EOT character, the central station disables the wire or optical fiber transmit interrupt, clears the communications receive interface, and enables receive inter-

rupts, to allow the interrupt routine to process incoming characters of the response. The Station Response Timer and the Station Response Timeout Flag are then cleared.

The module is then done and control passes to the start of FIG. **17**.

FIG. **20** shows a flowchart of part of the communications software for the central station that processes the part of packets from the remote station that contain input data.

At point **5**, a test is made **281** of whether input data is included in the unit subpacket. If not, control passes to point **6**. If input data is included in the unit subpacket, control passes to step **287**.

At point **6**, a test is made **282** of whether a delete message sequence is included in the unit subpacket. If not, control passes directly to step **283**. If yes, control passes to step **285**.

The status of the unit is then set **283** to Receiving and Responding or Not Receiving but Responding, as appropriate.

A test is then made **284** of whether another unit subpacket is in the response. If yes, control passes to point **1** in FIG. **19**. If not, control passes to point **4** in FIG. **19**.

At step **285**, a channel number is extracted from the unit subpacket, and that channel number used to delete the corresponding original message from the Message to Unit Queue and the Email Incoming Message Archive. The channel number is then deassigned from use by clearing the Assigned Bit in the Channel to Email Address Map for the corresponding channel.

A test is then made **286** of whether more messages should be deleted. If yes, control passes to step **285**. If not, control passes to step **283**.

At step **287**, input data is extracted for one message. The message channel number indicates the message involved.

An Input Acknowledge packet containing the Input Packet Number is then sent **288** by placing it in Packet to Unit Queue C.

A test is then made **289** of the Input Packet Number by comparing it with the Last Packet Received number (which, unlike the case of the packet numbers used for output data, is the same for all priorities). The comparison is made modulo **128**, with a received number considered greater than a last packet received number if it is between 1 and 63 above, modulo **128**, the last packet received. (Thus, if the last packet received was 125, and the new packet just received had a number of 3, the new packet would be considered greater than the last packet received and thus not a duplicate). If the number of the packet just received is less than or equal to that of the last packet received, it is considered a duplicate and is ignored, with control passing to step **294**. A received packet number is considered less than a last packet received number if it is between 1 and 63 below modulo **128**, the last packet received. If the number of the packet just received is greater than that of the last packet received, the input packet is processed.

A test is then made **290** of whether the input data is a request for more data from an email message only part of which was sent to the communications unit. If yes, another message and packet is formatted and placed **295** in the Message to Unit Queue and the appropriate Packet to Unit Queue. Control then passes to step **294**. If the input data is not a request for more data, the email address for the input data is then determined **291**. If the input data is a response (either a response selected from those provided with the message, a preprogrammed response, or an original message sent as a response), the channel number is used to look up

the corresponding email address of the sender of the message in the Channel to Email Address Map. If the input data is an original message, it either contains a 7-bit code that is converted to an email address by looking it up in the Preprogrammed Email Address List, or it contains the actual email address.

If the message or response is in compressed form, it is expanded **292**. FIG. 12 describes the format of different forms of compressed and uncompressed messages and responses. In the case of compressed responses the text is obtained by using a code to look up the expanded form of the response in an appropriate table, which replaces the codes before transmission of the message or response to its destination.

The resulting text after expansion and the addition of the electronic mail address of both the destination and originator is placed **293** in the Email Outgoing Message Queue. However, if the email address is another communications unit, the message is not placed in the Email Outgoing Message Queue but, instead, placed in the Email Incoming Message Archive and Email Incoming Message Queue.

A test is then made **294** of whether there is input data for more messages in the unit subpacket. If yes, control passes to point test **287**. If no, control passes to point **6**.

FIG. 21 shows a flowchart of the part of the communications software for the central station that selects and sends Data and other nonpoll packets to communications units via radio.

When started, the module first selects **301** the next packet to be sent. This is done as follows: There are seven queues: (Packet to Unit Queues A, B, C, D, E, F, and G) that hold packets, with an incoming message, such as that from a workstation via electronic mail, an incoming telephone call from a PABX system, or a message indicating that a FAX has come in, broken down into packets, with each packet placed in one of the Packet to Unit Queues depending upon the priority of the message. Packets that acknowledge input data from communication units (Input Acknowledge packets), or that acknowledge acknowledgements of Data packets (AckAck packets) are also placed in one of the queues (Queue C). A Data Confirm packet for each communications unit is entered in either Packet to Unit Queue F or G, depending upon the circumstances. At any given time, a Data Confirm packet for each unit is contained in either Queue F or Queue G.

To select the next packet to be sent, the oldest packet in each queue is retrieved (but ignoring packets marked as "Hold" or "Wait for Ack") and a calculation is made of the "urgency" of sending that packet, with urgency a measure of the extent to which not sending the data packet would result in allowing performance to lag behind what is expected for a particular queue.

The urgency calculation is made as follows: $urgency = t_{actual}/t_{expected}$, where t_{actual} is the actual time elapsed since the packet was entered into the queue, and $t_{expected}$ is a parameter selected for each queue so as to allocate priority between the queues and that generally reflects the amount of time a packet is normally expected to be in each queue. Typical values are 50 mS for Queue A (Ring), 500 mS for Queue B (Urgent), 1 second for Queue C (Input Ack, and AckAck) 5 seconds for Queue D (High), 10 seconds for Queue E (Normal), 60 seconds for Queue F (Data Confirm, expected acknowledgement), and 600 seconds for Queue G (Data Confirm, no expected acknowledgement). These values can vary depending upon the data rate of the radio circuit chosen, the number of units in the system, and the average

level of traffic per unit. In making the calculation, only Data packets that have the "Hold" and "Wait for Ack" bits set to 0 are considered. The packet to be sent is that packet from the queue that has the highest urgency measure, except that in making this decision, urgency values for packets in Queues F and G are set to a maximum value if they exceed that value (to avoid these latter queues from taking too much capacity in peak load periods).

(In the alternative embodiment in which units are polled, an urgency calculation is also made for packets in the Unit Poll Queues A to C. These queues have a $t_{expected}$ value of 100, 500, and 2000 mS, similar to that of the (Station) Poll Queues, with the Station ID field replaced by Unit ID fields. Unit IDs are moved in the Unit Poll Queues according to events in a manner similar to that of the entries in the (Station) Poll Queues so as to decrease response delay when traffic is sent. In addition, after the selection of a new packet, a test is made of whether the packet selected is a Unit Poll packet. If so, control is transferred immediately to point **1**, causing the packet to be sent regardless of the status of the unit.)

After a packet has been selected, a test is made **302** of the status of the unit that the packet is to be sent to. There are five possible status states: Receiving and Responding, Not Receiving but Responding, Not Receiving or Responding (i.e., out of building), Receiving but not Responding (i.e., in a room with no infrared sensor) and Not Responding (not responding and unclear why). For purposes of this module, these are collapsed into two states, depending upon whether the unit is Receiving (Receiving and Responding, Receiving but Not Responding, or Not Responding) or Not Receiving (either Not Receiving but Responding or Not Receiving or Responding).

If the unit is Receiving, the packet is formatted and the first character is transmitted **303** to initiate the interrupt handler. If the packet is a Data packet, the Wait for Ack bit is set and the packet remains in the queue. Data Confirm packets also remain in the queue. If the packet is an Input Acknowledge or AckAck packet, the packet is removed immediately from the queue. If the packet just initiated is a Data packet and the next packet from the same message is available, it is placed **304** into the appropriate Packet to Unit Queue.

If the packet is a Data packet, the frequency of polling of stations likely to be near the communication unit is increased **305**. This is done by looking up the unit in the Unit Status List and locating those stations that the unit has recently communicated with (the 10 stations as defined in the description of the Unit Status List data structure in FIG. 23). Each such station is moved to the highest priority polling queue, Poll Queue A, if it is not there already. The current time is also associated with the station entered into the queue and, if a station is already in Queue A, the time for that station is replaced with the current time. An entry is then made for the station and queue in the Time Event Queue, specifying a timeout time of the current time plus 90 seconds. The module is then done and control passes to test **211** in FIG. 17.

If the status of the unit is Not Receiving, a further test is made **306** of the priority of the packet. If it is Ring, a further test is made **307** of whether Caller ID information is included in the packet. If yes, Packet to Unit Queue D is searched **308** to see if there are any other packets that are exactly the same (i.e., with the same Caller ID information) as the selected packet, and in which the timing indicates they are simply additional rings of the same call. If so, the

selected packet is removed from the queue. If there are no such duplicate packets, the packet priority is changed to High and the packet removed from Packet to Unit Queue A and placed in Packet to Unit Queue D, and the Hold bit set so it will not be transmitted until a response is received from the unit (this provides a message to the user that a call was received, but not in real time). The module is then done.

If there is no Caller ID information, the Ring packet is removed **309** from the queue (resulting in the Ring being ignored) and the module is done.

If the packet priority resulting from test **306** is Other (Urgent, High or Normal), the packet is tagged **310** as Hold, and the module is done.

FIG. 22 shows a flowchart of the real-time clock interrupt module. The clock causes an interrupt every 1 mS, resulting in execution of the interrupt module. The Station Response Timer, a memory location which measures the time elapsed after a station poll packet has been sent, is first incremented **321**. The resulting value is then tested **322**. If it is 50 mS, the Station Response Timeout Flag is set **323**, indicating that 50 mS has elapsed with no response from the given station. If not, control passes directly to step **324**.

The Second clock, a memory location which provides a clock with one-second resolution, is then incremented **324**. The result is then tested **325**. If the result is 1000 mS, the Time of Day clock, a memory location which represents the absolute time and which has a resolution of 1 second, is then incremented **326**, and the Time Event Flag is set **327**, so that the main program will check the Time Event Queue. The Second clock is then cleared. The interrupt routine then dismisses.

FIGS. 23-31 show the data structures of the lists and queues used in the software for the microprocessor in the central communications station.

FIG. 23 shows the format of the Unit Status List. This list, for each unit, holds the unit ID code **330** (10 bits), the Unit Status **331** (3 bits), the last Packet Sequence Number (14 bits) for output data packets of 4 different priorities **332**, **333**, **334**, and **335**, the last Input Packet Number (7 bits) for input data packets **336**, and information from up to 10 stations (with three shown, **337**, **338**, and **339**) that have reported a response from the unit.

The Unit Status field **331** has five possible states: Receiving and Responding, Not Receiving but Responding, Receiving but Not Responding, Not Receiving or Responding, and Not Responding. Receiving and Responding means that the last response received from the unit reported a radio received signal reliability above a threshold value, and that the response was received within a timeout period (e.g., 120 seconds). Not Receiving but Responding means that the last response received from the unit reported a radio received signal reliability below the threshold value, and that the response was received within a timeout period. Not Receiving or Responding means that a response has not been received within the timeout period and that the last response was near an exit to the building (and the unit is presumed out of the building). Receiving but Not Responding means that a response has not been received within the timeout period and that the last response was near an area with no infrared sensors. Not Responding means that a response has not been received within the timeout period but there is no evidence the unit is in an unsensed area or out of the building.

The data structure for each station associated with a unit consists of the station ID **340**, the time of last contact with that station **341** (14 bits), the reliability of the radio signal received by the unit **342** (7 bits), and the amplitude of the

infrared signal from the unit received by that station **343** (7 bits).

The stations are ordered such that the most recent contact with the station is listed first, the next most recent contact second, etc. However, only time differences greater than a threshold time are considered in performing this ordering: stations reporting time differences less than this are considered to have received the signal at the same time. This threshold takes into account the maximum time between successive repetitions of a signal from a unit and the difference in the time to poll different stations (e.g., 30 seconds). In addition, for those stations receiving the last signal at the same time, according to this rule, the stations are listed in order of strength of the received signal from the unit, with the strongest signal listed first, etc. A single station is only listed once, with the most recent contact (or strongest, if there is no time difference according to the above rule) listed.

FIG. 24 shows the Message to Unit Queue, which holds messages to be sent to units. For each message in the queue the data structure consists of the unit ID **351** and the text **352** of the message (with the first character in the message an STX and the second character the channel number assigned to the message). Each message in this queue is eventually broken down into packets and copied to one of the Data Packet Queues.

FIG. 25 shows the data structure of the Packet to Unit Queues, including Queues A, B, C, D, E, F, and G. These queues hold Data, Input Acknowledge, AckAck, and Confirm Data packets that are waiting to be transmitted to a unit. Each queue has the same structure (not all fields are necessarily used), which consists of a Unit ID code **361** (10 bits), a Hold bit **362**, a Wait for Ack bit **363**, a count of the number of transmissions attempted **364**, a pointer to text **365** (to the Message to Unit Queue), and the Packet Sequence Number **366** (14 bits) entered when the packet is sent, and used to process the Acknowledgement when it is received.

The Hold bit is normally 0 but is set to 1 when the packet is to be held until a response has been received from the unit. The Wait for Ack bit is normally 0 but is set to 1 when the packet has been transmitted and the central station is waiting for it to be acknowledged.

Queue A is for Ring Data packets, Queue B for Urgent Data packets, Queue C for Input Acknowledge and AckAck packets, Queue D for High priority Data packets, Queue E for Normal priority Data packets, Queue F for Confirm Data packets for which data has been sent and an acknowledgement not received after an expected time, and Queue G for Confirm Data packets for which all acknowledgements have been received.

FIG. 26 shows the data structure of Poll Queues A, B, and C. Each queue contains a station ID code **371** and the time **372** the station was entered in that queue. Also associated with each queue is a single pointer for that queue **373** indicating which item in the queue is next in turn to be transmitted. The different queues, together with the poll selection algorithm, result in stations being polled at different frequencies, with stations in Queue A being polled at the highest frequency. Any station in the system is in one and only one queue at a given time. The time the station was entered in the queue is used to move the stations from a queue to a queue of lower priority after a given period of time.

(In the alternative embodiment in which units are polled, Unit Poll Queues A to C are used, with the same format as shown here for what would then be termed Station Poll Queues, except that the Station ID is replaced by a Unit ID.)

FIG. 27 shows the data structures for the Email Incoming Message Queue, the Email Incoming Message Archive, and the Email Outgoing Message Queue. The Email Incoming Message Queue contains electronic mail messages received through the Email Server that are waiting to be processed. Each item in the queue includes an email address 381 and message text 382. The Email Incoming Message Archive contains the complete message and holds it until the user deletes it at the communications unit. Each item in the message includes an email address 383, a pointer 384 to the next text byte that has not yet been copied to the Message to Unit Queue, and message text 385. The Email Outgoing Message Queue contains responses and messages waiting to be sent via the Email server to an email destination. Each item in the queue includes the destination email address 386, the originator's email address 387, and the text of the message 388.

FIG. 28 shows the data structures for the maps between email addresses and unit IDs and channels. The Email Address to Unit ID Map allows conversion of an Email Address 401 to the corresponding unit ID 402, while the Unit ID to Email Address Map allows conversion of the Unit ID 403 to the corresponding Email Address 404. The Channel to Email Address Map allows a channel number 405 sent by the communications unit to be translated to an email address 407 for a response to be sent, without the communications unit using an actual email address. An additional Assigned Bit field 406 indicates whether a particular channel is assigned or not, and another field 408 contains a pointer to the Email Incoming Message Archive, indicating the message involved. Note that channels 0 and 1 are not assigned in this way, being permanently reserved for original message transmissions (0) or communication with the PABX (1). The channel number is also included in a Delete message sent by the unit when the user has deleted a message, causing the message in the Email Incoming Message Archive to be deleted and the channel deassigned. Space is also provided to hold all information from a Delete operation in case the user reverses it with an Undelete.

FIG. 29 shows the data structure for the Input Data from Unit Queue, which holds packets received from a communications unit. This structure consists of the 10-bit ID of the unit the packet is from 409, the 7-bit channel number 410, the 7-bit Input Packet Number 411, and the input text 412.

FIG. 30 shows the data structures that hold the preprogrammed responses, messages, and email addresses. These include the Preprogrammed Response List (consisting, for each entry, of a 7-bit code 421 and the text for the response 422), the Preprogrammed Message List (consisting, for each entry, of a 7-bit code 423 and the text of the message 424), the Preprogrammed Email Address List (consisting, for each entry, of a 7-bit code 425 and an email address 426).

FIG. 31 shows the data structures for the Time Event Queue. This includes, for each entry, the absolute time of the future event 427, the type of event 428 (0 for Station Poll Queue Timeout, 1 for Unit Response Timeout), the Queue involved 429 (a particular Station Poll Queue or Packet to Unit Queue, and an ID field 430 containing either the Unit ID or station ID, as appropriate).

FIG. 32 shows the layout of the lamps, display and cursor, key, and thumbwheel on the front side of the remote unit.

The Ring/Urgent lamp 42 begins flashing at a rate of two flashes per second when a Ring packet is received, but then turns off after 4 flashes. The lamp also begins flashing at a rate of one flash every two seconds when an Urgent message is received, with the lamp turning to solid after 20 seconds.

If selected by the user, indicators will also be presented auditorily by means of the speaker 47. The Communications lamp 43 indicates the status of the communications circuits. If the lamp is turned on for any significant period of time, it indicates trouble. If a user has sent input data (i.e., responded to a message) but has not received an acknowledgement of it, the lamp turns solidly on. In addition, if Data (other than Ring) packets are found to be missing and the unit has not responded recently, the lamp will also be turned solidly on. In contrast, a momentary flicker of the lamp indicates that the circuit is working, with a single short flicker (150 mS) indicating a successful transmission of input data from the unit.

The action resulting from the key 48 depends on the location of the cursor 45 (represented as an arrow) relative to the text being displayed by the LCD 44. If the cursor is pointing to received message text, that message is deleted. (If the user deletes a message in error, selecting the "Undelete" command afterward will restore the message). If the cursor points to a response, that response is sent. If the cursor points to a command, that command is executed. If the cursor points to a preprogrammed message, that message is sent after prompting for an email address.

The thumbwheel 49 is rotated by the user's thumb to move the display window (i.e., that text actually displayed at any one time) up and down in the display memory. The "distance" covered by a particular degree of rotation depends upon the speed of rotation—rapid rotation results in more movement than does slower rotation.

FIG. 33 shows a variety of displays illustrating different situations and the interface presented in each situation. Display 451 indicates a typical message, with the example shown having the message aligned by the user with the thumbwheel so that the top line of the message is displayed at the top of the display field. The beginning and end of the message are indicated by right and left angle brackets, while responses that have been sent along with the message are displayed on each line surrounded by square brackets. The responses are chosen by the sender or software associated with origination of the message and are optional. If no responses are provided or none are appropriate, the user can choose from a set of preprogrammed responses or compose a response letter by letter. To respond to a message by choosing one of the responses received from a message, the user simply orients the display using the thumbwheel so that the desired response is to the right of the cursor, and presses the key. (Alternatively, instead or in addition to a cursor, the line the cursor is pointing to could display the characters in reverse, white on black, or with some similar distinctive form.) If one of the responses is "*MORE*", it indicates that additional data is available in the original message beyond that displayed. Selecting this response will cause transmission of this data to the communications unit. Just after the list of responses received with each message are two additional selections: "Go to responses" and "Go to messages". Pressing the key when the cursor points to either of these will cause the menu of preprogrammed responses or messages to be displayed, as appropriate.

Display 452 shows the top line that is displayed when a user moves the thumbwheel to the highest position in the Display Memory. (Another way to get there is by reversing the rotation of the thumbwheel twice in rapid succession.) The top two lines display status indicators, with one or more of the indicators shown displayed at a given time, as appropriate. If "High" is displayed it indicates that one or more of the unread messages has a priority of High. If "Voicemail" is displayed it indicates that the user has one or

more unheard voicemail messages. The user can either call the central voicemail system from a local telephone to listen to them or send a message asking that the messages be transcribed and sent to the communications unit. If "Fax" is displayed it indicates that a Fax message is waiting for the user. A message will also be received indicating which machine the Fax is at if there is more than one machine, and, optionally, a set of responses. If "Unread" is displayed, one or more messages have been received but not displayed by the user. Similarly, if "Print" is displayed it indicates that a print job is waiting for the user. If "Rcvr" is displayed it means that the received signal reliability has been less than 100% over the last N minutes, where N is typically 2. If "Trans" is displayed it means that a transmission from the unit has not been received by a remote station for the last N minutes, where N is typically 2. (The user can'tell this from receipt of a Confirm Data packet). "OK" means that the signal reliability has been 100% since receipt of the last packet successfully transmitted to the specific unit, or since receipt of a Confirm Data indicating that all packets sent have been received. Below the status indicators are menu selections that cause the display to move to a particular point appropriate to a specific goal. This is simply a shortcut to reach these menus; the same effect can also be achieved by moving the thumbwheel to move the display window through the display memory.

Display 453 shows an example of a display where a Ring message arrival has interrupted the normal display. This display is set by the user to display for a fixed period of time (e.g., 30 seconds) and then disappear if no action by the user is taken within this period. The second line indicates the ID (extension number and name) of the calling party, if known. The two lines at the bottom indicate the current location of the communications unit (room number, extension, person or department associated with extension). Lines 3-5 have the following menu selections: The "Send to Voicemail" selection transfers the caller immediately to the voicemail system to take a message, while the "Transfer to Ext" selection will cause the incoming call to be routed to the indicated extension the communications unit is nearest to. The "Transfer to New Ext" selection will display a different menu, not shown, that allows a variety of other options for allowing the user to transfer to an extension other than the one the user is nearest, including arranging for the caller to be placed on hold until the transfer is made. These options, when chosen, will result in a new message from the Central Station displayed as a Ring interrupt on the LCD verifying the action, such as "Transfer to X5410 accepted."

Display 454 shows examples of preprogrammed responses that can be selected by the user and sent. The user orients the desired response so it is to the right of the cursor and presses the key. The last selection in this list ("Return to display") does not send a response but causes a redisplay of the last message to be displayed. The display will also redisplay the last message after any response is sent.

Display 455 shows examples of preprogrammed original messages that can be selected by the user, with each message enclosed in curly brackets. If this display is entered by selecting the "Go to messages" selection from a displayed message, the message will be sent as a response to that message. Otherwise, selection of the message (by pressing the key) will result in the display of a menu of electronic mail addresses. When that selection is made (again with the key) the message will be sent. One of the choices from the menu of electronic mail addresses allows the user to compose an email address letter by letter. If none of the canned messages is appropriate, the user selects the first item on the

list ("Go to compose message") which allows messages to be composed letter by letter.

Display 456 shows the list of individual characters and associated commands that can be selected to compose a message or email address. The composed material is displayed at the top of this part of the display memory, as shown in the example "This is text of message". Each letter is selected by pressing the key; the message is sent when Done is selected. "Clear" will erase the composed message and allow the user to start over. "Backspace" erases one letter.

Another display, not shown in a figure, allows the user to choose one or more commands to be executed that control operation of the remote communications unit. Some parameters for operation are set by the user using the thumbwheel and key; other parameters are set at the central communications station by a user addressing an email message (from a workstation) appropriately to a utility program that sets such parameters, with the email message containing the appropriate information.

The following are examples of commands that can be selected by the user at the unit:

"Beep if message rcvd" causes an auditory alarm if any message has been received.

"Beep if Urg msg" causes an auditory alarm if an Urgent message has been received.

"Flash if Ring" causes the Ring/Urg lamp to flash if a Ring message has been received.

"Beep if Ring" causes an auditory alarm if a Ring message has been received. "Menu if Ring" causes a display of the user's location and the menu (shown as 453) to be displayed when a ring message has been received to allow the user to transfer the call to a nearby extension.

"Locate" prompts for an email address and returns the last known location of the unit associated with that address.

"Set privacy Mode" turns off the "locate" command (which allows other users to determine the last known location of a user) for this user.

Other commands allow a user to define new responses to be added to the menu, new original messages, and new email addresses.

FIG. 34 shows a flowchart of the architecture of the software for the communications unit. Software is divided into five primary modules: (1) A module for processing packets that have been received from the central station; (2) A module for redisplaying message and menu text when the thumbwheel has been moved; (3) A module for processing presses of the key on the communications unit; (4) A module for transmitting a packet from the unit; and (5) A module that changes indicators such as the lamps and auditory alarm at specific times to provide appropriate flashing or beeping effects. In addition, clock and communications interrupt modules, not shown in the figure, provide support to the above software.

At the start of the module, a test is made 461 of whether a packet has been received by the unit from the central station via radio. Such a packet is detected by an interrupt service routine that processes incoming characters from the unit communications interface, which generates an interrupt for each received character. the interrupt handler looks for an SOH character, placing received characters into a buffer when an SOH has been detected. When an EOT character is received, the handler sets a flag indicating that a packet is ready to be processed.

If a packet has been received, the packet processing module 462 is called, resulting in different actions depend-

ing on whether the packet is a Data, Input Acknowledge, AckAck, or Confirm Data packet. Details are described in FIGS. 35–36 and the associated text. In general, packets are first error checked and the Unit ID compared with the internal ID of the unit and ignored (except for use in computing signal reliability statistics) if an error is detected or if the packet is for another unit. A Data packet is entered into memory, displayed, and an indicator alarm triggered, depending upon the packet priority and other factors. An Input Acknowledge packet causes an Input Data packet that the unit has been holding to be deleted, and an AckAck packet causes an Acknowledge packet that the unit has been holding to be deleted. Receipt of either causes the unit to transmit immediately if there is input data or acknowledgements remaining in the Input Data Queue or Packet Acknowledgement Queue after the above deletions. A Confirm Data packet, if there is missing received data, causes an indicator light to turn on to alert the user that the unit must be reoriented in direction or moved in position to allow data from the unit to be received.

If a packet has not been received, a test is made 463 of whether the thumbwheel has moved. An interrupt handler is used, with a clock tick every 0.83333 mS resulting (after a software divide-by-64 counter) in the thumbwheel position being checked every 53.33 mS and, if it has moved beyond a threshold allowable drift, a flag is set indicating that the window in the display memory should be moved, and a value for the amount of movement calculated. Details of the software for monitoring the thumbwheel and calculating the velocity and distance of movement of the thumbwheel and the resulting movement 464 of the display text, as well as the software for displaying the text, are contained in a copending application entitled "Control of Miniature Personal Digital Assistant Using Menu and thumbwheel."

If the thumbwheel has not moved, a test is made 465 of whether the key has been pressed. If yes, the appropriate action is taken 466, depending upon the location of the cursor in the displayed text and the context. This action may be to display different text, to execute a command that changes a local parameter (e.g., silencing the auditory alarm), or to execute a command or select a response that results in input data being transmitted to a remote station and then to the central station. If a response is selected a subpacket is formatted with an appropriate response sequence, including an Input Packet Number and a channel number indicating the destination address of the response. This sequence number is entered after incrementing the current Input Packet Number saved as a variable. The channel number is that found in the Display Memory associated with the message the response is to. If an original message is selected a subpacket is formatted in the same manner as described above. Either a channel number or the text of an email address is sent, depending upon whether the address is in the preprogrammed list or composed by the user. Any such input data is held in the Input Data Queue until the next transmission of an input packet. If input data has been generated, the Transmit Flag is set so that the packet will be transmitted immediately.

If a key has not been pressed, a test is made 467 of whether it is time for a transmission to be made from the unit. This is done by testing the state of the Transmit Flag. This flag is set (as indicated above) by a key press that results in input data that needs to be sent, the receipt of a non-Ring Data packet (resulting in an Ack that needs to be sent), by a timer that sets the flag at regular intervals, or by the receipt of an Input Ack or AckAck packet when data still remains to be sent. The average time between intervals

varies depending upon the receipt of data packets, the generation of input data, and the passage of time. There are three different intervals: A "short interval" results in transmissions being made at an interval from 10–25 seconds, with the exact time determined by adding 10 to a 4-bit random number. A "medium" interval is from 26–57 seconds, determined by adding 26 to a 5-bit random number. A "long" interval is from 58–121 seconds, determined by adding 58 to a 6-bit random number. The entry of input data results in transmission at short intervals, after the initial transmission which is done immediately. The receipt of a Data, Input Ack, or AckAck packet results in transmission at medium intervals (if the unit is not already transmitting at short intervals), after the initial transmission done immediately. After a unit has transmitted at short intervals for 5 minutes, it proceeds to transmit at medium intervals (if there has been no additional activity). After a unit has transmitted at medium intervals for 10 minutes, it proceeds to transmit at long intervals (if there has been no additional activity). Increasing the time between transmissions reduces drain on the battery in the unit, and also, together with random determination of the time between transmissions, reduces the likelihood of collisions between transmissions of different units in the same room. (In the alternative embodiment in which polling of units is done by radio, the unit does not transmit autonomously in the manner described above, but transmits only when a poll packet has been received.)

When a unit transmits, it selects the first sequence of input data from the Input Data Queue, and the first acknowledgement (or sequence, if continuous) from the Packet Acknowledgement Queue. This data is entered, along with the Unit ID, into the Unit Transmission Buffer, according to the format shown in FIG. 12, and the transmission of that buffer initiated 468. If Input Data is being transmitted the Communications State variable is set to 3 to indicate that the Input Data Timer is on, and the Input Data Timer is set to 20 seconds. The same clock interrupt handler that is used for periodically checking the position of the thumbwheel is also used, by means of software counters, to measure the time between transmission intervals as well as the time to change the visual and auditory indicator states, as described below.

(In the alternative embodiment in which polling is done by radio, the Transmit Flag is similarly set by input data entered, the receipt of a packet resulting in an Ack, or the receipt of an Input Ack or AckAck packet when data still remains to be sent. However, the Transmit Flag is not set by a timer in the unit in the absence of other activity, but is set by the receipt of a Poll packet by radio.)

If it is not time to transmit, a test is made 469 of whether it is time to change the indicators, including the Ring/Urgent lamp, the Communications lamp, or the auditory alarm. These operations 470 are performed by the clock interrupt handler, and details are shown in FIG. 37.

After each event has been processed, control is passed to the start of the module, with the sequence of tests ensuring that the highest priority tasks are performed first.

FIG. 35 shows a flowchart of the part of the software module in the communications unit devoted to processing incoming packets that have been received by the unit via radio.

A test is first made 481 of whether the Unit ID in the packet matches the internal ID of the unit and that the packet successfully passes an error check (by comparing the received cyclic redundancy check with one computed from the received data). If the unit ID does not match or if an error is found, the packet is not used. A calculation is then made 482 of the received signal reliability and the packet process-

ing module is done. If the reliability drops below a certain threshold, the "Rcvr" indicator is turned on, and "OK" is turned off if it was previously on. (Signal reliability is based on the proportion of packets received with a correct error check, regardless of the unit ID, as a function of the total number of packets received over a window of the last 120 seconds.) If there are no errors and the Unit ID is correct, a calculation is made **483** of the received signal reliability, and a test is then made **484** of the packet type.

If the packet is a Data packet, a test is made **485** of the status of the received packet, in the sense of how it should be processed, with this status determined largely by the sequence number of the packet number and its relationship with the last packet received for the given priority (referred to as the LPRGP). A packet is "Displayable" if the received packet has a sequence number exactly one above the LPRGP, or if it has a sequence number more than one above the LPRGP (implying one or more missed packets) and the packet is the first packet in a message. A packet is "Unassigned to Message" (meaning that it cannot be identified as belonging to a particular message) if it has a sequence number more than one above the LPRGP and the packet is not the first packet in a message. A packet is a "Retransmitted Missing Packet" if the sequence number is less than the LPRGP. If the packet has a sequence number exactly matching the LPRGP, it is a duplicate copy of a previously received packet and is ignored.

If the received packet is Displayable, it is placed **486** in the appropriate item in the Incomplete Message Packet Map (determined by searching the map for an item in which the sequence number fits, or creating a new item if the packet is the first in a message). The received packet number is then stored in the LPRGP as its new value, and control passed to point **1** in FIG. **36** so that the packet can be displayed or otherwise acted upon.

If the received packet is a Retransmitted Missing Packet, the Incomplete Message Packet Map is searched **487** to see if the packet unambiguously fits in a map item. If yes, the packet is entered **488** into that item (or a new item created if the packet is the first in a message). The Packets Unassigned to Messages List is then searched to see if there are packets that can be fit into the Incomplete Message Packet Map as a result of the most recent entry. If so, those packets are moved **489** to the map.

A test is then made **490** of whether there are new displayable packets in the map item just modified. If yes, control passes to point **1** in FIG. **36** so that they can be displayed. If not, the module is done.

If the received Retransmitted Missing Packet does not fit in the map item (test **487**), control passes to step **491**.

If the received packet is Unassigned to Message (resulting from the packet not having a previous packet received and not being a first packet in a message, and thus unable to be stored in the Incomplete Message Packet Map), the packet is entered **491** in the Packets Unassigned to Messages List, and the module is done.

If the packet type is Confirm Data, a test is made **492** of whether a packet is missing (as indicated by either packet sequence numbers for one or more priorities contained in the Confirm Data packet, not matching the unit's LPRGP, or noncontinuous packet numbers of received packets). If yes, and, in addition, a response has not been received for a threshold time period (30 seconds for Urgent packets, 120 seconds for others), the unit must successfully respond before that packet will be retransmitted, and thus the Communications lamp is turned solidly on **493** (by setting the Communications State to 1 and the Communications Lamp

Bit to 1) to indicate to the user that the unit should be moved in orientation or position so as to reestablish contact. The module is then done. If no packets are missing, the module is done immediately.

If the packet type is AckAck, the packet sequence number contained in the AckAck packet is removed **494** from the Packet Acknowledgement Queue. (If the packet sequence number is not in the list the packet is ignored as redundant.) Control then passes to step **495**.

If the packet received is an Input Acknowledge, the relevant packet is deleted **496** from the Input Data Queue. In addition, the Input Data State is set to 0, turning off the associated timer.

A test is then made **495** of whether there is input remaining—either input data or acknowledgements—in either the Packet Acknowledgement Queue or Input Data Queue, after the above deletions have been made. If yes, the Transmit Flag is set **496** so that the unit will transmit immediately.

If the Communications lamp is on, it is turned off **497**. If the lamp is not on, and only if an Input Ack was received, it is set to flicker for 150 mS (by setting the Communications State to 2 and the Communications Timer to 180), indicating in either case that the central station has received input data from the unit. The module is then done.

If the packet type is Input Acknowledge, the indicated input packet in the Input Data Queue is deleted **498**. In addition, the "OK" indicator is turned on if the Rcvr indicator is also off, and the "Trans" indicator turned off, if previously on. The Transmit Received Timer is also set to 0. Control is then passed to step **495**. If the indicated input packet is not in the Input Data Queue, the Input Acknowledge packet is ignored as redundant.

FIG. **36** shows a flowchart of the part of the software in the communications unit that processes displayable incoming Data packets that have been received.

At point **1**, a test is made **511** of the priority of the packet. If the priority is Ring (indicating an incoming telephone call), a further test is made **512** of whether this is the first packet in the message (indicated by an STX as the first character in the text field). If yes, a further test is made **513** of whether the entire message is contained in the first packet. If no, the message is not displayed at this time, and the module is done. If yes, a further test is made **514** of whether the message is a normal Ring message or a Ring Followup message, which is identified with an ASCII SUB character just after the channel number. If the message is a Ring Followup message, control is passed to step **519**. If the message is a normal Ring, the Ring State is set **515** to 8 to start the Ring/Urgent lamp flashing. The Auditory (or vibratory) Alarm State variable is also set to 8 to initiate it, if appropriate. A test is then made **516** of whether a Ring Interrupt Display is being displayed at the present time. If no, control passes to step **519**. If yes, a test is made **517** of whether the Ring message is from the same caller as the Ring Interrupt being displayed. If yes, the time that the present Ring Interrupt Display will be displayed is extended **518** (by setting the Ring Interrupt State to 1 and the Ring Interrupt Timer to be 30 seconds from the present time), and the module is done. If no, the Ring Interrupt is displayed **518** for the new call, and the module is done.

The Ring Interrupt Display will be maintained until either the user selects a response, 30 seconds have elapsed, a Ring followup message has been received, or a new Ring packet has been received for a different incoming call than that just displayed.

If the received packet is not the first packet in the message (test **512**), a further test is made **520** of whether previous

packets in the same message have been received. If yes, control passes to step 514. If no, the just-received packet is discarded 521. (If a Ring packet is lost, other packets in the same message are discarded, with the unit then waiting until the next Ring). The module is then done.

If the packet priority is Urgent, a further test is made 522 of whether the received packet is the first packet in the message. If yes, the Urgent State is set 523 to 22 to initiate the lamp blinking, and the Auditory Alarm State set to 8 if appropriate. In addition, the "Unread" message variable is set. Control then passes to step 524. If this is not the first packet in the message, control passes immediately to step 524.

The packet is then entered 524 into the display memory. If the message has a special character indicating that this announces that a Fax, Voicemail message, or Print job is available, the appropriate text is entered into the Display Memory to allow the appropriate indicator to be turned on. If the character just before the EOM is an ETB, indicating that there is additional data, a "*MORE*" response is provided to the user as an option. The packet number of the received packet (note that its first 2 bits consist of the packet priority) is then placed 525 in the Packet Acknowledgement Queue. The Transmit Flag is then set 526 so as to initiate transmission of the Unit Transmission Buffer immediately. The module is then done.

If the packet priority is High or Normal, a further test is made 527 of whether the received packet is the first in the message. If yes, the "High" and/or "Unread" message variable is set 528, as appropriate, and control passed to step 524. If the received packet is not the first in the message, control is passed immediately to step 524.

FIG. 37 shows a flowchart of the first part of the clock interrupt software for the microprocessor in the communications unit.

An interrupt occurs every 0.83333 mS, resulting in execution of the clock interrupt software. Once initiated, a test is first made 531 of whether the thumbwheel has moved beyond a certain threshold level. This is done by first checking a Thumbwheel Timer, which ranges from 0-63. If it is 0, the thumbwheel movement is calculated and the timer reset to 63. If not, the Thumbwheel Timer is decremented. This results in checking the thumbwheel position every 53.333 mS. If the thumbwheel moved, the Thumbwheel Movement Flag is set 532 so that the main program can respond to the movement.

The Transmit Timer, which holds the time remaining until the next transmission from the unit, is then decremented by an appropriate amount 533, and the result tested 534. If the result is 0, the Transmit Flag is set 535, indicating to the main program that a transmission should be initiated. (Steps associated with the Transmit Timer and Flag are left out in the alternative embodiment in which transmissions result from a received poll rather than an elapsed time interval).

A test is then made 536 of the Auditory Alarm State. This variable is 0 if the alarm has not been initiated, from 1 to 7 if it has, and 8 if the initiation has just been requested by the main program. Each of the states 1-7 represent time intervals in which the alarm is sounding or silent, with the intervals having the following lengths: Sounding for 50 mS, silent for 150 mS, sounding for 50 mS, silent for 750 mS, sounding for 50 mS, silent for 150 mS, and sounding for 50 mS (for states 7 through 1, respectively). If the Auditory Alarm State variable is 8, control is passed to point 1. If it is 0, control passes to step 551. If it is from 1 to 7, the Auditory Alarm Timer is decremented 537 and the result tested 538. If the result is 0 (end of alarm interval), control is passed to point 1.

At point 1, the Auditory Alarm State variable is decremented 539, the Auditory Alarm Timer is set to the maximum value for the new state (depending upon the time interval for that state), and the Sounding/Silent Flag is set to 1 or 0 depending upon whether the new state is sounding or silent, respectively. Control then passes to step 540. If the result of test 538 is greater than zero, indicating that time still remains in that alarm interval, and the Sounding/Silent Flag indicates Sounding, the state of the Auditory Output Bit is toggled 540 (so as to create an on-off square wave with a period of 1.667 mS, resulting in an audio frequency of 600 hz plus harmonics). (Alternative embodiments might use a different sound pattern for different events, e.g., Ring, second ring for same caller, Urgent, etc., with a clock interrupt routine based on that shown here). Control then passes to step 551.

A test is then made 551 of the Ring Indicator State. If the Ring Indicator State variable is 8, control passes to point 2 to initiate a Ring indicator cycle.

At point 2, a test is made of whether the Urgent State is nonzero (indicating that an Urgent message is pending). If yes, the display indicating it is put on hold 552. This is done as follows: If the Urgent State is 1, indicating that the lamp is solidly on, the Urgent Hold State is set to 2, indicating a solid hold. If the Urgent State is 2 to 22, indicating that the lamp is in its blinking stage, the Urgent Hold State is set to 1, indicating a blinking hold. The Ring/Urgent Lamp Bit is then set to 0, Control then passes to step 555.

If the Ring Indicator State is 1-7, the Ring Indicator Timer is decremented 553, and the value after decrementing tested 554. If the result is greater than 0, control passes to point 4 in FIG. 38. If the result is 0, the Ring/Urgent Lamp Bit is toggled 555, the Ring Indicator State is decremented 556, and the Ring Timer is set 557 to 300, representing a value of 250 mS. Control then passes to point 4 in FIG. 38.

If the Ring Indicator State (test 551) is 0, ringing is not occurring, and control passes to point 3 in FIG. 38.

FIG. 38 shows a flowchart of the last part of the clock interrupt software for the microprocessor in the communications unit.

At point 3, a test is made 561 of whether a Ring Interrupt is pending, by testing the Ring Interrupt State. If it is 1 (yes, pending), the Ring Interrupt Timer is decremented 562. A test is then made 563 of the value of the Ring Interrupt Timer. If the result is 0, the old display is restored 564 (from the appropriate location in the Display Memory), and the Ring Interrupt State set to 0. Control then passes to step 565. If the Ring Interrupt Timer is greater than 0, control passes immediately to step 565. If the result of the test 561 of the Ring Interrupt State is 0, control also passes immediately to step 565.

A test is then made 565 of whether the Urgent indicator has been put on hold. (This is done by testing the Urgent Hold State, which is 2 if on hold from a solidly on lamp, 1 if on hold from a blinking lamp state, and 0 if not on hold.) If it is on hold, being solidly on, the Ring/Urgent Lamp Bit is turned on 566, the Urgent State is set 567 to 1, and control passes to point 4. If the Urgent indicator has been put on hold from a blinking state, the Urgent State is set 568 to 22, to reinitiate the blinking cycle from the beginning, and control passed to step 572.

If the Urgent indicator has not been put on hold, a test is made 569 of the Urgent State. If the Urgent State is 0 (no Urgent message pending) or 1 (lamp solidly on), control is passed to point 4. If the Urgent State is from 2 to 21 (representing intervals of on-off toggling every 1 second, resulting in a 1 sec on—1 sec off duty cycle every 2

seconds), the Urgent Timer is decremented **570** by 1, and a further test made **571** of the value of the Urgent Timer after such decrementing. If it is greater than 0, then the interval is not over, and control is passed to point **4**. If the Urgent Timer is 0, then the interval has expired, the Urgent State variable is decremented **573**, the Ring/Urgent Lamp Bit is toggled **574** (to turn the lamp on if previously off and vice-versa), and the Urgent Timer is set **575** to a value of 1200. (This represents 1000 mS, with each tick of the 0.83333 mS clock causing the timer to be decremented by 1). Control is then passed to point **4**.

If the Urgent State is 22 (Urgent just initiated), the Ring/Urgent Lamp Bit is set **572** to off (to make sure), and control passed to step **573**.

At point **4**, a test is made **585** of the Communications State. If it is set to 2 (flicker), indicating that a single flicker is being displayed, the Flicker Timer is decremented and, if the result is 0, the flicker has ended and the Communications State and Communications Lamp Bit are set **586** to 0. If the Communications State is set to 1 (input data sent), indicating that the Input Data Timer is on, the Timer is decremented **587** and the result tested **588**. It is 0, the Communications Lamp Bit is set **589** to be solidly on. The module is then done and the interrupt is dismissed. If the Input Data Timer is greater than 0, the module is also done. If the Communications State (test **585**) is 0, the interrupt is dismissed immediately. Also included in the interrupt module (but not shown in the figure) is code for determining whether an Input Acknowledge packet (either an InputAck or UnitAck) has been received within a timeout period. Each clock interrupt causes a Transmit Received Timer to be incremented, and a test is made to see if the timer is greater than a timeout period, e.g., 180 seconds. If yes, the "Trans" indicator is displayed, and the "OK" indicator is turned off, if previously on. Similarly, a Signal Received Timer is incremented and used to determine whether a reliable signal has been received for at least the last 120 seconds. If not, the "Rcvr" indicator is turned on, and "OK" is turned off, if previously on.

FIGS. **39–43** show the data structures used in the software for the communications unit.

FIG. **39** shows the data structure for the Incomplete Message Packet Map. Each item in the Map contains information available about packets related to a specific message that is incomplete (i.e., all packets in the message—a first packet, a last packet, and all intervening packets—have not been received). An entry is made in the Map only if the first packet in the message has been received; otherwise, a packet is entered in the Packets Unassigned to Messages List. This implies that the first packet entered into the Map for each message is the first packet in that message. Each item in the Map consists of a priority for the message **601**, a "packet slot" (e.g., **602**) for each of the 8 packets that can potentially be in a message (0 through 7), and the sequence number for the first packet **603** (14 bits). Each packet slot, in turn, expanded as indicated by the arrow, consists of a Received Bit **604**, which is set to either 1 or 0 depending on whether the corresponding packet has been received or not, and an indirect pointer **605** to the Packet Text List, which contains the actual text received for each message. (The pointer references the address of a pointer in the Pointer List that contains the actual address in the Packet Text List). During error-free transmission the first packet and any number of succeeding packets may be received (Received Bit set to 1) while following packets have not been received (bit set to 0). If a packet has been received, however, and any packet slot preceding it (i.e., to the left in the diagram) has its Received

Bit set to 0, the associated packet is missing. Note that the channel number for each message is stored in the Packet Text List in the first packet received for that message, just after the STX character.

Also associated with the Map (but not shown in a figure) are four 14-bit counters, one for each packet priority, known as the LPRGP (Last Packet Received for Given Priority). This contains the packet sequence number for the last packet received for each priority.

FIG. **40** shows the data structure for the Packets Unassigned to Messages List, used in the software in the communications unit. This list holds those packets that have been received but have not been assigned to a message in the Incomplete Message Packet Map because there is no information, or the information is ambiguous, about their relationship to a particular message. The list consists of the following fields for each received packet: The priority **606**, the packet sequence number **607** (14 bits), and a pointer **608** to the Packet Text List.

FIG. **41** shows the data structures for the Packet Text List. This contains the text of packets being tracked by the Incomplete Message Packet Map and Packets Unassigned to Messages List. The upper part of the figure contains the text itself (**612**, **614**, and **616**), with packets placed in the Packet Text List in the order in which they are received, with each text packet beginning with an SOH (**611**, **613**, and **615**), and terminated **617** by either an SOH (indicating the start of a following packet) or an ETB (if no packet follows). The lower part of the figure contains a 16-bit pointer for each packet that indicates the address of the beginning of the packet. When a packet with N bytes is removed from the list the remaining text in the list is moved up by N bytes to take the place of the deleted packet and the pointers recalculated appropriately.

FIG. **42** shows the data structure for the Display Memory and the associated Display Window. The Display Memory **621** contains all of the information that can be displayed by the unit, in the order that a user might view it by rotating the thumbwheel. At any given time, only a narrow window (equal to the size of the display) is visible, with data transferred from the Display Memory to the Display Window **622** (a small buffer memory that is part of the LCD and which drives the display) whenever the thumbwheel is moved. The information contained in the Display Memory includes status indicators and the top-level menu (see the description of the unit interface), all text of the received messages, text of preprogrammed responses, text of preprogrammed messages, text and data for the Compose operation, text of electronic mail addresses, and text of commands.

Also shown is a Pointer List **623**, which contains 10-bit addresses pointing to the beginning of each of the significant areas of memory, in bytes. A pointer is included for each of 3 priorities of received messages (Urgent, High, and Normal) and for each of the areas shown in the display memory diagram **621**. (The Status Indicator area begins at address 0). Within a message priority, messages are stored in the Display Memory in the order of receipt of the first packet. Each message has been formatted at the central station to fit into specific lines (with a maximum of 20 character per line). Each message begins with (just after the STX character) a nondisplayed character that contains the channel number. Each physical line of text is terminated by a newline character. The message itself is terminated by an ASCII ETX (or a BEL if the full message has not been received). Each response included with the message is then terminated by an ETX. (If the response extends across more than one physical

line each line is terminated by a newline character). The last response is terminated by an EOM, with the EOM appearing at the end of the message even if there are no responses.

Preprogrammed Responses, Messages, Addresses, Commands, and the Compose Menu are coded similarly, with each physical line terminated by a newline character if the response extends across a single physical line, and each response terminated by an ETX. The Compose Menu also includes space for holding a response composed by the user.

FIG. 43 shows the data structures for the Input Data Queue, Packet Acknowledge Queue, and Unit Transmission Buffer.

Each entry in the Input Data Queue consists of the channel number for the message 631, a tag 632 indicating whether the input data is in the form of actual text or compressed text using a code, and a pointer (10 bits) to the actual input text or the actual code in the display memory.

Each entry in the Packet Acknowledgement Queue consists of the 14-bit Packet Sequence Number 634 for the packet being acknowledged.

The Unit Transmission Buffer consists of the current input packet being (repeatedly) transmitted, and consists of a packet header 635, unit ID 636, data 637 (either input data, an acknowledgement, or both), error check 638 and EOT 639. (An alternative embodiment would allow either input data or an acknowledgement, but not both, or, at the other extreme, multiple input packets and acknowledgement packets, with the transmission capacity and reliability in both directions and battery capacity determining the optimum design).

FIG. 44 shows a flowchart of the software for the microprocessor in the remote communications station.

At the start of the module, a test is made 641 of whether a packet has been received from a communications unit via infrared light (or ultrasound). This is done by checking the Packet Ready flag, a flag that is set by an interrupt service routine when a complete packet has been received. The interrupt service routine does this by first looking for an SOH and, when it is found, placing each received character in a buffer until an EOT is received, at which time the flag is set. The interrupt service routine, in addition to sampling the data, also measures the amplitude of the infrared signal received and, when an EOT is received, appends that measurement to the packet, in the form of a 7-bit character placed just before the ETX character, as indicated in FIG. 14.

If a packet has been received via infrared, an error check is computed 642 for the packet. If the error check is not successful, the packet is thrown away, the Packet Ready flag is cleared and control passes to the start of the module.

If the error check is successful, the packet (including signal amplitude measure) is placed 643 in the Received Packets Queue, with only one such packet for each unit being held. If a second packet is received from the same unit, the first is discarded and replaced by the more recent packet. Control then passes to the start of the module.

If a new infrared packet has not been received, a test is made 644 of whether a Poll has been received from the central station on the wire or optical communications circuit. If yes, a further test is made 645 of whether a packet has been received from one or more units via infrared (i.e., is a response packet available to be sent?) since the last Poll. If not, a NAK character is transmitted 646 to the central station via the communications circuit, and control is passed to the start of the module. If yes, the received packets for each unit are combined together (but leaving out the CRC character for each packet and adding a new CRC computed for the

combined packet being transmitted) and the packet transmission initiated 647 by placing it in a buffer and transmitting the first character. The combined packet also includes a field with the elapsed time since the last response was received from the unit, the strength of the signal when the packet was received, and a field with a measure of the reliability of the radio signal being received by the unit. Control is then passed to the start of the module. As each character completes transmission, an interrupt is generated and an interrupt handler obtains a new character from the buffer and transmits it. During this period incoming characters from the communications circuit are ignored. When the entire packet is transmitted, the interrupt handler resumes processing received characters from the circuit.

If a poll has not been received, control passes to the start of the module.

I claim:

1. A method for transmitting a message to an individual, comprising the steps of:

- 20 originating said message addressed to said individual; transmitting the message to a central communications station;
- receiving and storing the message at said central communications station;
- creating a packet containing data from the message; transmitting said packet to a communications unit carried by the individual by the steps of:
 - (1) computing an error checking code and adding said code to the packet;
 - (2) adding a code to the packet identifying said communications unit;
 - (3) transmitting the packet by means of radio to the communications unit;
 - (4) receiving the packet at the communications unit;
 - (5) computing an error checking code;
 - (6) determining whether the packet has been correctly received by comparing the error checking code computed at the communications unit with the error checking code contained in the packet;
 - (7) constructing a packet at the communications unit comprising a code identifying the communications unit;
 - (8) adding a code identifying and thus acknowledging the received packet to said packet constructed at the communications unit, should the received packet contain a correct error checking code;
 - (9) transmitting the packet constructed at the communications unit from the communications unit via a medium selected from the group consisting of infrared light and ultrasonic sound to one or more of a plurality of remote stations, should the received packet contain a correct error checking code;
 - (10) receiving the packet constructed at the communications unit from the communications unit at a remote station and temporarily storing it;
 - (11) transmitting the packet constructed at the communications unit from said remote station, by means of a communications circuit via a medium selected from the group consisting of wire and optical fiber, to said central station;

repeating the steps of creating the packet containing data from the message and transmitting the packet to a communications unit carried by the individual, until all data in the message has been transmitted from the central station to the communications unit; displaying said message to the individual.

39

2. The method of claim 1, wherein the step of transmitting the packet from the communications unit comprises the steps of:

transmitting a poll packet from the central station containing a code identifying the communications unit; 5
receiving said poll packet at the communications unit; transmitting the packet from the communications unit.

3. The method of claim 1, wherein the step of transmitting the packet to the communications unit comprises the steps of:

determining a priority for each incoming message, with at least one level reserved for incoming telephone calls; assigning said priority to each packet the message is broken up into, with each packet containing a code indicating the priority; 10

allocating capacity of the radio communications channel such that messages with higher priority are given preference;

providing a humanly perceptible signal to the user at the communications unit when messages of particularly high priority have been received. 20

4. The method of claim 1, further comprising the steps of:

transmitting a packet from the central station to each communications unit containing a sequence number for the last packet transmitted containing message text; receiving said packet containing said sequence number at the communications unit;

determining whether packets containing message text have been transmitted to the communications unit but not received by the unit; 30

providing a humanly perceptible signal to the user when it has been determined that a packet containing message text has not been received.

5. The method of claim 1, wherein the step of transmitting the packet from the remote communications station comprises the steps of:

transmitting a poll packet from the central station to the remote station;

receiving said poll packet at the remote station;

transmitting a packet from the remote station to the central station in response to said poll packet that contains those packets received from communication units since the receipt of the last poll packet at the remote station. 40

6. The method of claim 1, wherein a plurality of packets is transmitted from the central station to the communications unit before an acknowledgement is received for any of the packets.

7. The method of claim 6, wherein transmission of a packet from the central station comprises the steps of:

assigning a sequence number to the packet;

transmitting the packet to the communications unit with said sequence number included as part of the packet;

receiving the packet and checking the packet for errors at the communications unit; 55

transmitting a response from the communications unit containing an acknowledgement of the original packet, with the acknowledgement containing the sequence number of the original packet. 60

8. The method of claim 7, wherein transmission of the packet comprises the steps of:

transmitting a packet containing a sequence number to the communications unit;

waiting for a predetermined length of time for a response from the communications unit containing an acknowledgement with the corresponding sequence number; 65

40

removing the packet from a queue of packets to be transmitted should an acknowledgement be received; ignoring any further acknowledgements that are received for packets already removed from said queue of packets to be transmitted;

retransmitting the packet to the communications unit, should an acknowledgement with the proper sequence number not be received within the predetermined length of time.

9. The method of claim 8, wherein retransmission of an unacknowledged packet comprises the steps of:

determining the identity of the remote station last receiving a packet from the communications unit;

determining the time of receipt of said packet from the communications unit; 15

computing the probability that the unit is likely to receive the retransmitted packet if it is transmitted at the time the probability is computed at;

retransmitting the packet if the probability of receipt is above a certain threshold value. 20

10. The method of claim 1, wherein the step of transmitting the packet from the communications unit comprises the steps of:

transmitting the packet from the communications unit;

waiting for a specified period of time until the next transmission of the packet; in which the above steps are carried out repeatedly. 25

11. The method of claim 10, wherein the time delay before the next transmission of the packet is determined by the steps of:

determining the time since the last receipt of a packet with message text;

computing a time delay such that the frequency of repeated transmissions decreases as the time since the last receipt of a packet with message text increases. 35

12. The method of claim 10, wherein the step of transmitting the packet from the communications unit comprises the steps of:

transmitting the packet from the communications unit;

transmitting a packet from the central station to the communications unit acknowledging the acknowledgement of the original packet;

receiving said packet acknowledging the acknowledgement at the communications unit; 40

removing the sequence number of the acknowledged packet from the list of packets for which acknowledgements will be sent.

13. The method of claim 10, wherein the repeated transmission of the packet from the communications unit continues with the packet containing the unit identification code alone, should all received packets have been acknowledged.

14. A method for transmitting a message to an individual and returning a response to the originator of said message, comprising the steps of:

originating the message addressed to said individual; transmitting the message to a central communications station;

receiving and storing the message at said central communications station;

creating a packet containing data from the message;

transmitting said packet to a communications unit carried by the individual by the steps of:

(1) computing an error checking code and adding said code to the packet;

41

- (2) adding a code to the packet identifying said communications unit;
- (3) transmitting the packet by means of radio to the communications unit;
- (4) receiving the packet at the communications unit;
- (5) computing an error checking code;
- (6) determining whether the packet has been correctly received by comparing the error checking code computed at the communications unit with the error checking code contained in the packet;
- (7) constructing a packet at the communications unit comprising a code identifying the communications unit;
- (8) adding a code identifying and thus acknowledging the received packet to said packet constructed at the communications unit, should the received packet contain a correct error checking code;
- (9) transmitting the packet constructed at the communications unit from the communications unit via a medium selected from the group consisting of infrared light and ultrasonic sound to one or more of a plurality of remote stations, should the received packet contain a correct error checking code;
- (10) receiving the packet from the communications unit at a remote station and temporarily storing it;
- (11) transmitting the packet originating from the communications unit from said remote station, by means of a communications circuit via a medium selected from the group consisting of wire and optical fiber, to said central station;
- repeating the steps of creating the packet containing data from the message and transmitting the packet to a communications unit carried by the individual, until all data in the message has been transmitted from the central station to the communications unit;
- displaying said message to the individual;
- accepting a response message by the individual at the communications unit in response to the received message;
- transmitting said response message from the communications unit by means of a medium selected from the group consisting of infrared light and ultrasonic sound to one or more of a plurality of remote stations;
- receiving the response message at a remote station and temporarily storing the response message;
- transmitting the response message from said remote station by means of a communications circuit via a medium selected from the group consisting of wire and optical fiber to the central station;
- receiving the response message at the central station;
- transmitting the response message from the central station to the originator of the message;
- receiving the response message by the originator of the message.
15. The method of claim 14, wherein the step of transmitting the response message comprises the steps of:
- transmitting the response message from the communications unit;
- waiting for a specified period of time until the next transmission; in which the above steps are carried out repeatedly.
16. The method of claim 14, wherein the step of transmitting a response message comprises the steps of:
- selecting said response message from a set of preprogrammed responses;

42

- encoding the response message as a numerical index to said set of preprogrammed responses rather than the text itself.
17. The method of claim 14, wherein transmitting the message and accepting a corresponding response message comprises the steps of:
- assigning a channel number to each message received at the central station;
- transmitting the message from the central station to the communications unit, with said channel number contained in the message;
- transmitting the response from the communications unit to the central station, with the channel number contained in the response;
- converting the channel number to an electronic mail address identifying the originator of the message;
- transmitting the response to the originator of the message by use of said electronic mail address.
18. The method of claim 14, further comprising the steps of:
- displaying a preprogrammed response to the user at the communications unit;
- editing the text of the response by the user at the communications unit;
- transmitting the modified response to the central station to update the corresponding list of preprogrammed responses stored at the central station.
19. The method of claim 14, wherein the step of transmitting the response message comprises the steps of:
- transmitting the response message from the communications unit, with the response message containing a sequence number identifying the particular response message;
- receiving the response message with corresponding sequence number at the remote station and forwarding it to the central station;
- receiving the response message with corresponding sequence number at the central station;
- transmitting a packet from the central station to the communications unit acknowledging the response message that contains the corresponding sequence number;
- ignoring further copies of the response message, as indicated by the sequence number, that may be received at the central station.
20. The method of claim 19, wherein the step of transmitting the response message comprises the steps of:
- transmitting the response message from the communications unit;
- waiting a specified period of time after transmission;
- providing a humanly perceptible signal to the user of the communications unit, should an acknowledgement of the response message fail to be received within said specified period of time.
21. The method of claim 14, further comprising the steps of:
- initiating a message requesting that a physical location be provided for the communications unit assigned to an individual;
- transmitting said message to the central station;
- determining the last known location of the communications unit assigned to said individual;
- transmitting a reply message to the initiator of the request containing the location of the communications unit.

43

22. The method of claim 21, wherein the step of transmitting the reply message to the initiator of the location request comprises the steps of:

determining whether the communications unit for which the request has been received has had a privacy mode selected by the user;

transmitting a message to the initiator of the location request indicating that said privacy mode has been selected, rather than indicating the location of the communications unit, should the privacy mode be selected.

23. The method of claim 14, further comprising the steps of:

transmitting part of the message stored at the central station to the communications unit;

displaying the part of the message received at the communications unit to the user, together with a response that, when chosen, requests additional text from the message;

choosing said response requesting additional text by the user;

transmitting a code representing the response together with identification of the message from the communications unit to a remote station and then to the central station;

transmitting additional text from the message from the central station to the communications unit;

displaying additional message text to the user.

24. The method of claim 23, further comprising the steps of:

the user performing an action at the communications unit communicating his or her intention of deleting a message;

44

deleting the part of said message received by the communications unit from its memory;

transmitting a code indicating a deletion request, together with identification of the message to be deleted, from the communications unit to the remote station and then to the central station;

deleting the message stored at the central station.

25. The method of claim 24, wherein the deletion of the message comprises the steps of:

deleting the part of the message received by the communications unit from its memory while saving the message in a temporary memory;

deleting the message stored at the central station, while saving the message in a temporary memory;

selecting a command by the user communicating the intention of reversing the delete action;

restoring the portion of the message received by the communications unit that had been deleted by obtaining the text from said temporary memory in the communications unit;

transmitting a code representing said reversing of the delete action to the remote station and then to the central station;

restoring the message in the central station that had been deleted to its original state by obtaining the message text from said temporary memory in the central station. the message text from said temporary memory in the central station.

* * * * *