



US005725519A

United States Patent [19]

[11] Patent Number: **5,725,519**

Penner et al.

[45] Date of Patent: **Mar. 10, 1998**

[54] **STENT LOADING DEVICE FOR A BALLOON CATHETER**

Primary Examiner—Glenn K. Dawson
Attorney, Agent, or Firm—Levisohn, Lerner, Berger & Langsam

[75] Inventors: **Abraham Penner**, Tel-Aviv; **Ofer Nativ**, Rishon Lezion, both of Israel

[57] **ABSTRACT**

[73] Assignee: **Medtronic InStent Israel Ltd.**, Holon, Israel

A device for loading a medical stent on a balloon catheter. A tube, preferable pre-installed with a stent, is secured to one component having a pulling knob. The tube with stent extends into the bore of a second component, also having a pulling knob. The bore of the second component is conical and reduces down in the direction of the first component. For intended use, the preselected balloon catheter is inserted within the confines of the lumen of the tube (which places it within the center of the stent). Then, the two knobs are pulled apart. The force of the pull causes the tube, with the stent around the catheter within it, to pass through the decreasing bore, thereby loading and compressing the stent onto the balloon catheter. The tube serves as the vehicle to carry the balloon catheter and stent through the bore for loading the stent onto the balloon catheter. The tube can be Teflon coated to facilitate the pulling and stent loading or, alternatively, the tube can be elastic and/or plastic.

[21] Appl. No.: **724,543**

[22] Filed: **Sep. 30, 1996**

[51] Int. Cl.⁶ **A61B 19/00**

[52] U.S. Cl. **606/1; 606/198**

[58] Field of Search **606/1, 108, 190.2; 29/234, 235, 282, 283**

[56] **References Cited**

U.S. PATENT DOCUMENTS

5,437,083	8/1995	Williams et al.	606/1
5,626,604	5/1997	Cottone	606/108
5,628,754	5/1997	Shevlin et al.	606/108
5,630,830	5/1997	Verbeek	606/108

21 Claims, 6 Drawing Sheets

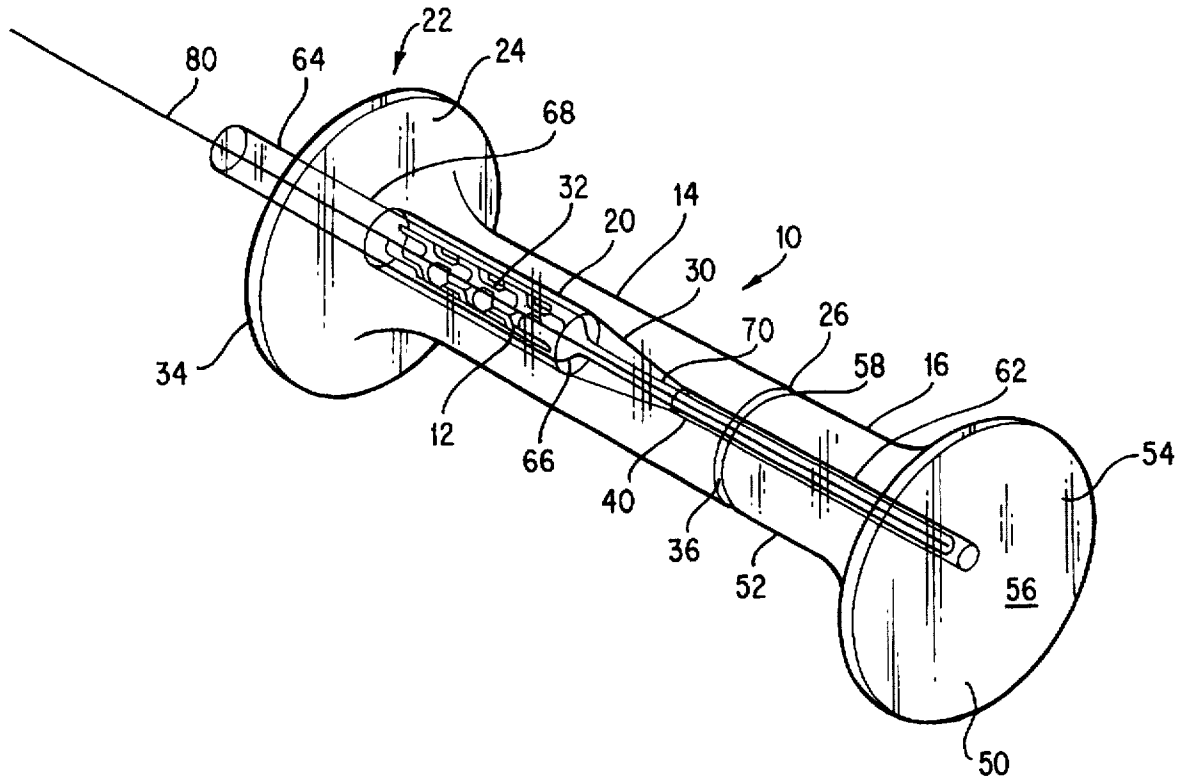

Edwards Lifesciences v. Boston Scientific
U.S. Patent No. 6,915,560
IPR2017-00444 EX. 2004

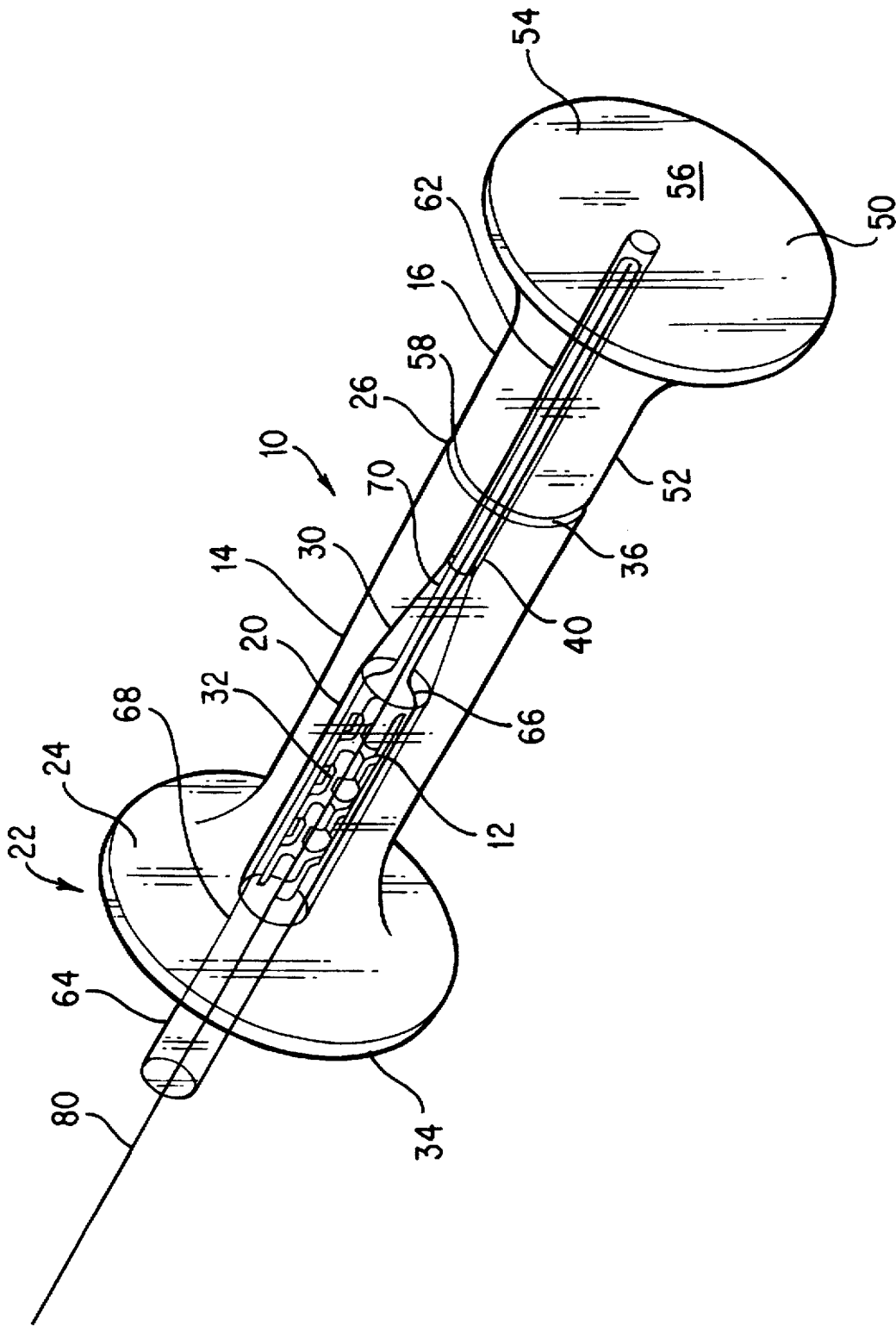

FIG. 1

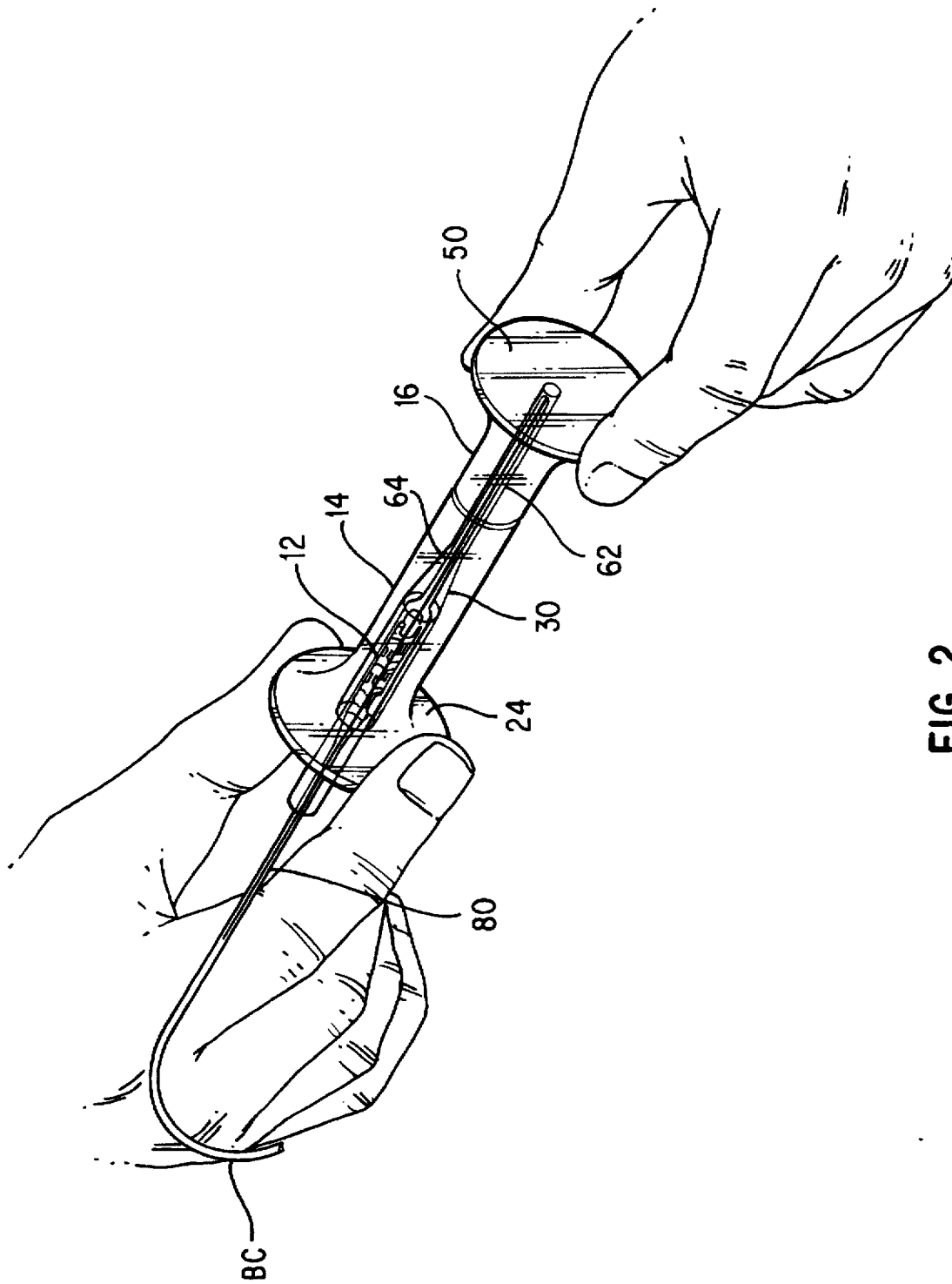

FIG. 2

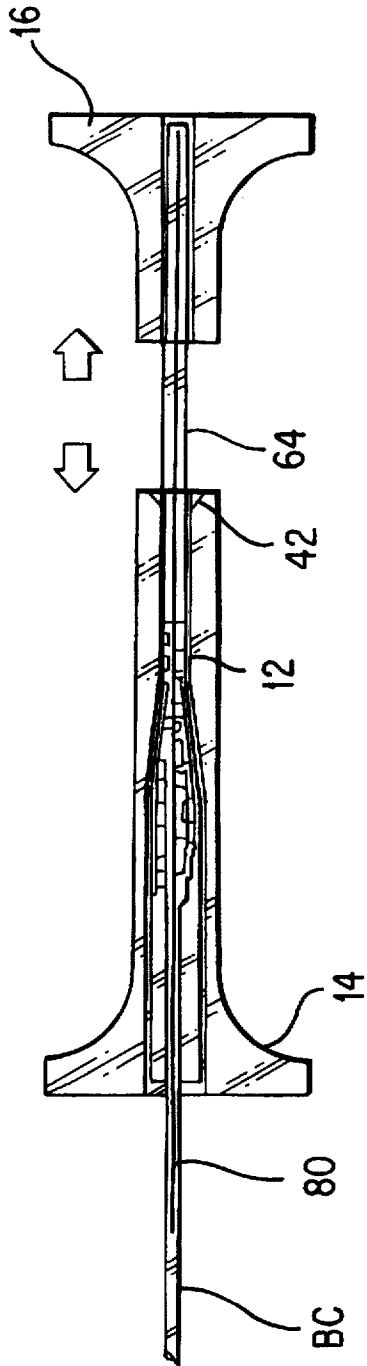

FIG. 3

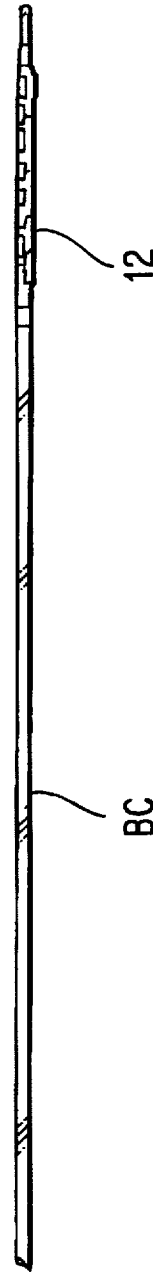

FIG. 6

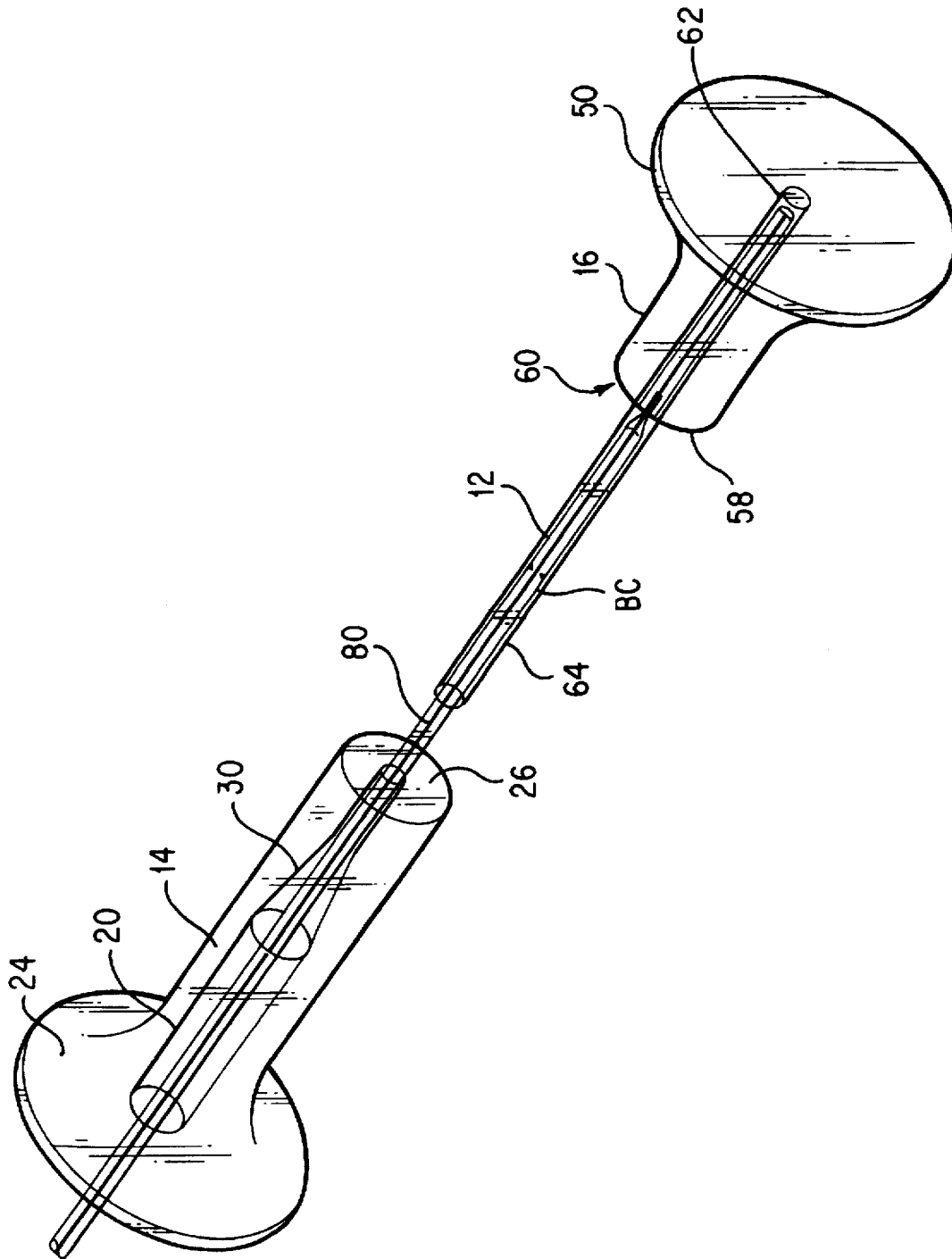

FIG. 4

Explore Litigation Insights

Docket Alarm provides insights to develop a more informed litigation strategy and the peace of mind of knowing you're on top of things.

Real-Time Litigation Alerts



Keep your litigation team up-to-date with **real-time alerts** and advanced team management tools built for the enterprise, all while greatly reducing PACER spend.

Our comprehensive service means we can handle Federal, State, and Administrative courts across the country.

Advanced Docket Research



With over 230 million records, Docket Alarm's cloud-native docket research platform finds what other services can't. Coverage includes Federal, State, plus PTAB, TTAB, ITC and NLRB decisions, all in one place.

Identify arguments that have been successful in the past with full text, pinpoint searching. Link to case law cited within any court document via Fastcase.

Analytics At Your Fingertips



Learn what happened the last time a particular judge, opposing counsel or company faced cases similar to yours.

Advanced out-of-the-box PTAB and TTAB analytics are always at your fingertips.

API

Docket Alarm offers a powerful API (application programming interface) to developers that want to integrate case filings into their apps.

LAW FIRMS

Build custom dashboards for your attorneys and clients with live data direct from the court.

Automate many repetitive legal tasks like conflict checks, document management, and marketing.

FINANCIAL INSTITUTIONS

Litigation and bankruptcy checks for companies and debtors.

E-DISCOVERY AND LEGAL VENDORS

Sync your system to PACER to automate legal marketing.